

Generating WLAN IEEE 802.11ax Signals

Application Note

Products:

- | R&S®SMW200A | R&S®WinIQSIM2™
- | R&S®SMBV100A
- | R&S®SGT100A

Rohde & Schwarz signal generators can generate standard-compliant WLAN IEEE 802.11ax signals for high efficiency (HE) receiver testing.

This application note helps to choose the right generator test solutions and explains step-by-step how to generate 802.11ax SISO and MIMO signals. Measurements, such as EVM, are presented to illustrate the signal performance. Furthermore, this document shows how to test 802.11ax receiver specifications and the newly introduced HE trigger-based PPDU specifications according to the IEEE P802.11ax/D1.3 specification draft.

Table of Contents

1	Introductory Note	5
2	Introduction	5
3	Choosing the Right Instrument(s)	6
3.1	Instruments overview	6
3.2	Possible test setups.....	7
3.2.1	Setups for SISO signal generation	7
3.2.2	Setup for noncontiguous 80+80 MHz channel (SISO)	8
3.2.2.1	SMBV and SGT	8
3.2.2.2	SMW.....	8
3.2.3	Setups for MIMO signal generation	9
3.3	Recommended test setups.....	11
4	Generating an 802.11ax Signal	13
4.1	Required instrument options	13
4.2	How to configure an 802.11ax (SISO) signal	14
4.2.1	General settings	14
4.2.2	Frame Blocks	14
4.2.2.1	Introduction.....	14
4.2.2.2	Configuration of an 802.11ax frame block.....	15
4.2.3	PPDU Configuration	16
4.2.3.1	PPDU “General” tab	16
4.2.3.2	PPDU “User Configuration” tab.....	17
4.2.3.3	PPDU “User Configuration” continued	19
4.2.3.4	PPDU “Spatial Mapping” tab.....	20
4.2.4	Configuring a 80+80 MHz signal	21
4.3	How to create a waveform file for the SGT	22
5	Signal Performance	23
5.1	Modulation accuracy.....	23
5.1.1	Constellation error / EVM performance	23
5.1.2	Center frequency leakage.....	25
5.2	Spectrum mask.....	27
5.3	Spectral flatness.....	27

6	Testing 802.11ax Receiver Specification	29
6.1	PER testing	29
6.2	Testing receiver specifications.....	31
6.2.1	Receiver minimum input sensitivity	31
6.2.2	Adjacent channel rejection.....	33
6.2.3	Nonadjacent channel rejection	35
6.2.4	Receiver maximum input level.....	36
7	Testing HE Trigger-Based PPDU Specifications	37
7.1	Introduction.....	37
7.2	Testing pre-correction accuracy requirements.....	38
7.2.1	Minimum transmit power	38
7.2.2	Absolute transmit power accuracy.....	38
7.2.3	Relative transmit power accuracy	39
7.2.4	RSSI measurement accuracy	39
7.2.5	Residual Carrier frequency offset error	40
7.2.6	Timing accuracy	40
7.3	Measurement setup.....	41
7.4	How to generate a trigger frame	42
8	Generating 802.11ax MIMO Signals.....	46
8.1	Introduction.....	46
8.2	How to configure an 802.11ax MIMO signal	46
8.2.1	System configuration.....	47
8.2.2	General settings	47
8.2.3	Transmit Antennas Setup	48
8.2.3.1	How to define Tx and Rx signals	48
8.2.3.2	Generating Tx antenna signals	50
8.2.3.3	Generating Rx antenna signals.....	51
8.2.4	Frame Blocks	52
8.2.5	PPDU Configuration	52
8.2.5.1	PPDU “General” tab	53
8.2.5.2	PPDU “User Configuration” tab.....	53
8.2.5.3	PPDU “User Configuration” continued.....	56
8.2.5.4	PPDU “Spatial Mapping” tab.....	56
8.3	Realtime channel simulation on SMW	57

9	Abbreviations	60
10	References.....	61
11	Ordering Information	61

1 Introductory Note

The following abbreviations are used in this application note for Rohde & Schwarz products:

- The R&S®SMW200A vector signal generator is referred to as SMW
- The R&S®SMBV100A vector signal generator is referred to as SMBV
- The R&S®SGT100A SGMA vector RF source is referred to as SGT
- The R&S®SGMA-GUI PC software is referred to as SGMA-GUI
- The R&S®WinIQSIM2™ simulation software is referred to as WinIQSIM2
- The R&S®FSW signal and spectrum analyzer is referred to as FSW

The WLAN IEEE 802.11ax standard, also known as High Efficiency WLAN (HEW), is referred to as 802.11ax.

The WLAN IEEE 802.11ac standard is referred to as 802.11ac.

2 Introduction

The goal of the 802.11ax amendment is to more efficiently use the 2.4 GHz and 5 GHz spectrum and to improve the user experience for challenging applications, such as video streaming and offloading, especially in dense locations with a large number of WLAN users. For background information on the 802.11ax technology, please see the “IEEE 802.11ax Technology Introduction” white paper (1MA222) available at:

<http://www.rohde-schwarz.com/appnote/1MA222>

Rohde & Schwarz signal generators can generate standard-compliant 802.11ax signals for high efficiency (HE) receiver testing offering excellent signal performance and ease of handling. This application note helps customers to choose the right generator test solutions (section 3) and explains step-by-step how to generate 802.11ax SISO and MIMO signals (section 4 and 8). Measurements, such as EVM, are presented to illustrate the signal performance (section 5). Furthermore, this document shows how to test 802.11ax receiver specifications (section 6) and the newly introduced HE trigger-based PPDU specifications (section 7) according to the IEEE P802.11ax/D1.3 specification draft.

3 Choosing the Right Instrument(s)

3.1 Instruments overview

The following table lists Rohde & Schwarz signal generators capable of generating 802.11ax signals and their supported maximum RF bandwidths.

Rohde & Schwarz signal generators for WLAN 802.11ax			
Instrument	Type	Maximum RF bandwidth	
SMW	High-end source Fading simulation One or two RF outputs	2000 MHz (internal I/Q baseband, B9 option) ¹ 160 MHz (internal I/Q baseband, B10 option) ¹ 2000 MHz (external I/Q inputs) ¹	
SMBV	Mid-range source	160 MHz (internal I/Q baseband) 528 MHz (external I/Q inputs)	
SGT	Mid-range source Small size for production usage ARB waveform playback only	240 MHz (internal I/Q baseband) ² 1000 MHz (external I/Q inputs) ²	

The SMW can be equipped with two baseband generators and two RF outputs (3 GHz, 6 GHz and 12.75 GHz options available as well as further high frequency options). It thus combines two complete vector signal generators in a single instrument. This high-end signal generator supports also fading channel simulation.

SMW with two basebands and two RF outputs

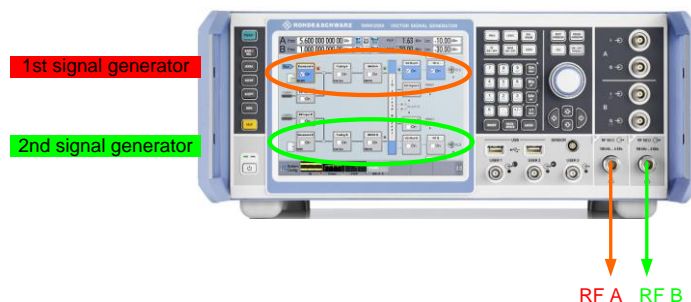

The SMBV is a signal generator of the mid-range class and can be equipped with one baseband generator and one RF output (3 GHz and 6 GHz options available).

SMBV

¹ RF frequency dependent value. See SMW data sheet for details (available at www.rohde-schwarz.com).

² RF frequency dependent value. See SGT data sheet for details.



The SGT can be equipped with one ARB generator and one RF output (3 GHz and 6 GHz options available). This compact signal generator is tailored for use in production. It has no display and is controlled via the SGMA GUI software running on a PC. The SGT plays back precalculated waveforms generated with the WinIQSIM2 software.

SGT



3.2 Possible test setups

3.2.1 Setups for SISO signal generation

802.11ax aims at higher throughputs by use of multi-user MIMO and higher modulation schemes, the channel bandwidths however remain the same as for the previous standard 802.11ac. The supported channel bandwidths are: 20 MHz, 40 MHz, 80 MHz, 80+80 MHz and 160 MHz. For the 80+80 MHz channel, two transmission modes are possible: contiguous mode and noncontiguous mode.

The following table summarizes the different 802.11ax channels and the required instruments to generate an 802.11ax signal for one Tx antenna.

802.11ax channels and corresponding generator solutions	
Channel bandwidth	Required instruments (for one Tx antenna signal)
20 MHz	one SMW (one RF output) or one SMBV or one SGT
40 MHz	
80 MHz	
80+80 MHz contiguous mode	
160 MHz	
80+80 MHz noncontiguous mode	one SMW (two RF outputs) or two SMBVs or two SGTs

A single signal generator (SMW, SMBV or SGT) can generate all 802.11ax channels except for the 80+80 MHz noncontiguous channel. To generate also the noncontiguous channel, either a single SMW with two RF outputs or two SMBVs or two SGTs can be used (see section 3.2.2 for details).

3.2.2 Setup for noncontiguous 80+80 MHz channel (SISO)

3.2.2.1 SMBV and SGT

To generate the 80+80 MHz noncontiguous channel, two SMBVs or two SGTs can be used. Each instrument generates one 80 MHz signal with appropriate RF frequency. The two RF output signals are added using a suitable RF combiner. To ensure that signal generation starts synchronously in both instruments, the master-slave setup is used.

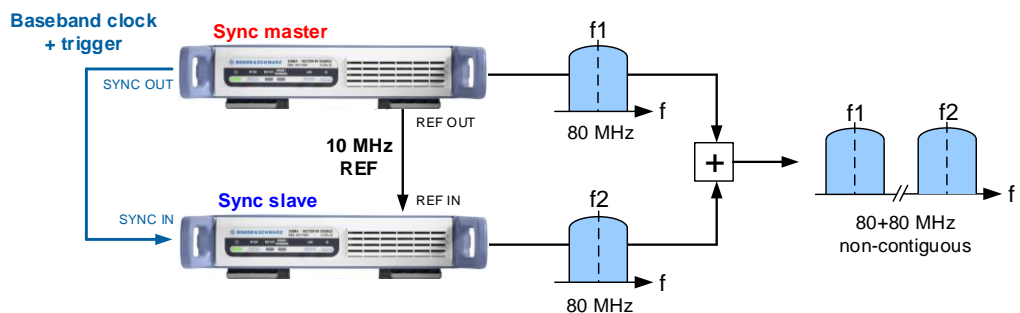

One instrument acts as master and supplies the synchronization signals to the slave instrument via just two connection cables. The master-slave setup enables highly synchronized test signals. It is described in detail in the application note "Time Synchronous Signals with Multiple R&S SMBV100A Vector Signal Generators" (1GP84) available at <http://www.rohde-schwarz.com/appnote/1GP84>

3.2.2.2 SMW

To generate the 80+80 MHz noncontiguous channel an SMW with two basebands and two RF outputs can be used. Each baseband generates one 80 MHz signal that is transmitted at the corresponding RF output with appropriate RF frequency. The two RF output signals are added using a suitable RF combiner. To ensure that signal generation starts synchronously in both basebands, baseband A is used to trigger baseband B.

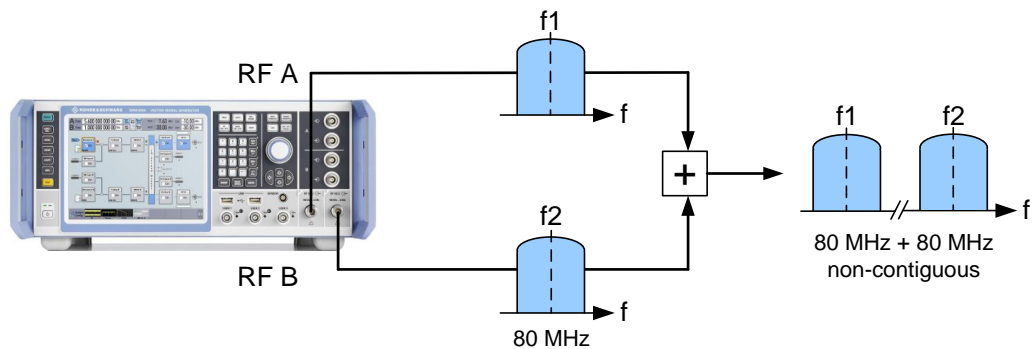

To synchronize both basebands, the following trigger settings are needed on the SMW:

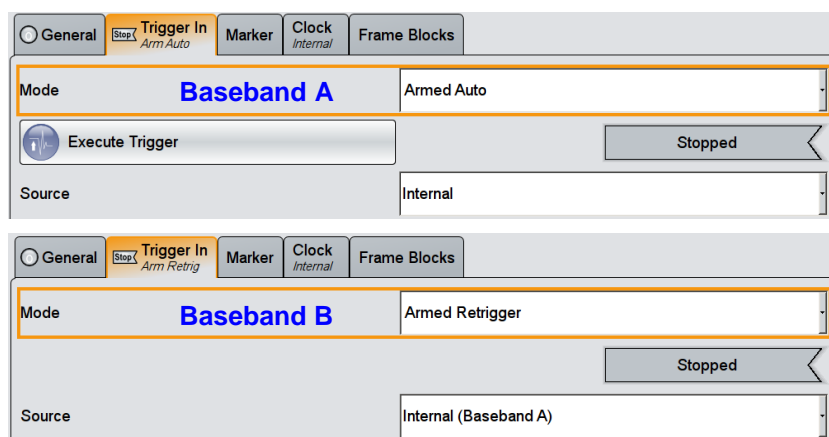

To actually start both basebands simultaneously, click the “Execute Trigger” button in baseband A.

The benefit of the SMW as a one-box solution for generating the 80+80 MHz noncontiguous channel is that the synchronization of the two 80 MHz signals is easy and straightforward.

3.2.3 Setups for MIMO signal generation

Generating multiple antenna signals requires multiple instruments – one RF output per antenna signal. Up to eight antennas are supported.

The following table summarizes the required instruments to generate 802.11ax MIMO signals.

802.11ax MIMO signals and corresponding generator solutions		
Number of antenna signals	Channel bandwidth	Required instruments
1	20/40/80/160 MHz and 80+80 MHz (contiguous)	one SMW (one RF output) / SMBV / SGT
2		one SMW (two RF outputs) or two SMBVs / SGTs
3		two SMWs or one SMW + one SGT or three SMBVs / SGTs
4		two SMWs or one SMW + two SGT or four SMBVs / SGTs
5		three SMWs or one SMW + three SGT or five SMBVs / SGTs
6		three SMWs or one SMW + four SGT or six SMBVs / SGTs
7		four SMWs or one SMW + five SGT or seven SMBVs / SGTs
8		four SMWs or one SMW + six SGT or eight SMBVs / SGTs

For example, one SMW with six connected SGTs is an easy-to-use MIMO system for generating eight antenna signals. Please see reference [5] for details on how to do the instrument setup (available at: <http://www.rohde-schwarz.com/appnote/1GP97>).



3.3 Recommended test setups

Compact and cost-efficient – SISO

To cover the 20/40/80/160 MHz and contiguous 80+80 MHz channels, the recommended solution is:

One SGT 6 GHz signal generator



To cover all channel bandwidths including the noncontiguous 80+80 MHz channel, the recommended solution is:

Two SGT 6 GHz signal generators



High-end and fading simulation – SISO

To cover all channel bandwidths (20/40/80/160 MHz, contiguous and noncontiguous 80+80 MHz), the recommended solution is:

One SMW 6 GHz signal generator (two basebands (B10 option) and two RF outputs)



Please see section 8.3 for details regarding the fading capabilities of the SMW.

Compact and cost-efficient – MIMO up to 8x8

For generating MIMO signals with up to eight antennas, the recommended solution is:

Up to eight SGT 6 GHz signal generators



4 Generating an 802.11ax Signal

4.1 Required instrument options

The signal generators can generate standard-compliant WLAN 802.11ax signals when equipped with the corresponding option/license.

Options for 802.11ax				
Instrument	Option (firmware integrated)	Prerequisite	WinIQSIM2 option (external software)	Prerequisite for WinIQSIM2 option
SMW	SMW-K142	SMW-K54	SMW-K442	SMW-K254
SMBV	SMBV-K142	SMBV-K54	SMBV-K442	SMBV-K254
SGT	---	---	SGT-K442	SGT-K254

The K142 (802.11ax) and K54 (802.11a/b/g/n/j/p) options are needed to generate WLAN 802.11ax signals via the instrument's internal baseband generators. In order to play back WLAN 802.11ax ARB waveforms generated with the WinIQSIM2 software, the K442 (802.11ax) and K254 (802.11a/b/g/n/j/p) options are needed.

The SMW and the SMBV need the K522 baseband extension (to 160 MHz RF bandwidth) option for generating the 160 MHz channel. The SGT needs the K521 ARB bandwidth extension (to 120 MHz RF bandwidth) option for generating the 80 MHz channel, and additionally the K522 ARB bandwidth extension (to 160 MHz RF bandwidth) option for generating the 160 MHz channel.

Key features of K142 and K442:

- Standard compliant test signals
- Generation of 20, 40, 80 and 160 MHz channels with a single signal generator
- Generation of noncontiguous 80+80 MHz channel with two signal generators and RF combining
- Support of all modulation and coding schemes (MCS 0-11) with BCC and LDPC channel coding
- Support of uplink and downlink signals with all four PPDU formats (single user, multi-user, single user extended range, trigger-based)
- Support of single or multi-user MIMO with flexible spatial stream configuration for up to 8 streams/antennas

4.2 How to configure an 802.11ax (SISO) signal

4.2.1 General settings

- ▶ Click on the “Baseband” block and select “IEEE 802.11...” from the list.

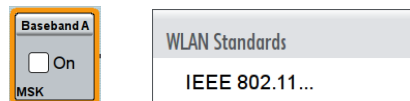

- ▶ First, select the transmission bandwidth, e.g. 160 MHz, in the “General” tab.

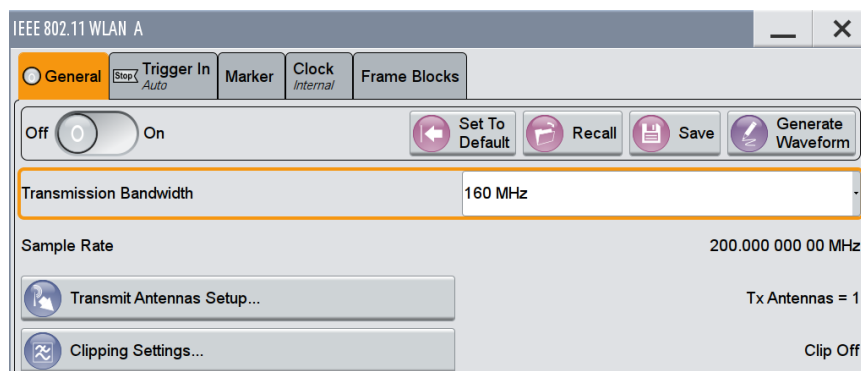

4.2.2 Frame Blocks

4.2.2.1 Introduction

The “Frame Blocks” tab enables the user to easily configure different signal blocks consisting of one or multiple WLAN frames of different 802.11 standards.

An HE device is required to comply with mandatory requirements of the legacy WLAN physical (PHY) layers. That is, an HE device operating in the 2.4 GHz will need to comply with the 802.11n PHY requirements and an HE device operating in the 5 GHz band will be required to be compliant with the 802.11n and 802.11ac PHY specifications. For these compliance tests, the user can configure different WLAN 802.11 signals via the “Frame Blocks” tab.

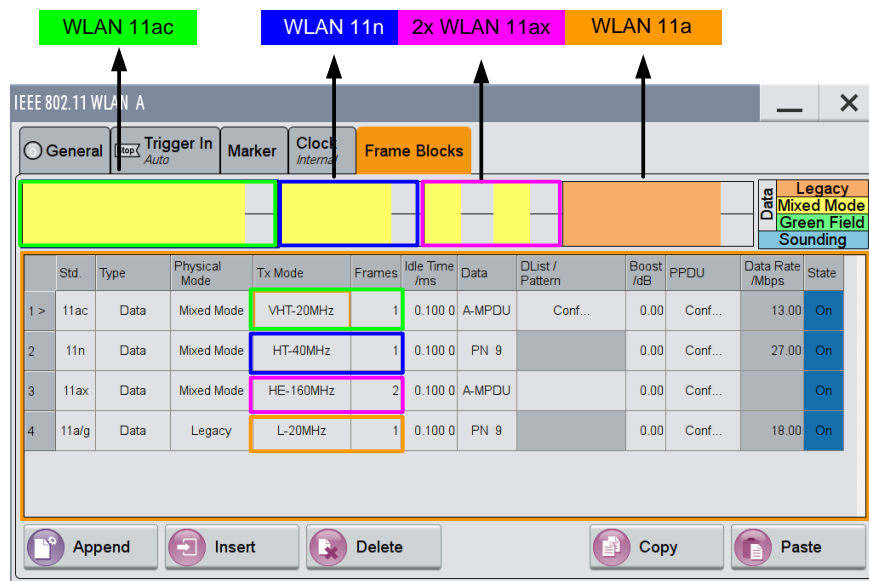

The “Append” button adds a new frame block (i.e. a new line) to the list. The user can create a sequence of frame blocks in this way. Each frame block can be configured individually. For example, the number of frames within this block can be set. Also the PPDU settings can be configured individually for each block.

4.2.2.2 Configuration of an 802.11ax frame block

- In the “Frame Blocks” tab, set the standard (“Std.”) to “11ax”.

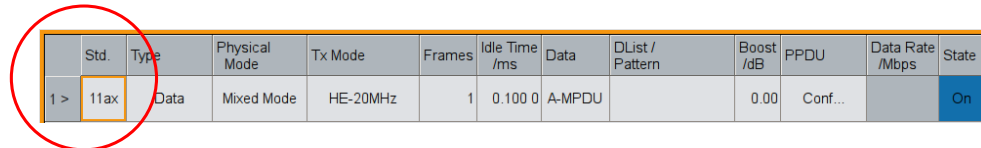

The transmission (Tx) mode is automatically set to HE transmission with a channel bandwidth of 20 MHz.

- Select the wanted channel bandwidth of the HE signal.

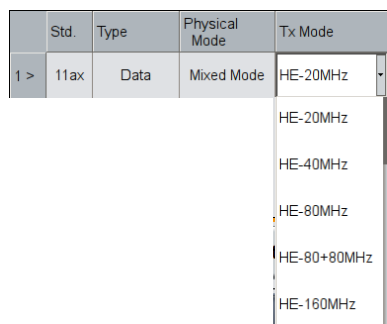

Note that the available channel bandwidths depend on the selection made for the transmission bandwidth in the “General” tab.

- Select the wanted number of HE frames to be generated within this frame block.

- ▶ Set the wanted idle time between the HE frames.

4.2.3 PDU Configuration

- ▶ Click “Conf...” in the “PDU” column of the frame blocks table to open the PDU configuration menu.

The PDU configuration menu has three tabs covered in the following sections:

- “General” tab
- “User Configuration” tab
- “Spatial Mapping” tab

4.2.3.1 PDU “General” tab

In the “General” tab, the user can set all general parameters for the HE signal.

The screenshot shows the 'IEEE 802.11 WLAN A: PDU Configuration for Frame Block 1' dialog box with the 'General' tab selected. The 'Stream Settings' section includes 'Spatial Streams' (1) and 'Space Time Streams' (1). The 'HE General Config' section includes 'Link Direction' (Downlink), 'PPDU Format' (HE SU), 'Guard' (0.8us), 'HE-LTF Symb Duration' (6.4us), 'Max PE Duration' (0us), 'Cur PE Duration' (0 us), 'Time Domain Windowing Active' (Off), and 'Transition Time' (100 ns). The 'Beam Change' checkbox is also Off.

- ▶ Set the link direction, i.e. uplink or downlink.

802.11ax distinguishes itself from legacy frames at the PHY layer by introducing four new PDU formats:

- Single user (HE SU)
- Multi-user (HE MU)
- Single user extended range (HE SU EXT)
- Trigger-based (HE TRIG)
- ▶ Set the wanted PDU format.
- ▶ Configure the rest of the parameters in section “HE General Config” as required.
- ▶ Configure the parameters in section “Additional HE-SIG-A Fields” as required.

The screenshot shows the 'Additional HE-SIG-A Fields' section of the configuration dialog. It includes 'BSS Color' (5), 'TXOP Duration' (127), 'Spatial Reuse' (0), and 'Doppler' (Off).

4.2.3.2 PPDU “User Configuration” tab

In the “User Configuration” tab, the user can set specific parameters for the HE user(s).

The settable parameters depend on the selected PPDU format, i.e. the “User Configuration” tab looks different for the different PPDU formats.

HE SU PPDU format

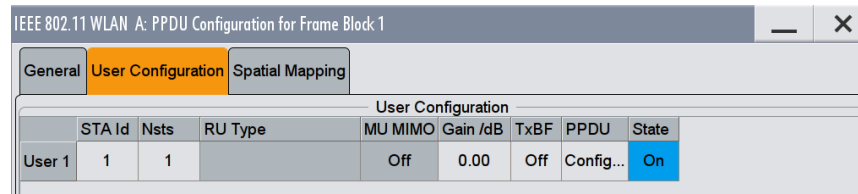

- ▶ Adjust the parameters for “User 1” as required, e.g. set the station identifier (STA-ID).
- ▶ Click “Config...” in the “PPDU” column of the table to open the PPDU configuration menu for “user 1”. (Continued in section 4.2.3.3).

HE MU PPDU format

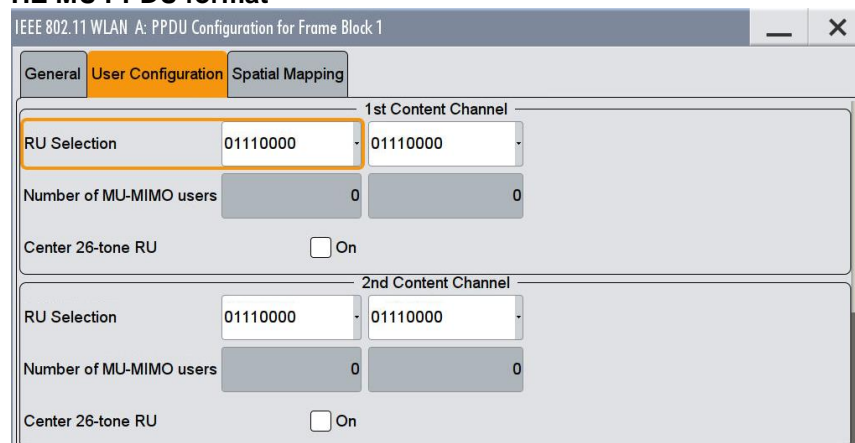

Since multiple users are intended recipients, the access point (AP) needs to tell the STAs which resource unit (RU) belongs to them. The AP uses the HE-SIG-B field in the HE MU PPDU to do this. The HE-SIG-B contains two fields:

- Common field, where RU allocation information is included
- User-specific field, where per-STA information belongs to (e.g. STA-ID, Nsts, etc.)

The HE-SIG-B has one or two content channels depending on the channel bandwidth. The content channel carries RU allocation and user-specific information defined for different segments of 20 MHz each. Please see reference [2] for more details on the standard.

- ▶ Choose the RU allocation by setting the parameters “RU Selection”.

In the screenshot above, the channel bandwidth is 80 MHz, so there are four times 20 MHz segments – two for each content channel. The selection is 01110000 for all segments in this example, which will result in four times four users occupying 52 tones/subcarriers each. See also reference [2].

“RU Selection” values containing “yyy” such as e.g. 11000yyy indicate selections supporting multi-user MIMO. Please refer to section 8.2.5.2 for MIMO signal generation. At this point, we only consider multiple users without MIMO, i.e. multi-user OFDMA.

User Configuration								
	STA Id	Nsts	RU Type	MU MIMO	Gain /dB	TxBF	PPDU	State
User 1	1	1	52-subc	Off	0.00	Off	Config...	On
User 2	2	1	52-subc	Off	0.00	Off	Config...	On
User 3	30	1	52-subc	Off	0.00	Off	Config...	On
User 4	44	1	52-subc	Off	0.00	Off	Config...	On
User 5	500	1	52-subc	Off	0.00	Off	Config...	On

- ▶ For each user, adjust the user-specific parameters as required, e.g. set the station identifier (STA-ID).
- ▶ For each user, click “Config...” in the “PPDU” column of the table to open the PPDU configuration menu for the respective user. (Continued in section 4.2.3.3).

HE SU EXT PPDU format – 20 MHz channel only

User Configuration								
	STA Id	Nsts	RU Type	MU MIMO	Gain /dB	TxBF	PPDU	State
User 1	1	1	242-subc	Off	0.00	Off	Config...	On

- ▶ Adjust the parameters for “User 1” as required, e.g. set the station identifier (STA-ID).
- ▶ Click “Config...” in the “PPDU” column of the table to open the PPDU configuration menu for “user 1”. (Continued in section 4.2.3.3).

HE TRIG PPDU format – Uplink only

1st Content Channel

RU Selection: 01110000

Number of MU-MIMO users: 0

Center 26-tone RU: On

2nd Content Channel

RU Selection: 01110000

Number of MU-MIMO users: 0

Center 26-tone RU: On

- ▶ Choose the RU allocation by setting the parameters “RU Selection”.
- ▶ Select the wanted user from the list by setting its “State” to “On”.

User Configuration							
	STA Id	Nsts	RU Type	MU MIMO	Gain /dB	PPDU	State
User 1	1	1	52-subc	Off	0.00	Config...	Off
User 2	1	1	52-subc	Off	0.00	Config...	Off
User 3	1	1	52-subc	Off	0.00	Config...	On
User 4	1	1	52-subc	Off	0.00	Config...	Off
User 5	1	1	52-subc	Off	0.00	Config...	Off

- ▶ Adjust the user-specific parameters for the selected user as required, e.g. set the station identifier (STA-ID).
- ▶ Click “Config...” in the “PPDU” column of the table to open the PPDU configuration menu for the selected user. (Continued in section 4.2.3.3).

4.2.3.3 PPDU “User Configuration” continued

The PPDU configuration menu for a particular HE user offers further setting parameters such as modulation and coding scheme (MCS).

MCS Configuration

- ▶ Choose a modulation and coding scheme (MCS 0 to MCS 11).

All related parameters are then set automatically. The user can select/change the modulation type (BPSK, QPSK, 16QAM, 64QAM, 256QAM, 1024QAM).

- ▶ Choose the channel coding.

Binary convolution coding (BCC) and low density parity check (LDPC) coding are supported.

IEEE 802.11 WLAN A: PPDU Configuration for Frame Block 1 / User 1

MCS Configuration | A-MPDU | Data | MAC Header & FCS

Modulation and Coding Scheme

MCS: 11 | Data Rate: 600.49Mbps / Bits per Symb 8 167

Stream 1: 1024QAM | Stream 2: 1024QAM | Stream 3: 1024QAM | Stream 4: 1024QAM

Stream 5: 1024QAM | Stream 6: 1024QAM | Stream 7: 1024QAM | Stream 8: 1024QAM

Ch. Coding: LDPC | Encoders: 1 | Cod Rate: 5/6 | DCM: On

Depending on the selected MCS, the number of forward error correction (FEC) encoders is set automatically.

A-MPDU Settings

The number of MAC protocol data units (MPDU – equivalent to PSDU) is “1” per default but can be adjusted by the user.

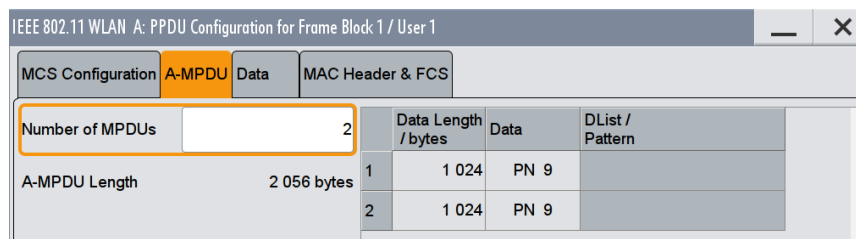

The user can set the size of the data field (“Data Length” parameter) and the data source, e.g. PN 9, for each MPDU.

The resulting size of the aggregated MPDU (A-MPDU) is displayed.

- ▶ For high modulation schemes (e.g. MCS 11) and high bandwidths (e.g. 80 MHz), it is recommended to adjust the “Data Length” parameter, e.g. to 16384 bytes, to get a decent number of data symbols.

Data Settings

The scrambler is enabled by default and uses either

- a fixed, selectable initialization value (“On (User Init)”) or
- a random initialization value (“On (Random Init)”) that is different for each frame.

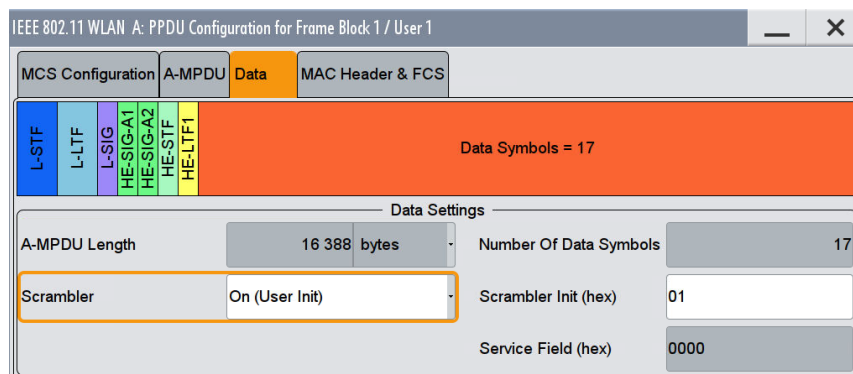

4.2.3.4 PPDU “Spatial Mapping” tab

In the “Spatial Mapping” tab, the user can select the spatial mapping matrix.

Spatial mapping can be interpreted as the distribution of the precoded data bits onto the different OFDM carriers. An 802.11ax transmitter tries to optimize the spatial mapping depending on the channel conditions by means of the channel sounding information received. Therefore, there is a spatial mapping matrix for every OFDM carrier. Additionally, spatial expansion is possible, which means that, for example, four space time streams can be effectively distributed to e.g. eight Tx antennas (see section 8.2.5.4 for details).

- ▶ Select the spatial mapping mode: “Direct”, “Indirect” or “Expansion”.

The available choices depend on the number of space time streams and the number of Tx antennas (see section 8.2 for details). If the number of space time streams equals the number of Tx antennas, all three choices for the spatial mapping matrix are possible: Direct, Indirect, and Expansion. If the number of space time streams is less than the number of Tx antennas, it is not possible to choose “Direct”.

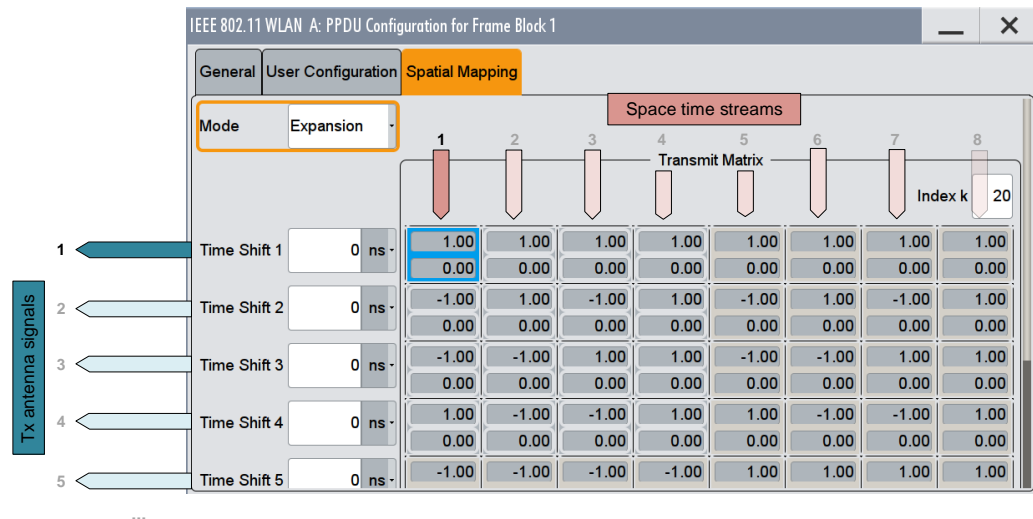

The matrix is displayed in the menu (the actual matrix consists only of the matrix elements marked in blue). Note that the shown matrix is only for illustration, it is not editable. Since there is a spatial mapping matrix for every OFDM carrier, the “Index k” parameter can be used to view the matrix of a particular OFDM carrier (i.e. “Index k” is the index of a subcarrier).

Depending on the mapping mode, the spatial mapping matrix is:

- a CSD matrix, i.e. a diagonal matrix with complex values that represent cyclic time shifts (used in direct mode)
- the product of a CSD matrix and a Hadamard unitary matrix (used in indirect mode)
- the product of a CSD matrix and a square matrix defined in the standard specification (used in expansion mode)

Whereas the Hadamard and the square matrix are predetermined, the CSD matrix can be configured by the user. The CSD matrix is diagonal and causes a time delay for the individual Tx antenna signals. On the SMW, the user can directly set this time delay via the “Time Shift” parameters.

- ▶ Adjust the “Time Shift” parameter as required.

4.2.4 Configuring a 80+80 MHz signal

For the 80+80 MHz channel, there is an additional setting parameter in the PPDU “General” tab: the “Segment” parameter.

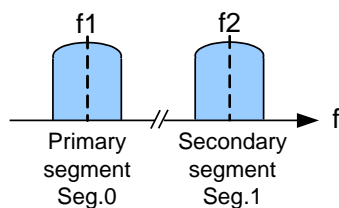
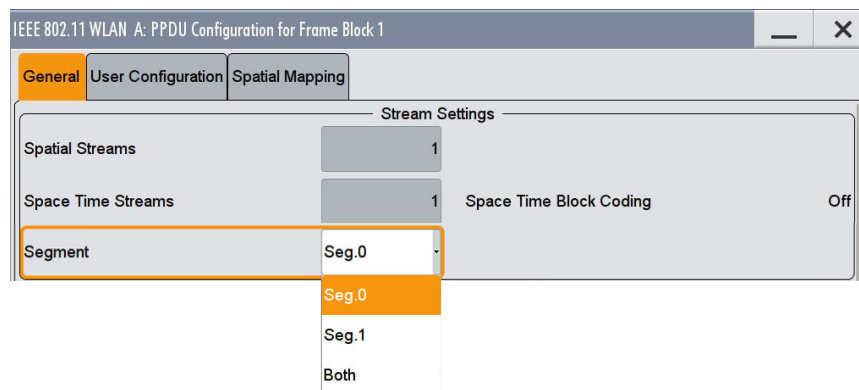

- ▶ Select “Seg.0” to generate the primary segment of the 80+80 MHz signal.
- ▶ Select “Seg.1” to generate the secondary segment.
- ▶ Select “Both” to generate the primary and secondary segment contiguously.

Note that selecting “Both” is only possible if the “Transmission Bandwidth” parameter is set to 160 MHz in the “General” tab.

4.3 How to create a waveform file for the SGT

802.11ax waveform files for playback on the SGT’s arbitrary waveform generator (ARB) are created with the WinIQSIM2 software. Please see the SGT getting started user manual on how to create and transfer waveform files – described in section “How to Create a Waveform File with R&S WinIQSIM2 and Load it in the ARB”.

The SGT getting started manual as well as the WinIQSIM2 software are downloadable free-of-charge on the SGT product website at www.rohde-schwarz.com/product/sgt100a.

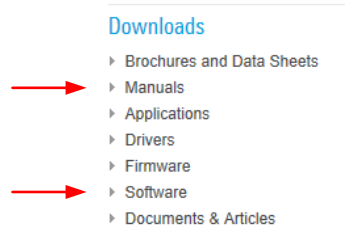

5 Signal Performance

This section demonstrates the signal performance of the SGT and SMW relevant for 802.11ax.

5.1 Modulation accuracy

5.1.1 Constellation error / EVM performance

To obtain optimal EVM results, the following settings should be made:

Generator:

- For high modulation schemes (e.g. MCS 11) and high bandwidths (e.g. 80 MHz), adjust the “Data Length” parameter, e.g. to 16384 bytes, to get a decent number of data OFDM symbols (e.g. 16, 17 or higher).

Analyzer:

- Perform auto level once. Generally, this yields already optimal EVM.
- Optionally, optimize the attenuation.
- Optionally, optimize the reference level such that the FSW is about to show the IF overload warning.

SMW

The following figure shows the measured EVM for an 80 MHz channel at 5.3 GHz and 0 dBm generated by the SMW with MCS 11 (1024-QAM).

HE_SU, 80 MHz @ 5.3 GHz

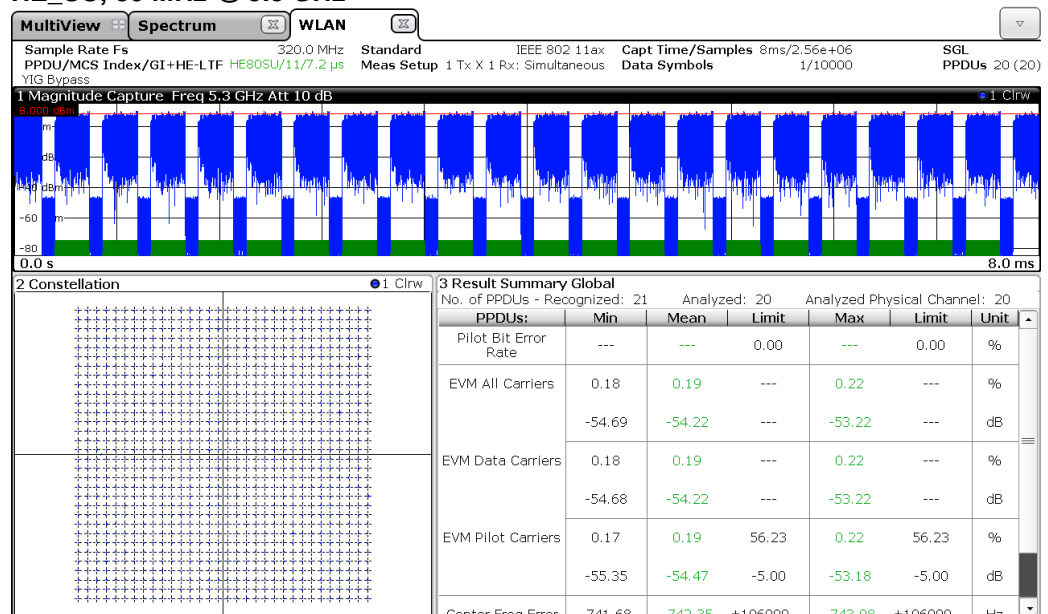

The EVM is -54 dB – measured standard-compliant with preamble-based channel estimation (payload-based channel estimation yields -55 dB).

SGT

The following figure shows the measured EVM for the identical signal (80 MHz channel at 5.3 GHz and 0 dBm, MCS 11) generated by the SGT.

HE_SU, 80 MHz @ 5.3 GHz

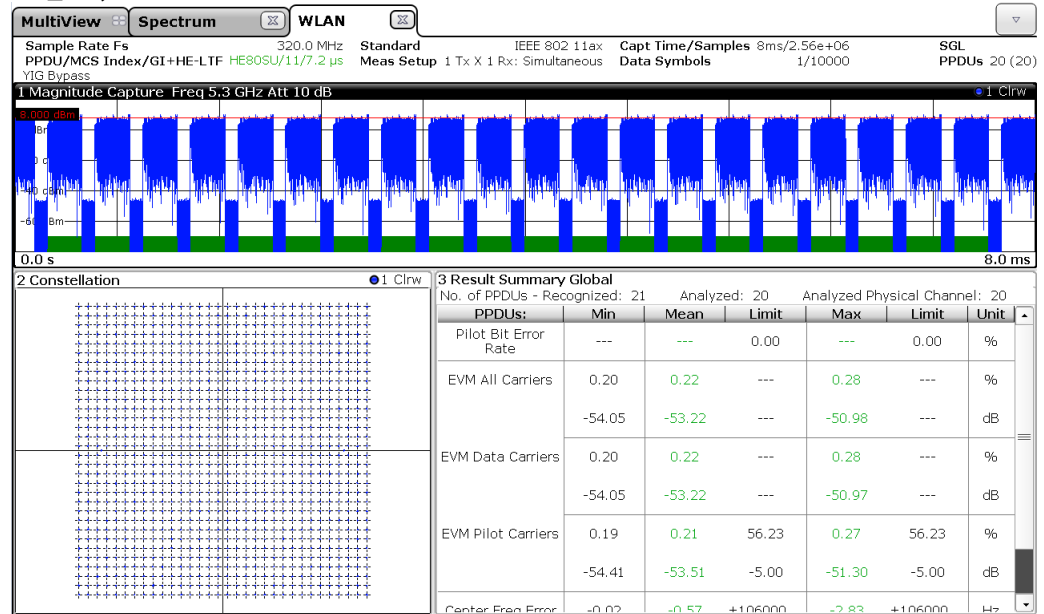

The EVM is -53 dB – measured standard-compliant with preamble-based channel estimation (payload-based channel estimation yields -54 dB).

The SGT maintains its excellent EVM performance over a wide level range as shown in the following figure. The measured 802.11ax signal was an 80 MHz channel in the 2.4 GHz and 5 GHz band with MCS 11 (1024-QAM) and 17 data OFDM symbols.

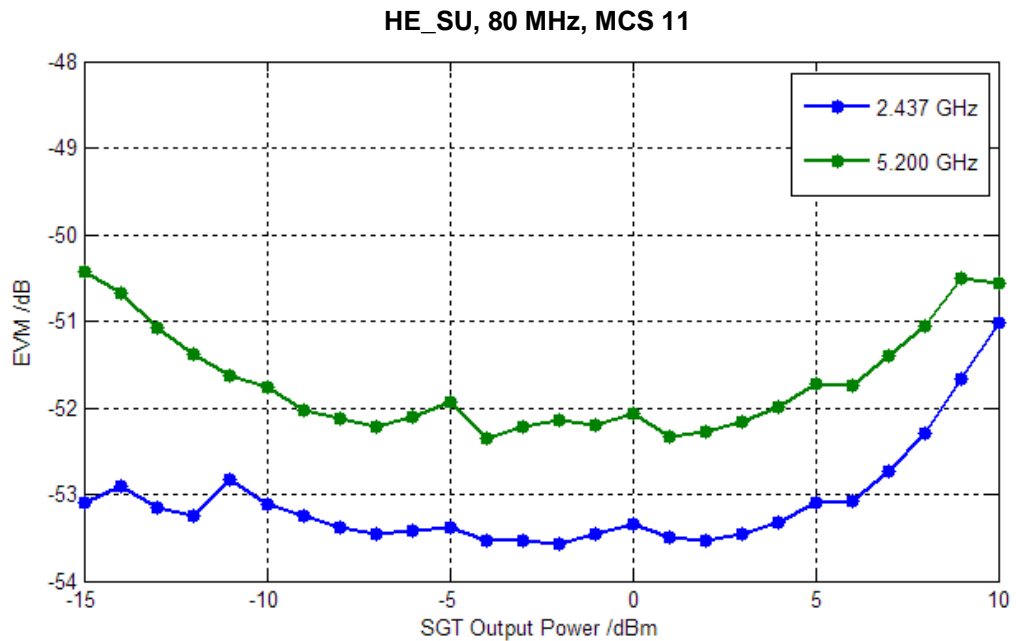

The EVM is below -50 dB – measured standard-compliant with preamble-based channel estimation, 20 PPDU's averaged.

According to the standard specification the allowed EVM for MCS 11 (1024-QAM) is -35 dB. The SMW and the SGT provide an EVM performance significantly lower than the specified limit for 802.11ax transmitters – the EVM-margin is 15 dB and more.

5.1.2 Center frequency leakage

The blue trace in the following figure shows the carrier leakage peak at the RF center frequency (i.e. LO frequency) of the SGT. To reveal the carrier leakage peak, the spectrum was captured during the idle time between two bursts.

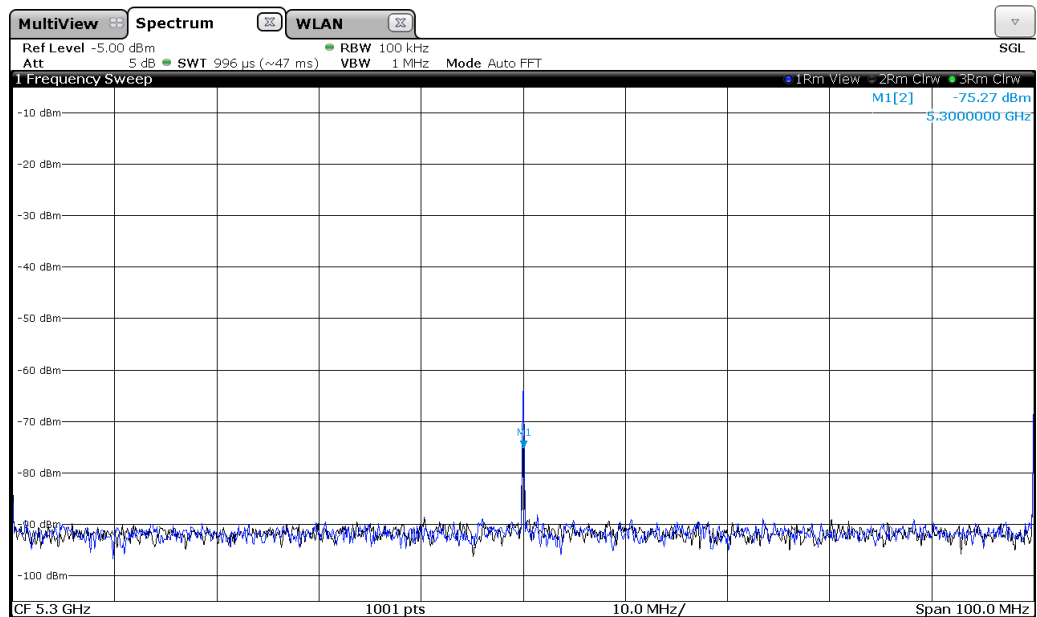

The carrier suppression is very good: about -64 dBm leakage at a transmit power of 0 dBm during bursts. The standard specification requires a suppression of better than -32 dB relative to the transmit power and not more than -20 dBm. The SGT and SMW easily fulfill this requirement specified for 802.11ax transmitters.

The carrier leakage is caused by a DC component in the I/Q signal. It can be even further suppressed if needed.

- Press the “Adjust I/Q Modulator at Current Frequency” button. (On the SGT, the button can be found in the “Internal Adjustments” menu; on the SMW in the “I/Q Modulator” menu.)

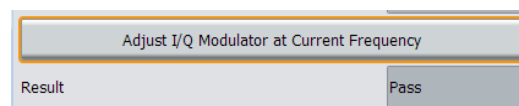

- Apply I and Q offsets to cancel any DC offsets. Adjust the “I Offset” and “Q Offset” in the “Digital Impairments” menu.

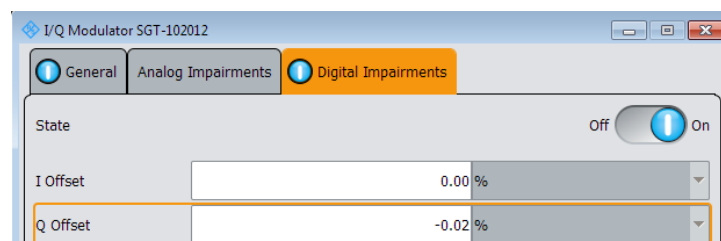

The black trace in the above figure shows the carrier leakage peak after applying suitable (small) I and Q offsets (found iteratively by marker measurement on FSW). The carrier leakage is now -75 dBm.

Please note that the center frequency leakage is also measured and displayed as parameter "I/Q Offset" on the FSW "WLAN" mode/application ("Result Summary Detailed" display).

5.2 Spectrum mask

The following figure shows a transmit spectral mask measurement for an 80 MHz downlink HE_SU signal generated by the SGT. The measurement uses the stipulated mask specifications.

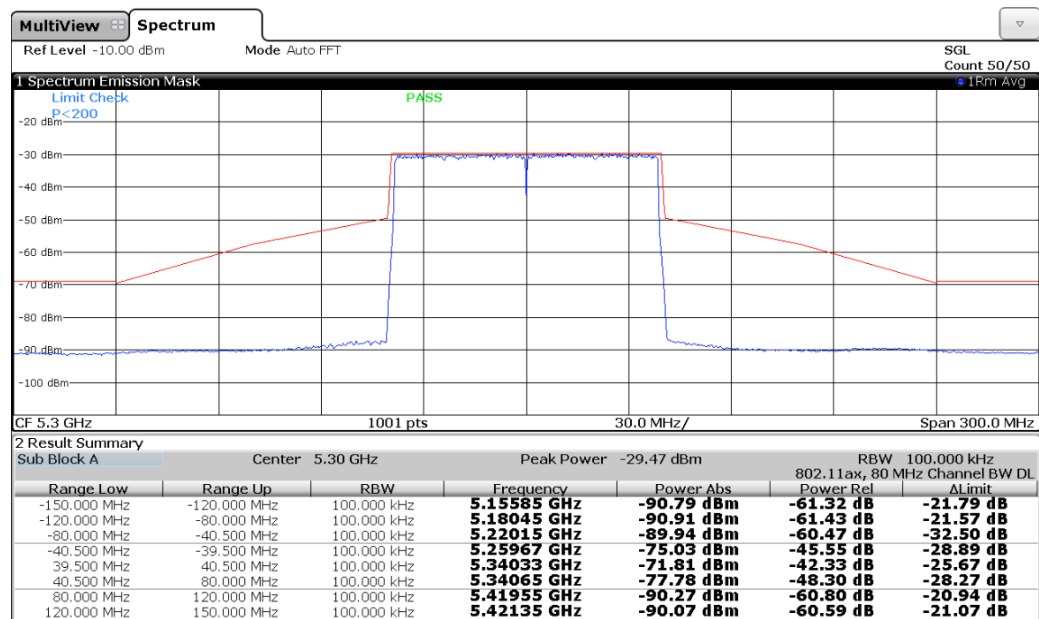

5.3 Spectral flatness

The following figure shows a spectral flatness measurement for an 80 MHz downlink HE_SU signal generated by the SGT.

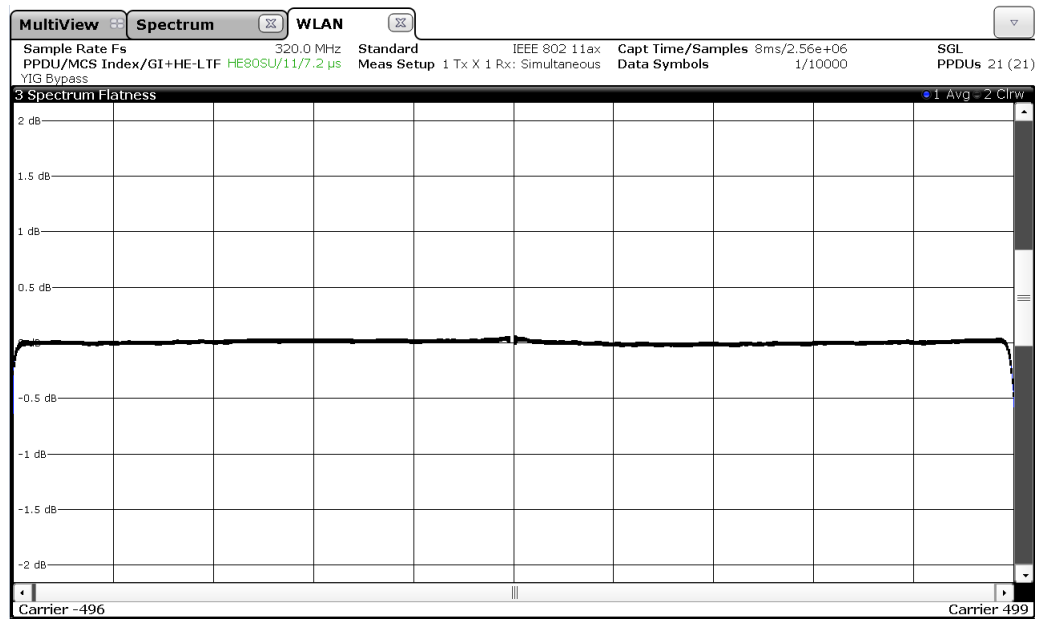

The extremely flat frequency response of the SGT (with internal baseband) can also be seen in the SGT's datasheet – measured with a very accurate power sensor.

6 Testing 802.11ax Receiver Specification

The standard draft [1] specifies packet error rate (PER) measurements for testing the receiver. Therefore, this section first presents how to perform PER measurements and then shows how to test the receiver specifications.

6.1 PER testing

The signal generators support packet error rate (PER) testing via the nonsignaling mode. They can generate standard-compliant 802.11ax test signals including MAC header.

Setting up the MAC header

- ▶ Activate the MAC Header and the frame check sequence (FCS) by setting the parameters “MAC Header” and “FCS” to “On”.
- ▶ Optionally enable the sequence control field.

IEEE 802.11 WLAN A: PDU Configuration for Frame Block 1 / User 1

MCS Configuration | A-MPDU | Data | **MAC Header & FCS**

MAC Header On FCS (checksum) On

Field	Value	Size
Frame Control (hex)	0000	2 bytes
Duration / ID (hex)	0000	2 bytes
Address 1 (hex)	0000 0000 0000	6 bytes
Address 2 (hex)	0000 0000 0000	6 bytes
Address 3 (hex)	0000 0000 0000	6 bytes
Seq Control	Enable <input checked="" type="checkbox"/>	4 bit
Fragmentation	Fragment <input type="checkbox"/>	4 bit
Sequence	Seq <input checked="" type="checkbox"/>	12 bit
Address 4 (hex)	0000 0000 0000	6 bytes
HT Config	0 - 6	bytes
Frame Body	0 - 65495	bytes
FCS	4	bytes

Start Number (hex) 0 Start Number (hex) 000
 Incremented Every 1 packet(s) Incremented Every 1 packet(s)

MAC Frame Control Field

Field	Value	Size
Protocol Version	00	2 bits (LSB)
Type	00	2 bits
Subtype	0000	4 bits
To DS	0	1 bit
From DS	0	1 bit
More Frag	0	1 bit
Retry	0	1 bit
Pwr Mgt	0	1 bit
More Data	0	1 bit
WEP	0	1 bit
Order	0	1 bit (MSB)

To perform nonsignaling PER measurements, the MAC header settings do not need to be configured but can be left at their default values. This generally works fine.

- ▶ Optionally, configure the MAC header settings as required.

Test setup

The user's equipment³ analyzes the transmitted FCS to evaluate if packets sent from the generator to the DUT were received error-free. All erroneous packets are counted and a PER (ratio between erroneous packets and total number of packets) is calculated. The user's equipment can further determine missing or retransmitted frames by evaluating the sequence control field.

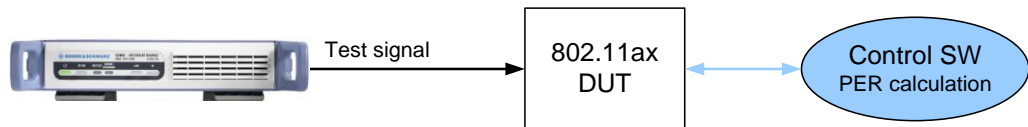

Generating 1000 frames once

For PER measurements, e.g. 1000 frames are generated and evaluated. The signal generation shall therefore stop after exactly 1000 frames.

- Set the “Frames” parameter in the “Frame Blocks” tab to 1000.

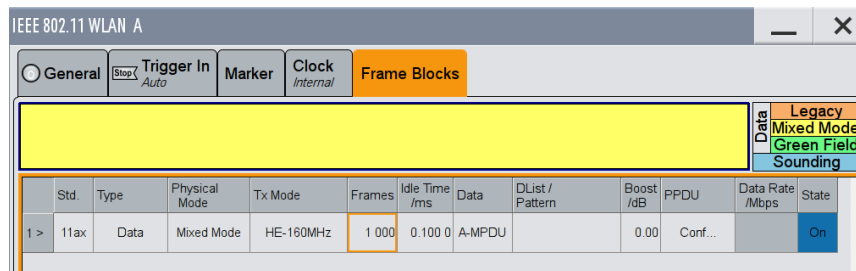

Per default, the 1000 frames are repeated continuously. To output the 1000 frames exactly once, the “Single” trigger mode is used.

- In the “Trigger In” tab⁴, set the trigger “Mode” to “Single”.

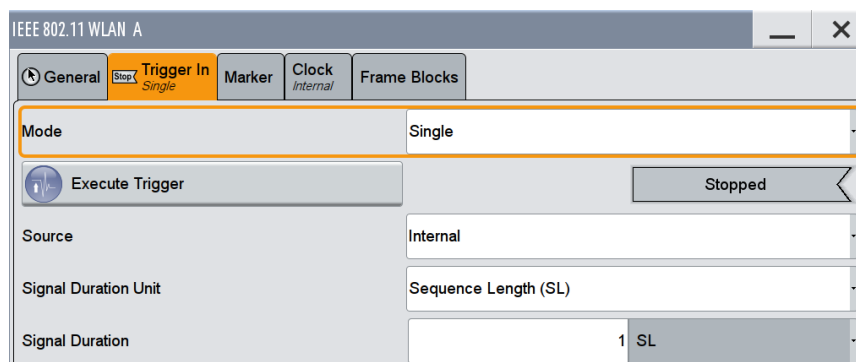

After executing the trigger, the 1000 frames will be output and then the signal generation stops.

³ The control and evaluation software is generally provided by the WLAN device manufacturer.

⁴ When working with the SGT, the trigger settings are done on the SGT in the ARB menu.

6.2 Testing receiver specifications

The 802.11ax standard draft [1] contains specific receiver testing requirements and limits:

Receiver specification		
According to IEEE P802.11ax/D1.3, June 2017, section 28.3.17		
Test	Draft section	Section in this application note
Receiver minimum input sensitivity	28.3.17.2	6.2.1
Adjacent channel rejection	28.3.17.3	6.2.2
Nonadjacent channel rejection	28.3.17.4	6.2.3
Receiver maximum input level	28.3.17.5	6.2.4
CCA sensitivity	28.3.17.6	N/A

6.2.1 Receiver minimum input sensitivity

The receiver under test must be able to provide a PER of 10 % or less for a given input level. The specified input level depends on the modulation and coding scheme and the channel bandwidth.

Specified settings [1]:

- Single user (HE SU)
- PSDU length:
 - 2048 bytes for BPSK modulation with DCM
 - 4096 bytes for all other modulations
- No Space time block coding (STBC)
- 800 ns guard interval
- Coding:
 - BCC for 20 MHz channels
 - LDPC for all other channels (greater than 20 MHz)

Example test setup for 1 spatial stream (i.e. for one Tx/Rx antenna pair)

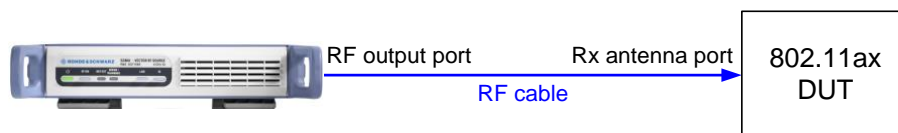

Settings for signal generator

- Channel bandwidth
 - ▶ IEEE 802.11 WLAN main menu, “General” tab → “Transmission Bandwidth” parameter: select as desired
 - ▶ IEEE 802.11 WLAN main menu, “Frame Blocks” tab → “Tx Mode” parameter: select as desired

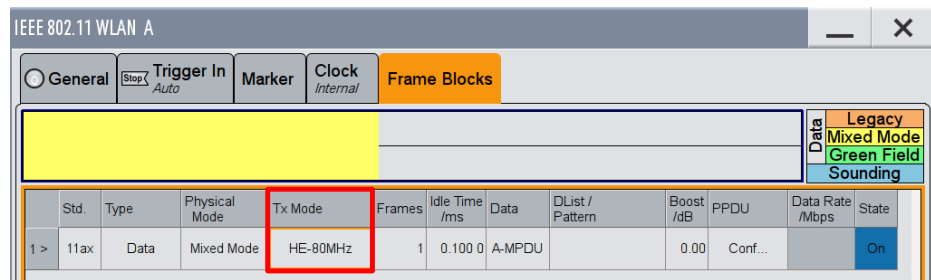

- Single user (HE SU)
 - ▶ IEEE 802.11 WLAN main menu, “Frame Blocks” tab → PPDU configuration menu, “General” tab → “PPDU Format” parameter: HE SU (default)
- No Space time block coding (STBC)
 - ▶ “Spatial Streams” parameter same value as “Space Time Streams”. Consequently, STBC is off (see also section 8.2.5.1 for details)
- 800 ns guard interval
 - ▶ “Guard” parameter: 0.8 us (default)

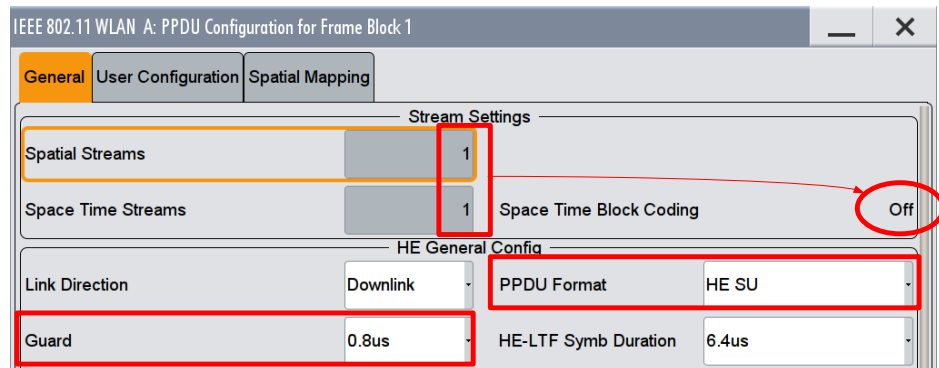

- MCS
 - ▶ PPDU configuration menu, “User Configuration” tab → PPDU configuration (continued) menu, “MCS Configuration” tab → “MCS” parameter: select as desired
- Coding:
 - BCC for 20 MHz channels
 - LDPC for all other channels (greater than 20 MHz)
- ▶ “Ch. Coding” parameter: LDPC (for all channels greater than 20 MHz)

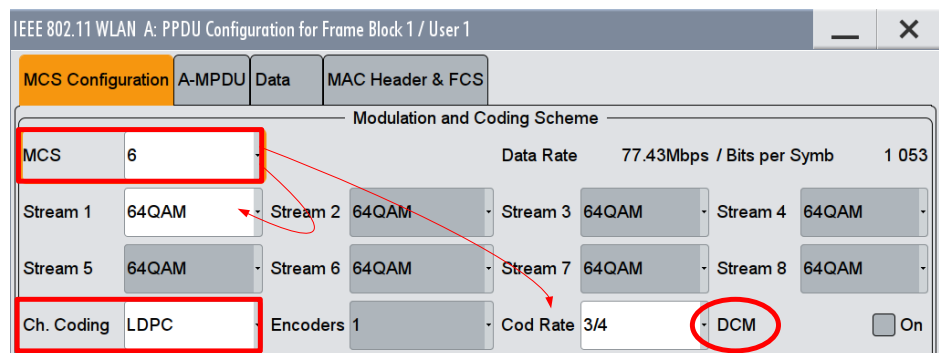

- PSDU length:
 - 2048 bytes for BPSK modulation with DCM
 - 4096 bytes for all other modulations
- ▶ PPDU configuration (continued) menu, “A-MPDU” tab → “Data Length” parameter: 4096 (for all modulation except BPSK with DCM); “Number of MPDUs” parameter: 1 (default)

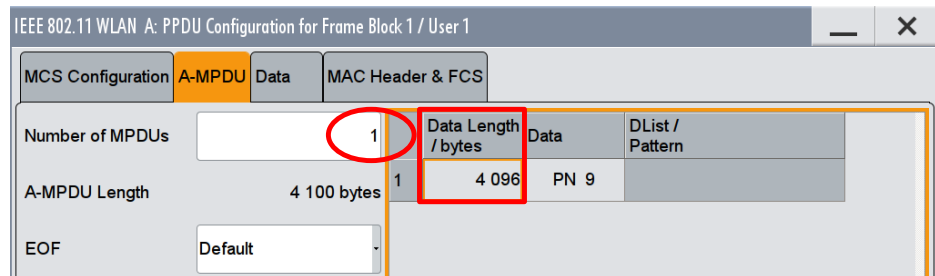

6.2.2 Adjacent channel rejection

The adjacent channel rejection (ACR) of the receiver under test is determined by raising the power of an interfering signal in the adjacent channel until the receiver shows a PER of 10 %. The difference in power between the wanted and the interfering signal is the ACR. The specified ACR (in dB) depends on the modulation and coding scheme and the channel bandwidth.

Specified settings [1]:

Wanted signal:

- Level: 3 dB above the sensitivity level (section 6.2.1)
- Single user (HE SU)
- No Space time block coding (STBC)
- 800 ns guard interval
- Coding:
 - BCC for 20 MHz channels
 - LDPC for all other channels (greater than 20 MHz)
- PSDU length:
 - 2048 bytes for BPSK modulation with DCM
 - 4096 bytes for all other modulations

Interfering signal:

- HE signal, unsynchronized with the wanted signal
- Channel bandwidth same as wanted signal (80 MHz for the 80+80 MHz channel)
- Center frequency is W MHz away from the center frequency of the wanted signal, where W is the channel bandwidth
- Minimum duty cycle of 50 %
- Single user (HE SU)
- No Space time block coding (STBC)
- 800 ns guard interval
- Coding:
 - BCC for 20 MHz channels
 - LDPC for all other channels (greater than 20 MHz)

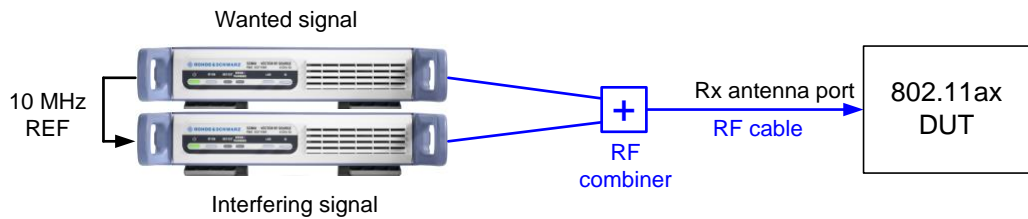
Example test setup for 1 spatial stream (i.e. for one Tx/Rx antenna pair)**Settings for signal generator****Wanted signal:**

- Channel bandwidth
 - ▶ see section 6.2.1
- Single user (HE SU)
 - ▶ see section 6.2.1
- No Space time block coding (STBC)
 - ▶ see section 6.2.1
- 800 ns guard interval
 - ▶ see section 6.2.1
- MCS
 - ▶ see section 6.2.1
- Coding
 - ▶ see section 6.2.1
- PSDU length
 - ▶ see section 6.2.1

Interfering signal:

- Channel bandwidth same as wanted signal (80 MHz for the 80+80 MHz channel)
 - ▶ see section 6.2.1
- Minimum duty cycle of 50 %
 - ▶ IEEE 802.11 WLAN main menu, “Frame Blocks” tab → “Idle Time” parameter: select as desired

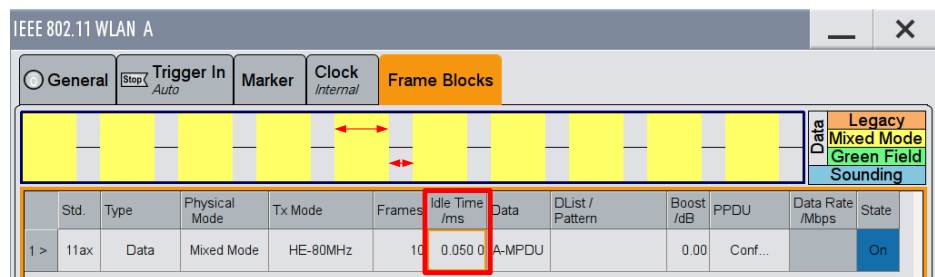

- Single user (HE SU)
 - ▶ see section 6.2.1
- No Space time block coding (STBC)
 - ▶ see section 6.2.1
- 800 ns guard interval
 - ▶ see section 6.2.1

- MCS: not explicitly specified
 - ▶ see section 6.2.1
- Coding:
 - ▶ see section 6.2.1
- PSDU length: not explicitly specified
 - ▶ see section 6.2.1
- HE signal, unsynchronized with the wanted signal

Normally, two signals of two separate generators (or from two basebands within one generator) are unsynchronized as long as there are no special means taken to synchronize them (see section 3.2.2).

 - ▶ IEEE 802.11 WLAN main menu, “General” tab → “Off/On” state: turn to “On” state asynchronous with turning the wanted signal to “On” state.

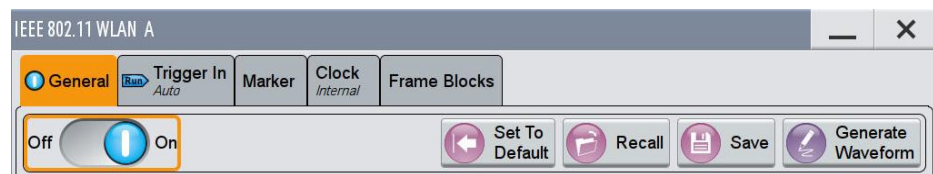

6.2.3 Nonadjacent channel rejection

The nonadjacent channel rejection (non-ACR) of the receiver under test is determined by raising the power of an interfering signal (in the alternate channel or further apart) until the receiver shows a PER of 10 %. The difference in power between the wanted and the interfering signal is the non-ACR. The specified non-ACR (in dB) depends on the modulation and coding scheme and the channel bandwidth.

Specified settings [1]:

Wanted signal:

- Level: 3 dB above the sensitivity level (section 6.2.1)
- Single user (HE SU)
- No Space time block coding (STBC)
- 800 ns guard interval
- Coding:
 - BCC for 20 MHz channels
 - LDPC for all other channels (greater than 20 MHz)
- PSDU length:
 - 2048 bytes for BPSK modulation with DCM
 - 4096 bytes for all other modulations

Interfering signal:

- HE signal, unsynchronized with the wanted signal
- Channel bandwidth same as wanted signal (80 MHz for the 80+80 MHz channel)
- Center frequency is at least $2 \times W$ MHz away from the center frequency of the wanted signal, where W is the channel bandwidth
- Minimum duty cycle of 50 %
- Single user (HE SU)
- No Space time block coding (STBC)
- 800 ns guard interval

- Coding:
 - BCC for 20 MHz channels
 - LDPC for all other channels (greater than 20 MHz)

Example test setup for 1 spatial stream (i.e. for one Tx/Rx antenna pair)

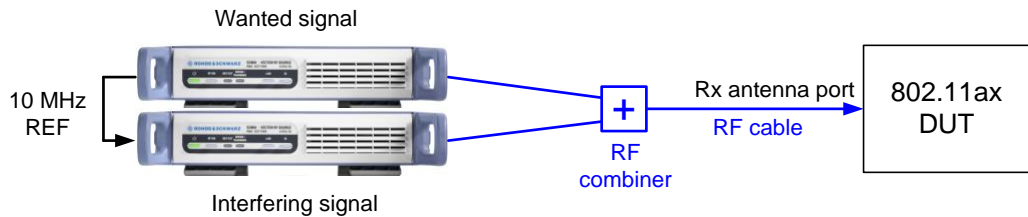

Settings for signal generator

The settings are the same as for the ACR test (only the center frequency of the interfering signal is different). Please see section 6.2.2 for details.

6.2.4 Receiver maximum input level

The receiver under test must be able to provide a PER of 10 % or less for a specified (maximum) input level. The specified input level depends on the frequency band (2.4 GHz and 5 GHz).

Specified settings [1]:

- All HE modulations
- PSDU length:
 - 2048 bytes for BPSK modulation with DCM
 - 4096 bytes for all other modulations

Example test setup for 1 spatial stream (i.e. for one Tx/Rx antenna pair)

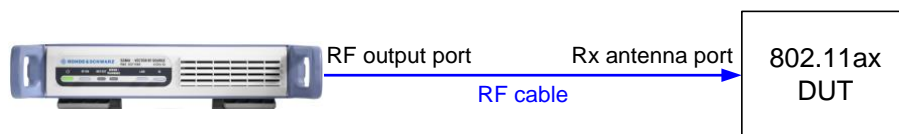

Settings for signal generator

The specification demands to meet the requirement “for any baseband HE modulation”. Please see section 1.1 for guidance how to configure a HE signal in general. In particular refer also to the following sections:

- MCS
 - ▶ see section 6.2.1
- PSDU length
 - ▶ see section 6.2.1

7 Testing HE Trigger-Based PPDU Specifications

7.1 Introduction

802.11ax introduces four new PPDU formats (HE SU, HE MU, HE SU EXT, HE TRIG) and adds new requirements for the HE trigger-based (HE TRIG) PPDU. These new requirements are needed because uplink OFDMA and multi-user MIMO rely on transmission accuracy and synchronization of the participating stations.

Multi-user uplink

In the OFDMA uplink, multiple stations (STAs) transmit simultaneously a trigger-based PPDU to the access point (AP).

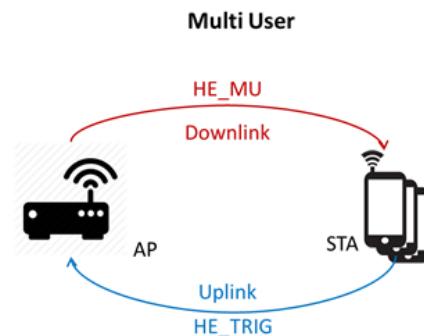

HE trigger-based PPDU transmission (in uplink) is preceded by a trigger frame sent by the AP (in downlink). This trigger frame is sent to all stations for coordinating the uplink transmission. The trigger frame includes information such as payload length, bandwidth, RU allocation, modulating scheme, etc. The participating STAs need to start transmission of the uplink signal after a specified time interval SIFS (short interframe space) after the end of the trigger frame as illustrated in the following figure.

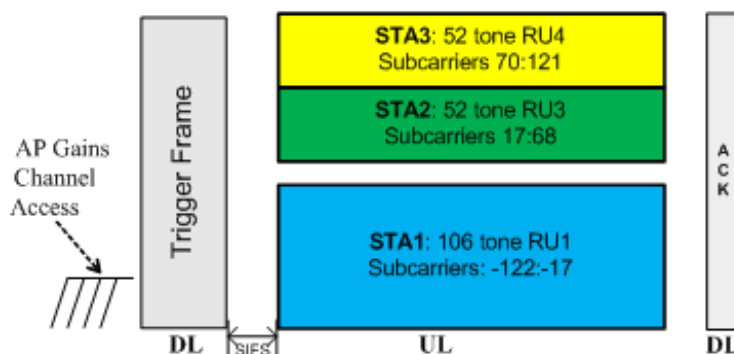

Pre-corrections

Since multiple STAs take part in the HE trigger-based PPDU transmission, it requires synchronization of transmission time, frequency, sampling clock and power by the participating STAs to mitigate interference issues [1]. Therefore the standard draft [1] specifies pre-corrections for these parameters. For example, frequency and sampling clock pre-corrections are needed to prevent inter-carrier interference. Power pre-correction is needed to minimize interference among different transmitting STAs. 802.11ax stipulates accuracy requirements for these pre-corrections that need to be met by the STA and therefore need to be tested.

7.2 Testing pre-correction accuracy requirements

The 802.11ax standard draft [1] contains specific requirements and limits for an HE trigger-based PPDU transmission:

Transmit requirements for an HE trigger-based PPDU		
According to IEEE P802.11ax/D1.3, June 2017, section 28.3.14		
Test (Pre-correction accuracy requirement)	Draft section	Section in this application note
Minimum transmit power	28.3.14.3	7.2.1
Absolute transmit power accuracy	28.3.14.3	7.2.2
Relative transmit power accuracy	28.3.14.3	7.2.3
RSSI measurement accuracy	28.3.14.3	7.2.4
Residual Carrier frequency offset error	28.3.14.3	7.2.5
Timing accuracy	28.3.14.3	7.2.6

7.2.1 Minimum transmit power

The STA under test must be able to provide a specified minimum transmit power. This test does not require a signal source and is therefore not covered in detail in this application note.

7.2.2 Absolute transmit power accuracy

The AP indicates the target RSSI (received signal strength indicator) in the trigger frame. The STA needs to calculate the transmit power required to meet the target RSSI.

$$Tx_{pwr}^{STA} = (Tx_{pwr}^{AP} - DL_{RSSI}) + Target_{RSSI}$$

Formula for calculating the uplink transmit power		
Parameter	Meaning	Information
T_{pwr}^{STA}	Uplink transmit power of the STA	To be determined
T_{pwr}^{AP}	Combined transmit power of all transmit antennas of the AP used to transmit the trigger frame	Signaled to the STA in the trigger frame
DL_{RSSI}	Average received power at the STA	Needs to be measured by the STA over the legacy preamble of the trigger frame
$Target_{RSSI}$	Target receive signal power average over the AP's antennas	Signaled to the STA in the trigger frame

The STA under test must be able to provide a specific transmit power with a specified accuracy. There are different accuracy requirements depending on the device class⁵. This test does not necessarily require a signal source and is therefore not covered in detail in this application note.

7.2.3 Relative transmit power accuracy

Because low cost devices (class B) have relaxed absolute transmit power accuracy requirements, an additional relative transmit accuracy requirement is added for them. The class B STA under test must be able to achieve a change in transmit power for consecutive HE trigger-based PPDU transmissions with a specified accuracy.

For this test, a signal generator emulates the AP sending trigger frames with different target RSSIs for example. This will cause the STA to change its transmit power. An instrument such as a power meter or a spectrum analyzer can measure the transmit power.

The measurement setup can be seen in section 7.3. Cable and coupler losses need to be taken into account.

7.2.4 RSSI measurement accuracy

To calculate the required transmit power according to the formula shown in section 7.2.2, the STA needs to measure the RSSI during the reception of the legacy preamble of the trigger frame. The STA under test must be able to measure the RSSI with a specified accuracy. There are different accuracy requirements depending on the device class⁵.

⁵ See the standard draft [1] for information on the device classes A and B.

For this test, a signal generator emulates the AP sending a trigger frame. The power level of the signal generator can be precisely set – losses of the connecting cable can be conveniently compensated by level offsets. The STA measures the received power over the legacy preamble of the trigger frame. The difference between the true power applied to the STA and the measured RSSI gives the RSSI measurement accuracy of the STA. It shall be measured for applied levels ranging from -82 dBm to -20 dBm in the 2.4 GHz band and -82 dBm to -30 dBm in the 5 GHz band.

The following figure shows the (simplest) measurement setup.

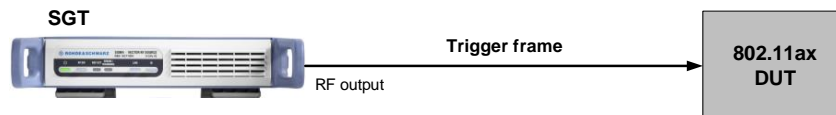

7.2.5 Residual Carrier frequency offset error

A STA needs to pre-compensate for carrier frequency offset (CFO) error to prevent inter-carrier interference between different participating STAs. After compensation, the absolute value of residual CFO error with respect to the trigger frame must be less than 350 Hz. The residual CFO error measurement is made at a received power of -60 dBm in the primary 20 MHz channel. The measurement takes place after the HE-SIG-A field in the HE trigger-based PPDU, e.g. during the HE-LTF.

For this test, a signal generator emulates the AP sending trigger frames. A 10 MHz reference frequency is shared between the signal generator and the measuring device – a spectrum analyzer. This way there is no frequency error between the signal generator and the spectrum analyzer. The residual CFO of the STA with respect to the signal generator, i.e. trigger frame, can therefore be measured precisely. The standard draft [1] specifies to do statistics over multiple CFO measurements. The measurement is made over multiple HE trigger-based PPDU packets (one CFO value per packet), and the complementary cumulative distribution function (CCDF) of measured CFO errors is calculated. At the 10 % point of the CCDF curve, the CFO error must be less than 350 Hz.

The measurement setup can be seen in section 7.3.

7.2.6 Timing accuracy

A STA participating in a HE trigger-based PPDU transmission needs to start transmission after a specified time interval SIFS after the end of the trigger frame. The STA under test must fulfill a timing accuracy of $\pm 0.4 \mu\text{s}$ for the SIFS, i.e. the transmission must start within a time period $\text{SIFS} \pm 0.4 \mu\text{s}$ after the end of the trigger frame.

For this test, a signal generator emulates the AP sending a trigger frame. Additionally, the signal generator sends a LVTTTL trigger signal to the measuring device – a spectrum analyzer. This LVTTTL trigger signal is sent synchronously with the end of the trigger frame. The spectrum analyzer is therefore triggered synchronously with the end of the trigger frame. By receiving and demodulating the HE trigger-based PPDU sent by the STA under test, the analyzer can precisely measure the time elapsed between the trigger / trigger frame and the start of the HE trigger-based PPDU transmission. The measured time minus the specified SIFS (i.e. 10 μ s in the 2.4 GHz and 16 μ s in the 5 GHz band) gives the timing error of the STA.

The measurement setup can be seen in section 7.3.

Since the trigger frame can be sent in different 802.11 (legacy) frame formats, the duration of the trigger frame can vary. It is therefore required to send a trigger signal at the end of the trigger frame, not at the beginning. On the signal generator, the following settings yield the needed trigger signal output.

- In the “Marker” tab, set the “Marker 1” to “Frame Inactive Part”.

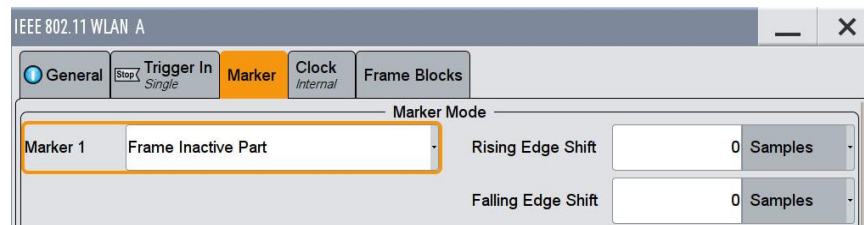

On the SMW and SGT, the Marker 1 signal is output per default at the “User 1” connector.

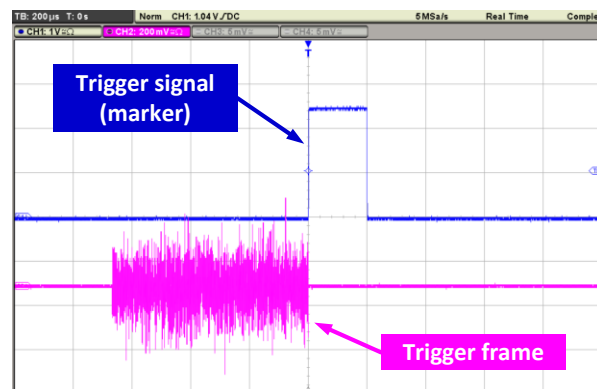

7.3 Measurement setup

The following figure shows the measurement setup for testing HE trigger-based PPDU transmit requirements according to the standard draft [1], section 28.3.14.

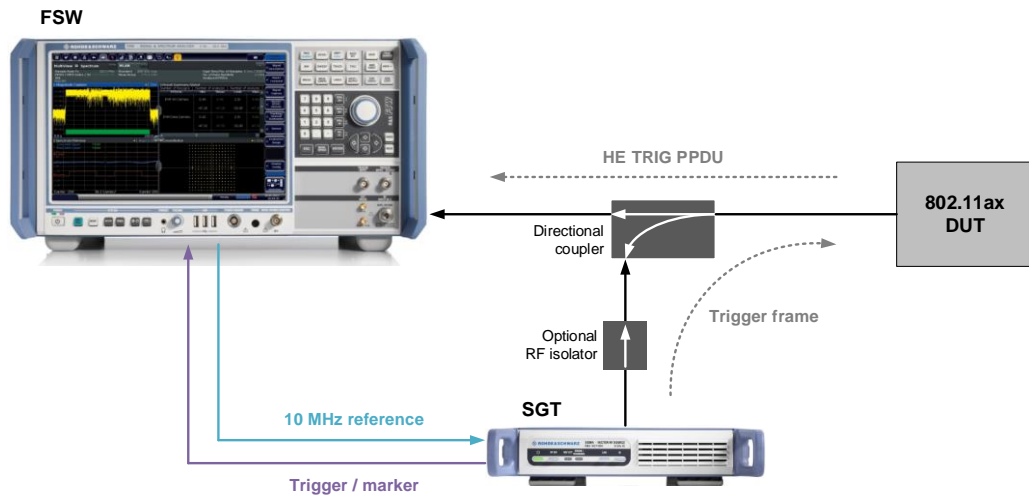

The SGT and FSW share a 10 MHz reference signal for frequency synchronization. The SGT sends a trigger frame to the STA under test. Additionally, the SGT provides a trigger signal to the FSW for time synchronization. The trigger signal marks the end of the trigger frame. The STA responds with sending a HE trigger-based frame. This signal is fed to the FSW for analysis. An RF directional coupler (e.g. a 9 dB coupler) is used to guide the signal flow. Since the coupler does not provide any isolation on its coupled port (used “wrong way” in this setup), an RF isolator (passive two-port device) is recommended when transmitting high power levels to protect the SGT from too much reverse power⁶. Directional couplers have the benefit of being available as broadband versions covering both, the 2.4 GHz and 5 GHz bands. RF circulators are an alternative choice in the above setup to guide the signal flow. However, their drawback is that broadband versions covering both frequency bands while offering high isolation are rarely available.

7.4 How to generate a trigger frame

The standard draft [1] defines various trigger frame variants. The signal generators support the “basic trigger variant”.

- In the “Frame Blocks” tab, select the standard (“Std.”).

Note that a trigger frame does not need to have the 802.11ax frame format but can also have another 802.11 (legacy) frame format. In fact, the trigger frame will likely be transmitted using a legacy format.

⁶ From the SGT datasheet: reverse power from 50 ohm (max. permissible RF power in output): 0.5 W

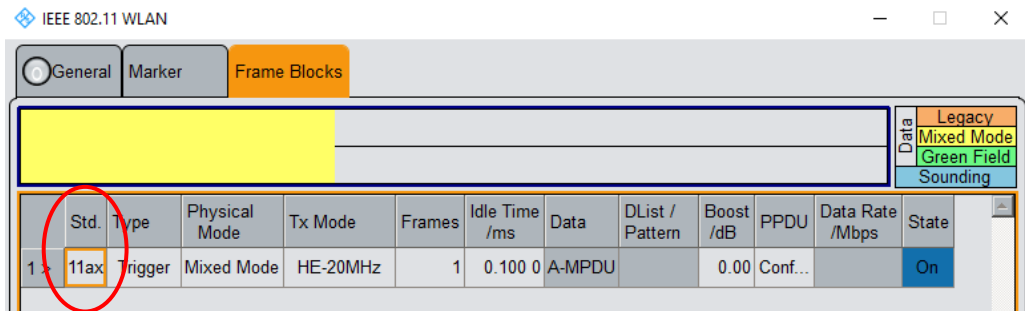

- ▶ Set the “Type” to “Trigger” in order to generate a trigger frame.

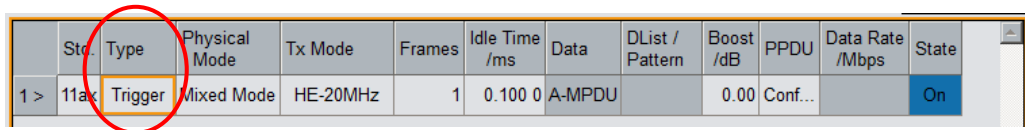

- ▶ Select the wanted channel bandwidth of the signal (“Tx Mode” column).
- ▶ Click “Conf...” in the “PPDU” column to open the PPDU configuration menu.
- ▶ Configure the PPDU settings as desired. (See also section 4.2.3 for details. The HE SU PPDU format is recommended for HE frames.)
- ▶ In the “MAC Header & FCS” tab, set the RA field as required.

The RA field of the trigger frame is the MAC address of the recipient STA.

- ▶ Configure the trigger frame settings as required, for example set the bandwidth (BW), RU allocation and MCS that the STA should use in the uplink trigger-based PPDU; set the target RSSI etc.

Please see the 802.11ax standard draft [1] for a description of the individual subfields and their encoding – in section “Trigger frame format”.

Note that the binary numbers in the “MAC Header & FCS” tab are LSB first! For example, a value of 111100000000 corresponds to 15 (decimal) not 3840 (decimal).

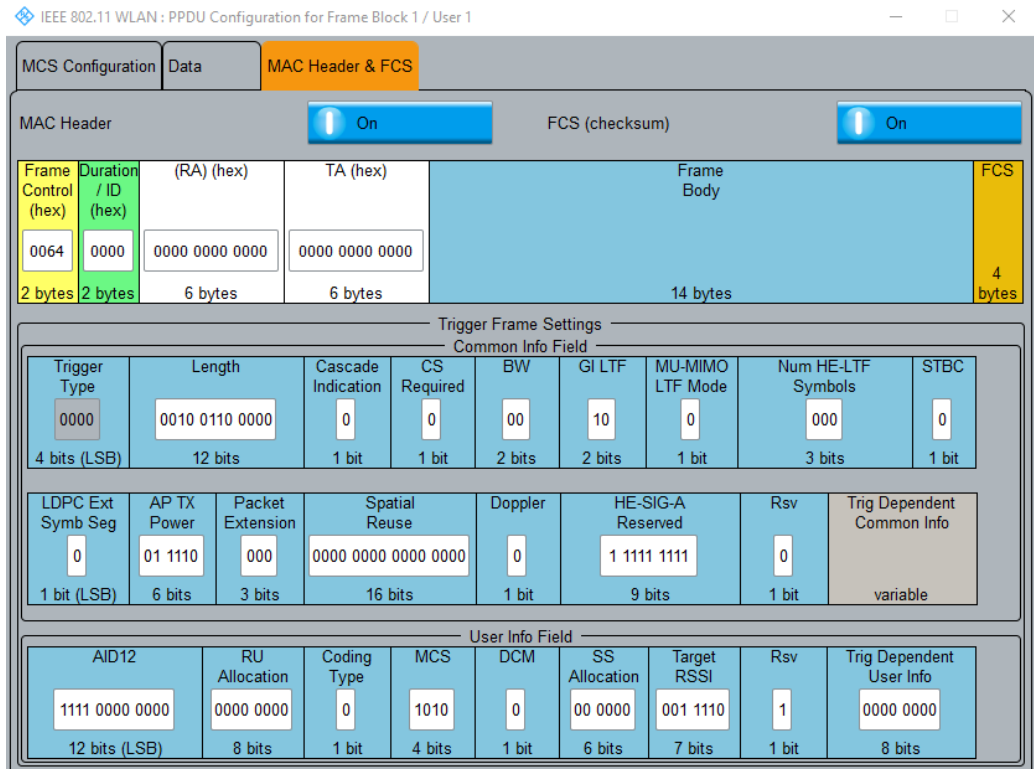

The trigger frame is a control frame. Its format is illustrated on the top of the “MAC Header & FCS” tab. The “Frame body” part of the trigger frame consists of the common info field and the user info field. Information contained in the common info field is the same for all participating MU STAs. Information contained in the user info field is specific to a particular MU STA. The user info field starts with the AID12 subfield to indicate the intended STA. The signal generators support one user info field, i.e. one recipient STA.

- ▶ Make sure that the AID12 subfield is set correctly. Otherwise the STA under test will not respond to the trigger frame with a HE TRIG PPDU transmission.

In real life, an AP assigns an association identifier (AID) to a STA during association. In a non-signaling test environment, there is no association and therefore no AID assigned. Consequently, the STA under test needs to be configured by a control software (generally provided by the manufacturer) to have a known AID.

To generate exactly one trigger frame, make the following settings:

- ▶ In the “Frame Blocks” tab, set one frame only (default).

	Std.	Type	Physical Mode	Tx Mode	Frames	Idle Time /ms	Data	DList / Pattern	Boost /dB	PPDU	Data Rate /Mbps	State
1 >	11ax	Trigger	Mixed Mode	HE-20MHz	1	0.100 0	A-MPDU		0.00	Conf...		On

- ▶ In the “Trigger In” tab⁷, set the trigger “Mode” to “Single”.

⁷ When working with the SGT, the trigger settings are done on the SGT, in the ARB menu.

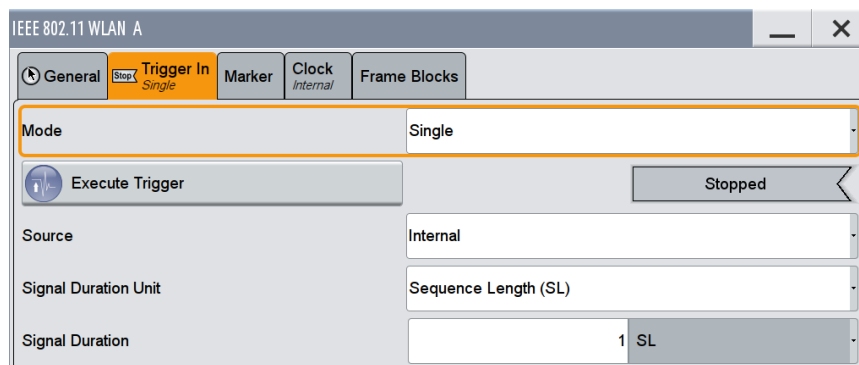

After executing the trigger, exactly one frame will be output and then the signal generations stops.

8 Generating 802.11ax MIMO Signals

The previous sections focused mainly on the SGT because this instrument is compact, cost-efficient and offers excellent signal performance. For MIMO signal generation where multiple antenna signals are needed, the SMW provides benefits which is why this section puts an increased focus on the SMW. The SMW gains in importance because it offers multiple basebands, multiple RF outputs (also external RF outputs via connected SGTs) and realtime fading simulation. However, the following sections 8.1 and 8.2 apply to all signal generators: SGT/WiniQSIM2, SMBV and SMW.

8.1 Introduction

There are two types of MIMO antenna signals: Tx signals and Rx signals as shown in the following figure.

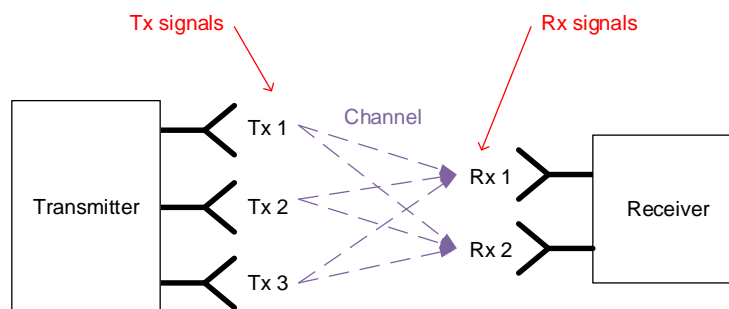

The signal generators can generate both types of signals. Tx signals are generated by default. However, it is also possible to generate Rx signals. An Rx signal consists of multiple (weighted) superimposed Tx signals. The weighting of Tx signals to form different Rx signals presents a very simplified, static channel emulation. It is supported by all signal generators (see section 8.2.3.3 for details). In contrast, true realtime channel simulation is only supported by the SMW. On the SMW, the Tx signals can be faded and added (to form Rx signals) by the fading modules (see section 8.3 for details).

The signal generators can generate up to eight 802.11ax Tx signals or Rx signals. Generating multiple Tx/Rx signals requires multiple instruments – one RF output per antenna signal. Please see section 3.2.3 for an overview about the possible MIMO setups.

8.2 How to configure an 802.11ax MIMO signal

This section applies to all signal generators (SGT/WiniQSIM2, SMBV and SMW); fading simulation is no subject.

8.2.1 System configuration

The “System Configuration” menu described in this section is specific to the SMW and not available on SGT/WiniQSIM2 and SMBV.

This section applies only to an SMW with two baseband generators and two RF outputs.

- ▶ Click on the “System Config” icon to open the “System Configuration” menu.

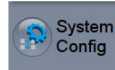

- ▶ In the “Fading/Baseband Config” tab, set the “Mode” parameter to “Advanced”.
- ▶ Set the “Basebands” parameter and the “Streams” parameter to “1” respectively.
- ▶ Set the “Entities” parameter to “2”.

Setting more than two entities is possible if the SMW is equipped with the SMW-K76 option. In this case, the user can set up to eight entities.

- ▶ On instruments equipped with SMW-K76, set the “Entities” parameter to the same value as the desired number of Tx antenna signals.
- ▶ Set the “BB Source Config” parameter to “Coupled Sources” and click the “OK” button.

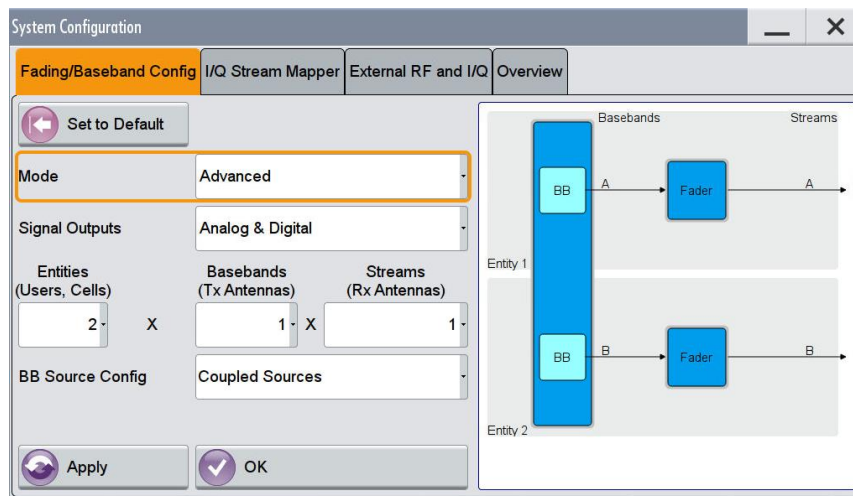

8.2.2 General settings

This and the following sections apply again to all signal generators: SGT/WiniQSIM2, SMBV and SMW.

- ▶ Click on the “Baseband” block and select “IEEE 802.11...” from the list.

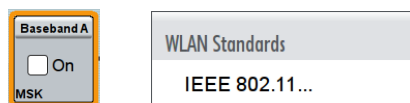

- First, select the transmission bandwidth, e.g. 160 MHz, in the “General” tab.

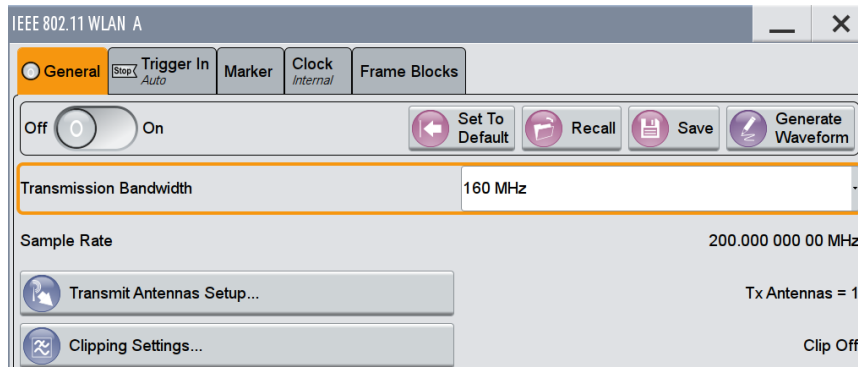

- Click on the “Transmit Antenna Setup” button to open the “Transmit Antenna Setup” menu.

8.2.3 Transmit Antennas Setup

- Set the “Antennas” parameter to the desired number of Tx antenna signals to be generated.

Up to eight Tx antenna signals are supported.



- Decide if a Tx signal or an Rx signal shall be generated by the baseband.

Per default, the baseband generates a Tx signal. The Tx signal can be routed directly to the RF output such that the RF signal corresponds to a Tx signal. On the SMW, Tx signals can also be routed to the fading modules (see section 8.3 for details). Alternatively, the baseband can generate an Rx signal. An Rx signal consists of multiple (weighted) superimposed Tx signals. It can be routed to the RF output such that the RF signal corresponds now to an Rx signal.

8.2.3.1 How to define Tx and Rx signals

Output	File	1 Real	1 Imag	2 Real	2 Imag	3 Real	3 Imag	4 Real	4 Imag	5 Real	5 Imag	6 Real	6 Imag	7 Real	7 Imag	8 Real	8 Imag	
O1	Baseband	1.00	0.00	0.00	0.00	0.00	0.00	0.00	0.00	0.00	0.00	0.00	0.00	0.00	0.00	0.00	0.00	Tx1
O2	File	ant2	0.00	0.00	1.00	0.00	0.00	0.00	0.00	0.00	0.00	0.00	0.00	0.00	0.00	0.00	0.00	Tx2
O3	File	ant3	0.00	0.00	0.00	0.00	1.00	0.00	0.00	0.00	0.00	0.00	0.00	0.00	0.00	0.00	0.00	Tx3
O4	File	ant4	0.00	0.00	0.00	0.00	0.00	0.00	1.00	0.00	0.00	0.00	0.00	0.00	0.00	0.00	0.00	Tx4
O5	File	ant5	0.00	0.00	0.00	0.00	0.00	0.00	0.00	1.00	0.00	0.00	0.00	0.00	0.00	0.00	0.00	Tx5
O6	File	ant6	0.00	0.00	0.00	0.00	0.00	0.00	0.00	0.00	1.00	0.00	0.00	0.00	0.00	0.00	0.00	Tx6
O7	File	ant7	0.00	0.00	0.00	0.00	0.00	0.00	0.00	0.00	0.00	0.00	1.00	0.00	0.00	0.00	0.00	Tx7
O8	File	ant8	0.00	0.00	0.00	0.00	0.00	0.00	0.00	0.00	0.00	0.00	0.00	0.00	0.00	1.00	0.00	Tx8

This menu is used to map the Tx antenna signals (Tx1 to Tx8 in the above screenshot) to the baseband output. The mapping determines if a single Tx signal or multiple superimposed Tx signals are present at the output of the baseband.

The Tx signals are mapped using simple matrix algebra: Multiplying the transmission matrix by the Tx input matrix gives the output matrix.

$$[\text{output matrix}] = [\text{transmission matrix}] \cdot [\text{Tx input matrix}]$$

Output	File	1 Real	1 Imag.	2 Real	2 Imag.	3 Real	3 Imag.	4 Real	4 Imag.	5 Real	5 Imag.	6 Real	6 Imag.	7 Real	7 Imag.	8 Real	8 Imag.		
O1	Baseband	1	W11	0.00	0	W12	0.00	0	W13	0.00	0	W14	0.00	0.00	0.00	0.00	0.00	0.00	Tx1
O2	File	ant2	0	W21	0.00	1	W22	0.00	0.00	0.00	0.00	0.00	0.00	0.00	0.00	0.00	0.00	0.00	Tx2
O3	File	ant3	0	W31	0.00	0.00	0.00	1.00	0.00	0.00	0.00	0.00	0.00	0.00	0.00	0.00	0.00	0.00	Tx3
O4	File	ant4	0	W41	0.00	0.00	0.00	0.00	1.00	0.00	0.00	0.00	0.00	0.00	0.00	0.00	0.00	0.00	Tx4
O5	File	ant5	0	W51	0.00	0.00	0.00	0.00	0.00	1.00	0.00	0.00	0.00	0.00	0.00	0.00	0.00	0.00	Tx5
O6	File	ant6	0	W61	0.00	0.00	0.00	0.00	0.00	0.00	1.00	0.00	0.00	0.00	0.00	0.00	0.00	0.00	Tx6
O7	File	ant7	0	W71	0.00	0.00	0.00	0.00	0.00	0.00	0.00	1.00	0.00	0.00	0.00	0.00	0.00	0.00	Tx7
O8	File	ant8	0	W81	0.00	0.00	0.00	0.00	0.00	0.00	0.00	0.00	0.00	0.00	0.00	1	W88	0.00	Tx8

output matrix
transmission matrix
Tx input matrix

This method gives the following possible output signals (O1 to O8):

$$\begin{aligned}
 O1 &= w_{11} \cdot Tx1 + w_{12} \cdot Tx2 + w_{13} \cdot Tx3 + w_{14} \cdot Tx4 + w_{15} \cdot Tx5 + w_{16} \cdot Tx6 + w_{17} \cdot Tx7 + w_{18} \cdot Tx8 \\
 O2 &= w_{21} \cdot Tx1 + w_{22} \cdot Tx2 + w_{23} \cdot Tx3 + w_{24} \cdot Tx4 + w_{25} \cdot Tx5 + w_{26} \cdot Tx6 + w_{27} \cdot Tx7 + w_{28} \cdot Tx8 \\
 O3 &= w_{31} \cdot Tx1 + w_{32} \cdot Tx2 + w_{33} \cdot Tx3 + w_{34} \cdot Tx4 + w_{35} \cdot Tx5 + w_{36} \cdot Tx6 + w_{37} \cdot Tx7 + w_{38} \cdot Tx8 \\
 &\dots \\
 O8 &= w_{81} \cdot Tx1 + w_{82} \cdot Tx2 + w_{83} \cdot Tx3 + w_{84} \cdot Tx4 + w_{85} \cdot Tx5 + w_{86} \cdot Tx6 + w_{87} \cdot Tx7 + w_{88} \cdot Tx8
 \end{aligned}$$

The elements of the transmission matrix (i.e. complex numbers $w_{11}, w_{12}, \dots, w_{88}$) can be used to weight the Tx signals individually for each output signal (O1 to O8). Generally, one output signal can be routed to the baseband output, the others can be saved to a file. Per default, the output signal O1 is routed to the baseband output (also in the WinIQSIM2 GUI).

Output	File
O1	Baseband A
O2	File ant2

Output signals routed to “File” are saved to the hard drive under the specified file path and name. The saved files can be transferred to another instrument for play back via its ARB generator.

There is one exception: an SMW equipped with multiple basebands. On such an instrument, the output signals (O1 to O8) can be routed to the other baseband outputs (up to eight with SMW-K76 option).

	Output	File
O1	Baseband A	
O2	Baseband B	
O3	Baseband C	
O4	Baseband D	
O5	Baseband E	
O6	Baseband F	
O7	Baseband G	
O8	Baseband H	

8.2.3.2 Generating Tx antenna signals

By default, the diagonal elements of the transmission matrix ($w_{11}, w_{22}, \dots, w_{88}$) are set to 1, while all other matrix elements are set to 0.

	Output	File	1 Real	1 Imag.	2 Real	2 Imag.	3 Real	3 Imag.	4 Real	4 Imag.	5 Real	5 Imag.	6 Real	6 Imag.	7 Real	7 Imag.	8 Real	8 Imag.	
O1	Baseband		1.00	0.00	0.00	0.00	0.00	0.00	0.00	0.00	0.00	0.00	0.00	0.00	0.00	0.00	0.00	0.00	Tx1
O2	File	ant2	0.00	0.00	1.00	0.00	0.00	0.00	0.00	0.00	0.00	0.00	0.00	0.00	0.00	0.00	0.00	0.00	Tx2
O3	File	ant3	0.00	0.00	0.00	0.00	1.00	0.00	0.00	0.00	0.00	0.00	0.00	0.00	0.00	0.00	0.00	0.00	Tx3
O4	File	ant4	0.00	0.00	0.00	0.00	0.00	0.00	1.00	0.00	0.00	0.00	0.00	0.00	0.00	0.00	0.00	0.00	Tx4
O5	File	ant5	0.00	0.00	0.00	0.00	0.00	0.00	0.00	0.00	1.00	0.00	0.00	0.00	0.00	0.00	0.00	0.00	Tx5
O6	File	ant6	0.00	0.00	0.00	0.00	0.00	0.00	0.00	0.00	0.00	0.00	1.00	0.00	0.00	0.00	0.00	0.00	Tx6
O7	File	ant7	0.00	0.00	0.00	0.00	0.00	0.00	0.00	0.00	0.00	0.00	0.00	0.00	1.00	0.00	0.00	0.00	Tx7
O8	File	ant8	0.00	0.00	0.00	0.00	0.00	0.00	0.00	0.00	0.00	0.00	0.00	0.00	0.00	0.00	1.00	0.00	Tx8

In this case, the above formulas reduce to

- O1 = Tx1
- O2 = Tx2
- O3 = Tx3
- ...
- O8 = Tx8

- ▶ Route one of these Tx signals to the baseband output by selecting “Baseband” as output.
- ▶ Optionally, save the remaining Tx signals to files by selecting “File” as output.

The saved waveform files (*.vv) can be played back via the ARB generators of further instruments. For example, eight SGTs can be used to generate eight Tx signals (Tx1 to Tx8), where each SGT plays back one of the generated files.

For example, if an SMW with two basebands and two RF outputs is used, one more Tx signal can be routed to the second baseband output by selecting “Baseband B” as output. Provided that no MIMO fading is applied, the RF signals will correspond to two Tx signals that can be transmitted over the air to the DUT.

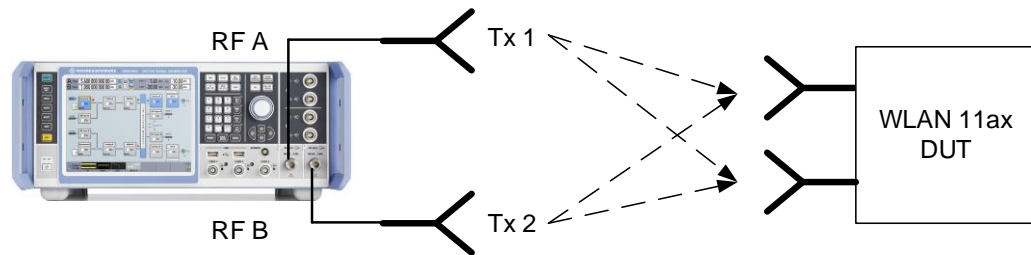

8.2.3.3 Generating Rx antenna signals

In MIMO systems with transmit diversity or spatial multiplexing, the receiver sees a superposition of the Tx signals at its antennas. Such a composite signal is termed Rx signal (see also section 8.1).

The user can set up Rx signals as a weighted combination (amplitude and phase) of up to eight Tx signals. Although, static weighting of Tx signals is not equivalent to time-varying statistical channel simulation, static weighting may be sufficient for basic diversity and MIMO receiver testing. (For more demanding MIMO tests with true channel emulation, a realtime MIMO fading simulator is required. Please see section 8.3 for details.)

- Combine the Tx signals by setting the elements of the transmission matrix (w_{11} , w_{12} , ..., w_{88}).

In the following example, four Tx antennas are used and only amplitude weighting is considered.

IEEE 802.11 WLAN: Transmit Antennas Setup

Antennas 4 Mapping Coordinates Cylindrical

	Output	File	1 Magn	1 Phase	2 Magn	2 Phase	3 Magn	3 Phase	4 Magn	4 Phase	
O1	Baseband		1.00	0.00	1.00	0.00	1.00	0.00	1.00	0.00	Tx1
O2	Off		1.00	0.00	1.00	0.00	1.00	0.00	1.00	0.00	Tx2
O3	Off		1.00	0.00	1.00	0.00	1.00	0.00	1.00	0.00	Tx3
O4	Off		1.00	0.00	1.00	0.00	1.00	0.00	1.00	0.00	Tx4

If all matrix elements are set to 1 (no weighting), the above formulas give the following output signals (O1 to O4). The signals Rx1 to Rx4 are all equal:

$$\begin{aligned} O1 &= Tx1 + Tx2 + Tx3 + Tx4 = Rx1 \\ O2 &= Tx1 + Tx2 + Tx3 + Tx4 = Rx2 \\ O3 &= Tx1 + Tx2 + Tx3 + Tx4 = Rx3 \\ O4 &= Tx1 + Tx2 + Tx3 + Tx4 = Rx4 \end{aligned}$$

If the matrix elements are set to values different than 1 (weighting), the above formulas give the following output signals (O1 to O4). The signals Rx1 to Rx4 may differ:

Example:

$$\begin{aligned} O1 &= Tx1 + 0.5 \cdot Tx2 + Tx3 + 0.5 \cdot Tx4 = Rx1 \\ O2 &= 0.8 \cdot Tx1 + Tx2 + 0.2 \cdot Tx3 + Tx4 = Rx2 \end{aligned}$$

$$O3 = 0.7 \cdot Tx1 + 0.5 \cdot Tx2 + 0.4 \cdot Tx3 + Tx4 = Rx3$$

$$O4 = 0.2 \cdot Tx1 + Tx2 + 0.8 \cdot Tx3 + 0.6 \cdot Tx4 = Rx4$$

In this example, signal Rx1 corresponds to a situation where signals Tx1 and Tx3 reach the Rx antenna with full signal strength while signals Tx2 and Tx4 are received with only half of the signal level.

- ▶ Route one of these Rx signals to the baseband output by selecting “Baseband” as output.
- ▶ Optionally, save the remaining Rx signals to files by selecting “File” as output.

The saved waveform files (*.vv) can be played back via the ARB generators of further instruments. For example, eight SGTs can be used to generate eight Rx signals (Rx1 to Rx8), where each SGT plays back one of the generated files.

For example, if an SMW with two basebands and two RF outputs is used, one more Rx signal can be routed to the second baseband output by selecting “Baseband B” as output. The RF signals will correspond to two Rx signals that can be fed to the DUT via cable.

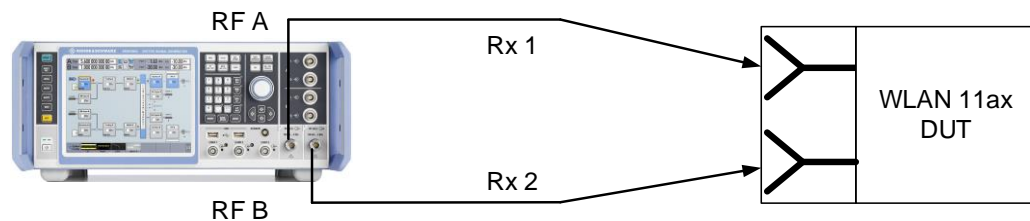

8.2.4 Frame Blocks

See section 4.2.2

8.2.5 PPDU Configuration

- ▶ Click “Conf...” in the “PPDU” column of the frame blocks table to open the PPDU configuration menu.

The PPDU configuration menu has three tabs:

- “General” tab
- “User Configuration” tab
- “Spatial Mapping” tab

8.2.5.1 PDU “General” tab

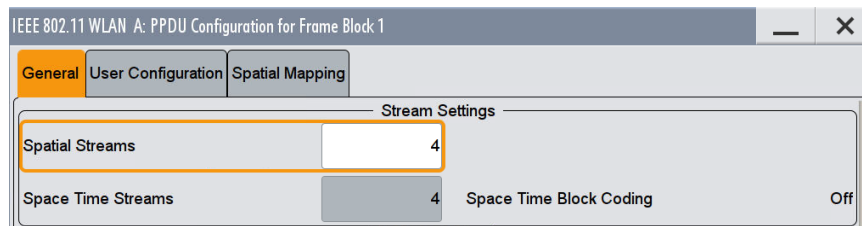

- Select the number of spatial streams (Nss).

The maximum number that can be selected depends on the set number of Tx antennas (configured in section 8.2.3).

Space time block coding (STBC) is an optional feature in 802.11ax and it is only defined for a single spatial stream (Nss=1). For Nss = 1, the “Space Time Streams” parameter can be edited. If the user sets the number of space time streams (Nsts) to “2”, STBC is automatically applied. More than 2 Nsts are not defined for STBC [1]. For Nss > 1, STBC is also not defined. The “Space Time Streams” parameter is therefore read only and automatically set to the value of Nss. The number of space time streams (Nsts) can be configured later in the “User Configuration” tab.

- Follow the instructions given in section 4.2.3.1 to configure the rest of the parameters in the “General” tab.

8.2.5.2 PDU “User Configuration” tab

The settable parameters depend on the selected PDU format:

HE SU PDU format

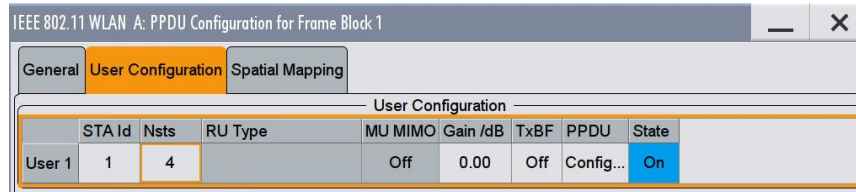

- Follow the instructions given in section 4.2.3.2.

Note that the “Nsts” parameter has been adjusted automatically according to the selection made in the “General” tab. For the HE SU format, there is no need to adjust this value.

HE MU PDU format

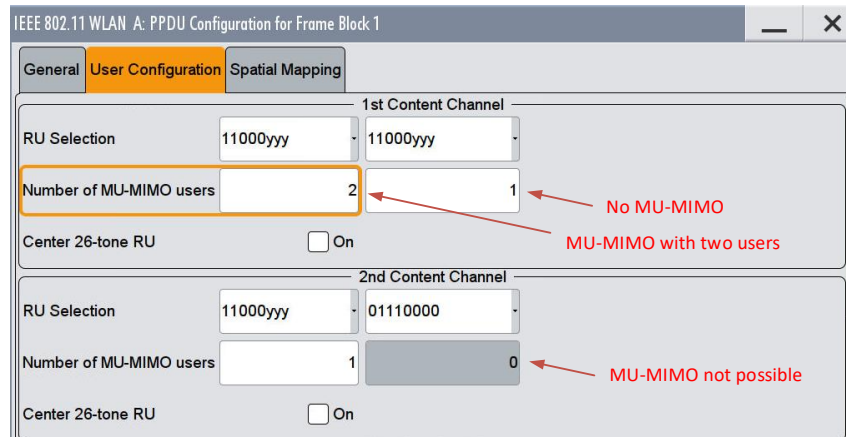

- Choose the RU allocation by setting the parameters “RU Selection”.

MU-MIMO transmissions are supported for RU sizes greater than or equal to 106 tones [1]. If the user chooses an RU allocation that includes such an RU size, the parameter “Number of MU-MIMO users” is editable. If the selected RU allocation does not include such an RU size, the parameter “Number of MU-MIMO users” will indicate “0”.

- To get MU-MIMO, set the “RU Selection” parameter to a value containing “yyy” such as 11000yyy.
- Adjust the parameters “Number of MU-MIMO users”. To get MU-MIMO, set a value greater than 1.

User Configuration									
	STA Id	Nsts	RU Type	MU MIMO	Gain /dB	TxBF	PPDU	State	
User 1	1	3	242-subc	On	0.00	Off	Config...	On] RU allocation 11000yyy] MU-MIMO with two users
User 2	1	1	242-subc	On	0.00	Off	Config...	On	
User 3	1	4	242-subc	Off	0.00	Off	Config...	On] RU allocation 11000yyy] RU allocation 11000yyy
User 4	1	4	242-subc	Off	0.00	Off	Config...	On	
User 5	1	4	52-subc	Off	0.00	Off	Config...	On] RU allocation 01110000
User 6	1	4	52-subc	Off	0.00	Off	Config...	On	
User 7	1	4	52-subc	Off	0.00	Off	Config...	On	
User 8	1	4	52-subc	Off	0.00	Off	Config...	On	

- For each user, adjust the user-specific parameters as required, e.g. set the station identifier (STA-ID).

The MU-MIMO users belonging to one RU (user 1 and 2 in the above example screenshot) need to share the available space time streams (4 in this example - user 1 uses three space times streams, user 2 uses one).

- For each MU-MIMO user, adjust the “Nsts” parameter. Note that Nsts cannot exceed 4 (according to [1]).

Note that for all non-MIMO users, there is no need to adjust the parameter “Nsts”. It is adjusted automatically according to the selection made in the “General” tab.

- For each user, click “Config...” in the “PPDU” column of the table to open the PDU configuration menu for the respective user. (Continued in section 8.2.5.3).

HE SU EXT PDU format – 20 MHz channel only

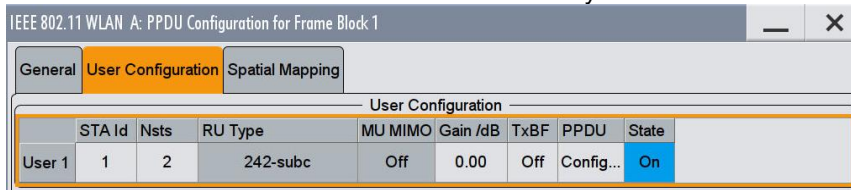

The HE SU EXT format uses only one spatial stream (according to [1]). STBC is possible.

- ▶ Follow the instructions given in section 4.2.3.2.

Note that the “Nsts” parameter has been adjusted automatically according to the selection made in the “General” tab. For the HE SU EXT format, there is no need to adjust this value.

HE TRIG PDU format – Uplink only

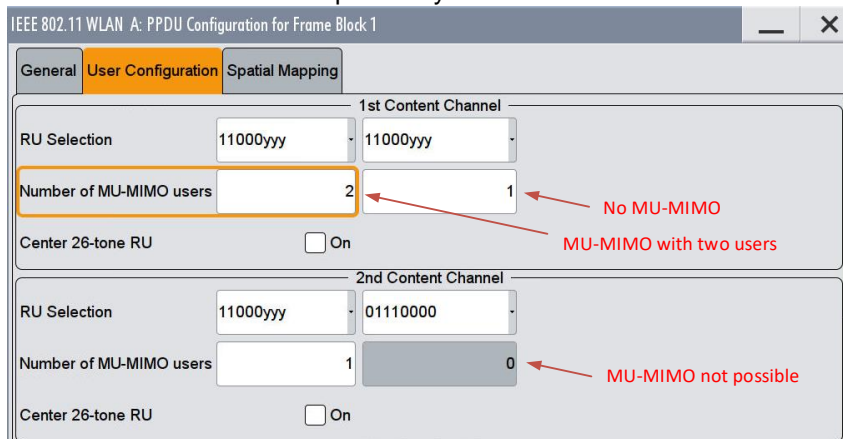

- ▶ Choose the RU allocation by setting the parameters “RU Selection”.
- ▶ To get MU-MIMO, set the “RU Selection” parameter to a value containing “yyy” such as 11000yyy.
- ▶ Adjust the parameters “Number of MU-MIMO users”. To get MU-MIMO, set a value greater than 1.

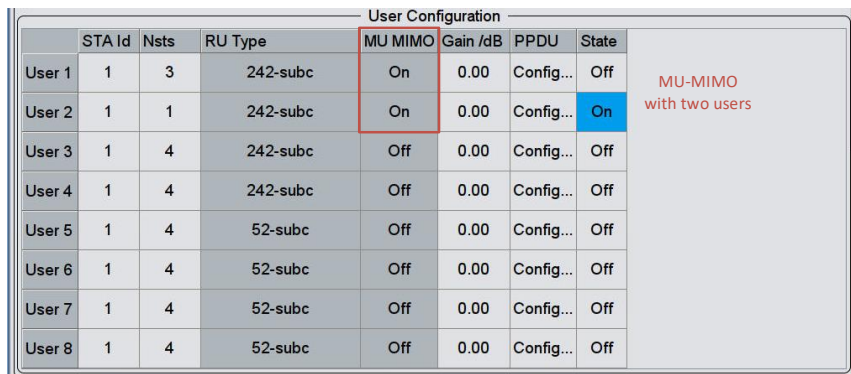

- ▶ Select the user that shall be generated by setting its “State” to “On”.

Note that only one user can be selected. If multiple users shall be generated simultaneously by the SMW, use the HE MU PPDU format described above.

- ▶ For the selected user, adjust the user-specific parameters as required, e.g. set the station identifier (STA-ID).
- ▶ If the selected user is a MU-MIMO user, adjust the “Nsts” parameter. Note that Nsts cannot exceed 4 (according to [1]).

If the selected user is not a MU-MIMO user, then there is no need to adjust the parameter “Nsts”. It is adjusted automatically according to the selection made in the “General” tab.

- ▶ For the selected user, click “Config...” in the “PPDU” column of the table to open the PPDU configuration menu for this user. (Continued in section 8.2.5.3).

8.2.5.3 PPDU “User Configuration” continued

See section 4.2.3.3.

8.2.5.4 PPDU “Spatial Mapping” tab

See also section 4.2.3.4 for a more detailed description.

- ▶ Select the spatial mapping mode: “Direct”, “Indirect” or “Expansion”.

The available choices depend on the number of space time streams and the number of Tx antennas. Note that the shown matrix (consisting of the elements marked in blue) is read-only.

The following figure shows an example of the spatial mapping matrix when four space time streams are mapped to eight Tx antennas by means of spatial expansion.

IEEE 802.11 WLAN A: PDU Configuration for Frame Block 1

General User Configuration **Spatial Mapping**

Mode Expansion

Space time streams

1 2 3 4 Transmit Matrix

Index k 20

		1	2	3	4							
Tx antenna signals	1	Time Shift 1	0 ns	1.00	1.00	1.00	1.00	1.00	1.00	1.00	1.00	1.00
	2	Time Shift 2	0 ns	-1.00	1.00	-1.00	1.00	-1.00	1.00	-1.00	1.00	1.00
	3	Time Shift 3	0 ns	-1.00	-1.00	1.00	1.00	-1.00	-1.00	1.00	1.00	1.00
	4	Time Shift 4	0 ns	1.00	-1.00	-1.00	1.00	1.00	-1.00	-1.00	1.00	1.00
	5	Time Shift 5	0 ns	-1.00	-1.00	-1.00	-1.00	1.00	1.00	1.00	1.00	1.00
	6	Time Shift 6	0 ns	1.00	-1.00	1.00	-1.00	-1.00	1.00	-1.00	1.00	1.00
	7	Time Shift 7	0 ns	1.00	1.00	-1.00	-1.00	-1.00	-1.00	1.00	1.00	1.00
	8	Time Shift 8	0 ns	-1.00	1.00	1.00	-1.00	1.00	-1.00	-1.00	1.00	1.00

- If required, set a time delay for the individual Tx antenna signals by adjusting the “Time Shift” parameters.

8.3 Realtime channel simulation on SMW

This section applies to the SMW only.

By introducing features like OFDMA, multi-user MIMO and increased outdoor operation, 802.11ax approaches cellular digital standards such as the 3GPP standards. As a consequence, some of the 802.11ax use cases approach those of traditional cellular systems and with it also the necessary test cases for those use cases. For example, testing under realistic outdoor fading conditions becomes more important for 802.11ax. For 3GPP standards, realtime channel simulation is common for testing outdoor scenarios with standardized channel models like 3GPP Urban Micro (UMi). 802.11ax will adapt to this kind of testing.

The SMW offers unique channel simulation capabilities. It can be equipped with fading modules to support MIMO scenarios with true channel simulation in realtime.

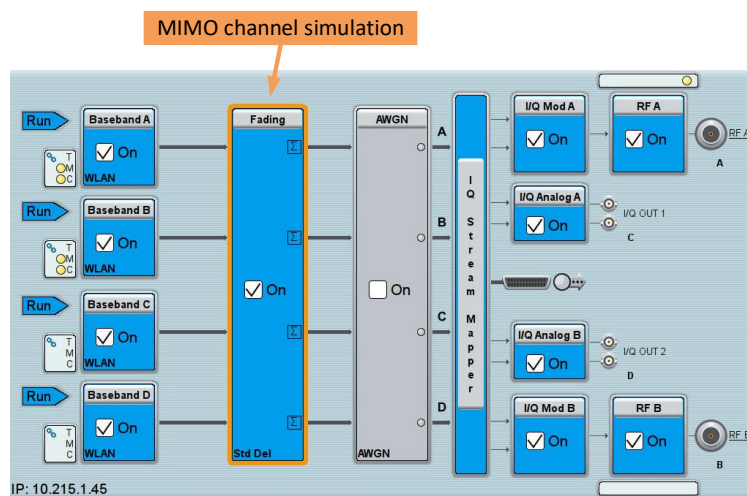

The input to the fading modules are Tx signals, the output signals are digitally realtime faded Rx signals.

The fading modules support MIMO scenarios up to 8x4 and 4x8. Please see the SMW data sheet for details (available at www.rohde-schwarz.com/brochure-datasheet/smw200a).

802.11ax considers two channel models:

- Spatial channel model (SCM)
- Path loss model

SCM

Indoor

The TGn and TGac spatial channel models (models A to F) are adopted as 802.11ax indoor channel models [4].

Outdoor

3GPP Urban Micro (UMi) and Urban Macro (UMa) channel models are used as the baseline of 802.11ax outdoor channel models [4]. UMi spatial channel models are chosen as the first choice of outdoor channel models while UMa spatial channel models serve as complementary models.

There is a need to expand the UMi and Uma spatial channel models to support 160 MHz bandwidth.

Path loss model

Indoor

The TGn path loss models (models B and D) are adopted as 802.11ax indoor path loss model [4]. Extra floor penetration loss and wall penetration loss shall be added to this path loss.

Outdoor

The 802.11ax outdoor path loss models are based on the 3GPP Urban Micro (UMi) path loss model.

Outdoor-to-indoor

For an outdoor-to-indoor scenario (non-line-of-sight only), building wall penetration loss and indoor path loss need to be added [4] to the outdoor path loss.

The SMW supports the TGn channel models A to F defined in the IEEE 802.11-03/940r4 document [6] for 802.11n and 802.11ac (≤ 40 MHz) as predefined settings – for MIMO configurations up to 4x4.

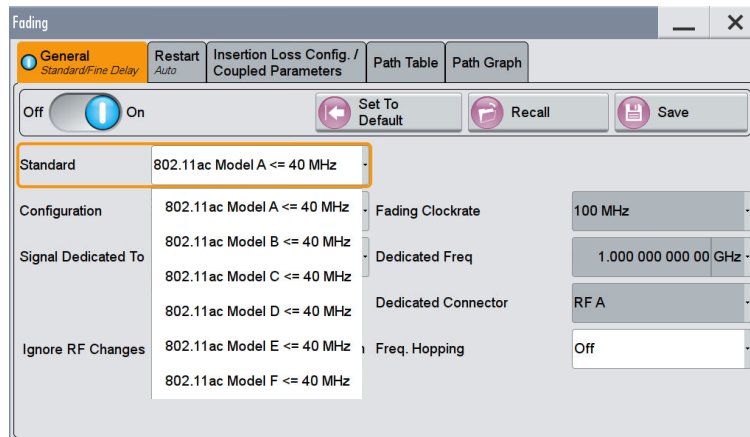

Many parameters such as antenna distance, angular spread, etc. can be flexibly adjusted by the user to create custom settings.

Furthermore, the SMW supports 3GPP UMi and UMa channel models for the 2x2 MIMO configuration as predefined settings – up to 160 MHz bandwidth.

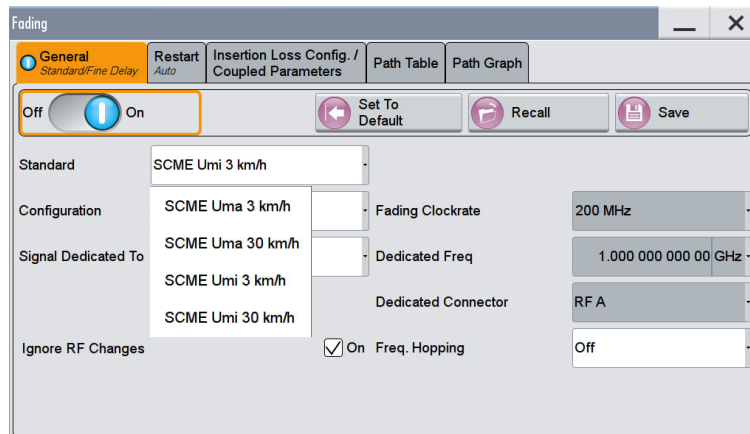

Again, many parameters such as the speed of the STA, angle of arrival/departure, etc. can be flexibly adjusted by the user to create custom settings – also for MIMO configurations other than 2x2.

9 Abbreviations

ACR	Adjacent channel rejection
A-MPDU	Aggregated MAC protocol data unit
AP	(WLAN) access point
ARB	Arbitrary waveform generator
BCC	Binary convolution coding
CSD	Cyclic shift delay
DCM	Dual sub-carrier modulation
DL	Downlink
DUT	Device under test
EVM	Error vector magnitude
FCS	frame check sequence
FEC	Forward error correction
GUI	Graphical user interface
HE	High efficiency
I/Q	In-phase/quadrature
LDPC	Low density parity check
MAC	Media access control
MIMO	Multiple input multiple output
MU	Multi user
MCS	Modulation and coding scheme
Nss	Number of spatial streams
Nsts	Number of space time streams
OFDM	Orthogonal frequency-division multiplexing
PER	Packet error rate
PHY	Physical layer
PLCP	Physical layer convergence protocol
PPDU	PLCP protocol data unit
PSDU	Physical layer service data unit
RF	Radio frequency
RSSI	Received signal strength indicator
RU	Resource unit
Rx	Receive
SCM	Spatial channel model
SIFS	Short interframe space
SISO	Single input single output
SU	Single user
STA	(WLAN) station
STBC	Space time block coding
TGac	Task group 802.11ac
TGn	Task group 802.11n
LVTTL	low-voltage transistor–transistor logic
Tx	Transmit
UL	Uplink
WLAN	Wireless local area network

10 References

- [1] IEEE 802, IEEE P802.11ax/D1.3 specification draft, June 2017
- [2] Rohde & Schwarz White Paper, “IEEE 802.11ax Technology Introduction” (1MA222)
- [3] Rohde & Schwarz Application Note, “Time Synchronous Signals with Multiple R&S®SMBV100A Vector Signal Generators” (1GP84)
- [4] IEEE 802, IEEE 802.11ax Channel Model Document, IEEE 802.11-14/0882r4, September 2014
- [5] Rohde & Schwarz Application Note, “Higher Order MIMO Testing with the R&S®SMW200A Vector Signal Generator” (1GP97)
- [6] IEEE 802, IEEE 802.11-03/940r4 “TGn Channel Models” document.
See: https://mentor.ieee.org/802.11/documents?is_dcn=940

11 Ordering Information

Please visit the Rohde & Schwarz product websites at www.rohde-schwarz.com for comprehensive ordering information on the following Rohde & Schwarz signal generators:

- R&S®SMW200A vector signal generator
- R&S®SMBV100A vector signal generator
- R&S®SGT100A SGMA vector RF source

About Rohde & Schwarz

Rohde & Schwarz is an independent group of companies specializing in electronics. It is a leading supplier of solutions in the fields of test and measurement, broadcasting, radiomonitoring and radiolocation, as well as secure communications. Established more than 75 years ago, Rohde & Schwarz has a global presence and a dedicated service network in over 70 countries. Company headquarters are in Munich, Germany.

Environmental commitment

- Energy-efficient products
- Continuous improvement in environmental sustainability
- ISO 14001-certified environmental management system



Regional contact

Europe, Africa, Middle East

+49 89 4129 12345

customersupport@rohde-schwarz.com

North America

1-888-TEST-RSA (1-888-837-8772)

customer.support@rsa.rohde-schwarz.com

Latin America

+1-410-910-7988

customersupport.la@rohde-schwarz.com

Asia/Pacific

+65 65 13 04 88

customersupport.asia@rohde-schwarz.com

China

+86-800-810-8228 /+86-400-650-5896

customersupport.china@rohde-schwarz.com

This application note and the supplied programs may only be used subject to the conditions of use set forth in the download area of the Rohde & Schwarz website.

R&S® is a registered trademark of Rohde & Schwarz GmbH & Co. KG; Trade names are trademarks of the owners.

Rohde & Schwarz GmbH & Co. KG

Mühlhofstraße 15 | D - 81671 München

Phone + 49 89 4129 - 0 | Fax + 49 89 4129 - 13777

www.rohde-schwarz.com