

Guidelines for MIMO Test Setups – Part 1

Application Note

Products:

- | R&S®SMBV100A
- | R&S®WinIQSIM2™

Multiple antenna systems, known as MIMO systems, form an essential part of today's wireless communications standards. This multi-antenna technology efficiently boosts the data throughput without requiring additional bandwidth, and has thus become a key technology. Rohde & Schwarz offers high-performance MIMO test solutions which provide static conditions without fading as well as simulation of complex fading scenarios.

This application note explains how to set up 4x4 and 8x8 MIMO systems using the R&S®SMBV100A signal generator for measurements under static conditions.

Table of Contents

1	Introductory Note	5
2	Overview	5
3	Brief Introduction to MIMO	7
3.1	Fading	7
3.2	MIMO Systems	8
3.3	Testing MIMO Systems	9
4	4x4 MIMO	12
4.1	Setup	12
4.2	Synchronizing the Generators	13
4.2.1	Cabling.....	14
4.2.2	Instrument Settings	15
4.3	Tx Signal Generation.....	17
4.3.1	Tx Signal Generation via Internal Options	17
4.3.1.1	LTE	17
4.3.1.2	WiMAX™	18
4.3.1.3	WLANn	19
4.3.2	Tx Signal Generation via ARB	20
4.4	Rx Signal Generation	20
4.4.1	Rx Signal Generation via Internal Option: WLANn	20
4.4.2	Rx Signal Generation via ARB.....	22
4.4.2.1	Unweighted Addition.....	23
4.4.2.2	Weighted Addition	24
4.5	AWGN.....	25
5	8x8 MIMO	26
5.1	Setup	26
5.2	Tx Signal Generation via ARB	27
5.3	Rx Signal Generation via ARB.....	27
5.3.1	Unweighted Addition	28
5.3.2	Weighted Addition	28
6	Phase-Coherent Signals	29

6.1	Setup	30
6.2	Phase Calibration and Time Alignment	31
6.2.1	Phase Calibration.....	31
6.2.2	Time Alignment	32
7	Summary	35
8	Abbreviations	35
9	Ordering Information	36

1 Introductory Note

This application note is part 1 of a pair of application notes.

- Part 1 (i.e. this application note) describes how to set up Rohde & Schwarz signal generators for MIMO scenarios without fading: “Guidelines for MIMO Test Setups – Part 1” (1GP50)
- Part 2 describes how to set up Rohde & Schwarz signal generators for MIMO scenarios with realtime fading: “Guidelines for MIMO Test Setups – Part 2” (1GP51)

The following abbreviations are used in this application note for Rohde & Schwarz test equipment:

- The R&S[®] SMBV100A vector signal generator is referred to as SMBV.
- The R&S[®] WinIQSIM2[™] simulation software is referred to as WinIQSIM2.

2 Overview

Frequency bandwidth is a limited resource. To make best use of it, today's wireless communications standards implement multiple antennas at the transmitter and receiver end. This multi-antenna technology is termed MIMO (multiple input, multiple output). MIMO efficiently increases the data throughput without requiring additional bandwidth or transmit power. MIMO is used in mobile communications (LTE, HSPA+) as well as in wireless local area networks (WLANn) and regional radio networks (WiMAX[™]). For these digital standards, the Rohde & Schwarz vector signal generators support MIMO precoding (i.e. distribution of the data onto the transmitters using spatial coding algorithms). The options for 3GPP LTE, 3GPP HSPA+, WiMAX[™] and WLAN 802.11n make it possible to generate standard-compliant MIMO (and SISO) signals.

An NxM MIMO system, consisting of N transmit and M receive antennas, involves NxM fading channels, since there is one channel from each transmitting to each receiving antenna. The higher the statistical independence of the channel characteristics, the better the achievable data transfer rate. However, under real operating conditions, the channel characteristics are generally not independent of each other. For example, the geometric arrangement of the antennas introduces a certain degree of correlation. Therefore, to achieve a realistic emulation of the transmission path, a MIMO fading simulator must account for the correlations of the individual fading channels.

Although simulation of the fading channels is absolutely essential for testing under real-world conditions, it involves a certain degree of complexity, which may be unnecessary for some (e.g. early-stage) measurements. Often, less complex test solutions without simulated fading are sufficient – for example to verify that the decoding and demodulation algorithms in a receiver work properly under ideal channel conditions. Rohde & Schwarz offers high-performance test solutions in both fields of application – for MIMO measurements with and without fading. The R&S[®]SMU200A or R&S[®]AMU200A signal generators can be used during all stages of device testing. They can be used for early-stage measurements without fading, as well as for simulating complex MIMO fading scenarios. If fading simulation is not a requirement for device testing, then the SMBV signal generator is ideally suited for setting up a MIMO test system. A test system consisting of several SMBVs is a cost-efficient solution which provides highly synchronized test signals for very accurate and repeatable measurements on devices under test.

Therefore, this application note focuses on MIMO test setups using SMBV signal generators. The setups for 4x4 and 8x8 MIMO and synchronization of the generators are described in detail (sections 4 and 5). Furthermore, this application note explains how to generate standard-compliant MIMO transmitter signals (section 4.3) as well as MIMO receiver signals (section 4.4). The term “MIMO receiver signals” refers to a weighted combination of the transmitter signals as seen by the MIMO receiver under static conditions without fading. Section 6 of this application note describes how to generate multiple phase-coherent RF signals.

While this application note covers MIMO test setups without fading, the separate application note “Guidelines for MIMO Test Setups – Part 2” (1GP51) describes how to set up the R&S[®]SMU200A or R&S[®]AMU200A signal generators for MIMO scenarios with realtime fading.

Besides this pair of application notes, several other MIMO-related application notes can be downloaded from the Rohde & Schwarz website:

- “Introduction to MIMO” (1MA142) covers the basics of the MIMO technology including data precoding, spatial diversity, spatial multiplexing and beamforming.
- “Phase Adjustment of Two MIMO Signal Sources with Option B90” (1GP67) explains how to adjust the RF phases of two or more signal generators and provides the PhaseTracker PC software, which makes it possible to achieve optimal phase coherence/alignment.
- “LTE Downlink MIMO (2x2) with R&S[®]SMU200A and R&S[®]FSQ” (1MA143) describes how to perform tests on LTE MIMO signals (downlink) using an R&S[®]SMU200A and an R&S[®]FSQ for signal generation and signal analysis, respectively.

3 Brief Introduction to MIMO

This section gives a brief introduction to MIMO systems. A more detailed description of the MIMO technology is given in the application note “Introduction to MIMO” (1MA142).

3.1 Fading

Under real-world conditions, the signal of one transmit antenna arrives at a receive antenna not just by direct line of sight, but also via multiple propagation paths. This multi-path propagation is called fading. This is especially prevalent in urban environments where the transmitted signal is reflected from objects such as buildings. As a result, the transmitter signal travels along different reflection paths to the receiver (Fig. 1). The receiver detects all these signals, which typically have different time delays, levels, phases and even frequency shifts due to Doppler effects (caused by moving transmitters or receivers). In a MIMO system a complex fading channel exists between each transmit and receive antenna pair. While the performance of a single input, single output (SISO) system with only one transmit and one receive antenna is degraded by the fading process, MIMO systems work best under multi-path conditions, i.e. in environments with strong fading. Fading is an essential component in MIMO systems, since sufficiently different – i.e. in the best case, uncorrelated – fading channels are required to distinguish the data streams coming from the different transmit antennas.

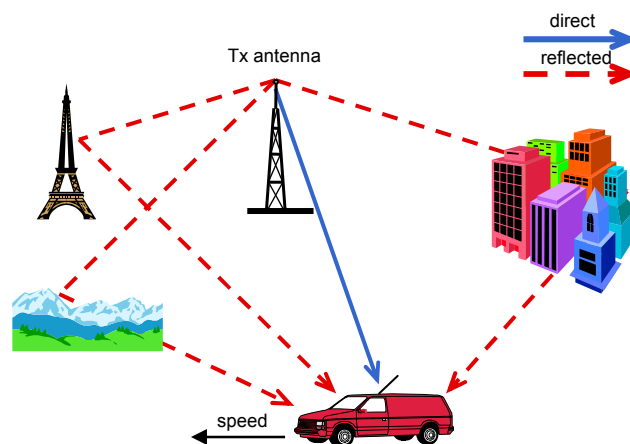

Fig. 1: Fading principle.

Uncorrelated fading channels are, however, only a best-case scenario. Under real operating conditions, the different fading channels are not fully independent of each other, due to the geometric arrangement of the antennas. For MIMO tests, it is therefore essential to simulate variable correlations between the different fading channels. Only by correlating the individual channels with each other can a realistic simulation of the entire MIMO system be achieved. This is important, since the benefit of MIMO systems depends on the degree of channel correlation, i.e. the higher the statistical independence of the different fading channels, the better the achievable data transfer rate.

3.2 MIMO Systems

When discussing MIMO systems, one must distinguish between spatial diversity systems and spatial multiplexing systems.

Spatial diversity is a MIMO technique that uses multiple transmit and receive antennas to increase the robustness of data transmission and thus indirectly the effective data rates. *Spatial diversity* means transferring essentially the *same* data stream simultaneously on the same frequency, such that the receive antennas obtain replicas of the signal. Typically, an additional antenna-specific coding is applied to the signals before transmission to increase the diversity effect. This means that each antenna transmits the same information stream, but with different coding. Often, Alamouti space-time coding is used. On the receiver side, the signal of the transmit antennas is received by the antennas over different, ideally uncorrelated propagation paths. This mitigates fading effects, because it is unlikely that the signals are affected in the same way by fading processes along the different propagation paths. Therefore, the signal-to-noise ratio at the receiver side and thus the robustness of data transmission is improved. Transmit diversity (multiple input, single output – MISO) and receive diversity systems (single input, multiple output – SIMO) are both special types of spatial diversity systems (Fig. 2).

Spatial multiplexing or “true” MIMO is a different MIMO technique that is used to significantly increase data rates or channel capacity. *Spatial multiplexing* means transferring *different* data streams simultaneously on the same frequency by using multiple transmit and receive antennas, i.e. fully exploiting the spatial dimension of the radio channel. In contrast to spatial diversity, no redundant data is transmitted. The data stream to be transmitted is split up into independent data streams, which are sent via the different transmit antennas. Spatial multiplexing thus increases the data rate of a single user, or the overall capacity in the case of multiple users. For single-user (SU) MIMO, the transmitted data streams belong to one user only, thus increasing the data rate of this single user. For multi-user (MU) or collaborative MIMO, the transmitted data streams belong to different users sharing the same radio channel. In this case, the overall capacity of the radio channel is increased, while the data rate of an individual user remains unchanged. Also, the user equipment (UE) must be equipped with just one transmit antenna (Fig. 2).

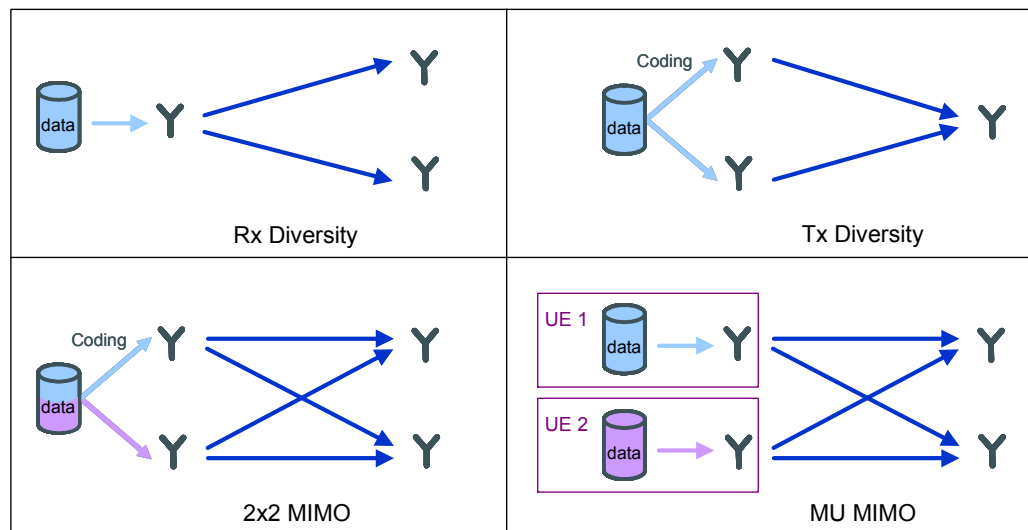

Fig. 2: Schematics of receive diversity (upper left), transmit diversity (upper right), “true” 2x2 MIMO (lower left) and multi-user MIMO (lower right).

3.3 Testing MIMO Systems

Many Rohde & Schwarz signal generators such as the R&S[®]SMBV100A, the R&S[®]SMU200A, the R&S[®]SMATE200A or the R&S[®]SMJ100A are able to generate MIMO transmitter signals. Standard-compliant SISO, transmit diversity and “true” MIMO signal generation are possible for modern communications standards such as LTE, HSPA+, WiMAX[™] and WLANn using the appropriate options. These signal generators provide MIMO transmitter signals with diversity or spatial multiplexing data precoding for the named digital standards. Up to four different transmit antennas can be simulated in this way.

Testing RF characteristics

The RF characteristics of a device under test, such as a MIMO receiver, are first tested without applying fading to the transmitter signals, i.e. leaving out realistic channel simulation. For these tests, all the vector signal generators mentioned above can be used. They generate the necessary MIMO transmitter signals (from 1x1 up to 4x4) for measuring the RF characteristics of the MIMO receiver such as demodulation and decoding capability, dynamic range, sensitivity (by applying AWGN), cross-talk between antennas and many more.

Static channel simulation

As the next step, measurements with elementary channel simulation can be performed. For these measurements, the transmitter signals are combined with specific weightings to create a test signal as seen by the receiver under static channel conditions. This static channel simulation can be used to test the algorithms of the receiver under well-defined conditions. The receiver must be able to reconstruct the different transmitter signals from the received signal. All the vector signal generators mentioned above can be used for these tests.

Phase-coherent signals

Phase-coherent RF signals can be used to create well-defined conditions for the MIMO receiver. Also, phase-coherent signals are essential for testing beamforming applications, which represent a special type of MIMO systems. Beamforming systems use multiple transmit antennas to create a radiation lobe by constructive interference of the transmitted signals. The resulting beam can be steered by adjusting the individual RF phases of the signals and weighting the signal amplitudes. In contrast to spatial multiplexing applications, beamforming is generally a direct line-of-sight technique, i.e. fading processes are unwanted.

The vector signal generators mentioned above offer an option (B90) that makes it possible to generate two or more phase-coherent signals for MIMO tests without fading. Note that a fading process would change the phase relations of the signals and destroy any phase coherence. Section 6 describes how to achieve optimal phase coherence with two or more signal generators.

Rohde & Schwarz test solution

Rohde & Schwarz offers a state-of-the-art test solution for MIMO without fading. The SMBV signal generator is ideally suited for building up a MIMO test setup due to its excellent performance and its attractive price, which makes it possible to set up a cost-efficient test solution.

This highly versatile generator is available in either 3 GHz or 6 GHz configuration. The internal options for digital standards enable generation of standard-compliant MIMO transmitter signals (up to 4x4) in a very user-friendly and effective way. Thus, the generators can be set up to form a high-performance 4x4 MIMO test system (see section 4 for details).

Besides internal signal generation, custom transmitter signals can also be generated via the arbitrary waveform generator (ARB) of the instruments. The internal ARB generator has a bandwidth of 120 MHz and a waveform memory of up to 256 Msamples. Using custom transmitter signals, it is possible to set up NxM MIMO test systems with more than four transmit/receive antennas, e.g. an 8x8 test system (see section 5 for details).

A MIMO test system consisting of SMBVs provides highly synchronized test signals. Note that very precise and stable alignment between the different signal generators is achieved without the need for an additional synchronization unit. The necessary synchronization signals such as a common clock and a common, precise trigger (optionally also a common local oscillator for phase-coherent signal generation) are provided by one of the SMBVs (master instrument). The signals are supplied to the other SMBVs (slave instruments) by simple daisy-chaining. The MIMO test system thus allows very accurate and repeatable measurements on devices under test.

Required options for one R&S® SMBV100A (minimum instrument configuration):

- 1x R&S® SMBV100A vector signal generator
- 1x R&S® SMBV-B51 baseband generator with ARB (32 Msamples)
- 1x R&S® SMBV-B103 frequency range 9 kHz to 3.2 GHz

Outlook – testing with fading

After testing under static conditions, i.e. without applying fading to the transmitter signals, the next step is to simulate real-world conditions. Modern digital standards stipulate sensitivity tests under multi-path conditions to ensure that the MIMO receiver is able to cope with these propagation conditions. The R&S® SMU200A and R&S® AMU200A signal generators offer integrated realtime fading for simulating the complex fading channels between the transmit and receive antennas, including the ability to specify channel correlations.

The application note “Guidelines for MIMO Test Setups – Part 2” (1GP51) focuses on these two instruments in spatial multiplexing configurations with applied realtime fading.

4 4x4 MIMO

A 4x4 MIMO system consisting of four transmit and four receive antennas involves sixteen transmission channels.

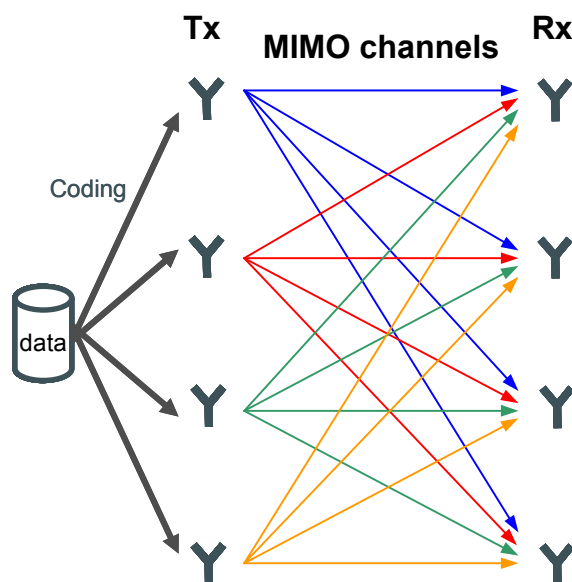

Fig. 3: Schematic of 4x4 MIMO with 16 transmission channels.

The signals of the four transmit antennas – the four Tx signals – can be generated internally using the digital standard options of the SMBV. Section 4.3 describes how to generate MIMO Tx signals with data precoding.

As shown in Fig. 3, the signal at one of the four receive antennas is a (weighted) combination of the different Tx signals. Such an Rx signal can be generated using the ARB generator of the SMBV. Section 4.4 describes how to generate the four MIMO Rx signals including weighted MIMO channels (i.e. static channel simulation).

The setup of the instruments for 4x4 MIMO is identical for Tx and Rx signal generation, and is described in the next section. Note that this setup does not provide phase-coherent output signals. How to achieve phase coherence in addition is described in section 6.

4.1 Setup

Fig. 4 shows a 4x4 MIMO test system consisting of four SMBVs for generating the MIMO signals (either Tx or Rx signals). Each SMBV generates one Tx/Rx signal.

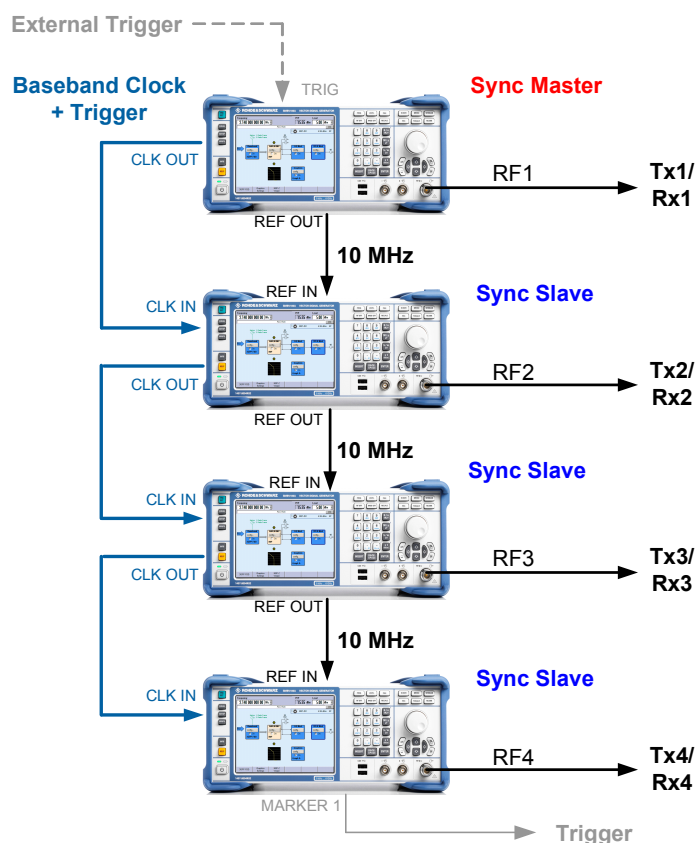

Fig. 4: 4x4 MIMO setup.

The setup is based on a master-slave principle. One SMBV acts as master, the remaining SMBVs as slaves. The slaves are controlled by the master, which provides the synchronization signals including trigger. The master SMBV itself can be controlled externally, e.g. by an external trigger signal for starting signal generation. Master-slave operation assures the perfect synchronization of the instruments. This master-slave synchronization mode is a standard feature of the SMBV – no option is needed for this operating mode.

The master-slave mode is common for Tx and Rx signal generation independent of the digital standard used. For this reason, the synchronization of the generators will be explained first.

4.2 Synchronizing the Generators

In this setup, each SMBV generates one Tx/Rx signal. To synchronize the four signals, the instruments need to be connected and configured as described in the following.

4.2.1 Cabling

The clock signal of the master instrument is fed to the slave instruments to provide a common baseband clock. In addition, this clock signal includes the trigger signal¹, i.e. the baseband clock and the trigger signal are transmitted via the same cable. This two-in-one synchronization signal yields enhanced trigger accuracy and thus assures that all four instruments start signal generation synchronously. The synchronization signal is output at the CLK OUT connector of the master instrument. There are two ways to distribute this clock signal to the slave:

- **Daisy-chaining:** The CLK OUT connector of the master SMBV is connected to the CLK IN connector of the first slave SMBV. The CLK OUT connector of the first slave SMBV is connected to the CLK IN connector of the second slave SMBV, and so on. The advantage of daisy-chaining is that setup is very simple. The clock signal is amplified internally to prevent attenuation of the signal level when connecting more than two instruments. Also, 50 Ω impedance matching is assured. However, this setup has a clock uncertainty of maximally one clock cycle per slave instrument. The frequency of the CLK OUT signal is always 50 MHz. The maximum uncertainty is thus $3 \times 20 \text{ ns} = 60 \text{ ns}$. If a higher precision is desired, the clock signal needs to be distributed by branching.
- **Branching:** A distribution amplifier is connected to the CLK OUT connector of the master SMBV to distribute the clock signal. The outputs of this distribution amplifier are connected to the CLK IN connectors of the slave SMBVs. The connecting cables from the master SMBV to each of the slave SMBVs must have exactly the same length and type. Note that tee connectors should not be used for branching! The reason for using a distribution amplifier is that this device provides impedance matching and signal amplification (which is needed to compensate the level reduction due to signal branching). The specified group delay of the distribution amplifier should be well below 60 ns, in order to benefit from the more complex setup.

The whole setup can be triggered externally (by an external trigger source) or internally (by the master instrument). An external trigger source is connected to the TRIG connector of the master SMBV only. The slave SMBVs are triggered by the master SMBV via the synchronization signal.

Additionally, the 10 MHz reference signal of the master SMBV has to be distributed to the slave SMBVs by daisy-chaining as shown in Fig 4. The REF OUT connector of the master SMBV is connected to the REF IN connector of the first slave SMBV. The REF OUT connector of the first slave SMBV is connected to the REF IN connector of the second slave SMBV, and so on.

¹ The trigger information is modulated onto the clock signal from firmware version 2.05.269 on.

4.2.2 Instrument Settings

One SMBV is defined as master instrument by configuring the Trigger/Marker/Clock menu (Fig. 5), which can be accessed via the digital standards menu. The Sync Mode is set to “Sync Master”. Clicking the “Set Synchronisation Settings” button automatically configures the trigger/marker settings for master-slave operation. These master-slave default settings may need to be modified in some cases as described below.

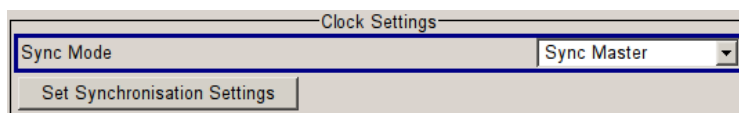

Fig. 5: Clock settings for the master instrument.

The other three SMBVs are configured as slave instruments by setting Sync Mode to “Sync Slave”. Again, clicking the “Set Synchronisation Settings” button automatically sets the trigger/marker settings for master-slave operation.

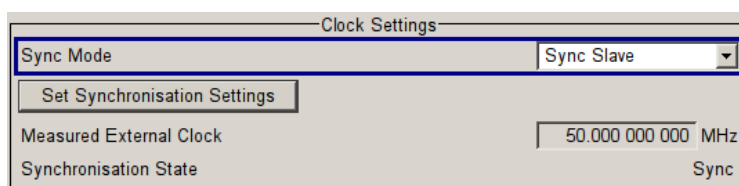

Fig. 6: Clock settings for the slave instrument.

The trigger settings of each instrument must be configured correctly to ensure high trigger accuracy.

- External triggering: The trigger settings for the master SMBV can be easily set automatically by clicking the “Set Synchronisation Settings” button (as already mentioned above) and are as follows: Mode is “Retrigger” or “Armed Retrigger”, Source is “External”, and option “Sync. Output To Ext. Trigger” should be enabled. The trigger settings for the slave SMBVs are identical: Mode is “Retrigger” or “Armed Retrigger”, and Source is “External”. Option “Sync. Output To Ext. Trigger” must be enabled if it is enabled at the master instrument, and disabled if it is disabled at the master instrument.

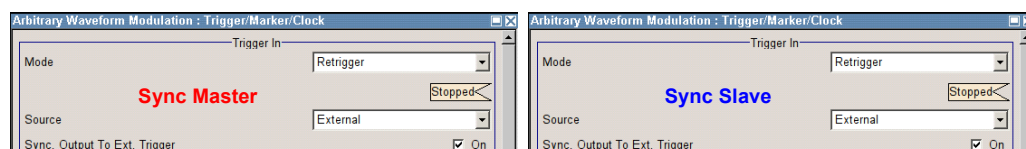

Fig. 7: Trigger settings for external triggering of master SMBV.

- Internal triggering: The trigger settings for the master SMBV are as follows: Any Mode can be selected, Source is “Internal”. The trigger settings for the slave SMBVs are as follows: Mode is “Retrigger” or “Armed Retrigger”, Source is “External”, and option “Sync. Output To Ext. Trigger” must be disabled.

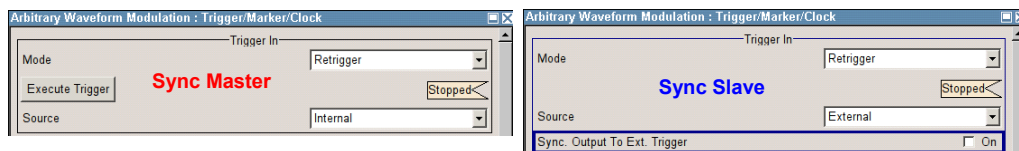

Fig. 8: Trigger settings for internal triggering of master SMBV.

The internal trigger signal can be supplied to a DUT, e.g. for synchronization. Clicking the “Set Synchronisation Settings” button automatically sets Marker 1 to “Trigger” (Fig. 9). With this setting, the trigger signal is output at the MARKER 1 connector of the SMBV (master and slaves). This trigger signal can be connected to the DUT.

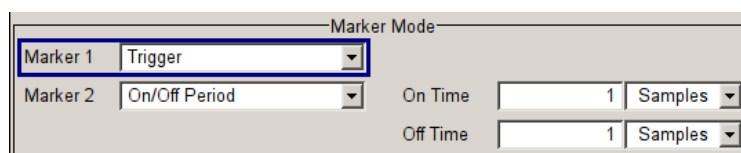

Fig. 9: Marker settings for master and slave instruments.

The Reference Oscillator setting needs to be configured as shown in Fig. 10. For the master SMBV the Source is set to “Internal”, and for the slave SMBVs the Source is set to “External”.

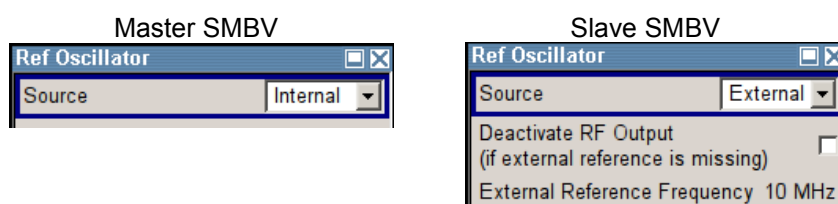

Fig. 10: Reference Oscillator settings for master and slave instruments.

4.3 Tx Signal Generation

The MIMO transmitter signal is generated in the baseband section of the SMBV. Each of the four SMBVs in the setup represents one transmit antenna (Fig. 11). The Tx signal can either be generated using the internal options for the digital standards, or they can be generated as waveform files (e.g. with WinIQSIM2) and played back using the internal arbitrary waveform generator (ARB).

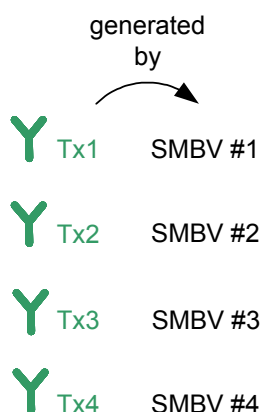

Fig. 11: Schematic of 4x4 MIMO Tx signal generation.

4.3.1 Tx Signal Generation via Internal Options

For 4x4 MIMO, each of the four SMBVs needs to be assigned to one of the four different transmit antennas for generating the signal of one dedicated antenna. The Tx signals with 4x4 data precoding can easily be generated by using the options for the digital standards such as LTE, WiMAX™ and WLANn. Configuring the baseband sections of the four SMBVs is straightforward, since the settings differ in only a few parameters (see following subsections). Here, it may be useful to use the Save/Recall functionality of the baseband section to save the settings made for one baseband (e.g. SMBV #1) and recall them for the other basebands (e.g. SMBV #2, #3, #4). The transfer of the settings file from one instrument to the other instruments can be done via USB stick or external USB HDD.

All four generators must start simultaneously. This is achieved by configuring the Trigger/Marker menu of the selected digital standard as described in section 4.2.

4.3.1.1 LTE

An LTE signal for 4x4 MIMO is generated by setting the Global MIMO Configuration to “4 TxAntennas” in the General DL Settings menu. To generate Tx1 the Simulated Antenna is set to “Antenna 1” (Fig. 12). To generate Tx2 the Simulated Antenna is set to “Antenna 2”. For generating Tx3 the Simulated Antenna is set to “Antenna 3”, and for generating Tx4 the Simulated Antenna is set to “Antenna 4”.

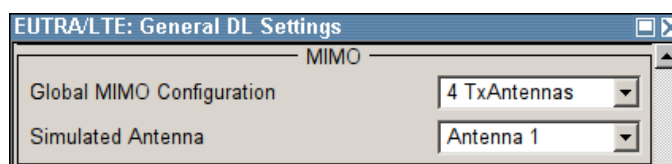

Fig. 12: LTE – MIMO settings for generating Tx1.

The precoding settings are configured as follows: In the DL Frame Configuration menu, click “Config...” in the Allocation Table to open the Enhanced Settings menu for the selected allocation. The Precoding Scheme can be set to “Tx Diversity” or “Spatial Multiplexing”. (More details on how to configure an LTE baseband signal can be found in the application note “LTE Downlink MIMO (2x2) with R&S[®]SMU200A and R&S[®]FSQ” (1MA143).)

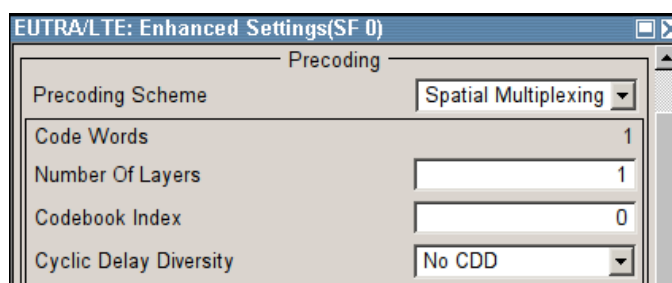

Fig. 13: LTE – Precoding setting for a single allocation.

4.3.1.2 WiMAX™

4x4 MIMO for a WiMAX™ OFDMA signal is implemented by setting the Space-Time Coding Mode to “4 Antennas, Matrix A” (coding algorithm for spatial diversity) or to “4 Antennas, Matrix B/C” (coding algorithm for spatial multiplexing). To generate Tx1 the Space-Time Coding Antenna is set to “Antenna 0” (Fig. 14), and to generate Tx2 it is set to “Antenna 2”. To generate Tx3 the Space-Time Coding Antenna is set to “Antenna 2”, and to generate Tx4 it is set to “Antenna 3”. The submenu for making these settings is called from the WiMAX menu by clicking the “Frame Configuration” button and then clicking “Config...” in the Zone Table. In the WiMAX menu, the Level Reference setting should be changed from “Preamble” (default) to “Subframe RMS Power w/o Preamble” (Fig. 15) to ensure that the levels of the four Tx signals will match.

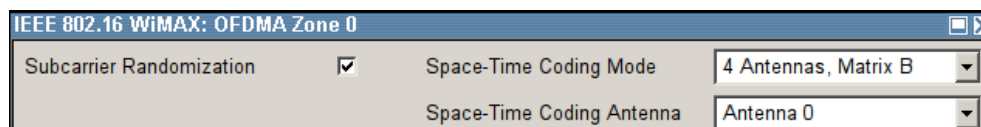

Fig. 14: WiMAX – MIMO settings for generating Tx1.

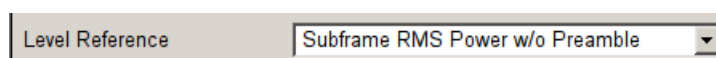
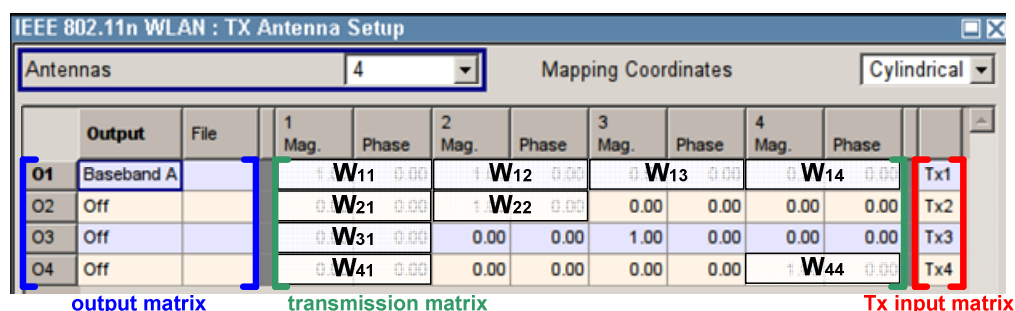

Fig. 15: WiMAX – Level Reference setting.

4.3.1.3 WLANn

WLANn signals for 4x4 MIMO are generated by selecting “4” Antennas in the Transmit Antennas Setup menu (Fig. 16). This menu is used to map the four possible Tx signals (Tx1 to Tx4) to the baseband output. The mapping is done via simple matrix algebra²: Multiplying the transmission matrix by the Tx input matrix gives the output matrix (see Fig. 16).

$$[\text{output matrix}] = [\text{transmission matrix}] \cdot [\text{Tx input matrix}]$$



	Output	File	1 Mag.	Phase	2 Mag.	Phase	3 Mag.	Phase	4 Mag.	Phase	
O1	Baseband A		W11	0.00	W12	0.00	W13	0.00	W14	0.00	Tx1
O2	Off		W21	0.00	W22	0.00	0.00	0.00	0.00	0.00	Tx2
O3	Off		W31	0.00	0.00	0.00	1.00	0.00	0.00	0.00	Tx3
O4	Off		W41	0.00	0.00	0.00	0.00	0.00	W44	0.00	Tx4

Fig. 16: WLANn – Transmit Antenna Setup menu.

This calculation yields the following output signals (O1 to O4), which can either be ignored by selecting Output “Off” or can be used as the baseband signal by selecting Output “Baseband A”:

$$\begin{aligned} O1 &= w_{11} \cdot Tx1 + w_{12} \cdot Tx2 + w_{13} \cdot Tx3 + w_{14} \cdot Tx4 \\ O2 &= w_{21} \cdot Tx1 + w_{22} \cdot Tx2 + w_{23} \cdot Tx3 + w_{24} \cdot Tx4 \\ O3 &= w_{31} \cdot Tx1 + w_{32} \cdot Tx2 + w_{33} \cdot Tx3 + w_{34} \cdot Tx4 \\ O4 &= w_{41} \cdot Tx1 + w_{42} \cdot Tx2 + w_{43} \cdot Tx3 + w_{44} \cdot Tx4 \end{aligned}$$

The above formulas show that to generate transmitter signals at the output of the SMBV, the diagonal elements of the transmission matrix (w_{11} , w_{22} , w_{33} , w_{44}) must be set to 1.0, while all other matrix elements must be set to 0.0, i.e. the default values of the transmission matrix must be used (Fig. 17).

$$\begin{aligned} O1 &= Tx1 \\ O2 &= Tx2 \\ O3 &= Tx3 \\ O4 &= Tx4 \end{aligned}$$

Now, to generate Tx1 the Output O1 is set to “Baseband A”. The other Outputs O2, O3 and O4 are then automatically set to “Off”. To generate Tx2 the Output O2 is set to “Baseband A”. For generating Tx3 the Output O3 is set to “Baseband A”, and for generating Tx4 the Output O4 is set to “Baseband A”.

² The transmission matrix can be used to combine the different Tx signals to create a Rx signal. This is explained in section 5.4.3.

Tx1

IEEE 802.11n WLAN : TX Antenna Setup

Antennas: 4 Mapping Coordinates: Cylindrical

	Output	File	1 Mag.	Phase	2 Mag.	Phase	3 Mag.	Phase	4 Mag.	Phase	
O1	Baseband A		1.00	0.00	0.00	0.00	0.00	0.00	0.00	0.00	Tx1
O2	Off		0.00	0.00	1.00	0.00	0.00	0.00	0.00	0.00	Tx2
O3	Off		0.00	0.00	0.00	0.00	1.00	0.00	0.00	0.00	Tx3
O4	Off		0.00	0.00	0.00	0.00	0.00	0.00	1.00	0.00	Tx4

Tx3

IEEE 802.11n WLAN : TX Antenna Setup

Antennas: 4 Mapping Coordinates: Cylindrical

	Output	File	1 Mag.	Phase	2 Mag.	Phase	3 Mag.	Phase	4 Mag.	Phase	
O1	Off		1.00	0.00	0.00	0.00	0.00	0.00	0.00	0.00	Tx1
O2	Off		0.00	0.00	1.00	0.00	0.00	0.00	0.00	0.00	Tx2
O3	Baseband A		0.00	0.00	0.00	0.00	1.00	0.00	0.00	0.00	Tx3
O4	Off		0.00	0.00	0.00	0.00	0.00	0.00	1.00	0.00	Tx4

Fig. 17: WLANn – MIMO settings for generating Tx1 or Tx3.

4.3.2 Tx Signal Generation via ARB

The user can also use WinIQSIM2 or any suitable software (e.g. MATLAB®) to create the Tx signals. These precalculated Tx signals (i.e. Tx waveforms) can be loaded into the arbitrary waveform generator (ARB) of the instruments and can then be played back. Thus, nearly any kind of custom Tx signal can be generated.

All four ARB generators have to start simultaneously. This is achieved by configuring the Trigger/Marker/Clock menu of the ARB generators as described in section 4.2.

The ARB generators can be used not only to generate MIMO Tx signals, but also to generate MIMO Rx signals as described in the next section.

4.4 Rx Signal Generation

As shown in Fig. 3, the signal at one of the four receive antennas is a (weighted) combination of the different Tx signals. Such an Rx signal can be generated using the ARB generator of the SMBV. Note that the WLANn standard is a special case. Here, the Rx signal can be generated directly via the digital standard option.

4.4.1 Rx Signal Generation via Internal Option: WLANn

For WLANn, the static addition of the Tx signals can be done via the digital standard option. That means the WLANn option can be used to create an Rx signal, which is then output from the SMBV.

To generate a 4x4 MIMO Rx signal, “4” Antennas are selected in the Transmit Antennas Setup menu (Fig. 18). This menu is used to combine the different Tx signals and route one of the resulting Rx signals (Rx1 to Rx4) to the baseband output of the SMBV. The Tx signals are combined using simple matrix algebra. Multiplying the transmission matrix by the Tx input matrix gives the output matrix (see Fig. 18).

$$[\text{output matrix}] = [\text{transmission matrix}] \cdot [\text{Tx input matrix}]$$

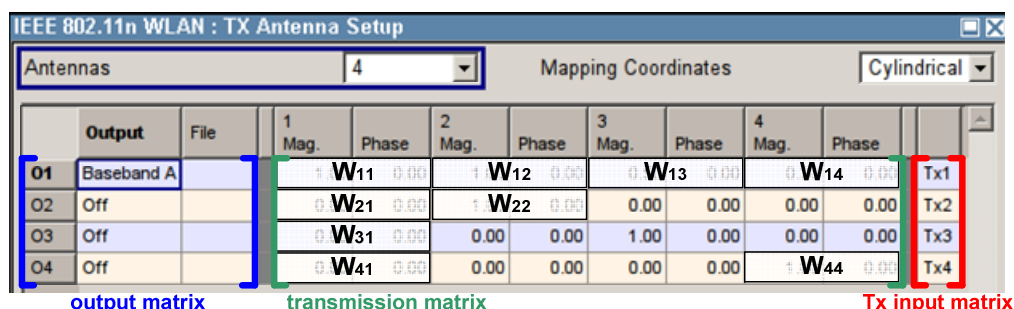

	Output	File	1 Mag.	Phase	2 Mag.	Phase	3 Mag.	Phase	4 Mag.	Phase	
O1	Baseband A		W11		W12		W13		W14		Tx1
O2	Off		W21		W22		0.00	0.00	0.00	0.00	Tx2
O3	Off		W31		0.00	0.00	1.00	0.00	0.00	0.00	Tx3
O4	Off		W41		0.00	0.00	0.00	0.00	W44		Tx4

Fig. 18: WLANn – Transmit Antenna Setup menu.

This calculation yields the following output signals (O1 to O4), which can either be ignored by selecting Output “Off” or can be used as the baseband signal by selecting Output “Baseband A”:

$$\begin{aligned} O1 &= w_{11} \cdot Tx1 + w_{12} \cdot Tx2 + w_{13} \cdot Tx3 + w_{14} \cdot Tx4 \\ O2 &= w_{21} \cdot Tx1 + w_{22} \cdot Tx2 + w_{23} \cdot Tx3 + w_{24} \cdot Tx4 \\ O3 &= w_{31} \cdot Tx1 + w_{32} \cdot Tx2 + w_{33} \cdot Tx3 + w_{34} \cdot Tx4 \\ O4 &= w_{41} \cdot Tx1 + w_{42} \cdot Tx2 + w_{43} \cdot Tx3 + w_{44} \cdot Tx4 \end{aligned}$$

The above formulas show that to generate receiver signals at the output of the SMBV, the elements of the transmission matrix (w_{11}, \dots, w_{44}) must be set to nonzero values. The Tx signals can be added with or without a weighting of the different MIMO channels. To combine the Tx signals without any weighting, all matrix elements (w_{11}, \dots, w_{44}) must be set to 1.0.

$$\begin{aligned} O1 &= Tx1 + Tx2 + Tx3 + Tx4 = Rx1 \\ O2 &= Tx1 + Tx2 + Tx3 + Tx4 = Rx2 \\ O3 &= Tx1 + Tx2 + Tx3 + Tx4 = Rx3 \\ O4 &= Tx1 + Tx2 + Tx3 + Tx4 = Rx4 \end{aligned}$$

The Tx signals can also be added including a weighting of the MIMO channels. In this case, the matrix elements (w_{11}, \dots, w_{44}) are set to values different than 1.0.

$$\text{For example, } O1 = Tx1 + 0.5 \cdot Tx2 + Tx3 + 0.25 \cdot Tx4 = Rx1$$

One SMBV can only output one Rx signal. Thus, one of the four signals O1 to O4 (corresponding to the signals Rx1 to Rx4) must be selected to be the baseband output signal. To generate Rx1 the Output O1 is set to “Baseband A”. The other Outputs (O2, O3 and O4) are then automatically set to “Off”. To generate Rx2 the Output O2 is set to “Baseband A”. For generating Rx3 the Output O3 is set to “Baseband A”, and for generating Rx4 the Output O4 is set to “Baseband A”.

Rx1

Output	File	1 Mag.	Phase	2 Mag.	Phase	3 Mag.	Phase	4 Mag.	Phase	
O1	Baseband A	1.00	0.00	0.50	0.00	1.00	0.00	0.25	0.00	Tx1
O2	Off	0.00	0.00	1.00	0.00	0.00	0.00	0.00	0.00	Tx2
O3	Off	0.00	0.00	0.00	0.00	1.00	0.00	0.00	0.00	Tx3
O4	Off	0.00	0.00	0.00	0.00	0.00	0.00	1.00	0.00	Tx4

Fig. 19: WLANn – MIMO settings for generating Rx1.

The baseband generators of the four SMBVs must start simultaneously. This is achieved by configuring the Trigger/Marker menu of the WLANn standard as described in section 4.2.

4.4.2 Rx Signal Generation via ARB

First, four Tx waveforms containing the different Tx signals (Tx1 to Tx4) need to be generated. The Tx signals can either be generated using the internal options of the SMBV or using the WinIQSIM2 simulation software. Generation of Tx signals is described in detail in section 4.3. The four Tx signals need to be saved as a waveform file by clicking the “Generate Waveform File” button in the digital standard menu. To create an Rx signal, the four Tx waveforms are combined using the ARB Multi Carrier feature of the SMBV or WinIQSIM2. The resulting Rx waveform, which includes the four transmitter signals, is then played back via the ARB generator of the SMBV. The SMBV thus outputs a 4x4 MIMO Rx signal (Fig. 20), which can be fed to the device under test. Each of the four SMBVs in the setup generates one Rx signal.

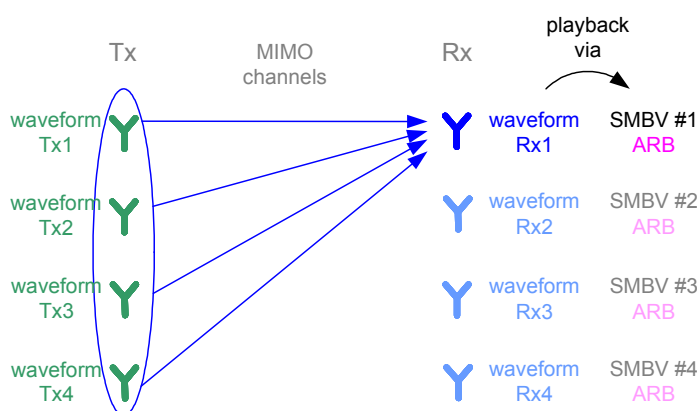

Fig. 20: Creation of an Rx signal.

All four ARB generators have to start simultaneously. This is achieved by configuring the Trigger/Marker menu of the ARB generator as described in section 4.2.

4.4.2.1 Unweighted Addition

Each of the four Tx waveforms represents a Tx signal of a dedicated transmit antenna. These waveforms can be “added up” using the ARB Multi Carrier feature of the SMBV or WinIQSIM2 (Fig. 21). For 4x4 MIMO the Number of Carriers is set to 4. The Carrier Spacing is set to 0.00 Hz to transmit all Tx signals at the same frequency. The Crest Factor Mode must be “Off”, otherwise the phase relations between the Tx signal will be altered. Fig. 22 shows the corresponding Carrier Table. Each of the four Tx waveforms is assigned to one carrier. The resulting output file is a multi carrier waveform with four superimposed carriers. This waveform is the desired Rx signal.

If the Tx waveforms are added without any weighting of the different MIMO channels, the receiver signals Rx1 to Rx4 will all be equal. Thus, the Rx waveform only has to be created once and can then be played back in all four ARB generators.

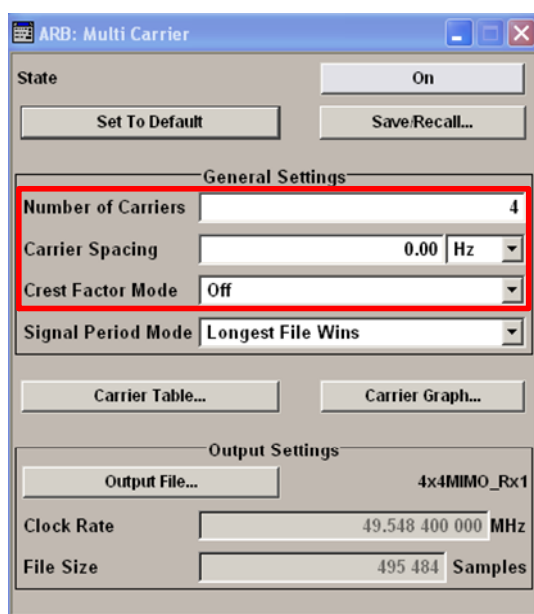

Fig. 21: ARB Multi Carrier menu of WinIQSIM2.

	State	Gain [dB]	Phase [deg]	Delay [ns]	File	Info...
0	On	0.00	0.00	0	4x4MIMO_Tx1	Info...
1	On	0.00	0.00	0	4x4MIMO_Tx2	Info...
2	On	0.00	0.00	0	4x4MIMO_Tx3	Info...
3	On	0.00	0.00	0	4x4MIMO_Tx4	Info...

Fig. 22: Carrier Table.

4.4.2.2 Weighted Addition

The Tx waveforms can also be added with a weighting of the MIMO channels. Fig. 23 shows the basic principle. Tx1 to Tx4 are added with different weightings (w_1 , w_2 , w_3 and w_4). For example, the weighting can be used to simulate different transmitter outputs or different signal levels at the receive antennas. It is also possible to simulate static attenuation along individual transmission paths.

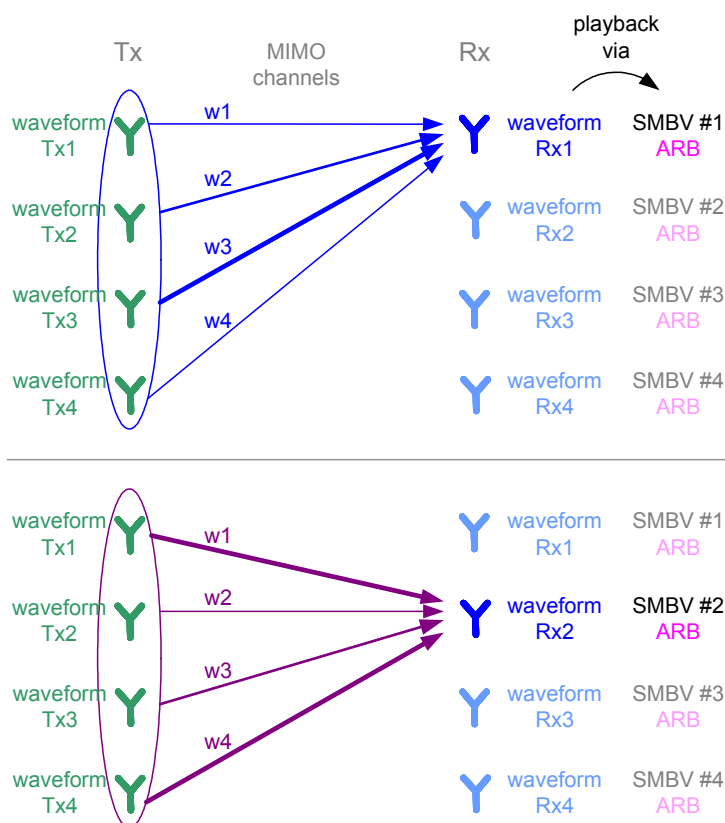

Fig. 23: Creation of different Rx signals.

The Tx waveforms can be combined using the ARB Multi Carrier feature as described in the previous section. The weighting is implemented via the Carrier Table by entering different Gain values for the Tx signals (Fig. 24). Note that 0.00 dBm is the maximum value and corresponds to full scale.

	State	Gain [dB]	Phase [deg]	Delay [ns]	File	Info...
0	On	-5.00	0.00	0	4x4MIMO_Tx1	Info...
1	On	-2.00	0.00	0	4x4MIMO_Tx2	Info...
2	On	0.00	0.00	0	4x4MIMO_Tx3	Info...
3	On	-5.00	0.00	0	4x4MIMO_Tx4	Info...

Fig. 24: Carrier Table with different Gain settings for the individual carriers.

The resulting multi carrier waveform is the desired Rx signal, e.g. Rx1. In a subsequent step, the weighting of the MIMO channels can be changed to generate the next Rx signal, e.g. Rx2, which will differ from Rx1 (see Fig. 23). This way, different Rx waveforms can be created and then played back via the four ARB generators.

The Carrier Table also gives the possibility to set the phases of the individual carriers, i.e. Tx signals. For example, when transmitting identical Tx signals (same waveform for Tx1 to Tx4), an appropriate phase setting can be used to generate test signals for beamforming scenarios.

4.5 AWGN

It is possible to superimpose noise on the Tx/Rx output signals using the noise generation option of the SMBV. An additive white Gaussian noise (AWGN) signal with selectable system bandwidth can be added to the baseband signal. The AWGN signal is added to the I/Q output signals of the baseband generator (incl. ARB) – see the block diagram in Fig. 25. For example, the AWGN signal can be used for simulating a certain signal-to-noise ratio at the device under test for testing the DUT's sensitivity.

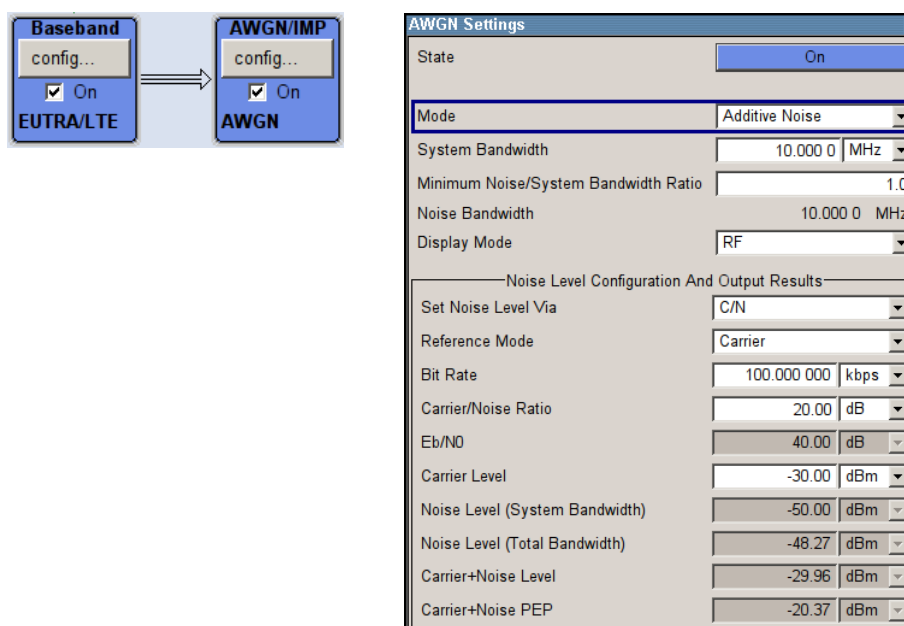

Fig. 25: AWGN function block (left) and AWGN settings menu (right).

5 8x8 MIMO

The 8x8 MIMO configuration consists of eight transmit and eight receive antennas, and involves 64 transmission channels.

For MIMO systems up to 4x4, the Tx signals can be generated using the digital standard options of the SMBV or WinIQSIM2. Setting up an 8x8 MIMO system requires Tx signals with 8x8 data-precoding. These eight Tx signals must be provided by the user as Rohde & Schwarz waveform files.

The setup of the instruments for 8x8 MIMO is identical for Tx and Rx signal generation, and is described in the next section. Using this setup for 8x8 Tx signal generation is described in section 5.2, and using it for 8x8 Rx signal is described in section 5.3.

5.1 Setup

Fig. 26 shows the 8x8 MIMO test system consisting of eight SMBVs for generating the Tx or Rx signals from waveform files using the ARB generator. Each SMBV generates a different Tx/Rx signal.

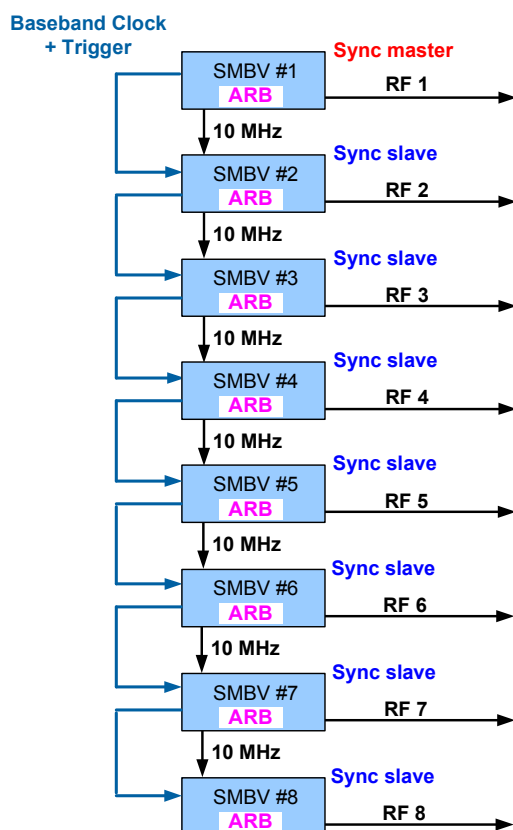

Fig. 26: 8x8 MIMO setup (with internal triggering).

To synchronize the output signals (RF 1 to RF 8), the instruments need to be connected and configured as described in section 4.2. One SMBV is defined as the master instrument, the other seven SMBVs are slaves. The clock signal of the master instrument is fed to the slave instruments to provide a common baseband clock (for details please refer to section 4.2.1). In addition, this clock signal includes the trigger signal, i.e. the baseband clock and the trigger signal are transmitted via the same cable. Additionally, the 10 MHz reference signal of the master instrument has to be distributed to the slave instruments. For the master SMBV, the Trigger/Marker/Clock menu of the ARB generator needs to be configured as shown in Fig. 5. For the slave SMBVs, this menu needs to be configured as shown in Fig. 6. The “Set Synchronisation Settings” button must be pushed for each instrument to automatically set all necessary trigger/marker settings.

5.2 Tx Signal Generation via ARB

Eight Tx signals with 8x8 data precoding must be computed by the user and stored as waveform files. Each of the eight Tx waveforms represents the Tx signal of a dedicated transmit antenna.

The precalculated Tx signals (i.e. Tx waveforms) are then loaded into the ARB generators of the instruments. The ARB generators are used to play back the Tx waveforms, and thus the SMBVs will generate MIMO transmitter signals (i.e. each SMBV outputs a different Tx signal).

All eight ARB generators must start simultaneously. This is achieved by configuring the Trigger/Marker menu of the ARB generator as described in section 4.2.

5.3 Rx Signal Generation via ARB

At first, eight Tx signals with 8x8 data precoding must be computed by the user and stored as waveform files. Each of the eight Tx waveforms represents the Tx signal of a dedicated transmit antenna.

The precalculated Tx signals (i.e. Tx waveforms) are then combined using the ARB Multi Carrier feature of the SMBV or WinIQSIM2 to create the Rx signals (described in detail in sections 4.4.2.1 and 4.4.2.2). Each of the resulting Rx signals includes the eight (weighted) transmitter signals. The generated Rx waveforms are then loaded into the ARB generators of the instruments. The ARB generators are used to play back the Rx waveforms, and thus the SMBVs will generate MIMO receiver signals (i.e. each SMBV outputs an Rx signal).

All eight ARB generators have to start simultaneously. This is achieved by configuring the Trigger/Marker menu of the ARB generator as described in section 4.2.

5.3.1 Unweighted Addition

The Tx waveforms are added up using the ARB Multi Carrier feature of the SMBV or WinIQSIM2 (Fig. 21). For 8x8 MIMO the Number of Carriers is set to 8. The Carrier Spacing is set to 0.00 Hz to transmit all Tx signals at the same frequency. The Crest Factor Mode must be “Off”, otherwise the phase relations between the Tx signal will be altered. Each of the eight Tx waveforms is assigned to one carrier using the Carrier Table. The resulting output file is a multi carrier waveform with eight superimposed carriers, which is the desired Rx signal.

If the Tx waveforms are added without any weighting of the different MIMO channels, the receiver signals Rx1 to Rx8 will all be equal. Thus, the Rx waveform only has to be created once, and can then be played back in all eight ARB generators.

5.3.2 Weighted Addition

The Tx waveforms can also be added including a weighting of the different MIMO channels, i.e. Tx1 to Tx8 are added with different weighting ($w_1, w_2, w_3, \dots, w_8$). Again, the Tx waveforms are combined using the ARB Multi Carrier feature as described in the previous section. The weighting is implemented via the Carrier Table by entering different Gain values for the Tx signals. Note that 0.00 dBm is the maximum value and corresponds to full scale. The resulting multi carrier waveform is the desired Rx signal, e.g. Rx1. In a next step, the weighting of the MIMO channels can be changed to generate the next Rx signal, e.g. Rx2 which then differs from Rx1. In this way, different Rx waveforms can be created.

The Carrier Table also gives the possibility to set the phases of the individual carriers, i.e. Tx signals. For example, when transmitting identical Tx signals (same waveform for Tx1 to Tx8), an appropriate phase setting can be used to generate test signals for beamforming scenarios.

6 Phase-Coherent Signals

During early test stages, it can be beneficial to operate with phase-coherent RF signals in order to create well-defined conditions for the device under test. Also, phase-coherent signals are required for beamforming applications. The B90 option of the SMBV makes it possible to generate such phase-coherent signals.

Strictly speaking, phase coherence is only defined for continuous wave (CW) carriers with equal frequencies (or for CW carriers whose frequencies are multiples of each other). These CW carriers are phase-coherent if there is a defined and stable phase relationship between them, i.e. phase coherence means that there is a fixed delta phase $\Delta\phi$ between the RF carriers.

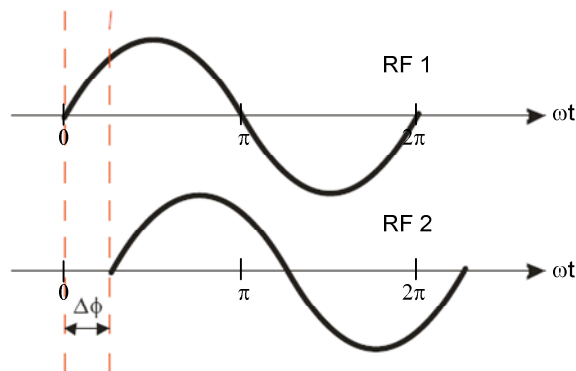

Fig. 27: Illustration of phase coherence.

If two signal generators are coupled via a common 10 MHz reference signal, they generate identical RF frequencies. However, this coupling cannot guarantee phase coherence of the RF signals. The instantaneous delta phase between these two RF signals is instable due to the following factors:

- Phase noise of the two synthesizers
- Weak coupling of the synthesizers via the 10 MHz reference signal and a long synthesis chain up to the RF domain. (For example, a phase change of only 0.1° in the 10 MHz reference signal results in a phase change of 10° for a 1 GHz RF signal.)
- Temperature differences that cause a change of the effective electrical length of some synthesizer components. This leads to a thermal phase drift between the two synthesizers. (Depending on the RF frequency used, this drift may be up to 20° when changing the ambient temperature by 1° .)

A stable delta phase between the two RF carriers can only be achieved by using a common local oscillator (LO) signal to generate both RF signals. This LO signal is used in both signal generators for upconverting the baseband signal to the RF. By using a common LO signal for the two I/Q modulators, phase drifts between the carriers are minimized, i.e. the delta phase between the two RF carriers remains fixed.

6.1 Setup

The B90 option makes it possible to distribute the LO signal generated by one SMBV to other SMBVs, such that multiple I/Q modulators can be driven by the same LO signal to generate phase-coherent RF signals. Fig. 28 shows a setup with four SMBVs.

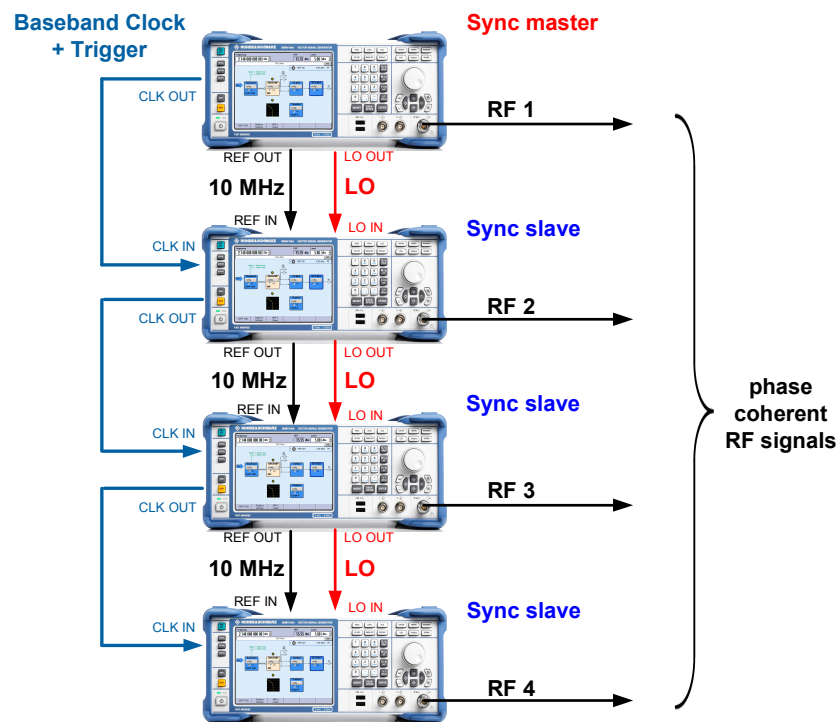

Fig. 28: Setup for generating phase-coherent signals (internal triggering).

The LO signal generated by the master instrument is fed to multiple slave instruments by simple daisy-chaining, i.e. the LO OUT connector of one instrument is connected to the LO IN connector of the next instrument. To prevent the LO signal level from getting weaker and weaker when cascading more than two instruments, the LO signal is internally amplified before redistribution. Naturally, the signal quality of the LO signal degrades slightly with each additional instrument, as does the RF signal quality. When connecting up to eight instruments, the RF signal quality of the last SMBV is still very good, but one must be aware that unlimited cascading is not possible.

The instruments must be configured and connected as described in section 4.2. In addition, the instrument needs to be configured for LO coupling as follows: For the master SMBV, the LO Coupling Mode must be set to “Internal” and the LO Out State to “On”. This means that the master SMBV is running with its internal LO synthesizer. The menu for making these settings is opened by clicking on the RF function block and selecting “LO Coupling” from the list. For the slave SMBVs, the LO Coupling Mode must be set to “External”. This means that the slave SMBVs are running with an external LO synthesizer. The LO Out State is set to “On” for all slave instruments (only for the last instrument can “Off” be selected).

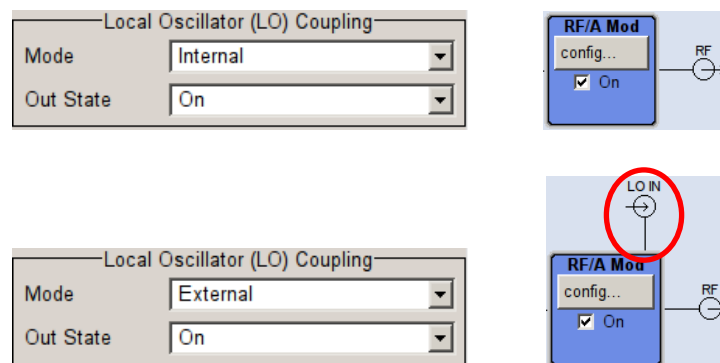

Fig. 29: Local Oscillator settings for master and slave instruments.

6.2 Phase Calibration and Time Alignment

6.2.1 Phase Calibration

If a common LO is used for all SMBVs, then there are stable delta phases (i.e. $\Delta\phi_{\text{RF1-RF2}}$, $\Delta\phi_{\text{RF1-RF3}}$, $\Delta\phi_{\text{RF1-RF4}}$) between the RF signals. This means the RF signals are phase-coherent. However, the delta phases are unknown. The question now is, what are the exact values of the individual delta phases at the RF outputs of the SMBVs, or even more importantly, at the device under test? Note that unequal cable lengths between the RF outputs and the DUT strongly impact the delta phases. For example, 1 mm of additional cable length leads to a phase shift of 7.2° at an RF frequency of 6 GHz. Therefore, the delta phases at the DUT must be calibrated prior to the use of the RF signals. The application note “Phase Adjustment of Two MIMO Signal Sources with Option B90” (1GP67) describes in detail how to calibrate the delta phases between the RF outputs; it not only describes multiple methods of performing this phase calibration manually, but also provides a software tool for performing the calibration automatically. Note that the phase calibration requires setting a phase offset in each SMBV for compensating the measured phase differences. Due to the coupled RF sections (common LO), this phase offset cannot be set directly in the RF section, but must be set in the baseband section of the instruments. Thus, using I/Q modulation is mandatory when using LO coupling. This means that the RF carriers (CW signals)

are generated via the baseband section, e.g. by using Custom Digital Modulation with BPSK modulation and Data Source “All 1”. The phase offset can be set in realtime via the baseband section, without requiring recalculation of the baseband signal. After phase calibration, the phase offsets in each SMBV will be adjusted such that the delta phases between the RF signals are all zero. Finally, a certain known phase relationship between the multiple RF carriers can be set by varying the phase offsets with respect to the calibrated “zero values”.

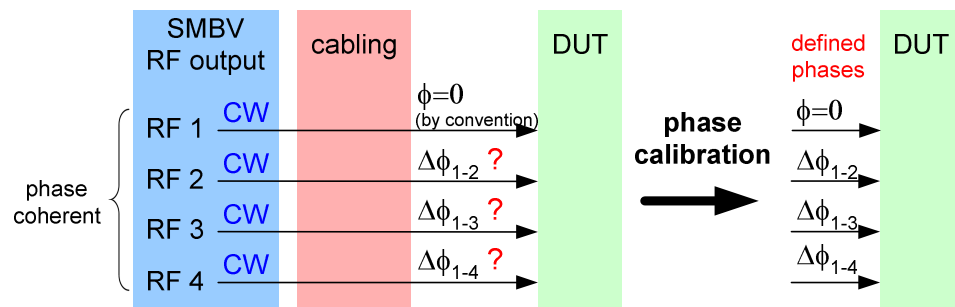

Fig. 30: Effect of phase calibration.

6.2.2 Time Alignment

So far we have considered only CW signals, but what about modulated³ signals? Is it possible to generate phase-coherent modulated signals? The answer is yes. However, it is important to perform a time alignment of the baseband signals and phase coherence is then only defined for the center carrier. Using the synchronization mode (i.e. common baseband clock + trigger) assures that the SMBVs start signal generation synchronously, which means that the modulated signals have equal timing with only a minimal residual uncertainty. This residual uncertainty is due to trigger transmission times (from master to slave) and internal processing times (at slave). However, due to slightly different cable lengths between the RF outputs and the device under test, the signals will have slightly different timings, i.e. there will be some Δt between the individual signals at the DUT (Fig. 33). These timing delays must be compensated. This is achieved by adjusting the parameter “I/Q Delay” of the SMBVs (AWGN/Impairments block).

³ Refers to every I/Q modulated RF signal except to a single CW carrier generated from a DC baseband signal.

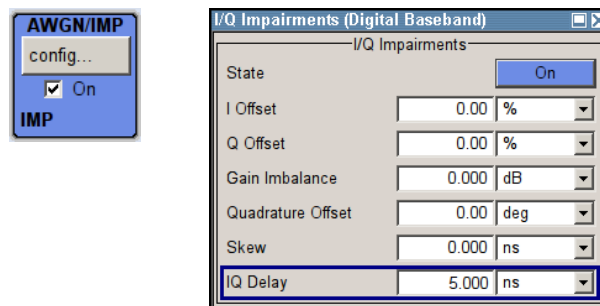

Fig. 31: Digital I/Q Impairments menu.

For CW signals, this time alignment is not necessary. So why do we need it for modulated signals? In the case of CW signals, the phase calibration (see section 6.2.1) ensures that the phases of the individual signals are synchronized, and due to the periodicity of CW signals it does not matter whether the signals start synchronous or not (Fig. 32). In contrast, for modulated signals a synchronous start (at the DUT) is crucial, as otherwise the signals will be misaligned in time (Fig. 32).

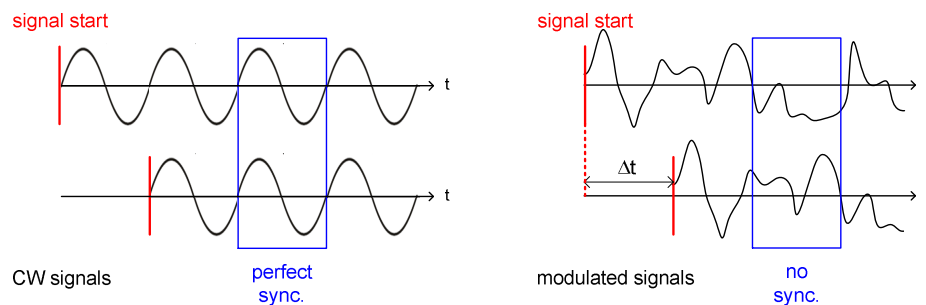

Fig. 32: Effect of different starting points for two CW signals (after phase calibration) and two modulated signals.

To achieve perfect synchronization in the baseband and RF domain for modulated signals, the following procedure must be performed:

Step 1: Phase calibration with CW signal.

For each SMBV, use a DC baseband signal and adjust the RF phase using the baseband parameter “Phase Offset” as explained in the application note 1GP67. After this calibration, the signals will have the same RF frequency, the same level and the same phase. For each SMBV, keep the resulting Phase Offset value for the next step.

Step 2: Time alignment with desired modulated signal.

When using the “spectrum analyzer plus combiner” setup recommended for phase calibration in 1GP67, set the spectrum analyzer to span = 100 MHz, resolution bandwidth = Auto and vary the I/Q Delay of the slave SMBV until the power measured is minimal. (Note that positive as well as negative I/Q Delays are possible.)

It is not a must, but quite helpful, to use an oscilloscope in parallel to see the time relation between the I (or Q) signals (analog baseband output) of both instruments. Note that the applied Phase Offset leads to a “deformation” of the I (or Q) signal. Therefore, use one of the following methods:

- Use XY-mode of the oscilloscope: The scope will show an ellipse, which turns into a line in the case of perfect time alignment.
- Use standard YT mode of the oscilloscope: Set the applied Phase Offset temporarily to 0° and align both curves in time. Then set the Phase Offset back to the original value.

After this alignment, the signals will have the exact same starting time (at the DUT).

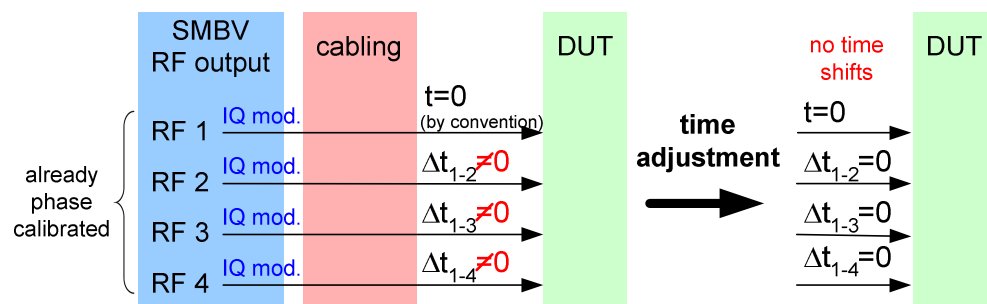

Fig. 33: Effect of time alignment.

Note that the phase calibration and the subsequent time alignment must be performed with the cables that will be used later for connecting to the DUT. The calibration and the alignment are only valid for these cables (i.e. cable lengths). To assure perfect synchronization of the signals, the cables must not be changed. The parameters “Phase Offset” and “I/Q Delay” which were used to achieve perfect synchronization remain the same after switching the generators off and on. This means they only have to be determined once and can then be used for an extended period (provided the setup does not change).

7 Summary

This application note explains how to set up MIMO systems for measurements under static conditions, i.e. without dynamic fading. The MIMO test solutions presented consist of several SMBV signal generators, which are ideally suited for such MIMO setups due to their excellent performance and attractive price. These MIMO solutions provide highly synchronized test signals without the need for an additional synchronization unit. This is achieved by a master-slave instrument configuration permitting very accurate and repeatable measurements on devices under test. The master-slave configuration provides coupling of the basebands via a common baseband clock and trigger signal, and also optional coupling of the RF sections via a common LO signal (B90 option). The common LO signal makes it possible to generate phase-coherent RF signals. Phase coherence for modulated signals is possible, but requires a calibration procedure which is outlined in this application note.

With the SMBV, standard-compliant MIMO transmitter signals can be easily created using the internal options for digital standards. In addition, custom transmitter signals can also be generated via the arbitrary waveform generator (ARB) of the instrument. This application note further explains how to generate MIMO receiver signals by static addition of (weighted) transmitter signals.

8 Abbreviations

ARB	Arbitrary Waveform Generator
AWGN	Additive White Gaussian Noise
CW	Continuous Wave
DUT	Device Under Test
LO	Local Oscillator
MIMO	Multiple Input, Multiple Output
RF	Radio Frequency
RMS	Root Mean Square
Rx	Receive
Tx	Transmit

9 Ordering Information

R&S® SMBV100A	Vector Signal Generator	1407.6004.02
R&S® SMBV-B103	Frequency option 3.2 GHz	1407.9603.02
R&S® SMBV-B106	Frequency option 6 GHz	1407.9703.02
R&S® SMBV-B1	Reference Oscillator OCXO	1407.8407.02
R&S® SMBV-B90	Phase Coherence	1407.9303.02
R&S® SMBV-B10	Baseband Generator with Digital Modulation (realtime) and ARB (32 Msample), 120 MHz RF bandwidth	1407.8607.02
R&S® SMBV-B50	Baseband Generator with ARB (32 Msample), 120 MHz RF bandwidth	1407.8907.02
R&S® SMBV-B51	Baseband Generator with ARB (32 Msample), 60 MHz RF bandwidth	1407.9003.02
R&S® SMBV-B55	Memory Extension for ARB to 256 Msample	1407.9203.02
R&S® SMBV-B92	Hard Disk (removable)	1407.9403.02
R&S® SMBV-K18	Digital Baseband Connectivity	1415.8002.02
R&S® SMBV-K42	Digital Standard 3GPP FDD	1415.8048.02
R&S® SMBV-K43	3GPP FDD Enhanced MS/BS Tests incl. HSDPA	1415.8054.02
R&S® SMBV-K45	3GPP FDD HSUPA	1415.8077.02
R&S® SMBV-K49	Digital Standard IEEE 802.16	1415.8119.02
R&S® SMBV-K54	Digital Standard IEEE 802.11n	1415.8160.02
R&S® SMBV-K55	Digital Standard EUTRA/LTE	1415.8177.02
R&S® SMBV-K59	Digital Standard HSPA+	1415.8219.02
R&S® SMBV-K242	Digital Standard 3GPP FDD (WinIQSIM2)	1415.8248.02
R&S® SMBV-K243	3GPP FDD Enhanced MS/BS Tests incl. HSDPA (WinIQSIM2)	1415.8254.02
R&S® SMBV-K245	3GPP FDD HSUPA (WinIQSIM2)	1415.8277.02
R&S® SMBV-K249	Digital Standard IEEE 802.16 (WinIQSIM2)	1415.8319.02
R&S® SMBV-K254	Digital Standard IEEE 802.11n (WinIQSIM2)	1415.8354.02
R&S® SMBV-K255	Digital Standard EUTRA/LTE (WinIQSIM2)	1415.8360.02
R&S® SMBV-K259	Digital Standard HSPA+ (WinIQSIM2)	1415.8377.02
R&S® SMBV-K62	Additive White Gaussian Noise (AWGN)	1415.8419.02

About Rohde & Schwarz

Rohde & Schwarz is an independent group of companies specializing in electronics. It is a leading supplier of solutions in the fields of test and measurement, broadcasting, radiomonitoring and radiolocation, as well as secure communications. Established 75 years ago, Rohde & Schwarz has a global presence and a dedicated service network in over 70 countries. Company headquarters are in Munich, Germany.

Environmental commitment

- Energy-efficient products
- Continuous improvement in environmental sustainability
- ISO 14001-certified environmental management system



Regional contact

USA & Canada

USA: 1-888-TEST-RSA (1-888-837-8772)

from outside USA: +1 410 910 7800

CustomerSupport@rohde-schwarz.com

East Asia

+65 65 13 04 88

CustomerSupport@rohde-schwarz.com

Rest of the World

+49 89 4129 137 74

CustomerSupport@rohde-schwarz.com

This application note and the supplied programs may only be used subject to the conditions of use set forth in the download area of the Rohde & Schwarz website.

R&S® is a registered trademark of Rohde & Schwarz GmbH & Co. KG. Trade names are trademarks of the owners.

Rohde & Schwarz GmbH & Co. KG

Mühlhofstraße 15 | D - 81671 München

Phone + 49 89 4129 - 0 | Fax + 49 89 4129 - 13777

www.rohde-schwarz.com