

Time Synchronous Signals with Multiple R&S®SMBV100A Vector Signal Generators Application Note

Products:

| R&S®SMBV100A

This application note explains how to synchronize the signals from multiple R&S®SMBV100A vector signal generators in time.

The synchronization of the instruments is based on a master-slave principle where one R&S®SMBV100A acts as master and supplies all necessary synchronization signals to the other instruments (slaves). The setup is simple and provides highly synchronized test signals.

Time synchronous signals are needed in several applications. The master-slave setup is ideal for basic MIMO tests, certain GNSS test scenarios and WLAN IEEE 802.11ac applications. Furthermore, synchronous baseband signals are the basis for generating phase coherent RF signals with the R&S®SMBV100A.

Table of Contents

1	Note	4
2	Introduction	4
3	Master-Slave Setup	5
3.1	Cabling	6
3.1.1	Clock Signal	6
3.1.2	Reference Frequency Signal	6
3.2	Settings	7
3.2.1	Clock Settings.....	7
3.2.2	Reference Frequency Settings.....	9
3.3	Triggering.....	9
3.3.1	External Triggering	9
3.3.2	Internal Triggering.....	11
3.4	Verification Measurement.....	13
3.5	Checking and Optimizing Signal Synchronization	15
3.6	Troubleshooting	17
4	Application – MIMO Test Setup.....	19
5	Application – GNSS Test Setup	21
6	Application – WLAN IEEE 802.11ac Test Setup.....	25
7	Remote Control of Master-Slave Setup	27
8	Phase Coherent Signal Generation	30
8.1	Cabling	30
8.2	Settings	31
8.3	Triggering.....	31
8.4	Phase Coherence for Continuous Wave (CW) Signals	32
8.5	Phase Coherence for I/Q Modulated Signals.....	34
8.5.1	Special Case: GNSS Test Setup for Carrier Phase Measurements.....	35
9	Application – Outphasing PA Test Setup.....	37
10	Summary.....	40

11	Abbreviations	41
12	References.....	41
13	Ordering Information	42

1 Note

The abbreviation “SMBV” is used in this application note for the Rohde & Schwarz product R&S®SMBV100A.

2 Introduction

This application note explains how to synchronize the signals from multiple SMBV vector signal generators in time (section 3). The synchronization of the instruments is based on a master-slave principle where one SMBV acts as master and supplies all necessary synchronization signals to the slave SMBVs. The setup is simple and provides highly synchronized signals without the need of an additional external synchronization unit. The master-slave mode is a standard feature of the SMBV's baseband generator options, the R&S®SMBV-B10, R&S®SMBV-B50 and R&S®SMBV-B51— no extra option is needed for this operating mode. It is available for all standards and the ARB.

Time synchronous signals are needed in several applications. For example, the master-slave setup is ideal for basic MIMO tests without fading simulation, certain GNSS test scenarios and WLAN IEEE 802.11ac applications with 80 MHz + 80 MHz channels (described in sections 4, 5 and 6, respectively). Synchronous baseband signals are also the basis for generating phase coherent RF carrier signals with the SMBV. For this purpose, the master-slave mode is used in combination with the phase coherence option of the SMBV (section 8). Phase coherent signals are needed, for example, for testing outphasing power amplifiers (section 9).

This application note also includes an example of remote control of a master-slave setup (section 7). The troubleshooting section (3.6) helps in debugging the setup.

3 Master-Slave Setup

Fig. 1 and 2 show the master-slave setup for two and four SMBVs, respectively.

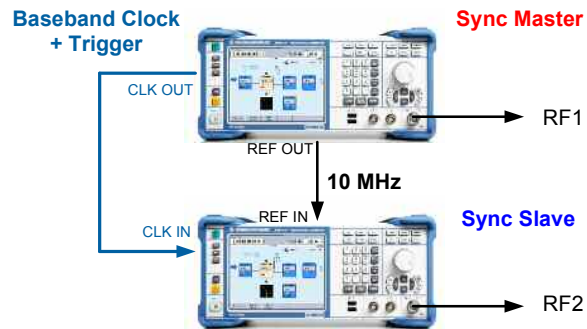

Fig. 1: Master-slave setup for two SMBVs.

One SMBV acts as master, the remaining SMBVs as slaves. The master provides clock and trigger signals for synchronization (via the same connection cables).

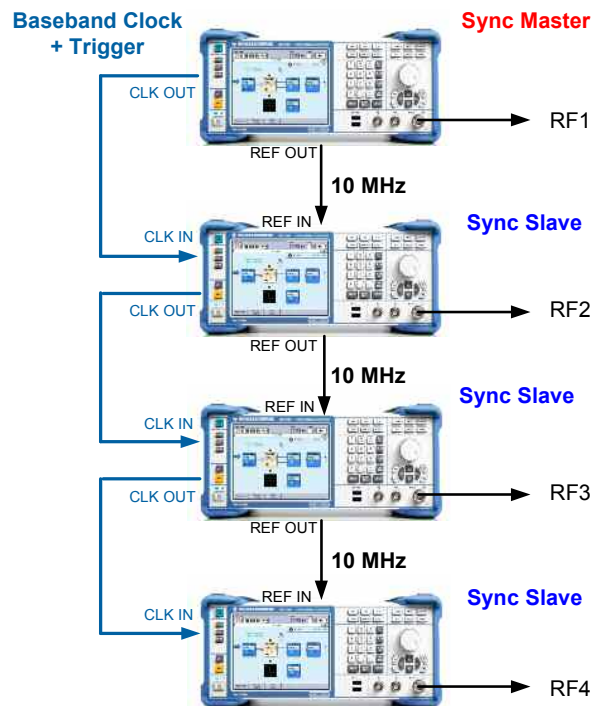

Fig. 2: Master-slave setup for four SMBVs.

3.1 Cabling

There are only two connection cables needed between each two SMBVs:

- one for the baseband clock
- one for the 10 MHz reference frequency

3.1.1 Clock Signal

The clock signal of the master is fed to the slaves to provide a *common baseband clock* for all instruments. The clock signal also includes the *trigger signal*¹. This means that the baseband clock and the trigger signal are transmitted via the same cable. This two-in-one synchronization signal yields enhanced trigger accuracy and assures that all SMBVs start signal generation synchronously. Furthermore, it assures that all SMBVs remain reliably synchronized.

The clock signal is distributed to the slaves by simple daisy-chaining: Connect the CLK OUT connector of the master SMBV to the CLK IN connector of the first slave SMBV. Connect the CLK OUT connector of the first slave SMBV to the CLK IN connector of the second slave SMBV, and so on.

The frequency of the distributed clock signal is always 50 MHz. The clock signal is amplified internally to prevent attenuation of the signal level when connecting more than two instruments in a daisy chain. Also, 50 Ω impedance matching is assured.

The master-slave setup has an intrinsic synchronization uncertainty, which is due to the fact that the trigger signal needs to travel from the master to the slave and then from slave to slave. This trigger delay depends on the length of the cables between the instruments. When the trigger signal arrives at a slave, the slave needs some time for internal processing before it can output the RF signal. This internal delay is, however, automatically compensated by the slave SMBV. Additionally, the SMBV can also compensate for the trigger delay. The user just needs to enter the lengths of the used cables. This automatic delay compensation² makes it possible to achieve virtually perfect time synchronization. With automatic delay compensation the residual synchronization uncertainty of the master-slave setup is <1 ns.

3.1.2 Reference Frequency Signal

The 10 MHz reference signal of the master is distributed to the slaves by simple daisy-chaining: Connect the REF OUT connector of the master SMBV to the REF IN connector of the first slave SMBV. Connect the REF OUT connector of the first slave SMBV to the REF IN connector of the second slave SMBV, and so on.

¹ The trigger information is modulated onto the clock signal for firmware versions 2.05.269 and higher.

² The automatic delay compensation is available for firmware versions 2.20.360.xx and higher.

3.2 Settings

3.2.1 Clock Settings

Master

Open the Trigger/Marker/Clock menu by clicking the “Clock” button in the digital standard main menu. The main menu is the first window that opens if a digital standard or the ARB is selected in the “Baseband” block of the SMBV.

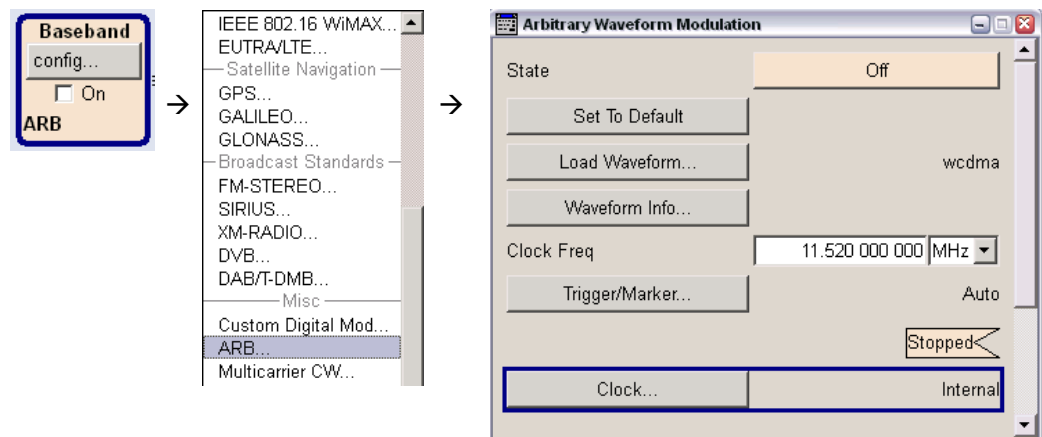

Set the “Sync Mode” to “Sync Master”. Click the “Set Synchronisation Settings” button. This automatically configures the trigger/marker settings for master-slave operation. (You may want to modify the trigger/marker settings for some applications as described in section 3.3.)

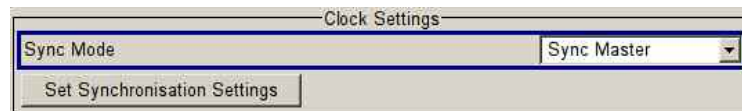

Slave

Open the Trigger/Marker/Clock menu by clicking the “Clock” button in the digital standard main menu. Set the “Sync Mode” to “Sync Slave”. Click the “Set Synchronisation Settings” button. This automatically configures the trigger/marker settings for master-slave operation.

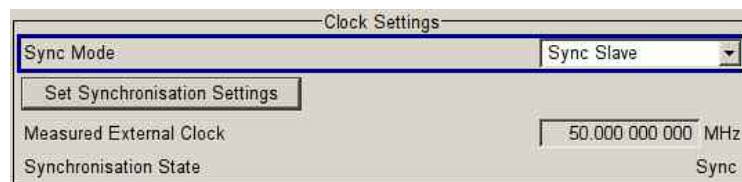

Click the “Global Trigger/Clock Settings” button.

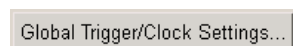

Set the “Automatic Delay Compensation State” to “On” (default setting). Enter the position of the slave SMBV within the daisy chain. If the instrument is the first slave in the chain, set the parameter “Slave Position in Chain” to “1”. If the instrument is the second slave in the chain, set the parameter to “2”, and so on. Finally, enter the physical lengths of the cables that are used to transmit the baseband clock. On the first slave SMBV, enter the cable length between the master and the first slave. On the second slave SMBV, enter the cable length between the master and the first slave *and* the cable length between the first and second slave. On the third slave, enter all three cable lengths, and so on. The following example illustrates how to configure the slaves:

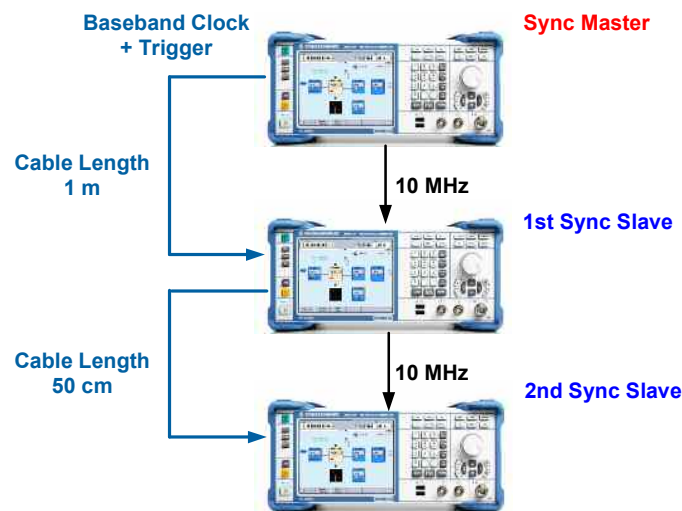

Example settings for 1st slave SMBV

Automatic Delay Compensation	
State	<input checked="" type="checkbox"/> On
Slave Position in Chain	1
Cable Length /m	
1	1.00

Example settings for 2nd slave SMBV

Automatic Delay Compensation	
State	<input checked="" type="checkbox"/> On
Slave Position in Chain	2
Cable Length /m	
1	1.00
2	0.50

Ordinary BNC cables contain dielectrics with a permittivity of $\epsilon_r = 2.7$ (or close to that). The synchronization accuracy of <1 ns can only be achieved if cables with this permittivity are used and the physical cable lengths are entered correctly. The default value is 0.5 m. If you use a longer or shorter cable and do not adjust the cable length setting, this will result in an uncompensated delay that can be up to several ns. For a permittivity of $\epsilon_r = 2.7$, the propagation speed of the signal in the cable is $c/\sqrt{\epsilon_r} = 1.8 \cdot 10^8$ m/s, where c is the speed of light. The trigger delay caused by a cable 1 m in length is thus 5.5 ns. For example, if you use a cable 1 m in length and do not adjust the cable length setting, there will be a discrepancy of 50 cm, which will result in an uncompensated delay of 2.75 ns.

3.2.2 Reference Frequency Settings

Master

Open the Reference Oscillator menu. Set the “Source” to “Internal”.

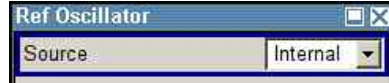

(It is also possible to use an external 10 MHz reference source connected to the REF IN connector of the master SMBV.)

Slave

In the Reference Oscillator menu, the “Source” has been automatically set to “External” by the “Set Synchronisation Settings” button.

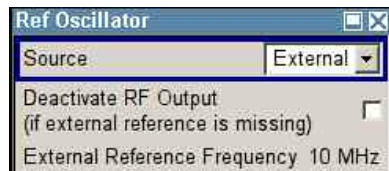

3.3 Triggering

The master-slave setup can be triggered in two different ways:

- External triggering
- Internal triggering

External triggering means that the master SMBV is triggered by an external trigger signal. Internal triggering means that the master SMBV uses its internal trigger signal. In both cases the slave SMBVs are triggered by the master SMBV.

3.3.1 External Triggering

Fig. 3 shows the master-slave setup for two SMBVs with external triggering.

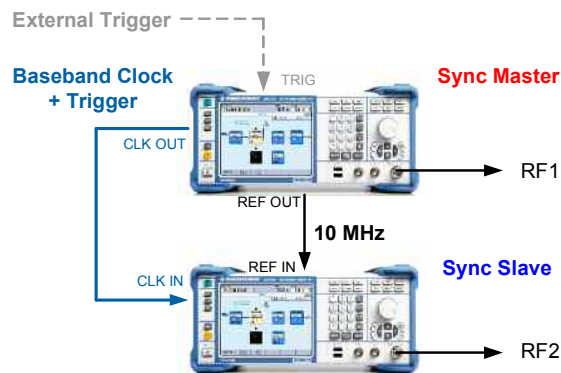

Fig. 3: Master-slave setup with external triggering.

Master

Connect an external trigger source to the TRIG connector. Note that you need to supply the external trigger signal only to the master; the slaves are triggered by the master via the clock line.

Open the Trigger/Marker/Clock menu by clicking the “Trigger/Marker” button in the digital standard main menu. The “Mode” has been automatically set to “Retrigger” by the “Set Synchronisation Settings” button. Set the “Source” to “External”. Enable the parameter “Sync. Output To Ext. Trigger” (default setting).

(You can also disable the parameter “Sync. Output To Ext. Trigger” if you desire. Please see the operating manual or the online help of your SMBV for details regarding the function of this parameter.)



Note that in “Retrigger” mode, signal generation starts automatically as soon as the baseband is turned on. If you do not want signal generation to start automatically, then use “Armed Retrigger” mode.

Slave

Open the Trigger/Marker/Clock menu by clicking the “Trigger/Marker” button in the digital standard main menu. The “Mode” has been automatically set to “Retrigger” and the “Source” to “External” by the “Set Synchronisation Settings” button. Enable the parameter “Sync. Output To Ext. Trigger” if you enabled it on the master instrument, and disable this parameter if you disabled it on the master instrument.



Note that in “Retrigger” mode, signal generation starts automatically as soon as the baseband is turned on. If you do not want signal generation to start automatically, then use “Armed Retrigger” mode.

Master and slave

For master and slave(s), configure the baseband signal according to your needs. Then, in the digital standard main menu of the master, set the “State” to “On”. Wait until the  sign appears. Afterwards, set the “State” to “On” for the slave(s).

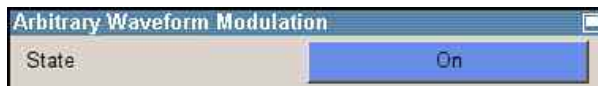

If the  sign has appeared at all slaves, the master-slave setup is ready.

Signal generation is synchronized in all instruments as soon as an external trigger event occurs.

3.3.2 Internal Triggering

Fig. 4 shows the master-slave setup for two SMBVs with internal triggering.

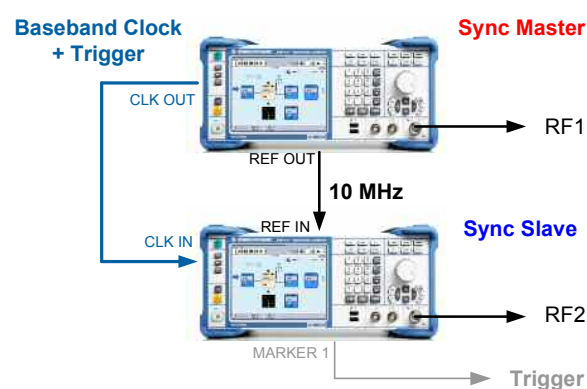

Fig. 4: Master-slave setup with internal triggering.

Master

The master generates the trigger signal internally. The slaves are triggered by the master via the clock line.

Open the Trigger/Marker/Clock menu by clicking the “Trigger/Marker” button in the digital standard main menu. The “Mode” has been automatically set to “Retrigger” by the “Set Synchronisation Settings” button. Set the “Source” to “Internal” (default setting).



Slave

Open the Trigger/Marker/Clock menu by clicking the “Trigger/Marker” button in the digital standard main menu. The “Mode” has been automatically set to “Retrigger” and the “Source” to “External” by the “Set Synchronisation Settings” button. Disable the parameter “Sync. Output To Ext. Trigger”.



Master and slave

For master and slave(s), configure the baseband signal according to your needs. Then, in the digital standard main menu of the master, set the “State” to “On”. Wait until the  sign appears. Afterwards, set the “State” to “On” for the slave(s).



If the  sign has appeared at all slaves, the master-slave setup is ready.

Signal generation is synchronized in all instruments as soon as you press the “Execute Trigger” button on the master SMBV.

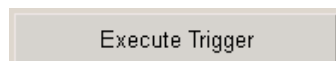

The internal trigger signal can be supplied to a DUT and other measuring equipment, e.g. for synchronization. In the Trigger/Marker/Clock menu, set Marker 1 to “Trigger”. With this setting, the internal trigger signal is output at the MARKER 1 connector of the SMBV (available for master and slaves). This trigger signal can be connected to the DUT and other measuring instruments.

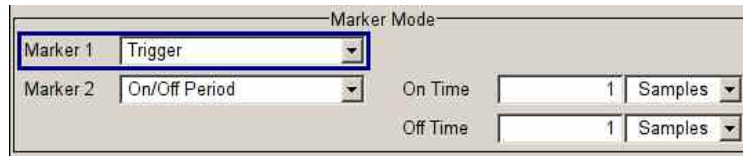

3.4 Verification Measurement

The master-slave setup as shown in Fig. 5 (internal triggering) is used for the measurement. Both SMBVs generate the same baseband signal so that they can be compared directly. The analog I signal of the master SMBV is fed to an oscilloscope, e.g. to an R&S®RTO or R&S®RTM. The I signal of the slave SMBV is fed to the second channel of the oscilloscope using a cable of the same type and of the exact same length. The MARKER 1 output signal can be used as trigger for the oscilloscope (see Fig. 5).

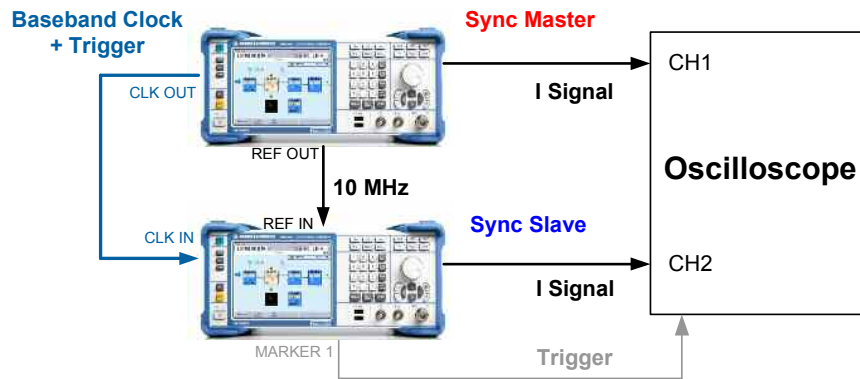

Fig. 5: Measurement setup for baseband time alignment.

A screenshot of the oscilloscope shows that the two I signals are synchronized.

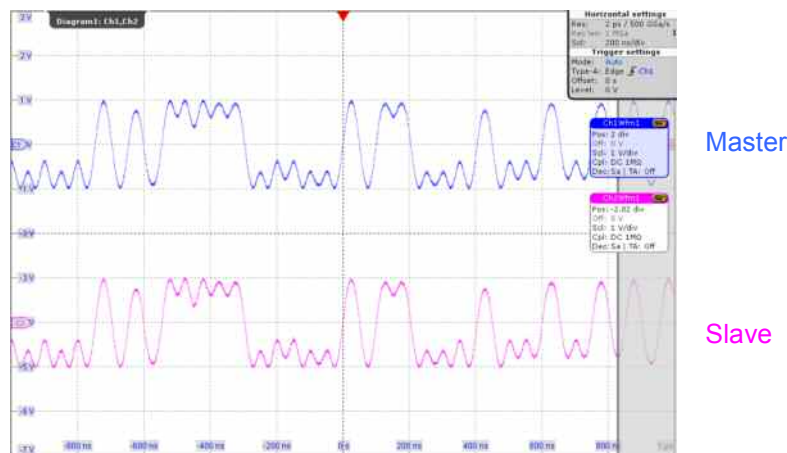

Fig. 6: I signals of the master and slave in the time domain (scale: 200 ns/div).

A closer look with overlaid oscilloscope traces shows the excellent alignment of the two I signals.

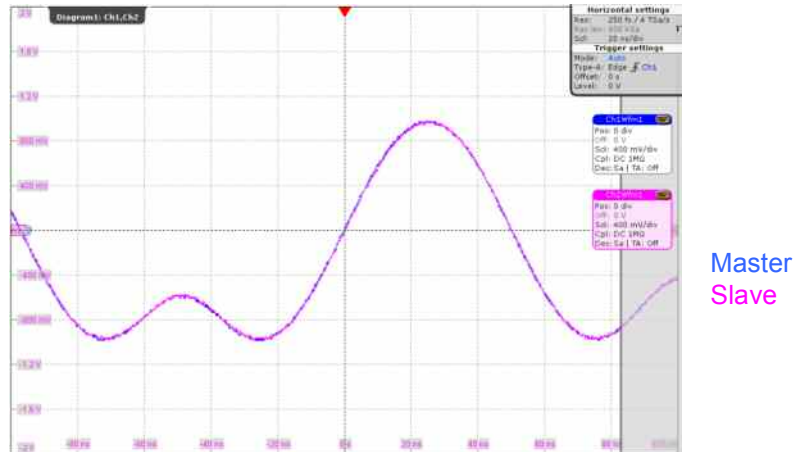

Fig. 7: I signals of the master and slave in the time domain (scale: 20 ns/div).

An even closer look shows a residual time difference between the two curves, which is measured using the oscilloscope cursors. In this example, the difference is only 0.31 ns.

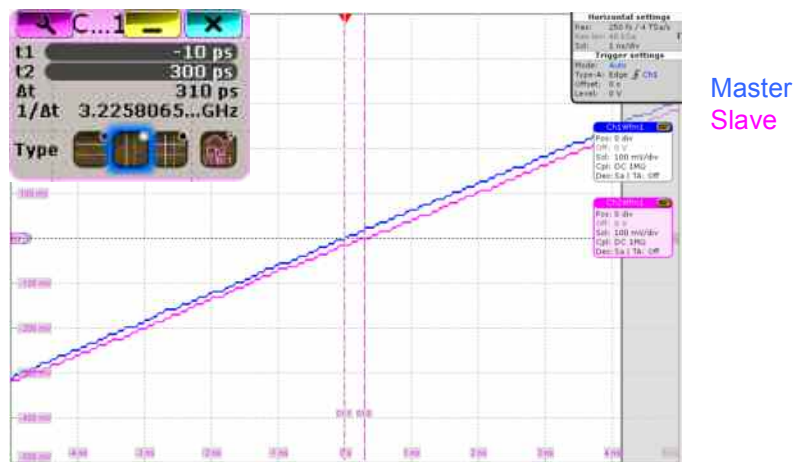

Fig. 8: I signals of the master and slave in the time domain (scale: 1 ns/div).

Note that it is essential to press the “Execute Trigger” button on the master SMBV to synchronize the instruments. Otherwise, if triggering is internal, the master and the slave do not output their signals synchronously.

The measurement shows that the two SMBVs are highly synchronized with a very small uncertainty of only 0.31 ns in this example. Note that a discrepancy between the entered cable lengths and the actually used cable lengths will lead to an uncertainty that can be up to several ns. For example, if the discrepancy between the entered and the used cable length is 50 cm, then an additional timing discrepancy of 2.5 ns between the two I signals would be observable on the oscilloscope (see section 3.2.1 for more details).

The perfect baseband synchronization normally translates into perfect synchronization of the RF signals. In some cases, the RF sections of the SMBVs can have a small influence on the synchronization. For example, if different RF output levels are used for the two SMBVs, the step attenuator settings can be different, which could lead to slightly different transit times in the RF sections. The influence would, however, be small. The additional time difference would be <1 ns.

3.5 Checking and Optimizing Signal Synchronization

For applications with extreme requirements regarding synchronization accuracy, the timing of the SMBVs can be cross-checked and even optimized (where applicable) with a simple test setup requiring only a conventional oscilloscope such as the R&S® RTM. This setup is shown in Fig. 5. Note that the cables feeding the I signals to the scope must be of the same type and exactly the same length. For example, the synchronization of the SMBVs may need optimization in case the precise cable lengths are not known and therefore only estimated lengths can be entered on the slave SMBVs. It is even possible to further optimize the excellent synchronization presented in the previous section to an uncertainty below the measured 0.31 ns.

A simple and fast adjustment technique is used to precisely align the SMBVs in time. First, use the oscilloscope cursors to measure the time difference between the I signals from the master and the slave. Note that both SMBVs need to generate (temporarily) the same baseband signal for this measurement. For example, we assume the measured difference between the two curves is 38 ns as can occur if the automatic delay compensation is disabled. (We choose an example with a “large” difference, since this can be better demonstrated with the oscilloscope.)

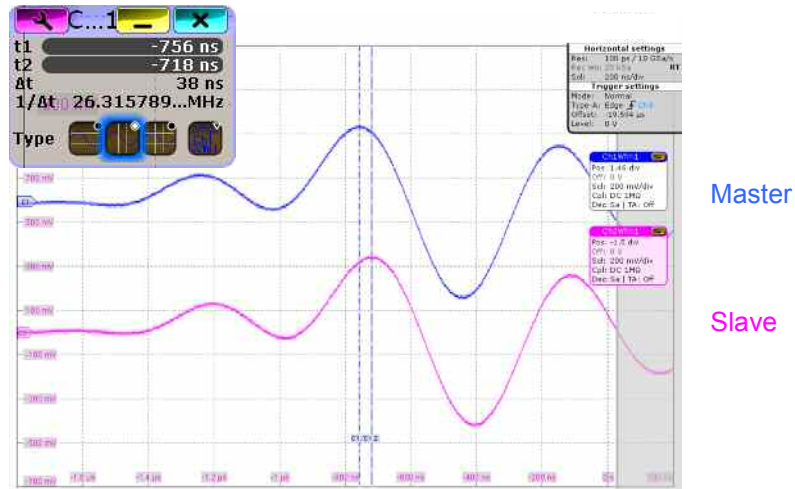
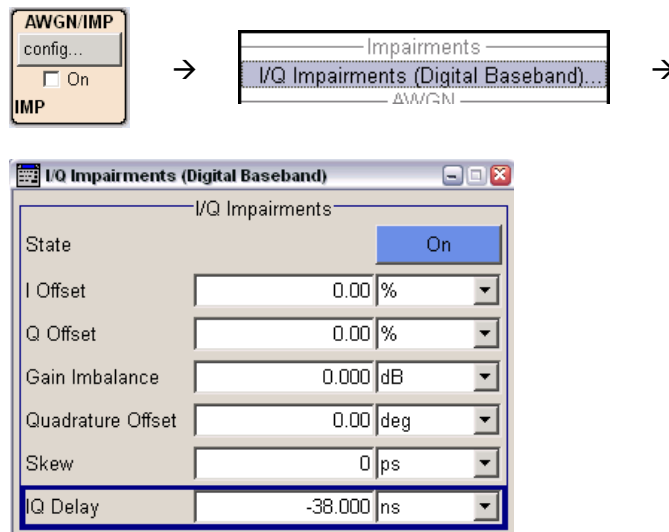

Fig. 9: I signals of the master and slave in the time domain before time alignment.

Open the I/Q Impairments (Digital Baseband) menu on the *slave* SMBV and enter the measured time difference as a negative I/Q delay.



In this example, the “IQ Delay” is set to –38 ns. Note that the I/Q delay can be set in realtime without interrupting the signal generation. You can therefore use this parameter for synchronization fine-tuning in realtime. Since its resolution is 1 picosecond, ultra-precise time alignment is possible. A screenshot of the oscilloscope shows that the two I signals are now perfectly aligned in time.

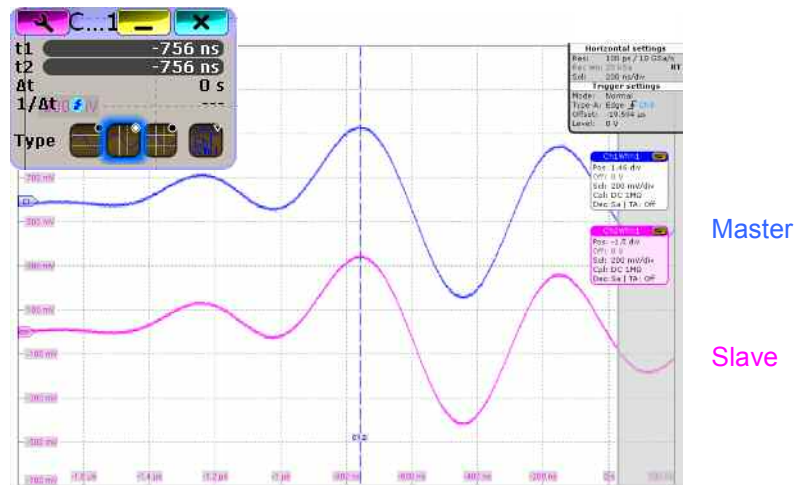

Fig. 10: I signals of the master and slave in the time domain after time alignment.

The I/Q delay that has been set to achieve perfect baseband synchronization is a constant and remains the same after switching the SMBVs off and on. This means that the I/Q delay has to be determined only once and can then be used for a longer period of time, provided the setup does not change.

The baseband signals generated by the SMBVs on the master-slave setup usually differ in real applications. However, for the measurement explained above, the SMBVs need to generate (temporarily) identical baseband signals. It does not matter which signal is generated, essential is only that the same signal is generated. After the time alignment, different baseband signals can be set on the SMBVs as required for the application.

3.6 Troubleshooting

This section helps you in debugging your setup. We list some types of failure and instructions on how to fix them.

- The measured time difference between the I signals from the master and the first slave is significantly greater than 1 ns.
 - Check if the automatic delay compensation is enabled. If it is not, enable it.
 - Check if the entered cable lengths for the automatic delay compensation are correctly set in each slave SMBV.
 - Check if the cables to the oscilloscope are of exactly the same length. If they are not, replace them with equally long cables of the same type.
 - Check if you are using the “Auto” trigger mode for the master SMBV. If so, change it to “Retrigger”.
 - Check if you disabled the parameter “Sync. Output To Ext. Trigger” on the slave SMBV when you use internal triggering of the master-slave setup. If the parameter is not disabled, disable it.
 - Press the “Execute Trigger” button on the master SMBV or initiate an external trigger event.

- Check the “Synchronisation State” of the slave SMBV. It must be “Sync”.
- The “Synchronisation State” of the slave SMBV is “Not Sync”.



- Check if the cable for the baseband clock is connected correctly.
- Check if the baseband of the master SMBV is turned on. If the baseband is turned off, then the master will not provide the clock signal to the slave. Therefore, make sure that the baseband of the master is turned on before you turn on the baseband of the slave.
- The oscilloscope does not trigger correctly.
 - Check if the marker mode of the used marker output is set to “Trigger” when using internal triggering.
 - Use the single-shot trigger mode of your oscilloscope. When the oscilloscope is waiting for the trigger signal, press the “Execute Trigger” button on the master SMBV to initiate a trigger signal or initiate an external trigger event.
- The curves of the I signals from the master and the slave look totally different on the oscilloscope, not just shifted against each other.
 - Check the “Synchronisation State” of the slave SMBV. It must be “Sync”.
 - Check if you generate the exact same signal in the basebands of both SMBVs. If you need two different baseband signals for your application, use temporarily identical signals for the measurement.
 - Check if you have applied a baseband phase offset in one of the instruments. If so, remove this phase offset temporarily for the measurement, since it leads to a deformation of the I signal.
 - Press the “Execute Trigger” button on the master SMBV or initiate an external trigger event.
- After power cycling the instruments, the slave SMBV shows the static error message “Baseband-Synchronisation between devices failed!”.
 - Click the “Set Synchronisation Settings” button of the slave SMBV and then press the “Execute Trigger” button on the master SMBV or initiate an external trigger event.
- The RF signals are not phase coherent even after precise time alignment of the baseband signals.
 - This is expected. The master-slave mode guarantees *time* synchronized RF signals but not *phase* coherent signals. This requires a common LO signal for master and slave instruments plus a phase calibration. Please see section 8 for details.

4 Application – MIMO Test Setup

Equipped with the respective options, the SMBV can generate standard-compliant SISO, transmit diversity and spatial multiplexing MIMO transmitter signals for the modern communications standards such as LTE, HSPA+, WiMAX™ and WLAN IEEE 802.11. Up to four different transmit antennas can be simulated with diversity or spatial multiplexing data precoding. If realtime fading simulation is not a requirement, several SMBVs in master-slave mode form a cost-efficient test system, for example for basic 2x2 or 4x4 MIMO testing. The time synchronized test signals allow accurate and repeatable measurements on MIMO receivers.

For example, a 4x4 MIMO system consists of four transmit and four receive antennas with 16 transmission channels.

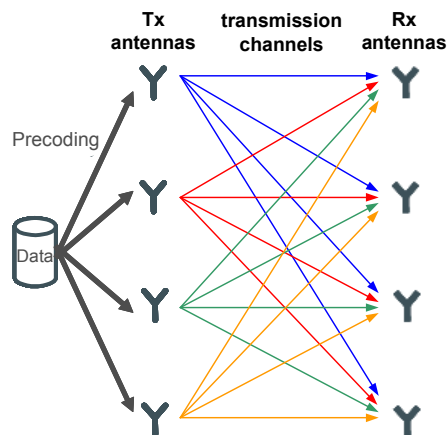

Fig. 11: Schematic of 4x4 MIMO with 16 transmission channels.

The signals of the four transmit antennas – the four Tx signals – can be generated using the digital standard options of the SMBV. The application note “Guidelines for MIMO Test Setups – Part 1” (1GP50) describes in detail how to generate these Tx signals with MIMO data precoding. The Tx signals can be used to measure the RF characteristics of the MIMO receiver without channel simulation, such as demodulation and decoding capability, dynamic range, sensitivity (by applying AWGN), cross-talk between antennas and many more.

As shown in Fig. 11, the signal at one of the four receive antennas is a (weighted) combination of the different Tx signals. Such an Rx signal can be generated using the ARB generator of the SMBV. The transmitter signals are combined with specific weightings to create an Rx signal as seen by the receiver under static channel conditions. Application note 1GP50 also describes how to generate these MIMO Rx signals. The Rx signals permit elementary channel simulation, which can be used to test the algorithms of the receiver under well-defined conditions. The receiver must be able to reconstruct the different transmitter signals from the received signal.

The setup used for 4x4 MIMO is identical for Tx and Rx signal generation. In both cases, four SMBVs are used in master-slave mode to ensure that signal generation starts synchronously in all instruments. Each SMBV generates one MIMO signal, either a Tx or Rx signal.

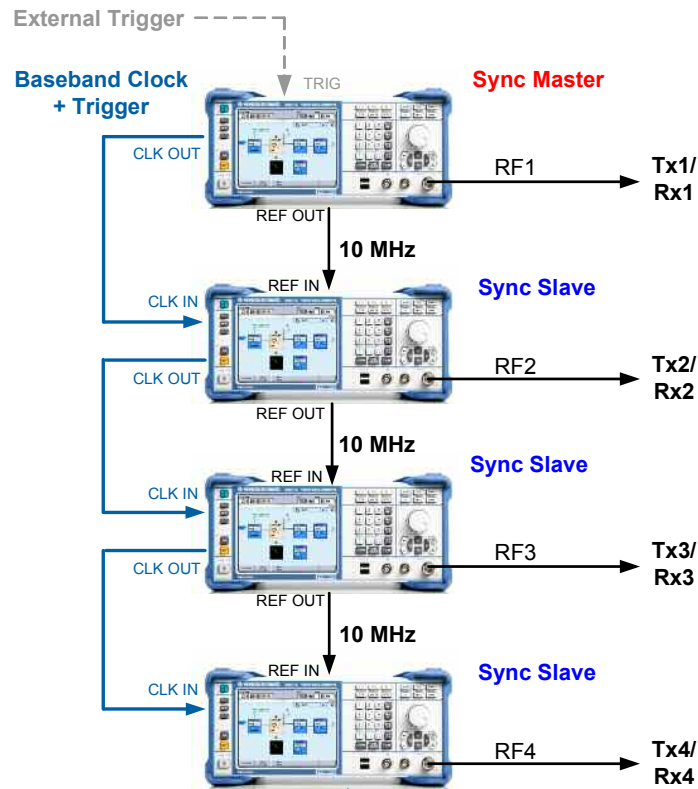

Fig. 12: Test setup for four antennas.

5 Application – GNSS Test Setup

Equipped with the respective options, the SMBV can generate signals for global navigation satellite systems (GNSS) such as GPS, Glonass and Galileo. The different GNSS signals can be simulated separately or simultaneously using the hybrid mode. The hybrid mode is very useful for GNSS receiver testing because in the real world, today's receivers "see" and process satellite signals of more than just a single satellite system.



Fig. 13: Sky view display of the SMBV showing the satellites visible in the sky.

Scenario example 1

One SMBV can simulate up to 12 satellites. This is sufficient to reproduce the maximum visible satellites of one GNSS system in the sky. The remaining satellites of this system are hidden beyond the horizon and thus invisible for the receiver. The SMBV can also simulate the visible satellites of another GNSS system in parallel (in a hybrid scenario), for example six GPS and six Glonass satellites. If more than 12 satellites are needed to reproduce the wanted satellite configuration in the sky, then a second SMBV can be used. For example, one SMBV simulates the GPS satellites while the second SMBV simulates the Glonass satellites. Up to 24 satellite signals can be simultaneously generated in this way. To ensure that signal generation starts synchronously in both instruments, the master-slave setup is used.

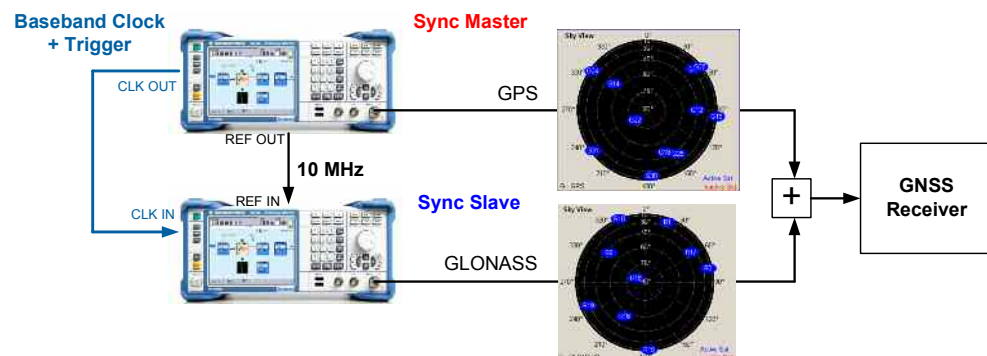

Fig. 14: Setup for simulating up to 24 satellites.

Connect and configure the master-slave setup as described in section 3. Follow the instructions given there but consider also the following points:

- One SMBV generates e.g. the GPS signals. Consequently, the master-slave mode has to be set via the Trigger/Marker/Clock menu of the GPS main menu.
- The second SMBV generates e.g. the Glonass signals. For this instrument, the master-slave mode has to be set via the Trigger/Marker/Clock menu of the Glonass main menu.

To assure that the simulated satellite constellations of both SMBVs match regarding location, date and time, the following settings need to be made:

- The same geographic location must be set in both SMBVs.
- The same simulation date and time must be set in both SMBVs.

There are two ways to set the different RF frequencies required for GPS and Glonass:

- Each SMBV is set to a different RF frequency. This is done automatically if the parameter “Use Common RF Frequency” is disabled in both instruments.

Use Common RF Frequency On

Frequency
1.575 420 000 000 GHz ▾

Frequency
1.602 000 000 000 GHz ▾

This simple method is recommended and should always be used if phase coherent RF signals are not required for testing.

- Both SMBVs are set to a common RF frequency, and a suitable frequency offset is applied in the baseband of each SMBV. This is done automatically by the SMBV if the parameter “Use Common RF Frequency” is enabled in both instruments.

Use Common RF Frequency On

Frequency
1.585 650 000 000 GHz ▾

A negative frequency offset is set implicitly in the baseband of one SMBV, a positive frequency offset in the baseband of the other SMBV. As a result, the actual output frequencies of the SMBVs differ: One SMBV outputs the GPS carrier frequency at 1.57542 GHz, and the other SMBV outputs the Glonass carrier frequency at 1.602 GHz.

This method is a bit more complex but has the benefit that the generation of phase coherent RF signals is possible as required for GNSS applications that evaluate the satellite signal carrier phase. For generating phase coherent RF signals, it is essential that the two SMBVs have the same RF carrier frequency setting (see section 6 for details). The limitation of this method, however, is that the two carrier frequencies cannot differ by more than 120 MHz.

Scenario example 2

In another test scenario, two SMBVs are used to simulate satellites at different RF carrier frequencies. For example, both instruments generate GPS signals, but one SMBV outputs an RF frequency of 1.57542 GHz corresponding to the L1 frequency and the other SMBV outputs 1.2276 GHz corresponding to the L2 frequency. By transmitting GPS signals on two frequencies, the receiver can compensate ionospheric effects that would otherwise increase the pseudorange³ error/bias. The positioning accuracy can thus be improved. To ensure the time synchronization of both SMBVs, the master-slave setup is used.

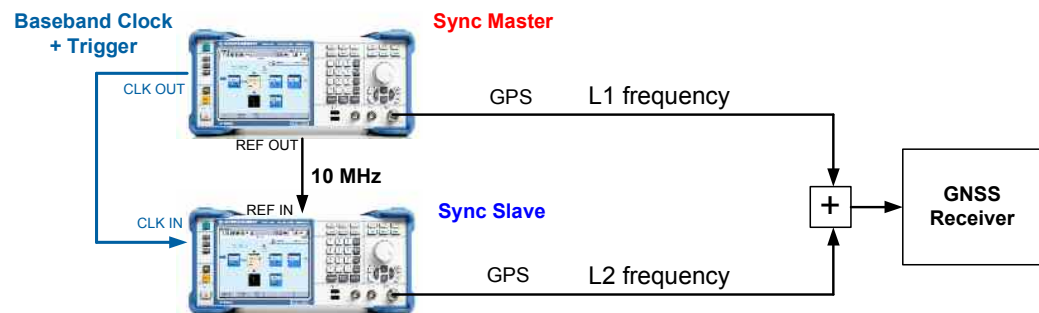
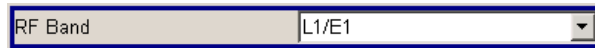

Fig. 15: Setup for multifrequency GNSS applications.

Connect and configure the master-slave setup as described in section 3. Each SMBV is set to a different RF frequency corresponding to the L1 and L2 frequency. This is done by setting the parameter “RF Band” to “L1/E1” or “L2”, respectively.



To assure that the simulated satellite constellations of both SMBVs match, the same geographic location and the same simulation date and time must be set in both SMBVs.

³ The pseudorange is the distance the satellite signal traveled from the satellite to the GNSS receiver.

In general, the master-slave setup with automatic delay compensation must be used for all GNSS test scenarios to assure precise time synchronization of the SMBVs. This is essential because otherwise the pseudorange bias can be substantial. The pseudorange is obtained by multiplying the speed of light (c) by the time the signal needs for traveling from the satellite to the receiver. Accuracy errors in the time synchronization of the SMBVs will cause pseudorange bias for the satellites as demonstrated by the following two examples:

pseudorange bias = travel time · c

- synchronization accuracy is 38 ns:
pseudorange bias = 38 ns · $3 \cdot 10^8$ m/s = 11.4 m
- synchronization accuracy is 1 ns:
pseudorange bias = 1 ns · $3 \cdot 10^8$ m/s = 0.3 m

With a very high accuracy of 1 ns, the uncertainty of the pseudorange is minimized to 0.3 m.

Which pseudorange bias is acceptable for testing depends on the application. The following table gives an overview of different GPS applications and their required precision ranges.

Precision ranges of GPS applications		
Application	Precision range	Setup
Commercial GPS C/A, code phase only	10 m to 15 m	Master-slave
Commercial GPS C/A, code phase + carrier phase	10 m to 15 m	Master-slave + phase coherence option
Military GPS, C/A and P code	5 m to 10 m	Master-slave
Multifrequency, e.g. GPS L1 and L2	5 m	Master-slave

For applications where the carrier phase of the GNSS signal is evaluated by the receiver, phase coherent RF signals are required. In this case, the master-slave setup needs to be upgraded and a phase calibration of the RF signals needs to be performed (as described in section 8).

6 Application – WLAN IEEE 802.11ac Test Setup

Equipped with the required options, the SMBV can generate standard-compliant WLAN IEEE 802.11ac signals. The 802.11ac standard supports higher data rates and wider RF signal bandwidths than its predecessor standards. Besides 20 MHz and 40 MHz channels (as used in the 802.11n standard), the 802.11ac standard also uses 80 MHz, 80 MHz + 80 MHz and 160 MHz channels.

For the 80 MHz + 80 MHz channel, two transmission modes are possible: contiguous mode and non-contiguous mode. The following table summarizes and illustrates the different 802.11ac bandwidths.

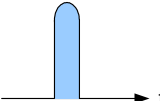
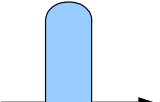
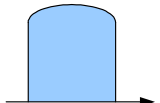
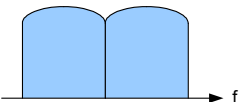
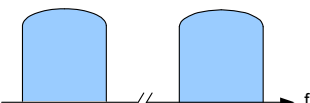
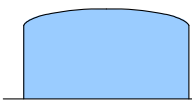
WLAN IEEE 802.11ac bandwidths		
Channel bandwidth	Channel bandwidth illustration	Required instrument
20 MHz		e.g. one SMBV
40 MHz		e.g. one SMBV
80 MHz		e.g. one SMBV
80 MHz + 80 MHz contiguous mode		e.g. two SMBVs
80 MHz + 80 MHz non-contiguous mode		e.g. two SMBVs
160 MHz		One R&S® AFQ100A/B baseband signal generator + e.g. one SMBV for upconversion

802.11ac signals with channel bandwidths of 20 MHz, 40 MHz and 80 MHz can be generated with just a single SMBV. To generate the 80 MHz + 80 MHz channel modes, two SMBVs are used. Each SMBV generates one 80 MHz signal with appropriate RF frequency. To ensure that signal generation starts synchronously in both instruments, the master-slave setup is used.

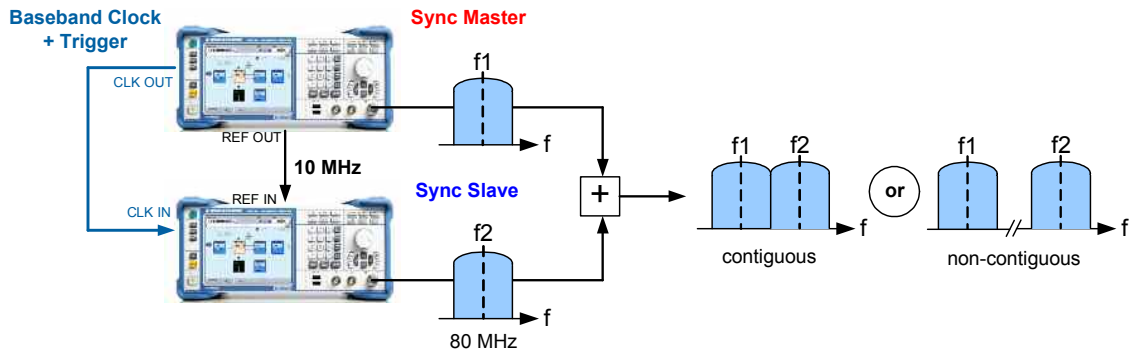

Fig. 16: Setup for WLAN IEEE 802.11ac 80 MHz + 80 MHz signal generation with the SMBV.

Connect and configure the master-slave setup (as described in section 3) via the Trigger/Marker/Clock menu of the IEEE 802.11 WLAN main menu. Set each SMBV to an appropriate RF frequency to achieve either contiguous or non-contiguous transmission.

7 Remote Control of Master-Slave Setup

The SMBV can be remote controlled via automated test programs using SCPI commands. The test program needs to control the master and the slaves in a coordinated way to avoid instrument and measurement errors.

Always configure the master SMBV first and turn on the baseband. Note that if the baseband of the master is turned off, then it will not provide the clock signal to the slave. This will lead to error messages on the slave SMBVs. Therefore, configure the master first and make sure that it has settled. Afterwards, configure the slaves.

The following example shows how to correctly configure the master-slave setup via remote control. Red commands are sent to the master and blue commands are sent to the slave. The “//” sign marks comments. For this example, the GNSS setup shown in Fig. 15 is used with internal triggering.

```
// start with defined state of master
*RST, *CLS
*OPC?
// query master for static errors
SYST:SERR?

// start with defined state of slave
*RST, *CLS
*OPC?
// query slave for static errors
SYST:SERR?

// clock settings of master
BB:GPS:CLOCK:SYNC:MODE MASTER
BB:GPS:CLOCK:SYNC:EXECUTE

// reference frequency setting of master
ROSC:SOURCE INTERNAL

// trigger settings of master, internal triggering
BB:GPS:TRIG:SEQ RETRIGGER
BB:GPS:TRIG:SOURCE INTERNAL

// configure baseband of master: GPS Signal, L1
...
...

// wait for command completion and check master for errors
*OPC?
SYST:ERR:ALL?

// turn on baseband of master
BB:GPS:STATE ON

// wait until master has settled
*OPC?
```

```
// clock settings of slave
BB:GPS:CLOCK:SYNC:MODE SLAVE
BB:GPS:CLOCK:SYNC:EXECUTE

// global clock settings of slave
INP:DELAY:ADCSTATE ON // activate automatic delay compensation
INP:DELAY:SPOSITION 1 // set position of slave in daisy chain
INP:DELAY:CLENGTH1 1 // set cable length to 1 m

// reference frequency setting of slave
ROSC:SOURCE EXTERNAL

// trigger settings of slave
BB:GPS:TRIG:SEQ RETRIGGER
BB:GPS:TRIG:SOURCE EXTERNAL
BB:GPS:TRIG:EXT:SYNC:OUTPUT OFF

// configure baseband of slave: GPS Signal, L2
...
...

// wait for command completion and check slave for errors
*OPC?
SYST:ERR:ALL?

// turn on baseband of slave
BB:GPS:STATE ON

// wait until slave has settled
*OPC?

// note: as long as the slave has not received a trigger event
// from the master, the slave will show a static error

// execute trigger at master
BB:GPS:TRIG:EXECUTE
*OPC?

// give the slave some time to turn the static error into a
// normal error (which is archived in the error queue)
// i.e. halt the execution of the program for 1 s, e.g. by using
// a sleep, delay or pause command

// query slave for static errors to check if the baseband
// synchronization succeeded
SYST:SERR?
```

If the baseband synchronization has failed, then a *static* error will appear on the slave SMBV. This static error is a permanent message and should be queried to check if the instruments are indeed synchronized.

For more information and tips about SCPI programming, see the application note “Top Ten SCPI Programming Tips for Signal Generators” (1GP79). It also explains the fundamental difference between normal and static errors.

8 Phase Coherent Signal Generation

The master-slave setup on its own does not provide phase coherent carrier signals. It “only” provides highly time synchronous signals. However, the master-slave setup serves as a basis for phase coherent vector signal generation with multiple SMBVs. A stable phase relationship between two RF carriers can be achieved by using a common local oscillator (LO) signal for upconverting the time synchronous baseband signals to the RF. This minimizes the phase drifts between the RF carriers. The SMBV offers the R&S®SMBV-B90 phase coherence option for generating phase coherent signals. This option makes it possible to distribute the LO signal generated by one SMBV to other SMBVs, allowing multiple I/Q modulators to be driven by the same LO signal. Consequently, all slave SMBVs have the same RF frequency as the master SMBV.

Please see also the application notes “Phase Adjustment of Two MIMO Signal Sources with Option B90” (1GP67) and “Guidelines for MIMO Test Setups – Part 1” (1GP50) for a more detailed introduction to phase coherence.

8.1 Cabling

The setup is simply a master-slave setup with additional LO connections.

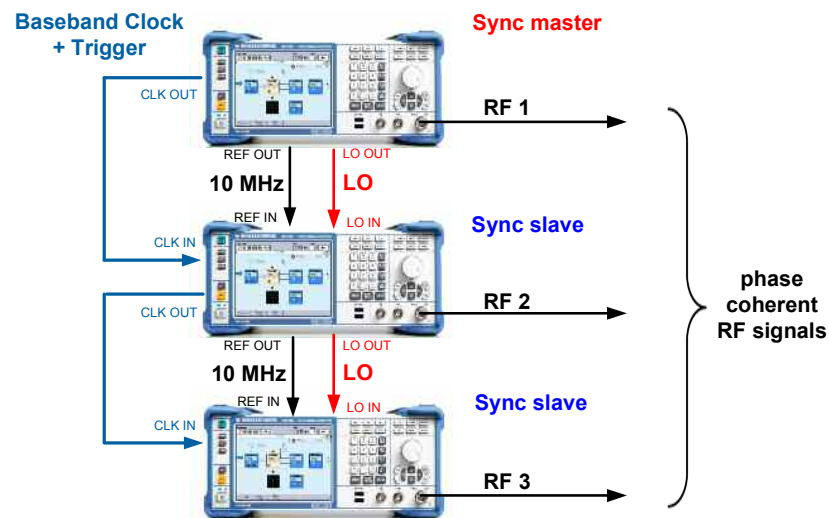

Fig. 17: Setup for generating three phase coherent signals (internal triggering).

The LO signal generated by the master instrument is fed to multiple slave instruments by simple daisy-chaining: Connect the LO OUT connector of the master SMBV to the LO IN connector of the first slave SMBV. Connect the LO OUT connector of the first slave SMBV to the LO IN connector of the second slave SMBV, and so on.

To prevent the LO signal from getting weaker and weaker when cascading more than two instruments, the LO signal is internally amplified before redistribution. Naturally, the signal quality of the LO signal degrades slightly with each additional instrument, as does the RF signal quality. Unlimited cascading is therefore not possible. But tests with four SMBVs show similarly good EVM performance for all instruments.

In addition, connect the SMBVs for the master-slave mode as described in section 3.

8.2 Settings

Configure the SMBVs for the master-slave mode as described in section 3. In addition, configure the instruments for LO coupling as follows:

Master

Click on the “RF/A Mod” function block and select “LO Coupling” from the list. Set the LO Coupling “Mode” to “Internal” and set the “Out State” to “On”. The master SMBV runs with its internal LO synthesizer.

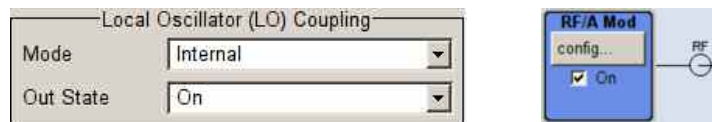

Slave

Click on the “RF/A Mod” function block and select “LO Coupling” from the list. Set the LO Coupling “Mode” to “External” and set the “Out State” to “On” (only the “Out State” of the last slave can be set to “Off”). The slave SMBVs use the external LO synthesizer signal from the master SMBV.

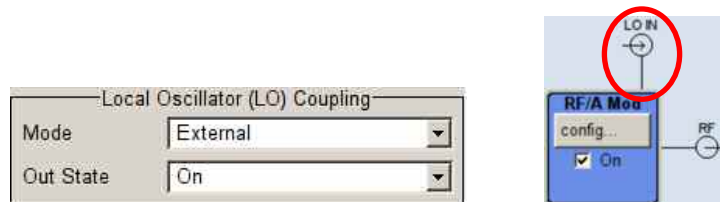

8.3 Triggering

The triggering of the setup is as described in section 3.3.

8.4 Phase Coherence for Continuous Wave (CW) Signals

A common LO signal ensures that the phase relationship between two RF carriers is stable, i.e. the delta phase ($\Delta\phi$) is constant. The RF signals are therefore phase coherent. However, the delta phase is unknown. The question now is, what is the exact value of the delta phase and how can it be adjusted to a specific, wanted value? The method used to perform this phase calibration is described in detail in the application note “Phase Adjustment of Two MIMO Signal Sources with Option B90” (1GP67). Fig. 18 shows the setup.

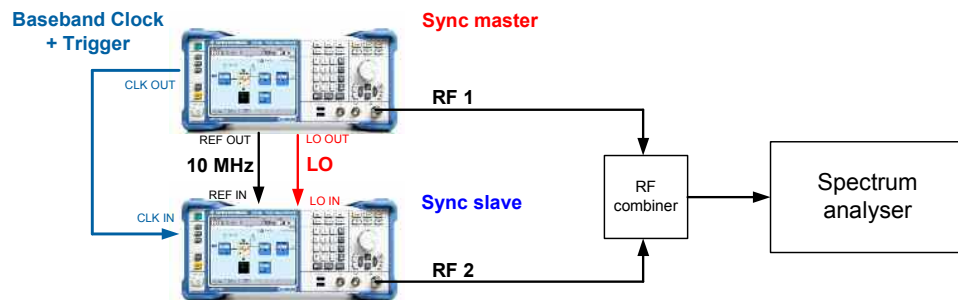
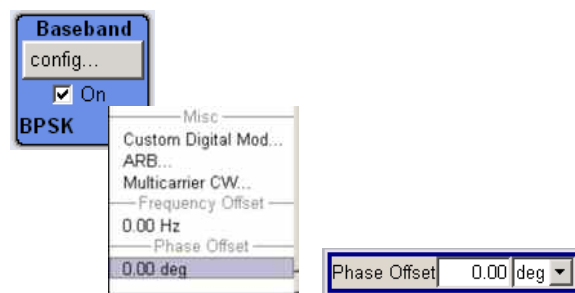

Fig. 18: Setup for phase calibration.

The phase calibration can be performed either manually or with the help of a software tool (that is part of 1GP67). In either case, the calibration is performed with CW signals. For calibration and later for phase adjustment, a phase offset needs to be set on the SMBV. Due to the coupled RF sections (common LO), this phase offset cannot be set directly in the RF section, but must be set in the baseband section of the SMBV. The use of I/Q modulation is therefore mandatory when using LO coupling. This means that the RF carriers (CW signals) are generated via the baseband section, e.g. by using “Custom Digital Modulation” with BPSK modulation and data source “All 1” or by using the ARB generator to play back a CW signal waveform generated with R&S® WinIQSIM2 simulation software.



The calibration method is based on the fact that two CW signal of identical RF frequency and level cancel each other out completely if they have a delta phase of 180° . In this case, they interfere destructively when added by means of an RF combiner. The level at the combiner output is thus an indication of the delta phase. The lower this level is, the closer the delta phase is to 180° .

The manual phase calibration procedure is as follows:

- Let the SMBVs warm up (for about 15 minutes).
- Generate a CW signal *in the baseband* of each SMBV, e.g. by using “Custom Digital Modulation” with BPSK modulation and data source “All 1”.
Note: Configure the master-slave setup (see section 3) from the used digital standard menu, e.g. “Custom Digital Modulation”.
- Set the RF frequency that you intend to use for your application (on the master SMBV).
- Set the same RF level in both SMBVs. Use the RF level you intend to use for your application.
- Set the spectrum analyzer to zero span.
- Adjust the baseband phase offset of the slave SMBV such that the power on the analyzer is minimal.
- Adjust the RF level of the slave SMBV such that the power on the analyzer is further minimized. In order to achieve “perfect” cancellation, the level of the two CW signals must match precisely. Due to the small level uncertainty of the SMBV and to slightly different cable losses in the setup, this might not be the case. For this reason, vary the RF level slightly by a few tenths of dB or less.
- Fine-adjust the baseband phase offset of the slave SMBV such that the power on the analyzer is absolutely minimal. For example, the power should decrease by about -60 dB for high RF levels such as 0 dBm.
- Now, the two CW signals have a delta phase of 180° . Therefore, subtract 180° from the phase offset set on the slave SMBV. For example, if the set phase offset is currently 267.60° , then enter $267.60^\circ - 180^\circ = 87.60^\circ$ as new phase offset.
- Now, the two CW signals have a delta phase of 0° . To adjust the delta phase to any desired value, use the phase offset of the master SMBV. This is the easiest method to set a certain phase relationship between the RF carriers.
- Done.

Generally, the phase offset required to align the RF phases remains the same after switching the SMBVs off and on again. Therefore, the required phase offset has to be determined only once and can then be used for an extended period of time, provided the setup as well as calibration-relevant settings are not changed and the SMBVs have warmed up. You need to repeat the calibration in the following cases:

- If you change the cables. The cables used during the phase calibration should also be used for connecting to the DUT, since they are “included” in the calibration. Therefore, the calibration is only valid for these cables.
- If you change the RF frequency.
- If you change the RF level when the attenuator mode is set to “Auto”.

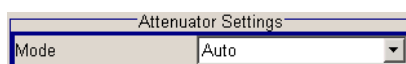

- If you reset the instrument. If a preset is performed, the calibration settings are lost.
- If the environmental conditions change noticeably, e.g. if the ambient temperature changes.

You do *not* need to repeat the calibration in the following cases:

- If you change the RF level when the attenuator mode is set to “Fixed”.

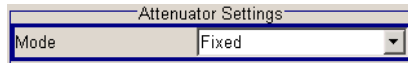

8.5 Phase Coherence for I/Q Modulated Signals

Due to the operating concept of the R&S®SMBV-B90 phase coherence option, CW signals need to be generated via the baseband section using I/Q modulation. However, in the following an I/Q modulated signal should always denote a “truly” modulated baseband signal.

Strictly speaking, phase coherence is only defined for CW carriers with equal frequencies (or for CW carriers whose frequencies are multiples of each other). However, it is still possible to use the SMBV’s phase coherence option also for I/Q modulated signals. In this case, phase coherence is only defined for the *center carriers* of the modulated signals!

Such signals are used, for example, for MIMO beamforming applications, GNSS carrier phase measurements, military applications and outphasing power amplifier testing (see section 9).

To achieve phase coherence for modulated signals, a precise synchronization of the signal sources is absolutely essential. The phase calibration with CW signals ensures that the phases of the RF signals are aligned, and due to the periodicity of CW signals, it does not matter whether the start of the signals is perfectly synchronous or not. In contrast, for I/Q modulated signals a synchronous start is crucial, for otherwise the signals will be misaligned in time.

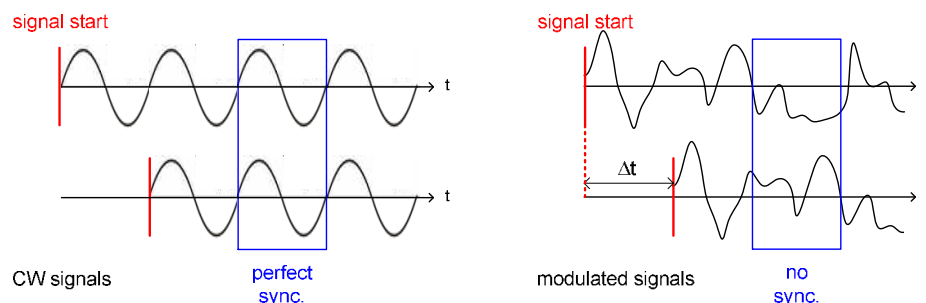

Fig. 19: Effect of unsynchronized start for two CW signals (after phase calibration) and two modulated signals.

The master-slave setup is therefore essential, since it offers highly synchronized RF signals. If you want to verify the time synchronization of the SMBVs, please refer to section 3.5.

The procedure for generating phase coherent I/Q modulated signals is as follows:

- Perform the phase calibration with two CW signals (as described in section 8.4) Make sure that you use equally long cables to connect to the combiner.
- Generate the wanted I/Q modulated signal in the baseband of each SMBV. Note: Configure the master-slave setup (see section 3) from the used digital standard menu, e.g. "EUTRA/LTE".
- Done.

Note that you do *not* need to repeat the phase calibration if you change the baseband signal, e.g. if you change from a "Custom Digital Modulation" signal to an ARB signal.

If you are unsure whether the cables and the combiner might introduce delays that degrade the time synchronization, you can use the setup shown in Fig. 18 to fine-adjust the time synchronization of the complete setup. (However, if you use a high-quality combiner and equally long cables, this adjustment is generally not needed.) The procedure is as follows:

- Perform the phase calibration with two CW signals. (Already done.)
- Generate the wanted I/Q modulated signal in the baseband of the master SMBV. Note: Configure the master-slave setup (see section 3) from the used digital standard menu, e.g. "EUTRA/LTE". (Already done.)
- Generate the *identical* signal in the baseband of the slave SMBV.
- Set the phase offset of the master SMBV to 180°. Both signals are now 180° out of phase.
- Adjust the parameter "I/Q Delay" of the slave SMBV such that the power on the analyzer is minimal. Note that it is possible to set positive as well as negative I/Q delays. The signals will only cancel each other out if the timing is precisely aligned.
- After this time alignment, set the slave SMBV to generate the wanted signal and set the phase offset of the master SMBV to any desired value.

8.5.1 Special Case: GNSS Test Setup for Carrier Phase Measurements

The phase calibration needs to be performed with the RF frequency and level that are intended to be used in the application. However, the levels of GNSS signals are extremely low, e.g. approx. -130 dBm. With attenuator mode "Fixed", the RF level can only be varied in a range of approximately 20 dB around the set level. Therefore, the level on the SMBV cannot be set significantly higher than approx. -120 dBm. Even if an external attenuator, e.g. a 30 dB attenuator, is used to externally attenuate the RF signal down to -120 dBm, the level set on the SMBV is still very low, e.g. approx. -90 dBm. A phase calibration at these low levels is possible but requires special care. The most important factor is the analyzer used for the phase calibration. The analyzer should have the following:

- A noise level as low as possible, since the noise floor of the analyzer is the limiting factor when measuring low signal levels. Modern high-end analyzers generally have very good noise performance
- A built-in pre-amplifier (option)

Perform the phase calibration as described in section 8.4. In addition, consider the following points:

- Set the smallest possible resolution bandwidth on the analyzer
- Use the 10 MHz reference of the master SMBV as external reference for the analyzer (frequency synchronization)
- Enable the pre-amplifier on the analyzer

Please see also the application note “Phase Adjustment of Two MIMO Signal Sources with Option B90” (1GP67). It explains in detail how to best perform the phase calibration with very low signal levels using Rohde & Schwarz spectrum analyzers.

As already mentioned, the phase calibration needs to be performed with the RF level that is intended to be used in the application. For GNSS signals, this level depends on the configured satellite scenario. Therefore, before starting the phase calibration, configure the wanted GNSS scenario on the master SMBV. In particular, set the reference power, the number of satellites and their individual levels (in relation to the reference power).

Ref. Power dBm ▾

Maximum Number Of Satellites ▾

	State	Standard	Signals	SV-ID	Power /dB
Sat 1	On	GPS	C/A	2	0.00
Sat 2	On	GPS	C/A	3	-5.00
Sat 3	On	GPS	C/A	4	0.00
Sat 4	On	GPS	C/A	5	-3.20
Sat 5	On	GPS	C/A	6	0.00

Turn on the GNSS signal and read the RF level setting in the header of the SMBV GUI. The displayed level is automatically calculated by the SMBV based on the configured GNSS scenario. This level needs to be used for the phase calibration.

Level dBm ▾

9 Application – Outphasing PA Test Setup

Mobile communications signals such as WCDMA signals or OFDM signals exhibit crest factors in the order of 10 dB, i.e. the instantaneous signal amplitude varies significantly over time. The power amplifier (PA) used must therefore be linear over this power range. The strong linearity requirements can, however, only be fulfilled at the expense of power conversion efficiency. Fig. 20 shows a typical setup for testing a linear PA. The SMBV generates the required test signal, e.g. a 3GPP signal with a crest factor of around 10 dB.

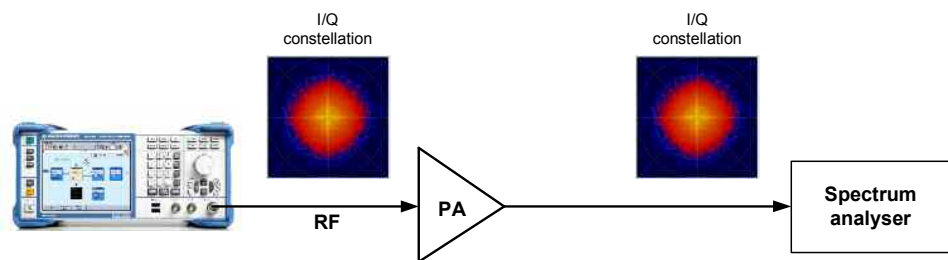

Fig. 20: Setup for testing a conventional linear power amplifier.

Due to the suboptimal efficiency of *linear* PAs, other, more efficient approaches are under investigation. One idea is to utilize *saturated* PAs. These have a high efficiency but the drawback is that they cannot be operated with amplitude-modulated signals. For this reason, they need to be integrated in a design concept that allows signals with varying amplitude to be generated. Polar modulation is one method that has been employed for GSM and EDGE [1]. Another method is outphasing: The wanted signal is first transformed into two signals, each purely phase-modulated with constant amplitude. The two signals carry the amplitude modulation information in their differential phase [2]. Since the two signals are constant in amplitude, they can be amplified with efficient saturated PAs. After amplification, the two signals are recombined. By superposing the signals, the original wanted signal is reconstructed.

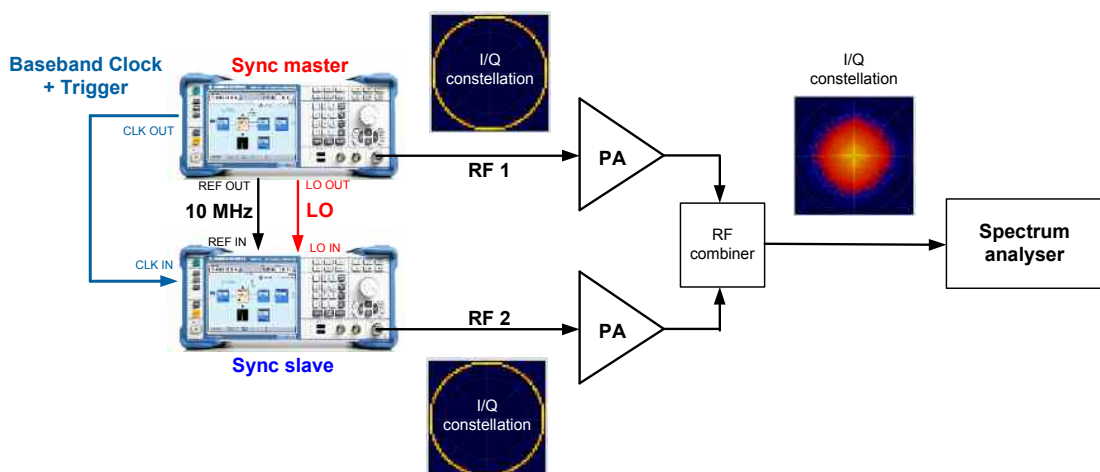

Fig. 21: Setup for testing (saturated) outphasing power amplifiers.

Fig. 21 shows a typical setup for testing outphasing PAs. Two SMBVs in master-slave configuration with the R&S®SMBV-B90 phase coherence option generate the required constant amplitude test signals. They can be loaded as waveform files into the ARBs of the SMBVs and played back synchronously. The R&S®SMBV-B90 option ensures that the RF phases of the two instruments are controlled and stable. Synchronous start and phase coherence are both crucial for the setup to work, because only with precise timing and stable RF phases is it possible to reconstruct the wanted signal with satisfying quality. Important signal characteristics are, for example, adjacent channel leakage ratio (ACLR) and error vector magnitude (EVM).

For demonstration purposes in this application note, we use the setup shown in Fig. 21 but without PAs. An ACLR measurement is used as indicator for precise time synchronization. The procedure is as follows:

- Perform the phase calibration with two CW signals (see section 6).
- Generate the two constant-amplitude signals using the ARBs of the SMBVs. Note: Configure the master-slave setup (see section 3) from the ARB menu.
- An ACLR measurement on a 3GPP test model 1 signal yields the following test result: lower channel 46.9 dB, upper channel 44.5 dB.

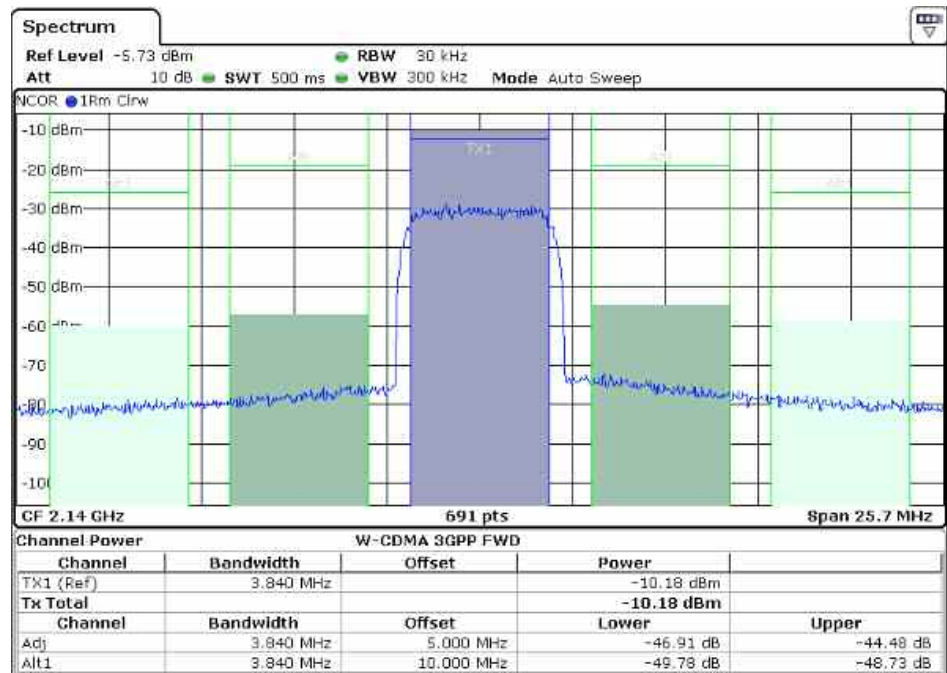

Fig. 22: ACLR measurement before fine-alignment.

- Adjust the parameter “I/Q Delay” of the slave SMBV such that the ACLR measured on the analyzer is optimized. Note that it is possible to set positive as well as negative I/Q delays. The ACLR will be optimal if the timing is absolutely precise. In this example, we set an I/Q delay of 0.7 ns. Note that already a very small delay of only 0.7 ns changes the ACLR result substantially by about 13 dB.
- After this fine-alignment, the ACLR measurement yields the following test result: lower channel 58.1 dB, upper channel 59.8 dB.

(The specified ACLR performance of the SMBV is typically > 69 dB. This performance is degraded due to the external cabling and the RF combiner.)

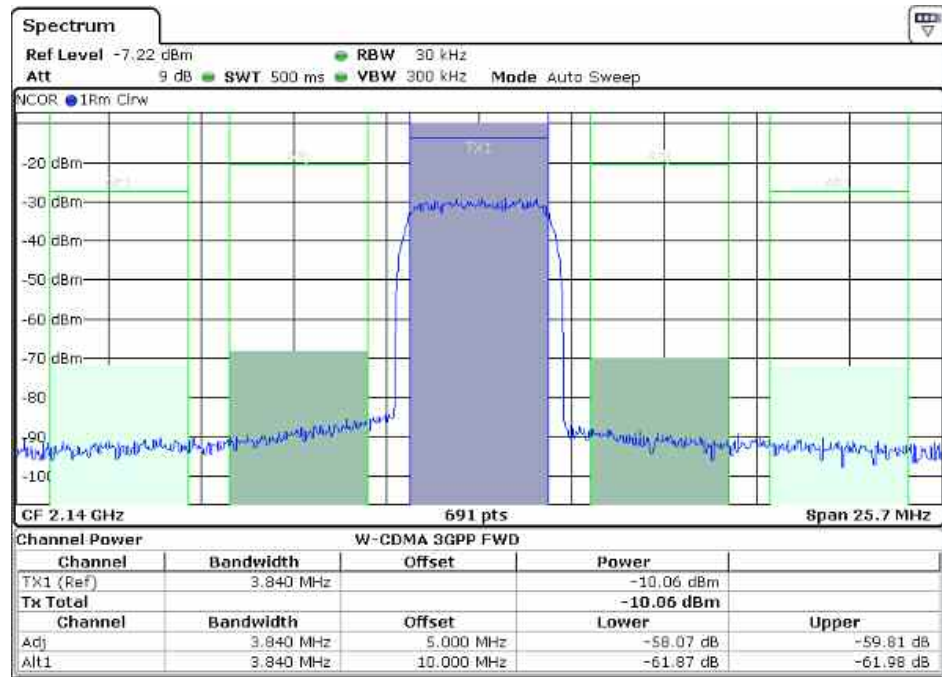

Fig. 23: ACLR measurement after fine-alignment.

- The measured EVM is 0.5 %.

10 Summary

The master-slave setup provides excellent time synchronization of several SMBVs. The user benefits from a very simple setup and easy configuration of the instruments. With the correct settings on the SMBVs, their output signals are highly synchronized with a minimal uncertainty of < 1 ns. This makes the master-slave setup the ideal test solution for a wide variety of applications such as basic MIMO tests without fading simulation, GNSS test scenarios with up to 24 satellites and WLAN IEEE 802.11ac applications with 80 MHz + 80 MHz channels.

11 Abbreviations

ACLR	Adjacent channel leakage ratio
ARB	Arbitrary waveform generator
CW	Continuous wave
DUT	Device under test
EVM	Error vector magnitude
Galileo	Galileo (global navigation satellite system of the European Union)
Glonass	Globalnaja Navigazionnaja Sputnikowaja Sistema (global navigation satellite system of the Russian Federation)
GNSS	Global navigation satellite system
GPS	Global positioning system (of the United States)
GPS CA	Global positioning system coarse acquisition
I/Q	In-phase/quadrature
LO	Local oscillator
MIMO	Multiple input multiple output
OFDM	Orthogonal frequency-division multiplexing
PA	Power amplifier
RF	Radio frequency
SISO	Single input single output
WCDMA	Wideband code division multiple access

12 References

- [1] Rohde & Schwarz Application Note, "Polar Modulation with R&S®SMU200A" (1GP58)
- [2] Advances in Radio Science, edition 4, pages 125-133, 2006, "WCDMA outphasing power amplifier with a software defined transmitter/receiver architecture for determination of the predistortion function" by W. Gerhard and R. Knöchel
- Rohde & Schwarz Application Note, "Guidelines for MIMO Test Setups – Part 1" (1GP50)
- Rohde & Schwarz Application Note, "Phase Adjustment of Two MIMO Signal Sources with Option B90" (1GP67)

13 Ordering Information

Please visit the R&S® SMBV100A product website for comprehensive ordering information at www.rohde-schwarz.com.

Base Unit		
R&S® SMBV100A	Vector Signal Generator	1407.6004.02
RF		
R&S® SMBV-B103	9 kHz to 3.2 GHz	1407.9603.02
R&S® SMBV-B106	9 kHz to 6 GHz	1407.9703.02
R&S® SMBV-B1	Reference Oscillator OCXO	1407.8407.02
R&S® SMBV-B1H	Reference Oscillator OCXO High Performance	1419.1602.02
R&S® SMBV-B90	Phase Coherence	1407.9303.02
Baseband		
R&S® SMBV-B10	Baseband Generator with Digital Modulation (realtime) and ARB (32 Msample), 120 MHz RF bandwidth	1407.8607.02
R&S® SMBV-B50	Baseband Generator with ARB (32 Msample), 120 MHz RF bandwidth	1407.8907.02
R&S® SMBV-B51	Baseband Generator with ARB (32 Msample), 60 MHz RF bandwidth	1407.9003.02
R&S® SMBV-B55	Memory Extension for ARB to 256 Msample	1407.9203.02
R&S® SMBV-B92	Hard Disk (removable)	1407.9403.02
R&S® SMBV-K18	Digital Baseband Connectivity	1415.8002.02
Digital Modulation Systems		
R&S® SMBV-K40	GSM/EDGE	1415.8031.02
R&S® SMBV-K41	EDGE Evolution	1415.8460.02
R&S® SMBV-K42	3GPP FDD	1415.8048.02
R&S® SMBV-K43	3GPP FDD Enhanced MS/BS Tests incl. HSDPA	1415.8054.02
R&S® SMBV-K45	3GPP FDD HSUPA	1415.8077.02
R&S® SMBV-K48	IEEE 802.11 (a/b/g)	1415.8102.02
R&S® SMBV-K49	IEEE 802.16	1415.8119.02
R&S® SMBV-K54	IEEE 802.11n	1415.8160.02
R&S® SMBV-K55	EUTRA/LTE	1415.8177.02
R&S® SMBV-K59	HSPA+	1415.8219.02
R&S® SMBV-K84	LTE Release 9 + Enhanced Features	1415.8477.02
R&S® SMBV-K86	IEEE 802.11ac	1415.8648.02
GNSS		
R&S® SMBV-K44	GPS	1415.8060.02
R&S® SMBV-K65	Assisted GPS	1415.8560.02
R&S® SMBV-K66	Galileo	1415.8590.02
R&S® SMBV-K91	GNSS Extension to 12 Satellites	1415.8577.02
R&S® SMBV-K92	GNSS Enhanced (e.g. moving scenarios, multipath)	1415.8583.02
R&S® SMBV-K93	GPS P code	1415.8660.02
R&S® SMBV-K94	Glonass	1415.8677.02
Digital Modulation Systems using R&S® WinIQSIM2		
R&S® SMBV-K240	GSM/EDGE	1415.8231.02
R&S® SMBV-K241	EDGE Evolution	1415.8454.02
R&S® SMBV-K242	3GPP FDD	1415.8248.02
R&S® SMBV-K243	3GPP FDD Enhanced MS/BS Tests incl. HSDPA	1415.8254.02
R&S® SMBV-K245	3GPP FDD HSUPA	1415.8277.02
R&S® SMBV-K248	IEEE 802.11 (a/b/g)	1415.8302.02
R&S® SMBV-K249	IEEE 802.16	1415.8319.02
R&S® SMBV-K254	IEEE 802.11n	1415.8354.02
R&S® SMBV-K255	EUTRA/LTE	1415.8360.02
R&S® SMBV-K259	HSPA+	1415.8377.02
R&S® SMBV-K284	LTE Release 9 + Enhanced Features	1415.8625.02
R&S® SMBV-K286	IEEE 802.11ac	1415.8654.02
Noise Generation		
R&S® SMBV-K62	Additive White Gaussian Noise (AWGN)	1415.8419.02

About Rohde & Schwarz

Rohde & Schwarz is an independent group of companies specializing in electronics. It is a leading supplier of solutions in the fields of test and measurement, broadcasting, radiomonitoring and radiolocation, as well as secure communications. Established more than 75 years ago, Rohde & Schwarz has a global presence and a dedicated service network in over 70 countries. Company headquarters are in Munich, Germany.

Environmental commitment

- Energy-efficient products
- Continuous improvement in environmental sustainability
- ISO 14001-certified environmental management system



Regional contact

Europe, Africa, Middle East

+49 89 4129 123 45

customersupport@rohde-schwarz.com

North America

1-888-TEST-RSA (1-888-837-8772)

customer.support@rsa.rohde-schwarz.com

Latin America

+1-410-910-7988

customersupport.la@rohde-schwarz.com

Asia/Pacific

+65 65 13 04 88

customersupport.asia@rohde-schwarz.com

This application note and the supplied programs may only be used subject to the conditions of use set forth in the download area of the Rohde & Schwarz website.

R&S® is a registered trademark of Rohde & Schwarz GmbH & Co. KG. Trade names are trademarks of the owners.

Rohde & Schwarz GmbH & Co. KG

Mühlhofstraße 15 | D - 81671 München

Phone + 49 89 4129 - 0 | Fax + 49 89 4129 - 13777

www.rohde-schwarz.com