

# Connectivity of R&S® Test Solutions with AWR® Visual System Simulator™ (VSS)

## Application Note

### Products:

R&S® AFQ100A/B	R&S® FSH 3/6/18
R&S® AMU200A	AWR® Microwave Office® (MWO)
R&S® SMBV100A	AWR® VSS
R&S® SMJ100A	AWR® TestWave™
R&S® SMU200A	AWR® Connected™
R&S® WinIQSIM2™	
R&S® FSG	
R&S® FSQ	
R&S® FSU	
R&S® FSV	

This application note describes how to connect R&S® test and measurement products quickly and seamlessly to AWR® Visual System Simulator™ (VSS) via a GPIB or LAN interface. Using AWR® Connected™ customized for Rohde & Schwarz hardware and R&S® WinIQSIM2™ signal simulation software, the flexibility of digital radio standards is highlighted and its integration into VSS is demonstrated.

---

## Table of Contents

<b>1</b>	<b>Introduction .....</b>	<b>3</b>
1.1	Connectivity Solutions .....	3
1.1.1	GPIB/LAN/RS-232 Connectivity via AWR® TestWave™ .....	3
1.1.2	AWR® Connected™ for Rohde & Schwarz .....	4
<b>2</b>	<b>Circuit-based Testing with DUT and R&amp;S® Signal Generators and Analyzers .....</b>	<b>5</b>
2.1	Using the TestWave™ Element "IQ Instrument Combined Generator and Measurement" via GPIB .....	5
2.2	Using the TestWave™ Element "IQ Instrument Combined Generator and Measurement" via LAN .....	11
2.2.1	IP Address and Subnet Mask for R&S® SMU200A Vector Signal Generator .....	11
2.2.2	IP Address and Subnet Mask for R&S® FSQ26 Signal Analyzer .....	12
2.3	Data Graph Examples for Evaluation of the Test Setup .....	14
<b>3</b>	<b>AWR Connected™ for R&amp;S® WinIQSIM2™ .....</b>	<b>18</b>
3.1	Signal Source Example within VSS .....	18
3.2	Signal Sink with LAN Transfer Example .....	22
<b>4</b>	<b>Measurement Import from R&amp;S® Signal Analyzers .....</b>	<b>26</b>
4.1	Connectivity of FSH3/6/18 with AWR® Design Environment™ via RS-232 .....	26
4.2	Transferring Data from R&S® Signal/Spectrum Analyzers to SoftPlot for TestWave™ for Documentation .....	29
<b>5</b>	<b>Conclusion.....</b>	<b>30</b>
<b>6</b>	<b>Literature.....</b>	<b>31</b>
<b>7</b>	<b>Ordering Information .....</b>	<b>31</b>

# 1 Introduction

## 1.1 Connectivity Solutions

### 1.1.1 GPIB/LAN/RS-232 Connectivity via AWR® TestWave™

The integration of R&S® test and measurement equipment with AWR® Design Environment™ provides a powerful framework for RF design and verification, ranging from component characterization to sub-system and system verification.

The principal benefit of integrating T&M equipment into the simulation environment is that it allows tasks to be performed in parallel. By comparing data measured on early DUT prototypes with simulation results, designs can be fine tuned. In addition, the same assumptions and signal types utilized in the simulation can be exercised in the real world. Manufacturers benefit from this parallel design-validate flow because it enhances design efficiency and provides a reduced timescale for product time-to-market. Designers, in turn, are given greater opportunity to create the best system architecture.

Seamless interconnectivity between R&S® vector signal generators, signal/spectrum analyzers and vector network analyzers and the AWR® Design Environment™ is possible via AWR® TestWave™ software which is an option to AWR®'s Microwave Office® and VSS. AWR® TestWave™ software supports a variety of R&S® test and measurement equipment and use cases. For further information, please refer to the AWR® TestWave™ documentation available from <http://web.awrcorp.com>.

Figure 1 illustrates the supported physical communications links via GPIB/LAN/Serial RS-232 interfaces. By integrating the T&M instruments with the simulation environment, measured and simulated data can be correlated and used for optimizing the design.

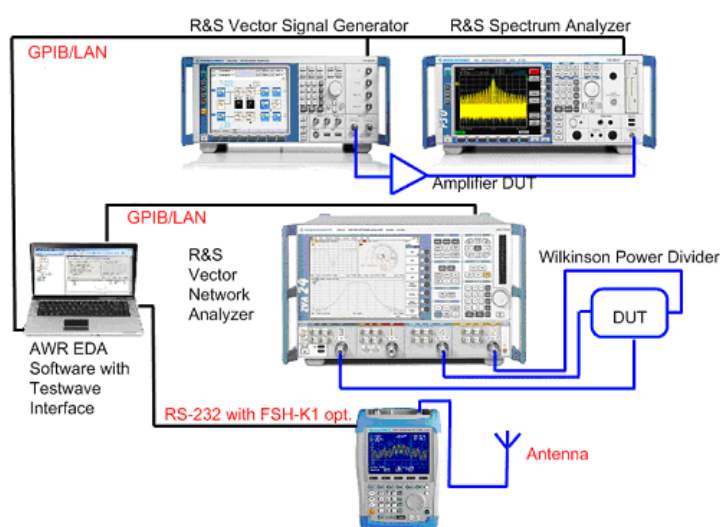

Figure 1: Connectivity options for R&S® test and measurement instruments with AWR® EDA software

VSS software is a comprehensive environment for the end-to-end design and optimization of communications systems. It enables the impact of "real-world" signal impairments and other factors to be evaluated early in the design cycle. It allows designers to create the best system architecture by optimizing each of its components from the behavioral through component levels in conjunction with AWR<sup>®</sup> Microwave Office<sup>®</sup> (MWO) software, and then use actual measurements to validate the final design.

This application note describes how to connect R&S<sup>®</sup> test equipment with AWR<sup>®</sup> VSS. Connectivity of R&S<sup>®</sup> test equipment with AWR<sup>®</sup> Microwave Office<sup>®</sup> is described in another application note [1].

### 1.1.2 AWR<sup>®</sup> Connected<sup>™</sup> for Rohde & Schwarz

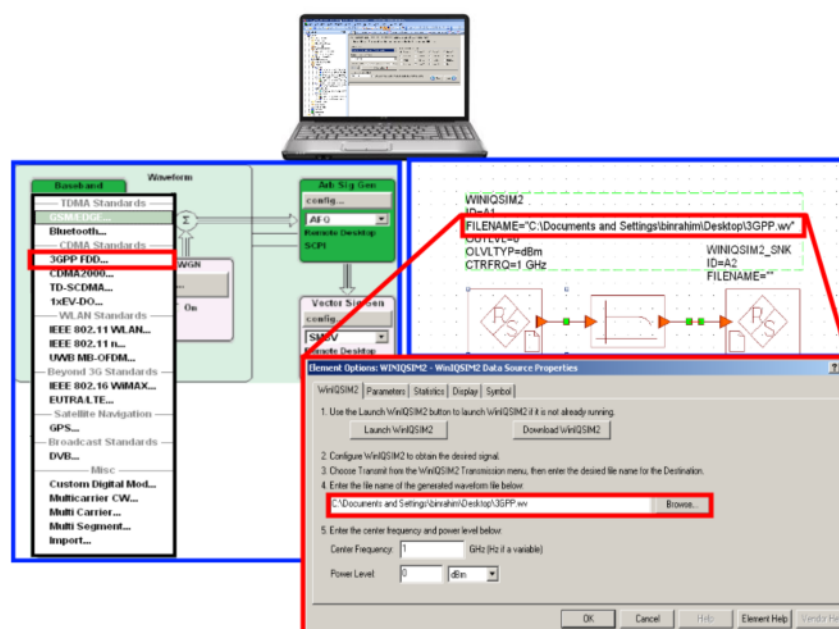

Figure 2: Generating digital radio standards in R&S<sup>®</sup> WinIQSIM2<sup>™</sup> and embedding into AWR<sup>®</sup> VSS

AWR<sup>®</sup> Connected<sup>™</sup> for Rohde & Schwarz is a comprehensive solution that integrates design and test domains for a wide range of modern communication standards. It includes the AWR<sup>®</sup> VSS software, the R&S<sup>®</sup> WinIQSIM2<sup>™</sup> Simulation Software, R&S<sup>®</sup> test & measurement (T&M) instruments and AWR<sup>®</sup> TestWave<sup>™</sup> software for the physical communication link via GPIB or LAN interface.

With AWR<sup>®</sup> Connected<sup>™</sup> for Rohde & Schwarz, the R&S<sup>®</sup> WinIQSIM2<sup>™</sup> Simulation Software is integrated within the Visual System Simulator<sup>™</sup> (VSS) software. The complete range of digitally-modulated signals generated by R&S<sup>®</sup> WinIQSIM2<sup>™</sup>, along with those already present within VSS, ensure that the same real-world test signals can be used throughout the design cycle (refer to Table 1) as well as for the design verification.

The integration of R&S® WinIQSIM2™ gives VSS access to today's advanced communication signals, including those for 3GPP LTE(FDD and TDD), 3GPP FDD/HSPA/HSPA+, and WiMAX. Enabling extremely accurate representations of signals in the VSS simulation environment ensures that engineers are simulating their designs with the same signal as the device will encounter in service.

**Table 1: Digital Radio Standards available from R&S® WinIQSIM2™**

R&S WinIQSim2 Release 2.05.222.33 Digital Standards						
TDMA	CDMA	WLAN	Beyond 3G	Satellite	Broadcast	Miscellaneous
GSM/ EDGE Bluetooth	3GPP FDD CDMA2000 TD-SCDMA 1xEV-DO	IEEE 802.11 WLAN IEEE 802.11N UWB MB-OFDM	IEEE 802.16 WiMAX EUTRA/LTE(FDD and TDD)	GPS	DVB	Custom Digital Modulation Multicarrier CW Multicarrier Multi Segment

## 2 Circuit-based Testing with DUT and R&S® Signal Generators and Analyzers

### 2.1 Using the TestWave™ Element "IQ Instrument Combined Generator and Measurement" via GPIB

Among the factors creating a need for integrated software design and hardware testing are: understanding RF impairments on modulated signals; developing component specifications; creating modulated signals; and performing end-to-end co-simulation and hardware-in-the-loop simulations. In this chapter, AWR® VSS is used to model and verify a transmission chain with a QPSK signal source and a real power amplifier as DUT to introduce real world impairments. The test setup is shown in Figure 3.

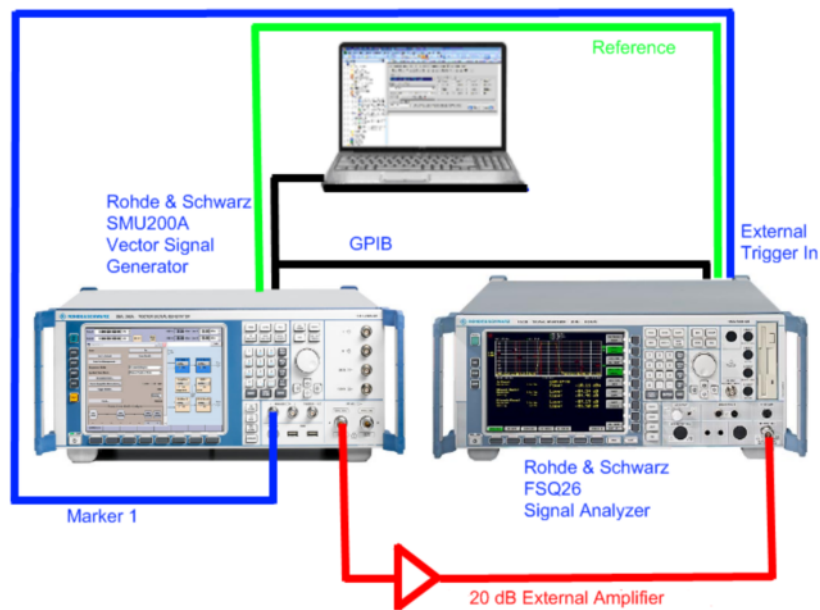

**Figure 3: Test Setup for measurements on an amplifier DUT controlled by VSS via GPIB**

In this example, the R&S® SMU200A vector signal generator and the R&S® FSQ signal analyzer are employed as test equipment. A commercial-off-the-shelf (COTS) 20 dB external amplifier is used as a DUT. A 10 MHz reference oscillator synchronization between the R&S® SMU200A and the R&S® FSQ is recommended. Triggering from Marker 1 of the R&S® SMU200A to External Trigger In of the R&S® FSQ is possible. First, GPIB connectivity between VSS and R&S® instruments will be explained. The following chapter will address LAN connectivity.

The QPSK signal is generated as baseband waveform by VSS and passed via GPIB interface to the ARB generator of the R&S® SMU200A. The R&S® SMU200A provides the RF signal as test signal to the power amplifier. The R&S® FSQ signal analyzer measures the RF output signal of the amplifier and provides the captured IQ data back to VSS via the GPIB interface. The IQ data can then be processed within VSS.

Figure 4 shows the VSS system diagram of this setup. TestWave™ provides an element TESTWAVE\_2PORT to configure and control the R&S® SMU200A vector signal generator and the R&S® FSQ signal analyzer from the system diagram. A sample file "QPSK\_SMU\_FSQ\_GPIB\_New.emp" for GPIB link is provided with this application note. The block diagram of the schematic is shown below in Figure 4.



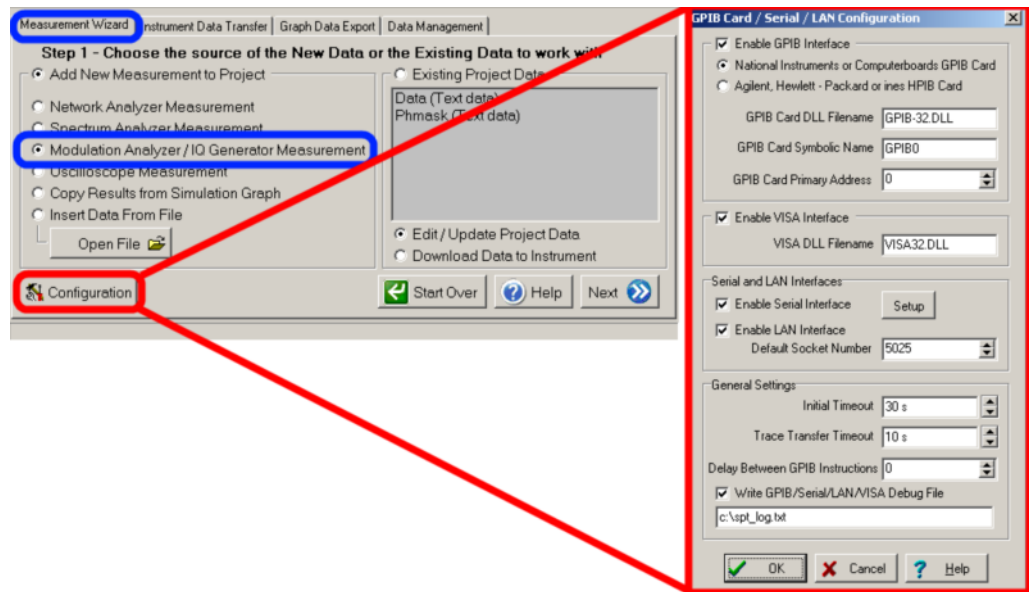



Figure 5: Establishing GPIB physical communication link via AWR® TestWave™

To configure the GPIB interface, start by moving the cursor to the bottom of the [Project Tree], and click on the  icon. Referring to Figure 5, tab [Measurement Wizard], select [Modulation Analyzer/IQ Generator Measurement] and ensure under [Configuration] that "Enable GPIB Interface" is checked.

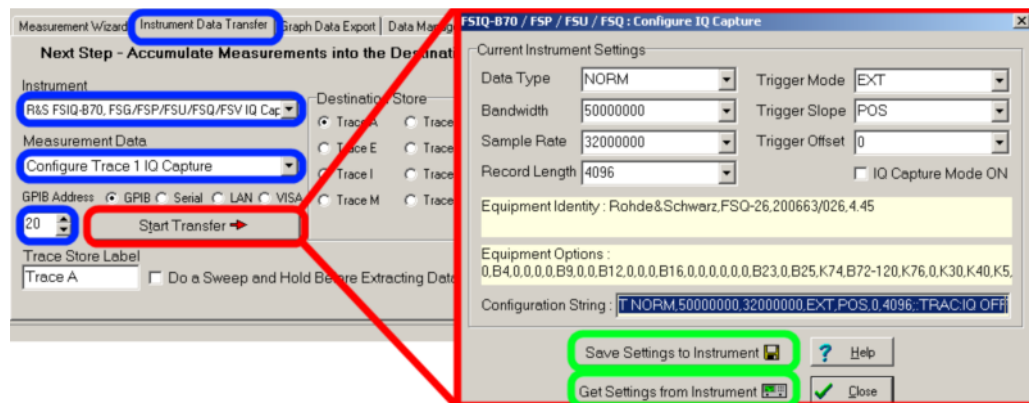

Figure 6: Data transfer from R&S®FSQ to AWR® Design Environment

Proceed to tab [Instrument Data Transfer] and select under [Instrument] "R&S FSIQ-B70, FSG/FSP/FSU/FSQ/FSV IQ Capture". Choose the [Measurement Data] as "Configure Trace 1 IQ Capture". Confirm the equipment GPIB address and select "Start Transfer".

A pop-up "FSIQ-B70/FSP/FSU/FSQ Configure IQ Capture" then will prompt for:

- Get Settings from Instrument→ It will "pull" settings from the signal analyzer
- Save Settings to Instrument→ Produce a Configuration String



In order to make it easier to transfer the following parameter setting within the TESTWAVE\_2PORT element, highlight the Configuration String (refer to Figure 6) with your mouse and copy it with (Ctrl+C). This setting will be useful to import to TESTWAVE\_2PORT secondary settings, i.e. as a default setting of the parameter VSAINITSTR1 (refer to Figure 8). This will help to ensure repeatability and reproducibility.

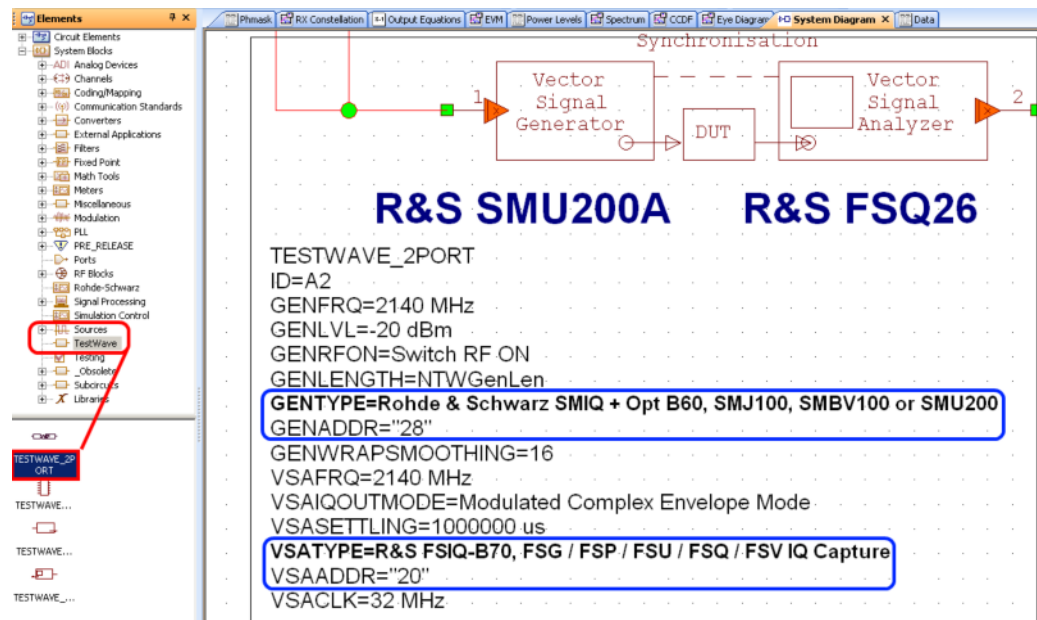

**Figure 7: TESTWAVE\_2PORT Primary Settings for GPIB**

From [Elements], select [Sources→TestWave] and select [TESTWAVE\_2PORT-IQ Instrument Combined Generator and Measurement]. Primary settings such as Center Frequency, Level for the Signal Generator and GPIB addresses can be set directly from the system diagram. Level for the Spectrum Analyzer can be initialized as shown in Figure 8 below.

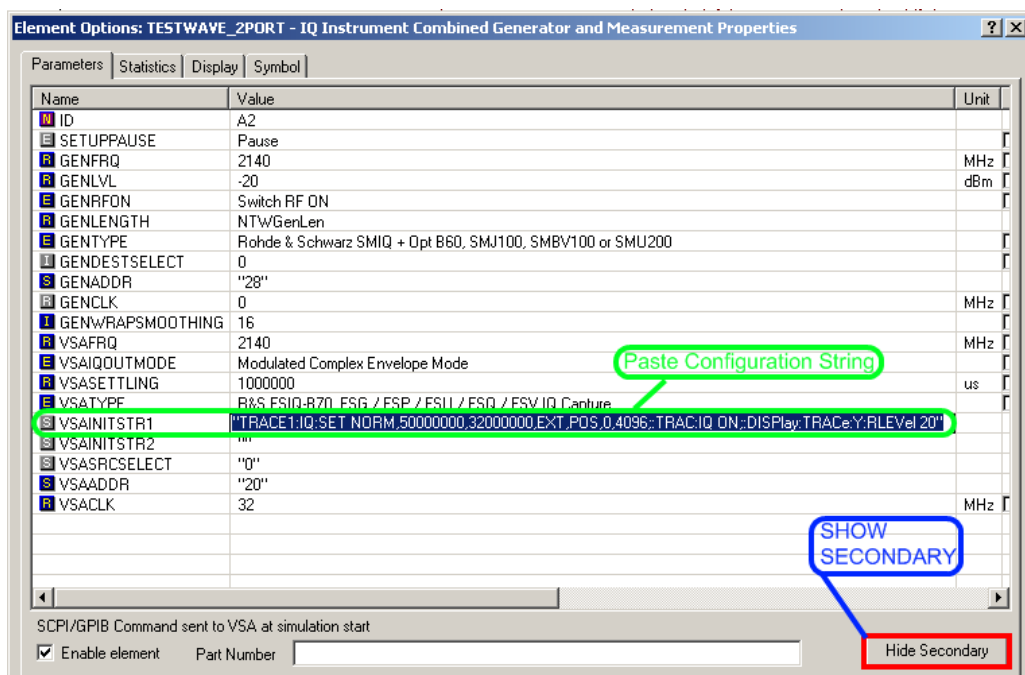
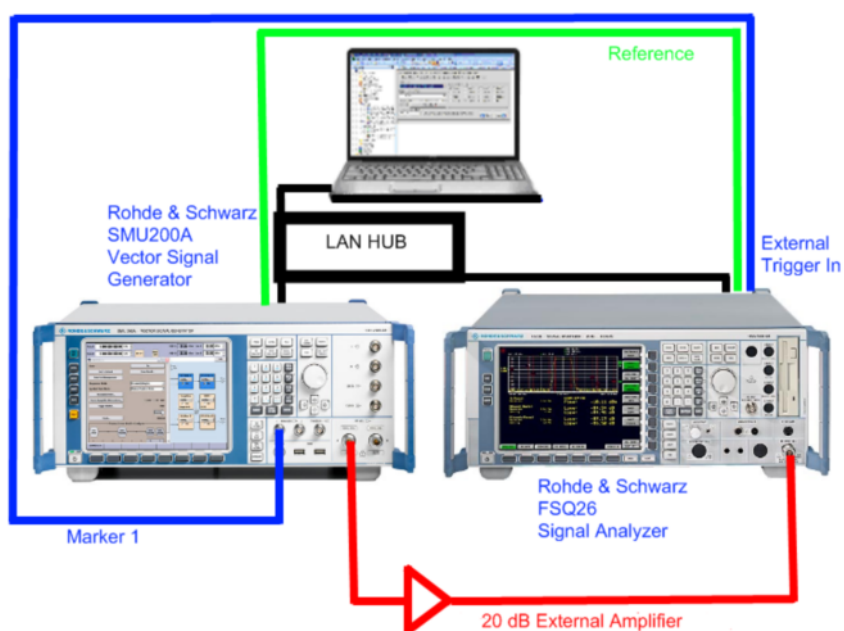

Figure 8: TESTWAVE\_2PORT Secondary Setting of VSAINITSTR1

Double-click on TESTWAVE\_2PORT on the system diagram and press "Show Secondary". The previously copied Configuration String can now be pasted with (Ctrl+V) to parameter VSAINITSTR1 as a default. The advantage of this practice is assure reproducibility in equipment settings especially when multiple users are utilizing a shared asset. Furthermore, spectrum analyzer reference levels can be initialized.

## 2.2 Using the TestWave™ Element "IQ Instrument Combined Generator and Measurement" via LAN

### 2.2.1 IP Address and Subnet Mask for R&S® SMU200A Vector Signal Generator



**Figure 9: Test setup for measurements on amplifier DUT controlled by VSS via LAN**

An alternative to GPIB is LAN connectivity. Depending on user preference, DHCP addressing can be used. For the examples in this application note, DHCP is set to "off". The instruments are configured with unique IP addresses and same subnet masks for remote control. For example, for a subnet mask of "255.255.255.0", the instruments can be configured to IP addresses of "10.0.0.X" where X is the unique address.

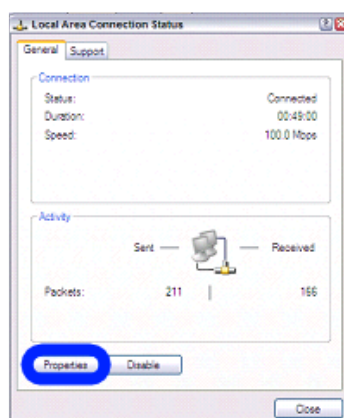

**Figure 10: Checking for LAN settings in R&S® SMU200A**

For the R&S®SMU200A, LAN settings can be checked via SETUP→Remote→Ethernet or via double-clicking Local Area Connections Status in the taskbar menu.

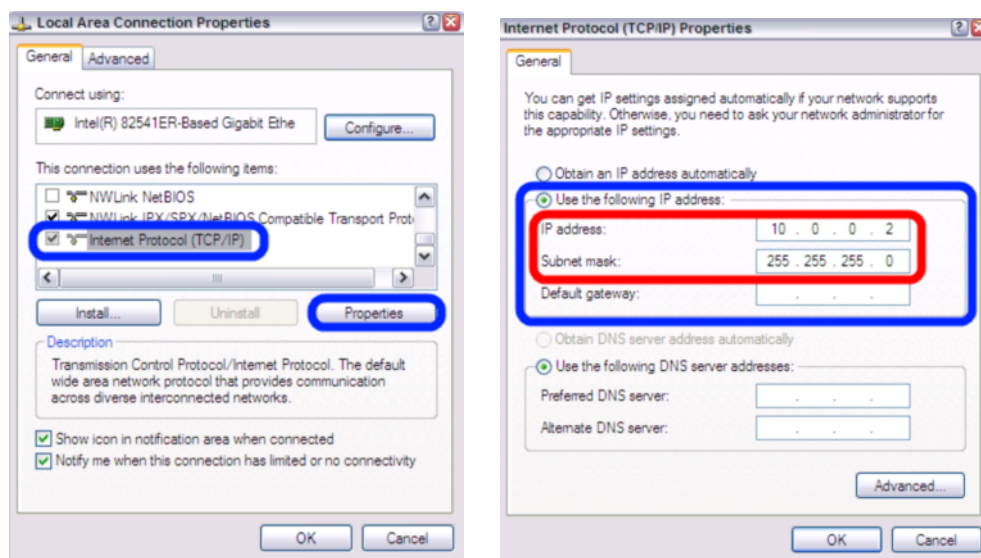

Figure 11: Setting R&S®SMU200A IP address and subnet mask

Once at Local Area Connection Status, choose "Properties" to go to Local Area Connection Properties. Scroll down to "Internet Protocol (TCP/IP)" and click "Properties". Ensure the subnet mask is "255.255.255.0" and R&S®SMU200A IP address is unique -- for example, "10.0.0.2". For additional information about LAN settings for the R&S®SMU200A, please refer to chapter 2.6 of the R&S®SMU200A operating manual.

### 2.2.2 IP Address and Subnet Mask for R&S®FSQ26 Signal Analyzer

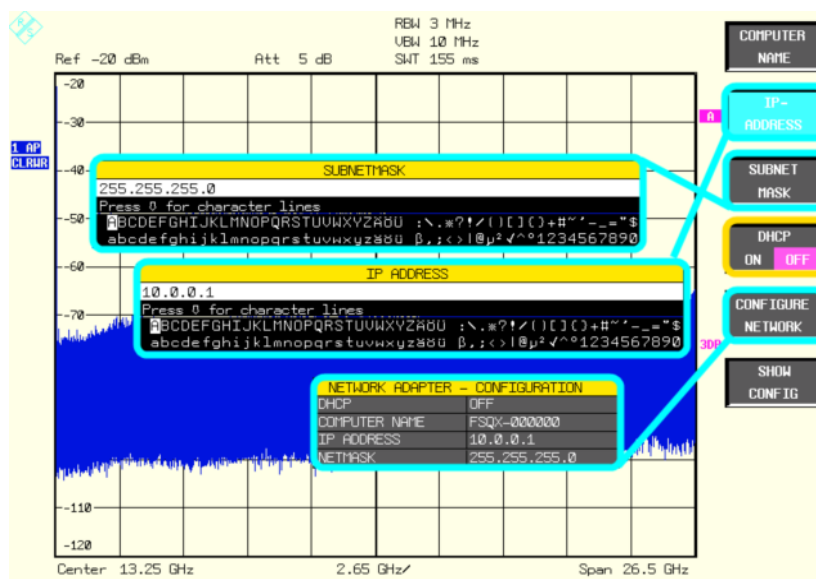

Figure 12: Checking and configuring LAN settings in R&S®FSQ26

Having set the R&S® SMU200A LAN configuration, we proceed to R&S® FSQ26 Signal Analyzer LAN configuration. Check and configure LAN settings directly from the Instrument Interface or WinXP™ environment. The former method simply involves SETUP→General Setup→Configure Network. Ensure that the subnet mask is "255.255.255.0" and that the R&S® FSQ26 IP address is unique, for example, "10.0.0.1".

```

R&S SMU200A      R&S FSQ26

TESTWAVE_2PORT
ID=A2
GENFRQ=2140 MHz
GENLVL=-20 dBm
GENRFON=Switch RF ON
GENLENGTH=NTWGenLen
GENTYPE=Rohde & Schwarz SMIQ + Opt B60, SMJ100, SMBV100 or SMU200
GENADDR="28"
GENWRAPSMOOTHING=16
VSAFRQ=2140 MHz
VSAIQOUTMODE=Modulated Complex Envelope Mode
VSASETTLING=1000000 us
VSAATYPE=R&S FSIQ-B70, FSG / FSP / FSU / FSQ / FSV IQ Capture
VSAADDR="10.0.0.1"
VSACLK=32 MHz

```

Figure 13: TESTWAVE\_2PORT Primary Settings for LAN

Once the network is established, simply match the corresponding IP addresses to the corresponding instruments in the [TESTWAVE\_2PORT-IQ Instrument Combined Generator and Measurement] block of the system diagram (see parameters GENADDR and VSAADDR in Figure 13). Both GPIB and LAN establishment of physical communications link are mutually exclusive and data capture is faster for the latter.

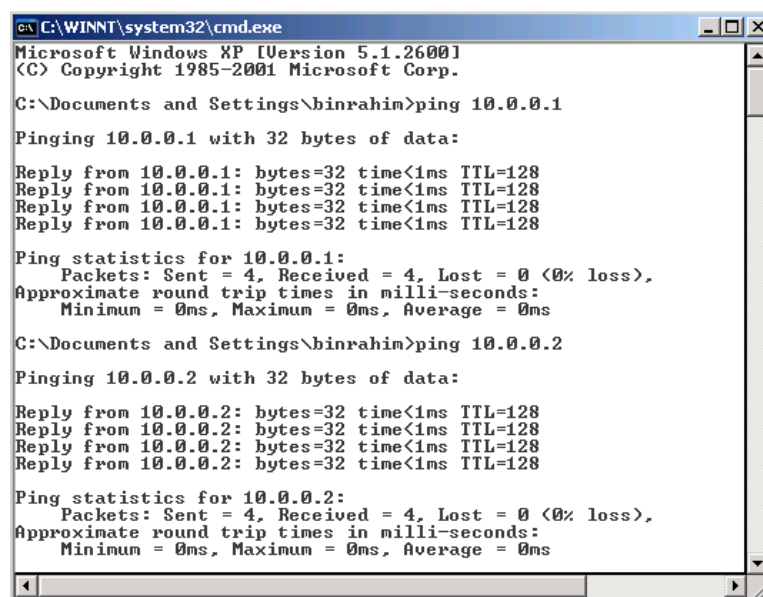

```

C:\WINNT\system32\cmd.exe
Microsoft Windows XP [Version 5.1.2600]
(C) Copyright 1985-2001 Microsoft Corp.

C:\Documents and Settings\binrahim>ping 10.0.0.1

Pinging 10.0.0.1 with 32 bytes of data:

Reply from 10.0.0.1: bytes=32 time<1ms TTL=128
Reply from 10.0.0.1: bytes=32 time<1ms TTL=128
Reply from 10.0.0.1: bytes=32 time<1ms TTL=128
Reply from 10.0.0.1: bytes=32 time<1ms TTL=128

Ping statistics for 10.0.0.1:
    Packets: Sent = 4, Received = 4, Lost = 0 (0% loss),
    Approximate round trip times in milli-seconds:
        Minimum = 0ms, Maximum = 0ms, Average = 0ms

C:\Documents and Settings\binrahim>ping 10.0.0.2

Pinging 10.0.0.2 with 32 bytes of data:

Reply from 10.0.0.2: bytes=32 time<1ms TTL=128
Reply from 10.0.0.2: bytes=32 time<1ms TTL=128
Reply from 10.0.0.2: bytes=32 time<1ms TTL=128
Reply from 10.0.0.2: bytes=32 time<1ms TTL=128

Ping statistics for 10.0.0.2:
    Packets: Sent = 4, Received = 4, Lost = 0 (0% loss),
    Approximate round trip times in milli-seconds:
        Minimum = 0ms, Maximum = 0ms, Average = 0ms

```

Figure 14: Ensuring that both instruments are on-line in the network

Using *ping* query at *Command Prompt*, both instrument IP addresses can be checked for successful connection by 0% loss return. As shown in Figure 14, the LAN connection of R&S®SMU200A with IP address 10.0.0.2 is successful with 0% loss. Likewise, the LAN connection for R&S®FSQ26 with IP address 10.0.0.1 is successful with 0% loss. For additional information about LAN settings for the R&S®FSQ26, please refer to Chapter 5 of the R&S®FSQ26 operating manual.

## 2.3 Data Graph Examples for Evaluation of the Test Setup

This chapter provides some examples for data graphs that are generated by the AWR® Design Environment™. These data graphs can be used to evaluate the system design and the full transmission chain.

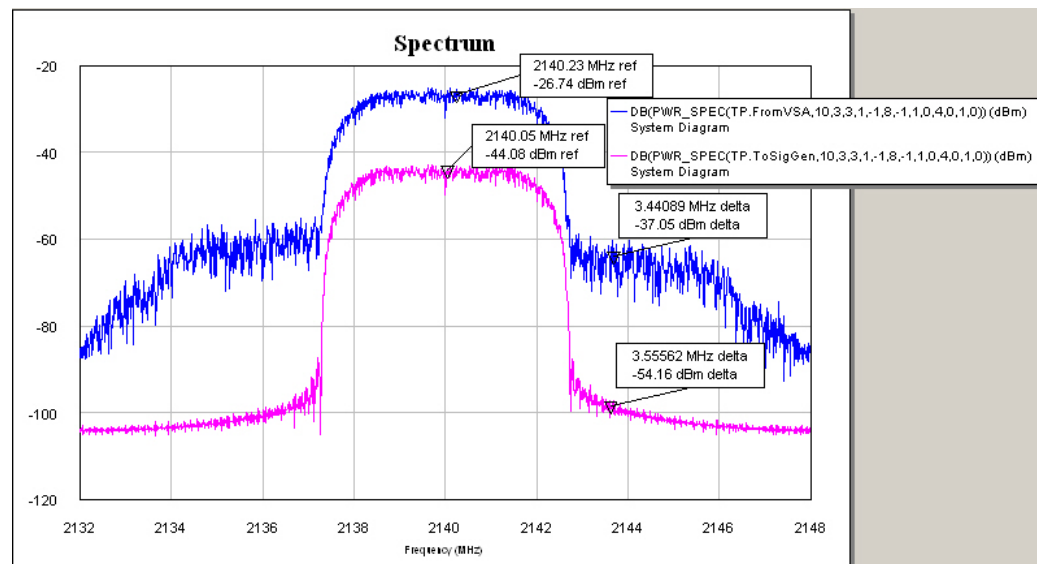
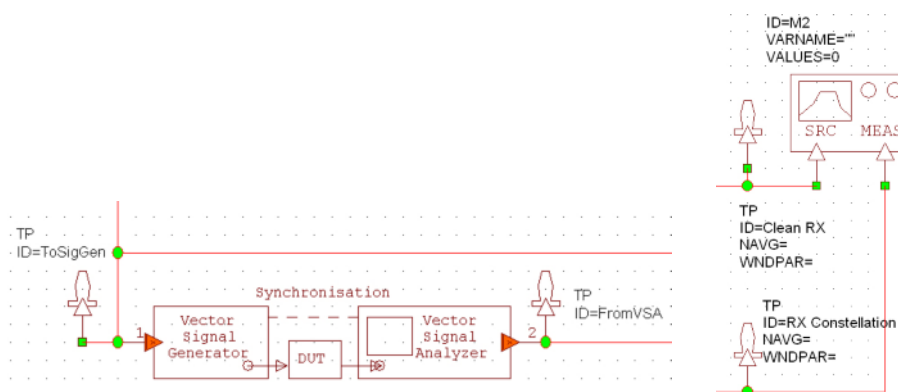

Figure 15: Pre-amplification and post-amplification of QPSK spectra

Using an external preamplifier as a DUT between the R&S®SMU200A Vector Signal Generator and R&S®FSQ Signal Analyzer, the spectrum plot clearly shows an amplification of 20 dB with considerable spectral regrowth. The selected RF test points "ToSigGen" (before the signal generator) and "FromVSA" (after the spectrum analyzer) are defined as shown in Figure 16 (left). They are used for spectrum measurements.



**Figure 16: RF test points and baseband IQ test points location**

As shown in Figure 16 (right), baseband IQ test points at the EVM block are used for evaluating EVM (error vector magnitude), constellation plots and the complementary cumulative distribution function (CCDF).

In the following sections, additional examples for data graphs are given. The complementary cumulative distribution function (CCDF) graph of Figure 17 shows the probability that the signal power will be above the average power level. The crest factor, or power log ratio of peak to average power, is the x-intercept. The crest factor evaluated at test point "From VSA" is lower than the crest factor evaluated at test point "To Sig Gen" due to compression of the amplifier.

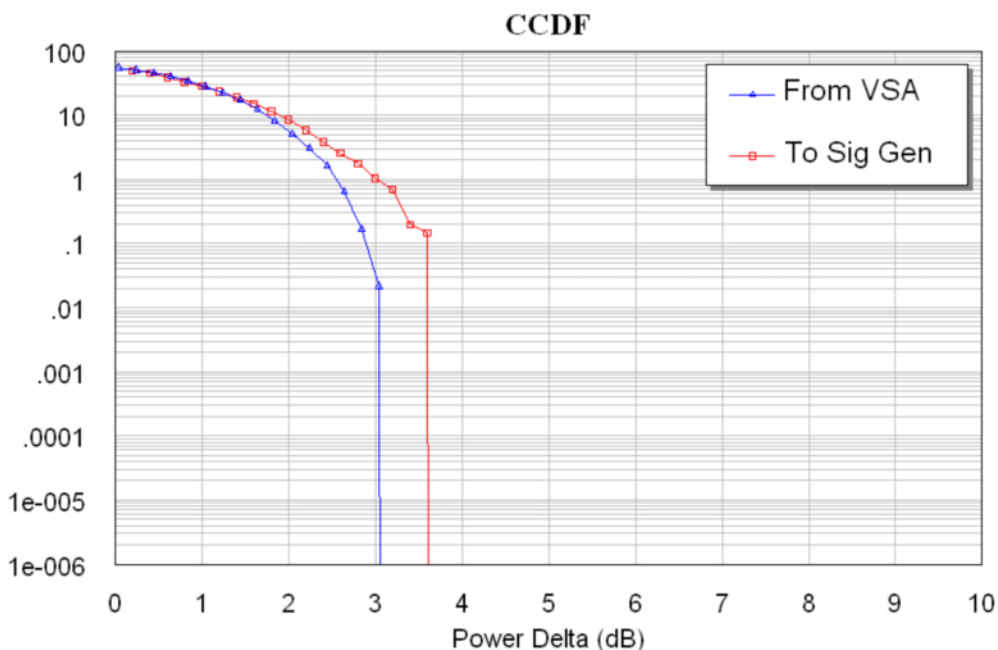

**Figure 17: Complementary cumulative distribution function (CCDF) graph of QPSK**

EVM is a measure of the difference between the reference waveform and the measured waveform. The compression of the amplifier increases the EVM of the QPSK signal as shown in Figure 18.

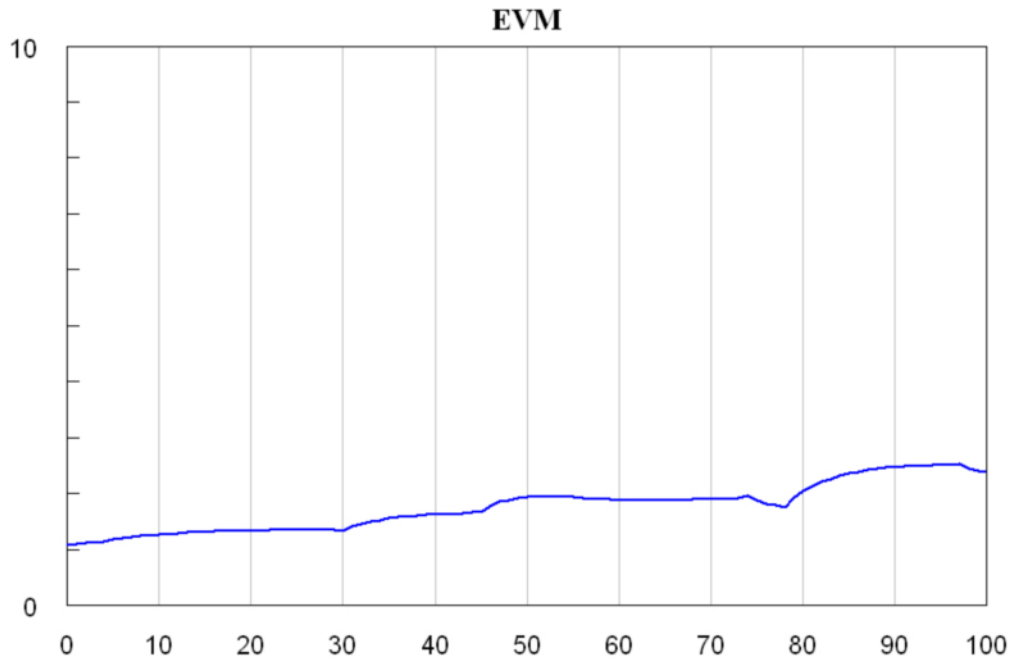

**Figure 18: Error vector magnitude of amplified QPSK**

This effect can also be observed in the constellation diagram in Figure 19.

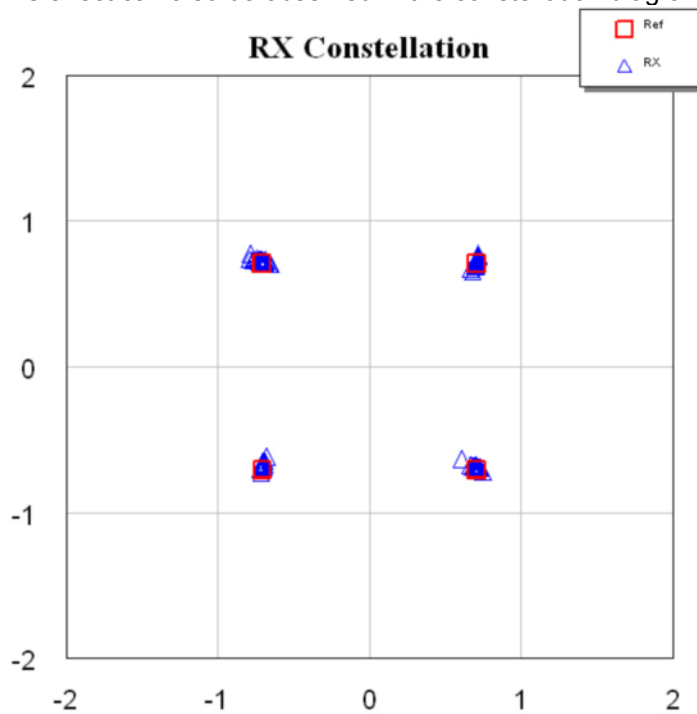

**Figure 19: Constellation plot of QPSK distortion under amplification**

The eye diagram can also be displayed. For QPSK, the dual power levels from the constellation diagram in Figure 19 correlate to the eye diagram crossings in Figure 20. The eye diagram displays state transitions with time and its deviances.



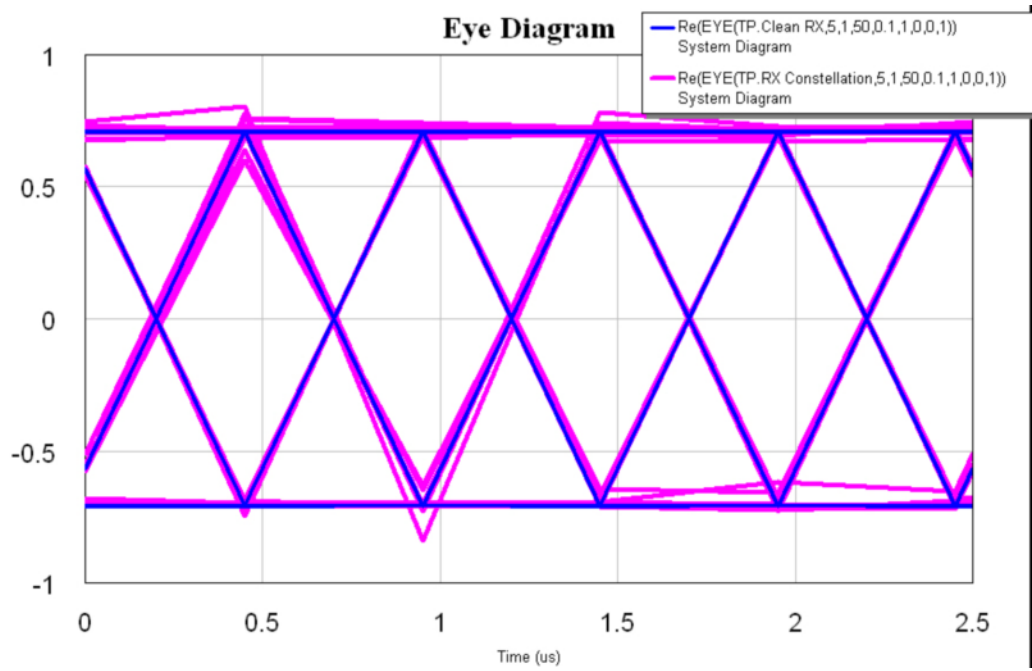

Figure 20: Eye diagram of QPSK

## 3 AWR Connected™ for R&S®WinIQSIM2™

### 3.1 Signal Source Example within VSS

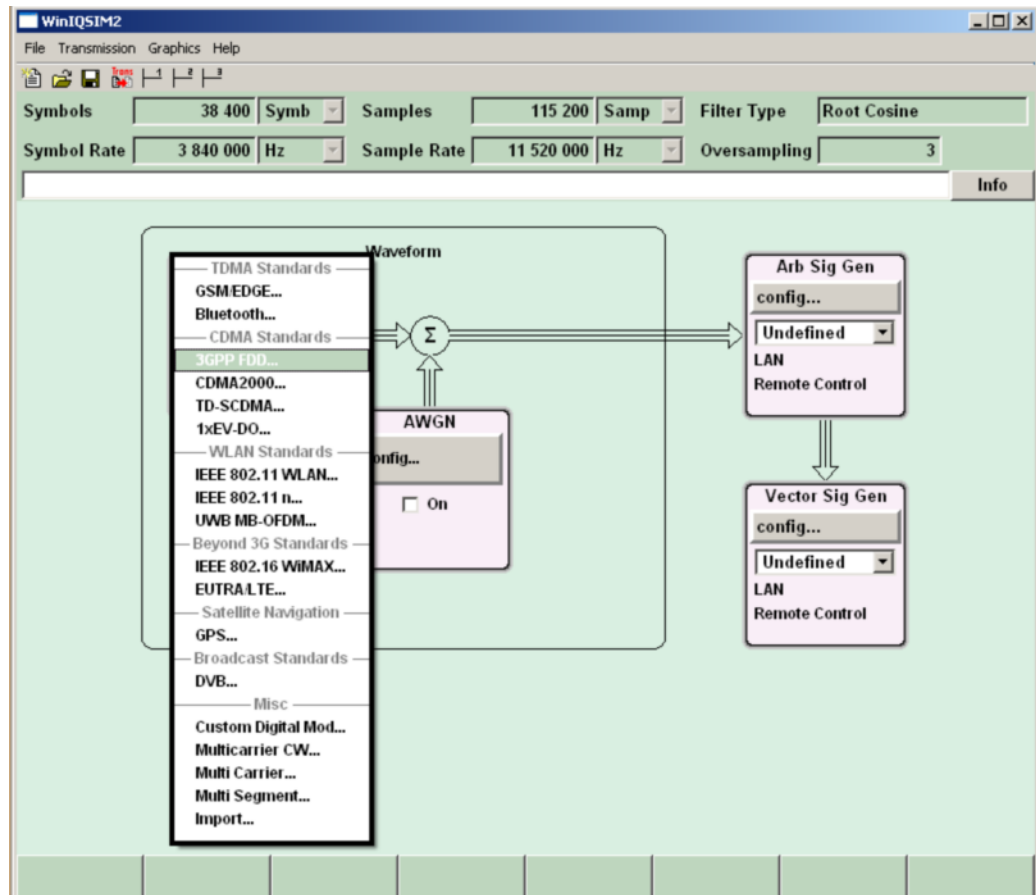

Figure 21: Various Digital Standards in the R&S®WinIQSIM2™ Simulation Software

With AWR® Connected™ for Rohde & Schwarz, the R&S®WinIQSIM2™ Simulation Software is integrated within the AWR® Visual System Simulator™ (VSS) software. The R&S®WinIQSIM2™ Simulation Software is freely downloadable from:

[http://www2.rohde-schwarz.com/en/products/test\\_and\\_measurement/signal\\_generation/WinIQSIM2.html](http://www2.rohde-schwarz.com/en/products/test_and_measurement/signal_generation/WinIQSIM2.html)

Using WinIQSIM2™ Source in AWR® Design Environment ensures that the same real-world test signals can be used throughout the design cycle and later on for the verification as well. The various digital standards are readily available as shown in Figure 21. Additive White Gaussian Noise (AWGN) can also be added for robust testing to simulate realistic environments. It is important to note that the R&S®WinIQSIM2™ Simulation Software is free, but to generate the \*.wv waveform file in the ARB of the R&S® signal generators, the corresponding generator option(s) must be purchased. Refer to Chapter 9 Ordering Information for further details about R&S®WinIQSIM2™ generator options.

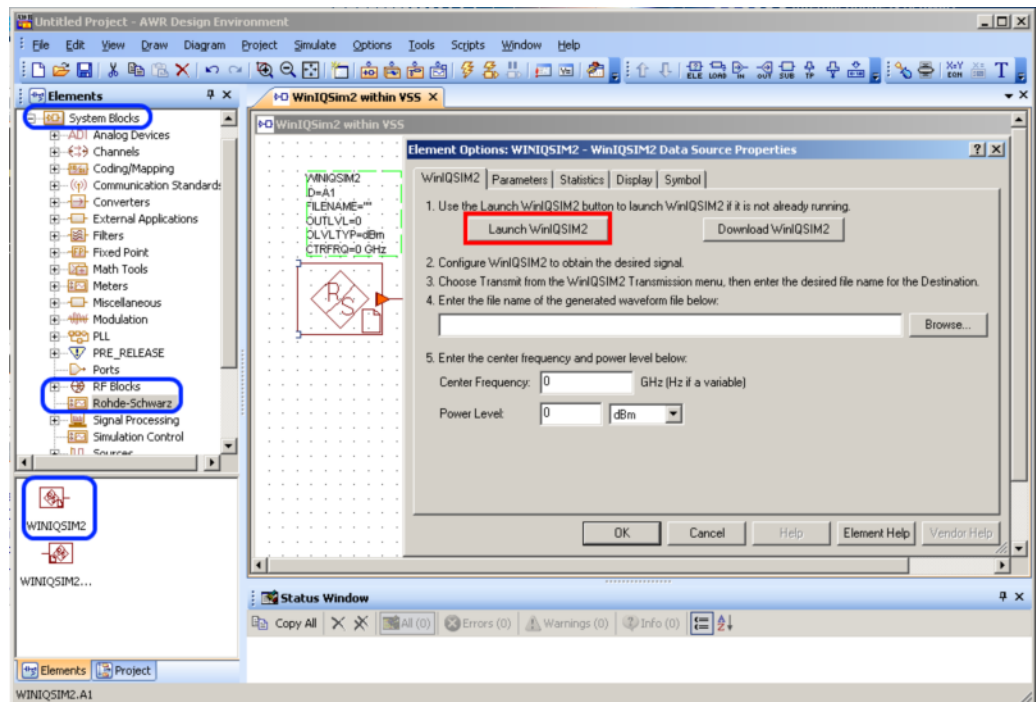

Figure 22: R&S® WinIQSIM2™ digital signal waveform embedding into AWR®

As shown in Figure 22, proceed to switch to the AWR® Design Environment bottom left pane [Elements], select [System Blocks→RF Blocks→Rohde & Schwarz→WinIQSIM2 Data Source]. Place it on a system diagram, double-click and choose "Launch WinIQSIM2".

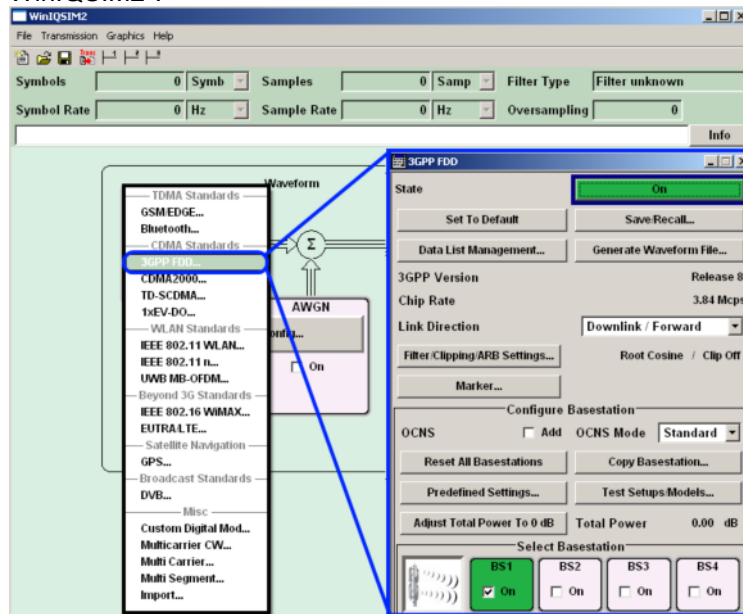

Figure 23: 3GPP WCDMA Downlink Test Model 1 (16 Channels) Configuration

As an example, a 3GPP WCDMA Downlink Test Model 1 (16 Channels) is chosen as shown in Figure 23.

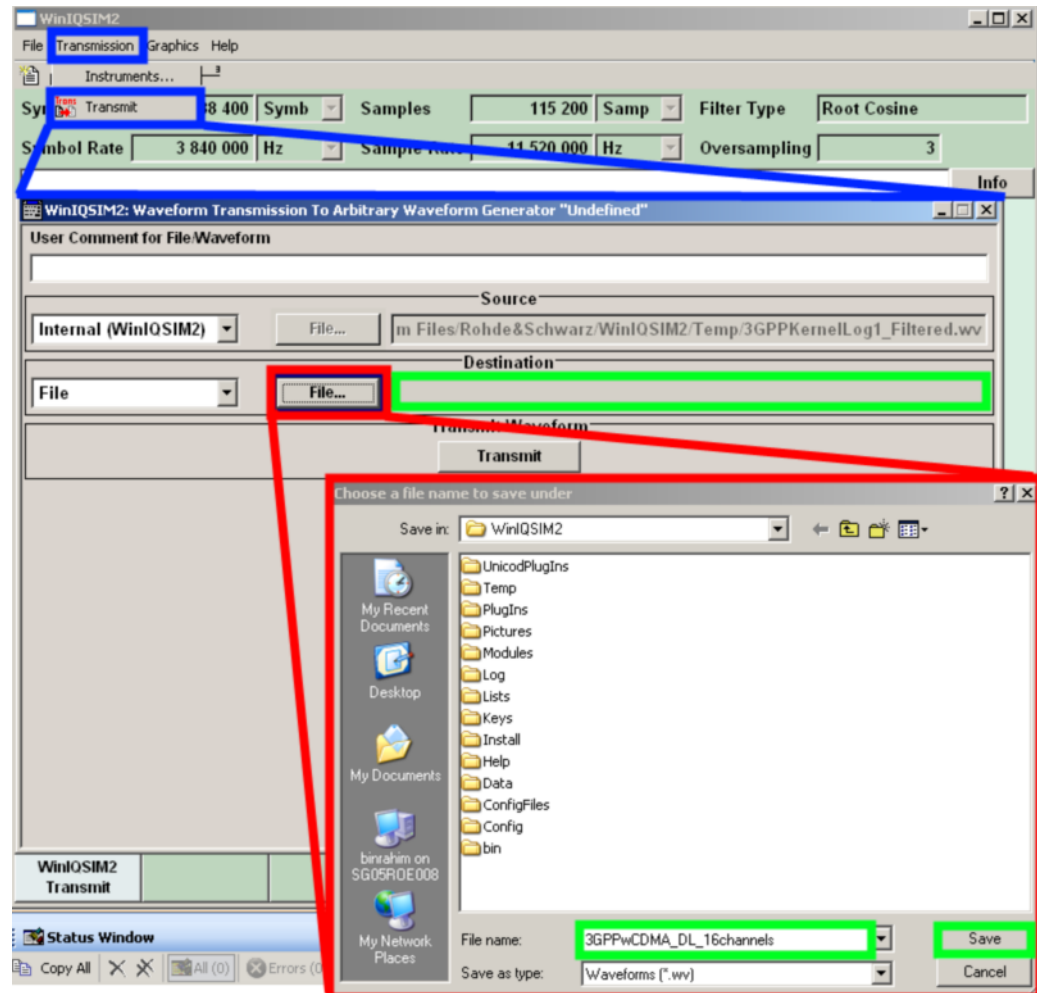

Figure 24: Defining the destination file of \*.wv format in R&S®WinIQSIM2™

Proceed to select from the R&S®WinIQSIM2™ taskbar [Transmission→Transmit]. Set [Source→Internal (WinIQSIM2)] and [Destination→File]. Select a meaningful file name and the file destination so that it can later be recalled and embedded in AWR® VSS.

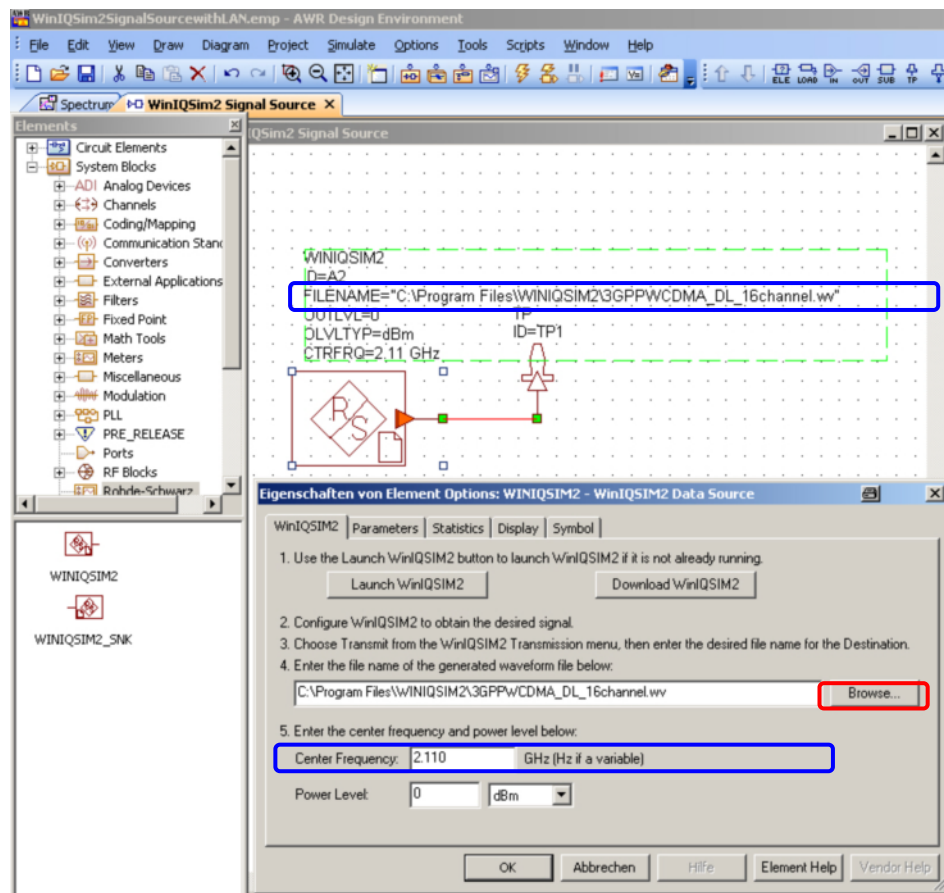

Figure 25: Calling out previously generated \*.wv file and embedding into AWR®

Browse the \*.wv waveform file from its address and embed it into AWR® VSS. Proceed to set the [Center Frequency] and [Power Level] and click "OK".

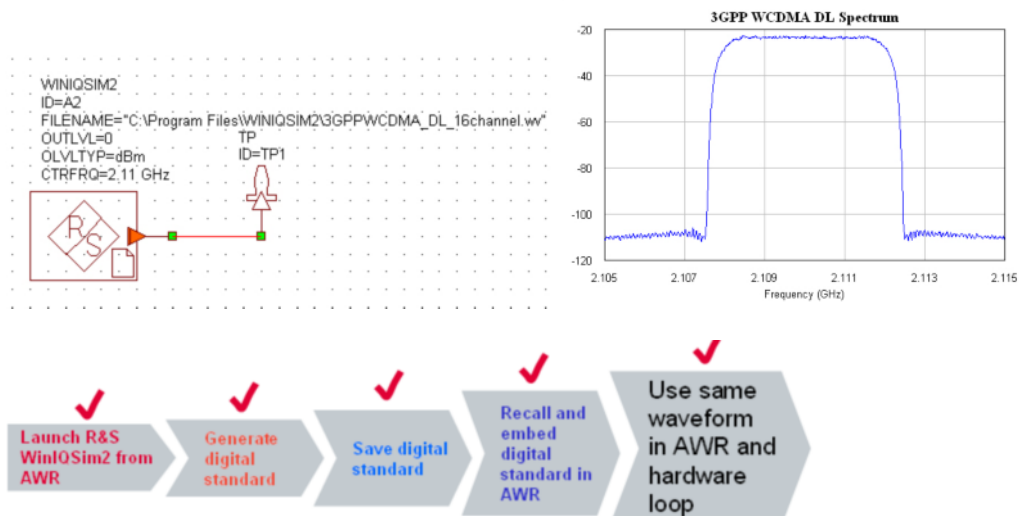

Figure 26: Setting a test point and plotting out the spectrum graph

Drop a testpoint to capture the signal data. At the taskbar, select to analyze and then to run/stop the simulator. A 3GPP WCDMA RF Spectrum with occupied bandwidth of less than 5MHz is shown in Figure 26. Besides RF Spectrum, other data such as In- (I) and Quadrature- (Q) phase can be extracted and plotted. This undistorted signal can be used as a reference signal to correlate it with a distorted real-world signal.

### 3.2 Signal Sink with LAN Transfer Example

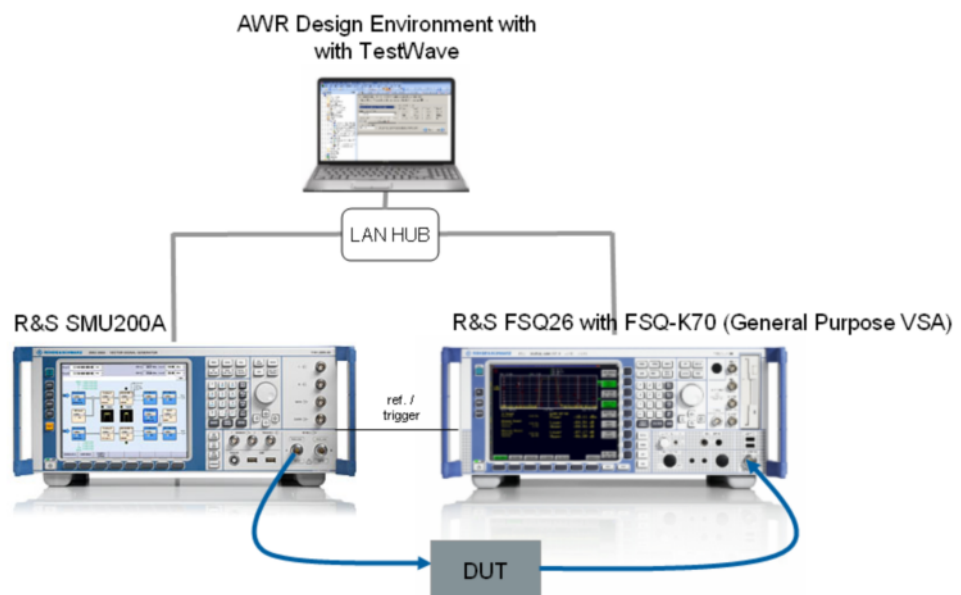

Figure 27: \*.wv file transfer to R&S®SMU200A via LAN, and signal analysis with R&S®FSQ26

This chapter describes a use case example based on the R&S®WinIQSIM2™ signal sink element that is provided with the AWR® VSS software. The example includes the creation of a modulated waveform in AWR® VSS which is captured in the R&S®WinIQSIM2™ signal sink element. This captured waveform is loaded into the ARB generator of the R&S®SMU200A. Fading (via option R&S®SMU-B14) and IQ impairments may be added to the signal as well. The signal is used for testing a DUT as shown in Figure 27. An R&S® signal analyzer FSQ26 including option FSQ-K70 (General Purpose Vector Signal Analysis) can be used for analysis, for example.

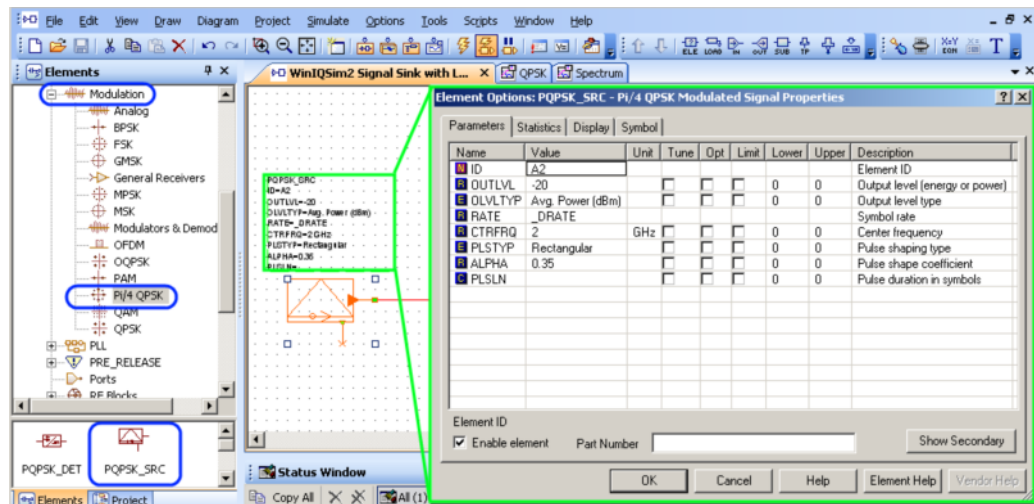

Figure 28: AWR VSS-generated Pi/4 QPSK modulated signal source

As an example, a Pi/4 QPSK modulated signal source is selected from [Elements], [System Blocks→Modulation→Pi/4 QPSK→POPSK\_SRC].

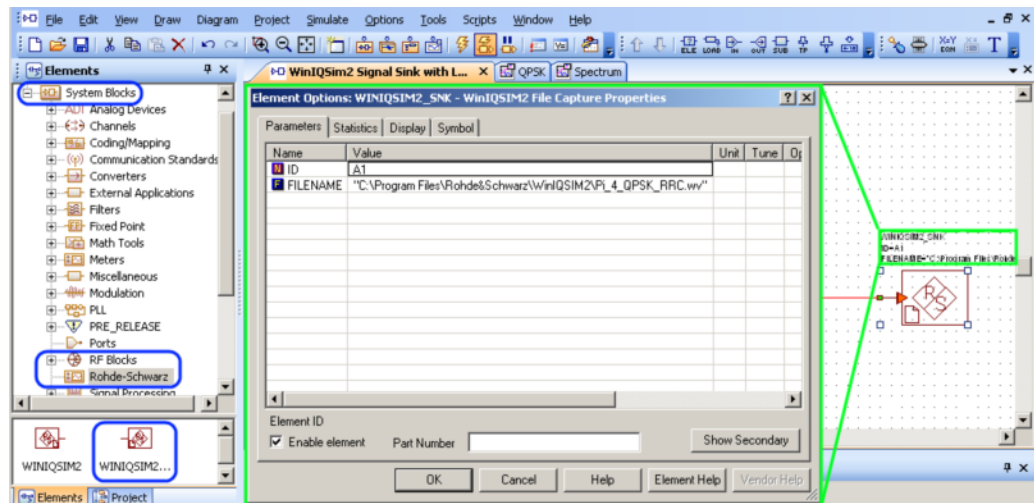

Figure 29: WinIQSIM2 Sink: saving \*.wv file to directory

After choosing the VSS-generated signal, a Pi/4 QPSK modulated signal in this section for example, proceed to switch to the AWR® Design Environment™ bottom left pane [Elements], select [System Blocks→RF Blocks→Rohde & Schwarz→WINIQSIM2\_SNK WinIQSIM2 File Capture]. Under [FILENAME], select an appropriate address that can be used to call the \*.wv file. For this particular example, the address to store the \*.wv file is "C:\Program Files\Rohde&Schwarz\WinIQSIM2\Pi\_4\_QPSK\_RRC.wv".

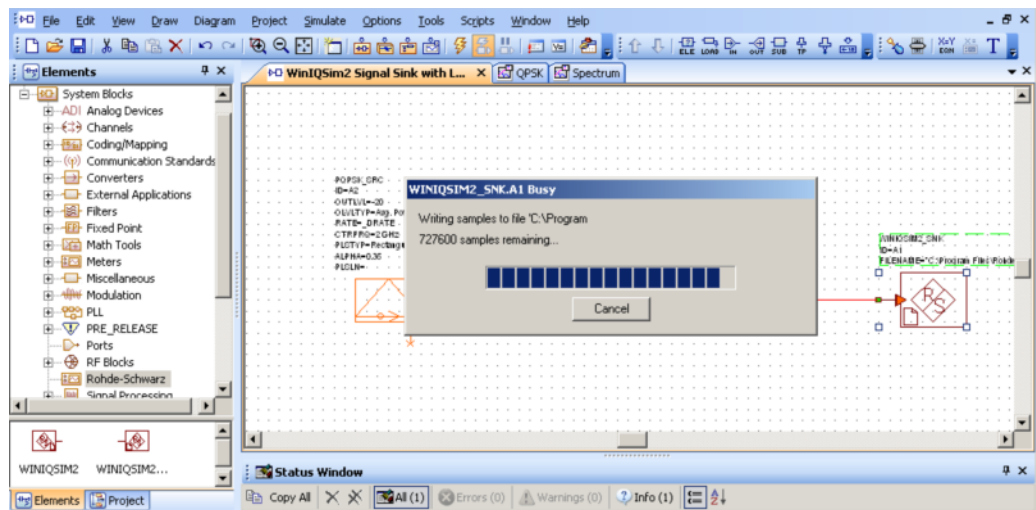

Figure 30: Pi/4 QPSK modulated signal source transfer to Rohde-Schwarz WinIQSIM2 Sink

The \*.wv file from AWR® VSS is first captured and embedded into the R&S® WinIQSIM2™ signal sink. Optionally, AWGN (additive white gaussian noise) can be added to the signal within R&S® WinIQSIM2™. Then the signal is transmitted (via LAN interface in this example) to the ARB Generator of the R&S® SMU200A .

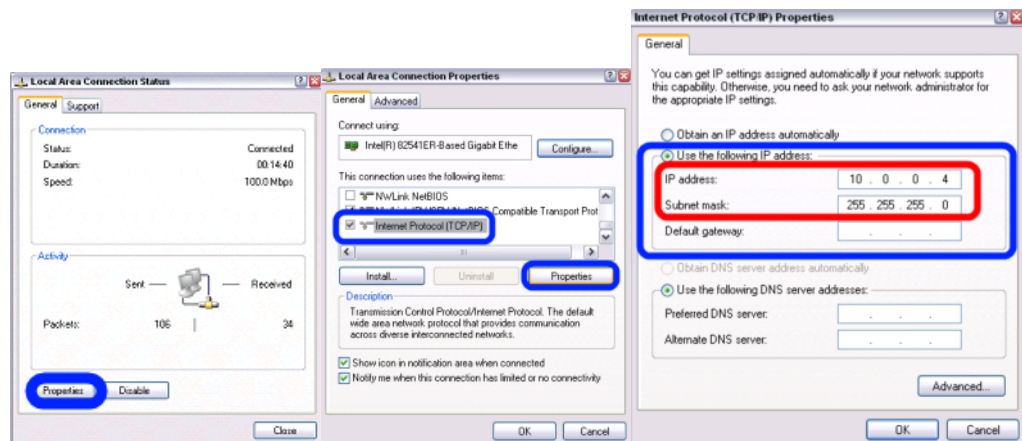

Figure 31: Setting the IP address and Subnet Mask

After embedding the Pi/4 QPSK modulated signal into the R&S® WinIQSIM2™ signal sink, the LAN connection can be established. For WinXP™-based R&S® SMU200A and R&S® FSQ26 instruments, LAN settings can be checked via SETUP→Remote→TCP/IP or via double-clicking Local Area Connections in the taskbar menu (refer to Figure 31).



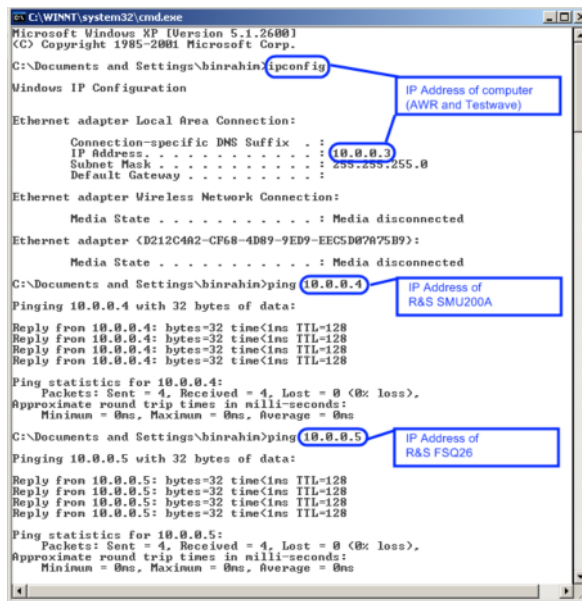

Figure 32: Checking for LAN connectivity

Once under Local Area Connection Status, choose "Properties" to go to Local Area Connection Properties. Scroll down to "Internet Protocol (TCP/IP)" and click "Properties". Ensure that the subnet mask is "255.255.255.0" and that the R&S® instruments used in the test setup have unique addresses. For this example, the IP address of the R&S®SMU200A is "10.0.0.4", and the IP address of the R&S®FSQ26 is "10.0.0.5". The computer is assigned an IP address of "10.0.0.3". Note that DHCP addressing would be possible as well.

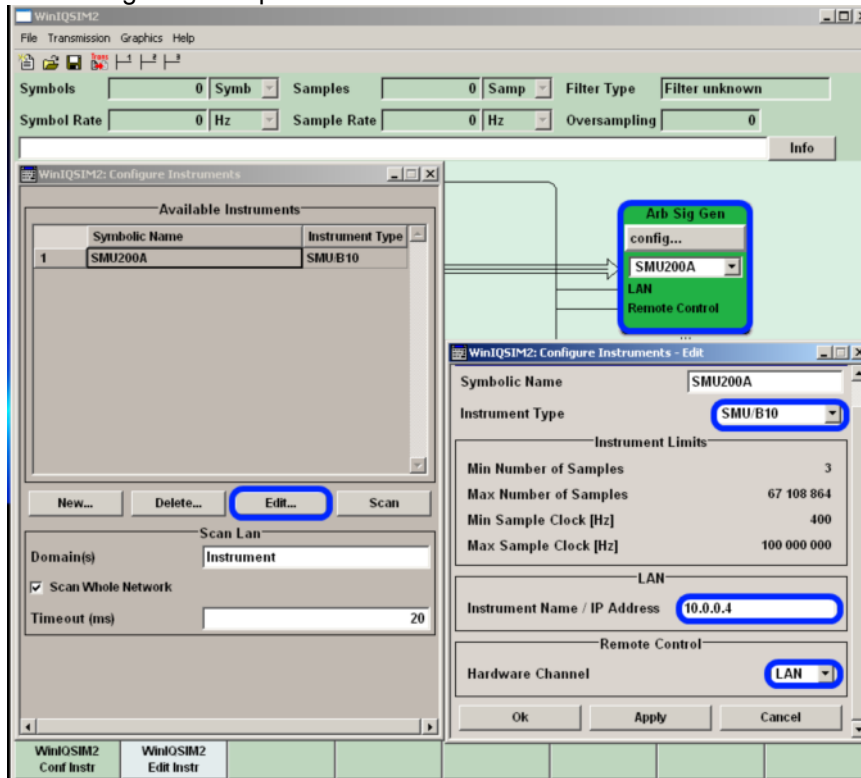

Figure 33: R&S® WinIQSIM2™ LAN configuration matched to instrument

As shown in Figure 33, ensure that the instrument IP address is matched in the [Arb Sig Gen] module of R&S®WinIQSIM2™. Ensure that the proper R&S®SMU200A Baseband ARB option is selected. For this example, SMU-B10 with 64 MSamples is used.

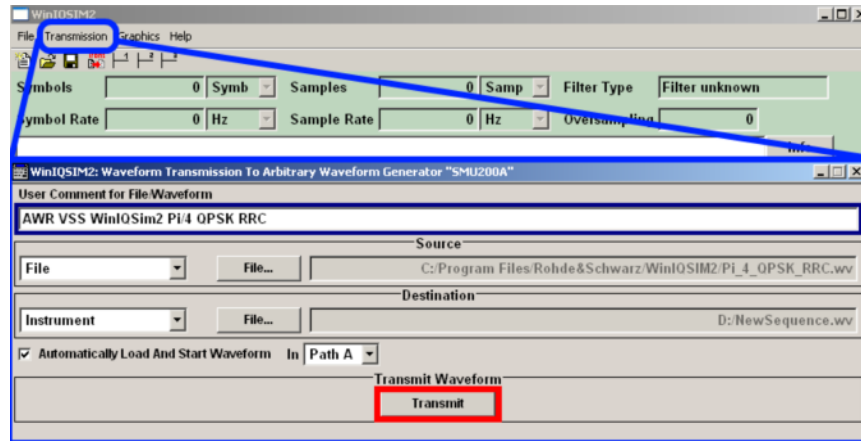

Figure 34: Setting source (File) and destination (Instrument) of \*.wv file

Select [Transmission→Transmit] from the R&S®WinIQSIM2™ taskbar. Set [Source→File] and [Destination→Instrument], as shown in Figure 34. Point the file destination to an appropriate directory on the instrument where the file would be saved. The VSS-generated Pi/4 QPSK in \*.wv format will be transferred to the instrument via LAN. If "Automatically Load and Start Waveform" is selected (see Figure 34), the waveform will immediately start to run on the instrument. Select "Transmit" to transmit to the R&S®SMU200A.

The signal is now available in the R&S®SMU200A, and can be applied to the DUT and later analyzed with the R&S®FSQ26.

## 4 Measurement Import from R&S®Signal Analyzers

### 4.1 Connectivity of FSH3/6/18 with AWR® Design Environment™ via RS-232

With AWR®TestWave™, measured data can be imported into the AWR® Design Environment. With the R&S®FSH-K1 remote option, data transfer via Serial RS-232 is possible. In this case, the Baud Rate is 19200.

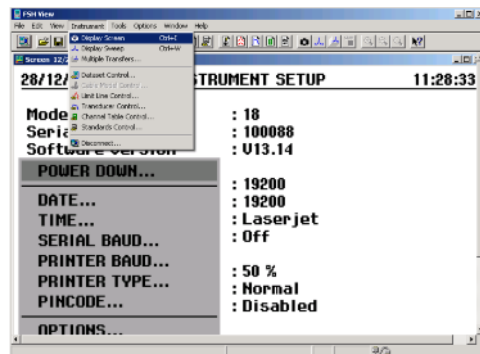

Figure 35: Using R&S®FSHView software to check Serial RS-232 19200 Baud Rate

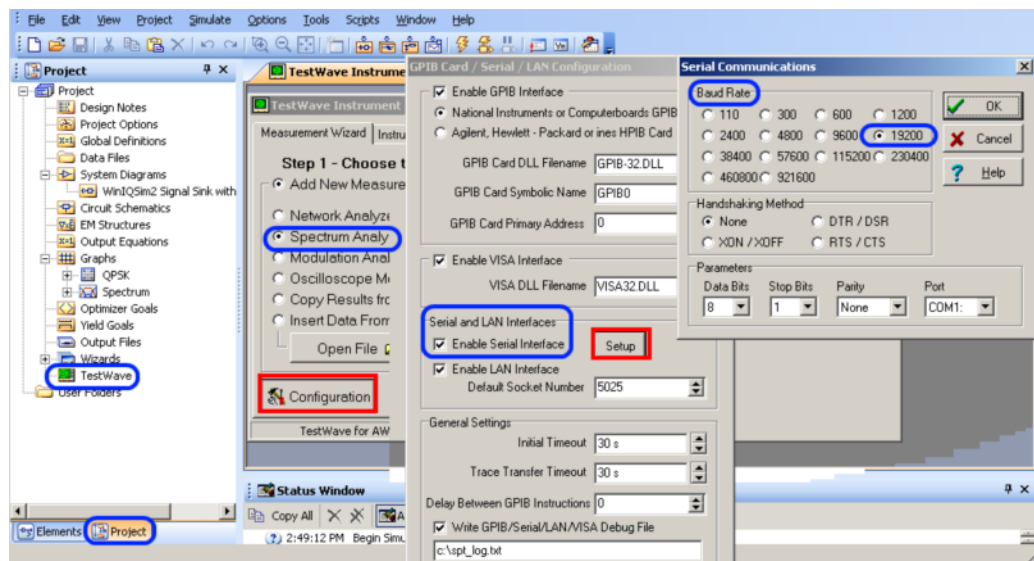



Figure 36: Direct embedding of R&S®FSH 3/6/18 data via RS-232 into AWR®

To embed R&S®FSH3/6/18 data via RS-232 in AWR® VSS, AWR® TestWave™ is utilized. At the bottom of the [Project Tree], click on the  icon. Referring to Figure 36, under [Measurement Wizard] tab, select [Spectrum Analyzer] and ensure under [Configuration] that "Enable Serial Interface" is checked. Enter the Baud Rate 19200 of the R&S®FSH3/6/18, the handshaking method and the COM Port.

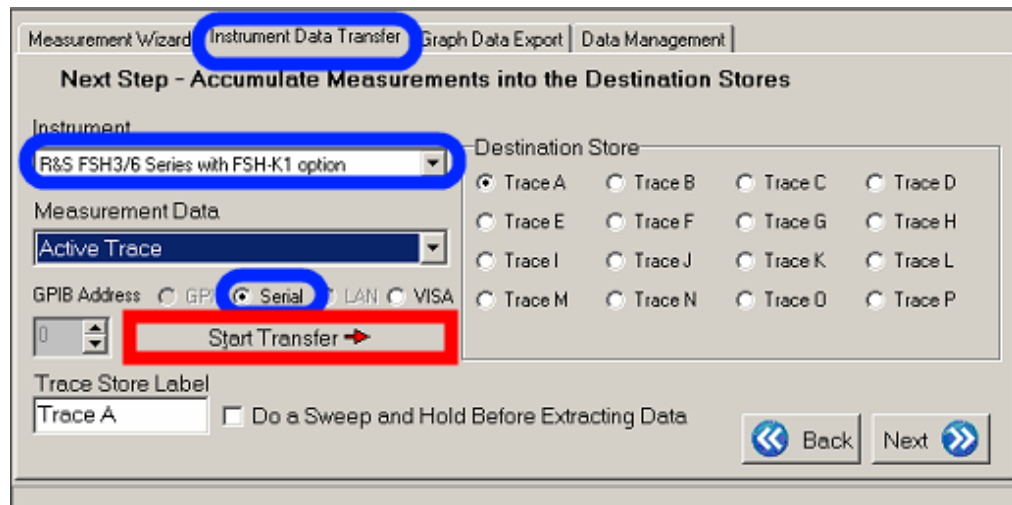

Figure 37: Transferring R&S®FSH 3/6/18 data via RS-232

Under [Instrument Data Transfer] tab, select [R&S FSH/3/6 Series with FSH-K1 option] and select [Start Transfer].

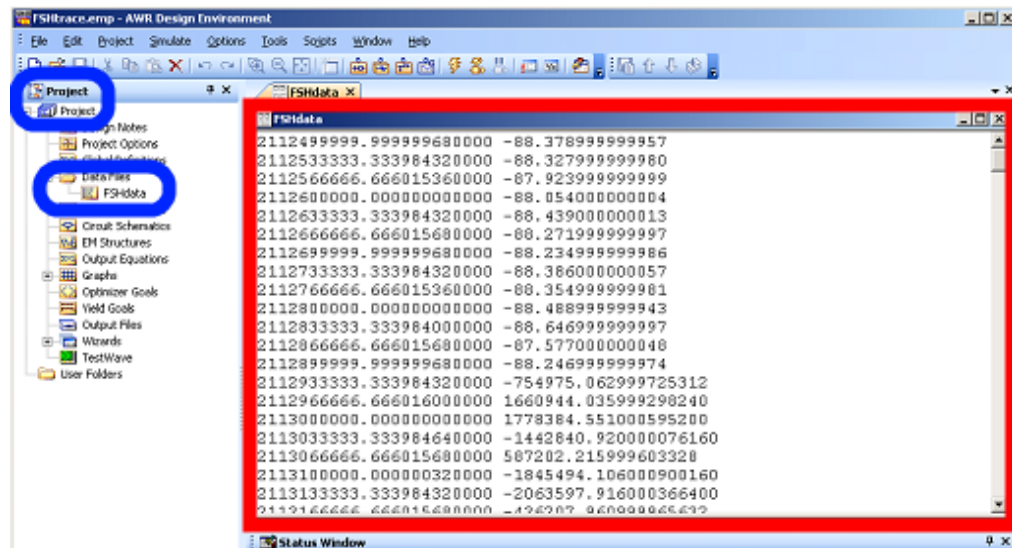

Figure 38: Naming and embedding data file into AWR® Design Environment™

Once embedded into AWR® Design Environment, the raw trace data can be used to plot a graph with measured versus simulated data, for example, or for additional processing. A convenient tool to illustrate the data is provided with TestWave™: SoftPlot for TestWave™ is presented in the subsequent sub-chapter.

## 4.2 Transferring Data from R&S® Signal/Spectrum Analyzers to SoftPlot for TestWave™ for Documentation

The AWR® Design Environment™ offers a relatively effortless way of documenting the data captured with R&S® test equipment. SoftPlot for TestWave™ enables designers to place high-quality graphic measurement traces into documents and presentations. SoftPlot for TestWave™ extracts only the unformatted data from the instrument and allows data styling in various ways. For example, the graticule type, style and scaling can be user-defined, and markers and limit lines added. In addition, the graph can be annotated in various ways, and if there are several traces they can be drawn in different pen styles, colors and tabulated formats. Editing can be done independently from the AWR® Design Environment™.

SoftPlot for TestWave™ supports GPIB/LAN/Serial RS-232 connectivity. In the following, an example based on LAN connectivity is shown.

In order to transfer data and plot the RF spectrum from an R&S®FSQ26 Signal Analyzer, start SoftPlot for TestWave™ using the following sequence: **Windows desktop→Start→Programs→AWR 2009→Testwave→Softplot for Testwave**. Under "Spectrum Analyzer" tab, select the relevant instrument type as "R&S FSE/FSG/FSIQ/FSL/FSP/FSQ/FSUP/FSV" and set the IP address ("10.0.0.1" in the example in Figure 39).

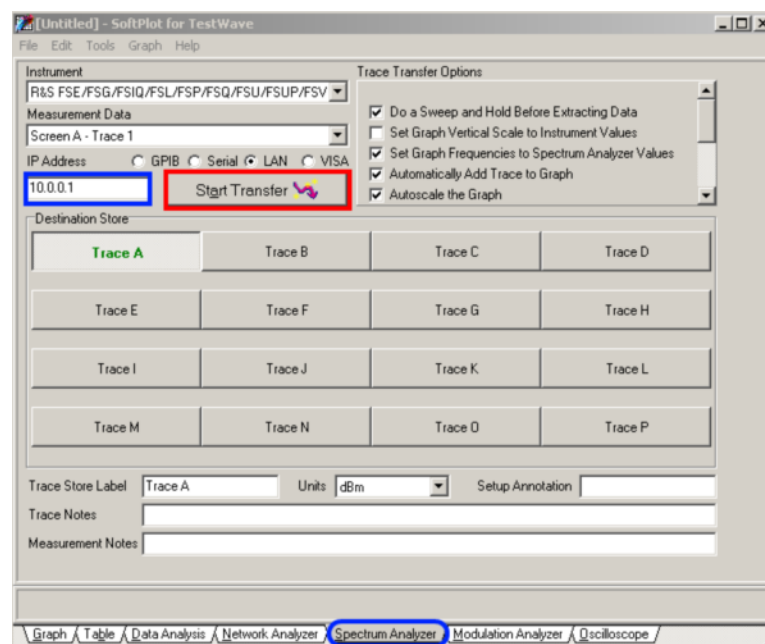

Figure 39: Using LAN to transfer data from the R&S®FSQ

Select "Start Transfer" and the captured raw data will be listed under the "Table" tab. Select "Graph" tab to obtain a plot of the RF spectrum. Figure 40 shows an example graph, the RF spectrum of an EUTRA/LTE (FDD) 20 MHz signal.

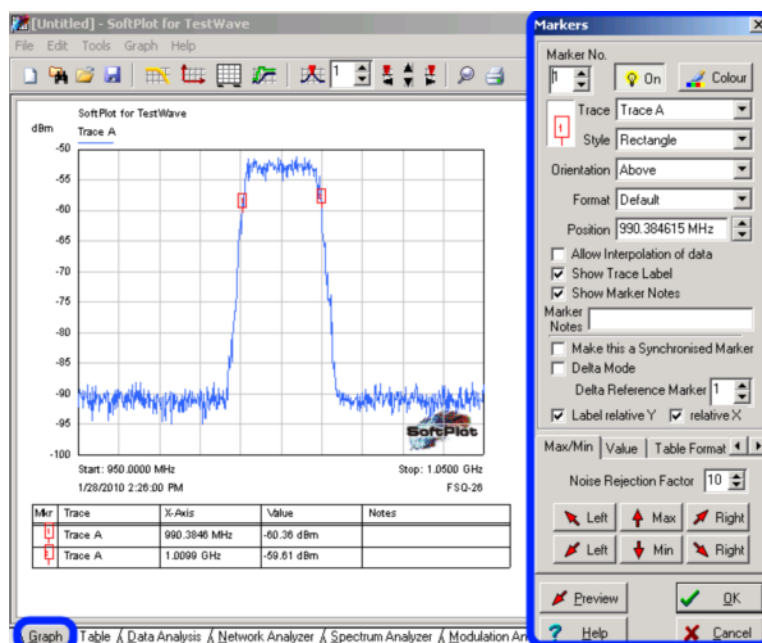

Figure 40: EUTRA/LTE(FDD) 20MHz RF Spectrum with markers/table using Softplot for TestWave™

Markers and corresponding tabulation as well as colour schemes are used to enhance the plot. SoftPlot for TestWave™ thus complements the design cycle for ease-of-documentation.

## 5 Conclusion

Microwave Office® and VSS from AWR are complete and comprehensive software suites for designing RF and microwave ICs, printed circuit boards (PCBs), modules and complex communications systems. Integrating test and measurement equipment from Rohde & Schwarz with AWR® MWO and VSS enhances the design flow by making it possible to compare simulation behavior to real world behavior by parallelizing tasks. Every stage of the design cycle can be verified and -- more importantly -- rectified at an early stage, thereby reducing design loop-backs.

AWR's TestWave™ solution provides the physical communication link between Rohde & Schwarz test and measurement equipment and the AWR software environment. Thus, signal generators and analyzers from Rohde & Schwarz can be seamlessly integrated to carry out cross-domain or "hardware-in-the-loop" simulations. For cross-domain measurements, the processed simulation signal is transferred to the Rohde & Schwarz vector signal generator, applied in the real world to the Device under Test (DUT), and coupled back to the simulation environment through the Rohde & Schwarz spectrum analyzer.

In addition, VSS integrates the R&S® WinIQSIM2 simulation software from Rohde & Schwarz to generate standard-compliant signals for all modern digital communication standards. With AWR® Connected™ for Rohde & Schwarz, the flexibility of digital radio standards generation using R&S® WinIQSIM2™ is advantageous since today's modern communication signals such as 3GPP LTE(FDD/TDD), 3GPP FDD/HSPA/HSPA+, and WiMAX™ are directly embedded into system design.

The generated signals provide the stimuli for the simulation. In this case, the simulation environment utilizes the same signal as used for the measurement with the Rohde & Schwarz equipment. The combination of Rohde & Schwarz instruments and R&S® WinIQSIM2 with AWR's VSS provides designers and engineers alike the best hardware-software platform for designing and optimizing their communications system.

## 6 Literature

- [1] Filter Design and Optimization Using the R&S® ZVA/ZVB/ZVT Integrated with AWR® EDA Software, Rohde & Schwarz Application Note 1MA163, [www.rohde-schwarz.com/appnote/1MA163](http://www.rohde-schwarz.com/appnote/1MA163)

## 7 Ordering Information

Ordering Information		
Vector Signal Generator		
<b>R&amp;S® SMU200A</b>		<b>1141.2005.02</b>
R&S® SMU-B102	1st RF path, Frequency range 100 kHz - 2.2 GHz	1141.8503.02
R&S® SMU-B103	1st RF path, Frequency range 100 kHz - 3GHz	1141.8603.02
R&S® SMU-B104	1st RF path, Frequency range 100 kHz – 4 GHz	1141.8703.02
R&S® SMU-B202	2nd RF path, Frequency range 100 kHz - 2.2 GHz	1141.9400.02
R&S® SMU-B203	2nd RF path, Frequency range 100 kHz - 3 GHz	1141.9500.02
R&S® SMU-B9	Baseband generator with dig. modulation (real time) and ARB (128 M Samples)	1161.0766.02
R&S® SMU-B10	Baseband generator with dig. modulation (real time) and ARB (64 M samples)	1141.7007.02

<b>Ordering Information</b>		
R&S® SMU-B11	Baseband generator with digital mod. (real time) and ARB (16 M samples)	1159.8411.02
R&S® SMU-B13	Baseband Main Module	1141.8003.04
R&S® SMU-B14	Fading Simulator	1160.1800.02
<b>R&amp;S® SMJ100A</b>		<b>1403.4507.02</b>
R&S® SMJ-B103	Frequency range 100 kHz - 3 GHz	1403.8502.02
R&S® SMJ-B106	Frequency range 100 kHz - 6 GHz	1403.8702.02
R&S® SMJ-B9	Baseband generator with dig. mod. (real time) and ARB (128 M Samples)	1404.1501.02
R&S® SMJ-B10	Baseband generator with dig. mod. (realtime) and ARB (64 MSamples)	1403.8902.02
R&S® SMJ-B11	Baseband generator with dig. mod. (realtime) and ARB (16 MSamples)	1403.9009.02
R&S® SMJ-B13	Baseband main module	1403.9109.02
R&S® SMJ-B50	Baseband generator; ARB only, 64 Msamples	1410.5505.02
R&S® SMJ-B51	Baseband generator; ARB only, 16 Msamples	1410.5605.02
<b>R&amp;S® SMBV100A</b>		<b>1407.6004.02</b>
R&S® SMBV-B103	Frequency range 9kHz to 3.2GHz	1407.9603.02
R&S® SMBV-B106	Frequency range 9KHz to 6GHz	1407.9703.02
R&S® SMBV-B1	Reference oscillator OCXO	1407.8407.02
R&S® SMBV-B10	Baseband Generator with Digital Modulation (real-time) and ARB (32 Msample), 120 MHz RF BW	407.8907.02
R&S® SMBV-B50	Baseband generator, ARB only (32MSamples)	1407.8907.02
R&S® SMBV-B51	Baseband generator, ARB only (32MSamples)	1407.9003.02
R&S® SMBV-B55	Memory extensionfor ARB to 256Msamples, Requires SMBV-B92	1407.9203.02
R&S® SMBV-B92	Hard disc	1407.9403.02
<b>Baseband Signal Generator</b>		
<b>R&amp;S® AFQ100A</b>		<b>1401.3003.02</b>
R&S® AFQ-B10	Waveform memory 256 Msamples	1401.5106.02
R&S® AFQ-B11	Waveform memory 1 Gsamples	1401.5206.02
<b>R&amp;S® AFQ100A</b>		1410.9000.02



Ordering Information		
R&S® AFQ-B12	Waveform memory 512 MSamples	1411.0007.02
<b>R&amp;S® AMU200A</b>		1402.4090.02
R&S® AMU-B9	Baseband generator with dig. mod. (realtime) and ARB (128 MSamples)	1402.8809.02
R&S® AMU-B10	Baseband generator with dig. mod. (realtime) and ARB (64 MSamples)	1402.5300.02
R&S® AMU-B11	Baseband generator with dig. mod. (realtime) and ARB (16 MSamples)	1402.5400.02
R&S® AMU-B13	Baseband Main Module	1402.5500.02
R&S® AMU-B14	Fading Simulator	1402.5600.02

### Digital Standards with R&S® WinIQSIM2™

R&S® WinIQSIM2™ software can be downloaded at no charge from

[http://www2.rohde-schwarz.com/en/products/test\\_and\\_measurement/signal\\_generation/software/WinIQSIM2.html](http://www2.rohde-schwarz.com/en/products/test_and_measurement/signal_generation/software/WinIQSIM2.html)

For use with R&S® signal generators, software options are required. The available options are listed in the following table for the R&S® SMU200A. Corresponding options are available for the other R&S® signal generators that are listed above. The R&S® WinIQSIM2™ options are then referred to as R&S® AFQ-K2xx, R&S® AMU-K2xx, R&S® SMJ-K2xx, and R&S® SMBV-K2xx.

Ordering Information		
WinIQSIM2™ Options		
R&S® SMU-K240	Digital standard GSM/EDGE	1408.5518.02
R&S® SMU-K241	Digital standard EDGE evolution	1408.7862.02
R&S® SMU-K242	Digital standard 3GPP FDD	1408.5618.02
R&S® SMU-K243	3GPP FDD enhanced MS/BS tests incl. HSDPA	1408.5718.02
R&S® SMU-K244	Digital standard GPS	1408.5818.02
R&S® SMU-K245	Digital standard HSUPA	1408.5918.02
R&S® SMU-K246	Digital standard CDMA2000 incl. 1xEV-DV	1408.6014.02
R&S® SMU-K247	Digital Standard 1XEV-DO REV.A	1408.7462.02
R&S® SMU-K248	Digital standard IEEE 802.11 (a/b/g)	1408.6114.02
R&S® SMU-K249	Digital standard IEEE 802.16	1408.6214.02
R&S® SMU-K250	Digital standard TD-SCDMA	1408.6314.02
R&S® SMU-K251	Digital standard TD-SCDMA enhanced features	1408.6414.02
R&S® SMU-K252	Digital Standard DVB-H	1408.7510.02

Ordering Information		
R&S® SMU-K254	Digital Standard IEEE 802.11n	1408.7610.02
R&S® SMU-K255	Digital Standard EUTRA	1408.7362.02
R&S® SMU-K256	Playback of XM Radio waveforms	1161.1240.02
R&S® SMU-K259	Digital standard HSPA+	1415.0101.02
R&S® SMU-K260	Digital standard Bluetooth Enhanced Data Rate	1408.8017.02
R&S® SMU-K261	Multicarrier CW signal generation	1408.6514.02
R&S® SMU-K262	Additive white Gaussian noise	1400.6609.02

Ordering Information		
Signal Analyzers		
<b>R&amp;S® FSQ</b>	<b>Up to 3.6, 8, 26.5 or 40 GHz</b>	<b>1155.5001.xx</b>
<b>R&amp;S® FSG</b>	<b>Up to 8 or 13.6 GHz</b>	<b>1309.0002.xx</b>
<b>R&amp;S® FSV</b>	<b>Up to 3.6, 7, 13.6, 30, 40 GHz</b>	<b>1307.9002.xx</b>
<b>R&amp;S® FSU</b>	<b>Up to 3.6, 8, 26.5, 43, 46, 50 or 67 GHz</b>	<b>1166.1660.xx</b>
R&S® FSQ-K70	Vector signal analysis	1161.8038.02
R&S® FSV-K70	Vector signal analysis	1310.8455.02
R&S® FSH3	Handheld spectrum analyzer 100 kHz - 3 GHz	1145.5850.03
R&S® FSH6	Handheld spectrum analyzer 100 kHz - 6 GHz	1145.5850.06
R&S® FSH18	Handheld Spectrum Analyzer 10MHz - 18GHz	1145.5850.18
R&S® FSH-K1	Remote control (via RS-232)	1157.3458.02

### **About Rohde & Schwarz**

Rohde & Schwarz is an independent group of companies specializing in electronics. It is a leading supplier of solutions in the fields of test and measurement, broadcasting, radiomonitoring and radiolocation, as well as secure communications. Established 75 years ago, Rohde & Schwarz has a global presence and a dedicated service network in over 70 countries. Company headquarters are in Munich, Germany.

### **Environmental commitment**

- Energy-efficient products
- Continuous improvement in environmental sustainability
- ISO 14001-certified environmental management system



### **Regional contact**

USA & Canada

USA: 1-888-TEST-RSA (1-888-837-8772)

from outside USA: +1 410 910 7800

[CustomerSupport@rohde-schwarz.com](mailto:CustomerSupport@rohde-schwarz.com)

East Asia

+65 65 13 04 88

[CustomerSupport@rohde-schwarz.com](mailto:CustomerSupport@rohde-schwarz.com)

Rest of the World

+49 89 4129 137 74

[CustomerSupport@rohde-schwarz.com](mailto:CustomerSupport@rohde-schwarz.com)

This application note and the supplied programs may only be used subject to the conditions of use set forth in the download area of the Rohde & Schwarz website.

R&S® is a registered trademark of Rohde & Schwarz GmbH & Co. KG. Trade names are trademarks of the owners.

**Rohde & Schwarz Regional Headquarters Singapore Pte.Ltd.**

10 Changi Business Park Central 2

#06-01/08

Singapore 486030

[Customersupport.asia@rohde-schwarz.com](mailto:Customersupport.asia@rohde-schwarz.com)