

5G Waveform Candidates

Application Note

Products:

- R&S®SMW200A
- R&S®SMW-K114
- R&S®FSW
- R&S®FS-K196

Enhanced Mobile Broadband, Massive Machine Type Communication, Ultra-reliable and low latency communication have been identified as the requirements to be supported by the 5th Generation of Mobile Communication, short 5G. 5G is extensively discussed in the wireless industry. A lot of research and pre-development is being conducted worldwide, including an analysis of the waveforms and access principles that are the basis for current LTE and LTE-Advanced networks.

In this application note we discuss potential 5G waveform candidates, list their advantages and disadvantages and compare them to Orthogonal Frequency Division Multiplexing (OFDM), which is used in LTE/LTE-Advanced.

Note:

Please find the most up-to-date document on our homepage <http://www.rohde-schwarz.com/appnote/1MA271>.

Table of Contents

1	Introduction	4
2	Definitions	5
3	What's wrong with OFDM?	6
3.1	Why OFDM as an access scheme in the first place?	6
3.2	Basic parameterization for OFDM in LTE/LTE-Advanced.	8
3.3	General limitations of OFDM	10
3.3.1	Cyclic Prefix overhead	10
3.3.2	Sensitivity to Frequency and Timing Offsets	10
3.3.3	High Peak-To-Average-Power Ratio (PAPR)	11
3.3.4	Spectral regrowth.....	13
4	PHY/MAC design for 5G	18
4.1	Application areas for 5G	18
4.2	General design principles for PHY/MAC layer	20
4.3	The ideal waveform and Gabor's Theorem	22
5	Waveform candidates for 5G	24
5.1	Introduction	24
5.2	FBMC - Filter-Bank Multi-Carrier	25
5.2.1	FBMC Advantages and Disadvantages	26
5.3	UFMC - Universal Filter Multi-Carrier	28
5.3.1	UFMC Advantages and Disadvantages	28
5.4	GFDM - Generalized Frequency Division Multiplex.....	29
5.4.1	GFDM Advantages and Disadvantages	30
5.5	Comparison of LTE with FBMC, GFDM and UFMC	31
5.5.1	Peak-To-Average Power Ratio (PAPR).....	31
5.5.2	Spectral regrowth: LTE vs. FBMC, UFMC, GFDM	34
5.5.3	Impact of power amplification to 5G waveform candidates	35
5.5.4	Robustness against Carrier Frequency Offsets (CFO).....	37
5.5.5	Impact of Noise	38
5.6	f-OFDM - filtered Orthogonal Frequency Division Multiplexing.....	40

6	Testing with 5G Waveform Candidates	41
6.1	5G Waveform Candidate Signal Generation	41
6.1.1	General Settings	41
6.1.2	Allocation Settings	43
6.2	5G Waveform Signal Analysis	44
7	General Implications to 5G PHY/MAC Design	49
7.1	Multi-Carrier or Single Carrier?	49
7.1.1	Low(er) Peak-To-Average-Power Ratio (PAPR)	49
7.1.2	Phase Noise at mm-Wave frequencies	51
7.1.3	Low-latency support requirement	51
7.2	Frequency Division Duplex (FDD) or Time Division Duplex (TDD)?	52
7.3	Interference Cancellation methodology required	52
8	Summary and Conclusion	54
9	Literature	55
10	Ordering Information	57

1 Introduction

With the ongoing worldwide transition from voice-centric mobile phones to smartphones and tablets, which was accelerated by the launch of LTE/LTE-Advanced networks worldwide beginning of 2010, mobile broadband data consumption has increased exponentially over the past 5 years. Network operators are forced to look into additional ways to increase overall system capacity by accessing additional or new spectrum and also increase peak and average data rates.

At the same time the 'Internet of Things' puts new demands on the network, provides new requirements that shall be supported by the network architecture and devices. The support of thousands of devices that demand i.e. a quick access to the network to transmit only a small amount of data (e.g. wireless security sensor) provides a tremendous challenge to the current technology. Last but not least the support of very latency-sensitive applications or applications that require an ultra-resilient communication link are seen as potential growth markets in the future.

Support of steering and control via a wireless communication links to support applications like mobile gaming, remote control of robots, autonomous driving and healthcare fall into this category. Those applications demand round trip times (RTT) in the order of 1 ms or less. These three trends (Enhanced Mobile Broadband, Massive Machine Type Communication, Ultra-reliable and low latency communication) have been identified as the requirements to be supported by the 5th Generation of Mobile Communication, short 5G. 5G is extensively discussed in the wireless industry. A lot of research and pre-development is being conducted worldwide, including an analysis of the waveforms and access principles that are the basis for current LTE and LTE-Advanced networks.

In this application note we discuss potential 5G waveform candidates, list their advantages and disadvantages and compare them to Orthogonal Frequency Division Multiplexing (OFDM), which is used in LTE/LTE-Advanced. We start with an analysis of OFDM, its parametrization for LTE and discuss the general disadvantages of OFDM as a waveform [Chapter 2]. Then we take a look at general design principles and guidelines for Physical (PHY) Layer and Medium Access Control (MAC) Layer. Chapter 4 gives an introduction to popular 5G waveform candidates, where in Chapter 5 Rohde & Schwarz test and measurement solutions are presented that support the generation and analysis of these waveforms. Chapter 6 discusses general implications for PHY and MAC design as they related to 5G, where Chapter 7 provides a summary and conclusion.

2 Definitions

Throughout this paper

- R&S®SMW200A Vector Signal Generator is referred to as SMW.
- R&S®FSW Signal and Spectrum Analyzer is referred to as FSW.

3 What's wrong with OFDM?

3.1 Why OFDM as an access scheme in the first place?

Before we answer the question what's potentially wrong with Orthogonal Frequency Division Multiplexing (OFDM), we have to explain why the multi-carrier transmission scheme was chosen in the first place. A multi-carrier transmission scheme subdivides the available channel bandwidth into several parallel sub-channels that are called subcarriers. Multiplexing between users can thus happen in both, frequency and time domain. Ideally, the spacing Δf between these subcarriers is selected in such a way that they are non-frequency selective. In that case these subcarriers experience a flat gain in the frequency domain that can be easily compensated for at the receiver side. For OFDM, several subcarriers are spaced at $\Delta f = 1/T_{Symbol}$, causing minimum cross-talk, also referred to as orthogonality.

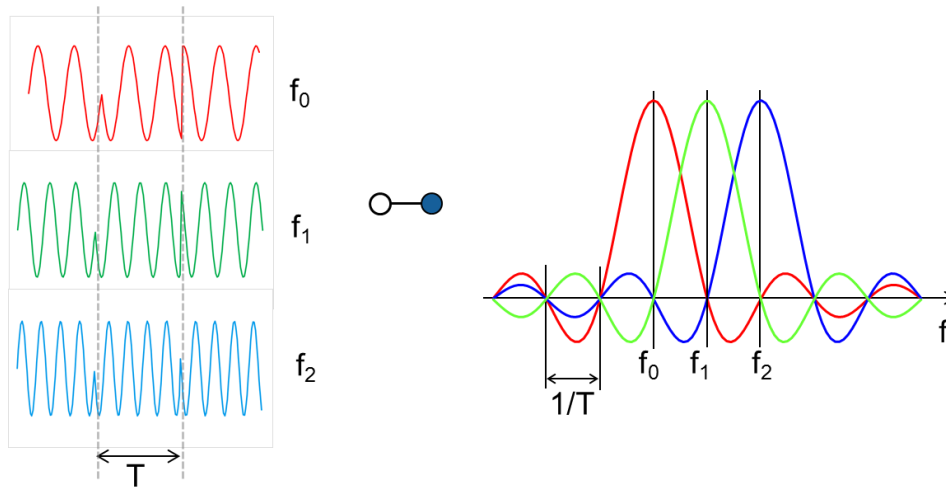

Fig. 3-1: Orthogonality in OFDM

Fig. 3-2 shows the basic block diagram for an OFDM transmitter. The digital data is mapped to complex symbols such as QPSK, 16QAM, 64QAM or 256QAM etc. depending on the digital standard. A serial parallel conversion turns the data stream into N streams, which correspond to the different carrier frequencies f_0, f_1, f_2 , etc. The central carrier (DC) is set to zero. At both edges additional, but unused subcarriers are added to achieve a total of $2N$ subcarriers, which can be converted from frequency into time domain by an Inverse Fast Fourier Transform (IFFT). To increase robustness against Inter-Symbol Interference (ISI) caused by multipath propagation on the radio channel the total symbol duration is further increased by adding a Cyclic Prefix (CP). A CP is a copy of the tail of a symbol placed at its beginning.

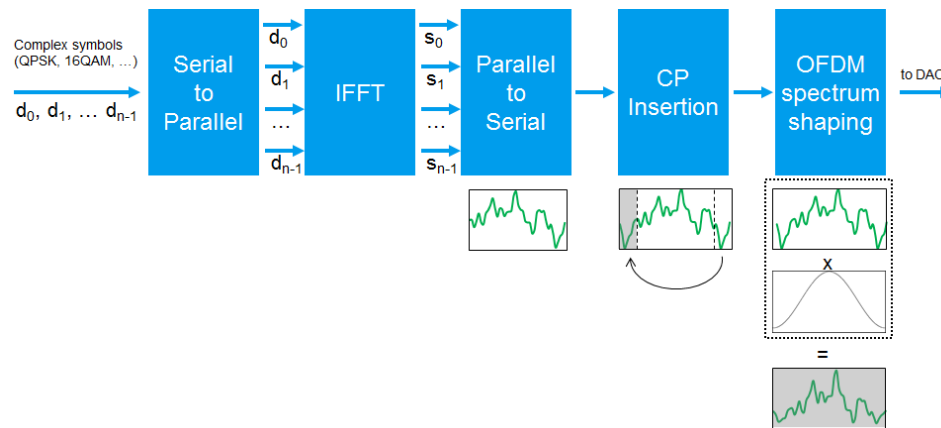

Fig. 3-2: OFDM Transmitter

The following advantages can be listed for an OFDM-based access scheme, such as OFDMA and SC-FDMA that are used for the Downlink and Uplink in LTE, respectively.

- **Spectral Efficiency** spectral efficiency means to utilize the available spectrum as efficient as possible. OFDM is a special case of a multi-carrier transmission. Instead of just dividing the spectrum into subcarrier and separating them by introducing guard bands these carriers overlap but are orthogonal due to the nature of the pulse shaping based on $\sin(x)/x$ function [see Fig. 3-1]. That makes OFDM very spectrum efficient.
- **Robustness against multi-path propagation and low complexity receiver.** The long symbol duration and required introduction of a Cyclic Prefix to overcome potential Inter-Symbol Interference (ISI) due to multi-path propagation of the radio channel allows the use of a one-tap equalizer approach at the receiver side.
- **Multiple user scheduling advantage.** Using Orthogonal Frequency Division Multiplexing Access (OFDMA) as access scheme allows not just separation of multiple user in the frequency domain by assigning one or multiple Resource Blocks¹ (RB) to an individual users, but also a scheduling of these resources in the time domain based on fixed Transmit Time Interval (TTI) of 1 ms. For the uplink (SC-FDMA) it is important to ensure proper synchronization of individual users at the receiving side. As an example, LTE uses the concept of Timing Advance (TA).

A more detailed introduction to OFDM and OFDMA and SC-FDMA can be found in [1].

¹ Transmission Bandwidth in LTE is organized as Resource Blocks (RB). 1 RB spans 12 subcarriers and corresponds to 180 kHz of bandwidth. 20 MHz channel bandwidth corresponds to 100 RB.

3.2 Basic parameterization for OFDM in LTE/LTE-Advanced.

According to [2] the main design criteria for an OFDM-based cellular system are the maximum expected delay spread T_d , the maximum Doppler frequency f_{dmax} and the targeted cell size. The propagation characteristics and mobility aspects that are represented by the delay spread and the Doppler frequency have an impact on choosing Cyclic Prefix length and subcarrier spacing. The following main design criteria can be identified:

$$T_{CP} \geq T_d \quad \text{to prevent Inter-Symbol Interference (ISI)} \quad (1)$$

$$\frac{f_{dmax}}{\Delta f} \ll 1 \quad \text{to keep Inter-Carrier Interference (ICI) due to Doppler effect low} \quad (2)$$

$$T_{CP}\Delta f \ll 1 \quad \text{for spectral efficiency} \quad (3)$$

Subcarrier Spacing and OFDM Symbol Duration. For LTE/LTE-Advanced a subcarrier spacing $\Delta f = 7.5$ kHz and $\Delta f = 15$ kHz is defined. However, up to now, all LTE deployments worldwide are using the subcarrier spacing of $\Delta f = 15$ kHz only. As the subcarrier spacing is inverse proportional to the symbol duration, the resulting symbol duration is given with $T_{Symbol} = 66.7 \mu s$. The same subcarrier spacing and thus symbol duration is applied in LTE Downlink and Uplink.

Sampling Frequency. The (Inverse) Fast Fourier Transform (I)FFT to transfer the parallel, orthogonal subcarrier from the frequency domain into the time domain and vice versa is set for the maximum supported bandwidth of 20 MHz to a size of 2048. With a subcarrier spacing of 15 kHz this results in a sampling frequency of $f_{sampling} = 30.72$ MHz², corresponding to a sampling time of $T_{sampling} = 32.55$ ns. The LTE sampling frequency is an 8-times multiple of the WCDMA chip rate (3.48 Mcps) and 25-times the chip rate of CDMA@2000 1xRTT. Selecting 15 kHz subcarrier spacing while assuming a power-of-two (I)FFT size was an argument to simplify the design of multi-mode terminals by allowing a single clock circuitry.

Subframe Duration, number of OFDM symbols. For backward compatibility to UMTS/WCDMA the duration of a radio frame in LTE is defined with 10 ms. A radio frame consists of 10 subframes which therefore have a length of 1 ms each. One subframe corresponds to the defined Transmit Time Interval (TTI). With a given sampling frequency of 30.72 MHz one subframe contains 30.720 Samples. A subframe is further subdivided into two time slots, 0.5 ms each or in other words 15360 Samples. An OFDM symbol is

² $f_{sampling} = 15 \text{ kHz} * 2048 = 30.72 \text{ MHz}$

represented by 2048 samples, thus 7 OFDM symbols can be placed into one time slot, leaving 1024 samples³.

Cyclic Prefix. These 1024 samples are being used as Cyclic Prefix (CP) for the 7 OFDM symbols. It has been decided that the first OFDM symbol in a time slot uses 160 Samples as Cyclic Prefix where each of the remaining 6 OFDM Symbols uses 144 Samples for its Cyclic Prefix. Applying the Sampling Time of 32.55 ns this results in a CP duration of $T_{CP} \approx 5.2 \mu\text{s}$ and $T_{CP} \approx 4.7 \mu\text{s}$, respectively. This is considered as "Normal Cyclic Prefix". For a subcarrier spacing of 15 kHz (and for 7.5 kHz) an "Extended Cyclic Prefix" is defined as well, reducing the number of available OFDM symbols to 6 (7.5 kHz: 3 OFDM symbols). For these two cases the CP is 512 Samples (= 16.7 μs for 15 kHz) and 1024 Samples (33.3 μs), respectively.

The maximum expected delay spread T_d depends on multipath propagation and thus varies greatly for rural area, urban and suburban area or a city center. In [3] a maximum r.m.s delay spread of 991 ns is defined. However, channel measurements suggest that the maximum expected delay spread in a city center could be up to 3.7 μs .

Nonetheless the selected Cyclic Prefix for LTE/LTE-Advanced (i.e. Normal CP) is well suited to prevent ISI as required by (1).

Doppler Frequency, Delay Spread. LTE is deployed in various frequency bands, starting at 700 MHz all the way up to 2.7 GHz as of today⁴. However, during the initial standardization process a carrier frequency of $f_c = 2 \text{ GHz}$ was used for all relevant simulation results. Maximum Doppler frequency is impacted by the carrier frequency and the velocity the system shall support. LTE is meant to support a 'High-Speed Train' (HST) scenario and thus speeds of up to $v = 300 \text{ km/h}$. With the Doppler Frequency defined as $f_{dmax} = f_c \frac{v}{c}$, where c corresponds to the speed of light, $f_{dmax} \approx 555 \text{ Hz}$.

With the given subcarrier frequency of 15 kHz design criteria (2) is fulfilled and thus ICI due to mobility is negligible.

As shown in [2] the product cyclic prefix and subcarrier spacing determines the spectral efficiency. The product shall be much smaller than 1 to ensure highest spectral efficiency. The smaller the better. With 15 kHz subcarrier spacing and a normal cyclic prefix of 4.7 μs this criteria is fulfilled.

³ 15360 Samples - 7*2048 = 1024

⁴ May 2016

3.3 General limitations of OFDM

Even with fulfilling all system design requirements listed in section 3.2, OFDM has certain limitations that makes it not the most suitable waveform for all the targeted application scenarios introduced in Chapter 1. For backward compatibility reasons, LTE and LTE-Advanced will be continued in the future and thus the idea is whether new services can be better introduced by the definition of an alternative waveform that complement the weaker aspects of OFDM. In the following paragraphs we will discuss these limitations one by one.

3.3.1 Cyclic Prefix overhead

The required addition of the CP adds redundancy to the transmission since the same content is transmitted twice as the CP is a copy of the tail of a symbol placed at its beginning [see Fig. 3-2]. This overhead can be expressed as a function of symbol duration and duration of the cyclic prefix $\beta_{Overhead} = \frac{T_{CP}}{T_{CP}+T_{Symbol}}$ [2].

Table 3-1 list the overhead for the defined subcarrier spacing in LTE/LTE-Advanced. As anticipated, the longer the CP, the more overhead. Please note that, as of today, all commercial LTE networks worldwide use 15 kHz subcarrier spacing with Normal Cyclic Prefix only.

Cyclic Prefix overhead for LTE/LTE-Advanced	
Normal Cyclic Prefix	$\beta_{Overhead}$
Subcarrier Spacing $\Delta f = 15$ kHz, 7 OFDM Symbols, CP = 4.7, 5.2 μ s	~6.6% ~7.2%
Extended Cyclic Prefix	$\beta_{Overhead}$
Subcarrier Spacing $\Delta f = 15$ kHz, 6 OFDM symbols, CP = 16.7 μ s	~20%
Subcarrier Spacing $\Delta f = 7.5$ kHz, 3 OFDM Symbols, CP = 33.3 μ s	~33.3%

Table 3-1: Cyclic Prefix (CP) Overhead in LTE/LTE-Advanced

3.3.2 Sensitivity to Frequency and Timing Offsets

The orthogonality in OFDM is based on the assumption that transmitter and receiver are using the exact same reference frequency. In terms of frequency offsets the orthogonality is lost, causing subcarrier leakage known as Inter-Carrier Interference (ICI). Frequency Errors typically arise by drifts of the local oscillator which are typically a function of voltage variations and temperature changes. Phase Noise adds to this error as well and at mm-Wave frequencies even turns into OFDMs Achilles heel. The true impact of phase noise, however, depends on the design approach to generate the signal.

3.3.3 High Peak-To-Average-Power Ratio (PAPR)

Another challenge with OFDM is the high Peak-to-Average-Power Ratio (PAPR) and thus the resulting crest factor. The high PAPR compared to a single-carrier transmission technique occurs due to the summation of the many individual subcarriers. At each instant these subcarriers typically have a different phase when compared to each other. However, occasionally they could all have the same value simultaneously which leads the output power to 'peak'. Due to the very high number of subcarriers in an OFDM system such as LTE supporting up to 20 MHz of bandwidth per carrier, the peak value can be very high compared to the average value. As it can be seen in Fig. 3-3 this doesn't happen too often, but if it does then more significantly.

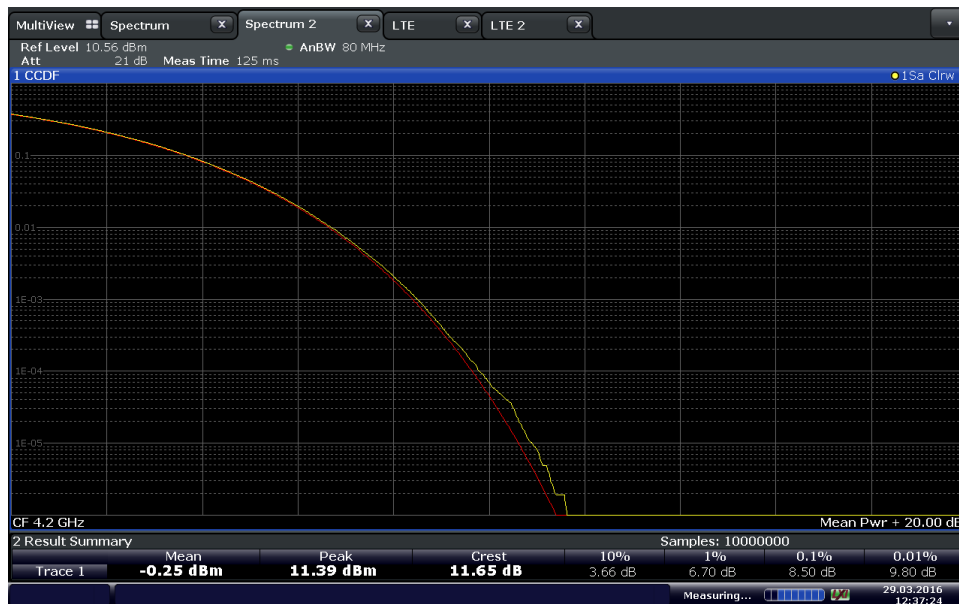

Fig. 3-3: CCDF measurement of a 20 MHz LTE Downlink Signal (E-TM 1.1); Crest Factor = 11.65 dB

3.3.3.1 Single Carrier Frequency Division Multiple Access (SC-FDMA)

The high PAPR in OFDM was the reason for introducing a slightly modified access technology for the LTE Uplink that is called Single Carrier Frequency Division Multiple Access, short SC-FDMA. The goal is to combine the advantage of a multi-carrier transmission principle such as OFDM with the advantage of a single carrier transmission technique. Single Carrier Transmission like i.e. Wideband CDMA (WCDMA) provides a much lower PAPR, that is, dependent on the design and manufacturer, around 4 dB or less. This allows a very efficient power amplifier design for battery-operated handsets. SC-FDMA attempts to lower the high PAPR of OFDM. The solution is another mathematical operation, an N-point Discrete Fourier Transform (DFT), prior to the subcarrier carrier mapping. Fig. 3-4 shows the block diagram for a SC-FDMA transmitter.

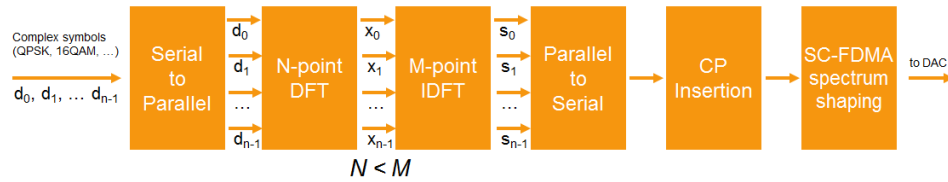

Fig. 3-4: SC-FDMA Transmitter

An N-point DFT is applied to the modulation symbols which are thus transformed into the frequency domain. Then an M-point IDFT is performed as in OFDM, where $N < M$, followed by parallel-to-serial conversion and insertion of CP. This method is understood as DFT-spread-OFDM as the DFT in the beginning spreads the modulated symbols over the subcarrier and thus every subcarrier carries a portion of each modulated symbol. While doing so, the PAPR is lowered but differs and depends on the used modulation scheme (i.e. QPSK, 16QAM, 64QAM⁵) and applied filtering at the end of the signal processing chain. Fig. 3-5 shows a CCDF measurement of 20 MHz LTE uplink signal with full Resource Block allocation where the three different modulation schemes are applied. As it can be seen there is a lower PAPR for QPSK then for 16QAM and 64QAM, respectively.

⁵ 64QAM is an optional modulation scheme for the LTE uplink.

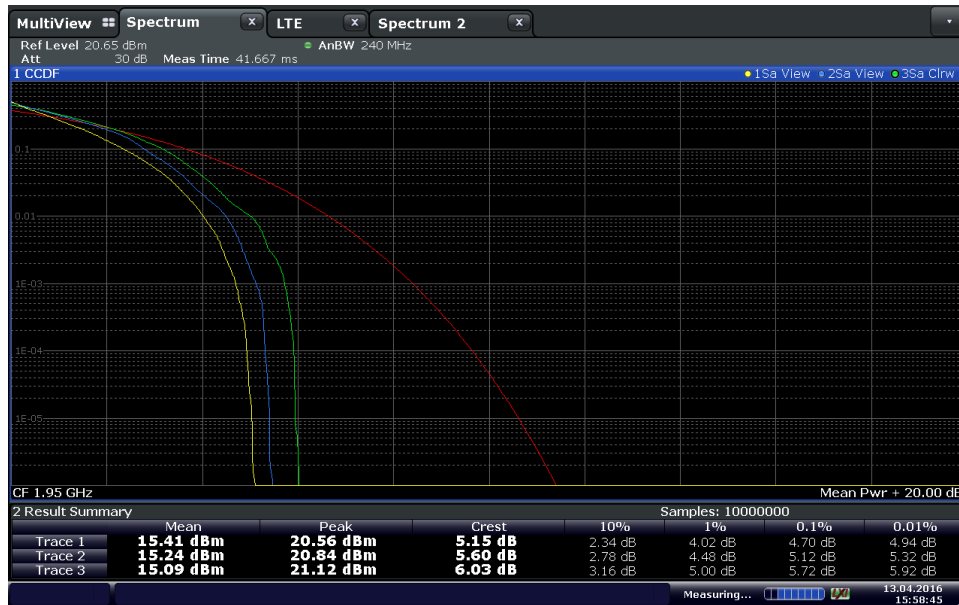

Fig. 3-5: CCDF measurement for 20 MHz LTE Uplink Signal, 100 RB allocated using QPSK (yellow; 5.15 dB Crest Factor), 16QAM (blue; 5.60 dB) and 64QAM (green; 6.03 dB) modulation⁶; red curve: Gaussian distribution

As it can be depicted from the figure, the crest factor is significantly lower than for the LTE Downlink Signal (compare Fig. 3-3) but not as low as for a single carrier transmission scheme like used in i.e. WCDMA (typical crest factor ~4 dB).

3.3.4 Spectral regrowth

The spectra of the sinc/x function shown in Fig. 3-1 shows beside the desired peak also some side lobes that result in a theoretical infinite bandwidth, causing some out-of-band emissions. Additionally, consecutive OFDM symbols are independent of each other there is a discontinuity in the time domain between them. In this way, OFDM differs from single carrier modulated signals after digital filtering. This discontinuity translates to spectral spikes in the frequency domain. Fig. 3-6 shows the power spectrum of a LTE Downlink signal with a bandwidth of 20 MHz where the spectral spikes are clearly visible.

⁶ These measurements were taken at 1.95 GHz carrier frequency with a generic power amplifier. The amplifier supports 20 MHz bandwidth and a frequency range from 50 MHz to 4 GHz. Typical input power is 0 dBm, maximum output power is +22 dBm, were typical gain is 20 dB at 1 GHz carrier frequency.

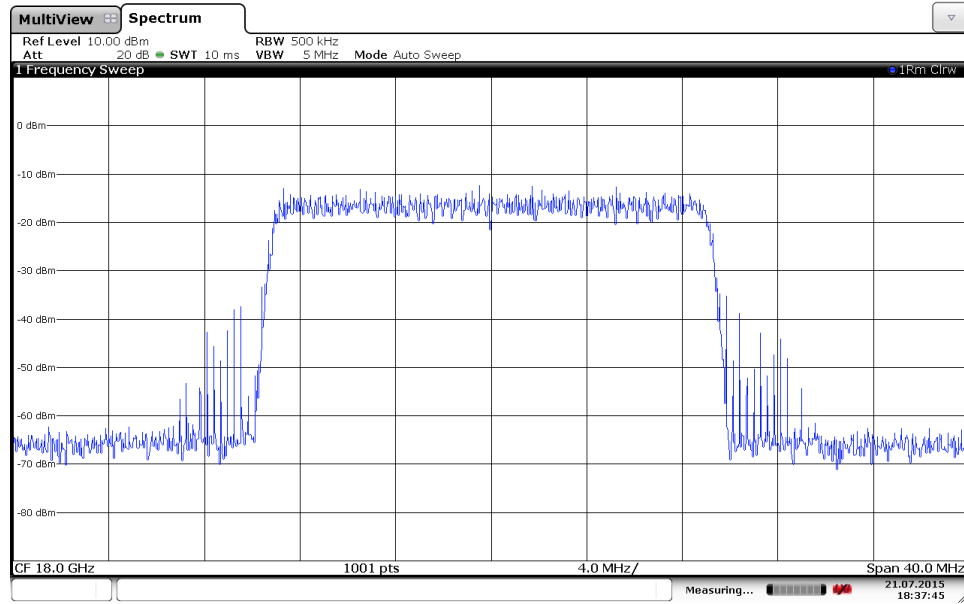

Date: 21.JUL.2015 18:37:45

Fig. 3-6: Power spectrum of 20 MHz LTE Downlink Signal showing spectral spikes

This typical characteristic can be improved by applying time domain windowing that smooths the transition from one symbol to another. Fig. 3-7 shows the spectral improvement while applying a Time Domain Windowing of 5 μ s.

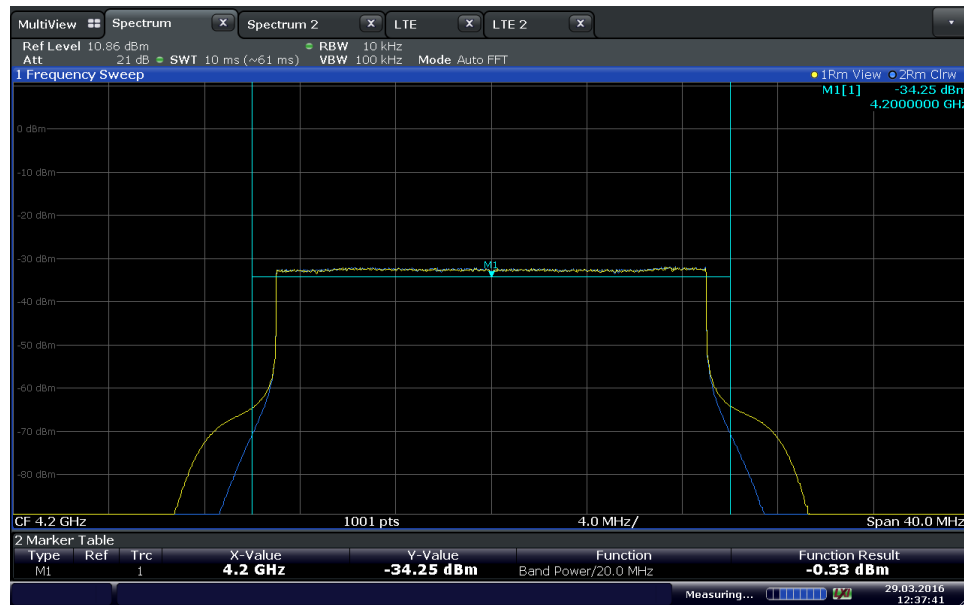

Fig. 3-7: Spectral improvement to a 20 MHz LTE Downlink Signal (yellow curve) while applying Time Domain Windowing (blue curve)

However, this comes at a cost as applying this technique introduces an overlap between consecutive symbols that impacts signal quality and results in a higher Error Vector

Magnitude (EVM)⁷. The transition time defines the duration of the overlap between two symbols. For a sampling rate of 30.72 MHz (20 MHz LTE Signal) a transition time of 1 μ s translates to 30 samples overlap.

Fig. 3-8 shows an Error Vector Magnitude (EVM) measurement according to the defined methodology by 3GPP using Rohde&Schwarz FSW Signal and Spectrum Analyzer. Time Domain Windowing is not active, as it is not stipulated by the standard. Fig. 3-9 shows the very same signal but with Time Domain Windowing active and a transition time of 5 μ s. The power spectrum has been clearly improved, however the EVM dropped by almost 12 dB.

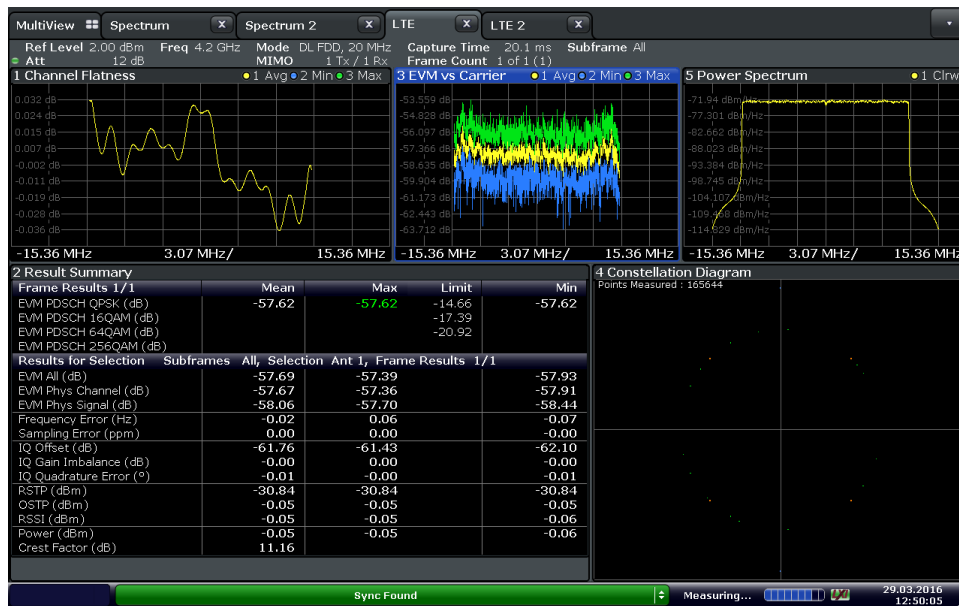

Fig. 3-8: Signal Quality measurements (i.e. Error Vector Magnitude, EVM) on a 20 MHz LTE Downlink Signal (E-TM 1.1)

⁷ Error Vector Magnitude (EVM) is a common figure of merit to measure signal quality for digitally modulated signals.

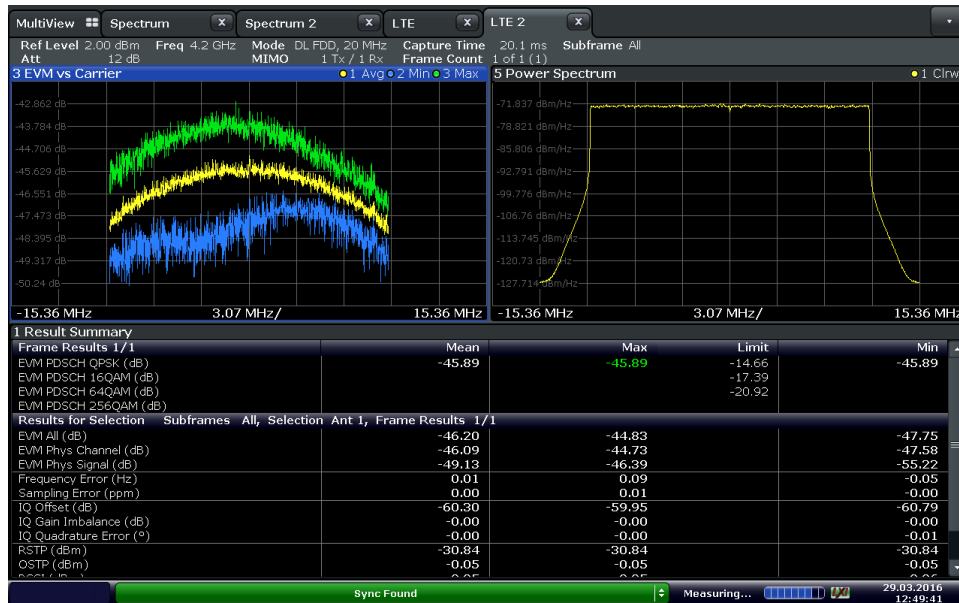

Fig. 3-9: Signal Quality measurements (i.e. Error Vector Magnitude, EVM) on a 20 MHz LTE Downlink Signal (E-TM 1.1) while Time Domain Windowing is applied

Because of this signal characteristic exact procedures of OFDM signal shaping for the LTE Downlink and Uplink are not standardized by 3GPP and therefore vendor specific. The design goal is to meet the standardized In-Band performance (signal quality i.e. EVM, signal flatness, In-Band emissions etc.) and Out-of-Band emission requirements (ACLR, SEM, Spurious Emissions etc.). Without spectral shaping the i.e. SEM would be violated. To allow the required filtering for each supported bandwidth a guard band is defined, reducing the available transmission bandwidth. For a 20 MHz LTE signal a 1 MHz guard band that is applied left and right and reduces the signal bandwidth to actual transmission bandwidth of 18 MHz [see Fig. 3-10].

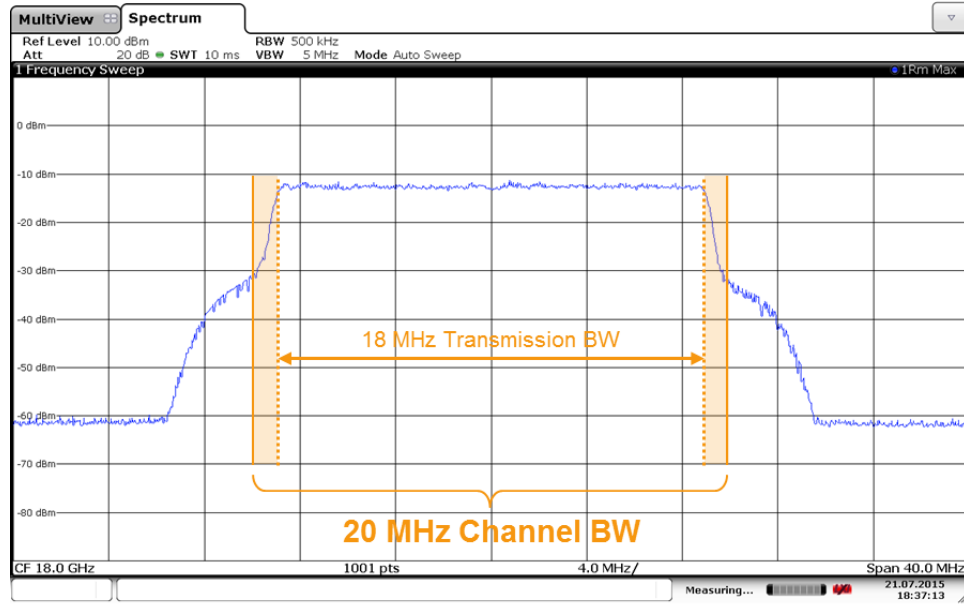

Fig. 3-10: Power spectrum of 20 MHz LTE Downlink Signal using 'Max Hold' detector

An improvement of these spectral characteristics for an OFDM-based signal is seen beneficial for any 5G technology and would lead to an improved utilization of the available radio spectrum.

4 PHY/MAC design for 5G

4.1 Application areas for 5G

Applications that shall be supported by the 5th generation (5G) of wireless communication can be grouped into three major categories. These categories are enhanced Mobile Broadband (eMBB), Massive Machine Type Communication (mMTC) and Ultra-reliable and Low Latency Communications. The following graphic, taken from the ITU⁸ paper "IMT⁹ Vision – Framework and overall objectives of the future development of IMT for 2020 and beyond" [5], illustrates these three categories and lists some applications for each category as an example.

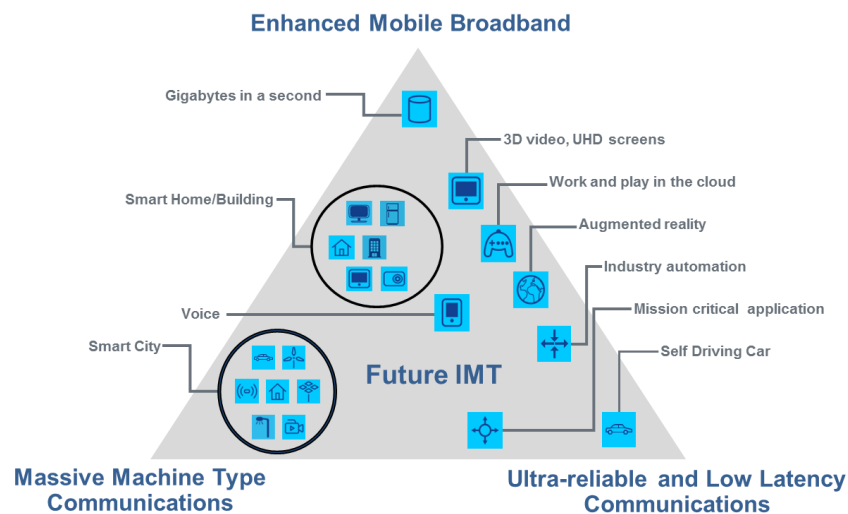

Fig. 4-1: Application categories for 5G [5]

These different categories imply different requirements for key performance indicator of a wireless technology. These requirements and their importance and priority for each of the application categories is shown in Fig. 4-2.

⁸ ITU - International Telecommunication Union

⁹ IMT - International Mobile Telephony, a program in which requirements and scenarios shall be identified for future generation of mobile technologies

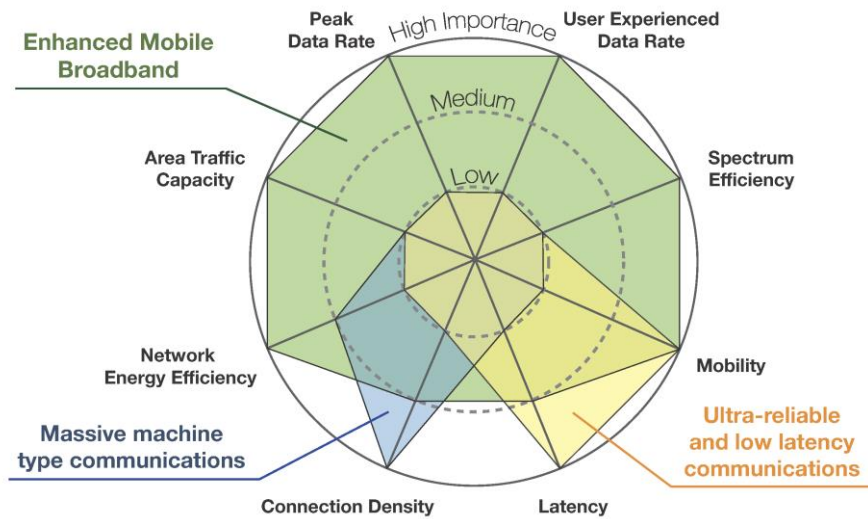

Fig. 4-2: Importance of Key Performance Indicator for major 5G application areas [5]

Last but not least 5G shall outperform 4G (= IMT-Advanced requirements e.g. met with LTE-Advanced) in terms of typical key performance indicators. A 5G technology shall provide peak data rates of up to 20 Gbps with average user data rates at about 100 Mbps. Latency shall be as low as 1 ms and mobility up to 500 km/h. Fig. 4-3 provides a general overview.

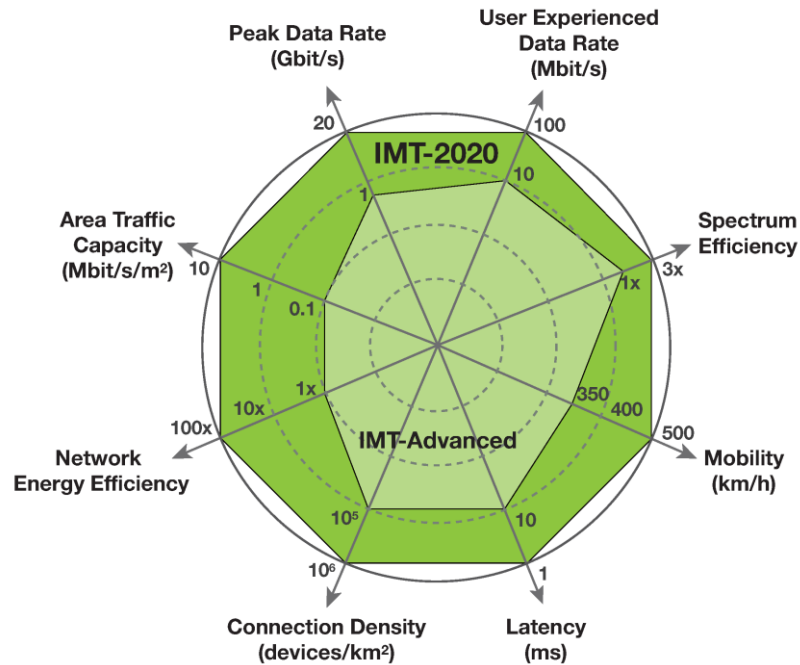

Fig. 4-3: Comparison of Key Performance Indicator (KPI) for 4G (IMT-Advanced) and 5G (IMT-2020) [5]

The different application areas and requirements in terms of key performance indicators put quite some constraints on a potential Physical Layer (PHY) and the Medium Access Control (MAC) layer design for 5G. In the following general guidelines shall be identified and discussed before looking into one specific aspect of the 5G PHY/MAC design toolkit that are 'waveforms' to overcome the described limitations of LTE using a OFDM-based waveform.

4.2 General design principles for PHY/MAC layer

The following graphic shows the general building blocks [in blue] that determine the design of the Physical Layer (PHY) and the Medium Access Control (MAC) layer for any communication technology, not just for the 5th generation of wireless communication. However, specific examples for 5G for each building block are listed below each block. We also would like to ask the reader to bear the holistic picture of the technology in mind and understand the topic of this application note is describing waveform candidates as one building block of the entire technology framework.

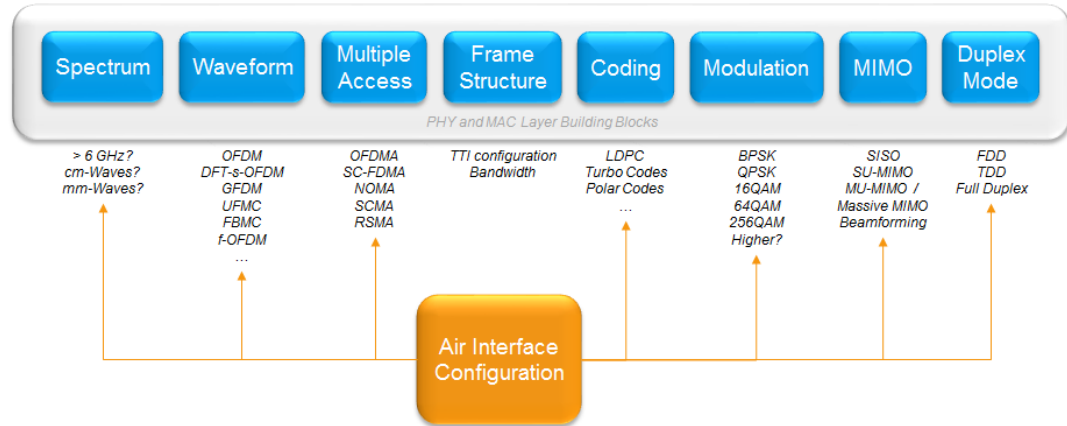

Fig. 4-4: 5G PHY and MAC Layer Building Blocks

Let's take a closer look at each building block:

Spectrum. To configure the air interface efficiently not just the application that shall be supported matters, but also the part of the spectrum that shall be utilized to support the application. In terms of enhanced Mobile Broadband (eMBB) frequencies up to 30 GHz, so called centimeter-waves (cm-Waves), are considered by the industry. More over millimeter-waves (mm-Waves) frequencies up to 100 GHz are also seen as applicable. At the World Radio Conference 2015 (WRC-15) it has been decided by the ITU to study frequencies between 24.25 and 86 GHz. The reason for moving up in frequency is simply the availability of much wider bandwidths compared to today's preferred frequency range for wireless communication that typically uses frequencies between 450 MHz and 6 GHz. Nonetheless some aspects currently discussed for 5G are also applicable for frequencies below 6 GHz, such as Massive MIMO, means the use of antenna arrays to realize Multi-User MIMO (MU-MIMO). Therefore 5G shall not be restricted to just cm-Wave and mm-Wave frequencies.

Waveform and Multiple Access. Standardization bodies, such as 3GPP or IEEE, have to determine if a single-carrier or a multi-carrier system is more suitable to operate at these frequencies. Therefore multiple access scheme proposals are currently studied for the considered frequency ranges and applications. See section 5 and following for further details.

Frame Structure. The chosen frame structure has significant impact on the achievable Round Trip Time (RTT) and thus overall latency. It also dictates backward compatibility to other legacy technologies, for example LTE. In LTE the radio frame duration has been selected to exactly the same as for 3G/WCDMA, thus simplifying handover between both technologies.

Coding. Very low error probability and highest spectral efficiency are key design targets for channel codes to be used in a future 5G communication system. The industry has to provide an answer which code family (e.g. LDPC, Turbo Codes or Polar Codes) are most suitable to support the different application scenarios in 5G.

Modulation. Modulation schemes impacts maximum achievable data rates, however higher-order modulation schemes (i.e. 64QAM) require a much higher Signal-to-Noise Ratio than robust modulation schemes (i.e. BPSK or QPSK) and impact the receiver design and architecture. LTE supports today 256QAM for small cell scenarios. For 5G, considering only cm-Wave and mm-Wave frequencies, robust modulation schemes are anticipated. The data rates up to 20 Gbps are realized while utilizing much wider bandwidths up to 2 GHz, depending on the frequency band.

MIMO/Beamforming. As the wavelengths at cm- and mm-Wave frequencies becomes smaller it allows of smaller antenna sizes. It is anticipated that 5G takes advantage of antenna arrays on the base station and device side. With help of hybrid beamforming schemes pencil beams are being generated that help to overcome the higher pathloss at these frequencies. For below 6 GHz significant capacity increase is anticipated while utilizing massive MU-MIMO using phase antenna arrays.

Duplex Mode. Considering cm- and mm-Wave frequencies Time Division Duplex (TDD) would have a significant advantage since the reciprocity of the channel could be utilized for beamforming and used by any precoding technique applied in the digital baseband.

4.3 The ideal waveform and Gabor's Theorem

From 4.2 we know that the waveform is one aspect in design tool kit for designing the PHY and MAC layer for the 5th Generation of Mobile Communication. An ideal waveform shall fulfil the following requirements:

- High spectral efficiency for high data rates and efficient use of the available spectrum.
- Low peak-to-average power ratio (PAPR) allowing efficient power amplifier design.
- Robust against Doppler shift to allow mobility.
- Support of asynchronous transmission and reception.

It was revealed in chapter 3 that OFDMA and SC-FDMA had been both selected as waveforms for LTE and LTE-Advanced and their limitations were discussed in 3.3. In Gabor's "Theory of Communication" [4] it was stated that ideally, a multi-carrier system such as OFDM, shall satisfy the following requirements:

- a) The subcarriers are mutually orthogonal in time and frequency to keep the receiver as simple as possible and keep the inter-carrier interference as low as possible.
- b) The transmission function is well localized in time and frequency. This provides immunity to ISI from multipath propagation (time spread) and to ICI from Doppler-shift (frequency spread). Good time localization is required to enable low latency.
- c) Maximal spectral efficiency, i.e. $\rho = (T \Delta f)^{-1}$ with ρ the spectral efficiency in data symbols per second per Hertz.

However, it was also proven in [4], that it is not possible to fulfil these three requirements all at the same time or in other words you can only get 2 out of 3. This now 70 year old conclusion will also have an impact on the waveform that is going to be selected for a future 5G wireless communication standard. Some proposals discussed in the wireless industry are OFDM- and therefore multi-carrier based. The most popular ones shall be described in more detail in the following sections.

5 Waveform candidates for 5G

5.1 Introduction

In section 3.3 we discussed general limitations of OFDM that result in major shortcomings to support applications identified to be part of a future 5G wireless communication standard. Thus, key players of the wireless industry and research institutes conducted research to challenge the design targets for LTE and LTE-Advanced and to overcome the identified shortcomings by proposing new PHY and MAC Layer concepts. One such program is the project for '5th Generation Non-Orthogonal Waveforms for Asynchronous Signaling', short 5GNOW¹⁰, which was sponsored by the European Union (EU). The project duration was 3 years, from January 2012 to February 2015, and was funded with €3.5M¹¹. The goal was to develop more spectrum-agile waveforms that further support asynchronous access methods which were seen favorable for machine type communication and thus the Internet of Things (IoT). The waveform candidates discussed in 5.2, 5.4, and 5.3 are some of the deliverables of the 5GNOW project that gained the most attention in the wireless industry in recent months.

The general idea behind all schemes that are discussed in more detail in the following sections is to use different pulse shaping filter than traditional OFDM. The three waveforms approach this concept from a different perspective. In general, it can be said, that applying a different filtering method will reduce the out-of-band emissions significantly and therefore improve spectral regrowth and spectrum efficiency. On the other hand the usage of another pulse shaping filter implies the reduction of orthogonality between adjacent subcarrier. In other words energy spreads from one carrier to another and thus introduces Inter-Carrier Interference (ICI) that needs to be compensated for. This increases complexity in the overall system, in particular on the receiving side.

¹⁰ http://www.5gnow.eu/?page_id=266

¹¹ <http://cordis.europa.eu/ip7/ict/future-networks/documents/call8-projects/5gnowfactsheet.pdf>

5.2 FBMC - Filter-Bank Multi-Carrier

FBMC stands for Filter-Bank Multi-Carrier. With FBMC a filtering on a subcarrier level is applied while using filter banks on transmit and receive side. There are different implementations of FBMC under discussion within the research community: Staggered Modulated Multitone (SMT), Cosine Modulated Multitone (CMT), and Filtered Multitone (FMT) were the focus seems to be on SMT FBMC. Fig. 5-1 shows the block diagram for the FBMC Transmitter Model as proposed in [6].

A linear-phase FIR prototype filter based on Root Raised Cosine (RRC) with a roll-off factor of 0.1 is used to create N polyphase filter A_k of length K .

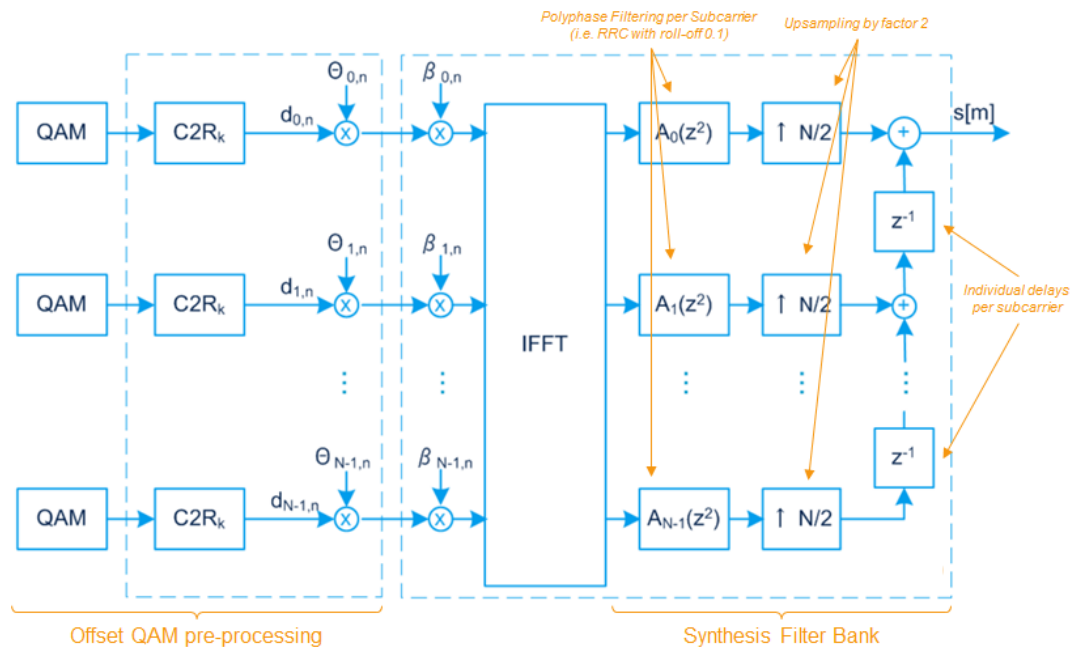

Fig. 5-1: FBMC Transmitter Model

K determines the overlapping factor that characterizes the prototype filter and defines the number of superimposing symbols in time. For FBMC it has been decided to use an overlapping factor of 4.

As it can be seen in Fig. 5-1 the filter bank is created by applying frequency shifts of k/N of the proposed prototype filter. This impacts orthogonality as energy spreads now between adjacent subcarriers (red, blue in Fig. 5-2) and thus creates Inter-Carrier Interference (ICI) between neighboring subcarriers. However, every all even subcarrier (red) and all odd subcarrier (blue) do not overlap and are therefore orthogonal to each other.

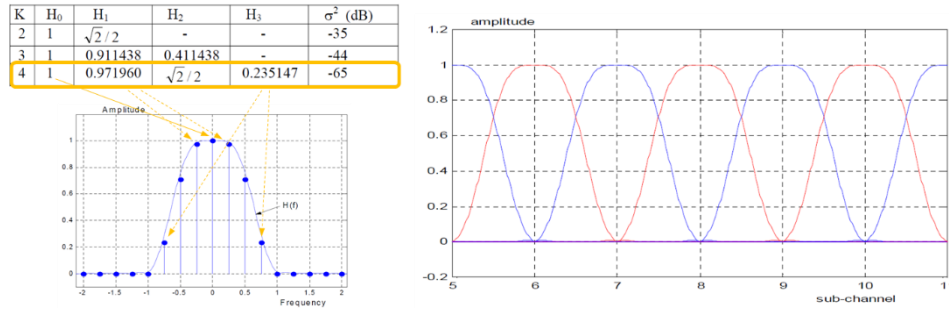

Fig. 5-2: Prototype Filter (K=4) and Filter Bank Synthesis by applying defined frequency shift k/N [7]

To maintain orthogonality within real and imaginary domain Offset QAM (OQAM) is used and applied to modulated data symbols. OQAM is achieved by shifting the in-phase components of a QAM system by half of the symbol length $T/2$ versus the out-phase components. If the time-shift is applied to the in-phase part of a carrier, it is applied to the out-phase part of its neighbors, interference is reduced to every second carrier. The OQAM receiver cancels out the ICI by ignoring the part of the received symbol not carrying the data. The use of OQAM eliminates the need for guard times and cyclic prefix that is therefore optional in FBMC [7] and thus increases spectral efficiency.

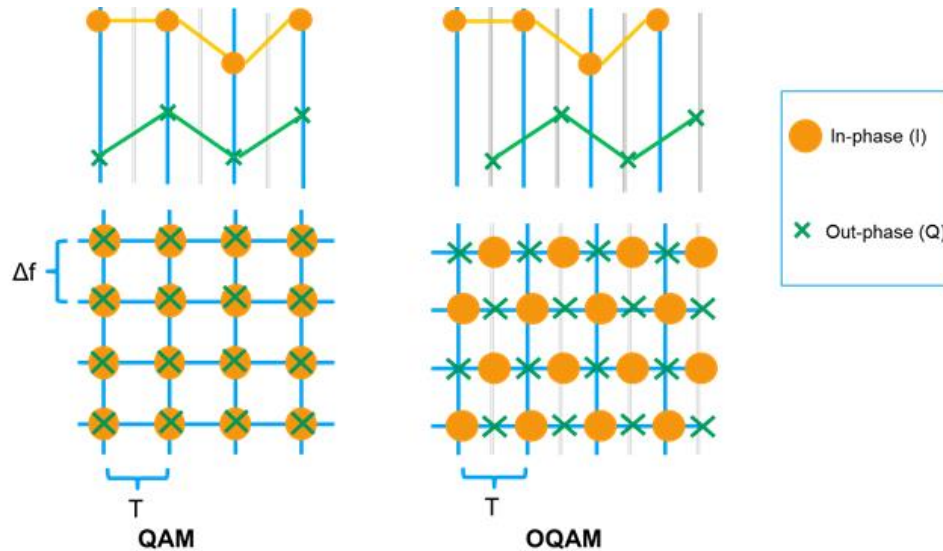

Fig. 5-3: Quadrature Amplitude Modulation (QAM) versus Offset QAM (QAM).

To allow asynchronous transmission and reception an upscaling scheme is applied. The transmitter model shown in Fig. 5-1 leads to higher implementation complexity, e.g. larger FFT sampling window size, typically factor 2 compared to OFDM.

5.2.1 FBMC Advantages and Disadvantages

According to [8] the good localization enables several scenarios targeted with 5G:

- Asynchronous transmission, no need for perfect synchronization like timing advance in LTE.
- Well suited for fragmented spectrum or cognitive radio.
- Robustness against high mobility.
- Efficient adaptation of basic parameters like SC spacing or symbol duration within one band possible.

In practice, a couple of issues have to be solved [9], [10]:

- Scattered pilot become more complex.
- MIMO schemes like Alamouti (space-time coding) do not work easily.
- 1 carrier guard between users needed in uplink or for frequency selective beamforming.
- Inefficient for short bursts due to long filter tails.

5.3 UFMC - Universal Filter Multi-Carrier

In contrast to FBMC UFMC groups subcarriers to sub-bands, that are then filtered. The filter parameters and number of carrier per subband are typically common. This prevents aliasing. Nonetheless non-contiguous subbands are possible to allow flexible utilization of the available spectrum. Therefore UFMC can be seen as a compromise between OFDM and FBMC. Fig. 5-4 shows the block diagram for an UFMC transmitter.

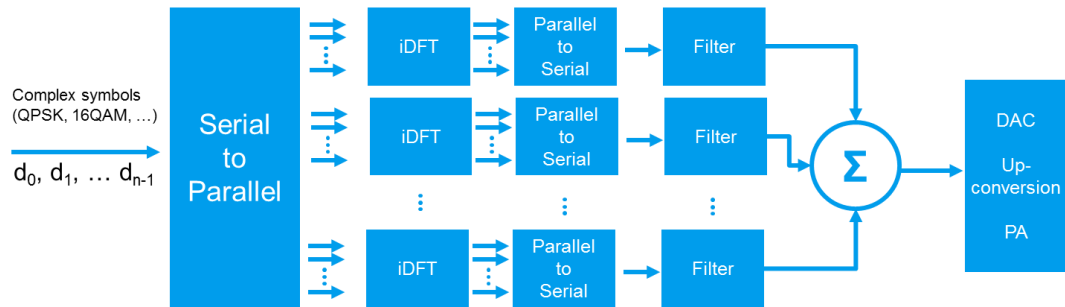

Fig. 5-4: UFMC Transmitter Block Diagram

There is no time overlap between subsequent UFMC symbols. The symbol duration is $N+L-1$ with N being the FFT size of the iFFT spreaders and L the length of the filter [11]. Like FBMC also in UFMC typically the FFT window size is increased, resulting in a higher implementation complexity. Also in UFMC the insertion of a guard interval as Cyclic Prefix is optional. A further feature of the unified frame structure is the usage of multiple signal layers. Here, users can be separated e.g. based on their interleavers, as done in Interleave-Division Multiple-Access (IDMA). This will introduce an additional degree of freedom for the system, improve robustness against crosstalk and helps to exploit the capacity of the multiple access channel (MAC). Altogether, the proposed new concepts offer an emboldening approach for dealing with the new challenges, faced by 5G wireless system designers [10], [12].

5.3.1 UFMC Advantages and Disadvantages

According to [11] UFMC provides promising advantages:

- Good spectral efficiency similar to FBMC.
- Less overhead required compared to FBMC.
- Well suited for short burst transmissions.
- Enabling low latency modes.

Remaining challenges are:

- As the complex orthogonality is partly lost, UFMC may not be suited for very high data rates.
- With high delay spread, multi-tap equalizers are to be applied

- Larger FFT size at receiver increases complexity
- Interference from partly overlapping sub-bands

5.4 GFDM - Generalized Frequency Division Multiplex

GFDM stands for Generalized Frequency Division Multiplex. The idea behind GFDM is to use also a filter bank multicarrier concept. One motivation behind GFDM has been the concept to spread the available spectrum for each user into multiple spectral segments, each of those segments having more or less bandwidth. With such a concept it could be very easy to implement cognitive radio concepts where a secondary transmitter occupies the white spaces from the incumbent spectrum owner. As an enhancement compared to FBMC, it provides additional features:

- A cyclic prefix (CP) is introduced. The CP might be introduced after multiplexing as described in [13], or before the filtering [14].
- Each subcarrier may have a different bandwidth.
- The filtering is done by circular convolution over a defined number of symbols, also referred to as tail biting. This introduces a segmentation also in the time domain.

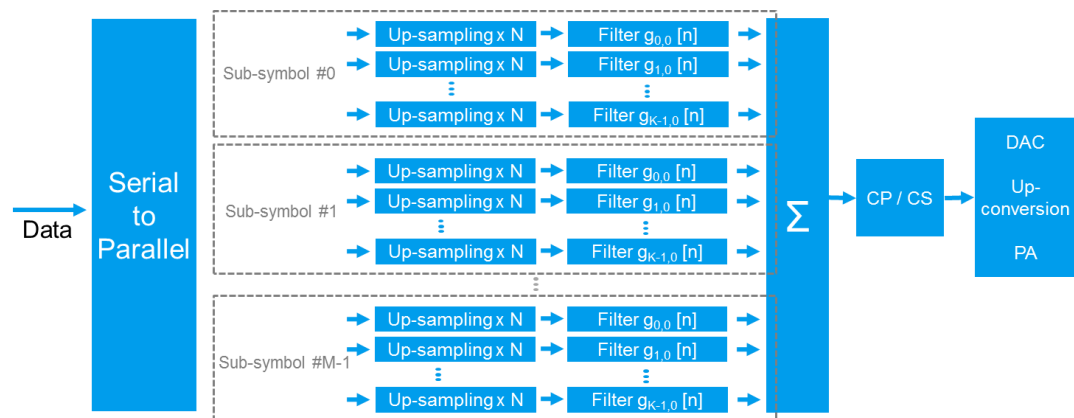

Fig. 5-5: GFDM Transmitter Model as described in [13]

$g_{k,m}[n]$ in Fig. 5-5 denotes the impulse response of a filter with N samples, while k , m , and n are subcarrier, subsymbol, and time sample indices, respectively. As an additional concept more affecting the MAC layer, the data in GFDM is transported in a block wise definition. Each block is led by a cyclic prefix and consists of several subsymbols. This would now allow the definition of a more flexible TTI length, e.g. for latency critical applications only a short number of subsymbols can be used to carry the data while in a less time critical communication, all the subsymbols can carry data for one specific user. In spectrum domain typically adjacent subcarriers will overlap, violating the orthogonality criterion like

mentioned already for other waveform candidates, but allowing the asynchronous transmission of data. This results in a systematic higher bit error rate, to compensate this, GFDM requires additional equalization and interference cancellation strategies especially at the receiver side.

5.4.1 GFDM Advantages and Disadvantages

According to [14] GFDM features the following advantages:

- Lower PAPR compared to OFDM¹².
- Low out-of-band radiation due to adjustable Tx-filtering.
- Frequency and time domain multi-user scheduling comparable to OFDM.
- White space aggregation even in heavily fragmented spectrum regions
- Block-based transmission using cyclic prefix insertion and efficient FFT-based equalization.

GFDM disadvantages are:

- Complicated receiver design.
- Matched filter with successive interference cancellation to remove ICI/SIS from filtering needed or alternatively OQAM must be used which again makes MIMO more difficult
- Symbol time offset (STO) estimation, Carrier frequency offset (CFO) estimation
- To suppress inter-subcarrier interference, high-order filtering and tail biting are needed [14]. Pre-cancellation or successive interference cancellation is also required to alleviate the inter-subcarrier interference that still exists after filtering [15].

¹² Result that could not be proven except in certain simulations, see section 5.5.1 in this application note.

5.5 Comparison of LTE with FBMC, GFDM and UPMC

5.5.1 Peak-To-Average Power Ratio (PAPR)

PAPR is one of the often mentioned disadvantages for OFDM and therefore also a limitation of the LTE (Downlink). Typically Crest Factor Reduction (CFR) techniques are applied to reduce PAPR and Digital Pre-Distortion (DPD) algorithms will then correct for any distortion implied by the hardware used to amplify the signal. Both techniques will allow a more efficient power amplifier design and help with the major limitations PAPR and spectral efficiency and spectral regrowth. Traditionally these techniques were only applied at base station side, but nowadays these are also used for mobile devices, mainly from the aspect of reducing power consumption and in that context using Envelope Tracking (ET) principles.

5.5.1.1 PAPR depends on payload data

In [Fig. 5-6](#) we compare a 20 MHz LTE Downlink Signal (Enhanced Test Model 1.1, E-TM1.1) with a FBMC, UPMC and GFDM signal of similar parameterization. The selected parameters for all three 5G waveforms are shown in [Table 5-1](#).

Parameterization for FBMC, UPMC, GFDM			
Waveform Type	FBMC	UPMC	GFDM
Number of subcarriers	2048	2048	2048
Number of active subcarrier	1200	1200	1200
Guard subcarrier	424	429	424
Subcarrier spacing	15 kHz	15 kHz	15 kHz
Cyclic Prefix length	144 Samples	144 Samples	144 Samples
Filter	RRC, $\alpha = 0.1$	Dolph-Chebyshev	RRC, $\alpha = 0.1$
Filter length	-	74 (60 dB stopband attenuation, Subband-Filter Pre-Equalization OFF)	-
Number of subbands	-	40	-
Payload, Modulation	PN9, QPSK	PN9, QPSK	PN9, QPSK

Table 5-1: Parameterization for FBMC, UPMC, and GFDM to compare with 20 MHz LTE Downlink Signal

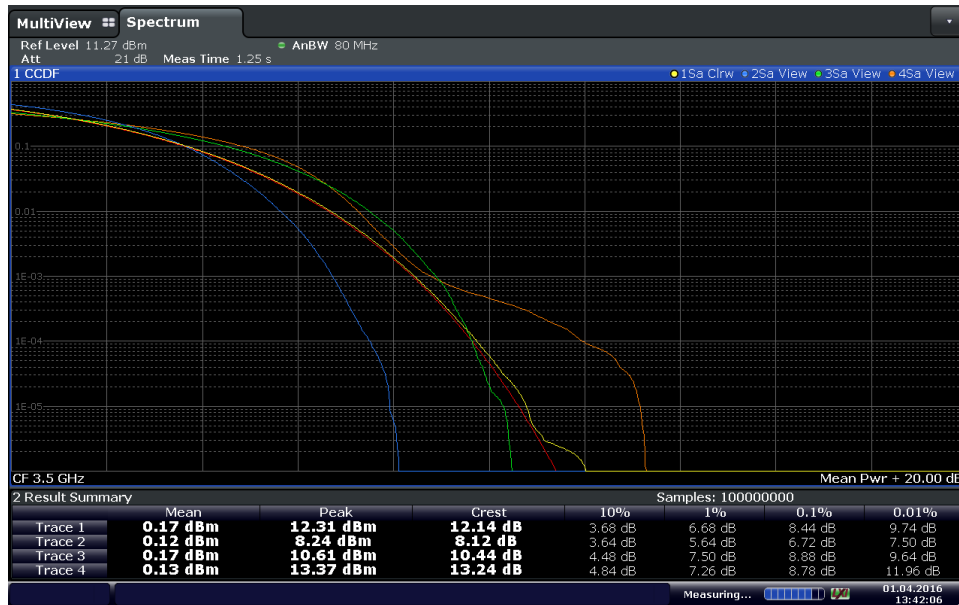

Fig. 5-6: CCDF for LTE (yellow), FBMC (blue), UFMC (green) and GFDM (orange)

From Fig. 5-6 the conclusion could be drawn that FBMC, UFMC, GFDM not only are more spectrum agile than LTE (see next section, Fig. 5-10) but in particular FBMC and UFMC also offer a significantly lower PAPR and have therefore a clear design advantage from RF Frontend perspective. However, this conclusion would not be accurate. LTE is a fully standardized technology and therefore uses channel coding and scrambling to randomize the data that is to be transmitted. FBMC, UFMC and GFDM on the other hand are Physical Layer concepts only that have been researched but not fully standardized and thus lack a definition of an adequate scrambling method and channel coding at this point. There is no scrambling of data, just a pure modulation and thus the PAPR as well as spectrum symmetry is impacted by the PN sequence that is being used as payload data. Table 5-2 shows the PAPR for LTE, with and without scrambling active, and the three waveforms for different PN sequences.

Comparing Peak-to-Average-Power Ratio (PAPR) for different PN Sequences					
Waveform	LTE	LTE (Scrambling OFF)	FBMC	UFMC	GFDM
PAPR for PN9	12.15 dB	10.13 dB	8.14 dB	10.44 dB	13.24 dB
PAPR for PN15	11.34 dB	12.89 dB	13.25 dB	14.02 dB	13.17 dB
PAPR for PN20	11.18 dB	17.18 dB	17.36 dB	14.63 dB	17.13 dB
PAPR for PN23	11.11 dB	17.56 dB	17.27 dB	14.74 dB	17.76 dB

Table 5-2: Comparing PAPR for LTE, FBMC, UFMC, GFDM using different PN Sequences as payload data

As it can be seen with scrambling 'ON' the PAPR is about constant for LTE were for all three waveform candidates and LTE without scrambling the PAPR greatly varies and is significantly higher for longer PN sequences.

As an example Fig. 5-7 shows the PAPR for FBMC using different PN sequences as payload data. For PN9 (yellow) the PAPR is 8.10 dB, where for PN15 (Trace 2, blue), PN20 (Trace 3, green) the PAPR is 13.12 dB and 17.49 dB, respectively.



Fig. 5-7: PAPR for FBMC using different PN Sequences as payload data

That the payload has an impact on PAPR due to the non-availability of a standardized scrambling method is a very important detail to know for any hardware-in-the-loop experiments and RF Frontend and component testing, such as filter or mixer, but power amplifier in particular.

5.5.1.2 Use data list functionality to overcome lack of scrambling for 5G Waveform Candidates

In order to overcome the lack of randomizing data via scrambling and channel coding for 5G waveform candidates such as FBMC, UFMC, GFDM we recommend to use the 'Data List' functionality in the R&S@SMW200A Vector Signal Generator. Instead of using PN sequences or generic bit pattern (All0, All1, etc.) as payload data it is possible to create and use a data list for this purpose. The data list could be a scrambled bit sequence to emulate randomized data.

In order to allow a fair comparison between 5G Waveform Candidates and LTE, the SMW software option for LTE Logfile Generation (SMW-K81) is very helpful. This option allows the user to create log files at different logging points in the signal processing chain. The relevant details how to use option K81 are described in [16]. Fig. 5-8 shows the LTE signal processing chain for the downlink.

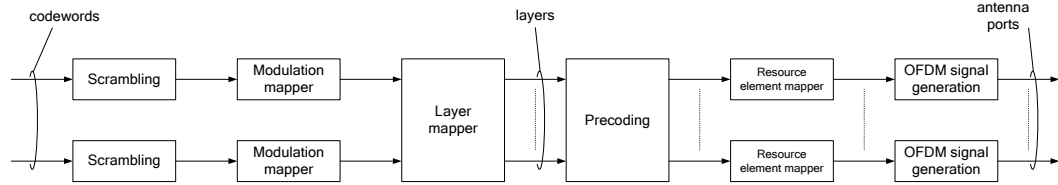

Fig. 5-8: LTE Downlink Signal Processing Chain [18]

K81 offers the possibility to log the bit sequence after scrambling (Point 6; see Fig. 5-9). The derived, scrambled bit sequence can be now used to generate a data list. How to create a data list for the R&S®SMW200A is described in [17].

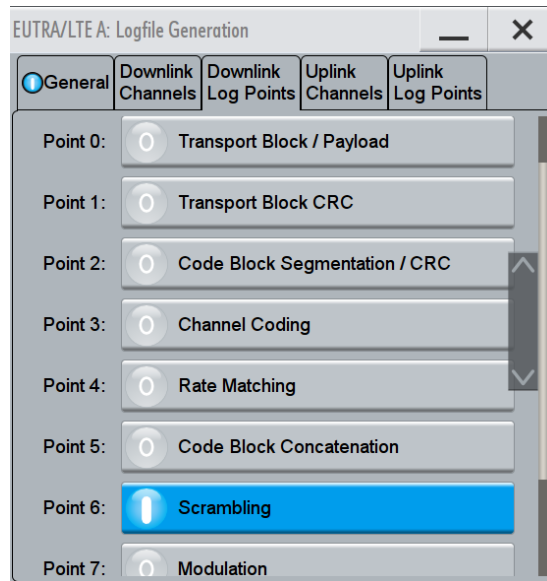

Fig. 5-9: LTE Logfile Generation - Option SMW-K81

This data list can then be used as payload data, see section 6.1.2.

5.5.2 Spectral regrowth: LTE vs. FBMC, UFMC, GFDM

One of the key design targets for all three waveform candidates researched in the 5GNOW project was to improve spectral regrowth compared to LTE. Fig. 5-10 shows all three waveforms, FBMC (blue), UFMC (green) and GFDM (yellow) compared to a 20 MHz LTE Downlink signal (yellow). The parameterization was chosen according to Table 5-1.

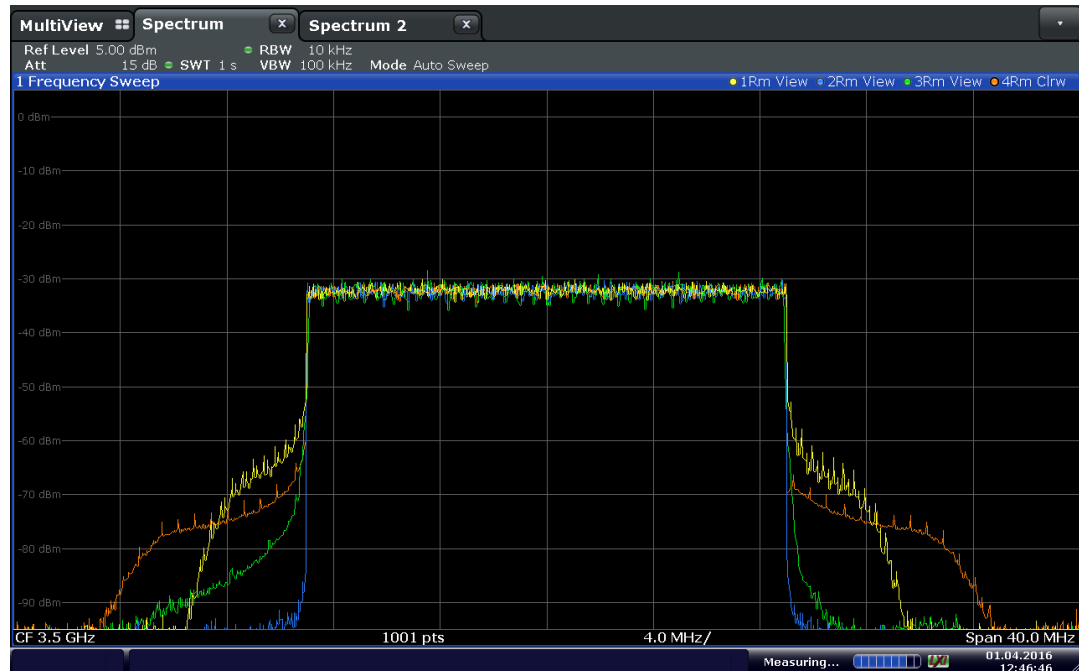

Fig. 5-10: Comparing 20 MHz LTE Downlink Signal (yellow) with FBMC (blue), UPMC (green) and GFDM (orange)

5.5.3 Impact of power amplification to 5G waveform candidates

In Fig. 5-10 we demonstrate the ideal case by means of connecting the signal generator directly to a spectrum analyzer. The better spectrum characteristics of the 5G waveform candidates is clearly visible. In a second step, a non-linear amplifier is introduced into the signal path. Fig. 5-11 compares LTE with FBMC, UPMC, GFDM that are again configured based on parameters listed in Table 5-1.

For this experiment a generic power amplifier was used, that supports a frequency range of 50 MHz to 4000 MHz. The maximum input power for the power amplifier is 0 dBm and it has a typical gain of 20 dB. Maximum achievable output power for the power amplifier is +20 dBm. At 0.00 dBm input power the power amplifier starts to go into saturation, higher input power would mean the power amplifier is in compression.

The input power for the power amplifier in Fig. 5-11 was -5.00 dBm. As it can be seen the spectral advantages of these waveforms start to vanish.

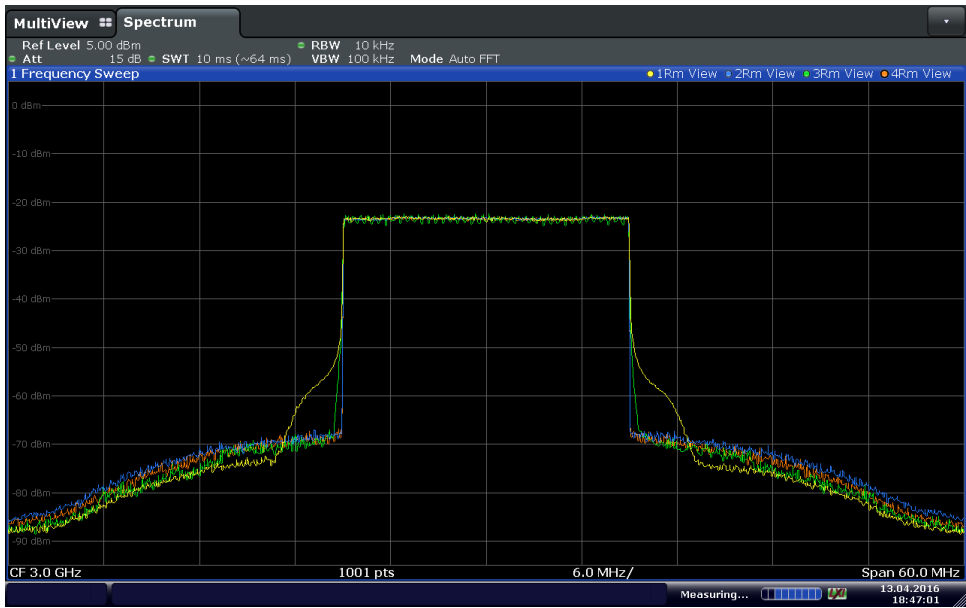

Fig. 5-11: LTE (yellow), FBMC (blue), UFMC (green), GFDM (orange) signal with amplifier, gain 20 dB, input power -5.00 dBm

Fig. 5-12 shows the very same measurement, same signal configuration for an input power of -2.00 dBm to the amplifier. The spectral advantages of the 5G waveforms seem to have almost vanished completely, compared to a 20 MHz LTE downlink signal. When using typical input power of 0.00 dBm this advantage is marginally, almost nonexistent.

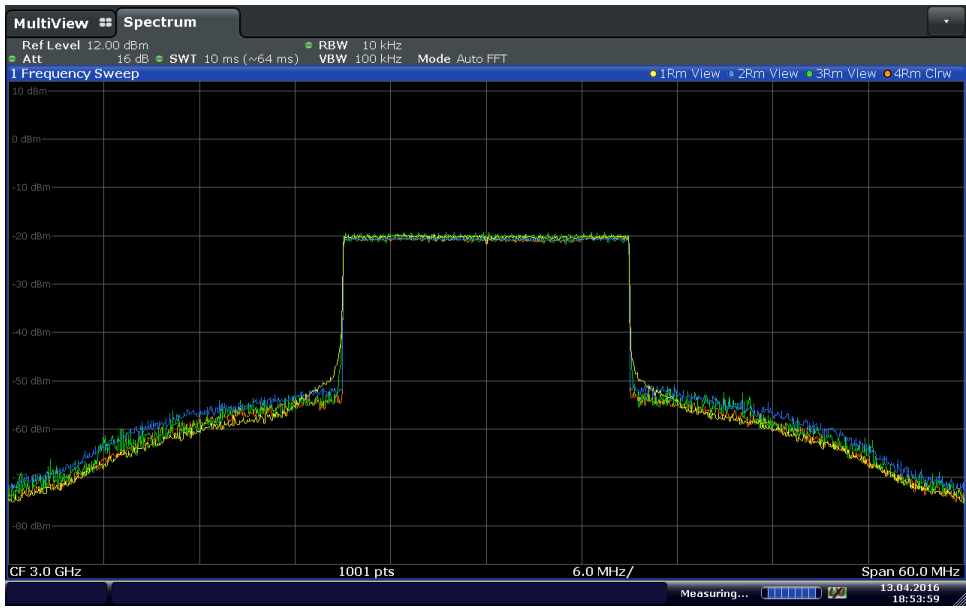

Fig. 5-12: LTE (yellow), FBMC (blue), UFMC (green), GFDM (orange) signal with amplifier input power -2.00 dBm

At this point it has to be mentioned that the used power amplifier is not optimized for cellular applications. So with real products going into a design different results shall be expected. The idea here is to demonstrate the impact of a non-linear device to the highlighted advantage of 5G waveform candidates, but any non-linearity will result in a spectral regrowth and there is the thread that this spectral regrowth may compensate for any optimization due to the waveform design.

5.5.4 Robustness against Carrier Frequency Offsets (CFO)¹³

Carrier frequency offsets (CFO) can arise in the channel (like Doppler shifts) and due to impairments in the transceiver components (like not perfectly synchronized oscillators). By this cause interferences between the carriers in the demodulation of the signal will emerge, which will in consequence increase the portion of incorrect demodulated symbols.

In our simulations the CFO is a relative quantity respective to the subcarrier spacing. E.g. a CFO of 0.1 corresponds to $0.1 \cdot 15 \text{ kHz} = 1.5 \text{ kHz}$. Note that for GFDM (with its greater spacing) the same absolute CFO is applied to sustain fairness. In practice one would of course deploy frequency synchronization, but to measure the robustness this is volitionally not done here. However we assume the phase rotation to be perfectly synchronized. [Fig. 5-13](#) shows some simulation results.

¹³ Results presented in Section [5.5.4](#) and [5.5.5](#) rely on the research and analysis provided in [\[19\]](#)

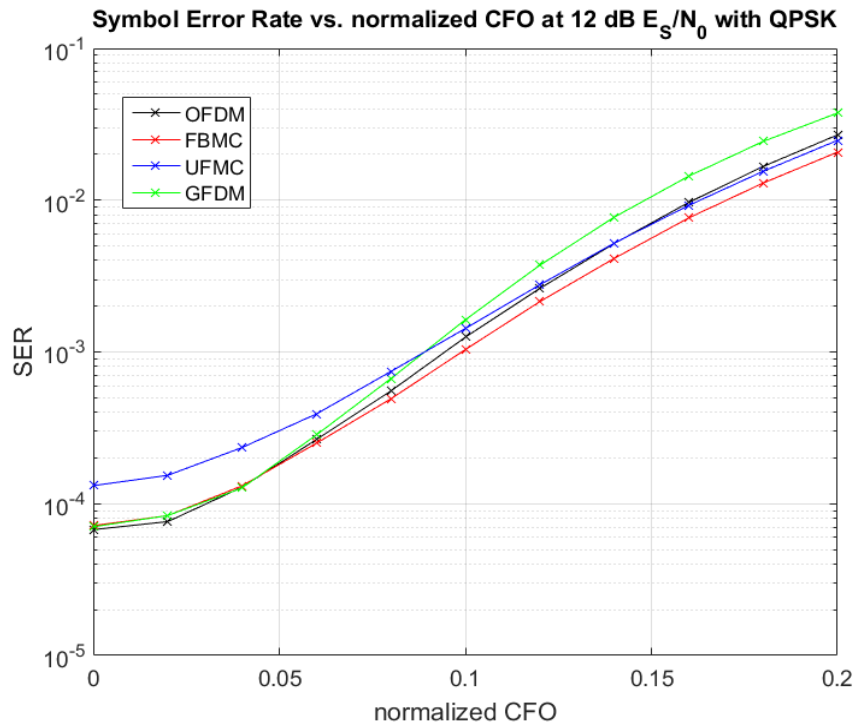

Fig. 5-13: Symbol Error Rate for increasing values of Carrier Frequency Offset normalized to carrier spacing (15 kHz) at 12 dB E_s/N_0

Here an AWGN channel is simulated with constant E_s/N_0 (12dB) and applied CFO to the signal. In the following we refer to the OFDM curve, since the interference introduced by CFO is well understood and described, e.g. in [18].

FBMC shows better robustness than OFDM. This is based on the fact that by shaping each subcarrier the side lobes of their spectra are considerably reduced and so are the interferences due to CFO.

Simulating UPMC with a rectangular pulse shape, the same behavior like OFDM would be observed. Therefore a filter length of 146 was chosen. For no carrier offset there is a higher error level, because the bit energy has to be split up to the filter tail, too. With increasing CFO the effect of better frequency localized per sub-bands appears and lets the curve approach to OFDM (where still no CP is considered and thus the bit energy is only spent on information).

Although OQAM was deployed in GFDM, it shows clearly the worst behavior of the three waveforms compared to OFDM. It is even more sensitive to CFO than OFDM.

5.5.5 Impact of Noise

To analyze the robustness against noise an Additive White Gaussian Noise (AWGN) was simulated. The noise power was defined by the ratio of energy per bit to noise power per

Hertz (E_b/N_0). This ratio is proportional to the well-known signal to noise ratio (SNR) and is referred to this for convenience.

In Fig. 5-14 the measurements of the bit error rate (BER) for several SNRs is depicted. Please note that the BER is further impacted by the receiver design concept using equalization algorithms and e.g. applying interference cancellation methods as an example.

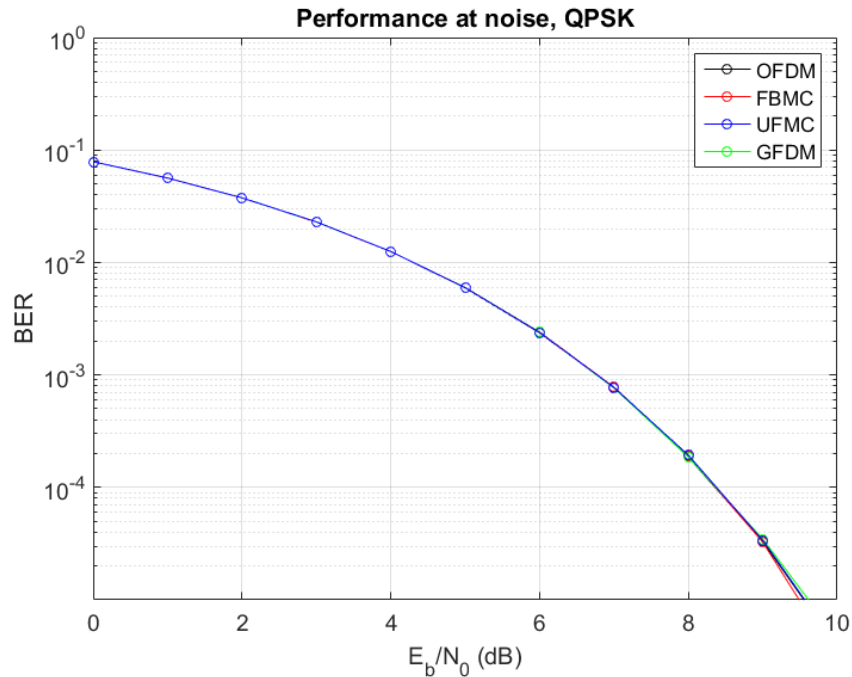

Fig. 5-14: Bit Error Rate (BER) for increasing values of Energy per Bit by Noise Power per Hz (E_b/N_0)

As it can be clearly seen, all waveforms perform equally and approach the theoretical transmission limit in an AWGN. This shows us that no form introduces self-interference of symbols or carrier. In case of GFDM and FBMC this is achieved by deploying OQAM. A few things have to be noted, though. In case of OFDM and GFDM the CPs are not considered in this simulation. So the energy can be completely used for the information part of the signal. For the CP to be present the energy would have to be split up to information and CP. Similarly a UFMC symbol consists of the actual information plus the filter response. To make a fair comparison, the filter length was set to one. Hence the UFMC is here equal to OFDM. So it must be considered that OFDM, GFDM and UFMC would perform worse depending on the length of CP, respectively the filter response length.

5.6 f-OFDM - filtered Orthogonal Frequency Division Multiplexing

Filtered OFDM (f-OFDM) is not a deliverable of the 5G NOW project, but is also considered as a waveform candidate for 5G. It's very similar to UFMC, as it creates multiple subbands. But it is based completely on the existing OFDM numerology, the main idea is to apply additional steps that are not considered in classic OFDM like a subband specific filter and to allow the parameterization of the numerology in a more flexible way.

A major difference to UFMC is that it allows completely different parameters for each sub-band for the subcarrier (SC) spacing, length of cyclic prefix (CP) and transmission time interval (TTI), etc. Sub-band-based filtering then suppresses the inter-sub-band interference [20]. Rather short filter with no overlap between symbols (w/o ISI) and fixed filter bandwidth can be used, but also longer filter where filter tails of consecutive symbols are allowed to overlap (w/ ISI) and have good localization in frequency. Sub-bands with different parameters can be allocated to different users and services. For instance, to provide ultra-low latency and high reliability for vehicle-to-vehicle communication, the symbol duration is shortened while the subcarrier spacing is enlarged.

[20] and [21] describe and discuss f-OFDM in detail.

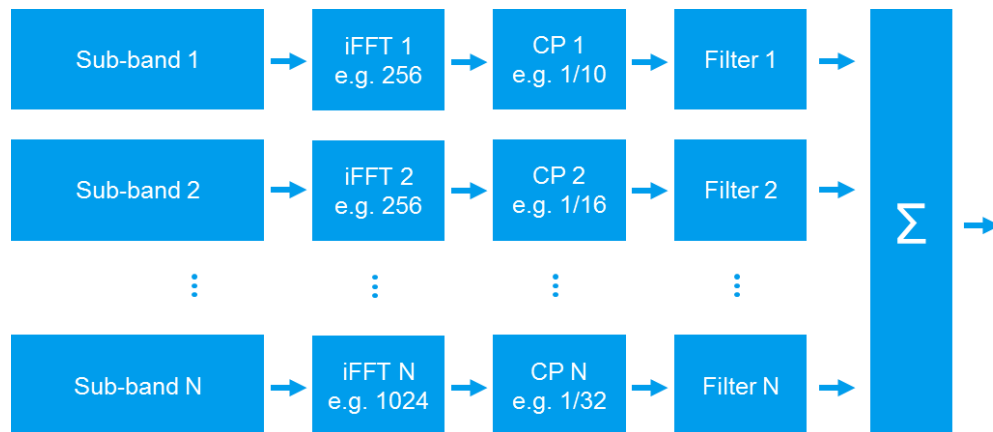

Fig. 5-15: Block Diagram for an f-OFDM Transmitter as described in [20]

6 Testing with 5G Waveform Candidates

6.1 5G Waveform Candidate Signal Generation

The Rohde & Schwarz R&S®SMW200A Vector Signal Generator with software option SMW-K114 supports the generation of all four 5G waveform candidates: FBMC, UFMC, GFDM and f-OFDM [Fig. 6-1].

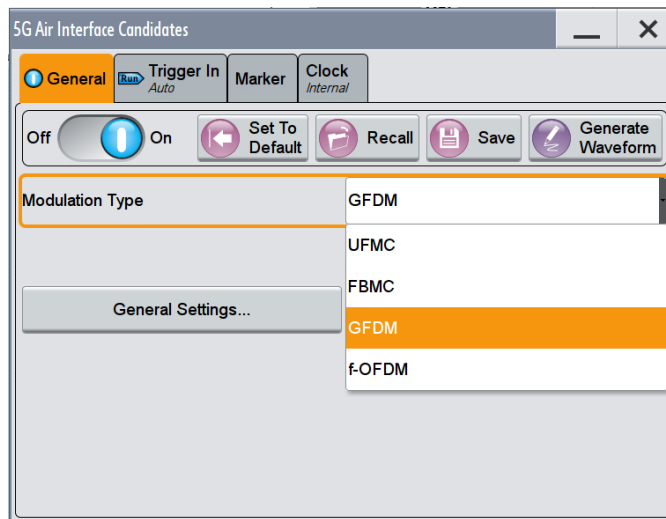

Fig. 6-1: Software Option SMW-K114 - 5G Air Interface Candidates

6.1.1 General Settings

Common for all waveforms is the configuration of "General Settings" and "Allocation Settings". As all waveform candidates are multi-carrier schemes and thus rely on OFDM in general the most common parameter such as total number of subcarrier, occupied number of subcarrier, subcarrier spacing, sequence length and cyclic prefix length can be set in the 'General Settings' menu [Fig. 6-2].

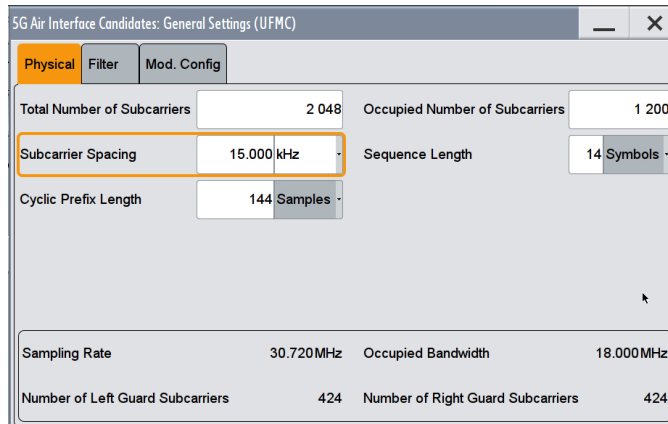

Fig. 6-2: UFMC with LTE-like parameterization

The next two tabs in the 'General Settings' menu (Filter, Modulation Configuration) allow the modification of waveform-specific parameter. As described earlier, all candidates using specific filtering methods which can be configured in the 'Filter' tab. UFMC uses Dolph-Chebyshev and the configurable parameter is the filter length. The possibility to load a user-defined filter, for instance created in a simulation environment like Matlab, also exists. For UFMC the 'Modulation Configuration' tab allows the definition of the number of subbands and activation of a pre-equalization filter for each subband.

Filter definition and Modulation Configuration is fixed for FBMC to Root-Raised Cosine filter with roll-off factor $\alpha=0.1$ and overlapping factor 4 like explained in chapter 5.2.

GFDM allows selection of four possible filters (RC, RRC, Dirichlet, Rectangular; see Fig. 6-3) as well as the definition of the data block size.

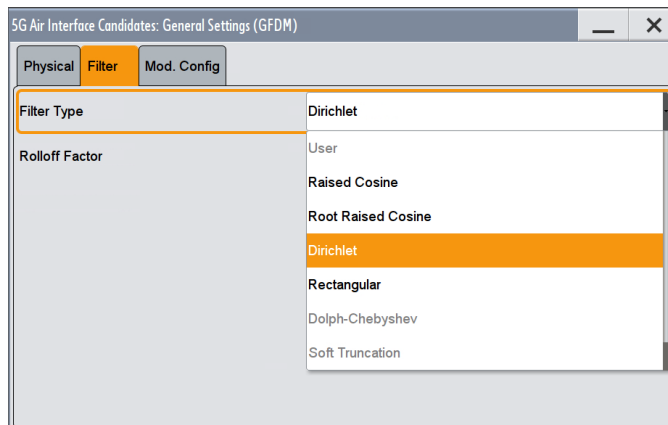

Fig. 6-3: GFDM Filter Selection

For f-OFDM the filter type, filter length and windowing method (Hanning, Hamming) can be selected by the user. As for UFMC the 'Modulation Configuration' allows the definition of subbands where the filter is applied too.

6.1.2 Allocation Settings

The 'Allocation Settings' menu is common for all four waveform candidates. It allows the definition of up to six users with individual data source (PN sequences, bit pattern, data list) and power leveling [Fig. 6-4].

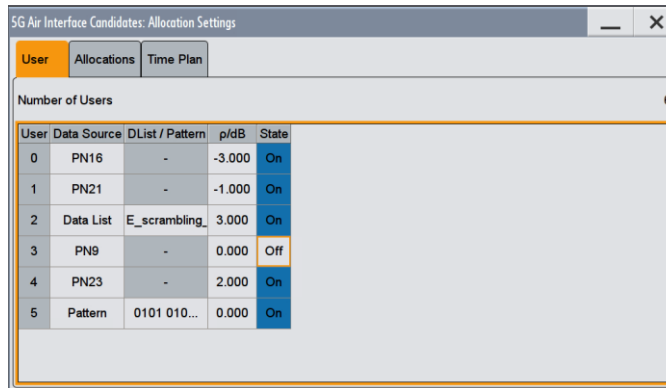

Fig. 6-4: User Definition for 5G Waveform Candidates

As a data source a data list can be selected, e.g. a scrambled bit sequence based to the LTE standard [Fig. 6-5]. Section 5.5.1.2 has further details how to generate a data list and why that is important for hardware-in-the-loop experiments.

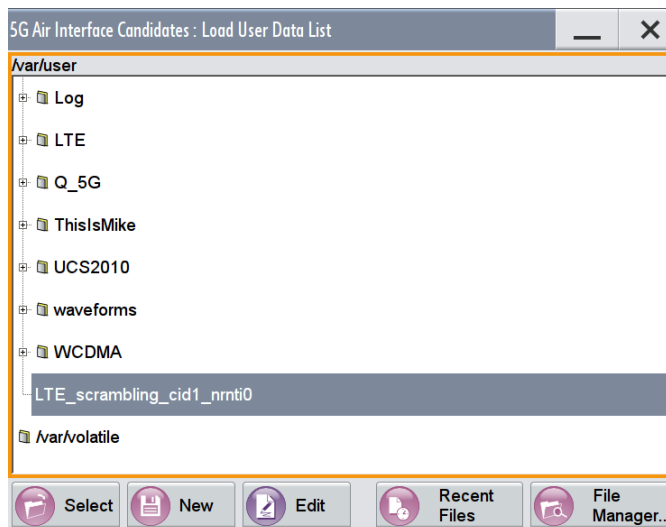

Fig. 6-5: Load data list as payload for 5G Waveform Candidates

The 'Allocations' tab allows now the configuration of the time and frequency domain. Up to 30 allocations can be selected. The example in Fig. 6-6 shows seven allocations for five different users where different number of symbols and carriers are occupied in time and frequency domain and different modulation schemes have been selected. Any conflict i.e. overlapping allocation between different users is indicated in the 'Conflict' column.

5G Air Interface Candidates: Allocation Settings

User Allocations Time Plan

Number of Allocations: 7

	Modulation	No. SC	No. Sym.	Offset SC	Offset Sym.	Physical Bits	Data Source	DList/Pattern	p/dB	Content Type	State	Conf.
0	QPSK	400	14	0	0	11200	User 0	-	-3.000	Data	On	
1	16QAM	100	8	400	6	3200	User 1	-	-1.000	Data	On	
2	64QAM	100	14	500	0	8400	User 2	-	1.000	Data	On	
3	256QAM	500	10	600	4	40000	User 4	-	5.000	Data	On	
4	QPSK	100	14	1100	0	2800	User 0	-	-3.000	Data	On	
5	64QAM	500	4	600	0	12000	User 5	-	2.000	Data	On	
6	64QAM	100	6	400	0	3600	User 5	-	0.000	Data	On	

Fig. 6-6: Allocation Settings for 7 Allocations, 5 different users

The 'Time Plan' tab provides a graphical overview on the selection.

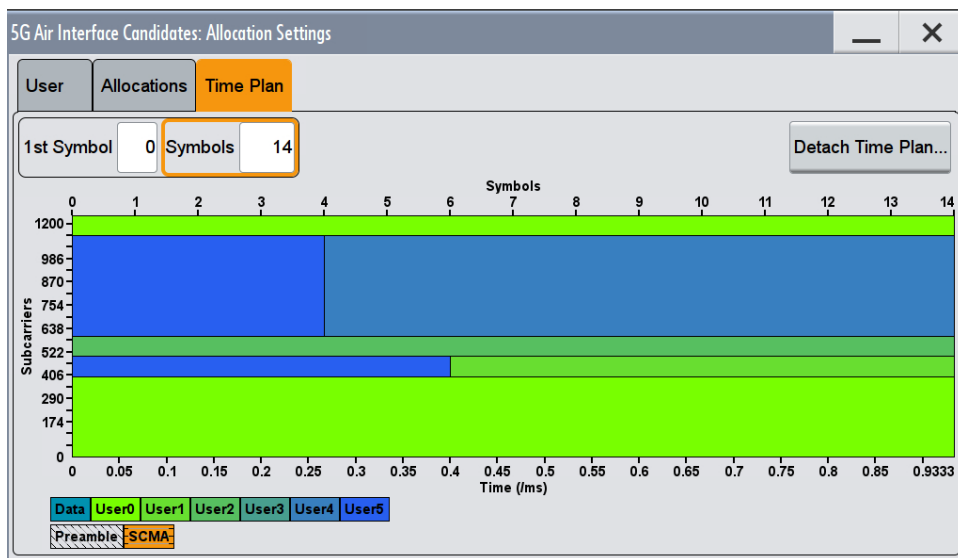

Fig. 6-7: Time Plan

6.2 5G Waveform Signal Analysis

To analyze 5G Waveform Candidates Rohde&Schwarz has extended the capabilities of its OFDM Vector Signal Analysis Software (FS-K96) and added analysis capabilities for UFMC and GFDM. Fig. 6-8 shows the demodulation of a UFMC signal.

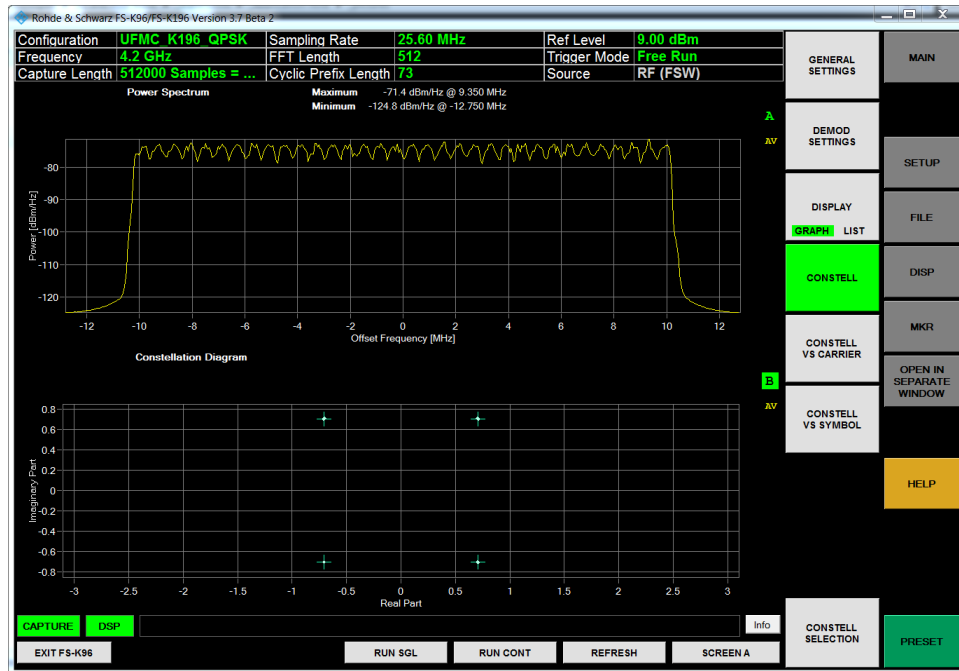

Fig. 6-8: Demodulation of a UFMC signal, QPSK modulation with FS-K196

Dependent on the format to be analyzed a configuration file has to be loaded into the software module to set the correct parameters for proper analysis. Two sample configuration files are installed with the software. They can be accessed within the default installation directory at C:\Program Files (x86)\Rohde-Schwarz\OFDM Vector Signal Analysis Software\CONFIGURATIONS; see Fig. 6-9.

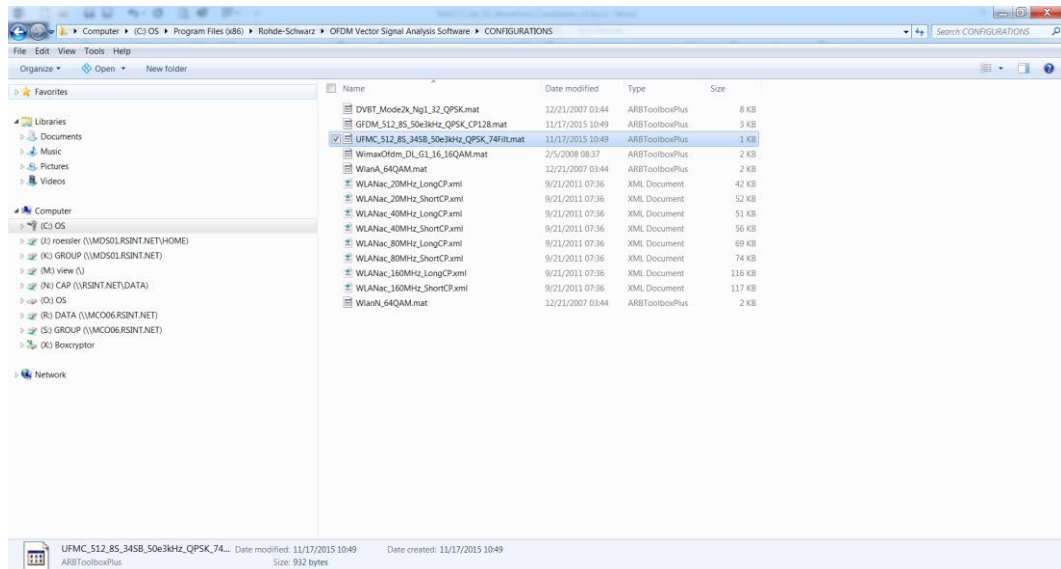

Fig. 6-9: Configuration Files for FS-K196

There are two example files: one for UFMC and one for GFDM. Both configuration files match the default configuration for these 5G waveform candidates generated by the R&S®SMW200A Vector Signal Generator. The configuration files can be loaded into FS-K96/FS-K196 per 'drag & drop' or via the 'Demodulation Settings' dialog. The only additional thing that needs to be set in the FS-K196 software is the correct sampling rate, in our example 25.6 MHz. The sampling rate can be derived from the R&S®SMW200A Vector Signal Generator [see Fig. 6-2].

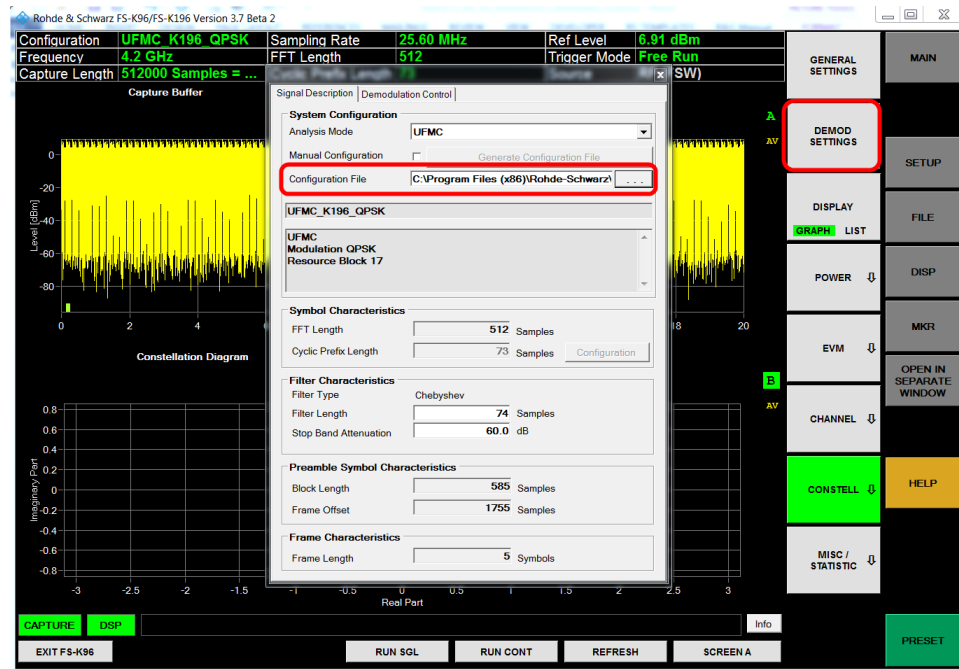

Fig. 6-10: Load Configuration File for FS-K96/FS-K196 via 'Demodulation Settings' dialog

To create a new or modify an existing configuration file for i.e. UFMC a file generator called **gen_ufmc.mat** has been added to the FS-K96/K196 software. The file can be found in the installation directory at C:\Program Files (x86)\Rohde-Schwarz\OFDM Vector Signal Analysis Software\TOOLSMATLAB. The easiest way to use this configuration file generator is to have Matlab installed on your computer. If you open the generator file, you can edit all parameters as needed, i.e. change modulation scheme, and other relevant parameter and then hit the 'RUN' button; see Fig. 6-11.

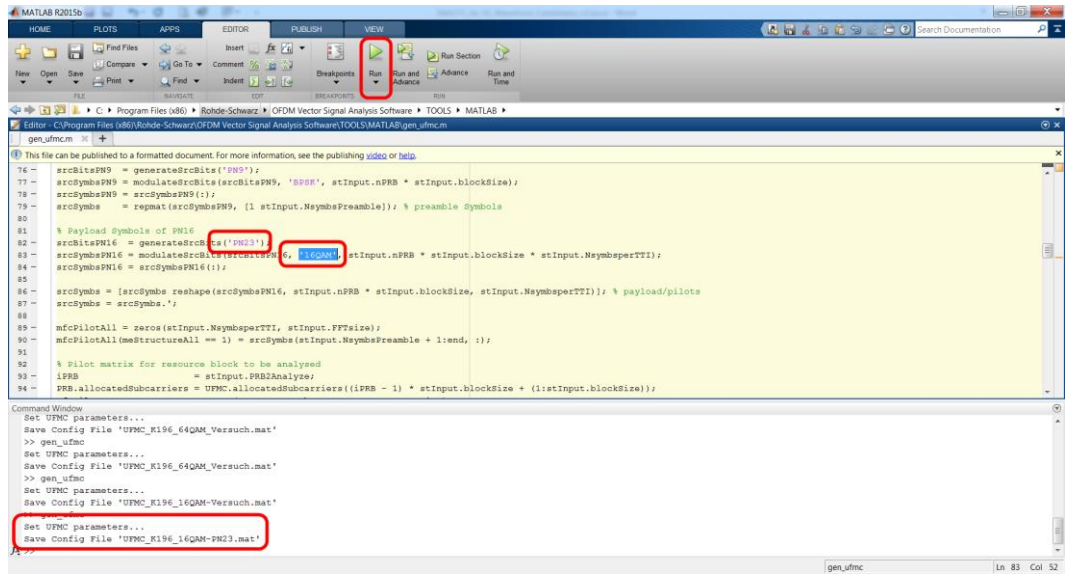

Fig. 6-11: Create new or modify an existing configuration file for FS-K196

The parameters will be set accordingly, a new configuration file is created and stored in the given directory. In the example the modulation scheme was changed to 16QAM and the payload data was changed to PN23. Fig. 6-12 represents an analysis of this signal after the configuration file was loaded into FS-K196. The constellation diagram shows - as expected - a 16QAM modulation.

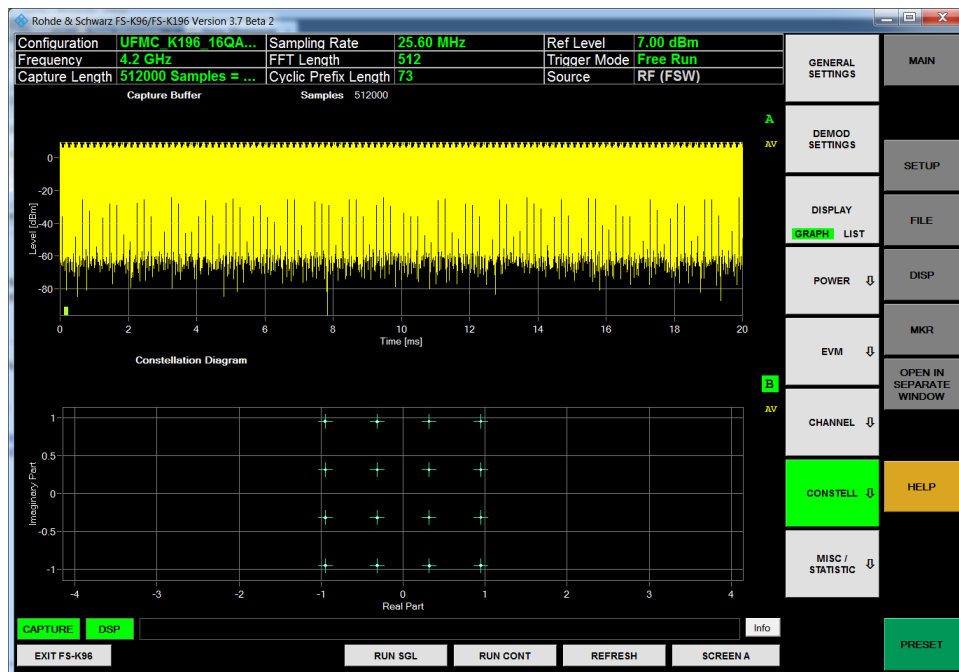

Fig. 6-12: Analyzing 16QAM UPMC signal

The result summary an EVM of -50 dB (~0.32%) and a crest factor of about 15 dB. The reasons behind the high crest factor are explained in section 5.5.1.1.



Fig. 6-13: Result Summary 16QAM UPMC Signal

7 General Implications to 5G PHY/MAC Design

7.1 Multi-Carrier or Single Carrier?

7.1.1 Low(er) Peak-To-Average-Power Ratio (PAPR)

The Peak-to-Average Power Ratio (PAPR) of a signal depends first and foremost on the type of the signal itself. Is it a single carrier or a multi-carrier signal? Single Carrier Transmission techniques tend to have a significantly lower PAPR than multi-carrier schemes such as OFDM. Let's compare two signals, one of each family, for their PAPR.

The signal represented in [Fig. 7-1](#) shows a "tweaked" 802.11ad signal. The sampling rate is reduced to 660 Msps, so that the occupied bandwidth is 500 MHz. The carrier frequency is 28 GHz, one of the frequency candidates for 5G. 802.11ad defines 3 different physical layer modes: single carrier, Low Power PHY and OFDM-based PHY¹⁴. The latter two are optional. The signal in [Fig. 7-1](#) is based on the mandatory single carrier PHY. As it can be seen from the constellation diagram the modulation for the data symbols is 16QAM, the required Preamble is BPSK modulated, represented by the two dots on the Inphase-component axis.

¹⁴ At the writing of this application note IEEE 802.11ad was considering to remove the two OFDM-based PHY modes from the standard. A final decision wasn't made at the time of releasing this paper.



Fig. 7-1: Single Carrier signal with PAPR (Crest Factor) of 6.592 dB

The signal in Fig. 7-2 is an 8k-FFT-based OFDM signal with 100 kHz subcarrier spacing, 64QAM modulation and a bandwidth of 500 MHz. The carrier frequency is also 28 GHz.



Fig. 7-2: Multi-Carrier Signal (OFDM) with PAPR (Crest Factor) of 10.29 dB

As it can be seen the PAPR (Crest Factor) for the single carrier signal is around 6.6 dB, whereas for the OFDM-based signal it is 10.3 dB. The lower PAPR has a significant design advantage for power amplifier, especially for battery operated devices. Even with integration of fast chipsets (processors) and high-resolution, power hungry displays into modern handsets and tablets, the power amplifier is still consuming the majority of energy from the battery that is powering the device. Single carrier transmission with its lower PAPR allows a more efficient power amplifier design and will therefore preserve battery power.

Why then multicarrier? OFDM was selected as basis for LTE due to the lack of bandwidth at sub-6 GHz frequencies, allowing multi-user scheduling in the frequency domain and time domain using OFDMA. While transitioning to cm-Wave and mm-Wave frequencies more bandwidth becomes available that can be assigned to a few user, even one user for a very short amount of time and still ensures an in average higher data rate. So the requirement to efficiently schedule multiple users in a given (smaller) bandwidth becomes relaxed compared to LTE and therefore might benefit single carrier over multi-carrier transmission scheme, in particular at very high frequencies beyond 30 GHz.

From an implementation perspective it should be noted that the energy consumption of A/D converters is not to be neglected. This leads to the idea of implementing beamforming strategies only on the RF part means all phase weights at the antenna array would be the same phase weight for all spectral components. Multicarrier waveforms would not be able to show their benefit of a frequency division multiplexing scheduling scheme and a single carrier scheme would be sufficient by applying a TDM behavior to multiplex several users.

7.1.2 Phase Noise at mm-Wave frequencies

Phase Noise generally increases with frequency and frequency and clock offsets become even more significant at higher frequencies. This is a disadvantage to any multi-carrier transmission scheme such as OFDM as these offsets impact orthogonality and make it more challenging to keep synchronization.

7.1.3 Low-latency support requirement

As discussed in section 2.3.1 the addition of the CP adds an overhead to the transmission that depends on symbol duration and CP length. As one requirement for a 5G standard is to support low-latency and latency-sensitive applications, the duration of the Transmit Time Interval (TTI) needs to be shortened. As an example: in LTE the TTI is defined as one subframe with a duration of 1 ms. A subframe is comprised by 14 OFDM Symbols, normal cyclic prefix length assumed. To shorten the TTI a logical step would be to shorten OFDM symbol duration, which in fact would mean a wider subcarrier spacing in frequency domain. Another solution would be to change the definition of TTI to e.g. only span "a few"

OFDM symbols. That would require the adaptation of the currently defined (HARQ¹⁵) feedback process in LTE. As for a new 5G standard either new frame structure is required or enhanced, more flexible feedback mechanisms.

7.2 Frequency Division Duplex (FDD) or Time Division Duplex (TDD)?

Today, 90% of all LTE/LTE-Advanced networks are FDD based. Therefore it's a valid question if also majority of 5G systems will be FDD based. Moving to higher frequencies to access wider bandwidth requires the use of phase array antennas to create 'pencil' beams to overcome the higher path loss. It is anticipated that these antenna arrays have to be used in both directions downlink and uplink to achieve acceptable system performance. A TDD-based system would have clear advantage in this case since transmit and receive is using the same frequency and thus the radio channel is reciprocal. A receiver could very easy determine Angle-of-Arrival (AoA) or Direction-of-Arrival (DoA) of an incoming signal based on e.g. embedded pilots (reference signals) and use this information to do proper pre-coding of its transmit signal in the digital domain and fine tuning of the beam while using phase sifters connected to the antenna elements within the antenna array.

7.3 Interference Cancellation methodology required

All the 5G waveform candidates described in chapter 4 introduce artificial Inter-Carrier Interference and/or Inter-Symbol Interference by applying different pulse shaping filter or proprietary filter designs. For proper signal quality measurements i.e. Error Vector Magnitude (EVM) it is required to cancel this interference at the receiving side. Typically a standardization body like the 3rd Generation Partnership Project (3GPP), responsible for LTE/LTE-Advanced/LTE-Advanced-Pro defines the method how to obtain signal quality measurements like EVM and at which point in the signal processing chain. Fig. 7-3 shows the measurement point for EVM for an LTE base station. The EVM is measured after equalization, means after amplitude and phase correction per subcarrier.

¹⁵ HARQ - Hybrid Automatic Repeat ReQuest

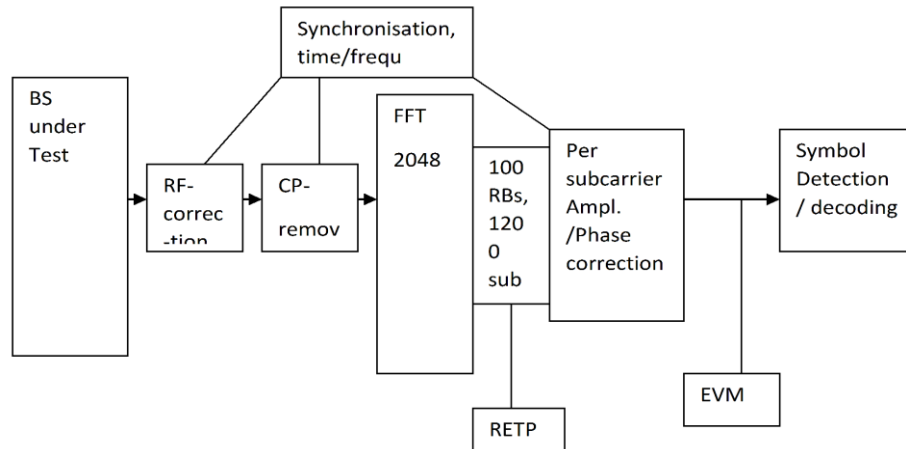

Fig. 7-3: Measurement Points for LTE Base Station Test as defined in [22]

As for LTE as a 4G standard also for a future 5G standard a definition on how to measure signal quality, i.e. EVM, based on a defined signal. This definition has to include the measurement point in the signal processing chain. Based on current trends for 5G waveform definition using different pulse shaping techniques or proprietary filter designs interference cancellation using an adequate cancellation algorithm is anticipated.

8 Summary and Conclusion

In this application note the limitations of LTE and OFDM as the underlying waveform were analyzed. Potential 5G Waveform Candidates were introduced and compared to OFDM in terms of spectral regrowth, peak-to-average power ratio (PAPR), carrier frequency offset and presence of noise.

The spectral advantages in terms of out-of-band emission of the discussed 5G waveform candidates are more or less vanished when the signal is amplified and thus experience the non-linear behavior and characteristic of the RF front-end, in particular the power amplifier.

It should be noted that the experiments in this application note were carried out using a generic power amplifier, covering a wide frequency range and up to 20 MHz of bandwidth. The component was not optimized for these waveforms.

It can be concluded that much more research, further testing and hardware-in-the-loop experiments are required to preserve the (spectral) advantages that these new waveform types show in typical simulations and make them also visible in reality.

Rohde & Schwarz continues to optimize its 5G test solutions for this and all other purposes currently being considered for the 5th Generation of wireless communications.

9 Literature

- [1] Rohde & Schwarz: Application Note [1MA111](#) "UMTS Long Term Evolution (LTE) Technology Introduction, 2012
- [2] Stefania Sesia, Issam Toufik, Matthew Baker, "LTE - From Theory to Practice", 2009
- [3] 3GPP TS 36.101, User Equipment (UE) radio transmission and reception, V12.9.0, October 2015 (Release 12)
- [4] D. Gabor; Theory of Communications, London: Institution of Electrical Engineering, 1946.
- [5] IMT Vision – “Framework and overall objectives of the future development of IMT for 2020 and beyond”, June 19, 2015, https://www.itu.int/dms_pubrec/itu-r/rec/m/R-REC-M.2083-0-201509-!!!PDF-E.pdf
- [6] Viholainen, A.; Bellanger, M.; Huchard, M.; "PHYDAS - PHYsical layer for Dynamic AccesS and cognitive radio", Report D5.1, January 2009
- [7] Bellanger, M.; & others, FBMC physical layer: a primer, June 2010
- [8] F. Schaich, "Filterbank Based Multi Carrier Transmission (FBMC) – evolving OFDM," in IEEE European Wireless Conference, Lucca, Italy, 2010.
- [9] Markku Renfors (EURASIP Member), Pierre Siohan, Behrouz Farhang-Boroujeny, and Faouzi Bader, "Editorial Filter Banks for Next Generation Multicarrier Wireless Communications," EURASIP Journal on Advances in Signal Processing, vol. 2010, 2010
- [10] Thorsten Wild, Frank Schaich, Yejian Chen, "5G Air Interface Design based on Universal Filtered (UF-)OFDM," in Proceedings of the 19th International Conference on Digital Signal Processing, 20-23 August 2014.
- [11] Schaich, F. ; Alcatel-Lucent, Bell Labs., Stuttgart, Germany ; Wild, T., "Waveform contenders for 5G — OFDM vs. FBMC vs. UFMC," in Communications, Control and Signal Processing (ISCCSP), 2014 6th International Symposium on, 2014.
- [12] Vida Vakilian, Thorsten Wild; Frank Schaich; Stephan ten Brink; Jean-Francois Frigon, "Universal-Filtered Multi-Carrier Technique for Wireless Systems Beyond LTE," in IEEE Global Communications Conference, Atlanta, 2013.
- [13] Ivan S Gaspar, Luciano L Mendes, Nicola Michailow and Gerhard Fettweis, "A synchronization technique for generalized frequency division multiplexing," EURASIP Journal on Advances in Signal Processing, vol. 2014:67, 2014.
- [14] Gerhard Fettweis, Marco Krondorf and Steffen Bittner, "GFDM - Generalized Frequency Division Multiplexing," in IEEE 69th Vehicular Technology Conference, 2009. VTC Spring 2009. , Barcelona, Spain, 2009.

-
- [15] Gerhard Fettweis, Marco Krondorf and Steffen Bittner, "GFDM - Generalized Frequency Division Multiplexing," in IEEE 69th Vehicular Technology Conference, 2009. VTC Spring 2009. , Barcelona, Spain, 2009.
 - [16] R&S@SMW-K55/-K69/-K81/-K84/-K85/-K112/-K113 EUTRA/LTE User Manual LTE closed-loop BS test, Logfile Generation, Rel.9/Rel.10/Rel.11/Rel.12, Enhanced Features
 - [17] R&S@SMW200A Vector Signal Generator, User Manual
 - [18] Q. a. J. N. Bai, On the effects of carrier frequency offset on cyclic prefix based OFDM and filter bank based multicarrier systems, Signal Processing Advances in Wireless Communications (SPAWC), 2010 IEEE Eleventh International Workshop on. IEEE, 2010.
 - [19] Schmaehling, M., Lang A., Slim, I., Radio Testing of 5G modulation waveform candidates, EDICON paper, 2015
 - [20] Xi Zhang, Ming Jiay, Lei Chen, Jianglei May, Jing Qiu, "Filtered-OFDM — Enabler for Flexible Waveform in The 5th Generation Cellular Networks," in accepted to IEEE Globecom, San Diego, CA, Dec. 2015.
 - [21] M. J. a. J. M. Javad Abdoli, "Filtered OFDM: A New Waveform for Future Wireless Systems," in Huawei Technologies Canada Co. Ltd., Ottawa, Ontario CANADA.

10 Ordering Information

Type	Designation	Order No.
R&S@SMW200A	Vector Signal Generator	1412.0000.02
R&S@SMW-B140	RF path A	1414.1633.02
R&S@SMW-B13XT	Wideband baseband main module	1413.8005.02
R&S@SMW-B22	FM/φM Modulator and Enhanced Phase Noise Performance	1413.2207.02
R&S@SMW-B9	Wideband Baseband Generator with ARB	1413.7350.02
R&S@SMW-K515	ARB memory extension to 2 Gsamples	1413.9360.02
R&S@SMW-K526	Baseband Extension to 2 GHz RF bandwidth	1413.9318.02
R&S@SMW-K55	EUTRA/LTE	1413.4180.02
R&S@SMW-K114	5G Air Interface Candidates	1414.1985.02
R&S@FSW43	Signal And Spectrum Analyzer	1312.8000K43
R&S@FSW-B21	LO/IF Ports for External Mixers	1313.1100.43
R&S@FSW-B24	Preamplifier, 100 kHz to 43 GHz	1313.0832.43
R&S@FSW-B25	Electronic Attenuator	1313.0990.02
R&S@FSW-B512	512 MHz Analysis Bandwidth	1313.4296.04
R&S@FSW-B2000	2 GHz Analysis Bandwidth	1325.4750.02
R&S@FS-K70	Vector Signal Analysis	1313.1416.02
R&S@FS-K100	EUTRA/LTE FDD BS Measurements	1313.1545.02
R&S@FS-K101	EUTRA/LTE FDD UE Measurements	1313.1568.02
R&S@FS-K96	OFDM Vector Signal Analysis Software	1310.0202.06

R&S®FS-K196	5G Air Interface Candidates	1309.9200.06
R&S®RTO2044	Digital Oscilloscope	1329.7002.44
R&S®RTO-B4	OCXO 10 MHz	1304.8305.02
R&S®RTO-B110	Memory Option 1 Gsample	1329.7090.02

Rohde & Schwarz

The Rohde & Schwarz electronics group offers innovative solutions in the following business fields: test and measurement, broadcast and media, secure communications, cybersecurity, radiomonitoring and radiolocation. Founded more than 80 years ago, this independent company has an extensive sales and service network and is present in more than 70 countries.

The electronics group is among the world market leaders in its established business fields. The company is headquartered in Munich, Germany. It also has regional headquarters in Singapore and Columbia, Maryland, USA, to manage its operations in these regions.

Regional contact

Europe, Africa, Middle East
+49 89 4129 12345
customersupport@rohde-schwarz.com

North America
1 888 TEST RSA (1 888 837 87 72)
customer.support@rsa.rohde-schwarz.com

Latin America
+1 410 910 79 88
customersupport.la@rohde-schwarz.com

Asia Pacific
+65 65 13 04 88
customersupport.asia@rohde-schwarz.com

China
+86 800 810 82 28 | +86 400 650 58 96
customersupport.china@rohde-schwarz.com

Sustainable product design

- Environmental compatibility and eco-footprint
- Energy efficiency and low emissions
- Longevity and optimized total cost of ownership



This application note and the supplied programs may only be used subject to the conditions of use set forth in the download area of the Rohde & Schwarz website.

R&S® is a registered trademark of Rohde & Schwarz GmbH & Co. KG; Trade names are trademarks of the owners.

Rohde & Schwarz GmbH & Co. KG
Mühlhofstraße 15 | 81671 Munich, Germany
Phone + 49 89 4129 - 0 | Fax + 49 89 4129 - 13777

www.rohde-schwarz.com