

Application Note

5G NR FR1 NON-STANDALONE UE RF CONFORMANCE TESTING

EN-DC Mode According to 3GPP 38.521-3

Products:

- ▶ R&S®CMX500
- ▶ R&S®CMW500
- ▶ R&S®CMsquares

Yong Shi | 1SL368 | Version 0e | 06.2021

<https://www.rohde-schwarz.com/appnote/1SL368>

ROHDE & SCHWARZ

Make ideas real



Contents

1	Overview.....	6
2	General Information.....	8
2.1	Frequency Range (FR1 vs. FR2)	8
2.2	5G NR Non Standalone EN-DC Mode	8
2.2.1	NR EN-DC Inter-band	10
2.2.2	NR EN-DC Intra-band Contiguous	11
2.2.3	NR EN-DC Intra-band Non-contiguous	12
2.3	3GPP Test Specifications.....	12
3	Configure 5G NR EN-DC RF Test.....	12
3.1	Default Conditions	14
3.1.1	Test Environmental Conditions	14
3.1.2	Test Frequency and Test Channel Bandwidth	14
3.1.3	Test SCS for NR Cell	16
3.2	Reference Measurement Channel (RMC)	17
3.2.1	Resource Allocation	17
3.2.2	Modulation.....	18
3.2.3	NR Uplink RMC.....	18
3.2.4	NR Downlink RMC	20
3.2.5	E-UTRA Uplink RMC.....	22
3.2.6	E-UTRA Downlink RMC	24
3.3	Signal Power Level.....	27
3.3.1	Uplink Signal Level.....	27
3.3.2	Downlink Default Power Level.....	28
3.4	Downlink PDSCH and PDCCH Configuration	30
3.5	Propagation Condition.....	31
3.6	LTE Anchor Agnostic Approach for EN-DC FR1 Tests	31
4	Preparation of Test.....	34
4.1	Architecture	34
4.2	Hardware Requirement	34
4.3	Software Requirement.....	34
4.4	General Operations in CMsquares	34
4.4.1	LTE/NR Cell Setup and EN-DC Mode Activation	36
4.4.2	LTE/NR Tx Measurement.....	37
4.4.3	LTE/NR Rx Measurement	40
5	Transmitter Characteristic Tests.....	40
5.1	Maximum Output Power for Inter-band EN-DC within FR1 (6.2B.1.3).....	41

5.1.1	Test Purpose	41
5.1.2	Test Preparations	42
5.1.3	Test Procedure	44
5.1.4	Test Requirement and Results	45
5.2	Maximum Output Power Reduction for Inter-band EN-DC within FR1 (6.2B.2.3) 46	
5.2.1	Test Purpose	46
5.2.2	Test Preparations	47
5.2.3	Test Procedure	48
5.2.4	Test Requirement and Results	48
5.3	Minimum Output Power for Inter-band EN-DC within FR1 (6.3B.1.3)	48
5.3.1	Test Purpose	49
5.3.2	Test Preparations	49
5.3.3	Test Procedure	50
5.3.4	Test Requirement and Results	50
5.4	Tx ON/OFF Time Mask for Inter-band EN-DC within FR1 (6.3B.3.3)	51
5.4.1	Test Purpose	51
5.4.2	Test Preparations	52
5.4.3	Test Procedure	54
5.4.4	Test Requirement and Results	55
5.5	Frequency Error for Inter-band EN-DC within FR1 (6.4B.1.3)	56
5.5.1	Test Purpose	56
5.5.2	Test Preparations	56
5.5.3	Test Procedure	57
5.5.4	Test Requirement and Results	57
5.6	Error Vector Magnitude for Inter-band EN-DC within FR1 (6.4B.2.3.1)	58
5.6.1	Test Purpose	58
5.6.2	Test Preparations	59
5.6.3	Test Procedure	62
5.6.4	Test Requirement and Results	62
5.7	Carrier Leakage for inter-band EN-DC within FR1 (6.4B.2.3.2)	64
5.7.1	Test Purpose	64
5.7.2	Test Preparations	64
5.7.3	Test Procedure	66
5.7.4	Test Requirement and Results	67
5.8	In-band Emissions for Inter-band EN-DC within FR1 (6.4B.2.3.3)	68
5.8.1	Test Purpose	68
5.8.2	Test Preparations	69
5.8.3	Test Procedure	71
5.8.4	Test Requirement and Results	72

5.9	EVM Equalizer Flatness for Inter-band EN-DC within FR1 (6.4B.2.3.4).....	74
5.9.1	Test Purpose	74
5.9.2	Test Preparations	74
5.9.3	Test Procedure.....	76
5.9.4	Test Requirement and Results	77
5.10	Occupied Bandwidth for Inter-Band EN-DC within FR1 (6.5B.1.3).....	79
5.10.1	Test Purpose	79
5.10.2	Test Preparations	80
5.10.3	Test Procedure.....	81
5.10.4	Test Requirement and Results	81
5.11	Spectrum Emission Mask for Inter-band EN-DC within FR1 (6.5B.2.3.1).....	82
5.11.1	Test Purpose	82
5.11.2	Test Preparations	82
5.11.3	Test Procedure.....	83
5.11.4	Test Requirement and Results	83
5.12	Adjacent Channel Leakage Ratio for Inter-band EN-DC within FR1 (6.5B.2.3.3)	
	86	
5.12.1	Test Purpose	86
5.12.2	Test Preparations	86
5.12.3	Test Procedure.....	87
5.12.4	Test Requirement and Results	88
6	Receiver Characteristic Tests.....	89
6.1	Reference Sensitivity for Inter-band EN-DC within FR1 (7.3B.2.3)	89
6.1.1	General	89
6.1.2	EN-DC Band Combination without Exception	90
6.1.3	EN-DC Band Combination with Exception	92
6.2	Maximum Input Level for Inter-band EN-DC within FR1 (7.4B.3).....	96
6.2.1	Test Purpose	96
6.2.2	Test Preparations	96
6.2.3	Test Procedure.....	98
6.2.4	Test Requirement and Results	99
7	Literature	99
8	Appendix	100
A	FR1 Frequencies.....	101
A.1	NR FR1 Operating Bands	101
A.2	Inter-band EN-DC Configuration within FR1 (two bands).....	102
A.3	Intra-band EN-DC Contiguous within FR1.....	104
A.4	Intra-band EN-DC Non-contiguous within FR1.....	105
B	Initial Test Conditions	106

B.1	Test Frequencies for E-UTRA FDD Operating Band 1	106
B.2	Test Channel Bandwidth for 5G NR FR1	107
B.3	Test Frequency for 5G NR FR1	108
B.4	Test SCS for 5G NR FR1	109
C	Initial Bandwidth Part (BWP)	112
D	Resource Block Allocation of Reference Measurement Channels (RMC).....	113
D.1	E-UTRA RB allocation of Uplink RMC.....	113
D.2	NR RB Allocation of Uplink RMC	114
D.3	NR RB Allocation of Downlink RMC	117

1 Overview

5G New Radio (NR) is a radio access technology (RAT) specified by 3rd Generation Partnership Project (3GPP) in release 15 technical standard which was first published in 2018. It is designed to enhance the spectrum efficiency to meet the diverse needs of wireless communication applications, such as enhanced mobile broadband (eMBB), massive machine type communications (mMTC) and ultra-reliable and low latency communications (URLLC).

Two deployment modes are defined for 5G NR technology

- non-standalone (NSA) mode involving both E-UTRA (access technology used for LTE) and 5G NR RAT
- standalone (SA) mode allows the user equipment (UE) to access 5G core network (5GC) over LTE or 5G NR RAT

All 5G NR air interface related core specifications as well as associated test specifications are included in the 3GPP 38 series specifications. In an UE product lifecycle, UE vendor is obliged to go through the device certification process by passing all the required conformance tests which include RF, protocol, performance tests before official launch of the product. RF conformance testing is of course essential for the market access. The conformity of 3GPP specification has to be ensured even in the early product R&D phase.

This application note aims to guide the R&D reader through the 5G NR Frequency Range 1 (FR1) NSA RF UE conformance test according to 3GPP38.521-3 [1] based on mobile radio tester R&S®CMX and associated web user interface R&S®CMSquares in interactive operation mode, i.e. manual operation mode, through test configuration examples. After reading this application note, the reader should be able to conduct 3GPP RF conformance tests with proper settings manually and understand measurement results in R&S®CMSquares.

The whole application note is structured in the following way:

Chapter 2 gives general information about 5G NR frequency and related 3GPP test specifications

Chapter 3 explains some import parameters used for the conformance testing and how the proper value settings are determined

Chapter 4 shows the system requirements and some basic operations on the test equipment

Chapter 5 describes in great details of transmitter conformance test cases including the parameter settings, test procedure, test requirement and measurement results in R&S®CMSquares

Similar to Chapter 5, receiver conformance test cases are described in Chapter 6

Finally, some important tables from the 3GPP specification for quick reference are quoted in the Appendix

The following abbreviations are used for R&S® products throughout the whole application note:

- ▶ R&S®CMW500 Radio Communication Tester is referred to as CMW
- ▶ R&S®CMX500 Radio Communication Tester is referred to as CMX
- ▶ R&S®CMSquares web based graphical user interface is referred to as CMSquares

In this application note, E-UTRA and LTE are synonymous terms.

The relevant test requirement and measurement result of this application note are based on a device under test (DUT) with EN-DC band combination of NR n78 and E-UTRA Band 1 under normal environmental test condition. Citations of the corresponding 3GPP specifications clauses in this application note are exclusively based on the capability of the used DUT. Other DUT with different UE capability can the applied 3GPP clause deviate.

The application note is written based on the current CMX implementation with composite software (CSW) version 6.60.22 and reflects the status quo of the test coverage. The features are subject to change.

It is assumed that the reader already has a deep understanding of the 5G NR standard as well as the testing aspects. If not, then please refer to the 5G NR eBook [2] for more detailed overview on the fundamentals, procedures, testing aspects of the 5G NR technology.

2 General Information

In this chapter, some general information with respect to different 5G NR FR1 deployment scenarios and 3GPP test specifications are given.

2.1 Frequency Range (FR1 vs. FR2)

3GPP specification [3] has defined 5G NR frequency range (FR) as listed in Table 2-1.

Operating Frequency Range Designation	Corresponding Frequency Range
FR1	410 MHz - 7125 MHz
FR2	24250 MHz – 52600 MHz

Table 2-1 NR frequency range [3]

Different operating frequency impacts the testing methodology. The conformance tests in FR2 (millimeter wave range) can only be performed in Over the Air (OTA) environment. Whereas FR1 conformance tests can still be performed under conventional conducted mode, i.e. with direct RF connection between the DUT and tester.

In this application note, conformance test cases in FR1 are addressed, i.e. in conducted test mode. If more details about the OTA testing are required, please refer to R&S OTA testing white paper [4].

The entire NR FR1 operating band is listed in Annex A.1. The allowance of the operating band is subject to the local authority and the support of UE capability. Some operating bands are defined both in E-UTRA and NR. The prefix "n" of the operating band indicates the NR band.

Furthermore, 3GPP defines also the test channel bandwidth (CBW) and the supported test subcarrier spacing (SCS) of each FR1 band which can be referred in Annex B.2 and B.4, respectively.

2.2 5G NR Non Standalone EN-DC Mode

5G NR can be operated with two different modes from high-level network topology perspective, namely, non-standalone (NSA) and standalone (SA) mode as shown in Fig. 2-1 and Fig. 2-2, respectively.

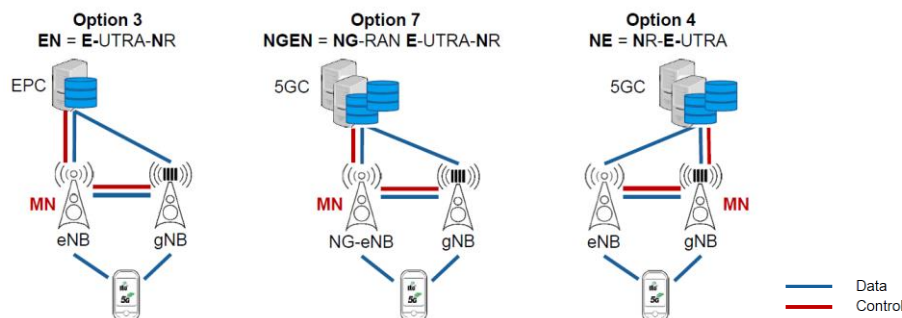

Fig. 2-1 5G NR Non-Standalone (NSA) modes

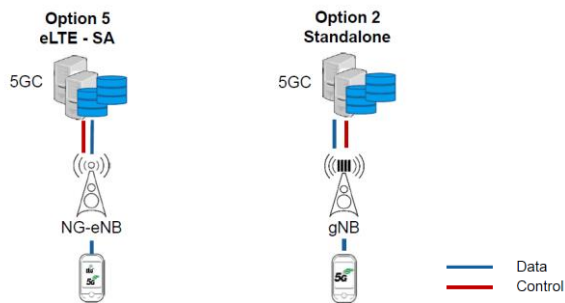

Fig. 2-2 5G NR Standalone (SA) modes

In SA mode, UE is connected to the 5GC (5G Core) network over LTE or NR RAT. Whereas NSA mode, besides NR RAT, it still relies on the assistance of the E-UTRA to transfer data or controlling information.

If we further break down the deployment scenarios in NSA mode, there are three operation modes defined by 3GPP, i.e. Option 3, 7 and 4 as shown in Fig. 2-1.

Option 3 is the 5G initial approach that allows fast deployment of the 5G service for network operators with minor modification to the existing 4G network. In this deployment option, radio access part consists of both LTE eNodeB (eNB) and 5G gNodeB (gNB). As illustrated in Fig. 2-3, it leverages the eNB and LTE core network (EPC) to anchor 5G NR using the dual connectivity (DC) feature where LTE acts as a master node (MN) or anchor carrier to carry control signaling and both LTE and NR are used for data traffic.

Therefore, option 3 is also called EN-DC mode where EN comes from the first alphabet of both E-UTRA and NR RAT. DC is the abbreviation of dual connectivity.

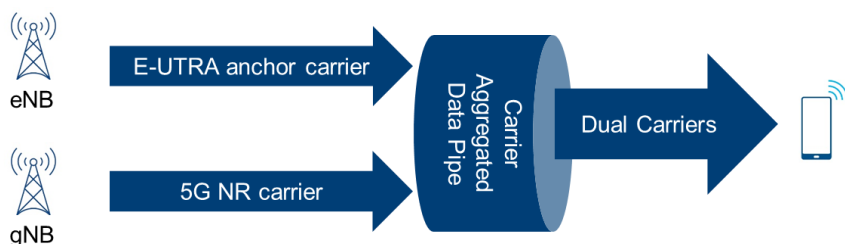

Fig. 2-3 5G NR EN-DC operation mode (Option 3)

In this application note, the described conformance test cases are all based on NSA EN-DC mode. SA mode, as well as option 7 and 4 deployment in NSA mode are out of the scope here.

In EN-DC mode, three aggregation modes are considered as shown in Fig. 2-4, i.e. inter-band, intra-band contiguous and intra-band non-contiguous. For information completeness purpose, details about the band configuration and bandwidth requirements of each aggregation mode are described in chapter 2.2.1, 2.2.2 and 2.2.3, respectively. However, this application note, we will be focusing only on the EN-DC inter-band mode.

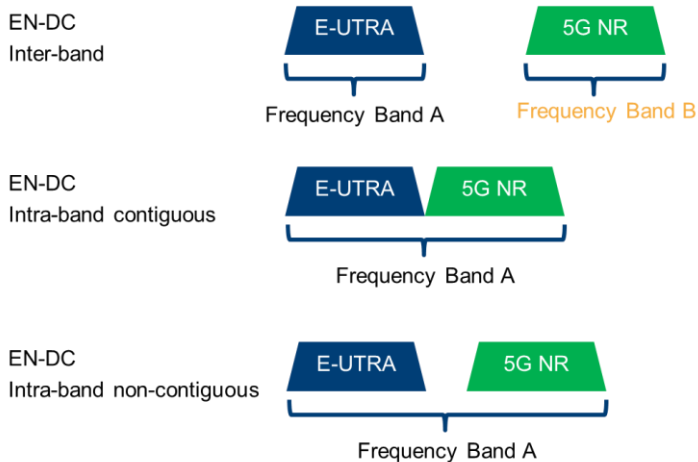

Fig. 2-4 5G NR EN-DC aggregation modes

2.2.1 NR EN-DC Inter-band

Complete definition of EN-DC inter-band combination with 2 up to 6 bands can be found in TS38.521-3 [1] clause 5.5B.4. For quick reference, inter-band EN-DC configuration consisting of only two bands within FR1 can be found in Annex.A.2 as well.

The inter-band EN-DC configuration contains information about the E-UTRA band and NR band combination, and its individual allowed bandwidth class.

EN-DC configuration	Uplink EN-DC configuration	Single UL allowed
...
DC_1A_n78A DC_1A_n78C	DC_1A_n78A	No
...
DC_66A_n78A	DC_66A_n78A	No

Table 2-2 Example of an inter-band EN-DC configurations within FR1 (two bands)

As an example shown in Table 2-2, the EN-DC configuration has the following naming convention

DC_<E-UTRA Band><E-UTRA Bandwidth Class>_<NR Band><NR Bandwidth Class>¹

Bandwidth class given in the EN-DC configuration defines the bandwidth of the aggregated transmission and maximum number of component carriers that are supported by the UE.

The E-UTRA bandwidth class is specified in TS36.521-1 [5], clause 5.4.2A as shown in Table 2-3 below

CA Bandwidth Class	Aggregated Transmission Bandwidth Configuration	Number of contiguous CC
A	$N_{RB,agg} \leq 100$	1
B	$25 < N_{RB,agg} \leq 100$	2
C	$100 < N_{RB,agg} \leq 200$	2
D	$200 < N_{RB,agg} \leq 300$	3
E	$300 < N_{RB,agg} \leq 400$	4
F	$400 < N_{RB,agg} \leq 500$	5
I	$700 < N_{RB,agg} \leq 800$	8

Table 2-3 E-UTRA CA bandwidth classes and corresponding nominal guard bands (TS36.521-1 [5], clause 5.4.2A)

¹ The italic font indicates that this is a placeholder.

The NR bandwidth class is defined in TS38.521-1 [6], clause 5.3A.5 as also shown in Table 2-4 below

NR CA bandwidth class	Aggregated channel bandwidth	Number of contiguous CC
A	$BW_{\text{Channel}} \leq BW_{\text{Channel,max}}$	1
B	$20 \text{ MHz} \leq BW_{\text{Channel,CA}} \leq 100 \text{ MHz}$	2
C	$100 \text{ MHz} < BW_{\text{Channel,CA}} \leq 2 \times BW_{\text{Channel,max}}$	2
D	$200 \text{ MHz} < BW_{\text{Channel,CA}} \leq 3 \times BW_{\text{Channel,max}}$	3
E	$300 \text{ MHz} < BW_{\text{Channel,CA}} \leq 4 \times BW_{\text{Channel,max}}$	4
G	$100 \text{ MHz} < BW_{\text{Channel,CA}} \leq 150 \text{ MHz}$	3
H	$150 \text{ MHz} < BW_{\text{Channel,CA}} \leq 200 \text{ MHz}$	4
I	$200 \text{ MHz} < BW_{\text{Channel,CA}} \leq 250 \text{ MHz}$	5
J	$250 \text{ MHz} < BW_{\text{Channel,CA}} \leq 300 \text{ MHz}$	6
K	$300 \text{ MHz} < BW_{\text{Channel,CA}} \leq 350 \text{ MHz}$	7
L	$350 \text{ MHz} < BW_{\text{Channel,CA}} \leq 400 \text{ MHz}$	8
NOTE: $BW_{\text{Channel,max}}$ is maximum channel bandwidth supported among all bands in a release		

Table 2-4 NR CA bandwidth classes (TS38.521-1 [6], clause 5.3A.5)

Example:

FR1 EN-DC inter-band configuration DC_1A_n78A reveals the dual connectivity consists of E-UTRA Band1 and NR Band n78. Both RATs support bandwidth class A, meaning both of them consist of one component carrier with maximum 100 MHz channel bandwidth for E-UTRA and maximum allowed channel bandwidth for NR band n78. The maximum allowed channel bandwidth for a NR band is defined in TS38.521-1 [6] clause 5.3.5. In our case, NR band n78 has maximum 100 MHz channel bandwidth.

2.2.2 NR EN-DC Intra-band Contiguous

For intra-band contiguous EN-DC, bandwidth class is specified in TS38.521-3 [1], clause 5.3B as also shown in Table 2-5. As of now, three bandwidth class combinations are specified. They are derived originally from the bandwidth class of E-UTRA and NR given in Table 2-3 and Table 2-4 in chapter 2.2.1.

Bandwidth class	Number of contiguous CC	
	E-UTRA	NR
AA	1	1
CA	2	1
DA	3	1

Table 2-5 Intra-band contiguous EN-DC bandwidth class (TS38.521-3 [1], clause 5.3B)

FR1 EN-DC Intra-band contiguous band channel configuration defined in 3GPP TS38.101-3 [7] clause 5.5B.2 can be referred in Annex A.3, Table 8-3 of this application note.

The configurations are defined by using naming convention

$DC_{(n)} \langle E\text{-UTRA/NR Band} \rangle \langle E\text{-UTRA Bandwidth Class} \rangle \langle NR Bandwidth Class \rangle^1$

The channel bandwidth combination sets of each defined channel configuration specified originally in TS38.521-3 [1], clause 5.3B.1.2 are listed in Annex A.3, Table 8-4 of this application note.

Example:

$DC_{(n)}41CA$ denotes Intra-band EN-DC in band 41 containing E-UTRA carriers (As shown in Table 2-3, E-UTRA bandwidth class C: 2 CCs with channel bandwidth between 100 and 200 resource blocks (RBs), i.e. maximum 40 MHz) and NR carrier (As shown in Table 2-4, NR bandwidth class A: 1 CC with maximum channel bandwidth 100 MHz) that results in 140 MHz maximum aggregated bandwidth in total.

2.2.3 NR EN-DC Intra-band Non-contiguous

FR1 EN-DC Intra-band non-contiguous band channel configurations are defined in TS38.101-3 [7] clause 5.5B.3 that can be also referred in Annex A.4, Table 8-5 in this application note.

The bandwidth class definition of E-UTRA and NR can be referred to Table 2-3 and Table 2-4 correspondingly.

The naming convention is as follows:

DC_<E-UTRA Band><E-UTRA Bandwidth Class>_<NR Band><NR Bandwidth Class>¹

Interpretation of the channel configuration from the previous chapters can be applied here as well.

Same as EN-DC intra-band contiguous case, each channel configuration has also defined channel bandwidth combination set. This can be found in Annex A.4, Table 8-6 for further reference.

2.3 3GPP Test Specifications

For 5G NR UE RF conformance test, several specifications are released by 3GPP. They are summarized in Table 2-6.

Test Specification	Scope
TS 38.521 - 1	RF Conformance (Tx & Rx) FR1 conducted tests
TS 38.521 - 2	RF Conformance (Tx & Rx) FR2 radiated tests
TS 38.521 - 3	RF Conformance (Tx & Rx) FR1/FR2 interworking (NSA) with radiated tests in FR2

[Table 2-6 Overview of 3GPP test specifications](#)

The main focus of this application note is the UE transmitter and receiver conformance testing in EN-DC operation mode (see chapter 2.2) in FR1 frequency band. Therefore, all the FR1 NSA EN-DC conformance test cases defined in TS38.521-3 [1] are our primitive reference. In case the test cases require LTE anchor agnostic approach (details see in chapter 3.6), the corresponding test case reference will then be redirected to TS38.521-1 [6] accordingly.

Besides the test specifications listed in Table 2-6, core specification TS 38.101-3 [7] for EN-DC mode is a reference where the UE minimum requirements are included. In contrast to the core specification, the test specification TS38.521-3 [1]/TS38.521-1 [6] relaxes the test requirement by additional test tolerance (TT) which is then defined in test requirements section of each test case in the specification.

3 Configure 5G NR EN-DC RF Test

Each conformance test case from the test specification has one or more test configuration tables that consist of two parts, namely, default conditions and the test parameters. An example is shown in Table 3-1.

Table 6.2B.1.3.4.1-1: Test configuration table

Default Conditions								
Test Environment as specified in TS 38.508-1 [6] clause 4.1				NC, TL/VL, TL/VH, TH/VL, TH/VH				
Test Frequencies as specified in TS 38.508-1 [6] clause 4.3.1 and TS 36.508 [6]				Low for E-UTRA CC1 and NR CC1, Mid for E-UTRA CC1 and NR CC1, High for E-UTRA CC1 and NR CC1				
Test EN-DC channel bandwidth as specified in TS 36.508 [6] clause 4.3.1 and TS 38.508-1 clause 4.3.1				5MHz for E-UTRA CC1 and Lowest for NR CC1, Highest for E-UTRA CC1 and Highest for NR CC1				
Test SCS for the NR cell as specified in TS 38.521-1 [8] Table 5.3.5-1				Lowest, Highest				
Test Parameters								
Test ID	Test Freq	E-UTRA BW	NR BW	Downlink Configuration	EN-DC Uplink Configuration			
					E-UTRA Cell		NR Cell	
					Modulation	RB allocation (NOTE 1)	Modulation (NOTE 3)	RB allocation (NOTE 2)
1	High	Default	Default	N/A	QPSK	1RB_Right	DFT-s-OFDM Pi/2 BPSK	Inner_1RB_Right
2	Low	Default	Default		QPSK	1RB_Left	DFT-s-OFDM Pi/2 BPSK	Inner_1RB_Left
3	Default	Default	Default		QPSK	Partial_Allocation	DFT-s-OFDM Pi/2 BPSK	Inner_Full
NOTE 1: The specific configuration of each RB allocation is defined in Table 6.1-1 in current specification.								
NOTE 2: The specific configuration of each RB allocation is defined in Table 6.1-1 in TS 38.521-1 [8].								
NOTE 3: DFT-s-OFDM Pi/2 BPSK test applies only for UEs which supports Pi/2 BPSK in NR FR1								

Table 3-1 Example of a test configuration table

The default conditions contain following requirements

1. Test environment (TS 38.508-1 [8] clause 4.1) covering normal and extreme high/extreme low conditions with respect to temperature and voltage
2. Test frequency and test channel bandwidth (NR in TS 38.508-1 [8] clause 4.3.1 and LTE in TS 36.508 [9] clause 4.3.1), see Chapter 3.1.2
3. Test subcarrier spacing (SCS) for NR cell (TS 38.521-1 [6] Table 5.3.5-1), see Chapter 3.1.3

Unless otherwise stated, test channel bandwidth shall be prioritized in the selecting of test points. That means, appropriate SCS shall be selected only after test channel bandwidth is determined.

For sake of simplicity, all the test cases described in this application note do not consider the environmental condition requirements. In other words, all the tests are conducted under normal room temperature and DUT is supplied with nominal voltage.

The test parameters of the test configuration defines the indexed test points. Each test point associated with a test ID contains:

1. Test frequency, test channel bandwidth. Unless otherwise explicitly specified, the default conditions need to be applied.
2. If specified, EN-DC downlink reference channel configurations, incl. modulation type and resource block (RB) allocations for E-UTRA, NR. See Chapter 3.2.
3. EN-DC uplink reference channel configurations, incl. modulation type and resource block (RB) allocations for both E-UTRA and NR. See Chapter 3.2.

There are normally numerous test points (test IDs) defined in the test configuration table of each test case. For conformance testing, all the test points have to be executed if they are applicable. In some cases, one test point may even consist of several test runs which should reflect all the combinations of the specified test conditions. For example, Test ID 1 in Table 3-1 contains 2 test runs (2 default test bandwidths per definition in the default condition part of the table). In Chapter 5 and 6 of this application note, we only choose one test point as an example to show the principle of the test configuration. The chosen example is the basis of the subsequent descriptions and the measurement results of the test case.

Besides test configuration table, other parameters have to be configured prior to starting the measurements as well, such as:

1. Uplink initial power, see Chapter 3.3.1

2. Downlink initial power, see Chapter 3.3.2

As per test specification, no fading and AWGN is added for the propagation condition.

3.1 Default Conditions

The default test conditions described in this chapter apply to both transmitter and receiver tests.

3.1.1 Test Environmental Conditions

All the tests described in the subsequent chapters are assumed to be conducted under normal room temperature. The test environment (extreme high/extreme low temperature and voltage) is out of the scope of this application note.

For getting more detailed information about the test environmental requirements, please refer to TS38.508-1 [8] clause 4.1.

3.1.2 Test Frequency and Test Channel Bandwidth

The low, mid and high test frequency range indicates the location of the carrier center frequency in the low, middle and high edge of the operating band, respectively. Based on the operating band of E-UTRA and NR, specifications given in Table 3-2 can be referred to determine the low, mid and high range of the test frequency. Furthermore, low/mid/high test channel bandwidth as per the requirement of the default conditions in each test case can also be referred in the specification indicated in Table 3-2.

RAT	Duplex Mode	3GPP Specification	Remark
E-UTRA	FDD	TS36.508 [9], Chapter 4.3.1.1.x, where placeholder x indicates the E-UTRA band	Specified test channel bandwidth (Low, Mid, High)
	TDD	TS36.508 [9], Chapter 4.3.1.2	Specified test channel bandwidth (Low, Mid, High)
NR	FDD/TDD	TS38.508-1 [8], Chapter 4.3.1.0A-4.3.1.0C	Specified test channel bandwidth (Low, Mid, High)
		TS38.508-1 [8], Chapter 4.3.1.1.x, where placeholder x indicates the NR band	Specified test frequencies (Low, Mid, High)

Table 3-2 Overview of 3GPP specifications for test frequency and test bandwidth for E-UTRA and NR

Example:

Table 3-3 highlights the E-UTRA Band 1 test frequency in mid-range with 20 MHz channel bandwidth defined in TS36.508 [9], clause 4.3.1.1.1 (FDD Band 1)

Test Frequency ID	Bandwidth [MHz]	N _{UL}	Frequency of Uplink [MHz]	N _{DL}	Frequency of Downlink [MHz]
Low Range	5	18025	1922.5	25	2112.5
	10	18050	1925	50	2115
	15	18075	1927.5	75	2117.5
	20	18100	1930	100	2120
Mid Range	5/10/15/20	18300	1950	300	2140
High Range	5	18575	1977.5	575	2167.5
	10	18550	1975	550	2165
	15	18525	1972.5	525	2162.5
	20	18500	1970	500	2160

Table 3-3 Test frequencies for E-UTRA channel bandwidth for operating band 1 (TS36.508 [9], Table 4.3.1.1.1-1)

Following E-UTRA settings need to be set in CMSquares to reflect the test frequency and channel bandwidth configurations

1. Duplex Mode
2. Frequency Band Indicator
3. Frequency Bandwidth / Downlink Resource Blocks
4. Range Choice
5. Frequency Bandwidth / Uplink Resource Blocks

Fig. 3-1 shows the configuration fields that correspond to above mentioned parameters

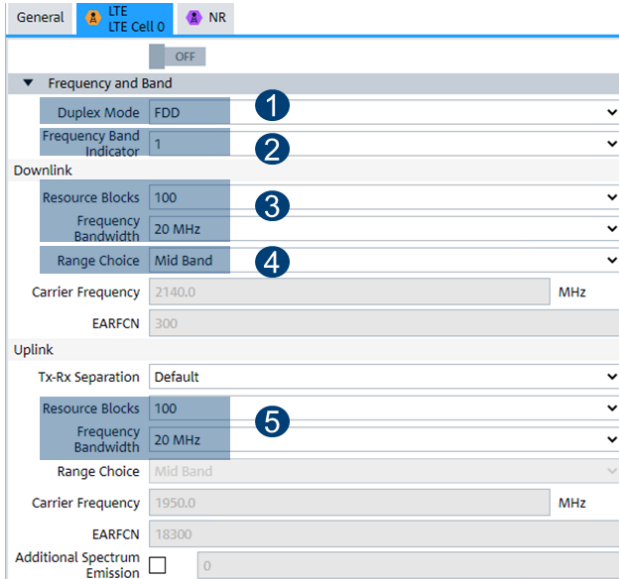

Fig. 3-1 Configuration of test frequency and bandwidth of E-UTRA in CMsquares

For 5G NR, test channel bandwidth is summarized in Annex B.2.

Example:

As shown in Table 3-4, mid test channel bandwidth for NR band n78 is 50 MHz

NR band / UE Mid Test Channel bandwidth	
NR Band	Mid [MHz]
n1	15, 20
...	...
n78	50
...	...
n86	203

Table 3-4 Definition of mid test channel bandwidths in 5G NR FR1 (TS38.508-1 [8], Table 4.3.1-1)

TS38.508-1 [8] clause 4.3.1.1.1 defines the low, mid and high range of the test frequencies for NR bands. The range is also linked to the location of the Point A, accordingly. E.g. the selected mid range test frequency has Point A location in the middle. Refer to the example below to understand the settings in CMsquares.

Example:

Test frequency of NR band n78 with 30 kHz SCS can be found in TS38.508-1 [8], Table 4.3.1.1.1.78-2. See also Annex B.3, Table 8-10.

The configuration of mid range of test frequency is highlighted in Table 3-5 below.

Table 4.3.1.1.1.78-2: Test frequencies for NR operating band n78, SCS 30 kHz and ΔF_{Raster} 30 kHz.

CBW [MHz]	carrier Bandwidth [PRBs]	Range		Carrier centre [MHz]	Carrier centre [ARFCN]	point A [MHz]	absolute Frequency Point A [ARFCN]	offsetTo Carrier [Carrier PRBs]	SS block SCS [kHz]	GSCN	absolute FrequencySSB [ARFCN]	k_{SSB}	Offset Carrier CORESET#0 [RBs] Note 2	CORE SET#0 Index (Offset [RBs]) Note 1	offsetTo PointA (SIB1) [PRBs] Note 1
100	273	Downlink & Uplink	Low	3350.01	623334	3300.87	620058	0	30	7711	620352	6	0	2 (2)	4
			Mid	3549.99	636666	3464.13	630942	102		7850	633696	18	0	2 (2)	208
			High	3750	650000	3519.42	634628	504		7989	647040	4	0	3 (3)	1014

Note 1: The CORESET#0 Index and the associated CORESET#0 Offset refers to Table 13-4 in TS 38.213 [22]. The value of CORESET#0 Index is signalled in controlResourceSetZero (pdcch-ConfigSIB1) in the MIB. The offsetToPointA IE is expressed in units of resource blocks assuming 15 kHz subcarrier spacing for FR1 and 60 kHz subcarrier spacing for FR2.

Note 2: The parameter Offset Carrier CORESET#0 specifies the offset from the lowest subcarrier of the carrier and the lowest subcarrier of CORESET#0. It corresponds to the parameter $\Delta F_{\text{OffsetCORESET-0-Carrier}}$ in Annex C expressed in number of common RBs.

Table 3-5 Example of test frequency determination of NR FR1

Following NR settings need to be set in CMsquares to reflect the test frequency and channel bandwidth configurations:

1. Frequency Range
2. Duplex Mode
3. Frequency Band Indicator
4. Subcarrier Spacing
5. Carrier Bandwidth
6. Point A Location

Fig. 3-2 shows the configuration fields that correspond to above mentioned parameters

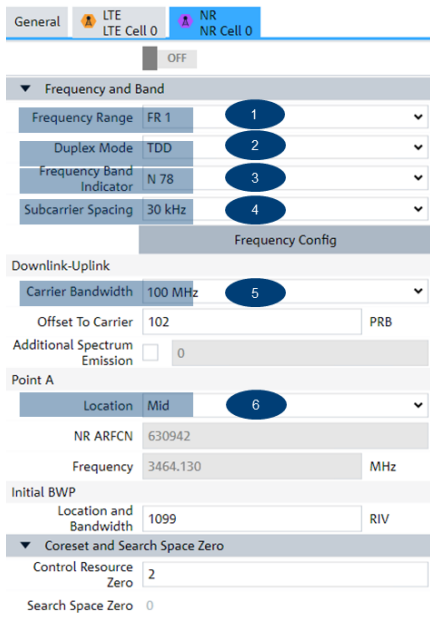

Fig. 3-2 Configuration of test frequency and bandwidth of NR

By simply setting the Point A location to Mid, other highlighted parameters in Table 3-5 such as carrier center frequency, Point A ARFCN, offset to carrier, K_{SSB} etc. are automatically configured in CMsquares.

3.1.3 Test SCS for NR Cell

The SCS support of each NR operating band with respect to the channel bandwidth can be referred in Annex.B.4, Table 8-11

Example:

NR band n78 operating with 100 MHz channel bandwidth has the lowest SCS 30 kHz, highest SCS 60 kHz. Setting for SCS in CMSquares can refer to Fig. 3-2.

3.2 Reference Measurement Channel (RMC)

Reference Measurement Channel (RMC) is defined by the 3GPP specification to fix the variable test parameters so that the tests can be conducted in a reliable and repeatable environment. Both E-UTRA and NR have RMC defined in downlink and uplink direction.

Uplink RMC is mainly for transmitter characteristic tests and for the receiver characteristic where the UL signal is relevant. For FR1 EN-DC tests, uplink RMCs as listed in Table 3-6 need to be applied. See Chapter 3.2.3 and 3.2.5 for details.

Unless otherwise stated, references to the specification for downlink RMCs of E-UTRA and NR are listed in Table 3-7. Depending on the different test purpose, appropriate DL RMC needs to be selected. See Chapter 3.2.4 and 3.2.6 for details.

RAT	Duplex Mode	3GPP Specification
E-UTRA	FDD	TS 36.521-1 [5], Annex A, clause A.2.2
	TDD	TS 36.521-1 [5], Annex A, clause A.2.3
NR	FDD	TS 38.521-1 [6], Annex A, clause A.2.2
	TDD	TS 38.521-1 [6], Annex A, clause A.2.3

Table 3-6 Overview of 3GPP specifications for E-UTRA and NR uplink reference measurement channel

RAT	Duplex Mode	3GPP Specification
E-UTRA	FDD	TS 36.521-1 [5], Annex A, clause A.3.2, A3.2A
	TDD	TS 36.521-1 [5], Annex A, clause A.3.2, A3.2A
NR	FDD	TS 38.521-1 [6], Annex A, clause A.3.2
	TDD	TS 38.521-1 [6], Annex A, clause A.3.3

Table 3-7 Overview of 3GPP specifications for E-UTRA and NR downlink reference measurement channel

3.2.1 Resource Allocation

The downlink and uplink RB allocations for E-UTRA and NR cell in each test case are specified in the test parameters part of the test configuration table. The look-up tables for the specified RB allocation can be found in Annex D.1, Table 8-13 and Annex D.2, Table 8-14 or Table 8-15 for E-UTRA and NR, respectively, where the starting point of the RB allocation and number of the allocated RB are determined.

Example:

Table 3-8 shows an example of test parameters of a test case containing RB allocations

Test Parameters								
Test ID	Test Freq	E-UTRA BW	NR BW	Downlink Configuration	EN-DC Uplink Configuration			
					E-UTRA Cell		NR Cell	
					Modulation	RB allocation (NOTE 1)	Modulation (NOTE 3)	RB allocation (NOTE 2)
1	High	Default	Default	N/A	QPSK	1RB_Right	DFT-s-OFDM PI/2 BPSK	Inner_1RB_Right

Table 3-8 Example of test parameters with RB allocation

By referring Annex D.1 Table 8-13, if E-UTRA operates with 20 MHz bandwidth, "1RB_Right" reveals 1@99 allocation, i.e. RB start position = 99 and the number of RB = 1.

By referring Annex D.2 Table 8-14, if NR operates with 100 MHz bandwidth, 30 kHz SCS, DFT-s-OFDM (with transform precoding), "Inner_1RB_Right" denotes the RB allocation as 1@271, i.e. RB start position = 271 and the number of RB = 1.

If the test case requires REFSSENS RB allocation for NR, then Annex D.2 Table 8-15 has to be applied.

3.2.2 Modulation

In each conformance test case, an RMC defines typically the configuration of the RB allocation and applied modulation type.

As listed in Table 3-9, NR physical channels support different modulation types, i.e. QPSK, 16QAM, 64QAM or 256QAM, including optional $\pi/2$ -BPSK modulation in case transform precoding DFT-s-OFDM in the uplink is enabled.

Direction	NR Physical Channel	Supported Modulation Type
Downlink	PBCH	QPSK
	PDCCH	QPSK
	PDSCH	QPSK, 16QAM, 64QAM or 256QAM
Uplink	PUCCH	CP-OFDM: BPSK (PUCCH format 1), QPSK (PUCCH format 1/2)
		DFT-OFDM: $\pi/2$ -BPSK (PUCCH format 3/4), QPSK (PUCCH format 3/4)
	PUSCH	CP-OFDM: QPSK, 16QAM, 64QAM or 256QAM
		DFT-s-OFDM: $\pi/2$ -BPSK, QPSK, 16QAM, 64QAM or 256QAM

Table 3-9 NR supported modulation types

Modulation coding scheme (MCS) defines the number of useful bits transmitted per transport block which in turn determines the transmission data rate. Each one is identified by a unique index in an associated MCS table, a so called MCS index.

MCS index together with MCS table determines the target code rate required by the RMC. These two parameters are configurable in CMSquares.

In our application here, the RMC configuration given by each test case in the test specification is in form of RB allocation and modulation type which has to be mapped to MCS index and MCS table on CMX. The way of mapping is explained in subsequent chapters 3.2.3, 3.2.4, 3.2.5 and 3.2.6.

3.2.3 NR Uplink RMC

First of all, the appropriate NR uplink RMC table from the 3GPP specification (see Table 3-7) needs to be mapped based on the following parameters

1. Duplex mode²
2. Channel bandwidth
3. SCS³
4. Uplink OFDM waveform⁴
5. Modulation type⁵
6. Allocated resource blocks

Example

The definition of a NR uplink RMC with configuration (TDD, CBW 100 MHz, SCS 30 kHz, using DFT-s-OFDM, PUSCH with QPSK modulation, 270 RBs) can be found in TS38.521-1 [6], clause A.2.3.2. The

² FDD or TDD

³ 15, 30 or 60 kHz

⁴ DFT-s-OFDM or CP-OFDM

⁵ Modulation type: $\pi/2$ -BPSK (only for DFT-s-OFDM), QPSK, 16QAM, 64QAM or 256QAM

related RMC configuration table is shown and highlighted in Table 3-10. The yellow marked parameter items need to be configured in CMSquares. The selection of the MCS table is determined by NOTE2 of the corresponding RMC table and depends on the type of the transform pre-coding. An overview of the MCS table associated with the table in TS38.214 [10] and transform pre-coding is given in Table 3-11.

In the example here, according to NOTE2 of the RMC configuration table, MCS index is based on the Table 6.1.4.1-1 defined in TS38.214 [10] and DFT-s-OFDM is used in the uplink transform pre-coding. By referring Table 3-11, 64QAM MCS table should be configured on CMSquares.

Table A.2.3.2-2: Reference Channels for DFT-s-OFDM QPSK for 30kHz SCS

Parameter	Channel bandwidth	Subcarrier Spacing	Allocated resource blocks	DFT-s-OFDM Symbols per slot (Note 1)	Modulation	MCS Index (Note 2)	Target Coding Rate	Payload size for slots 8, 9, 18 and 19	Transport block CRC	LDPC Base Graph	Number of code blocks per slot for slots 8, 9, 18 and 19 (Note 3)	Total number of bits per slot for slots 8, 9, 18 and 19	Total modulated symbols per slot for slots 8, 9, 18 and 19
Unit	MHz	kHz						Bits	Bits			Bits	
5-100	30	1	11	QPSK	2	1/6	48	16	2	1	264	132	
5	30	5	11	QPSK	2	1/6	256	16	2	1	1320	660	
5	30	10	11	QPSK	2	1/6	504	16	2	1	2640	1320	
10	30	12	11	QPSK	2	1/6	608	16	2	1	3168	1584	
10	30	24	11	QPSK	2	1/6	1192	16	2	1	6336	3168	
15	30	18	11	QPSK	2	1/6	928	16	2	1	4752	2376	
15	30	36	11	QPSK	2	1/6	1800	16	2	1	9504	4752	
20	30	25	11	QPSK	2	1/6	1256	16	2	1	6600	3300	
20	30	50	11	QPSK	2	1/6	2472	16	2	1	13200	6600	
25	30	32	11	QPSK	2	1/6	1608	16	2	1	8448	4224	
25	30	64	11	QPSK	2	1/6	3240	16	2	1	16896	8448	
30	30	36	11	QPSK	2	1/6	1800	16	2	1	9504	4752	
30	30	75	11	QPSK	2	1/6	3752	16	2	1	19800	9900	
40	30	50	11	QPSK	2	1/6	2472	16	2	1	13200	6600	
40	30	100	11	QPSK	2	1/6	5000	24	2	2	26400	13200	
50	30	64	11	QPSK	2	1/6	3240	16	2	1	16896	8448	
50	30	128	11	QPSK	2	1/6	6408	24	2	2	33792	16896	
60	30	81	11	QPSK	2	1/6	4040	24	2	2	21384	10692	
60	30	162	11	QPSK	2	1/6	8064	24	2	3	42768	21384	
80	30	108	11	QPSK	2	1/6	5384	24	2	2	28512	14256	
80	30	216	11	QPSK	2	1/6	10752	24	2	3	57024	28512	
90	30	120	11	QPSK	2	1/6	5896	24	2	2	31680	15840	
90	30	243	11	QPSK	2	1/6	12040	24	2	4	64152	32076	
100	30	135	11	QPSK	2	1/6	6864	24	2	2	35640	17820	
100	30	270	11	QPSK	2	1/6	13320	24	2	4	71280	35640	

Note 1: PUSCH mapping Type-A and single-symbol DM-RS configuration Type-1 with 2 additional DM-RS symbols, such that the DM-RS positions are set to symbols 2, 7, 11. DMRS is [TDM'ed] with PUSCH data.

Note 2: MCS Index is based on MCS table 6.1.4.1-1 defined in TS 38.214 [12].

Note 3: If more than one Code Block is present, an additional CRC sequence of L = 24 Bits is attached to each Code Block (otherwise L = 0 Bit)

Table 3-10 Example NR uplink RMC with configuration (TDD, CBW 100 MHz, SCS 30 kHz, DFT-s-OFDM, PUSCH with QPSK modulation, 270 RBs allocation)

Table in TS38.214	Type of Uplink Transform Precoding	MCS Table Name in CMSquares
Table 6.1.4.1-1	DFT-s-OFDM	64 QAM
Table 5.1.3.1-1	CP-OFDM	64 QAM
Table 5.1.3.1-2	Not relevant	256 QAM

Table 3-11 Mapping of MCS table vs. transform precoding and tables in TS38.214 [10]

To create NR uplink RMC as in the given example, the overall parameters need to be considered in CMSquares are⁶

1. Duplex mode (TDD)
2. SCS (30 kHz)
3. Channel bandwidth (100 MHz)
4. Uplink OFDM waveform (DFT-s-OFDM)⁷

⁶ The values in the bracket are given according to our example. The slot where the resource has to be allocated is defined in the RMC.

⁷ Optional, in our example here, DFT-s-OFDM is enabled.

5. MCS table (**64QAM**)⁸
6. MCS index (**2**)
7. RB numbers (**270**)

The settings in CMsquares are shown in Fig. 3-3.

NR Cell 0 > UE Slot Scheduling

Slot Index	0	1	2	3	4	5	6	7	7	8	9
	DL	DL	DL	DL	DL	DL	DL	DL	UL	UL	UL
Start RB	-	0	0	0	0	0	0	-	-	0	0
# RB	-	273	273	273	273	273	273	-	-	270	270
MCS	-	4	4	4	4	4	4	-	-	2	2
DCI Format	-	DCI 11	DCI 11	DCI 11	DCI 11	DCI 11	DCI 11	-	-	DCI 01	DCI 01
MIMO Scheme	-	SISO	SISO	SISO	SISO	SISO	SISO	-	-	SISO	SISO

Fig. 3-3 Setting of a NR uplink RMC in CMsquares

3.2.4 NR Downlink RMC

First of all, locate the NR downlink RMC in the 3GPP specification (see Table 3-7) based on the following parameters

1. Duplex mode⁹
2. Channel bandwidth
3. SCS¹⁰
4. Modulation type¹¹

⁸ MCS table name is determined based on the NOTE2 of the example RMC table (Table 6.1.4.1-1 in TS38.214) and DFT-s-OFDM. As shown in the relationship Table 3-11, 64QAM MCS table should be selected due to

⁹ FDD or TDD

¹⁰ 15, 30 or 60 kHz

¹¹ Modulation type: QPSK, 64QAM or 256QAM

Example

The definition of a NR downlink RMC (TDD, CBW 100 MHz, SCS 30 kHz, PDSCH with QPSK modulation) can be found in TS38.521-1 [6], clause A.3.3.2. It is now highlighted in Table 3-12 below. The marked parameter items need to be then configured in CMsquares. As we can see, the required MCS index and MCS table are specified directly in the RMC table.

Table A.3.3.2-2: Fixed reference channel for receiver requirements (SCS 30 kHz, TDD, QPSK 1/3)

Parameter	Unit	Value										
Channel bandwidth	MHz	5	10	15	20	25	30	40	50	60	80	100
Subcarrier spacing configuration μ		1	1	1	1	1	1	1	1	1	1	1
Allocated resource blocks		11	24	38	51	65	78	106	133	162	217	273
Subcarriers per resource block		12	12	12	12	12	12	12	12	12	12	12
Allocated slots per Frame		13	13	13	13	13	13	13	13	13	13	13
MCS Index		4	4	4	4	4	4	4	4	4	4	4
MCS Table for TBS determination		64QAM										
Modulation		QPSK	QPSK	QPSK	QPSK	QPSK	QPSK	QPSK	QPSK	QPSK	QPSK	QPSK
Target Coding Rate		1/3	1/3	1/3	1/3	1/3	1/3	1/3	1/3	1/3	1/3	1/3
Maximum number of HARQ transmissions		1	1	1	1	1	1	1	1	1	1	1
Information Bit Payload per Slot												
For Slots 0,1,2 and Slot i, if mod(i, 10) = {7,8,9} for i from {0,...,19}	Bits	N/A	N/A	N/A	N/A	N/A	N/A	N/A	N/A	N/A	N/A	N/A
For Slot i, if mod(i, 10) = {0,1,2,3,4,5,6} for i from {3,...,19}	Bits	736	1608	2472	3368	4224	4992	6912	8712	10504	14088	17928
Transport block CRC	Bits	16	16	16	16	24	24	24	24	24	24	24
LDPC base graph		2	2	2	2	1	1	1	1	1	1	1
Number of Code Blocks per Slot												
For Slots 0,1,2 and Slot i, if mod(i, 10) = {7,8,9} for i from {0,...,19}	CBs	N/A	N/A	N/A	N/A	N/A	N/A	N/A	N/A	N/A	N/A	N/A
For Slot i, if mod(i, 10) = {0,1,2,3,4,5,6} for i from {3,...,19}	CBs	1	1	1	1	1	1	1	2	2	2	3
Binary Channel Bits per Slot												
For Slots 0,1,2 and Slot i, if mod(i, 10) = {7,8,9} for i from {0,...,19}	Bits	N/A	N/A	N/A	N/A	N/A	N/A	N/A	N/A	N/A	N/A	N/A
For Slot i, if mod(i, 10) = {0,1,2,3,4,5,6} for i from {3,...,19}	Bits	2376	5184	8208	11016	14040	16848	22896	28728	34992	46872	58968
Max. Throughput averaged over 1 frame	Mbps	0.810	2.1.769	2.719	3.705	4.646	5.491	7.603	9.583	11.554	15.497	19.721
Note 1: Additional parameters are specified in Table A.3.1-1 and Table A.3.3.1-1. Note 2: If more than one Code Block is present, an additional CRC sequence of L = 24 Bits is attached to each Code Block (otherwise L = 0 Bit) Note 3: SS/PBCH block is transmitted in slot #0 of each frame. Note 4: Slot i is slot index per frame.												

Table 3-12 Example NR downlink RMC with configuration (TDD, CBW 100 MHz, SCS 30 kHz, PDSCH with QPSK modulation)

To create NR downlink RMC as in the given example, the overall parameters need to be configured in CMsquares are¹²

1. Duplex mode (**TDD**)
2. SCS (**30 kHz**)
3. Channel bandwidth (**100 MHz**)
4. MCS table (**64QAM**)
5. MCS index (**4**)
6. RB numbers (**273**)

The settings in CMsquares are shown in Fig. 3-4

QPSK (for measurements of the receiver characteristic and also apply for the modulated interferer used in test case 7.5, 7.6 and 7.8)

64QAM (for maximum input level test case 7.4, UE does not support PDSCH 256QAM)

256QAM (for maximum input level test case 7.4, UE support PDSCH 256QAM)

¹² The values in the bracket are given according to our example. The slot where the resource has to be allocated is defined in the RMC.

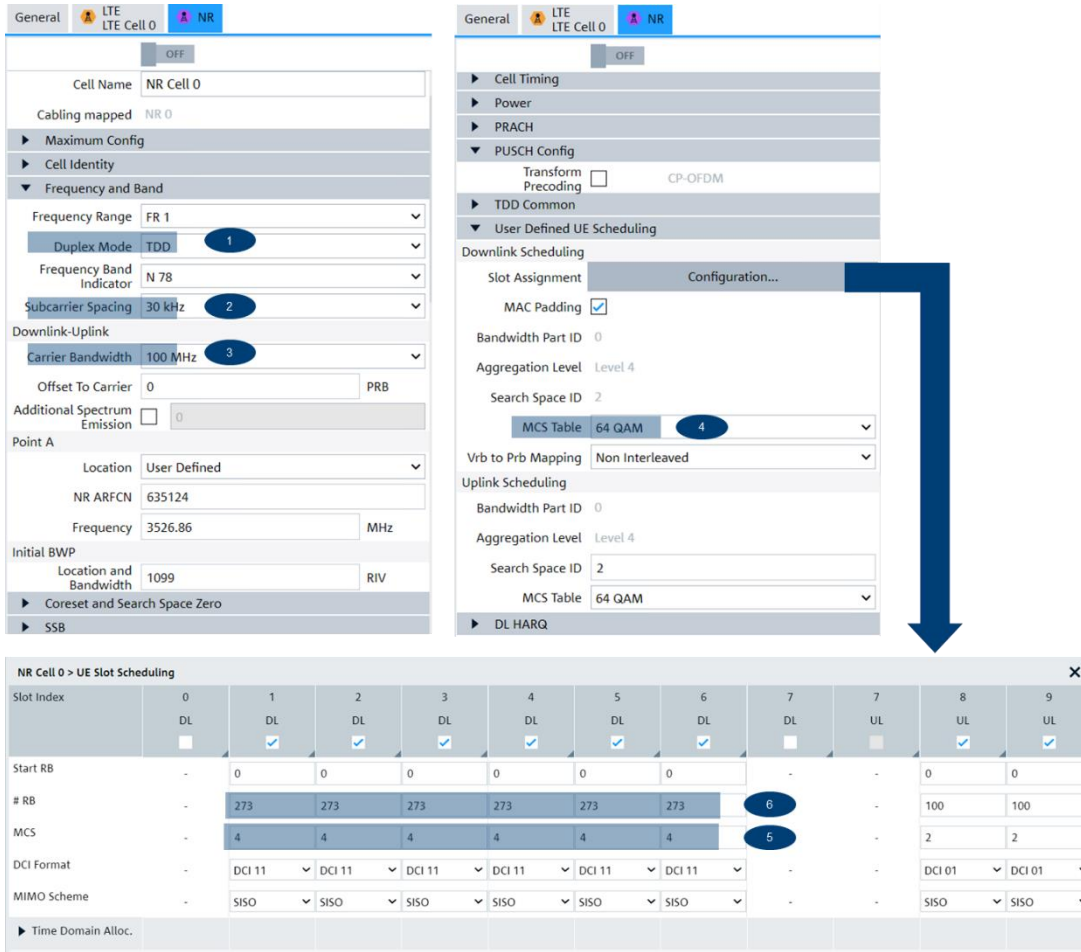

Fig. 3-4 Setting of a NR downlink RMC in CMSquares

3.2.5 E-UTRA Uplink RMC

Find appropriate E-UTRA uplink RMC out of the TS 36.521-1 [5] Annex A.2 at first based on the following parameters

1. Duplex mode¹³
2. Channel bandwidth¹⁴
3. Modulation type¹⁵
4. Allocated resource blocks¹⁶

Example

The definition of a E-UTRA uplink RMC (FDD, CBW 20 MHz, PUSCH with QPSK modulation, full 100 RBs) can be found in TS36.521-1 [5] clause A.2.2.1.1 The related RMC configuration is shown and highlighted in Table 3-13.

¹³ FDD or TDD

¹⁴ 1.4, 3, 5, 10, 15 or 20 MHz

¹⁵ QPSK, 16QAM, 64QAM or 256QAM

¹⁶ Full or partial allocation with respect to the channel bandwidth

Table A.2.2.1.1-1: Reference Channels for QPSK with full RB allocation

Parameter	Unit	Value					
		1.4	3	5	10	15	20
Channel bandwidth	MHz	1.4	3	5	10	15	20
Allocated resource blocks		6	15	25	50	75	100
DFT-OFDM Symbols per Sub-Frame		12	12	12	12	12	12
Modulation		QPSK	QPSK	QPSK	QPSK	QPSK	QPSK
Target Coding rate		1/3	1/3	1/3	1/3	1/5	1/6
Payload size	Bits	600	1544	2216	5160	4392	4584
Transport block CRC	Bits	24	24	24	24	24	24
Number of code blocks per Sub-Frame (Note 1)		1	1	1	1	1	1
Total number of bits per Sub-Frame (Note 1)	Bits	1728	4320	7200	14400	21600	28800
Total symbols per Sub-Frame		864	2160	3600	7200	10800	14400
UE Category		≥ 1	≥ 1	≥ 1	≥ 1	≥ 1	≥ 1

Note 1: If more than one Code Block is present, an additional CRC sequence of L = 24 Bits is attached to each Code Block (otherwise L = 0 Bit)

Table 3-13 Example E-UTRA uplink RMC with configuration (FDD, CBW 20 MHz, PUSCH with QPSK modulation, Full 100RB allocation)

To setup E-UTRA uplink RMC given in the example in CMsquares, following parameters need to be configured

1. Duplex mode (**FDD**)
2. Channel bandwidth (**20 MHz**)
3. RB numbers (**100**)
4. MCS index (**2**)

The settings in CMsquares are shown in Fig. 3-5



Fig. 3-5 Setting of a E-UTRA uplink RMC in CMsquares

How to actually map RMC definition Table 3-13 to the associated MCS index? This can be determined by one of the two methods described below.

Method 1:

Look-up method in 3 steps

1. Identify the payload size of the RMC. In the example shown above, the selected RMC (100 RB allocation) has payload size of 4584 bits.
2. By checking transport block size Table 7.1.7.2.1-1 in TS36.213 [11], 100 RBs and 4584 payload size corresponds to TBS index 2
3. Look up uplink MCS Table 8.6.1-1 in TS36.213 [11]. It indicates that TBS index 2 is mapped to MCS index 2.

This procedure is illustrated in Fig. 3-6

TS36.521, Table A.2.2.1.1-1 Reference Channels for QPSK with full RB allocation

Parameter	Unit	Value					
Channel bandwidth	MHz	1.4	3	5	10	15	20
Allocated resource blocks		6	15	25	50	75	100
DFT-OFDM Symbols per Sub-Frame		12	12	12	12	12	12
Modulation		QPSK	QPSK	QPSK	QPSK	QPSK	QPSK
Target Coding rate		1/3	1/3	1/3	1/3	1/5	1/6
Payload size	Bits	600	1544	2216	5160	4392	4584
Transport block CRC	Bits	24	24	24	24	24	24
Number of code blocks per Sub-Frame (Note 1)		1	1	1	1	1	1
Total number of bits per Sub-Frame (Note 1)	Bits	1728	4320	7200	14400	21600	28800
Total symbols per Sub-Frame		864	2160	3600	7200	10800	14400
UE Category		≥ 1	≥ 1	≥ 1	≥ 1	≥ 1	≥ 1

Note 1: If more than one Code Block is present, an additional CRC sequence of L = 24 Bits is attached to each Code Block (otherwise L = 0 Bit)

QPSK: $Q_m=2$

TS36.213, Table 7.1.7.2.1-1: Transport block size table

I_{TBS}	N_{RB}									
	91	92	93	94	95	96	97	98	99	100
0	2536	2536	2600	2600	2664	2664	2728	2728	2728	2792
1	3368	3368	3368	3496	3496	3496	3496	3624	3624	3624
2	4136	4136	4136	4264	4264	4264	4392	4392	4392	4584
3	5352	5352	5352	5544	5544	5544	5736	5736	5736	5736
4	6456	6456	6712	6712	6968	6968	6968	6968	6968	7224
5	7992	7992	8248	8248	8248	8504	8504	8760	8760	8760
6	9528	9528	9528	9912	9912	9912	10296	10296	10296	10296
7	11064	11448	11448	11448	11448	11832	11832	11832	12216	12216

TS36.213, Table 8.6.1-1: Modulation, TBS index and redundancy version table for PUSCH

MCS Index	Modulation Order	TBS Index	Redundancy Version
I_{MCS}	Q_m	I_{TBS}	ν_{MRS}
0	2	0	0
1	2	1	0
2	2	2	0
3	2	3	0
4	2	4	0
5	2	5	0
6	2	6	0
7	2	7	0
8	2	8	0
9	2	9	0
10	2	10	0

Fig. 3-6 Example of Determination of the MCS Index to its associated RMC

Method 2:

UE scheduling in CMSquares is implemented in such a way that by giving the MCS index, the expected TBS size and code rate are calculated automatically in conjunction with the applied modulation type. On the other hand, each RMC defined in the specification has an expected target code rate. Our task here is to figure out the appropriate MCS index so that the calculated code rate in the CMSquares matches the expected code rate given by the specification.

By adopting either method described above, the mapping of the MCS index and its correlated TBS index with respect to the number of the UL RB allocation and required modulation type is summarized in Table 3-14.

Modulation		UL RB Allocation												
		1	4	5	6	8	12	15	16	18	25	50	75	100
		Index												
QPSK	TBS	5	6	5	6	6	6	6	5	6	5	6	3	2
	MCS	5	6	5	6	6	6	6	5	6	5	6	3	2
16QAM	TBS	19	19	19	19	19	19	14	14	14	11	19	14	11
	MCS	20	20	20	20	20	20	15	15	15	12	20	15	12

Table 3-14 MCS index of E-UTRA UL RMC with respect to RB allocation and modulation type

According to Table 3-14, the MCS index 2 needs to be configured in order to create a RMC (FDD, CBW 20MHz, PUSCH with QPSK modulation, Full 100RB allocation as highlighted in Table 3-13).

3.2.6 E-UTRA Downlink RMC

In 5G NR EN-DC mode, E-UTRA servers as an anchor carrier. As listed in Table 3-15, there are few of the E-UTRA downlink RMC tables defined in TS36.521-1 [5]. The selection of the RMC table is based on the following criteria:

1. Test purpose
2. Duplex mode
3. Modulation type

Within an RMC table, a respective RMC configuration is defined according to the applied channel bandwidth configuration (or number of allocated RBs).

Duplex Mode	Test Purpose	RMC Table in TS36.521-1 [5] Annex A.3	Modulation Type	RB Allocation	Target Code Rate
FDD	for clause 7 Receiver characteristic tests, except 7.4 Maximum input level	Tables A.3.2-1	QPSK	Full	1/3
TDD	for clause 7 Receiver characteristic tests, except 7.4 Maximum input level	Tables A.3.2-2	QPSK	Full	1/3
FDD	for 7.4 Maximum input level	Tables A.3.2-3	64QAM	Full	3/4
TDD	for 7.4 Maximum input level	Tables A.3.2-4	64QAM	Full	3/4
FDD	for 7.4 Maximum input level	Tables A.3.2-5	256QAM	Full	4/5
TDD	for 7.4 Maximum input level	Tables A.3.2-6	256QAM	Full	4/5
FDD	for clause 6 transmitter tests	Tables A.3.2A-1	QPSK	Partial	1/3 ¹⁷
TDD	for clause 6 transmitter tests	Tables A.3.2A-2	QPSK	Partial	1/3 ¹⁷

Table 3-15 E-UTRA downlink RMC

Example

Referring to Table 3-15, if we test 7.4 maximum input level test in FDD mode with 20 MHz CBW and 64QAM modulation, then the RMC Tables A.3.2-3 should be selected with the highlighted column as RMC configuration as shown in Table 3-16¹⁸

Table A.3.2-3: Fixed Reference Channel for Maximum input level for UE Categories 3-8 (FDD)

Parameter	Unit	Value					
		1.4	3	5	10	15	20
Channel bandwidth	MHz	6	15	25	50	75	100
Allocated resource blocks		12	12	12	12	12	12
Subcarriers per resource block		8	9	9	9	9	9
Allocated subframes per Radio Frame		64QAM	64QAM	64QAM	64QAM	64QAM	64QAM
Modulation		3/4	3/4	3/4	3/4	3/4	3/4
Target Coding Rate		8	8	8	8	8	8
Number of HARQ Processes	Processes	1	1	1	1	1	1
Maximum number of HARQ transmissions							
Information Bit Payload per Sub-Frame							
For Sub-Frames 1,2,3,4,6,7,8,9	Bits	2984	8504	14112	30576	46888	61664
For Sub-Frame 5	Bits	n/a	n/a	n/a	n/a	n/a	n/a
For Sub-Frame 0	Bits	n/a	6456	12576	28336	45352	61664
Transport block CRC	Bits	24	24	24	24	24	24
Number of Code Blocks per Sub-Frame (Note 3)							
For Sub-Frames 1,2,3,4,6,7,8,9		1	2	3	5	8	11
For Sub-Frame 5		n/a	n/a	n/a	n/a	n/a	n/a
For Sub-Frame 0		n/a	2	3	5	8	11
Binary Channel Bits Per Sub-Frame							
For Sub-Frames 1,2,3,4,6,7,8,9	Bits	4104	11340	18900	41400	62100	82800
For Sub-Frame 5	Bits	n/a	n/a	n/a	n/a	n/a	n/a
For Sub-Frame 0	Bits	n/a	8820	16380	38880	59580	80280
Max. Throughput averaged over 1 frame	kbps	2387.2	7448.8	12547	27294	42046	55498
Note 1:	2 symbols allocated to PDCCH for 20 MHz, 15 MHz and 10 MHz channel BW. 3 symbols allocated to PDCCH for 5 MHz and 3 MHz. 4 symbols allocated to PDCCH for 1.4 MHz						
Note 2:	Reference signal, Synchronization signals and PBCH allocated as per TS 36.211 [8]						
Note 3:	If more than one Code Block is present, an additional CRC sequence of L = 24 Bits is attached to each Code Block (otherwise L = 0 Bit)						

Table 3-16 Example E-UTRA downlink RMC with configuration (FDD, CBW 20 MHz) for 7.4 maximum input level test purpose

¹⁷ To ensure constant transport block size in 1.4MHz, the code rate for subframes varies approx. within {1/8-1/3}

¹⁸ Attention: no resource allocation in subframe 5

In E-UTRA downlink, there are three MCS tables defined in the TS36.213 [11] in total, namely table 7.1.7.1-1 for max 64-QAM, table 7.1.7.1-1A for max 256-QAM and table 7.1.7.1-1B for max 1024-QAM. However, for 3GPP RF tests, only max 64-QAM MCS table (covers QPSK, 16QAM and 64QAM modulation type with MCS index from 0 to 28) or max 256-QAM MCS tables (covers 256QAM with MCS index from 20-27) are adopted.

Table 3-17 gives an overview over the MCS index and MCS table selections with respect to the modulation type, DL RB allocation (channel bandwidth) as per E-UTRA DL RMC configuration.

Modulation Type	MCS Table	Index	DL RB Allocation					
			6	15	25	50	75	100
			Channel Bandwidth (MHz) ²⁰					
			1.4	3	5	10	15	20
QPSK	64QAM	TBS	4	5	5	5	5	5
		MCS	4	5	5	5	5	5
64QAM	64QAM	TBS	21	23	23	24	25	24
		MCS	23	25	25	26	27	26
256QAM	256QAM	TBS	29	31	30	32	32	32
		MCS	23	25	24	26	26	26

Table 3-17 MCS index and MCS table of E-UTRA DL RMC with respect to RB allocation and modulation type

By referring Table 3-16 and Table 3-17, the RMC of the example shall have the following configurations

1. Duplex mode (**FDD**)
2. Channel bandwidth (**20 MHz**)
3. # PDCCH Symbols (**2 symbols**)²⁰
4. RB numbers (**100**)
5. MCS table (**64QAM**)
6. MCS index (**26**)

The settings in CMsquares are shown in Fig. 3-7

²⁰ The number of PDCCH symbols should be configured as stated in the NOTE1 of the RMC table, i.e. 2 symbols allocated to PDCCH for 20 MHz, 15 MHz and 10MHz channel BW. 3 symbols allocated to PDCCH for 5 MHz and 3 MHz. 4 symbols allocated to PDCCH for 1.4 MHz

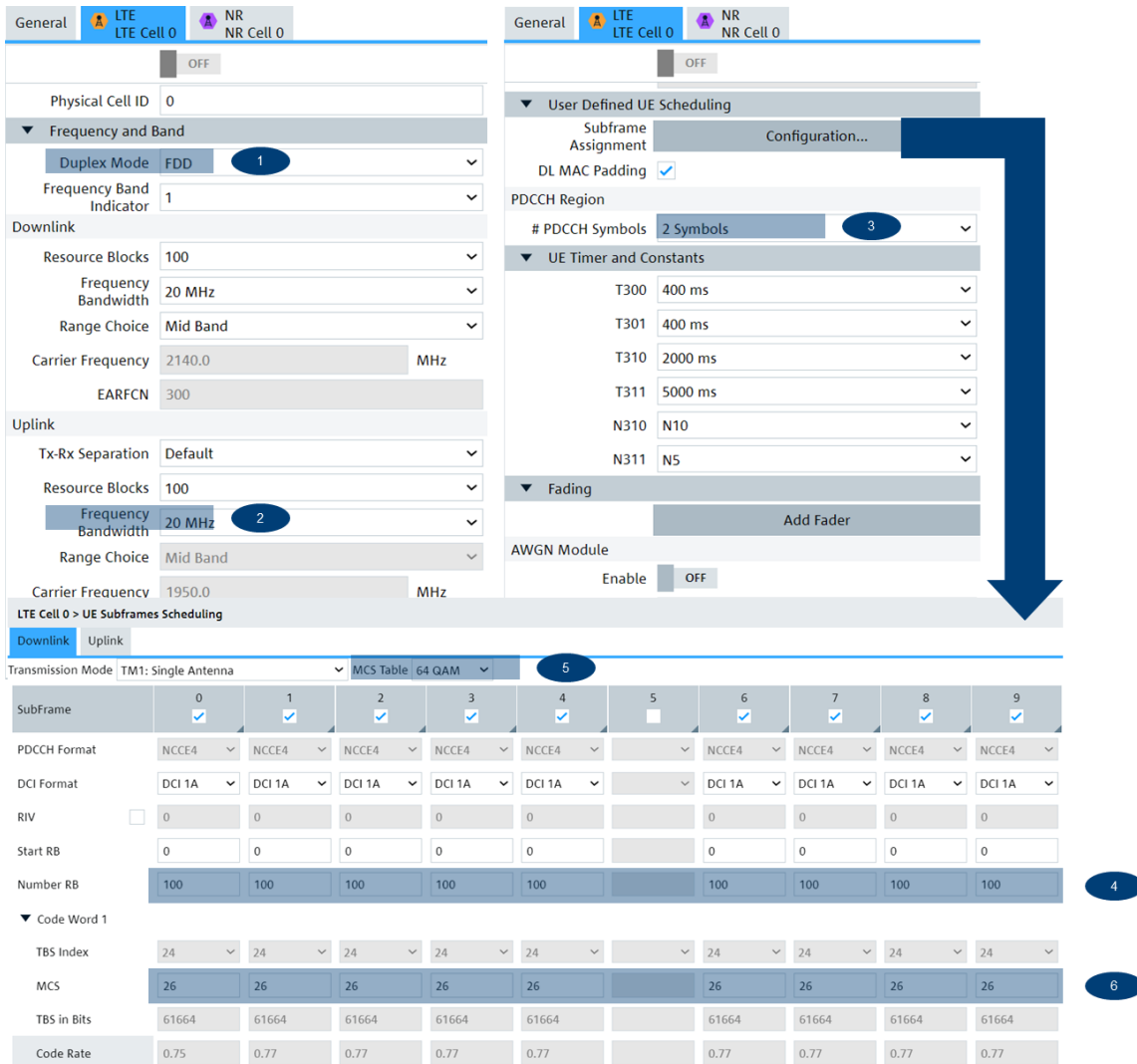

Fig. 3-7 Setting of a E-UTRA downlink RMC in CMSquares

3.3 Signal Power Level

3.3.1 Uplink Signal Level

The uplink signal level for E-UTRA and NR is specified by the 3GPP specification given in Table 3-18.

RAT	Duplex Mode	3GPP Specification
E-UTRA	FDD/TDD	TS 36.521-1 [5], Annex H
NR	FDD/TDD	TS 38.521-1 [6], Annex G

Table 3-18 Overview of 3GPP specifications for uplink signal level

Following rules are defined there. Uplink signal power level control is usually configured through transmit power control (TPC) commands specified explicitly in each test case and signaled to UE via RRC messages. Otherwise, the uplink signal power setting from the default RRC message defined in TS36.508 [9] (E-UTRA) and TS38.508 [8] (NR) with appropriate TPC has to be adopted to maintain the necessary power level in order to keep the call during the test.

Default E-UTRA uplink signal power level defined in TS36.508 [9], clause 4.6.3 is given in Table 3-19.

IE	Value
----	-------

Nominal PUCCH ²¹	-117 dBm
Nominal PUSCH ²²	-85 dBm
UE PUCCH ²¹	0
UE PUSCH ²²	0
Filter Coefficient ²²	fc4
Alpha ²²	0.8
p-Max	Test case dependent

Table 3-19 Default uplink power level for E-UTRA

Default NR uplink signal power level defined in TS38.508-1 [8], clause 4.6.3 is given in Table 3-20.

IE	Value
P0-NominalWithGrant ²⁴	-90 dBm
Alpha ²⁴	0.8
P0 ²⁴	0
p-Max	Test case dependent

Table 3-20 Default uplink power level for NR

So, in this application note, unless otherwise stated in the test case, the default uplink power level configurations from Table 3-19 and Table 3-20 are adopted.

3.3.2 Downlink Default Power Level

Table 3-21 summarizes the 3GPP specification references of downlink default power level for both E-UTRA and NR.

RAT	Duplex Mode	3GPP Specification	Remark
E-UTRA	FDD/TDD	TS 36.521-1 [5], Annex C.0	Table 3-22 in this application note
NR	FDD/TDD	TS 38.521-1 [6], Annex C.0	Table 3-23 in this application note

Table 3-21 Overview of applied 3GPP specification for downlink default power level

Unless otherwise specified in the test case, downlink default power level should be applied as given in Table 3-22 and Table 3-23 for E-UTRA and NR, respectively. In both tables, downlink power level is determined by parameter RS EPRE (cell specific reference signal energy per resource element) or channel BW power (maximum cell power). Both parameters are correlated with each other by Eqn. 3-1.

$$RS\ EPRE + 10 * \log_{10} \left(\frac{SCS}{15} \right) = Channel\ BW\ Power - 10 * \log_{10} (Number\ of\ RBs * 12)$$

Eqn. 3-1 Correlation of RS EPRE and Channel BW Power

	Unit	Channel bandwidth					
		1.4 MHz	3 MHz	5 MHz	10 MHz	15 MHz	20 MHz
Number of RBs		6	15	25	50	75	100
Channel BW Power	dBm	-66	-62	-60	-57	-55	-54
RS EPRE	dBm/15kHz	-85	-85	-85	-85	-85	-85

Note 1: The channel bandwidth powers and RB allocations are informative, based on -85dBm/15kHz RS_EPRES, then scaled according to the number of RBs and rounded to the nearest integer dBm value. Full RE allocation with no boost or deboost is assumed in this calculation, but allocation may vary during setup.

Note 2: The power level is specified at each UE Rx antenna.

Table 3-22 Default downlink power level for E-UTRA (TS36.521-1 [5], Table C.0-1)

²¹ Parameters used for the E-UTRA PUCCH power control. Details can be referred to TS36.213 [11], clause 5.1.2.1

²² Parameters used for the E-UTRA PUSCH power control. Details can be referred to TS36.213 [11], clause 5.1.1.1

²⁴ Parameters used for the NR PUSCH power control. Details can be referred to TS38.213 [16], clause 7.1

As given in Table 3-22, RS EPRE is fixed independent of number of allocated RBs. Whereas the channel BW power varies which depends on the allocated RBs (or channel bandwidth). Therefore, it is simpler to configure constant RS EPRE as downlink power level for E-UTRA.

Fig. 3-8 is a snapshot of E-UTRA downlink power level settings in CMsquares

1. Frequency Bandwidth
2. RS EPRE (-85 dBm/15kHz)

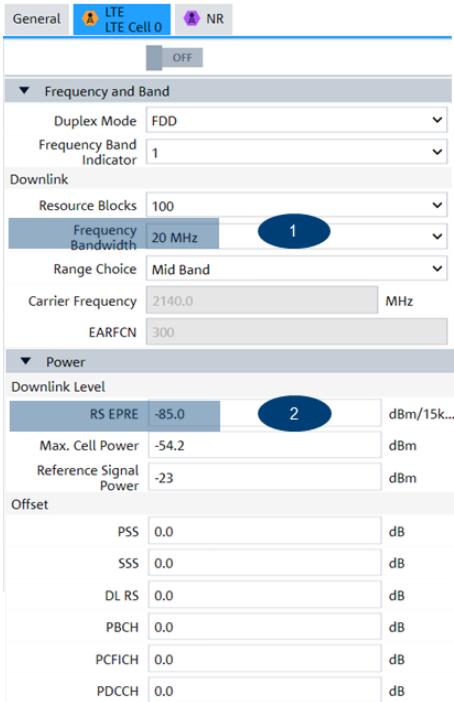

Fig. 3-8 Default E-UTRA downlink power level

Default downlink power levels for NR are listed in Table 3-23.

SCS (kHz)		Unit	Channel bandwidth											
			5 MHz	10 MHz	15 MHz	20 MHz	25 MHz	30 MHz	40 MHz	50 MHz	60MHz	80 MHz	90 MHz	100 MHz
15	Number of RBs		25	52	79	106	133	160	216	270	N/A	N/A	N/A	N/A
	Channel BW power	dBm	-60	-57	-55	-54	-53	-52	-51	-50	N/A	N/A	N/A	N/A
30	Number of RBs		11	24	38	51	65	78	106	133	162	217	245	273
	Channel BW power	dBm	-61	-57	-55	-54	-53	-52	-51	-50	-49	-48	-47	-47
60	Number of RBs		N/A	11	18	24	31	38	51	65	79	107	121	135
	Channel BW power	dBm	N/A	-58	-56	-54	-53	-52	-51	-50	-49	-48	-47	-47
	RS EPRE	dBm/15kHz	-85	-85	-85	-85	-85	-85	-85	-85	-85	-85	-85	-85
Note 1:		The channel bandwidth powers are informative, based on -85dBm/15kHz SS/PBCH SSS EPRE, then scaled according to the number of RBs and rounded to the nearest integer dBm value. Full RE allocation with no boost or deboost is assumed.												
Note 2:		The power level is specified at each UE Rx antenna.												
Note 3:		DL level is applied for any of the Subcarrier Spacing configuration () with the same power spectrum density of -85dBm/15kHz.												

Table 3-23 Default downlink power level for NR (TS38.521-1 [6], Table C.0-1)

In contrast to E-UTRA, 5G NR has variable SCS, therefore RS EPRE is not fixed any more. Be noted that the RS EPRE is given in the specification as -85 dBm/15 kHz depending on the SCS of the SSB. If SSB has 30 kHz SCS, then the default RS EPRE has to be converted accordingly, i.e. -82 dBm, same applies to 60 kHz SCS. The mapping between RS EPRE and SCS is listed in Table 3-24.

FR1 SCS	RS EPRE (dBm)
15	-85
30	-82
60	-79

Table 3-24 NR default downlink power level conversion based on SCS

So, there are two equivalent ways for 5G NR to configure the downlink power level, either the SSB EPRE according to Table 3-24 or total cell power that corresponds to the defined channel BW power in Table 3-23. Both parameters are linked with each other. Change of one parameter will cause the adaptation of the other parameter, accordingly.

Fig. 3-9 is the snapshot showing the two alternative ways to configure the downlink power level in CMsquares.

1. Subcarrier Spacing
2. Carrier Bandwidth
3. SSB EPRE or Total Cell Power

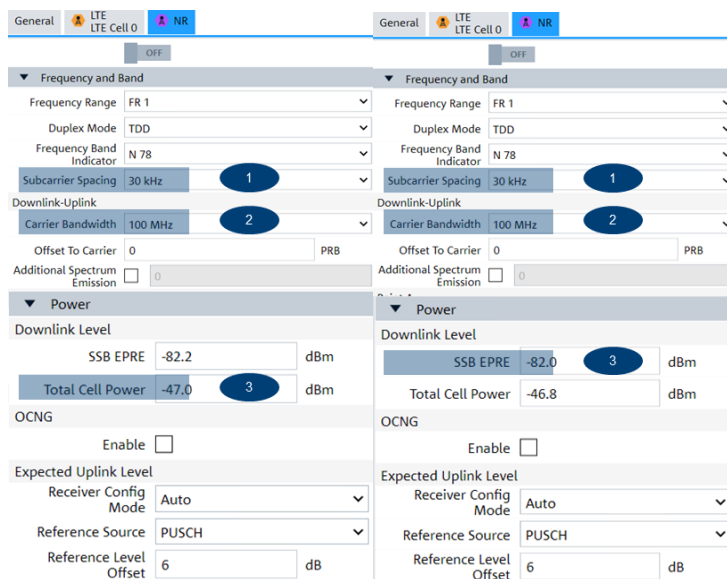

Fig. 3-9 Default NR downlink power level (two alternative ways)

3.4 Downlink PDSCH and PDCCH Configuration

For FR1 EN-DC transmitter tests, PDSCH and PDCCH configuration needs to follow the specification given in Table 3-25.

For ease of use, there is no need for the user to configure additionally on CMX. The default settings of CMX fulfill already the requirements normally.

RAT	Duplex Mode	3GPP Specification	Remark
E-UTRA	FDD	TS 36.521-1 [5], Annex C.2, Table C.2-2	
	TDD	TS 36.521-1 [5], Annex C.2, Table C.2-3	
NR	FDD/TDD	TS 38.521-1 [6], Annex A.3.1, Table A.3.1-1 TS 38.521-1 [6], Annex A.3.2.1, Table A.3.2.1-1	

		TS 38.521-1 [6] , Annex C.2, Table C.2-2	
	TDD	TS 38.521-1 [6] , Annex C.2, clause C.2.3	TDD UL-DL pattern for SCS 15 kHz
		TS 38.521-1 [6] , Annex C.2, clause C.2.4	TDD UL-DL pattern for SCS 30 kHz

Table 3-25 Overview of 3GPP specifications for downlink PDSCH and PDCCH configuration

3.5 Propagation Condition

As defined in the 3GPP specification (see Table 3-26), no fading and AWGN are required for the RF conformance tests.

Propagation condition with fading and AWGN is considered by the performance tests which is however not the focus of this application note.

RAT	3GPP Specification	Remark
E-UTRA	TS36.521-1 [5], Annex B.0	No Fading and AWGN
NR	TS38.521-1 [6], Annex B.0	No Fading and AWGN

Table 3-26 Overview of 3GPP specifications for propagation condition

3.6 LTE Anchor Agnostic Approach for EN-DC FR1 Tests

LTE anchor-agnostic approach is considered as measurements on the NR carrier under conditions where the LTE anchor resources do not interfere with NR operation. The configuration defined in this chapter ensures the establishment of such conditions.

Table 3-27 outlines the EN-DC test cases requiring LTE anchor agnostic approach in this application note. It will be explicitly mentioned in each test case in the subsequent chapter 5 and 6 if LTE anchor agnostic approach is desired.

Test Case Number	Description	Remark
6.2B.2.3	UE Maximum Output power reduction for inter-band EN-DC within FR1	
6.3B.1.3	Minimum output power for inter-band EN-DC within FR1	
6.3B.3.3	Tx ON/OFF time mask for inter-band EN-DC within FR1	
6.4B.1.3	Frequency error for Inter-band EN-DC within FR1	
6.4B.2.3.1	Error Vector Magnitude for inter-band EN-DC within FR1	
6.4B.2.3.2	Carrier Leakage for inter-band EN-DC within FR1	
6.4B.2.3.3	In-band Emissions for inter-band EN-DC within FR1	
6.4B.2.3.4	EVM Equalizer Flatness for inter-band EN-DC within FR1	
6.5B.1.3	Occupied bandwidth for Inter-Band EN-DC within FR1	
6.5B.2.3.1	Spectrum emissions mask for Inter-band EN-DC within FR1	
6.5B.2.3.3	Adjacent Channel Leakage Ratio for inter-band EN-DC within FR1	
7.3B.2.3	Reference sensitivity for Inter-band EN-DC within FR1 (2 CCs)	Apply to EN-DC combination without exception
7.4B.3	Maximum Input Level for Inter-band EN-DC within FR1	

Table 3-27 Test cases require LTE anchor agnostic approach

The configuration of the LTE anchor is defined in TS38.521-3 [1] clause 4.6, Table 4.6-1, 4.6-2, 4.6-3, 4.6-4 and 4.6-5.

Following parameters with the values in the bracket need to be set for the LTE cell to meet the LTE anchor agnostic approach requirement.

Test frequency and bandwidth settings

1. Duplex Mode (FDD or TDD, UE capability dependent)
2. Frequency Band (LTE band under test, UE capability dependent)

3. Resource Blocks or Frequency Bandwidth (**25 RBs or 5 MHz**)
4. Range Choice (**Mid**)

The following power level relevant parameters are taken from TS36.508 [9] clause 4.6.3:

5. RS EPRE (**-85 dBm**)
6. Reference Signal Power (**18 dBm**)
7. Nominal PUCCH (**-117**)
8. Nominal PUSCH (**-85**)
9. UE PUCCH (**0**)
10. UE PUSCH (**0**)
11. Filter Coefficient (**4**)
12. Alpha (**0.8**)
13. TPC (**keep**)

Fig. 3-10 shows the initial parameter settings in CMsquares.



Fig. 3-10 LTE anchor agnostic approach settings in CMsquares

After the EN-DC connection is established, UE can be restricted by configuring 0 RB allocation in both DL and UL direction in LTE part. This can be achieved as shown in Fig. 3-11.

General LTE Cell 0 NR NR Cell 0

User Defined UE Scheduling
Subframe Assignment Configuration...

Enter user defined UE scheduling

Downlink Uplink

Transmission Mode TM1: Single Antenna MCS Table 64 QAM

Subframe 0 1 2 3 4 5 6 7 8 9

PDCCH Format NCCE4 NCCE4 NCCE4 NCCE4 NCCE4 NCCE4 NCCE4 NCCE4 NCCE4 NCCE4

DCI Format DCI 0 DCI 0 DCI 0 DCI 0 DCI 0 DCI 0 DCI 0 DCI 0 DCI 0 DCI 0

RIV 0 0 0 0 0 0 0 0 0 0

Start RB 0 0 0 0 0 0 0 0 0 0

Number RB 6 6 6 6 6 6 6 6 6 6

Code Word 1

TBS Index 5 5 5 5 5 5 5 5 5 5

MCS 5 5 5 5 5 5 5 5 5 5

TBS in Bits 504 504 504 504 504 504 504 504 504 504

Code Rate 0.31 0.31 0.31 0.31 0.31 0.31 0.31 0.31 0.31 0.31

Apply Apply and Close Cancel

1

2 Deselect all subframes to disable DL resource allocation

3 Deselect all subframes to disable UL resource allocation

4 Apply the changes and close the window

Fig. 3-11 Disable downlink and uplink resource allocation

1. Go to "User Defined UE Scheduling" section of LTE configuration, select "Configuration...",
2. Disable the resource allocation by deselecting the check boxes of each subframe in downlink
3. Disable the resource allocation for all subframes in uplink
4. Pressing "Active and Close" button to confirm the changes and exit the window.

4 Preparation of Test

In this chapter, brief information about the CMX setup and basic operations of the CMsquares are given.

4.1 Architecture

For RF parametric tests according to TS38.521-3 [1], CMX minimum footprint setup (one CMW and one CMX) or extended setup can be adopted. In Fig. 4-1, it shows an exemplary extended setup (two CMWs and one CMX). Up to four CMWs can be supported by the extended setup.

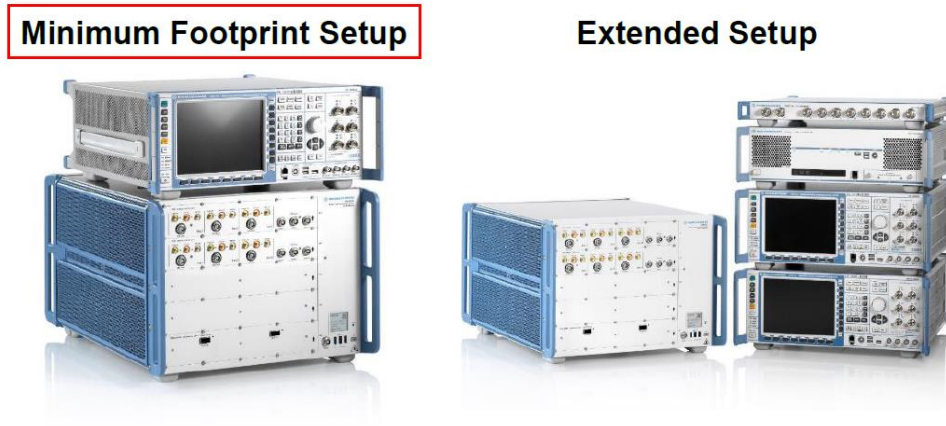

Fig. 4-1 CMX Mini Setup vs. Extended Setup

The system cabling of the setup and corresponding hardware requirements can be found in [12] or refer to [13].

In chapter 5 and 6 of this application note, the described test cases are conducted on CMX minimum footprint setup.

4.2 Hardware Requirement

System cabling of the setup and corresponding hardware requirements can be found in [12] or [13].

4.3 Software Requirement

CMX software is distributed in a form of composite software (CSW) via R&S installation manager (IM). For more details, refer to installation instruction in [12].

4.4 General Operations in CMsquares

CMsquares is a web based graphic user interface (GUI) of the CMX that allows the user to operate the equipment either remotely from a control PC or locally on the CMX.

Local operation

On CMX locally, simply launch a Web browser, e.g Chrome, and in address field enter "localhost:5555" to access the CMSquares

Remote operation

As prerequisite, CMX is reachable from remote control PC. This can be checked by pinging the IP address of the CMX from remote control PC.

On remote control PC, launch a Web browser, and enter either domain name "cmw50050-<serial number of the CMX>:5555", e.g. cmw50050-157043:5555 or <IP address of your CMX>:5555 in the browser's address field. In Fig. 4-2, it shows the access of CMSquares by giving the domain name in the browser.

In both local and remote access case, the browser opens the CMSquares main window as shown in Fig. 4-2. Each function area in CMSquares is called a Square, e.g. Test environment square.

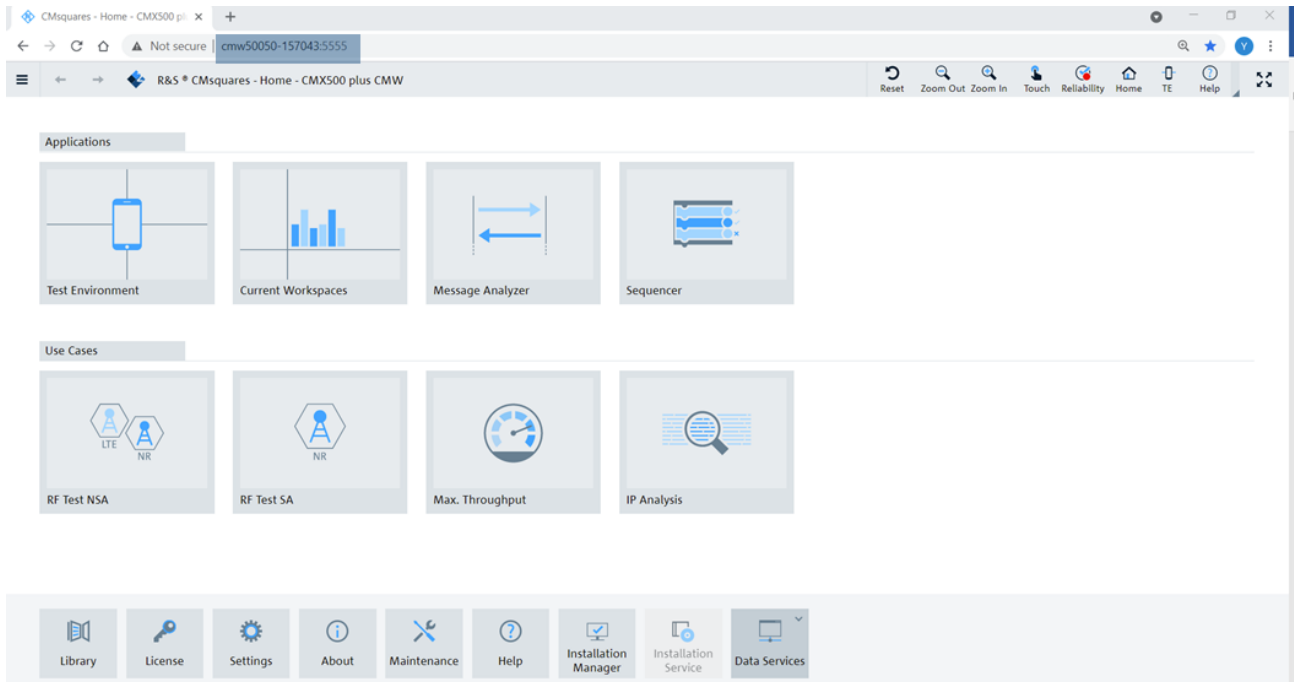

Fig. 4-2 CMSquares main window

"Test Environment" square allows the user to setup the cells and perform the measurements.

The GUI layout of the "Test environment" square is presented in Fig. 4-3.

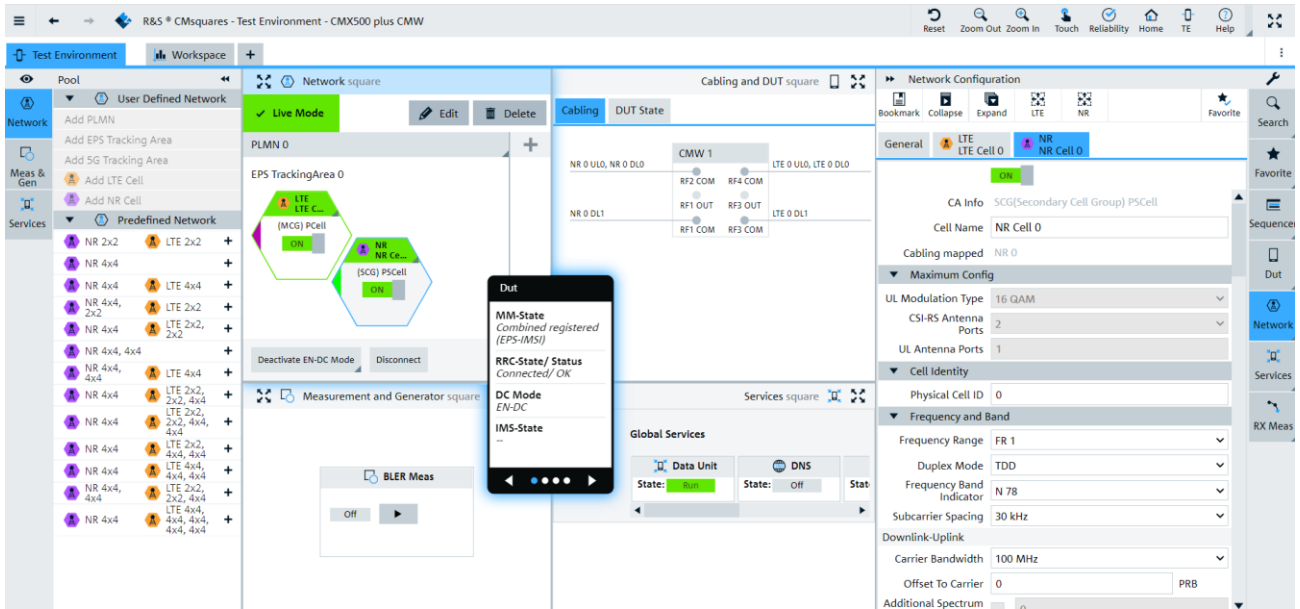

Fig. 4-3 CMsquares test environment square

Further information about how to operate the CMsquares, please refer to CMX user manual [13]

LTE and NR test personalities are included in test environment square of CMsquares. The parameter configurations of each personality are documented in greater details in the CMX signaling application user manual [14].

4.4.1 LTE/NR Cell Setup and EN-DC Mode Activation

For performing the RF conformance tests according to [1], the DUT has to be activated in EN-DC mode. This is done by following steps on CMX as shown in Fig. 4-4.

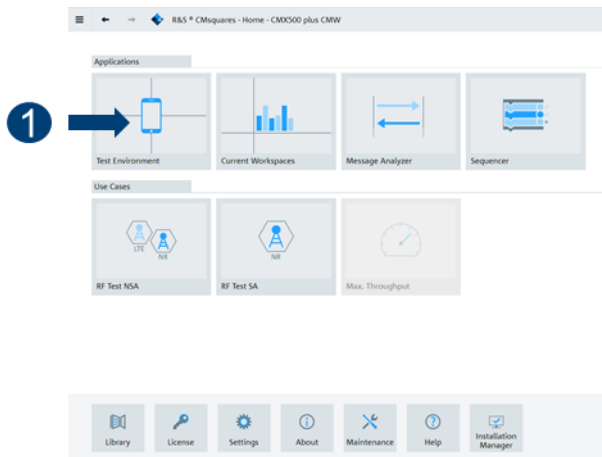

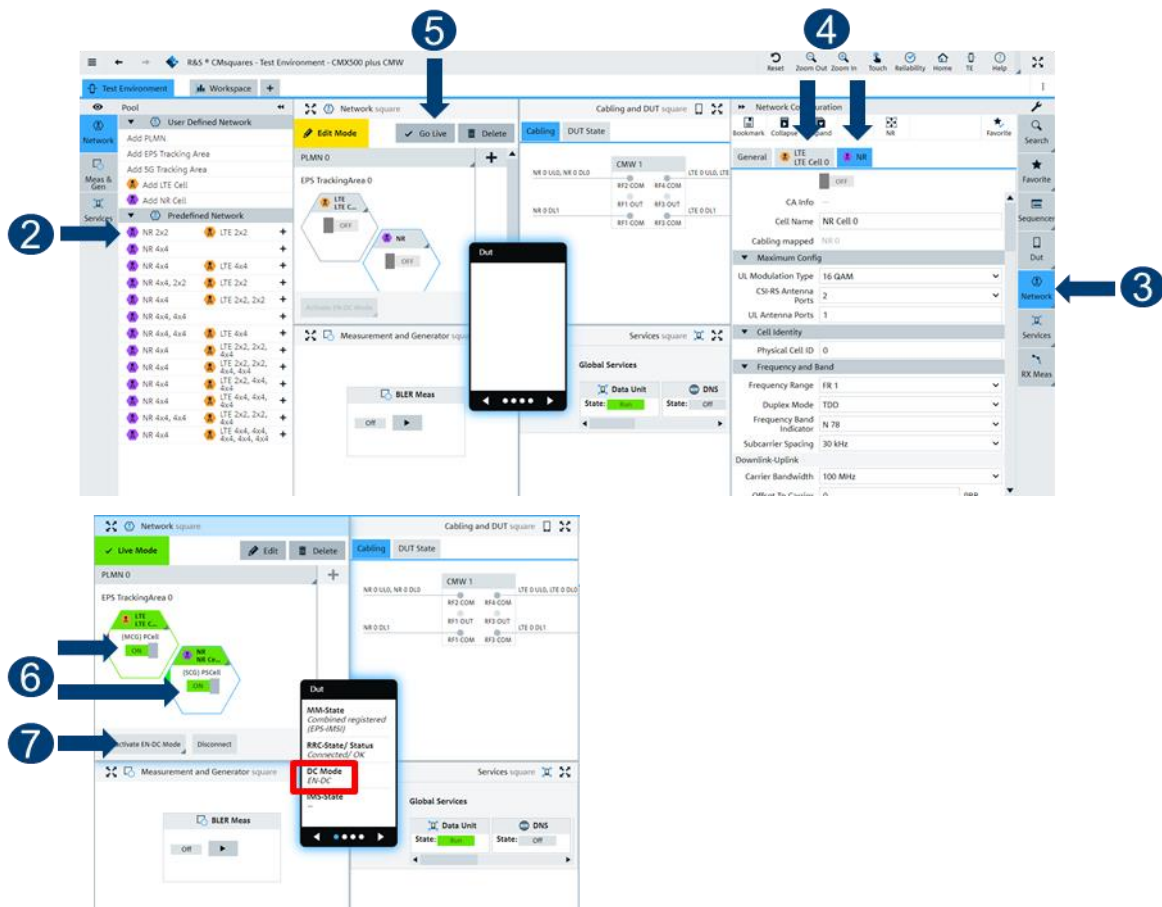

Fig. 4-4 Start CMsquares and activate EN-DC mode

1. In CMsquares main window, select "Test Environment" square
2. Choose Predefined Network "NR 2x2 LTE 2x2"
3. Select "Network"
4. Configure both NR and LTE cell (for cell parameter setting details, please see in section "Cell Parameter Settings" of each test case described in Chapter 5 and 6)
5. Click "Go Live"
6. Turn on the LTE and NR cell. Wait until both LTE and NR cell are ready (status in green), then switch on the DUT with inserted test SIM card from R&S
7. After DUT is registered to LTE cell successfully, click on "Activate EN-DC mode". DUT is now expected to enter the EN-DC mode. This can be observed by checking DUT's DC mode in CMsquares which should be now showing 'EN-DC' (see highlighted in Fig. 4-4)

4.4.2 LTE/NR Tx Measurement

As precondition of performing Tx measurement, DUT should be activated in EN-DC mode. Otherwise, follow the procedure in chapter 4.4.1 to activate the EN-DC mode.

To start the measurements in LTE or NR, e.g. Tx measurement, go through following steps on CMX as indicated in Fig. 4-5.

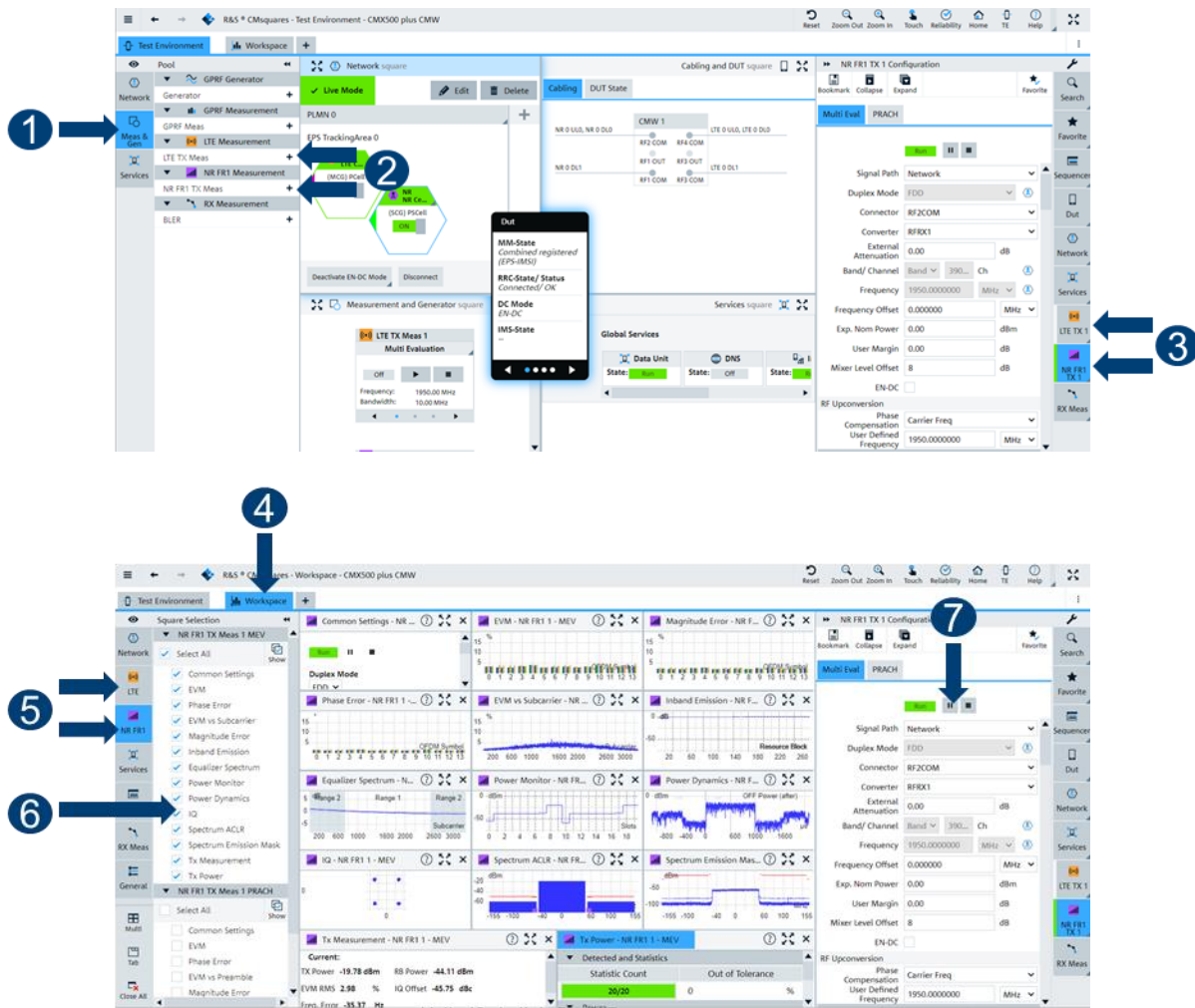



Fig. 4-5 Enable and start LTE and NR multi-evaluation measurements²⁵

1. Go to "Meas & Gen" in "Test Environment" square
2. Create the LTE and/or NR Measurement instance by clicking on "+" sign
3. Go to "LTE", "NR" configuration to config the multi-evaluation measurements²⁵ (for configuration details, please see in section "Multi-Evaluation Measurement Settings" of each test case described in Chapter 5)
4. Click on "Workspace"
5. Click on "LTE" or "NR" to open the selection list of the measurements (All available LTE and NR Tx measurements are shown in Fig. 4-6)
6. Depending on the test case requirement, activate the checkbox to select measurement item in question.
7. Press  button to start the measurement. The selected measurement results are then presented.

²⁵ R&S multi-evaluation is a measurement method that different transmitter evaluations are based on an identical sampling data set. This results in fast test speed as well as greater test depth.

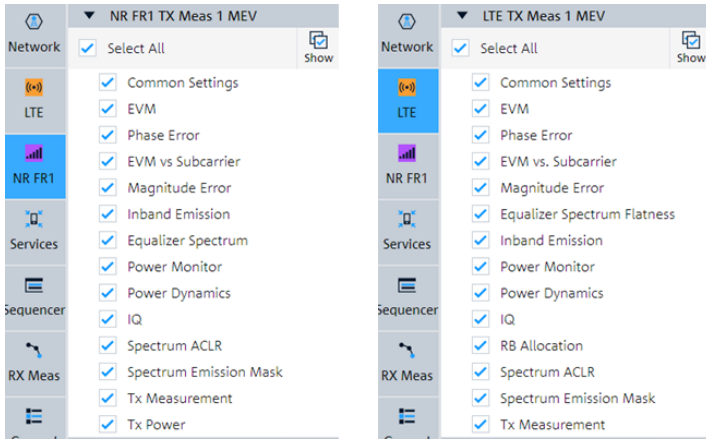

Fig. 4-6 NR and LTE Tx measurements

If we dive into the CMX multi-evaluation settings for E-UTRA and NR, in principle, following settings shown in Fig. 4-7 need to be configured for NR, unless otherwise stated in the test case. The same concept applies to the settings for E-UTRA, too.

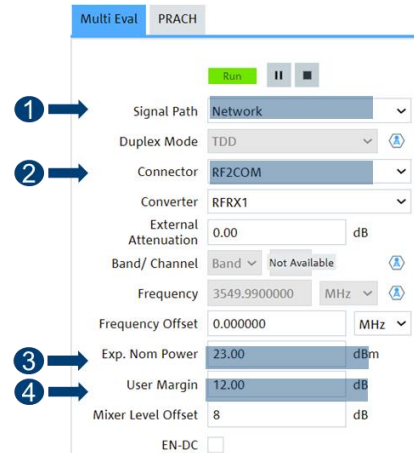

Fig. 4-7 NR multi-evaluation settings

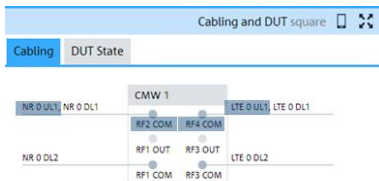

Fig. 4-8 Indication of cabling for a CMX mini footprint setup

1. Set signal path to "Network" so that the majority of the parameter settings in the measurement configuration are aligned with the settings in the cell configuration.
2. The connectors of E-UTRA and NR need to be configured properly according to the connector assignments which is presented graphically in the "Cabling and DUT" square of the CMSquares. As an example shown in Fig. 4-8, the cabling of minimum footprint setup is presented where NR and LTE signal is routed to RF2COM and RF4COM, respectively.
3. Expected nominal power has to be configured based on the DUT transmission power that varies from test case depending on the test requirement, e.g. UE maximum output power test case expects the UE sends the maximum transmission power for power class 3 UE, therefore, in the snapshot given in Fig. 4-7, the expected nominal power is configured as 23 dBm.
4. User margin is used to adjust the reference level for the measurement on CMX.

In order to measure the DUT uplink transmission power correctly, proper "expected nominal power" and "user margin" in the measurement settings of NR or LTE are required. These two parameters determine the measurement reference level which is calculated according to Eqn. 4-1

$$\text{Reference Level} = \text{Expected Nominal Power} + \text{User Margin}$$

Eqn. 4-1 Measurement reference level on CMX

Too low reference level might lead to the "Input Overdriven" of the power measurement. As a rule of thumb, the reference level can be set as the maximum expected DUT transmission power plus crest factor, e.g. approx. 12 dB for OFDM system.

For time mask related measurement, e.g. ON/OFF mask measurement, in order to measure OFF power more accurately, the recommended reference level should be set to -10 dBm based on the CMX implementation.

4.4.3 LTE/NR Rx Measurement

Same as Tx measurement, the DUT should be in EN-DC mode before the Rx measurement is started.

Fig. 4-9 indicates the procedure how to start the Rx measurement in CMsquares.

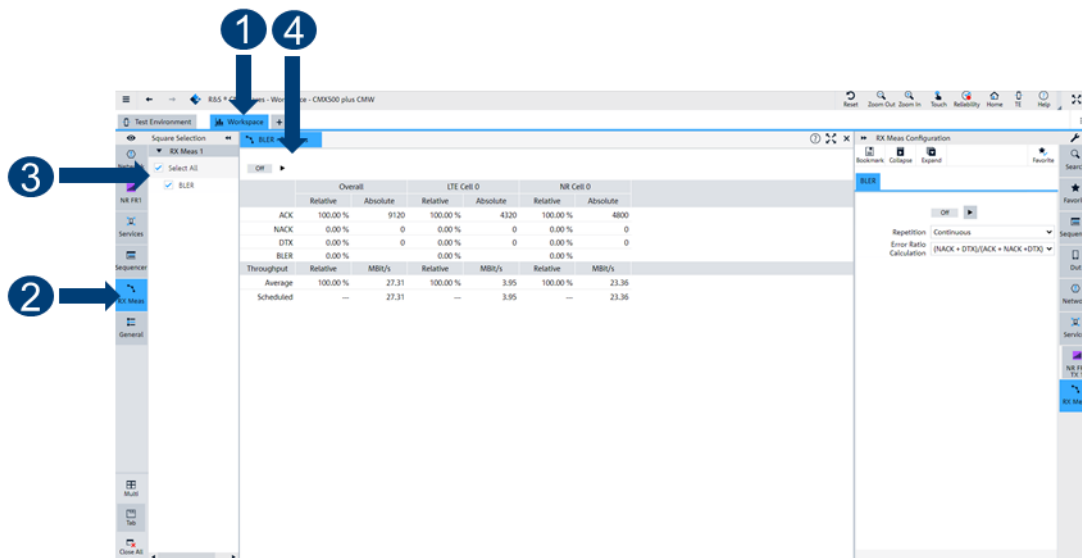

Fig. 4-9 Start the Rx measurement

1. Click on "Workspace"
2. Select "RX Meas" from the side bar
3. Select the BLER measurement items
4. Press  button to start the RX measurement. The BLER measurement results are then presented.

5 Transmitter Characteristic Tests

The FR1 EN-DC transmitter characteristic test cases described in this application note are listed in Table 5-1.

Chapter	Test Case Number from 3GPP TS 38.521-3 [1]	Test Case Designation
5.1	6.2B.1.3	UE Maximum Output Power for Inter-Band EN-DC within FR1
5.2	6.2B.2.3	UE Maximum Output power reduction for inter-band EN-DC within FR1
5.3	6.3B.1.3	Minimum output power for inter-band EN-DC within FR1
5.4	6.3B.3.3	Tx ON/OFF time mask for inter-band EN-DC within FR1
5.5	6.4B.1.3	Frequency Error for inter-band EN-DC within FR1
5.6	6.4B.2.3.1	Error Vector Magnitude for inter-band EN-DC within FR1
5.7	6.4B.2.3.2	Carrier Leakage for inter-band EN-DC within FR1
5.8	6.4B.2.3.3	In-band Emissions for inter-band EN-DC within FR1
5.9	6.4B.2.3.4	EVM Equalizer Flatness for inter-band EN-DC within FR1
5.10	6.5B.1.3	Occupied bandwidth for Inter-Band EN-DC within FR1
5.11	6.5B.2.3.1	Spectrum emissions mask for Inter-band EN-DC within FR1
5.12	6.5B.2.3.3	Adjacent Channel Leakage Ratio for inter-band EN-DC within FR1

Table 5-1 NR FR1 EN-DC transmitter characteristic test cases

Unless otherwise stated, LTE anchor agnostic approach is NOT applied. In case LTE anchor agnostic approach is required, the specification reference is redirected to the SA conformance test specification TS38.521-1 [6] accordingly.

In the subsequent part of this document, the description of each test case has following structure

- ▶ Test purpose is defined by TS38.521-3 [1] or TS38.521-1 [6] (in LTE anchor agnostics approach case)
- ▶ Test preparations consist of three parts
 - Part 1: Example test configuration which is extracted out of the original test configuration table of the test case from TS38.521-3 [1] or TS38.521-1 [6] (in LTE anchor agnostics approach case). The example test configuration that is considered in each test case is highlighted in bold font and the subsequent information are all based on it.
 - Part 2: Cell parameter settings on CMX contains most important parameter settings and their value in CMsquares which reflects the example configuration selected in Part 1.
 - Part 3: Measurement settings explains the necessary settings for multi evaluation measurement in CMsquares.
- ▶ Test procedure describes the operation procedures
- ▶ Test requirement and measurement results in CMsquares are interpreted and presented

5.1 Maximum Output Power for Inter-band EN-DC within FR1 (6.2B.1.3)

5.1.1 Test Purpose

To verify that the error of the UE maximum output power does not exceed the range prescribed by the specified nominal maximum output power and tolerance. An excess maximum output power has the possibility to interfere to other channels or other systems. An insufficient maximum output power decreases the coverage area [1].

Either power class 2 or power class 3 can be supported by 5G NR FR1 UE. The power class 3 is the default power class unless otherwise stated. The power class differs in the maximum transmission power. Test requirement details can be found in Chapter 5.1.4.

5.1.2 Test Preparations

5.1.2.1 Example Test Configuration

Example

Test ID 4

Default Conditions								
Test Environment as specified in TS 38.508-1 [6] clause 4.1			NC, TL/VL, TL/VH, TH/VL, TH/VH					
Test Frequencies as specified in TS 38.508-1 [6] clause 4.3.1 and TS 36.508 [6]			High for E-UTRA CC1 and NR CC1					
Test EN-DC channel bandwidth as specified in TS 36.508 [6] clause 4.3.1 and TS 38.508-1 clause 4.3.1			Highest for E-UTRA CC1 and Highest for NR CC1					
Test SCS for the NR cell as specified in TS 38.521-1 [8] Table 5.3.5-1			Lowest					
Test Parameters								
Test ID	Test Freq	E-UTRA BW	NR BW	Downlink Configuration	EN-DC Uplink Configuration			
					E-UTRA Cell		NR Cell	
					Modulation	RB allocation (NOTE 1)	Modulation (NOTE 3)	RB allocation (NOTE 2)
4	High	Default	Default	N/A	QPSK	1RB_Right	DFT-s-OFDM QPSK	Inner_1RB_Right
NOTE 1: The specific configuration of each RB allocation is defined in Table 6.1-1 in current specification.								
NOTE 2: The specific configuration of each RB allocation is defined in Table 6.1-1 in TS 38.521-1 [8].								
NOTE 3: DFT-s-OFDM Pi/2 BPSK test applies only for UEs which supports Pi/2 BPSK in NR FR1								

Table 5-2 Example of a test configuration out of TS38.521-3 [1] Table 6.2B.1.3.4.1-1

5.1.2.2 Cell Parameter Settings

E-UTRA and NR settings of the test case on CMX with consideration of the example test configuration given in the previous section are summarized in Table 5-3

Parameters	E-UTRA		NR	
	Configuration	Value	Configuration	Value
Frequency Range				FR1
Duplex Mode		FDD		TDD
Band		1		n78
Test Frequency	High	Nul = 18500 Ndl = 500	High	See Table 5-4
Test Channel Bandwidth	Highest	20 MHz	Highest	100 MHz
Test SCS			Lowest	30 kHz
UL RMC Modulation	QPSK	MCS index 5	DFT-s-OFDM QPSK	MCS index 2 MCS table 64QAM
UL RMC RB Allocation	1RB_Right	1@99	Inner_1RB_Right	1@271
Default Downlink Power		-85 dBm/15 kHz (RS EPRE)		-47 dBm (Total Cell Power)
MAC Padding		Enable		Enable
PUSCH Transform Precoding				Enable
Initial BWP				1099
TPC		Max		Max
p-Max		20		20

Table 5-3 Test parameters settings for maximum output power

Table 4.3.1.1.1.78-2: Test frequencies for NR operating band n78, SCS 30 kHz and ΔF_{Raster} 30 kHz.

CBW [MHz]	carrier Bandwidth [PRBs]	Range	Carrier centre [MHz]	Carrier centre [ARFCN]	point A [MHz]	absolute Frequency PointA [ARFCN]	offsetTo Carrier [Carrier PRBs]	SS block SCS [kHz]	GSCN	absolute FrequencySSB [ARFCN]	k_{SSB}	Offset Carrier CORESET#0 [RBs] Note 2	CORE SET#0 Index (Offset [RBs]) Note 1	offsetTo PointA (SIB1) [PRBs] Note 1	
100	273	Downlink & Uplink	Low	3350.01	623334	3300.87	620058	0	30	7711	620352	6	0	2 (2)	4
			Mid	3549.99	636666	3464.13	630942	102		7850	633696	18	0	2 (2)	208
			High	3750	650000	3519.42	634628	504		7989	647040	4	0	3 (3)	1014

Note 1: The CORESET#0 Index and the associated CORESET#0 Offset refers to Table 13-4 in TS 38.213 [22]. The value of CORESET#0 Index is signalled in controlResourceSetZero (pdcch-ConfigSIB1) in the MIB. The offsetToPointA IE is expressed in units of resource blocks assuming 15 kHz subcarrier spacing for FR1 and 60 kHz subcarrier spacing for FR2.

Note 2: The parameter Offset Carrier CORESET#0 specifies the offset from the lowest subcarrier of the carrier and the lowest subcarrier of CORESET#0. It corresponds to the parameter $\Delta F_{\text{OffsetCORESET0-carrier}}$ in Annex C expressed in number of common RBs.

Table 5-4 High-range test frequency configuration of NR n78, CBW 100 MHz and SCS 30 kHz (TS38.508-1 [8], Table 4.3.1.1.1.78-2)

Fig. 5-1 shows the E-UTRA signaling parameter settings for test ID 4

The screenshot displays the configuration interface for LTE Cell 0 and NR Cell 0. The 'Uplink Scheduling' section is highlighted with a blue arrow. Key parameters include:

- Frequency and Band:** Duplex Mode: FDD, Frequency Band Indicator: 1.
- Downlink:** Resource Blocks: 100, Frequency Bandwidth: 20 MHz, Range Choice: High Band, Carrier Frequency: 2160.0 MHz, EARFCN: 500.
- Uplink:** Tx-Rx Separation: Default, Resource Blocks: 100, Frequency Bandwidth: 20 MHz, Range Choice: High Band, Carrier Frequency: 1970.0 MHz, EARFCN: 18500.
- Cell Timing:** Timing Offset: 0 μ s, System Frame Number Offset: 0 # Frames.
- Power:** Downlink Level: RS EPRE: -85.0 dBm/15k..., Max. Cell Power: -54.2 dBm.
- Signaled Parameters:** Nominal PUCCH: -117 dBm, Nominal PUSCH: -85 dBm, UE PUCCH: 0 dB, UE PUSCH: 0 dB, Filter Coefficient: 4, Alpha: 0.8, p-Max: 20 dBm.
- Power Control:** TPC: Max, Channel Type: PUSCH.
- PRACH:** Antenna Config: MIMO Scheme: SISO 1x1.
- Antenna Ports:** # CRS Antenna Ports: 1, Beamforming No. of Antenna Ports: 1, DL IQ Data Streams: 1 Streams.
- User Defined UE Scheduling:** Subframe Assignment: Configuration..., DL MAC Padding: .
- PDCCH Region:** # PDCCH Symbols: 2 Symbols.
- UE Timer and Constants:**

Uplink Scheduling

SubFrame	0	1	2	3	4	5	6	7	8	9
SubFrame	<input checked="" type="checkbox"/>	<input checked="" type="checkbox"/>	<input checked="" type="checkbox"/>	<input checked="" type="checkbox"/>	<input checked="" type="checkbox"/>	<input checked="" type="checkbox"/>	<input checked="" type="checkbox"/>	<input checked="" type="checkbox"/>	<input checked="" type="checkbox"/>	<input checked="" type="checkbox"/>
PDCCH Format	NCCE4	NCCE4	NCCE4	NCCE4	NCCE4	NCCE4	NCCE4	NCCE4	NCCE4	NCCE4
DCI Format	DCI 0	DCI 0	DCI 0	DCI 0	DCI 0	DCI 0	DCI 0	DCI 0	DCI 0	DCI 0
RIV	0	0	0	0	0	0	0	0	0	0
Start RB	99	99	99	99	99	99	99	99	99	99
Number RB	1	1	1	1	1	1	1	1	1	1
Code Word 1										
TBS Index	5	5	5	5	5	5	5	5	5	5
MCS	5	5	5	5	5	5	5	5	5	5
TBS in Bits	72	72	72	72	72	72	72	72	72	72
Code Rate	0.33	0.33	0.33	0.33	0.33	0.33	0.33	0.33	0.33	0.33

Fig. 5-1 E-UTRA settings on CMX

Fig. 5-2 shows the NR signaling parameter settings for test ID 4.

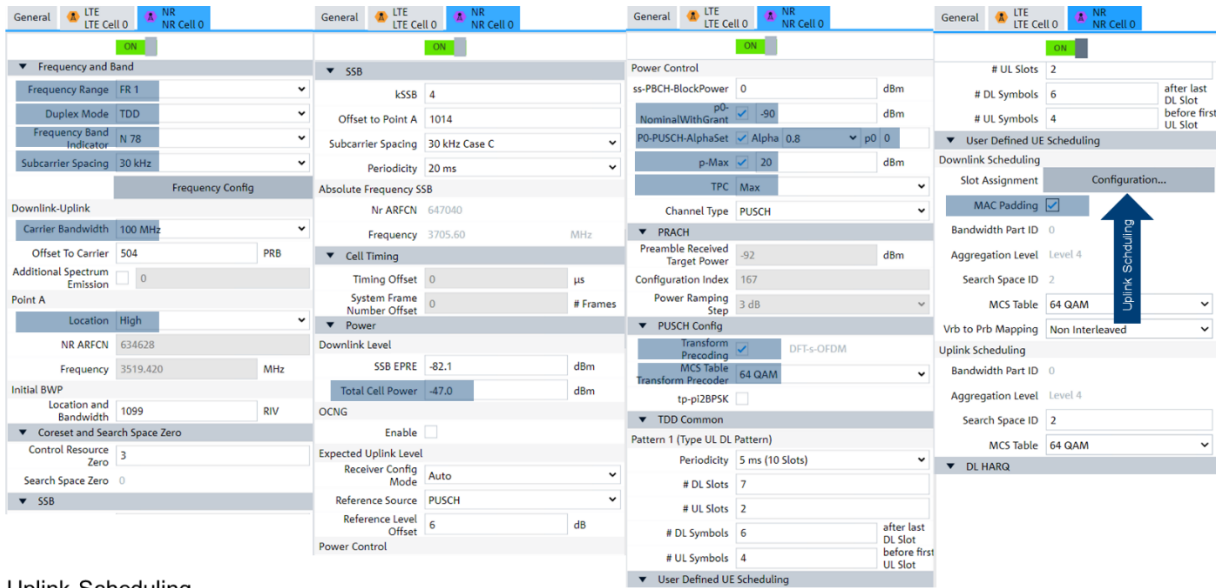

Uplink Scheduling

NR Cell 0 > UE Slot Scheduling												
Slot Index	0	1	2	3	4	5	6	7	7	8	9	
	DL	DL	DL	DL	DL	DL	DL	UL	UL	UL	UL	
Start RB	-	0	0	0	0	0	0	-	-	271	271	
# RB	-	273	273	273	273	273	273	-	-	1	1	
MCS	-	4	4	4	4	4	4	-	-	2	2	
DCI Format	-	DCI 11	DCI 11	DCI 11	DCI 11	DCI 11	DCI 11	-	-	DCI 01	DCI 01	
MIMO Scheme	-	SISO	SISO	SISO	SISO	SISO	SISO	-	-	SISO	SISO	

Fig. 5-2 NR settings on CMX

5.1.2.3 Multi-Evaluation Measurement Settings

E-UTRA and NR multi-evaluation settings in CMsquares are highlighted in Fig. 5-3 (see also 4.4.2).



E-UTRA

NR

Fig. 5-3 E-UTRA and NR measurement settings

5.1.3 Test Procedure

1. Configure the LTE and NR cell with configurations (see 5.1.2.2)

2. Configure the LTE and NR multi-evaluation measurement (see 5.1.2.3)
3. Turn on both LTE and NR cell
4. Switch on DUT and wait until DUT is registered on LTE cell
5. Activate EN-DC mode
6. Select and start the "Tx Measurement"

5.1.4 Test Requirement and Results

The test requirement defined for this test case is given in Table 5-5 with Test Tolerance (TT) specified in Table 5-6.

Table 6.2B.1.3.5-1: Maximum output power for inter-band EN-DC (two bands)

EN-DC configuration	Power class 3 (dBm)	Tolerance (dB)
DC_1A_n28A	23	+2 +TT/-3-TT
DC_1A_n40A	23	+2 +TT/-3-TT
DC_1A_n51A	23	+2 +TT/-3-TT
DC_1A_n77A	23	+2 +TT/-3-TT
DC_1A_n78A	23	+2 +TT/-3-TT
DC_1A_n84A_ULSUP-TDM_n78A		
DC_1A_n84A_ULSUP-FDM_n78A		
DC_1A_n79A		

[Table 5-5 Test requirement \(TS38.521-3 \[1\] Table 6.2B.1.3.5-1\)](#)

Table 6.2B.1.3.5-3: Test Tolerance for UE maximum output power (Overlapping UL transmission)

			TT for overall output power								
			NR								
			BW ≤ 20MHz			20 MHz < BW ≤ 40MHz			40MHz < BW ≤ 100MHz		
			f ≤ 3.0GHz	3.0GHz < f ≤ 4.2GHz	4.2GHz < f ≤ 6.0GHz	f ≤ 3.0GHz	3.0GHz < f ≤ 4.2GHz	4.2GHz < f ≤ 6.0GHz	f ≤ 3.0GHz	3.0GHz < f ≤ 4.2GHz	4.2GHz < f ≤ 6.0GHz
E-UTRA	BW ≤ 20MHz	f ≤ 3.0GHz	0.7 dB	1.0 dB	1.0 dB	0.7 dB	1.0 dB	1.0 dB	1.0 dB	1.0 dB	1.0 dB
		3.0GHz < f ≤ 4.2GHz	1.0 dB	1.0 dB	1.0 dB	1.0 dB	1.0 dB	1.0 dB	1.0 dB	1.0 dB	1.0 dB

[Table 5-6 Test Tolerance \(TS38.521-3, Table 6.2B.1.3.5-3\)](#)

Furthermore, the NOTE3 in TS38.521-3 [1] Table 6.2B.1.3.5-1 defines additional relaxation of the lower tolerance by 1.5 dB as long as the test frequency is confined within F_{UL_low} and $F_{UL_low} + 4$ MHz or $F_{UL_high} - 4$ MHz and F_{UL_high} where F_{UL_low} and F_{UL_high} are the lowest and highest frequency of the uplink operating band, respectively. In our example, the selected test frequency does not fall in that range, since we test in the mid test frequency range.

Therefore, the total test requirement by taking all the tolerances into account turns to be:

Lower limit of maximum output power = $23-3-1 = 19$ dBm

Upper limit of maximum output power = $23+2+1 = 26$ dBm

The measurements on the CMX gives following results as shown in Fig. 5-4 (E-UTRA) and Fig. 5-5 (NR).

UE Output power in E-UTRA: 19.62 dBm

Tx Measurement - LTE 1 - MEV						
Detected and Statistics						
Statistic Count	Allocation	Modulation	Channel Type	Out of Tolerance	View Filter Throughput	
20/20	NoRB: 1 OffsetRB: 99	QPSK	PUSCH	0 %	100 %	%
Power						
	Current	Average	Min	Max	Std Dev	
Tx Power [dBm]	19.75	19.62	19.46	19.99	0.09	
Peak Power [dBm]	23.34	23.26	23.14	23.49	0.05	
RB Power [dBm]	19.64	19.60	19.45	19.89	0.07	

Fig. 5-4 Tx measurement of E-UTRA

UE Output power in NR: 19.20 dBm

Tx Measurement - NR FR1 1 - MEV						
Detected and Statistics						
Statistic Count	Allocation	Modulation	Channel Type	Out of Tolerance	View Filter Throughput	
20/20	NoRB: 1 OffsetRB: 271	QPSK	PUSCH	0 %	100 %	%
Power						
	Current	Average	Min	Max	Std Dev	
Tx Power [dBm]	18.96	19.20	18.90	19.47	0.15	
PEAK Power [dBm]	25.41	25.43	25.38	25.56	0.03	
RB Power [dBm]	18.91	19.18	18.91	19.48	0.15	

Fig. 5-5 Tx measurement of NR

The maximum output power is the summation of the maximum output power of each antenna connector. Since the DUT tested here uses separate antenna for LTE and NR. Therefore, the overall output power should be the sum of both maximum output power of LTE and NR.

UE output power of E-UTRA in mW = $10^{(19.62/10)} = 91.62$ mW

UE output power of NR in mW = $10^{(19.20/10)} = 83.18$ mW

Overall maximum UE output power in dBm = $10 * \log_{10}(91.62 + 83.18) = 22.4$ dBm which is within the limit (19~26 dBm).

5.2 Maximum Output Power Reduction for Inter-band EN-DC within FR1 (6.2B.2.3)

This test case should apply LTE anchor agnostic approach.

For more details, refer to TS38.521-1 [6], clause 6.2.2.1

5.2.1 Test Purpose

The increase of the modulation order will cause a higher crest factor. Potentially in the max transmission power condition, the amplifier may already operate in the top of the linear area. By increasing the crest factor, the amplifier might enter into non-linear area which could result in higher adjacent cell leakage ratio (ACLR). Therefore, UE is allowed to reduce the maximum output power due to higher order modulations and transmit bandwidth configurations [6].

The conformance requirements of maximum power reduction (MPR) with respect to the UE power class, uplink modulation, allocated resource blocks can be found in [6] clause 6.2.2.3.

5.2.2 Test Preparations

5.2.2.1 Example Test Configuration

Example

Test ID 27

Initial Conditions				
Test Environment as specified in TS 38.508-1 [5] subclause 4.1		Normal, TL/VL, TL/VH, TH/VL, TH/VH		
Test Frequencies as specified in TS 38.508-1 [5] subclause 4.3.1		Low range, High range		
Test Channel Bandwidths as specified in TS 38.508-1 [5] subclause 4.3.1		Lowest, Highest		
Test SCS as specified in Table 5.3.5-1		Lowest , Highest		
Test Parameters for Channel Bandwidths				
Test ID	Freq	Downlink Configuration	Uplink Configuration	
		N/A for Maximum Power	Modulation (NOTE 2)	RB allocation (NOTE 1)
27	Default		CP-OFDM 16 QAM	Inner Full
NOTE 1: The specific configuration of each RB allocation is defined in Table 6.1-1.				
NOTE 2: DFT-s-OFDM Pi/2 BPSK test applies only for UEs which supports half Pi BPSK in FR1.				
NOTE 3: UE operating in TDD mode with Pi/2 BPSK modulation and UE indicates support for UE capability powerBoosting-pi2BPSK and the IE powerBoostPi2BPSK is set to 1 for bands n40, n41, n77, n78 and n79.				
NOTE 4: UE operating in FDD mode, or in TDD mode in bands other than n40, n41, n77, n78 and n79, or in TDD mode the IE powerBoostPi2BPSK is set to 0 for bands n40, n41, n77, n78 and n79.				

Table 5-7 Example of a test configuration out of TS38.521-1 [6] Table 6.2.2.4.1-1

5.2.2.2 Cell Parameter Settings

Since this test case requires the LTE anchor agnostic approach, LTE settings can be referred in chapter 3.6.

NR settings on CMX can generally refer to chapter 5.1.2.2 by configuration given in Table 5-8.

Parameters	NR	
	Configuration	Value
Frequency Range		FR1
Duplex Mode		TDD
Band		n78
Test Frequency	High range	See Table 5-4
Test Channel Bandwidth	Highest	100 MHz
Test SCS	Lowest	30 kHz
DL RMC (Modulation)	N/A	e.g. MCS index 4 MCS table 64QAM
DL RMC (RB Allocation)	N/A	e.g. 273@0
UL RMC (Modulation)	CP-OFDM 16QAM	MCS index 10 MCS table 64QAM
UL RM (RB Allocation)	Innen Full	137@68
Downlink Power Level	Total Cell Power	-47 dBm
Uplink Power Control	P0-NominalWithGrant	-90 dBm
	Alpha	0.8
	P0	0
	TPC	Max
DFT-s-OFDM		Disable
MAC Padding		Enable
Initial BWP		1099

Table 5-8 Test parameters settings for maximum power reduction (MPR)

5.2.2.3 Multi-Evaluation Measurement Settings

NR multi-evaluation settings can generally refer to chapter 5.1.2.3

5.2.3 Test Procedure

1. Configure the LTE cell according to LTE anchor agnostic approach, see chapter 3.6
2. Configure the NR cell according to the configurations given in Table 5-8
3. Configure the NR multi-evaluation measurement
4. Turn on both LTE and NR cell
5. Switch on DUT and wait until DUT is registered on LTE cell
6. Activate EN-DC mode
7. Reduce the LTE uplink RB allocation to 0 RB as given in 3.6
8. Start the MPR measurement in the NR as given in 4.4.2 (select "Tx Measurement" measurement)

5.2.4 Test Requirement and Results

The MPR test requirement of test ID 27 for a power class 3 DUT operating in NR band n78 with contiguous RB allocation can be found in Table 5-9. By considering the 1dB TT (specified in TS38.521-1 [6] Table 6.2.2.5-5), the DUT should transmit the power in range of 17 ~ 26 dBm where the 2 dB MPR is already included in the calculation of lower limit.

Table 6.2.2.5-3: UE Power Class test requirements (for Bands n48, n77, n78, n79) for Power Class 3 (contiguous allocation)

Test ID	P _{PowerClass} (dBm)	$\Delta P_{PowerClass}$ (dB)	MPR (dB)	$\Delta T_{C,c}$ (dB)	P _{C_{MAX}L,f,c} (dBm)	T(P _{C_{MAX}L,f,c}) (dB)	T _{L,c} (dB)	Upper limit (dBm)	Lower limit (dBm)
27	23	0	2	0	21.0	2.0	3	25.0 + TT	18.0 - TT

NOTE 1: P_{PowerClass} is the maximum UE power specified without taking into account the tolerance.
NOTE 2: TT for each frequency and channel bandwidth is specified in Table 6.2.2.5-5.

Table 5-9 Test requirement of MPR (TS38.521-1 [6], Table 6.2.2.5-3)

The measurement result of CMX in Fig. 5-6 shows 19.09 dBm average transmission power that is within the range of the conformance requirement (17~ 26 dBm).

Moreover, test relevant configuration information, such as RB allocation (137 RBs, start position 68), 16QAM modulation, are displayed in the CMsquares too.

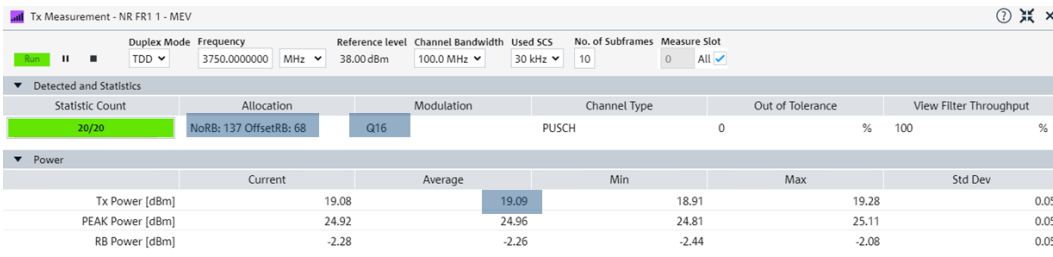

Fig. 5-6 Test result of maximum power reduction (MPR)

5.3 Minimum Output Power for Inter-band EN-DC within FR1 (6.3B.1.3)

This test case should apply LTE anchor agnostic approach.

For more details, refer to TS38.521-1 [6], clause 6.3.1.3

5.3.1 Test Purpose

To verify the UE's ability to transmit with a broadband output power (with full RB allocation) below the value specified in the test requirement when the power is set to a minimum value [6].

5.3.2 Test Preparations

5.3.2.1 Example Test Configuration

Example

Test ID 1

Initial Conditions			
Test Environment as specified in TS 38.508-1 [5] subclause 4.1		Normal, TL/VL, TL/VH, TH/VL, TH/VH	
Test Frequencies as specified in TS 38.508-1 [5] subclause 4.3.1		Low range, Mid range, High range	
Test Channel Bandwidths as specified in TS 38.508-1 [5] subclause 4.3.1		Lowest, Mid, Highest	
Test SCS as specified in Table 5.3.5-1		Highest	
Test Parameters for Channel Bandwidths			
Test ID	Downlink Configuration	Uplink Configuration	
	N/A for minimum output power test case	Modulation	RB allocation (NOTE 1)
1		DFT-s-OFDM QPSK	Outer Full
NOTE 1: The specific configuration of each RB allocation is defined in Table 6.1-1.			

Table 5-10 Example of test configuration out of TS38.521-1 [6] Table 6.3.1.4.1-1

5.3.2.2 Cell Parameter Settings

Since this test case requires the LTE anchor agnostic approach, LTE settings can be referred in chapter 3.6.

NR settings on CMX can generally refer to chapter 5.1.2.2 by configuration given in Table 5-11.

Parameters	NR	
	Configuration	Value
Frequency Range		FR1
Duplex Mode		TDD
Band		n78
Test Frequency	High range	See Table 5-4
Test Channel Bandwidth	Highest	100 MHz
Test SCS	Highest	60 kHz
DL RMC (Modulation)	N/A	e.g. MCS index 4 MCS table 64QAM
DL RMC (RB Allocation)	N/A	e.g. 273@0
UL RMC (Modulation)	DFT-s-OFDM QPSK	MCS index 2 MCS table 64QAM
UL RM (RB Allocation)	Outer Full	135@0
Downlink Power Level	SSB ERPE	-82 dBm
Uplink Power Control	P0-NominalWithGrant	-90 dBm
	Alpha	0.8
	P0	0

	TPC	Min
DFT-s-OFDM		Enable
MAC Padding		Enable
Initial BWP		1099

Table 5-11 Test parameter settings for minimum output power

5.3.2.3 Multi-Evaluation Measurement Settings

NR multi-evaluation settings can generally refer to chapter 5.1.2.3.

The expected nominal power setting has to be adjusted here to set -33 dBm as shown in Fig. 5-7.

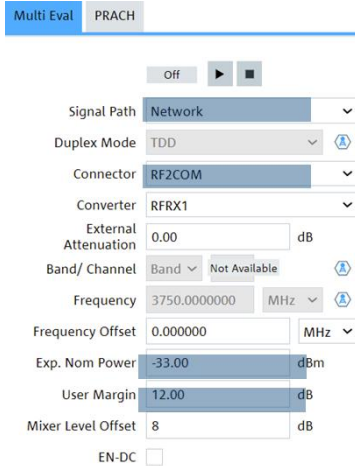

Fig. 5-7 NR multi-evaluation configuration for minimum output power test

5.3.3 Test Procedure

1. Configure the LTE cell according to LTE anchor agnostic approach, see chapter 3.6
2. Configure the NR cell according to the configurations given in Table 5-11
3. Configure the NR multi-evaluation measurement
4. Turn on both LTE and NR cell
5. Switch on DUT and wait until DUT is registered on LTE cell
6. Activate EN-DC mode
7. Reduce the LTE uplink RB allocation to 0 RB as given in 3.6
8. Start the measurement in the NR as given in 4.4.2 (select "Tx Measurement" measurement)

5.3.4 Test Requirement and Results

In Table 5-12, it shows the Test requirement given by TS38.521-1 [6], clause 6.3.1.5

Table 6.3.1.5-1: Minimum output power

Channel bandwidth (MHz)	Minimum output power (dBm)	Measurement bandwidth (MHz)
5	-40+TT	4.515
10	-40+TT	9.375
15	-40+TT	14.235
20	-40+TT	19.095
25	-39+TT	23.955
30	-38.2+TT	28.815
40	-37+TT	38.895
50	-36+TT	48.615
60	-35.2+TT	58.35
80	-34+TT	78.15
90	-33.5+TT	88.23
100	-33+TT	98.31

NOTE 1: TT for each frequency and channel bandwidth is specified in Table 6.3.1.5-2

Table 5-12 Test requirement of minimum output power (TS38.521-1 [6], Table 6.3.1.5-1)

After looking up TS38.521-1 [6] Table 6.3.1.5-2, we know that the test tolerance (TT) in our case here is 1.3 dB (BW = 100 MHz, f = 3750 MHz). So, minimum output power at 100 MHz CBW should not be greater than -33 dBm + 1.3 dB = -31.7 dBm.

The Tx power measurement in CMSquares shown in Fig. 5-8 indicates the average Tx power of -49.61 dBm which conforms the test requirement (<-31.7 dBm). Therefore, the test is passed.

Detected and Statistics						
Statistic Count	Allocation	Modulation	Channel Type	Out of Tolerance	View Filter Throug..	
20/20	NoRB: 135 OffsetRB: 0	QPSK	PUSCH	0 %	100	
Power						
	Current	Average	Min	Max	Std Dev	
Tx Power [dBm]	-49.72	-49.61	-49.75	-49.48	0.09	
PEAK Power [dBm]	-39.34	-39.17	-40.09	-37.82	0.37	
RB Power [dBm]	-71.08	-70.97	-71.11	-70.83	0.09	

Fig. 5-8 Minimum output power measurement result

5.4 Tx ON/OFF Time Mask for Inter-band EN-DC within FR1 (6.3B.3.3)

This test case should apply LTE anchor agnostic approach.

For more details, refer to TS38.521-1 [6], clause 6.3.3.2

5.4.1 Test Purpose

The transmit power time mask for transmit ON/OFF defines the transient period(s) allowed between transmit OFF power and transmit ON power symbols (transmit ON/OFF). Transmit OFF power is considered when the UE is not allowed to transmit on any of its ports.

Transmission of the wrong power increases interference to other channels, or increases transmission errors in the uplink channel [6].

Fig. 5-9 shows the transmit ON/OFF time mask measurement as defined in [6].

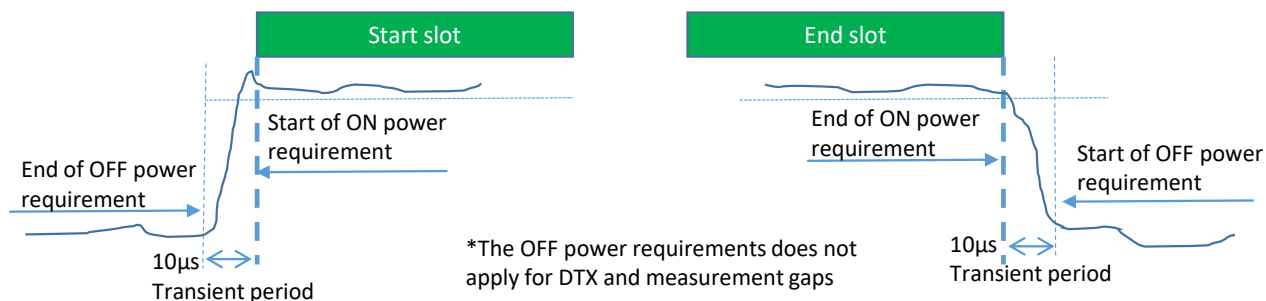

Fig. 5-9 General ON/OFF time mask for NR UL transmission in FR1 [6]

5.4.2 Test Preparations

5.4.2.1 Example Test Configuration

Example

Test ID 1

Initial Conditions			
Test Environment as specified in TS 38.508-1 [5] subclause 4.1		Normal, TL/VL, TL/VH, TH/VL, TH/VH	
Test Frequencies as specified in TS 38.508-1 [5] subclause 4.3.1		Low range, Mid range, High range (NOTE 2)	
Test Channel Bandwidths as specified in TS 38.508-1 [5] subclause 4.3.1		Lowest, Mid, Highest	
Test SCS as specified in Table 5.3.5-1		Lowest , Highest	
Test Parameters for Channel Bandwidths			
Test ID	Downlink Configuration	Uplink Configuration	
	N/A for minimum output power	Modulation	RB allocation (NOTE 1)
1	test case	CP-OFDM QPSK	Outer Full
NOTE 1: The specific configuration of each RB allocation is defined in Table 6.1-1.			
NOTE 2: For NR band n28, 30MHz test channel bandwidth is tested with Low range and High range test frequencies.			

Table 5-13 Example of test configuration out of TS38.521-1 [6] Table 6.3.3.2.4.1-1

5.4.2.2 Cell Parameter Settings

Since this test case requires the LTE anchor agnostic approach, LTE settings can be referred in chapter 3.6.

NR settings in CMsquares can be referred to Fig. 5-10 based on the configurations given in Table 5-14.

According to the test purpose, test ON power just in one slot where the neighbor slots are powered OFF (have no resource allocation). As per [6], UL slot 8 is the only UL slot with resource allocation. The DL slot 1 resource allocation shown in Fig. 5-10 is required during the initial EN-DC connection setup. After the EN-DC mode is activated, the DL slot 1 resource allocation can be deactivated.

Parameters	NR		Remark
	Configuration	Value	
Frequency Range		FR1	
Duplex Mode		TDD	
Band		n78	
Test Frequency	High range	See Table 5-4	
Test Channel Bandwidth	Highest	100 MHz	
Test SCS	Lowest	30 kHz	
DL RMC (Modulation)	N/A	e.g. MCS index 4	

		MCS table 64QAM	
DL RMC (RB Allocation)	N/A	e.g. 273@0	
UL RMC (Modulation)	CP-OFDM QPSK	MCS index 2 MCS table 64QAM	
UL RM (RB Allocation)	Outer Full	273@0	Only allocate slot 8
Downlink Power Level	SSB ERPE	-82 dBm	
Uplink Power Control	ss-PBCH-BlockPower	21 dBm	
	P0-NominalWithGrant	-100 dBm	
	Alpha	0.8	
	P0	0	
	TPC	Keep	Open loop
DFT-s-OFDM		Disable	
TDD Common	Periodicity	5 ms	
	# DL Slots	6	
	# UL Slots	3	
	# DL Symbols	6	
	# UL Symbols	4	
MAC Padding		Enable	
Initial BWP		1099	

Table 5-14 Test parameter settings for Tx ON/OFF time mask

The figure displays three screenshots of the CMX software interface for configuring NR settings. The first screenshot shows the 'Frequency and Band' section with parameters: FR 1, TDD, N 78, 30 kHz, 100 MHz Carrier Bandwidth, 504 PRB Offset To Carrier, 3519.420 MHz Frequency, and 1099 Initial BWP. The second screenshot shows the 'Power' section with parameters: SSB EPRE -82.0 dBm, Total Cell Power -46.9 dBm, ss-PBCH-BlockPower 21 dBm, P0 -100 dBm, Alpha 0.8, and TPC Keep. The third screenshot shows the 'TDD Common' section with parameters: Periodicity 5 ms (10 Slots), # DL Slots 6, # UL Slots 3, # DL Symbols 6, # UL Symbols 4, MAC Padding checked, and Configuration Mode NOT Configured. A blue arrow labeled 'RMC Configuration' points from the TDD Common settings to the 'NR Cell 0 > UE Slot Scheduling' table below.

Slot Index	0	1	2	3	4	5	6	6	7	8	9
	DL	DL	DL	DL	DL	DL	DL	UL	UL	UL	UL
Start RB	-	0	-	-	-	-	-	-	-	0	-
# RB	-	273	-	-	-	-	-	-	-	273	-
MCS	-	4	-	-	-	-	-	-	-	2	-
DCI Format	-	DCI 11	-	-	-	-	-	-	-	DCI 01	-
MIMO Scheme	-	SISO	-	-	-	-	-	-	-	SISO	-
Time Domain Alloc.											
Start Symbol	-	2	-	-	-	-	-	-	-	0	-
# Symbols	-	12	-	-	-	-	-	-	-	14	-
Channel Mapping	-	TYPE A	-	-	-	-	-	-	-	TYPE A	-
Slot Offset (k0 k2)	-	0	-	-	-	-	-	-	-	3	-

Fig. 5-10 NR settings of Tx ON/OFF time mask on CMX

5.4.2.3 Multi-Evaluation Measurement Settings

The ON power and OFF power is measured on CMX in two separate steps. This requires that the NR multi-evaluation settings for ON power and OFF power measurement are configured separately (see Fig. 5-11).

The setting differs in the "expected nominal power" parameter where 32 dBm and -10 dBm is recommended to be configured for ON power and OFF power measurement, accordingly (see 4.4.2).

During OFF power measurement, the warning message "input overdriven" will appear due to the fact that the ON power level is far above the reference level (-10 dBm) which can actually be ignored. Because the focal measurement is OFF power but not ON power here. In order to avoid the termination of the measurement under this circumstance, "Measure on exception" option has to be activated in this case (see right hand side of Fig. 5-11).

In order to measure on the specified uplink slot, the measurement slot needs to be set to 8 or 18 (30 kHz SCS, with 5 ms transmission periodicity).

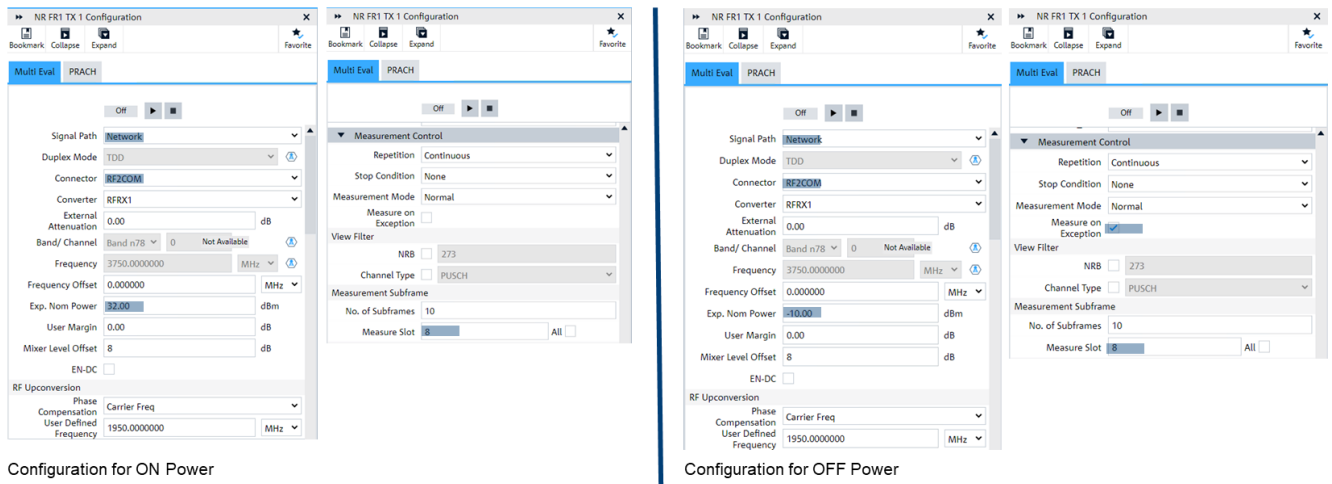

Fig. 5-11 NR measurement settings of ON power and OFF power

5.4.3 Test Procedure

1. Configure the LTE cell according to LTE anchor agnostic approach, see chapter 3.6
2. Configure the NR cell according to the configurations given in Table 5-11
3. Turn on both LTE and NR cell
4. Switch on DUT and wait until DUT is registered on LTE cell
5. Activate EN-DC mode
6. Reduce the LTE uplink RB allocation to 0 RB as given in 3.6
7. Deactivate the NR downlink RB allocation
8. Configure the NR multi-evaluation measurement (configuration for ON power measurement, see 5.4.2.3)
9. Start measurement in the NR as given in 4.4.2 (select "Power Dynamics" measurement)
10. Configure the NR multi-evaluation measurement (configuration for OFF power measurement, see 5.4.2.3)
11. Restart the "Power Dynamics" measurement.

5.4.4 Test Requirement and Results

Table 5-15 is the test requirement given by TS38.521-1 [6], clause 6.3.3.2.5

Table 6.3.3.2.5-1: General ON/OFF time mask

SCS	Channel bandwidth / minimum output power / measurement bandwidth													
	[kHz]	5 MHz	10 MHz	15 MHz	20 MHz	25 MHz	30 MHz	40 MHz	50 MHz	60 MHz	80 MHz	90 MHz	100 MHz	
Transmit OFF power		$\leq -50+TT$ dBm												
Transmission OFF Measurement bandwidth		4.515	9.375	14.235	19.095	23.955	28.815	38.895	48.615	58.35	78.15	88.23	98.31	
Expected Transmission ON Measured power for CP-OFDM	15	-3.6	0.4	1.4	2.7	3.6	4.4	5.7	6.7	N/A	N/A	N/A	N/A	
	30	-4.2	-0.8	1.2	2.5	3.5	4.3	5.7	6.6	7.5	8.8	9.3	9.8	
	60	N/A	-1.2	1.0	2.2	3.3	4.2	5.5	6.5	7.4	8.7	9.2	9.7	
ON Power Tolerance		$\pm (9+TT)$ dB												

NOTE 1: TT for each frequency and channel bandwidth is specified in Table 6.3.3.2.5-2

Table 5-15 Test requirement of general ON/OFF time mask (TS38.521-1 [6], Table 6.3.3.2.5-1)

TS38.521-1 [6] clause 6.3.3.2.5-1 specifies the test tolerance (TT) which in our case is 1.8 dB (BW = 100 MHz, f = 3750 MHz). Therefore, following limit should apply

Transmit OFF power $\leq -50 + TT = -48.2$ dBm

Transmit ON power (30 kHz SCS, 100 MHz CBW) = 9.8 dBm \pm 10.8 dB (ON power tolerance)

That means, the Transmit ON power should be in the range -1 dBm to 20.6 dBm.

The ON power and OFF power measurements in CMsquares are shown in Fig. 5-12²⁷. From the results, we can read out 11.42 dBm ON power, -66.08 dBm OFF power (before the ON power slot), and -66.06 dBm OFF power (after the ON power slot). All the measured values are in range.

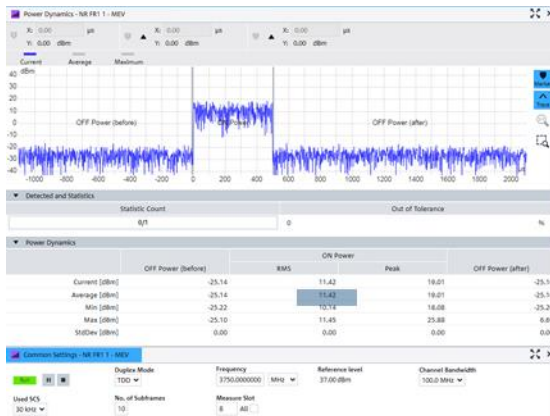

On Power 11.42 dBm

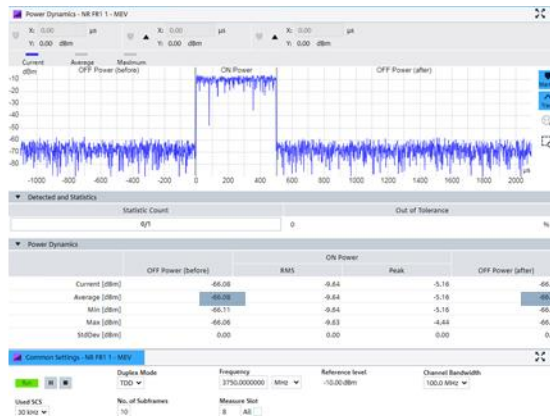

OFF Power (before) -66.08 dBm

OFF Power (after) -66.06 dBm

Fig. 5-12 Tx ON/OFF power measurement result

²⁷ The limit violation of OFF power when measuring the ON power can be ignored. Because the reference level (32 dBm) is configured in the NR measurement which effectively increases the noise floor level. This level overwhelms the actual OFF power. When measuring OFF power, the warning "Input overdriven" in CMsquares appears due to the measurement of ON power which is far above the reference level, e.g. -10 dBm. Therefore, for OFF power measurement, actually this warning message is of no relevance (see also Fehler! Verweisquelle konnte nicht gefunden werden.).

5.5 Frequency Error for Inter-band EN-DC within FR1 (6.4B.1.3)

This test case should apply LTE anchor agnostic approach.

For more details, refer to TS38.521-1 [6], clause 6.4.1

5.5.1 Test Purpose

As defined in [6], this test verifies the ability of both, the receiver and the transmitter, to process frequency correctly.

Receiver: to extract the correct frequency from the stimulus signal, offered by the system simulator, under ideal propagation conditions and low level.

Transmitter: to derive the correct modulated carrier frequency from the results, gained by the receiver.

5.5.2 Test Preparations

5.5.2.1 Example Test Configuration

Example

Test ID 1

Initial Conditions				
Test Environment as specified in TS 38.508-1 [5] subclause 4.1			Normal, TL/VL, TL/VH, TH/VL, TH/VH	
Test Frequencies as specified in TS 38.508-1 [5] subclause 4.3.1			Mid range	
Test Channel Bandwidths as specified in TS 38.508-1 [5] subclause 4.3.1			Highest	
Test SCS as specified in Table 5.3.5-1			Lowest	
Test Parameters				
	Downlink Configuration		Uplink Configuration	
Test ID	Modulation	RB allocation	Modulation	RB allocation
1	CP-OFDM QPSK	Full RB (NOTE 1)	DFT-s-OFDM QPSK	REFSENS (NOTE 2)
NOTE 1: Full RB allocation shall be used per each SCS and channel BW as specified in Table 7.3.2.4.1-2				
NOTE 2: REFSENS refers to Table 7.3.2.4.1-3 which defines uplink RB configuration and start RB location for each SCS, channel BW and NR band.				

Table 5-16 Example of a test configuration out of TS38.521-1 [6] Table 6.4.1.4.1-1

5.5.2.2 Cell Parameter Settings

Since this test case requires the LTE anchor agnostic approach, LTE settings can be referred in chapter 3.6.

NR settings on CMX can refer to chapter 5.1.2.2 by configuration given in Table 5-17

Parameters	NR	
	Configuration	Value
Frequency Range		FR1
Duplex Mode		TDD
Band		n78
Test Frequency	Mid	See Table 5-4
Test Channel Bandwidth	Highest	100 MHz
Test SCS	Lowest	30 kHz
DL RMC (Modulation)	CP-OFDM QPSK	MCS index 4

		MCS table 64QAM
DL RMC (RB Allocation)	Full RB	273@0
UL RMC (Modulation)	DFT-s-OFDM QPSK	MCS index 2 MCS table 64QAM
UL RM (RB Allocation)	REFSENS	270@0
Downlink Power Level	SSB ERPE	-82 dBm
Uplink Power Control	P0-NominalWithGrant	-90 dBm
	Alpha	0.8
	P0	0
	TPC	Max
DFT-s-OFDM		Enable
MAC Padding		Enable
Initial BWP		1099

Table 5-17 Test parameters settings for frequency error test

5.5.2.3 Multi-Evaluation Measurement Settings

NR multi-evaluation settings can refer to chapter 5.1.2.3

5.5.3 Test Procedure

1. Configure the LTE cell according to LTE anchor agnostic approach, see chapter 3.6
2. Configure the NR cell with configurations given in Table 5-17
3. Configure the NR multi-evaluation measurement given in 5.1.2.3
4. Turn on both LTE and NR cell
5. Switch on DUT and wait until DUT is registered on LTE cell
6. Activate EN-DC mode
7. Reduce the LTE uplink RB allocation to 0 RB as given in 3.6
8. Measure the NR as given in 4.4.2 (select "Tx Measurement" measurement)

5.5.4 Test Requirement and Results

The frequency error Δf must fulfil the test requirement: $|\Delta f| \leq (0.1 \text{ PPM} + 15 \text{ Hz})$

PPM stands for Parts per Million, 1 PPM means $1/10^6$ part of nominal frequency. The conversion of PPM into equivalent variation in Hz can be seen in Eqn. 5-1.

*Variation in Hz = $f * \text{PPM} = f * 10^{-6}$* , where f is the center frequency

Eqn. 5-1 PPM in unit Hz

Taking the above definition of PPM and together with the test requirement into account, we can concretize the test requirement for NR n78 operated in Mid band as follows: The uplink center frequency is 3549.99 MHz, the frequency variation of 0.1PPM is about 355 Hz, therefore the total $|\Delta f| \leq (0.1 \text{ PPM} + 15 \text{ Hz}) = 370 \text{ Hz}$.

The test result in Fig. 5-13 shows the average frequency error $|\Delta f|$ is 7.93 Hz which is within the test requirement limit 370 Hz.

Tx Measurement - NR FR1 1 - MEV												
Detected and Statistics												
Statistic Count	Allocation		Modulation		Channel Type		Out of Tolerance		View Filter		Throughput	
20/20	NoRB: 270 OffsetRB: 0		QPSK		PUSCH		0 %		100 %		%	
Power												
	Current		Average		Min		Max		Std Dev			
Tx Power [dBm]	17.63		17.62		17.45		17.69				0.06	
PEAK Power [dBm]	25.59		25.56		25.41		25.81				0.05	
RB Power [dBm]	-6.66		-6.67		-6.84		-6.60				0.06	
Tx Measurement												
	Current		Average		Extreme		Std Dev					
	l	h	l	h	l	h	l	h	l	h		
EVM RMS [%]	3.50	3.41	3.48	3.39	3.58	3.51	0.07	0.07			0.07	
EVM Peak [%]	13.34	12.82	13.66	13.58	16.90	16.87	0.70	0.88			0.88	
EVM DMRS [%]	3.78	3.69	3.59	3.51	3.88	3.78	0.15	0.16			0.16	
MErr RMS [%]	2.46	2.40	2.45	2.39	2.53	2.48	0.05	0.05			0.05	
MErr Peak [%]	11.98	11.66	12.38	12.05	16.01	15.60	0.83	0.76			0.76	
MErr DMRS [%]	2.65	2.58	2.53	2.47	2.71	2.65	0.10	0.11			0.11	
PhErr RMS [°]	1.42	1.39	1.41	1.38	1.47	1.44	0.03	0.03			0.03	
PhErr Peak [°]	7.40	7.18	7.37	7.29	9.02	8.89	0.44	0.44			0.44	
PhErr DMRS [°]	1.55	1.51	1.46	1.43	1.59	1.56	0.07	0.07			0.07	
IQ Offset [dBc]		-46.84		-46.05		-44.45		0.52			0.52	
Freq Error [Hz]		-17.61		-7.93		84.57		21.88			21.88	
Freq Error [ppm]		-0.00		-0.00		0.02		0.01			0.01	
Sample Clock Error [ppm]		-0.00		0.00		0.04		0.01			0.01	
Timing Error [Ts]		-404.21		-404.07		-404.33		0.17			0.17	

Fig. 5-13 Test result of frequency error

5.6 Error Vector Magnitude for Inter-band EN-DC within FR1 (6.4B.2.3.1)

This test case should apply LTE anchor agnostic approach.

For more details, refer to TS38.521-1 [6], clause 6.4.2.1

5.6.1 Test Purpose

As defined in [6], the Error Vector Magnitude (EVM) is a measure of the difference between the reference waveform and the measured waveform. This difference is called the error vector. Before calculating the EVM, the measured waveform is corrected by the sample timing offset and RF frequency offset. Then the carrier leakage shall be removed from the measured waveform before calculating the EVM.

The measured waveform is further equalized using the channel estimates subjected to the EVM equalizer spectrum flatness requirement specified in TS38.521-1 [6] clause 6.4.2.4.3. For DFT-s-OFDM waveforms, the EVM result is defined after the front-end FFT and IDFT as the squares root of the ratio of the mean error vector power to the mean reference power expressed as a %. For CP-OFDM waveforms, the EVM result is defined after the front-end FFT as the squares root of the ratio of the mean error vector power to the mean reference power expressed as a %.

The basic EVM measurement interval in the time domain is one preamble sequence for the PRACH and the duration of PUCCH/PUSCH channel, or one hop, if frequency hopping is enabled for PUCCH and PUSCH in the time domain. The EVM measurement interval is reduced by any symbols that contains an allowable power transient as defined in TS38.521-1 [6] clause 6.3.3.3.

Note: EVM measurement needs to be conducted on PUSCH, PUCCH and PRACH channels. In this chapter, the measurement on PUSCH is described.

5.6.2 Test Preparations

5.6.2.1 Example Test Configuration

Example

Test Configuration for PUSCH, Test ID 9

Initial Conditions			
Test Environment as specified in TS 38.508-1 [5] subclause 4.1		Normal	
Test Frequencies as specified in TS 38.508-1 [5] subclause 4.3.1		Mid range	
Test Channel Bandwidths as specified in TS 38.508-1 [5] subclause 4.3.1		Highest	
Test SCS as specified in Table 5.3.5-1		All (Lowest SCS is selected in this example)	
Test Parameters			
Test ID	Downlink Configuration	Uplink Configuration	
	N/A	Modulation (NOTE 3)	RB allocation (NOTE 1)
9		CP-OFDM QPSK	Inner Full
NOTE 1: The specific configuration of each RB allocation is defined in Table 6.1-1.			
NOTE 2: Test Channel Bandwidths are checked separately for each NR band, which applicable channel bandwidths are specified in Table 5.3.5-1.			
NOTE 3: DFT-s-OFDM PI/2 BPSK test applies only for UEs which supports half Pi BPSK in FR1.			

Table 5-18 Example of a test configuration out of TS38.521-1 [6] Table 6.4.2.1.4.1-1

5.6.2.2 Cell Parameter Settings

Since this test case requires the LTE anchor agnostic approach, LTE settings can be referred in chapter 3.6.

NR settings on CMX can generally refer to chapter 5.1.2.2 by configuration given in Table 5-19

Parameters	NR	
	Configuration	Value
Frequency Range		FR1
Duplex Mode		TDD
Band		n78
Test Frequency	Mid	See Table 5-4
Test Channel Bandwidth	Highest	100 MHz
Test SCS	Lowest	30 kHz
DL RMC (Modulation)	N/A	e.g. MCS index 4 MCS table 64QAM
DL RMC (RB Allocation)	N/A	e.g. 273@0
UL RMC (Modulation)	CP-OFDM QPSK	MCS index 2 MCS table 64QAM
UL RM (RB Allocation)	Inner Full	137@68
Downlink Power Level	Total Cell Power	-47 dBm
Uplink Power Control	P0-NominalWithGrant	-90 dBm
	Alpha	0.8
	P0	0

	TPC ³⁰	Max / Closed Loop
	Target Power Total ³¹	-31 dBm
	Tolerance ³¹	1 dB
DFT-s-OFDM		Disable
MAC Padding		Enable
Initial BWP		1099

Table 5-19 Test parameters settings for Error Vector Magnitude (EVM)

Test case requires UE to send uplink power level in P_{umax} and P_{min} at test step 1.2 and 1.4 in TS38.521-1 [6], clause 6.4.2.1.4.2, respectively.

TPC is set to MAX when the UE is required to send P_{umax} uplink power.

In case that the UE is required to send nominal uplink power level P_{min} , the specification requires that the UE output power should be measured in the so called uplink power control window which is in the range $P_{\text{min}} + \text{MU}$ to $P_{\text{min}} + (\text{MU} + \text{Uplink power control window size})$ dB, where

- ▶ P_{min} is defined in Table 6.3.1.3-1 of TS38.521-1. In our example here, it is -33 dBm for 100 MHz test channel bandwidth
- ▶ MU is the test system uplink power measurement uncertainty and is specified in TS38.521-1 [6], Table F.1.2-1 for the carrier frequency f and the channel bandwidth BW. In our example, carrier frequency is 3549.99 MHz, channel BW is 100 MHz and $-40\text{dBm} \leq P_{\text{UL}} \leq -33\text{dBm} \leq -25\text{dBm}$, therefore, MU is $\pm 3.0\%$ of P_{UL} , i.e. ± 1 dB
- ▶ Uplink power control window size = 1dB (UE power step size) + 0.7dB (UE power step tolerance) + (Test system relative power measurement uncertainty), where, the UE power step tolerance is specified in TS 38.101-1, Table 6.3.4.3-1 and is 0.7dB for 1dB power step size, and 1dB for the Test system relative power measurement uncertainty as specified in TS38.521-1 [6], Table F.1.2-1. Therefore, the total uplink power control window size is 2.7dB. For more details about the uplink power control window, refer to Annex F.4.2.1 in [1].

By considering above values given in the test case, we have the following calculation to determine the expected UL target power range

$$\text{UL target power (lower limit)} = P_{\text{min}} + \text{MU} = (-33 \text{ dBm}) + 1 \text{ dB} = -32 \text{ dBm}$$

$$\text{UL target power (upper limit)} = P_{\text{min}} + \text{MU} + \text{uplink power control window size} = (-33 \text{ dBm}) + 1 \text{ dB} + 2.7 \text{ dB} = -29.3 \text{ dBm}$$

As long as the measured UL power is in the range between -32 dBm and -29.3 dBm, it is considered that the nominal power level P_{min} is reached. Therefore, no further TPC is needed to be sent to UE to increase or decrease the UL power. Otherwise, if measured UL power is out of range, then UE will be commanded by the proper TPC to adjust the transmit power until the measured UL power is in the range.

This kind of approach is implemented on CMX using closed loop TPC with its associated configurable parameters, i.e. target power total and tolerance. As illustrated in Fig. 5-14, we configure target power total to be half of the uplink power control window size (in dB) above the lower limit of UL target power and set the tolerance to be the half of the uplink power control window size. The ultimate goal here is to create an intended test condition so that the UE transmitted UL power should be no lower than P_{min} . In this test case, our calculation for these two parameters are as follows,

$$\text{Tolerance} = 1/2 * \text{uplink power control window size} = 1/2 * 2.7 \text{ dB} = 1.4 \text{ dB}$$

³⁰ TPC is set according to the test step. If UE is required to transmit P_{UMAX} , TPC should be set to Max. In P_{min} case, due to the requirement in test step 1.4 of TS38.521-1 [6], clause 6.4.2.1.4.2. TPC is set to Closed Loop. For that TPC type, target power level and tolerance in the subsequent parameter settings have to be considered.

³¹ This parameter setting is only configurable in CMSquares and relevant when TPC is set to Closed Loop

Target power total = Nominal target power level (e.g. P_{min}) + MU + Tolerance = $-33 + 1 + 1.4 = -30.5$ dBm

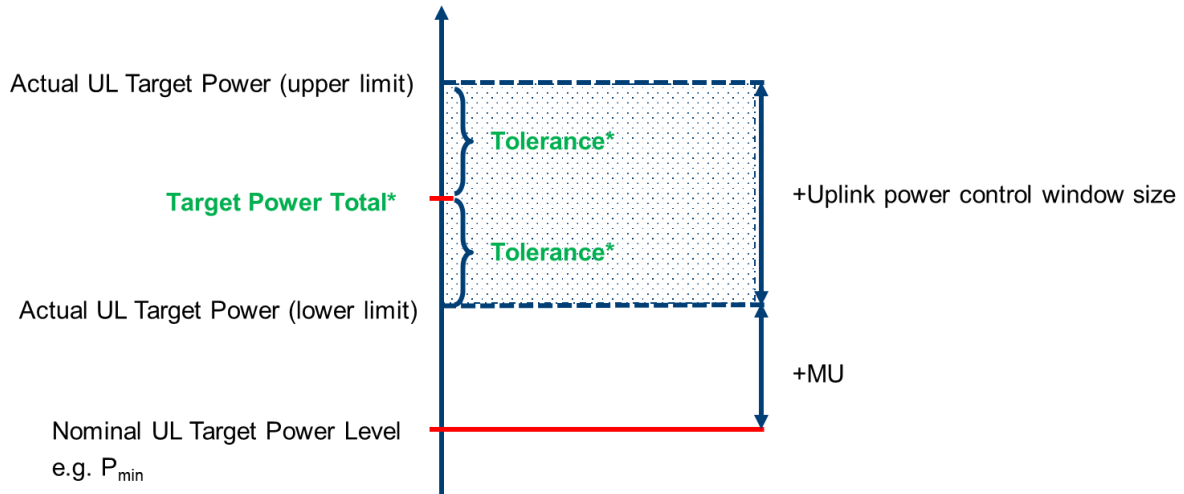

* Target Power Total and Tolerance are the configurable parameters in Cmsquares. Tolerance = $1/2 \times$ uplink power control window size

Fig. 5-14 Calculation of target power total and tolerance

The way of calculating "target power total" and "tolerance" described above applies also to other test cases, e.g. carrier leakage test (see chapter 5.7) and in-band emissions (see chapter 5.8).

Finally, uplink power control settings in Cmsquares for P_{umax} and P_{min} can be seen in Fig. 5-15.

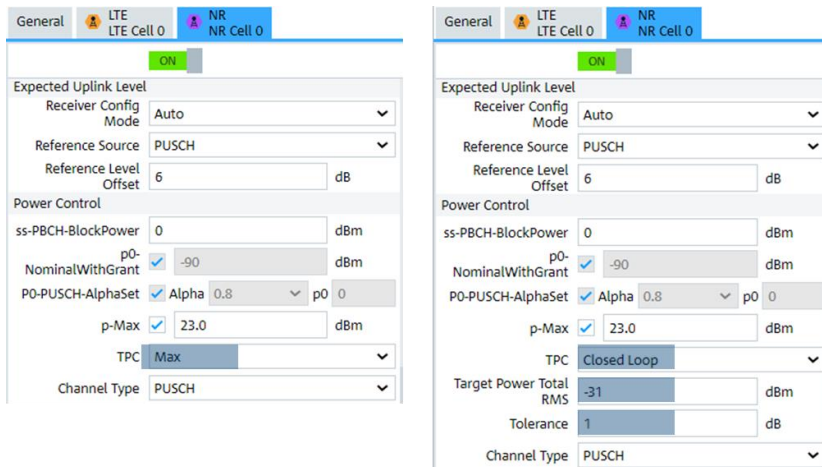

Fig. 5-15 Uplink power control setting, P_{umax} (left) and P_{min} (right)

The uplink RMC configuration is shown in Fig. 5-16

NR Cell 0 > UE Slot Scheduling											
Slot Index	0	1	2	3	4	5	6	7	7	8	9
	DL	DL	DL	DL	DL	DL	DL	DL	UL	UL	UL
Start RB	-	0	0	0	0	0	0	-	-	68	68
# RB	-	273	273	273	273	273	273	-	-	137	137
MCS	-	4	4	4	4	4	4	-	-	2	2
DCI Format	-	DCI 11	DCI 11	DCI 11	DCI 11	DCI 11	DCI 11	-	-	DCI 01	DCI 01
MIMO Scheme	-	SISO	SISO	SISO	SISO	SISO	SISO	-	-	SISO	SISO
▶ Time Domain Alloc.											

Fig. 5-16 Uplink scheduling for EVM testing

5.6.2.3 Multi-Evaluation Measurement Settings

NR multi-evaluation settings can generally refer to chapter 5.1.2.3

The expected nominal power should be adapted in accordance with the P_{umax} and P_{min} case as shown in Fig. 5-17.

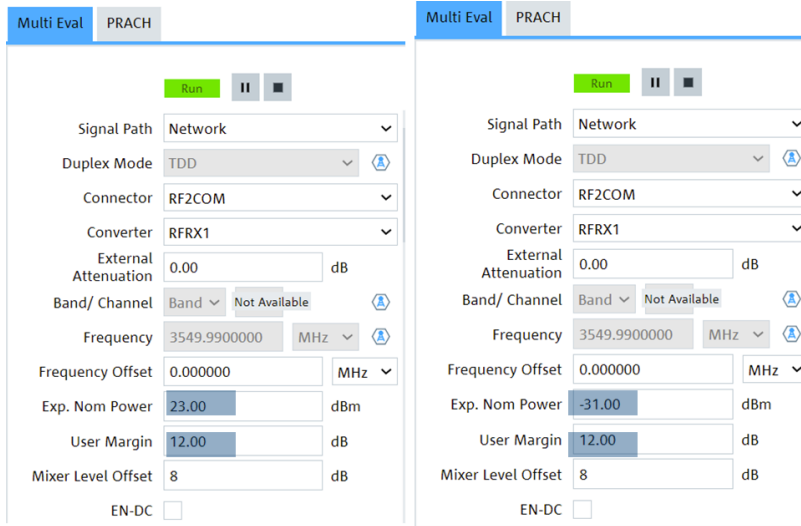

Fig. 5-17 NR multi-evaluation configuration for P_{umax} (left) and P_{min} (right)

5.6.3 Test Procedure

Below described procedure is valid for EVM measurement on PUSCH

1. Configure the LTE cell according to LTE anchor agnostic approach, see chapter 3.6
2. Configure the NR cell according to the configurations given in Table 5-19, and set maximum uplink output power P_{umax} (set TPC to Max)
3. Configure the NR multi-evaluation measurement. Set 23 dBm (P_{umax}) as expected nominal power.
4. Turn on both LTE and NR cell
5. Switch on DUT and wait DUT is registered on LTE cell
6. Activate EN-DC mode
7. Reduce the LTE uplink RB allocation to 0 RB as given in 3.6
8. Start the EVM measurement in the NR as given in 4.4.2 (select "EVM" measurement)
9. Set minimum uplink output power P_{min} (set target power total/tolerance and TPC Closed Loop)
10. Set expected nominal power to P_{min} value in the NR Multi-evaluation measurement
11. Restart the EVM measurement

5.6.4 Test Requirement and Results

Test requirement for EVM is shown in Table 5-20 according to TS38.521-1 [6], Table 6.4.2.1.5-1

Table 6.4.2.1.5-1: Test requirements for Error Vector Magnitude

Parameter	Unit	Average EVM Level
Pi/2-BPSK	%	30 + TT
QPSK	%	17.5 + TT
16 QAM	%	12.5 + TT
64 QAM	%	8 + TT
256 QAM	%	3.5 + TT

Note 1: TT is defined in Table 6.4.2.1.5-2.

Table 5-20 Test requirement of EVM (TS38.521-1 [6], Table 6.4.2.1.5-1)

The applied test tolerance TT is defined in TS38.521-1 [6], Table 6.4.2.1.5-2

Table 6.4.2.1.5-2: Test Tolerance

Parameter	Unit	Average EVM Level
Pi/2-BPSK	%	0
QPSK	%	0
16 QAM	%	0
64 QAM	%	0
256 QAM	%	0.3 for $15 \text{ dBm} < P_{UL}$ 0.8 for $-25 \text{ dBm} < P_{UL} \leq 15 \text{ dBm}$ 1.1 for $-40 \text{ dBm} \leq P_{UL} \leq -25 \text{ dBm}$

Table 5-21 Test tolerance (TS38.521-1 [6], Table 6.4.2.1.5-2)

Therefore, in our example here, the PUSCH EVM as well as EVM_{DMRS} with QPSK modulation shall not exceed 17.5% (TT = 0%).

The EVM measurement results in P_{umax} and P_{min} case are all within the limit of 17.5% (see Fig. 5-18 and Fig. 5-19, respectively).

Also, the measured UE uplink power levels revealed in the measurement results are in the following range.

P_{umax} case, 19 ~ 26 dBm (requirement of UE maximum output power in Chapter 5.1)

P_{min} case, -29.3 ~ -32.0 dBm (based on the description in Chapter 5.6.2.2)

Thus, the measured EVM in both cases are valid.

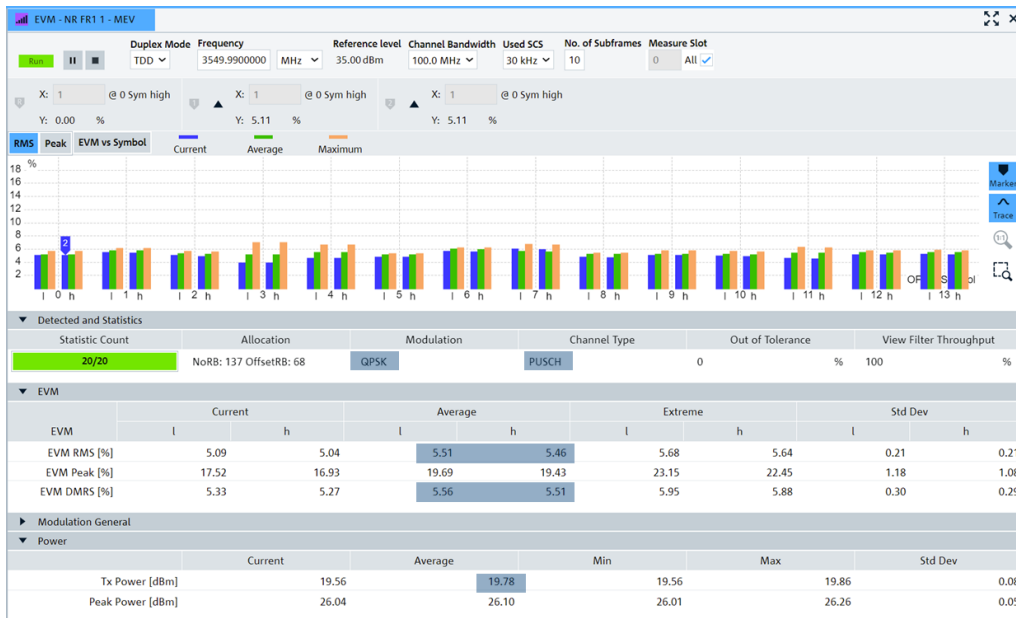

Fig. 5-18 EVM and EVM_{DMRS} measurement result (P_{umax} case)

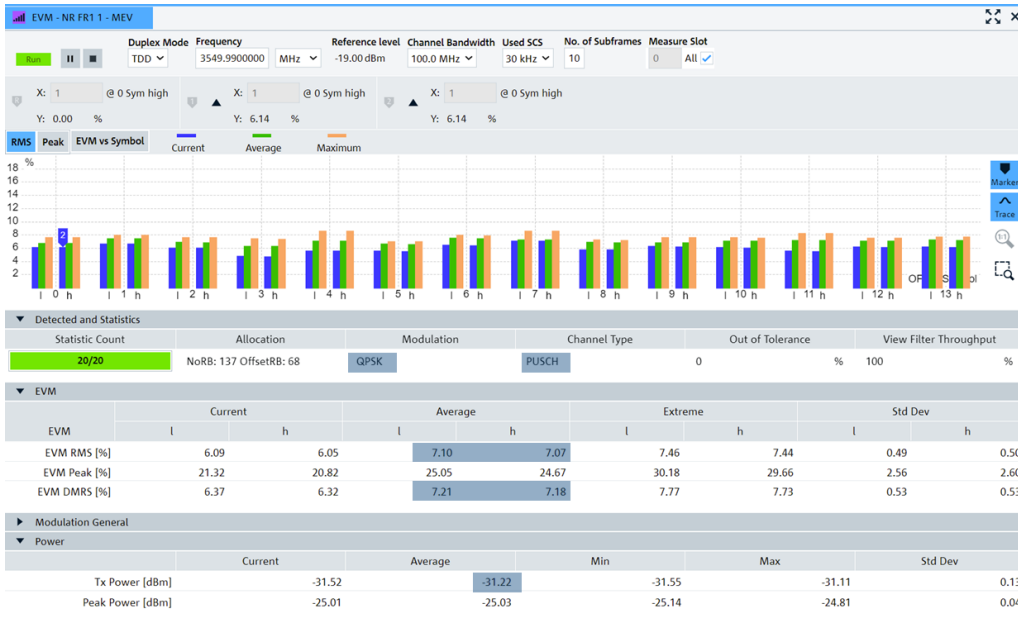

Fig. 5-19 EVM and EVM_{DMRS} measurement result (P_{min} case)

5.7 Carrier Leakage for inter-band EN-DC within FR1 (6.4B.2.3.2)

This test case should apply LTE anchor agnostic approach.

For more details, refer to TS38.521-1 [6], clause 6.4.2.2

5.7.1 Test Purpose

Carrier leakage is a form of interference caused by crosstalk or DC offset of the I/Q signal during the signal direct up-conversion. The measurement of this impairment is referred to as I/Q origin offset. Carrier leakage expresses itself as unmodulated sine wave with the carrier frequency or center frequency of aggregated transmission bandwidth configuration. It is an interference of approximately constant amplitude and independent of the amplitude of the wanted signal.

The purpose of this test is to exercise the UE transmitter to verify its modulation quality in terms of carrier leakage [6].

5.7.2 Test Preparations

5.7.2.1 Example Test Configuration

Example

Test ID 1

Initial Conditions	
Test Environment as specified in TS 38.508-1 [5] subclause 4.1	Normal
Test Frequencies as specified in TS 38.508-1 [5] subclause 4.3.1	Low range, Mid range, High range
Test Channel Bandwidths as specified in TS 38.508-1 [5] subclause 4.3.1	Mid
Test SCS as specified in Table 5.3.5-1	Lowest

Test Parameters			
Test ID	Downlink Configuration	Uplink Configuration	
	N/A	Modulation	RB allocation (NOTE 1, 3)
1		DFT-s-OFDM QPSK	Inner_1RB_Left

NOTE 1: The specific configuration of each RB allocation is defined in Table 6.1-1.
NOTE 2: Test Channel Bandwidths are checked separately for each NR band, which applicable channel bandwidths are specified in Table 5.3.5-1.
NOTE 3: When the signalled DC carrier position is at Inner_1RB_Left, use Inner_1RB_Right for UL RB allocation.

Table 5-22 Example of a test configuration out of TS38.521-1 [6] Table 6.4.2.2.4.1-1

5.7.2.2 Cell Parameter Settings

Since this test case requires the LTE anchor agnostic approach, LTE settings can be referred in chapter 3.6.

NR settings on CMX can generally refer to chapter 5.1.2.2 by configuration given in Table 5-23 and Table 5-25.

Parameters	NR	
	Configuration	Value
Frequency Range		FR1
Duplex Mode		TDD
Band		n78
Test Frequency	Mid Range	See Table 5-24
Test Channel Bandwidth	Mid	50 MHz
Test SCS	Lowest	15 kHz
DL RMC (Modulation)	N/A	e.g. MCS index 4 MCS table 64QAM
DL RMC (RB Allocation)	N/A	e.g. 273@0
UL RMC (Modulation)	DFT-s-OFDM QPSK	MCS index 2 MCS table 64QAM
UL RM (RB Allocation)	Inner_1RB_Left	1@1
Downlink Power Level	Total Cell Power	-50 dBm
Uplink Power Control	P0-NominalWithGrant	-90 dBm
	Alpha	0.8
	P0	0
	TPC	Close Loop
	Target Power Total RMS	See Table 5-25
	Tolerance	See Table 5-25
DFT-s-OFDM		Enable
MAC Padding		Enable
Initial BWP		1924

Table 5-23 Test parameter settings for carrier leakage test

Table 4.3.1.1.1.78-1: Test frequencies for NR operating band n78, SCS 15 kHz and ΔF_{Raster} 15 kHz.

CBW [MHz]	carrier Bandwidth [PRBs]	Range	Carrier centre [MHz]	Carrier centre [ARFCN]	point A [MHz]	absolute Frequency Point A [ARFCN]	offsetTo Carrier [Carrier PRBs]	SS block SCS [kHz]	GSCN	absolute Frequency SSB [ARFCN]	k_{SSB}	Offset Carrier CORE SET#0 [RBs] Note 2	CORE SET#0 Index (Offset [RBs]) Note 1	offsetTo PointA (SIB1) [PRBs] Note 1	
50	270	Downlink & Uplink	Low	3325.02	621668	3300.72	620048	0	30	7711	620352	4	3	0 (2)	5
		Mid	3549.99	636666	3507.33	633822	102	7867		635328	6	1	0 (2)	105	
		High	3774.99	651666	3659.97	643998	504	8024		650400	6	3	1 (6)	513	

Note 1: The CORESET#0 Index and the associated CORESET#0 Offset refers to Table 13-3 in TS 38.213 [22]. The value of CORESET#0 Index is signalled in controlResourceSetZero (pdcch-ConfigSIB1) in the MIB. The offsetToPointA IE is expressed in units of resource blocks assuming 15 kHz subcarrier spacing for FR1 and 60 kHz subcarrier spacing for FR2.
Note 2: The parameter Offset Carrier CORESET#0 specifies the offset from the lowest subcarrier of the carrier and the lowest subcarrier of CORESET#0. It corresponds to the parameter $\Delta F_{\text{OffsetCORESET0Carrier}}$ in Annex C expressed in number of common RBs.

Table 5-24 Mid-Range test frequency configuration of NR n78, CBW 50 MHz and SCS 15 kHz (TS38.508-1, Table 4.3.1.1.1.78-1)³²

In this test case, the test procedure specified by TS38.521-1 [6] clause 6.4.2.2.4.2 requires the UE to send nominal uplink power at 10 dBm, 0 dBm, -30 dBm and P_{min} in different test steps with close loop TPC.

As explained in previous chapter 5.6.2.2, measurement uncertainty (MU) and uplink power control window size need to be considered so that the target power total value and its tolerance can be determined and configured on CMX in the end.

By checking TS38.521-1 [6] Table F.1.2-1, if 3.0GHz < f ≤ 4.2GHz and 40MHz < BW ≤ 100MHz, MU for carrier leakage is ±1.6 dB, test system relative power measurement uncertainty is ±1 dB

Uplink power control window size = 1dB (UE power step size) + 0.7 dB (UE power step tolerance) + (Test system relative power measurement uncertainty) = 2.7 dB

CMX parameters "target power total" and "tolerance" are calculated according to chapter 5.6.2.2 . The applied values with respect to the required nominal uplink power can be found in Table 5-25.

Nominal Uplink Power (dBm)	Target Power Total (dBm)	Tolerance (dB)
10	13.0	1.3
0	3.0	1.3
-30	-27.1	1.3
-36 ³⁵ (P _{min})	-33.1	1.3

Table 5-25 Target power total and tolerance settings for CMsquares

5.7.2.3 Multi-Evaluation Measurement Settings

NR multi-evaluation settings can refer to chapter 5.1.2.3

The expected nominal power should be set in accordance with the nominal uplink power given in Table 5-25.

5.7.3 Test Procedure

1. Configure the LTE with following configurations (LTE anchor agnostic approach, see chapter 3.6)
2. Configure the NR cell with configurations given in Table 5-23
3. Turn on both LTE and NR cell
4. Switch on DUT and wait until DUT is registered on LTE cell
5. Activate EN-DC mode
6. Reduce the LTE uplink RB allocation to 0 RB as given in 3.6
7. Set the close loop TPC in NR and set the "total target power" and "tolerance" value given in Table 5-25 (for nominal uplink power 10dB/ 0dB/ -30dB/ P_{min})
8. Configure the NR multi evaluation measurement ("expected nominal power" setting should associate with the nominal uplink power)
9. Measure the NR as given in 4.4.2 (select "Tx Measurement" measurement)
10. Repeat Step 7 to 9 until all the specified nominal uplink power levels are tested

³² Informative. As long as the range is specified in CMsquares, the associated parameters are automatically set on CMX.

³⁵ According to TS38.521-1 [6] Table 6.3.1.3-1, nominal uplink P_{min} is -36 dBm for CBW 50 MHz

5.7.4 Test Requirement and Results

Test requirement defined by the specification is shown in Table 5-26

Table 6.4.2.2.5-1: Test requirements for Relative Carrier Leakage Power

Parameters UE output power	Relative limit (dBc)
10 + MU to 10 + (MU + Uplink power control window size) dBm	-28 + TT
0 + MU to 0 + (MU + Uplink power control window size) dBm	-25 + TT
-30 + MU to -30 + (MU + Uplink power control window size) dBm	-20 + TT
P _{min} + MU to P _{min} + (MU + Uplink power control window size) dBm	-10 + TT
<p>NOTE 1: The measurement bandwidth is 1 RB and the limit is expressed as a ratio of measured power in one non-allocated RB to the measured total power in all allocated RBs.</p> <p>NOTE 2: The applicable frequencies for this limit depend on the parameter <i>txDirectCurrentLocation</i> in <i>UplinkTxDirectCurrent</i> IE, and are those that are enclosed either in the RBs containing the carrier leakage frequency, or in the two RBs immediately adjacent to the carrier leakage frequency but excluding any allocated RB.</p> <p>NOTE 3: N_{RB} is the Transmission Bandwidth Configuration (see Section 5.3).</p> <p>NOTE 4: MU is the test system uplink power measurement uncertainty and is specified in Table F.1.2-1 for the carrier frequency <i>f</i> and the channel bandwidth BW.</p> <p>NOTE 5: Uplink power control window size = 1dB (UE power step size) + 0.7dB (UE power step tolerance) + (Test system relative power measurement uncertainty), where, the UE power step tolerance is specified in TS 38.101-1 [2], Table 6.3.4.3-1 and is 0.7dB for 1dB power step size, and the Test system relative power measurement uncertainty is specified in Table F.1.2-1.</p> <p>NOTE 6: Test tolerance TT = 0.8 dB.</p> <p>NOTE 7: P_{min} is the minimum output power according to Table 6.3.1.3-1.</p>	

Table 5-26 Test requirement of carrier leakage (TS38.521-1 [6] Table 6.4.2.2.5-1)

By considering following facts:

- a) MU = ±1.6 dB
- b) Uplink power control window size = 2.7 dB
- c) TT = 0.8 dB

The test requirements Table 5-26 can be converted into Table 5-27

Nominal Uplink Power (dBm)	Expected Measured UE Output Power (dBm)	Relative Carrier Leakage Power (dBc)
10	11.6 ~ 14.3	< -27.2
0	1.6 ~ 4.3	< -24.2
-30	-28.4 ~ -25.7	< -19.2
P _{min} = -36 @ CBW = 50 MHz	-34.4 ~ -31.7	< -9.2

Table 5-27 Test requirement of carrier leakage

For the carrier leakage test case, we need to ensure that the measured UE output power is in the range (pre-condition) and the corresponding relative carrier leakage power does not exceed the limit as given in Table 5-27.

Fig. 5-20 shows that the carrier leakage power measured at 10 dBm UE nominal uplink power. According to Table 5-27, UE should be sending power in the range of 11.6 dBm and 14.3 dBm. The actual measured UE

output power is 12.35 which is in range. Measured IQ offset (i.e. carrier leakage) is -44.08 dBc which is below the limit -27.2 dBc. Therefore, the measured result is considered as valid and pass.

The same check can be also applied in other nominal uplink power cases, i.e. 0, -30 and P_{min} , with the corresponding limit values listed in Table 5-27.

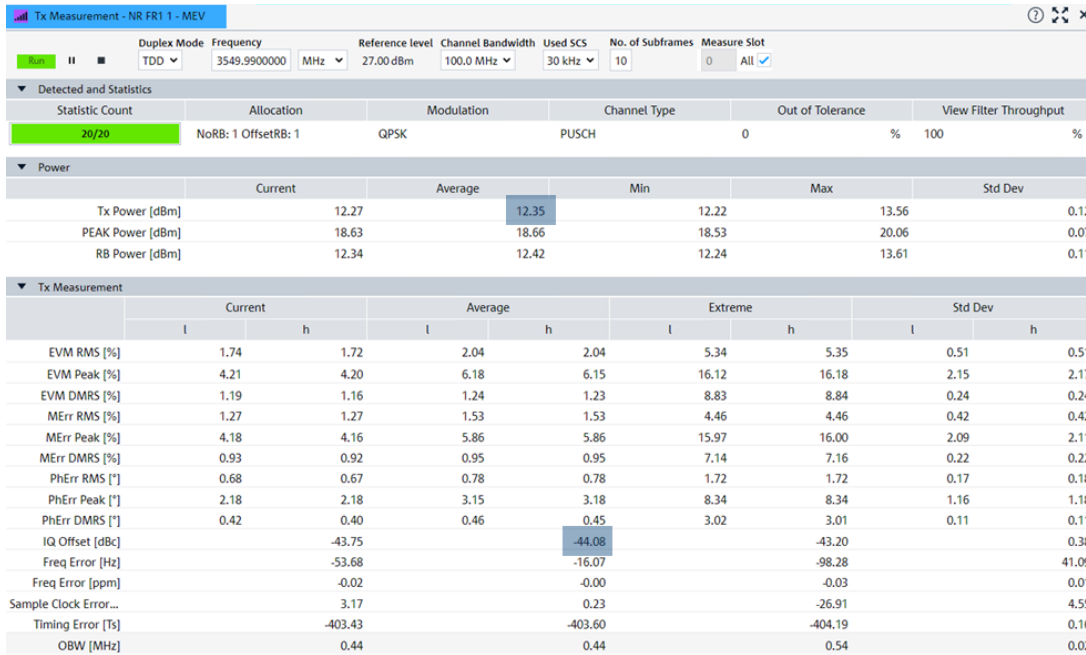

Fig. 5-20 Measurement result of carrier leakage with 10 dBm UE nominal output power

5.8 In-band Emissions for Inter-band EN-DC within FR1 (6.4B.2.3.3)

This test case should apply LTE anchor agnostic approach.

For more details, refer to TS38.521-1 [6], clause 6.4.2.3

The following section describes the in-band emissions (IBE) measurement on PUSCH

5.8.1 Test Purpose

5G NR uses frequency scheduling with a granularity of resource blocks. If the UE is scheduled with less RBs than the maximum RBs, it should be verified that there is no unwanted emission in non-scheduled RB as this would interfere other users in the cell.

According to [6], the in-band emissions (IBE) is a measure of the interference falling into the non-allocated resources blocks.

The IBE is defined as the average emission across 12 sub-carriers and as a function of the RB offset from the edge of the allocated UL transmission bandwidth. The IBE is measured as the ratio of the UE output power in a non-allocated RB to the UE output power in an allocated RB.

The purpose of this test is to exercise the UE transmitter to verify its modulation quality in terms of IBE.

5.8.2 Test Preparations

5.8.2.1 Example Test Configuration

Example

Test Configuration Table for PUSCH, Test ID 3

Initial Conditions			
Test Environment as specified in TS 38.508-1 [5] subclause 4.1		Normal	
Test Frequencies as specified in TS 38.508-1 [5] subclause 4.3.1		Mid range	
Test Channel Bandwidths as specified in TS 38.508-1 [5] subclause 4.3.1		Highest	
Test SCS as specified in Table 5.3.5-1		Lowest	
Test Parameters			
Test ID	Downlink Configuration	Uplink Configuration	
	N/A	Modulation	RB allocation (NOTE 1)
3		CP-OFDM QPSK	Inner_1RB_Left
NOTE 1: The specific configuration of each RB allocation is defined in Table 6.1-1.			
NOTE 2: Test Channel Bandwidths are checked separately for each NR band, which applicable channel bandwidths are specified in Table 5.3.5-1.			

Table 5-28 Example of a test configuration out of TS38.521-1 [6] Table 6.4.2.3.4.1-1

5.8.2.2 Cell Parameter Settings

Since this test case requires the LTE anchor agnostic approach, LTE settings can be referred in chapter 3.6.

NR settings on CMX can generally refer to chapter 5.1.2.2 by configuration given in Table 5-29 and Table 5-30.

Parameters	NR	
	Configuration	Value
Frequency Range		FR1
Duplex Mode		TDD
Band		n78
Test Frequency	Mid	See Table 5-4
Test Channel Bandwidth	Highest	100 MHz
Test SCS	Lowest	30 kHz
DL RMC (Modulation)	N/A	e.g. MCS index 4 MCS table 64QAM
DL RMC (RB Allocation)	N/A	e.g. 273@0
UL RMC (Modulation)	CP-OFDM QPSK	MCS index 2 MCS table 64QAM
UL RM (RB Allocation)	Inner_1RB_Left	1@1
Downlink Power Level	Total Cell Power	-47 dBm
Uplink Power Control	P0-NominalWithGrant	-90 dBm
	Alpha	0.8
	P0	0
	TPC	Closed Loop
	Target Power Total	See Table 5-30
	Tolerance	See Table 5-30
DFT-s-OFDM		Disable
MAC Padding		Enable

Initial BWP		1099
--------------------	--	------

Table 5-29 Test parameter settings for In-band emissions

This test case is tested under 4 different nominal uplink power levels, i.e. 10 dBm, 0 dBm, -30 dBm and P_{min} (i.e. -33 dBm for CBW 100 MHz, refer to TS38.521-1 [6] Table 6.3.1.3-1) with 1 RB allocation.

For each uplink power level, UE output power should be measured within the uplink power control window, defined as $+MU$ to $+(MU + \text{Uplink power control window size})$ dB of the uplink power level, where

- ▶ MU is the test system uplink power measurement uncertainty and is specified in TS38.521-1 [6], Table F.1.2-1 for the carrier frequency f and the channel bandwidth BW. In our example, carrier frequency is 3549.99 MHz, channel BW is 100 MHz, therefore, MU is ± 1.6 dB
- ▶ Uplink power control window size = 1dB (UE power step size) + 0.7dB (UE power step tolerance) + (Test system relative power measurement uncertainty), where, the UE power step tolerance is specified in TS 38.101-1, Table 6.3.4.3-1 and is 0.7dB for 1dB power step size, and ± 1 dB for the test system relative power measurement uncertainty as specified in TS38.521-1 [6], Table F.1.2-1. Therefore, the uplink power control window size is 2.7dB.

Close loop TPC related parameters "target power total" and "tolerance" on CMX are calculated according to chapter 5.6.2.2 . The applied values with respect to the required nominal uplink power can be found in Table 5-30.

Nominal Uplink Power (dBm)	Target Power Total (dBm)	Tolerance (dB)
10	13.0	1.3
0	3.0	1.3
-30	-27.1	1.3
-33 (P_{min})	-30.1	1.3

Table 5-30 UE output power and tolerance for In-band emission tests

An example is shown in Fig. 5-21 to indicate the uplink power control settings when 10 dBm nominal uplink power is required by the test case.

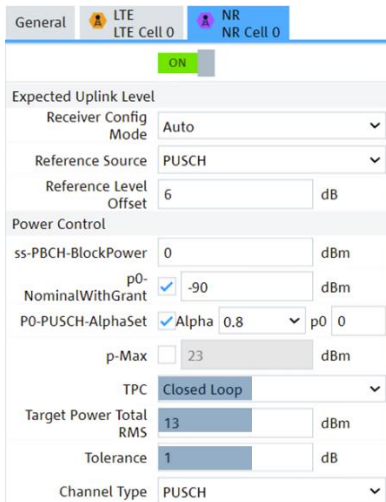

Fig. 5-21 Uplink power control setting (for 10 dBm nominal uplink power)

The uplink RMC configuration is shown in Fig. 5-22.

NR Cell 0 > UE Slot Scheduling											
Slot Index	0	1	2	3	4	5	6	7	7	8	9
	DL	DL	DL	DL	DL	DL	DL	DL	UL	UL	UL
Start RB	-	0	0	0	0	0	0	-	-	1	1
# RB	-	273	273	273	273	273	273	-	-	1	1
MCS	-	4	4	4	4	4	4	-	-	2	2
DCI Format	-	DCI 11	DCI 11	DCI 11	DCI 11	DCI 11	DCI 11	-	-	DCI 01	DCI 01
MIMO Scheme	-	SISO	SISO	SISO	SISO	SISO	SISO	-	-	SISO	SISO

▶ Time Domain Alloc.

Fig. 5-22 Uplink scheduling for in-band emission testing

5.8.2.3 Multi-Evaluation Measurement Settings

NR multi-evaluation settings can generally refer to chapter 5.1.2.3

The expected nominal power should be set in accordance with the nominal uplink power given in Table 5-30. The corresponding setting can be referred in Fig. 5-23.

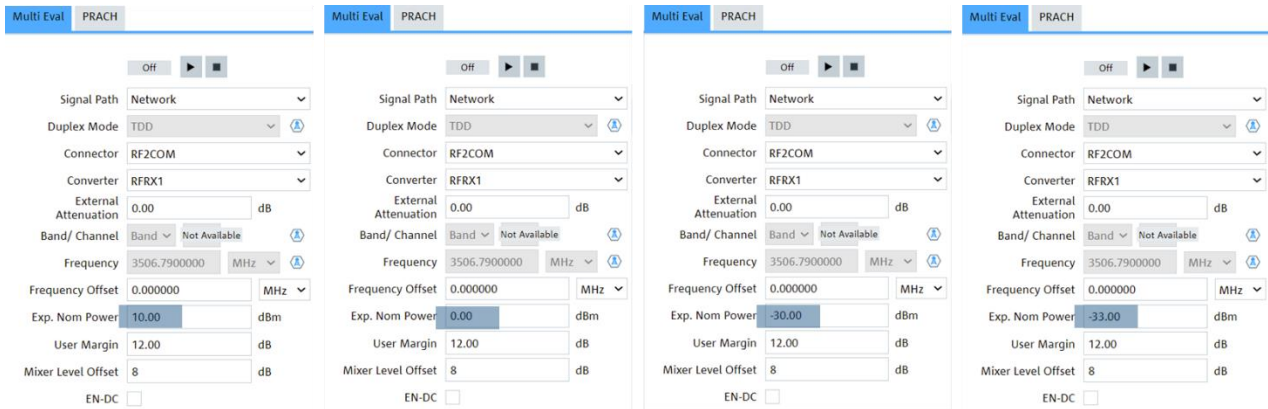

Fig. 5-23 NR multi-evaluation configuration for in-band emission

5.8.3 Test Procedure

The described procedure is valid for in-band emission measurement on PUSCH

1. Configure the LTE cell according to LTE anchor agnostic approach, see chapter 3.6
2. Configure the NR cell according to the configurations given in Table 5-29
3. Turn on both LTE and NR cell
4. Switch on DUT and wait until DUT is registered on LTE cell
5. Activate EN-DC mode
6. Reduce the LTE uplink RB allocation to 0 RB as given in 3.6
7. Set the close loop TPC in NR and set the "total target power" and "tolerance" value given in Table 5-30 (for nominal uplink power 10dB/ 0dB/ -30dB/ P_{min})
8. Configure the NR multi evaluation measurement ("expected nominal power" setting should associate with the nominal uplink power)
9. Start the in-band emission measurement (IBE) in the NR (see 4.4.2, select "Inband Emission" measurement)

10. Repeat Step 7 to 9 until all the specified nominal uplink power levels are tested

5.8.4 Test Requirement and Results

Test requirement defined by the specification is shown in Table 5-31 with 0.8 dB TT according to NOTE11 .

Table 6.4.2.3.5-1: Test requirements for in-band emissions

Parameter description	Unit	Limit (NOTE 1)		Applicable Frequencies
General (NOTE 12)	dB	$\max \left\{ -25 - 10 \cdot \log_{10} (N_{RB} / L_{CRB}), \right.$ $20 \cdot \log_{10} EVM - 3 - 5 \cdot (\Delta_{RB} - 1) / L_{CRB}, \quad + TT$ $\left. -57 \text{ dBm} + 10 \log_{10} (SCS / 15 \text{ kHz}) - \overline{P_{RB}} \right\}$		Any non-allocated (NOTE 2)
IQ Image (NOTE 12)	dB	-28 + TT	Image frequencies when output power > 10 dBm	Image frequencies (NOTES 2, 3)
		-25 + TT	Image frequencies when output power ≤ 10 dBm	
Carrier leakage (NOTE 12)	dBc	-28 + TT	Output power > 10 dBm	Carrier leakage frequency (NOTES 4, 5)
		-25 + TT	0 dBm ≤ Output power ≤ 10 dBm	
		-20 + TT	-30 dBm ≤ Output power < 0 dBm	
		-10 + TT	-40 dBm ≤ Output power < -30 dBm	
<p>NOTE 1: An in-band emissions combined limit is evaluated in each non-allocated RB. For each such RB, the minimum requirement is calculated as the higher of $P_{RB} - 30$ dB and the power sum of all limit values (General, IQ Image or Carrier leakage) that apply. P_{RB} is defined in NOTE 10.</p> <p>NOTE 2: The measurement bandwidth is 1 RB and the limit is expressed as a ratio of measured power in one non-allocated RB to the measured average power per allocated RB, where the averaging is done across all allocated RBs.</p> <p>NOTE 3: The applicable frequencies for this limit are those that are enclosed in the reflection of the allocated bandwidth, based on symmetry with respect to the carrier leakage frequency, but excluding any allocated RBs.</p> <p>NOTE 4: The measurement bandwidth is 1 RB and the limit is expressed as a ratio of measured power in one non-allocated RB to the measured total power in all allocated RBs.</p> <p>NOTE 5: The applicable frequencies for this limit depend on the parameter $txDirectCurrentLocation$ in <i>UplinkTxDirectCurrent</i> IE, and are those that are enclosed either in the RBs containing the carrier leakage frequency, or in the two RBs immediately adjacent to the carrier leakage frequency, but excluding any allocated RB.</p> <p>NOTE 6: L_{CRB} is the Transmission Bandwidth (see Section 5.3).</p> <p>NOTE 7: N_{RB} is the Transmission Bandwidth Configuration (see Section 5.3).</p> <p>NOTE 8: EVM is the limit specified in Table 6.4.2.1.3-1 for the modulation format used in the allocated RBs.</p> <p>NOTE 9: Δ_{RB} is the starting frequency offset between the allocated RB and the measured non-allocated RB (e.g. $\Delta_{RB} = 1$ or $\Delta_{RB} = -1$ for the first adjacent RB outside of the allocated bandwidth).</p> <p>NOTE 10: $\overline{P_{RB}}$ is an average of the transmitted power over 10 sub-frames normalized by the number of allocated RBs, measured in dBm.</p> <p>NOTE 11: Test tolerance TT = 0.8 dB.</p> <p>NOTE 12: In case the parameter 3300 or 3301 is reported from UE via $txDirectCurrentLocation$ IE, IQ Image and Carrier leakage limit do not apply and General limit applies for all non-allocated frequencies.</p>				

Table 5-31 Test requirement (TS38.521-1 [6], Table 6.4.2.3.5-1)

The measurements are performed at allocated frequencies, non-allocated frequencies (general), image frequency of the allocated frequency (IQ image) and the carrier leakage frequency (IQ offset).

A combined relative limit line is applied to evaluate the IBE and plotted in the CMSquares to visualize the measurement results.

The determination of a combined limit line can be summarized in three steps as follows:

Step 1: Determine the limit of "general" on all non-allocated RB

It is calculated based on the formula given in the test requirement Table 5-31. Following three components are calculated

- ▶ $-25 - 10 * \log_{10}(N_{RB}/L_{CRB})$
- ▶ $20 * \log_{10}(EVM) - 3 - 5 * (|\Delta_{RB}| - 1)/L_{CRB}$
- ▶ $-57 + 10 * \log_{10}(SCS/15) - P_{RB}$

Where

N_{RB} is the total number of RBs within the test channel bandwidth

L_{CRB} is the number of allocated RBs

EVM is the maximum allowed EVM in percent which is defined in Table 6.4.2.1.3-1 of [6]. Its value depends on the used modulation type

$|\Delta RB|$ is the distance of the RB from the closest allocated RB

SCS is subcarrier spacing

P_{RB} is the measured mean power of all allocated RBs

The largest value of the above mentioned three components plus 0.8 dB TT is considered as the limit of "general" (non-allocated RB) in dB. Each non-allocated RB has its own "general" limit.

Step 2: Determine the limit of IQ image (on image frequency of the allocated frequency) and IQ offset (on carrier frequency)

The limit is UE transmission power dependent. Its value is given in Table 5-31.

Step 3: Determine the entire combined limit line

Apply the following MAX operation to determine the combined limit line

$MAX \{P_{RB} - 29.2 \text{ dB}, \text{ power sum of all limit values (General, IQ Image or IQ offset) that apply}\}$

Remarks:

- ▶ -29.2 dB is the minimum "general" limit (0.8 TT is added)
- ▶ Second term in the max operation is the summation of the limit containing general, IQ image or IQ offset. It means that
 - For non-allocated RBs at image frequencies of allocated RBs, limit of IQ image should be added to general limit
 - For carrier frequency (in the middle of the channel bandwidth), limit of IQ offset should be added to general limit

It sounds complicated to determine the IBE limit line. But good news is that it is really an easy task for CMX user. Basically, only the modulation type needs to be selected. The CMX's default settings in IBE limit definition are already specification conformed. As shown in Fig. 5-24, for our example here, QPSK modulation is selected. The whole IBE limit line is then generated automatically by CMX.

	n/2-BPSK		n/2-BPSK with shaping		QPSK		16-QAM		64-QAM		256-QAM	
Enable	<input checked="" type="checkbox"/>		<input checked="" type="checkbox"/>		<input checked="" type="checkbox"/>		<input checked="" type="checkbox"/>		<input checked="" type="checkbox"/>		<input checked="" type="checkbox"/>	
General Min	-29.2	dB	-29.2	dB	-29.2	dB	-29.2	dB	-29.2	dB	-29.2	dB
General EVM	30.0	%	30.0	%	17.5	%	12.5	%	8.0	%	3.5	%
General RB Power	-57.0	dBm	-57.0	dBm	-57.0	dBm	-57.0	dBm	-57.0	dBm	-57.0	dBm
IQ Image > 10 dBm	-27.2	dB	-27.2	dB	-27.2	dB	-27.2	dB	-27.2	dB	-27.2	dB
IQ Image <= 10 dBm	-24.2	dB	-24.2	dB	-24.2	dB	-24.2	dB	-24.2	dB	-24.2	dB
IQ Offset @ Output Power												
> 10 dBm	-27.2	dBc	-27.2	dBc	-27.2	dBc	-27.2	dBc	-27.2	dBc	-27.2	dBc
> 0 dBm	-24.2	dBc	-24.2	dBc	-24.2	dBc	-24.2	dBc	-24.2	dBc	-24.2	dBc
> -30 dBm	-19.2	dBc	-19.2	dBc	-19.2	dBc	-19.2	dBc	-19.2	dBc	-19.2	dBc
> -40 dBm	-9.2	dBc	-9.2	dBc	-9.2	dBc	-9.2	dBc	-9.2	dBc	-9.2	dBc

Fig. 5-24 Limit of IBE with QPSK modulation

The IBE measurement results with UE nominal target power level @10 dBm is presented in Fig. 5-25. As we can clearly see that the blue measured levels are all beneath the red combined limit line with respect to general, IQ image and carrier leakage (DC carrier leakage due to IQ offset).

Same as explained in 5.7, additional check of the UE transmission power is required to ensure its conformity with the test requirement. We read in Fig. 5-25 that UE transmits at 13.01 dBm which is in the range of 11.6 dBm and 14.3 dBm at 10 dBm nominal target power level (see Table 5-27).

Therefore, the IBE measurement here is valid and pass.

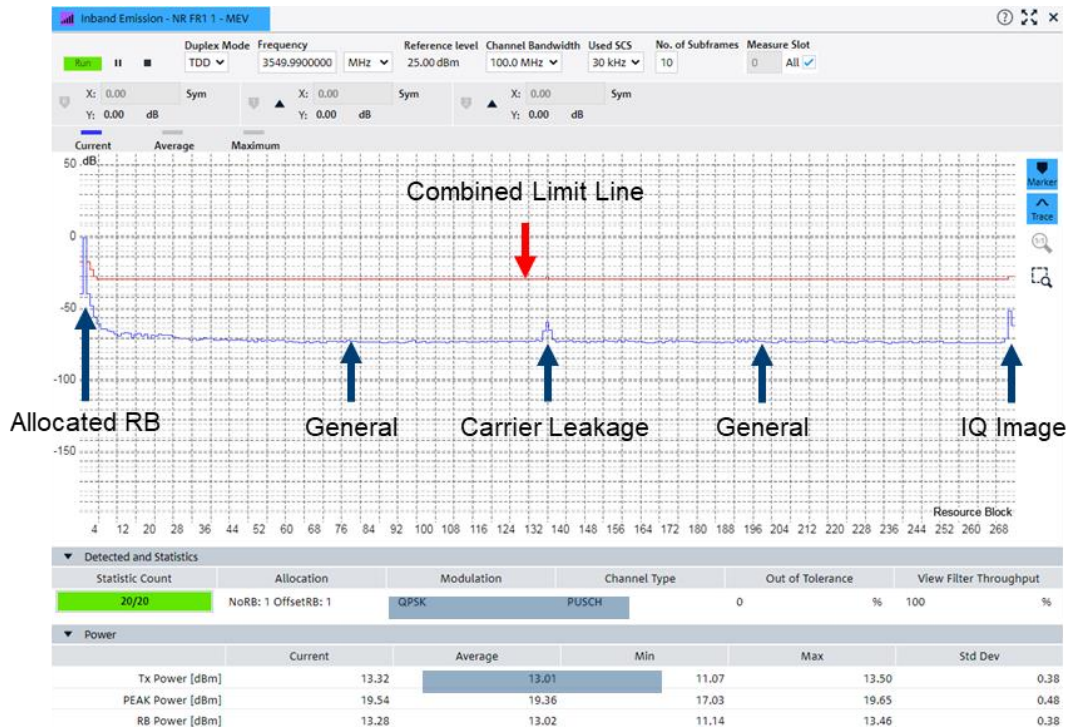

Fig. 5-25 Test result of In-band emission with UE target power level @10 dBm

5.9 EVM Equalizer Flatness for Inter-band EN-DC within FR1 (6.4B.2.3.4)

This test case should apply LTE anchor agnostic approach.

For more details, refer to TS38.521-1 [6], clause 6.4.2.4

5.9.1 Test Purpose

As defined in [6], the zero-forcing equalizer correction applied in the EVM measurement process (as described in TS38.521-1 [6] Annex E) must meet a spectral flatness requirement for the EVM measurement to be valid. The EVM equalizer spectrum flatness is defined in terms of the maximum peak-to-peak ripple of the equalizer coefficients (dB) across the allocated uplink block, at which the equalizer coefficients are generated by the EVM measurement process. The basic measurement interval is the same as for EVM.

The EVM equalizer spectrum flatness requirement does not limit the correction applied to the signal in the EVM measurement process but for the EVM result to be valid, the equalizer correction that was applied must meet the EVM equalizer spectrum flatness minimum requirements.

5.9.2 Test Preparations

5.9.2.1 Example Test Configuration

Example

Test ID 2

Initial Conditions	
Test Environment as specified in TS 38.508-1 [5] subclause 4.1	Normal, TL/VL, TL/VH, TH/VL, TH/VH

Test Frequencies as specified in TS 38.508-1 [5] subclause 4.3.1		Mid range	
Test Channel Bandwidths as specified in TS 38.508-1 [5] subclause 4.3.1		Highest	
Test SCS as specified in Table 5.3.5-1		Lowest	
Test Parameters			
Test ID	Downlink Configuration	Uplink Configuration	
		Modulation	RB allocation (NOTE 1)
2	N/A	CP-OFDM QPSK	Outer Full
NOTE 1: The specific configuration of each RB allocation is defined in Table 6.1-1.			
NOTE 2: Test Channel Bandwidths are checked separately for each NR band, which applicable channel bandwidths are specified in Table 5.3.5-1.			

Table 5-32 Example of a test configuration out of TS38.521-1 [6] Table 6.4.2.4.4.1-1

5.9.2.2 Cell Parameter Settings

Since this test case requires the LTE anchor agnostic approach, LTE settings can be referred in chapter 3.6.

NR settings on CMX can generally refer to chapter 5.1.2.2 by configuration given in Table 5-33.

Parameters	NR	
	Configuration	Value
Frequency Range		FR1
Duplex Mode		TDD
Band		n78
Test Frequency	Mid	See Table 5-4
Test Channel Bandwidth	Highest	100 MHz
Test SCS	Lowest	30 kHz
DL RMC (Modulation)	N/A	e.g. MCS index 4 MCS table 64QAM
DL RMC (RB Allocation)	N/A	e.g. 273@0
UL RMC (Modulation)	CP-OFDM QPSK	MCS index 2 MCS table 64QAM
UL RM (RB Allocation)	Outer Full	273@0
Downlink Power Level	Total Cell Power	-47 dBm
Uplink Power Control	P0-NominalWithGrant	-90 dBm
	Alpha	0.8
	P0	0
	TPC	Max
DFT-s-OFDM		Disable
MAC Padding		Enable
Initial BWP		1099

Table 5-33 Test parameters settings for EVM equalizer flatness

The power control settings in CMsquares can be referred to Fig. 5-26.

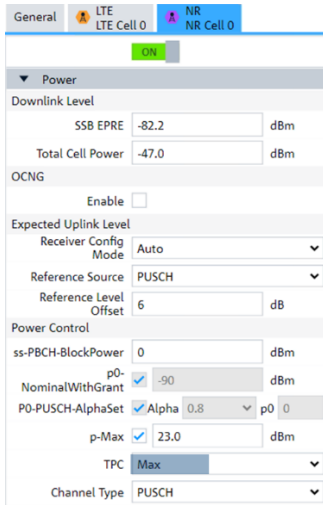

Fig. 5-26 Power control settings

Fig. 5-27 shows the uplink RMC configuration based on the configuration of Table 5-33.

NR Cell 0 > UE Slot Scheduling											
Slot Index	0	1	2	3	4	5	6	7	7	8	9
	DL	DL	DL	DL	DL	DL	DL	DL	UL	UL	UL
Start RB	-	0	0	0	0	0	0	-	-	0	0
# RB	-	273	273	273	273	273	273	-	-	273	273
MCS	-	4	4	4	4	4	4	-	-	2	2
DCI Format	-	DCI 11	DCI 11	DCI 11	DCI 11	DCI 11	DCI 11	-	-	DCI 01	DCI 01
MIMO Scheme	-	SISO	SISO	SISO	SISO	SISO	SISO	-	-	SISO	SISO
▶ Time Domain Alloc.											

Fig. 5-27 Uplink scheduling for EVM equalizer flatness testing

5.9.2.3 Multi-Evaluation Measurement Settings

NR multi-evaluation settings can generally refer to chapter 5.1.2.3, see also 4.4.2.

5.9.3 Test Procedure

1. Configure the LTE cell according to LTE anchor agnostic approach, see chapter 3.6
2. Configure the NR cell according to the configurations given in Table 5-33
3. Configure the NR multi-evaluation measurement
4. Turn on both LTE and NR cell
5. Switch on DUT and wait until DUT is registered on LTE cell
6. Activate EN-DC mode
7. Reduce the LTE uplink RB allocation to 0 RB as given in 3.6
8. Start the EVM equalizer flatness measurement in the NR as given in 4.4.2 (select "Equalizer Spectrum" measurement)

5.9.4 Test Requirement and Results

Test requirements for EVM equalizer flatness under normal condition and extreme condition are shown in Table 5-34 and Table 5-35, respectively. Normal condition and extreme condition differs in the offset of the measured sub-carrier frequency F_{UL_Meas} to the band edge frequency in uplink direction. Offset for normal condition is 3 MHz and for extreme condition is 5 MHz.

In either condition, two frequency ranges, namely, range 1 and range 2 are defined in Table 5-34 and Table 5-35 correspondingly.

Table 6.4.2.4.5-1: Requirements for EVM equalizer spectrum flatness (normal conditions)

Frequency range	Maximum ripple [dB]
$F_{UL_Meas} - F_{UL_Low} \geq 3$ MHz and $F_{UL_High} - F_{UL_Meas} \geq 3$ MHz (Range 1)	4 + TT (p-p)
$F_{UL_Meas} - F_{UL_Low} < 3$ MHz or $F_{UL_High} - F_{UL_Meas} < 3$ MHz (Range 2)	8 + TT (p-p)

NOTE 1: F_{UL_Meas} refers to the sub-carrier frequency for which the equalizer coefficient is evaluated
 NOTE 2: F_{UL_Low} and F_{UL_High} refer to each E-UTRA frequency band specified in Table 5.5-1
 NOTE 3: Test tolerance TT = 1.4 dB.

[Table 5-34 Test requirement of EVM equalizer flatness under normal condition \(TS38.521-1 \[6\], Table 6.4.2.4.5-1\)](#)

Table 6.4.2.4.5-2: Minimum requirements for EVM equalizer spectrum flatness (extreme conditions)

Frequency range	Maximum Ripple [dB]
$F_{UL_Meas} - F_{UL_Low} \geq 5$ MHz and $F_{UL_High} - F_{UL_Meas} \geq 5$ MHz (Range 1)	4 + TT (p-p)
$F_{UL_Meas} - F_{UL_Low} < 5$ MHz or $F_{UL_High} - F_{UL_Meas} < 5$ MHz (Range 2)	12 + TT (p-p)

NOTE 1: F_{UL_Meas} refers to the sub-carrier frequency for which the equalizer coefficient is evaluated
 NOTE 2: F_{UL_Low} and F_{UL_High} refer to each E-UTRA frequency band specified in Table 5.5-1
 NOTE 3: Test tolerance TT = 1.4 dB.

[Table 5-35 Test requirement of EVM equalizer flatness under extreme condition \(TS38.521-1 \[6\], Table 6.4.2.4.5-2\)](#)

As illustrated in Fig. 5-28, four measurements of each condition have to be conducted which include

1. Maximum allowed ripple in range 1
2. Maximum allowed ripple in range 2
3. Maximum ripple between the upper side of range 2 and lower side of range 1, i.e. Max (range 2) - Min (range 1)
4. Maximum ripple between the upper side of range 1 and lower side of range 2, i.e. Max (range 1) - Min (range 2)

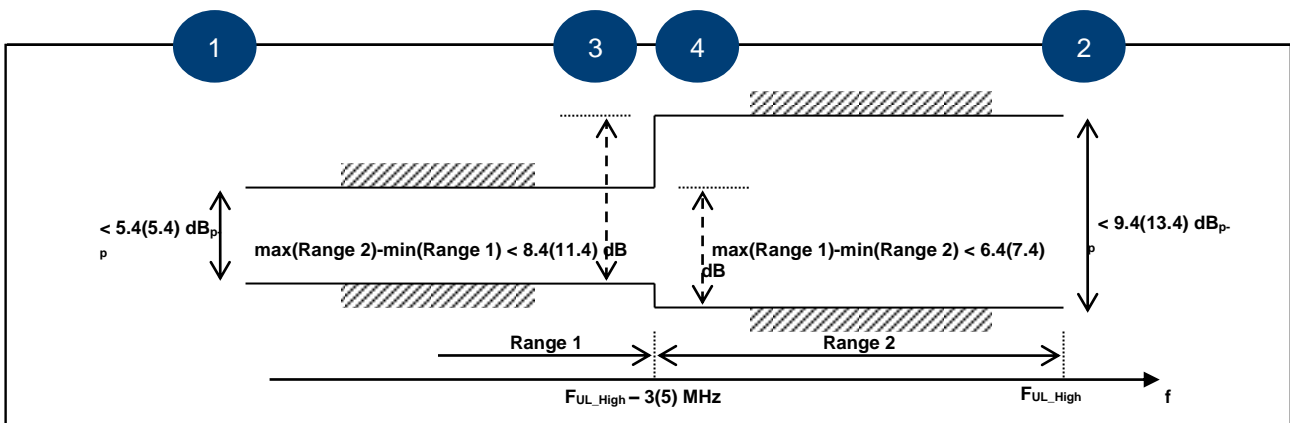

Fig. 5-28 Limits of EVM equalizer flatness⁴⁰ (TS38.521-1 [6] Figure 6.4.2.4.5-1)

EVM equalizer flatness measurements and limits are summarized in Table 5-36 in a tabular format.

Measurements		Maximum Ripple (dB)	
		Normal Condition	Extreme Condition
1	Range 1	5.4	5.4
2	Range 2	9.4	13.4
3	Maximum (Range2) - Minimum (Range 1)	8.4	11.4
4	Maximum (Range1) - Minimum (Range 2)	6.4	7.4

Table 5-36 Summary of EVM equalizer flatness measurements and limits

The limits as well as the offset to the band edge can be configured in CMSquares as shown in Fig. 5-29.

	n/2-BPSK		n/2-BPSK with shaping		QPSK		16-QAM		64-QAM		256-QAM	
Enable	<input checked="" type="checkbox"/>		<input checked="" type="checkbox"/>		<input checked="" type="checkbox"/>		<input checked="" type="checkbox"/>		<input checked="" type="checkbox"/>		<input checked="" type="checkbox"/>	
Range 1	5.4	dBpp	7.4	dBpp	5.4	dBpp	5.4	dBpp	5.4	dBpp	5.4	dBpp
Range 2	9.4	dBpp	15.4	dBpp	9.4	dBpp	9.4	dBpp	9.4	dBpp	9.4	dBpp
Max(Range 1) - Min(Range 2)	6.4	dB	0.0	dB	6.4	dB	6.4	dB	6.4	dB	6.4	dB
Max(Range 2) - Min(Range 1)	8.4	dB	0.0	dB	8.4	dB	8.4	dB	8.4	dB	8.4	dB
Band Edge Distance	3.0	MHz	0.0	MHz	3.0	MHz	3.0	MHz	3.0	MHz	3.0	MHz

Fig. 5-29 Limit of EVM equalizer flatness (normal condition)

In our example here, as per NR operating band definition in Annex A.1 or TS38.521-1 [6] Table 5.2-1, NR band n78 has F_{UL_low} 3300 MHz and F_{UL_high} 3800 MHz. Then the range 1 and range 2 determinations are as follows:

Range 1 (normal condition): $3303 \text{ MHz} = F_{UL_low} + 3 \text{ MHz} \leq F_{UL_Meas} \leq F_{UL_high} - 3 \text{ MHz} = 3797 \text{ MHz}$

Range 2 (normal condition): $F_{UL_Meas} \leq 3303 \text{ MHz}$ or $F_{UL_Meas} \geq 3797 \text{ MHz}$

Range 1 (extreme condition): $3305 \text{ MHz} = F_{UL_low} + 5 \text{ MHz} \leq F_{UL_Meas} \leq F_{UL_high} - 5 \text{ MHz} = 3795 \text{ MHz}$

Range 2 (extreme condition): $F_{UL_Meas} \leq 3305 \text{ MHz}$ or $F_{UL_Meas} \geq 3795 \text{ MHz}$

Since mid-range test frequency is chosen in the example configuration, the frequency range is 3499.99-3599.99 MHz in 100 MHz CBW case (see Table 8-10 in Annex B.3), the measured frequencies are all in the range 1. No measurements in range 2 are available. As shown in Fig. 5-30, the range 1 ripple has measurement value 0.55 dB which is within the limit of 5.4 dB for normal condition. So, the test is passed.

⁴⁰ The limits of extreme condition are given in the bracket. The test tolerance is considered.

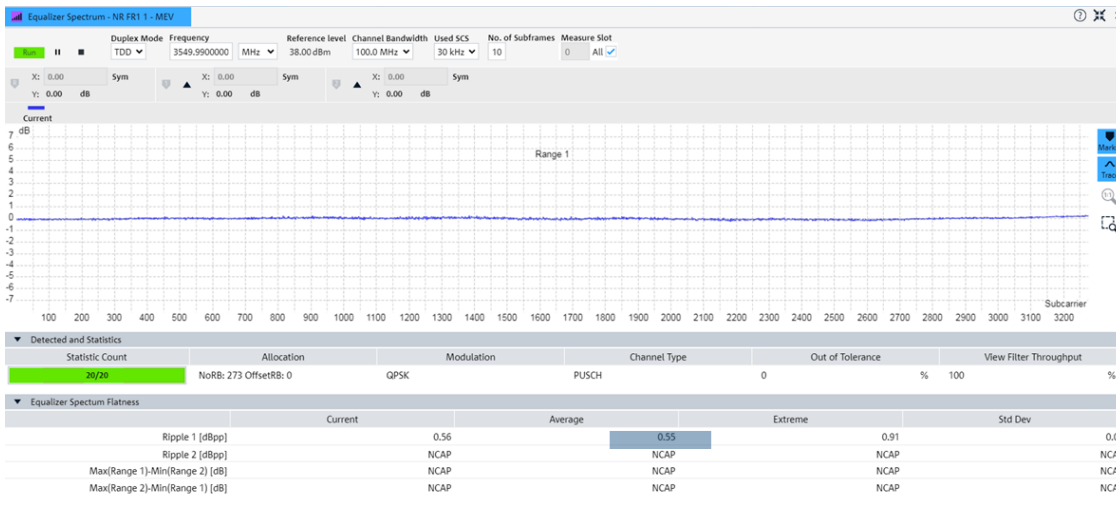

Fig. 5-30 Test result of EVM equalizer flatness (range 1)

If we only change the test frequency to high range and keep the rest of the example configurations, then part of the measured frequencies will fall into the range2, i.e. $F_{UL_Meas} \geq 3797$ MHz in normal condition. The entire measurement results in CMsquares with both measurements in range 1 and range 2 are shown in Fig. 5-31. All four measurements are in the range by comparing the limits given in Table 5-36.

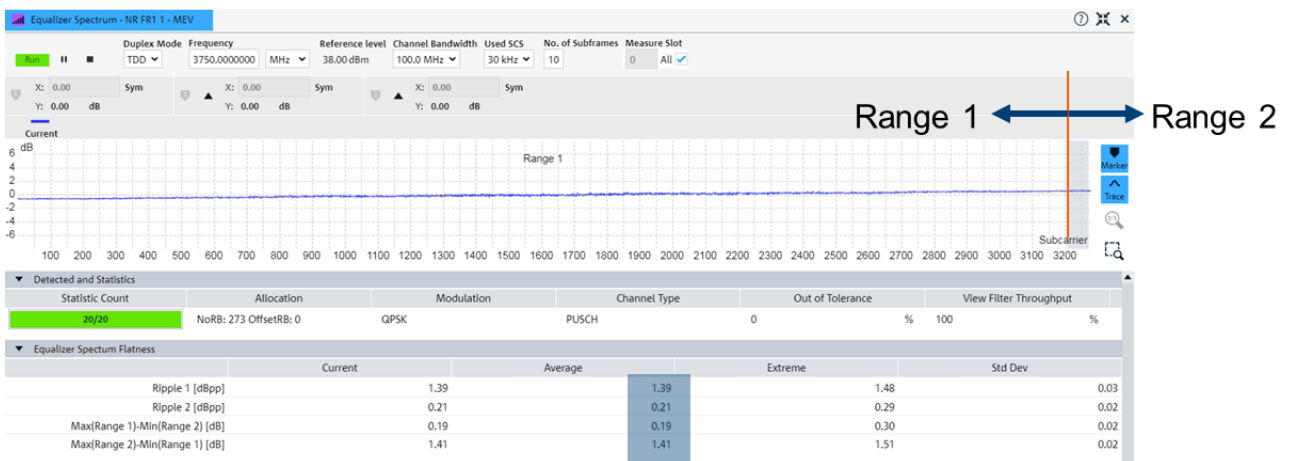

Fig. 5-31 Test result of EVM equalizer flatness (range 1 and range 2)

5.10 Occupied Bandwidth for Inter-Band EN-DC within FR1 (6.5B.1.3)

This test case should apply LTE anchor agnostic approach.

For more details, refer to TS38.521-1 [6], clause 6.5.1

5.10.1 Test Purpose

Occupied bandwidth (OBW) is defined as the bandwidth containing 99 % of the total integrated mean power of the transmitted spectrum on the assigned channel [6]. It is a fundamental spectral emissions measurement which is motivated by operators who have adjacent channels in the same band and want to avoid interference into each other by faulty UEs. Typically, OBW is executed at max power and max bandwidth, limit lines scale with the channel bandwidth.

This test case is to verify that the UE OBW for all transmission bandwidth configurations supported by the UE are less than their specific limits.

5.10.2 Test Preparations

5.10.2.1 Example Test Configuration

Example

Test ID 1

Initial Conditions			
Test Environment as specified in TS 38.508-1 [5] subclause 4.1		Normal	
Test Frequencies as specified in TS 38.508-1 [5] subclause 4.3.1		Mid range	
Test Channel Bandwidths as specified in TS 38.508-1 [5] subclause 4.3.1		Highest	
Test SCS as specified in Table 5.3.5-1		Lowest	
Test Parameters			
Test ID	Downlink Configuration	Uplink Configuration	
	N/A for occupied bandwidth test case	Modulation	RB allocation (NOTE 1)
1		CP-OFDM QPSK	Outer_full
NOTE 1: The specific configuration of each RB allocation is defined in Table 6.1-1.			

Table 5-37 Example of a test configuration out of TS38.521-1 [6] Table 6.5.1.4.1-1

5.10.2.2 Cell Parameter Settings

Since this test case requires the LTE anchor agnostic approach, LTE settings can be referred in chapter 3.6.

NR settings on CMX can generally refer to chapter 5.1.2.2 and 5.9.2.2

Parameters	NR	
	Configuration	Value
Frequency Range		FR1
Duplex Mode		TDD
Band		n78
Test Frequency	Mid	See Table 5-4
Test Channel Bandwidth	Highest	100 MHz
Test SCS	Lowest	30 kHz
DL RMC (Modulation)	N/A	e.g. MCS index 4 MCS table 64QAM
DL RMC (RB Allocation)	N/A	e.g. 273@0
UL RMC (Modulation)	CP-OFDM QPSK	MCS index 2 MCS table 64QAM
UL RM (RB Allocation)	Outer Full	273@0
Downlink Power Level	Total Cell Power	-47 dBm
Uplink Power Control	P0-NominalWithGrant	-90 dBm
	Alpha	0.8
	P0	0
	TPC	Max
DFT-s-OFDM		Disable
MAC Padding		Enable
Initial BWP		1099

Table 5-38 Test parameters settings for occupied bandwidth

5.10.2.3 Multi-Evaluation Measurement Settings

NR multi-evaluation settings can generally refer to chapter 5.1.2.3, see also 4.4.2.

5.10.3 Test Procedure

The same test procedure described in chapter 5.9.3 can be applied here.

Except in step 8, select "Tx Measurement" for OBW measurement.

5.10.4 Test Requirement and Results

Test requirement for OBW is shown in Table 5-39 according to TS38.521-1 [6], Table 6.5.1.5-1.

99% of the total power should not exceed the OBW given in this table.

Table 6.5.1.5-1: Occupied channel bandwidth

Channel bandwidth (MHz)	Occupied channel bandwidth / NR Channel bandwidth											
	5 MHz	10 MHz	15 MHz	20 MHz	25 MHz	30 MHz	40 MHz	50 MHz	60 MHz	80 MHz	90 MHz	100 MHz
5	10	15	20	25	30	40	50	60	80	90	100	

Table 5-39 Test requirement of occupied bandwidth (OBW) (TS38.521-1 [6], Table 6.5.1.5-1)

Pre-defined OBW limits in CMSquares are shown in Fig. 5-32.

Bandwidth	5.0 MHz	10.0 MHz	15.0 MHz	20.0 MHz	25.0 MHz	30.0 MHz
OBW Limit [MHz]	<input checked="" type="checkbox"/> 5.0	<input checked="" type="checkbox"/> 10.0	<input checked="" type="checkbox"/> 15.0	<input checked="" type="checkbox"/> 20.0	<input checked="" type="checkbox"/> 25.0	<input checked="" type="checkbox"/> 30.0
Bandwidth	40.0 MHz	50.0 MHz	60.0 MHz	80.0 MHz	90.0 MHz	100.0 MHz
OBW Limit [MHz]	<input checked="" type="checkbox"/> 40.0	<input checked="" type="checkbox"/> 50.0	<input checked="" type="checkbox"/> 60.0	<input checked="" type="checkbox"/> 80.0	<input checked="" type="checkbox"/> 90.0	<input checked="" type="checkbox"/> 100.0

Fig. 5-32 Limits of OBW

OBW measurement result on CMX is shown in Fig. 5-33. The measured average OBW is 97.35 MHz which does not exceed 100 MHz OBW in 100 MHz CBW case as defined in the test requirement (in Table 5-39). Therefore, the test is passed.

Statistic	Count	Allocation	Modulation	Channel Type	Out of Tolerance	View Filter	Throughput
26/26	NoRB: 273	OffsetRB: 0	QPSK	PUSCH	0	%	100

Power	Current		Average		Min		Max		Std Dev
	l	h	l	h	l	h	l	h	
Tx Power [dBm]	18.22	18.22	18.27	18.27	18.03	18.50			0.12
PEAK Power [dBm]	25.59	25.59	25.63	25.63	25.45	25.85			0.08
RB Power [dBm]	-6.12	-6.12	-6.07	-6.07	-6.31	-5.85			0.12

Tx Measurement	Current		Average		Extreme		Std Dev	
	l	h	l	h	l	h	l	h
EVM RMS [%]	4.61	4.55	4.67	4.61	5.20	5.14	0.28	0.28
EVM Peak [%]	22.11	22.52	22.47	22.47	26.13	26.16	1.39	1.40
EVM DMRS [%]	4.51	4.44	4.54	4.47	5.03	4.95	0.24	0.24
MERR RMS [%]	3.27	3.22	3.30	3.26	3.66	3.61	0.19	0.20
MERR Peak [%]	20.74	20.94	19.82	19.61	22.82	22.69	1.07	1.16
MERR DMRS [%]	3.20	3.17	3.21	3.16	3.56	3.49	0.18	0.18
PHERR RMS [°]	1.87	1.84	1.90	1.87	2.12	2.09	0.12	0.12
PHERR Peak [°]	11.17	9.94	10.34	9.88	12.96	11.86	0.68	0.71
PHERR DMRS [°]	1.82	1.79	1.84	1.81	2.04	2.01	0.10	0.10
IQ Offset [dBc]	-47.62	-47.62	-47.07	-47.07	-45.63	-45.63	0.46	0.46
Freq Error [Hz]	1.58	1.58	1.88	1.88	63.60	63.60	23.97	23.97
Freq Error [ppm]	0.00	0.00	0.00	0.00	0.02	0.02	0.01	0.01
Sample Clock Error [ppm]	0.00	0.00	0.00	0.00	0.03	0.03	0.01	0.01
Timing Error [ns]	-403.51	-403.51	-403.51	-403.51	-403.73	-403.73	0.09	0.09
OBW [MHz]	97.35	97.35	97.35	97.35	97.35	97.35	0.01	0.01

Fig. 5-33 Test result of occupied bandwidth

5.11 Spectrum Emission Mask for Inter-band EN-DC within FR1 (6.5B.2.3.1)

This test case should apply LTE anchor agnostic approach.

For more details, refer to TS38.521-1 [6], clause 6.5.2.2

5.11.1 Test Purpose

As defined in [6], out-of-band emissions are unwanted emissions immediately outside the nominal channel. They result from the modulation process and from non-linearity in the transmitter, but they do not include spurious emissions.

The adjacent channel leakage ratio (ACLR) and the spectrum emission mask (SEM) are part of the out-of-band emissions test. The two test cases qualify different aspects of the out-of-band performance: The SEM is for checking the performance point by point (RBW), and the ACLR is used to check the integration results (channel bandwidth).

SEM test is motivated by regulators, i.e. guarantee that one transmitter does not affect any other receiver, independent of what technology. SEM corresponds to a mask, that scales with the bandwidth and the limits depend on the offset from the carrier edge. Therefore, the purpose of the SEM test is to verify that the power of any UE emission will not exceed the specified level for the corresponding channel bandwidth.

5.11.2 Test Preparations

5.11.2.1 Example Test Configuration

Example

Test ID 17

Default Conditions						
Test Environment as specified in TS 38.508-1 [5] subclause 4.1				Normal		
Test Frequencies as specified in TS 38.508-1 [5] subclause 4.3.1				Low range		
Test Channel Bandwidths as specified in TS 38.508-1 [5] subclause 4.3.1				Lowest, Highest		
Test SCS as specified in Table 5.3.5-1				Lowest, Highest		
Test Parameters for Channel Bandwidths						
Test ID	Freq	ChBw	SCS	Downlink Configuration	Uplink Configuration	
		Default	Default	N/A for Spectrum Emission Mask test case	Modulation (NOTE 2)	RB allocation (NOTE 1)
17	High				CP-OFDM QPSK	Edge_1RB_Right
NOTE 1: The specific configuration of each RF allocation is defined in Table 6.1-1.						
NOTE 2: DFT-s-OFDM PI/2 BPSK test applies only for UEs which supports half Pi BPSK in FR1.						
NOTE 3: For Power Class 3 testing, include two steps for UE operating in bands n40, n41, n77, n78 and n79, with IE powerBoostPi2BPSK set to 1 and 0 separately.						

[Table 5-40 Example of a test configuration out of TS38.521-1 \[6\] Table 6.5.2.2.4.1-1](#)

5.11.2.2 Cell Parameter Settings

Since this test case requires the LTE anchor agnostic approach, LTE settings can be referred in chapter 3.6.

NR settings on CMX can generally refer to chapter 5.1.2.2 by configuration given in Table 5-41.

Parameters	NR	
	Configuration	Value
Frequency Range		FR1
Duplex Mode		TDD
Band		n78
Test Frequency	Low	See Table 5-4
Test Channel Bandwidth	Highest	100 MHz
Test SCS	Lowest	30 kHz
DL RMC (Modulation)	N/A	e.g. MCS index 4 MCS table 64QAM
DL RMC (RB Allocation)	N/A	e.g. 273@0
UL RMC (Modulation)	CP-OFDM QPSK	MCS index 2 MCS table 64QAM
UL RM (RB Allocation)	Edge_1RB_Right	1@272
Downlink Power Level	SSB ERPE	-82 dBm
Uplink Power Control	P0-NominalWithGrant	-90 dBm
	Alpha	0.8
	P0	0
	TPC	Max
DFT-s-OFDM		Disable
MAC Padding		Enable
Initial BWP		1099

Table 5-41 Test parameters settings for spectrum emission mask

5.11.2.3 Multi-Evaluation Measurement Settings

NR multi-evaluation settings can generally refer to chapter 5.1.2.3, see also 4.4.2.

5.11.3 Test Procedure

1. Configure the LTE cell according to LTE anchor agnostic approach, see chapter 3.6
2. Configure the NR cell according to the configurations given in Table 5-41.
3. Configure the NR multi-evaluation measurement.
4. Turn on the LTE and NR cell, see chapter 4.4.1
5. Switch on DUT and wait until DUT is registered on LTE cell
6. Activate EN-DC mode
7. Reduce the LTE uplink RB allocation to 0 RB as given in 3.6
8. Start the spectrum emission mask measurement in the NR as given in 4.4.2 (select "Spectrum Emission Mask" measurement)

5.11.4 Test Requirement and Results

Test requirement of SEM is shown in Table 5-42 according to TS38.521-1 [6], Table 6.5.2.2.5-1.

Table 6.5.2.2.5-1: General NR spectrum emission mask

Spectrum emission limit (dBm) / Channel bandwidth													
Δf_{oob} (MHz)	5 MHz	10 MHz	15 MHz	20 MHz	25 MHz	30 MHz	40 MHz	50 MHz	60 MHz	80 MHz	90 MHz	100 MHz	Measurement bandwidth
$\pm 0-1$	-13 + TT	-13 + TT	-13 + TT	-13 + TT	-13 + TT	-13 + TT	-13 + TT						1 % channel bandwidth
$\pm 0-1$								-24 + TT	-24 + TT	-24 + TT	-24 + TT	-24 + TT	30 kHz
$\pm 1-5$	-10 + TT	-10 + TT	-10 + TT	-10 + TT	-10 + TT	-10 + TT	-10 + TT	-10 + TT	-10 + TT	-10 + TT	-10 + TT	-10 + TT	1 MHz
$\pm 5-6$	-13 + TT	-13 + TT	-13 + TT	-13 + TT	-13 + TT	-13 + TT	-13 + TT	-13 + TT	-13 + TT	-13 + TT	-13 + TT	-13 + TT	
$\pm 6-10$	-25 + TT	-25 + TT	-25 + TT	-25 + TT	-25 + TT	-25 + TT	-25 + TT	-25 + TT	-25 + TT	-25 + TT	-25 + TT	-25 + TT	
$\pm 10-15$		-25 + TT	-25 + TT	-25 + TT	-25 + TT	-25 + TT	-25 + TT	-25 + TT	-25 + TT	-25 + TT	-25 + TT	-25 + TT	
$\pm 15-20$			-25 + TT	-25 + TT	-25 + TT	-25 + TT	-25 + TT	-25 + TT	-25 + TT	-25 + TT	-25 + TT	-25 + TT	
$\pm 20-25$				-25 + TT	-25 + TT	-25 + TT	-25 + TT	-25 + TT	-25 + TT	-25 + TT	-25 + TT	-25 + TT	
$\pm 25-30$					-25 + TT	-25 + TT	-25 + TT	-25 + TT	-25 + TT	-25 + TT	-25 + TT	-25 + TT	
$\pm 30-35$						-25 + TT	-25 + TT	-25 + TT	-25 + TT	-25 + TT	-25 + TT	-25 + TT	
$\pm 35-40$							-25 + TT	-25 + TT	-25 + TT	-25 + TT	-25 + TT	-25 + TT	
$\pm 40-45$								-25 + TT	-25 + TT	-25 + TT	-25 + TT	-25 + TT	
$\pm 45-50$									-25 + TT	-25 + TT	-25 + TT	-25 + TT	
$\pm 50-55$								-25 + TT	-25 + TT	-25 + TT	-25 + TT	-25 + TT	
$\pm 55-60$									-25 + TT	-25 + TT	-25 + TT	-25 + TT	
$\pm 60-65$										-25 + TT	-25 + TT	-25 + TT	
$\pm 65-80$											-25 + TT	-25 + TT	
$\pm 80-85$												-25 + TT	
$\pm 85-90$													
$\pm 90-95$												-25 + TT	
$\pm 95-100$													
$\pm 100-105$												-25 + TT	

Note 1: The first and last measurement position with a 30 kHz filter is at Δf_{oob} equals to 0.015 MHz and 0.985 MHz.
 Note 2: At the boundary of spectrum emission limit, the first and last measurement position with a 1 MHz filter is the inside of +0.5MHz and -0.5MHz, respectively.
 Note 3: The measurements are to be performed above the upper edge of the channel and below the lower edge of the channel.
 Note 4: TT for each frequency and channel bandwidth is specified in Table 6.5.2.2.5-2.

Table 5-42 Test requirement (TS38.521-1 [6], Table 6.5.2.2.5-1)

SEM is measured with different resolution bandwidth (RBW), 1% of channel bandwidth or 30 kHz depending on the tested channel bandwidth. The SEM limits scale based on the tested channel bandwidth and the offset from the assigned bandwidth.

By referring to TS38.521-1 [6], Table 6.5.2.2.5-2, the tested carrier frequency is in the range of $3.0\text{GHz} < f \leq 4.2\text{GHz}$, therefore $TT = 1.8\text{ dB}$ is applied here.

For 100 MHz CBW, four Δf_{oob} areas are specified, i.e. $\pm 0-1$, $\pm 1-5$, $\pm 5-100$, $\pm 100-105$ MHz.

The limit line of four frequency areas together with TT can be defined in CMX as shown in Fig. 5-34, this will be applied for the limit check of the measurement result later on. The given start and stop frequencies refer to the measurement position. Note 1 and Note 2 in the test requirement Table 5-42 are considered here. Not only the limit line is defined, but also RBW, i.e. measurement bandwidth can be specified as per test requirement.

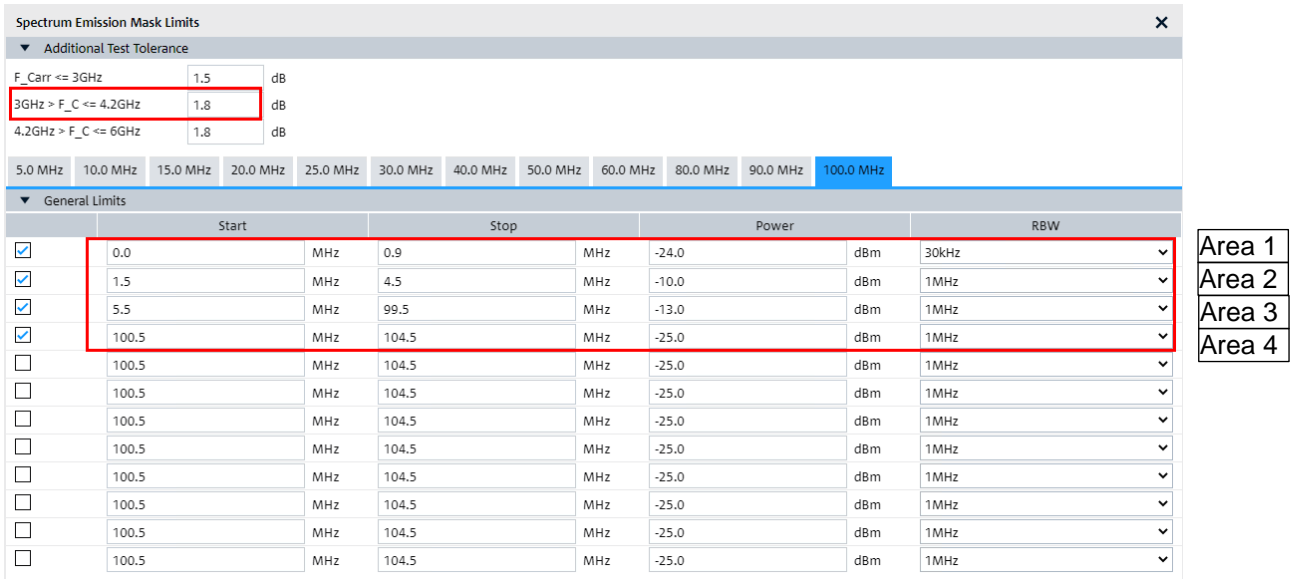

Fig. 5-34 Limit of spectrum emission mask and test tolerance configuration on CMX

Fig. 5-35 shows the measurement result of SEM. The traced values are all under the limits in both negative and positive areas⁴¹.

More detailed results are presented in tabular view in "Margin" section of SEM (see lower part of the Fig. 5-35). The margin can be expressed as:

$$Margin = \text{minimum}[P(f)_{mask} - P(f)_{trace}],$$

where $P(f)_{mask}$ is the emission limit (power) at frequency f in dBm, $P(f)_{trace}$ is the measured power at frequency f in dBm

The margin indicates the vertical distance between the spectrum emission mask limit line and a trace. For each emission mask area, the margin represents the "worst" value within the area.

A positive margin indicates that the trace is located under the limit line. Whereas, the negative value indicates the trace exceed the limit line. In our example here, all the values in both negative and positive areas have positive margins. Therefore, the test is passed.

⁴¹ Positive areas are the areas where the measurements are performed above the upper edge of the channel. Negative areas are the areas where the measurements are performed below the lower edge of the channel.

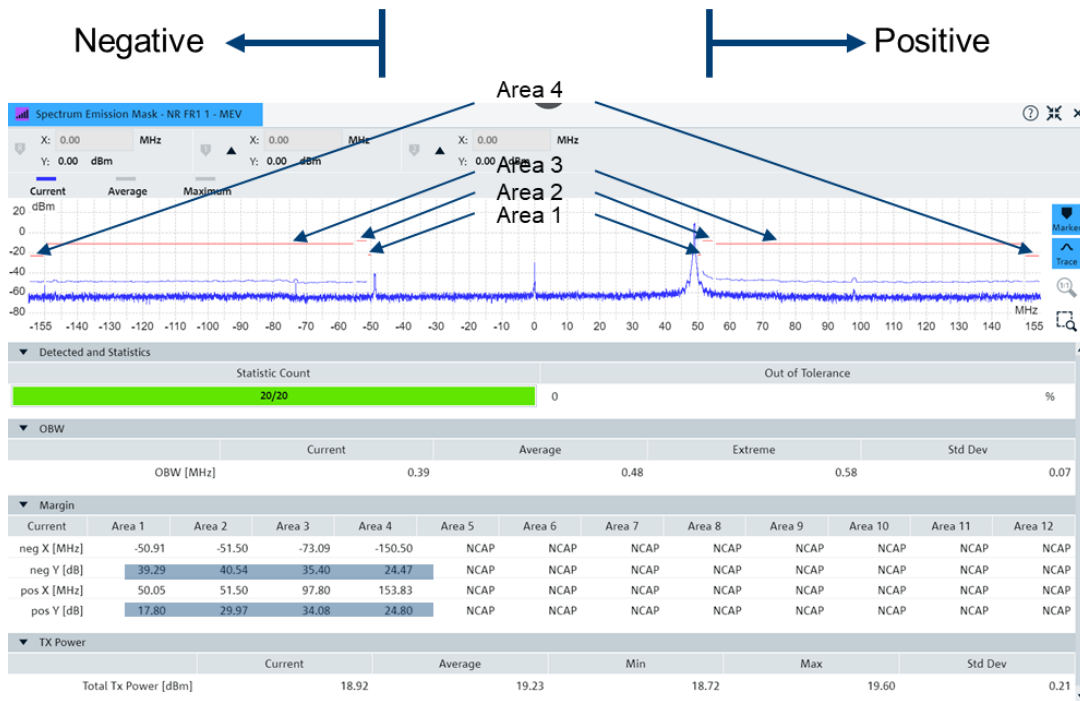

Fig. 5-35 Test result of spectrum emission mask

5.12 Adjacent Channel Leakage Ratio for Inter-band EN-DC within FR1 (6.5B.2.3.3)

This test case should apply LTE anchor agnostic approach.

For more details, refer to TS38.521-1 [6], clause 6.5.2.4.1

5.12.1 Test Purpose

Adjacent Channel Leakage Ratio (ACLR) is the ratio of the filtered mean power centered on the assigned NR channel frequency to the filtered mean power centered on an adjacent NR channel frequency at nominal channel spacing. Like SEM test, ACLR is also part of the out-of-band emissions test.

This test is to verify that UE transmitter does not cause unacceptable interference to adjacent channels in terms of ACLR [6].

The test case is applicable for both power class 2 and power class 3 UE. In the following description, we refer only power class 3 UE.

5.12.2 Test Preparations

5.12.2.1 Example Test Configuration

Example

Test ID 24

Default Conditions	
Test Environment as specified in TS 38.508-1 [5] subclause 4.1	Normal, TL/VL, TL/VH, TH/VL, TH/VH

Test Frequencies as specified in TS 38.508-1 [5] subclause 4.3.1					Low range	
Test Channel Bandwidths as specified in TS 38.508-1 [5] subclause 4.3.1					Highest	
Test SCS as specified in Table 5.3.5-1					Lowest	
Test Parameters for Channel Bandwidths						
Test ID	Freq	ChBw	SCS	Downlink Configuration	Uplink Configuration	
		Default	Default	N/A for Adjacent Channel Leakage Ratio test case	Modulation (NOTE 2)	RB allocation (NOTE 1)
24	Low				CP-OFDM QPSK	Edge_1RB_Left
NOTE 1: The specific configuration of each RF allocation is defined in Table 6.1-1.						
NOTE 2: DFT-s-OFDM PI/2 BPSK test applies only for UEs which supports half Pi BPSK in FR1.						
NOTE 3: For Power Class 3 testing, UE operating in TDD mode with PI/2 BPSK modulation, and UE indicating support for UE capability powerBoosting-pi2BPSK, the IE powerBoostPi2BPSK is set to 1 for bands n40, n41, n77, n78 and n79.						
NOTE 4: For Power Class 3 testing, UE operating in FDD mode, or in TDD mode in bands other than n40, n41, n77, n78 and n79, or in TDD mode the IE powerBoostPi2BPSK is set to 0 for bands n40, n77, n78 and n79.						

Table 5-43 Example of a test configuration out of TS38.521-1 [6] Table 6.5.2.4.1.4.1-1

5.12.2.2 Cell Parameter Settings

Same as described in chapter 5.11.2.2. Apply test parameter settings given by Table 5-44.

Parameters	NR	
	Configuration	Value
Frequency Range		FR1
Duplex Mode		TDD
Band		n78
Test Frequency	Low	See Table 5-4
Test Channel Bandwidth	Highest	100 MHz
Test SCS	Lowest	30 kHz
DL RMC (Modulation)	N/A	e.g. MCS index 4 MCS table 64QAM
DL RMC (RB Allocation)	N/A	e.g. 273@0
UL RMC (Modulation)	CP-OFDM QPSK	MCS index 2 MCS table 64QAM
UL RM (RB Allocation)	Edge_1RB_Left	1@0
Downlink Power Level	SSB ERPE	-82 dBm
Uplink Power Control	P0-NominalWithGrant	-90 dBm
	Alpha	0.8
	P0	0
	TPC	Max
DFT-s-OFDM		Disable
MAC Padding		Enable
Initial BWP		1099

Table 5-44 Test parameters settings for adjacent channel leakage power ratio

5.12.2.3 Multi-Evaluation Measurement Settings

NR multi-evaluation settings can generally refer to chapter 5.1.2.3, see also 4.4.2.

5.12.3 Test Procedure

The same test procedure as described in chapter 5.11.3 can be applied here.

Except in step 8, select "Spectrum ACLR" for ACLR measurement.

5.12.4 Test Requirement and Results

The ACLR is calculated based on the ratio between the power of the allocated NR channel and power of the first NR adjacent channel on both lower and upper side of the assigned NR channel, respectively. Test requirement of ACLR is shown in Table 5-45 and its associated test tolerance is given in Table 5-46. The test requirement needs to be fulfilled in case the absolute adjacent channel power is higher than -50 dBm.

Table 6.5.2.4.1.5-2: NR ACLR requirement

	Power class 1	Power class 2	Power class 3
NR ACLR		31 - TT dB	30 - TT dB
NOTE 1: TT for each frequency and channel bandwidth is specified in Table 6.5.2.4.1.5-3.			

Table 5-45 Test requirement of ACLR (TS38.521-1 [6], Table 6.5.2.4.1.5-2)

Table 6.5.2.4.1.5-3: Test Tolerance (NR ACLR)

	$f \leq 3.0\text{GHz}$	$3.0\text{GHz} < f \leq 4.2\text{GHz}$	$4.2\text{GHz} < f \leq 6.0\text{GHz}$
BW \leq 100MHz	0.8 dB	0.8 dB	0.8 dB

Table 5-46 Test Tolerance (TS38.521-1 [6], Table 6.5.2.4.1.5-3)

Based on the above requirements, the limit together with the test tolerance can be configured on CMX as shown in Fig. 5-36.

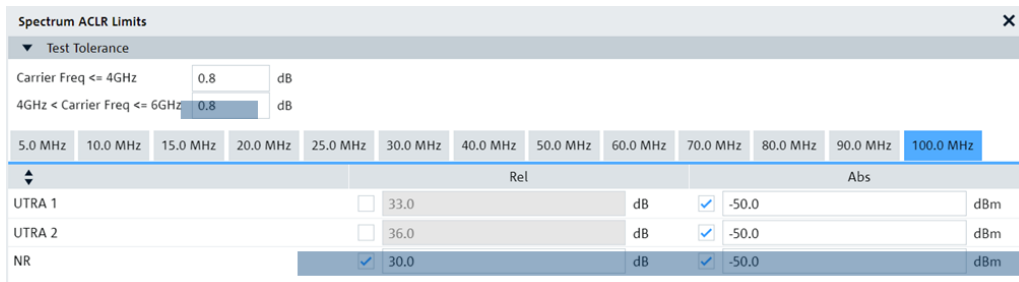

Fig. 5-36 Limit of ACLR in CMsquares

The ACLR measurement in CMsquares can be found in Fig. 5-37.

The measured absolute power of both adjacent channels to lower and higher side of the assigned NR channel are higher than -50 dBm, according to the test requirement, the minimum ACLR to each adjacent channel (relative power) is 29.2 dB (0.8 dB TT is included). This is the NR ACLR limit line as depicted in red in Fig. 5-37. The actual measured ACLR is 41.13 dB (lower channel) and 42.13 dB (higher channel) that are higher than the minimum 29.2 dB ACLR. Therefore, the test is pass.

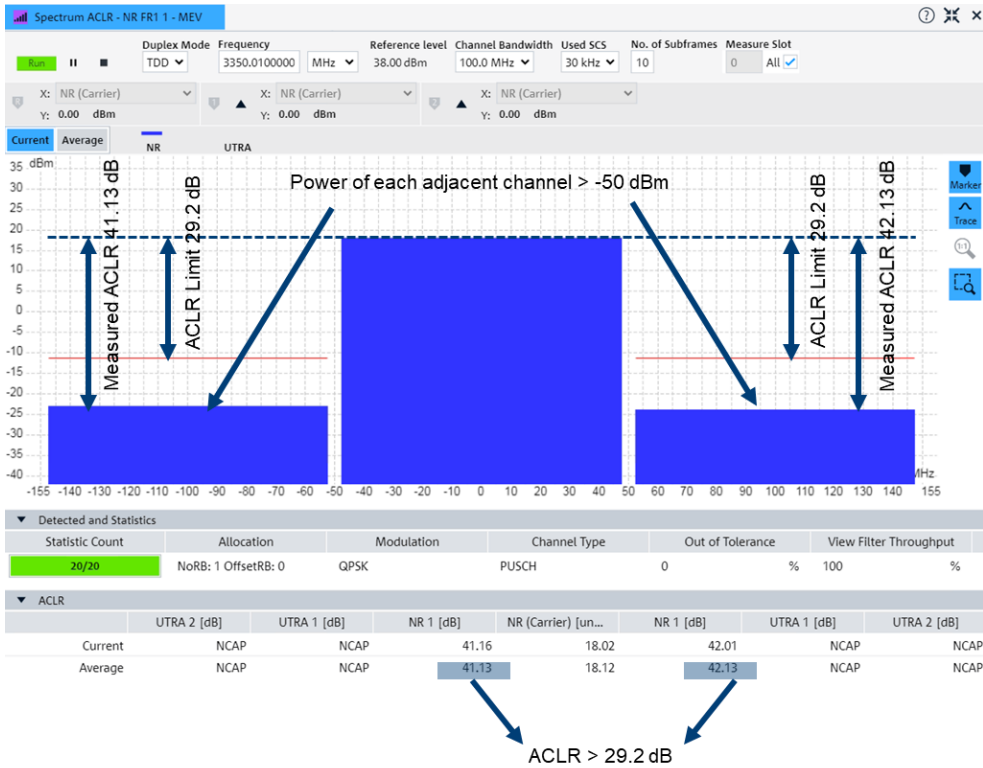

Fig. 5-37 Test result of adjacent channel leakage ratio

6 Receiver Characteristic Tests

The FR1 EN-DC receiver characteristic test cases described in this application note are listed in Table 6-1.

Chapter	Test Case Number from 3GPP TS 38.521-3 [1]	Test Case Designation
6.1	7.3B.2.3	Reference sensitivity for Inter-band EN-DC within FR1
6.2	7.4B.3	Maximum Input Level for Inter-band EN-DC within FR1

Table 6-1 NR FR1 EN-DC receiver characteristic test cases

6.1 Reference Sensitivity for Inter-band EN-DC within FR1 (7.3B.2.3)

6.1.1 General

Reference sensitivity test is to verify the ability of UE to receive data with a given average throughput for a specified reference measurement channel, under conditions of low signal level, ideal propagation and no added noise. A UE unable to meet the throughput requirement under these conditions will decrease the effective coverage area [1].

The test case contains two test scenarios, namely, inter-band EN-DC without exception (see 6.1.2) and with exception where maximum sensitivity degradation (MSD) is allowed under certain conditions (see 6.1.3).

6.1.2 EN-DC Band Combination without Exception

For EN-DC combinations with no exception requirements should apply LTE anchor agnostic approach.

For more details, refer to TS38.521-1 [6], clause 7.3.2

6.1.2.1 Test Purpose

See 6.1.1

6.1.2.2 Test Preparations

6.1.2.2.1 Example Test Configuration

Example

Test ID 1

Initial Conditions				
Test Environment as specified in TS 38.508-1 [5] subclause 4.1		Normal, TL/VL, TL/VH, TH/VL, TH/VH		
Test Frequencies as specified in TS 38.508-1 [5] subclause 4.3.1		Low range (NOTE 4)		
Test Channel Bandwidths as specified in TS 38.508-1 [5] subclause 4.3.1		Lowest, Mid, Highest (NOTE 4) Lowest UL / Lowest DL, Lowest UL / Highest DL (NOTE 3)		
Test SCS as specified in Table 5.3.5-1		Lowest		
Test Parameters				
Test ID	Downlink Configuration		Uplink Configuration	
	Modulation	RB allocation	Modulation	RB allocation
1	CP-OFDM QPSK	Full RB (NOTE 1)	DFT-s-OFDM QPSK	REFSENS (NOTE 2)
<p>NOTE 1: Full RB allocation shall be used per each SCS and channel BW as specified in Table 7.3.2.4.1-2.</p> <p>NOTE 2: REFSENS refers to Table 7.3.2.4.1-3 which defines uplink RB configuration and start RB location for each SCS, channel BW and NR band.</p> <p>NOTE 3: According to asymmetric channel bandwidths specified in clause 5.3.6.</p> <p>NOTE 4: For n70, in addition to default test configurations, additional configurations shall be used to verify reference sensitivity requirements with the UE TX-RX frequency separation of 295MHz (table 5.4.4-1): 5 MHz CH BW with DL @ low range, UL @ mid range 5 MHz CH BW with DL @ mid range, UL @ high range 10 MHz CH BW with DL @ low range, UL @ high range</p>				

Table 6-2 Example of a test configuration out of TS38.521-1 [6] Table 7.3.2.4.1-1

6.1.2.2.2 Cell Parameter Settings

Since this test case requires the LTE anchor agnostic approach, LTE settings can be referred in chapter 3.6.

NR settings on CMX can generally refer to chapter 5.1.2.2 by configuration given in Table 6-3.

Parameters	NR	
	Configuration	Value
Frequency Range		FR1
Duplex Mode		TDD
Band		n78
Test Frequency	Low	See Table 5-4
Test Channel Bandwidth	Highest	100 MHz
Test SCS	Lowest	30 kHz
DL RMC (Modulation)	CP-OFDM QPSK	MCS index 4, MCS table 64QAM

DL RMC (RB Allocation)	Full RB ⁴²	273@0
UL RMC (Modulation)	DFT-s-OFDM QPSK	MCS index 2, MCS table 64QAM
UL RM (RB Allocation)	REFSENS ⁴³	270@0
Downlink Power Level	SSB ERPE	-85.6 dBm + TT ⁴⁴ (TT =1 dB, 3.0GHz < f ≤ 6.0 GHz)
Uplink Power Control	P0-NominalWithGrant	-90 dBm
	Alpha	0.8
	P0	0
	TPC	Max
DFT-s-OFDM		Enable
MAC Padding		Enable
Initial BWP		1099
OCNG	OCNG	Enable
	PDSCH Power Offset	User Defined 0 dB
	PDSCH Modulation Type	QPSK ⁴⁵
	PDCCH Power Offset	User Defined 0 dB

Table 6-3 Test parameters settings for reference sensitivity without exception

OFDMA Channel Noise Generator (OCNG) should be turned on in the receiver characteristic tests to simulate the existence of other users in the non-allocated RBs.

The downlink power, OCNG and uplink power control settings for reference sensitivity test in CMsquares are shown in Fig. 6-1. With this setting, the OCNG fulfills the requirements specified in Annex A.5.2.1 of [6] for TDD mode.

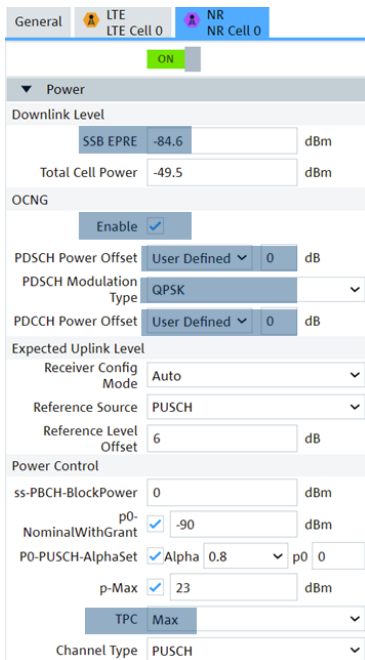

Fig. 6-1 Power and OCNG configuration in CMsquares for reference sensitivity test

6.1.2.3 Test Procedure

1. Configure the LTE cell according to LTE anchor agnostic approach, see chapter 3.6

⁴² Refer to Annex D.3 or TS38.521-1 [6], Table 7.3.2.4.1-2 for DL RB allocation

⁴³ Refer to TS38.521-1 [6], Table 7.3.2.4.1-3 for REFSENS RB allocation

⁴⁴ Refer to TS38.521-1 [6], Table 7.3.2.5-3 for TT

⁴⁵ Example configuration adopts QPSK modulation for PDSCH

2. Configure the NR cell according to the configurations given in Table 6-3.
3. Turn on the LTE and NR cell, see chapter 4.4.1
4. Switch on DUT and wait until DUT is registered on LTE cell
5. Activate EN-DC mode
6. Reduce the LTE uplink RB allocation to 0 RB as given in 3.6
7. Start the Rx BLER Measurement as described in 4.4.3

6.1.2.4 Test Requirement and Results

The test requires that the throughput shall be $\geq 95\%$ of the maximum throughput of the reference measurement channels at the reference receive power level given in Table 6-4.

Table 7.3.2.5-1: Reference sensitivity QPSK P_{REFSENS}

Operating Band	Operating band / SCS / Channel bandwidth / Duplex-mode													Duplex Mode
	SCS kHz	5 MHz (dBm)	10 MHz (dBm)	15 MHz (dBm)	20 MHz (dBm)	25 MHz (dBm)	30 MHz (dBm)	40 MHz (dBm)	50 MHz (dBm)	60 MHz (dBm)	80 MHz (dBm)	90 MHz (dBm)	100 MHz (dBm)	
n78 ¹	15		-95.8 +TT	-94.0 +TT	-92.7 +TT			-89.6 +TT	-88.6 +TT					TDD
	30		-96.1 +TT	-94.1 +TT	-92.9 +TT			-89.7 +TT	-88.7 +TT	-87.9 +TT	-86.6 +TT	-86.1 +TT	-85.6 +TT	
	60		-96.5 +TT	-94.4 +TT	-93.1 +TT			-89.9 +TT	-88.8 +TT	-88.0 +TT	-86.7 +TT	-86.2 +TT	-85.7 +TT	

NOTE 1: Four Rx antenna ports shall be the baseline for this operating band except for two Rx vehicular UE.
NOTE 2: The transmitter shall be set to P_{UMAX} as defined in subclause 6.2.4
NOTE 3: ³ indicates that the requirement is modified by -0.5 dB when the assigned NR channel bandwidth is confined within 1475.9-1510.9 MHz.
NOTE 4: The requirement is modified by -0.5 dB when the assigned UE channel bandwidth is confined within 3300 - 3800 MHz.
NOTE 5: For these bandwidths, the minimum requirements are restricted to operation when carrier is configured as a downlink carrier part of CA configuration.
NOTE 6: TT for each frequency and channel bandwidth is specified in Table 7.3.2.5-3.

Table 6-4 Test requirement (TS38.521-1 [6], Table 7.3.2.5-1)

In our example here, under the condition that the reference receive power level is $-85.6 + \text{TT}$ ($\text{TT} = 1 \text{ dB}$) = -84.6 dBm and with the presence of OCNB, DUT achieves 100% throughput as shown in the measurement result (in Fig. 6-2) which is higher than 95%. Therefore, the test is passed.

	Overall		LTE Cell 0		NR Cell 0	
	Relative	Absolute	Relative	Absolute	Relative	Absolute
ACK	100.00 %	13800	0.00 %	0	100.00 %	13800
NACK	0.00 %	0	0.00 %	0	0.00 %	0
DTX	0.00 %	0	0.00 %	0	0.00 %	0
BLER	0.00 %		0.00 %		0.00 %	
Throughput	Relative	MBit/s	Relative	MBit/s	Relative	MBit/s
Average	100.00 %	23.36	NaN %	0.00	100.00 %	23.36
Scheduled	---	23.36	---	0.00	---	23.36

Fig. 6-2 Throughput measurement of reference sensitivity without exceptions

6.1.3 EN-DC Band Combination with Exception

6.1.3.1 Test Purpose

Particular NR FR1 EN-DC inter-band combinations degrade the reference sensitivity. The degradation is usually caused by one of the following reasons

1. UL harmonic interference
2. receiver harmonic mixing

3. cross band isolation
4. dual uplink operation

The affected inter-band EN-DC band combinations defined in TS38.521-3 [1] clause 7.3B.2.0.3 are allowed to apply maximum sensitivity degradation (MSD) which means the relaxation of reference sensitivity can be considered here.

When testing inter-band EN-DC combination with exceptions, LTE anchor agnostic approach should NOT be adopted.

6.1.3.2 Test Configuration

TS38.521-3, clause 7.3B.2.3.4.2 specifies the different test configurations tables for individual reference sensitivity exception tests.

Example

2 bands (E-UTRA band2 and NR n78)

This band combination as per definition in TS38.521-3 [1] Table 7.3B.2.0.3.1-1 allows reference sensitivity exceptions due to UL harmonic interference.

Test configurations table for reference sensitivity exceptions due to UL harmonic interference consists of two parts,

- ▶ Initial test conditions TS38.521-3 [1] Table 7.3B.2.3.4.2.1-1 (Table 6-5)
- ▶ Individual test configuration for each defined band combination due to UL harmonic interference, e.g. Table 7.3B.2.3.4.2.1-2_5 for EN-DC 2_n78 combination (Table 6-6)

Table 7.3B.2.3.4.2.1-1: Initial test conditions for reference sensitivity exceptions due to UL harmonic interference for EN-DC in NR FR1

Initial Conditions							
Test Environment as specified in TS 38.508-1 [6] clause 4.1				Normal, TL/VL, TL/VH, TH/VL, TH/VH			
NR Test Frequencies as specified in TS 38.508-1 [6] clause 4.3.1				Mid range for E-UTRA and NR, unless otherwise specified in Table 7.3B.2.3.4.2.1-2_1 to Table 7.3B.2.3.4.2.1-2_28			
E-UTRA Test Frequencies as specified in TS 38.508-1 [11] clause 4.3.1							
NR Test Channel Bandwidths as specified in TS 38.508-1 [6] clause 4.3.1				Highest NRB_agg, unless otherwise specified in Table 7.3B.2.3.4.2.1-2_1 to Table 7.3B.2.3.4.2.1-2_28			
E-UTRA Test Channel Bandwidths as specified in TS 36.508 [11] clause 4.3.1							
NR Test SCS as specified in Table 5.3.5-1				Lowest supported SCS otherwise specified			
Test Parameters							
Downlink Configuration				Uplink Configuration			
E-UTRA Cell		NR Cell		E-UTRA Cell		NR Cell	
Modulation	RB allocation	Modulation	RB allocation	Modulation	RB allocation	Modulation	RB allocation
QPSK	Full RB	CP-OFDM QPSK	Full RB (NOTE 1)	QPSK	Full RB	DFT-s-OFDM QPSK	Full RB (NOTE 1)
NOTE 1: Full RB allocation shall be used per each SCS and channel BW as specified in Table 7.3.2.4.1-2 of TS 38.521-1 [8].							

Table 6-5 Initial test conditions for reference sensitivity level due to UL harmonic interference (TS38.521-3 [1] Table 7.3B.2.3.4.2.1-1)

Table 7.3B.2.3.4.2.1-2_5: Test configurations table for exceptions due to UL harmonic interference for EN-DC 2_n78

Test ID	E-UTRA Band 2			NR Band n78		
	Channel BW (MHz)	F _c (UL) (MHz) N _{UL}	UL allocation (L _{CRB})	NR F _c (DL) (MHz) N _{DL}	NR CBW (MHz)	UL allocation (L _{CRB})
1	10	1855 MHz/ 18650	25@12	3710.01 MHz/ 647334	Lowest	REFSENS (NOTE 2)
2		1855 MHz/ 18650	50@0	3710.01 MHz/ 647334	Mid Highest	REFSENS (NOTE 2)
3		1865 MHz/ 18750	25@12	3730.02 MHz/ 648668	Lowest	REFSENS (NOTE 2)
4		1865 MHz/ 18750	50@0	3730.02 MHz/ 648668	Mid Highest	REFSENS (NOTE 2)
5		1875MHz/ 18850	25@12	3750 MHz/ 650000	Lowest	REFSENS (NOTE 2)
6		1875 MHz/ 18850	50@0	3750 MHz/ 650000	Mid Highest	REFSENS (NOTE 2)

NOTE 1: Test frequencies are selected to fulfil Note 2 and 13 in Table 7.3B.2.0.3.1-1.
NOTE 2: REFSENS refers to Table 7.3.2.4.1-3 in TS 38.521-1 [8] which defines uplink RB configuration and start RB location for each SCS, channel BW and NR band.

Table 6-6 Test conditions for reference sensitivity level due to UL harmonic interference, EN-DC 2_n78 combination (TS38.521-3 [1] Table 7.3B.2.3.4.2.1-2_5)

Let's pick Test ID 6 and test highest CBW (100 MHz) for NR.

By referring both configurations tables (Table 6-5 and Table 6-6), we have the summarized parameter settings as given in Table 6-7.

Parameters	E-UTRA		NR	
	Configuration	Value	Configuration	Value
Frequency Range				FR1
Duplex Mode		FDD		TDD
Band		2		n78
Test Frequency	User defined	Nul = 18850 Ndl = 850	High	See Table 5-4
Test Channel Bandwidth		10 MHz	Highest	100 MHz
Test SCS			Lowest	30 kHz
DL RMC (Modulation)	QPSK	MCS index 5 MCS table 64QAM	CP-OFDM QPSK	MCS index 4 MCS table 64QAM
DL RMC (RB Allocation)	Full RB	50@0	Full RB ⁴⁶	273@0
UL RMC (Modulation)	QPSK	MCS index 6	DFT-s-OFDM QPSK	MCS index 2 MCS table 64QAM
UL RMC (RB Allocation)		50@0	REFSENS ⁴⁷	270@0
Downlink Power Level	RS EPRE	-95 dBm/15 kHz ⁴⁸	SSB ERPE	-70.3 dBm ⁴⁹
Uplink Power Control	TPC	Max	TPC	Max
DFT-s-OFDM				Enable
MAC Padding		Enable		Enable
Initial BWP				1099
OCNG	OCNG	Enable	OCNG	Enable
	PDSCH Power Offset	User Defined 0 dB	PDSCH Power Offset	User Defined 0 dB

⁴⁶ Refer to Annex D.3 or TS38.521-1 [6], Table 7.3.2.4.1-2 for DL RB allocation

⁴⁷ Refer to TS38.521-1 [6], Table 7.3.2.4.1-3 for REFSENS RB allocation

⁴⁸ Refer to TS 36.521-1 [5] Table 7.3.3-1

⁴⁹ This value is determined based on the description on page 90

	PDSCH Modulation Type	QPSK	PDSCH Modulation Type	QPSK
	PDCCH Power Offset	User Defined 0 dB	PDCCH Power Offset	User Defined 0 dB

Table 6-7 Test parameters settings for reference sensitivity with exception

In reference receiver power level with exceptions case, NR downlink power level is determined as follows:

Reference receiver power level WITH exceptions

$$= \text{Reference receiver power level WITHOUT exceptions} + \text{MSD} + \Delta R_{IB,c} + TT$$

Where

Reference receiver power level WITHOUT exceptions can be referred in TS38.521-1 [6], Table 7.3.2.3-1 for the tested NR band.

MSD, see Table 6-8 or TS38.521-3 [1] Table 7.3B.2.0.3.1-1

$\Delta R_{IB,c}$, is allowed reference sensitivity relaxation due to support for CA or DC operation for serving cell c (see TS38.521-3 [1], Table 7.3B.3.3.1-1)

TT, is test tolerance (see TS38.521-3 [1] Table 7.3B.2.3.5-1a)

So, in our example here, -85.6 dBm for receiver power level without exceptions for n78, 13.8 dB MSD for EN-DC 2_n78 combination as shown in Table 6-8, 0.5 dB $\Delta R_{IB,c}$ for NR, and 1 dB TT. The overall calculation results in

$$-85.6 + \text{MSD} + \Delta R_{IB,c} + TT = -85.6 + 13.8 + 0.5 + 1 = -70.3 \text{ dBm}$$

Table 7.3B.2.0.3.1-1: Reference sensitivity exceptions (MSD) due to UL harmonic for EN-DC in NR FR1

E-UTRA or NR Band / Channel bandwidth of the affected DL band / MSD													
UL band	DL band	5 MHz (dB)	10 MHz (dB)	15 MHz (dB)	20 MHz (dB)	25 MHz (dB)	30 MHz (dB)	40 MHz (dB)	50 MHz (dB)	60 MHz (dB)	80 MHz (dB)	90 MHz (dB)	100 MHz (dB)
1, 3	n77 ^{2, 13}		23.9	22.1	20.9			17.9	16.8	16.0	14.8	14.3	13.8
	n77 ³		1.1	0.8	0.3								
2	n78 ^{2, 13}		23.9	22.1	20.9			17.9	16.8	16.0	14.8	14.3	13.8
	n78 ³		1.1	0.8	0.3								

Table 6-8 Reference sensitivity exceptions (MSD) due to UL harmonic for EN-DC in NR FR1 (TS38.521-3 [1] Table 7.3B.2.0.3.1-1)

In reference sensitivity with exceptions case, the OCNB needs to be enabled as well.

6.1.3.3 Test Procedures

1. Configure the NR and LTE cell with appropriate test configurations given in Table 6-7
2. Turn on the LTE and NR cell, see chapter 4.4.1
3. Switch on DUT and wait until DUT is registered on LTE cell
4. Activate EN-DC mode
5. Start the Rx BLER Measurement as described in 4.4.3

6.1.3.4 Test Requirement and Results

The test requires that the throughput shall be $\geq 95\%$ of the maximum throughput of the reference measurement channels at the reference receive power level given in TS38.521-3 [1] Table 7.3B.2.3.5-1, Table 7.3B.2.3.5-2, Table 7.3B.2.3.5-3, and Table 7.3B.2.3.5-4 for MSDs due to uplink harmonic, harmonic mixing, cross band isolation and dual uplinks, respectively.

In our example here, test requirement TS38.521-3 [1] Table 7.3B.2.3.5-1 applies. The DUT achieves $\geq 95\%$ of the maximum throughput of the reference measurement channels at the reference receive power level at -70.3 dBm and with the presence of OCNG. The throughput measurement in CMsquares (in Fig. 6-3) indicates DUT achieves 97.65% of the maximum throughput which is higher than 95% limit. Therefore, the test is passed.

	Overall		LTE Cell 0		NR Cell 0	
	Relative	Absolute	Relative	Absolute	Relative	Absolute
ACK	98.66 %	68368	100.00 %	29700	97.65 %	38668
NACK	0.73 %	506	0.00 %	0	1.28 %	506
DTX	0.61 %	426	0.00 %	0	1.08 %	426
BLER	1.34 %		0.00 %		2.35 %	
Throughput	Relative	MBit/s	Relative	MBit/s	Relative	MBit/s
Average	97.99 %	26.76	100.00 %	3.95	97.65 %	22.81
Scheduled	---	27.31	---	3.95	---	23.36

Fig. 6-3 Throughput measurement of reference sensitivity with exceptions

6.2 Maximum Input Level for Inter-band EN-DC within FR1 (7.4B.3)

This test case should apply LTE anchor agnostic approach.

For more details, refer to TS38.521-1 [6], clause 7.4

6.2.1 Test Purpose

Maximum input level tests the UE's ability to receive data with a given average throughput for a specified reference measurement channel, under conditions of high signal level, ideal propagation and no added noise.

A UE unable to meet the throughput requirement under these NR conditions will decrease the coverage area in the vicinity of a gNodeB [6].

6.2.2 Test Preparations

6.2.2.1 Example Test Configuration

Example

Initial Conditions			
Test Environment as specified in TS 38.508-1 [5] subclause 4.1		Normal	
Test Frequencies as specified in TS 38.508-1 [5] subclause 4.3.1		Mid range (NOTE 5)	
Test Channel Bandwidths as specified in TS 38.508-1 [5] subclause 4.3.1		Lowest, Mid, Highest (NOTE 4)	
Test SCS as specified in Table 5.3.5-1		Lowest	
Test Parameters for Channel Bandwidths			
Downlink Configuration		Uplink Configuration	
Modulation	RB allocation	Modulation	RB allocation
CP-OFDM 64 QAM	NOTE 1	DFT-s-OFDM QPSK	NOTE 2
CP-OFDM 256 QAM	NOTE 1	DFT-s-OFDM QPSK	NOTE 2

NOTE 1: The specific configuration of downlink RB allocation is defined in Table 7.3.2.4.1-2.
NOTE 2: The specific configuration of uplink RB allocation is defined in Table 7.3.2.4.1-3.
NOTE 3: In a band where UE supports 4Rx, the test shall be performed only with 4Rx antennas ports connected.
NOTE 4: For n70, highest test channel bandwidth shall be Highest UL / Highest DL according to asymmetric channel bandwidths specified in clause 5.3.6.
NOTE 5: For NR band n28, 30MHz test channel bandwidth is tested with High range test frequencies.

Table 6-9 Example of a test configuration out of TS38.521-1 [6] Table 7.4.4.1-1

6.2.2.2 Cell Parameter Settings

Since this test case requires the LTE anchor agnostic approach, LTE settings can be referred in chapter 3.6.

NR settings on CMX can generally refer to chapter 5.1.2.2 by configuration given in Table 6-10.

Parameters	NR	
	Configuration	Value
Frequency Range		FR1
Duplex Mode		TDD
Band		n78
Test Frequency	Mid	See Table 5-4
Test Channel Bandwidth	Highest	100 MHz
Test SCS	Lowest	30 kHz
DL RMC (Modulation)	CP-OFDM 64QAM	MCS index 24, MCS table 64QAM
DL RMC (RB Allocation)	Full RB	273@0
UL RMC (Modulation)	DFT-s-OFDM QPSK	MCS index 2, MCS table 64QAM
UL RM (RB Allocation)	REFSENS	270@0
Downlink Power Level	Total Cell Power	-20-TT = -21 dBm (64QAM case) ⁵⁰ , TT: 1 dB (3.0GHz < f ≤6.0GHz)
Uplink Power Control	P0-NominalWithGrant	-90 dBm
	Alpha	0.8
	P0	0
	TPC	Closed Loop
	Target Power Total RMS	13.4 dBm ⁵¹
	Tolerance	1.3 ⁵¹
DFT-s-OFDM		Enable
MAC Padding		Enable
Initial BWP		1099
OCNG	OCNG	Enable
	PDSCH Modulation Type	64QAM
	PDSCH Power Offset	User Defined 0 dB

Table 6-10 Test parameters settings for Maximum Input Level

Hereafter are some remarks regarding the downlink and uplink power settings of this test case.

According to TS38.521-1 [6] Table 7.4.5-1, the downlink signal level or maximum input level from DUT's prospect should consider the test tolerance (TT) which is defined in TS38.521-1 [6] Table 7.4.5-3. In our example, when testing carrier frequency between 3.0GHz < f ≤ 6.0GHz, 1 dB TT should be applied. The maximum input level should be -20 dBm -1 dB = -21 dBm with test configuration of 100 MHz CBW, 64QAM modulation on PDSCH.

For uplink transmission power level, it has to fulfill the UL transmission requirement given in NOTE 1 of TS38.521-1 [6] Table 7.4.5-1, UL close loop target power is calculated with two steps:

Step 1:

⁵⁰ Refer to TS38.521-1 [6] Table 7.4.5-3 for TT

⁵¹ See the calculation below this table

Calculate the allowed lower bound of UE configured maximum output power $P_{CMAX_L,f,c}$ according to the formula Eqn. 6-1 in TS38.521-1 [6], clause 6.2.4.3

$$P_{CMAX_L,f,c} = \min \left\{ (P_{PowerClass} - \Delta P_{PowerClass}) - \max(\max(MPR_c + \Delta MPR_c, A-MPR_c) + \Delta T_{IB,c} + \Delta T_{C,c} + \Delta T_{RxsRS}, P-MPR_c), P_{EMAX,c} - \Delta T_{C,c} \right\}$$

Where parameters in the formula and their values are given in Table 6-11

Eqn. 6-1 Calculation of $P_{CMAX_L,f,c}$ (see TS38.521-1 [6], clause 6.2.4.3)

Parameter Name	Value	Remark
$P_{EMAX,c}$	23 dBm	value given by the p-Max IE to signal the UE about the maximum UL power allowed in the cell c.
$\Delta T_{C,c}$	0 dB	the condition stated in NOTE 3 of Table 6.2.1-1 in TS38.101-1 does not apply for a serving cell c in our case here. Otherwise, 1.5 dB should be applied.
$P_{PowerClass}$	23 dBm	maximum UE power specified in TS38.521-1 [6] Table 6.2.1.3-1 without taking the tolerance into account
$\Delta P_{PowerClass}$	0 dB	conditions given in TS38.521-1 [6] clause 6.2.4.3 do not apply
$\Delta T_{IB,c}$	0.3 dB (E-UTRA) 0.8 dB (NR)	additional tolerance for serving cell c as specified in TS 38.101-3 [7]. Table 6.2B.4.2.3.1-1, including EN-DC combination, DC_1_n78
MPR_c	2.5 dB	Maximum output power reduction for serving cell c is defined in TS38.521-1 [6], clause 6.2.2.3 Example, DFT-s-OFDM, 64QAM
$A-MPR_c$	0	Additional maximum output power reduction for serving cell c is defined in TS38.521-1, clause 6.2.3.3
ΔMPR_c	0	If the relative channel bandwidth is larger than 4% for TDD bands or 3% for FDD bands, the ΔMPR is defined in Table 6.2.2.3-3 of TS38.521-1 [6]
$P-MPR_c$	0	For UE conducted conformance test. This parameter is irrelevant
ΔT_{RxsRS}	0	It is applied when UE transmits SRS other than first SRS port, otherwise, it is 0.

Table 6-11 Parameters and their values for calculating $P_{CMAX_L,f,c}$

By inserting the values of Table 6-11 to Eqn. 6-1, we know $P_{CMAX_L,f,c}$ is 19.7 dBm.

TS38.521-1 [6] Table 7.4.5-1 NOTE1 specifies initially the UE transmission target power level at

$P_{CMAX_L,f,c} - 4$ dB, in our case, 15.7 dBm.

Step 2:

Apply the uplink power control window to measure the uplink transmission power, defined as -MU to -(MU + Uplink power control window size) dB, Where

1. $MU = \pm 1.0$ dB, for $3.0\text{GHz} < f \leq 4.2\text{GHz}$ (refer to Table F.1.3-1 of TS38.521-1)
2. Uplink power control window size = 1dB (UE power step size) + 0.7dB (UE power step tolerance) + 1.0 dB, $40\text{MHz} < f \leq 100\text{MHz}$ (Test system relative power measurement uncertainty). Thus, uplink power control window size = 2.7 dB

Overall uplink power control window is -1 ~ -3.7 dB

So, the target power level confined in the uplink power control window should be $(P_{CMAX_L,f,c} - 4 - 1)$ dBm > target power level > $(P_{CMAX_L,f,c} - 4 - 3.7)$ dBm, i.e. 14.7 dBm > target power level > 12 dBm

Apply the same calculation principle as illustrated in chapter 5.6.2.2. We will expect the target power total level 13.4 dBm with tolerance of 1.3 dB. The calculated values for these two parameters need to be entered in the CMSquares. It ensures that the UE's transmission power is kept in the range of the uplink control window. Otherwise, TPC command is sent to UE to increase or decrease the uplink transmission power.

Same as reference sensitivity test case in chapter 6.1, OCNG should also be enabled in this test case.

6.2.3 Test Procedure

1. Configure the LTE cell according to LTE anchor agnostic approach, see chapter 3.6

2. Configure the NR cell according to the configurations given in Table 6-10.
3. Turn on the LTE and NR cell, see chapter 4.4.1
4. Switch on DUT and wait until DUT is registered on LTE cell
5. Activate EN-DC mode
6. Reduce the LTE uplink RB allocation to 0 RB as given in 3.6
7. Start the Rx BLER Measurement as described in 4.4.3

6.2.4 Test Requirement and Results

The throughput measurement derived in test procedure shall be $\geq 95\%$ of the maximum throughput of the reference measurement channels as specified in DL reference measurement channels in TS38.521-1 [6], Annex A.3

Table 7.4.5-1: Maximum input level

Rx Parameter	Units	Channel bandwidth												
		5 MHz	10 MHz	15 MHz	20 MHz	25 MHz	30 MHz	40 MHz	50 MHz	60 MHz	70 MHz	80 MHz	90 MHz	100 MHz
Power in Transmission Bandwidth Configuration	dBm	-25 ² -TT				-24 ² -TT	-23 ² -TT	-22 ² -TT	-21 ² -TT	-20 ² -TT				
		-27 ³ -TT				-26 ³ -TT	-25 ³ -TT	-24 ³ -TT	-23 ³ -TT	-22 ³ -TT				
NOTE 1: The transmitter shall be set to 4dB below P _{C_{MAX},L1,c} at the minimum uplink configuration specified in Table 7.3.2.3-3 with P _{C_{MAX},L1,c} as defined in subclause 6.2.4.														
NOTE 2: Reference measurement channel is Annex A.3.2.3 or A.3.3.3 for 64 QAM.														
NOTE 3: Reference measurement channel is Annex A.3.2.4 or A.3.3.4 for 256 QAM.														
NOTE 4: TT for each frequency is specified in Table 7.4.5-3.														

Table 6-12 Test requirement of Maximum input level (TS38.521-1 [6], Table 7.4.5-1)

The measurement result in Fig. 6-4 shows that the DUT achieves 100% throughput under the test condition of maximum input level (with -21 dBm downlink power level as shown in Table 6-12). The measured throughput is above the lower limit 95%. Therefore, the test is passed.

BLER - RX Meas							
	Overall		LTE Cell 0		NR Cell 0		
	Relative	Absolute	Relative	Absolute	Relative	Absolute	
ACK	100.00 %	13800	0.00 %	0	100.00 %	13800	
NACK	0.00 %	0	0.00 %	0	0.00 %	0	
DTX	0.00 %	0	0.00 %	0	0.00 %	0	
BLER	0.00 %		0.00 %		0.00 %		
Throughput	Relative	MBit/s	Relative	MBit/s	Relative	MBit/s	
Average	100.00 %	177.09	NaN %	0.00	100.00 %	177.09	
Scheduled	---	177.09	---	0.00	---	177.09	

Fig. 6-4 Throughput measurement of maximum input level

7 Literature

- [1] 3GPP TS38.521-3 V16.4.0 (2020-06), "User Equipment (UE) conformance specification; Radio transmission and reception; Part 3: Range 1 and Range 2 Interworking operation with other radios (Release 16)".
- [2] Rohde & Schwarz, "5G NR ebook," [Online]. Available: <https://www.rohde-schwarz.com/5G-ebook>.

- [3] 3GPP TS38.104 V16.4.0 (2020-06), "Base Station (BS) radio transmission and reception (Release 16)".
- [4] Rohde & Schwarz, "White paper: Over-The-Air RF Conformance Measurement On 5G NR Devices," 2021.
- [5] 3GPP TS36.521-1 V16.5.0 (2020-06), "Evolved Universal Terrestrial Radio Access (E-UTRA); User Equipment (UE) conformance specification; Radio transmission and reception; Part 1: Conformance testing".
- [6] 3GPP TS38.521-1 V16.5.0 (2020-09), "NR; User Equipment (UE) conformance specification; Radio transmission and reception; Part 1: Range 1 Standalone; (Release 15)".
- [7] 3GPP TS38.101-3 V16.4.0 (2020-06), "User Equipment (UE) radio transmission and reception; Part 3: Range 1 and Range 2 Interworking operation with other radios (Release 16)".
- [8] 3GPP TS38.508-1 V16.4.0 (2020-06), "5GS; User Equipment (UE) conformance specification; Part 1: Common test environment (Release 16)".
- [9] 3GPP TS36.508 V16.5.0 (2020-06), "Evolved Universal Terrestrial Radio Access (E-UTRA) and Evolved Packet Core (EPC); Common test environments for User Equipment (UE) conformance testing (Release 16)".
- [10] 3GPP TS38.214 V16.2.0 (2020-06), "Technical Specification Group Radio Access Network NR; Physical layer procedures for data (Release 16)".
- [11] 3GPP TS36.213 V16.3.0 (2020-09), "Technical Specification Group Radio Access Network; Evolved Universal Terrestrial Radio Access (E-UTRA); Physical layer procedures (Release 16)".
- [12] Rohde & Schwarz, "R&S@CMX500/CMW500 5G NR FR1 Test Setup Quick Setup Instructions".
- [13] Rohde & Schwarz, "R&S@CMX500 Radio Communication Tester User Manual".
- [14] Rohde & Schwarz, "R&S@CMX500 Signaling Applications User Manual".
- [15] Rohde & Schwarz, "Application Note: LTE RF Measurements with the R&S@CMW500 according to 3GPP TS 36.521-1".
- [16] 3GPP TS38.213 V16.2.0 (2020-06), "NR; Physical layer procedures for control (Release 16)".

8 Appendix

In this appendix, some of the conformance test case relevant configuration tables from 3GPP technical specification are listed for quick reference.

Various test configurations of the conformance tests still require the reference to the original 3GPP specifications.

A FR1 Frequencies

A.1 NR FR1 Operating Bands

NR operating band	Uplink (UL) operating band BS receive / UE transmit $F_{UL,low} - F_{UL,high}$	Downlink (DL) operating band BS transmit / UE receive $F_{DL,low} - F_{DL,high}$	Duplex mode
n1	1920 MHz – 1980 MHz	2110 MHz – 2170 MHz	FDD
n2	1850 MHz – 1910 MHz	1930 MHz – 1990 MHz	FDD
n3	1710 MHz – 1785 MHz	1805 MHz – 1880 MHz	FDD
n5	824 MHz – 849 MHz	869 MHz – 894 MHz	FDD
n7	2500 MHz – 2570 MHz	2620 MHz – 2690 MHz	FDD
n8	880 MHz – 915 MHz	925 MHz – 960 MHz	FDD
n12	699 MHz – 716 MHz	729 MHz – 746 MHz	FDD
n14	788 MHz – 798 MHz	758 MHz – 768 MHz	FDD
n18	815 MHz – 830 MHz	860 MHz – 875 MHz	FDD
n20	832 MHz – 862 MHz	791 MHz – 821 MHz	FDD
n25	1850 MHz – 1915 MHz	1930 MHz – 1995 MHz	FDD
n26	814 MHz – 849 MHz	859 MHz – 894 MHz	FDD
n28	703 MHz – 748 MHz	758 MHz – 803 MHz	FDD
n29	N/A	717 MHz – 728 MHz	SDL
n30	2305 MHz – 2315 MHz	2350 MHz – 2360 MHz	FDD
n34	2010 MHz – 2025 MHz	2010 MHz – 2025 MHz	TDD
n38	2570 MHz – 2620 MHz	2570 MHz – 2620 MHz	TDD
n39	1880 MHz – 1920 MHz	1880 MHz – 1920 MHz	TDD
n40	2300 MHz – 2400 MHz	2300 MHz – 2400 MHz	TDD
n41	2496 MHz – 2690 MHz	2496 MHz – 2690 MHz	TDD
n48	3550 MHz – 3700 MHz	3550 MHz – 3700 MHz	TDD
n50	1432 MHz – 1517 MHz	1432 MHz – 1517 MHz	TDD
n51	1427 MHz – 1432 MHz	1427 MHz – 1432 MHz	TDD
n53	2483.5 MHz – 2495 MHz	2483.5 MHz – 2495 MHz	TDD
n65	1920 MHz – 2010 MHz	2110 MHz – 2200 MHz	FDD
n66	1710 MHz – 1780 MHz	2110 MHz – 2200 MHz	FDD
n70	1695 MHz – 1710 MHz	1995 MHz – 2020 MHz	FDD
n71	663 MHz – 698 MHz	617 MHz – 652 MHz	FDD
n74	1427 MHz – 1470 MHz	1475 MHz – 1518 MHz	FDD
n75	N/A	1432 MHz – 1517 MHz	SDL
n76	N/A	1427 MHz – 1432 MHz	SDL
n77	3300 MHz – 4200 MHz	3300 MHz – 4200 MHz	TDD
n78	3300 MHz – 3800 MHz	3300 MHz – 3800 MHz	TDD
n79	4400 MHz – 5000 MHz	4400 MHz – 5000 MHz	TDD
n80	1710 MHz – 1785 MHz	N/A	SUL
n81	880 MHz – 915 MHz	N/A	SUL
n82	832 MHz – 862 MHz	N/A	SUL
n83	703 MHz – 748 MHz	N/A	SUL
n84	1920 MHz – 1980 MHz	N/A	SUL
n86	1710 MHz – 1780 MHz	N/A	SUL
n89	824 MHz – 849 MHz	N/A	SUL
n90	2496 MHz – 2690 MHz	2496 MHz – 2690 MHz	TDD
n91	832 MHz – 862 MHz	1427 MHz – 1432 MHz	FDD2
n92	832 MHz – 862 MHz	1432 MHz – 1517 MHz	FDD2
n93	880 MHz – 915 MHz	1427 MHz – 1432 MHz	FDD2
n94	880 MHz – 915 MHz	1432 MHz – 1517 MHz	FDD2
n95 ¹	2010 MHz – 2025 MHz	N/A	SUL

NOTE 1: This band is applicable in China only.
NOTE 2: Variable duplex operation does not enable dynamic variable duplex configuration by the network, and is used such that DL and UL frequency ranges are supported independently in any valid frequency range for the band.

Table 8-1 Operating band of FR1 [3]

A.2 Inter-band EN-DC Configuration within FR1 (two bands)

EN-DC configuration	Uplink EN-DC configuration (NOTE 1)	Single UL allowed
DC_1A_n28A	DC_1A_n28A	No
DC_1A_n40A	DC_1A_n40A	No
DC_1A_n51A	DC_1A_n51A	No
DC_1A_n77A7 DC_1A_n77C7	DC_1A_n77A	DC_1_n77
DC_1A_n78A7 DC_1A_n78C7	DC_1A_n78A	No
DC_1A_n79A7 DC_1A_n79C7	DC_1A_n79A	No
DC_2A_n5A	DC_2A_n5A	No
DC_2A_n41A DC_2C_n41A	DC_2A_n41A DC_2C_n41A	No
DC_2A_n66A	DC_2A_n66A	DC_2_n66
DC_2A_n71A	DC_2A_n71A	No
DC_2A_n78A	DC_2A_n78A	DC_2_n78
DC_3A_n7A	DC_3A_n7A	No
DC_3A_n28A	DC_3A_n28A	No
DC_3A_n40A	DC_3A_n40A	No
DC_3A_n41A DC_3C_n41A	DC_3A_n41A DC_3C_n41A	DC_3_n41
DC_3A_n51A	DC_3A_n51A	No
DC_3A_n77A7 DC_3A_n77C7	DC_3A_n77A	DC_3_n77
DC_3A_n78A7 DC_3A_n78C7 DC_3C_n78A7	DC_3A_n78A	DC_3_n78
DC_3A_n79A7 DC_3A_n79C7	DC_3A_n79A	No
DC_5A_n2A	DC_5A_n2A	No
DC_5A_n40A	DC_5A_n40A	No
DC_5A_n66A	DC_5A_n66A	DC_5_n66
DC_5A_n78A7	DC_5A_n78A	No
DC_7A_n28A	DC_7A_n28A	No
DC_7A_n51A	DC_7A_n51A	No
DC_7A_n66A DC_7C_n66A	DC_7A_n66A	No
DC_7A_n78A7	DC_7A_n78A	No
DC_7C_n78A7	DC_7A_n78A	No
DC_7A-7A_n78A7	DC_7A_n78A	No
DC_8A_n40A7	DC_8A_n40A	No
DC_8A_n41A DC_8A_n41C DC_8A_n41(2A)	DC_8A_n41A	No
DC_8A_n77A7	DC_8A_n77A	No
DC_8A_n78A7	DC_8A_n78A	No

DC_8A_n79A7	DC_8A_n79A	No
DC_11A_n77A7	DC_11A_n77A	No
DC_11A_n78A7	DC_11A_n78A	No
DC_11A_n79A7	DC_11A_n79A	No
DC_12A_n5A	DC_12A_n5A	No
DC_12A_n66A	DC_12A_n66A	No
DC_12A_n78A	DC_12A_n78A	DC_12_n78
DC_13A_n66A	DC_13A_n66A	No
DC_18A_n77A7	DC_18A_n77A	No
DC_18A_n78A7	DC_18A_n78A	No
DC_18A_n79A7	DC_18A_n79A	No
DC_19A_n77A7 DC_19A_n77C7	DC_19A_n77A	No
DC_19A_n78A7 DC_19A_n78C7	DC_19A_n78A	No
DC_19A_n79A7 DC_19A_n79C7	DC_19A_n79A	No
DC_20A_n8A	DC_20A_n8A	DC_20_n8
DC_20A_n28A8,10	DC_20A_n28A	No
DC_20A_n51A	DC_20A_n51A	No
DC_20A_n77A7	DC_20A_n77A	No
DC_20A_n78A7	DC_20A_n78A	No
DC_21A_n77A7 DC_21A_n77C7	DC_21A_n77A	No
DC_21A_n78A7 DC_21A_n78C7	DC_21A_n78A	No
DC_21A_n79A7 DC_21A_n79C7	DC_21A_n79A	No
DC_25A_n41A	DC_25A_n41A	No
DC_26A_n41A	DC_26A_n41A	No
DC_26A_n77A7	DC_26A_n77A	No
DC_26A_n78A7	DC_26A_n78A	No
DC_26A_n79A7	DC_26A_n79A	No
DC_28A_n51A	DC_28A_n51A	No
DC_28A_n77A7 DC_28A_n77C7	DC_28A_n77A	No
DC_28A_n78A7 DC_28A_n78C7	DC_28A_n78A	No
DC_28A_n79A7 DC_28A_n79C7	DC_28A_n79A	No
DC_30A_n5A	DC_30A_n5A	No
DC_30A_n66A	DC_30A_n66A	No
DC_38A_n78A7	N/A	No
DC_39A_n41A DC_39C_n41A	DC_39A_n41A DC_39C_n41A	No
DC_39A_n78A5, 7	DC_39A_n78A	No
DC_39A_n79A7	DC_39A_n79A	No
DC_40A_n41A	DC_40A_n41A	No
DC_40A_n77A	N/A	No
DC_41A_n77A DC_41C_n77A	DC_41A_n77A	No
DC_41A_n78A DC_41C_n78A	DC_41A_n78A	No

DC_41A_n79A6,7 DC_41C_n79A6,7	DC_41A_n79A	No
DC_42A_n51A	DC_42A_n51A	No
DC_42A_n77A3,4,9 DC_42A_n77C3,4,9 DC_42C_n77A3,4,9 DC_42C_n77C3,4,9 DC_42D_n77A3,4,9 DC_42E_n77A3,4,9	N/A	N/A
DC_42A_n78A3,4,9 DC_42A_n78C3,4,9 DC_42C_n78A3,4,9 DC_42C_n78C3,4,9 DC_42D_n78A3,4,9 DC_42E_n78A3,4,9	N/A	N/A
DC_42A_n79A9 DC_42A_n79C9 DC_42C_n79A9 DC_42C_n79C9 DC_42D_n79A9 DC_42E_n79A9	N/A	N/A
DC_46A_n78A2 DC_46C_n78A2 DC_46D_n78A2 DC_46E_n78A2	N/A	N/A
DC_48A_n5A	DC_48A_n5A	No
DC_48A_n66A	DC_48A_n66A	No
DC_66A_n2A	DC_66A_n2A	DC_66_n2
DC_66A_n5A	DC_66A_n5A	DC_66_n5
DC_66A_n41A	DC_66A_n41A	No
DC_66A_n71A	DC_66A_n71A	No
DC_66A_n78A	DC_66A_n78A	No
<p>NOTE 1: Uplink EN-DC configurations are the configurations supported by the present release of specifications.</p> <p>NOTE 2: Restricted to E-UTRA operation when inter-band carrier aggregation is configured. The downlink operating band for Band 46 is paired with the uplink operating band (external E-UTRA band) of the carrier aggregation configuration that is supporting the configured PCell.</p> <p>NOTE 3: The minimum requirements apply only when there is non-simultaneous Tx/Rx operation between E-UTRA and NR carriers. This restriction applies also for these carriers when applicable EN-DC configuration is part of a higher order EN-DC configuration.</p> <p>NOTE 4: The minimum requirements for intra-band contiguous or non-contiguous EN-DC apply. The intra-band requirements also apply for these carriers when applicable EN-DC configuration is a subset of a higher order EN-DC configuration.</p> <p>NOTE 5: The frequency range above 3600 MHz for Band n78 is not used in this combination.</p> <p>NOTE 6: The frequency range below 2506 MHz for Band 41 is not used in this combination.</p> <p>NOTE 7: Applicable for UE supporting inter-band EN-DC with mandatory simultaneous Rx/Tx capability.</p> <p>NOTE 8: The frequency range in band n28 is restricted for this band combination to 703-733 MHz for the UL and 758-788 MHz for the DL.</p> <p>NOTE 9: The combination is not used alone as fall back mode of other band combinations in which UL in Band 42 is not used.</p> <p>NOTE 10: The maximum power spectral density imbalance between downlink carriers is within [6] dB. The power spectral density imbalance condition also applies for these carriers when applicable EN-DC configuration is a subset of a higher order EN-DC configuration.</p>		

Table 8-2 Inter-band EN-DC configuration within FR1, two bands (TS38.521-3 [1], Table 5.5B.4.1-1)

A.3 Intra-band EN-DC Contiguous within FR1

Following Table 8-3 lists the intra-band EN-DC contiguous within FR1

EN-DC Configuration	Uplink EN-DC configuration (NOTE 1)	Single UL allowed
DC_(n)41AA ⁵ DC_(n)41CA ⁵ DC_(n)41DA ⁵	DC_(n)41AA	Yes ³
DC_(n)41CA ⁵	DC_41A_n41A	Yes ³

DC_(n)41DA ⁵		
DC_(n)71AA ²	DC_(n)71AA	No ⁴
<p>NOTE 1: Uplink EN-DC configurations are the configurations supported by the present release of specifications.</p> <p>NOTE 2: Requirements in this specification apply for NR SCS of 15 kHz only.</p> <p>NOTE 3: Single UL allowed due to potential emission issues, not self-interference.</p> <p>NOTE 4: For UE(s) supporting dynamic power sharing it is mandatory to do dual simultaneous UL. For UE(s) not supporting dynamic power sharing single UL is allowed.</p> <p>NOTE 5: The minimum requirements only apply for non-simultaneous Tx/Rx between all carriers.</p>		

Table 8-3 Intra-band contiguous EN-DC configurations (TS38.101-3 [1] clause 5.5B.2)

FR1 EN-DC intra-band contiguous configuration and bandwidth combination is listed in Table 8-4

E-UTRA – NR configuration / Bandwidth combination set								
Downlink EN-DC configuration	Uplink EN-DC configurations	Component carriers in order of increasing carrier frequency			Maximum aggregated bandwidth (MHz)	Bandwidth combination set		
		Channel bandwidths for E-UTRA carrier (MHz)	Channel bandwidths for NR carrier (MHz)	Channel bandwidths for E-UTRA carrier (MHz)				
DC_(n)41AA	DC_(n)41AA	20	40, 60, 80,100		120	0		
			40, 60, 80,100	20				
		20	40, 50, 60, 80,100		120	1		
			40, 50, 60, 80,100	20				
DC_(n)41CA	DC_(n)41AA1, DC_41A_n41A2	20+20	40, 60, 80,100		140	0		
			40, 60, 80,100	20+20				
		20+20	40, 50, 60, 80,100		140	1		
			40, 50, 60, 80,100	20+20				
DC_(n)41DA	DC_(n)41AA1, DC_41A_n41A2	20+20+20	40, 60, 80,100		160	0		
			40, 60, 80,100	20+20+20				
		20+20+20	40, 50, 60, 80,100		160	1		
			40, 50, 60, 80,100	20+20+20				
DC_(n)71AA	DC_(n)71AA	15	5		20	0		
			10	5, 10				
			5	5, 10, 15				
				5			15	
				5, 10			10	
				5, 10, 15			5	

NOTE 1: Void
NOTE 2: Void
NOTE 3: Void
NOTE 4: The channel bandwidths for E-UTRA or NR carrier should be at least supported in one of the BCS indicated in E-UTRA bandwidth combination sets or NR bandwidth combination sets if reported.

Table 8-4 EN-DC configurations and bandwidth combination sets defined for intra-band contiguous EN-DC (TS38.512-3 [1] clause 5.3B.1.2)

A.4 Intra-band EN-DC Non-contiguous within FR1

FR1 EN-DC Intra-band non-contiguous channel configuration TS38.101-3 [7] clause 5.5B.3 is listed in Table 8-5

EN-DC Configuration	Uplink EN-DC configuration (NOTE 1)	Single UL allowed
DC_3A_n3A	DC_3A_n3A ²	Yes ²
DC_41A_n41A ³ DC_41C_n41A ³ DC_41D_n41A ³	DC_41A_n41A	Yes ⁴
DC_66A_n66A	DC_66A_n66A ⁵	Yes ⁵
<p>NOTE 1: Uplink EN-DC configurations are the configurations supported by the present release of specifications.</p> <p>NOTE 2: Only single switched UL is supported in Rel.15</p> <p>NOTE 3: The minimum requirements only apply for non-simultaneous Tx/Rx between all carriers.</p> <p>NOTE 4: Single UL allowed due to potential emission issues, not self-interference.</p> <p>NOTE 5: Only single switched UL is supported.</p>		

Table 8-5 Intra-band non-contiguous EN-DC configurations (TS38.503 [7] clause 5.5B.3)

FR1 EN-DC intra-band non-contiguous configuration and bandwidth combination is listed in Table 8-6

E-UTRA – NR configuration / Bandwidth combination set						
Downlink EN-DC configuration	Uplink EN-DC configurations	Component carriers in order of increasing carrier frequency			Maximum aggregated bandwidth (MHz)	Bandwidth combination set
		Channel bandwidths for E-UTRA carrier (MHz)	Channel bandwidths for NR carrier (MHz)	Channel bandwidths for E-UTRA carrier (MHz)		
DC_3A_n3A	DC_3A_n3A(1)		5, 10, 15, 20, 25, 30	5, 10, 15, 20	50	0
DC_41A_n41A	DC_41A_n41A	20	40, 60, 80,100		120	0
			40, 60, 80,100	20		
		20	40, 50, 60, 80,100		120	1
			40, 50, 60, 80,100	20		
DC_41C_n41A	DC_41A_n41A	20+20	40, 60, 80,100		140	0
			40, 60, 80,100	20+20		
		20+20	40, 50, 60, 80,100		140	1
			40, 50, 60, 80,100	20+20		
DC_41D_n41A	DC_41A_n41A	20+20+20	40, 60, 80,100		160	0
			40, 60, 80,100	20+20+20		
		20+20+20	40, 50, 60, 80,100		160	1
			40, 50, 60, 80,100	20+20+20		
NOTE 1: Only single switched UL is supported in Rel-15.						

Table 8-6 EN-DC configurations and bandwidth combination sets defined for intra-band non-contiguous EN-DC (TS38.521-3 [1] clause 5.3B.1.3)

B Initial Test Conditions

B.1 Test Frequencies for E-UTRA FDD Operating Band 1

Test Frequency ID	Bandwidth [MHz]	N _{UL}	Frequency of Uplink [MHz]	N _{DL}	Frequency of Downlink [MHz]
Low Range	5	18025	1922.5	25	2112.5
	10	18050	1925	50	2115
	15	18075	1927.5	75	2117.5
	20	18100	1930	100	2120

Mid Range	5/10/15/20	18300	1950	300	2140
High Range	5	18575	1977.5	575	2167.5
	10	18550	1975	550	2165
	15	18525	1972.5	525	2162.5
	20	18500	1970	500	2160

Table 8-7 Test frequencies for E-UTRA FDD Band 1 (TS36.508 [9], Table 4.3.1.1.2-1)

Test frequencies in other FDD E-UTRA bands can be found in TS36.508 [9] clause 4.3.1.1

B.2 Test Channel Bandwidth for 5G NR FR1

NR Band / UE Test Channel Bandwidth			
NR Band	Low	Mid	High
n1	5	15 ⁶ , 20 ⁷	20 ⁶ , 40 ⁷
n2	5	15	20
n3	5	15	30
n5	5	15	20
n7	5	15	20
n8	5	15	20
n12	5	10	15
n20	5	15	20
n25	5	15	20
n28	5	15	20
n29	5 ²	10 ²	10 ²
n34	5	10	15
n38	5	15	20
n39	5	20	40
n40	5	30	80
n41	10	60	100
n48	5 ⁴ , 10 ⁵	20 ⁴ , 40 ⁵	40 ³ , 100 ⁴
n50	5	20	80
n51	5	5	5
n65	5	15	20
n66	5	20	40
n70	5	15	15 ¹ /25 ²
n71	5	10	20
n74	5	15	20
n75	5 ²	15 ²	20 ²
n76	5 ²	5 ²	5 ²
n77	10	50	100
n78	10	50	100
n79	40	60	100
n80	5 ³	20 ³	30 ¹

n81	5 ³	15 ³	20 ¹
n82	5 ³	15 ³	20 ¹
n83	5 ³	15 ³	20 ¹
n84	5 ³	15 ³	20 ¹
n86	5 ³	20 ³	40 ¹
	<p>NOTE 1: For UEs with limited UE channel bandwidth capability, if the above defined low channel bandwidth is not supported by the UE, select the closest channel bandwidth in both DL and UL. This shall apply only for Rel.15 UEs..</p> <p>Note 2: This UE channel bandwidth is applicable only to downlink.</p> <p>Note 3: This UE channel bandwidth is applicable only to uplink.</p> <p>Note 4: Applicable for use as SCell in CA or SCell in DC configuration.</p> <p>Note 5: Applicable for use as single carrier, PCell in CA or PCell in DC configuration.</p>	<p>Note 1: For UEs with limited UE channel bandwidth capability, if mid channel BW is not supported by the UE, select the closest lower channel BW supported by the UE in both UL and DL. This shall apply only for Rel 15 UEs.</p> <p>Note 2: This UE channel bandwidth is applicable only to downlink.</p> <p>Note 3: This UE channel bandwidth is applicable only to uplink.</p> <p>Note 4: Applicable when for use as single carrier, PCell in CA or PCell in DC configuration.</p> <p>Note 5: Applicable for use as SCell in CA or SCell in DC configuration.</p> <p>Note 6: This Mid test channel bandwidth is applicable to UEs supporting maximum channel bandwidth 20MHz.</p> <p>Note 7: This Mid test channel bandwidth is applicable to UEs supporting maximum channel bandwidth 40MHz.</p>	<p>NOTE 1: This UE channel bandwidth is applicable only to uplink.</p> <p>NOTE 2: This UE channel bandwidth is applicable only to downlink.</p> <p>NOTE 3: Applicable for use as single carrier, PCell in CA or PCell in DC configuration.</p> <p>NOTE 4: Applicable for use as DL SCell in CA or DL SCell in DC configuration.</p> <p>NOTE 5: For UEs with limited UE channel bandwidth capability, if the above defined high channel bandwidth is not supported by the UE, select the closest channel bandwidth in both DL and UL. This shall apply only for Rel-15 UEs.</p> <p>Note 6: This High test channel bandwidth is applicable to UEs supporting maximum channel bandwidth 20MHz.</p> <p>Note 7: This High test channel bandwidth is applicable to UEs supporting maximum channel bandwidth 40MHz.</p>

Table 8-8 Test channel bandwidth for NR FR1 bands (TS38.508 [8], clause 4.3.1.0A-4.3.1.0D)

B.3 Test Frequency for 5G NR FR1

In TS38.508-1 [8] clause 4.3.1.1.1, FR1 test frequencies are defined for each NR operating band and its' associated SCS.

Each test frequency table is named with following naming convention: Table 4.3.1.1.1.X-Y

Where

X is the NR FR1 operating band number without prefix "n", e.g. X = 78 when FR1 band n78 is under test

Y indicates the SCS (1 = 15 kHz SCS, 2 = 30 kHz SCS, 3 = 60 kHz SCS)

Example:

TS38.508-1 [8] Table 4.3.1.1.1.78-1 defines the test frequencies for n78, 15 kHz SCS (see Table 8-9)

CBW [MHz]	carrier Bandwidth [PRBs]	Range			Carrier centre [MHz]	Carrier centre [ARFCN]	point A [MHz]	absolute Frequency Point A [ARFCN]	offsetTo Carrier [Carrier PRBs]	SS block SCS [kHz]	GSCN	absolute Frequency SSB [ARFCN]	k _{SSB}	Offset Carrier CORE SET#0 [RBs] Note 2	CORE SET#0 Index (Offset [RBs]) Note 1	offsetTo PointA (SIB1) [PRBs] Note 1
		Downlink & Uplink	Low	Mid												
10	52	Downlink & Uplink	Low	3305.01	620334	3300.33	620022	0	30	7711	620352	6	1	1 (6)	7	
			Mid	3549.99	636666	3526.95	635130	102								
			High	3795	653000	3699.6	646640	504								
15	79	Downlink & Uplink	Low	3307.5	620500	3300.39	620026	0	30	7711	620352	2	1	1 (6)	7	
			Mid	3549.99	636666	3524.52	634968	102								
			High	3792.48	652832	3694.65	646310	504								
20	106	Downlink & Uplink	Low	3310.02	620668	3300.48	620032	0	30	7711	620352	8	0	1 (6)	6	
			Mid	3549.99	636666	3522.09	634806	102								
			High	3789.99	652666	3689.73	645982	504								
40	216	Downlink & Uplink	Low	3320.01	621334	3300.57	620038	0	30	7711	620352	2	0	1 (6)	6	
			Mid	3549.99	636666	3512.19	634146	102								
			High	3780	652000	3669.84	644656	504								
50	270	Downlink & Uplink	Low	3325.02	621668	3300.72	620048	0	30	7711	620352	4	3	0 (2)	5	
			Mid	3549.99	636666	3507.33	633822	102								
			High	3774.99	651666	3659.97	643998	504								

Note 1: The CORESET#0 Index and the associated CORESET#0 Offset refers to Table 13-3 in TS 38.213 [22]. The value of CORESET#0 Index is signalled in controlResourceSetZero (pdcc-ConfigSIB1) in the MIB. The offsetToPointA IE is expressed in units of resource blocks assuming 15 kHz subcarrier spacing for FR1 and 60 kHz subcarrier spacing for FR2.

Note 2: The parameter Offset Carrier CORESET#0 specifies the offset from the lowest subcarrier of the carrier and the lowest subcarrier of CORESET#0. It corresponds to the parameter $\Delta F_{\text{OffsetCORESET-0-Carrier}}$ in Annex C expressed in number of common RBs.

Table 8-9 Test frequencies of 5G NR FR1 band n78, 15 kHz SCS (TS38.508-1 [8], Table 4.3.1.1.1.78-1)

TS38.508-1 [8] Table 4.3.1.1.1.78-2 defines the test frequencies for n78, 30 kHz SCS (see Table 8-10)

CBW [MHz]	carrier Bandwidth [PRBs]	Range			Carrier centre [MHz]	Carrier centre [ARFCN]	point A [MHz]	absolute Frequency Point A [ARFCN]	offsetTo Carrier [Carrier PRBs]	SS block SCS [kHz]	GSCN	absolute Frequency SSB [ARFCN]	k _{SSB}	Offset Carrier CORE SET#0 [RBs] Note 2	CORE SET#0 Index (Offset [RBs]) Note 1	offsetTo PointA (SIB1) [PRBs] Note 1
		Downlink & Uplink	Low	Mid												
10	24	Downlink & Uplink	Low	3305.01	620334	3300.69	620046	0	30	7711	620352	18	0	2 (2)	4	
			Mid	3549.99	636666	3508.95	633930	102								
			High	3795	653000	3609.24	640616	504								
15	38	Downlink & Uplink	Low	3307.5	620500	3300.66	620044	0	30	7711	620352	20	0	2 (2)	4	
			Mid	3549.99	636666	3506.43	633762	102								
			High	3792.48	652832	3604.2	640280	504								
20	51	Downlink & Uplink	Low	3310.02	620668	3300.84	620056	0	30	7711	620352	8	0	2 (2)	4	
			Mid	3549.99	636666	3504.09	633606	102								
			High	3789.99	652666	3599.37	639958	504								
40	106	Downlink & Uplink	Low	3320.01	621334	3300.93	620062	0	30	7711	620352	2	0	2 (2)	4	
			Mid	3549.99	636666	3494.19	632946	102								
			High	3780	652000	3579.48	638632	504								
50	133	Downlink & Uplink	Low	3325.02	621668	3301.08	620072	0	30	7711	620352	16	0	1 (1)	2	
			Mid	3549.99	636666	3489.33	632622	102								
			High	3774.99	651666	3569.61	637974	504								
60	162	Downlink & Uplink	Low	3330	622000	3300.84	620056	0	30	7711	620352	8	0	2 (2)	4	
			Mid	3549.99	636666	3484.11	632274	102								
			High	3769.98	651332	3559.38	637292	504								
80	217	Downlink & Uplink	Low	3340.02	622668	3300.96	620064	0	30	7711	620352	0	0	2 (2)	4	
			Mid	3549.99	636666	3474.21	631614	102								
			High	3759.99	650666	3539.49	635966	504								
90	245	Downlink & Uplink	Low	3345	623000	3300.9	620060	0	30	7711	620352	4	0	2 (2)	4	
			Mid	3549.99	636666	3469.17	631278	102								
			High	3754.98	650332	3529.44	635296	504								
100	273	Downlink & Uplink	Low	3350.01	623334	3300.87	620058	0	30	7711	620352	6	0	2 (2)	4	
			Mid	3549.99	636666	3464.13	630942	102								
			High	3750	650000	3519.42	634628	504								

Note 1: The CORESET#0 Index and the associated CORESET#0 Offset refers to Table 13-4 in TS 38.213 [22]. The value of CORESET#0 Index is signalled in controlResourceSetZero (pdcc-ConfigSIB1) in the MIB. The offsetToPointA IE is expressed in units of resource blocks assuming 15 kHz subcarrier spacing for FR1 and 60 kHz subcarrier spacing for FR2.

Note 2: The parameter Offset Carrier CORESET#0 specifies the offset from the lowest subcarrier of the carrier and the lowest subcarrier of CORESET#0. It corresponds to the parameter $\Delta F_{\text{OffsetCORESET-0-Carrier}}$ in Annex C expressed in number of common RBs.

Table 8-10 Test frequencies of 5G NR FR1 band n78, 30 kHz SCS (TS38.508-1 [8], Table 4.3.1.1.1.78-2)

B.4 Test SCS for 5G NR FR1

In default condition table of each conformance test case, test SCS requirement is defined. The supported SCS of each FR1 operating band is specified in TS38.521-1 [6], Table 5.3.5-1 as shown below in Table 8-11.

NR Band	NR band / SCS / UE Channel bandwidth													
	SCS kHz	5 MHz	10 ^{1,2} MHz	15 ² MHz	20 ² MHz	25 ² MHz	30 MHz	40 MHz	50 MHz	60 MHz	70 MHz	80 MHz	90 ⁶ MHz	100 MHz
n1	15	Yes	Yes	Yes	Yes									
	30		Yes	Yes	Yes									

	60		Yes	Yes	Yes									
n2	15	Yes	Yes	Yes	Yes									
	30		Yes	Yes	Yes									
	60		Yes	Yes	Yes									
n3	15	Yes	Yes	Yes	Yes	Yes	Yes							
	30		Yes	Yes	Yes	Yes	Yes							
	60		Yes	Yes	Yes	Yes	Yes							
n5	15	Yes	Yes	Yes	Yes									
	30		Yes	Yes	Yes									
	60													
n7	15	Yes	Yes	Yes	Yes									
	30		Yes	Yes	Yes									
	60		Yes	Yes	Yes									
n8	15	Yes	Yes	Yes	Yes									
	30		Yes	Yes	Yes									
	60													
n12	15	Yes	Yes	Yes										
	30		Yes	Yes										
	60													
n20	15	Yes	Yes	Yes	Yes									
	30		Yes	Yes	Yes									
	60													
n25	15	Yes	Yes	Yes	Yes									
	30		Yes	Yes	Yes									
	60		Yes	Yes	Yes									
n28	15	Yes	Yes	Yes	Yes ⁹									
	30		Yes	Yes	Yes ⁹									
	60													
n29	15	Yes	Yes											
	30		Yes											
	60													
n34	15	Yes	Yes	Yes										
	30		Yes	Yes										
	60		Yes	Yes										
n38	15	Yes	Yes	Yes	Yes									
	30		Yes	Yes	Yes									
	60		Yes	Yes	Yes									
n39	15	Yes	Yes	Yes	Yes	Yes	Yes	Yes						
	30		Yes	Yes	Yes	Yes	Yes	Yes						
	60		Yes	Yes	Yes	Yes	Yes	Yes						
n40	15	Yes	Yes	Yes	Yes	Yes	Yes	Yes	Yes					
	30		Yes	Yes	Yes	Yes	Yes	Yes	Yes	Yes		Yes		
	60		Yes	Yes	Yes	Yes	Yes	Yes	Yes	Yes		Yes		
n41	15		Yes	Yes	Yes		Yes	Yes	Yes					
	30		Yes	Yes	Yes		Yes	Yes	Yes	Yes		Yes	Yes ⁶	Yes
	60		Yes	Yes	Yes		Yes	Yes	Yes	Yes		Yes	Yes ⁶	Yes
n48	15	Yes ⁷	Yes	Yes	Yes			Yes	Yes ⁸					

	30		Yes	Yes	Yes			Yes	Yes ⁸	Yes ⁸		Yes ⁸	Yes ^{8,10}	Yes ⁸
	60		Yes	Yes	Yes			Yes	Yes ⁸	Yes ⁸		Yes ⁸	Yes ^{8,10}	Yes ⁸
n50	15	Yes	Yes	Yes	Yes			Yes	Yes					
	30		Yes	Yes	Yes			Yes	Yes	Yes		Yes ³		
	60		Yes	Yes	Yes			Yes	Yes	Yes		Yes ³		
n51	15	Yes												
	30													
	60													
n65	15	Yes	Yes	Yes	Yes									
	30		Yes	Yes	Yes									
	60		Yes	Yes	Yes									
n66	15	Yes	Yes	Yes	Yes			Yes						
	30		Yes	Yes	Yes			Yes						
	60		Yes	Yes	Yes			Yes						
n70	15	Yes	Yes	Yes	Yes ³	Yes ³								
	30		Yes	Yes	Yes ³	Yes ³								
	60		Yes	Yes	Yes ³	Yes ³								
n71	15	Yes	Yes	Yes	Yes									
	30		Yes	Yes	Yes									
	60													
n74	15	Yes	Yes	Yes	Yes									
	30		Yes	Yes	Yes									
	60		Yes	Yes	Yes									
n75	15	Yes	Yes	Yes	Yes									
	30		Yes	Yes	Yes									
	60		Yes	Yes	Yes									
n76	15	Yes												
	30													
	60													
n77	15		Yes	Yes	Yes			Yes	Yes					
	30		Yes	Yes	Yes			Yes	Yes	Yes	Yes ^{10,11}	Yes	Yes ^{6,10}	Yes
	60		Yes	Yes	Yes			Yes	Yes	Yes	Yes ^{10,11}	Yes	Yes ^{6,10}	Yes
n78	15		Yes	Yes	Yes			Yes	Yes					
	30		Yes	Yes	Yes			Yes	Yes	Yes	Yes ^{10,11}	Yes	Yes ⁶	Yes
	60		Yes	Yes	Yes			Yes	Yes	Yes	Yes ^{10,11}	Yes	Yes ⁶	Yes
n79	15							Yes	Yes					
	30							Yes	Yes	Yes		Yes		Yes
	60							Yes	Yes	Yes		Yes		Yes
n80	15	Yes	Yes	Yes	Yes	Yes	Yes							
	30		Yes	Yes	Yes	Yes	Yes							
	60		Yes	Yes	Yes	Yes	Yes							
n81	15	Yes	Yes	Yes	Yes									
	30		Yes	Yes	Yes									
	60													
n82	15	Yes	Yes	Yes	Yes									
	30		Yes	Yes	Yes									
	60													

n83	15	Yes	Yes	Yes	Yes													
	30		Yes	Yes	Yes													
	60																	
n84	15	Yes	Yes	Yes	Yes													
	30		Yes	Yes	Yes													
	60		Yes	Yes	Yes													
n86	15	Yes	Yes	Yes	Yes			Yes										
	30		Yes	Yes	Yes			Yes										
	60		Yes	Yes	Yes			Yes										
n95	15	Yes	Yes	Yes														
	30		Yes	Yes														
	60		Yes	Yes														
<p>NOTE 1: 90% spectrum utilization may not be achieved for 30kHz SCS. NOTE 2: 90% spectrum utilization may not be achieved for 60kHz SCS. NOTE 3: This UE channel bandwidth is applicable only to downlink. NOTE 4: For test configuration tables from the transmitter and receiver tests in Section 6 and 7 that refer to this table for test SCS, the Lowest SCS refers to lowest supported SCS per channel bandwidth, Highest SCS refers to highest supported SCS per channel bandwidth. NOTE 5: For test configuration tables from the transmitter and receiver tests in Section 6 and 7 that refer to this table and list the test SCS as Mid or any other value; if that value is not supported by the UE in UL and/or DL, select the closest SCS supported by the UE in both UL and DL. NOTE 6: This UE channel bandwidth is optional in R15. NOTE 7: For this bandwidth, the minimum requirements are restricted to operation when carrier is configured as an SCell part of DC or CA configuration. NOTE 8: For this bandwidth, the minimum requirements are restricted to operation when carrier is configured as a downlink SCell part of CA configuration. NOTE 9: For the 20 MHz bandwidth, the minimum requirements are specified for NR UL carrier frequencies confined to either 713-723 MHz or 728-738 MHz. NOTE 10: This UE channel bandwidth is optional in R16. NOTE 11: This UE channel bandwidth is not applicable in R15.</p>																		

Table 8-11 Test SCS for NR operating band (TS38.521-1 [6] Table 5.3.5-1)

C Initial Bandwidth Part (BWP)

The specification TS38.508-1 [8], clause 4.3.1.0D (see Table 8-12 below) defines the initial BWP for FR1 and locationandbandwidth with respect to the channel bandwidth and its applied SCS.

BW [MHz]	SCS [kHz]	L_RBs (MAX NRB)	locationAndBandwidth (Note 1)
5	15	25	6600
5	30	11	2750
5	60	N/A	N/A
10	15	52	14025
10	30	24	6325
10	60	11	2750
15	15	79	21450
15	30	38	10175
15	60	18	4675
20	15	106	28875
20	30	51	13750
20	60	24	6325
25	15	133	36300
25	30	65	17600
25	60	31	8250

30	15	160	32174
30	30	78	21175
30	60	38	10175
40	15	216	16774
40	30	106	28875
40	60	51	13750
50	15	270	1924
50	30	133	36300
50	60	65	17600
60	15	N/A	N/A
60	30	162	31624
60	60	79	21450
70	15	N/A	N/A
70	30	189	24199
70	60	93	25300
80	15	N/A	N/A
80	30	217	16499
80	60	107	29150
90	15	N/A	N/A
90	30	245	8799
90	60	121	33000
100	15	N/A	N/A
100	30	273	1099
100	60	135	36850

Note 1: The value for locationAndBandwidth parameter is calculated as the RIV value in accordance to TS 38.214 [21] with $N_{BWP}^{size} = 275$, $RB_{start} = 0$ and $L_{RBs} = \text{Max NRB for each bandwidth and subcarrier spacing}$.

Table 8-12 locationAndBandwidth in BWP for FR1

The parameter locationandbandwidth defines the BWP allocation in frequency domain and occupied bandwidth. It is given in resource indication value (RIV) format which is calculated by taking the starting RB position and allocated number of RBs into account. For example, RIV = 1099 is calculated when RBstart = 0 $L_{RB} = 275$ is considered. Please refer to TS38.213 [16] and TS38.214 [10] for detailed information about RIV calculation.

D Resource Block Allocation of Reference Measurement Channels (RMC)

D.1 E-UTRA RB allocation of Uplink RMC

Table 8-13 shows the RB allocation of uplink RMC for E-UTRA

Channel Bandwidth	RB allocation			
	Full_Allocation	Partial_Allocation	1RB_Left	1RB_Right
1.4MHz	6@0	5@0	1@0	1@5

3MHz	15@0	4@0	1@0	1@14
5MHz	25@0	8@0	1@0	1@24
10MHz	50@0	12@0	1@0	1@49
15MHz	75@0	16@0	1@0	1@74
20MHz	100@0	18@0	1@0	1@99
NOTE: Partial Allocation corresponds to the test points with 0dB MPRsingle,E-UTRA for QPSK modulation type included in TS 36.521-1 Table 6.2.2.4.1-1.				

Table 8-13 E-UTRA common uplink configuration (TS38.521-3 [1], Table 6.1-1)

D.2 NR RB Allocation of Uplink RMC

Table 8-14 shows the RB allocation of uplink RMC for 5G NR

Channel Bandwidth	SCS(kHz)	OFDM	RB allocation							
			Edge_Full_Left	Edge_Full_Right	Edge_1RB_Left	Edge_1RB_Right	Outer_Full	Inner_Full	Inner_1RB_Left	Inner_1RB_Right
5MHz	15	DFT-s	2@0	2@23	1@0	1@24	25@0	12@6	1@1	1@23
		CP	2@0	2@23	1@0	1@24	25@0	13@6	1@1	1@23
	30	DFT-s	2@0	2@9	1@0	1@10	10@0	5@21	1@1	1@9
		CP	2@0	2@9	1@0	1@10	11@0	5@21	1@1	1@9
	60	DFT-s	N/A	N/A	N/A	N/A	N/A	N/A	N/A	N/A
		CP	N/A	N/A	N/A	N/A	N/A	N/A	N/A	N/A
10MHz	15	DFT-s	2@0	2@50	1@0	1@51	50@0	25@12	1@1	1@50
		CP	2@0	2@50	1@0	1@51	52@0	26@13	1@1	1@50
	30	DFT-s	2@0	2@22	1@0	1@23	24@0	12@6	1@1	1@22
		CP	2@0	2@22	1@0	1@23	24@0	12@6	1@1	1@22
	60	DFT-s	2@0	2@9	1@0	1@10	10@0	5@21	1@1	1@9
		CP	2@0	2@9	1@0	1@10	11@0	5@21	1@1	1@9
15MHz	15	DFT-s	2@0	2@77	1@0	1@78	75@0	36@18	1@1	1@77
		CP	2@0	2@77	1@0	1@78	79@0	39@19	1@1	1@77
	30	DFT-s	2@0	2@36	1@0	1@37	36@0	18@9	1@1	1@36
		CP	2@0	2@36	1@0	1@37	38@0	19@9	1@1	1@36
	60	DFT-s	2@0	2@16	1@0	1@17	18@0	9@4	1@1	1@16
		CP	2@0	2@16	1@0	1@17	18@0	9@4	1@1	1@16
20MHz	15	DFT-s	2@0	2@104	1@0	1@105	100@0	50@25	1@1	1@104
		CP	2@0	2@104	1@0	1@105	106@0	53@26	1@1	1@104
	30	DFT-s	2@0	2@49	1@0	1@50	50@0	25@12	1@1	1@49
		CP	2@0	2@49	1@0	1@50	51@0	25@12	1@1	1@49
	60	DFT-s	2@0	2@22	1@0	1@23	24@0	12@6	1@1	1@22
		CP	2@0	2@22	1@0	1@23	24@0	12@6	1@1	1@22
25MHz	15	DFT-s	2@0	2@131	1@0	1@132	128@0	64@32	1@1	1@131
		CP	2@0	2@131	1@0	1@132	133@0	67@33	1@1	1@131
	30	DFT-s	2@0	2@63	1@0	1@64	64@0	32@16	1@1	1@63
		CP	2@0	2@63	1@0	1@64	65@0	33@16	1@1	1@63
	60	DFT-s	2@0	2@29	1@0	1@30	30@0	15@7	1@1	1@29
		CP	2@0	2@29	1@0	1@30	31@0	15@7	1@1	1@29
30MHz	15	DFT-s	2@0	2@158	1@0	1@159	160@0	80@40	1@1	1@158
		CP	2@0	2@158	1@0	1@159	160@0	80@40	1@1	1@158
	30	DFT-s	2@0	2@76	1@0	1@77	75@0	36@18	1@1	1@76

40MHz	60	CP	2@0	2@76	1@0	1@77	78@0	39@19	1@1	1@76
		DFT-s	2@0	2@36	1@0	1@37	36@0	18@9	1@1	1@36
	15	CP	2@0	2@36	1@0	1@37	38@0	19@9	1@1	1@36
		DFT-s	2@0	2@214	1@0	1@215	216@0	108@54	1@1	1@214
	30	CP	2@0	2@214	1@0	1@215	216@0	108@54	1@1	1@214
		DFT-s	2@0	2@104	1@0	1@105	100@0	50@25	1@1	1@104
60	CP	2@0	2@104	1@0	1@105	106@0	53@26	1@1	1@104	
	DFT-s	2@0	2@49	1@0	1@50	50@0	25@12	1@1	1@49	
50MHz	15	CP	2@0	2@49	1@0	1@50	51@0	25@121	1@1	1@49
		DFT-s	2@0	2@268	1@0	1@269	270@0	135@67	1@1	1@268
	30	CP	2@0	2@268	1@0	1@269	270@0	135@67	1@1	1@268
		DFT-s	2@0	2@131	1@0	1@132	128@0	64@32	1@1	1@131
	60	CP	2@0	2@131	1@0	1@132	133@0	67@33	1@1	1@131
		DFT-s	2@0	2@63	1@0	1@64	64@0	32@16	1@1	1@63
60MHz	15	CP	2@0	2@63	1@0	1@64	65@0	33@16	1@1	1@63
		DFT-s	N/A	N/A	N/A	N/A	N/A	N/A	N/A	N/A
	30	CP	N/A	N/A	N/A	N/A	N/A	N/A	N/A	N/A
		DFT-s	2@0	2@160	1@0	1@161	162@0	81@40	1@1	1@160
	60	CP	2@0	2@160	1@0	1@161	162@0	81@40	1@1	1@160
		DFT-s	2@0	2@77	1@0	1@78	75@0	36@18	1@1	1@77
80MHz	15	CP	2@0	2@77	1@0	1@78	79@0	39@191	1@1	1@77
		DFT-s	N/A	N/A	N/A	N/A	N/A	N/A	N/A	N/A
	30	CP	N/A	N/A	N/A	N/A	N/A	N/A	N/A	N/A
		DFT-s	2@0	2@215	1@0	1@216	216@0	108@54	1@1	1@215
	60	CP	2@0	2@215	1@0	1@216	217@0	109@54	1@1	1@215
		DFT-s	2@0	2@105	1@0	1@106	100@0	50@25	1@1	1@105
90MHz	15	CP	2@0	2@105	1@0	1@106	107@0	53@261	1@1	1@105
		DFT-s	N/A	N/A	N/A	N/A	N/A	N/A	N/A	N/A
	30	CP	N/A	N/A	N/A	N/A	N/A	N/A	N/A	N/A
		DFT-s	2@0	2@243	1@0	1@244	240@0	120@60	1@1	1@243
	60	CP	2@0	2@243	1@0	1@244	245@0	123@61	1@1	1@243
		DFT-s	2@0	2@119	1@0	1@120	120@0	60@30	1@1	1@119
100MHz	15	CP	2@0	2@119	1@0	1@120	121@0	61@30	1@1	1@119
		DFT-s	N/A	N/A	N/A	N/A	N/A	N/A	N/A	N/A
	30	CP	N/A	N/A	N/A	N/A	N/A	N/A	N/A	N/A
		DFT-s	2@0	2@271	1@0	1@272	270@0	135@67	1@1	1@271
	60	CP	2@0	2@271	1@0	1@272	273@0	137@68	1@1	1@271
		DFT-s	2@0	2@133	1@0	1@134	135@0	64@32	1@1	1@133
100MHz	60	CP	2@0	2@133	1@0	1@134	135@0	67@331	1@1	1@133

Note 1: The allocated RB number LCRB is $\text{ceil}(\text{NRB}/2) - 1$ in order to meet Inner RB allocation definition ($\text{RBStart,Low} \leq \text{RBStart} \leq \text{RBStart,High}$) described in subclause 6.2.2 of TS 38.101-1 [2].

[Table 8-14 NR Common Uplink Configuration \(TS38.521-1 \[6\], Table 6.1-1\)](#)

If REFSSENS RB allocation is required, e.g. reference sensitivity test case, then RB resource allocation should follow the scheme in TS38.521-1 [6], Table 7.3.2.4.1-3. Table 8-15 lists the subset of the original table.

Operating Band	SCS kHz	25 MHz	30 MHz	40 MHz	50 MHz	60 MHz	80 MHz	90 MHz	100 MHz	Duplex Mode
n1	15	128@51	128@321	128@881	128@1421					FDD
	30	64@11	64@141	64@421	64@691					
	60	30@11	30@81	30@211	30@351					
n2	15									FDD
	30									

	60									
n3	15	50@831	50@1101							FDD
	30	24@411	24@541							
	60	10@211	10@281							
n5	15									FDD
	30									
	60									
n7	15									FDD
	30									
	60									
n8	15									FDD
	30									
	60									
n12	15									FDD
	30									
	60									
n20	15									FDD
	30									
	60									
n25	15									FDD
	30									
	60									
n26	15									FDD
	30									
n28	15		25@1351							FDD
	30		10@681							
	60									
n30	15									FDD
	30									
	60									
n34	15									TDD
	30									
	60									
n38	15									TDD
	30									
	60									
n39	15	128@0	160@0	216@0						TDD
	30	64@0	75@0	100@0						
	60	30@0	36@0	50@0						
n40	15	128@0	160@0	216@0	270@0					TDD
	30	64@0	75@0	100@0	128@0	162@0	216@0			
	60	30@0	36@0	50@0	64@0	75@0	100@0			

n41	15		160@0	216@0	270@0					TDD
	30		75@0	100@0	128@0	162@0	216@0	243@0	270@0	
	60		36@0	50@0	64@0	75@0	100@0	120@0	135@0	
n48	15			216@0						TDD
	30			100@0						
	60			50@0						
n50	15			216@0	270@0					TDD
	30			100@0	128@0	162@0	NOTE 3			
	60			50@0	64@0	75@0	NOTE 3			
n51	15									TDD
	30									
	60									
n65	15									FDD
	30									
	60									
n66	15	128@51	160@0	216@0						FDD
	30	64@11	75@31	100@61						
	60	30@11	36@21	50@11						
n70	15	NOTE 3								FDD
	30	NOTE 3								
	60	NOTE 3								
n71	15									FDD
	30									
	60									
n74	15									FDD
	30									
	60									
n77	15			216@0	270@0					TDD
	30			100@0	128@0	162@0	216@0	243@0	270@0	
	60			50@0	64@0	75@0	100@0	120@0	135@0	
n78	15			216@0	270@0					TDD
	30			100@0	128@0	162@0	216@0	243@0	270@0	
	60			50@0	64@0	75@0	100@0	120@0	135@0	
n79	15			216@0	270@0					TDD
	30			100@0	128@0	162@0	216@0		270@0	
	60			50@0	64@0	75@0	100@0		135@0	

Table 8-15 FR1 Uplink RB Configuration for REFSENS (Subset of TS38.521-1 [6], Table 7.3.2.4.1-3)

D.3 NR RB Allocation of Downlink RMC

Channel Bandwidth	SCS(kHz)	LCRBmax	Outer RB allocation / Normal RB allocation
5MHz	15	25	25@0

	30	11	11@0
	60	N/A	N/A
10MHz	15	52	52@0
	30	24	24@0
	60	11	11@0
15MHz	15	79	79@0
	30	38	38@0
	60	18	18@0
20MHz	15	106	106@0
	30	51	51@0
	60	24	24@0
25MHz	15	133	133@0
	30	65	65@0
	60	31	31@0
30MHz	15	160	160@0
	30	78	78@0
	60	38	38@0
40MHz	15	216	216@0
	30	106	106@0
	60	51	51@0
50MHz	15	270	270@0
	30	133	133@0
	60	65	65@0
60MHz	15	N/A	N/A
	30	162	162@0
	60	79	79@0
80MHz	15	N/A	N/A
	30	217	217@0
	60	107	107@0
90MHz	15	N/A	N/A
	30	245	245@0
	60	121	121@0
100MHz	15	N/A	N/A
	30	273	273@0
	60	135	135@0

NOTE 1: Test Channel Bandwidths are checked separately for each NR band, the applicable channel bandwidths are specified in Table 5.3.5-1.

Table 8-16 NR FR1 Downlink RB Allocation (TS38.521-1 [6], Table 7.3.2.4.1-2)

Rohde & Schwarz

The Rohde & Schwarz electronics group offers innovative solutions in the following business fields: test and measurement, broadcast and media, secure communications, cybersecurity, monitoring and network testing. Founded more than 80 years ago, the independent company which is headquartered in Munich, Germany, has an extensive sales and service network with locations in more than 70 countries.

www.rohde-schwarz.com



Rohde & Schwarz training

www.training.rohde-schwarz.com

Rohde & Schwarz customer support

www.rohde-schwarz.com/support



R&S® is a registered trademark of Rohde & Schwarz GmbH & Co. KG
Trade names are trademarks of the owners.

1SL368 | Version 0e | 06.2021

Application Note | 5G NR FR1 Non-Standalone UE RF Conformance Testing

Data without tolerance limits is not binding | Subject to change

© 2021 Rohde & Schwarz GmbH & Co. KG | 81671 Munich, Germany

www.rohde-schwarz.com