



R&S®SFU broadcast test system

ANSI/SCTE 40 Conformance Testing Using the R&S®SFU, R&S®SFE and R&S®SFE100

Application Note

The Society of Cable Telecommunications Engineers (SCTE) defined the ANSI/SCTE 40 specification: Digital Cable Network Interface Standard. ANSI/SCTE 40 tests are designed to test conformance of set-top boxes and other cable receiving equipment to ensure that they will operate correctly when installed in a cable system. The tests are a combination of noise (AWGN and phase noise), AM hum, micro-reflections, digital and analog adjacent channels, and other discrete interferences. These impairments are found on most cable systems to some degree. Rohde & Schwarz provides set-top box manufacturers with an easy solution to perform conformance testing in line with ANSI/SCTE 40 by using the R&S®SFU broadcast test system and the R&S®SFE100 broadcast tester. The R&S®SFU is able to perform most of the test procedures in one unit. Furthermore, additional test transmitters allow the simulation of full channel loading. This Application Note explains the specific test requirements, a possible setup, and the configuration using the R&S®SFU/SFE100.



Contents

1	Introduction.....	3
2	ANSI/SCTE 40 in Brief	3
3	Test Setup for ANSI/SCTE 40 Conformance Testing.....	6
	Generating CW Full Channel Load	6
	Optioning the R&S® Test Transmitters	7
4	Configuring the Main R&S® SFU for ANSI/SCTE 40 Testing.....	8
	Basic Configuration	8
	Phase Noise Generation	9
	AM Hum and Micro-Reflections Using the Fading Option	10
	Applying Discrete Interferers.....	11
	Adjacent Channels Using the Arbitrary Generator	11
	Generating Additive White Gaussian Noise (AWGN).....	12
5	Configuring R&S® SFE/SFE100s for Full Channel Load Simulation.....	13
6	References	15
7	Additional Information	15
8	Ordering Information	16
	R&S® SFU	16
	R&S® SFE	17
	R&S® SFE100	18

1 Introduction

Theory and practice – two different worlds. Modulation, transmission, and demodulation of signals are simple tasks in theory. But in practice, errors and inaccuracies occur in each of these steps. In order to ensure that the consumer is able to receive a television service properly under these non-perfect conditions, set-top boxes must be designed to cope with such conditions.

The Society of Cable Telecommunications Engineers (SCTE) defined the ANSI/SCTE 40 specification: Digital Cable Network Interface Standard. ANSI/SCTE 40 tests are designed to test conformance of set-top boxes and other cable receiving equipment to ensure that they will operate correctly when installed in a cable system. The tests are a combination of noise (AWGN and phase noise), AM hum, micro-reflections, digital and analog adjacent channels, and other discrete interferences. These impairments are found to some degree on most cable systems.

Rohde & Schwarz provides set-top box manufacturers with an easy solution to perform conformance testing in line with ANSI/SCTE 40 by using the R&S® SFU and R&S® SFE/SFE100. The R&S® SFU is able to perform most of the test procedures in one unit. Furthermore, additional test transmitters allow the simulation of full channel loading.

This Application Note explains the specific test requirements, a possible setup, and the configuration using the R&S® SFU/SFE/SFE100.

2 ANSI/SCTE 40 in Brief

The ANSI/SCTE 40 test is designed to test the receiving equipment in a worst case scenario; therefore, the impairments are required to be simultaneously present during the test. The test schematic looks as follows:

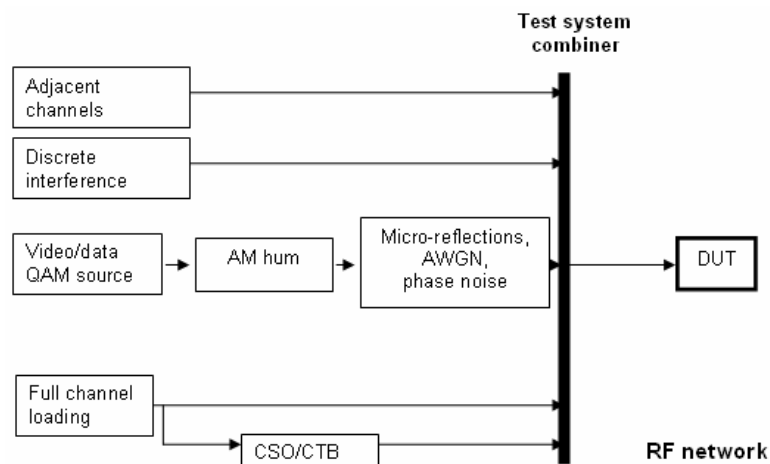
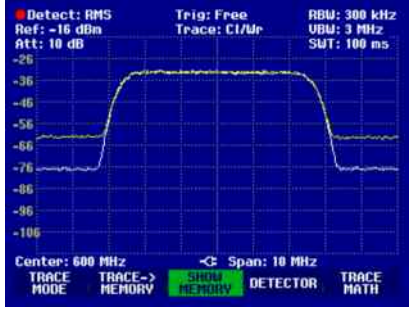
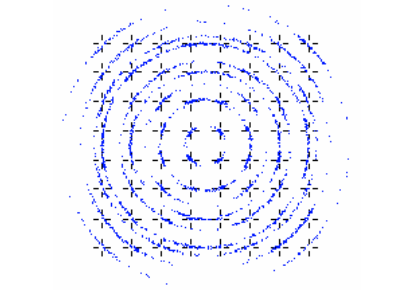

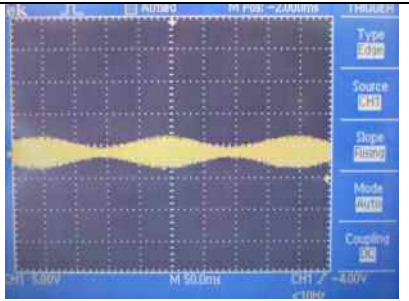

Fig. 1: ANSI/SCTE 40 test schematic

ANSI/SCTE 40 Conformance Testing Using the R&S® SFU, R&S® SFE and SFE100

The impairments are defined as follows:

Impairments	Description	Schematic
Additive white Gaussian noise (AWGN)	27 dB C/(N+I) for 64 QAM 33 dB C/(N+I) for 256 QAM	
Phase noise	-88 dBc / Hz at 10 kHz offset from channel carrier frequency	
Micro-reflections	-10 dB @ 0.5 us -15 dB @ 1.0 us -20 dB @ 1.5 us -30 dB @ 4.5 us	
AM hum	3 %	

**ANSI/SCTE 40 Conformance Testing Using the R&S® SFU,
R&S® SFE and SFE100**

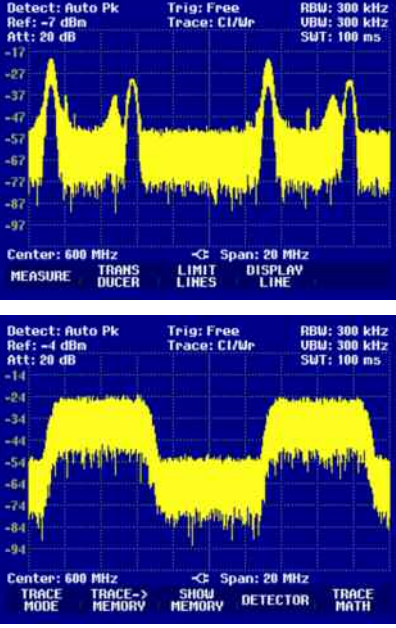
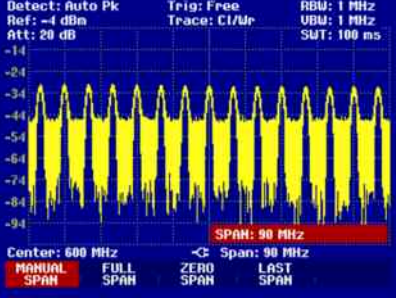
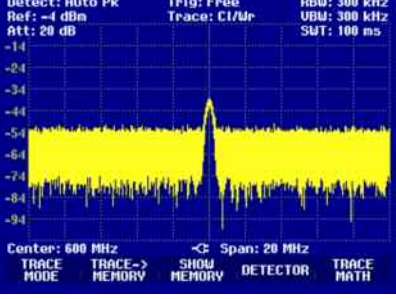
<p>Adjacent channels</p>	<p><i>Analog:</i></p> <p><i>Modulation depth = 87.5 %, audio/video -10 dB.</i></p> <p><i>Digital:</i></p> <ul style="list-style-type: none"> • 64 QAM: symbol rate = 5.056931 MHz, Nyquist filter alpha = 18 %. • 256 QAM: symbol rate = 5.360537 MHz, Nyquist filter alpha = 12 %. 	
<p>Channel loading</p>	<p><i>Continuous wave (CW) at 6 MHz spacing on every relevant channel. Adjusted till intermodulation products in the useful channel reach -53 dBc.</i></p>	
<p>Discrete interferer</p>	<p><i>Continuous wave (CW) signal at center frequency with -53 dBc.</i></p>	

3 Test Setup for ANSI/SCTE 40 Conformance Testing

As we have seen in chapter 2, ANSI/SCTE 40 conformance testing requires the modulated useful signal as well as all impairments to be present at the same time. A possible setup of the complete test scenario can look as follows:

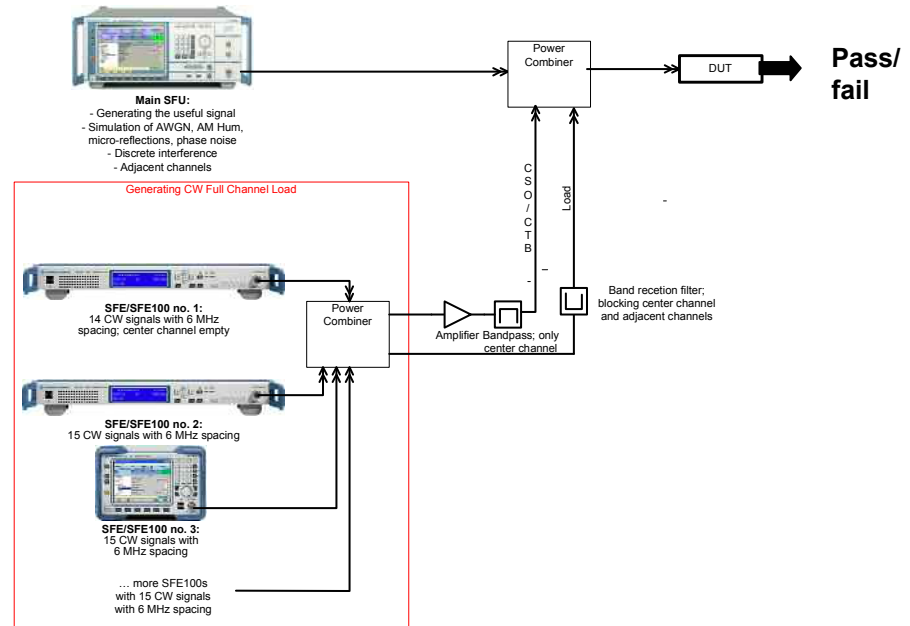

Fig. 2: ANSI/SCTE 40 Test Setup

Whether a DUT passes the test could be determined by subjective pass/fail criteria or alternatively bit error rate measurement. For more information on how to perform bit error measurements using the R&S® SFU, please refer to [2].

The “main R&S® SFU” generates the useful J.83B signal. Furthermore, AWGN, AM hum, micro-reflections, phase noise, adjacent channel, as well as discrete interferers can be simulated in this unit.

Generating CW Full Channel Load

As we know from section two of this document, full channel loading as well as CSO/CTB intermodulation products need to be added to the outgoing signal. For simulation, it is sufficient to have CW signals at the channel center frequencies of the TV bands as replacement for the actual TV signals.

The R&S® SFE/SFE100 has an IQ output bandwidth of 100 MHz. In order to create full channel loading for all relevant TV bands, multiple R&S® SFE/SFE100s are required. The waveforms contain 14 or 15 CW signals (90 MHz bandwidth used).

ANSI/SCTE 40 Conformance Testing Using the R&S® SFU, R&S® SFE and SFE100

For the generation of the CSO/CTB intermodulation products, the channel under test (center channel) needs to be empty. Therefore, the following scheme to generate the CW carriers is used:

CSO/CTB channel = useful channel

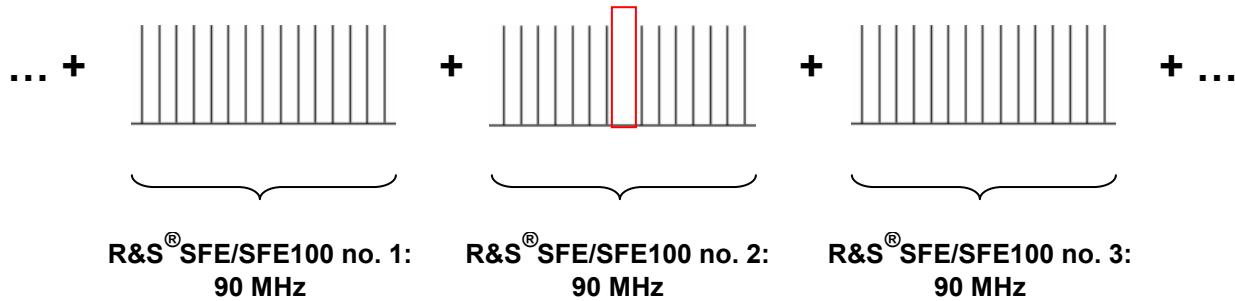

The full channel load needs to be passed through an amplifier in order to generate the second- or third-order intermodulation products in the useful channel. Afterwards bandpass filtering is applied to the center channel, in order to only have the intermodulation products in the output spectrum.

From the channel load combiner, a second path is added to the signal coming from the main R&S® SFU. This signal is band-rejection-filtered on the three center channels (adjacent channel and useful channel are not overlaid with CW signals), as there the useful signals as well as the adjacent channels are present while testing.

Optioning the R&S® Test Transmitters

The main R&S® SFU unit generating the useful signals and all other impairments except CSO/CTB and full channel load should be configured as follows to allow conformance testing in line with ANSI/SCTE 40:

	Device options									
Impairments	TS generator (R&S®SFU-K20) or TRP Player (R&S®SFU-K22)	J.83/B coder (R&S®SFU-K5)	Phase noise (R&S®SFU-K41)	Noise generator AWGN (R&S®SFU-K40)	Multinoise use (R&S®SFU-K43)	Fading simulator, 20 paths (R&S®SFU-B30)	Interferer management (R&S®SFU-K37)	Arbitrary generator (R&S®SFU-K35)	Memory extension (R&S®SFU-B3)	Cable interferer (R&S®SFU-K356)
Discrete interference	X	X								
AWGN	X	X		X	X					
Phase noise	X	X	X		X					
Micro-relections	X	X				X				
AM hum	X	X				X				
Adjacent channels	X	X					X	X	X	X

ANSI/SCTE 40 Conformance Testing Using the R&S® SFU, R&S® SFE and SFE100

To generate the full channel load by means of R&S® SFE/SFE100s, the following R&S® SFE/SFE100 configuration is required in each case:



	Arbitrary generator (R&S® SFE/SFE100-K35)	Memory extension (R&S® SFE/SFE100-B3)	Cable interferer (R&S® SFU-K356)
Impairments			
Full channel load	X	X	X
CSO/CTB	X	X	X

Although ANSI/SCTE 40 testing requires every impairment to be present at the same time, the previous two tables show the option dependency for each impairment. Thus, it can be easily determined, which options are no longer required, if impairments can already be generated with other existing equipment.

4 Configuring the Main R&S® SFU for ANSI/SCTE 40 Testing

Basic Configuration

This “Basic Configuration” section explains which fundamental configurations are necessary to perform ANSI/SCTE 40 testing using bit error ratio (BER) measurement as deviation criterion.

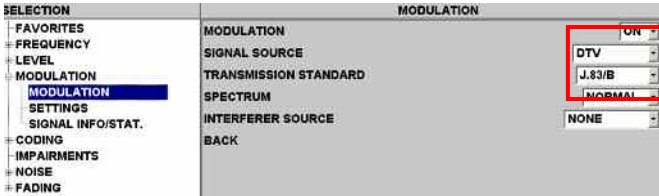
1.	Preset the R&S® SFU: 
2.	Switch to TX application: 
3.	Select J.83/B modulation standard in the MODULATION menu: 

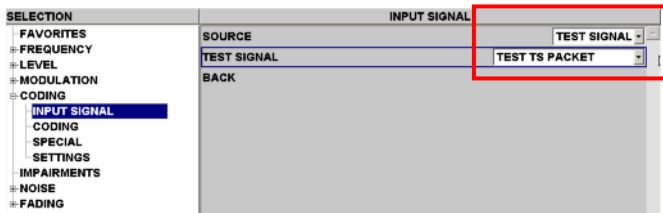
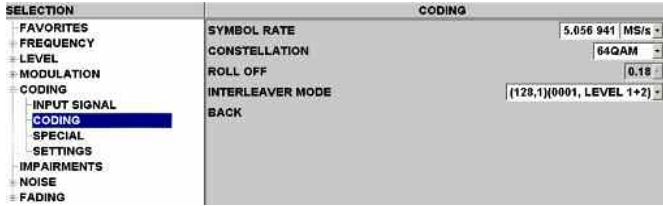
4. Select CODING → INPUT SIGNAL, and choose TEST SIGNAL as source, and TEST TS PACKET as test signal.
 
5. Select CODING → CODING, and specify SYMBOL RATE, CONSTELLATION and INTERLEAVER MODE.
 

Phase Noise Generation

As described in the previous chapter, it is required to have $-88 \text{ dBc/Hz @ } 10 \text{ kHz}$ offset. Proceed as follows to configure the main R&S® SFU:

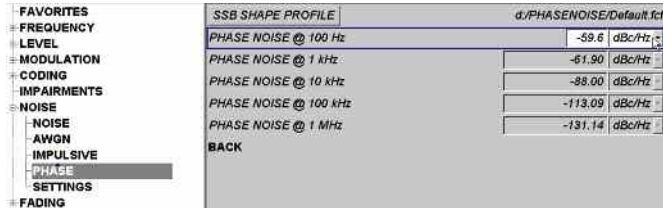
1. Select NOISE → PHASE; then take, for example, the default.fcf file and adjust the “PHASE NOISE @ 100 Hz” value, until $-88 \text{ dBc/Hz @ } 10 \text{ kHz}$ is reached.
 

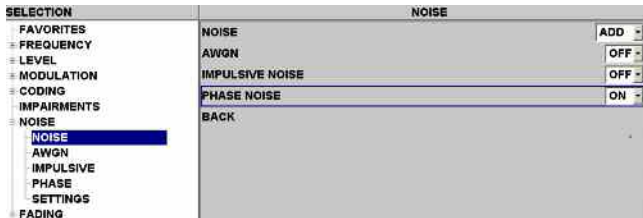
Note: If application-specific phase noise shapes need to be created, please refer to [4] for more information.
2. Activate phase noise by accessing the NOISE → NOISE menu, set noise to “ADD”, and phase noise to “ON”.
 

AM Hum and Micro-Reflections Using the Fading Option

1. Select FADING → SETTINGS, and select reference “DOPPLERFREQ”:

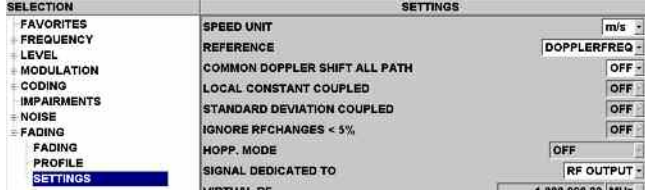

2. Go to FADING → PROFILE, and enter following configuration:

	1-1	1-2	1-3	1-4	1-5	2-1	2-2
STATE	ON	ON	ON	ON	ON	ON	ON
PROFILE	PURE DOPPLER	PURE DOPPLER	PURE DOPPLER	STATIC PATH	STATIC PATH	STATIC PATH	STATIC PATH
PATH LOSS (Db)	36.47	0	36.47	10	15	20	30
BASIC DELAY	0	0	0	0	0	0	0
ADDIT. DELAY	0	0	0	.5μ	1.0μ	1.5μ	4.5μ
RESULTING DELAY	0	0	0	0.50	1.0	1.5	4.5
POWER RATIO (Db)	0	0	0	0	0	0	0
CONST PHASE (Deg)	0.0	0.0	0.0	0.0	0.0	0.0	0.0
SPEED	44.97	0.0	44.97	0	0	0	0
FREQ RATIO	-1.0	1.0	1.0	0	0	0	0
RES DOPPLER SHIFT(Hz)	-60.0	0.0	60.0	0	0	0	0
CORRECTION PATH	OFF	OFF	OFF	OFF	OFF	OFF	OFF
COEFFICIENT [%]	0	0	0	0	0	0	0
PHASE (DEG)	0.00	0.00	0.00	0.00	0.00	0.00	0.00
LOG NORMAL STATE	OFF	OFF	OFF	OFF	OFF	OFF	OFF
LOCAL CONSTANT (M)	200.00	200.00	200.00	200.00	200.00	200.00	200.00
STANDARD DEV. (Db)	0	0	0	0	0	0	0

I: The first three paths are used to simulate AM hum. While path 1_2 is used for the main signal, assigning -60 Hz. Doppler shift to path 1_1 and +60 Hz to path 1_3 generates the desired AM hum of 60 Hz. For 50 Hz AM hum, change the values to ±50 Hz accordingly. The path loss setting on paths 1-1 and 1-3 finally define the modulation depth. The formula is as follows:

PATH LOSS (Db) = 20*log(m/2), where m is the modulation depth.

In this example, the AM hum is 3 % corresponding to m = 0.03. This results in sidebands with attenuations of 36.47 dB.

II: Here the four micro-reflection paths are defined.

Applying Discrete Interferers

The discrete interferer in this context means an unmodulated carrier, also referred to as continuous wave (CW). In order to apply discrete interference by means of the R&S® SFU the impairments can be used.

1. Select IMPAIRMENTS, switch modulator impairments to “ON” and vary the I OFFSET setting:

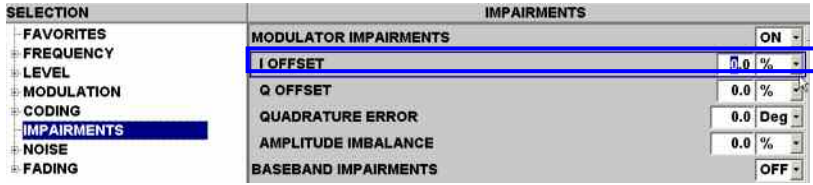

The relative output power of CW (= r, [dB]) in relation to the level indicator of the R&S® SFU is computed as follows:

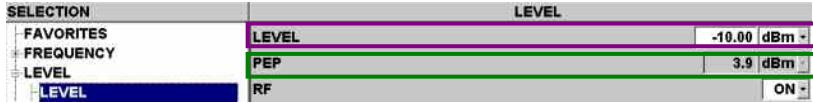
$$r = 20 * \log (I \text{ OFFSET}) + \text{PEP [dBm]} - \text{Level [dBm]}$$

Adjacent Channels Using the Arbitrary Generator

Upper and lower adjacent channels are generated using the arbitrary generator. With the R&S® SFU-K37 interferer management option, it is possible to add the interferer signals to the wanted signal. Please refer also to [3] for more details.

1. Select MODULATION → MODULATION, and choose “ARB” as interferer source. Furthermore, specify “BEFORE NOISE” for interferer addition.

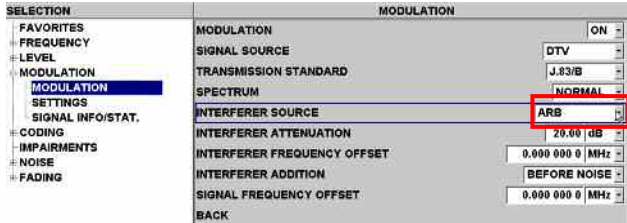

Interferer attenuation can then be varied to meet the requirements.

2. Access the “ARB” application by double-clicking the “ARB” button.



3. Access ARB → ARB, and click “LOAD WAVEFORM”:



Select one of the following three waveforms of the cable interferer library:

- SCTE_2CH_64QAM.WV: Two digital adjacent channels with 64 QAM modulation.
- SCTE_2CH_256QAM.WV: Two digital adjacent channels with 256 QAM modulation.
- SCTE_2CH_NTSC.WV: Two analog adjacent channels with NTSC signals.

Generating Additive White Gaussian Noise (AWGN)

A specific C/(N+I) needs to be specified, when all other interferences such as CSO, CTB, and discrete interferers are present. This can be done using the AWGN option of the R&S® SFU:

1. Activate AWGN noise by accessing the NOISE → NOISE menu, set noise to “ADD” and AWGN to “ON”.



2. Select NOISE → AWGN, and vary the C/N value until the C/(N+I) requirement is met.

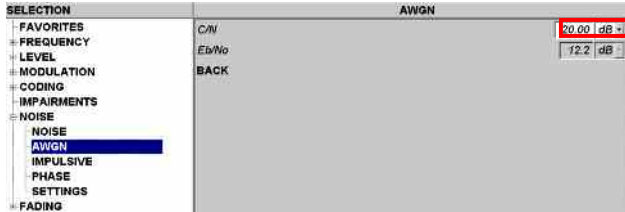





5 Configuring R&S® SFE/SFE100s for Full Channel Load Simulation

The R&S® SFU-K356 cable interferer library provides two different channel load waveforms which can be generated using the arbitrary waveform generator:

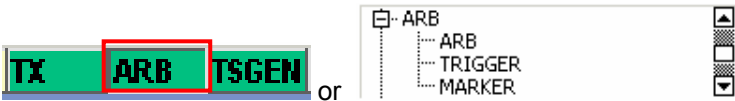
- FullCWLoad.wv: Containing 15 CW signals in 6 MHz spacing.
- FullCWLoad_NoCenter.wv: Containing 14 CW signals in 6 MHz spacing. Center channel empty.

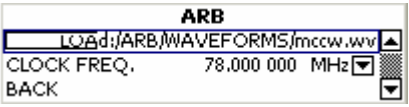
Proceed as follows to output the desired spectrum (besides the Windows GUI, also the control via front display of the R&S® SFE100 is shown):

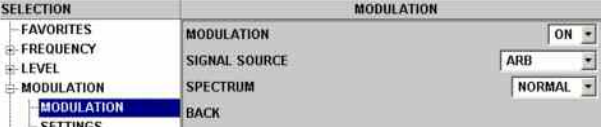
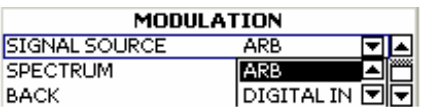
1.	Preset the R&S® SFE/SFE100
2.	Switch to ARB application: 
3.	Access ARB → ARB, and click “LOAD WAVEFORM”:  or  Select one of the above waveforms.
4.	Switch to TX application: 
5.	Go to MODULATION → MODULATION, and select “ARB” as signal source.  or 

6. Select FREQUENCY → FREQUENCY and enter the desired center frequency.

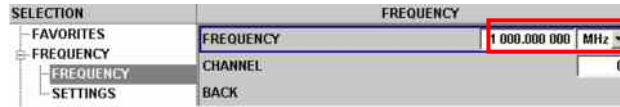

OR

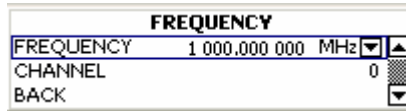

Note: The frequency setting needs to be incremented or decremented in 90 MHz steps on the different R&S® SFE/SFE100s for continuous channel load.

7. Select LEVEL → LEVEL, and adjust the output power as desired:



OR

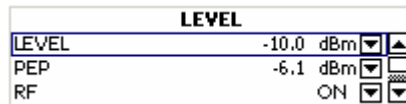

6 References

- [1] Society of Cable Telecommunications Engineers (Ed.) (2004). American National Standard, ANSI/SCTE 40 2004, Digital Cable Network Interface Standard.
- [2] Tan, C K (2005). Application Note 7BM51. Measuring Bit Error Rate using the R&S® SFU-K60 Option. Munich: Rohde & Schwarz GmbH & Co. KG website: <http://www.rohde-schwarz.com>.
- [3] Tan, C K (2005). Application Note 7BM50. Generating Interference Signals using the R&S® SFU-K37 Option. Munich: Rohde & Schwarz GmbH & Co. KG website: <http://www.rohde-schwarz.com>.
- [4] Gsoedl, Harald (2006). Application Note 7BM63. Phase Noise Profile Creator for the R&S® SFU. Munich: Rohde & Schwarz GmbH & Co. KG website: <http://www.rohde-schwarz.com>.

7 Additional Information

Our Application Notes are regularly revised and updated. Check for any changes at <http://www.rohde-schwarz.com>.

Please send any comments or suggestions about this Application Note to Broadcasting-TM-Applications@rohde-schwarz.com.

8 Ordering Information

R&S® SFU

Type	Designation	Order no.
R&S SFU	Broadcast Test System	2110.2500.02
R&S SFU-B1	Coder Extension 1	2110.7424.02
R&S SFU-B10	Coder Extension 10	2110.7747.02
R&S SFU-B11	ETI Input/Output	2110.7553.03
R&S SFU-B30	Fading Simulator	2110.7530.02
R&S SFU-B31	Fading Simulator Extension to 40 Paths	2110.7547.02
R&S SFU-B4	Memory Extension 2	2110.7453.02
R&S SFU-B5	User I/O	2110.7460.02
R&S SFU-B8	Additional Hard Disk	2110.7501.02/03
R&S SFU-B90	High Power and Overvoltage Protection	2110.8008.02
R&S SFU-K1	DVB-T/H Coder	2110.7301.02
R&S SFU-K10	MediaFLO Coder	2110.7524.02
R&S SFU-K108	AMC Coder	only on request
R&S SFU-K11	T-DMB/DAB Coder	2110.7518.02
R&S SFU-K120	DMB-TH Coder	2110.7760.02
R&S SFU-K190	ATV Standard B/G Coder	2110.8050.02
R&S SFU-K191	ATV Standard D/K Coder	2110.8037.02
R&S SFU-K192	ATV Standard I	2110.8043.02
R&S SFU-K193	ATV Standard M/N Coder	2110.8066.02
R&S SFU-K194	ATV Standard L Coder	2110.8072.02
R&S SFU-K199	Multi ATV Predefined	2110.8089.02
R&S SFU-K2	DVB-C Coder	2110.7324.02
R&S SFU-K20	TS Generator	2110.7476.02
R&S SFU-K21	TS Recorder	2110.7482.02
R&S SFU-K22	TRP Player	2110.7499.02
R&S SFU-K221	T-DMB/DAB Streams	2110.4348.02
R&S SFU-K23	Video Generator	2110.7799.02
R&S SFU-K3	DVB-S/DSSNG Coder	2110.7330.02
R&S SFU-K30	Enhanced Fading	2110.7560.02
R&S SFU-K32	DAB Gaussian Fading	2110.7630.02
R&S SFU-K35	ARB Generator	2110.7601.02
R&S SFU-K351	T-DMB/DAB Waveforms	2110.4277.02
R&S SFU-K352	DVB-H Waveforms	2110.4425.02
R&S SFU-K353	DRM Waveforms	2110.4554.02
R&S SFU-K354	DTV Interferers	2110.4690.02
R&S SFU-K356	Cable Interferers	2110.3212.02
R&S SFU-K4	ATSC/8VSB Coder	2110.7353.02
R&S SFU-K37	Interferer Management	2110.7647.02
R&S SFU-K40	Noise AWGN	2110.7653.02
R&S SFU-K41	Phase Noise	2110.7660.02
R&S SFU-K42	Impulsive Noise	2110.7676.02
R&S SFU-K43	Multinoise Use	2110.7682.02
R&S SFU-K5	J.83/B Coder	2110.7360.02
R&S SFU-K8	ISDB-T Coder	2110.7376.02
R&S SFU-K80	BER Measurements	2110.7782.02
R&S SFU-K7	DMB-T Coder	2110.7382.02
R&S SFU-K8	DVB-S2 Coder	2110.7399.02
R&S SFU-K80	Extended I/Q	2110.7953.02
R&S SFU-K81	Realtime Disabled	2110.7960.02
R&S SFU-K82	Realtime Enabled	2110.7976.02
R&S SFU-K9	DIRECTV	2110.7401.02
R&S SFU-U43	Upgrade Kit for R&S SFU-K43	2110.7699.02
R&S DV-DVBH	DVB-H Stream Library	2085.8704.02
R&S DV-H264	H.264 Stream Library	2085.7650.02
R&S DV-HDTV	HDTV Sequences	2085.7650.02
R&S DV-ISDBT	ISDB-T Stream Library	2085.9146.02
R&S DV-TCM	Test Card M Streams	2085.7708.02

**ANSI/SCTE 40 Conformance Testing Using the R&S® SFU,
R&S® SFE and SFE100**

R&S® SFE

Type	Designation	Order no.
R&S SFE	Broadcast Tester	2112.4300.02
R&S SFE-K1	DVB-T/H	2113.4010.02
R&S SFE-K2	DVB-C	2113.4032.02
R&S SFE-K3	DVB-S/DSNG	2113.4055.02
R&S SFE-K4	ATSC/8VSB	2113.4078.02
R&S SFE-K5	J.83/B	2113.4090.02
R&S SFE-K6	ISDB-T/ISDB-Tsb	2113.4110.02
R&S SFE-K8	DVB-S2	2113.4132.02
R&S SFE-K9	DirectTV	2113.4155.02
R&S SFE-K10	MediaFLO™	2113.4178.02
R&S SFE-K11	T-DMB/DAB	2113.4190.02
R&S SFE-K12	DTMB	2113.4210.02
R&S SFE-K190	ATV-B/G	2113.4655.02
R&S SFE-K191	ATV-D/K	2113.4678.02
R&S SFE-K192	ATV-I	2113.4690.02
R&S SFE-K193	ATV-M/N	2113.4710.02
R&S SFE-K194	ATV-L	2113.4732.02
R&S SFE-K195	ATV Multistandard	2113.4755.02
R&S SFE-K20	TS Generator, includes SDTV stream library	2113.4878.02
R&S DV-DVBH	DVB-H Stream Library	2085.8704.02
R&S DV-TCM	Test Card M-Streams	2085.7708.02
R&S DV-HDTV	HDTV Sequences	2085.7650.02
R&S DV-H264	H.264 Stream Library	2085.9052.02
R&S DV-ISDBT	ISDB-T Stream Library	2085.9146.02
R&S SFU-K221	T-DMB/DAB Streams	2113.4348.02
R&S SFE-K23	Video Generator	2113.4890.02
R&S ATV Video	ATV Video Signals	2110.4831.02
R&S SFE-K22	TRP Player	2113.5274.02
R&S SFE-K35	ARB Generator model	2113.4932.02
R&S SFU-K351	T-DMB/DAB Waveforms	2110.4277.02
R&S SFU-K352	DVB-H Waveforms	2110.4425.02
R&S SFU-K353	DRM Waveforms	2110.4554.02
R&S SFU-K354	DTV Interferer Waveforms	2110.4690.02
R&S SFU-K355	MediaFLO™ Waveforms	2110.2974.02
R&S SFU-K356	Cable Interferer Waveforms	2110.3212.02
R&S SFE-K40	AWGN Generator	2113.4910.02
R&S SFE-K60	BER Measurement	2113.5151.02
R&S SFE-K80	Digital I/Q Input	2113.5251.02
R&S SFE-B3	Memory Extension	2112.4500.02

ANSI/SCTE 40 Conformance Testing Using the R&S® SFU, R&S® SFE and SFE100

R&S® SFE100

Type	Designation	Order no.
R&S SFE100	Test Transmitter	2112.4100.02 / 2112.4100.03
R&S SFE100-K1	DVB-T/H	2113.4003.02
R&S SFE100-K2	DVB-C	2113.4026.02
R&S SFE100-K3	DVB-S/DSNG	2113.4049.02
R&S SFE100-K4	ATSC/8VSB	2113.4061.02
R&S SFE100-K5	J.83/B	2113.4084.02
R&S SFE100-K6	ISDB-T/ISDB-Tsb	2113.4103.02
R&S SFE100-K8	DVB-S2	2113.4126.02
R&S SFE100-K9	DirecTV	2113.4149.02
R&S SFE100-K10	MediaFLO™	2113.4161.02
R&S SFE100-K11	T-DMB/DAB	2113.4184.02
R&S SFE100-K12	DTMB	2113.4203.02
R&S SFE100-K190	ATV-B/G	2113.4649.02
R&S SFE100-K191	ATV-D/K	2113.4661.02
R&S SFE100-K192	ATV-I	2113.4684.02
R&S SFE100-K193	ATV-M/N	2113.4703.02
R&S SFE100-K194	ATV-L	2113.4726.02
R&S SFE100-K20	TS Generator, includes SDTV stream library	2113.4861.02
R&S DV-DVBH	DVB-H Stream Library	2085.8704.02
R&S DV-TCM	Test Card M-Streams	2085.7708.02
R&S DV-HDTV	HDTV Sequences	2085.7650.02
R&S DV-H264	H.264 Stream Library	2085.9052.02
R&S DV-ISDBT	ISDB-T Stream Library	2085.9146.02
R&S SFU-K221	T-DMB/DAB Streams	2113.4348.02
R&S SFE100-K22	TRP Player	2113.5268.02
R&S SFE100-K23	Video Generator	2113.4884.02
R&S SFE100-K35	ARB Generator model	2113.4926.02
R&S SFU-K351	T-DMB/DAB Waveforms	2110.4277.02
R&S SFU-K352	DVB-H Waveforms	2110.4425.02
R&S SFU-K353	DRM Waveforms	2110.4554.02
R&S SFU-K354	DTV Interferer Waveforms	2110.4690.02
R&S SFU-K355	MediaFLO™ Waveforms	2110.2974.02
R&S SFU-K356	Cable Interferer Waveforms	2110.3212.02
R&S SFE100-K80	Extended IQ Input	2113.5245.02
R&S SFE100-B90	Power Amplifier	2112.4900.02
R&S SFE100-B3	Memory Extension	2112.4400.02

If you want to know more about Rohde & Schwarz products, check out our website or contact our local sales representative.



ROHDE & SCHWARZ GmbH & Co. KG · Mühldorfstraße 15 · D-81671 München · Postfach 80 14 69 · D-81614 München ·
Tel (089) 4129 -0 · Fax (089) 4129 - 13777 · Internet: <http://www.rohde-schwarz.com>

This Application Note and the supplied programs may only be used subject to the conditions of use set forth in the download area of the Rohde & Schwarz website.