

# R&S® DVM Family

## DTV monitoring and analysis



**75** Years of  
Driving  
Innovation



# R&S®DVM Family

## At a glance

The R&S®DVM family of instruments combines the tools needed for all monitoring and analysis applications in the area of digital television signal generation and distribution. An extensive range of analysis tools is available to support the development and testing of digital television equipment such as multiplexers, encoders, modulators and associated components.

The R&S®DVM family consists of four base units and one expansion unit, all of which have extremely compact designs. All four base units can be configured in accordance with customer requirements and expanded whenever necessary.

Multiple RF, IP and transport stream signals can be monitored and analyzed simultaneously. For example, up to four RF signals can be monitored in a single height unit at the same time.

Extensive testing can be carried out on a variety of data services. Such as videotext, subtitles, system software updates (SSU) and DVB-H signals including electronic service guide (ESG). Video and audio elementary streams (MPEG-2, MPEG-4/AVC/H.264, AAC and AC-3) are analyzed using special software tools.

A hardware decoder processes SD and HD signals coded with either MPEG-2 or MPEG-4/AVC/H.264 to enable the fast and simple analysis of various video formats. Using the qPSNR analysis, the encoding quality of these video signals is also tested and visualized in realtime.

- Minimal installation effort due to low space requirements and combination of various functions in one instrument
- Minimal training required due to intuitive operating concept
- Cost-effective and future-ready modular design
- Portable and simple operation due to small, lightweight design and integrated display (R&S®DVM400)

R&S®DVM400





R&S®DVM400 – universal and portable

### R&S®DVM400 – universal and portable

- ▀ Broadest scope of functions – ideal for development and maintenance
- ▀ Monitoring/analysis of transport streams and contents
- ▀ Monitoring, analysis and demodulation of RF signals of various standards
- ▀ Monitoring, analysis and transcoding of IPTV signals (Gigabit Ethernet)
- ▀ Powerful generator and recorder options with extensive TS libraries and TS multiplexer software
- ▀ Simultaneous operation of multiple functions
- ▀ Small and lightweight, therefore ideal for portable applications



R&S®DVM100/R&S®DVM100L – the space saver

### R&S®DVM100/R&S®DVM100L – the space saver

- ▀ Ideal for network operators and program providers
- ▀ Monitoring/analysis of transport streams and contents
- ▀ Monitoring, analysis and demodulation of RF signals <sup>1)</sup> of various standards
- ▀ Monitoring of up to 20 signals in one system when expanded with the R&S®DVM120



R&S®DVM50 – the starter package

### R&S®DVM50 – the starter package

- ▀ Particularly cost-effective solution for all monitoring and analysis tasks, whether in the lab, for service applications or unattended in the field
- ▀ Monitoring/analysis of transport streams and contents
- ▀ Monitoring, analysis and demodulation of RF signals of various standards
- ▀ Operation via external PC



R&S®DVM120 – the expansion unit

### R&S®DVM120 – the expansion unit

- ▀ Add-on to the R&S®DVM100, R&S®DVM100L and R&S®DVM400 for simultaneous monitoring of more than four signals in one system
- ▀ Integration into the base unit user interface

<sup>1)</sup> R&S®DVM100L only.

# R&S®DVM Family

## Benefits and key features

### Variety of interfaces for high flexibility

- ▮ Support for different types of interfaces
- ▮ Low space requirements – simultaneous utilization of different interfaces

### Security due to extensive range of monitoring functions

- ▮ Detailed monitoring and error logging
- ▮ Complete monitoring of all important RF characteristics
- ▮ R&S®DVM400: complete monitoring of up to 512 TS IP connections
- ▮ Monitoring of transport stream characteristics in accordance with TR 101290 and other advanced criteria
- ▮ Monitoring of additional characteristics using templates
- ▮ Simple recording and archiving of transport stream segments by means of the TS Capture function

### Effective operation due to detailed configuration options

- ▮ Individually configurable measurements
- ▮ Permanent or temporary suppression of error messages with Hiding of Events function
- ▮ Protection against unauthorized use with Protection Management function
- ▮ Monitoring of multiple signals through a single input with Scheduler Suite

### Powerful network functions

- ▮ Operation via an integrated web server
- ▮ Integration in network management systems via the built-in SNMP interface
- ▮ Transmission of transport stream elements or programs in the network using the Streaming function
- ▮ Simple data exchange using FTP
- ▮ Firewall-protected access

### Extensive analysis and visualization functions

- ▮ In-depth TS analysis including PCR and PTS
- ▮ Analysis of DVB-H signals, including ESG
- ▮ Detailed data service analysis
- ▮ Analysis of video encoding quality (qPSNR analysis)
- ▮ Detailed elementary stream analysis using separate software tools

### Fast program identification and video quality assessment

- ▮ Extensive functions decoding

### Transport stream recording and generation

- ▮ The R&S®DVM400 offers additional functions for recording and generating transport streams

Rear view of the R&S®DVM100L, including four ASI and two RF interfaces



# Variety of interfaces for high flexibility

## Support for different types of interfaces

A wide variety of interfaces are available with the R&S®DVM family of instruments:

- TS interfaces
  - ASI/SMPTE310M
  - SPI (R&S®DVM400 only)
- IP interfaces (R&S®DVM400 only)
  - Electrical (RJ-45)
  - Optical (SFP housing)
- RF interfaces
  - DVB-T/H (2k and 8k mode)
  - DVB-S/S2
  - DVB-C
  - J.83/B
  - ATSC/8VSB

## Low space requirements – simultaneous utilization of different interfaces

Different types of interfaces can be integrated in a single instrument at the same time. The R&S®DVM400, for example, can be furnished with all of the aforementioned interfaces. Even multiple interfaces of the same type can be installed. Each of the R&S®DVM instruments can simultaneously monitor up to four signals. The R&S®DVM50 can monitor a maximum of four DVB-T signals, for example. The R&S®DVM120 expansion unit makes it possible to monitor up to eight additional signals. In addition to being internally measured, transport streams contained in RF and IP signals can also be output over BNC connectors.

Large-scale integration offers significant advantages:

- Monitoring applications: simple integration even when space is at a premium
- Portable operation in different networks: Only one instrument is required, regardless of the transmission standard being used

Side view of the R&S®DVM400 with all available interfaces except for the SPI interface, which is on the front panel



# Security due to extensive range of monitoring functions

Overview of the measurement results of a TS IP connection including the graphic display of delay factor and media loss rate

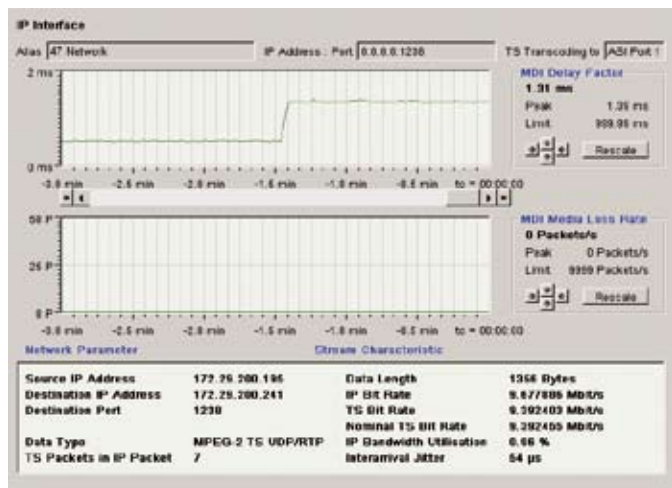

Constellation diagram and measurement results displayed for a DVB-T signal

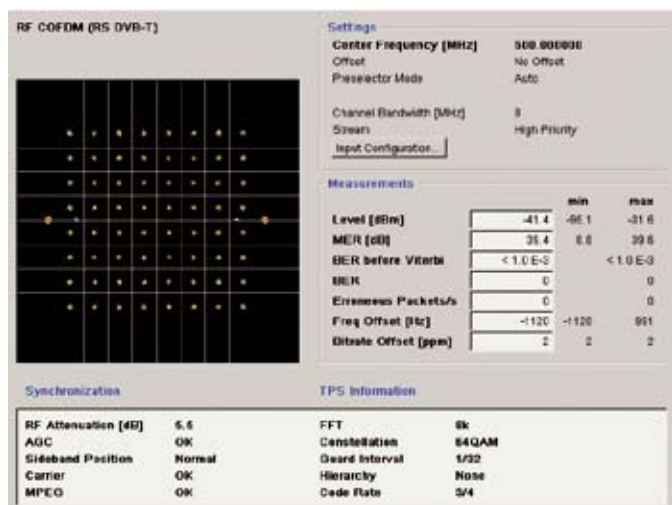

## Detailed monitoring and error logging

All signals are monitored seamlessly at the RF, IP and multiplex levels (MPEG-2 TS). Errors are logged with detailed additional information and statistically recorded. Each error scenario triggers alarm relays, SNMP traps and display icons. The user can individually configure the alarm triggers.

## Complete monitoring of all important RF characteristics

The signal characteristics that can be monitored include level, frequency deviation, BER, MER, C/N, SNR and  $E_b/N_o$ <sup>1)</sup>

The constellation diagram presents the measurement results in a clear structure. The measurement accuracy is outstanding. When performing a MER measurement of a DVB-T signal for instance, a typical value of 38 dB is achieved. This enables the detection of even minor signal modifications at high signal quality.

## R&S®DVM400: complete monitoring of up to 512 TS IP connections

Extensive measurements permit a reliable assessment of the signal quality. These measurements include delay factor (MDI-DF), media loss rate (MDI-MLR), IP bit rate, IP packet jitter, IP inter-arrival time and payload bit rate. The MDI-DF and MDI-MLR measurement results are graphically displayed for simple analysis.

## Monitoring of transport streams in accordance with TR 101290 and other advanced criteria

All<sup>2)</sup> of the characteristics specified in the TR 101290 Measurement Guidelines with priority 1, 2 and 3 are simultaneously monitored for every component of all transport streams being analyzed.

<sup>1)</sup> Measurements are standards-dependent.

<sup>2)</sup> Buffer-related measurements are excluded. These can be analyzed for a selected video or audio element.

## Additional monitoring criteria

- Encryption: verification of the encryption status and the changing of the key (odd/even)
- TS Modification: This function checks whether the transport stream has been modified. Under certain conditions, these modifications can go undetected when performing measurements in line with TR 101 290, but they may be unintentional. Audio loss, for example, is not detected in line with TR 101 290 if the multiplexer modifies the PMT accordingly
- DVB-H signals: Monitoring is performed to check the time slicing and to determine whether the transmitted content is received intact and error-free
- SFNs (DVB-T): The MIP is completely monitored in line with TR 101 290
- Data rates: Element types such as audio and video are monitored to determine if they comply with the specified upper and lower data rate limits. For intermittent transmissions such as with DVB-H, the duration of the measurement cycle for averaging can be set for as long as 150 seconds. Shorter measurement cycles (100 ms) can be selected in order to determine data rate peaks. The various profiles (MGB) are implemented in line with TR 101290. This ensures the comparability of the results

## Monitoring of additional characteristics using templates

Template monitoring allows the comparison of numerous transport stream characteristics with predefined values. There are many types of errors that can only be detected in this way. For example:

- Missing programs
- Missing program elements such as audio
- Data rates that exceed or fall short of the specified limits for single programs or components
- Incorrect program identifiers

A special feature of this function is the automatic generation of a template based on the transport stream being applied. The template is generated simply by pressing a key, which eliminates cumbersome manual setup.

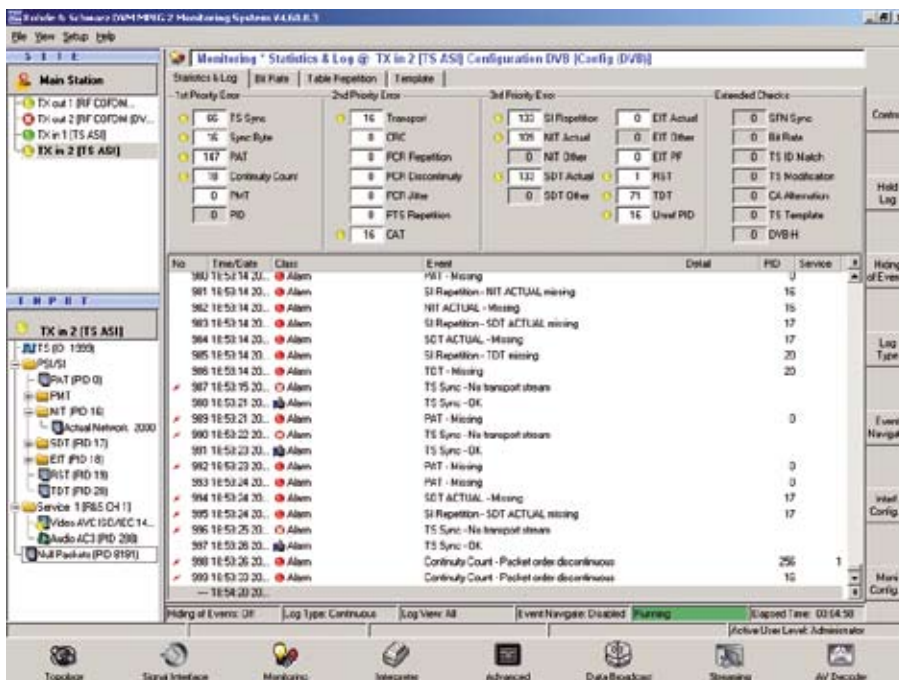

R&S®DVM graphical user interface: overview of the monitored signals as well as the contents of a selected signal (left), log entries and error counter (right)

## Simple recording and archiving of transport stream segments by means of the TS Capture function

The TS Capture function allows event-controlled archiving of transport stream segments on the system hard disk for later analysis and for verification or documentation purpose. This makes it possible to automatically record incorrect segments. The function supports simultaneous monitoring of up to 20 transport streams. The TS recordings can be configured by means of versatile settings such as PID filter, pretrigger size and start event.

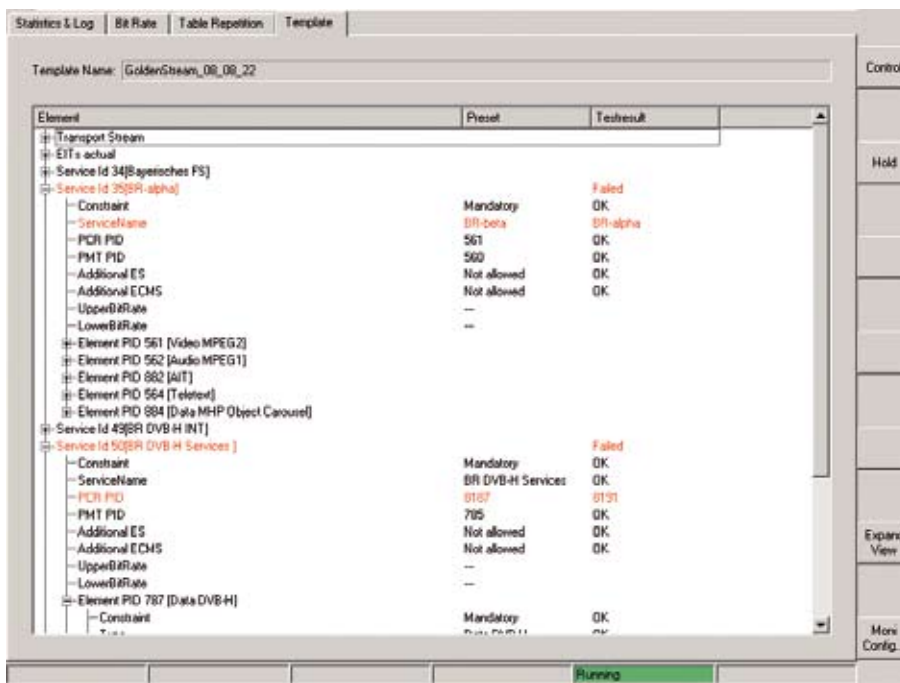

Fast and simple verification of the measurement results derived from the Template monitoring function

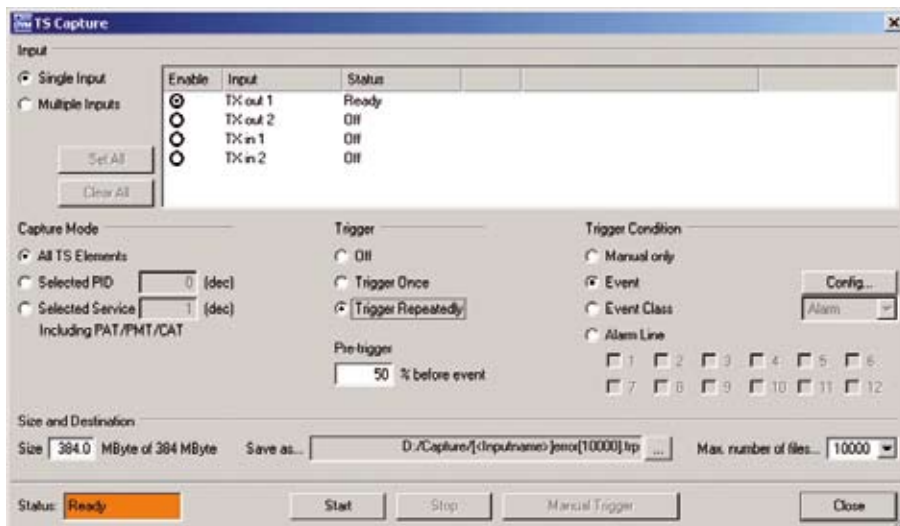

TS Capture: configuration window



# Effective operation due to detailed configuration options

## Individually configurable measurements

Each measurement can be individually activated. In addition to measurement-specific properties, characteristics such as threshold values and priority level can be configured.

## Permanent or temporary suppression of error messages with Hiding of Events function

The Hiding of Events function permits the permanent or temporary suppression of error messages for specific measurements and TS elements. Messages related to already detected but unrecoverable errors can be suppressed without completely deactivating the measurement in progress.

## Protection against unauthorized use with Protection Management function

In the case of monitoring applications, multiple users might need access to the same instrument. These users might have to perform different tasks. To prevent incorrect operation and unauthorized access, different functions can be individually activated for each user:

- Viewer: display of monitoring results and settings
- Operator: viewer rights plus use of analysis tools, start, stop and clear for monitoring
- Administrator: operator rights plus configuration of the monitoring functions and the instrument, operations with data files, firmware update and access to the operating system

Each user receives a unique user name and password.

Configuration window of Hiding of Events function

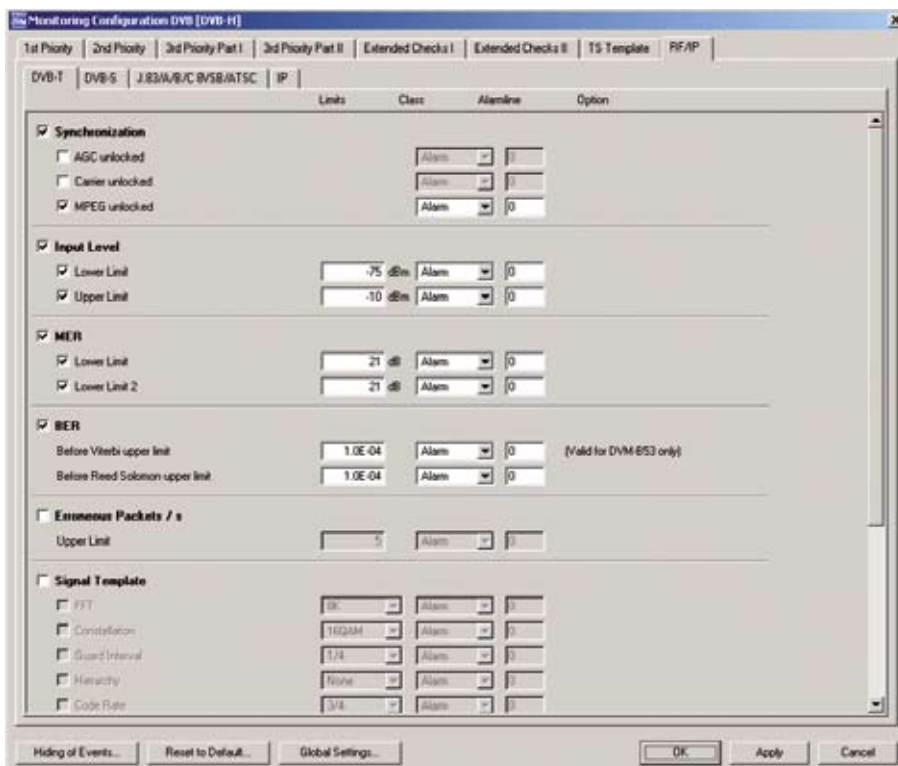
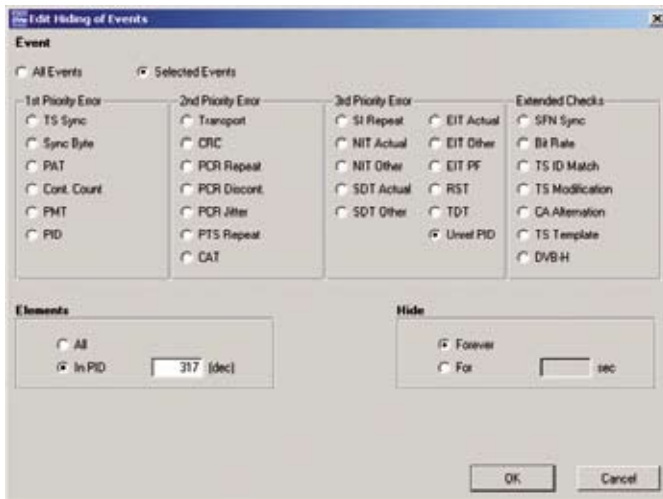

Monitoring configuration: configuration window for all signal monitoring measurements; the RF measurements tab is shown

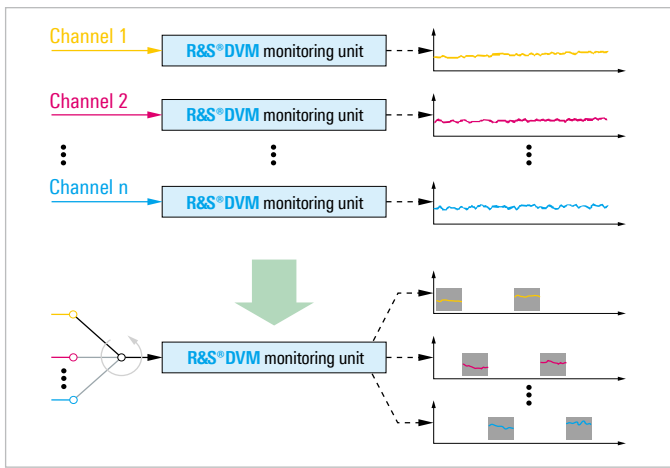

The Scheduler Suite enables a single unit of the R&S®DVM monitoring system to check any number of channels in sequence

The internal ASI switching matrix of the R&S®DVM monitoring systems permits cyclic selection of four TS ASI feeds; this number can be increased by using an external router

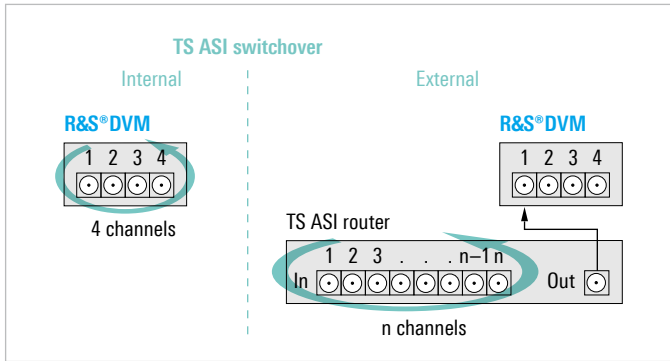

Configuration of the monitoring times by means of the graphical user interface

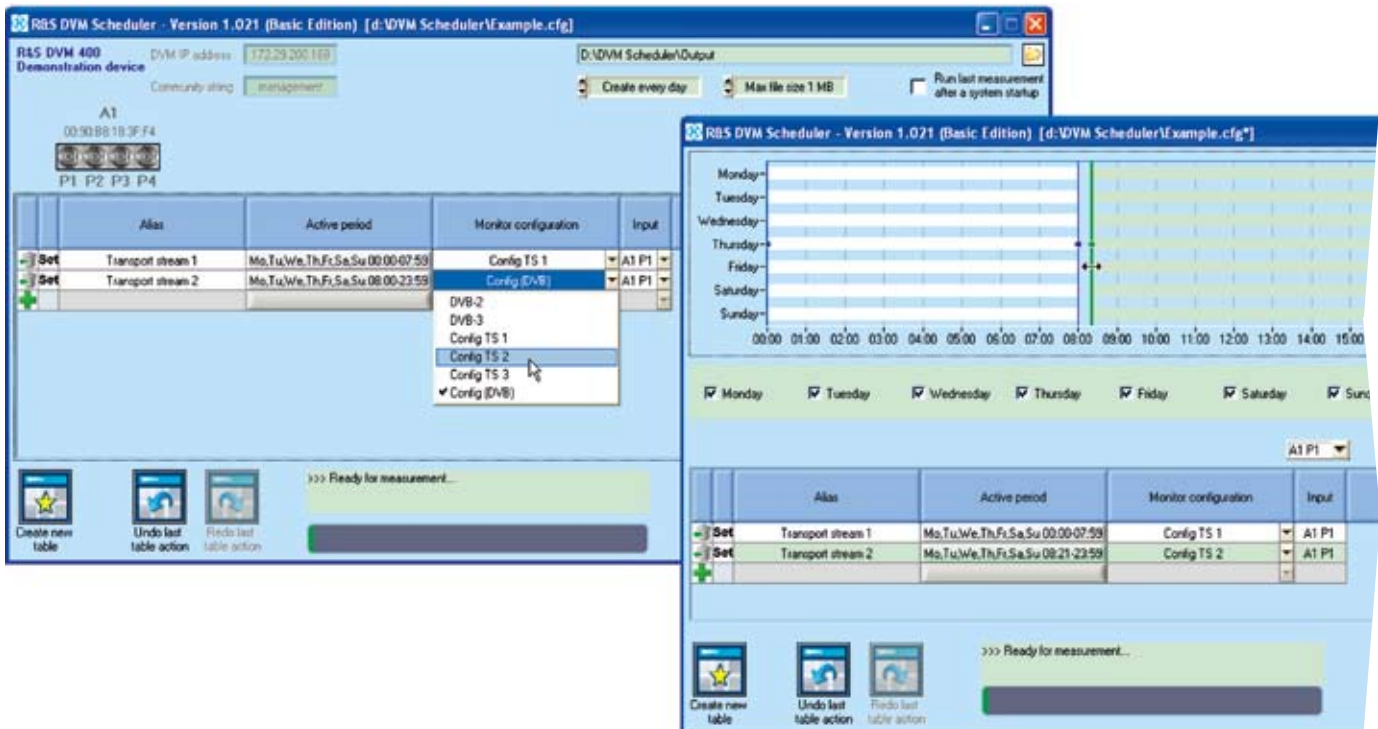

## Monitoring of multiple signals through a single input with the Scheduler Suite

The Scheduler Suite expands the functionality of the instruments through the automatic, time-controlled switching of the monitored signal and the monitoring configuration.

In addition, the Scheduler Suite logs the RF measurement values and provides a graphic display.

### Switching of the signal

By switching between signals or interfaces, multiple signals can be sequentially monitored with only one instrument:

- ▮ ASI: selection of a different interface on the instrument or on an external ASI switching matrix
- ▮ RF: selection of a different receive frequency
- ▮ IP: selection of a different IP address

### Monitoring configuration

The current monitoring configuration can be adapted automatically when a different signal is selected. This ensures that the configuration always matches the signal being monitored.

# Powerful network functions

## Operation via an integrated web server

The integrated web server permits convenient remote operation of the instruments. This is done via an Internet browser that supports Java. The web servers supports two types of access:

- Using the Viewer application, measurement results from up to five different locations can be independently and simultaneously reviewed. All monitoring results, including the graphic displays, are shown. Up to six constellation diagrams can be simultaneously displayed
- The R&S®DVM Desktop application can be used to conduct analyses and modify configurations. The functions correspond to those on the instrument and access can be restricted with the Protection Management feature

## Integration in network management systems via the built-in SNMP interface

The instruments of the R&S®DVM family feature an SNMP interface, allowing easy integration into network management systems. Errors detected by the instrument are signaled via SNMP traps. Each of the monitoring functions is individually configurable. All results derived from the monitoring functions can be queried.

## Transmission of transport stream elements or programs in the network using the Streaming function

Selected TS elements or programs can be sent to any network IP address for external processing and analysis. This function, which is available with each instrument of the R&S®DVM family, can be carried out independent of an IPTV interface. It can be used, for example, to display a video program on a remote PC.

For some applications, a low data rate must be maintained. In this case, the Low Bit-Rate Streaming function can be used to significantly reduce the data rate of MPEG-2 SDTV signals (~ 400 kbit/s).

## Simple data exchange using FTP

The instruments of the R&S®DVM family feature a password-protected FTP server for the simple exchange of data.

## Firewall-protected access

An integrated firewall protects the instruments from unauthorized access.

Presentation of the measurement results with the Viewer application

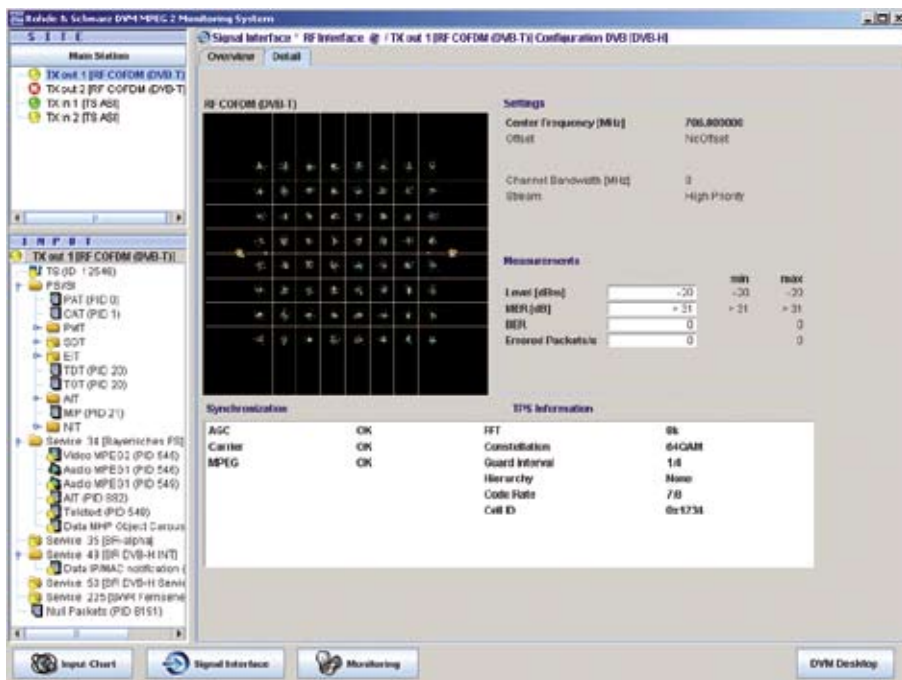

# Extensive analysis and visualization functions

All analysis and visualization functions can be used during monitoring. The graphical user interface is structured so that it also displays the status of all monitored signals.

## In-depth TS analysis including PCR and PTS

- Graphic display of data and table repetition rates with average, maximum and minimum values
- SI, PSI and PSIP table interpretation
- TS and PES packet header interpretation
- Header MAP
  - Graphic display of the TS packet distribution of a select PID in the transport stream
- PCR analysis
  - Graphic display of PCR offset, PCR drift rate, PCR overall jitter, PCR accuracy, PCR repetition with zoom and scroll functions
  - Profiles: MGF1, MGF2, MGF3
- PTS analysis
  - Graphic display of PTS/PCR delay and PCR repetition with zoom and scroll functions
- Realtime buffer analysis
  - Graphic display of the various model buffers
  - Supported video formats: SDTV and HDTV, MPEG-2 and H.264/AVC/MPEG-4 coded
  - Supported audio format: MPEG-1 layer 2
  - Methods: video buffer verifier (VBV), leak method, hypothetical reference decoder (HRD)

Buffer analysis: display of the individual buffers in chronological sequence

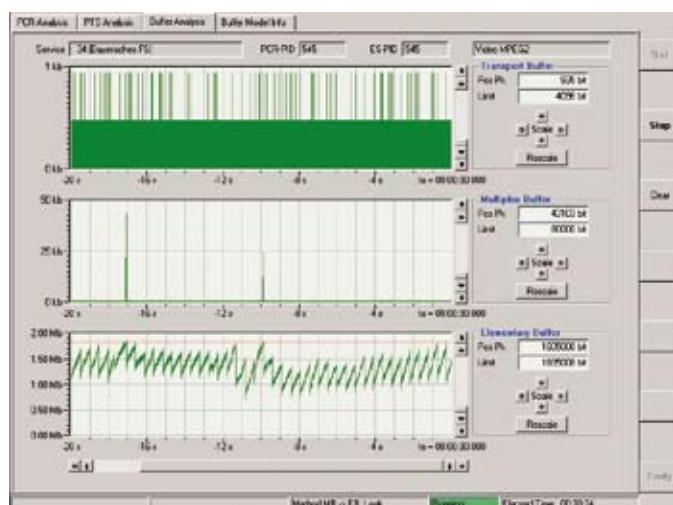

PCR analysis: display of the measurement values in chronological sequence

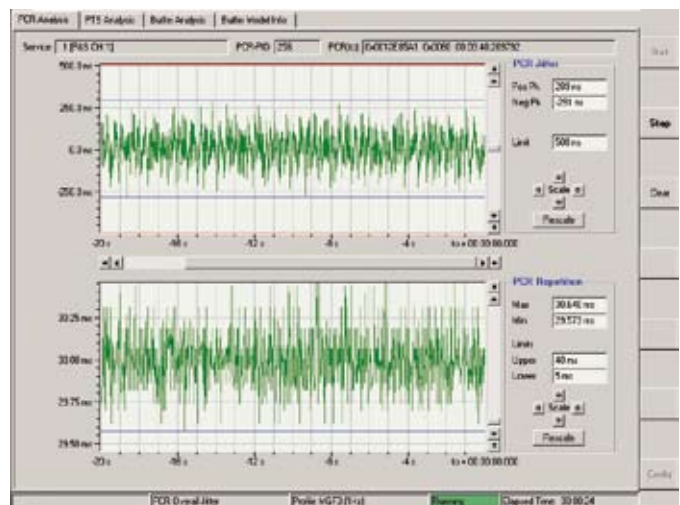

## Analysis of DVB-H signals, including ESG

All important characteristics of a live signal are analyzed in detail:

- Time slicing and bursts
  - Graphic display of the data rates as well as detailed information regarding the data rates and timing
- MPE FEC
  - Error protection characteristics: data segment and structure
  - Detected transmission errors: before and after FEC (row, frame and IP packets)
- Electronic service guide (ESG)
  - Support for OMA BCAST ESG and DVB IPDC ESG (XML format)
  - Parsing information and warnings
  - Checking of the signaling in the transport stream (PSI/SI, NIT and INT linkage)
  - Checking of the ESG processing flow
  - ESG service view: overview of all programs with detailed information
  - ESG transport analysis view: display of the ESG protocol components (FDT elements, bootstrap, SGDD, SGDU, etc.)
  - Saving of extracted ESG files
  - Saving of analysis reports
- Video decoding
  - Realtime de-encapsulation and forward error correction of individual programs
  - Display of the decoded program

Analysis of DVB-H time slicing

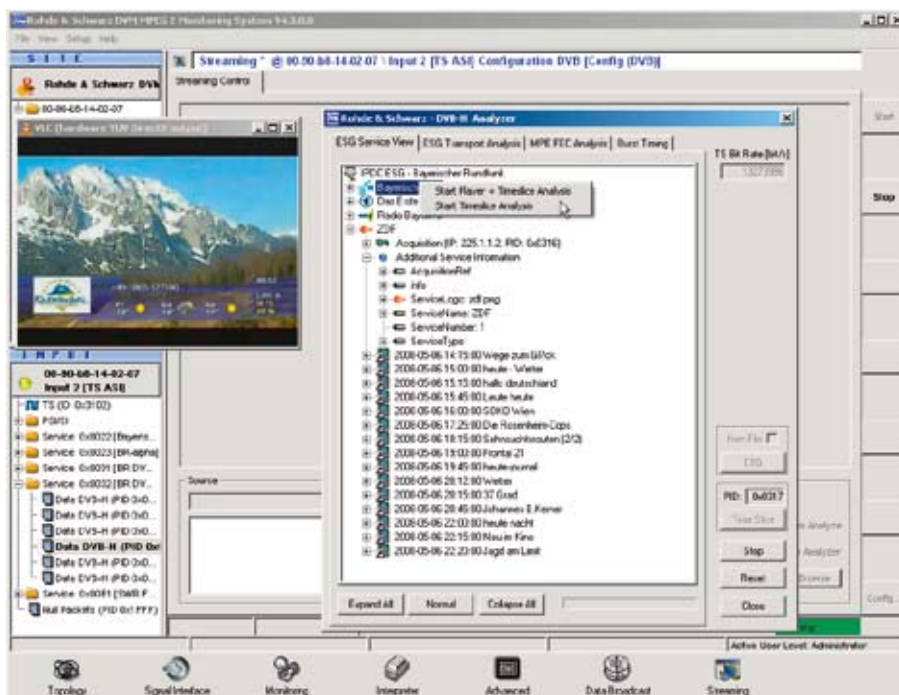
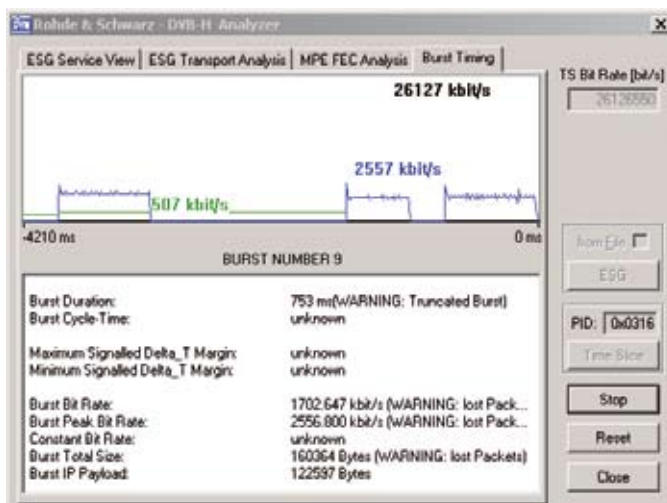

R&S®DVM GUI with ESG service view and decoded DVB-H program

## Detailed data service analysis

The transmission protocols of a wide range of data service can be analyzed directly in the live signal. The following protocols are supported:

- ▮ DVB object carousel – MHP application download
- ▮ DVB data carousel – system software update (SSU)
- ▮ Multiprotocol encapsulation (MPE) – IP data transmission
- ▮ Data streaming – videotext, subtitles, VPS, WSS and proprietary data transmission
- ▮ Data piping – proprietary data transmission

Extensive analysis functions are available:

- ▮ Checking of data services signaling
- ▮ Interpreter for the protocol segments
- ▮ Raw data display of the transmitted content
- ▮ Extensive timing measurements: data rates, repetition rates and loading times for object and data carousels

## Analysis of video encoding quality (qPSNR analysis)

The encoding quality (qPSNR) of a selected program is analyzed in realtime. Supported video formats are SDTV and HDTV up to 1080i, MPEG-2 or H.264/AVC/MPEG-4 coded.

The analysis encompasses the following:

- ▮ Continuous monitoring of all I frames
- ▮ Graphic display of the qPSNR values versus time and as a histogram
- ▮ Logging of all measurement values in a .CSV file on the hard disk
- ▮ Offline analysis of I, B and P frames if quality falls below preset limits

## Detailed elementary stream analysis using separate software tools

The analysis of video and audio elementary streams is carried out using separate software tools.

- ▮ R&S®DV-ESA: detailed analysis of MPEG-2 video elementary streams
- ▮ R&S®DVM-K200/201: detailed analysis of video elementary streams (H.264/AVC/MPEG-4 coded) and audio elementary streams (MPEG-1/2, AAC or Dolby AC-3 coded)

### Carousel analysis

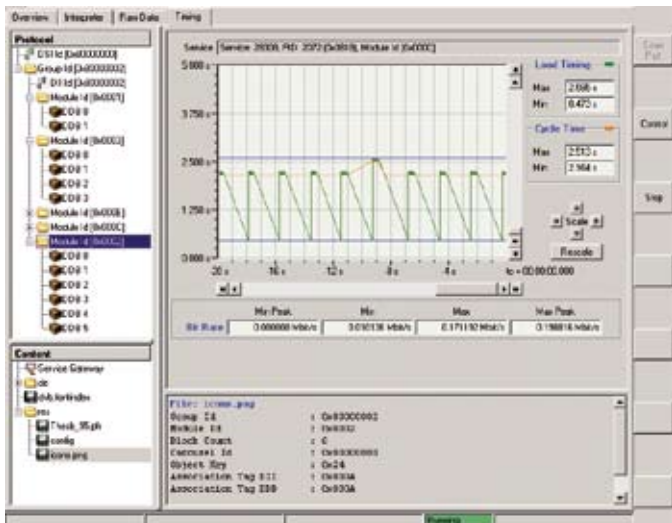

### qPSNR analysis – analysis of the video encoding quality

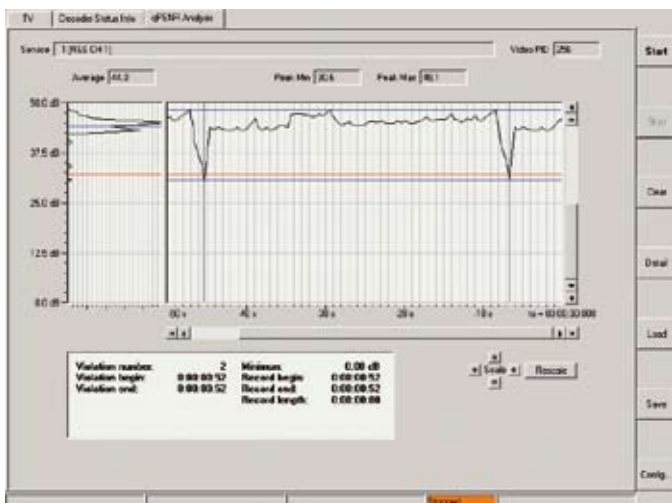

# Fast program identification and video quality assessment

## Extensive functions decoding

The optional hardware decoder allows any program in the various transport streams to be decoded. The transport stream is fed into the instrument via an RF, IP or ASI interface. Supported formats:

- Video: SDTV and HDTV up to 1080i, MPEG-2 or H.264/AVC/MPEG-4 coded
- Audio: MPEG-1 layer 2 and Dolby Digital

The video and audio signals can be presented on external displays through a wide variety of interfaces <sup>1)</sup> (DVI/HDMI, SDI/HD-SDI, RGB/YPbPr and CCVS).

An on-screen display (OSD) provides a quick overview of the technical characteristics of an HD video signal.

With the R&S®DVM400, the picture is also presented on the integrated display.

<sup>1)</sup> Instrument-dependent.

## Decoded picture with OSD



# Transport stream recording and generation

## The R&S®DVM400 offers additional functions for recording and generating transport streams

This functionality is controlled via an additional GUI.

The features include the following:

- Seamless and endless generation of MPEG-2 transport streams
  - Transport stream recording and playback
  - Extensive transport libraries
- For details, see the “Stream Libraries” data sheet, PD 5213.7202.31

- Software for generating transport streams

The R&S®DV-ASC advanced stream combiner software option makes it possible to create transport streams for generation via the R&S®DVM400 generator hardware. The functions are described in the R&S®DV-ASC data sheet, PD 5213.7654.31



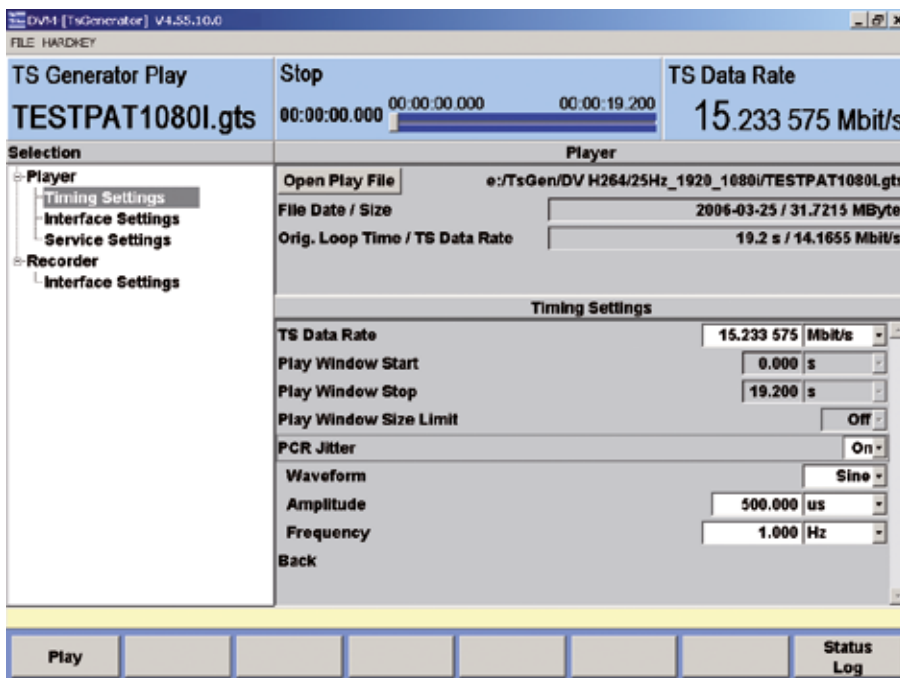

Graphic user interface for transport stream recording and generation



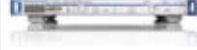

# R&S®DVM Family

## Model overview

Base units					Expansion unit
	R&S®DVM50 <sup>1)</sup>	R&S®DVM100	R&S®DVM100L	R&S®DVM400	R&S®DVM120
					
Height	1 HU	1 HU	1 HU	4 HU	1 HU
Number of transport streams that can be monitored in parallel	1 to 4	1 to 4	1 to 4	1 to 4	1 to 4 (with RF inputs) 1 to 8 (without RF inputs)
Number of RF signals that can be demodulated and monitored in parallel	1 to 4	–	1 to 2	1 to 4	1 to 4
Expansion by the R&S®DVM120 for a total of:	–	20 TS and 16 RF inputs	20 TS and 18 RF inputs	20 TS and 20 RF inputs	–
Local operation	PC required	via external monitor, external keyboard and mouse	via external monitor, external keyboard and mouse	integrated color display, keys and rotary knob; if necessary, external mouse and keyboard	via base units
Remote operation via web server	yes	yes	yes	yes	via base units
SNMP (incl. traps)	yes	yes	yes	yes	via base units
Alarm relays	–	yes	yes	yes	via base units
TS monitoring and analysis including TS capture	yes	yes	yes	yes	yes
ES and data service analysis	yes	yes	yes	yes	yes
Streaming function	via PC interface	yes	yes	yes	via base units
Software decoder	yes	yes	yes	yes	yes
Hardware decoder with various interfaces	yes	yes	yes	yes	yes
Recorder and generator options	–	–	–	yes	–
Gigabit Ethernet/IP interface, monitoring functions and transcoding	–	–	–	yes	–
Reference clock input	–	–	–	yes	–
SPI input and output	–	–	–	yes	–

<sup>1)</sup> The operation of the R&S®DVM50 requires a PC. Some of the functions specified are only available via the PC.

# Application and configuration examples

## Example 1: monitoring at the transmitter site

The operator of a DVB-T network monitors the broadcast signals (2) at the transmitter site with respect to errors at the RF and transport stream levels. Additionally, the operator monitors the transport streams fed to the transmitter. Neither detailed analyses nor transport stream recordings are required.

### Instrument configuration

R&S®DVM100L		
1 ×	R&S®DVM100L	MPEG-2 monitoring system
1 ×	R&S®DVM-B1	MPEG analysis board
4 ×	R&S®DVM-K1	TS monitoring, activation of one channel
1 ×	R&S®DVM-B500	RF carrier board
2 ×	R&S®DVM-B53	DVB-T/DVB-H receiver module, 2k and 8k mode

## Example 2: monitoring at the multiplex center

The operator of a multiplex center checks the generated transport streams (6) for correctness. Some of the signals to be processed are received via satellite and cable (three DVB-S2 and six DVB-C signals). For cost reasons, these signals are monitored only in the Scan mode (RF signals and the contained TS). For visualizing the broadcast programs (SD and HD, with MPEG-2 or H.264 coding) the operator uses external displays connected to the R&S®DVM100L/120. The operator occasionally performs analyses on the transport stream and records TS segments.

### Instrument configuration

R&S®DVM100L		
1 ×	R&S®DVM100L	MPEG-2 monitoring system
1 ×	R&S®DVM-B1	MPEG analysis board
4 ×	R&S®DVM-K1	TS monitoring, activation of one channel
1 ×	R&S®DVM-K2	TS capture, recording by MPEG analysis board
1 ×	R&S®DVM-K10	In-depth analysis
1 ×	R&S®DVM-K12	TS template monitoring
1 ×	R&S®DVM-B500	RF carrier board for R&S®DVM-B50/B51
1 ×	R&S®DVM-B50	Demodulator module
1 ×	R&S®DVM-K501	DVB-C, J.83/A/C demodulation
1 ×	R&S®DVM-B51	DVB-S/DVB-S2 receiver module
1 ×	R&S®DVM-B30	Video and audio hardware decoder (SDTV)
1 ×	R&S®DVM-K32	HDTV and Dolby decoding upgrade
and R&S®DVM120		
1 ×	R&S®DVM120	MPEG-2 monitoring system
1 ×	R&S®DVM-B1	MPEG analysis board
4 ×	R&S®DVM-K1	TS monitoring, activation of one channel
1 ×	R&S®DVM-B30	Video and audio hardware decoder (SDTV)
1 ×	R&S®DVM-K32	HDTV and Dolby decoding upgrade

### Example 3: DTV analyzer for portable applications

The operator of a DVB-C network uses a portable instrument for checking both the broadcast signals (DVB-C) as well as the signals (Gigabit Ethernet) distributed on the backbone. To check the DVB-C signals, the operator requires high dynamic range during the MER measurement. The transport stream, elementary streams or data services are repeatedly analyzed and TS segments are recorded. The operator displays the broadcast programs (SD and HD, with MPEG-2 or H.264 coding) directly on the instrument.

#### Instrument configuration

R&S®DVM400		
1 x	R&S®DVM400	Digital video measurement system
1 x	R&S®DVM400-B1	MPEG analysis board
1 x	R&S®DVM-K1	TS monitoring, activation of one channel
1 x	R&S®DVM-K2	TS capture, recording by MPEG analysis board
1 x	R&S®DVM-K10	In-depth analysis
1 x	R&S®DVM-K11	Data broadcast analysis
1 x	R&S®DV-ESA	Elementary stream analyzer, MPEG-2 ES analysis
1 x	R&S®DVM400-B30	Video and audio hardware decoder (SDTV)
1 x	R&S®DVM-K32	HDTV and Dolby decoding upgrade
1 x	R&S®DVM400-B500	RF carrier board and decoder extension
1 x	R&S®DVM-B50	Demodulator module
1 x	R&S®DVM-K501	DVB-C, J.83/A/C demodulation
1 x	R&S®DVM-K509	High-quality MER measurements
1 x	R&S®DVM400-B40	Gigabit Ethernet interface module

### Example 4: universal instrument in development

For the development of DTV components, a designer employs a "jack-of-all-trades".

#### Instrument configuration

R&S®DVM400		
1 x	R&S®DVM400	Digital video measurement system
<b>Transport stream monitoring and analysis</b>		
1 x	R&S®DVM400-B1	MPEG analysis board
1 x	R&S®DVM-K1	TS monitoring, activation of one channel
1 x	R&S®DVM-K2	TS capture, recording by MPEG analysis board
1 x	R&S®DVM-K10	In-depth analysis
1 x	R&S®DVM-K12	TS template monitoring
<b>Data service and elementary stream analysis</b>		
1 x	R&S®DVM-K11	Data broadcast analysis
1 x	R&S®DV-ESA	Elementary stream analyzer, MPEG-2 ES analysis
1 x	R&S®DVM-K200	H.264 analyzer
1 x	R&S®DVM-K201	Dolby AC-3 audio option for H.264 analyzer
<b>Video and audio decoding</b>		
1 x	R&S®DVM400-B30	Video and audio hardware decoder (SDTV)
1 x	R&S®DVM-K30	HD/SD – SDI video output
1 x	R&S®DVM-K32	HDTV and Dolby decoding upgrade
<b>RF monitoring, analysis and demodulation</b>		
1 x	R&S®DVM400-B500	RF carrier board and decoder extension
1 x	R&S®DVM400-B504	RF carrier board extension
1 x	R&S®DVM-B50	Demodulator module
1 x	R&S®DVM-K501	DVB-C, J.83/A/C demodulation
1 x	R&S®DVM-K502	J.83/B demodulation
1 x	R&S®DVM-K503	ATSC/8VSB demodulation
1 x	R&S®DVM-K509	High-quality MER measurements
1 x	R&S®DVM-B51	DVB-S/DVB-S2 receiver module
1 x	R&S®DVM-B53	DVB-T/DVB-H receiver module, 2k and 8k mode
<b>Transport stream generation, recording and playback</b>		
1 x	R&S®DVM400-B2	TS generator (GTS)
1 x	R&S®DVM400-B3	Upgrade TS recorder (TRP), up to 90 Mbit/s
1 x	R&S®DVM400-B4	Upgrade TS recorder (TRP), up to 214 Mbit/s
1 x	R&S®DV-HDTV	HDTV sequences
1 x	R&S®DV-H264	H.264 stream library
1 x	R&S®DV-DVBH	DVB-H stream library
1 x	R&S®DV-TCM	Test card M sequences
1 x	R&S®DV-ASC	Advanced stream combiner

# Configuration of the instruments

R&S®DVM50 V1.23

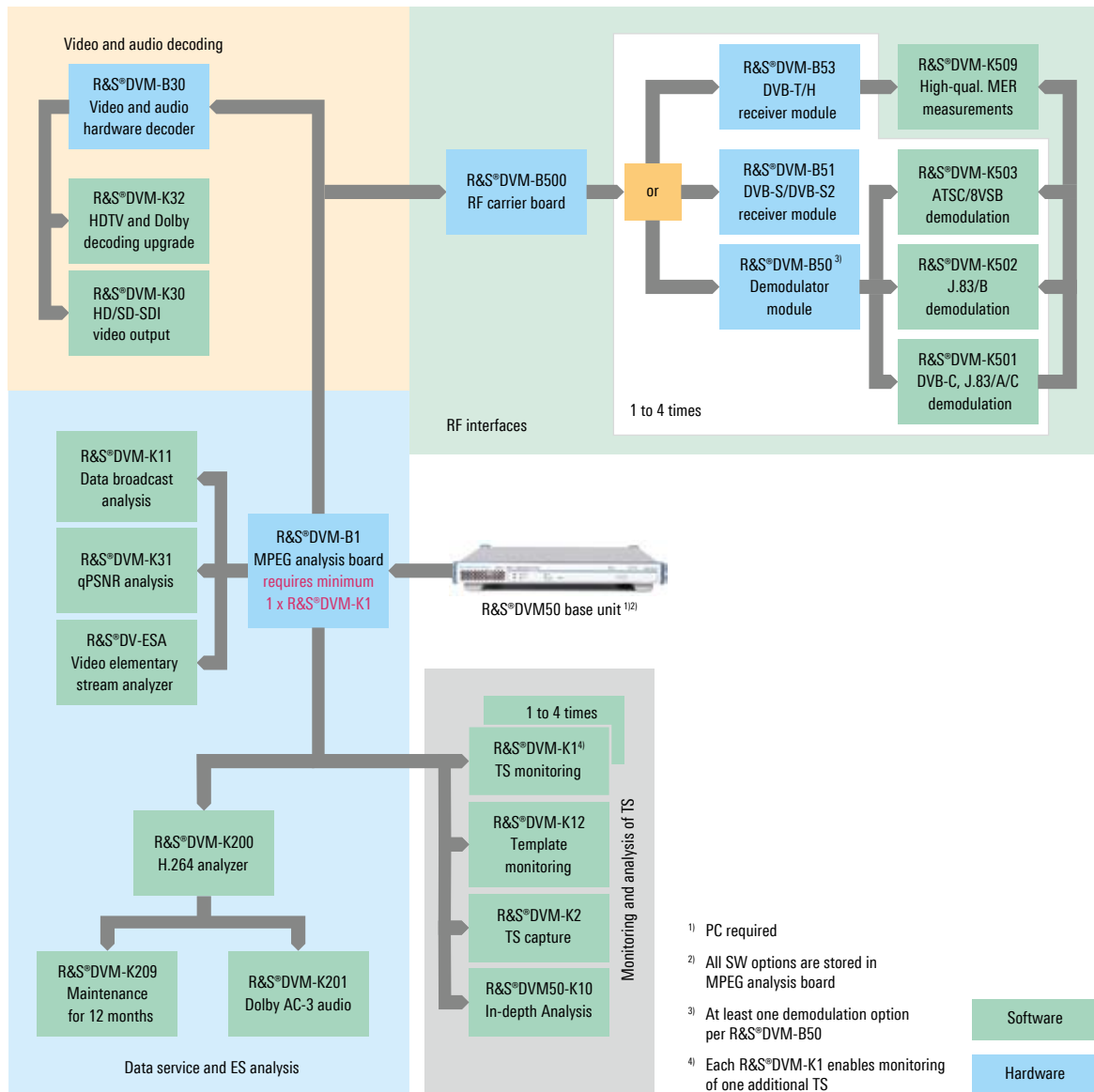

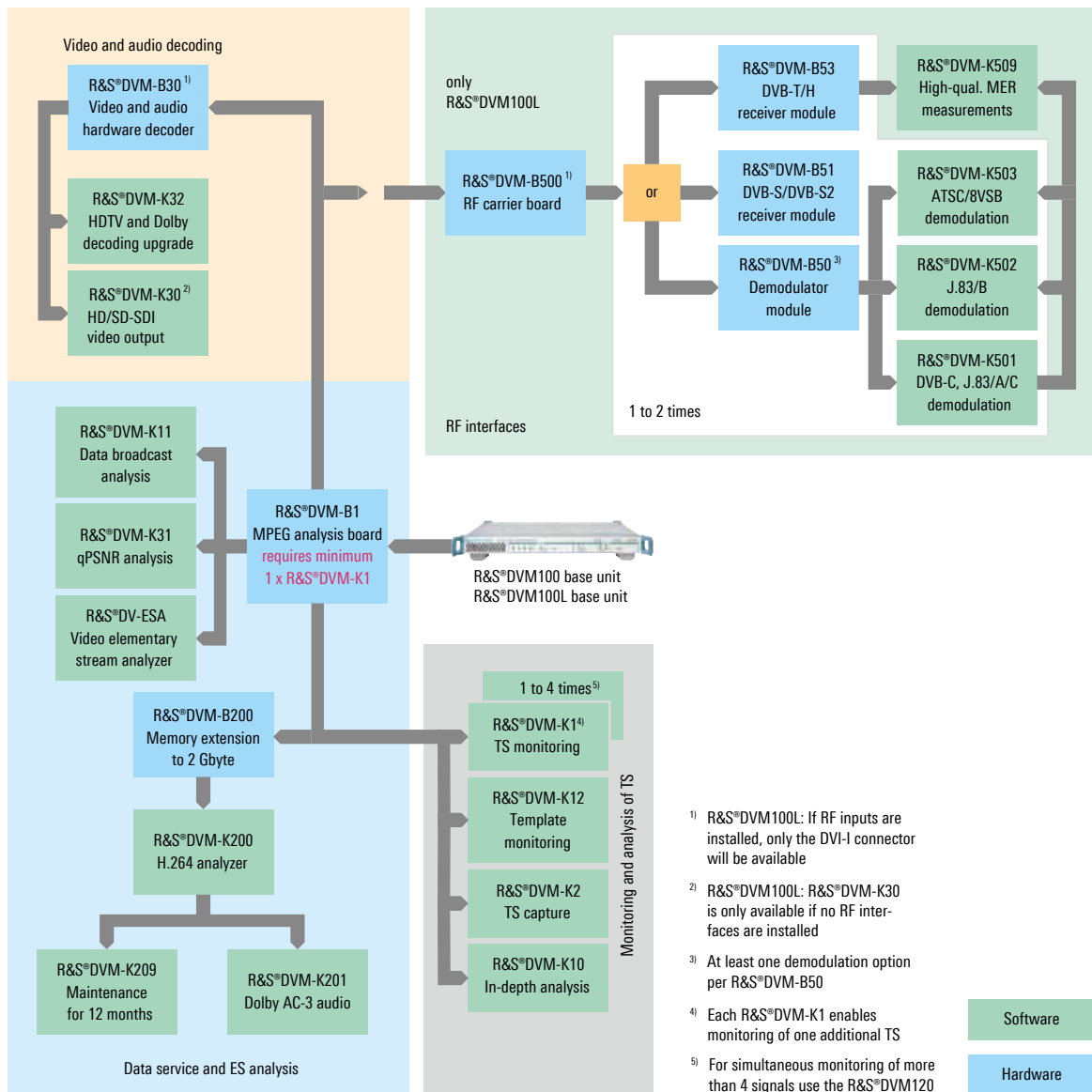

<sup>1)</sup> R&S®DVM100L: If RF inputs are installed, only the DVI-I connector will be available

<sup>2)</sup> R&S®DVM100L: R&S®DVM-K30 is only available if no RF interfaces are installed

<sup>3)</sup> At least one demodulation option per R&S®DVM-B50

<sup>4)</sup> Each R&S®DVM-K1 enables monitoring of one additional TS

<sup>5)</sup> For simultaneous monitoring of more than 4 signals use the R&S®DVM120

Software
Hardware

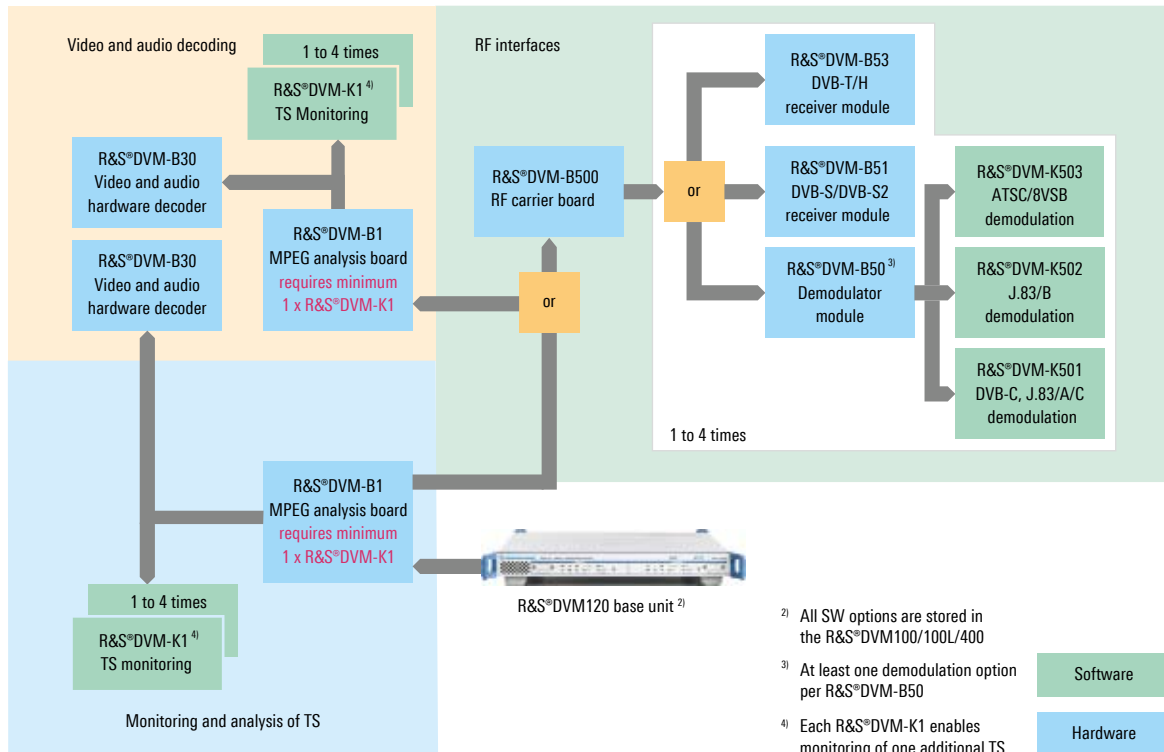

<sup>2)</sup> All SW options are stored in the R&S®DVM100/100L/400

<sup>3)</sup> At least one demodulation option per R&S®DVM-B50

<sup>4)</sup> Each R&S®DVM-K1 enables monitoring of one additional TS

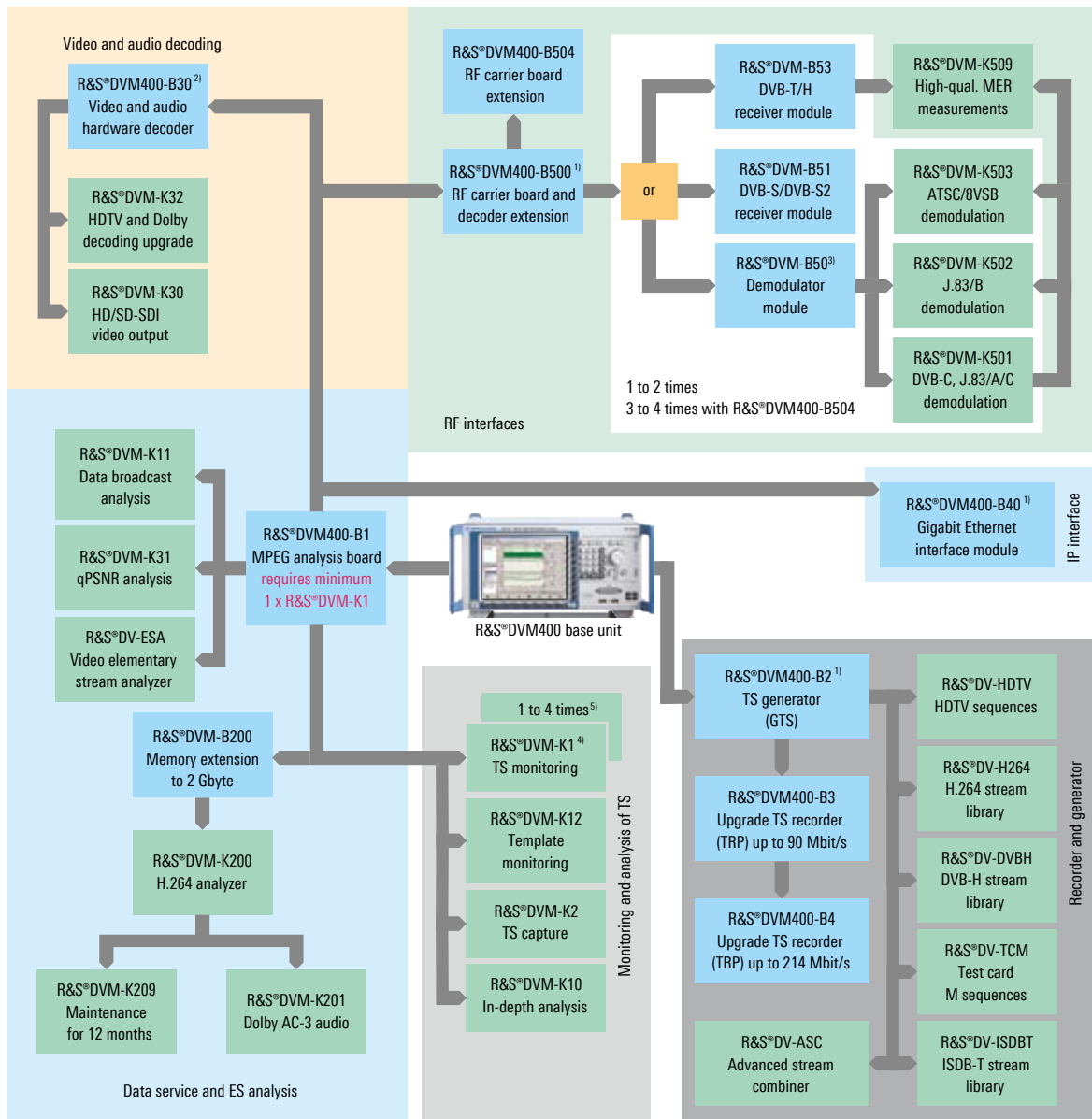

<sup>1)</sup> Only 2 choices from the following 3 possible:  
 - R&S®DVM400-B500  
 - R&S®DVM400-B2  
 - R&S®DVM400-B40

<sup>3)</sup> At least one demodulation option per R&S®DVM-B50

<sup>4)</sup> Each R&S®DVM-K1 enables monitoring of one additional TS

<sup>2)</sup> Use of the integrated display and speaker of the R&S®DVM400-B30 hardware decoder requires the R&S®DVM400-B500

<sup>5)</sup> For simultaneous monitoring of more than 4 signals use the R&S®DVM120

Software
Hardware

# Ordering information

Designation	Type	Order No.
<b>Base units</b>		
MPEG-2 Monitoring System Accessories: quick start guide in printed format, operating manual on CD, power cable, crossed patch cable, CD with firmware	R&S®DVM50	2085.1900.03
MPEG-2 Monitoring System Accessories: quick start guide in printed format, operating manual on CD, power cable, crossed patch cable, CD with firmware, connector for relay contacts	R&S®DVM100	2085.1600.03
MPEG-2 Monitoring System Accessories: quick start guide in printed format, operating manual on CD, power cable, crossed patch cable, CD with firmware, connector for relay contacts	R&S®DVM100L	2112.7050.02
Digital Video Measurement System Accessories: quick start guide in printed format, operating manual on CD, power cable, crossed patch cable, CD with firmware, connector for relay contacts, mouse	R&S®DVM400	2085.1800.03
<b>Expansion unit</b>		
MPEG-2 Monitoring System Accessories: power cable, crossed patch cable	R&S®DVM120	2085.1700.03
<b>Transport stream monitoring and analysis</b>		
MPEG Analysis Board	R&S®DVM-B1	2085.3283.02
MPEG Analysis Board	R&S®DVM400-B1	2085.5505.02
TS Monitoring, activation of one channel	R&S®DVM-K1	2085.5211.02
TS Capture, recording by MPEG analysis board	R&S®DVM-K2	2085.5234.02
In-Depth Analysis	R&S®DVM-K10	2085.5228.02
In-Depth Analysis	R&S®DVM50-K10	2085.5434.02
TS Template Monitoring	R&S®DVM-K12	2085.5328.02
<b>Data service and elementary stream analysis</b>		
qPSNR Analysis, video coding real-time analysis	R&S®DVM-K31	2085.5457.02
Data Broadcast Analysis	R&S®DVM-K11	2085.5311.02
Elementary Stream Analyzer, MPEG-2 ES analysis	R&S®DV-ESA	2085.8904.02
H.264 Analyzer	R&S®DVM-K200	2112.7850.02
Dolby AC-3 Audio, option for H.264 analyzer	R&S®DVM-K201	2112.7867.02
Maintenance for 12 Months, option for H.264 analyzer	R&S®DVM-K209	2112.7873.02
<b>Video and audio decoding</b>		
Video and Audio Hardware Decoding Video: SDTV, MPEG-2, H.264 Audio: MPEG-1/2	R&S®DVM-B30	2085.5570.02
Video and Audio Hardware Decoding Video: SDTV, MPEG-2, H.264 Audio: MPEG-1/2	R&S®DVM400-B30	2085.5540.02
HD/SD-SDI Video Output	R&S®DVM-K30	2085.5440.02
HDTV and Dolby Decoding Upgrade	R&S®DVM-K32	2085.5486.02
<b>RF monitoring, analysis and demodulation</b>		
RF Carrier Board	R&S®DVM-B500	2085.5634.02
RF Carrier Board and Decoder Extension	R&S®DVM400-B500	2085.5563.02
RF Carrier Board Extension	R&S®DVM400-B504	2085.5670.02
Demodulator Module	R&S®DVM-B50	2085.5605.02
DVB-C, J.83/A/C Demodulation	R&S®DVM-K501	2112.7815.02
J.83/B Demodulation	R&S®DVM-K502	2112.7821.02
ATSC/8VSB Demodulation	R&S®DVM-K503	2112.7838.02
High-quality MER measurements for R&S®DVM-B50 and R&S®DVM-B53	R&S®DVM-K509	2112.7844.02
DVB-S/DVB-S2 Receiver Module	R&S®DVM-B51	2085.5611.02
DVB-T/DVB-H Receiver Module, 2k and 8k mode	R&S®DVM-B52	2085.5657.02



Designation	Type	Order No.
<b>IPTV monitoring, analysis and transcoding (R&amp;S®DVM400 only)</b>		
Gigabit Ethernet Interface Module	R&S®DVM400-B40	2085.5557.03
<b>Transport stream generation, recording and playback (R&amp;S®DVM400 only)</b>		
TS Generator (GTS)	R&S®DVM400-B2	2085.5511.02
Upgrade TS Recorder (TRP), up to 90 Mbit/s	R&S®DVM400-B3	2085.5528.03
Upgrade TS Recorder (TRP), up to 214 Mbit/s	R&S®DVM400-B4	2085.5534.03
HDTV Sequences	R&S®DV-HDTV	2085.7650.02
H.264 Stream Library	R&S®DV-H264	2085.9052.02
DVB-H Stream Library	R&S®DV-DVBH	2085.8704.02
Test Card M Sequences	R&S®DV-TCM	2085.7708.02
Advanced Stream Combiner, dongle for USB interface	R&S®DV-ASC	2085.8804.03
<b>Rack installation kits</b>		
19" Adapter, 1 HU, 1/1 for design 2000 housing for R&S®DVM50/100/100L/120	R&S®ZZA-111	1096.3254.00
19" Adapter for design 2000 housing, 4U, 7/8 T250 for R&S®DVM400	R&S®ZZA-S03	1105.6756.00
<b>Extras</b>		
Memory Extension, to 2 Gbyte	R&S®DVM-B200	2085.5592.02
Keyboard with USB Interface (US keyboard)	R&S®PSL-Z2	1157.6870.03
Mouse with USB Interface, optical	R&S®PSL-Z10	1157.7060.02
Documentation of R&S®DVM50/100/120/400 Calibration Values	R&S®DVM-DCV	2082.0490.29
Operating manual, printed format	–	2085.1839.12
Type designation: accessories (-Z), option (-B), software (-K)		
<b>Service options</b>		
Service options can only be ordered in connection with the purchase of an instrument.		
Repair service		
One-Year Repair Service following the warranty period	R&S®RO2DVM50 R&S®RO2DVM100 R&S®RO2DVM100L R&S®RO2DVM400 R&S®RO2DVM120	please contact your local sales office
Two-Year Repair Service following the warranty period	R&S®RO3DVM50 R&S®RO3DVM100 R&S®RO3DVM100L R&S®RO3DVM400 R&S®RO3DVM120	please contact your local sales office
Four-Year Repair Service following the warranty period	R&S®RO5DVM50 R&S®RO5DVM100 R&S®RO5DVM100L R&S®RO5DVM400 R&S®RO5DVM120	please contact your local sales office
Calibration service		
Two-Year Calibration Service	R&S®CO2DVM50 R&S®CO2DVM100 R&S®CO2DVM100L R&S®CO2DVM400 R&S®CO2DVM120	please contact your local sales office
Three-Year Calibration Service	R&S®CO3DVM50 R&S®CO3DVM100 R&S®CO3DVM100L R&S®CO3DVM400 R&S®CO3DVM120	please contact your local sales office
Five-Year Calibration Service	R&S®CO5DVM50 R&S®CO5DVM100 R&S®CO5DVM100L R&S®CO5DVM400 R&S®CO5DVM120	please contact your local sales office

## Service you can rely on

- | In 70 countries
- | Person-to-person
- | Customized and flexible
- | Quality with a warranty
- | No hidden terms

## About Rohde & Schwarz

Rohde & Schwarz is an independent group of companies specializing in electronics. It is a leading supplier of solutions in the fields of test and measurement, broadcasting, radiomonitoring and radiolocation, as well as secure communications. Established 75 years ago, Rohde & Schwarz has a global presence and a dedicated service network in over 70 countries. Company headquarters are in Munich, Germany.

## Regional contact

Europe, Africa, Middle East

+49 1805 12 42 42\* or +49 89 4129 137 74

customersupport@rohde-schwarz.com

North America

1-888-TEST-RSA (1-888-837-8772)

customer.support@rsa.rohde-schwarz.com

Latin America

+1-410-910-7988

customersupport.la@rohde-schwarz.com

Asia/Pacific

+65 65 13 04 88

customersupport.asia@rohde-schwarz.com

Certified Quality System

**ISO 9001**

DQS REG. NO 1954 QM

Certified Environmental System

**ISO 14001**

DQS REG. NO 1954 UM

Certified Quality System

**EN 9100**

DQS REG. NO 310133 ASH

Certified Quality System

**AQAP-2110**

Audit report GP T3.1-NO 05.03

For data sheet, see  
PD 5213.5274.22  
and [www.rohde-schwarz.com](http://www.rohde-schwarz.com)

## Rohde & Schwarz GmbH & Co. KG

Mühlendorfstraße 15 | 81671 München

Phone +498941 290 | Fax +498941 29121 64

[www.rohde-schwarz.com](http://www.rohde-schwarz.com)

R&S® is a registered trademark of Rohde & Schwarz GmbH & Co. KG  
Trade names are trademarks of the owners | Printed in Germany (kk)  
PD 5213.5274.12 | Version 03.00 | September 2008 | R&S®DVM Family  
Data without tolerance limits is not binding | Subject to change

\*0.14 €/min within German wireline network; rates may vary in other networks (wireline and mobile) and countries.