

R&S® GSACSM COMMUNICATION SYSTEM MONITORING

Satcom mission planning

Product Brochure
Version 01.00

ROHDE & SCHWARZ

Make ideas real



AT A GLANCE

R&S®GSACSM communication system monitoring is a satmon software solution for remote spectrum monitoring and signal analysis. R&S®GSACSM comes with classic spectrum analyzer functions, trapping systems, as well as advanced signal detection and identification algorithms. The modern, adaptive GUI makes it easy to implement use cases, e.g. interference identification or satcom transponder analysis.

Remote spectrum monitoring

R&S®GSACSM provides an interface for communicating with remote spectrum analyzers via remote connections; users can access their devices from all over the world. R&S®GSACSM supports monitoring of signals for one device at a time and for many different devices at once. R&S®GSACSM also handles different users monitoring the same device. Both a standalone application and a server/client solution are available.

Satellite transponder monitoring

R&S®GSACSM autonomously scans transponder signals and identifies carriers, e.g. DVB-S, DVB-S2 and DVB-CID. Scanning and evaluating signals continuously makes it possible to detect wanted carriers with detailed information such as baud rate, modulation scheme, FEC rate, C/N and carrier frequency offset. It is also possible to track and identify unwanted services.

Carrier-in-carrier (CiC) detection

Systems using R&S®GSACSM can perform carrier-in-carrier detection tasks, which are a major feature in modern VSAT systems. Tasks such as paired carrier multiple access (PCMA) detection and signal identification and under-carrier signal analysis can be executed to find unwanted interferers in such systems.



KEY FACTS

- ▶ Multichannel power measurement, history logging and alarm trapping
- ▶ Classic software-based spectrum analyzer functions
- ▶ Adaptive GUI and tailored special purpose solutions
- ▶ Autonomous detection and identification of terrestrial and satellite signals (e.g. GSM, DECT, DVB-S, DVB-S2)
- ▶ Autonomous detection and identification of paired-carrier multiple access (PCMA) and time-division multiple access (TDMA) signals
- ▶ Autonomous detection and identification of under-carrier signals
- ▶ Autonomous detection and identification of DVB carrier identification (DVB-CID) signals
- ▶ Simultaneous operations on multiple remote spectrum analyzers
- ▶ Remote spectrum monitoring over narrowband low latency connections

BENEFITS

Easy implementation of complex use cases

▶ [page 4](#)

Spectrum measurement tasks for interpreting signals precisely

▶ [page 5](#)

Spectrum scanning and carrier classification

▶ [page 6](#)

Detection and separation of PCMA signals

▶ [page 8](#)

TETRA scanning and analysis

▶ [page 9](#)

Cross-polarization measurement

▶ [page 10](#)

Under-carrier detection

▶ [page 11](#)

RF path measurement

▶ [page 12](#)

Power monitoring, recording, replay, import and export

▶ [page 14](#)

Distributed network structure

▶ [page 16](#)

TCP/IP acceleration middleware

▶ [page 17](#)

EASY IMPLEMENTATION OF COMPLEX USE CASES

Clear views of spectrum displays and measurement results

R&S®GSACSM has a modern style similar to other common applications. This makes it easy to use; even unexperienced users can obtain meaningful results.

Signal markers provide quick, smart overview of signal parameters

Power values can be shown by adding markers to the chart as shown in the screenshot below.

Multi-device monitoring with docking manager function

R&S®GSACSM allows simultaneous monitoring of multiple devices. Parallel monitoring is shown in the screenshot on the left, where two devices are displayed side by side. This makes it easy to see the uplink and downlink signal at the same time.

Multi-user monitoring

Systems using R&S®GSACSM allow multiple users to connect to a single device at the same time. To avoid race conditions, device settings can only be changed by the first user connected to the device. A second user can only view the measurement results.

Clear views of measurement results and signal parameters

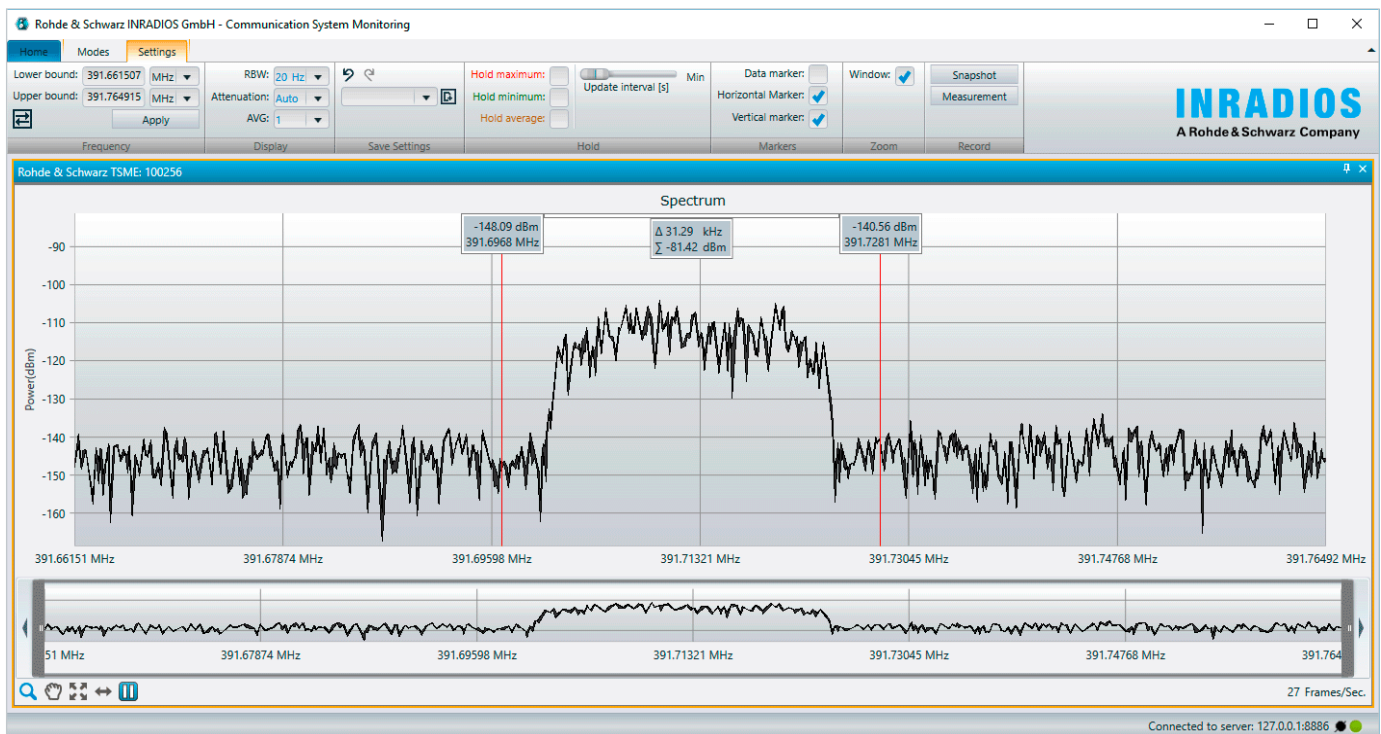

SPECTRUM MEASUREMENT TASKS FOR INTERPRETING SIGNALS PRECISELY

Spectrogram for identifying signal parts by in color-coded waterfall charts

Systems using R&S®GSACSM are able to monitor the power spectral density of any spectrum analyzer input signal. This helps identify potential unwanted signal sources. The spectrogram feature illustrates this with 2D and 3D waterfall charts.

Spectrum density for identifying sporadic signal parts

The spectrum density measurement feature monitors time-varying and superimposed signals by capturing and analyzing continuous spectrums over time. Rare or superimposed events that cannot be detected using the ordinary spectrum analyzer functions can be visualized in a spectrum density chart.

Alarm trapping helps identify suspicious signals automatically

R&S®GSACSM is capable of setting alarm thresholds to inform users when unwanted signals occur. Users can define spectrum signal masks to ensure that every suspicious carrier is immediately identified.

2D and 3D spectrogram

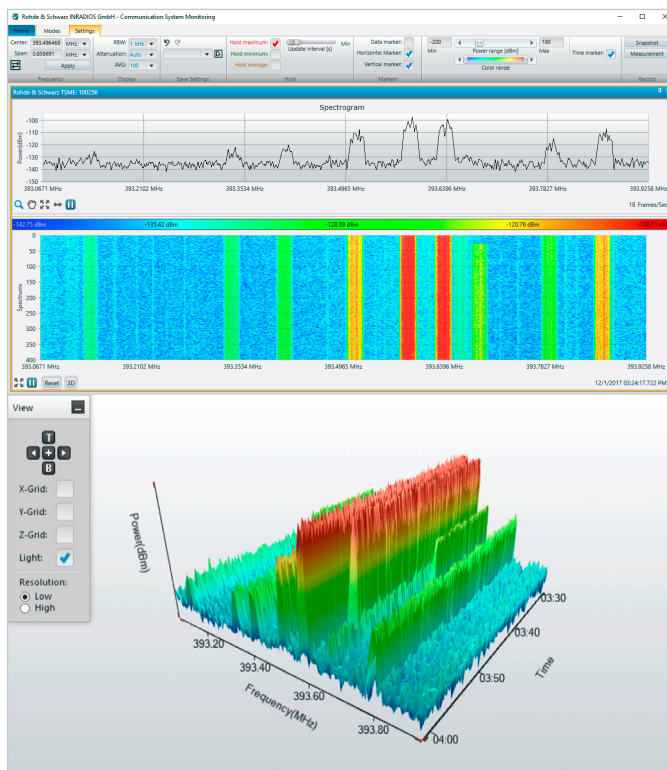

Spectrum density view

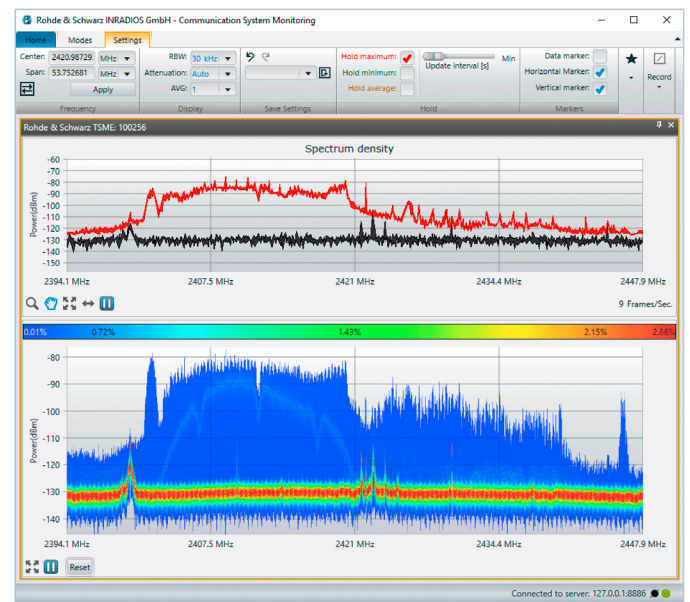

Alarm trapping with signal masks



SPECTRUM SCANNING AND CARRIER CLASSIFICATION

Autonomous spectrum scanning and carrier identification for satellite transponder monitoring

Clear visualization of constellation diagrams and signal parameters per carrier

The R&S®GSACSM classification feature enables systems to autonomously scan spectrum signals and identify carriers. Carriers are visualized in color-coded charts and in lists. The chart and list elements make it easy to identify each carrier. The sniper tool lets users add new areas to select a specific carrier for further processing.

Large variety of standards and types of modulation can be identified (DVB-S, DVB-S2, IESS, GSM, etc.)

All collected signal parameters and the constellation diagram are displayed so that the user sees all necessary details at a glance. Since users may not be able to determine the actual signal class, the table clearly shows the detection and classification features.

Detection features and supported standards

Detection/ classification features	Supported standards
Satcom	DVB-S, DVB-S2, IESS, SCPC, TDMA
Carrier-in-carrier	various, e.g. Comtech DoubleTalk
Terrestrial	GSM downlink, LTE
Modulation	M-QAM, M-DPSK, M-FSK, M-PSK, OFDM, DSSS, CDMA
DVB-CID	DVB-Carrier ID

Signal detection and identification

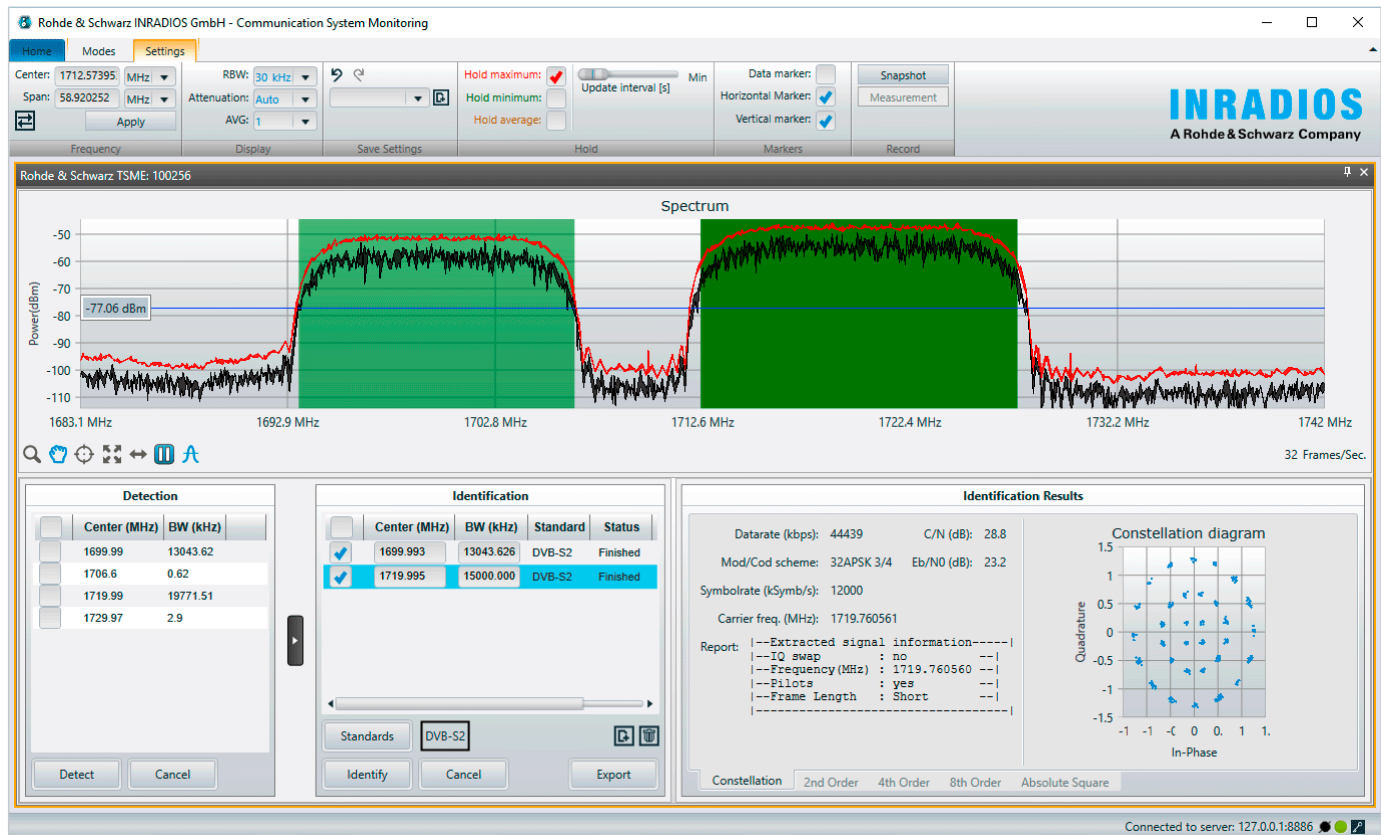

Autonomous, continuous spectrum scanning and carrier detection and demodulation for DVB-CID signals

Autonomous detection and identification of CIDs for satcom signals

Modern satellite communications has to deal with a lot of signal interference that needs to be efficiently avoided. The Digital Video Broadcasting organization specified a carrier ID (CID) that identifies the host carrier, effectively reducing interference between satellite signals, e.g. DVB-S2.

CSM list supported SCPC

Manufacturer (SCPC)	Description
COMTECH	LDPC 2/3
	LDPC 3/4
	VersaFEC 0.642L
	VersaFEC 0.789L
	VersaFEC 0.803
IDirect	TPC 0.793 Infinity
Radyne	TPC 3/4 VSAT defacto
Various	TPC 3/4
Various	TPC 7/8
Various	TPC 7/8 VSAT defacto

Clear visualization of CID parameters (global unique ID, GPS coordinates, etc.)

Systems using R&S®GSACSM can handle CID signals, i.e. they will be detected and then demodulated. The CID-specific “global unique ID”, the GPS coordinates and the telephone number are extracted. The global unique ID allows users to identify their satellite signal precisely.

CSM list supported TDMA

Manufacturer (TDMA)	Description
ViaSat	LinkWay, LinkWay2, Surfbeam, SkyLinX DDS
Nortel	DASA-SKYWAN (IDU 200, 3000, 5000), DASA-SKYWAN (IDU 7000)
PolarSat	VSATplus II, VSATplus III
Nera	Satlink
Gilat	Skyblaster, FaraWay, SkyEdge, SkyEdge II, DialAway, Sky Star VARIANT
Hughes	DIRECWAY (IPoS), PE5
Shiron	InterSKY
Comtec	SkyWire
SatNet	Advantech/EMS
Taychon Networks	Taychon
NEC	NEXTAR48 (IC), NEXTAR4A (OC), NEXTAR Bandwidth On Demand, NEXTARV0

DVB carrier identification detection and demodulation

The screenshot displays the Rohde & Schwarz INRADIO Communication System Monitoring interface. The main window shows a spectrum plot titled "DVB Carrier Identification" with Power (dBm) on the y-axis (50 to 130) and Frequency (MHz) on the x-axis (1316.9 to 1329.1). A green shaded region highlights a carrier signal between approximately 1318.9 MHz and 1327.1 MHz. Below the plot, the "DVB CID Control" panel has "Identify" and "Detecting carriers: [checked]" buttons. The "Identification" table shows the following data:

Host Center (MHz)	Host BW (kHz)	Global Unique ID	Frequency Offset (Hz)	Status
1323.000000	7911.130000	00 90 B8 FF FF 1C 2B AE	220	Finished

The "Identification Results" panel displays the following extracted parameters:

- Global Unique ID: 00 90 B8 FF FF 1C 2B AE
- Frequency Offset (Hz): 220
- Latitude: 51°03'1.465"N
- Longitude: 13°44'14.143"E
- Telephone Number: +49 35134099970
- Delta PSD (dB): -27

At the bottom right, it shows "Connected to server: 127.0.0.1:8886".

DETECTION AND SEPARATION OF PCMA SIGNALS

The software solution R&S®GSACSM is able to detect, to identify and to separate paired carrier multiple access (PCMA) carriers. These carriers consist of two signals originating from two different ground stations. At the satellite, these two signals are summed together and transmitted back to earth. The two ground stations can access the other signal by subtracting their own. However, in a monitoring setup, both signals are unknown.

Detection and classification of PCMA signals

Very often, this type of transmission is hard to identify by the operator. Here, the R&S®GSACSM software can help by detecting and classifying PCMA carriers clearly. In addition, several parameters of the carrier are measured such as modulation, symbol rate, the amplitude ratio and the frequency shift between the two signals.

Separation of PCMA signals

The R&S®GSACSM also provides a feature to separate the two signals within the PCMA carrier for a defined number of symbols. This is done for providing further insight into the signals and to measure the carrier parameters even more precisely. The screenshot below shows the separation of a PCMA carrier with two QPSK-modulated carriers.

Setup with carrier-in-carrier

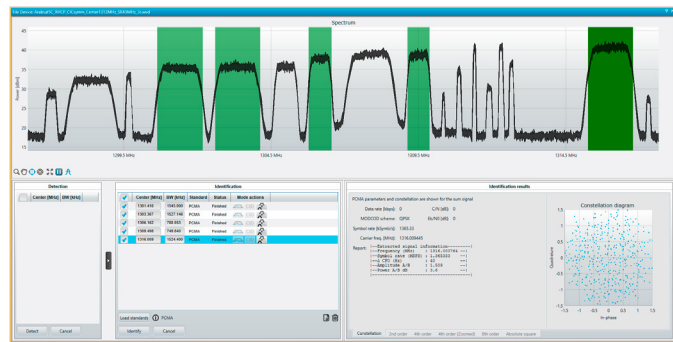
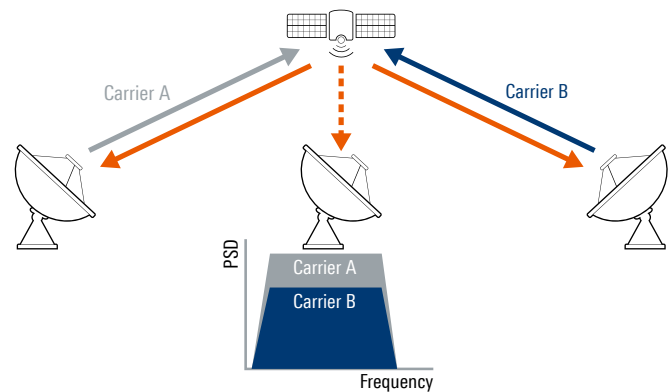

Detection and classification of symmetric carrier-in-carrier signals

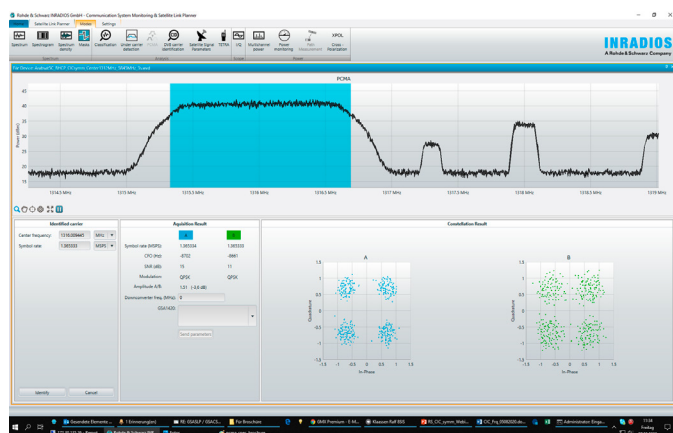

Separation of symmetric carrier-in-carrier signals together with their constellation diagrams

TETRA SCANNING AND ANALYSIS

Terrestrial trunked radio (TETRA) is a European standard for a trunked radio system. It was designed for use by government agencies, emergency services, public safety networks, transport services and the military. R&S®GSACSM enables the user to continuously monitor all channels within the TETRA band and to read various information from each active TETRA carrier. In addition, it provides a feature to execute a panorama scan.

Identifying and analyzing TETRA signals

The TETRA mode of R&S®GSACSM provides identification and continuous monitoring of TETRA signals. It focuses on fast identification algorithms and optimized usability for TETRA transmissions. As the TETRA channels are built-in directly in the software, the scanning and identification can be started with a one-click-operation by the user. After that, the identified channels are marked in green (see screenshot below). The scanning process can be carried out once or in a continuous manner.

In addition to the constellation diagram, several specific information are displayed for each identified TETRA carrier, e.g.:

ARFCN	Absolute radio frequency channel number
DL/UL frequency	frequency used by downlink/uplink carriers
MCC	mobile country code
MNC	mobile network code
LAC	local area code
MCCH	main control channel yes/no
CP/SNR	channel power/signal-to-noise ratio
Data rate	data rate of the carrier
MODCOD	type of modulation and used code rate

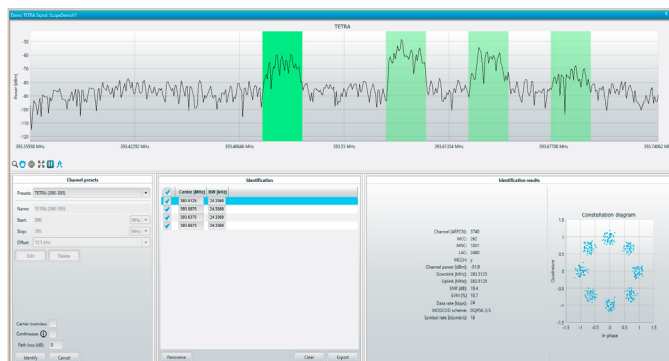

TETRA signal detection with their technical parameters and constellation diagram

Panorama measurement for TETRA signals

The panorama measurement mode in R&S®GSACSM allows to check the signal power of a TETRA carrier in 360° at one specific measurement point. The measurement is performed in azimuth steps, assuming that the user rotates accordingly.

As a result, the measured power for each channel and each azimuth step is displayed graphically and numerically. In the graphical results, the power values are color-coded by local area code (LAC). Thus, both the signal strength and the origin of one specific TETRA carrier can be recognized at the same time.

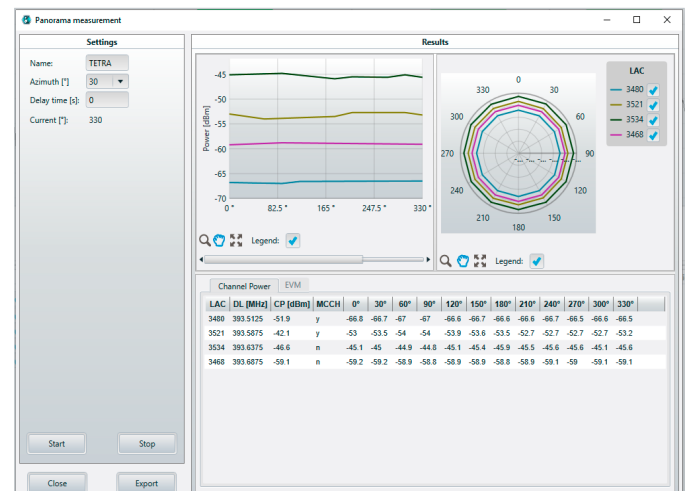

Panorama measurement of TETRA signals

CROSS-POLARIZATION MEASUREMENT

Cross-polarization (XPOL) distortions can occur if both polarization planes (horizontal and vertical) of an antenna are used. If a power offset to either plane occurs, for example because the low-noise blocks (LNB) are not set correctly, the orthogonality of the planes is no longer maintained. Thus, the power in the other plane can become affected and distortions can occur.

Measurement of cross-polarization

The XPOL mode of R&S®GSACSM can analyze the power difference measured by two sensors in different polarization planes. The two sensors can be either two distinct devices or one device with two RF inputs. R&S®GSACSM shows the spectra of both inputs and carries out the measurement of the power difference for a beacon signal or for a dedicated carrier.



Cross-polarization measurement results

UNDER-CARRIER DETECTION

Systems using R&S®GSACSM can be used to detect and identify unwanted signals beneath the useful signal.

Identification of suspicious interferers using under-carrier detection

In the satcom domain, the unwanted signal can originate from another satellite or a satcom terminal which is configured incorrectly. However, the interfering signal can also have a terrestrial source. For example, 5G signals cause more and more problems in traditional satellite communications in C band.

The screenshot below shows an example setup where a DVB-S signal interferes with a much stronger IESS carrier. The interferer can first be made visible by demodulating and subtracting the wanted signal. Second, the interferer is detected and classified.

Under-carrier detection and identification

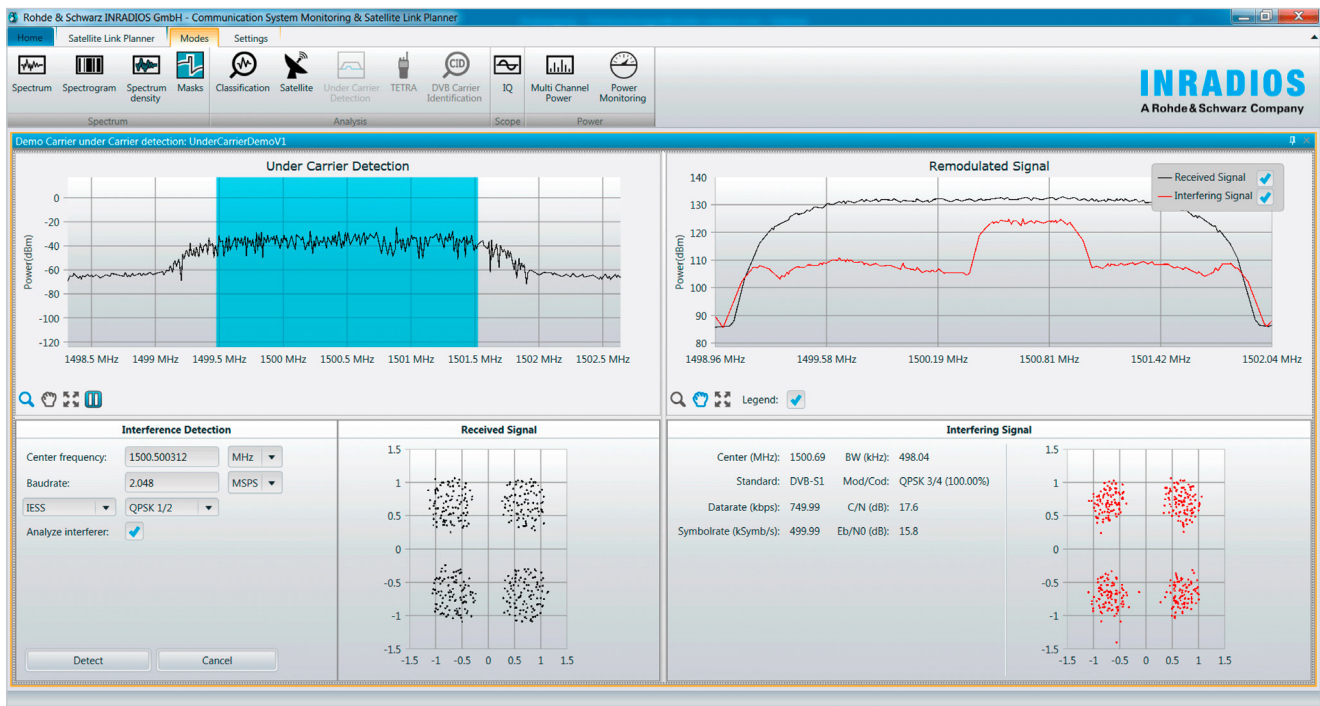

RF PATH MEASUREMENT

For many satellite operators, one important performance criterion is to know the signal level along the entire signal path. At the same time, they need to monitor the power density masks of the carriers of interest to avoid any interferences to adjacent satellite systems. Therefore, the RF path measurement mode of R&S®GSACSM enables the user to optimize reception and antenna positioning.

Carrier EIRP measurement

To determine the required power of each carrier at the satellite (carrier EIRP), the R&S®GSACSM application calculates the ground station gain. It then adds the total signal path loss to the measured receiver power levels at each carrier ground station. To determine the carrier station gain, you require a reference signal with a known power level. Furthermore, the total signal path loss must already be known, for example as a result of a path loss measurement.

R&S®GSACSM application uses a signal generator to inject a known pilot signal in the signal path for measurement. A spectrum analyzer measures the receiver power levels at each carrier ground station. R&S®GSACSM application then calculates the ground station gain at the known pilot frequency, and the radiated power for each carrier at the satellite.

Pilot signal measurement

In a pilot signal measurement, a Rohde&Schwarz signal generator generates a pilot signal and adds it to the actual input signal at the ground station. R&S®GSACSM application uses the pilot signal to measure the signal path gain at a given frequency of the receiver from the low-noise block (LNB) downconverter to a modem or a receiver.

Based on the measured station gain, the R&S®GSACSM can calculate various carrier parameters, for example:

- ▶ The frequency-dependent station gains from the antenna flange to the L band patch field
- ▶ The spectral signal power density at the receiving antenna
- ▶ The effective radiated power (EIRP) of the carrier at the satellite antenna (downlink)

Carrier EIRP measurement

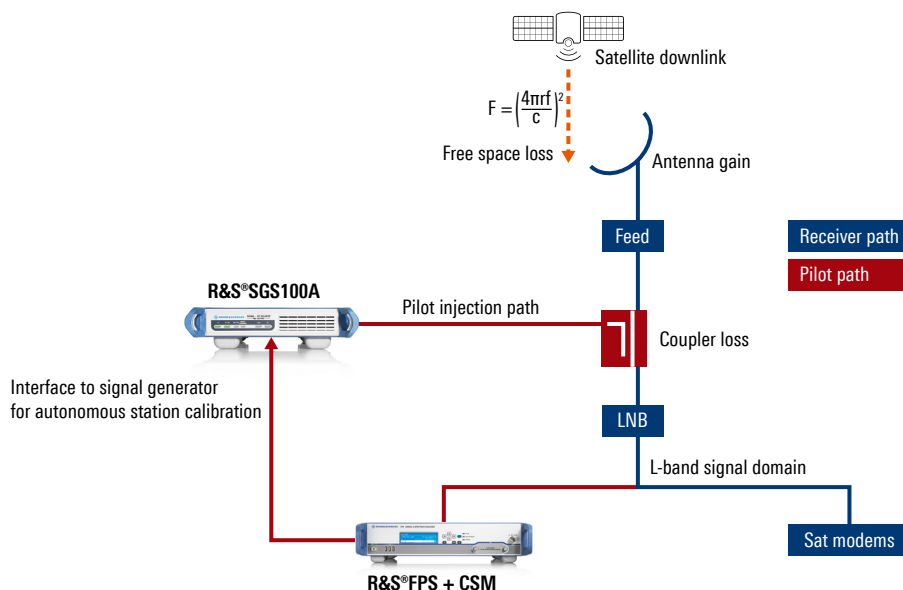

Path loss measurement

To determine the power loss along the entire signal path, you must first determine the ground station gain. After this you must determine the path loss from the satellite via the antenna to the receiver of the ground station. To determine the ground station gain, the pilot signal measurement can be used.

In a system for which the antenna gain-to-noise-temperature (G/T) is already known, R&S®GSACSM can also determine the ground station loss from the G/T value. To determine the current signal attenuation due to free space propagation and optionally, rain and atmosphere attenuation, you also require a known beacon signal provided by the communications system. Based on the beacon signal, R&S®GSACSM application determines the total path loss from the satellite to the ground station.

Detailed path measurements for several carriers



POWER MONITORING, RECORDING, REPLAY, IMPORT AND EXPORT

Easy power monitoring via multichannel service tables

Systems using R&S®GSACSM monitor RF power by using multichannel service tables. This feature helps users who are unfamiliar with spectrum signals. The service table bar chart also helps visualize the RF power in a certain band.

Easy power monitoring over a certain amount of time

Another way to support power measurement tasks is to use R&S®GSACSM power monitoring feature. It can monitor the RF power of various subbands in parallel over a defined amount of time. Users can easily add new power subbands, which will be displayed in the spectrum chart. For each power subband, a new power time chart will be generated displaying the overall RF power in a certain interval.

Easily record and replay spectrum signals

Systems using R&S®GSACSM can record, replay and exchange measurements to view and process records offline.

Quickly import and export records to and from R&S®GSACSM

To make it easier to share records, records can be exported and imported so that users can easily analyze each other's measurements.

Offline signal processing with the file device feature

Records can be replayed for offline analysis.

Power monitoring with service tables

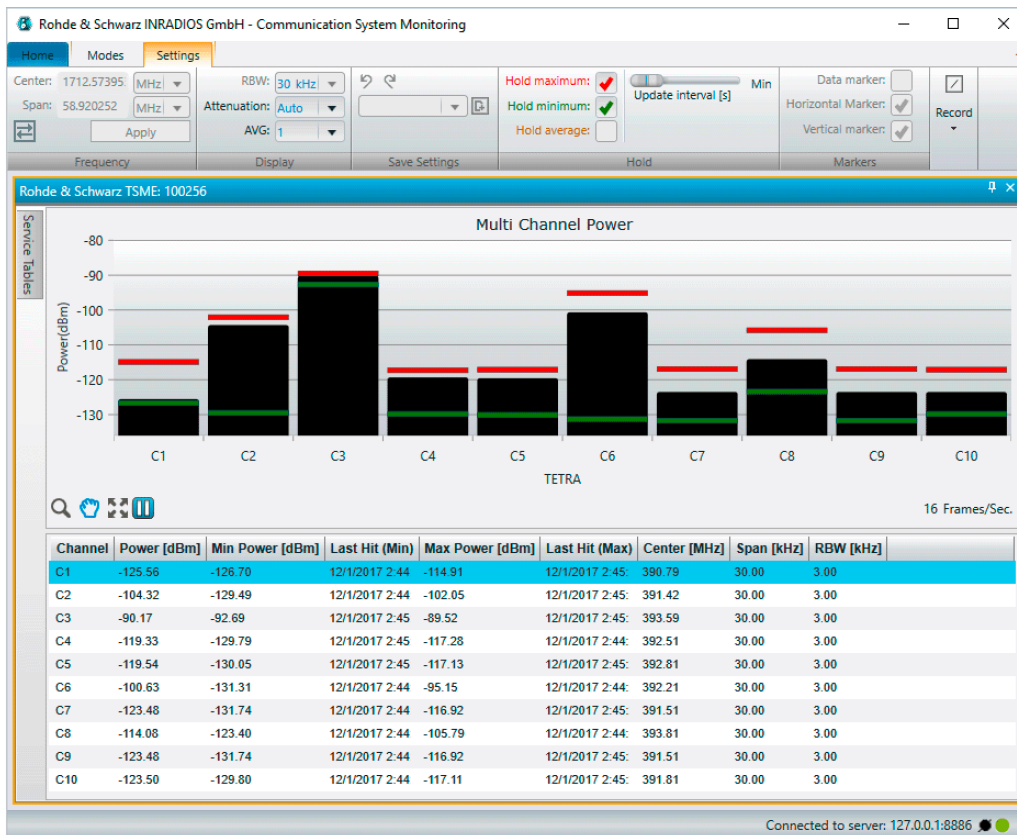

Power monitoring over a defined amount of time



Replay of a previously recorded measurement

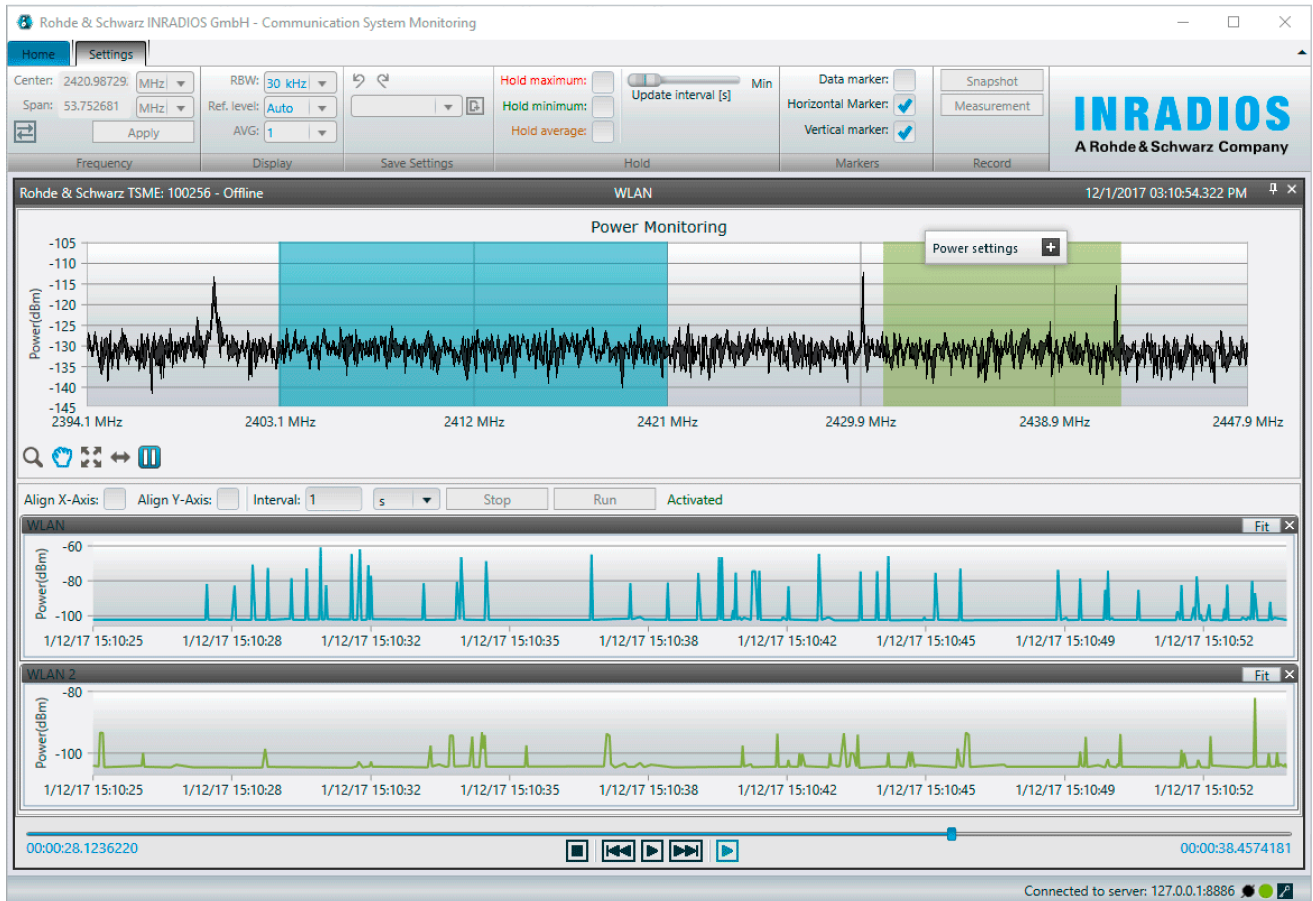

DISTRIBUTED NETWORK STRUCTURE

Scalable client/server architecture

In a scalable client/server architecture, R&S®GSACSM allows remote spectrum analysis in distributed systems. Operators can manage their instruments (RF components, e.g. R&S®NRQ6) in different locations.

Simultaneously managing different receivers and analyzers

R&S®GSACSM supports the following Rohde & Schwarz sensor instruments:

- ▶ R&S®TSME6 ultracompact drive test scanner
- ▶ R&S®FSW signal and spectrum analyzer
- ▶ R&S®FPS signal and spectrum analyzer
- ▶ R&S®FSV and R&S®FSVA signal and spectrum analyzer
- ▶ R&S®FPL spectrum analyzer
- ▶ R&S®ESMD wideband monitoring receiver
- ▶ R&S®ESME wideband monitoring receiver
- ▶ R&S®NRQ6 frequency selective power sensor

Examples of standalone and client/server scenarios

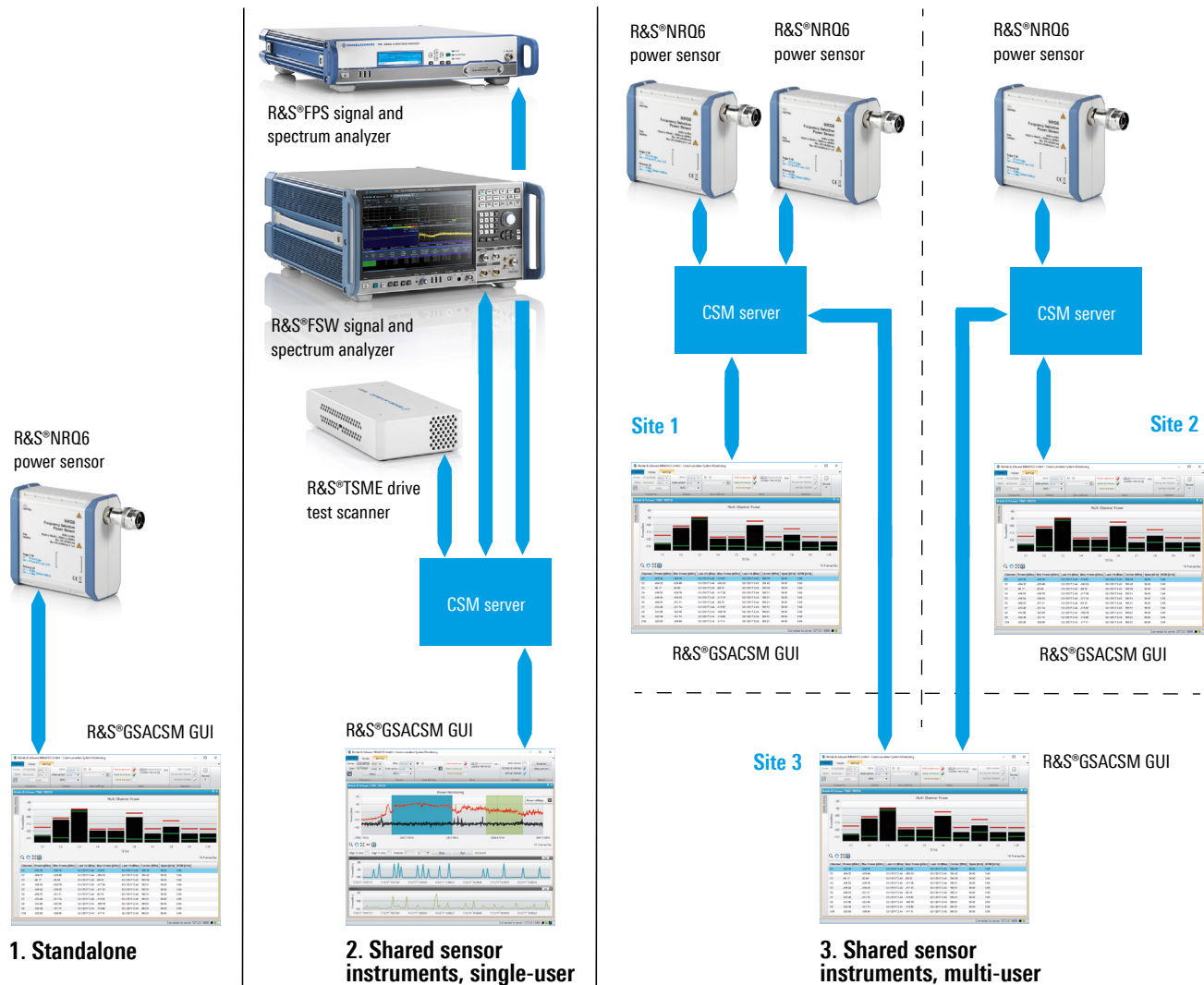

TCP/IP ACCELERATION MIDDLEWARE

Remote spectrum monitoring over narrowband links and long latency links

R&S®GSACSM executes remote spectrum monitoring tasks even over narrowband and low latency connections such as satellite links, ensuring data communications between servers and sensors (see figure below).

Communications over narrowband and low latency connections

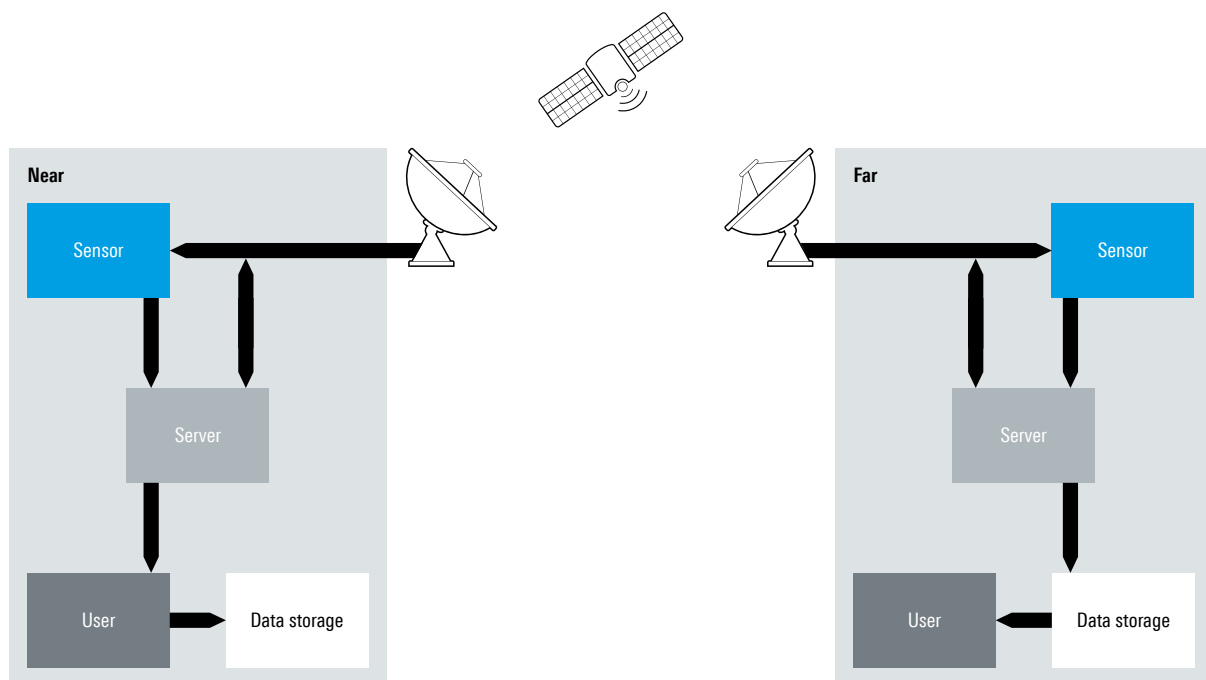

SPECIFICATIONS

Specifications	
CPU and operating system	x86 CPU, Windows 7 or newer
.Net Framework required	.Net Framework version 4.5
Minimum HDD space required for installation	500 Mbyte
RAM required	min. 1 Gbyte, 2 Gbyte recommended
Sensor interfaces supported	LAN/WLAN connection, USB port optional
Application domains	satcom transponder modeling and carrier link budget analysis
	satcom operations, definition of modulation and coding
	satcom transponder optimization
Spectrum mode	live measurement with spectrum analyzers
Spectrogram mode	2D and 3D waterfall spectrum analysis
Spectrum density mode	spectrum frequency occurrence analysis
Mask mode	alarm trapping with email notification
Classification mode	basic detection and identification of terrestrial, satellite, TDMA and PCMA signals
Under-carrier detection mode	advanced signal analysis for underlying interfering signals
Satellite mode	continuous scanning, identifying and alarm trapping for satellite signals
DVB-CID	continuous scanning for DVB-CID signals
Scope mode	I/Q data display
Multichannel power mode	power monitoring via service tables
Power monitoring mode	power monitoring in a specific frequency band over a certain time
Recording	record, replay, export and import measurements
Offline processing	load I/Q data files to detect and demodulate signals offline
Supported Rohde&Schwarz sensor instruments	R&S®TSME6 ultra compact drive test scanner
	R&S®FSW, R&S®FPS, R&S®FSV signal and spectrum analyzers; R&S®FSC, R&S®FSL spectrum analyzers
	R&S®NRQ6 frequency selective power sensor
	R&S®MSR200 dual satellite receiver
Supported Rohde&Schwarz system solutions	VSAT solution provided by Rohde&Schwarz
Software signal processing bandwidth	determined by I/Q bandwidth of sensor in usage
Maximum simultaneous users per CSM server	not limited, practically limited by the processing capabilities of the CPU
Maximum simultaneous sensors connected to the CSM server	not limited, practically limited by the processing capabilities of the CPU
TCP/IP acceleration	supports CSM measurements with remote sensors over long latency low throughput links, e.g. data rate < 10 kbit/s, latency > 1 s
Application domains	<ul style="list-style-type: none"> ▶ satcom transponder monitoring and carrier analysis ▶ identification/classification of unknown signals ▶ under-carrier signal analysis and demodulation ▶ satcom operations with alarming/trapping functions ▶ 24/7 power monitoring of carriers ▶ DVB-CID carrier ID demodulation

ORDERING INFORMATION

Designation	Type	Order No.
Communication system monitoring (CSM) base packages		
CSM standalone software (for Windows OS)	R&S®GSACSMSTA	3065.3532.02
CSM server software (for Windows OS and Linux OS)	R&S®GSACSMSVR	3065.3526.02
CSM client software (for Windows OS)	R&S®GSACSMCLNT	3065.3510.02
Communication system monitoring (CSM) modes		
CSM X-Pol measurement mode	R&S®GSACSMXPOL	3065.3503.02
CSM analysis mode	R&S®GSACSMANA	3065.3490.02
CSM power monitoring mode	R&S®GSACSMPOWR	3065.3484.02
CSM measurements option	R&S®GSACSMMEAS	3065.3478.02
CSM remote access	R&S®GSACSMREMT	3065.3461.02
CSM HF path measurements	R&S®GSACSMPTH	3069.3889.02
Advanced signal analysis for CSM analysis mode option (R&S®GSACSMANA)		
CSM classification and analysis of TETRA signals	R&S®GSACSMCTTR	3065.3455.02
CSM classification satcom	R&S®GSACSMCSAT	3065.3432.02
CSM classification carrier-under-carrier analysis	R&S®GSACSMCCUC	3065.3426.02
CSM classification paired carrier detection	R&S®GSACSMPCD	3065.3410.02

Your local Rohde & Schwarz expert will help you find the best solution for your requirements.
To find your nearest Rohde & Schwarz representative, visit www.sales.rohde-schwarz.com

Service that adds value

- ▶ Worldwide
- ▶ Local and personalized
- ▶ Customized and flexible
- ▶ Uncompromising quality
- ▶ Long-term dependability

Rohde & Schwarz

The Rohde&Schwarz technology group is among the trail-blazers when it comes to paving the way for a safer and connected world with its leading solutions in test & measurement, technology systems and networks&cybersecurity. Founded more than 85 years ago, the group is a reliable partner for industry and government customers around the globe. The independent company is headquartered in Munich, Germany and has an extensive sales and service network with locations in more than 70 countries.

www.rohde-schwarz.com

Sustainable product design

- ▶ Environmental compatibility and eco-footprint
- ▶ Energy efficiency and low emissions
- ▶ Longevity and optimized total cost of ownership

Certified Quality Management

ISO 9001

Certified Environmental Management

ISO 14001

Rohde & Schwarz training

www.training.rohde-schwarz.com

Rohde & Schwarz customer support

www.rohde-schwarz.com/support

