

# R&S®M3TR

## Software Defined Radios

### Radio family for tactical communications

**SOVERON**  
True independence is a choice







# Contents

## **R&S®M3TR – a generation of high-performance digital radios**

▷ page 4

## **The three Ms: multiband, multimode, multirole**

▷ page 6

## **R&S®MR300xH/U multiband tactical radio**

▷ page 8

## **R&S®MR3000P tactical handheld transceiver**

▷ page 9

## **Configuration with external power amplifiers**

▷ page 10

## **Configuration overview of vehicle/command post station**

▷ page 11

## **Configuration overview of handheld transceiver**

▷ page 12

## **Configuration overview of tactical radio**

▷ page 14

## **Ease of operation**

▷ page 16

## **Software options**

▷ page 18

## **Automatic link establishment (ALE)**

▷ page 19

**EPM (ECCM) waveforms**

▷ page 20

**R&S®MR300xH/U voice communications**

▷ page 22

**R&S®MR300xH/U data communications**

▷ page 24

**GPS services**

▷ page 28

**Built-in test system (BIT)**

▷ page 29

**Channel/net memory**

▷ page 30

**Accessories for the R&S®MR3000P tactical handheld transceiver**

▷ page 31

**Accessories for the R&S®MR300xH/U multiband tactical radio**

▷ page 32

**Antennas**

▷ page 34

**Configuration overview with power amplifiers and docking station**

▷ page 37

**R&S®VT3050 50 W VHF/UHF power amplifier**

▷ page 38

**R&S®VT3050C 50 W VHF/UHF compact power amplifier**

▷ page 39

**R&S®VK3150 150 W HF power amplifier**

▷ page 40

**R&S®VK3150C 150 W HF compact power amplifier**

▷ page 41

**R&S®MG3500 500 W HF power amplifier**

▷ page 42

**R&S®IV3001 power supply unit/mounting frame**

▷ page 43

**SOVERON® and R&S®M3TR – typical vehicle/command post installation**

▷ page 44

**R&S®RNMS3000 radio network management system**

▷ page 46

**Product overview**

▷ page 48

**Service partner program – partnership at eye level**

▷ page 51

Note: Frequencies are rounded to full MHz to increase readability. For detailed frequencies, see the respective data sheet. Some of the pictures show options.

# R&S®M3TR – a generation of high-performance digital radios

## The challenge

Today's military missions are characterized by joint operations of multinational armed forces. Interoperability of the equipment, especially in the field of communications, is therefore the primary objective of the international partners responsible for creating one of the most important aspects for efficient cooperation. The R&S®M3TR features maximum flexibility in terms of frequency bands and waveforms for practically all services and platforms.

## The solution

The R&S®M3TR software defined radio family is a generation of high-performance digital radios. The heart of the integrated communications system is the lightweight R&S®MR300xH/R&S®MR300xU manpack radio, which offers solutions for all aspects of tactical communications as well as uniform and reduced interservice logistics. A lightweight handheld version (R&S®MR3000P) complements the radio family. Like the manpack radios, the R&S®MR3000P supports both open and secure communications modes.

R&S®MR300xH/R&S®MR300xU in vehicular application





### Base units

- ▮ R&S®MR300xH multiband tactical radio for HF/VHF
- ▮ R&S®MR300xU multiband tactical radio for VHF/UHF
- ▮ R&S®MR3000P handheld transceiver for VHF

### Key features

- ▮ Multiband capability
- ▮ Multiwaveform capability
- ▮ Software-configurable
- ▮ Selective links in one net
- ▮ GPS reporting and message services
- ▮ User-friendly HMI (single-knob control for basic operation)

### Logistics and readiness

- ▮ Low volume and weight
- ▮ Built-in test down to the module level
- ▮ Common logistics concept for reduced costs throughout lifecycle
- ▮ Common human-machine interface (R&S®MR300xH/R&S®MR300xU)
- ▮ Automatic firmware update of external components
- ▮ Synthesizer calibration via antenna connector
- ▮ Minimal training required
- ▮ Excellent flexibility
- ▮ High MTBF
- ▮ Power-saving mode

R&S®MR300xH/R&S®MR300xU manpack radio



# The three Ms: multiband, multimode, multirole

## Multiband

For applications using various services and networks, different types of radio units were previously required. The R&S®M3TR covers the entire spectrum from the HF to the VHF to the UHF band, allowing interoperability as well as uniform and reduced interservice logistics. The frequency flexibility of the R&S®M3TR meets various national and international regulations, providing global operation in fast-changing missions and environments.

### Multiband tactical radio family

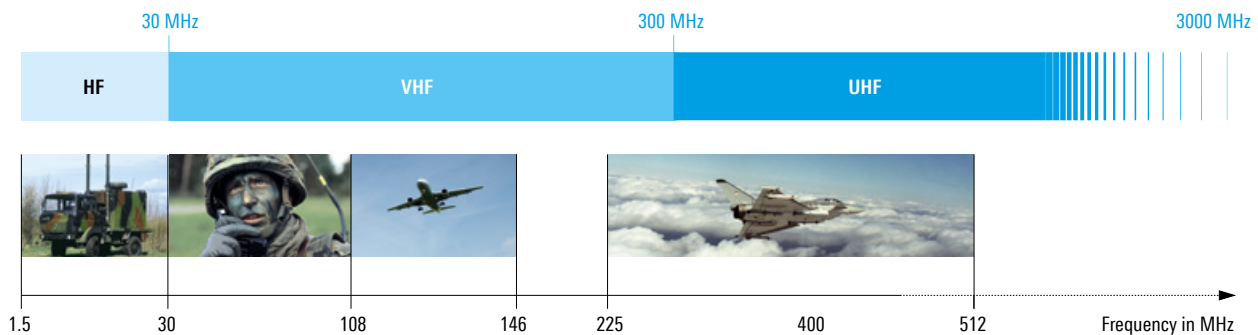

**R&S®M3TR vehicular station** 1.5 MHz to 512 MHz:  
R&S®MR300xH/R&S®MR300xU with external power amplifiers



**VHF/UHF manpack** 25 MHz to 512 MHz:  
R&S®MR300xU



**HF/VHF manpack** 1.5 MHz to 108 MHz:  
R&S®MR300xH



**VHF handheld** 25 MHz to 146 MHz:  
R&S®MR3000P



# Multimode

A software radio not only offers flexible network solutions, it also integrates existing national or company standards into a single unit. Thanks to optimized protocols and waveforms, the R&S®MR300xH/R&S®MR300xU attains maximum throughput rates for digital voice, data and position localization.

# Multirole

The multirole features of a software defined radio are mainly determined by its ease of integration into tactical communications networks. In addition to its use as a functional terminal in the individual subnet, e.g. CNR or PRN, it can also act as an interface between the various subnets. The R&S®M3TR can be used on diverse platforms and features interfaces to fixed networks such as WAN and LAN, as well as intelligent gateway and relay/rebroadcast functions such as routing of selective calls for subscribers inside/outside the home network.

Multimode: available waveforms		
<b>BLOS</b>	HF wideband modem	in line with MIL-STD-188-110C App. D, prepared for 48 kHz data link channels
	modem waveforms	in line with <ul style="list-style-type: none"> <li>■ STANAG 4285</li> <li>■ STANAG 4529</li> <li>■ STANAG 4539</li> <li>■ STANAG 4415</li> <li>■ MIL-STD-188-110B section 5.3 + App. C</li> </ul>
	2nd generation (2G) ALE	in line with <ul style="list-style-type: none"> <li>■ FED-STD-1045/46/49</li> <li>■ MIL-STD-188-141B App. A+B</li> </ul>
	3rd generation (3G) ALE	in line with STANAG 4538
	EPM (ECCM)	in line with R&S®SECOM-H, full interoperability with R&S®M3SR Series4100
	FF modulation	in line with AM, FM, SSB
<b>LOS</b>	EPM (ECCM)	in line with <ul style="list-style-type: none"> <li>■ R&amp;S®SECOM-V</li> <li>■ R&amp;S®SECOM-P, full interoperability with R&amp;S®MR3000P and SOVERON®VR</li> <li>■ R&amp;S®SECOS 5/16 TDMA, full interoperability with R&amp;S®M3AR, R&amp;S®M3SR Series4400</li> <li>■ HAVE QUICK II</li> </ul>
	modem waveforms	VHF/UHF modem, up to 72 000 bit/s
<b>Security</b>		embedded COMSEC, 256-bit key
		interface for various external COMSEC devices
<b>Digital voice</b>		vocoders adapted to mode of operation, available bandwidth and channel quality

# R&S®MR300xH/U

## multiband tactical radio

The R&S®MR300x radios form a family of high-performance digital radios covering the HF, VHF and UHF bands. Thanks to various high-speed data modes and protocols as well as multiple anti-jam modes for HF, VHF and UHF, they perfectly integrate into tactical communications networks.

The radios are software-configurable and reprogrammable. Manpacks of the R&S®M3TR family are based on one mechanical platform, with a common logistics concept, identical physical interfaces and one human-machine interface (HMI).

### Key features

- ▮ Software-configurable
- ▮ Multiband capability (1.5 MHz to 512 MHz with external devices)
- ▮ Multiwaveform capability (HF House, VHF/UHF tactical and G-A-G waveforms)
- ▮ Embedded EPM (ECCM) in line with R&S®SECOM and R&S®SECOS, HAVE QUICK II
- ▮ Selective links in one net
- ▮ Integrated GPS, position report
- ▮ Removable front panel for flexible use and integration
- ▮ User-friendly HMI
- ▮ High data rate of up to 72 000 bit/s
- ▮ IP over air capability (R&S®IPoA)
- ▮ SIP based remote voice operation
- ▮ MTBF > 7500 hours





# R&S®MR3000P

## tactical handheld transceiver

The R&S®MR3000P is a small, lightweight, handheld transceiver that perfectly complements the R&S®M3TR family. Though compact, the R&S®MR3000P has all the features required of a tactical transceiver. It provides reliable connections, even in topographically difficult terrain, and is suitable for flexible integration into tactical networks. Since the transceiver can interoperate with the R&S®M3TR, it enables continuous radiocommunications both within and between forces. The expanded frequency range of the handheld transceiver also supports interoperability. It covers tactical VHF as well as parts of the HF and VHF air traffic control bands.

Due to its jam-resistant digital waveform with embedded software encryption (R&S®SECOM-P), the R&S®MR3000P provides high-quality connections. Moreover, its transmit power of up to 5 W allows high ranges, even in difficult terrain. For network planning and configuration purposes, established tools such as R&S®RNMS3000 can be used. Seamless integration into tactical networks with fixed and vehicle stations as well as highly mobile forces is possible without any problem. The R&S®MR3000P features an integrated crypto module of the highest security level to provide protection for confidential messages.

### Key features

- Multiband capability (25 MHz to 146 MHz)
- Embedded EPM (ECCM) in line with R&S®SECOM-P
- 5 W RF output power
- Secure transmission of voice, data and short messages
- Selective calling with sender authentication
- GPS position report
- MTBF > 10 000 hours



# Configuration with external power amplifiers



The R&S®M3TR is designed to provide exceptional flexibility for networking via RF networks on air. The radios can be used in portable, vehicular and stationary applications including installations in movable containers and shelters. Their rugged hardware complies with the individual MIL-STDs dealing with environmental conditions. Shockmounts are provided for mobile use.

A wide range of antennas adapted to the various applications (portable, mobile, base station) are available. Radio functions can be remote controlled using an RC unit.

Covered frequency ranges and RF power for different configurations

				HF	Tactical VHF	ATC		Air defense		
				1.5	30	108	146	225	400	512
Frequency in MHz				1.5	30	108	146	225	400	512
Manpack radio		Amplifier								
R&S®MR300xH HF/VHF tactical radio	R&S®MR300xU VHF/UHF tactical radio	R&S®VK3150C, R&S®VK3150 or R&S®MG3500	R&S®VT3050C or R&S®VT3050							
•				20 W	10 W					
•		•		150 W	10 W					
•			•	20 W	50 W					
•		•	•	150 W	50 W					
	•			RX	10 W					
	•	•		150 W	10 W					
	•		•	RX	50 W					
	•	•	•	150 W	50 W					



# Configuration overview of vehicle/ command post station

This example of a radio station consists of the manpack radio with audio and data accessories, and two power amplifiers. Amplifiers are available as compact versions or as standalone units. A compact amplifier (R&S®VT3050C or R&S®VK3150C) also includes the frame for mechanically fastening a radio in a vehicular installation and can be equipped with options for connecting external audio distribution systems or field telephones. Standalone

amplifiers are connected to a compact amplifier to further increase the usable frequency range of the system. Amplifiers increase output power up to 50 W in the VHF and UHF bands and up to 150 W or 500 W in the HF band. If these power amplifiers are used, a single R&S®M3TR radio (R&S®MR300xH or R&S®MR300xU) spans the entire frequency range from 1.5 MHz to 512 MHz without any gaps.



R&S®VK3150 HF power amplifier or  
R&S®VT3050 VHF/UHF power amplifier



R&S®VT3050C VHF/UHF compact  
amplifier or R&S®VK3150C HF  
compact amplifier



R&S®FK3150 antenna tuning unit

## Audio/data accessories

- ▮ Handsets/headsets
- ▮ Speakers
- ▮ Vehicle intercom
- ▮ Radio wire integration



## VHF/UHF antennas

- ▮ VHF
- ▮ UHF
- ▮ Multiband



## HF antennas

- ▮ Whip
- ▮ Wire
- ▮ NVIS



## Remote control

- ▮ RC units
- ▮ RC software



## Data transmission/networking

- ▮ Tactical PC/PDA
- ▮ Message handling software
- ▮ Blue force tracking



## Mission planning

- ▮ Fillguns
- ▮ Mission planner software
- ▮ Remote device loader software
- ▮ Remote distributor software



# Configuration overview of handheld transceiver

## Radio configuration



R&S®GP3021 fillgun



R&S®CS3021 central update tool

## Audio accessories



R&S®GA3022 headset



R&S®GA3023 handheld microphone/speaker



R&S®M3TR MR3000P handheld transceiver

## Handheld antennas



R&S®HV3031 GPS receiver



R&S®HV3021 long tape antenna



R&S®HV3022 short tape antenna



## Chargers and batteries



R&S®IB3022  
battery pack, Li-ion



R&S®IC3022 universal  
battery charger, AC, for  
up to eight batteries



R&S®IC3023  
battery charger,  
DC



R&S®IC3024  
battery charger, AC,  
for one battery

## Other accessories



R&S®MZ3021 bag



R&S®MZ3022 set bag



R&S®MZ3023  
battery pack bag



R&S®IV3021 vehicle support



R&S®HV3088L long tape antenna



R&S®HD3001 long wire antenna

# Configuration overview of tactical radio

## Radio configuration



R&S®GP3000 fillgun

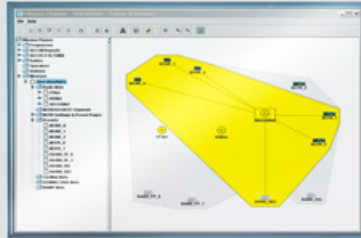

R&S®RNMS3000 mission planner

## Accessories



R&S®GK3005 connecting cable for detachable front panel

## Audio accessories



R&S®GA3002 headset



R&S®GA3005 loudspeaker



R&S®GA3001 handset



R&S®GA3003 microphone/speaker



R&S®M3TR MR3000H/U tactical radio

## Manpack antennas



R&S®AK3001 HF wire antenna



R&S®HV3007 HF whip antenna



R&S®GK3019 long wire/BNC adapter



R&S®HV3004 VHF whip antenna



R&S®HV3009 UHF whip antenna





R&S®MZ3088 rucksack

### Data communications



Battle management system



Cables, e.g. R&S®GK3003 data cable



### Chargers and batteries



R&S®IC3001 vehicle battery charger



R&S®IC3000 battery charger, stationary



R&S®IB3001 standard battery pack, lithium-ion

### Software options

- ▮ R&S®GS3001S R&S®SECOM-H
- ▮ R&S®GS3006S HAVE QUICK II
- ▮ R&S®GS3030S R&S®SECOM-V/R&S®SECOM-P
- ▮ R&S®GS3516S R&S®SECOS 5/16 TDMA
- ▮ R&S®GS4101S ALE 2G
- ▮ R&S®GS4155S ALE 2G, ALE 3G, STANAG 4538
- ▮ R&S®GM4120S HF modem  
STANAG 4285, STANAG 4529, STANAG 4539, STANAG 4415
- ▮ R&S®GM4121S secure voice/data
- ▮ R&S®GM4123S HF wideband modem  
in line with MIL-STD-188-110C App. D



R&S®HD3088 VHF hang-up antenna

# Ease of operation

The R&S®M3TR radios offer many diverse functions that help ensure straightforward, secure and error-free operation.

The functions are available via hierarchically structured menus and context-sensitive softkeys. The clever concept and the arrangement of the control elements allow intuitive control of the radio even under difficult outside conditions and without having the removable front panel in view.



### Menu-oriented user interface and PC based tools

The R&S®MR300xH/R&S®MR300xU user interface is menu-oriented and easy to use. Its eleven-step rotary switch for the operating mode allows direct access to the nine most often used modes (nets) of the radio. These modes contain the complete setting of parameters such as the transmit power, the hailing frequency, the link mode, the EPM (ECCM) procedure and other net-specific adjustments. These preset pages are conveniently prepared with a PC or at a central location using the R&S®RNMS3000 radio net management software, and are loaded into the radio over the data connector before a mission starts.

### Convenient and easy link establishment

Link establishment is convenient and easy. The operator chooses a mode (position 1 to 9 of the rotary switch) and activates the push-to-talk key or data transmission mode on the terminal. Everything else is done automatically. Two additional positions are available: MAN to use the radio in manual mode for fixed-frequency operation and MORE to access up to 90 additional preset pages via the radio keypad.

Data interface

AF connector

Microphone

Antenna connector

Speaker

TX LED signaling

Operation switch

Channel/net selector

AF connector

Easy-to-read backlit display

PTT key

Keypad

Battery





# Software options

As a software defined radio, the R&S®M3TR is able to run a wide variety of waveforms. To provide radio systems that perfectly fit user needs and applications, radio software can be ordered on the basis of communications requirements.

Upgrades by adding new waveforms or extending the frequency range of radio networks are also possible in this concept. Communications networks can therefore be tailored to always find the best compromise between current communications needs and budgetary setup.

## EPM (ECCM) waveforms

Type	Designation	Runs in frequency range	Support of waveform by		
			R&S®MR3000H/ R&S®MR3000U	R&S®MR3001H/ R&S®MR3001U	R&S®MR3002H/ R&S®MR3002U
R&S®GS3001S	R&S®SECOM-H	1.5 MHz to 30 MHz	•	•	•
R&S®GS3030S	R&S®SECOM-V	30 MHz to 108 MHz/ 121 MHz to 512 MHz	•	•	•
R&S®GS3030S	R&S®SECOM-P	30 MHz to 88 MHz	•	•	•
R&S®GS3006S	HAVE QUICK II	225 MHz to 400 MHz		•	
R&S®GS3516S	R&S®SECOS 5/16 TDMA	225 MHz to 400 MHz		•	
R&S®GM4121S	Secure voice/data	1.5 MHz to 108 MHz			•

## Automatic link establishment (ALE)

Type	Designation	Runs in frequency range	Support of waveform by		
			R&S®MR3000H/ R&S®MR3000U	R&S®MR3001H/ R&S®MR3001U	R&S®MR3002H/ R&S®MR3002U
R&S®GS4101S	ALE 2G, FED-STD-1045/46/49	1.5 MHz to 30 MHz			•
R&S®GS4155S	ALE 2G, FED-STD-1045/46/49, ALE 3G, STANAG 4538 (FLSU, LP, LDL, HDL, xDL, OD, ALM)	1.5 MHz to 30 MHz			•

## Modem waveforms

Type	Designation	Runs in frequency range	Support of waveform by		
			R&S®MR3000H/ R&S®MR3000U	R&S®MR3001H/ R&S®MR3001U	R&S®MR3002H/ R&S®MR3002U
R&S®GM4120S	HF modem in line with STANAG 4285, STANAG 4529, STANAG 4539, STANAG 4415	1.5 MHz to 30 MHz			•
R&S®GM4123S	HF wideband modem in line with MIL-STD-188-110C App. D	1.5 MHz to 30 MHz			•
R&S®GS3030S	VHF/UHF modem, 72 000 bit/s	30 MHz to 512 MHz	•	•	•

# Automatic link establishment (ALE)

## ALE 2G (R&S®GS4101S)

The common basic protocol standards for ALE are FED-STD-1045/1046/1049 and MIL-STD-188-141B App. A+B, known as 2nd generation or 2G ALE. It uses non-synchronized scanning of channels, and it takes about several seconds to half a minute to repeatedly scan through an entire list of channels looking for calls.

## ALE 2G/ALE 3G (R&S®GS4155S)

The latest ALE standard uses accurate time synchronization via GPS-locked clocks or a time server to achieve faster and more dependable linking. It is generally known as 3rd generation or 3G ALE. Synchronization may reduce

the calling time to achieve a link to less than 10 seconds. Although 3G ALE is better and more reliable, the existence of a large installed base of 2G ALE radio systems and the wide availability of equipment have made 2G the baseline standard for global interoperability.

Links are set up over fast link setup (FLSU) and kept stable using link maintenance (LM). Users can choose between open or encrypted LSU. Occupancy detection (OD) prevents collisions in the network.

## xDL protocols (R&S®GS4155S)

The Rohde&Schwarz ALE 3G built-in xDL data link protocols are LDL and HDL. They offer acknowledged point-to-point delivery of datagrams over an already established HF link. Each protocol is optimized for different channel conditions and datagram sizes to enable high throughput in all communications scenarios. A good throughput can be achieved even under very challenging channel conditions below 0 dB SNR.

The low latency data link protocol (LDL) is optimized for delivering small datagrams in all channel conditions and also longer datagrams in poor channel conditions. It supports a maximum data rate of approx. 300 bit/s.

The high-throughput data link protocol (HDL) is optimized for delivering large datagrams in medium to good channel conditions and supports a maximum data rate of approx. 3400 bit/s.

The R&S®GM4121S software can be used to additionally encrypt xDL transmitted data.

The Rohde&Schwarz IP over air (R&S®IPoA) interface provides transparent IP functionality over the xDL data link protocol. It can be used to set up communications systems that require a transparent connection of IP networks over HF radio links. IP based applications – such as situational awareness or message handling systems – are enabled to exchange their data over such radio links. A standard IP interface allows a user application to be easily and economically connected to the HF radiocommunications system.

Alternatively, xDL protocols can be used for serial data transfer over the RS-232-C interface.

Note: To run ALE on an R&S®MR300xU radio, the R&S®VK3150 power amplifier together with a docking station or the R&S®VK3150C compact power amplifier and accessories such as an antenna coupler are required.





# EPM (ECCM) waveforms

## R&S®SECOM-V and R&S®SECOM-H

The R&S®SECOM waveform (R&S®SECOM-V for the VHF and UHF bands, R&S®SECOM-H for HF) is setting new standards with its high hop rates and secure synchronization. It ensures powerful protection against detection, interception, jamming and spoofing. User data (R&S®SECOM-V: digital voice or data) is transmitted completely digitally and in encrypted form. Within one R&S®SECOM-V net, several subnets and sublinks can be established simultaneously in the point-to-point and point-to-multipoint modes. Network synchronization and access can be planned and controlled individually for each user. Methods such as late net entry or hailing (R&S®SECOM-V) are available for this purpose.

R&S®SECOM is a combination of COMSEC and TRANSEC for encrypted voice and data communications in the frequency hopping mode.

The COMSEC part of the R&S®SECOM method is based on the R&S®RSCA crypto algorithm developed by Rohde&Schwarz. The method uses key lengths of up to 256 bit (approx.  $10^{77}$  variants). Assuming uninterrupted transmission, the same bit sequence would be repeated after about  $2 \times 10^9$  years. The keys required can be distributed by means of a key distribution device or directly from a PC. All keys are encrypted and the deciphered original is present only in the read-protected security processor. Crypto units complying with NATO standards such as ELCRODAT 4-2/R&S®MMC3000 may be used as an external option.

To plan communications networks and links, a PC based radio network management system is available. This tool allows users to generate keysets, plan frequency resources, define user channels and services and set up complete networks of radios. After the desired networks have been defined, the resulting data can be easily distributed to the radios by means of a fillgun or directly by using one of the radios' data interfaces.

## R&S®SECOM-V (R&S®GS3030S)

R&S®SECOM is optimized for tactical communications and operates in the full VHF/UHF band. It is implemented as a software option running on all R&S®MR300xH/ R&S®MR300xU tactical radios.

R&S®SECOM-V was developed to meet as closely as possible the network demands of the primarily land based mobile users of tactical radio services. R&S®SECOM-V is attuned to the requirements of land forces, where the implementation and management of complex network structures are in the foreground. The primarily hierarchical command structure of the armed forces should be mapped as closely as possible to the communications network. To this end, users can be organized in networks using the same frequency pool and the same key – one each for TRANSEC and COMSEC.

Possible address modes are point-to-point, point-to-multipoint and broadcast. Network synchronization and access can be controlled by each user. Late net entry is available for this purpose.





### **R&S®SECOM-V automatic net entry and time beacon**

The radio automatically performs a net entry whenever synchronization is lost (R&S®M300xU/R&S®M300xH display message: NSYN). The time reference unit of an R&S®SECOM-V net automatically takes care of maintaining synchronization before it is lost. If the time beacon function is not active, a net entry may need to be performed from time to time.

### **R&S®SECOM-V out-of-band hailing**

Out-of-band hailing is an outstanding feature that considerably enhances the multiband capabilities of the R&S®M3TR radio with cross-band hailing. The latest software release makes it possible to scan FF calls over the entire frequency range from 1.5 MHz to 512 MHz. This means real multiband operation, since even HF calls can be received while operating the radio in the VHF/UHF range. All FF modulation and squelch modes for the detection of signals are supported.

### **R&S®SECOM-H (R&S®GS3001S)**

R&S®SECOM-H is a Rohde&Schwarz proprietary frequency hopping HF radiocommunications waveform. R&S®SECOM-H is based on a multiwaveform concept and is designed to operate in environments where a certain percentage of the hop set frequencies are blocked due to either intentional disturbances (i.e. jamming) or unintentional disturbances, as well as environments experiencing severe Doppler spread and/or multipath delay. It is based on modem waveforms that can be adapted to the specific characteristics of the HF channel and its propagation.

R&S®SECOM-H provides digital voice services (low bit rate vocoder at 600 bit/s, 1200 bit/s or 2400 bit/s, adjustable). To ensure reliable links even in severely degraded channels, free hop set search (FHS) is available. FHS is an algorithm for the automatic adaptation of hop sets (ALE-like) based on channel evaluation. Radios in a point-to-point link will generate and use an advanced hop set containing only frequencies that have proven good HF performance. Channels are evaluated by measuring S/N, and results are shared between radios in the link during a three-way handshake.

For network synchronization, either the master-slave process or GPS can be used as the network time source. GPS based network time eliminates the need for manual net entry; all stations in the network remain synchronized as long as the GPS signal is received.

Note: To have sufficient output power on an R&S®MR300xU radio in R&S®SECOM-H mode, the R&S®VK3150(C) HF power amplifier and other system components are required.

### **R&S®SECOM-P (R&S®GS3030S)**

R&S®SECOM-P is the standard EPM (ECCM) method for the R&S®MR3000P handheld transceiver. It was especially optimized for use on small, lightweight terminal equipment. Even for this platform, R&S®SECOM-P offers maximum performance and battery operating time. Since R&S®SECOM-P can also be loaded into R&S®MR300xH/R&S®MR300xU equipment as a software option and is also available as a loadable waveform for SOVERON®VR, R&S®SECOM-P provides full interoperability between all tactical radios from Rohde&Schwarz.

### **R&S®SECOS 5/16 TDMA (R&S®GS3516S)**

The R&S®SECOS air-ground-air waveform provides interoperability in the EPM (ECCM) mode between the R&S®M3TR and the R&S®M3AR and R&S®M3SR Series4400 radios. Besides digital voice mode, data transmission with data rates of up to 16000 bit/s is supported. Both TDMA and non-TDMA modes are implemented. For details on R&S®SECOS implementation in the R&S®M3TR, see the related Technical Information (R&S®SECOS). Network synchronization for R&S®SECOS can be accomplished using the master-slave process via an external time source or by using GPS as the network time.

Note: To have sufficient output power on an R&S®MR3001H radio in R&S®SECOS mode, the R&S®VT3050 or R&S®VT3050C VHF/UHF power amplifier is required.

### **R&S®SECOS 5/16 TDMA guard receiver**

The guard receiver function monitors up to two channels in background mode. This allows operators who are occupied with R&S®SECOS voice or data traffic and receive an emergency call to transmit on one of these dedicated frequencies without having to use another radio.

### **HAVE QUICK II (R&S®GS3006S)**

The NATO ground-air-ground waveform HAVE QUICK II provides interoperability in the EPM (ECCM) mode between the R&S®M3TR, R&S®M3AR, R&S®M3SR Series4400 radios and various types of legacy equipment.

Note: To have sufficient output power on an R&S®MR3101H radio in HAVE QUICK II mode, the R&S®VT3050 or R&S®VT3050C VHF/UHF power amplifier is required.

# R&S®MR300xH/U

## voice communications

### Analog voice

The following signal modulations are available:

- ▮ J3E (USB, LSB)
- ▮ A3E (AM)
- ▮ H3E (AM)
- ▮ F3E (FM)

### Squelch

The R&S®M3TR supports the following squelch types:

- ▮ Received signal strength indication (RSSI)
- ▮ 150 Hz tone squelch
- ▮ Signal squelch (CTCSS selective calling)
- ▮ Syllabic squelch (digital recognition of voice components in signal)

### Digital voice (optional)

For communications under the EPM (ECCM) methods R&S®SECOM-V, R&S®SECOM-H, R&S®SECOM-P and R&S®SECOS 5/16 TDMA, voice is transmitted in digital form. The following vocoders are available:

#### R&S®SECOM-V (R&S®GS3030S)

- ▮ MELPe vocoder 2400 bit/s
- ▮ AMBE vocoder 2400/4800/9600/16000 bit/s
- ▮ CVSD vocoder 16000 bit/s

MELPe is the standard vocoder for R&S®SECOM waveforms. It offers the best voice quality and is extremely insensitive to background noise. Due to their favorable characteristics, MELPe vocoders were also a preferred choice for military radiocommunications technology when defining STANAGs.

AMBE is used for voice over data transmission under R&S®SECOM-V. It makes use of the R&S®SECOM-V 16000 bit/s channel with vocoder-specific FEC. This voice mode provides reliable good-quality and jam-proof communications. The data rate can be selected on the HMI. The AMBE vocoder is ideal for the voice over data operating mode since it supports all R&S®SECOM-V data rates from 2400 bit/s to 16000 bit/s.

#### R&S®SECOM-H (R&S®GS3001S)

- ▮ MELPe vocoder 600 bit/s
- ▮ MMBE vocoder 1200 bit/s
- ▮ AMBE vocoder 2400 bit/s

The 1200 bit/s vocoder was specially developed for the demanding task of setting up reliable links with good quality under the poor channel conditions usually found in the HF range. As an integral component of the R&S®SECOM-H HF waveform, it is optimized for use together with this frequency hopping method. For interoperability with R&S®SECOM-V in rebroadcast applications, the 2400 bit/s vocoder can also be selected in the R&S®SECOM-H mode.

#### R&S®SECOM-P (R&S®GS3030S)

- ▮ CVSD vocoder 16000 bit/s

#### R&S®SECOS digital voice (R&S®GS3516S)

- ▮ CVSD vocoder 16000 bit/s
- ▮ AMBE vocoder 16000 bit/s



### Secure voice/data (R&S®GM4121S)

Secure voice/data (SVD) enables encrypted connections in FF channels. Just like for frequency hopping R&S®SECOM waveforms, the R&S®RSCA crypto algorithm is used. SVD can be used standalone on FF channels or together with ALE 3G. MELPe vocoders are used to digitize the analog voice signals. In ALE 3G mode, SVD encryption can be applied to both voice and xDL data communications. SVD offers:

- Fair to good speech quality
- Very robust real-time voice communications
- Automode capability
- Fast late entry capability

### Last ditch voice (R&S®GM4121S)

Poor quality HF channels are primarily a problem for tactical radiocommunications. In order to ensure reliable connections in such environments despite these disadvantages, the radio must employ extremely robust transmission methods. With LDV, the digitized voice message is first stored temporarily in the transmitting radio and then transmitted at data rates between about 30 bit/s and 300 bit/s using the LDL data protocol that is part of ALE 3G. This helps ensure that the recipient receives the voice messages under almost all circumstances, though not in real time like a conventional voice call.

Messages up to 60 s are supported. Each station can store one LDV message. The user is informed about new received LDV messages on the HMI and via an audio indication. The user can also play back the received LDV message until a new LDV message is received.

### Voice over IP, SIP and phone patch

Voice over IP, especially with the SIP and RTP protocols, is standard today in many professional communications networks. The radios from the R&S®M3TR and R&S®M3SR Series4100 families have an IP interface as standard. Consequently, they can also be used to transmit digital voice to and from the radio. In addition to connecting radio networks via a local area network (LAN) or adding radio components to a LAN, the primary focus is on the following applications:

- Remote operation of tactical radios via standardized media, such as Ethernet, directional radio or satellite. One line or one channel suffices for voice traffic, data transmission and remote control
- Simple connection of the radios to telecommunications networks (phone patch) through the standardized IP interface

A phone patch is always of interest when a mobile device from a radio network is to be used to connect to a telephone network subscriber. This could be for public networks, but also for government or corporate networks. The phone patch is often part of a radio access point (RAP). The RAP acts as a gateway between radio networks and wireline networks. The R&S®M3TR and R&S®M3SR Series4100 radio families also offer state-of-the-art IP based solutions for this application. Instead of analog telephone lines, LAN connections now establish contact to the radio world.

For transmission of the voice signals on the wireline side, the system supports standard protocols for IP telephony, such as SIP and RTP. A dedicated radio in the radio network serves as a gateway between the wireless and wireline networks. To do this, the radio connects to the receiving end via an SIP proxy router, which could, for instance, be an IP-enabled telephone. In this way, any subscribers in the radio network are able to reach the subscriber in the fixed network directly via the subscriber's network address. Telephone numbers can be stored conveniently in the radio; as a result, users can look up who they want to call in their radio's address book, just as they would on a mobile phone. The gateway radio also handles protocol conversion of the incoming RTP packets. In the radio network, work continues as usual with vocoders that have been adapted to the radio channels.

In addition to the gateway between the wireless and wireline networks, it is also possible, of course, to link geographically separated radio networks via a LAN connection. This can be necessary when no direct radio contact is possible due to topographical conditions, or when LOS networks deployed at different locations are to be interconnected. Both the R&S®SECOM-H/R&S®SECOM-V waveforms and ALE 3G support this function.

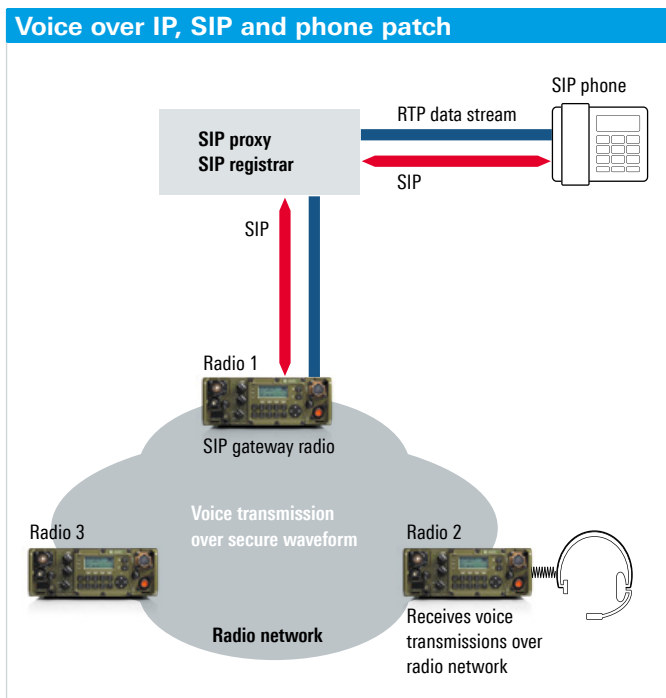



# R&S®MR300xH/U

## data communications

### HF wideband, MIL-STD-188-110C App. D and STANAG 5069 (R&S®GM4123S)

Thanks to a harmonized, embedded HF wideband concept, the radios include HF wideband functionality to establish long-range data links on a 24 kHz channel and are already prepared for 48 kHz channels. Increased bandwidth (24 kHz or 48 kHz) offers flexibility in terms of data rate (up to 240 kbps) and robustness over a significantly wider range.

HF wideband may be used to reliably link groups of vessels organized in local networks to a strategic backbone network, which avoids the need for SatCom or allows critical situations to be overcome in a SatCom denied environment.

The R&S®M3TR supports all currently planned HF wideband related waveforms and standards covered by NATO's HF House.

### Beyond line of sight communications in a SatCom denied environment

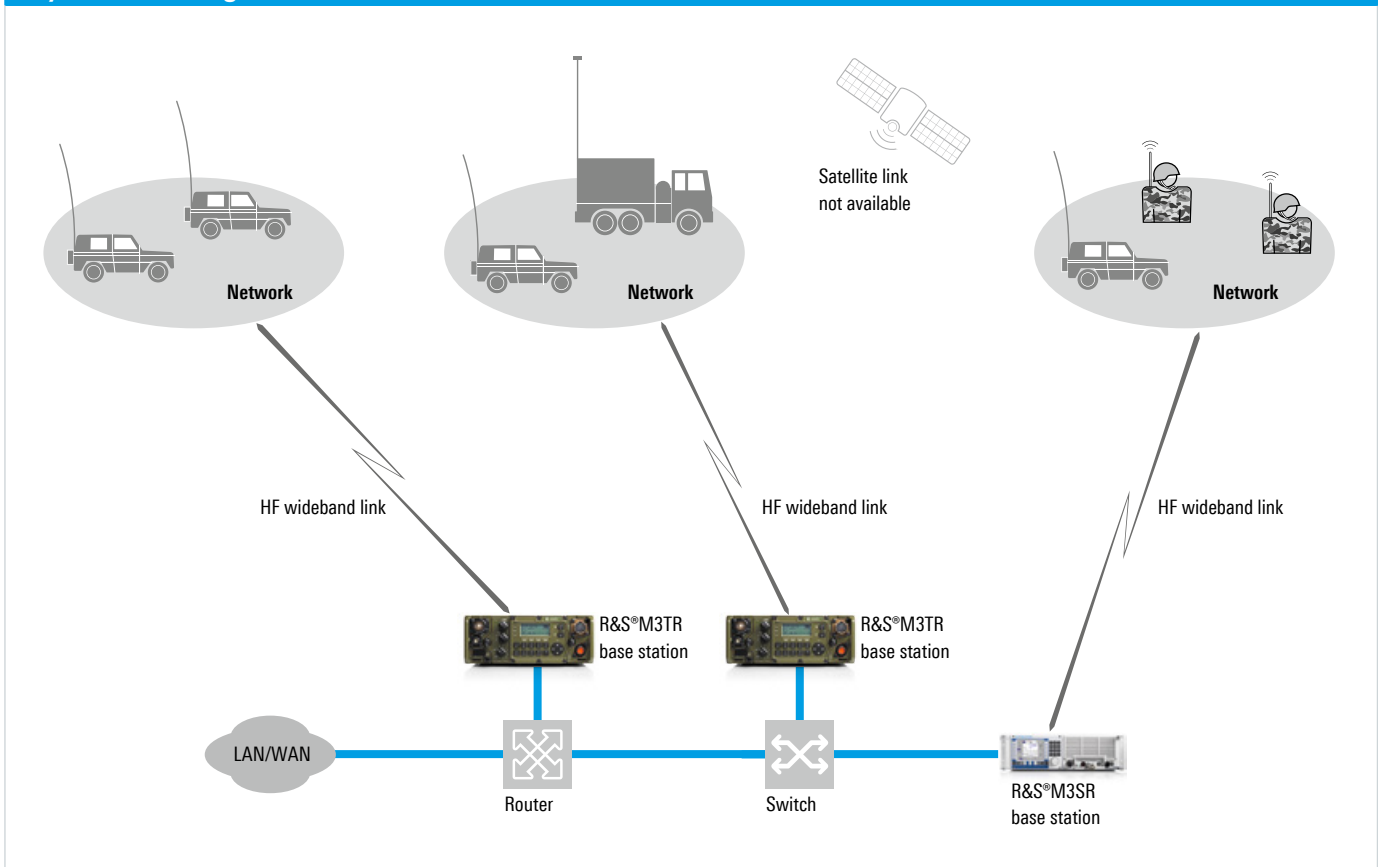

### Voice priority over data (VPoD)

There is also a solution available for situations in which voice and data communications are simultaneously needed. Using VPoD, it is possible to interrupt an ongoing data link by simply pressing the push-to-talk key. Users can send emergency calls right from the ongoing data connection. After the emergency call is over, the radio returns to the original data transmission.

### VPoD supported waveforms

- R&S®SECOM-V
- ALE 3G (STANAG 4538) xDL

Note: To run HF waveforms on an R&S®MR300xU radio, the R&S®VK3150 power amplifier together with a docking station or the R&S®VK3150C compact amplifier and accessories such as an antenna coupler are required.

### STANAG 4285 data mode (R&S®GM4120S)

For backward interoperability, the non-self-identifying STANAG 4285 modem waveform is available. STANAG 4285 is a low and medium-rate maritime HF waveform from 75 bit/s to 3600 bit/s.

### STANAG 4539 data mode (R&S®GM4120S)

The STANAG 4539 HF modem enables self-identifying (auto-baud) data communications (up to 12800 bit/s) in a 3 kHz channel in the HF frequency range.

STANAG 4539 is based on more than one standardized modem waveform:

- STANAG 4415 (very robust traffic waveform at 75 bit/s)
- MIL-STD-188-110B (low and medium rate serial tone waveforms from 150 bit/s to 2400 bit/s)
- MIL-STD-188-110B App. C (high data rate waveforms from 3200 bit/s to 12800 bit/s)

### R&S®SECOS 5/16 TDMA (R&S®GS3516S)

Data transmission with data rates of up to 16000 bit/s is supported. Both TDMA and non-TDMA modes are implemented. For details on R&S®SECOS implementation in the R&S®M3TR, see the related Technical Information (R&S®SECOS).

### R&S®SECOM-V data mode (R&S®GS3030S)

In R&S®SECOM-V, data rates up to 16000 bit/s are possible. User data rates span from 600 bit/s to 9600 bit/s depending on FEC share and number of retransmissions. R&S®SECOM-V uses binary continuous phase FSK modulation with a shift of 6.25 kHz. For detailed information, see the related Technical Information (R&S®SECOM-V).





## 72 000 bit/s VHF/UHF modem (R&S®GS3030S)

For mobile radiocommunications, military users often employ terminal equipment with a narrow bandwidth and limited channel capacity. Such equipment has limited data transmission capability. The new software based high-speed modem for the R&S®M3TR allows the transmission of radio data at high rates:

- Up to 72 000 bit/s
- Auto-baud capability

The modem can be operated either using the integrated IP over air protocol or transparently via the serial interface. It supports 10 different waveforms with various data rates. All waveforms are operable in the VHF/UHF frequency range from 30 MHz to 512 MHz.

The VHF/UHF modem user data rate ranges from 16 000 bit/s to 72 000 bit/s, depending on the set bandwidth.

## R&S®IPoA – IP radio transmission

The R&S®IPoA embedded radio protocol provides transparent IP functionality over the air. It can be used to set up communications systems that require transparent connection of IP networks over radio links. Such radio links enable IP based applications – such as situational awareness or message handling systems – to exchange data.

An R&S®MR300xH/R&S®MR300xU radio equipped with R&S®IPoA includes static IP router functionality. The network structure can be configured by entering IP subnets to be routed to different destinations over the air interface. This can be done very easily with the R&S®RNMS3000 network management system. In addition to the standard IP address of the physical Ethernet interface (which is used, for example, for remote control), a second IP address represents the radio's air interface. Using the configuration

tool, the network can be configured to route e.g. wired IP subnets to different destinations over the air interface. The radio can be connected via an Ethernet connector (RJ-45) to 10BASE-T and 100BASE-T network equipment (such as hubs, switches and routers) provided by the R&S®VT3050C and R&S®VK3150C compact power amplifiers. If R&S®IPoA functionality is to be used with manpack radios, the R&S®MR300xH/R&S®MR300xU data connector on the front panel must be used. For this application, the Ethernet interface can be software-configured to this connector.

## R&S®IPoA protocol functionality

The embedded R&S®IPoA protocol currently supports internet protocol version 4 (IPv4). An internal address mapping function ensures that data is delivered to the correct recipient. The IP packets are transmitted transparently over the radio channel. Data link performance depends on the current channel properties and propagation conditions of the radio link. An error detection mechanism prevents the protocol from delivering erroneous data to the connected network; further error correction techniques (e.g. ARQ secured data) are implemented.

## R&S®IPoA supported waveforms

- R&S®SECOM-V
- VHF/UHF modem
- ALE 3G (STANAG 4538) xDL

## R&S®IPoA – transparent IP data transfer over air

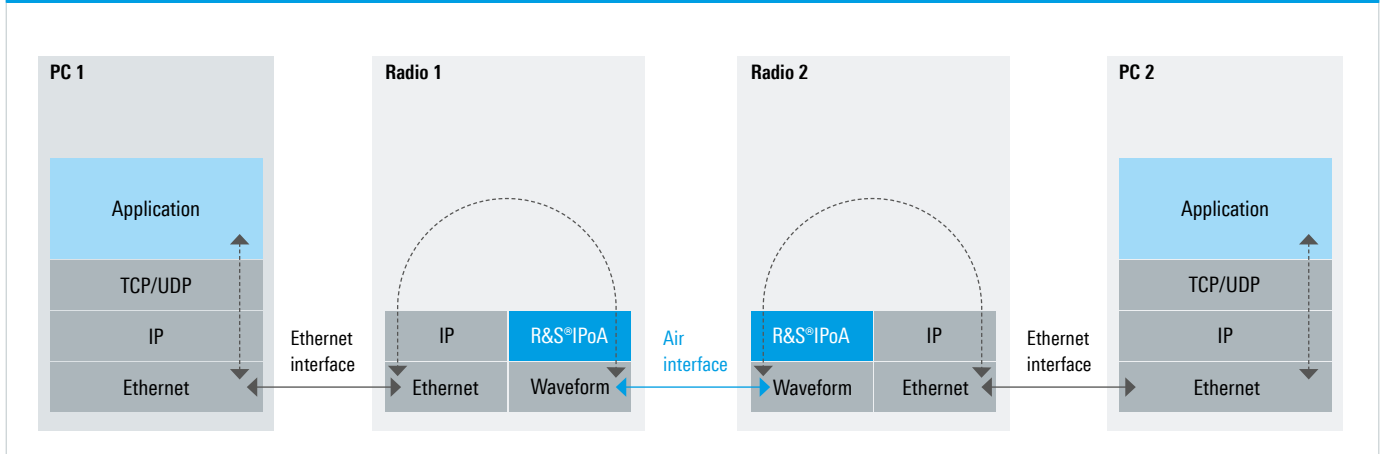



## R&S®IPoA message service

Messages and text information can be transmitted directly from the radio HMI as well as from external sources. Each R&S®IPoA capable waveform supports the following applications:

### Alarm messages

Alarm messages are messages that are preconfigured during mission planning. They can be selected on the HMI and then transmitted. Alarm messages place almost no load on the channel and are therefore always transmitted with the highest priority

### Short data messages

Short data messages (SDM) can be entered directly on the HMI keyboard (similar to entering an SMS on a mobile phone). Addressing (PtP, PtM) is possible depending on the underlying waveform.

## R&S®IPoA – routing information

R&S®IPoA supports automatic routing of IP packets in networks with a fixed backbone (e.g. wired, SatCom or directional radio based) and a mobile, R&S®IPoA based structure. If a mobile radio operator (station Charlie in the figure below) changes from radio network A to the neighboring radio network B, all the operator needs to do is select the preset for the new R&S®IPoA network on the radio. As

soon as the radio becomes active in the new network, the RIP gateway radio assigned to that network (station Bravo in the figure below) automatically sends an RIP message to the RIP router in the fixed network. The radio has now been registered on the new network, and all IP packets addressed to Charlie will be routed to the new network.

An RIP router forwards incoming IP packets to the neighboring router that provides the shortest path to the destination (minimum number of hops; lowest metric). For stations that no longer generate IP traffic, the metric is increased at regular intervals until it reaches the maximum value preconfigured in R&S®RNMS, i.e. 16 (= unreachable = default value in R&S®RNMS). This ensures that when the radio has changed to a new network, all messages transmitted reach their destination without the operator having to make any modifications to the network configuration.

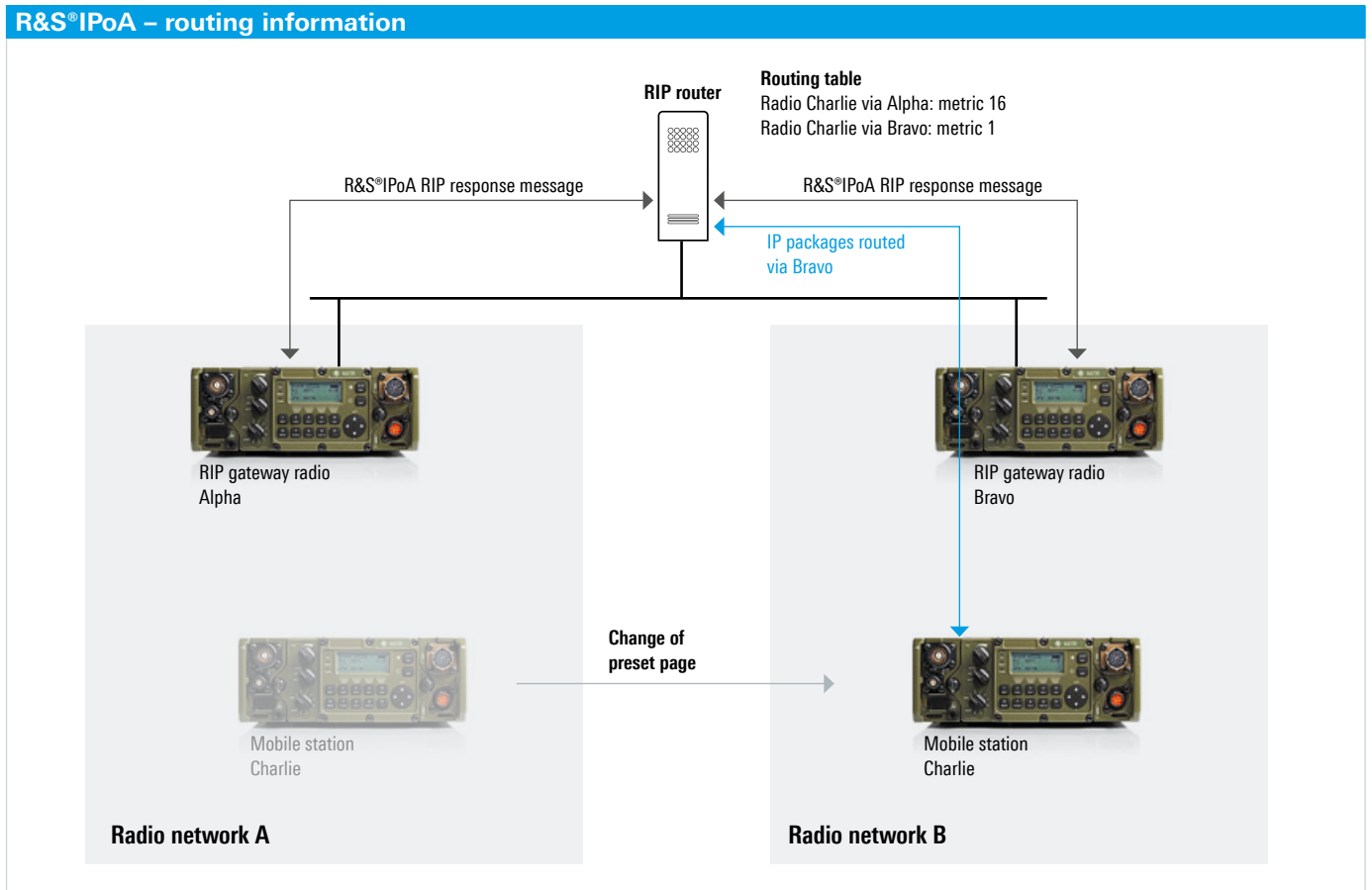

# GPS services

## GPS reporting

Operators can send their own position in a waveform-specific net. A dedicated radio (GPS controller) can poll the positions of all other net members. The GPS controller can be connected to an external application (i.e. a command and control software system) to make GPS information available on a digital map, for example. The external application can poll the GPS controller to get the latest GPS information of all members of the network.

## Transmission of GPS information

The polling of GPS information is initiated by the GPS controller. After the transmission is initiated, all active GPS providers send their GPS information sequentially to the GPS controller. The transmission of GPS information can be switched on/off at the GPS controller. GPS reporting can be stopped in this way. Collisions between individual transmissions of GPS information are prevented.

## GPS controller

The GPS controller is a manpack or vehicular radio (R&S®MR300xH/R&S®MR300xU). GPS controllers request the GPS information from the GPS providers either at a user's request or periodically.

## GPS position information

The GPS controller stores the latest GPS information from each radio in an internal table. This table is updated each time GPS information is received by the GPS controller. The following GPS information is provided by each GPS provider radio:

- Position (WGS84, GEO, UTM, MGRS)
- Velocity
- UTC time
- Fix quality (number of satellites that are visible)

## GPS reporting – supported waveforms

- R&S®SECOM-V
- R&S®SECOM-P
- VHF/UHF modem
- ALE 3G (STANAG 4538)

## GPS receiver module on the R&S®MR300xH and R&S®MR300xU

The GPS receiver module is built into the manpack. The R&S®HV3003 GPS antenna or other embedded GPS antennas, e.g. R&S®HV3012, R&S®HV3013, R&S®HV3015, R&S®HV3019, are required to receive GPS signals.

## GPS receiver module on the R&S®MR3000P (option)

A GPS receiver module is available for the R&S®MR3000P (handheld). It integrates both the GPS antenna and the receiver module and is connected to the audio connector of the handheld transceiver. External audio equipment can still be used with the GPS module installed.



R&S®HV3031 GPS receiver module  
for the R&S®MR3000P

# Built-in test system (BIT)

## Built-in test system

All components of the R&S®M3TR radio system are equipped with a BIT system that provides three modes:

- Power-on BIT (PBIT)
- Initiated BIT (IBIT)
- Continuous BIT (CBIT)

The PBIT is always performed after powering on the unit.

The IBIT is executed when manually activated by the operator. The CBIT is continuously performed during operation.

The BIT enables fault location down to the module level of functional groups. Faults are stored in a fault journal for later evaluation.

## Operating hours counter

- Display of operating time since last power-on operation
- Display of total operating time

## PBIT

After power-on, the power-on built-in test (PBIT) starts automatically. The PBIT takes less than one second. It is a quick, reasonably in-depth test of the main functions such as the receive and transmit mode. The PBIT also detects installed modules and options and their versions.

## IBIT

The initiated built-in test (IBIT) is the most in-depth of the built-in tests. It requires no additional equipment such as loop test cables. The IBIT takes about five seconds.

## CBIT

The continuous built-in test (CBIT) is the least in-depth of these tests. Unlike the PBIT and IBIT, it is a continuous test that runs in the background. The CBIT has no impact on radio operation or radio settings. The CBIT information is updated every second when the radio is switched on and in operating mode.

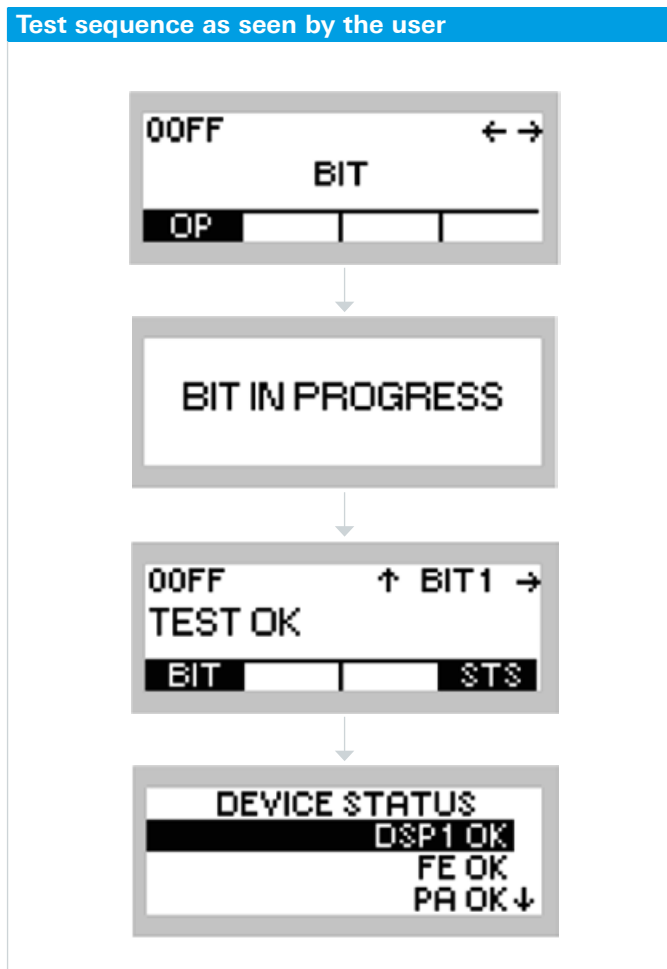



# Channel/net memory

A radio can store different presets containing radio link data:

## Nets

A net is a set of parameters specifying a configured FF or FH network containing all relevant data for link setup and traffic. Nets are stored in preset pages accessible by the rotary switch of the radio or by the keypad. Depending on the actual configuration, up to nine (R&S®MR3000P) or up to 99 (R&S®MR300xH/R&S®MR300xU) presets can be defined and stored in the radio.

## Channels (R&S®MR300xH/R&S®MR300xU)

A channel is a set of parameters specifying an FF channel (TX and RX frequency, modulation, RF power, etc.). Channel data can be stored in both the manual preset or in one of the remaining 99 presets. In total, 450 channels are available:

### First 400 channels

- ▮ Can be generated during R&S®RNMS3000 configuration
- ▮ Can be entered directly on the radio HMI
- ▮ Available on manual preset page (PP 0)

### Locked channels

- ▮ If the above channels are locked during the R&S®RNMS generation process, they cannot be changed on the radio HMI

### Remaining 50 channels

- ▮ Can only be generated during R&S®RNMS configuration
- ▮ Will appear on their own preset page

### Channel and band scanning

In the FF mode, it is possible to scan either the stored channels or a fixed frequency range. The user can define the dwell and hold time and the squelch type for the activity criteria. For band scanning, the user can set the start and stop frequency and the step width for the desired frequency range. If occupancy is detected, the scan can be stopped and the detected frequency stored in the channel memory. For channel scanning, the user can also define a priority channel.

## Mission planner – FF channel management

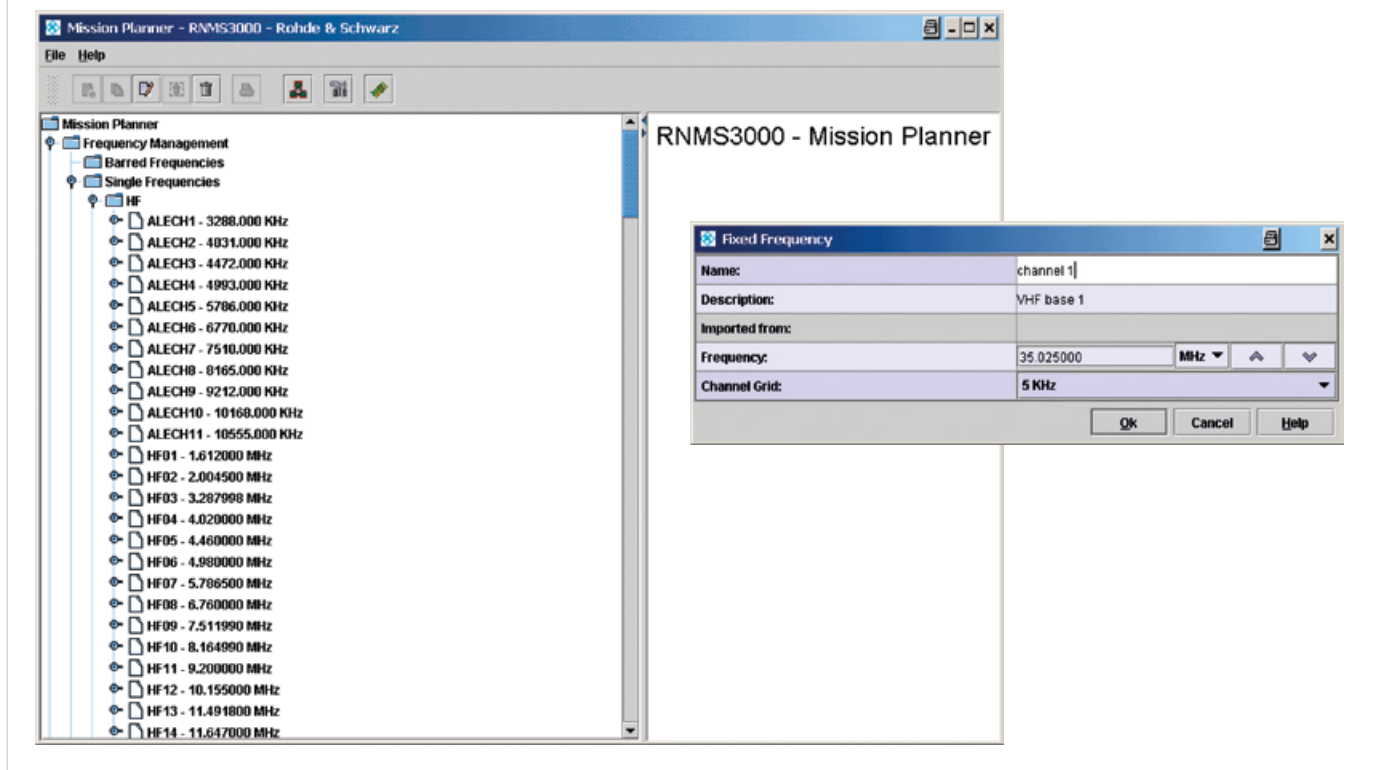

# Accessories for the R&S®MR3000P tactical handheld transceiver



**R&S®GA3023 handheld microphone/speaker**



**R&S®GA3022 headset with PTT or VOX**



**R&S®IB3022 battery pack, Li-ion**



**R&S®IC3022 universal battery charger, AC, stationary**  
Automatic charging of up to eight R&S®IB3022 Li-ion batteries



**R&S®IV3021 vehicle support**  
Vehicle mount with charger



**R&S®GP3021 fillgun**  
For transmitting all relevant preset information as well as COMSEC/TRANSEC keys



**R&S®IC3023 vehicle battery charger, DC**  
Automatic charging of two R&S®IB3022 Li-ion batteries



**R&S®IC3024 battery charger, AC, mobile**  
Automatic charging of one R&S®IB3022 Li-ion battery



**R&S®HV3031 GPS receiver**  
TAIP interface

# Accessories for the R&S®MR300xH/U multiband tactical radio



## R&S®GA3001 handset with PTT, microphone and earpiece

The R&S®GA3001 handset can be connected to the audio connector of the R&S®MR300xH and R&S®MR300xU radios, as well as to the remote control unit and other system components of the R&S®M3TR radio family.



## R&S®GA3002 headset with PTT, microphone and earpiece

The R&S®GA3002 is a headset for single/double ear use and can be worn on the right or left ear. A flexible cut-out polymer ear pad provides user comfort without masking outside noise. The microphone is fitted to an adjustable flexible support.



## R&S®GA3003 microphone/speaker

The R&S®GA3003 consists of a loudspeaker box with built-in audio amplifier and microphone.



## R&S®GA3005 loudspeaker

For connection to the R&S®M3TR audio socket with a through connection to R&S®GA3001/R&S®GA3002; 2 m, 5 m or 10 m cable



## R&S®IB3001 standard battery pack, Li-ion

Rechargeable, 28.8 V/5.5 Ah



## R&S®IC3000 battery charger, AC, stationary

Automatic charging of up to eight R&S®IB3001 Li-ion batteries. A power supply cable is supplied with each charger.



## R&S®IC3001 vehicle battery charger, DC, mobile

Automatic charging of one R&S®IB3001 Li-ion battery. Add-on: R&S®GK3020 power supply cable for R&S®IC3001 vehicle battery charger, delivery without battery pack



## R&S®ZR3001 battery charger set

For connection to R&S®IC3001 or R&S®IV3001





**R&S®FK3150 antenna tuning unit, 150 W**

Shown with recommended extra:  
R&S®KS3150F mounting frame



**R&S®GP3000 fillgun**  
**R&S®GP3100 fillgun (HAVE QUICK II mode)**  
**R&S®GK3021 fillgun to PC with USB cable**

Fillguns for R&S®M3TR and R&S®M3SR Series4100;  
for transmitting all relevant preset information and  
COMSEC/TRANSEC keys



**R&S®GB3031R single remote control unit**

With 3.5 m, 8 m or 12 m connecting cable



**R&S®GK3005 connecting cable**

For detachable front panel, max. 1.5 m length



**R&S®GH3041 universal RCB converter**

The R&S®GH3041 provides conversion functionalities  
between coaxial RCB interfaces (as used in R&S®M3TR  
applications) and optical RCB interfaces (as used in  
R&S®M3SR Series4100 applications) and vice versa, i.e. to  
be used in connection with the R&S®FK4115M antenna  
tuning unit.

# Antennas

## HF band



**R&S®HV3007 whip antenna**

**1.5 MHz to 30 MHz, 25 W**

For manpack applications



**R&S®AK3001 wire antenna**

**1.5 MHz to 30 MHz, 150 W**

For manpack applications,  
long wire adapter,  
R&S®GK3019 model .04 required



**R&S®AK3031 wire dipole antenna**

**2 MHz to 90 MHz, 25 W**

**Mast: R&S®KM3032**

For manpack applications,  
BNC adapter,  
R&S®GK3019 model .02 required



**R&S®HA104 whip antenna**

**1.5 MHz to 30 MHz, 150 W**

For vehicle applications,  
suitable for ground waves and vertically polarized  
low-angle sky waves,  
R&S®FK3150 antenna tuning unit required



**R&S®AK503 HF antenna system**

**1.5 MHz to 30 MHz, 150 W**

**Mast: R&S®KM011**

For vehicle applications,  
R&S®FK3150 antenna tuning unit required

# Antennas

## VHF band



**R&S®HV3004 whip antenna**  
 25 MHz to 108 MHz, 25 W  
 For manpack applications



**R&S®HV3020 whip antenna**  
 25 MHz to 108 MHz, 25 W  
 For manpack applications, long radiator



**R&S®HD3088 hang-up antenna**  
 30 MHz to 88 MHz, 12.6 W  
 For manpack applications  
 BNC adapter,  
 R&S®GK3019 model .02 required



**R&S®HD3001 long wire antenna**  
 30 MHz to 88 MHz, 25 W  
 For manpack applications,  
 high-gain directional antenna



**R&S®HV3021 long tape antenna**  
 25 MHz to 146 MHz, 5 W  
 For handheld applications,  
 long radiator



**R&S®HV3022 short tape antenna**  
 25 MHz to 146 MHz, 5 W  
 For handheld applications



**R&S®HV3012 whip antenna**  
 30 MHz to 108 MHz, 50 W  
 For vehicle applications,  
 low-profile antenna



**R&S®HV3015 whip antenna**  
 30 MHz to 108 MHz, 50 W  
 Mast: R&S®KM3031  
 For vehicle and stationary applications



**R&S®HV3088L long tape antenna, foldable**  
 30 MHz to 88 MHz, 5 W  
 For handheld transceivers



# Antennas

## VHF/UHF band



**R&S®HV3009 whip antenna**

**118 MHz to 400 MHz, 15 W**

For manpack applications



**R&S®HV3019 whip antenna**

**100 MHz to 512 MHz, 50 W**

**Mast: R&S®KM3031**

For vehicle and stationary applications



**R&S®HV3013 whip antenna**

**225 MHz to 450 MHz, 50 W**

**Mast: R&S®KM3031**

For vehicle and stationary applications



**R&S®HK061 broadband vehicle communications antenna**

**30 MHz to 600 MHz, 100 W**

For vehicle and stationary applications



**R&S®HK055L1 broadband mobile antenna**

**27.5 MHz to 600 MHz, 50 W (< 30 MHz), 100 W (> 30 MHz)**

**Mast: R&S®KM055**

For vehicle applications

# Configuration overview with power amplifiers and docking station

## External amplifiers – available models

- 50 W VHF/UHF power amplifier, standalone unit
- 50 W VHF/UHF power amplifier, compact version
- 150 W HF power amplifier, standalone unit
- 150 W HF power amplifier, compact version
- 500 W HF power amplifier

### VHF/UHF antennas

- Whip antennas
- Wire antennas



### HF antennas

- Whip antennas
- Wire antennas
- NVIS antennas

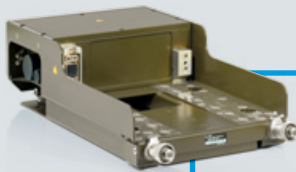

R&S®IV3001 <sup>1) 2)</sup>  
mounting frame



R&S®VT3050 <sup>1)</sup>  
50 W VHF/UHF  
power amplifier



R&S®VK3150 <sup>2)</sup>  
150 W  
HF amplifier



R&S®FK3150 <sup>3)</sup>  
antenna tuning unit

Power supply

<sup>1)</sup> The R&S®IV3001 and the R&S®VT3050 can be replaced with the R&S®VT3050C.

<sup>2)</sup> The R&S®IV3001 and the R&S®VK3150 can be replaced with the R&S®VK3150C.

<sup>3)</sup> The R&S®FK3150 can be replaced with the R&S®FK4115M and the R&S®GH3041.

# R&S®VT3050

## 50 W VHF/UHF

### power amplifier

The R&S®VT3050 50 W VHF power amplifier supports continuous operation across the 30 MHz to 512 MHz band with 50 W transmit power. The R&S®VT3050 is a member of the R&S®M3TR family of multiband tactical radio systems. This power amplifier meets the need for military voice and data communications in all analog and digital fixed frequency and frequency hopping modes supported by the R&S®MR300xH/R&S®MR300xU tactical radio. The amplifier is especially designed for high linearity to satisfy the requirements of the R&S®M3TR family's high-speed radio modem for 72 000 bit/s. It supports medium to fast frequency hopping.

A collocation option is available for the VHF low band (30 MHz to 88 MHz). The co-site filter is factory-installed. Fully automatic operation (controlled from the transceiver) and rapid tuning capability are provided.

Operational configuration and BITE/fault status reporting are performed via the radios. The R&S®VT3050 uses rugged tactical packaging and meets the same environmental specifications for temperature, shock, vibration and submersibility as the rest of the R&S®M3TR family. Operation is fully automatic. Built-in test equipment (BITE) and diagnostic testing are fully integrated into the radio system. The VHF/UHF amplifier is mounted separately with an independent shockmount. This provides additional flexibility when installing tactical radio systems into vehicles.

An R&S®M3TR VHF/UHF system can be easily upgraded to multiband operation. The serial control bus of the R&S®M3TR allows combinations of radios with up to two external amplifiers. By adding an R&S®VK3150 HF amplifier and an R&S®FK3150 antenna tuning unit, the system can be expanded to a frequency range of 1.5 MHz to 512 MHz.

For use with standard VHF and UHF antennas, the amplifier features two configurable RF outputs. The frequency that splits the available frequency range of 30 MHz to 512 MHz is user-selectable. Possible settings could be, for instance, 30 MHz to 108 MHz for the RF<sub>Low</sub> output, leaving 108 MHz to 512 MHz for the RF<sub>High</sub> output. If a multiband antenna such as the R&S®HK055L1/R&S®HK061 is used, the entire range of 30 MHz to 512 MHz can be routed to one of the outputs.

R&S®VT3050 50 W VHF/UHF power amplifier





# R&S®VT3050C 50 W VHF/UHF compact power amplifier

The R&S®VT3050C 50 W VHF/UHF compact power amplifier accommodates an R&S®MR300xU or R&S®MR300xH manpack radio. The R&S®VT3050C supports continuous operation across the 30 MHz to 512 MHz band with 50 W transmit power. The R&S®VT3050C accepts an R&S®MR300xU or R&S®MR300xH manpack radio (not included in the equipment supplied) as a plug-in exciter. Because each R&S®MR300xH/R&S®MR300xU manpack radio features a rear system connector, the radio can be mounted and dismounted quickly.

Connectors on the front panel provide the most important interfaces such as RF, audio, power supply lines and a digital bus to control external equipment. For standard applications, it is not necessary to plug cables into the radio's front panel. This provides "jerk and run" capability in an emergency, or convenient handling if the radio is temporarily used as a manpack. The R&S®VT3050C operates on a 24 V or 12 V (with reduced output power) vehicle power supply.

The R&S®VT3050C with options



## Key features

- ▮ Frequency range from 30 MHz to 512 MHz
- ▮ Very compact, easy to install
- ▮ Output power of 50 W CW and PEP
- ▮ Frequency hopping capability (HAVE QUICK II, R&S®SECOM-V, R&S®SECOM-P, R&S®SECOS)
- ▮ Protected against antenna mismatch, overload, overvoltage
- ▮ High MTBF
- ▮ Upgradeable to multiband operation (interface for R&S®VK3150 HF power amplifier, 1.5 MHz to 512 MHz)

## Options

### Co-site filter

A collocation option is available for the VHF low band (30 MHz to 88 MHz). The co-site filter is factory-installed. Fully automatic operation (controlled from the host radio) and rapid tuning capability are provided.

### Field telephone interface

This option provides a two-wire interface to connect the amplifier to a field telephone. The operator can select four modes for routing telephone calls from and to the radio:

- ▮ Audio-radio: audio interface connected to radio
- ▮ Radio-phone: field telephone connected to radio
- ▮ Audio-phone: field telephone connected to audio interface
- ▮ Audio-radio-phone: field telephone connected to radio and audio interface

### Audio/data interface

This option provides a versatile audio/data interface including power lines, audio, data and control signals. It is used to connect external devices such as an ELCRODAT 4-2, R&S®MMC3000 or KY57 cipher unit.

### MIL-STD-188-220B modem interface

This option makes it possible to set up radio data networks in line with the MIL-STD-188-220B standard (interoperability standard for digital message transfer device subsystems). The IP based protocol supports up to 32 network nodes in fixed-channel operation.

# R&S®VK3150 150 W HF power amplifier

The R&S®VK3150 150 W HF power amplifier increases the HF output power of the R&S®MR300xH/R&S®MR300xU manpack radios to 150 W PEP or 100 W average. The R&S®VK3150 provides medium-power/medium-range communications links. Typical applications include mobile or base station installations for general-purpose HF SSB voice and data communications.

Continuous coverage is provided over the 1.5 MHz to 30 MHz frequency range. The power amplifier section has a broadband design and fully supports frequency agile operating modes (automatic link establishment, slow frequency hopping). When used with the automatic R&S®FK3150 HF antenna tuning unit, the output of the R&S®VK3150 is automatically matched to most rod and whip antennas.

Built-in self-test features permit operators or maintenance personnel to fully check the radio and the power amplifier down to the module level. Fault conditions are displayed on the radio's front-panel display.

The R&S®MR300xH/R&S®MR300xU manpack acts as an exciter for the power amplifier, avoiding the disadvantages of radio/booster solutions with respect to unwanted emissions. The HF power amplifier is mounted separately on an independent shockmount with room for proper air flow. This provides additional flexibility when installing tactical radio systems into vehicles.

The R&S®VK3150 uses rugged tactical packaging and meets the same environmental specifications for temperature, shock, vibration and submersibility as the rest of the R&S®M3TR family.

R&S®VK3150 150 W HF power amplifier



# R&S®VK3150C

## 150 W HF compact power amplifier

The R&S®VK3150C is an HF power amplifier for the R&S®MR300xU and R&S®MR300xH manpack radios. The R&S®VK3150C makes it possible to configure very compact HF stations with a maximum output power of 150 W. The power amplifier is therefore ideal for mobile deployment scenarios in tactical radio applications. Like the R&S®VT3050C, its VHF/UHF counterpart, all R&S®MR300x manpacks can be operated as exciters by simply plugging them into the amplifier. If the need arises for a portable radio during the mission, the manpack can be easily removed from the power amplifier without having to disconnect cables or use tools. The R&S®VK3150C seamlessly and fully supports all Rohde&Schwarz HF waveforms, including frequency hopping and ALE processes.

The power amplifier comes with a wide range of standard interfaces, such as audio and Ethernet, as well as interfaces to a VHF/UHF power amplifier and antenna couplers for smooth system integration. The R&S®VK3150C also offers options that allow, for example, external cryptographic devices to be used.

### Key features

- ▮ Frequency range from 1.5 MHz to 30 MHz
- ▮ Output power of 150 W PEP
- ▮ Extremely compact, easy to install on all mobile platforms
- ▮ Wide input voltage range
- ▮ Full support of frequency agile HF waveforms (EPM, ALE)
- ▮ Optical and coaxial ATU interface
- ▮ Upgradeable to multiband operation (interface for R&S®VT3050 VHF/UHF power amplifier, 1.5 MHz to 512 MHz)

### Options

#### Field telephone interface

This option provides a two-wire interface to connect the amplifier to a field telephone. The operator can select four modes for routing telephone calls from and to the radio:

- ▮ Audio-radio: audio interface connected to radio
- ▮ Radio-phone: field telephone connected to radio
- ▮ Audio-phone: field telephone connected to audio interface
- ▮ Audio-radio-phone: field telephone connected to radio and audio interface

#### Audio/data interface

This option provides a versatile audio/data interface including power lines, audio, data and control signals. It is used to connect external devices such as an ELCRODAT 4-2, R&S®MMC3000 or KY57 cipher unit.

The R&S®VK3150C with options





# R&S®MG3500

## 500 W HF power amplifier

The R&S®MG3500 power amplifier increases the HF output power of an R&S®MR300xH/R&S®MR300xU radio in the HF range up to max. 500 W. This makes reliable medium and long-range connections via ground wave and sky wave possible. Typical applications include stationary and semi-mobile installations for tactical radio networks.

### Key features

- Frequency range from 1.5 MHz to 30 MHz
- Output power of 500 W CW and PEP
- Frequency hopping capability (R&S®SECOM-H)
- Mismatch and short-circuit protection
- High MTBF

### Operating modes

The amplifier operates in the entire HF range from 1.5 MHz to 30 MHz. In addition to the analog modes (AM, FM, SSB), frequency agile radio techniques such as ALE and R&S®SECOM-H offered in the R&S®M3TR are also supported.

The R&S®MG3500 500 W power amplifier with the radio in shockmounted frame (option)



Broadband antennas (VSWR < 2) can be directly connected to the amplifier. If the R&S®FK4190M antenna tuning unit is added, standard rod, whip or wire antennas can also be used. In this case, the R&S®FK4190M is automatically controlled and tuned by the receiver. Hop sets and scan groups for the frequency agile modes are learned for the connected antenna, and the associated data records are stored in the tuning unit. The tuning processes are largely performed automatically and do not require the operator to take any special steps.

### Reliability

The R&S®MG3500 is fully integrated into the built-in test (power-on test and continuous test) of the radio. Error messages from the amplifier are output on the radio HMI for the operator. To make service easier, error messages down to the module level can be called up.

### Power supply

The R&S®MG3500 can operate in either single-phase or three-phase mode. In addition, emergency operation from a 24 V DC power supply is possible (max. HF output power is then 100 W).

### Environmental and EMC properties

Like all system components of the R&S®M3TR family, the R&S®MG3500 has also been subjected to rigorous quality testing. It meets the requirements of the MIL-STD-810F and MIL-STD-461E standards.

### Multiband extension

All R&S®MR300xH/R&S®MR300xU radios support multiband operation. The frequency range of an R&S®M3TR HF system equipped with the R&S®MG3500 can also be extended to cover the VHF/UHF range. This is done by connecting the R&S®MG3500 to the extension port of an R&S®VT3050C amplifier. This combination then permits continuous operation at all frequencies between 1.5 MHz and 512 MHz. This configuration supports all R&S®M3TR EPM (ECCM) and modem options in the VHF and UHF range.

### Design

The R&S®MG3500 HF power amplifier is modular with a 19" rackmount design. Any R&S®MR300xH/R&S®MR300xU radio can be operated as an exciter for controlling the R&S®MG3500 power amplifier. It can be replaced without requiring tools, or it may be used temporarily as a manpack radio. The interfaces on the manpack radio (audio, serial data/control, GPS antenna connector, etc.) of course remain accessible even after the radio has been installed in the R&S®MG3500.

# R&S®IV3001 power supply unit/ mounting frame

The R&S®IV3001 power supply unit is a DC-powered vehicle mounting frame for R&S®MR300xU and R&S®MR300xH manpack radios. The R&S®IV3001 is ideal for platforms that are limited in terms of vehicle load capacity, space and power. The internal manpack power amplifier of an R&S®MR300xU or R&S®MR300xH eliminates the need for expensive, external amplifiers that heavily load the onboard power supply.

This configuration still provides output power up to 10 W in the VHF band (plus up to 10 W in the UHF band and 20 W in the HF band, depending on the manpack version). Therefore, when used with powerful antennas, these systems provide sufficient radio coverage for vehicles that are not suitable for conventional radio equipment, e.g. small jeeps, quads and inflatable dinghies. If more output power is needed, the R&S®IV3001 can be connected to external power amplifiers (R&S®VK3150 or R&S®VT3050). All R&S®IV3001 models can be ordered with or without an integrated charger.

All R&S®IV3001 models come with an Ethernet interface for remote control and data transfer.

## Key features

- Operation with internal manpack power amplifier or connection to external amplifier
- Installation without additional shockmounting for wheeled and tracked vehicles
- Extremely compact, easy to install on all mobile platforms
- 12 V or 24 V operation, low power consumption
- UPS functionality, automatic switchover to a connected R&S®IB3001 battery when the vehicle power supply fails
- Wide range of interfaces
- Optional charger, functionality for loading connected R&S®IB3001 batteries
- Upgradeable to multiband operation (interface for R&S®VT3050 VHF/UHF power amplifier or R&S®VK3150 HF power amplifier)

R&S®IV3001 power supply unit/mounting frame



# SOVERON<sup>®</sup> and R&S<sup>®</sup>M3TR – typical vehicle/command post installation

## VHF/UHF antennas

- ▮ Whip antennas
- ▮ Wire antennas



## SOVERON<sup>®</sup> VR

VHF/UHF, 50 W,  
with R&S<sup>®</sup>KS5100VR mounting frame

## R&S<sup>®</sup>GB5100

remote control unit



## Data communications/networking

- ▮ Rugged notebooks
- ▮ Message handling software
- ▮ Battle management systems



## Audio accessories

- ▮ Handsets/headsets
- ▮ Loudspeakers
- ▮ Vehicle intercoms







### HF antennas

- ▮ Whip antennas
- ▮ Wire antennas
- ▮ NVIS antennas

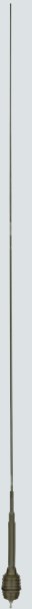

### R&S®MR3000H/R&S®MR3000U

HF, 150 W, integrated in the R&S®VK3150C compact amplifier

### R&S®FK3150

antenna coupler



### Radio net management

- ▮ Fill guns
- ▮ Mission planner software
- ▮ Data loader software

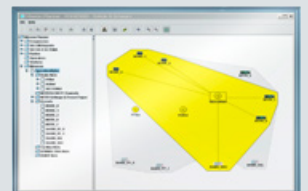

# R&S®RNMS3000

## radio network management system

Utilization planning, radio network configuration and data distribution

### Increased significance for a radio network management system

In today's world, information exchange via voice and data is indispensable for military forces to fulfill their increasing mission requirements. Handling all these communications demands with their complex waveforms requires an extended network management system. By offering R&S®RNMS3000, Rohde&Schwarz provides such a radio network management system. It enables military leaders to turn their Rohde&Schwarz combat radio equipment into a robustly networked communications system based on mission demand and on complex hierarchical structures, especially in joint or combined missions. In the past, many parameters had to be adjusted on the radios, which required highly skilled users. In the future, the configuration complexity will be done during the preparative configuration of a management system.

### R&S®RNMS3000 – the convenient way to empower the capabilities of Rohde&Schwarz radios in networks

The R&S®RNMS3000 software supports centralized network management, where one central organizational unit performs the complete mission planning, as well as decentralized management, where the various configuration steps are accomplished at various military hierarchical levels. The R&S®RNMS3000 software suite, consisting of the mission planner, the remote device loader and the remote distributor, offers the following functions:

- ▮ Management of security keys
- ▮ Frequency assignments
- ▮ Establishment of logical nets
- ▮ Distribution of mission files

The objective is to provide mission-tailored and secured radiocommunications networks. Especially the R&S®RNMS3000 capability to manage NATO-specific waveforms, as well as general HF House waveforms and Rohde&Schwarz proprietary waveforms, underlines its broad range of applications.

### Comprehensive waveform support

- ▮ NATO waveforms
- ▮ HF House waveforms
- ▮ R&S®SECOM waveforms
- ▮ R&S®SECOS waveform

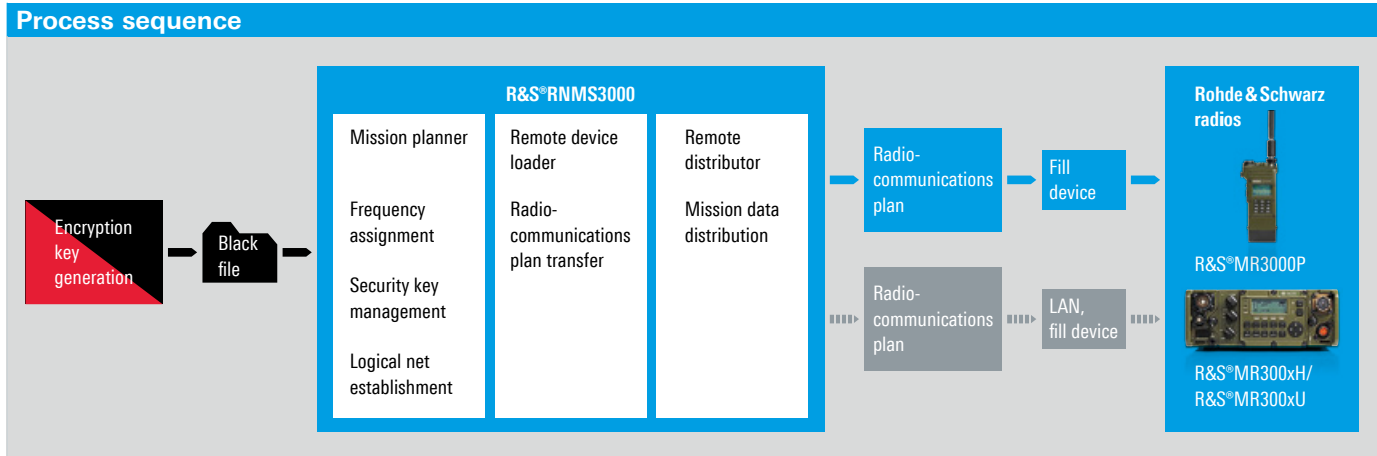

## Highlights

- Support of all Rohde&Schwarz radios and all frequencies
- Support of voice and data services
- Network planning, mission file generation and distribution with one software suite
- Target-oriented software guidance with wizards

## Key features

- Mission planner – mission-tailored network planning
  - Frequency assignment
  - Hop set generation and management
  - Security key management
  - Efficient mission planning
- Remote device loader – mission-optimized radio-communications plan transfer
  - Secure file transfer
  - Effective hardware programming
- Remote distributor – extended mission data distribution
  - File distribution over existing IP networks
  - Event log and status control

## Effective mission planning

The mission planner software allows mission-optimized and time-critical software use. The program provides target-oriented software navigation via wizards to allow the operator to plan missions with a focus on the essential parameters. In case of a configuration error, R&S®RNMS3000 displays a fault message including advice to support the error search process. The created mission file and configuration progress are saved automatically in a database to avoid losing critical mission data due to a hardware failure.

## Geographical dispersed radio network planning

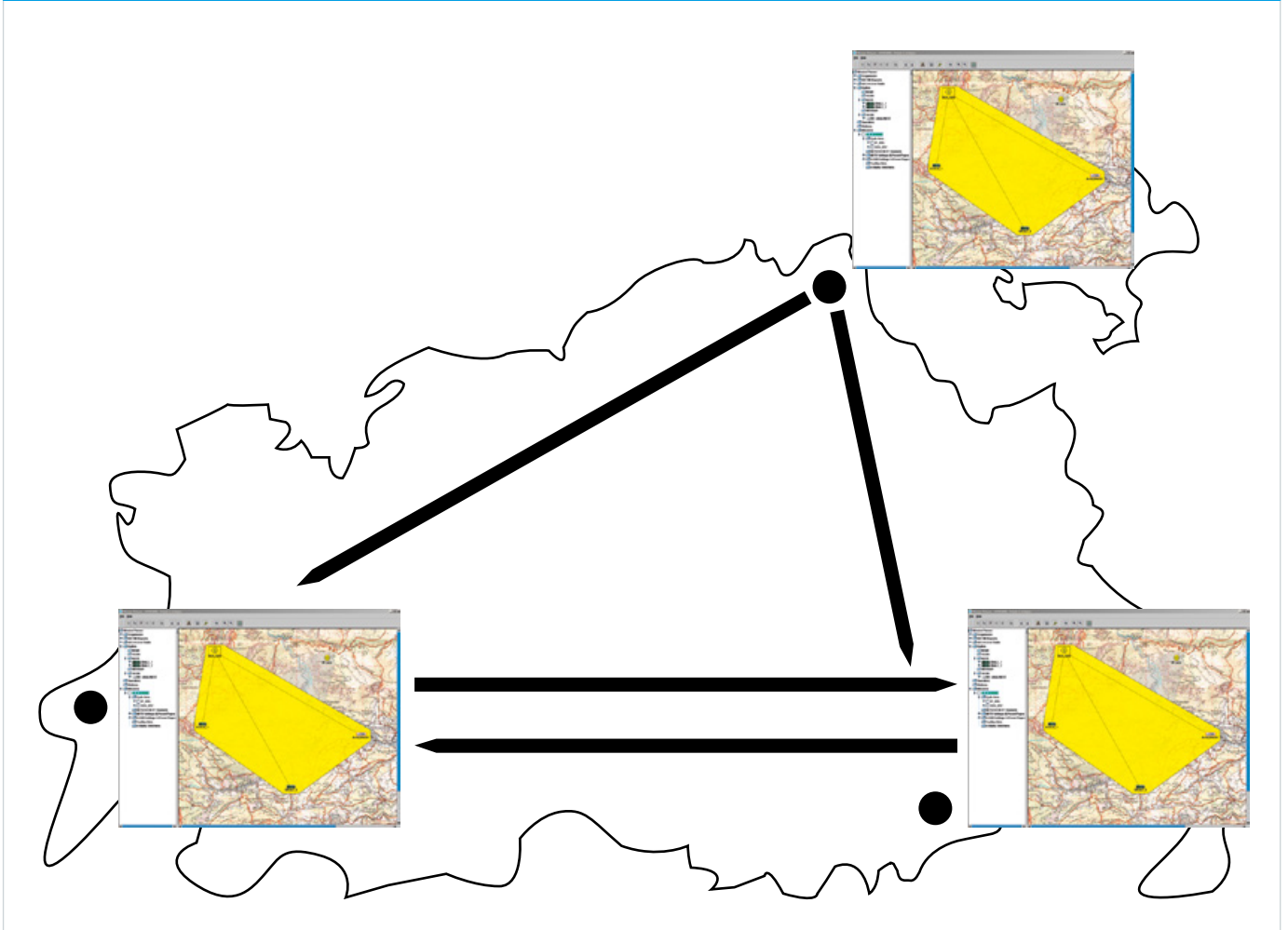



# Product overview

Designation	Type
<b>R&amp;S®M3TR radio family</b>	
<b>HF/VHF tactical radio, 0.5 W to 10 W (HF up to 20 W)</b>	
Int. GPS receiver, ATU, RS-232-C and IP interface	R&S®MR3000H
Int. GPS receiver, ATU, RS-232-C and IP interface; prepared for HAVE QUICK II and/or R&S®SECOS 5/16 TDMA	R&S®MR3001H
Int. GPS receiver, ATU, RS-232-C and IP interface; prepared for HF waveforms	R&S®MR3002H
<b>VHF/UHF tactical radio, 0.5 W to 10 W</b>	
Int. GPS receiver, RS-232-C and IP interface	R&S®MR3000U
Int. GPS receiver, RS-232-C and IP interface; prepared for HAVE QUICK II and/or R&S®SECOS 5/16 TDMA	R&S®MR3001U
Int. GPS receiver, RS-232-C and IP interface; prepared for HF waveforms	R&S®MR3002U
<b>Tactical handheld transceiver, 0.2 W and 5 W</b>	
Handheld transceiver	R&S®MR3000P
<b>Mating connector set (R&amp;S®MR300xH/R&amp;S®MR300xU)</b>	
Mating connector set	R&S®GK3004
<b>EPM (ECCM) support equipment (R&amp;S®MR300xH/R&amp;S®MR300xU)</b>	
Key generation equipment for R&S®SECOM incl. R&S®KGE3000 key generation module	R&S®CP3000
Fillgun for transmitting all relevant preset information as well as COMSEC/TRANSEC keys	R&S®GP3000
HAVE QUICK II fillgun for transmitting all relevant preset information	R&S®GP3100
Key distribution device for R&S®SECOS 5/16 TDMA	R&S®KDD3750
<b>Power amplifiers (R&amp;S®MR300xH/R&amp;S®MR300xU)</b>	
500 W HF power amplifier for R&S®MR300xH/R&S®MR300xU radios; 1.5 MHz to 30 MHz; standalone	R&S®MG3500
150 W HF power amplifier for R&S®MR300xH/R&S®MR300xU radios; 1.5 MHz to 30 MHz	R&S®VK3150
150 W HF compact power amplifier for R&S®MR300xH/R&S®MR300xU radios	R&S®VK3150C
1.5 MHz to 30 MHz	
1.5 MHz to 30 MHz; with field telephone and audio/data interface	
50 W VHF/UHF power amplifier for R&S®MR300xH/R&S®MR300xU radios; 30 MHz to 512 MHz; with/without co-site filter	R&S®VT3050
50 W VHF/UHF compact power amplifier for R&S®MR300xH/R&S®MR300xU radios	R&S®VT3050C
30 MHz to 512 MHz	
30 MHz to 512 MHz; with co-site filter	
30 MHz to 512 MHz; with field telephone and audio/data interface	
30 MHz to 512 MHz; with co-site filter, field telephone, audio/data interface and MIL-STD-188-220C modem	
<b>Batteries and chargers (R&amp;S®MR300xH/R&amp;S®MR300xU)</b>	
Standard battery pack, Li-ion, rechargeable; 28.8 V/5.5 Ah	R&S®IB3001
Battery charger, AC, stationary; automatic charging of up to eight R&S®IB3001 Li-ion batteries	R&S®IC3000
Battery charger, DC, mobile; automatic charging of one R&S®IB3001 Li-ion battery	R&S®IC3001
Battery charger set; for connection to R&S®IC3001 or R&S®IV3001	R&S®ZR3001
Power supply cables for chargers must be ordered separately	
<b>Docking stations and accessories (R&amp;S®MR300xH/R&amp;S®MR300xU)</b>	
Single remote control unit with 3.5/8/12 m connecting cable	R&S®GB3031R
Different RF interfaces and power filter options available on request	
Power supply unit/mounting frame (different models available)	R&S®IV3001
<b>Mounting frame with shockmounts</b>	
For R&S®VT3050 or R&S®VK3150 power amplifier	R&S®KS3000V
For R&S®VT3050C or R&S®VK3150C power amplifier	R&S®KS3001V
For R&S®FK3150 antenna tuning unit	R&S®KS3150F
Blower unit for R&S®VK3150 or R&S®VT3050 power amplifiers	R&S®KL3000V
<b>Audio accessories (R&amp;S®MR300xH/R&amp;S®MR300xU)</b>	
Handset with PTT microphone and earpiece	R&S®GA3001
Headset with PPT microphone and one/two earpiece(s)	R&S®GA3002
Loudspeaker/microphone	R&S®GA3003
Loudspeaker for connection to R&S®MR300xH/R&S®MR300xU audio socket with through connection to R&S®GA3001/GA3002; length of cable: 2/5/10 m	R&S®GA3005

Designation	Type
<b>Control cables, data cables, RF cables, power supply cables (R&amp;S®MR300xH/R&amp;S®MR300xU)</b>	
Various cables available on request; must be ordered separately	
<b>Manpack antennas (R&amp;S®MR300xH/R&amp;S®MR300xU)</b>	
Wire antenna for manpack or stationary use; 1.5 MHz to 30 MHz; 150 W	R&S®AK3001
Wire dipole antenna for manpack use; 2 MHz to 90 MHz; 25 W; broadband antenna; with/without mast	R&S®AK3031
Long wire antenna; 30 MHz to 88 (108) MHz; 30 W high-gain directional antenna	R&S®HD3001
Hang-up antenna; terminated with BNC connector; 30 MHz to 88 MHz; power rating: 12.5 W into 50 Ω	R&S®HD3088
GPS antenna for manpack and vehicle applications; active; magnetic holder; L1 band	R&S®HV3003
Whip antenna for manpack; 25 MHz to 88 (108) MHz; 20 W	R&S®HV3004
Long whip antenna for manpack; 1.5 MHz to 30 MHz; 25 W	R&S®HV3007
Whip antenna for manpack; 118 MHz to 400 MHz (88 MHz to 450 MHz); 15 W	R&S®HV3009
<b>Vehicular antennas (R&amp;S®MR300xH/R&amp;S®MR300xU)</b>	
HF antenna system for mobile use; 1.5 MHz to 30 MHz; 150 W	R&S®AK503
Whip antenna for vehicle use; 1.5 MHz to 30 MHz; 150 W	R&S®HA104
Whip antenna for vehicle use; 30 MHz to 108 MHz; 75 W; low profile; with/without GPS base	R&S®HV3012
Whip antenna for vehicle or stationary use; 225 MHz to 512 MHz; 50 W; center-fed; with/without GPS base	R&S®HV3013
Whip antenna for vehicle or stationary use; 30 MHz to 108 MHz; 50 W; center-fed; with/without GPS base	R&S®HV3015
Whip antenna for vehicle or stationary use; 100 MHz to 400 (512) MHz; 50 W; center-fed; with/without GPS base	R&S®HV3019
Broadband vehicle communications antenna; 30 MHz to 600 MHz; color: CARC383 (green)	R&S®HK061
<b>Stationary antennas (R&amp;S®MR300xH/R&amp;S®MR300xU)</b>	
Broadband mobile antenna; 27.5 MHz to 600 MHz; color: green or sand yellow	R&S®HK055L1
Mast for antennas; 8.5 m height	R&S®KM3031
Mast for antennas; 7 m height	R&S®KM3032
Whip antenna for stationary use; 225 MHz to 512 MHz; 50 W; center-fed; with mast	R&S®HV3013
Whip antenna for stationary use; 30 MHz to 108 MHz; 50 W; center-fed; with mast	R&S®HV3015
Whip antenna for stationary use; 100 MHz to 400 (512) MHz; 50 W; center-fed; with mast	R&S®HV3019
GPS antenna supplement for R&S®HK055L1	R&S®KM055
For further antennas, see the "Antennas and Accessories" catalog	
<b>Antenna adapters (R&amp;S®MR300xH/R&amp;S®MR300xU)</b>	
Different antenna adapters available on request	
<b>Antenna tuning unit (R&amp;S®MR300xH/R&amp;S®MR300xU)</b>	
Antenna tuning unit; 1.5 MHz to 30 MHz; 150 W	R&S®FK3150
Antenna tuning unit; 1.5 MHz to 30 MHz; 150 W; with RCB interface; FH capability; color: RAL 7001	R&S®FK4115M
Universal RCB converter	R&S®GH3041
<b>Rucksacks and manpack bags (R&amp;S®MR300xH/R&amp;S®MR300xU)</b>	
Transport bag for R&S®KM011 mast; color: olive drab	R&S®MZ3011
Rucksack for R&S®AK3031 antenna; color: camouflage or olive drab	R&S®MZ3031
Rucksack for R&S®MR300xH/R&S®MR300xU and accessories; color: camouflage or olive drab	R&S®MZ3060
Rucksack for R&S®MR300xH/R&S®MR300xU, R&S®XV3088 and accessories; color: camouflage	R&S®MZ3088
Transport bag for R&S®AK503 antenna, antenna head, radiators and ropes; color: olive drab	R&S®MZ3503
<b>Handheld transceiver and accessories (R&amp;S®MR3000P)</b>	
Tactical handheld transceiver, 25 MHz to 146 MHz; 0.2 W/5 W; including R&S®SECOM-P	R&S®MR3000P
Central update tool for R&S®MR3000P radio	R&S®CS3021
Handheld microphone/speaker	R&S®GA3023
Serial data cable	R&S®GK3028
Power supply cable for R&S®IV3021	R&S®GK3029
Fillgun for transmitting all relevant preset information as well as COMSEC/TRANSEC keys	R&S®GP3021
GPS receiver	R&S®HV3031
Battery pack, Li-ion, for R&S®MR3000P radio	R&S®IB3022
Battery charger, AC, stationary, for R&S®MR3000P radio; automatic charging of up to eight R&S®IB3022 Li-ion batteries	R&S®IC3022
Vehicle charger, DC, for R&S®MR3000P radio	R&S®IC3023
Charger, AC, mobile for R&S®MR3000P radio; automatic charging of one R&S®IB3022 Li-ion battery	R&S®IC3024
Vehicle support; vehicle mount with charger for R&S®MR3000P radio	R&S®IV3021
Long tape antenna for R&S®MR3000P radio; 1.1 m length	R&S®HV3021
Short tape antenna for R&S®MR3000P radio; 0.5 m length	R&S®HV3022

Designation	Type
Long tape antenna, foldable; power rating: 5 W at 50 Q; 1.5 m length	R&S®HV3088L
Bag for R&S®MR3000P radio	R&S®MZ3021
Set bag for R&S®MR3000P radio and accessories	R&S®MZ3022
Battery pack bag for R&S®MR3000P radio	R&S®MZ3023
<b>R&amp;S®RNMS3000 radio network management system</b>	
Mission planner	R&S®DS3100M
Remote device loader	R&S®DS3300D
Remote distributor	R&S®DS3321D
<b>Test system for radio equipment of the R&amp;S®M3xR family</b>	
Base system; mobile rack version; complete set of radio test equipment including system racks and base software suite	R&S®UCS226XB
R&S®M3TR BASE, system interface base; radio adaption box and cabling set including specific radio test software package	R&S®UCS-B20

The radio systems described are hardware and software configurable. The system delivered has the configuration as confirmed in the order.

Your local Rohde&Schwarz expert will help you determine the optimum solution for your requirements. To find your nearest Rohde&Schwarz representative, visit [www.sales.rohde-schwarz.com](http://www.sales.rohde-schwarz.com)

Today's network centric operations are based on full interoperability between joint and combined missions

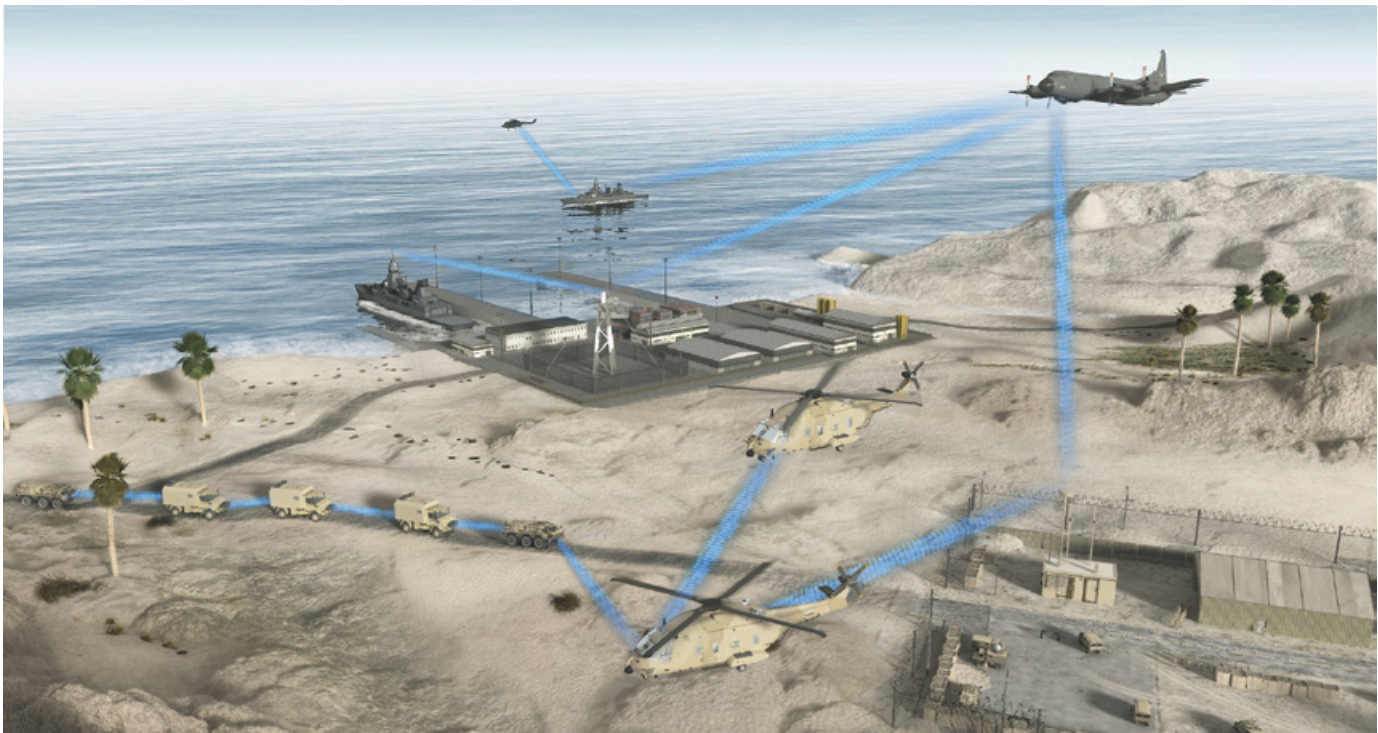



# Service partner program – partnership at eye level

The main aspiration of Rohde&Schwarz is to deliver high-reliability, high-availability radiocommunications solutions that support the operational effectiveness and security of the armed forces during missions. Every system and every device requires expert maintenance to ensure its availability in missions throughout the product lifecycle and useful life. It may be crucial to your success to perform part of the maintenance work yourself – directly and flexibly using the infrastructure of your own organization and the expertise of your employees.

This is why Rohde&Schwarz has developed the service partner program. As a service partner of Rohde&Schwarz, you are able to service your Rohde&Schwarz communications systems on your own. The scope of services is tailored to your requirements and expectations.

The Rohde&Schwarz service partner program lets you benefit from a flexible service concept that ensures the availability of your devices and makes use of your own staff and infrastructure.

## As a Rohde&Schwarz service partner, you have access to the following services

### R&S®UCS radio test equipment

The R&S®UCS test equipment enables you to self-service your transceivers, meeting the highest quality, convenience and cost-efficiency requirements. The test equipment will be selected according to the required scope of servicing.

### Training

Various Rohde&Schwarz training modules empower your staff to service your transceivers on their own. Depending on the type of service partner agreement, you can use different training modules.

### Software updates

As our partner, you will receive all the software updates that you need for preventive and corrective maintenance.

### Spare parts

A local pool of spare parts tailored to your requirements enables you to immediately perform preventive and corrective maintenance. This pool will be replenished when necessary.

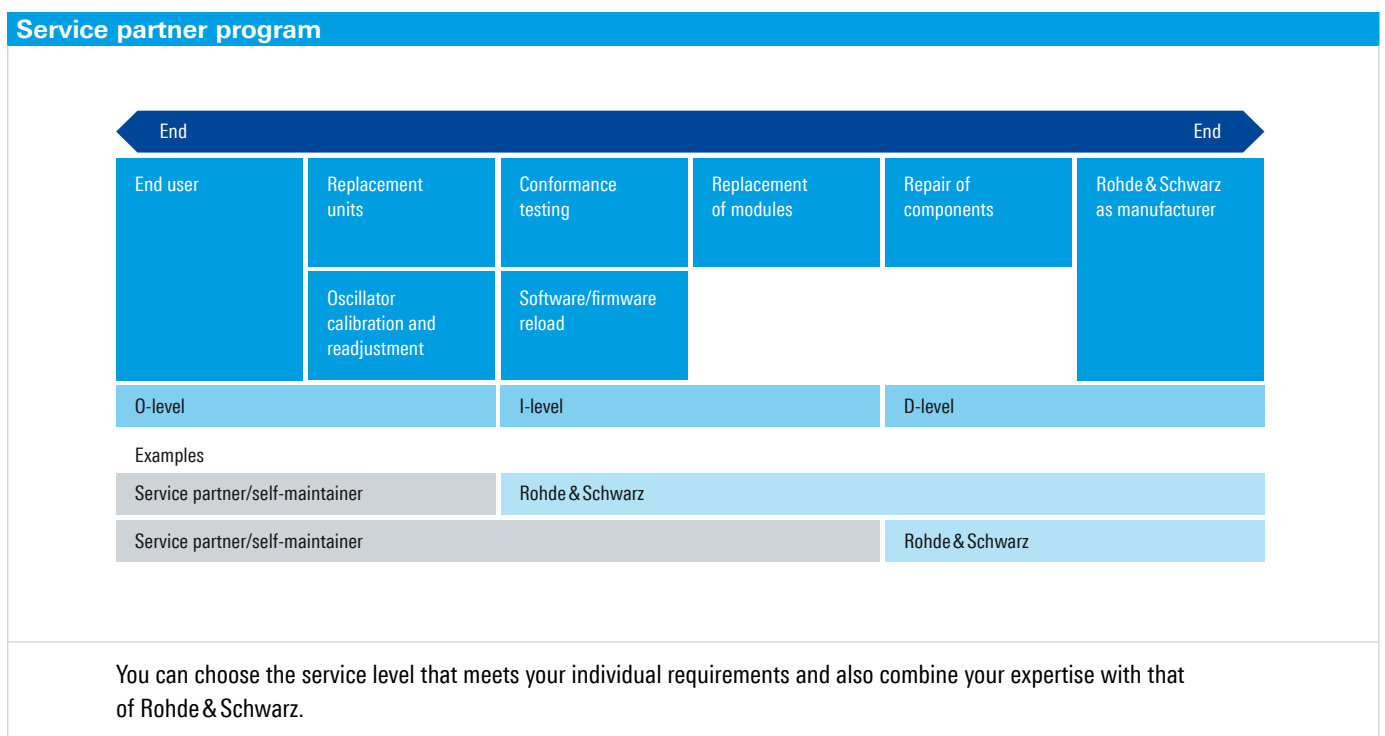

## Service that adds value

- ▮ Worldwide
- ▮ Local and personalized
- ▮ Customized and flexible
- ▮ Uncompromising quality
- ▮ Long-term dependability

## Rohde & Schwarz

The Rohde & Schwarz electronics group offers innovative solutions in the following business fields: test and measurement, broadcast and media, secure communications, cybersecurity, monitoring and network testing. Founded more than 80 years ago, the independent company which is headquartered in Munich, Germany, has an extensive sales and service network with locations in more than 70 countries.

[www.rohde-schwarz.com](http://www.rohde-schwarz.com)

## Sustainable product design

- ▮ Environmental compatibility and eco-footprint
- ▮ Energy efficiency and low emissions
- ▮ Longevity and optimized total cost of ownership

Certified Quality Management

**ISO 9001**

Certified Environmental Management

**ISO 14001**

Certified Quality Management

**AQAP-2110**

## Regional contact

- ▮ Europe, Africa, Middle East | +49 89 4129 12345  
[customersupport@rohde-schwarz.com](mailto:customersupport@rohde-schwarz.com)
- ▮ North America | 1 888 TEST RSA (1 888 837 87 72)  
[customer.support@rsa.rohde-schwarz.com](mailto:customer.support@rsa.rohde-schwarz.com)
- ▮ Latin America | +1 410 910 79 88  
[customersupport.la@rohde-schwarz.com](mailto:customersupport.la@rohde-schwarz.com)
- ▮ Asia Pacific | +65 65 13 04 88  
[customersupport.asia@rohde-schwarz.com](mailto:customersupport.asia@rohde-schwarz.com)

R&S® is a registered trademark of Rohde & Schwarz GmbH & Co. KG

Trade names are trademarks of the owners

PD 5213.9228.12 | Version 07.00 | May 2019 (ch)

R&S®M3TR Software Defined Radios

Data without tolerance limits is not binding | Subject to change

© 2008 - 2019 Rohde & Schwarz GmbH & Co. KG | 81671 Munich, Germany



5213922812