

# R&S® PowerTSVP INDUSTRIAL HIGH-POWER AND SWITCHING APPLICATION CHASSIS

Open test platform based on CAN bus



Product Brochure  
Version 02.00

**ROHDE & SCHWARZ**

Make ideas real



# AT A GLANCE

The R&S®PowerTSVP industrial high-power and switching application chassis was created as a cost-efficient subsystem for switching applications. It can be used to build systems ranging from dedicated switching instruments up to complex switching applications inside test and measurement systems.

## Key facts

- ▶ Modular switching instrument chassis
- ▶ Standard 19", 4 HU rackmount enclosure
- ▶ 16 peripheral slots for switching instrumentation
- ▶ Rear I/O support for easy system cabling (IEEE 1101.11-1998)
- ▶ Sophisticated analog measurement bus subsystem
- ▶ Support of system wide trigger concept
- ▶ Seamless test adaptation by using standardized adapter components
- ▶ Simple and efficient module connection concept
- ▶ Easily expandable ATE switching
- ▶ High pin count switching applications, e.g. for in-circuit test (ICT)
- ▶ High-power switching
- ▶ Cost-effective peripheral control via controller area network (CAN)

## Most common applications

- ▶ Expanding the number of input pins for general purpose signals using the R&S®TS-PMB high density relay matrix module; suitable for functional and in-circuit test scenarios
- ▶ Switching of high-power signals coming from DUTs or going into loads using the high-power switching modules
- ▶ Integrating customer-defined or application-specific modules or original loads related to the DUTs
- ▶ Separating the switching or load unit built with the R&S®PowerTSVP chassis and measurement unit

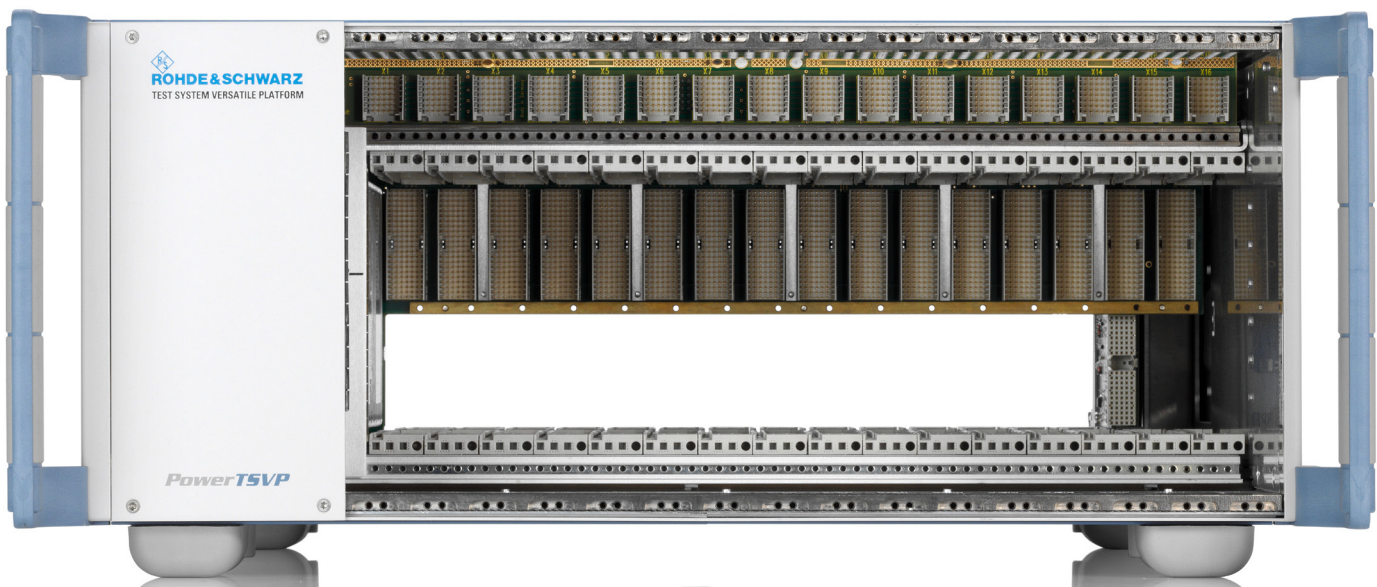

# PRODUCT INTRODUCTION

The analog measurement bus from the R&S®TSVP architecture routes general purpose signals from switching modules to various measurement and stimulus instruments.

The analog bus lines from an R&S®PowerTSVP chassis are connected to an R&S®TSVP master chassis for signal acquisition and various measurements by means of the R&S®TS-PK01 analog bus extension cable.

The R&S®PowerTSVP is an industrial chassis including one power supply, with space for an additional power supply in adherence to the identical concept for the R&S®CompactTSVP. The serial control backplane provides 16 slots for CAN based R&S®TSVP modules and includes the system-wide trigger support.

The CAN bus remote control is implemented as the R&S®TS-PSYS2 system control module which is part of the R&S®PowerTSVP.

This remote connection is provided as an accessory as well (R&S®TS-PK02; cable from R&S®TS-PSYS1 to R&S®TS-PSYS2).

Power switching and the interconnection of external power supplies and electronic loads to DUTs are provided via the optional R&S®TSVP power switching modules.

Power signal handling is usually not possible inside laboratory equipment. With a remote power switching unit such as the R&S®PowerTSVP, it is possible to prepare adaptations close to the DUT power signals or adjacent to power supplies and loads.

# R&S®TSVP MODULE FORMATS AND FEATURES

The main objective behind the R&S®PowerTSVP is to offer an inherently flexible and cost-effective modular test and measurement platform. The performance of the platform product should be sophisticated enough that even VXI test system applications can be addressed by the platform technology. Although tight integration and electronic miniaturization help when building powerful devices with smaller footprints, available board space is still a major issue.

The board space of a 3 HU CompactPCI or PXI module is the same as the Eurocard mechanical packaging measuring 160 mm × 100 mm (length × height). Therefore, the R&S®TSVP module format was extended by 130 mm in length to bring primary switching and signal conditioning on board.

## Analog measurement bus

The analog measurement bus offers short routing of signals to the measurement modules and electrical immunity to the digital signals on the backplane.

The eight lines of the system-wide analog measurement bus are available at all peripheral slots. They are used to temporarily interconnect DUT signals routed via switching modules and various measurement or stimulus modules that have access to the analog measurement bus.

The multilayer backplane implements three-dimensional shielding with adjacent ground lines for optimized signal quality and seamless signal interconnection. The connectors to the modules are implemented as modified C-module connectors (2 mm metric system).

The analog bus is located directly above the front connector area where space is provided for onboard signal conditioning and signal routing by means of coupling relays for the analog bus.

## General concept of the R&S®PowerTSVP module format

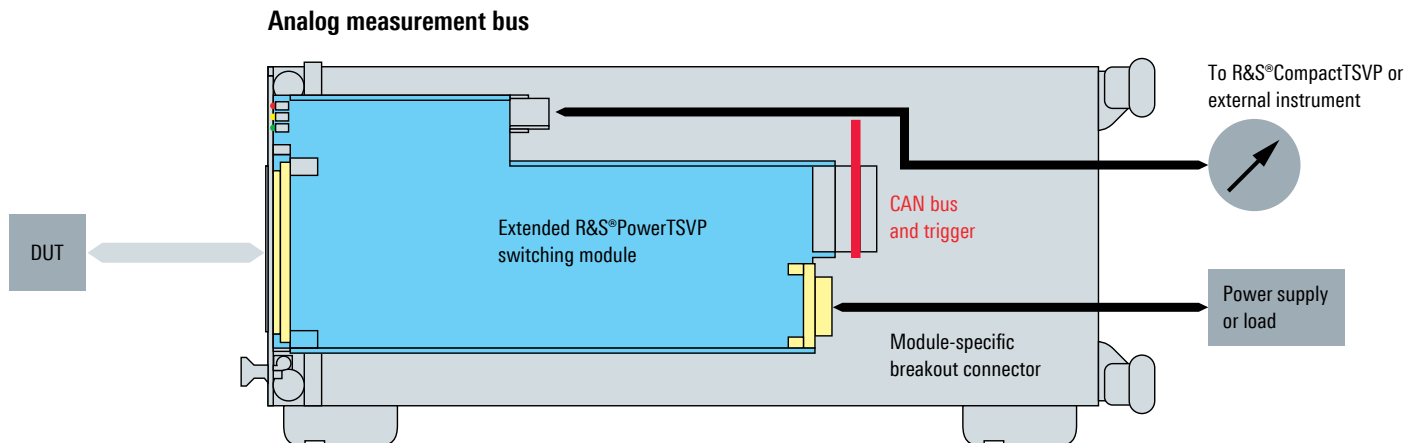

### Versatile backplane architecture

The R&S®PowerTSVP comprises the control backplane which provides 16 peripheral slots in line with the CAN bus specification CAN 2.0b.

The power-switching module offers a breakout connector to the rear side of the switching instrument. This rear side cabling is truly beneficial when deploying a 19" rack-mountable standard test adapter, which is available for the R&S®PowerTSVP as a set of off-the-shelf products, ready for use in production test applications.

Slots 1 to 16 also include the system wide triggering and a high-precision system clock of 10 MHz for synchronization.

### Variable power backplane

The R&S®PowerTSVP chassis offers space for two power supply slots which are implemented as CompactPCI power interfaces in line with the PICMG 2.11 Rev. 1.0 standard.

The power interface at slots A3 and A4 is equipped with one R&S®TS-PPS1 module.

The adjacent slots A1 and A2 can be used to extend the available power by means of the R&S®TS-PCPA extension kit, which includes one power supply unit, backplane extension and cabling. This feature can be used for optimized availability or current sharing for fully equipped chassis configurations that require an extended power budget.

### System backplane architecture of the R&S®PowerTSVP

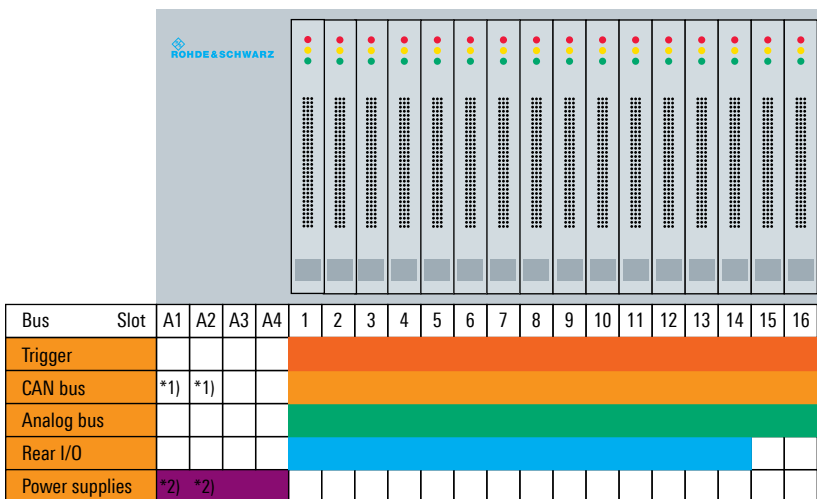

\*1) with R&S®TS-PXB2 option  
 \*2) with R&S®TS-PCPA option

### Cooling considerations for secure operation

The slot area is equipped with four radial low-noise fans. The fans are mounted above the slot area and deliver consistent airflow from bottom to top. The fans are temperature controlled, and the temperature inside the R&S®PowerTSVP chassis is measured at four locations.

### Test adapter accessories

To accelerate incorporation of the R&S®PowerTSVP into production test environments in a quick and cost effective manner, an entire set of mass interconnection support products has been created. The platform modules are equipped with a 96-pin DIN41612 connector which is easy to manipulate and convenient for wiring. The interfacing of the R&S®TS-PAD4 test adapter receiver frame to the R&S®PFPID4 interchangeable test adapter frame is implemented by the R&S®TS-PAX4 signal modules on the test instrument side.

### Test adapter accessories

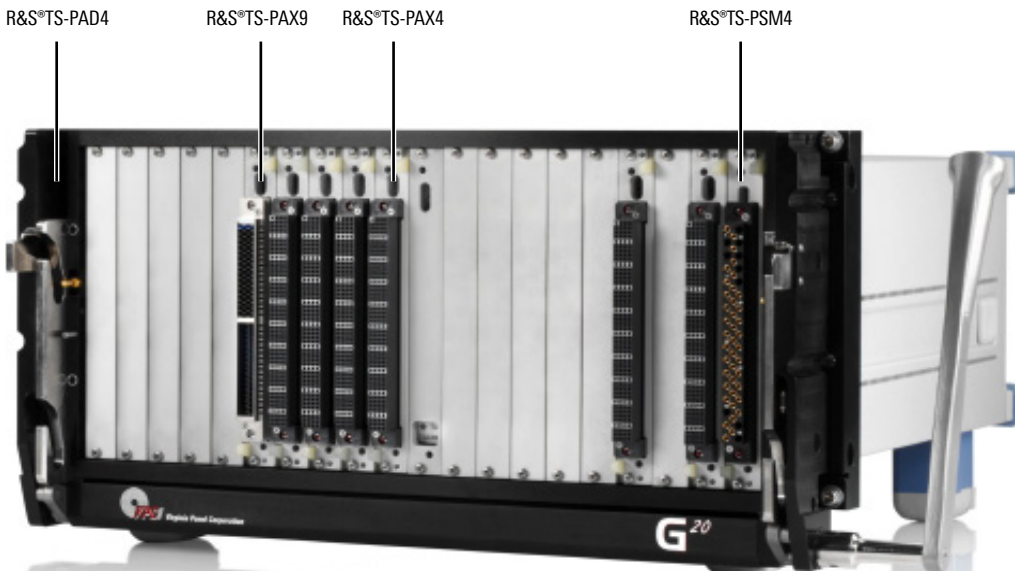

### Serial system control module with CAN bus

To allow relay based switching modules offered as part of the R&S®TSVP product family to be deployed, the back-plane is equipped with a CAN serial communications bus at slots 1 to 16.

The low-noise and interference resistant CAN bus ensures high reliability and high signal quality. In addition, the interfaces for switching modules have been simplified significantly while still providing sufficient performance for setting up switching paths using mechanical relays.

In line with Rohde&Schwarz overall commitment to industrial standards, various reliable and high-performance serial communications standards are available to choose from. One straightforward approach is the deployment of a CAN bus, which has been used successfully in automotive electronics for many years.

The interface is physically implemented as a rear transmission module (RTM) – the R&S®TS-PSYS2 system control module – located at the rear side of slot 15. The module is included with the R&S®PowerTSVP and contains additional system administration functionalities such as temperature monitoring and digital I/O lines to interface automation devices with 24 V digital I/O levels.

The R&S®TS-PSYS2 system control module is used to route the CAN bus to the internal R&S®PowerTSVP switching modules which are based on the cost efficient CAN bus remote control.

### Block diagram of the R&S®TS-PSYS2 CAN bus system control module

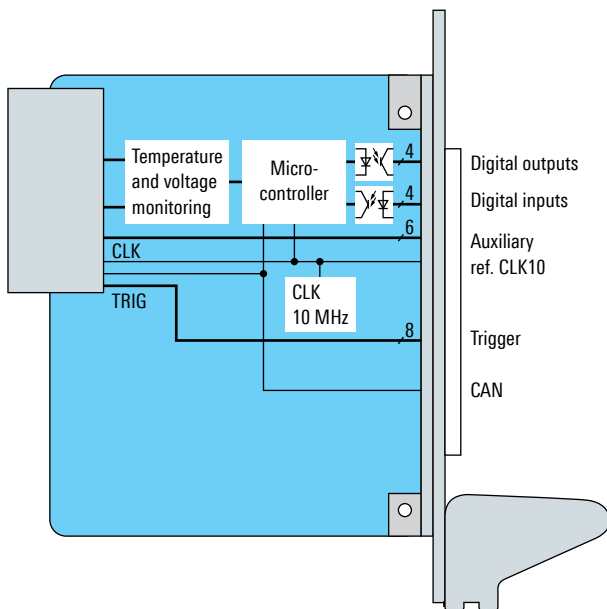

# SOFTWARE SUPPORT

The R&S®TS-PSYS2 system control module is configured and controlled by a device driver DLL. Function panels and online help are available as common features for the LabWindows/CVI driver software.

As with every modular instrumentation product in the R&S®TSVP family, a soft front panel is provided.

# SECURITY BY SELF-TEST AND DIAGNOSTICS FEATURES

The built-in self-test capability of the R&S®TS-PSYS2 system control module includes automated evaluation of module functionality.

The comprehensive self-test software concept using an R&S®TS-PSAM instrument module provides ready-to-run self-test sequences for every R&S®TSVP platform product.

Soft front panel of the R&S®TS-PSYS2 system control module.

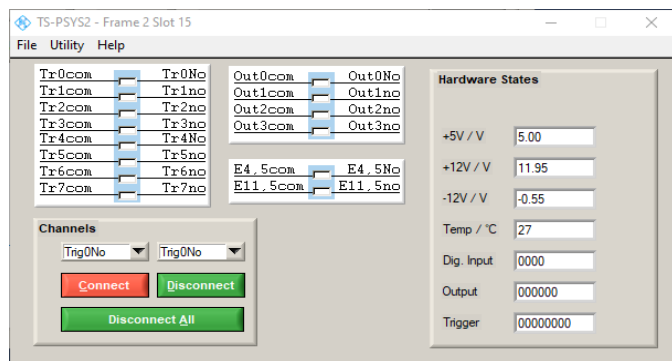

A comprehensive self-test program is provided for the R&S®TS-PSYS2 system control module.

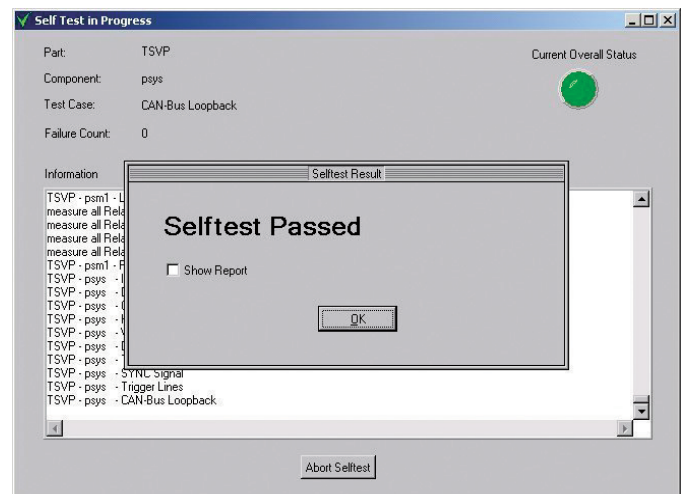



# SYSTEM LAYOUT

## R&S®CompactTSVP and R&S®PowerTSVP

The combination of the R&S®CompactTSVP and the R&S®PowerTSVP stands for high performance and high pin count ATE systems. For high-power applications, the parts of a system that handle signals with high currents or high voltages can be separated to ensure a safe distance from the R&S®CompactTSVP as a dedicated measurement unit.

R&S®CompactTSVP

R&S®PowerTSVP



## R&S®PowerTSVP

Medium pin count ATE with an external standard PC using a CAN bus interface to control the R&S®PowerTSVP chassis. The CAN interface can be based on various standard interfaces such as USB to CAN. With this application scenario, correctly dimensioned switching applications can be used for various requirements ranging from general purpose signals, high power load and power supply switching.



# SPECIFICATIONS

## Specifications

### Control backplane

Bus systems	trigger bus, 8 signals	CAN 2.0b, 1 Mbit
Slots 1 to 16		16 peripheral slots for CAN bus controlled modules
Slots A3 and A4		1 power supply for CompactPCI, P47 connector (2 slots wide)
Slots A1 and A2		2 extensions such as for redundant power supply, DUT supply
<b>System control module</b>	R&S®TS-PSYS2	rear I/O interface for CAN bus (CAN 2.0b)
		4 outputs, PhotoMOS relay, 42 V, 200 mA
		4 inputs, optocoupler, 2.4 V to 42 V, 5 mA
		2 switchable external supply voltages: ▶ 1157.8508.02 X30.20: 4.5 V, X30.21: 11.5 V ▶ 1157.9910.20 X30.20: 5.0 V, X30.21: 12.0 V
		8 switchable external trigger inputs/outputs
		4 monitoring lines: temperature, 5 V, +12 V, -12 V
		buffered clock
		10 MHz, $\pm(1.5 \text{ ppm} + 1 \text{ ppm/year})$

### Analog measurement bus backplane

Analog bus lines		8 (breakout connector at rear side)
Voltage	DC	max. 120 V
	AC	max. 50 V (RMS)
Current		max. 1 A
Bandwidth		typ. 40 MHz (3 dB)
Crosstalk		typ. < -60 dB (100 kHz), typ. < -45 dB (1 MHz), typ. < -26 dB (10 MHz)

### AC power supply

AC power supply module	modular device for standard CompactPCI power interface	250 W, P47 connector
Input voltage		100 V to 240 V $\pm 10\%$ (AC)
Input frequency		50 Hz to 60 Hz $\pm 5\%$
Power consumption		max. 250 VA
Output voltages	+3.3 V	40 A
	+5 V	40 A
	+12 V	5.5 A
	-12 V	2 A

### Power consumption frame including R&S®TS-PSYS2

	+3.3 V	typ. 1 mA
	+5 V	typ. 750 mA
	+12 V	typ. 500 mA
	-12 V	typ. 1 mA

### General data

Environmental conditions		
Temperature	operating temperature range	+5°C to +40°C
	storage temperature range	-10°C to +60°C
Damp heat		+40°C, 80% rel. humidity, steady state, in line with EN 60068-2-78
Altitude	operating	up to 2000 m

## Specifications

### Mechanical resistance

Vibration	sinusoidal	in line with EN 60068-2-6, frequency range: 5 Hz to 55 Hz, displacement: 0.3 mm (peak-to-peak) (1.8 g at 55 Hz), frequency range: 55 Hz to 150 Hz, acceleration: 0.5 g constant
	random	in line with EN 60068-2-64, 8 Hz to 500 Hz, acceleration 1.2 g (RMS); 5 min/axis
Shock		shock test in line with MIL-STD-810G, method 516.6, procedure I: shock response spectrum ramp 6 dB/octave up to 45 Hz, 45 Hz to 2000 Hz: max. 40 g

### Product conformity

Electromagnetic compatibility	EU: in line with EMC Directive 2014/30/EC	applied harmonized standards: ► EN 61326-1 (industrial environment) ► EN 61326-2-1 ► EN 55011 Group 1, Class A
Electrical safety	EU: in line with Low Voltage Directive 2014/35/EC	applied harmonized standard: EN 61010-1
	USA	applied standard: UL 61010
	Canada	applied standard: CSA-C22.2 No. 61010-1
RoHS	EU: in line with the restriction of the use of hazardous substances in electrical and electronic equipment 2011/65/EU	compliant; applied harmonized standard: EN IEC 63000
Dimensions	W × H × D	465 mm × 193 mm × 517 mm (18.31 in × 7.60 in × 20.35 in) (19", 4 HU)
Weight	base unit	11 kg (24.25 lb)
	with typical options	18 kg (39.68 lb)

# ORDERING INFORMATION

Designation	Type	Order number
R&S®PowerTSVP industrial high-power and switching application chassis	R&S®TSVP	1157.8043.02
<b>Related products</b>		
Power supply extension kit, includes power supply, power backplane and cabling	R&S®TS-PCPA	1165.1509.02
Analog bus extension cable	R&S®TS-PK01	1166.4147.02
RF shielding kit	R&S®TS-PSK1	1157.9004.02
Backplane extension module, CAN bus, 2 slots	R&S®TS-PXB2	1512.3600.02
CAN bus control cable	R&S®TS-PK02	1166.4160.02
Cable set	R&S®TS-PK04P	1157.9104.03
19" adapter, 4 HU	R&S®ZZA-411	1096.3283.00

Your local Rohde&Schwarz expert will help you determine the optimum solution for your requirements. To find your nearest Rohde&Schwarz representative, visit [www.sales.rohde-schwarz.com](http://www.sales.rohde-schwarz.com)

## Service that adds value

- ▶ Worldwide
- ▶ Local and personalized
- ▶ Customized and flexible
- ▶ Uncompromising quality
- ▶ Long-term dependability

## Rohde & Schwarz

The Rohde&Schwarz technology group is among the trailblazers when it comes to paving the way for a safer and connected world with its leading solutions in test & measurement, technology systems and networks & cybersecurity. Founded more than 85 years ago, the group is a reliable partner for industry and government customers around the globe. The independent company is headquartered in Munich, Germany and has an extensive sales and service network with locations in more than 70 countries.

[www.rohde-schwarz.com](http://www.rohde-schwarz.com)

## Sustainable product design

- ▶ Environmental compatibility and eco-footprint
- ▶ Energy efficiency and low emissions
- ▶ Longevity and optimized total cost of ownership

Certified Quality Management

**ISO 9001**

Certified Environmental Management

**ISO 14001**

## Rohde & Schwarz training

[www.training.rohde-schwarz.com](http://www.training.rohde-schwarz.com)

## Rohde & Schwarz customer support

[www.rohde-schwarz.com/support](http://www.rohde-schwarz.com/support)

