

R&S® FSVA/FSV Signal and Spectrum Analyzer Quick Start Guide



1321.3066.02 – 06

This manual describes the following R&S FSVA/FSV models with firmware version 3.30 and higher:

- R&S®FSVA4 (1321.3008K05)
- R&S®FSVA7 (1321.3008K08)
- R&S®FSVA13 (1321.3008K14)
- R&S®FSVA30 (1321.3008K31)
- R&S®FSVA40 (1321.3008K41)
- R&S®FSV4 (1321.3008K04)
- R&S®FSV7 (1321.3008K07)
- R&S®FSV13 (1321.3008K13)
- R&S®FSV30 (1321.3008K30)
- R&S®FSV40 (1321.3008K39/1321.3008K40)

It also applies to the following R&S®FSV models. However, note the differences described in [Chapter 1.5, "Notes for Users of R&S FSV 1307.9002Kxx Models"](#), on page 11.

- R&S®FSV3 (1307.9002K03)
- R&S®FSV7 (1307.9002K07)
- R&S®FSV13 (1307.9002K13)
- R&S®FSV30 (1307.9002K30)
- R&S®FSV40 (1307.9002K39/1307.9002K40)

© 2017 Rohde & Schwarz GmbH & Co. KG

Mühlendorfstr. 15, 81671 München, Germany

Phone: +49 89 41 29 - 0

Fax: +49 89 41 29 12 164

Email: info@rohde-schwarz.com

Internet: www.rohde-schwarz.com

Subject to change – Data without tolerance limits is not binding.

R&S® is a registered trademark of Rohde & Schwarz GmbH & Co. KG.

Trade names are trademarks of their owners.

Throughout this manual, products from Rohde & Schwarz are indicated without the ® symbol, e.g. R&S®FSV is indicated as R&S FSV.

Basic Safety Instructions

Always read through and comply with the following safety instructions!

All plants and locations of the Rohde & Schwarz group of companies make every effort to keep the safety standards of our products up to date and to offer our customers the highest possible degree of safety. Our products and the auxiliary equipment they require are designed, built and tested in accordance with the safety standards that apply in each case. Compliance with these standards is continuously monitored by our quality assurance system. The product described here has been designed, built and tested in accordance with the EC Certificate of Conformity and has left the manufacturer's plant in a condition fully complying with safety standards. To maintain this condition and to ensure safe operation, you must observe all instructions and warnings provided in this manual. If you have any questions regarding these safety instructions, the Rohde & Schwarz group of companies will be happy to answer them.

Furthermore, it is your responsibility to use the product in an appropriate manner. This product is designed for use solely in industrial and laboratory environments or, if expressly permitted, also in the field and must not be used in any way that may cause personal injury or property damage. You are responsible if the product is used for any purpose other than its designated purpose or in disregard of the manufacturer's instructions. The manufacturer shall assume no responsibility for such use of the product.

The product is used for its designated purpose if it is used in accordance with its product documentation and within its performance limits (see data sheet, documentation, the following safety instructions). Using the product requires technical skills and, in some cases, a basic knowledge of English. It is therefore essential that only skilled and specialized staff or thoroughly trained personnel with the required skills be allowed to use the product. If personal safety gear is required for using Rohde & Schwarz products, this will be indicated at the appropriate place in the product documentation. Keep the basic safety instructions and the product documentation in a safe place and pass them on to the subsequent users.

Observing the safety instructions will help prevent personal injury or damage of any kind caused by dangerous situations. Therefore, carefully read through and adhere to the following safety instructions before and when using the product. It is also absolutely essential to observe the additional safety instructions on personal safety, for example, that appear in relevant parts of the product documentation. In these safety instructions, the word "product" refers to all merchandise sold and distributed by the Rohde & Schwarz group of companies, including instruments, systems and all accessories. For product-specific information, see the data sheet and the product documentation.

Safety labels on products

The following safety labels are used on products to warn against risks and dangers.

Symbol	Meaning	Symbol	Meaning
	Notice, general danger location Observe product documentation		ON/OFF Power
	Caution when handling heavy equipment		Standby indication
	Danger of electric shock		Direct current (DC)

Basic Safety Instructions

Symbol	Meaning	Symbol	Meaning
	Caution ! Hot surface		Alternating current (AC)
	Protective conductor terminal To identify any terminal which is intended for connection to an external conductor for protection against electric shock in case of a fault, or the terminal of a protective earth		Direct/alternating current (DC/AC)
	Earth (Ground)		Class II Equipment to identify equipment meeting the safety requirements specified for Class II equipment (device protected by double or reinforced insulation)
	Frame or chassis Ground terminal		EU labeling for batteries and accumulators For additional information, see section "Waste disposal/Environmental protection", item 1.
	Be careful when handling electrostatic sensitive devices		EU labeling for separate collection of electrical and electronic devices For additional information, see section "Waste disposal/Environmental protection", item 2.
	Warning! Laser radiation For additional information, see section "Operation", item 7.		

Signal words and their meaning

The following signal words are used in the product documentation in order to warn the reader about risks and dangers.



Indicates a hazardous situation which, if not avoided, will result in death or serious injury.



Indicates a hazardous situation which, if not avoided, could result in death or serious injury.



Indicates a hazardous situation which, if not avoided, could result in minor or moderate injury.



Indicates information considered important, but not hazard-related, e.g. messages relating to property damage.

In the product documentation, the word ATTENTION is used synonymously.

These signal words are in accordance with the standard definition for civil applications in the European Economic Area. Definitions that deviate from the standard definition may also exist in other economic areas or military applications. It is therefore essential to make sure that the signal words described here are always used only in connection with the related product documentation and the related product. The use of signal words in connection with unrelated products or documentation can result in misinterpretation and in personal injury or material damage.

Basic Safety Instructions

Operating states and operating positions

The product may be operated only under the operating conditions and in the positions specified by the manufacturer, without the product's ventilation being obstructed. If the manufacturer's specifications are not observed, this can result in electric shock, fire and/or serious personal injury or death. Applicable local or national safety regulations and rules for the prevention of accidents must be observed in all work performed.

1. Unless otherwise specified, the following requirements apply to Rohde & Schwarz products: predefined operating position is always with the housing floor facing down, IP protection 2X, use only indoors, max. operating altitude 2000 m above sea level, max. transport altitude 4500 m above sea level. A tolerance of $\pm 10\%$ shall apply to the nominal voltage and $\pm 5\%$ to the nominal frequency, overvoltage category 2, pollution degree 2.
2. Do not place the product on surfaces, vehicles, cabinets or tables that for reasons of weight or stability are unsuitable for this purpose. Always follow the manufacturer's installation instructions when installing the product and fastening it to objects or structures (e.g. walls and shelves). An installation that is not carried out as described in the product documentation could result in personal injury or even death.
3. Do not place the product on heat-generating devices such as radiators or fan heaters. The ambient temperature must not exceed the maximum temperature specified in the product documentation or in the data sheet. Product overheating can cause electric shock, fire and/or serious personal injury or even death.

Electrical safety

If the information on electrical safety is not observed either at all or to the extent necessary, electric shock, fire and/or serious personal injury or death may occur.

1. Prior to switching on the product, always ensure that the nominal voltage setting on the product matches the nominal voltage of the mains-supply network. If a different voltage is to be set, the power fuse of the product may have to be changed accordingly.
2. In the case of products of safety class I with movable power cord and connector, operation is permitted only on sockets with a protective conductor contact and protective conductor.
3. Intentionally breaking the protective conductor either in the feed line or in the product itself is not permitted. Doing so can result in the danger of an electric shock from the product. If extension cords or connector strips are implemented, they must be checked on a regular basis to ensure that they are safe to use.
4. If there is no power switch for disconnecting the product from the mains, or if the power switch is not suitable for this purpose, use the plug of the connecting cable to disconnect the product from the mains. In such cases, always ensure that the power plug is easily reachable and accessible at all times. For example, if the power plug is the disconnecting device, the length of the connecting cable must not exceed 3 m. Functional or electronic switches are not suitable for providing disconnection from the AC supply network. If products without power switches are integrated into racks or systems, the disconnecting device must be provided at the system level.
5. Never use the product if the power cable is damaged. Check the power cables on a regular basis to ensure that they are in proper operating condition. By taking appropriate safety measures and carefully laying the power cable, ensure that the cable cannot be damaged and that no one can be hurt by, for example, tripping over the cable or suffering an electric shock.

Basic Safety Instructions

6. The product may be operated only from TN/TT supply networks fuse-protected with max. 16 A (higher fuse only after consulting with the Rohde & Schwarz group of companies).
7. Do not insert the plug into sockets that are dusty or dirty. Insert the plug firmly and all the way into the socket provided for this purpose. Otherwise, sparks that result in fire and/or injuries may occur.
8. Do not overload any sockets, extension cords or connector strips; doing so can cause fire or electric shocks.
9. For measurements in circuits with voltages $V_{rms} > 30$ V, suitable measures (e.g. appropriate measuring equipment, fuse protection, current limiting, electrical separation, insulation) should be taken to avoid any hazards.
10. Ensure that the connections with information technology equipment, e.g. PCs or other industrial computers, comply with the IEC 60950-1 / EN 60950-1 or IEC 61010-1 / EN 61010-1 standards that apply in each case.
11. Unless expressly permitted, never remove the cover or any part of the housing while the product is in operation. Doing so will expose circuits and components and can lead to injuries, fire or damage to the product.
12. If a product is to be permanently installed, the connection between the protective conductor terminal on site and the product's protective conductor must be made first before any other connection is made. The product may be installed and connected only by a licensed electrician.
13. For permanently installed equipment without built-in fuses, circuit breakers or similar protective devices, the supply circuit must be fuse-protected in such a way that anyone who has access to the product, as well as the product itself, is adequately protected from injury or damage.
14. Use suitable overvoltage protection to ensure that no overvoltage (such as that caused by a bolt of lightning) can reach the product. Otherwise, the person operating the product will be exposed to the danger of an electric shock.
15. Any object that is not designed to be placed in the openings of the housing must not be used for this purpose. Doing so can cause short circuits inside the product and/or electric shocks, fire or injuries.
16. Unless specified otherwise, products are not liquid-proof (see also section "Operating states and operating positions", item 1). Therefore, the equipment must be protected against penetration by liquids. If the necessary precautions are not taken, the user may suffer electric shock or the product itself may be damaged, which can also lead to personal injury.
17. Never use the product under conditions in which condensation has formed or can form in or on the product, e.g. if the product has been moved from a cold to a warm environment. Penetration by water increases the risk of electric shock.
18. Prior to cleaning the product, disconnect it completely from the power supply (e.g. AC supply network or battery). Use a soft, non-linting cloth to clean the product. Never use chemical cleaning agents such as alcohol, acetone or diluents for cellulose lacquers.

Operation

1. Operating the products requires special training and intense concentration. Make sure that persons who use the products are physically, mentally and emotionally fit enough to do so; otherwise, injuries or material damage may occur. It is the responsibility of the employer/operator to select suitable personnel for operating the products.

Basic Safety Instructions

2. Before you move or transport the product, read and observe the section titled "Transport".
3. As with all industrially manufactured goods, the use of substances that induce an allergic reaction (allergens) such as nickel cannot be generally excluded. If you develop an allergic reaction (such as a skin rash, frequent sneezing, red eyes or respiratory difficulties) when using a Rohde & Schwarz product, consult a physician immediately to determine the cause and to prevent health problems or stress.
4. Before you start processing the product mechanically and/or thermally, or before you take it apart, be sure to read and pay special attention to the section titled "Waste disposal/Environmental protection", item 1.
5. Depending on the function, certain products such as RF radio equipment can produce an elevated level of electromagnetic radiation. Considering that unborn babies require increased protection, pregnant women must be protected by appropriate measures. Persons with pacemakers may also be exposed to risks from electromagnetic radiation. The employer/operator must evaluate workplaces where there is a special risk of exposure to radiation and, if necessary, take measures to avert the potential danger.
6. Should a fire occur, the product may release hazardous substances (gases, fluids, etc.) that can cause health problems. Therefore, suitable measures must be taken, e.g. protective masks and protective clothing must be worn.
7. Laser products are given warning labels that are standardized according to their laser class. Lasers can cause biological harm due to the properties of their radiation and due to their extremely concentrated electromagnetic power. If a laser product (e.g. a CD/DVD drive) is integrated into a Rohde & Schwarz product, absolutely no other settings or functions may be used as described in the product documentation. The objective is to prevent personal injury (e.g. due to laser beams).
8. EMC classes (in line with EN 55011/CISPR 11, and analogously with EN 55022/CISPR 22, EN 55032/CISPR 32)
 - Class A equipment:
Equipment suitable for use in all environments except residential environments and environments that are directly connected to a low-voltage supply network that supplies residential buildings
Note: Class A equipment is intended for use in an industrial environment. This equipment may cause radio disturbances in residential environments, due to possible conducted as well as radiated disturbances. In this case, the operator may be required to take appropriate measures to eliminate these disturbances.
 - Class B equipment:
Equipment suitable for use in residential environments and environments that are directly connected to a low-voltage supply network that supplies residential buildings

Repair and service

1. The product may be opened only by authorized, specially trained personnel. Before any work is performed on the product or before the product is opened, it must be disconnected from the AC supply network. Otherwise, personnel will be exposed to the risk of an electric shock.

Basic Safety Instructions

- Adjustments, replacement of parts, maintenance and repair may be performed only by electrical experts authorized by Rohde & Schwarz. Only original parts may be used for replacing parts relevant to safety (e.g. power switches, power transformers, fuses). A safety test must always be performed after parts relevant to safety have been replaced (visual inspection, protective conductor test, insulation resistance measurement, leakage current measurement, functional test). This helps ensure the continued safety of the product.

Batteries and rechargeable batteries/cells

If the information regarding batteries and rechargeable batteries/cells is not observed either at all or to the extent necessary, product users may be exposed to the risk of explosions, fire and/or serious personal injury, and, in some cases, death. Batteries and rechargeable batteries with alkaline electrolytes (e.g. lithium cells) must be handled in accordance with the EN 62133 standard.

- Cells must not be taken apart or crushed.
- Cells or batteries must not be exposed to heat or fire. Storage in direct sunlight must be avoided. Keep cells and batteries clean and dry. Clean soiled connectors using a dry, clean cloth.
- Cells or batteries must not be short-circuited. Cells or batteries must not be stored in a box or in a drawer where they can short-circuit each other, or where they can be short-circuited by other conductive materials. Cells and batteries must not be removed from their original packaging until they are ready to be used.
- Cells and batteries must not be exposed to any mechanical shocks that are stronger than permitted.
- If a cell develops a leak, the fluid must not be allowed to come into contact with the skin or eyes. If contact occurs, wash the affected area with plenty of water and seek medical aid.
- Improperly replacing or charging cells or batteries that contain alkaline electrolytes (e.g. lithium cells) can cause explosions. Replace cells or batteries only with the matching Rohde & Schwarz type (see parts list) in order to ensure the safety of the product.
- Cells and batteries must be recycled and kept separate from residual waste. Rechargeable batteries and normal batteries that contain lead, mercury or cadmium are hazardous waste. Observe the national regulations regarding waste disposal and recycling.
- Follow the transport stipulations of the carrier (IATA-DGR, IMDG-Code, ADR, RID) when returning lithium batteries to Rohde & Schwarz subsidiaries.

Transport

- The product may be very heavy. Therefore, the product must be handled with care. In some cases, the user may require a suitable means of lifting or moving the product (e.g. with a lift-truck) to avoid back or other physical injuries.
- Handles on the products are designed exclusively to enable personnel to transport the product. It is therefore not permissible to use handles to fasten the product to or on transport equipment such as cranes, fork lifts, wagons, etc. The user is responsible for securely fastening the products to or on the means of transport or lifting. Observe the safety regulations of the manufacturer of the means of transport or lifting. Noncompliance can result in personal injury or material damage.

Instrucciones de seguridad elementales

3. If you use the product in a vehicle, it is the sole responsibility of the driver to drive the vehicle safely and properly. The manufacturer assumes no responsibility for accidents or collisions. Never use the product in a moving vehicle if doing so could distract the driver of the vehicle. Adequately secure the product in the vehicle to prevent injuries or other damage in the event of an accident.

Waste disposal/Environmental protection

1. Specially marked equipment has a battery or accumulator that must not be disposed of with unsorted municipal waste, but must be collected separately. It may only be disposed of at a suitable collection point or via a Rohde & Schwarz customer service center.
2. Waste electrical and electronic equipment must not be disposed of with unsorted municipal waste, but must be collected separately.
Rohde & Schwarz GmbH & Co. KG has developed a disposal concept and takes full responsibility for take-back obligations and disposal obligations for manufacturers within the EU. Contact your Rohde & Schwarz customer service center for environmentally responsible disposal of the product.
3. If products or their components are mechanically and/or thermally processed in a manner that goes beyond their intended use, hazardous substances (heavy-metal dust such as lead, beryllium, nickel) may be released. For this reason, the product may only be disassembled by specially trained personnel. Improper disassembly may be hazardous to your health. National waste disposal regulations must be observed.
4. If handling the product releases hazardous substances or fuels that must be disposed of in a special way, e.g. coolants or engine oils that must be replenished regularly, the safety instructions of the manufacturer of the hazardous substances or fuels and the applicable regional waste disposal regulations must be observed. Also observe the relevant safety instructions in the product documentation. The improper disposal of hazardous substances or fuels can cause health problems and lead to environmental damage.

For additional information about environmental protection, visit the Rohde & Schwarz website.

Instrucciones de seguridad elementales

¡Es imprescindible leer y cumplir las siguientes instrucciones e informaciones de seguridad!

El principio del grupo de empresas Rohde & Schwarz consiste en tener nuestros productos siempre al día con los estándares de seguridad y de ofrecer a nuestros clientes el máximo grado de seguridad. Nuestros productos y todos los equipos adicionales son siempre fabricados y examinados según las normas de seguridad vigentes. Nuestro sistema de garantía de calidad controla constantemente que sean cumplidas estas normas. El presente producto ha sido fabricado y examinado según el certificado de conformidad de la UE y ha salido de nuestra planta en estado impecable según los estándares técnicos de seguridad. Para poder preservar este estado y garantizar un funcionamiento libre de peligros, el usuario deberá atenerse a todas las indicaciones, informaciones de seguridad y notas de alerta. El grupo de empresas Rohde & Schwarz está siempre a su disposición en caso de que tengan preguntas referentes a estas informaciones de seguridad.

Instrucciones de seguridad elementales











Además queda en la responsabilidad del usuario utilizar el producto en la forma debida. Este producto está destinado exclusivamente al uso en la industria y el laboratorio o, si ha sido expresamente autorizado, para aplicaciones de campo y de ninguna manera deberá ser utilizado de modo que alguna persona/cosa pueda sufrir daño. El uso del producto fuera de sus fines definidos o sin tener en cuenta las instrucciones del fabricante queda en la responsabilidad del usuario. El fabricante no se hace en ninguna forma responsable de consecuencias a causa del mal uso del producto.

Se parte del uso correcto del producto para los fines definidos si el producto es utilizado conforme a las indicaciones de la correspondiente documentación del producto y dentro del margen de rendimiento definido (ver hoja de datos, documentación, informaciones de seguridad que siguen). El uso del producto hace necesarios conocimientos técnicos y ciertos conocimientos del idioma inglés. Por eso se debe tener en cuenta que el producto solo pueda ser operado por personal especializado o personas instruidas en profundidad con las capacidades correspondientes. Si fuera necesaria indumentaria de seguridad para el uso de productos de Rohde & Schwarz, encontraría la información debida en la documentación del producto en el capítulo correspondiente. Guarde bien las informaciones de seguridad elementales, así como la documentación del producto, y entréguelas a usuarios posteriores.







Tener en cuenta las informaciones de seguridad sirve para evitar en lo posible lesiones o daños por peligros de toda clase. Por eso es imprescindible leer detalladamente y comprender por completo las siguientes informaciones de seguridad antes de usar el producto, y respetarlas durante el uso del producto. Deberán tenerse en cuenta todas las demás informaciones de seguridad, como p. ej. las referentes a la protección de personas, que encontrarán en el capítulo correspondiente de la documentación del producto y que también son de obligado cumplimiento. En las presentes informaciones de seguridad se recogen todos los objetos que distribuye el grupo de empresas Rohde & Schwarz bajo la denominación de "producto", entre ellos también aparatos, instalaciones así como toda clase de accesorios. Los datos específicos del producto figuran en la hoja de datos y en la documentación del producto.

Señalización de seguridad de los productos

Las siguientes señales de seguridad se utilizan en los productos para advertir sobre riesgos y peligros.

Símbolo	Significado	Símbolo	Significado
	Aviso: punto de peligro general Observar la documentación del producto		Tensión de alimentación de PUESTA EN MARCHA / PARADA
	Atención en el manejo de dispositivos de peso elevado		Indicación de estado de espera (standby)
	Peligro de choque eléctrico		Corriente continua (DC)
	Advertencia: superficie caliente		Corriente alterna (AC)
	Conexión a conductor de protección		Corriente continua / Corriente alterna (DC/AC)

Instrucciones de seguridad elementales

Símbolo	Significado	Símbolo	Significado
	Conexión a tierra		El aparato está protegido en su totalidad por un aislamiento doble (reforzado)
	Conexión a masa		Distintivo de la UE para baterías y acumuladores Más información en la sección "Eliminación/protección del medio ambiente", punto 1.
	Aviso: Cuidado en el manejo de dispositivos sensibles a la electrostática (ESD)		Distintivo de la UE para la eliminación por separado de dispositivos eléctricos y electrónicos Más información en la sección "Eliminación/protección del medio ambiente", punto 2.
	Advertencia: rayo láser Más información en la sección "Funcionamiento", punto 7.		

Palabras de señal y su significado

En la documentación del producto se utilizan las siguientes palabras de señal con el fin de advertir contra riesgos y peligros.



Indica una situación de peligro que, si no se evita, causa lesiones graves o incluso la muerte.



Indica una situación de peligro que, si no se evita, puede causar lesiones graves o incluso la muerte.



Indica una situación de peligro que, si no se evita, puede causar lesiones leves o moderadas.



Indica información que se considera importante, pero no en relación con situaciones de peligro; p. ej., avisos sobre posibles daños materiales.

En la documentación del producto se emplea de forma sinónima el término CUIDADO.

Las palabras de señal corresponden a la definición habitual para aplicaciones civiles en el área económica europea. Pueden existir definiciones diferentes a esta definición en otras áreas económicas o en aplicaciones militares. Por eso se deberá tener en cuenta que las palabras de señal aquí descritas sean utilizadas siempre solamente en combinación con la correspondiente documentación del producto y solamente en combinación con el producto correspondiente. La utilización de las palabras de señal en combinación con productos o documentaciones que no les correspondan puede llevar a interpretaciones equivocadas y tener por consecuencia daños en personas u objetos.

Instrucciones de seguridad elementales

Estados operativos y posiciones de funcionamiento

El producto solamente debe ser utilizado según lo indicado por el fabricante respecto a los estados operativos y posiciones de funcionamiento sin que se obstruya la ventilación. Si no se siguen las indicaciones del fabricante, pueden producirse choques eléctricos, incendios y/o lesiones graves con posible consecuencia de muerte. En todos los trabajos deberán ser tenidas en cuenta las normas nacionales y locales de seguridad del trabajo y de prevención de accidentes.

1. Si no se convino de otra manera, es para los productos Rohde & Schwarz válido lo que sigue: como posición de funcionamiento se define por principio la posición con el suelo de la caja para abajo, modo de protección IP 2X, uso solamente en estancias interiores, utilización hasta 2000 m sobre el nivel del mar, transporte hasta 4500 m sobre el nivel del mar. Se aplicará una tolerancia de $\pm 10\%$ sobre el voltaje nominal y de $\pm 5\%$ sobre la frecuencia nominal. Categoría de sobrecarga eléctrica 2, índice de suciedad 2.
2. No sitúe el producto encima de superficies, vehículos, estantes o mesas, que por sus características de peso o de estabilidad no sean aptos para él. Siga siempre las instrucciones de instalación del fabricante cuando instale y asegure el producto en objetos o estructuras (p. ej. paredes y estantes). Si se realiza la instalación de modo distinto al indicado en la documentación del producto, se pueden causar lesiones o, en determinadas circunstancias, incluso la muerte.
3. No ponga el producto sobre aparatos que generen calor (p. ej. radiadores o calefactores). La temperatura ambiente no debe superar la temperatura máxima especificada en la documentación del producto o en la hoja de datos. En caso de sobrecalentamiento del producto, pueden producirse choques eléctricos, incendios y/o lesiones graves con posible consecuencia de muerte.

Seguridad eléctrica

Si no se siguen (o se siguen de modo insuficiente) las indicaciones del fabricante en cuanto a seguridad eléctrica, pueden producirse choques eléctricos, incendios y/o lesiones graves con posible consecuencia de muerte.

1. Antes de la puesta en marcha del producto se deberá comprobar siempre que la tensión preseleccionada en el producto coincida con la de la red de alimentación eléctrica. Si es necesario modificar el ajuste de tensión, también se deberán cambiar en caso dado los fusibles correspondientes del producto.
2. Los productos de la clase de protección I con alimentación móvil y enchufe individual solamente podrán enchufarse a tomas de corriente con contacto de seguridad y con conductor de protección conectado.
3. Queda prohibida la interrupción intencionada del conductor de protección, tanto en la toma de corriente como en el mismo producto. La interrupción puede tener como consecuencia el riesgo de que el producto sea fuente de choques eléctricos. Si se utilizan cables alargadores o regletas de enchufe, deberá garantizarse la realización de un examen regular de los mismos en cuanto a su estado técnico de seguridad.
4. Si el producto no está equipado con un interruptor para desconectarlo de la red, o bien si el interruptor existente no resulta apropiado para la desconexión de la red, el enchufe del cable de conexión se deberá considerar como un dispositivo de desconexión. El dispositivo de desconexión se debe poder alcanzar fácilmente y debe estar siempre bien accesible. Si, p. ej., el enchufe de conexión a la red es el dispositivo de desconexión, la longitud del cable de conexión no debe superar 3 m).
Los interruptores selectores o electrónicos no son aptos para el corte de la red eléctrica. Si se

Instrucciones de seguridad elementales

integran productos sin interruptor en bastidores o instalaciones, se deberá colocar el interruptor en el nivel de la instalación.

5. No utilice nunca el producto si está dañado el cable de conexión a red. Compruebe regularmente el correcto estado de los cables de conexión a red. Asegúrese, mediante las medidas de protección y de instalación adecuadas, de que el cable de conexión a red no pueda ser dañado o de que nadie pueda ser dañado por él, p. ej. al tropezar o por un choque eléctrico.
6. Solamente está permitido el funcionamiento en redes de alimentación TN/TT aseguradas con fusibles de 16 A como máximo (utilización de fusibles de mayor amperaje solo previa consulta con el grupo de empresas Rohde & Schwarz).
7. Nunca conecte el enchufe en tomas de corriente sucias o llenas de polvo. Introduzca el enchufe por completo y fuertemente en la toma de corriente. La no observación de estas medidas puede provocar chispas, fuego y/o lesiones.
8. No sobrecargue las tomas de corriente, los cables alargadores o las regletas de enchufe ya que esto podría causar fuego o choques eléctricos.
9. En las mediciones en circuitos de corriente con una tensión $U_{\text{eff}} > 30 \text{ V}$ se deberán tomar las medidas apropiadas para impedir cualquier peligro (p. ej. medios de medición adecuados, seguros, limitación de tensión, corte protector, aislamiento etc.).
10. Para la conexión con dispositivos informáticos como un PC o un ordenador industrial, debe comprobarse que éstos cumplan los estándares IEC60950-1/EN60950-1 o IEC61010-1/EN 61010-1 válidos en cada caso.
11. A menos que esté permitido expresamente, no retire nunca la tapa ni componentes de la carcasa mientras el producto esté en servicio. Esto pone a descubierto los cables y componentes eléctricos y puede causar lesiones, fuego o daños en el producto.
12. Si un producto se instala en un lugar fijo, se deberá primero conectar el conductor de protección fijo con el conductor de protección del producto antes de hacer cualquier otra conexión. La instalación y la conexión deberán ser efectuadas por un electricista especializado.
13. En el caso de dispositivos fijos que no estén provistos de fusibles, interruptor automático ni otros mecanismos de seguridad similares, el circuito de alimentación debe estar protegido de modo que todas las personas que puedan acceder al producto, así como el producto mismo, estén a salvo de posibles daños.
14. Todo producto debe estar protegido contra sobretensión (debida p. ej. a una caída del rayo) mediante los correspondientes sistemas de protección. Si no, el personal que lo utilice quedará expuesto al peligro de choque eléctrico.
15. No debe introducirse en los orificios de la caja del aparato ningún objeto que no esté destinado a ello. Esto puede producir cortocircuitos en el producto y/o puede causar choques eléctricos, fuego o lesiones.
16. Salvo indicación contraria, los productos no están impermeabilizados (ver también el capítulo "Estados operativos y posiciones de funcionamiento", punto 1). Por eso es necesario tomar las medidas necesarias para evitar la entrada de líquidos. En caso contrario, existe peligro de choque eléctrico para el usuario o de daños en el producto, que también pueden redundar en peligro para las personas.

Instrucciones de seguridad elementales

17. No utilice el producto en condiciones en las que pueda producirse o ya se hayan producido condensaciones sobre el producto o en el interior de éste, como p. ej. al desplazarlo de un lugar frío a otro caliente. La entrada de agua aumenta el riesgo de choque eléctrico.
18. Antes de la limpieza, desconecte por completo el producto de la alimentación de tensión (p. ej. red de alimentación o batería). Realice la limpieza de los aparatos con un paño suave, que no se deshilache. No utilice bajo ningún concepto productos de limpieza químicos como alcohol, acetona o diluyentes para lacas nitrocelulósicas.

Funcionamiento

1. El uso del producto requiere instrucciones especiales y una alta concentración durante el manejo. Debe asegurarse que las personas que manejen el producto estén a la altura de los requerimientos necesarios en cuanto a aptitudes físicas, psíquicas y emocionales, ya que de otra manera no se pueden excluir lesiones o daños de objetos. El empresario u operador es responsable de seleccionar el personal usuario apto para el manejo del producto.
2. Antes de desplazar o transportar el producto, lea y tenga en cuenta el capítulo "Transporte".
3. Como con todo producto de fabricación industrial no puede quedar excluida en general la posibilidad de que se produzcan alergias provocadas por algunos materiales empleados —los llamados alérgenos (p. ej. el níquel)—. Si durante el manejo de productos Rohde & Schwarz se producen reacciones alérgicas, como p. ej. irritaciones cutáneas, estornudos continuos, enrojecimiento de la conjuntiva o dificultades respiratorias, debe avisarse inmediatamente a un médico para investigar las causas y evitar cualquier molestia o daño a la salud.
4. Antes de la manipulación mecánica y/o térmica o el desmontaje del producto, debe tenerse en cuenta imprescindiblemente el capítulo "Eliminación/protección del medio ambiente", punto 1.
5. Ciertos productos, como p. ej. las instalaciones de radiocomunicación RF, pueden a causa de su función natural, emitir una radiación electromagnética aumentada. Deben tomarse todas las medidas necesarias para la protección de las mujeres embarazadas. También las personas con marcapasos pueden correr peligro a causa de la radiación electromagnética. El empresario/operador tiene la obligación de evaluar y señalar las áreas de trabajo en las que exista un riesgo elevado de exposición a radiaciones.
6. Tenga en cuenta que en caso de incendio pueden desprenderse del producto sustancias tóxicas (gases, líquidos etc.) que pueden generar daños a la salud. Por eso, en caso de incendio deben usarse medidas adecuadas, como p. ej. máscaras antigás e indumentaria de protección.
7. Los productos con láser están provistos de indicaciones de advertencia normalizadas en función de la clase de láser del que se trate. Los rayos láser pueden provocar daños de tipo biológico a causa de las propiedades de su radiación y debido a su concentración extrema de potencia electromagnética. En caso de que un producto Rohde & Schwarz contenga un producto láser (p. ej. un lector de CD/DVD), no debe usarse ninguna otra configuración o función aparte de las descritas en la documentación del producto, a fin de evitar lesiones (p. ej. debidas a irradiación láser).
8. Clases de compatibilidad electromagnética (conforme a EN 55011 / CISPR 11; y en analogía con EN 55022 / CISPR 22, EN 55032 / CISPR 32)
 - Aparato de clase A:
Aparato adecuado para su uso en todos los entornos excepto en los residenciales y en aquellos conectados directamente a una red de distribución de baja tensión que suministra corriente a edificios residenciales.
Nota: Los aparatos de clase A están destinados al uso en entornos industriales. Estos aparatos

Instrucciones de seguridad elementales

pueden causar perturbaciones radioeléctricas en entornos residenciales debido a posibles perturbaciones guiadas o radiadas. En este caso, se le podrá solicitar al operador que tome las medidas adecuadas para eliminar estas perturbaciones.

- Aparato de clase B:
Aparato adecuado para su uso en entornos residenciales, así como en aquellos conectados directamente a una red de distribución de baja tensión que suministra corriente a edificios residenciales.

Reparación y mantenimiento

1. El producto solamente debe ser abierto por personal especializado con autorización para ello. Antes de manipular el producto o abrirlo, es obligatorio desconectarlo de la tensión de alimentación, para evitar toda posibilidad de choque eléctrico.
2. El ajuste, el cambio de partes, el mantenimiento y la reparación deberán ser efectuadas solamente por electricistas autorizados por Rohde & Schwarz. Si se reponen partes con importancia para los aspectos de seguridad (p. ej. el enchufe, los transformadores o los fusibles), solamente podrán ser sustituidos por partes originales. Después de cada cambio de partes relevantes para la seguridad deberá realizarse un control de seguridad (control a primera vista, control del conductor de protección, medición de resistencia de aislamiento, medición de la corriente de fuga, control de funcionamiento). Con esto queda garantizada la seguridad del producto.

Baterías y acumuladores o celdas

Si no se siguen (o se siguen de modo insuficiente) las indicaciones en cuanto a las baterías y acumuladores o celdas, pueden producirse explosiones, incendios y/o lesiones graves con posible consecuencia de muerte. El manejo de baterías y acumuladores con electrolitos alcalinos (p. ej. celdas de litio) debe seguir el estándar EN 62133.

1. No deben desmontarse, abrirse ni triturarse las celdas.
2. Las celdas o baterías no deben someterse a calor ni fuego. Debe evitarse el almacenamiento a la luz directa del sol. Las celdas y baterías deben mantenerse limpias y secas. Limpiar las conexiones sucias con un paño seco y limpio.
3. Las celdas o baterías no deben cortocircuitarse. Es peligroso almacenar las celdas o baterías en estuches o cajones en cuyo interior puedan cortocircuitarse por contacto recíproco o por contacto con otros materiales conductores. No deben extraerse las celdas o baterías de sus embalajes originales hasta el momento en que vayan a utilizarse.
4. Las celdas o baterías no deben someterse a impactos mecánicos fuertes indebidos.
5. En caso de falta de estanqueidad de una celda, el líquido vertido no debe entrar en contacto con la piel ni los ojos. Si se produce contacto, lavar con agua abundante la zona afectada y avisar a un médico.
6. En caso de cambio o recarga inadecuados, las celdas o baterías que contienen electrolitos alcalinos (p. ej. las celdas de litio) pueden explotar. Para garantizar la seguridad del producto, las celdas o baterías solo deben ser sustituidas por el tipo Rohde & Schwarz correspondiente (ver lista de recambios).
7. Las baterías y celdas deben reciclarse y no deben tirarse a la basura doméstica. Las baterías o acumuladores que contienen plomo, mercurio o cadmio deben tratarse como residuos especiales. Respete en esta relación las normas nacionales de eliminación y reciclaje.

Instrucciones de seguridad elementales

8. En caso de devolver baterías de litio a las filiales de Rohde & Schwarz, debe cumplirse las normativas sobre los modos de transporte (IATA-DGR, código IMDG, ADR, RID).

Transporte

1. El producto puede tener un peso elevado. Por eso es necesario desplazarlo o transportarlo con precaución y, si es necesario, usando un sistema de elevación adecuado (p. ej. una carretilla elevadora), a fin de evitar lesiones en la espalda u otros daños personales.
2. Las asas instaladas en los productos sirven solamente de ayuda para el transporte del producto por personas. Por eso no está permitido utilizar las asas para la sujeción en o sobre medios de transporte como p. ej. grúas, carretillas elevadoras de horquilla, carros etc. Es responsabilidad suya fijar los productos de manera segura a los medios de transporte o elevación. Para evitar daños personales o daños en el producto, siga las instrucciones de seguridad del fabricante del medio de transporte o elevación utilizado.
3. Si se utiliza el producto dentro de un vehículo, recae de manera exclusiva en el conductor la responsabilidad de conducir el vehículo de manera segura y adecuada. El fabricante no asumirá ninguna responsabilidad por accidentes o colisiones. No utilice nunca el producto dentro de un vehículo en movimiento si esto pudiera distraer al conductor. Asegure el producto dentro del vehículo debidamente para evitar, en caso de un accidente, lesiones u otra clase de daños.

Eliminación/protección del medio ambiente

1. Los dispositivos marcados contienen una batería o un acumulador que no se debe desechar con los residuos domésticos sin clasificar, sino que debe ser recogido por separado. La eliminación se debe efectuar exclusivamente a través de un punto de recogida apropiado o del servicio de atención al cliente de Rohde & Schwarz.
2. Los dispositivos eléctricos usados no se deben desechar con los residuos domésticos sin clasificar, sino que deben ser recogidos por separado.
Rohde & Schwarz GmbH & Co.KG ha elaborado un concepto de eliminación de residuos y asume plenamente los deberes de recogida y eliminación para los fabricantes dentro de la UE. Para desechar el producto de manera respetuosa con el medio ambiente, diríjase a su servicio de atención al cliente de Rohde & Schwarz.
3. Si se trabaja de manera mecánica y/o térmica cualquier producto o componente más allá del funcionamiento previsto, pueden liberarse sustancias peligrosas (polvos con contenido de metales pesados como p. ej. plomo, berilio o níquel). Por eso el producto solo debe ser desmontado por personal especializado con formación adecuada. Un desmontaje inadecuado puede ocasionar daños para la salud. Se deben tener en cuenta las directivas nacionales referentes a la eliminación de residuos.
4. En caso de que durante el trato del producto se formen sustancias peligrosas o combustibles que deban tratarse como residuos especiales (p. ej. refrigerantes o aceites de motor con intervalos de cambio definidos), deben tenerse en cuenta las indicaciones de seguridad del fabricante de dichas sustancias y las normas regionales de eliminación de residuos. Tenga en cuenta también en caso necesario las indicaciones de seguridad especiales contenidas en la documentación del producto. La eliminación incorrecta de sustancias peligrosas o combustibles puede causar daños a la salud o daños al medio ambiente.

Se puede encontrar más información sobre la protección del medio ambiente en la página web de Rohde & Schwarz.

Customer Support

Technical support – where and when you need it

For quick, expert help with any Rohde & Schwarz equipment, contact one of our Customer Support Centers. A team of highly qualified engineers provides telephone support and will work with you to find a solution to your query on any aspect of the operation, programming or applications of Rohde & Schwarz equipment.

Up-to-date information and upgrades

To keep your instrument up-to-date and to be informed about new application notes related to your instrument, please send an e-mail to the Customer Support Center stating your instrument and your wish. We will take care that you will get the right information.

Europe, Africa, Middle East

Phone +49 89 4129 12345
customersupport@rohde-schwarz.com

North America

Phone 1-888-TEST-RSA (1-888-837-8772)
customer.support@rsa.rohde-schwarz.com

Latin America

Phone +1-410-910-7988
customersupport.la@rohde-schwarz.com

Asia/Pacific

Phone +65 65 13 04 88
customersupport.asia@rohde-schwarz.com

China

Phone +86-800-810-8228 /
+86-400-650-5896
customersupport.china@rohde-schwarz.com



Contents

1 Preface.....	5
1.1 For Your Safety.....	5
1.2 Conventions Used in the Documentation.....	5
1.3 How to Use the Help System.....	7
1.4 New Features for R&S FSP Users.....	8
1.5 Notes for Users of R&S FSV 1307.9002Kxx Models.....	11
2 Documentation Overview.....	12
2.1 Quick Start Guide.....	12
2.2 Operating Manuals and Help.....	12
2.3 Service Manual.....	13
2.4 Instrument Security Procedures.....	13
2.5 Basic Safety Instructions.....	13
2.6 Data Sheets and Brochures.....	13
2.7 Release Notes and Open Source Acknowledgment (OSA).....	14
2.8 Application Notes, Application Cards, White Papers, etc.....	14
3 Front and Rear Panel View.....	15
3.1 Front Panel View.....	15
3.2 Rear Panel View.....	25
4 Preparing for Use.....	32
4.1 Putting into Operation.....	32
4.2 Connecting USB Devices.....	44
4.3 Connecting an External Monitor.....	46
4.4 R&S FSVA/FSV Setup.....	46
4.5 Windows Operating System.....	56

5 Firmware Update and Installation of Firmware Options	62
5.1 Firmware Update.....	62
5.2 Activating Firmware Options.....	63
6 Basic Operations.....	65
6.1 Information in the Diagram Area.....	65
6.2 Means of User Interaction.....	73
6.3 Setting Parameters.....	83
6.4 Changing the Display.....	89
7 Basic Measurement Examples.....	99
7.1 Measuring a Sinusoidal Signal.....	99
7.2 Measuring Harmonics of Sinusoidal Signals.....	104
7.3 Measuring Signal Spectra with Multiple Signals.....	108
7.4 Measurements in Zero Span.....	115
7.5 Storing and Loading Instrument Settings.....	127
8 Controlling the R&S FSVA/FSV Remotely.....	130
8.1 Operation with Windows Remote Desktop	130
8.2 Operation with a VNC Client.....	137
8.3 Brief Introduction to Remote Control.....	139
8.4 Remote Control Interfaces and Protocols.....	161
8.5 Configuring the GPIB Interface.....	164
8.6 Setting Up a Network (LAN) Connection.....	165
8.7 How to Configure the LAN Using the LXI Web Browser Interface	172
8.8 Configuring the Network.....	175
Index.....	180

1 Preface

1.1 For Your Safety

The R&S FSVA/FSV is designated for use in industrial, administrative, and laboratory environments. Use the R&S FSVA/FSV only for its designated purpose. Observe the safety and usage instructions documented in the user manual, as well as operating conditions and performance limits stated in the data sheet.

The product documentation helps you use the R&S FSVA/FSV safely and efficiently. Keep the product documentation in a safe place and pass it on to subsequent users.

Safety information is part of the product documentation. It warns you about potential dangers and gives instructions how to prevent personal injury or damage caused by dangerous situations. Safety information is provided as follows:

- In the "Basic Safety Instructions", safety issues are grouped according to subjects. For example, one subject is electrical safety. The "Basic Safety Instructions" are delivered with the R&S FSVA/FSV in different languages in print.
- Throughout the documentation, safety instructions are provided when you need to take care during setup or operation. Always read the safety instructions carefully. Make sure to comply fully with them. Do not take risks and do not underestimate the potential danger of small details such as a damaged power cable.

1.2 Conventions Used in the Documentation

1.2.1 Typographical Conventions

The following text markers are used throughout this documentation:

Conventions Used in the Documentation

Convention	Description
"Graphical user interface elements"	All names of graphical user interface elements on the screen, such as dialog boxes, menus, options, buttons, and softkeys are enclosed by quotation marks.
KEYS	Key names are written in capital letters.
File names, commands, program code	File names, commands, coding samples and screen output are distinguished by their font.
<i>Input</i>	Input to be entered by the user is displayed in italics.
Links	Links that you can click are displayed in blue font.
"References"	References to other parts of the documentation are enclosed by quotation marks.

1.2.2 Conventions for Procedure Descriptions

When operating the instrument, several alternative methods may be available to perform the same task. In this case, the procedure using the touchscreen is described. Any elements that can be activated by touching can also be clicked using an additionally connected mouse. The alternative procedure using the keys on the instrument or the on-screen keyboard is only described if it deviates from the standard operating procedures.

The term "select" may refer to any of the described methods, i.e. using a finger on the touchscreen, a mouse pointer in the display, or a key on the instrument or on a keyboard.

1.2.3 Notes on Screenshots

When describing the functions of the product, we use sample screenshots. These screenshots are meant to illustrate as much as possible of the provided functions and possible interdependencies between parameters. The shown values may not represent realistic usage scenarios.

The screenshots usually show a fully equipped product, that is: with all options installed. Thus, some functions shown in the screenshots may not be available in your particular product configuration.

1.3 How to Use the Help System

Calling context-sensitive and general help

- ▶ To display the general help dialog box, press the HELP key on the front panel. The help dialog box "View" tab is displayed. A topic containing information about the current menu or the currently opened dialog box and its function is displayed.



For standard Windows dialog boxes (e.g. File Properties, Print dialog etc.), no context-sensitive help is available.

- ▶ If the help is already displayed, press the softkey for which you want to display help. A topic containing information about the softkey and its function is displayed.



If a softkey opens a submenu and you press the softkey a second time, the submenu of the softkey is displayed.

Contents of the help dialog box

The help dialog box contains four tabs:

- "Contents" - contains a table of help contents
- "View" - contains a specific help topic
- "Index" - contains index entries to search for help topics
- "Zoom" - contains zoom functions for the help display

To change between these tabs, press the tab on the touchscreen.

Navigating in the table of contents

- To move through the displayed contents entries, use the UP ARROW and DOWN ARROW keys. Entries that contain further entries are marked with a plus sign.
- To display a help topic, press the ENTER key. The "View" tab with the corresponding help topic is displayed.
- To change to the next tab, press the tab on the touchscreen.

Navigating in the help topics

- To scroll through a page, use the rotary knob or the UP ARROW and DOWN ARROW keys.
- To jump to the linked topic, press the link text on the touchscreen.

Searching for a topic

1. Change to the "Index" tab.
2. Enter the first characters of the topic you are interested in. The entries starting with these characters are displayed.
3. Change the focus by pressing the ENTER key.
4. Select the suitable keyword by using the UP ARROW or DOWN ARROW keys or the rotary knob.
5. Press the ENTER key to display the help topic.

The "View" tab with the corresponding help topic is displayed.

Changing the zoom

1. Change to the "Zoom" tab.
2. Set the zoom using the rotary knob. Four settings are available: 1-4. The smallest size is selected by number 1, the largest size is selected by number 4.

Closing the help window

- ▶ Press the ESC key or a function key on the front panel.

1.4 New Features for R&S FSP Users

The R&S FSVA/FSV introduces new features in R&S Signal and Spectrum Analyzers. If you have used an R&S FSP before, you can find some useful information in the list below:

- The touchscreen feature is used to control softkeys and dialog boxes. This makes working with the user interface easy.

New Features for R&S FSP Users

- Markers and display lines can also be moved using the touchscreen. Furthermore, it provides an alternative way to change instrument settings, as function fields like RBW or center frequency can be touched and the input field appears.
- There is a new key to open the Windows "Start" menu.
- There is a new key to activate the on-screen keyboard, which allows easy input of files names, for example, or other alphanumerical values. It also works outside the analyzer firmware, for example to perform a printer installation under Windows.
- The new UNDO/REDO keys allow you to undo or redo user inputs.
- The new DISPLAY key opens a menu to configure features like enabling and disabling of the touchscreen, the toolbar with icons or the soft or mini soft front panel. You can also hide softkeys there.
- The new MAXIMIZE/SPLIT and CHANGE FOCUS keys can be used to move the blue focus frame in displays with diagrams and tables, to enlarge the view of one of the diagrams or tables to fullsize.
- The new HOME key returns to the first softkey menu of an application.
- The new USER key allows you to configure user-defined softkeys for instrument settings.
- The new PEAK SEARCH key carries out a marker peak search for the active marker.
- The new RUN SINGLE and RUN CONT keys control the sweep control without having to change the softkey menu.
- The new MEAS CONFIG key directly opens the configuration menu if a measurement like ACLR was selected.
- The FSP hotkeys to start firmware options were moved to the new FSV MODE key, which opens a softkey menu with the applications.
- The FSV-K9 "Power Sensor" softkey and the FSV-B10 external generator control are in the menu of the new INPUT/OUTPUT key.
- The new AUTO SET key allows for automatic level and frequency adjustment routines. Although the routine is optimized for sinusoidal signals, the minimum measurement time can also be set for bursted signals, for example.
- For frequency sweep mode, the "Sweep type" can be configured in the SWEEP or AUTO SET menu. In sweep type "Auto" mode, the analyzer decides according to the settings like span, sweep time, RBW, etc. whether a swept frequency sweep or an FFT sweep shall be carried out to ensure best measurement speed.

New Features for R&S FSP Users

- With the sweep type "Sweep", only swept frequency sweeps can be selected; for the sweep type "FFT", only FFT sweeps can be selected. In the FSP, the FFT mode was under the "Filter type" softkey. In the FSV, this setting is now under "Sweep type".
- The HELP key provides context sensitive online help including remote commands.
- After entering an application once (like analog demodulation), a second tab is opened in the upper part of the display. This allows easy switching between applications simply by touching the tabs.
- 16 markers are supported and a marker table is available. If tables get too large you can scroll using the touchscreen or maximize the table using the CHANGE FOCUS and MAXIMIZE/SPLIT keys.
- A wizard is available in the TRACE menu to easily set up all 6 traces at a glance.
- Dialog boxes and input fields are on the upper right side of the display to be near the softkeys. They can be moved to any place on the screen and re-appear there when re-opened.
- An FSP-compatible mode can be selected. In this case, the FSV behaves as an FSP (e.g. same number of sweep points, bandwidths like FSP, etc.) and also identifies itself at the *IDN command as an FSP. Thus, FSP remote programs can be re-used.
- Under "Setup > Display Setup" various themes for the color definition can be found, including a "GrayStone" theme that makes the FSV look like it has FSP softkeys.
- USB connectors are available on the front.
- The instrument account password has changed from the FSP to FSV. The account password is no longer *instrument* but rather *894129*. Thus, you can easily retrieve local instrument control after Remote Desktop usage via the instrument's number pad.
- There is a link on the Windows Desktop and in the "Start" menu to access the R&S user data. The link points to the standard directory of hardcopies and save/recall files, so if the files are to be copied on a memory stick they can be found easily.
- The FSP cold boot feature with the decimal point no longer exists. Instead, the shutdown and calibration files can be deleted via the link "Delete Shutdown Files" in the "Start > All Programs" menu, if necessary.
- The optional external mixer functionality has been improved to provide more flexibility and conveniency, in particular:

Notes for Users of R&S FSV 1307.9002Kxx Models

- Mixer settings for each band are saved and maintained even after presetting the instrument; they can be preset explicitly using the "Preset Band" function
- If a second range (harmonic) is available, it can be activated and defined freely, also for standard bands
- When using two ranges for a band, the handover frequency can be defined freely within the overlapping frequency range, also for standard bands
- Additional traces are available for use when using the signal identification functions Signal ID and Auto ID
- All available conversion loss tables are offered for selection; validity tests are performed after selection

1.5 Notes for Users of R&S FSV 1307.9002Kxx Models

Users of R&S FSV 1307.9002Kxx models should consider the following differences to the description of the newer R&S FSVA/FSV 1321.3008Kxx models:

- Functions that are based on the Windows 10 operating system (e.g. printing or setting up networks) may have a slightly different appearance or require different settings on the Windows XP based models. For such functions, refer to the Windows documentation or the documentation originally provided with the R&S FSV instrument.
- The R&S FSV 1307.9002K03 model is restricted to a maximum frequency of 3 GHz, whereas the R&S FSVA/FSV1321.3008K04 model has a maximum frequency of 4 GHz.
- The bandwidth extension option R&S FSV-B160 (1311.2015.xx) is not available for the R&S FSV 1307.9002Kxx models. The maximum usable I/Q analysis bandwidth for these models is 28 MHz, or with option R&S FSV-B70, 40 MHz.

2 Documentation Overview

This section provides an overview of the R&S FSVA/FSV user documentation. Unless specified otherwise, you find the documents on the R&S FSVA/FSV product page at: www.rohde-schwarz.com/manual/FSVA

2.1 Quick Start Guide

Introduces the R&S FSVA/FSV and describes how to set up and start working with the product. Includes basic operations, typical measurement examples, and general information, e.g. safety instructions, etc. A printed version is delivered with the instrument. A PDF version is available for download on the Internet.

2.2 Operating Manuals and Help

Separate operating manuals are provided for the base unit and the software options:

- **Base unit manual**
Contains the description of all instrument modes and functions. It also provides an introduction to remote control, a complete description of the remote control commands with programming examples, and information on maintenance, instrument interfaces and error messages. Includes the contents of the getting started manual.
- **Software option manual**
Contains the description of the specific functions of an option. Basic information on operating the R&S FSVA/FSV is not included.

The contents of the operating manuals are available as help in the R&S FSVA/FSV. The help offers quick, context-sensitive access to the complete information for the base unit and the software options.

All operating manuals are also available for download or for immediate display on the Internet.

2.3 Service Manual

Describes the performance test for checking the rated specifications, module replacement and repair, firmware update, troubleshooting and fault elimination, and contains mechanical drawings and spare part lists.

The service manual is available for registered users on the global Rohde & Schwarz information system (GLORIS, <https://gloris.rohde-schwarz.com>).

2.4 Instrument Security Procedures

Deals with security issues when working with the R&S FSVA/FSV in secure areas. It is available for download on the Internet.

2.5 Basic Safety Instructions

Contains safety instructions, operating conditions and further important information. The printed document is delivered with the instrument.

2.6 Data Sheets and Brochures

The data sheet contains the technical specifications of the R&S FSVA/FSV. It also lists the options and their order numbers as well as optional accessories.

The brochure provides an overview of the instrument and deals with the specific characteristics.

See www.rohde-schwarz.com/brochure-datasheet/FSV

Application Notes, Application Cards, White Papers, etc.

2.7 Release Notes and Open Source Acknowledgment (OSA)

The release notes list new features, improvements and known issues of the current firmware version, and describe the firmware installation.

The open source acknowledgment document provides verbatim license texts of the used open source software.

See www.rohde-schwarz.com/firmware/FSV

2.8 Application Notes, Application Cards, White Papers, etc.

These documents deal with special applications or background information on particular topics.

See www.rohde-schwarz.com/appnlication/FSV

3 Front and Rear Panel View

3.1 Front Panel View

This chapter describes the front panel, including all function keys and connectors.

Figure 3-1 shows the front panel view of the R&S FSVA. (The R&S FSV is very similar.) The individual elements are described in more detail in the subsequent sections.

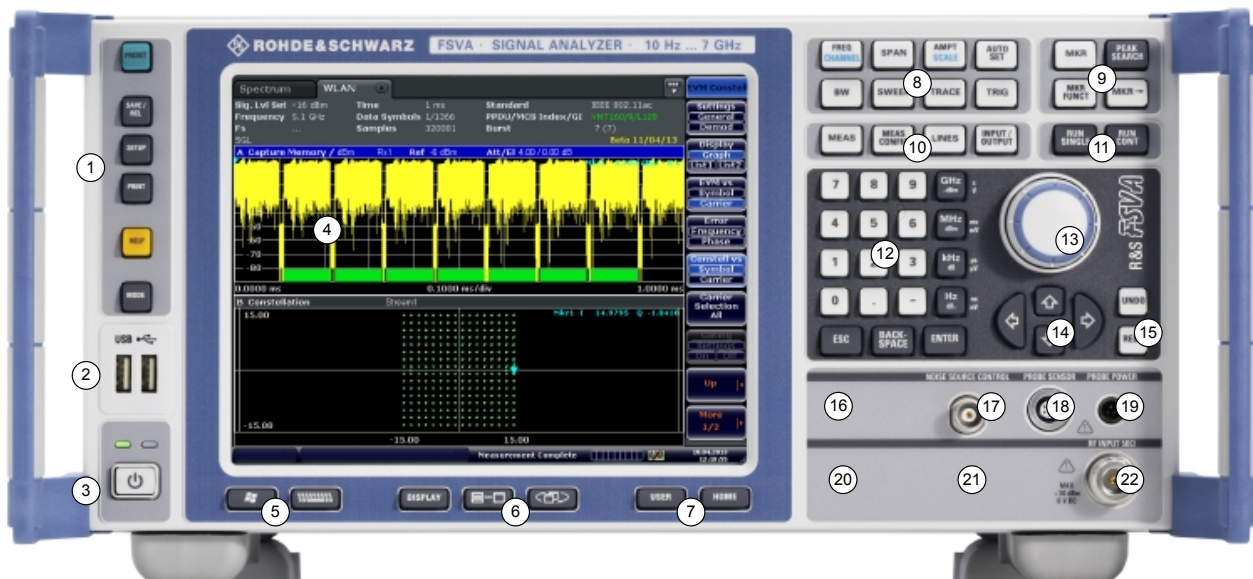

Figure 3-1: Front panel view of an R&S FSVA

No.	Description	See
1	General device functions e.g. Change mode, Setup, Default Settings, Help.	Chapter 3.1.1, "Function Keys on the Front Panel" , on page 17
2	USB connector for external devices, e.g. keyboard, mouse	Chapter 3.1.3, "Connectors on the Front Panel" , on page 21
3	ON/OFF switch	Chapter 4.1.8, "Switching the Instrument On and Off" , on page 42
4	Touchscreen; display area for measurement results	Chapter 3.1.2, "Touchscreen Display" , on page 20





Front Panel View

No.	Description	See
5	Auxiliary functions to display Windows Start menu or on-screen keyboard	Chapter 3.1.1, "Function Keys on the Front Panel" , on page 17
6	Display options for screen	Chapter 6.4, "Changing the Display" , on page 89
7	Navigation options for screen menu	Chapter 6.2.6, "Arrow Keys, UNDO/REDO Keys" , on page 78
8	Measurement control settings, e.g. frequency, levels	Chapter 3.1.1, "Function Keys on the Front Panel" , on page 17
9	Marker functions	Chapter 3.1.1, "Function Keys on the Front Panel" , on page 17
10	Measurement configuration	Chapter 3.1.1, "Function Keys on the Front Panel" , on page 17
11	Measurement start	Chapter 3.1.1, "Function Keys on the Front Panel" , on page 17
12	Numeric keyboard, units and data entry keys	Chapter 6.2.4, "Keypad" , on page 77
13	Rotary knob	Chapter 6.2.5, "Rotary Knob" , on page 78
14	Arrow keys	Chapter 6.2.6, "Arrow Keys, UNDO/REDO Keys" , on page 78
15	Undo/redo functions	Chapter 6.2.6, "Arrow Keys, UNDO/REDO Keys" , on page 78
16	AF output with volume control, optional	Chapter 3.1.4, "Optional Front Panel Connectors" , on page 22
17	Noise source control	Chapter 3.1.3, "Connectors on the Front Panel" , on page 21
18	Power sensor, optional	Chapter 3.1.4, "Optional Front Panel Connectors" , on page 22
19	Probe power connector - supply voltage for measurement accessories	Chapter 3.1.3, "Connectors on the Front Panel" , on page 21
20	Tracking generator output, optional	Chapter 3.1.4, "Optional Front Panel Connectors" , on page 22
21	External mixer (LO output, IF input), optional	Chapter 3.1.4, "Optional Front Panel Connectors" , on page 22
22	RF input	Chapter 3.1.3, "Connectors on the Front Panel" , on page 21

3.1.1 Function Keys on the Front Panel

A detailed description of the corresponding menus and the other function keys is provided in chapter 6 "Instrument Functions" of the Operating Manual.

Table 3-1: Front panel function keys

Function key	Assigned functions
	Switches the instrument on and off.
General device functions	
PRESET	Resets the instrument to the default state.
SAVE/RCL	Provides the functions for saving/loading instrument settings and for managing stored files.
SETUP	Provides basic instrument configuration functions, e.g.: <ul style="list-style-type: none"> • Reference frequency (external/internal), noise source • Date, time, display configuration • LAN interface • Self-alignment • Firmware update and enabling of options • Information about instrument configuration incl. firmware version and system error messages • Service support functions (self test etc.)
PRINT	Customizes the printout, selects and configures the printer.
HELP	Displays the Online Help.
MODE	Provides the selection between firmware options.
External functions	
	Displays Windows Start menu.
	Toggles the on-screen keyboard display: <ul style="list-style-type: none"> • at the top of the screen • at the bottom of the screen • off
Display options	
DISPLAY	Opens a dialog box to switch screen elements on or off.
	Switches between maximized and split display of focus area.
	Switches focus area between table and diagram.

Function key	Assigned functions
Navigation functions	
USER	Allows you to define and use softkeys to load user-specific settings files.
HOME	Jumps to the highest softkey menu level of the current firmware option.
Measurement settings	
FREQ (CHANNEL)	Sets the center frequency as well as the start and stop frequencies for the frequency range under consideration. This key is also used to set the frequency offset and the signal track function. (CHANNEL for special applications)
SPAN	Sets the frequency span to be analyzed.
AMPT (SCALE)	Sets the reference level, the displayed dynamic range, the RF attenuation and the unit for the level display. Sets the level offset and the input impedance. Activates the preamplifier (option RF Preamplifier, R&S FSV-B22). (SCALE for special applications)
AUTO SET	Enables automatic settings for level, frequency or sweep type mode.
BW	Sets the resolution bandwidth and the video bandwidth.
SWEEP	Sets the sweep time and the number of measurement points. Selects continuous measurement or single measurement.
TRACE	Configures the measured data acquisition and the analysis of the measurement data.
TRIG	Sets the trigger mode, the trigger threshold, the trigger delay, and the gate configuration in the case of gated sweep.
Marker functions	
MKR	Sets and positions the absolute and relative measurement markers (markers and delta markers).
PEAK SEARCH	Performs a peak search for active marker. If no marker is active, normal marker 1 is activated and the peak search is performed for it.

Function key	Assigned functions
MKR FUNC	Provides additional analysis functions of the measurement markers: <ul style="list-style-type: none"> • Frequency counter (Sig Count) • Fixed reference point for relative measurement markers (Ref Fixed) • Noise marker (Noise Meas) • Phase noise • n dB down function • AM/FM audio demodulation (with option R&S FSV-B3) • Peak list
MKR->	Used for search functions of the measurement markers (maximum/minimum of the trace). Assigns the marker frequency to the center frequency, and the marker level to the reference level. Restricts the search area (Search Limits) and characterizes the maximum points and minimum points (Peak Excursion).
Measurement functions	
MEAS	Provides the measurement functions: <ul style="list-style-type: none"> • Measurement of multicarrier adjacent channel power (Ch Power ACLR) • Carrier to noise spacing (C/N C/No) • Occupied bandwidth (OBW) • Spectrum emission mask measurement (Spectrum Emission Mask) • Spurious emissions (Spurious Emissions) • Measurement of time domain power (Time Domain Power) • Signal statistics: amplitude probability distribution (APD) and cumulative complementary distribution function (CCDF) • Third-order intercept point (TOI) • AM modulation depth (AM Mod Depth)
MEAS CONFIG	Used to define measurement configuration.
LINES	Configures display lines and limit lines.
INPUT/OUTPUT	Displays softkeys for input/output functions.
Measurement start functions	
RUN SINGLE	Starts a single new measurement (Single Sweep Mode).
RUN CONT	Starts a continuous measurement (Continuous Sweep Mode).
Function execution	
UNDO	Reverts last operation.
REDO	Repeats previously reverted operation.

3.1.2 Touchscreen Display

All measurement results are displayed in the screen on the front panel. Additionally, the screen display provides status and setting information and allows you to switch between various measurement tasks. The screen is touch-sensitive, offering an alternative means of user interaction for quick and easy handling of the device.

The [Figure 3-2](#) shows the touchscreen display of the R&S FSVA/FSV. The individual elements are described in more detail in [Chapter 6, "Basic Operations"](#), on page 65.

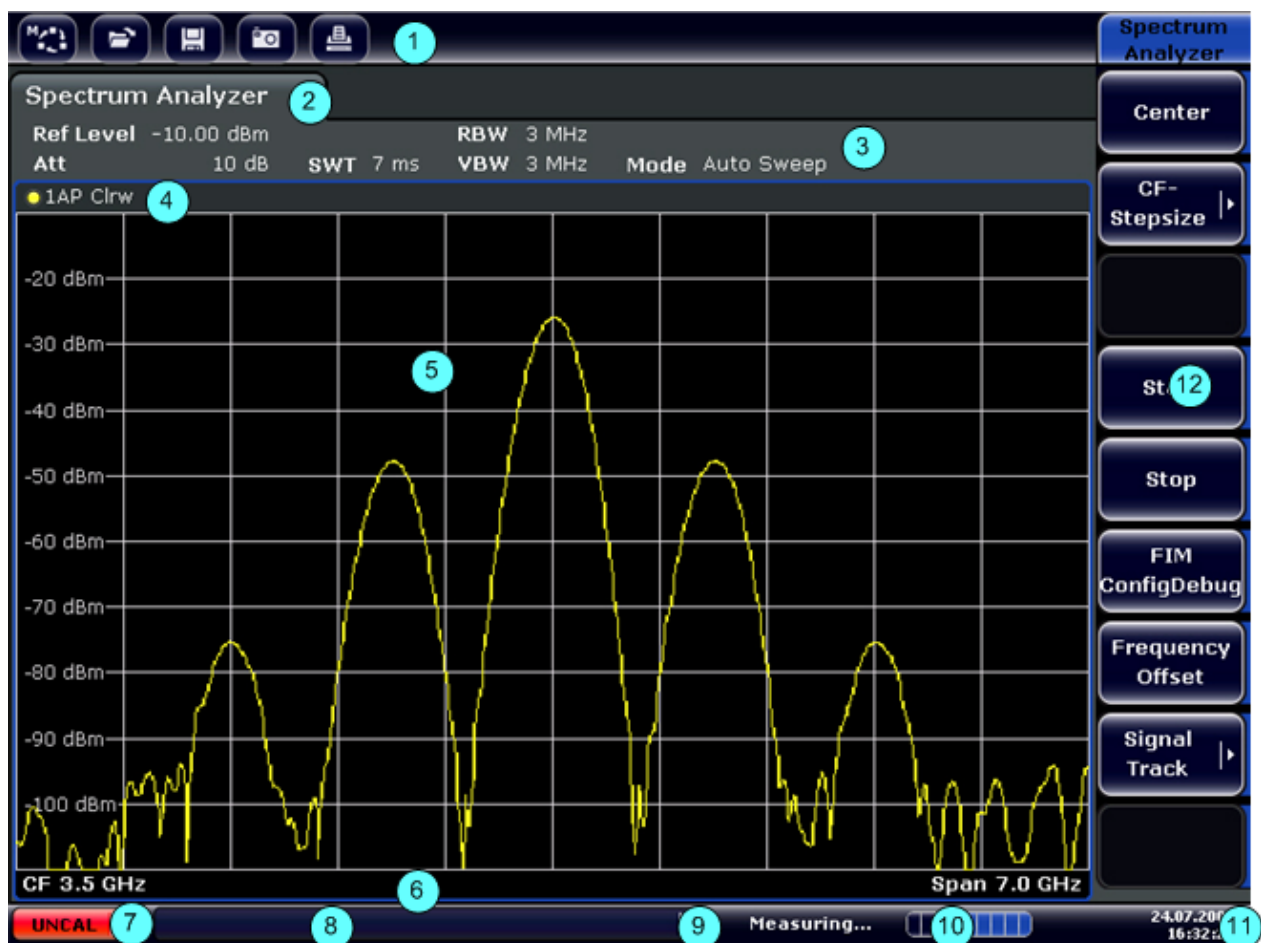

Figure 3-2: Touchscreen elements

- 1 = Toolbar with standard application functions, e.g. print, save/open file etc.
- 2 = Tabs for individual measurement tasks
- 3 = Channel information bar for current measurement settings
- 4 = Diagram header with diagram-specific (trace) information
- 5 = Measurement results area
- 6 = Diagram footer with diagram-specific information, depending on measurement mode
- 7 = Error indicator

- 8 = Error message, if available
- 9 = Device status
- 10 = Progress bar for measurement
- 11 = Date and time display
- 12 = Softkeys for menu access

3.1.3 Connectors on the Front Panel

This section describes the front connectors and interfaces of the R&S FSVA/FSV. Optional connectors and interfaces are indicated by the option name in brackets. Most connectors on the front panel (except for USB) are located at the bottom right-hand side.

3.1.3.1 USB

The front panel provides two female USB connectors to connect devices like a keyboard or mouse. Also a memory stick can be connected to store and reload instrument settings and measurement data.

3.1.3.2 NOISE SOURCE CONTROL

The noise source control female connector is used to provide the supply voltage for an external noise source, e.g., to measure the noise figure and gain of amplifiers and frequency converting DUTs.

Conventional noise sources require a voltage of +28 V in order to be switched on and 0 V to be switched off. The output supports a maximum load of 100 mA.

3.1.3.3 RF INPUT 50Ω

The RF input is to be connected to the DUT via a cable equipped with an appropriate connector.

NOTICE**Risk of instrument damage**

Do not overload the input. For maximum allowed values, see the data sheet.

For AC-coupling, a DC input voltage of 50 V must never be exceeded. For DC-coupling, DC voltage must not be applied at the input. In both cases, noncompliance will destroy the input mixers.

3.1.3.4 PROBE POWER

The R&S FSVA/FSV provides a connector for supply voltages of +15 V to -12 V and ground for active probes and preamplifiers. A maximum current of 140 mA is available. This connector is suitable as power supply for high-impedance probes from Agilent.

3.1.3.5 POWER SENSOR

The LEMOSA female connector is used to connect power sensors of the R&S NRP family (requires option R&S FSVA/FSV-K9). For details on supported power sensors see the data sheet.

3.1.4 Optional Front Panel Connectors**3.1.4.1 AF OUTPUT (Audio Demodulator option, R&S FSV-B3)**

Headphones equipped with a miniature jack plug can be connected to the AF output female connector. The internal impedance is 10 Ω . The output voltage can be set by using the volume control to the right of the female connector. If a plug is connected, the internal loudspeaker is automatically switched off.

The female connector and volume control are available only with the audio demodulator option (R&S FSV-B3). To use the AF OUTPUT, in the "In-/Output" menu (INPUT/OUTPUT key), select "Video Output". The output voltage (volume) is 1V.

⚠ CAUTION**Risk of hearing damage**

Before putting on the headphones, make sure that the volume setting is not too high to protect your hearing.

3.1.4.2 Tracking Generator Output (GEN OUTPUT 50Ω, Option R&S FSV-B9)

The R&S FSVA/FSV is equipped with an optional tracking generator and therefore provides a tracking generator output connector.

The output of the tracking generator is to be connected to the DUT via a cable equipped with a male N connector. The female connector is available only with the tracking generator option (R&S FSV-B9).

If the output is active, the LED is green.

NOTICE**Risk of damaging the tracking generator**

To avoid damaging the tracking generator, make sure that the reverse power (i.e. input power caused, for example, by reflections in the test setup) never exceeds 1 W RF power. Do not apply a DC voltage at the output.

For details, refer to the data sheet.

**Sensitive DUTs concerning matching**

For DUTs with sensitive RF characteristics with regard to matching (VSWR) at the input, insert a 10 dB attenuator between the DUT and the tracking generator.

3.1.4.3 Connections for External Mixers (EXT MIXER, Option R&S FSV-B21)

External mixers can be connected at the LO OUT/IF IN and IF IN female connectors (option R&S FSV-B21 for R&S FSVA/FSV 30 and R&S FSVA/FSV 40 instruments). Both two-port and three-port mixers can be used. Connect the mixer as follows:

-  Use the supplied coaxial cable to feed in the LO signal. If no external mixers are connected to the R&S FSVA/FSV, cover the two front connectors LO OUT / IF IN and IF IN with the SMA caps supplied.

Three-port mixer

Three-port mixer:

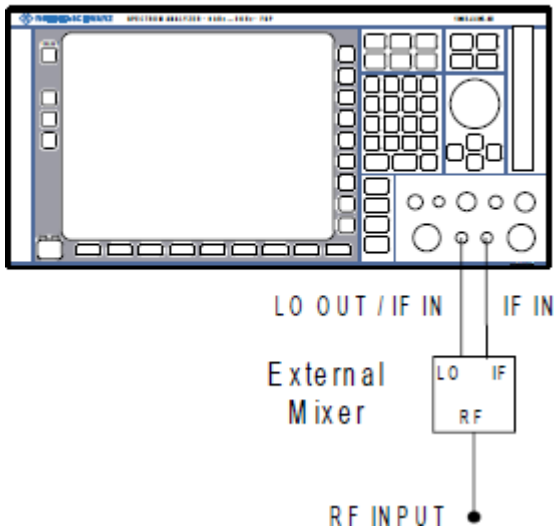

1. Connect the LO OUT / IF IN output of the R&S FSVA/FSV to the LO port of the external mixer.
2. Connect the IF IN input of the R&S FSVA/FSV to the IF port of the external mixer.
3. Feed the signal to be measured to the RF input of the external mixer.

Two-port mixer

Two-port mixer:

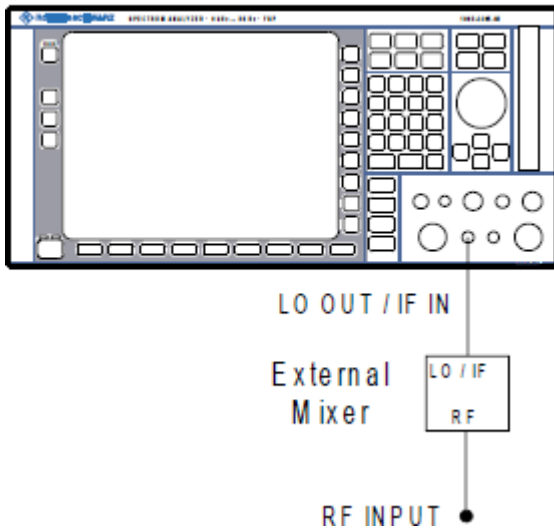

1. Connect the LO OUT / IF IN output of the R&S FSVA/FSV to the LO/IF port of the external mixer. The nominal LO level is 15.5 dBm. Because of the diplexer contained in the R&S FSVA/FSV, the IF signal can be tapped from the line which is used to feed the LO signal to the mixer.
2. Feed the signal to be measured to the RF input of the external mixer.

3.2 Rear Panel View

Figure 3-3 shows the rear panel view of the R&S FSVA/FSV. The individual elements are described in more detail in the subsequent sections. Optional connectors and interfaces are indicated by the option name in brackets.



Figure 3-3: Rear panel view

- 1 = LAN
- 2 = TRIGGER OUTPUT
- 3 = IF/VIDEO
- 4 = USB
- 5 = AUX PORT
- 6+7 = External generator control (option B10)
- 8 = EXT TRIGGER / GATE IN
- 9+10 = DIGITAL BASEBAND INPUT/OUTPUT connectors (option B17)
- 11 = MONITOR (VGA)
- 12 = REF IN
- 13 = REF OUT
- 14 = GPIB interface
- 15 = AC Power Supply Connection and Main Power Switch with fuse
- 16 = EXT REF with OCXO option (-B4)

3.2.1 Standard Rear Panel Connectors

3.2.1.1 AC Power Supply Connection and Main Power Switch

An AC power supply connector and main power switch are located in a unit on the rear panel of the instrument.

Main power switch function:

Position 1: The instrument is in operation.

Position O: The entire instrument is disconnected from the AC power supply.

For details refer to [Chapter 4.1.8, "Switching the Instrument On and Off"](#), on page 42.



Warm-up time for OCXO

When the instrument is switched on, the OCXO requires an extended warm-up time (see data sheet).

3.2.1.2 LAN

The LAN interface can be used to connect the R&S FSVA/FSV to a local network for remote control, printouts and data transfer. The assignment of the RJ-45 connector supports twisted-pair category 5 UTP/STP cables in a star configuration (UTP stands for *unshielded twisted pair*, and STP for *shielded twisted pair*).

3.2.1.3 MONITOR (VGA)

The female VGA connector is used to connect an external monitor. Step-by-step instructions how to connect an external monitor are provided in [Chapter 4.3, "Connecting an External Monitor"](#), on page 46.

3.2.1.4 EXT TRIGGER / GATE IN

The female connector for external trigger/gate input is used to control the measurement by means of an external signal. The voltage levels can range from 0.5 to 3.5 V. The default value is 1.4 V. The typical input impedance is 10 k Ω .

3.2.1.5 REF IN

As a reference signal, you can either use the internal reference, or connect an external one. The setup menu is used to switch between the internal and an external reference. The REF IN female connector is used as an input for a 1-20 MHz reference signal. The required input level is 0-10 dBm.

3.2.1.6 REF OUT

This connector can be used to provide an external reference signal (e.g. the OCXO or ultra high precision reference signal) to other devices that are connected to this instrument. The REF OUT female connector can output a 10 MHz reference signal with an output level of 0 dBm.

3.2.1.7 GPIB interface

The GPIB interface is in compliance with IEEE488 and SCPI. A computer for remote control can be connected via this interface. To set up the connection, a shielded cable is recommended. For more details refer to chapter 7 "Remote Control Basics" in the Operating Manual.

3.2.1.8 TRIGGER OUTPUT

The female BNC connector can be used to provide a signal to another device. The signal is TTL compatible (0 V / 5 V). The "Trigger out" softkey in the "In-/Output" menu (INPUT/OUTPUT key) is used to control the trigger output.

3.2.1.9 IF/VIDEO

The female BNC connector can be used for various outputs:

- Intermediate frequency (IF) output of approximately 20 MHz
- Video output (1V)

The "In-/Output" menu (INPUT/OUTPUT key) is used to select between the IF and video output.

3.2.1.10 USB

The rear panel provides two additional female USB connectors to connect devices like keyboard and mouse. Also, a memory stick can be connected to store and reload instrument settings and measurement data.



EMI impact on measurement results

Electromagnetic interference (EMI) can affect the measurement results. To avoid any impact, make sure that the following conditions are met:

- Use suitable double-shielded cables.
- Do not use USB connecting cables exceeding 1 m in length.
- Use only USB devices that remain within the permissible EMI limits.
- Always terminate any connected IEC-bus cables with an instrument or controller.

3.2.1.11 AUX PORT

The 9 pole SUB-D male connector provides control signals for controlling external devices. The voltage levels are of the TTL type (5 V).



Pin	Signal	Description
1	+5 V / max. 250 mA	Supply voltage for external circuits
2 to 7	I/O	Control lines for user ports (see User manual)
8	GND	Ground
9	READY FOR TRIGGER	Signal indicating that the instrument is ready to receive a trigger signal (Low active = 0 V)

NOTICE

Short-circuit hazard

Always observe the designated pin assignment. A short-circuit can damage the port.

3.2.2 Optional Rear Panel Connectors

3.2.2.1 OCXO option (R&S FSV-B4)

This option generates a very precise 10 MHz reference signal with an output level of ≥ 0 dBm. If installed, and if no external signal or ultra high precision reference is used (see "[Ultra High Precision Reference Option \(R&S FSV-B14\)](#)" on page 30), this signal is used as an internal reference. It can also be used to synchronize other connected devices via the REF OUT connector.



Warm-up time for OCXO

When the instrument is switched on, the OCXO requires an extended warm-up time (see data sheet).



Ultra High Precision Reference Option (R&S FSV-B14)

Alternatively to the OCXO reference, an ultra high precision reference (option R&S FSV-B14) is available. This option generates an even more precise 10 MHz reference signal with an output level of ≥ 0 dBm. If installed, and if no external signal is used, this signal is used as an internal reference (also if an OCXO reference is installed). It can also be used to synchronize other connected devices via the REF OUT connector.

3.2.2.2 External Generator Control Option (R&S FSV-B10)

The external generator control option provides an additional GPIB and an AUX CONTROL connector.

The GPIB connector can be used to connect the external generator to the R&S FSVA/FSV.

The female AUX CONTROL connector is required for TTL synchronization, if supported by the generator.

For details on connecting an external generator see the "External Generator Control" section of the R&S FSVA/FSV User Manual.

3.2.2.3 Digital Baseband Interface (R&S FSV-B17)

The R&S FSVA/FSV Digital Baseband Interface option (R&S FSV-B17) provides an online digital I/Q data interface on the rear panel of the instrument for input and output. The digital input and output can be enabled in the base unit or in one of the applications (where available).

4 Preparing for Use

4.1 Putting into Operation

This section describes the basic steps to be taken when setting up the R&S FSVA/FSV for the first time.

⚠ WARNING**Risk of injury due to disregarding safety information**

Observe the information on appropriate operating conditions provided in the data sheet to prevent personal injury or damage to the instrument. Read and observe the basic safety instructions provided with the instrument, in addition to the safety instructions in the following sections. In particular:

- Do not open the instrument casing.
-

NOTICE**Risk of instrument damage due to inappropriate operating conditions**

Specific operating conditions are required to ensure accurate measurements and to avoid damage to the instrument. Observe the information on appropriate operating conditions provided in the basic safety instructions and the instrument's data sheet.

NOTICE**Risk of instrument damage due to inappropriate operating conditions**

An unsuitable operating site or test setup can damage the instrument and connected devices. Before switching on the instrument, observe the information on appropriate operating conditions provided in the data sheet. In particular, ensure the following:

- All fan openings are unobstructed and the airflow perforations are unimpeded. The minimum distance from the wall is 10 cm.
- The instrument is dry and shows no sign of condensation.
- The instrument is positioned as described in the following sections.
- The ambient temperature does not exceed the range specified in the data sheet.
- Signal levels at the input connectors are all within the specified ranges.
- Signal outputs are connected correctly and are not overloaded.

NOTICE**Instrument damage caused by electrostatic discharge**

Electrostatic discharge (ESD) can damage the electronic components of the instrument and the device under test (DUT). Electrostatic discharge is most likely to occur when you connect or disconnect a DUT or test fixture to the instrument's test ports. To prevent electrostatic discharge, use a wrist strap and cord and connect yourself to the ground, or use a conductive floor mat and heel strap combination.

**EMI impact on measurement results**

Electromagnetic interference (EMI) may affect the measurement results.

To suppress generated electromagnetic interference (EMI):

- Use suitable shielded cables of high quality. For example, use double-shielded RF and LAN cables.
- Always terminate open cable ends.
- Note the EMC classification in the data sheet.

4.1.1 Unpacking and Checking the Instrument

To remove the instrument from its packaging and check the equipment for completeness, proceed as follows:

1. Pull off the polyethylene protection pads from the instrument's rear feet.
2. Carefully remove the pads from the instrument handles at the front.
3. Pull off the corrugated cardboard cover that protects the rear of the instrument.
4. Carefully unthread the corrugated cardboard cover at the front that protects the instrument handles and remove it.
5. Check the equipment for completeness using the delivery note and the accessory lists for the various items.
6. Check the instrument for any damage. If there is damage, immediately contact the carrier who delivered the instrument. Make sure not to discard the box and packing material.



Packing material

Retain the original packing material. If the instrument needs to be transported or shipped later, you can use the material to protect the control elements and connectors.

4.1.2 Accessory List

The instrument comes with the following accessories:

- Power cable
- Quick Start Guide

4.1.3 Placing or Mounting the Instrument

The R&S FSVA/FSV is designed for use under laboratory conditions, either on a bench top or in a rack.

Bench Top Operation

If the R&S FSVA/FSV is operated on a bench top, the surface should be flat. The instrument can be used in horizontal position, standing on its feet, or with the support feet on the bottom extended.

⚠ WARNING

Risk of injury if feet are folded out

The feet can fold in if they are not folded out completely or if the instrument is shifted. Collapsing feet can cause injury or damage the instrument.

- Fold the feet completely in or out to ensure stability of the instrument. Never shift the instrument when the feet are folded out.
- When the feet are folded out, do not work under the instrument or place anything underneath.
- The feet can break if they are overloaded. The overall load on the folded-out feet must not exceed 500 N.

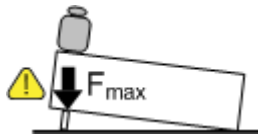

⚠ WARNING**Risk of injury if stacking heavy instruments**

A stack of instruments can tilt over and cause injury if not stacked correctly. Furthermore, the instruments at the bottom of the stack can be damaged due to the load imposed by the instruments on top.

Observe the following instructions when stacking instruments:

- Never stack more than three instruments. If you need to stack more than three instruments, install them in a rack.
- The overall load imposed on the lowest instrument must not exceed 500 N.
- It is best if all instruments have the same dimensions (width and length). If you need to stack smaller instruments on the top, the overall load imposed on the lowest instrument must not exceed 250 N.
- If the instruments have foldable feet, fold them in completely.

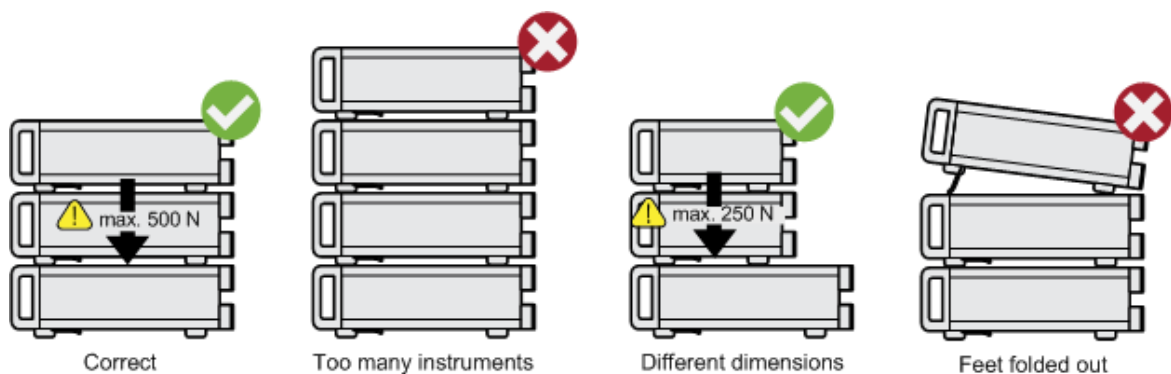
**Rackmounting**

The R&S FSVA/FSV can be installed in a rack using a rack adapter kit (for the order no., see data sheet). The installation instructions are part of the adapter kit.

NOTICE**Risk of instrument damage due to insufficient airflow in a rack**

If the instrument is run with insufficient airflow for a longer period, the instrument overheats, which can disturb the operation and even cause damage.

Make sure that all fan openings are unobstructed, that the airflow perforations are unimpeded, and that the minimum distance from the wall is 10 cm.

4.1.4 Connecting the AC Power

The R&S FSVA/FSV is equipped with an AC power supply connector. The R&S FSVA/FSV can be used with different AC power voltages and adapts itself automatically to it. Refer to the datasheet for the requirements of voltage and frequency. The AC power connector is located on the rear panel of the instrument.



- ▶ Connect the R&S FSVA/FSV to the AC power supply using the supplied power cable.
Since the instrument is assembled in line with the specifications for safety class EN61010, it may only be connected to an outlet that has a ground contact.

4.1.5 Changing the AC Supply Fuse

Only fuses of the type IEC 60 127-T3.15H/250 V should be used. Those fuses are used for all of the specified nominal AC supply voltages.

To change the AC supply fuses

1. Disconnect the power cable.
2. Open the flap covering the fuse holder using a small screwdriver (or similar).
3. Remove the fuse holder.

4. Remove both fuses and install the new ones.
5. Reinsert the fuse holder.
6. Close the flap.

4.1.6 Using an Optional DC Power Supply

When only DC power is available, for example from a battery or in a vehicle, an optional DC power supply adapter (R&S FSV-B30) can be connected to the R&S FSVA/FSV to operate the instrument with a DC voltage of 10 V to 28 V.

For installation instructions see the option's installation guide.

⚠ WARNING**Shock hazard due to power supply**

If you use external power supplies to supply the equipment with DC safety extra low voltage (SELV), make sure the requirements for reinforced or double insulation are met, according to DIN/EN/IEC 61010 (UL61010, CAN CSA C22.2 No. 61010) or DIN/EN/IEC 60950 (UL60950, CAN CSA C22.2 No. 60950). Otherwise you may be injured due to electrical shock.

Before switching on the R&S FSVA/FSV, switch on the DC power supply:

Switching the DC power supply on

1. Connect the R&S FSVA/FSV DC power supply device to the DC power source (e.g. battery pack or vehicle) as described in the option's installation guide.
2. Set the switch on the DC power supply to "I". A green LED indicates that the DC power supply is ready for operation.
3. In case of overvoltage or undervoltage, the DC power supply switches off automatically. This state is indicated by means of a red LED.
4. Set the power switch on the rear panel to "I".
5. Press the ON/OFF key on the front panel. A green LED above the ON/OFF key indicates that the instrument is ready for operation.

Switching the DC power supply off

1. Press the ON/OFF key on the front panel of the R&S FSVA/FSV and wait until the instrument has shut down.
2. Switch off the power switch on the rear panel of the R&S FSVA/FSV.
3. Switch off the DC power supply.

4.1.7 Using an Optional Battery Pack and Charger (Options R&S FSV-B32/-B34)

A lithium-ion battery pack with four rechargeable batteries is available for all R&S FSVA/FSV instruments (R&S FSV-B32). This battery pack also requires the DC power supply adapter (option R&S FSV-B30, see [Chapter 4.1.6, "Using an Optional DC Power Supply"](#), on page 38). To charge these batteries, an additional external battery charger is available (option R&S FSV-B34).

For installation instructions see the option's installation guide.

Switching on the battery pack

1. Connect the battery pack to the R&S FSVA/FSV as described in the installation guide.
Note: The batteries must be charged before initial use, see [Chapter 4.1.7.1, "Charging the Battery Pack"](#), on page 40.
2. Set the switch on the battery pack to "I".
3. Set the switch on the DC power supply to "I". A green LED indicates that the DC power supply is ready for operation.
4. In case of undervoltage, the DC power supply switches off automatically. This state is indicated by means of a red LED.
5. Set the power switch on the rear panel to "I".
6. Press the ON/OFF key on the front panel. A green LED above the ON/OFF key indicates that the instrument is ready for operation.

Switching off the battery pack

1. Press the ON/OFF key on the front panel of the R&S FSVA/FSV and wait until the instrument has shut down.

2. Switch off the power switch on the rear panel of the R&S FSVA/FSV.
3. Switch off the DC power supply.
4. Switch off the battery pack.

4.1.7.1 Charging the Battery Pack

The battery pack is not charged in the factory. The rechargeable batteries must be charged before they are used for the first time.

The R&S FSVA/FSV-B34 charger is a standalone charging device which can be used to charge all four rechargeable batteries of the R&S FSVA/FSV-B32 battery pack simultaneously. The rechargeable batteries can be charged at ambient temperatures of 0 °C to +45 °C.

1. Undo the knurled screws (10) on the front of the battery pack and open the flap (11).
2. Pull the rechargeable batteries (12) by the tab out of the housing.

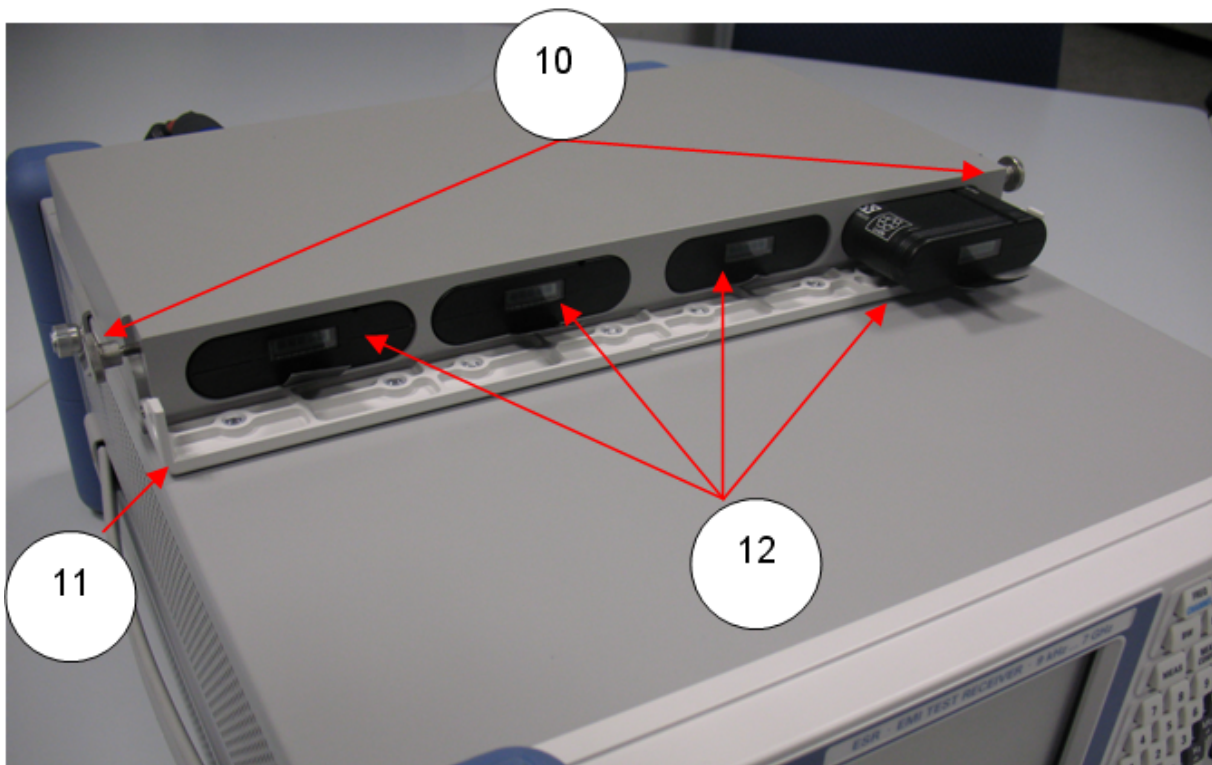

Figure 4-1: Battery compartment

3. Connect the power cable to the charger.

4. Insert the rechargeable batteries into the charging slots of the charger.



Figure 4-2: R&S FSVA/FSV-B34 charger

LEDs indicate the operating state of each charging slot:

- Charging
Green LED flashes
- Charging completed
Green LED remains lit
- Fault
Red LED lights up

5. When charging has been completed, the rechargeable batteries can be removed from the charger. The LCD on the front of the rechargeable battery indicates the charge level in increments of 20 %.
6. Insert the rechargeable batteries into the battery pack and close the flap on the front. Secure the flap using the two knurled screws.

4.1.8 Switching the Instrument On and Off

Switching the instrument on

If an optional DC power supply (R&S FSV-B30) or an optional battery pack (R&S FSV-B32) is used, you must switch on these devices first; see [Chapter 4.1.6, "Using an Optional DC Power Supply"](#), on page 38 or [Chapter 4.1.7, "Using an Optional Battery Pack and Charger \(Options R&S FSV-B32/-B34\)"](#), on page 39.

1. Press the AC power switch on the rear panel to position "I".
The instrument is supplied with AC power.
2. Press the ON/OFF key on the front panel.
After booting, the instrument is ready for operation. A green LED above the ON/OFF key indicates this.



Warm-up time for OCXO

When the instrument is switched on, the OCXO requires an extended warm-up time (see data sheet).

Switching the instrument off

1. Press the ON/OFF key on the front panel.
2. Change the AC power switch on the rear panel to position "O", or disconnect the instrument from the AC power supply.

The R&S FSVA/FSV changes into off mode.

NOTICE

Risk of losing data

If you switch off the running instrument using the rear panel switch or by disconnecting the power cord, the instrument loses its current settings. Furthermore, program data can be lost.

Press the ON/STANDBY key first to shut down the application properly.

4.1.9 Performing a Self Alignment and a Self Test



Operating temperature

Before performing this functional test, make sure that the instrument has reached its operating temperature (for details, refer to the data sheet).

Performing a self alignment

1. Press the SETUP key.
2. Press the "Alignment" softkey.
3. Press the "Self Alignment" softkey.

Once the system correction values have been calculated successfully, a message is displayed.



To display the alignment results again later

- Press the SETUP key.
- Press the "Alignment" softkey.
- Press the "Show Align Results" softkey.

Performing a self test

The self test does not need to be repeated every time the instrument is switched on. It is only necessary when instrument malfunction is suspected.

1. Press the SETUP key.
2. Press the "More" softkey.
3. Press the "Service" softkey.
4. Press the "Selftest" softkey.

Once the instrument modules have been checked successfully, a message is displayed.

4.1.10 Checking the Supplied Options

The instrument may be equipped with both hardware and firmware options. In order to check whether the installed options correspond to the options indicated on the delivery note, proceed as follows.

1. Press the SETUP key.
2. Press the "System Info" softkey.
3. Press the "Versions + Options" softkey.
A list with hardware and firmware information is displayed.
4. Check the availability of the hardware options as indicated in the delivery note.
For an overview of the available options, refer to the datasheet.

4.2 Connecting USB Devices

The USB interfaces of the R&S FSVA/FSV allow you to connect USB devices directly to the instrument. Increase the number of possible connections using USB hubs. Due to the large number of available USB devices, there is almost no limit to the expansions that are possible with the R&S FSVA/FSV.

The following list shows various USB devices that can be useful:

- Memory stick for easy transfer of data to/from a computer (e.g. firmware updates)
- CD-ROM drives for easy installation of firmware applications
- Keyboard or mouse to simplify the entry of data, comments, filenames, etc.
- Printer for printing measurement results
- Power sensors, e.g. of the NRP Zxy family

Installing USB devices is easy under Windows, because all USB devices are plug&play. After a device is connected to the USB interface, the operating system automatically searches for a suitable device driver.

If Windows does not find a suitable driver, it prompts you to specify a directory that contains the driver software. If the driver software is on a CD, connect a USB CD-ROM drive to the instrument before proceeding.

When a USB device is then disconnected from the R&S FSVA/FSV, Windows immediately detects the change in hardware configuration and deactivates the corresponding driver.

All USB devices can be connected to or disconnected from the instrument during operation.

Connecting a memory stick or CD-ROM drive

If installation of a memory stick or CD-ROM drive is successful, Windows informs you that the device is ready to use. The device is made available as a new drive and is displayed in Windows Explorer. The name of the drive depends on the manufacturer.

Connecting a keyboard

The keyboard is detected automatically when it is connected. The default input language is English – US.

Select "Start > Settings > Time & language > Region & language > Add a language" to configure the keyboard language. To access the Windows operating system, press the Windows key on the external keyboard.

Connecting a mouse

The mouse is detected automatically when it is connected.

Select "Start > Settings > Devices > Mouse & touchpad" to configure the mouse properties. To access the Windows operating system, press the Windows key on the external keyboard.

Connecting a printer

When printing a file, the instrument checks whether a printer is connected and turned on and whether the appropriate printer driver is installed. If necessary, printer driver installation is initiated. You only have to install a printer driver once.

To install a printer, select "Start > Settings > Devices > Add a printer or scanner". To access the Windows operating system, press the Windows key on the external keyboard.

You can load updated and improved driver versions or new drivers from an installation disk, USB memory stick or another external storage medium. If the instrument is integrated in a network, you can also install driver data stored in a network directory.

Select "Start > Settings > Devices > Device Manager > Update Device drivers" to install the driver.

4.3 Connecting an External Monitor

You can connect an external monitor to the "MONITOR" connector on the instrument's rear panel.

For details on the connector refer to [Chapter 3.2.1.3, "MONITOR \(VGA\)"](#), on page 27.

1. Connect the external monitor to the R&S FSVA/FSV.
2. Press the SETUP key.
3. Press the "General Setup" softkey.
4. Press the "More" softkey.
5. Press the "Configure Monitor" softkey.

The configuration of the connected monitor is determined and displayed in the standard Windows configuration dialog box.

6. In the configuration dialog box, you can switch from the internal monitor (laptop icon) to the external monitor (monitor icon), or both (double monitor icon).
If the external monitor is selected, the R&S FSVA/FSV display is disabled. The screen content (measurement screen) formerly displayed on the R&S FSVA/FSV is displayed on the external screen. If you select both monitors, the R&S FSVA/FSV screen and the external screen are both active.

4.4 R&S FSVA/FSV Setup

This section describes how to setup the instrument.

- [Changing the Language of the Instrument Interface](#)..... 47
- [Selecting the Frequency Reference Signal](#)..... 47
- [Setting the Date and Time](#)..... 48
- [Aligning the Touchscreen](#)..... 49

- [Setting the Screen Colors](#)..... 50
- [Setting the Display Power Save Function](#)..... 53
- [Selecting and Configuring Printers](#)..... 54

4.4.1 Changing the Language of the Instrument Interface

You can change the language of the R&S FSVA/FSV graphical user interface (softkeys, dialog boxes, input settings etc.) to the any other installed language, if available.



If you do not understand the currently used interface language, this may be difficult. Thus, the position of the required elements in the menu is provided in the following procedure for convenience.

1. Select the SETUP hardkey.
2. Select the "General Settings" softkey (5th from the top).
3. Select the "Language" softkey (6th from the top).
4. Select an available interface language.

All softkeys, dialog boxes, input settings etc. are displayed in the selected language.



To change the default input language of an external keyboard, use the standard Windows operating system function (see "[Connecting a keyboard](#)" on page 45).

Remote command:

SYST:DISP:LANG 'en', see R&S FSVA/FSV User Manual

4.4.2 Selecting the Frequency Reference Signal

You can switch the reference signal for frequency processing of the R&S FSVA/FSV between the internal reference and an external reference signal at 10 MHz as follows:

1. Press the SETUP key.

2. Press the "Reference Int/Ext" softkey until it is in the desired state.



External reference signal

It is important that the external reference signal is deactivated when switching from external to internal reference to avoid interactions with the internal reference signal.

Remote commands:

```
ROSC:SOUR EXT
```

```
ROSC:EXT:FREQ 20
```

4.4.3 Setting the Date and Time

You can set the date and time for the internal real time clock as follows:

Opening the Date and Time Properties dialog box

1. Press the SETUP key.
2. Press the "General Setup" softkey.
3. Press the "Time + Date" softkey to open the "Date and Time Properties" dialog box.

The "Date & Time" tab is displayed.

Changing the date

1. Press the arrow on the "Month" field to display the list.
2. Select the month from the list.
3. Select the year by clicking on the up and down arrow buttons next to the "Year" field.
4. Select the day in the calendar display or enter the date via the keyboard.
5. Click "OK".

Remote command

```
SYST:DATE 2008,10,1
```

Changing the time

You can change hours, minutes and seconds independently of each other.

1. Select the hour, minute or seconds area of the "Time" field.
2. Enter the required setting via the keyboard or rotary knob.
3. Repeat these steps until the hour, minute and second settings are correct.
4. Click "OK".

Remote command

```
SYST:TIME 12,30,30
```

Changing the time zone

1. Select the "Time Zone" tab.
2. Press the arrow on the "Time Zone" field to display the list.
3. Select the required time zone from the list.
4. Optionally, select the "Automatically adjust clock for daylight saving changes" check box.
5. Click "OK".

4.4.4 Aligning the Touchscreen

When the device is delivered, the touchscreen is initially aligned. However, it may become necessary to adjust the alignment later, e.g. after an image update or after exchanging a hard disk. If you notice that touching a specific point on the screen does not achieve the correct response, try adjusting the alignment.



If the touchscreen is so out of order that you cannot navigate properly, connect an external mouse to the R&S FSVA/FSV and follow the steps described below to start re-alignment.

1. Press the SETUP key.
2. Press the "Alignment" softkey.
3. Press the "Touchscreen Alignment" softkey.

- Using a finger or any other pointing device, press the 4 markers on the screen.

The touchscreen is aligned according to the executed pointing operations.

4.4.5 Setting the Screen Colors

To change the colors of the displayed objects, two default color settings are provided. Alternatively, you can change the color of objects individually using predefined colors or using colors of your own definition.



Some color settings are defined by the selected theme, see [Chapter 6.4.9, "Selecting a Theme"](#), on page 96, and cannot be changed individually.

4.4.5.1 Displaying the Screen Colors Submenu

- Press the SETUP key.
- Press the "Display Setup" softkey.
- Press the "More" softkey.
- Press the "Screen Colors" softkey.

The "Screen Colors" submenu is displayed.

4.4.5.2 Using the Default Color Settings

To select the default setting for brightness, tint and color saturation of all screen objects:

- In the "Screen Colors" submenu (see [Chapter 4.4.5.1, "Displaying the Screen Colors Submenu"](#), on page 50), press the "Set to Default" softkey.
The "Set User Colors to Default" dialog box is displayed.
- Select one of the default color sets. The color schemes are selected in such a manner that all screen elements are visible optimally regardless whether

viewed from above or below. In the instrument's default setting, "Default Colors 1" is active.

Remote commands:

```
DISP:CMAP:DEF1
```

```
DISP:CMAP:DEF2
```

4.4.5.3 Using the Predefined Color Set

1. In the screen colors submenu (see [Chapter 4.4.5.1, "Displaying the Screen Colors Submenu"](#), on page 50), press the "Select Screen Color Set" softkey. The "Select Screen Color Set" dialog box is displayed.
2. Select the "User Defined Colors" option.
3. In the screen colors submenu, press the "Select Object" softkey. The "Screen Color Setup" dialog box is displayed.



4. Press the arrow on the "Selected Object" list and select the object for which you want to change the color setting.
5. Select the color you want to use for the object. The defined color is displayed in the "Preview" box.

- Repeat the steps for all objects that you want to change in color.
- To change to user-defined colors, press the "Userdefined Colors" softkey. For details refer to [Chapter 4.4.5.4, "Defining and Using a User-Defined Color Set"](#), on page 52.
- Click "OK" to accept the new settings and to close the dialog box.

Remote command:

```
DISP:CMAP1 ... 41:PDEF <color>
```

4.4.5.4 Defining and Using a User-Defined Color Set

- In the screen colors submenu (see [Chapter 4.4.5.1, "Displaying the Screen Colors Submenu"](#), on page 50), press the "Select Screen Color Set" softkey. The "Select Screen Color Set" dialog box is displayed.
- Select the "User Defined Colors" option.
- In the "Screen Colors" submenu, press the "Select Object" softkey. The "Screen Color Setup" dialog box is displayed.

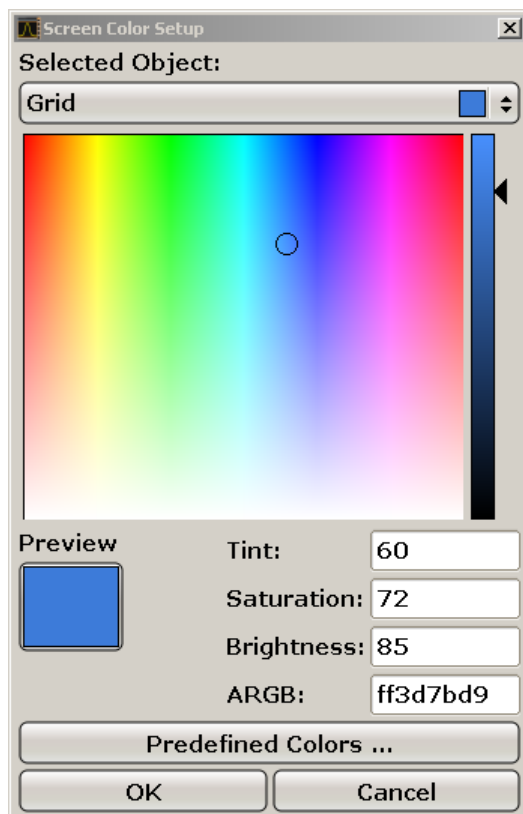

4. Press the arrow on the "Selected Object" list and select the object for which you want to change the color setting.
5. In the color palette, select the color you want to use for the object, or enter values for tint, saturation and brightness.
The defined color is displayed in the "Preview" box.
Note: In the continuous color spectrum ("Tint") red is represented by 0% and blue by 100%.
6. Repeat the steps for all objects for which you want to change the color.
7. To change to predefined colors, press the "Predefined Colors" softkey. For details refer to [Chapter 4.4.5.3, "Using the Predefined Color Set"](#), on page 51.
8. Click "OK" to accept the new settings and to close the dialog box.

Remote command:

```
DISP:CMAP1 . . . 41:HSL <hue>,<sat>,<lum>
```

4.4.6 Setting the Display Power Save Function

The R&S FSVA/FSV provides a feature for automatically switching off its screen after a user-defined period of time. The background lighting is disabled if no entries are made from the front panel after the selected response time (key, softkey and rotary knob).

Activating display power save

1. Press the SETUP key.
2. Press the "Display Setup" softkey.
3. Press the "More" softkey.
4. Press the "Display Pwr Save On/Off" softkey.
The power save mode is activated ("On" is highlighted), and the dialog box to enter the response time is displayed.
5. Enter the desired response time in minutes and confirm the entry with the ENTER key.

The screen is disabled (turns dark) after the selected period of time.

Deactivating Display Power Save

- ▶ In the "Display Setup" submenu, press the "Display Pwr Save On/Off" softkey again.

"Off" is highlighted and the power save mode is switched off.

4.4.7 Selecting and Configuring Printers

You can printout your measurement results using a local printer or a network printer. The instrument supports two independent printout settings. This allows you to quickly switch between output to a file and a printer.

4.4.7.1 Configuring the Printer and the Printout

1. Press the PRINT key.
2. Press the "Device Setup" softkey.

The "Hardcopy Setup" dialog box is displayed.

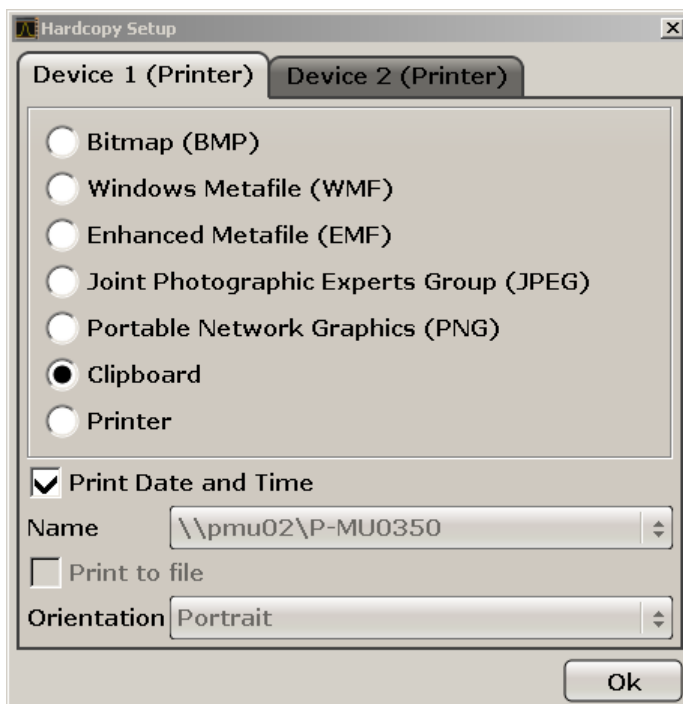

3. To change the tab in order to define the second print setting, press the tab on the screen.
4. Define the output by selecting the required options.

- To save the hardcopy in an image file, select one of the image types. Depending on the image type, the color depth varies (e.g. 4-bit for BMP, 24-bit for PNG and JPEG).
- To copy the image to the clipboard, select the "Clipboard" option.
- To use a preconfigured network printer, select the "Printer" option.

Note: The "Name", "Print to File" and "Orientation" fields are only available if the "Printer" option is selected. You can perform the following steps only with the "Printer" option selected.

5. In the "Name" field, select the desired printer type.
6. To redirect the output to a postscript file rather than a printer, select the "Print to file" option.
7. In the "Orientation" field, select the desired orientation.
8. Optionally, activate the "Print Date and Time" option to add this information to the printout.
9. Click "OK" to accept the settings and to close the dialog box.

4.4.7.2 Selecting the Printout Colors

1. Press the PRINT key.
2. Press the "Colors" softkey.
3. To print in color, press the "Select Print Color Set" softkey to select the color set.

The "Select Print Color Set" dialog box is displayed.

4. Select the color set by using the arrow keys and confirm your selection by pressing the ENTER key.
 - "Screen Colors (Print)" option: The current screen colors are used for the printout. Independently of the current screen colors, the background is printed in white and the grid in black.
Remote command: `HCOP:CMAP:DEF1`
 - "Optimized Colors" option: This setting improves the color clarity of the printout. Trace 1 is printed in blue, trace 2 in black, trace 3 in bright green, trace 4 in pink, trace 5 in sea green, trace 6 in dark red, and the markers in sky blue. The background is printed in white and the grid in black. The

other colors correspond to the screen colors of the default color setting of the "Setup" menu.

Remote command: `HCOP:CMAP:DEF2`

- "User Defined Colors" option: You define and use your own color set for the printout. For details how to proceed refer to [Chapter 4.4.5.4, "Defining and Using a User-Defined Color Set"](#), on page 52.

Remote command: `HCOP:CMAP:DEF3`

- "Screen Colors (Hardcopy)" option: The current screen colors without any changes for a hardcopy. For details on the output format see [Chapter 4.4.7.1, "Configuring the Printer and the Printout"](#), on page 54 .

Remote command: `HCOP:CMAP:DEF4`

5. If you want a black-and-white printout, press the "Color On/Off" softkey to switch off the color. In the black-and-white printout, all background colors are printed out in white and all color lines in black. This allows you to improve contrast on the printout.

Remote command: `HCOP:DEV:COL ON`

4.5 Windows Operating System

The instrument contains the Windows 10 operating system which has been configured according to the instrument's features and needs. Changes in the system setup are only required when peripherals like keyboard or a printer are installed or if the network configuration does not comply with the default settings. After the R&S FSVA/FSV is started, the operating system boots and the instrument firmware is started automatically.

To ensure that the instrument software functions properly, certain rules must be adhered to concerning the operating system.

NOTICE**Risk of rendering instrument unusable**

The instrument is equipped with the Windows 10 operating system. You can install additional software on the instrument, however, additional software can impair instrument function. Thus, run only programs that Rohde & Schwarz has tested for compatibility with the instrument software.

The drivers and programs used on the instrument under Windows 10 are adapted to the instrument. Only install update software released by Rohde & Schwarz to modify existing instrument software.

The following program packages have been tested:

- R&S Power Viewer Plus - virtual power meter for displaying results of the power sensor R&S NRP-Zxx (install only this component!)
- Symantec Endpoint Security – virus-protection software
- FileShredder - for reliable deletion of files on the hard disk

4.5.1 Virus Protection

Take appropriate steps to protect your instruments from infection. Use strong firewall settings and scan any removable storage device used with a Rohde & Schwarz instrument regularly. It is also recommended that you install anti-virus software on the instrument. Rohde & Schwarz does NOT recommend running anti-virus software in the background ("on-access" mode) on Windows-based instruments, due to potentially degrading instrument performance. However, Rohde & Schwarz does recommend running it during non-critical hours.

For details and recommendations, see the following Rohde & Schwarz white paper:

- [1EF96: Malware Protection Windows 10](#)

4.5.2 Service Packs and Updates

Microsoft regularly creates security updates and other patches to protect Windows-based operating systems. These are released through the Microsoft Update website and associated update server. Instruments using Windows, especially those that connect to a network, should be updated regularly.

For details and recommendations, see the Rohde & Schwarz White Paper [1EF96: Malware Protection Windows 10](#)

4.5.3 Login

Windows 10 requires that users identify themselves by entering a user name and password in a login window. By default, the R&S FSVA/FSV provides two user accounts:

- **"Instrument"**: an administrator account with unrestricted access to the computer/domain
- **"NormalUser"**: a standard user account with limited access

Automatic login

For the administrator account, an automatic login function is active by default. If activated, login is carried out automatically for the administrator (with full access) in the background when the R&S FSVA/FSV is started, without having to enter a password. This function is active until you explicitly deactivate it or change the password.

For information on how to deactivate or reactivate the automatic login, refer to [Chapter 4.5.3.1, "Automatic Login Function"](#), on page 59.

Passwords

For all default user accounts, the initial password is *894129*. Note that this password is very weak, and it is recommended that you change the password for both users after initial login.

You can change the password in Windows 10 for any user at any time via "Start > Settings > Account > SignIn Options > Password > Change".



Changing the password and use of auto-login function

Note that when you change the default passwords, the default auto-login function no longer works! Reactivate it manually as described in ["Reactivating the automatic login function"](#) on page 60.

4.5.3.1 Automatic Login Function

When shipped, the instrument automatically logs on the default "Instrument" user to Windows 10 using the default password.

Switching users when using the automatic login function

Which user account is used is defined during login. If automatic login is active, the login window is not displayed. However, you can also switch the user account to be used when the automatic login function is active.

1. Press the "Windows" key or the CTRL + ESC key combination on your keyboard to access the operating system of the R&S FSVA/FSV (see also [Chapter 4.5.4, "Accessing the Start Menu"](#), on page 60).



2. Press CTRL + ALT + DEL, then select "Sign out".

The "Login" dialog box is displayed, in which you can enter the different user account name and password.

Deactivating the automatic login function

To deactivate the automatic login function, perform the following steps:

1. Press the "Windows" key or the CTRL + ESC key combination on your keyboard to access the operating system of the R&S FSVA/FSV (see also [Chapter 4.5.4, "Accessing the Start Menu"](#), on page 60).



2. In the "Start" menu, select "All applications > Windows System > Run".

The "Run" dialog box is displayed.

3. Enter the command `C:\R_S\INSTR\USER\NO_AUTOLOGIN.REG`.

4. Press the ENTER key to confirm.

This command deactivates the automatic login function. The next time you switch on the instrument, the operating system prompts you to enter your user name and password before it starts the firmware.

Adapting the automatic login function to a new password

If you change the "Instrument" user's password, which is used during automatic login, this function no longer works. Adapt the settings for the command that activates the auto login function first.

1. Open the `C:\R_S\INSTR\USER\NO_AUTOLOGIN.REG` file in any text editor (e.g. Notepad).
2. In the line `"DefaultPassword"="894129"`, replace the default password (894129) by the new password for automatic login.
3. Save the changes to the file.

Reactivating the automatic login function

1. Press the "Windows" key or the CTRL + ESC key combination on your keyboard to access the operating system of the R&S FSVA/FSV (see also [Chapter 4.5.4, "Accessing the Start Menu"](#), on page 60).



2. In the "Start" menu, select "All applications > Windows System > Run". The "Run" dialog box is displayed.
3. Enter the command `C:\R_S\INSTR\USER\AUTOLOGIN.REG`.
4. Press the ENTER key to confirm.
This command reactivates automatic login function. It is active the next time the instrument reboots.

4.5.4 Accessing the Start Menu

The Windows "Start" menu provides access to the Windows 10 functionality and installed programs.

To open the "Start" menu:

- ▶ In Windows 10:



Press the "Windows" key or the CTRL + ESC key combination on your (external) keyboard.

All necessary system settings can be defined in the "Start > Settings" menu (for required settings refer to the Windows 10 documentation and to the hardware description).

5 Firmware Update and Installation of Firmware Options

This chapter describes how to update the firmware and how to activate optional firmware packages.



Updating the firmware or installing optional firmware requires administrator rights (see [Chapter 4.5.3, "Login"](#), on page 58).

5.1 Firmware Update

You can install a new firmware version using one of the following methods:

- Copying the files to the instrument using USB devices (e.g. a memory stick), GPIB, or LAN
- Using the "Remote Installation" feature in a LAN network

Copying the files to the instrument

1. Press the SETUP key.
2. Press the "More" softkey.
3. Press the "Firmware Update" softkey.
The "Firmware Update" dialog box is displayed.
4. Enter the drive name and directory via the keypad.
Example: The installation files are stored on a memory stick in the `Update` directory. After you insert the memory stick, it will be detected as drive `D:`. Therefore, the required path specification is `D:\UPDATE`.
5. If you install via LAN using the Remote Desktop application, enter the drive name and directory or press the "Browse" button to locate the directory:
 - a) In the displayed dialog box, select the drive.
 - b) On the selected drive, select the folder that contains the installation file (*.exe).
 - c) Press the "Select" button to confirm your selection and go back to the "Firmware Update" dialog box.

6. Press "Execute"
The installation program will guide you through the installation.
7. After the firmware update, the "UNCAL" status display indicates the necessity of a self alignment. Perform a self alignment (for details refer to [Chapter 4.1.9, "Performing a Self Alignment and a Self Test"](#), on page 43).
Remote command: `SYST:FIRM:UPD 'D:\FW_UPDATE'`

Performing a remote installation from a Windows PC

This method requires a LAN connection from the instrument to a Windows PC (see [Chapter 8.6.1, "Connecting the Instrument to the Network"](#), on page 166).

1. Run the `Setup.exe` file on your PC.
2. Select "Remote Installation" and click the "Next" button.
3. Select the packages you want to install and click the "Next" button.
4. Your LAN subnet is scanned and all found instruments are listed.
Note: The setup procedure communicates with the instrument via LAN, which means the file must pass the firewall. Therefore, add the `Setup.exe` file to your firewall rules, then restart the scan by clicking "Rescan".
5. Select the instruments you want to update. You can select up to 5 instruments to update at the same time.
Note: All instruments in your LAN structure are included in the list. Make sure you select the correct instruments!
To display further options, click the "Options" button.
6. Start installation by clicking "Install".
7. Confirm that you want to reboot the instrument in order to activate the firmware update. The instrument restarts automatically.

5.2 Activating Firmware Options

Firmware options are enabled by entering license keys as described here.

To activate firmware options

1. Press the SETUP key.

2. Press the "More" softkey.
3. Press the "Option Licenses" softkey.
4. Press the "Install Option" softkey.
An edit dialog box is displayed.
5. Enter the option key number using the keypad.
6. Press the ENTER key.
If validation is successful, the message "option key valid" is displayed. If the validation fails, the option software is not installed.
7. Reboot the instrument.



With time-limited licenses, a message box appears if an option is about to expire. Press the "OK" button to resume using the R&S FSVA/FSV. If an option has already expired, a message box appears for you to confirm. In this case, all instrument functions are unavailable (including remote control) until the R&S FSVA/FSV is rebooted.

Alternatively, you can activate options using an XML file.

To activate firmware options using an XML file

1. Press the SETUP key.
2. Press the "More" softkey.
3. Press the "Option Licenses" softkey.
4. Press the "Install Option by XML" softkey.
An edit dialog box is displayed.
5. Enter or browse for the name of an XML file on the instrument that contains the option key.
6. Press "Select."
If validation is successful, the message "option key valid" is displayed. If the validation fails, the option software is not installed.
7. Reboot the instrument.

6 Basic Operations

This chapter gives an overview on how to work with the R&S FSVA/FSV. It describes what kind of information is displayed in the diagram area, how to operate the R&S FSVA/FSV via the front panel keys and other interaction methods, and how to use the Online Help.

It also describes the user interface elements listed in [Figure 3-2](#) in more detail.

 Note the [Conventions Used in the Documentation](#) concerning procedure descriptions and terminology described at the beginning of this manual.

6.1 Information in the Diagram Area

The following figure shows a measurement diagram during analyzer operation. All different information areas are labeled. They are explained in more detail in the following sections.

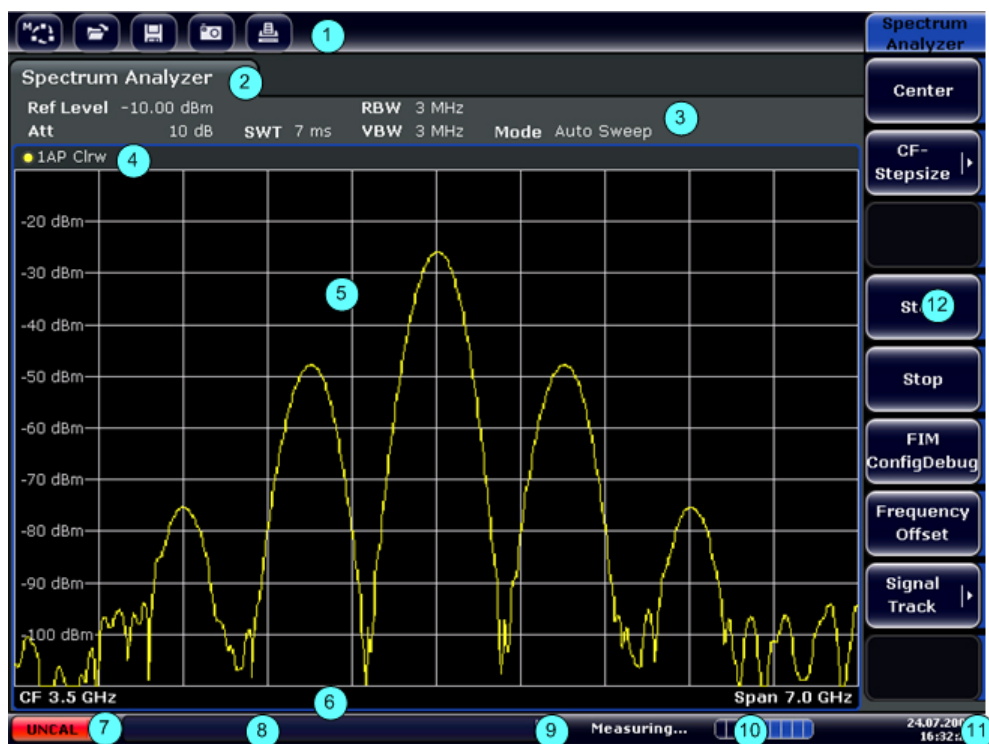



Figure 6-1: Screen layout of the R&S FSVA/FSV during analyzer operation

- 1 = Toolbar
- 2 = Channel information bar for firmware and measurement settings
- 3 = Toolbar toggle icon
- 4 = Diagram header with diagram-specific (trace) information
- 5 = Diagram area
- 6 = Diagram footer with diagram-specific information, depending on measurement mode
- 7 = Device status bar with error messages, progress bar and date/time display

6.1.1 Channel Display

Using the R&S FSVA/FSV you can handle several different measurement tasks (channels) at the same time (although they can only be performed asynchronously). For each channel, a separate tab is displayed on the screen. In order to switch from one channel display to another, simply press the corresponding tab.



The  icon on the tab label indicates that the displayed trace no longer matches the current instrument settings. This may be the case, for example, if a trace is frozen and the instrument settings are changed. As soon as a new measurement is performed, the icon disappears.

To start a new channel

1. Click the icon in the toolbar at the top of the screen (see also [Chapter 6.2.1, "Toolbar"](#), on page 74 on how to display the toolbar).
2. Select the softkey for the required measurement mode.
A new tab is displayed for the new channel.

6.1.2 Display of Hardware Settings

Information on hardware settings are displayed in the channel bar above the diagram.

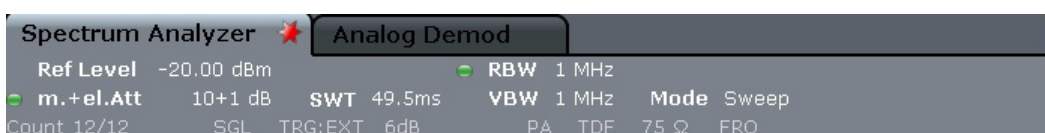



Invalid settings

A bullet next to the hardware setting indicates that user-defined settings are used, not automatic settings. A green bullet indicates this setting is valid and the measurement is correct. A red bullet indicates an invalid setting that does not provide useful results.

It is the user's responsibility to remedy such a situation.



Editing settings in the channel bar

All settings that are displayed in the channel bar can easily be edited by touching the setting in the display (with a finger or mouse pointer). The corresponding (edit) dialog box is displayed where you can edit the setting.

In spectrum mode, the R&S FSVA/FSV shows the following settings:

Ref Level	Reference level
m.+el.Att	Mechanical and electronic RF attenuation that has been set.
Ref Offset	Reference level offset
SWT	Sweep time that has been set. If the sweep time does not correspond to the value for automatic coupling, a bullet is displayed in front of the field. The color of the bullet turns red if the sweep time is set below the value for automatic coupling. In addition, the UNCAL flag is shown. In this case, the sweep time must be increased.
RBW	Resolution bandwidth that has been set. If the bandwidth does not correspond to the value for automatic coupling, a green bullet appears in front of the field.
VBW	Video bandwidth that has been set. If the bandwidth does not correspond to the value for automatic coupling, a green bullet is displayed in front of the field.
Compatible	Compatible device mode (FSP, FSU, default; default not displayed)
Mode	Indicates which sweep mode type is selected: <ul style="list-style-type: none"> • "Auto FFT": automatically selected FFT sweep mode • "Auto sweep": automatically selected swept sweep mode • "FFT": manually selected FFT sweep mode • "Sweep": manually selected swept sweep mode
Mod	Analog demodulation mode (AM/FM/PM), option R&S FSV-K7 only

Information in the Diagram Area

AQT	Acquisition time; for ACP/CCDF measurements, IQ analyzer and option R&S FSV-K7
DBW	Demodulation bandwidth option R&S FSV-K7 only
Dig Out	State of digital output, option R&S FSV-B17 only

6.1.3 Measurement Settings Information

In addition to the common hardware settings, the channel bar above the diagram also displays information on instrument settings that affect the measurement results even though this is not immediately apparent from the display of the measured values. This information is displayed in gray font and only when applicable for the current measurement, as opposed to the common hardware settings that are always displayed.

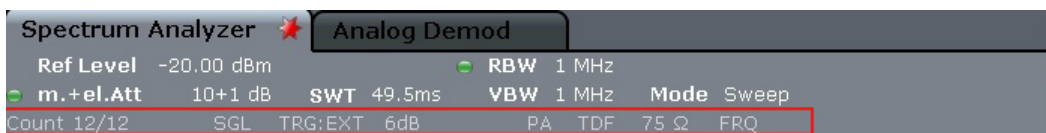

The following types of information may be displayed, if applicable.

Label	Description
SGL	The sweep is set to single sweep mode.
Sweep Count	The current signal count for measurement tasks that involve a specific number of subsequent sweeps (see "Sweep Count" setting in "Sweep" menu in the Operating manual)
TRG	Trigger source (for details see trigger settings in the "TRIG" menu in the Operating manual) <ul style="list-style-type: none"> • EXT: External • VID: Video • RFP: RF power • IFP: IF power • BBP: Baseband power • PSE: Power sensor • TIM: Time • SQL: Squelch
6dB/RRC/CHN	Filter type for sweep bandwidth (see BW menu in the Operating manual)
PA	The preamplifier is activated.
GAT	The frequency sweep is controlled via the EXT TRIG/GATE IN connector.
TDF	A transducer factor is activated.

Label	Description
75 Ω	The input impedance of the instrument is set to 75 Ω.
FRQ	A frequency offset ≠ 0 Hz is set.
DC/AC	An external DC or AC calibration signal is in use.
Inp	Input source: digital I/Q (option R&S FSV-B17 only)

6.1.4 Diagram-specific and Trace Information

Diagram-specific information, e.g. concerning traces, is indicated in the diagram header and footer.

Trace information in diagram header

The diagram header (above the diagram) contains the following trace information:



The header may contain a user-defined introductory title, see [Chapter 6.4.7, "Adding a Title to the Diagram Header"](#), on page 96.



Editing settings in the diagram header

All settings that are displayed in the diagram header can easily be edited by selecting the setting in the display (by tapping or clicking). The corresponding (edit) dialog box is displayed in which you can edit the setting.

Norm/NCor

Correction data is not used.

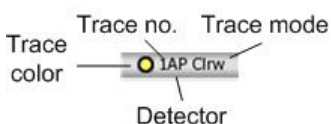

Trace color		Color of trace display in diagram
Trace no.		Trace number (1 to 6)
Detector		Selected detector:
	AP	AUTOPEAK detector
	Pk	MAX PEAK detector

Information in the Diagram Area

	Mi	MIN PEAK detector
	Sa	SAMPLE detector
	Av	AVERAGE detector
	Rm	RMS detector
	QP	QUASIPeAK detector
	CA	CISPR Average detector
	RA	RMS Average detector
Trace Mode		Sweep mode:
	ClrW	CLEAR/WRITE
	Max	MAX HOLD
	Min	MIN HOLD
	Avg	AVERAGE (Lin/Log/Pwr)
	View	VIEW

Marker information in Diagram Grid

The x and y axis positions of the last 2 markers or delta markers that were set, as well as their index, are displayed within the diagram grid, if available. The value in the square brackets after the index indicates the trace to which the marker is assigned. (Example: M1[1] defines marker 1 on trace 1.) For more than 2 markers, a separate marker table is displayed beneath the diagram.

If applicable, the active measurement function for the marker and its main results are indicated, as well. The functions are indicated with the following abbreviations:

FXD	Reference fixed marker active
PHNoise	Phase noise measurement active
CNT	Frequency counter active
TRK	Signal track active
NOise	Noise measurement active
MDepth	Measurement of the AM modulation depth active
TOI	TOI measurement active

Marker Information in Marker Table

In addition to the marker information displayed within the diagram grid, a separate marker table may be displayed beneath the diagram. This table provides the following information for all active markers:

Type	Marker type: N (normal), D (delta), T (temporary, internal), PWR (power sensor)
Dgr	Diagram number
Trc	Trace to which the marker is assigned
Stimulus	x-value of the marker
Response	y-value of the marker
Func	Activated marker or measurement function
Func .Result	Result of the active marker or measurement function

Mode-dependant Information in Diagram Footer

The diagram footer (beneath the diagram) contains the following information, depending on the current mode:

Mode	Label	Information
FREQ	CF	Center frequency (between start and stop)
	Span	Frequency span
SPAN	CF (1.0 ms/)	Zero span

For most modes, the number of sweep points shown in the display are indicated in the diagram footer. In zoom mode, the (rounded) number of currently displayed points are indicated.

The diagram footer can be removed from the display temporarily, see [Chapter 6.4.8, "Removing the Diagram Footer"](#), on page 96.

6.1.5 Instrument and Status Information

Global instrument settings, the instrument status and any irregularities are indicated in the status bar beneath the diagram.





Hiding the status bar

You can hide the status bar display, e.g. in order to enlarge the display area for the measurement results.

1. Press the DISPLAY key.
2. In the "Display Settings" dialog box, select "Status Bar State: Off".
The status bar is no longer displayed.



- To display the status bar again, select "Status Bar State: On".

SCPI command:

```
DISP:SBAR:STAT OFF
```

The following information is displayed:

Instrument status

	The instrument is configured for operation with an external reference.
	The optional Digital Baseband interface (B17) is being used for digital input
	The optional Digital Baseband interface (B17) is being used to provide digital output

Error information

If errors or irregularities are detected, a keyword and an error message, if available, are displayed in the status bar.



The following keywords are used:

UNCAL	<p>One of the following conditions applies:</p> <ul style="list-style-type: none"> • Correction data has been switched off. • No correction values are available. This occurs, for example, if a firmware update is performed followed by a cold start of the instrument. • Record the correction data by performing a self alignment (for details refer to Chapter 4.1.9, "Performing a Self Alignment and a Self Test", on page 43).
OVL	<p>Overload of the input mixer.</p> <ul style="list-style-type: none"> • Increase the RF attenuation (for RF input). • Reduce the input level (for digital input)

IFOVL	Overload of the IF signal path after the input mixer. <ul style="list-style-type: none"> • Increase the reference level.
LOUNL	Error in the instrument's frequency processing hardware was detected.
NO REF	Instrument was set to an external reference but no signal was detected on the reference input.
OVEN	OCXO reference frequency (option R&S FSV-B4) has not yet reached its operating temperature. The message usually disappears a few minutes after power has been switched on.
FIFO OVL	for option R&S FSV-B17 only

Progress

The progress of the current operation is displayed in the status bar.



Date and time

The date and time settings of the instrument are displayed in the status bar.



6.2 Means of User Interaction

The instrument provides a user interface for operation that does not require an external keyboard, using the following means of interaction:

- [Chapter 6.2.1, "Toolbar"](#), on page 74
- [Chapter 6.2.2, "Touchscreen"](#), on page 75
- [Chapter 6.2.3, "On-screen Keyboard"](#), on page 76
- [Chapter 6.2.5, "Rotary Knob"](#), on page 78
- [Chapter 6.2.6, "Arrow Keys, UNDO/REDO Keys"](#), on page 78
- [Chapter 6.2.7, "Softkeys"](#), on page 79
- [Chapter 6.2.9, "Dialog Boxes"](#), on page 82

All tasks necessary to operate the instrument can be performed using this user interface. Apart from instrument specific keys, all other keys that correspond to an external keyboard (e.g. arrow keys, ENTER key) operate conform to Microsoft.

For most tasks, there are at least 2 alternative methods to perform them:

- Using the touchscreen
- Using other elements provided by the front panel, e.g. the keypad, rotary knob, or arrow and position keys

6.2.1 Toolbar

Standard functions can be performed via the icons in the toolbar at the top of the screen, if available (see [Chapter 6, "Basic Operations"](#), on page 65). By default, this toolbar is not displayed.

Displaying the toolbar

- ▶ Press the "Toolbar" icon to the right of the tabs in the display to toggle the toolbar on or off.



Alternatively:











1. Press the SETUP key.
2. Press the "Display Setup" softkey.
3. Press the "Tool Bar State On/Off" softkey.
Or:
4. Press the DISPLAY key.
5. In the "Display Settings" dialog box, select "Tool Bar State: On".
The toolbar is displayed at the top of the screen.

Remote:

```
DISP:TBAR:STAT ON
```

The following functions are available:

Table 6-1: Standard Application Functions in the Toolbar

Icon	Description
	Opens the "Select Mode" menu (see Chapter 6.1.1, "Channel Display" , on page 66)
	Opens an existing measurement (settings) file
	Stores the current measurement file
	Prints the current measurement screen
	Saves the current measurement screen as a file (screenshot)
	Reverts last operation.
	Repeats previously reverted operation.
	Selection mode: the cursor can be used to select (and move) markers in a zoomed display
	Zoom mode: displays a dotted rectangle in the diagram that can be expanded to define the zoom area. Can be repeated several times.
	Zoom off: the diagram is displayed in its original size

6.2.2 Touchscreen

A touchscreen is a screen that is touch-sensitive, i.e. it reacts in a specified way when a particular element on the screen is tapped by a finger or a pointing device, for example. Any user interface elements that can be clicked on by a mouse pointer can also be tapped on the screen to trigger the same behavior, and vice versa. Using the touchscreen, the following tasks (among others) can be performed by the tap of your finger:

- Changing a setting
- Changing the display
- Moving a marker
- Zooming into a diagram
- Saving or printing results and settings

To imitate a right-click by mouse using the touchscreen, for example to open a context-sensitive menu for a specific item, press the screen for about 1 second.

Deactivating and Activating the Touchscreen Function

The touchscreen function can be deactivated, e.g. when the instrument is being used for demonstration purposes and tapping the screen should not provoke an action.

1. Press the DISPLAY key.
2. In the dialog box, select one of the following options:
 - "Touchscreen ON": touchscreen function is active for the entire screen
 - "Touchscreen OFF": touchscreen is deactivated for the entire screen
 - "DIAGRAM TOUCH OFF": touchscreen is deactivated for the diagram area of the screen, but active for the surrounding softkeys, toolbars and menus.

SCPI command:

```
DISP:TOUCH:STAT OFF
```

6.2.3 On-screen Keyboard

The on-screen keyboard is an additional means of interacting with the instrument without having to connect an external keyboard.

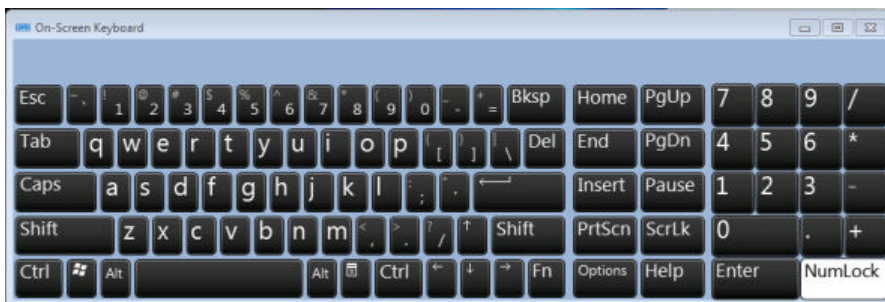

The on-screen keyboard display can be switched on and off as desired using the "On-Screen Keyboard" function key beneath the screen.



When you press this key, the display switches between the following options:

- Keyboard displayed at the top of the screen
- Keyboard displayed at the bottom of the screen
- No keyboard displayed



You can use the TAB key on the on-screen keyboard to move the focus from one field to another in dialog boxes.

6.2.4 Keypad



The keypad is used to enter alphanumeric parameters. It contains the following keys:

- Alphanumeric keys
Enters numbers and (special) characters in edit dialog boxes. For details refer to [Chapter 6.3.1, "Entering Numeric Parameters"](#), on page 83 and [Chapter 6.3.2, "Entering Alphanumeric Parameters"](#), on page 84.
- Decimal point
Inserts a decimal point "." at the cursor position.

- Sign key
Changes the sign of a numeric parameter. In the case of an alphanumeric parameter, inserts a "-" at the cursor position.
- Unit keys (GHz/-dBm MHz/dBm, kHz/dB and Hz/dB)
These keys add the selected unit to the entered numeric value and complete the entry.
In the case of level entries (e.g. in dB) or dimensionless values, all units have the value "1" as multiplying factor. Thus, they have the same function as an ENTER key. The same is true for an alphanumeric entry.
- ESC key
Closes all kinds of dialog boxes, if the edit mode is not active. Quits the edit mode, if the edit mode is active. In dialog boxes that contain a "Cancel" button it activates that button.
For "Edit" dialog boxes the following mechanism is used:
 - If data entry has been started, it retains the original value and closes the dialog box.
 - If data entry has not been started or has been completed, it closes the dialog box.
- BACKSPACE key
 - If an alphanumeric entry has already been started, this key deletes the character to the left of the cursor.

- If no input field is currently active, the most recently entered value is undone, i.e. the previous value is retrieved. Thus, you can toggle between two values (e.g. spans).
- ENTER key
 - Concludes the entry of dimensionless entries. The new value is accepted.
 - With other entries, this key can be used instead of the "Hz/dB" unit key.
 - In a dialog box, presses the default or focused button.
 - In a dialog box, activates the edit mode for the focused area, if available. For details on the edit mode refer to [Chapter 6.3.3, "Navigating in Dialog Boxes"](#), on page 86.
 - In a dialog box, activates or deactivates the selected option of the focused area, if the edit mode is active.

6.2.5 Rotary Knob



The rotary knob has several functions:

- Increments (clockwise direction) or decrements (counter-clockwise direction) the instrument parameter at a defined step width in the case of a numeric entry.
- Shifts the selection bar within focused areas (e.g. lists), if the edit mode is activated.
- Shifts markers, limit lines, etc on the screen.
- Acts like the ENTER key, when it is pressed. For details refer to [Chapter 6.3.3, "Navigating in Dialog Boxes"](#), on page 86.
- Moves the scroll bar vertically, if the scroll bar is focused and the edit mode is activated.

For details on the edit mode refer to [Chapter 6.3.3, "Navigating in Dialog Boxes"](#), on page 86.

6.2.6 Arrow Keys, UNDO/REDO Keys

The arrow keys are used for navigation. The UNDO/REDO keys support you during input.



UPARROW/DNARROW keys

The UPARROW or DNARROW keys do the following:

- In a numeric edit dialog box, increase or decrease the instrument parameter.
- In a list, scroll forward and backward through the list entries.
- In a table, move the selection bar vertically.
- In windows or dialog boxes with vertical scroll bar, move the scroll bar.

LEFTARROW/RIGHTARROW keys

The LEFTARROW or RIGHTARROW keys do the following:

- In an alphanumeric edit dialog box, move the cursor.
- In a list, scroll forward and backward through the list entries.
- In a table, move the selection bar horizontally.
- In windows or dialog boxes with horizontal scroll bar, move the scroll bar.

UNDO/REDO keys

- The UNDO key reverts the previously performed action, i.e. the status before the previous action is retrieved.
The undo function is useful, for example, if you are performing a zero span measurement with several markers and a limit line defined and accidentally click the "ACP" softkey. In this case, very many settings would be lost. However, if you press UNDO immediately afterwards, the previous status is retrieved, i.e. the zero span measurement and all settings.
- The REDO key repeats the previously reverted action, i.e. the most recently performed action is repeated.



The UNDO function is not available after a PRESET or "RECALL" operation. When these functions are used, the history of previous actions is deleted.

6.2.7 Softkeys

Softkeys are virtual keys provided by the software. Thus, more functions can be provided than those that can be accessed directly via the function keys on the device. Softkeys are dynamic, i.e. depending on the selected function key, a different list of softkeys is displayed on the right side of the screen

(For details on function keys in general see [Chapter 3.1.1, "Function Keys on the Front Panel"](#), on page 17.)

A list of softkeys for a certain function key is also called a menu. Each softkey can either represent a specific function, or a submenu that in turn represents several softkeys.

Selecting softkeys

- ▶ A particular softkey is selected by pressing the key on the screen with a finger, mouse pointer or other pointing device.



Softkeys can only be operated via the screen, there are (usually) no corresponding function keys.

Navigating in softkey menus

- The "More" softkey indicates that the menu contains more softkeys than can be displayed at once on the screen. When pressed, it displays the next set of softkeys.
- If the softkey label contains a ">" symbol, it represents a submenu of further softkeys. When you press it, the submenu is displayed.
- The "Up" key switches to the next higher level of the menu.
- The start menu of the current measurement mode is accessed directly by pressing the HOME key on the front panel.

Softkey actions

A softkey performs one of the following actions when pressed:

- Opens a dialog box to enter data.
- Switches a function on or off.
- Opens a submenu (only softkeys with a ">" symbol).

Recognizing the softkey status by color

In the factory configuration, a softkey is highlighted orange when a corresponding dialog box is open. If it is a toggle softkey, the current state is highlighted blue. If an instrument function is not available temporarily due to a specific setting, the associated softkey is deactivated and its text is colored gray.

Some softkeys belong to a certain (firmware) option. If this option is not implemented in your device, the associated softkeys are not displayed.

Hiding softkeys

You can hide the softkey display, e.g. when using remote control, in order to enlarge the display area for the measurement results. When you press a function key on the front panel, the softkeys are displayed temporarily, enabling you to perform a certain task with the softkeys. They are then automatically hidden again when they have not been used for a specified time. Any edit dialog boxes required for entry remain in the display.

1. Press the DISPLAY key.
2. In the "Display Settings" dialog box, select "Softkey Bar State: Off".
The softkeys are no longer displayed.

► To display the softkeys again, select "Softkey Bar State: On".

Remote:

```
DISP:SKEY:STAT OFF
```

6.2.8 Context-sensitive Menus

Markers and traces in the display, as well as the information in the channel bar, have context-sensitive menus. If you right-click on a marker or trace in the display, or information in the channel bar (or touch it for about 1 second), a menu is displayed which contains the same functions as the corresponding softkey. This is useful, for example, when the softkey display is hidden (see [Chapter 6.2.7, "Softkeys"](#), on page 79).

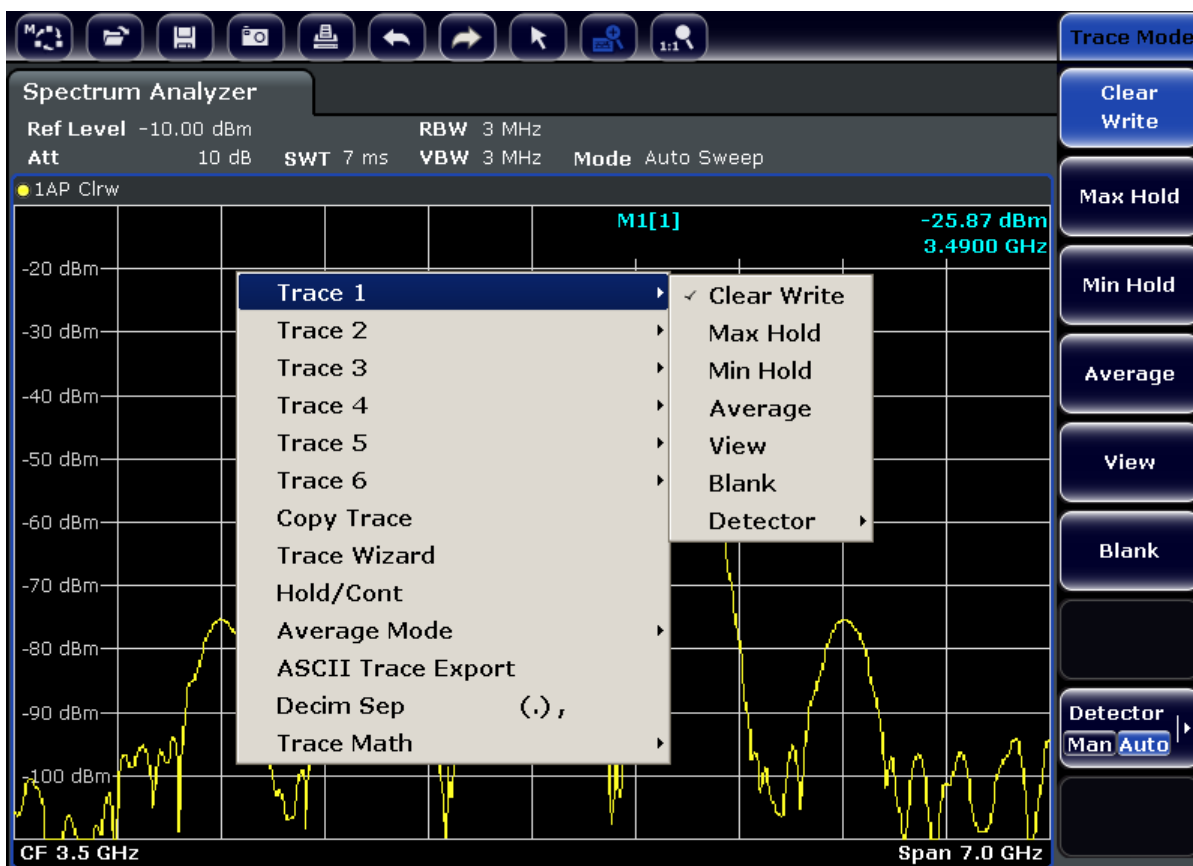

If a menu entry contains an arrow to the right of it, a submenu is available for that entry.

- To close the menu, press the ESC key or click in the display outside of the menu.

6.2.9 Dialog Boxes

In most cases, the R&S FSVA/FSV dialog boxes are designed to enter a numeric value. In the documentation, these dialog boxes are called "edit dialog boxes". Dialog boxes that are not only designed for parameter entry have a more complex structure and, in the documentation, are called "dialog boxes". The navigation in Windows dialog boxes differs in some aspects from the navigation in R&S FSVA/FSV dialog boxes. For details, see [Chapter 6.3.3, "Navigating in Dialog Boxes"](#), on page 86.

The following figure shows an example of a edit dialog box:

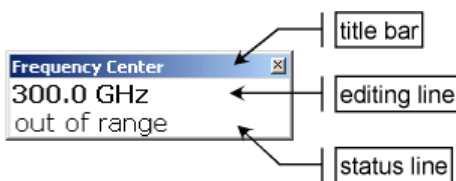

Figure 6-2: Edit dialog box for parameter entry

The title bar shows the name of the parameter that was selected. The entry is performed in the editing line. When the dialog box is displayed, the focus is on the editing line and it contains the currently used parameter value and its unit. The optional third line shows status and error messages which always refer to the current entry.

6.3 Setting Parameters

This section describes how to perform the following basic tasks in the R&S FSVA/FSV:

- [Chapter 6.3.1, "Entering Numeric Parameters"](#), on page 83
- [Chapter 6.3.2, "Entering Alphanumeric Parameters"](#), on page 84
- [Chapter 6.3.3, "Navigating in Dialog Boxes"](#), on page 86

6.3.1 Entering Numeric Parameters

If a field requires numeric input, the keypad provides only numbers.

1. Enter the parameter value using the keypad, or change the currently used parameter value by using the rotary knob (small steps) or the UPARROW or DNARROW keys (large steps).
2. After entering the numeric value via keypad, press the corresponding unit key. The unit is added to the entry.
3. If the parameter does not require a unit, confirm the entered value by pressing the ENTER key or one of the unit keys. The editing line is highlighted in order to confirm the entry.

6.3.2 Entering Alphanumeric Parameters

If a field requires alphanumeric input, you can use the on-screen keyboard to enter numbers and (special) characters (see also [Chapter 6.2.3, "On-screen Keyboard"](#), on page 76).

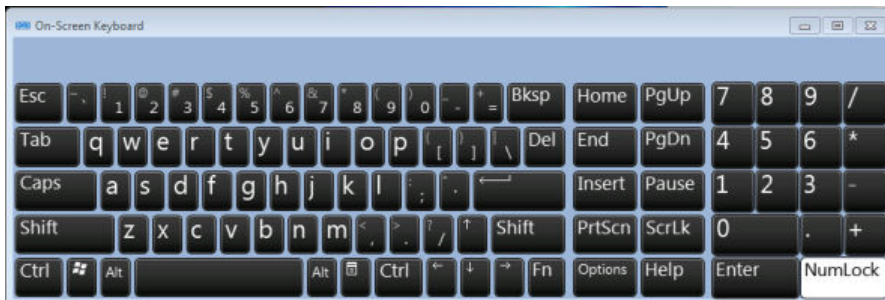

Figure 6-3: On-screen keyboard

Alternatively, you can use the keypad. Every alphanumeric key provides several characters and one number. The decimal point key (.) provides special characters, and the sign key (-) toggles between capital and small letters. For the assignment refer to [Table 6-2](#).

Entering numbers and (special) characters via the keypad

1. Press the key once to enter the first possible value.
2. All characters available via this key are displayed.
3. To choose another value provided by this key, press the key again, until your desired value is displayed.
4. With every key stroke the next possible value of this key is displayed. If all possible values have been displayed, the series starts with the first value again. For information on the series refer to [Table 6-2](#).
5. To change from capital to small letters and vice versa, press the sign key (-).
6. When you have chosen the desired value, wait for 2 seconds (to use the same key again), or start the next entry by pressing another key.

Entering a blank

- ▶ Press the "Space" bar, or press the "0" key and wait 2 seconds.

Correcting an entry:

1. Using the arrow keys, move the cursor to the right of the entry you want to delete.
2. Press the BACKSPACE key.
3. The entry to the left of the cursor is deleted.
4. Enter your correction.

Completing the entry

- ▶ Press the ENTER key or the rotary knob.

Aborting the entry

- ▶ Press the ESC key.
The dialog box is closed without changing the settings.

Table 6-2: Keys for alphanumeric parameters

Key name (upper inscription)	Series of (special) characters and number provided
7	7 μ Ω ° € ¥ \$ ¢
8	A B C 8 Ä Å Ç
9	D E F 9 É
4	G H I 4
5	J K L 5
6	M N O 6 Ñ Ö
1	P Q R S 1
2	T U V 2 Ü
3	W X Y Z 3
0	<blank> 0 – @ + / \ < > = % &
.	. * : _ , ; " ' ? () #
–	<toggles between capital and small letters>

6.3.3 Navigating in Dialog Boxes

Some of the dialog boxes are not only for parameter entry, and therefore have a more complex structure. The following figure shows an example.

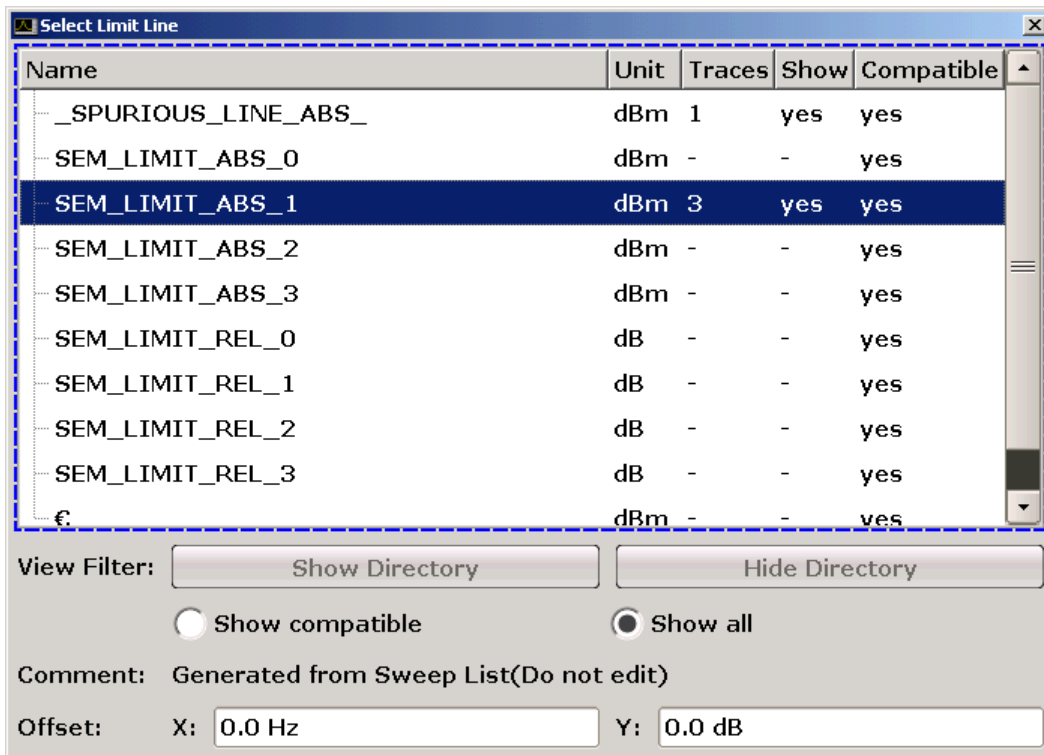

Changing the focus

The focus on the graphical user interface is moved by pressing an element on the screen, or via the rotary knob. The focused area is marked with a blue frame (see [Figure 6-4](#)). If this area consists of more than one element, e.g. lists of options or tables, you must first switch to the edit mode in order to make changes. A focused area in the edit mode is marked with a dashed blue frame (see [Figure 6-5](#)).

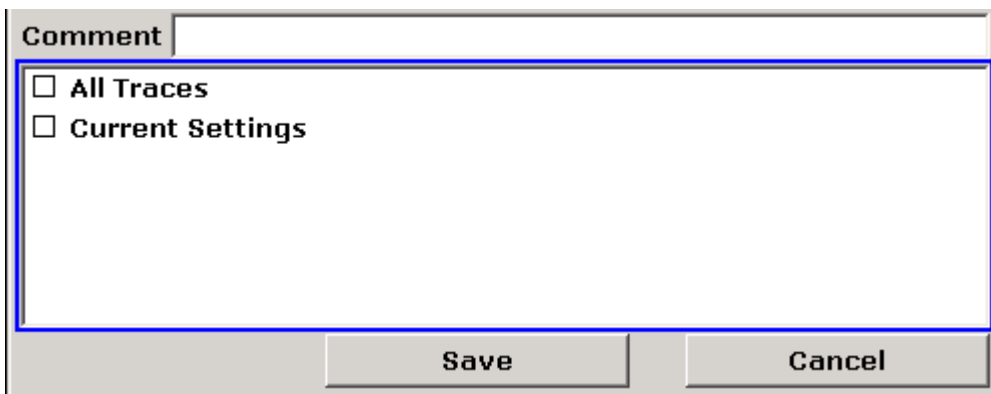

Figure 6-4: Focused area

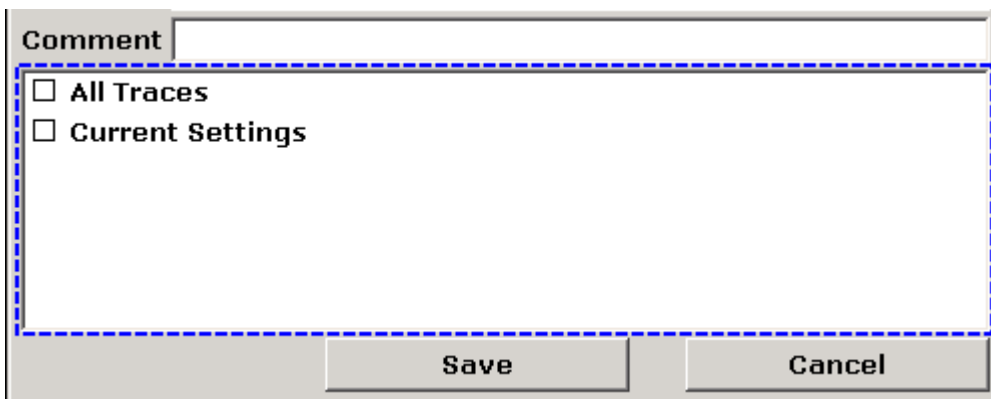

Figure 6-5: Focused area in edit mode



Edit mode

When using the touchscreen for focus changes, all focused areas are in the edit mode automatically, if available. Otherwise, you must switch to edit mode manually.

Switching to edit mode

1. Press the ENTER key.
2. To quit the edit mode, press the ESC key.

Working in dialog boxes

- To edit alphanumeric parameters, use the keypad or the on-screen keyboard. For details see [Chapter 6.3.1, "Entering Numeric Parameters"](#), on page 83

and [Chapter 6.3.2, "Entering Alphanumeric Parameters"](#), on page 84. If you edit fields, the edit mode is activated automatically when you start typing.

- To move the focus to the next interface element (e.g. field, option, list), press it on the screen, or turn the rotary knob.
- To select or deselect an option, press the option on the screen.
Alternatively:
 - If the focused area consists of more than one option and the edit mode is not active, change into the edit mode.
 - Scroll through the list of options using the arrow keys or the rotary knob (only for vertical direction) until the option you want to activate or deactivate is highlighted.
 - Press the rotary knob or the ENTER key to confirm your selection.
The option is activated or deactivated, depending on its previous setting.
 - To leave the edit mode, press the ESC key.
- To open a drop-down list, press the arrow next to the list. Alternatively, press the ENTER key or the rotary knob. When opened, the list is in edit mode.
- To select an entry without opening a drop-down list, use the arrow keys to browse through the list entries.
- To select a list entry, press the entry on the screen.
Alternatively:
 - If the edit mode is not active, change into the edit mode.
 - Scroll through the list using the arrow keys or the rotary knob until the list entry you want to select is highlighted.
 - Confirm your choice by pressing the rotary knob or the ENTER key.
If a drop-down list was opened, it is closed.
- To change from one tab to the next, press the tab on the screen.
- To press a button in a dialog box, press the button on the screen.
Alternatively:
 - Place the focus on the desired button using the rotary knob.
 - Confirm your choice by pressing the rotary knob or the ENTER key.
- To close the dialog box and accept the changes, press the "OK" button.
- To close the dialog box without accepting the changes, press the ESC key or the "Cancel" button.

Particularities in Windows dialog boxes

In some cases, e.g. if you want to install a printer, original Windows dialog boxes are used. In these dialog boxes, the navigation behavior is different to the one you are used to from R&S FSVA/FSV applications. In the following, the important differences and useful tips are listed:

- The rotary knob and function keys do not work. Do not use them. Use the touchscreen instead.

6.4 Changing the Display

6.4.1 Changing the Focus

Any selected function is always performed on the currently focussed element in the display, e.g. a dialog field, diagram, or table row. Which element is focussed is indicated by a blue frame (diagram, window, table) or is otherwise highlighted (softkey, marker etc.). Moving the focus is most easily done by tapping on the element on the touchscreen. Alternatively, use the "Tab" key on the on-screen keyboard or the rotary knob to move the focus from one element to the next on the display.



To move the focus on the screen between any displayed diagrams or tables, press the "Change focus" function key on the front panel. The focus moves from the diagram to the first table to the next table etc. and then back to the diagram.

6.4.2 Switching between Split and Maximized Display



In some measurement modes, a table with markers or measurement results is displayed beneath the diagram. In this case, you may wish to maximize the diagram or table display in order to see more details.

Press the SPLIT/MAXIMIZE key on the front panel to switch between a split screen and a full screen (maximized display). In maximized display, the table or diagram currently focused is maximized. In split display, both the diagram and any available tables are displayed in one screen.

SCPI command:`DISP:WIND:SIZE`

6.4.3 Soft and Mini Soft Front Panel Display

When working with an external monitor or operating via remote control on a computer, it is useful to be able to interact with the R&S FSVA/FSV without requiring the keypad and keys located on the front panel of the instrument. Therefore, a "Soft Front Panel" display is available, which simulates the entire front panel of the instrument (except for the external connectors) on the screen. You can switch between "normal" screen display and extended display. In the extended display, the keys and other hardware controls of the instrument are simulated on the screen.

If you require a Soft Front Panel but do not want to lose too much space for results in the display area, a mini soft Front Panel is available. The mini version displays only the hardkeys in a separate window in the display area. This window can be closed automatically after pressing a key, or remain open, as desired. Using the Mini Front Panel, the R&S FSVA/FSV interface is fully operable from a monitor with a resolution of 1024x768 pixels.

Switching to soft Front Panel display

1. Press the SETUP key.
2. Press the "General Setup" softkey.
3. Press the "More" softkey.
4. Press the "Soft Front Panel" softkey.
Alternatively:
5. Press the DISPLAY key.
6. In the "Display Settings" dialog box, select "Front Panel State: On".
The extended display appears on the screen.

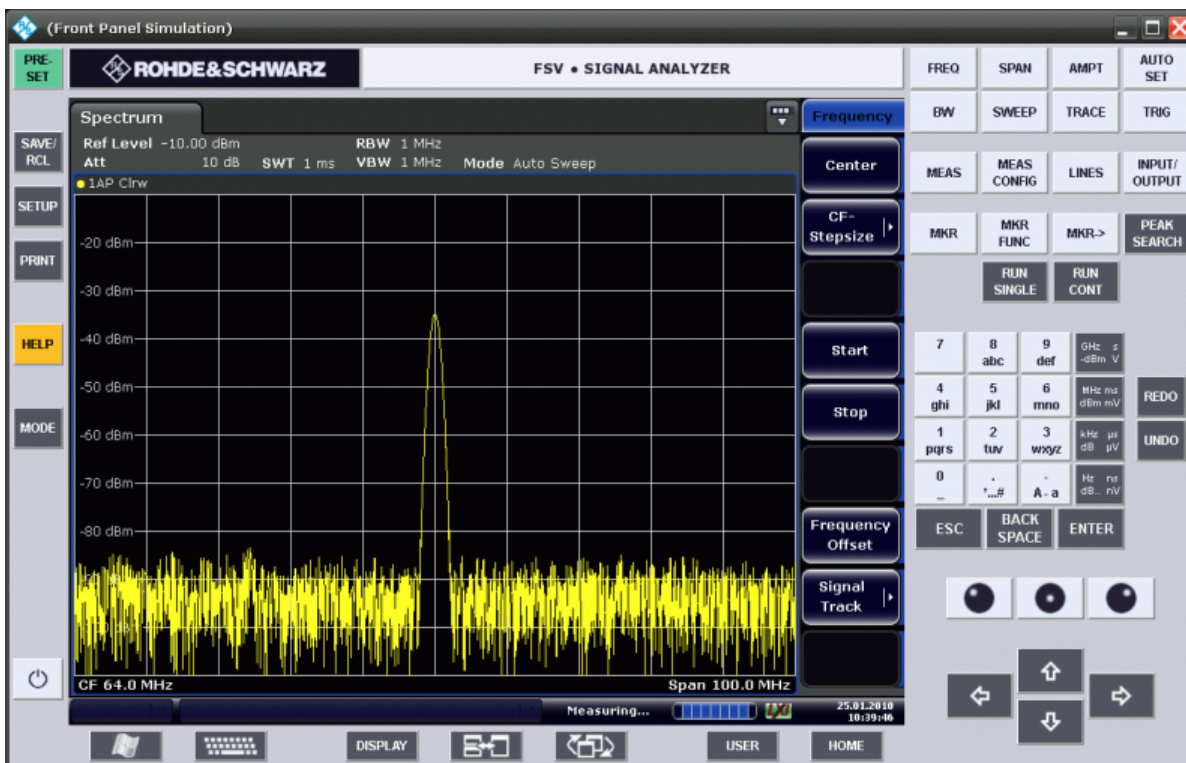

Using the F6 key you can toggle the Front Panel display on and off.

Remote: SYST:DISP:FPAN:STAT ON

Working with the Soft Front Panel

Basic operation with the soft Front Panel is identical to normal operation. To activate a key, either press the key on the touchscreen, or click on it with the mouse pointer. To simulate the use of the rotary knob, use the additional keys displayed between the keypad and the arrow keys:

Icon	Function
	Turn left
	Enter
	Turn right

Switching to Mini Front Panel display

1. Press the DISPLAY key.

- In the "Display Settings" dialog box, select "Mini Front Panel State: On". The "Mini Front Panel" window appears on the screen. It can be moved anywhere on the screen where it does not interfere with your current task.



Using the key combination ALT + M you can toggle the Mini Front Panel display on and off.

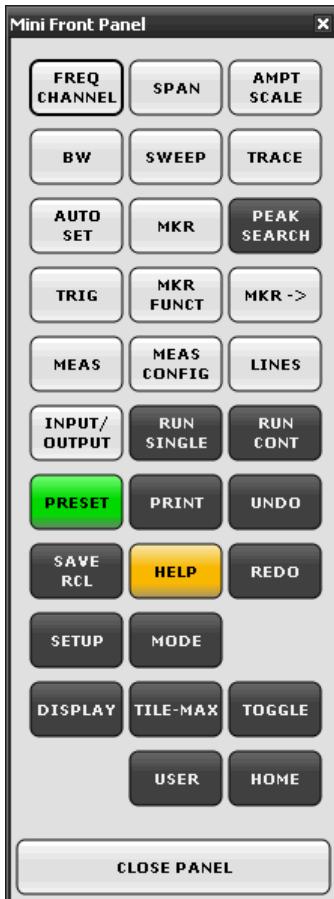

Auto close option

By default, the "Auto close" option is activated and the Mini Front Panel window closes automatically after you select a key. This is useful if you only require the Front Panel display to press a single function key.

If you want the window to remain open, deactivate the "Auto close" option. You can close the window manually by clicking "Close Panel" or the key combination ALT + M.

6.4.4 Enlarging the Display Area

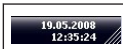

You can enlarge the screen display area if you are using an external monitor or the Soft and Mini Soft Frontpanel display (see [Chapter 6.4.3, "Soft and Mini Soft Front Panel Display"](#), on page 90). To do so, drag the lower right corner of the window to the required size. In standard display, a small icon is displayed in the lower right corner of the screen.

6.4.5 Displaying the Toolbar

Standard file functions can be performed via the icons in the toolbar at the top of the screen (see the [Chapter 6.2.1, "Toolbar"](#), on page 74). By default, this toolbar is not displayed.

To display the toolbar:

1. Press the DISPLAY key.
2. Under "Select Tool Bar State", select "On".

Alternatively:

1. Press the SETUP key.
2. Press the "Display Setup" softkey.
3. Press the "Tool Bar State On/Off" softkey.

The toolbar is displayed at the top of the screen.

6.4.6 Zooming into the Diagram

You can zoom into the diagram to visualize the measurement results in greater detail. Using the touchscreen or a mouse pointer you can easily define the area to be enlarged.



Zoom and the number of sweep points

Note that zooming is merely a visual tool, it does not change any measurement settings, such as the number of sweep points!

You should increase the number of sweep points before zooming, as otherwise the function has no real effect (see the "Sweep Points" softkey, described in the Operating Manual and online help).

To zoom into the diagram

1. Display the toolbar as described in [Chapter 6.4.5, "Displaying the Toolbar"](#), on page 93.
2.  Click on the "Zoom On" icon in the toolbar.
A dotted rectangle is displayed in the diagram.

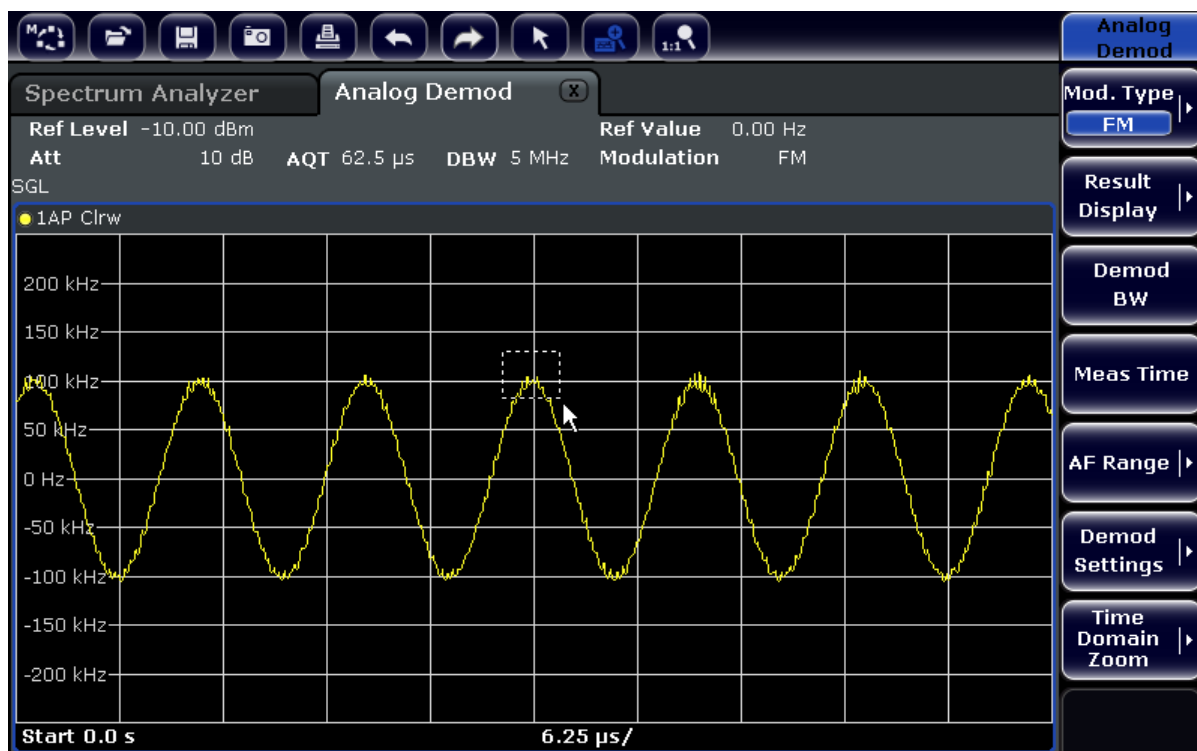

3. Drag the lower right corner of the rectangle (either via touchscreen or a mouse pointer) to define the area in the diagram to be enlarged.
4. Repeat these steps, if necessary, to enlarge the diagram further.



Scrolling in the zoomed display

You can scroll the diagram area to display the entire diagram using the scrollbars at the right and at the bottom of the diagram.

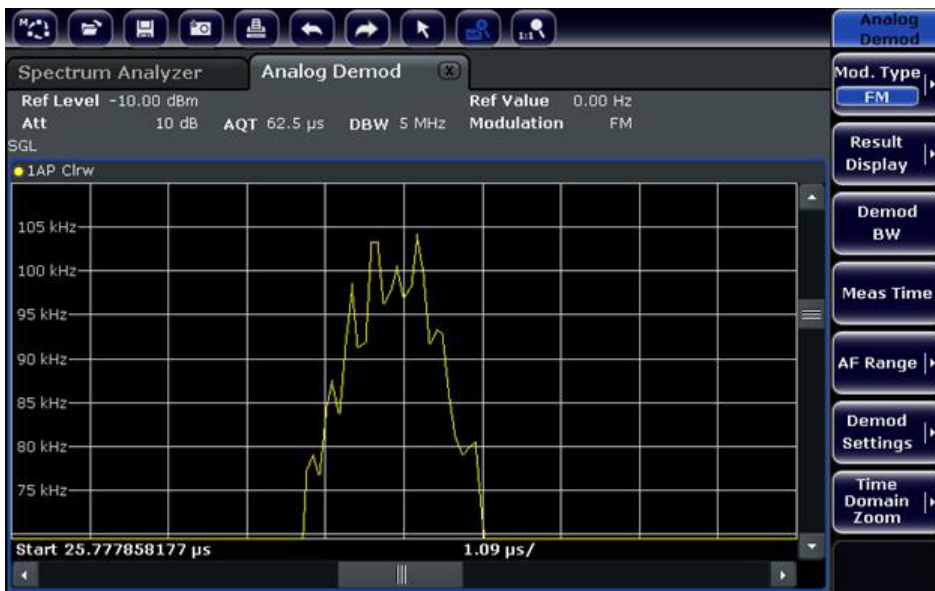

To return to selection mode in the diagram

While you are in zoom mode, touching the screen changes the zoom area. In order to select or move a trace or marker, you must switch back to selection mode:



- ▶ Click on the "Selection mode" icon in the toolbar.

To return to original display



- ▶ Click on the "Zoom Off" icon in the toolbar.
A dotted rectangle is displayed in the diagram.

Remote commands:

1. Activate the zoom mode:
DISP:ZOOM ON
2. Define the zoom area:

```
DISP:ZOOM:AREA 5,30,20,100
```

3. Hide the overview window:

```
DISP:ZOOM:OVER OFF
```

6.4.7 Adding a Title to the Diagram Header

You can add an introductory title to the trace information in the diagram header.

1. Press the SETUP key.
2. Press the "Display Setup" softkey.
3. Press the "Screen Title On/Off" softkey.
An edit dialog box is displayed.
4. Enter the title and press "ENTER".
The title is displayed at the beginning of the diagram header.

6.4.8 Removing the Diagram Footer

Some additional diagram-specific information is displayed in the diagram footer (see [Chapter 6.1.4, "Diagram-specific and Trace Information"](#), on page 69). This footer can be removed from display if necessary.

1. Press the SETUP key.
2. Press the "Display Setup" softkey.
3. Press the "Annotation On/Off" softkey.
The footer is displayed beneath the diagram or removed from display.

6.4.9 Selecting a Theme

You can select a theme for the screen display. The theme defines the colors used for keys and screen elements, for example. The default theme is "BlueOcean".

Selecting a theme

1. Press the SETUP key.
2. Press the "Display Setup" softkey.

3. Press the "More" softkey.
4. Press the "Theme Selection" softkey. A list of available themes is displayed.
5. Select the desired theme from the list.
The screen display changes according to the selected theme.

SCPI command:

```
DISPlay:THEMe:SElect
```

6.4.10 Displaying and Setting the Date and Time

You can switch the date and time display in the diagram footer on or off. By default, it is displayed. You can also switch between German and US format.

Switching the date and time display off

1. Press the SETUP key.
2. Press the "Display Setup" softkey.
3. Press the "Time+Date" softkey to "Off".

Changing the format

1. Press the SETUP key.
2. Press the "Display Setup" softkey.
3. Press the "Time+Date Format" softkey until the required format is selected.

Setting the date and time

To set the date and time, click on the date and time display in the diagram footer. The standard Windows "Date and Time Properties" dialog is displayed and you can set the correct date and time.

6.4.11 Changing the Display Update Rate

When performance is poor due to slow data transfer (for example during remote control), it may be helpful to decrease the frequency with which the screen display is updated.

To decrease the display update rate

1. Press the DISPLAY key.

The "Display Settings" dialog box is opened.

2. Under "Display Update Rate", select "Slow".

The display is updated less frequently, and performance for measurements should improve. When data transfer is no longer a problem, you can set the update rate back to "Fast" in the same way.

7 Basic Measurement Examples

The following measurement examples are intended as an introduction to operating the R&S FSVA/FSV. The User Manual contains additional and more advanced examples. Refer to chapter "Advanced Measurement Examples" to find the following topics:

- High-Sensitivity Harmonics Measurements
- Separating Signals by Selecting an Appropriate Resolution Bandwidth
- Intermodulation Measurements
- Measuring Signals in the Vicinity of Noise
- Measuring Noise Power Density
- Measurement of Noise Power within a Transmission Channel
- Measuring Phase Noise
- Measuring Channel Power and Adjacent Channel Power

For a more detailed description of the basic operating steps, e.g. selecting menus and setting parameters, refer to [Chapter 6, "Basic Operations"](#), on page 65.

7.1 Measuring a Sinusoidal Signal

One of the most common measurement tasks that can be handled by using a signal analyzer is determining the level and frequency of a signal. When measuring an unknown signal, you can usually start with the presets.

⚠ WARNING**High input values**

If levels higher than +30 dBm (=1 W) are expected or are possible, a power attenuator must be inserted before the RF input of the analyzer. If this is not done, signal levels exceeding 30 dBm can damage the RF attenuator or the input mixer. The total power of all occurring signals must be taken into account.

Test setup

- Connect the RF output of the signal generator to the RF input of R&S FSVA/FSV.

Table 7-1: Signal generator settings (e.g. R&S SMU)

Frequency	128 MHz
Level	-30 dBm

7.1.1 Measuring the Level and Frequency Using Markers

The level and frequency of a sinusoidal signal can be measured easily by using the marker function. The R&S FSVA/FSV always displays its amplitude and frequency at the marker position. The frequency measurement uncertainty is determined by the frequency reference of the R&S FSVA/FSV, the resolution of the marker frequency display and the number of sweep points.

1. Reset the instrument by pressing the PRESET key.
2. Connect the signal to be measured to the *RF INPUT* analyzer input on the instrument front panel.
3. Set the center frequency to *128 MHz*.
 - a) Press the **FREQ** key.
The dialog box for the center frequency is displayed.
 - b) In the dialog box, enter *128* using the numeric keypad and confirm the entry with the **MHz** key.
4. Reduce the frequency span to *1 MHz*.
 - a) Press the **SPAN** key.
 - b) In the dialog box, enter *1* using the numeric keypad and confirm the entry by pressing the **MHz** key.

Note: Coupled settings. When the frequency span is defined, the resolution bandwidth, the video bandwidth and the sweep time are automatically adjusted, because these functions are defined as coupled functions in the presettings.
5. Measure the level and frequency using the marker by pressing the **MKR** key. The marker is activated and automatically set on the maximum of the trace. The level and frequency values measured by the marker are displayed in the marker field at the top edge of the screen. They can be taken as the measurement result.

Measuring a Sinusoidal Signal

M1[1]	-30.00 dBm
	128.00000 MHz

The field header indicates the number of the marker (Marker 1) and the trace on which the marker is located ([1] = Trace 1).

Note: Performing a peak search. When a marker is initially activated, it automatically performs the peak search function (as shown in the example). If a marker was already active, you have to press the PEAK SEARCH key on the front panel or the "Peak" softkey in the MKR > menu in order to set the currently active marker to the maximum of the displayed signal.

7.1.1.1 Increasing the Frequency Resolution

The frequency resolution of the marker is predefined by the pixel resolution of the trace. A trace uses 691 pixels, i.e. if the frequency span is 1 MHz, each pixel corresponds to a span of approx. 1.4 kHz. This corresponds to a maximum uncertainty of +/- 0.7 kHz.

You can increase the pixel resolution of the trace by reducing the frequency span.

Reducing the frequency span to 10 kHz

1. Press the SPAN key.
2. Using the numeric keypad, enter *10* in the dialog box and confirm the entry with the KHZ key.

The generator signal is measured using a span of 10 kHz. The pixel resolution of the trace is now approx. 14 Hz (10 kHz span / 691 pixels) , i.e. the precision of the marker frequency display increases to approx. ± 7 Hz.

7.1.1.2 Setting the Reference Level

With signal analyzers, the reference level is the level at the upper limit of the diagram. To achieve the widest dynamic range possible for a spectrum measurement, use the entire level span of the signal analyzer. In other words, the highest level that occurs in the signal should be located at the top edge of the diagram (=reference level) or immediately below it.



Low Reference Levels

If the selected reference level is lower than the highest signal that occurs in the spectrum, the signal path in the R&S FSVA/FSV is overloaded.

In this case, the message "IFOVL" is displayed in the error message field.

In the presettings, the value of the reference level is -10 dBm. If the input signal is -30 dBm, the reference level can be reduced by 20 dB without causing the signal path to be overloaded.

Reducing the reference level by 20 dB

1. Press the AMPT key.
The amplitude menu is displayed. The "Ref Level" softkey is highlighted in red to indicate that it is activated for data entry. The dialog box for the reference level is also opened.
2. Using the numeric keypad, enter 30 and confirm the entry with the - DBM key.
The reference level is set to -30 dBm. The maximum of the trace is near the maximum of the measurement diagram. However, the increase in the displayed noise is not substantial. Thus, the distance between the signal maximum and the noise display (=dynamic range) has increased.

Setting the marker level equal to the reference level

The marker can also be used to shift the maximum value of the trace directly to the top edge of the diagram. If the marker is located at the maximum level of the trace (as in this example), the reference level can be moved to the marker level as follows:

1. Press the MKR key.
2. Press the "Ref Lvl = Mkr Lvl" softkey.

The reference level is set equal to the measured level where the marker is located.

Thus, setting the reference level is reduced to two keystrokes.

7.1.2 Measuring the Signal Frequency Using the Frequency Counter

The built-in frequency counter allows you to measure the frequency more accurately than measuring it with the marker. The frequency sweep is stopped at the marker, and the R&S FSVA/FSV measures the frequency of the signal at the marker position.

In the following example, the frequency of the generator at 128 MHz is shown by using the marker.

Prerequisite

In this example, a precise frequency measurement is to be performed. Therefore, connect the signal generator's "Ref OUT" connector to the analyzer's "Ref IN" connector.

1. Set the signal analyzer to the default state by pressing the PRESET key.
The R&S FSVA/FSV is set to its default state.
2. Set the center frequency and the span.
 - a) Press the **FREQ** key and enter 128 MHz.
The center frequency of the R&S FSVA/FSV is set to 128 MHz.
 - b) Press the **SPAN** key and enter *1 MHz*.
The frequency span of the R&S FSVA/FSV is set to 1 MHz.
3. In the "Setup" menu, select "Reference Ext".
4. Activate the marker by pressing the **MKR** key.
The marker is activated and set to the signal maximum. The level and the frequency of the marker are displayed in the marker field (diagram header or marker table).
5. Activate the frequency counter by pressing the "Sig Count On/Off" softkey in the "MKR FUNC" menu.
The result of frequency counting is displayed in the selected resolution in the marker field.

Measuring Harmonics of Sinusoidal Signals

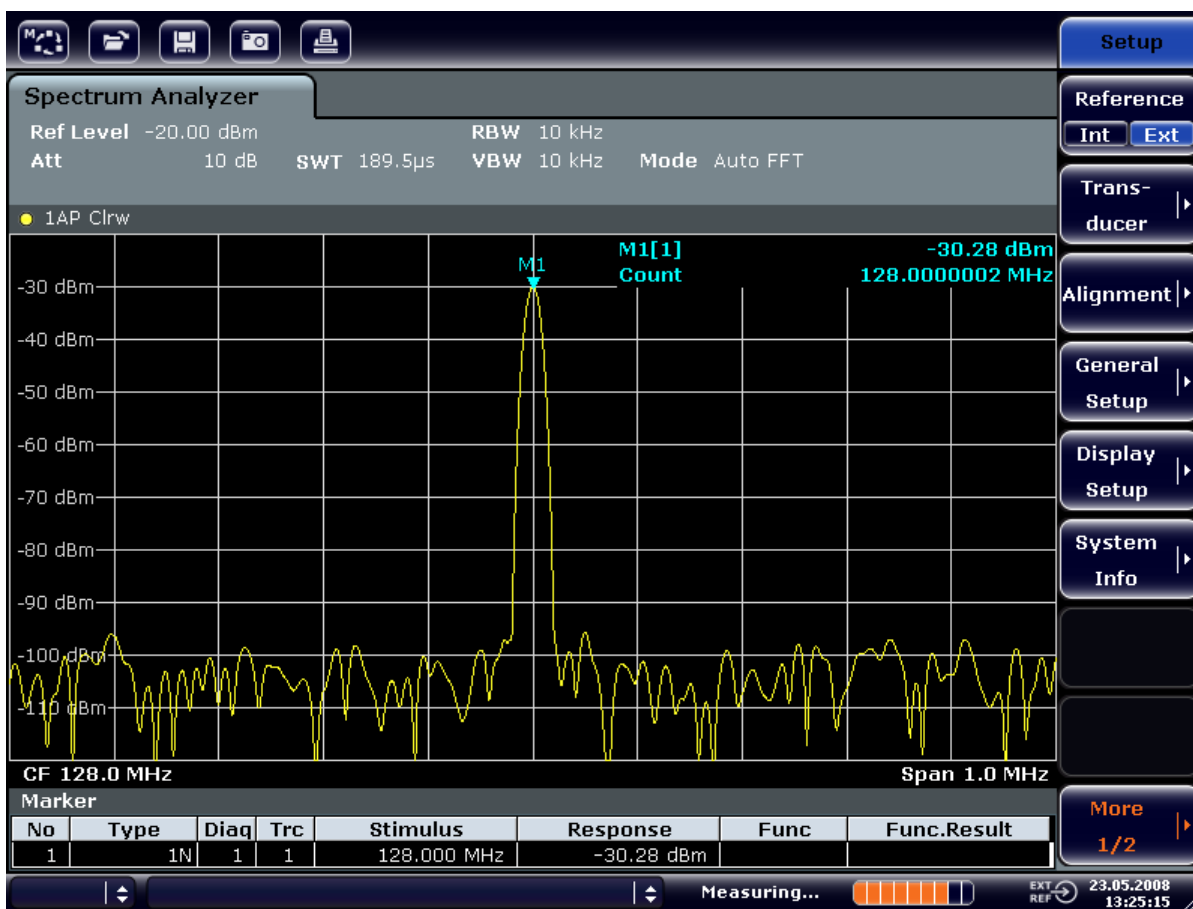

Figure 7-1: Measurement of the frequency with the frequency counter



Prerequisites for using the internal frequency counter

In order to obtain a correct result when measuring the frequency with the internal frequency counter, an RF sinusoidal signal or a spectral line must be available. The marker must be located more than 25 dB above the noise level to ensure that the specified measurement accuracy is adhered to.

7.2 Measuring Harmonics of Sinusoidal Signals

Measuring the harmonics of a signal is a very common task that can be performed optimally by using a Signal and Spectrum Analyzer.

In the following example, the generator signal with 128 MHz and -20 dBm is used again.

Measuring Harmonics of Sinusoidal Signals

Measuring the Suppression of the First and Second Harmonic of an Input Signal

1. Set the signal analyzer to the default state by pressing the PRESET key.
The R&S FSVA/FSV is in the default state.
2. Set the start frequency to 100 MHz and the stop frequency to 400 MHz.
 - a) Press the **FREQ** key.
 - b) Press the "Start" softkey and enter *100 MHz*.
 - c) Press the "Stop" softkey and enter *400 MHz*.
The R&S FSVA/FSV displays the fundamental and the first and second harmonics of the input signal.
3. To average (smooth) the noise, reduce the video bandwidth.
 - a) Press the **BW** key.
 - b) Press the "Video BW Manual" softkey and enter *100 kHz*.
4. Set the attenuation to 0 dB.
 - a) Press the **AMPT** key.
 - b) Press the "RF Atten Manual" softkey.
 - c) Enter *0 dB* in the edit dialog box.
5. Activate the marker by pressing the **MKR** key.
"Marker 1" is activated and positioned to the signal maximum (fundamental at 128 MHz). The level and frequency of the marker is displayed in the marker field.
6. Activate the delta marker and measure the harmonic suppression.
 - a) In the "MKR" menu, press the "Marker 2" softkey.
"Marker 2" is activated as a delta marker ("D2 [1]"). It is automatically set on the largest harmonic of the signal. The frequency offset and level offset from marker 1 are displayed in the channel information bar.
 - b) In the "MKR" menu, press the "Marker 3" softkey.
"Marker 3" is activated as a delta marker ("D3 [1]"). It is automatically set on the next largest harmonic of the signal. The frequency offset and level offset from marker 1 on the fundamental are displayed in the channel information bar (see [Figure 7-2](#)).

Measuring Harmonics of Sinusoidal Signals

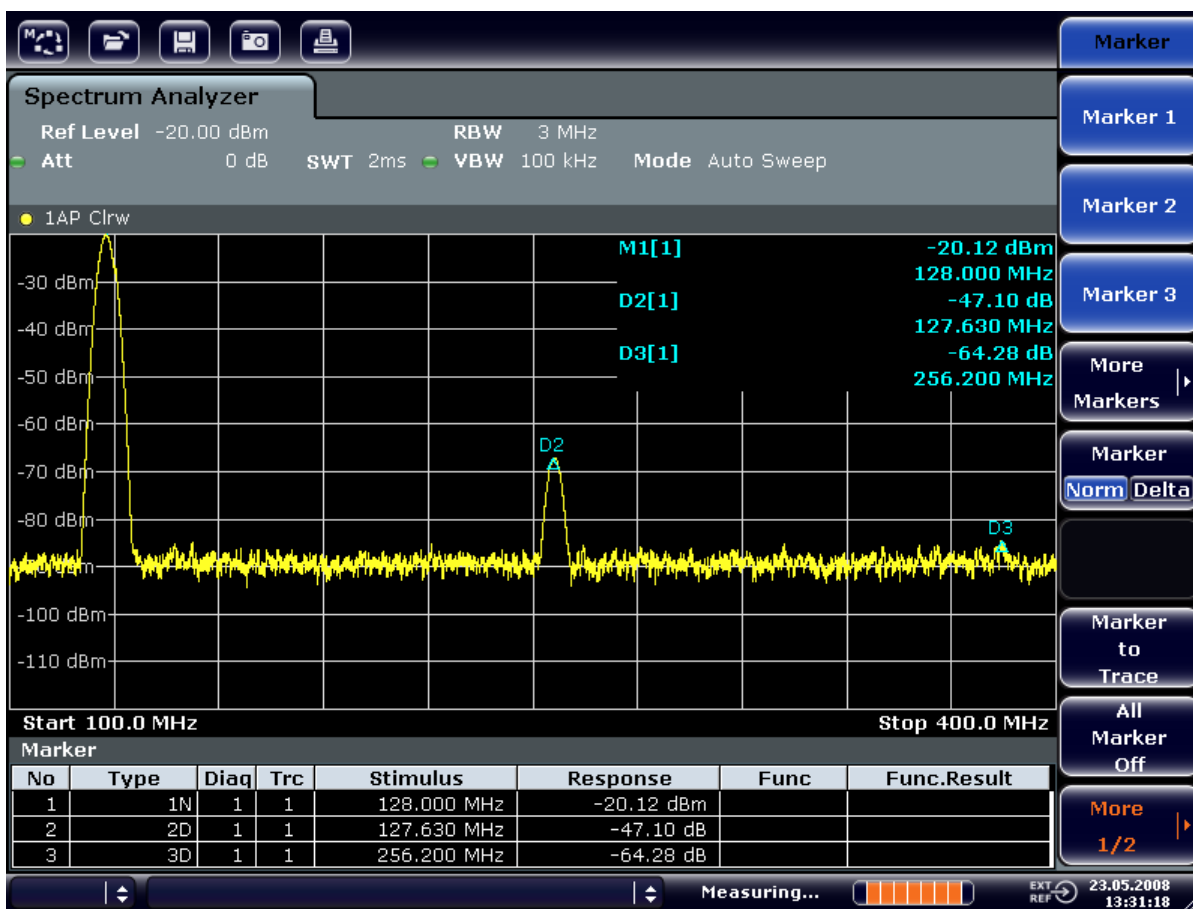

Figure 7-2: Measuring the harmonic suppression of the internal reference generator.

Delta markers D2 [1] and D3 [1] show the offset of the first and second harmonics from the fundamental.

Reducing Noise

The signal analyzer offers three methods to differentiate the harmonics of a signal from the noise effectively:

- Reducing the video bandwidth
- Averaging the trace
- Reducing the resolution bandwidth

Reducing the video bandwidth and averaging the traces cause the noise from the analyzer or the DUT to be reduced, depending on which component is larger. Both averaging methods reduce the measurement uncertainty, particularly in the case of small signal-to-noise ratios, because the measurement signal is also separated from the noise.

Measuring Harmonics of Sinusoidal Signals

Reducing the noise by reducing the video bandwidth

1. Press the BW key.
2. Press the "Video BW Manual" softkey.
3. Reduce the video bandwidth to 1 kHz (for example), by entering 1 kHz.
This smooths the noise significantly, and the sweep time is increased to 200 ms. In other words, the measurement will take significantly more time. The video bandwidth that is displayed is marked with a bullet to indicate that it is no longer coupled to the resolution bandwidth (see [Figure 7-3](#)).

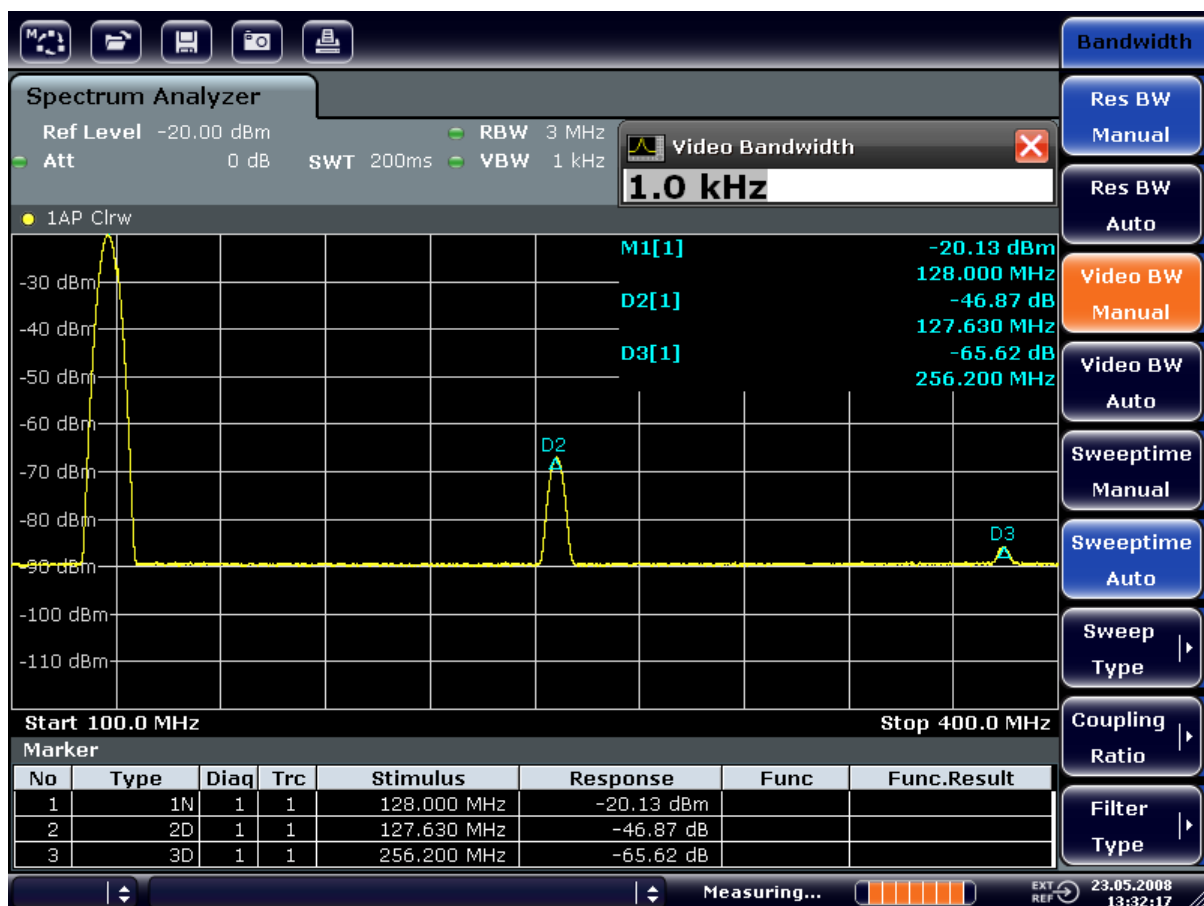

Figure 7-3: Suppression of noise during harmonics measurement by reducing video bandwidth

4. Recouple the video bandwidth to the resolution bandwidth.
 - a) Press the BW key.
 - b) Press the "Video BW Auto" softkey.

Reducing the noise by averaging the trace

1. Press the TRACE key.

Measuring Signal Spectra with Multiple Signals

2. Press the "Trace Wizard" softkey.
3. For "Trace 1", press the button in the "Trace Mode" column and select "Average" from the list.
The noise component of the trace is smoothed by averaging 10 successive traces.
4. Switch off trace averaging by pressing the button in the "Trace Mode" column and selecting "Clear Write" from the list.

Reducing the noise by reducing the measurement bandwidth

The noise is reduced in proportion to the bandwidth by reducing the resolution bandwidth, i.e. reducing the resolution bandwidth by a factor of 10 also reduces the noise by a factor of 10 (which corresponds to 10 dB). The amplitude of sinusoidal signals is not affected by reducing the resolution bandwidth.

1. Set the resolution bandwidth to 10 kHz.
 - a) Press the BW key.
 - b) Press the "Res BW Manual" softkey and enter *10 kHz*.
The noise decreases by approx. 25 dB compared to the previous setting. Since the video bandwidth is coupled to the resolution bandwidth, it is reduced to 30 kHz in proportion to the resolution bandwidth. This causes the sweep time to increase to 3.0 seconds.
2. Reset the resolution bandwidth (couple it to the span) by pressing the "Res BW Auto" softkey in the "BW" menu.

7.3 Measuring Signal Spectra with Multiple Signals

7.3.1 Separating Signals by Selecting the Resolution Bandwidth

A basic feature of a Signal and Spectrum Analyzer is the ability to separate the spectral components of a mixture of signals. The resolution at which the individual components can be separated is determined by the resolution bandwidth. Selecting a resolution bandwidth that is too large may make it impossible to distinguish between spectral components, i.e. they are displayed as a single component.

Measuring Signal Spectra with Multiple Signals

An RF sinusoidal signal is displayed using the passband characteristic of the defined resolution filter (RBW). Its specified bandwidth is the 3 dB bandwidth of the filter.

Two signals with the same amplitude can be resolved if the resolution bandwidth is smaller than or equal to the frequency spacing of the signal. If the resolution bandwidth is equal to the frequency spacing, the spectrum display shows a level drop of 3 dB precisely in the center of the two signals. Decreasing the resolution bandwidth makes the level drop larger, which thus makes the individual signals clearer.

Higher spectral resolution at a narrower bandwidth is accomplished through longer sweep times at the same span. Reducing the resolution bandwidth by a factor of 3 increases the sweep time by a factor of 9.

Example:

Separating Two Signals

The two signals have a level of -30 dBm each at a frequency spacing of 30 kHz

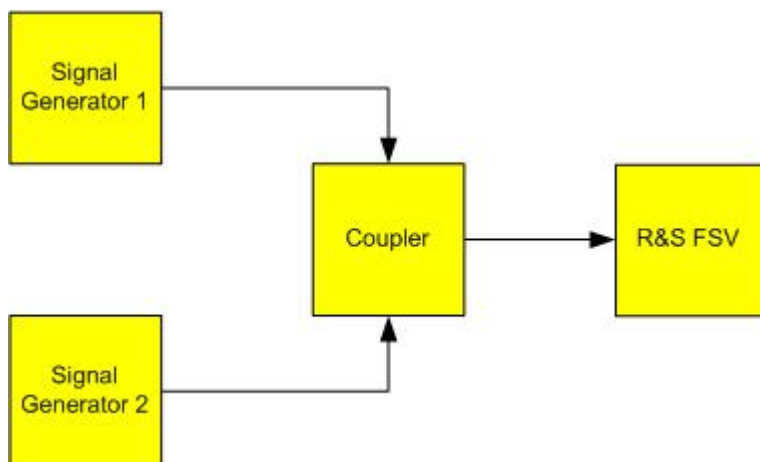

Table 7-2: Signal generator settings (e.g. R&S SMU)

	Level	Frequency
Signal generator 1	-30 dBm	128,00 MHz
Signal generator 2	-30 dBm	128,03 MHz

1. Set the signal analyzer to the default state by pressing the PRESET key. The R&S FSVA/FSV is set to its default state.
2. Set the center frequency to 128.015 MHz and the frequency span to 300 kHz.
 - a) Press the FREQ key and enter 128.015 MHz.

Measuring Signal Spectra with Multiple Signals

- b) Press the SPAN key and enter *300 kHz*.
3. Set the resolution bandwidth to 30 kHz and the video bandwidth to 1 kHz.
 - a) Press the BW key
 - b) Press the "Res BW Manual" softkey and enter *30 kHz*.
 - c) Press the "Video BW Manual" softkey and enter *1 kHz*.

Note: Larger video bandwidths. The video bandwidth is set to 1 kHz in order to make the level drop in the center of the two signals clearly visible. At larger video bandwidths, the video voltage that results from envelope detection is not sufficiently suppressed. This produces additional voltages, which are visible in the trace, in the transition area between the two signals.

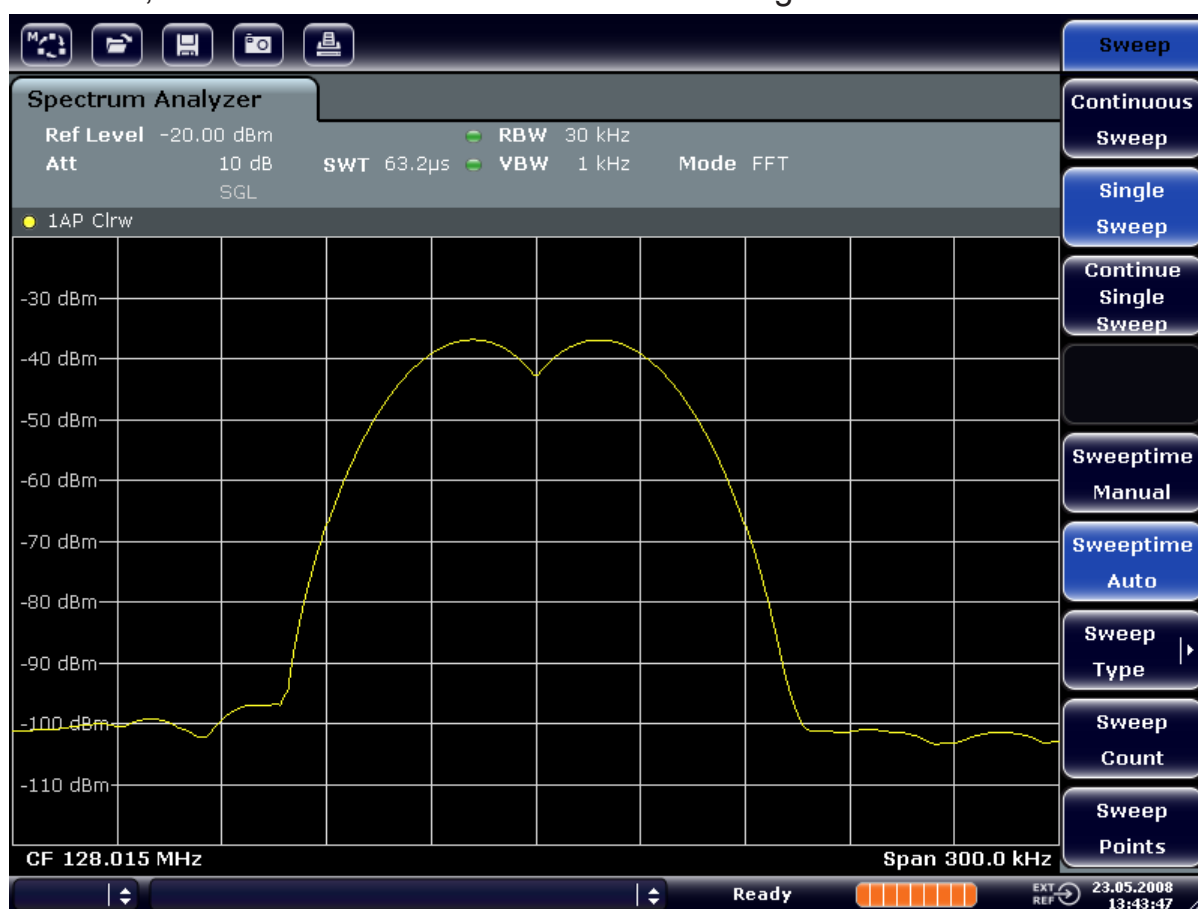

Figure 7-4: Measurement of two equally-leveled RF sinusoidal signals with the resolution bandwidth which corresponds to the frequency spacing of the signals

Matching generator and R&S FSVA/FSV frequencies

The level drop is located exactly in the center of the screen only if the generator frequencies match the frequency display of the R&S FSVA/FSV exactly.

To achieve exact matching, the frequencies of the generators and the R&S FSVA/FSV must be synchronized.

Measuring Signal Spectra with Multiple Signals

- Set the resolution bandwidth to 100 kHz. To do so, in the bandwidth menu, press the "Res BW Manual" softkey and enter *100 kHz*. It is no longer possible to clearly distinguish the two generator signals.

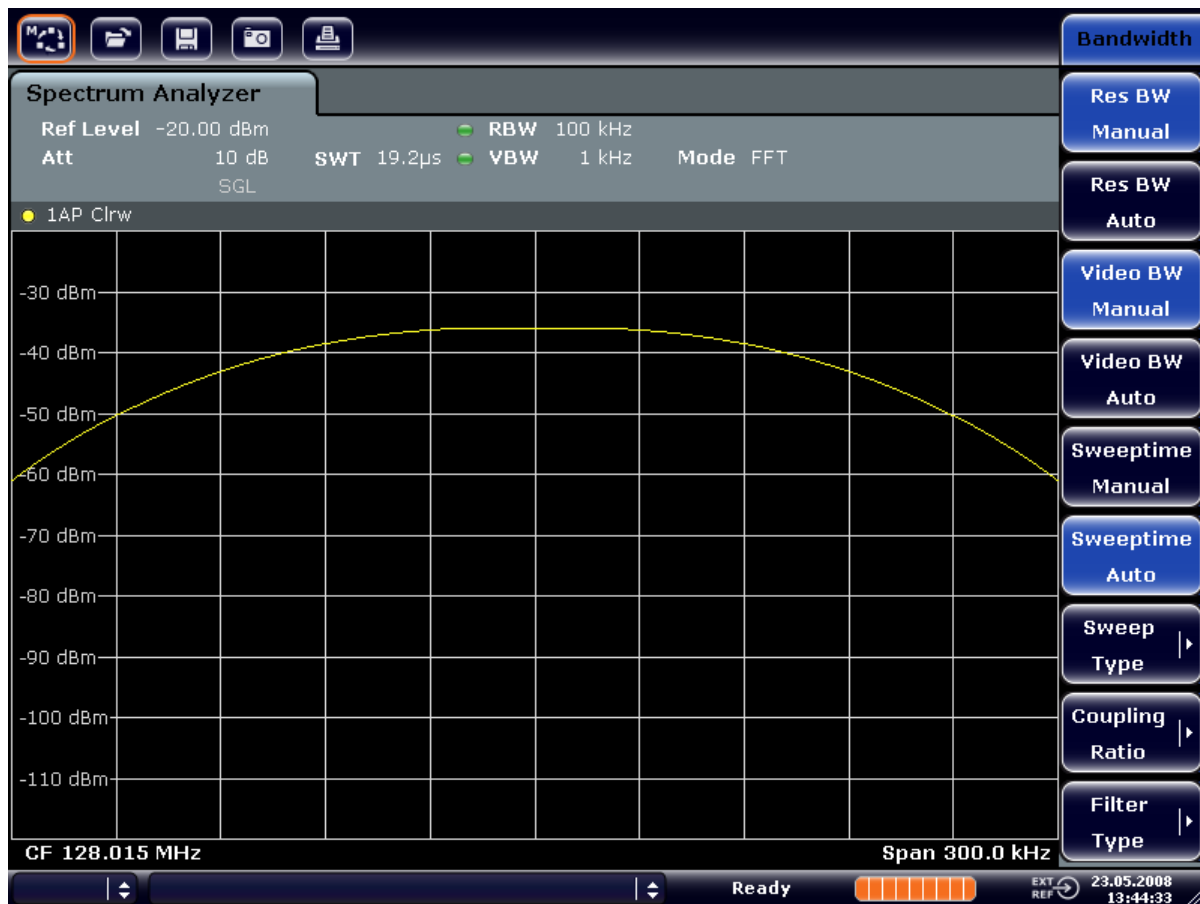

Figure 7-5: Measurement of two equally-leveled RF sinusoidal signals with a resolution bandwidth which is larger than their frequency spacing

Note: Reducing the resolution bandwidth. The resolution bandwidth (RBW) can be reduced again by turning the rotary knob counterclockwise, thus yielding a higher frequency resolution.

- Set the resolution bandwidth to 1 kHz. To do so, in the bandwidth menu, press the "Res BW Manual" softkey and enter *1 kHz*. The two generator signals are shown with high resolution. However, the sweep time becomes longer. At smaller bandwidths, the noise display decreases simultaneously (10 dB decrease in noise floor for a decrease in bandwidth by a factor of 10).

Measuring Signal Spectra with Multiple Signals

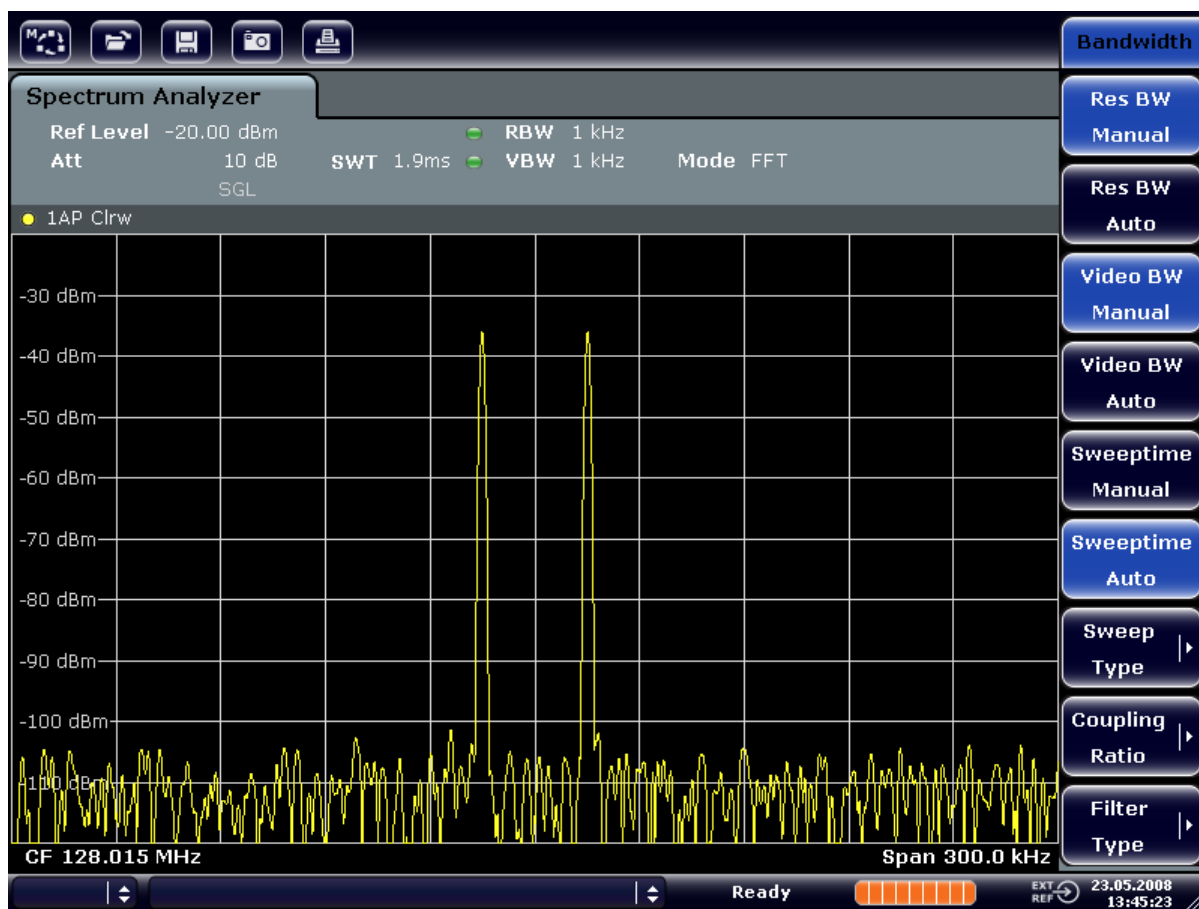

Figure 7-6: Measurement of two equally-leveled RF sinusoidal signals with a resolution bandwidth (1 kHz) which is significantly smaller than their frequency spacing

7.3.2 Measuring the Modulation Depth of an AM-Modulated Carrier (Span > 0)

In the frequency range display, the AM side bands can be resolved with a narrow bandwidth and measured separately. The modulation depth of a carrier modulated with a sinusoidal signal can then be measured. Since the dynamic range of a signal analyzer is very large, extremely small modulation depths can also be measured precisely. For this purpose, the R&S FSVA/FSV provides measurement routines that output the modulation depth numerically in % directly.

Test setup

Measuring Signal Spectra with Multiple Signals

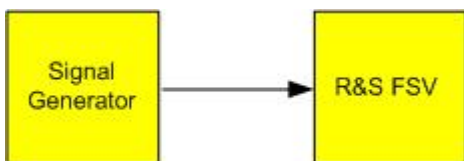

Table 7-3: Signal generator settings (e.g. R&S SMU)

Frequency	128 MHz
Level	-30 dBm
Modulation	50 % AM, 10 kHz AF

1. Set the signal analyzer to the default state by pressing the PRESET key. The R&S FSVA/FSV is set to its default state.
2. Set the center frequency to 128 MHz and span to 50 kHz.
 - a) Press the **FREQ** key and enter *128 MHz*.
 - b) Press the **SPAN** key and enter *50 kHz*.
3. Activate the marker function for measuring the AM modulation depth.
 - a) Press the **MEAS** key.
 - b) Press the "More" key.
 - c) Press the "AM Mod Depth" softkey.

The R&S FSVA/FSV automatically sets a marker to the carrier signal in the center of the diagram and one delta marker each to the upper and lower AM sidebands. The R&S FSVA/FSV calculates the AM modulation depth from the level differences of the delta markers to the main marker and outputs the numeric value in the marker field.

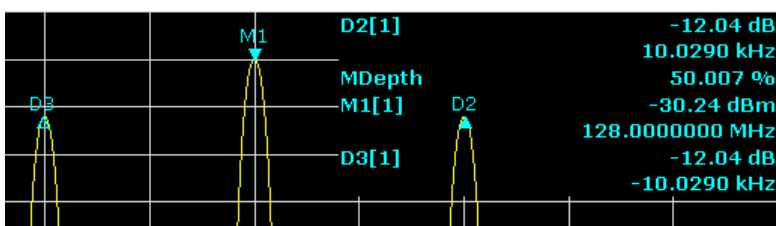

Figure 7-7: Measurement of the AM modulation depth

The modulation depth is displayed as "MDepth". The frequency of the AF signal can be obtained from the frequency display of the delta marker.

7.3.3 Measuring AM-Modulated Signals

The signal analyzer rectifies the RF input signal and displays it as a magnitude spectrum. The rectification also demodulates AM-modulated signals. The AF voltage can be displayed in zero span if the modulation sidebands fall within the resolution bandwidth.

Displaying the AF of an AM-modulated signal (Zero Span)

Test setup

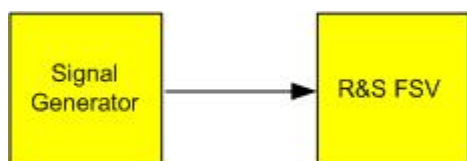

Table 7-4: Signal generator settings (e.g. R&S SMU)

Frequency	128 MHz
Level	-30 dBm
Modulation	50 % AM, 1 kHz AF

1. Set the signal analyzer to the default state by pressing the PRESET key. The R&S FSVA/FSV is set to its default state.
2. Set the center frequency to 128 MHz and the span to 0 Hz.
 - a) Press the **FREQ** key and enter *128 MHz*.
 - b) Press the **SPAN** key and enter *0 Hz* or press the "Zero Span" softkey.
3. Set the sweep time to 2.5 ms.
 - a) Press the **SWEEP** key.
 - b) Press the "Sweeptime Manual" softkey.
 - c) Enter *2.5 ms*.
4. Set the reference level to +6 dBm and the display range to linear.
 - a) Press the **AMPT** key and enter *6 dBm*.
 - b) Press the "Range" softkey.
 - c) Press the "Range Linear %" softkey.
5. Set triggering in response to the AF signal by using the video trigger to produce a static image.
 - a) Press the **TRIG** key.
 - b) Press the "Trg/Gate Source" softkey and select "Video" using the arrow keys.

- c) Press the "Trg/Gate Level" softkey and enter 50%.
The trigger level is displayed as a horizontal line across the entire measurement diagram. The R&S FSVA/FSV displays the 1 kHz AF signal as a static image in zero span. Use a headset to listen to the AF.
6. Activate the internal AM demodulator.
 - a) Press the MKR FUNC key.
 - b) Press the "Marker Demod" softkey.
The R&S FSVA/FSV automatically switches on the AM audio demodulator. A 1 kHz tone can be heard over headset. If necessary, use the volume control knob for AF OUTPUT on the front panel to turn up the volume.

7.4 Measurements in Zero Span

For radio transmission systems that use the TDMA method (e.g. GSM or IS136), transmission quality is determined not only by spectral characteristics but also by characteristics in zero span. A timeslot is assigned to each user since several users share the same frequency. Smooth operation is ensured only if all users adhere exactly to their assigned timeslots.

Both the power during the send phase as well as the timing and duration of the TDMA burst, and rise and fall times of the burst, are important.

7.4.1 Measuring the Power Characteristic of Burst Signals

To measure power in zero span, the R&S FSVA/FSV offers easy-to-use functions that measure the power over a predefined time.

7.4.1.1 Measuring the Power of a GSM Burst During the Activation Phase

Test setup

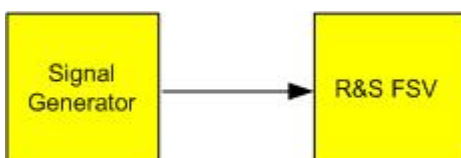

Table 7-5: Signal generator settings (e.g. R&S SMU)

Frequency	890 MHz
Level	0 dBm
Modulation	GSM, one timeslot activated

1. Set the signal analyzer to the default state by pressing the PRESET key. The R&S FSVA/FSV is set to its default state.
2. Set the center frequency to 890 MHz, the span to 0 Hz and the resolution bandwidth to 1 MHz.
 - a) Press the **FREQ** key and enter *890 MHz*.
 - b) Press the **SPAN** key and enter *0 Hz*, or press the "Zero Span" softkey.
3. Set the reference level of the R&S FSVA/FSV to 10 dBm (= level of the signal generator +10 dB) and set the attenuation to 20 dB.
 - a) Press the **AMPT** key.
 - b) Enter *10 dBm*.
 - c) Press the "Rf Atten Manual" softkey.
 - d) Enter *20 dB*.
4. Set the sweep time to 1 ms.
 - a) Press the **SWEEP** key.
 - b) Press the "Sweeptime Manual" softkey and enter *1 ms*.
The R&S FSVA/FSV shows the GSM burst continuously across the display.
5. By using the video trigger, set triggering on the rising edge of the burst.
 - a) Press the **TRIG** key.
 - b) Press the "Trg/Gate Source" softkey and select "Video" using the arrow keys.
 - c) Press the "Trg/Gate Level" softkey and enter *70%*.
The R&S FSVA/FSV shows a static image with the GSM burst at the start of the trace. The trigger level is displayed as a horizontal line labeled with the absolute level for the trigger threshold in the measurement diagram.
6. Configure power measurement in zero span.
 - a) Press the **MEAS** key.
 - b) Press the "Time Domain Power" softkey to open the submenu.
 - c) Switch the "Limits" softkey to "On."
 - d) Press the "Left Limit" softkey.

- e) By turning the rotary knob clockwise, move the vertical line to the start of the burst.
- f) Press the "Right Limit" softkey.
- g) By turning the rotary knob counterclockwise, set the second vertical line to the end of the burst.

The R&S FSVA/FSV displays the average (mean) power during the activation phase of the burst.

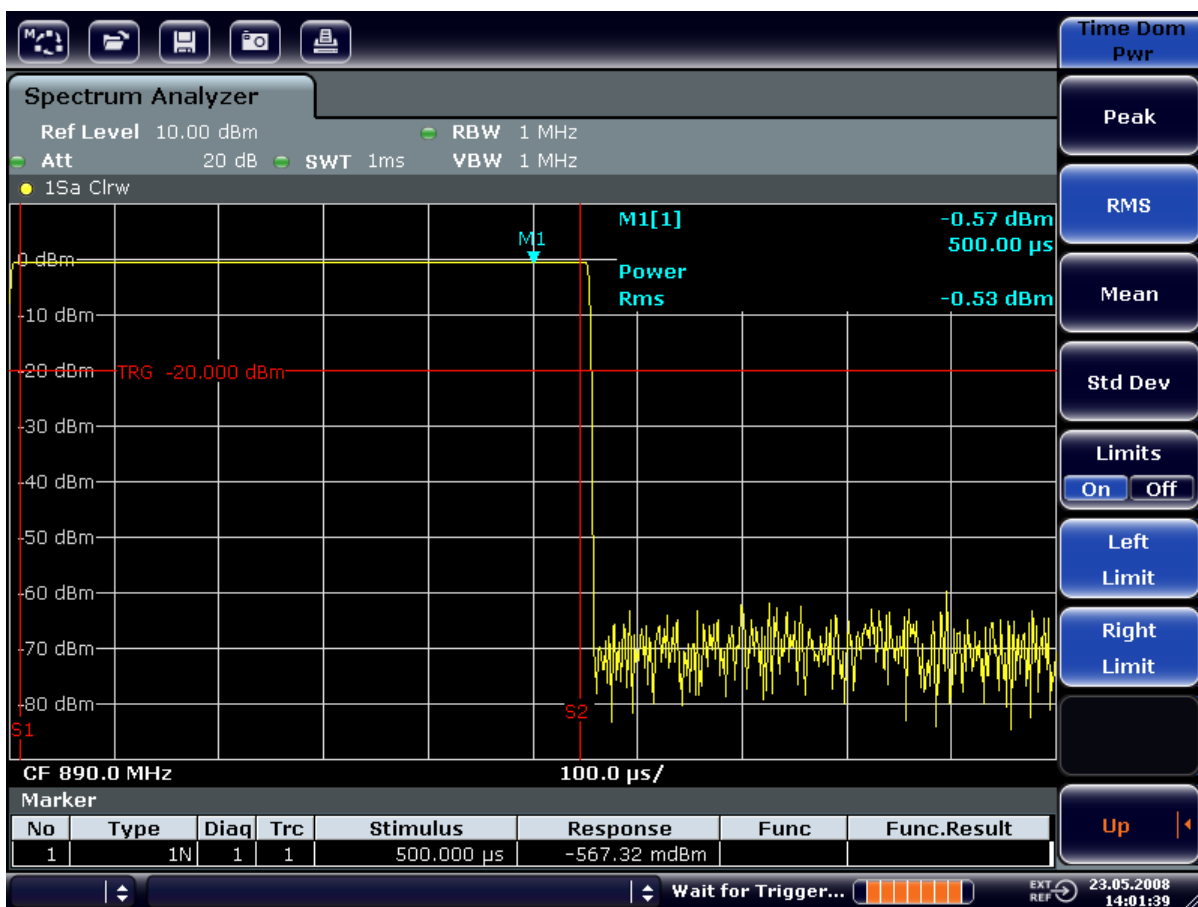

Figure 7-8: Measurement of the average power during the burst of a GSM signal

7.4.1.2 Measuring the Edges of a GSM Burst with High Time Resolution

Because of the high time resolution of the R&S FSVA/FSV at the 0 Hz display range, the edges of TDMA bursts can be measured precisely. The edges can be shifted to the screen area by using the trigger offset.

Test setup

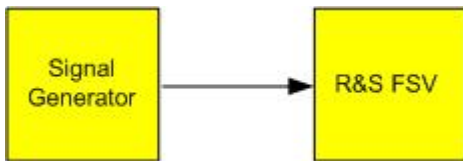

Table 7-6: Signal generator settings (e.g. R&S SMU)

Frequency	890 MHz
Level	0 dBm
Modulation	GSM, one timeslot activated

The measurement is based on the setting in the example above for measuring the power of the GSM during the activation phase.

1. Switch off the power measurement.
 - a) Press the MEAS key.
 - b) Press the "All Functions Off" softkey.
2. Increase the time resolution to 100 μ s.
 - a) Press the SWEEP key.
 - b) Press the "Sweeptime Manual" softkey and enter 100 μ s.
3. Using the trigger softkey, shift the rising edge of the GSM burst to the center of the screen.
 - a) Press the TRIG key.
 - b) Press the "Trigger Offset" softkey.

Measurements in Zero Span

- c) By turning the rotary knob counterclockwise, move the trigger offset until the burst edge can be seen in the center of the screen, or enter $-50 \mu\text{s}$. The R&S FSVA/FSV displays the rising edge of the GSM burst.

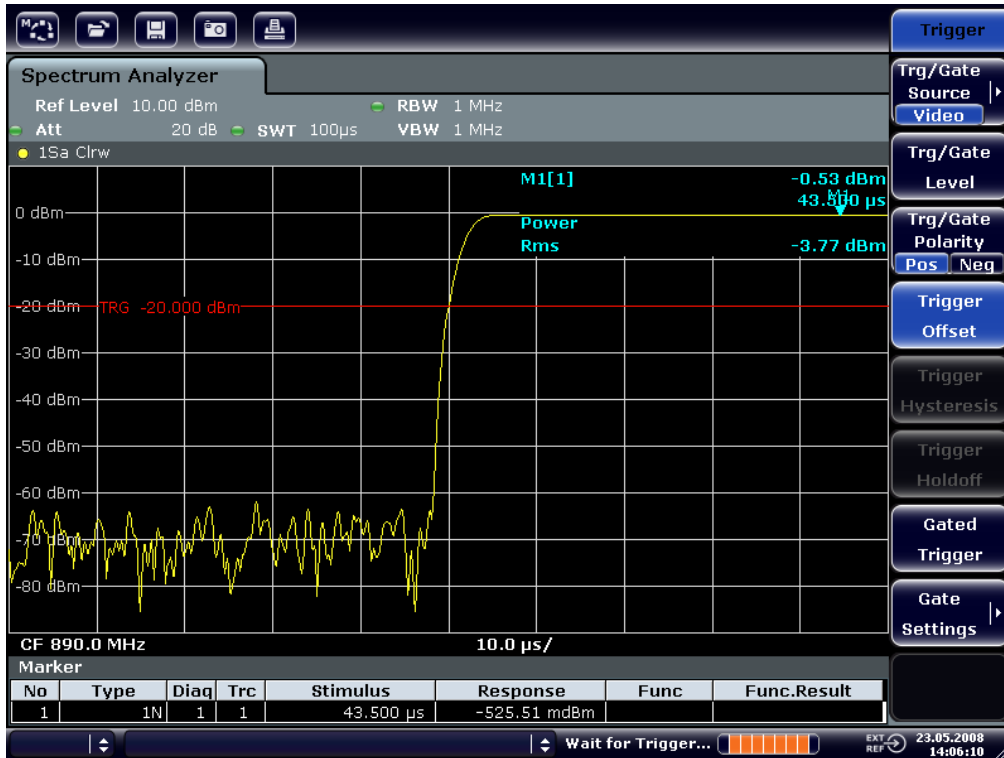

Figure 7-9: Rising edge of the GSM burst displayed with high time resolution

4. Using the trigger offset, move the falling edge of the burst to the center of the screen. To do so, switch the "Trg/Gate Polarity" softkey to "Neg". The R&S FSVA/FSV displays the falling edge of the GSM burst.



Figure 7-10: Falling edge of the GSM burst displayed with high time resolution

7.4.2 Measuring the Signal-to-Noise Ratio of Burst Signals

When TDMA transmission methods are used, the signal-to-noise ratio or the deactivation dynamic range can be measured by comparing the power values during the activation phase and the deactivation phase of the transmission burst. For this purpose, the R&S FSVA/FSV provides the function for measuring absolute and relative power in zero span. In the following example, the measurement is performed using a GSM burst.

Signal-to-Noise Ratio of a GSM Signal

Test setup

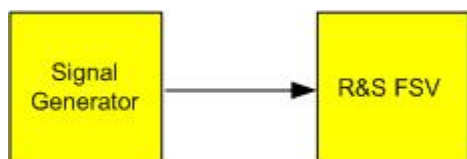

Table 7-7: Signal generator settings (e.g. R&S SMU)

Frequency	890 MHz
Level	0 dBm
Modulation	GSM, one time slot is switched on

1. Set the signal analyzer to the default state by pressing the PRESET key. The R&S FSVA/FSV is set to its default state.
2. Set the center frequency to 890 MHz, the span to 0 Hz and the resolution bandwidth to 1 MHz.
 - a) Press the **FREQ** key and enter *890 MHz*.
 - b) Press the **SPAN** key and enter 0 Hz or press the "Zero Span" softkey.
 - c) Press the **BW** key.
 - d) Press the "Res BW Manual" softkey and enter *1 MHz*.
3. Set the reference level of the R&S FSVA/FSV to 0 dBm (= level of the signal generator) by pressing the **AMPT** key and entering *0 dBm*.
4. Set the sweep time to 2 ms.
 - a) Press the **SWEEP** key.
 - b) Press the "Sweeptime Manual" softkey and enter *2 ms*.
The R&S FSVA/FSV shows the GSM burst continuously across the display.
5. Use the trigger source "Video" and the trigger polarity "Pos" to trigger on the rising edge of the burst and shift the start of burst to the center of the screen.
 - a) Press the **TRIG** key.
 - b) Press the "Trg/Gate Source" softkey and select "Video" using the arrow keys.
 - c) Press the "Trg/Gate Level" softkey and enter *70%*.
The R&S FSVA/FSV shows a static image with the GSM burst at the start of the trace.
 - d) Press the "Trigger Offset" softkey and enter *-1 ms*.
The R&S FSVA/FSV shows the GSM burst in the right half of the measurement diagram.
6. Configure the power measurement in zero span.
 - a) Press the **MEAS** key.
 - b) Press the "Time Domain Power" softkey to open the submenu.
 - c) Switch the "Limits" softkey to "On."
 - d) Press the "Left Limit" softkey.

- e) Using the rotary knob, move the vertical line to the start of the burst.
- f) Press the "Right Limit" softkey.
- g) Using the rotary knob, move the second vertical line to the end of the burst.

The R&S FSVA/FSV displays the power during the activation phase of the burst.

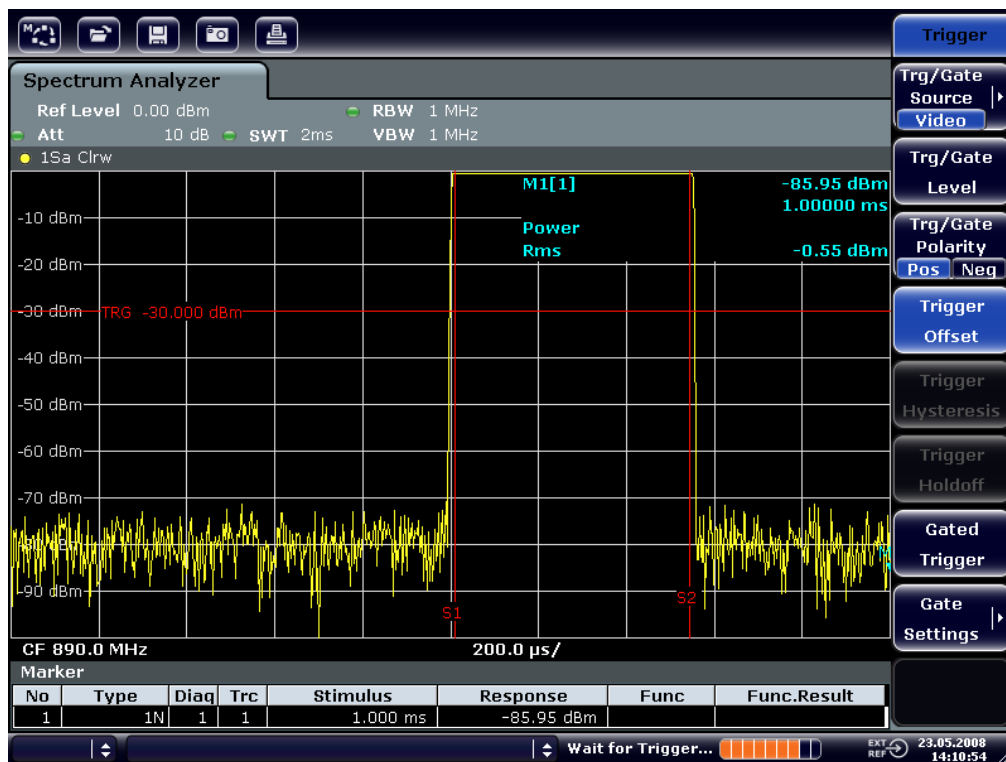

Figure 7-11: Power measurement during the activation phase of the burst

- 7. Measure the power during the deactivation phase of the burst.
 - a) Press the TRIG key.

- b) Switch the "Trg/Gate Polarity" softkey to "Neg."

The R&S FSVA/FSV initiates triggering in response to the falling edge of the burst. This shifts the burst to the left-hand half of the measurement diagram. The power is measured in the deactivation phase. The start of the burst is shifted to the center of the screen and the power during the deactivation phase is measured.

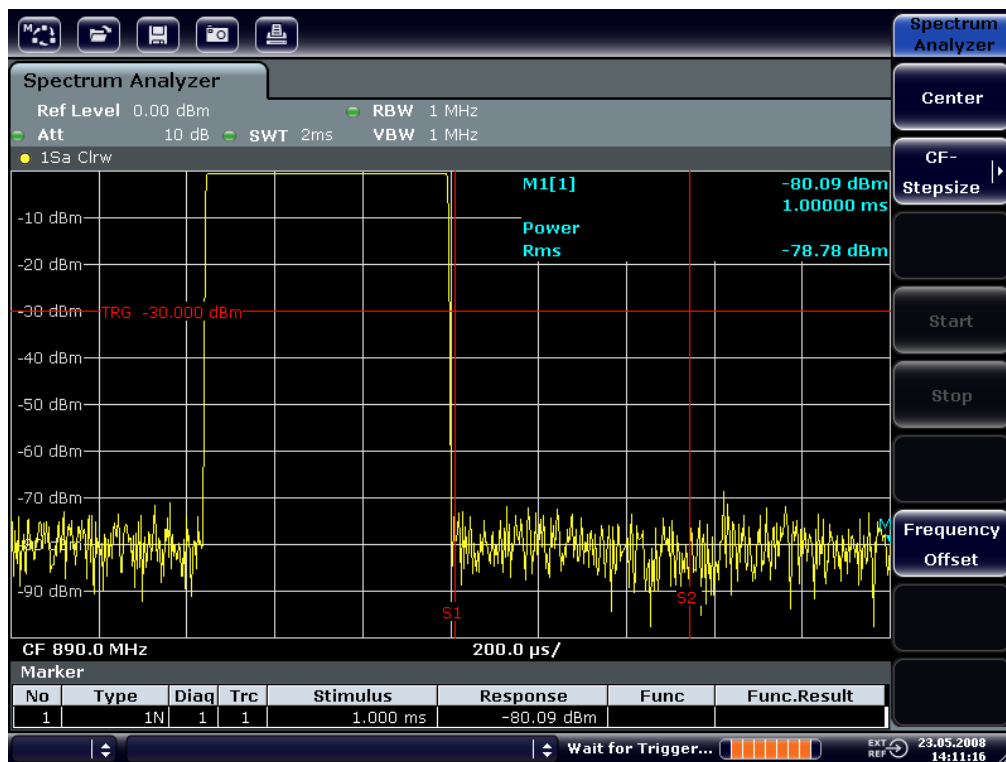

Figure 7-12: Measurement of the signal-to-noise ratio of a GSM burst signal in zero span.

7.4.3 Measuring FM-Modulated Signals

Since signal analyzers can display only the magnitude of the measurement signal by using the envelope detector, the modulation of FM-modulated signals cannot be measured directly as in the case of AM-modulated signals. The voltage at the output of the envelope detector remains constant for FM-modulated signals as long as the frequency deviation of the signal is located within the flat part of the passband characteristic of the employed resolution filter. Amplitude variation occurs only if the instantaneous frequency extends into a falling edge of the filter curve. This behavior can be used to demodulate FM-modulated signals. The center frequency of the analyzer is set in such a manner that the nominal frequency of the measurement signal is located on a filter edge (below or above the center

frequency). The resolution bandwidth and the frequency offset must be selected in such a manner that the instantaneous frequency is located in the linear part of the filter edge. As a result, the frequency variation of the FM-modulated signal is transformed into an amplitude variation that can be displayed on screen in zero span.

Displaying the AF of an FM-Modulated Carrier

Test setup

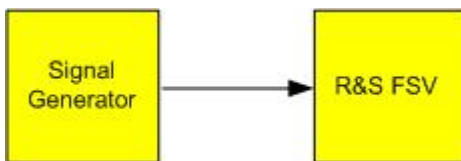

Table 7-8: Signal generator settings (e.g. R&S SMU)

Frequency	128 MHz
Level	-20 dBm
Modulation	FM 0 kHz deviation (i.e. FM modulation is deactivated), 1 kHz AF

1. Set the signal analyzer to the default state by pressing the PRESET key. The R&S FSVA/FSV is set to its default state.
2. Set the center frequency to 127.50 MHz and the span to 300 kHz.
 - a) Press the **FREQ** key and enter *127.50 MHz*.
 - b) Press the **SPAN** key and enter *300 kHz*.
3. Set the resolution bandwidth to 300 kHz.
 - a) Press the **BW** key.
 - b) Press the "Res BW Manual" softkey and enter *300 kHz*.
 - c) Press the "Video BW Manual" softkey and enter *30 kHz*.
4. Set the display range to 20 dB and shift the filter trace to the center of the screen.
 - a) Press the **AMPT** key.
 - b) Press the "Range" softkey
 - c) Press the "Range Log Manual" softkey and enter *20 dB*.
 - d) Press the "Up↑" softkey.
 - e) Press the "More" softkey.
 - f) Switch the "Grid" softkey to "Rel".
 - g) Press the "Up↑" softkey.
 - h) Press the "Ref Level" softkey.

- i) Using the rotary knob, set the reference level such that the filter edge at the center frequency intersects the -10 dB level line. The filter edge of the 300 kHz filter is displayed. This corresponds to the demodulator characteristic for FM signals with a steepness of approx. 18 dB/140 kHz. This can be verified using the marker and delta marker.

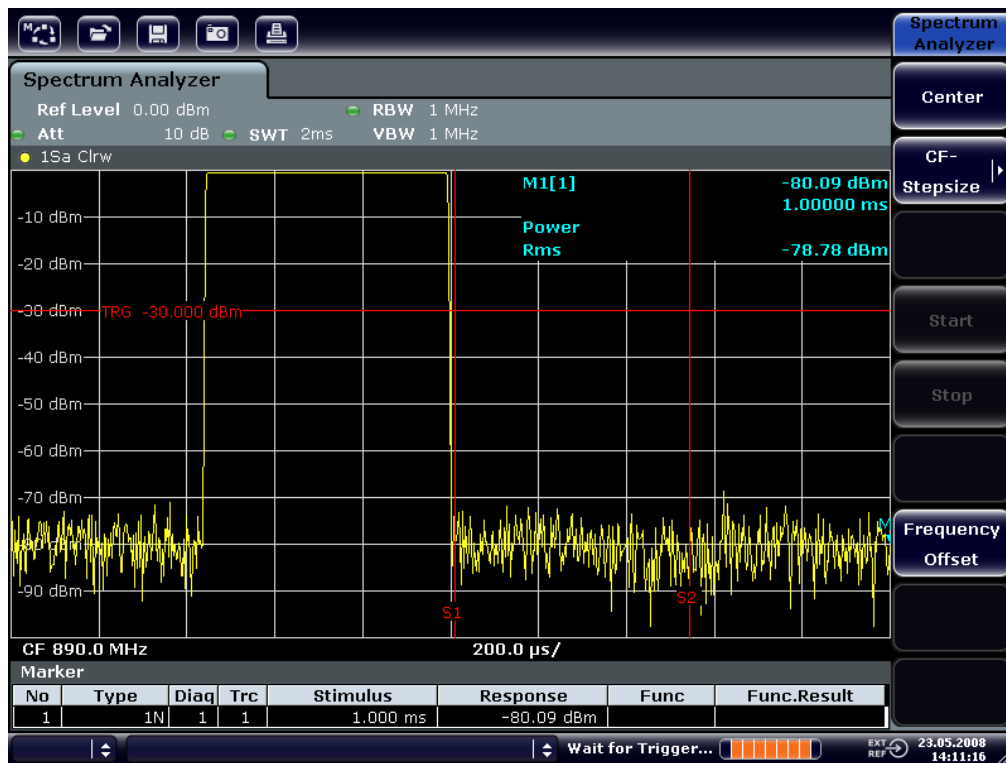

Figure 7-13: Display of the filter edge of the 300 kHz filter as an FM discriminator characteristic

5. Set the FM deviation to 50 kHz on the signal generator.
6. Set the span to 0 Hz on the R&S FSVA/FSV.
 - a) Press the SPAN key.
 - b) Press the "Zero Span" softkey.
The demodulated FM signal is displayed. The signal crosses the screen continuously.
7. Establish a stable display using video triggering.
 - a) Press the TRIG key.
 - b) Press the "Trg/Gate Source" softkey and select "Video" using the arrow keys.

- c) Press the "Trg/Gate Level" softkey and enter 50%.
 A static image for the FM AF signal is produced.
 Result: (-10 (5) dB; this yields a deviation of 100 kHz when the steepness of the demodulator characteristic is 5 dB/100 kHz.

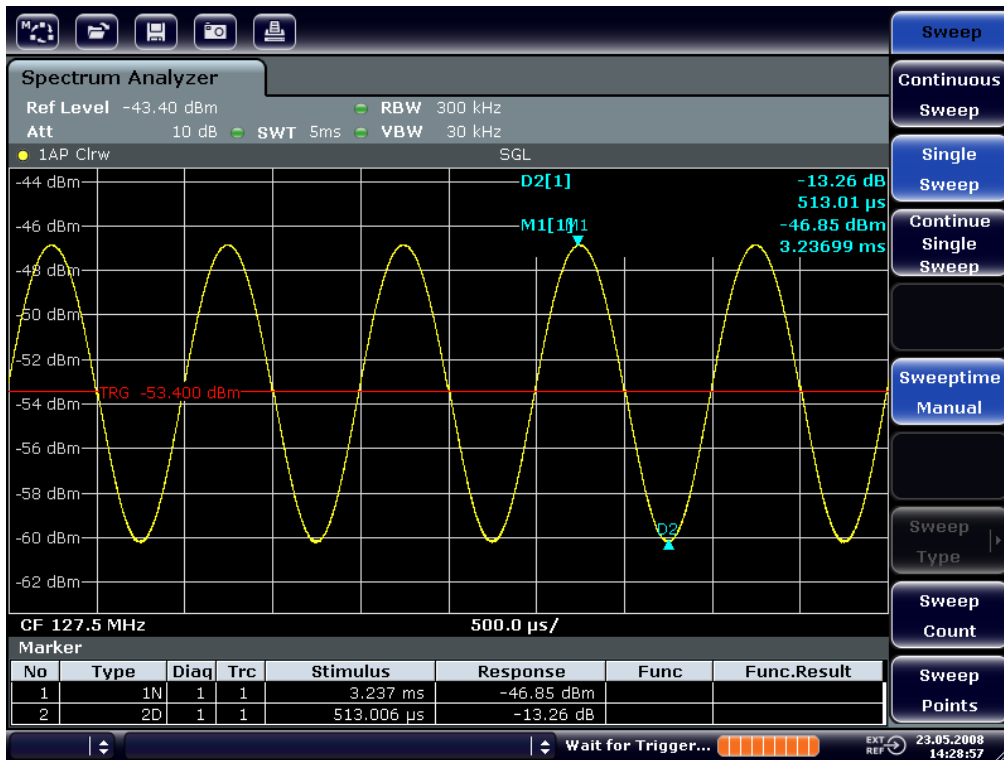

Figure 7-14: Demodulated FM signal

8. Determine the deviation.
- Press the MKR key.
 Marker 1 is activated and placed on the peak of the curve.
 - Press the "Marker 2" softkey.
 - Press the MKR key.
 - Press the "More" softkey.
 - Press the "Min" softkey.
 Marker 2 (delta marker) is placed on the minimum of the curve. The level difference is 13.3 dB, which corresponds to the peak-to-peak deviation. With the filter slope of 18 dB/140 kHz, the deviation can be calculated as follows:

$$\text{deviation} = \frac{1}{2} \times \frac{13.3 \times 140}{18} \text{ kHz} = \frac{1}{2} \times 103 \text{ kHz} = 51.7 \text{ kHz}$$

7.5 Storing and Loading Instrument Settings

The R&S FSVA/FSV can store complete instrument settings together with instrument configurations and measurement data in a settings file. The data is stored on the built-in hard disk or - if selected - on a USB device (e.g. memory stick) or on a network drive. The hard disk has the drive letter C:.

In the default state, the current settings are stored. This includes the settings of the measurement functions, the activated limit lines and the active transducer factor.

7.5.1 Storing an Instrument Configuration (without Traces)

1. Press the SAVE/RCL key.
2. Press the "Save" softkey.

The dialog box for instrument configurations is displayed. The File Name field is in edit mode and contains a suggestion for a new name.

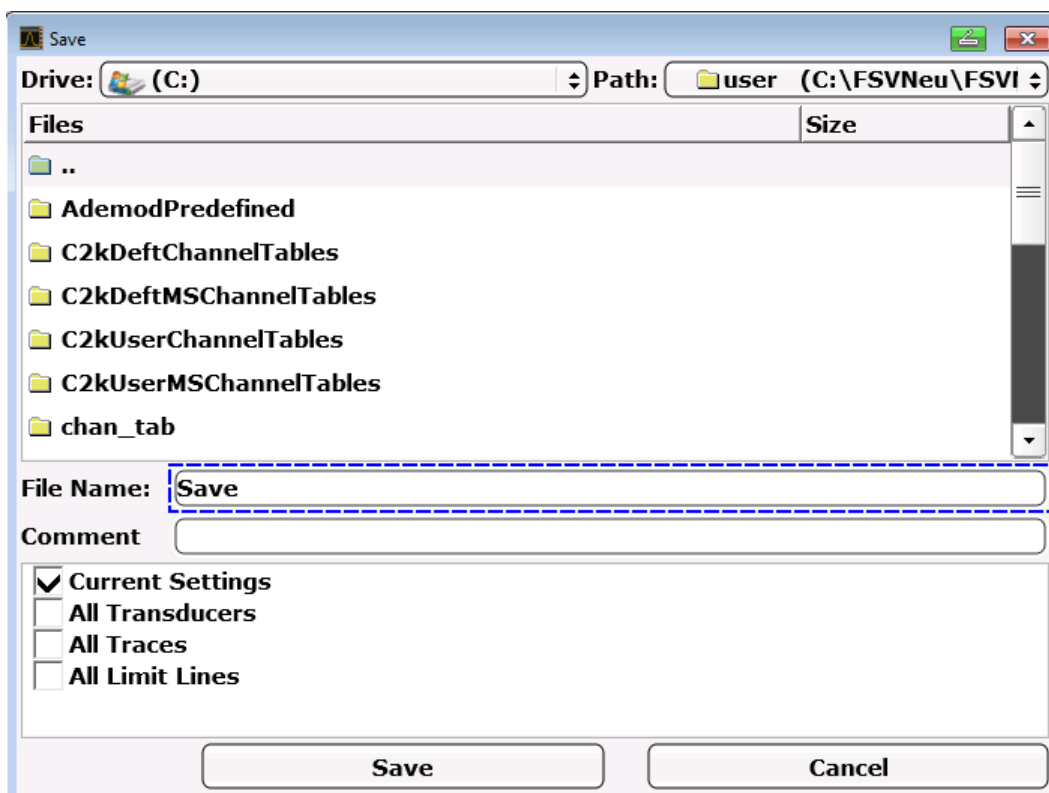

3. To change the suggested name, enter a name for the settings file to be stored.

Storing and Loading Instrument Settings

The name may contain letters and digits. For details on alphanumeric entries see [Chapter 6.3.2, "Entering Alphanumeric Parameters"](#), on page 84.

4. To store the file in a directory different to the default directory, select the required path in the `Files` area.

If the path is not changed, the default path for the instrument configurations (`C:\R_S\Instr\user`) is used.

Note: The selected directory is automatically used for any further save and recall operations.

5. Press the "Save File" softkey.
The settings file is stored and the dialog box is closed.

7.5.2 Storing Traces

Before you can store traces, you must first select the corresponding item entry. To do so, proceed as follows:

1. Press the SAVE/RCL key.
2. Press the "Save" softkey.
3. To change the suggested name, enter a file name.
4. Select the "All Traces" option.
5. Press the "SAVE" button.

7.5.3 Loading an Instrument Configuration (with Traces)

1. Press the SAVE/RCL key.
2. Press the "Recall" softkey.
3. If necessary, select the path under which the file to be loaded is stored.
4. Define the settings file to be loaded. One of the following ways is possible:
 - Click in the `File Name` field and enter the file name via the keyboard or keypad.
 - Select the file from the selection list using the touchscreen or mouse.

Alternatively:

- a) Press the "Select File" softkey.
The focus is set on the files list.
 - b) Using the rotary knob or arrow keys, focus the settings file to be loaded and confirm by pressing the rotary knob or the ENTER key.
5. To load traces, select the "All Traces" option.
Note: The "All Traces" option is only available if the selected file contains traces.
 6. Press the "Recall" button in the dialog box, or the "Recall File" softkey.
The settings file is loaded. During loading, the R&S FSVA/FSV detects which items the selected settings file contains and, if applicable, ignores any items that were selected but are not available.

7.5.4 Configuring Automatic Loading

If the R&S FSVA/FSV is switched on in the factory default state, it loads the instrument settings that it had when switched off (provided that it was switched off using the ON / OFF key on the front panel; see [Chapter 4.1.8, "Switching the Instrument On and Off"](#), on page 42. If the instrument is preset, it loads the pre-settings.

You can alter these settings and define a settings file to be loaded. This requires performing the following procedure. Be aware that the chosen settings file is loaded both while booting and presetting.

1. Press the SAVE/RCL key.
2. Press the "Startup Recall" softkey.
3. Press the "Startup Recall (On/Off)" softkey to activate the recall function.
4. Press the "Select Dataset" softkey.
The "Startup Recall" dialog box is displayed.
5. If necessary, select the path under which the file to be loaded is stored.
6. Select the settings file to be loaded (DFL file).
7. Press the "Select" button in the dialog box.

8 Controlling the R&S FSVA/FSV Remotely

In addition to working with the R&S FSVA/FSV interactively, located directly at the instrument, it is also possible to operate and control it from a remote PC.

Various methods for remote control are supported:

- Using the Windows Remote Desktop application in a LAN network (see [Chapter 8.1, "Operation with Windows Remote Desktop"](#), on page 130)
- Using Virtual Network Computing (VNC, see [Chapter 8.2, "Operation with a VNC Client"](#), on page 137)
- Connecting the instrument to a (LAN) network (see [Chapter 8.6, "Setting Up a Network \(LAN\) Connection"](#), on page 165)

For details on remote control interfaces see [Chapter 8.4, "Remote Control Interfaces and Protocols"](#), on page 161

• Operation with Windows Remote Desktop	130
• Operation with a VNC Client	137
• Brief Introduction to Remote Control	139
• Remote Control Interfaces and Protocols	161
• Configuring the GPIB Interface	164
• Setting Up a Network (LAN) Connection	165
• How to Configure the LAN Using the LXI Web Browser Interface	172
• Configuring the Network	175

8.1 Operation with Windows Remote Desktop

In production test and measurement, a common requirement is central monitoring of the T&M instruments for remote maintenance and remote diagnostics. Equipped with the Windows Remote Desktop software, the R&S FSVA/FSV ideally meets requirements for use in production. (The computer that is used for remote operation is called "controller" here.)

- Access to the control functions via a virtual front panel (soft front panel)
- Printout of measurement results directly from the controller
- Storage of measured data on the controller's hard disk

The R&S FSVA/FSV is connected via a LAN, in which case the Windows operating system also supports a connection via a modem. This section describes the configuration of the R&S FSVA/FSV and the Remote Desktop Client of the controller. Details on how to set up a modem connection are described in the Windows documentation.

8.1.1 Configuring the R&S FSVA/FSV for Remote Operation



To avoid problems, use a fixed IP address.

When a DHCP server is used, a new IP address is assigned each time the instrument is restarted. This address must first be determined on the instrument itself. Thus, using a DHCP server is not suitable for remote operation of the R&S FSVA/FSV via Remote Desktop.



With the factory settings, the default "instrument" user can connect to the R&S FSVA/FSV with the Remote Desktop program of the controller immediately. No further configuration is required. However, if the connection fails or other users need to connect, this section provides basic instructions on setting up the Remote Desktop for the R&S FSVA/FSV.

1. Press the "Windows" key on the external keyboard or the CTRL + ESC key combination on your keyboard to access the operating system.
2. In the Windows "Start" menu, select "Settings > System".
3. Search for "remote access".
4. Select "Allow remote access to your computer".
5. Define which users are to be given access to the R&S FSVA/FSV via Remote Desktop.

Note: The user account under which configuration is carried out is automatically enabled for Remote Desktop.

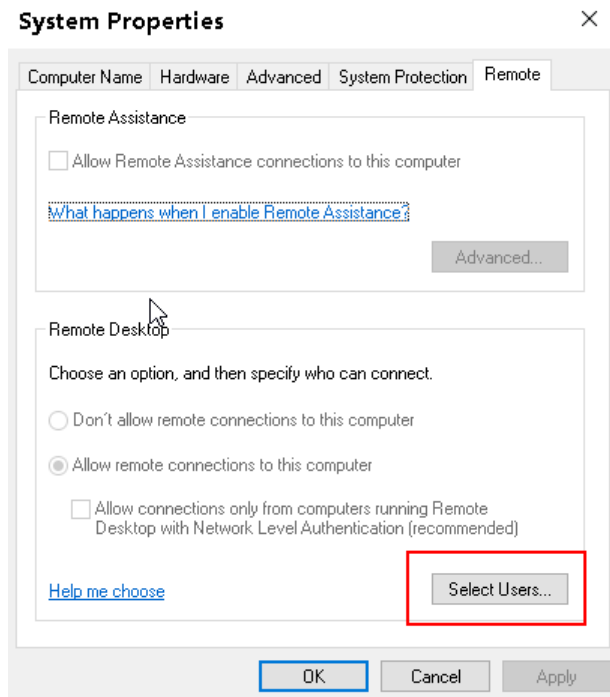

- a) Select the "Select Users" button.
 - b) Select the users or create new user accounts as described in [Chapter 8.8.2, "Creating Users"](#), on page 176.
 - c) Select "OK" to confirm the settings.
6. The R&S FSVA/FSV is now ready for connection setup with the Remote Desktop program of the controller.

8.1.2 Configuring the Controller



Remote Desktop Client

The Windows Remote Desktop Client is part of the operating system and can be accessed via "Start > All Applications > Windows Accessories > Remote Desktop Connection".

1. Press the "Windows" key on the external keyboard or the CTRL + ESC key combination on your keyboard to access the operating system.
2. From the "Start" menu, select "All Programs > Accessories > Remote Desktop Connection".
The "Remote Desktop Connection" dialog box is displayed.

3. Select the "Options >>" button.
The dialog box is expanded to display the configuration data.

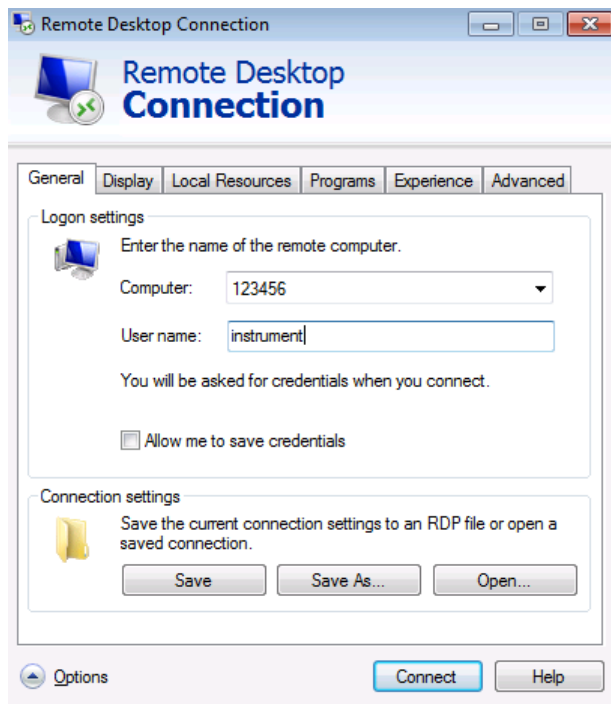

4. Open the "Experience" tab.
The settings on this tab are used to select and optimize the connection speed.
5. In the list, select the appropriate connection (for example: LAN (10 Mbps or higher)).
Depending on your selection (and how powerful the connection is), the options are activated or deactivated.
6. To improve the performance, you can deactivate the "Desktop background", "Show contents of window while dragging" and "Menu and window animation" options.
7. Open the "Local Resources" tab for enabling printers, local drives and serial interfaces.
8. If you will need to access drives of the controller from the R&S FSVA/FSV (e.g. in order to store settings or to copy files from the controller to the R&S FSVA/FSV), select "More", then enable the "Drives" option.

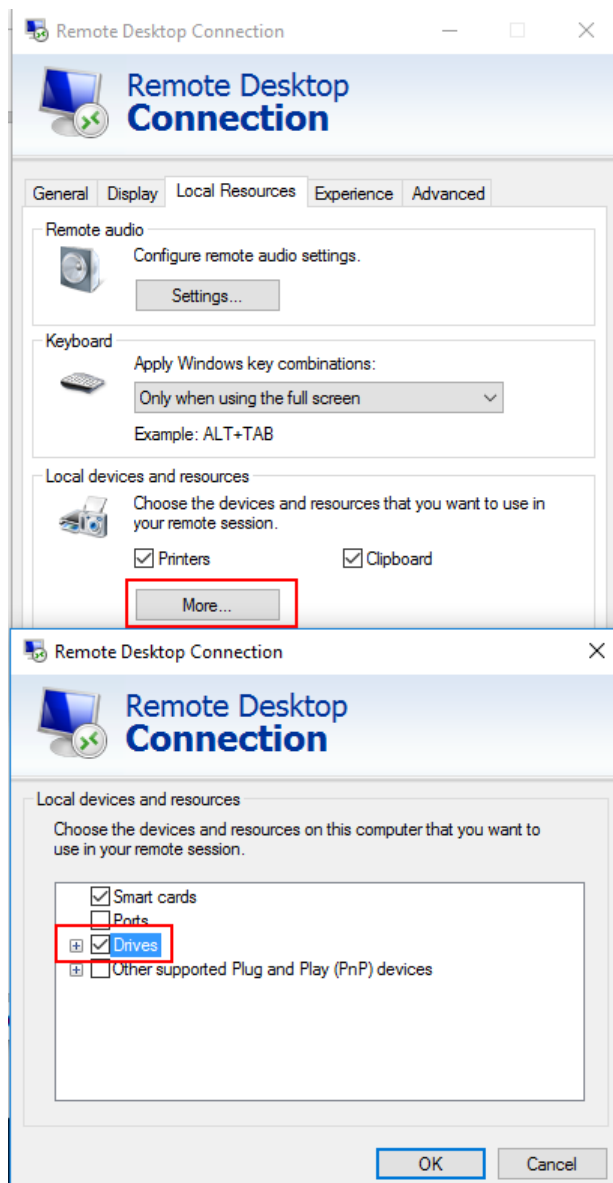

Windows will then map drives of the controller to the corresponding network drives.

9. To use printers connected to the controller while accessing them from the R&S FSVA/FSV, activate the "Printers" option. Do not change the remaining settings.
10. Open the "Display" tab.
The options for configuring the R&S FSVA/FSV screen display are displayed.
11. Under "Remote desktop size", you can set the size of the R&S FSVA/FSV window on the desktop of the controller.
12. Under "Colors", do not change the settings.

13. Set the "Display the connection bar when I use the full screen" option:
 - If activated, a bar showing the network address of the R&S FSVA/FSV will appear at the top edge of the screen. You can use this bar to reduce, minimize or close the window.
 - If deactivated, the only way you can return to the controller desktop from the R&S FSVA/FSV screen in full screen mode is to select "Disconnect" from the "Start" menu.

8.1.3 Starting and Terminating Remote Operation

Setting up a connection to the R&S FSVA/FSV

1. In the "Remote Desktop Connection" dialog box (see [Chapter 8.1, "Operation with Windows Remote Desktop"](#), on page 130), open the "General" tab.
2. In the "Computer" field, enter the IP address of the R&S FSVA/FSV.
In the "User name" field, enter *instrument* to log in as an administrator, or *Normal User* to log in as a standard user.
In the "Password" field, enter *894129*.
3. To save the connection configuration for later use:
 - a) Select the "Save As" button.
The "Save As" dialog box is displayed.
 - b) Enter the name for the connection information (* .RDP).
4. To load an existing connection configuration:
 - a) Select the "Open" button.
The "Open" dialog box is displayed.
 - b) Select the * .RDP file.
5. Select the "Connect" button.
The connection is set up.
6. If the "Drives" option is activated on the "Local Resources" tab, a warning is displayed indicating that the drives are enabled for access from the R&S FSVA/FSV.
Select "OK" to confirm the warning.
7. After a few moments, the R&S FSVA/FSV screen is displayed.

Operation with Windows Remote Desktop

If a dark screen appears or a dark square appears in the upper left-hand corner of the screen, you must restart the R&S FSVA/FSV in order to see the modified screen resolution.

 <p>Analyzer</p>	<ul style="list-style-type: none"> • Press the key combination ALT + F4. • The R&S FSVA/FSV firmware is shut down, which may take a few seconds. • On the desktop, double-tap the "Analyzer" icon.
--	---

The firmware restarts and then automatically opens the "Soft Front Panel", i.e. the user interface on which all front panel controls and the rotary knob are mapped to buttons.

- To deactivate or activate the "Soft Front Panel", press the F6 key. After the connection is established, the R&S FSVA/FSV screen is displayed in the "Remote Desktop" application window.

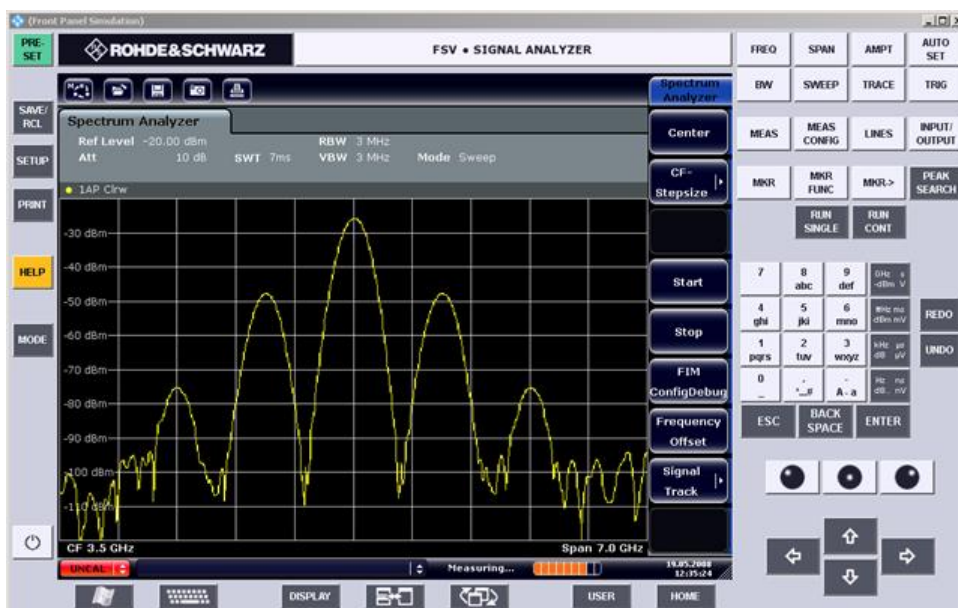

You can operate all keys and softkeys using the mouse. The rotary knob is simulated using the knob buttons.

The Windows "Start" menu can be made available by expanding the "Remote Desktop" window to full size.

During the connection with the controller, the login entry is displayed on the R&S FSVA/FSV screen.

Terminating Remote Desktop control

The connection can be terminated by the controller or by a user at the R&S FSVA/FSV:

- ▶ ● On the controller, close the "Remote Desktop" window.
The connection to the R&S FSVA/FSV is terminated (any time is possible).
- On the R&S FSVA/FSV, a user logs on.
The connection to the controller is terminated as a result. A message is displayed on the controller display indicating that another user has assumed control of the instrument.

Restoring the connection to the R&S FSVA/FSV

Follow the instructions above for setting up a connection to the R&S FSVA/FSV. If the connection is terminated and then restored, the R&S FSVA/FSV remains in the same state.

8.1.4 Deactivating the R&S FSVA/FSV via Remote Operation

1. Click the R&S FSVA/FSV soft front panel and close the application with the key combination ALT + F4.
2. Click the desktop and press the key combination ALT + F4 to shut down the R&S FSVA/FSV.
A safety query is displayed to warn you that the instrument cannot be reactivated via remote operation and asks you whether you want to continue the shutdown process.
3. Respond to the safety query with "Yes".
The connection with the controller is terminated and the R&S FSVA/FSV is shut down.

8.2 Operation with a VNC Client

Virtual Network Computing (VNC) allows you to control the R&S FSVA/FSV (the VNC server) from a remote computer (the VNC client), for example to monitor the instruments in a production line. The handling of a VNC system is similar to using

the Windows Remote Desktop, but VNC has some advantages compared to the Remote Desktop.

- You can view the contents of the instrument display on more than one client
- VNC clients are available for many operating systems. Thus, a VNC is independent of the platform you are using.
- You can still control the instrument itself when a remote connection has been established, and see what is happening on both the instrument display and the client. With the display running, you can also change settings both on the instrument and with the client simultaneously. (Using the Remote Desktop turns off the display and viewing the display contents is only possible on the controlling computer.)
- The complete mini soft front panel is available on the client ("Alt-M" opens the mini soft front panel).

All R&S FSVA/FSV instruments as of firmware version 3.0 support a VNC and are delivered with a version of the TightVNC software. On the client side, you can use a web browser or a VNC client to access the instrument.

Using a web browser

If you are using a web browser (for example Microsoft Internet Explorer), enter the IP address of the instrument and the port you are using for the connection into the address bar to establish a connection (for example "192.0.2.0:5800").

The browser then opens an interface that allows you to control the instrument after you have entered the password.

The default port is 5800 and the default password is 894129, but you can change this on the VNC software that comes with the instrument if required.

Note that using a browser requires you to install Java in order to run properly.

Using a VNC client

Alternatively, you can install a VNC client on your computer (for example a program like TightVNC) and use that to access the instrument. In that case, start the client and enter the IP address of the instrument to establish a connection.

8.3 Brief Introduction to Remote Control

The instrument can be remote-controlled via the network (LAN interface). For details on configuring the LAN interface see [Chapter 8.6, "Setting Up a Network \(LAN\) Connection"](#), on page 165.

The instrument can be remote-controlled via the network (LAN interface). For details on configuring the LAN interface see [Chapter 8.6, "Setting Up a Network \(LAN\) Connection"](#), on page 165.

For details on setting the interface see [Chapter 8.5, "Configuring the GPIB Interface"](#), on page 164.

The following programming examples are structured hierarchically, i.e. the later examples are based on the preceding ones. This allows you to easily assemble a well-functioning program by using the modules of the program examples. More complex examples are provided in the Operating Manual, chapter "Remote Control - Programming Examples"

8.3.1 Basic Steps in Remote Control Programming

The following examples explain how to program the instrument and can be used as a basis for solving enhanced programming tasks.

Visual Basic was used as the programming language. However, the programs can be implemented in other languages as well.



Using backslashes

In programming languages such as C, C++ or programs such as MATLAB or NI Interactive Control, a backslash starts an escape sequence (e.g. "\n" is used to start a new line). In these programming languages and programs, two backslashes instead of one must be used in remote commands, e.g. in ["Storing Instrument Settings"](#) on page 157

instead of `MMEM:STOR:STAT 1, 'C:\USER\DATA\TEST1'`

use `MMEM:STOR:STAT 1, 'C:\\USER\\DATA\\TEST1'`

8.3.1.1 Linking the Remote Control Library for Visual Basic

Programming notes:

- **Outputting text using the print function**

Using the print method, this example displays the value of the variable `MyVar` in the "Immediate" window of the Visual Basic development environment. Note that the print method only applies to objects that can display text.

```
Debug.Print MyVar
```

- **Accessing the functions of the VISA32.DLL**

To enable users to create Visual Basic control applications, the `VISA32.BAS` file must be added to a project so that functions of the `VISA32.DLL` can be called. In addition, the `VPPTYPE.BAS` file must be added to the project. This file contains constants and definitions for error handling, timeout values, etc.

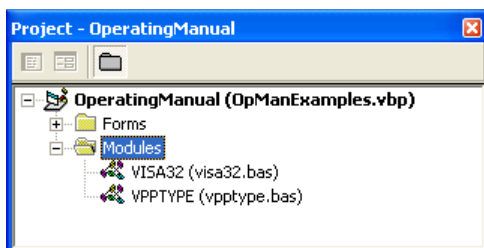

The modules `visa32.bas` and `vpptype.bas` can be found under `<VXIpnPath>\WinNT\include` (typically `C:\VXIpn\WinNt\include`). As an alternative, a reference to the `VISA32.DLL` can be added to the project.

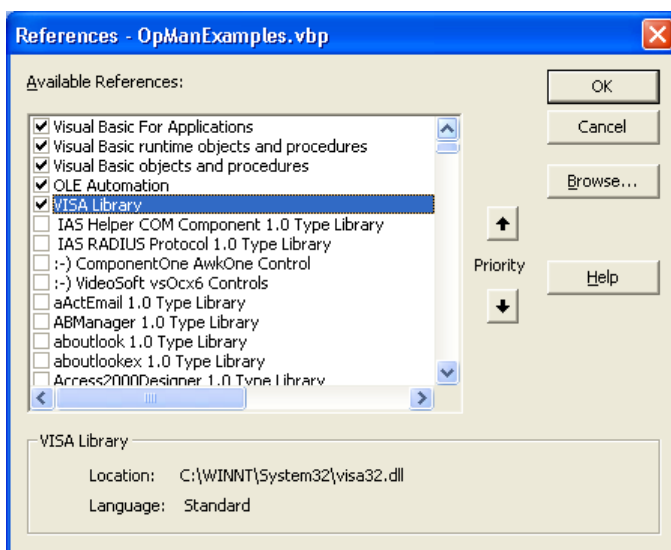

- **Creating a response buffer**

Since the DLL returns zero-terminated strings in responses, a string of sufficient length must be created before the functions `InstrRead()` and `ilrd()` are called, because Visual Basic inserts a length specification in front of the strings and this specification is not updated by the DLL. The following two means of creating the length specification for a string are provided:

```
Dim Rd as String * 100
Dim Rd as String
Rd = Space$(100)
```

- **Creating Wrapper Procedures for Writing and Reading**

Since the "VISA" functions require command and response strings and their corresponding length in two separate parameters, the main program code is easier to read and maintain if the read and write functions are encapsulated. Here, the procedure `InstrWrite()` encapsulates the function `viWrite()` and `InstrRead()` encapsulates `viRead()`. In addition, these wrappers include status checking:

```
Public Sub InstrWrite(ByVal vi As Long, ByVal Cmd As String)
Dim status As Long
Dim retCount As Long
    'Send command to instrument and check for status
status = viWrite(vi, Cmd, Len(Cmd), retCount)
    'Check for errors - this will raise an error if status is not VI_SUCCESS
CALL CheckError(vi, status)
End Sub

Public Sub InstrRead(ByVal vi As Long, Response As String, _
    ByVal count As Long, retCount As Long)
Dim status As Long
'Initialize response string
Response = Space(count)
    '...and read
status = viRead(vi, Response, count, retCount)
    'Check for errors - this will raise an error if status is not VI_SUCCESS
CALL CheckError(vi, status)
    'adjust string length
Response = Left(Response, retCount)
End Sub
```

The following function illustrates status/error checking. The procedure raises an exception when a VISA error occurs:

```
Public Sub CheckError(ByVal vi As Long, status As Long)
Dim ErrorMessage As String * 1024

'Initialize error message string
```

```

ErrorMessage = ""
If (status < 0) Then
    'Query the error message from VISA
    If (viStatusDesc(vi, status, ErrorMessage) = VI_SUCCESS) Then
        Err.Description = ErrorMessage
    End If
    Err.Raise (status)
End If
End Sub

```

8.3.1.2 Initialization and Default State

At the start of each program, the global variables used by all subroutines must be created. The remote control and the instrument settings will then be changed to a defined default state. The two subroutines `InitController` and `InitDevice` are used for this.

Creating Global Variables

In Visual Basic, global variables are stored in modules (data extension `.BAS`). Thus, at least one module (e.g. `GLOBALS.BAS`) must be created that contains the variables used by all subroutines, e.g. the variables for device addresses used by the remote control driver.

For all example programs shown below, the file must contain the following instructions:

```

Global analyzer As Long
Global defaultRM As Long

```

Initializing the Remote Control Session

```

REM ----- Initializing the remote control session -----
Public SUB Initialize()
    Dim status As Long
    'CALL viOpenDefaultRM to get the resource manager handle
    'Store this handle in defaultRM. The function viStatusDesc
    'returns a text description of the status code returned by viOpenDefaultRM
    status = viOpenDefaultRM(defaultRM)
    status = viStatusDesc(defaultRM, status, Response)
    'Open the connection to the device and store the handle
    'Note: The timeout value in viOpen() applies only for opening the interface
    'For setting the communication timeout, set the VI_ATTR_TMO_VALUE attribute
    'timeout values are in milliseconds
    'This example assumes the instrument IP address 10.0.0.10

```

Brief Introduction to Remote Control

```
'If the network provides a name resolution mechanism, the hostname of
'the instrument can be used instead of the numeric IP address
'the resource string for GPIB would be "GPIB::20::INSTR''
status = viOpen(defaultRM, "TCPIP::10.0.0.10::INSTR'', 0, 1000, analyzer)
'status = viOpen(defaultRM, "TCPIP::<hostname>::INSTR'', 0, 1000, analyzer)
'status = viOpen(defaultRM, "GPIB::20::INSTR'', 0, 1000, analyzer)
'Set timeout value - here 5s
status = viSetAttribute(vi, VI_ATTR_TMO_VALUE, 5000)
END SUB
REM *****
```

Initializing the Instrument

Set the remote control status registers and instrument settings to the default state.

```
REM ----- Initializing the instrument -----
Public SUB InitDevice()
CALL InstrWrite(analyzer, "*CLS")      'Reset status register
CALL InstrWrite(analyzer, "*RST")      'Reset instrument
END SUB
REM*****
```

Switching the Screen Display On and Off

In the default setting, all remote control commands are carried out with the screen display switched off in order to attain optimum measurement speed. During the development phase of remote control programs, however, the screen display is required in order to visually check both the programming of the settings and the measurement results.

The following examples show functions with which the screen display can be switched on or off during remote control operation.

```
REM ----- Switching on the screen display -----
Public SUB DisplayOn()
CALL InstrWrite(analyzer, "SYST:DISP:UPD ON")
      'Switch on screen display
END SUB
REM*****
REM ----- Switching off the screen display -----
Public SUB DisplayOff()
CALL InstrWrite(analyzer, "SYST:DISP:UPD OFF")
      'Switch off screen display
END SUB
REM*****
```

Configuring the Power Save Function for the Display

During remote control operation, it is often unnecessary to display the measurement results on screen. Although the command `SYSTEM:DISPLAY:UPDATE OFF` switches off the display of the measurement results, thus significantly improving speed in remote control operation, the display itself and the background lighting in particular remain switched on.

If you also want to switch off the display itself, you must use the power save function by setting the response time in minutes prior to activation.



The display is reactivated immediately when you press a key on the instrument's front panel.

```
Public SUB PowerSave()
CALL InstrWrite(analyzer, "DISPlay:PSAVe:HOLDoff 1")
    'Set response time to 1 minute
CALL InstrWrite(analyzer, "DISPlay:PSAVe ON")
    'Switch on Power Save function
```

8.3.1.3 Sending Simple Instrument Setting Commands

This example shows how the center frequency, span and reference level of the instrument are set.

```
REM ----- Instrument setting commands -----
PUBLIC SUB SimpleSettings()
CALL InstrWrite(analyzer, "FREQUENCY:CENTER 128MHz")
    'Center frequency 128 MHz
CALL InstrWrite(analyzer, "FREQUENCY:SPAN 10MHZ")
    'Set span to 10 MHz
CALL InstrWrite(analyzer, "DISPLAY:TRACE:Y:RLEVEL -10dBm")
    'Set reference level to -10dBm
END SUB
REM *****
```

8.3.1.4 Switching to Manual Operation

```
REM ----- Switching instrument to manual operation -----
CALL viGpibControlREN(analyzer, VI_GPIB_REN_ADDRESS_GTL)
    'Set instrument to Local state
REM *****
```

8.3.1.5 Reading Out Instrument Settings

The settings made above can now be read out. To do so, the abbreviated commands are used.

```

REM ----- Reading out instrument settings -----
PUBLIC SUB ReadSettings()
Dim retCount as Long
Cffrequency$ = SPACE$(20)    'Provide text variable (20 characters)
CALL InstrWrite(analyzer, "FREQ:CENT?")
    'Request center frequency
CALL InstrRead(analyzer, Cffrequency$, 20, retCount)
    'Read value
CR&S FSVan$ = SPACE$(20)    'Provide text variable (20 characters)
CALL InstrWrite(analyzer, "FREQ:SPAN?")
    'Request span
CALL InstrRead(analyzer, CR&S FSVan$, 20, retCount)
    'Read value
RLlevel$ = SPACE$(20)    'Provide text variable (20 characters)
CALL InstrWrite(analyzer, "DISP:TRAC:Y:RLEV?")
    'Request ref level setting
CALL InstrRead(analyzer, RLlevel$, 20, retCount)
    'Read value
REM ----- Displaying values in the Immediate window -----
Debug.Print "Center frequency: "; Cffrequency$,
Debug.Print "Span:           "; CR&S FSVan$,
Debug.Print "Reference level: "; RLlevel$,
END SUB
REM*****

```

8.3.1.6 Marker Positioning and Readout

```

REM ----- Example of marker function -----
PUBLIC SUB ReadMarker()
Dim retCount as Long
CALL InstrWrite(analyzer, "CALC:MARKER ON;MARKER:MAX")
    'Activate marker 1 and search for peak
MKmark$ = SPACE$(30)    'Provide text variable (30 characters)
CALL InstrWrite(analyzer, "CALC:MARK:X?;Y?")
    'Query frequency and level
CALL InstrRead(analyzer, MKmark$, 30, retCount)
    'Read value
REM ----- Displaying values in the Immediate window -----
Debug.Print "Marker frequency/level "; MKmark$,

```



```
END SUB
```

```
REM *****
```

8.3.1.7 Command Synchronization

The synchronization methods used in the following example are described in the Operating Manual, chapter "Remote Control - Basics", section "Command Sequence and Command Synchronization".

```
REM ----- Commands for command synchronization -----
PUBLIC SUB SweepSync()
Dim retCount as Long
Dim SRQWaitTimeout As Long
Dim eventType As Long
Dim eventVi As Long
REM The command INITiate[:IMMEDIATE] starts a single sweep if the
REM command INIT:CONT OFF has already been sent. The next command
REM must not be carried out until a full sweep has been completed.
CALL InstrWrite(analyzer, "INIT:CONT OFF")
REM ----- First method: Using *WAI -----
CALL InstrWrite(analyzer, "ABOR;INIT:IMM; *WAI")
REM ----- Second method: Using *OPC? -----
OpcOk$ = SPACE$(2) 'Provide space for *OPC? response
CALL InstrWrite(analyzer, "ABOR;INIT:IMM; *OPC?")
REM ----- In this case, the controller can use other instruments -----
CALL InstrRead(analyzer, OpcOk$, 2, retCount)
'Wait for "1" from *OPC?
REM ----- Third method: Using *OPC -----
REM In order for the Service Request function to be used with a GPIB
REM driver from National Instruments, the setting "Disable
REM Auto Serial Poll" must be set to "yes" with IBCONF!
CALL InstrWrite(analyzer, "*SRE 32") 'Enable Service Request for ESR
CALL InstrWrite(analyzer, "*ESE 1") 'Set event enable bit for operation
'complete bit
CALL viEnableEvent(vi, VI_EVENT_SERVICE_REQ, VI_QUEUE, 0)
'Enable the event for service request
CALL InstrWrite(analyzer, "ABOR;INIT:IMM; *OPC")
'Start sweep with Synchronization to OPC
SRQWaitTimeout = 5000 'Allow 5s for sweep completion
'Now wait for the service request
CALL viWaitOnEvent(vi, VI_EVENT_SERVICE_REQ, SRQWaitTimeout, _
eventType, eventVi)
CALL viClose(eventVi) 'Close the context before continuing
CALL viDisableEvent(vi, VI_EVENT_SERVICE_REQ, VI_QUEUE)
'Disable subsequent events
```

```
REM Resume main program here.
```

```
END SUB
```

```
REM *****
```

Reading Output Buffers

```
REM ----- Subroutine for the individual STB bits -----
```

```
Public SUB Outputqueue()      'Reading the output queue
```

```
Dim retCount as Long
```

```
result$ = SPACE$(100)      'Create space for response
```

```
CALL InstrRead(analyzer, result$, 100, retCount)
```

```
Debug.Print "Contents of Output Queue : "; result$
```

```
END SUB
```

```
REM *****
```

Reading Error Messages

```
REM ----- Subroutine for evaluating the error queue -----
```

```
Public SUB ErrorQueueHandler()
```

```
Dim retCount as Long
```

```
ERROR$ = SPACE$(100)      Subroutine for evaluating the error queue
```

```
CALL InstrWrite(analyzer, "SYSTEM:ERROR?")
```

```
CALL InstrRead(analyzer, ERROR$, 100, retCount)
```

```
Debug.Print "Error Description : "; ERROR$
```

```
END SUB
```

```
REM *****
```

8.3.2 Detailed Programming Examples

In the following sections, typical programming examples for setting measurement parameters and functions, general settings, printout and data management are provided.

8.3.2.1 Default Setting of the R&S FSVA/FSV

The following settings provide typical examples of how to change the default setting of the R&S FSVA/FSV.

Note that only some of the settings are necessary depending on the application example. In many cases, it is not necessary to set resolution bandwidth, video bandwidth and sweep time since these parameters are automatically calculated in the default setting when the span is changed. Likewise, the input attenuation is automatically calculated in the default setting as a function of the reference level.

Last of all, the level detectors are linked to the selected trace mode in the default setting.

The settings automatically calculated in the default setting are indicated with an asterisk (*) in the following program example.

Setting the Remote Control Status Registers

```
REM *****
Public Sub SetupStatusReg()

'----- IEEE 488.2 status register -----
CALL InstrWrite(analyzer,"*CLS")      'Reset status registers
CALL InstrWrite(analyzer,"*SRE 168")  'Enable Service Request for
'  STAT:OPER-,STAT:QUES- and ESR-Register
CALL InstrWrite(analyzer,"*ESE 61")   'Set event enable bit for:
'  operation complete 'command-, execution-,
'  device dependent- and query error
'----- SCPI status register -----
CALL InstrWrite(analyzer,"STAT:OPER:ENAB 0")
'  Disable OPERation Status reg
CALL InstrWrite(analyzer,"STAT:QUES:ENAB 0")
'  Disable questionable Statusreg
End Sub
REM *****
```

Default Settings for Measurements

```
REM *****
Public Sub SetupInstrument()

'----- Default setting f the R&S FSV -----
CALL SetupStatusReg      'Configure status registers
CALL InstrWrite(analyzer,"*RST")  'Reset instrument
CALL InstrWrite(analyzer,"SYST:DISP:UPD ON")
'  ON: screen display on
'  OFF: off (improved performance)
CALL InstrWrite(analyzer,"INIT:CONT OFF")
'  Single sweep mode
'----- Frequency setting -----
CALL InstrWrite(analyzer,"FREQUENCY:CENTER 100MHz")
'  Center frequency
CALL InstrWrite(analyzer,"FREQ:SPAN 1 MHz")
'  Span
'----- Level setting -----
CALL InstrWrite(analyzer,"DISP:WIND:TRAC:Y:RLEV -20dBm")
'  Reference level
```

```

CALL InstrWrite(analyzer,"INP:ATT 10dB")
    'Input attenuation  (*)
'----- Level scaling -----
CALL InstrWrite(analyzer,"DISP:WIND:TRAC:Y:SPAC LOG")
    'Log level axis
CALL InstrWrite(analyzer,"DISP:WIND:TRAC:Y:SCAL 100dB")
    'Level range
CALL InstrWrite(analyzer,"DISP:WIND:TRAC:Y:SCAL:MODE ABS")
    'Absolute scaling
CALL InstrWrite(analyzer,"CALC:UNIT:POW DBM")
    'y meas. unit
'----- Trace and detector setting -----
CALL InstrWrite(analyzer,"DISP:TRAC1:MODE AVER")
    'Trace1 average
CALL InstrWrite(analyzer,"AVER:TYPE VID")
    'Average mode video; "LIN" for linear
CALL InstrWrite(analyzer,"SWE:COUN 10")
    'Sweep count
CALL InstrWrite(analyzer,"DISP:TRAC2 OFF")
    'Trace2 blank
CALL InstrWrite(analyzer,"DISP:TRAC3 OFF")
    'Trace3 blank
CALL InstrWrite(analyzer,"DISP:TRAC4 OFF")
    'Trace4 blank
CALL InstrWrite(analyzer,"DISP:TRAC5 OFF")
    'Trace5 blank
CALL InstrWrite(analyzer,"DISP:TRAC6 OFF")
    'Trace6 blank
CALL InstrWrite(analyzer,"CALC:MATH:STAT OFF")
    'Trace difference off
CALL InstrWrite(analyzer,"DET1 RMS")
    'Detector Trace1  (*)
CALL InstrWrite(analyzer,"DET2:AUTO ON")
    'Detector Trace2  (*)
CALL InstrWrite(analyzer,"DET3:AUTO ON")
    'Detector Trace3  (*)
CALL InstrWrite(analyzer,"DET4:AUTO ON")
    'Detector Trace4  (*)
CALL InstrWrite(analyzer,"DET5:AUTO ON")
    'Detector Trace5  (*)
CALL InstrWrite(analyzer,"DET6:AUTO ON")
    'Detector Trace6  (*)
'----- Bandwidths and sweep time -----
CALL InstrWrite(analyzer,"BAND:RES 100KHz")
    'Resolution bandwidth  (*)
CALL InstrWrite(analyzer,"BAND:VID 1MHz")

```

```
'Video bandwidth    (*)
CALL InstrWrite(analyzer,"SWE:TIME 100ms")
'Sweep time         (*)
END SUB
```

8.3.2.2 Using Markers and Delta Markers

The markers are used for marking points on traces, reading out measurement results and for selecting a display area quickly.

Marker Search Functions, Restricting the Search Range

The following example is based on an AM-modulated signal at 100 MHz that has the following characteristics:

Carrier signal level	-30 dBm
AF frequency	100 kHz
Modulation depth	50 %

Marker 1 and then delta marker 2 are set to the largest maximum points on the trace. The frequency and level are then read. In the following measurements, the instrument's default setting can be used for measurements (SetupInstrument).

```
REM *****
Public Sub MarkerSearch()
Dim retCount as Long
result$ = Space$(100)
CALL SetupInstrument 'Default Setting
'----- Peak search without search range limits-----
CALL InstrWrite(analyzer,"INIT:CONT OFF")
'Switch to single sweep
CALL InstrWrite(analyzer,"CALC:MARK:PEXC 6DB")
'Define peak excursion
CALL InstrWrite(analyzer,"CALC:MARK:STAT ON")
'Enable marker 1
CALL InstrWrite(analyzer,"CALC:MARK:TRAC 1")
'Set marker 1 to trace 1
CALL InstrWrite(analyzer,"INIT;*WAI") 'Perform sweep with sync
CALL InstrWrite(analyzer,"CALC:MARK:MAX;X?;Y?")
'Marker to peak; read frequency and level
CALL InstrRead(analyzer, result$, 100, retCount)
Debug.Print "Marker 1: ";result$
CALL InstrWrite(analyzer,"CALC:DELT2:STAT ON;MAX;MAX:LEFT")
'Activate delta marker 2,
```

```

' set to peak and then to next peak left
CALL InstrWrite(analyzer,"CALC:DELT2:X?;Y?")
' Read delta marker 2 frequency and level
result$ = Space$(100)
CALL InstrRead(analyzer, result$, 100, retCount)
Debug.Print "Delta 2: ";result$
'----- Peak search with search range limit in x direction -----
CALL InstrWrite(analyzer,"CALC:MARK:X:SLIM:STAT ON;LEFT _
0Hz;RIGHT 100.05MHz")
' Activate search limit,
' set at right below AF
CALL InstrWrite(analyzer,"CALC:DELT3:STAT ON;MAX;MAX:RIGHT")
' Activate delta marker 3,
' set to peak and then to next peak right
CALL InstrWrite(analyzer,"CALC:DELT3:X:REL?;;CALC:DELT3:Y?")
' Read delta marker 3 frequency and level;
' both must have a value of 0
result$ = Space$(100)
CALL InstrRead(analyzer, result$, 100, retCount)
Print "Delta 3: ";result$
'----- Peak search with search range limit in y direction -----
CALL InstrWrite(analyzer,"CALC:THR:STAT ON")
CALL InstrWrite(analyzer,"CALC:THR -35DBM")
' Activate threshold and set it above the AF
CALL InstrWrite(analyzer,"CALC:DELT3:STAT ON;MAX;MAX:NEXT")
' Activate delta marker 3,
' set to peak and then to next peak
' => is not found
CALL InstrWrite(analyzer,"CALC:DELT3:X:REL?;;CALC:DELT3:Y?")
' Query and read delta marker 3
' frequency and level;
' both must have a value of 0
result$ = Space$(100)
CALL InstrRead(analyzer, result$, 100, retCount)
Debug.Print "Delta 3: ";result$
'---- Setting center frequency and reference level with markers -----
CALL InstrWrite(analyzer,"CALC:MARK2:FUNC:CENT")
' Delta marker 2 -> marker and
' center frequency = marker 2
CALL InstrWrite(analyzer,"CALC:MARK2:FUNC:REF")
' Ref level = marker 2
CALL InstrWrite(analyzer,"INIT;*WAI")      'Sweep with sync
END SUB
REM *****

```

Frequency Counting

The following example is based on a signal at 100 MHz with a level of -30 dBm. Again, the instrument's default setting can be used (SetupInstrument). The purpose of frequency counting is to determine the exact frequency of the signal at 100 MHz.

```

REM *****
Public Sub MarkerCount()
Dim retCount as Long
CALL SetupInstrument 'Default setting
'----- Defining signal frequency with frequency counter -----
CALL InstrWrite(analyzer,"INIT:CONT OFF")
    'Switch to single sweep
CALL InstrWrite(analyzer,"CALC:MARK:PEXC 6DB")
    'Define peak excursion
CALL InstrWrite(analyzer,"CALC:MARK:STAT ON")
    'Activate marker 1
CALL InstrWrite(analyzer,"CALC:MARK:TRAC 1")
    'Set marker 1 to trace 1
CALL InstrWrite(analyzer,"CALC:MARK:X 100MHz")
    'Set marker 1 to 100 MHz
CALL InstrWrite(analyzer,"CALC:MARK:COUNT ON")
    'Activate frequency counter
CALL InstrWrite(analyzer,"INIT;*WAI") 'Perform sweep with sync
CALL InstrWrite(analyzer,"CALC:MARK:COUNT:FREQ?")
    'Query and read measured frequency
result$ = Space$(100)
CALL InstrRead(analyzer, result$, 100, retCount)
Debug.Print "Marker Count Freq: ";result$
END SUB
REM *****

```

Working with a Fixed Reference Point

The following example is based on a signal at 100 MHz with a level of -20 dBm. Thus, the harmonics of the signal are located at 200 MHz, 300 MHz, etc. For high-quality signal sources, these harmonics may be located outside the dynamic range of the R&S FSVA/FSV. Nevertheless, to measure the harmonic suppression, the level setting must be changed to higher sensitivity when measuring the harmonics. In this case, it may be necessary to suppress the carrier by using a notch filter in order to prevent the RF input of the R&S FSVA/FSV from being overloaded.

Thus, two measurements with different level settings are performed in the following example. First, a high reference level is used on the carrier frequency, and then a low reference level is used on the frequency of the third harmonic.

The default setting of the R&S FSVA/FSV for measurements ("SetupInstrument") is also used as a starting point here, after which adaptations for the measurement are carried out.

```

REM *****
Public Sub RefFixed()
Dim retCount as Long
CALL SetupInstrument      'Default setting
'----- Measuring the reference point -----
CALL InstrWrite(analyzer,"INIT:CONT OFF")
      'Switch to single sweep
CALL InstrWrite(analyzer,"CALC:MARK:PEXC 6DB")
      'Define peak excursion
CALL InstrWrite(analyzer,"CALC:MARK:STAT ON")
      'Activate marker 1
CALL InstrWrite(analyzer,"CALC:MARK:TRAC 1")
      'Set marker 1 to trace 1
CALL InstrWrite(analyzer,"INIT;*WAI")      'Perform sweep with sync
CALL InstrWrite(analyzer,"CALC:MARK:MAX")
      'Set marker 1 to 100 MHz
CALL InstrWrite(analyzer,"CALC:DELT:FUNC:FIX ON")
      'Define reference point
'----- Setting frequency, level and bandwidth for measuring harmonics -----
CALL InstrWrite(analyzer,"FREQ:CENT 400MHz;Span 1MHz")
      'Set freq of 3rd harmonic
CALL InstrWrite(analyzer,"BAND:RES 1kHz")
      'Set suitable RBW
CALL InstrWrite(analyzer,"SWEEP:TIME:AUTO ON")
      'Couple sweep time
CALL InstrWrite(analyzer,"INP:ATT:AUTO ON")
      'Select more sensitive level setting
CALL InstrWrite(analyzer,"DISP:WIND:TRAC:Y:RLEV -50dBm")
CALL InstrWrite(analyzer,"INIT;*WAI")      'Perform sweep with sync
CALL InstrWrite(analyzer,"CALC:DELT:MAX;X:REL?;Y?")
      'Read delta marker
result$ = Space$(100)
CALL InstrRead(analyzer, result$, 100, retCount)
      'Read frequency and level
Debug.Print "Deltamarker 1: "; result$
END SUB
REM *****

```

Measuring Noise and Phase Noise

When phase noise is measured, the noise power related to a bandwidth of 1 Hz is set in relation to the power of an adjacent carrier signal. A commonly used offset between the measured frequency and the carrier frequency is 10 kHz.

When noise is measured, the measured absolute level is related to a bandwidth of 1 Hz.

The following example is also based on a signal at 100 MHz with a level of -30 dBm. Two markers are used to determine both the noise and the phase noise at a 10 kHz offset from the carrier signal.

```
REM *****
Public Sub Noise()
Dim retCount as Long
'----- Default setting of the R&S FSV -----
CALL SetupStatusReg 'Configure status register
CALL InstrWrite(analyzer,"*RST") 'Reset instrument
CALL InstrWrite(analyzer,"INIT:CONT OFF")
'Single sweep mode
'----- Setting the frequency -----
CALL InstrWrite(analyzer,"FREQUENCY:CENTER 100MHz")
'Center frequency
CALL InstrWrite(analyzer,"FREQ:SPAN 100 kHz")
'Span
'----- Setting the level -----
CALL InstrWrite(analyzer,"DISP:WIND:TRAC:Y:RLEV -20dBm")
'Reference level
CALL InstrWrite(analyzer,"INIT;*WAI") 'Perform sweep with sync
'----- Setting the reference point -----
CALL InstrWrite(analyzer,"CALC:MARK:PEXC 6DB")
'Define peak excursion
CALL InstrWrite(analyzer,"CALC:MARK:STAT ON")
'Activate marker 1
CALL InstrWrite(analyzer,"CALC:MARK:TRAC 1")
'Set marker 1 to trace 1
CALL InstrWrite(analyzer,"CALC:MARK:MAX")
'Set marker 1 to 100 MHz
CALL InstrWrite(analyzer,"CALC:DELT:FUNC:PNO ON")
'Define reference point for phase noise
'----- Measuring the phase noise -----
CALL InstrWrite(analyzer,"CALC:DELT:X 10kHz")
'Position delta marker
CALL InstrWrite(analyzer,"CALC:DELT:FUNC:PNO:RES?")
'Query and output phase noise result
result$ = Space$(100)
```

```

CALL InstrRead(analyzer, result$, 100, retCount)
Debug.Print "Phase Noise [dBc/Hz]: "; result$
'----- Measuring the noise -----
CALL InstrWrite(analyzer,"CALC:MARK:X 99.96MHz")
'Position marker 1
CALL InstrWrite(analyzer,"CALC:MARK:FUNC:NOIS:RES?")
'Query and output result
result$ = Space$(100)
CALL InstrRead(analyzer, result$, 100, retCount)
Print "Noise [dBm/Hz]: "; result$
END SUB
REM *****

```

8.3.2.3 Reading Out Trace Data

In the following example, the trace data obtained with the default setting is read from the instrument and displayed in a list on the screen. Readout occurs first in binary format and then in ASCII format, once with the span > 0 and once with the span = 0.

In binary format, the header of the message with the length specification is evaluated and used to calculate the x-axis values.

In ASCII format, merely the list of level values is output.

Binary data is read out in three steps:

1. The number of digits in the length specification is read out.
2. The length specification itself is read out.
3. The trace data itself is read out.

The procedure is required for programming languages that only support structures with data types of the same type (arrays, such as with Visual Basic), because the data types of the header and data sections are different in binary data.

The "VISA" library provides only a mechanism for reading into string buffers. In order to convert the data into an array of single precision values, the string contents must be copied into a buffer of that type. The following example uses an operating system function for the copy operation. The function declaration must be added to a module (.bas) as follows:



Array dimensions

The arrays for the measured data are dimensioned so they provide sufficient space for trace data of the R&S FSVA/FSV (691 measurement points).

```

REM *****
Public Sub ReadTrace()
'----- Creating variables -----
Dim traceData(1400) As Single      'Buffer for floating point binary data
Dim digits As Byte                'Number of characters in
    'length specification
Dim traceBytes As Integer         'Len. of trace data in bytes
Dim traceValues As Integer        'No. of meas. values in buff.
Dim BinBuffer as String * 5600    'String buffer for binary data
Dim retCount as Long
asciiResult$ = Space$(28000)      'Buffer for ASCII trace data
result$ = Space$(100)            'Buffer for simple results
startFreq$ = Space$(100)         'Buffer for start frequency
span$ = Space$(100)              'Buffer for span
'----- Default setting of the R&S FSV -----
CALL SetupInstrument              'Default setting
CALL InstrWrite(analyzer,"INIT:CONT OFF")
    'Switch to single sweep
CALL InstrWrite(analyzer,"INIT;*WAI")    'Perform sweep with sync
'----- Defining the frequency range for output -----
CALL InstrWrite(analyzer,"FREQ:START?")    'Read start frequency
CALL InstrRead(analyzer,startFreq$, 100, retCount)
startFreq = Val(startFreq$)
CALL InstrWrite(analyzer,"FREQ:SPAN?")      'Read span
CALL InstrRead(analyzer,span$, 100, retCount)
span = Val(span$)
'----- Reading out in binary format -----
CALL InstrWrite(analyzer, "FORMAT REAL,32")
    'Set binary format
CALL InstrWrite(analyzer, "TRAC1? TRACE1")
    'Read trace 1
CALL InstrRead(analyzer, result$, 2, retCount)
    'Read and store length
digits = Val(Mid$(result$, 2, 1))    'spec. for number of characters
result$ = Space$(100)                'Reinitialize buffer
CALL InstrRead(analyzer, result$, digits, retCount)
    'Read and store length
traceBytes = Val(Left$(result$, digits))
    'specification
CALL InstrRead(analyzer, BinBuffer, traceBytes, retCount)

```

```

'Read trace data into buffer
CopyMemory traceData(0), ByVal BinBuffer, traceBytes
'Copy data into float array
'----- Outputting binary data as frequency/level pairs -----
traceValues = traceBytes/4      'Single precision = 4 bytes
stepsize = span/traceValues     'Calculate frequency step size
For i = 0 To traceValues - 1
Debug.Print "Value["; i; "] = "; startFreq+stepsize*i; ", "; traceData(i)
Next i
'----- Default setting of zero span -----
CALL InstrWrite(analyzer,"FREQ:SPAN 0Hz")
'Switch to zero span
CALL InstrWrite(analyzer,"INIT;*WAI")      'Perform sweep with sync
'----- Reading out in ASCII format -----
CALL InstrWrite(analyzer,"FORMAT ASCII")
'Set ASCII format
CALL InstrWrite(analyzer,"TRAC1? TRACE1")
'Read and output
CALL InstrRead(analyzer, asciiResult$)
Print "Contents of Tracel: ",asciiResult$      'trace 1
END SUB
REM *****

```

8.3.2.4 Storing and Loading Instrument Settings

Settings and measured data can be stored and loaded. You can define which data set is loaded when the instrument is preset or started.

Storing Instrument Settings

In the following example, the settings/measured data to be stored are defined initially, in which case only the hardware settings are stored. However, the selection commands for the other settings are specified with the state "OFF" for the sake of completeness.

```

REM *****
Public Sub StoreSettings()
'This subroutine selects the settings to be stored and creates the
'data record "TEST1" in the directory C:\R_S\Instr\user. It uses the default
'setting and resets the instrument after the setting is stored.
'----- Default settings of the R&S FSV -----
CALL SetupInstrument
CALL InstrWrite(analyzer,"INIT:CONT OFF")
'Change to single sweep
CALL InstrWrite(analyzer,"INIT;*WAI")      'Perform sweep with sync

```

```
'----- Selection of settings to be stored -----
CALL InstrWrite(analyzer,"MMEM:SEL:HWS ON")
    'Store hardware settings
CALL InstrWrite(analyzer,"MMEM:SEL:TRAC OFF")
    'Do not store any traces
CALL InstrWrite(analyzer,"MMEM:SEL:LIN:ALL OFF")
    'Store only the activated limit lines
'----- Storing on the instrument -----
CALL InstrWrite(analyzer,"MMEM:STOR:STAT 1,'C:\R_S\Instr\user\TEST1'")
'----- Resetting the instrument -----
CALL InstrWrite(analyzer,"*RST")
END SUB
REM *****
```

Loading Instrument Settings

In the following example, the TEST1 data record stored under C:\R_S\Instr\user is loaded by the instrument:

```
REM *****
Public Sub LoadSettings()
    'This subroutine loads the TEST1 data record in the directory
    'C:\R_S\Instr\user.
    '----- Default setting of the status register -----
    CALL SetupStatusReg    'Configure status register
    '----- Loading the data record -----
    CALL InstrWrite(analyzer,"MMEM:LOAD:STAT 1,'C:\R_S\Instr\user\TEST1'")
    '----- Perform measurement using loaded data record -----
    CALL InstrWrite(analyzer,"DISP:TRAC1:MODE WRIT")
        'Set trace to Clr/Write
    CALL InstrWrite(analyzer,"INIT;*WAI")    'Start sweep
END SUB
REM *****
```

Setting the Data Record for Startup Recall

In the following example, the first step is to change the R&S FSVA/FSV to the default state. In the next step, the TEST1 data record stored under C:\R_S\Instr\user is selected for the startup recall function, i.e. the data record is then set after each *RST, presetting and each time the instrument is started. For demonstration purposes, the command *RST is carried out again.

```
REM *****
Public Sub StartupRecallSettings()
    '----- Resetting the R&S FSV -----
    CALL InstrWrite(analyzer,"*RST")
```

```
'----- Default setting of the status register -----
CALL SetupStatusReg      'Configure status register
'----- Selecting the startup recall data record -----
CALL InstrWrite(analyzer,"MMEM:LOAD:AUTO 1,'C:\R_S\Instr\user\TEST1'")
'----- Activating the startup recall data record -----
CALL InstrWrite(analyzer,"*RST")
END SUB
REM *****
```

8.3.2.5 Configuring and Starting a Printout

The following example shows how to configure the output format and output device for printing out a measurement screen. The procedure is as follows:

1. Set the measurement you want for the printout.
2. Check which output devices are available on the instrument.
3. Select an output device.
4. Select the output interface.
5. Configure the output format.
6. Start the printout with synchronization to completion.

It is assumed that the desired setting is a signal at 100 MHz with a power of -20 dBm. It is also assumed that the sixth printer out of the available printers that are listed is the one you want. The printout is first output to the selected printer and then to a file.

```
REM *****
Public Sub HCopy()
Dim retCount as Long
Dim SRQWaitTimeout As Long
Dim eventType As Long
Dim eventVi As Long
Dim statusSRQ As Long
DIM Devices(100) as string      'Create buffer for printer name
FOR i = 0 TO 49
    Devices$(i) = Space$(50)    'Preallocate buffer for printer name
NEXT i
'----- Default setting of the R&S FSV -----
CALL SetupStatusReg      'Configure status register
CALL InstrWrite(analyzer,"*RST")      'Reset instrument
```

```

CALL InstrWrite(analyzer,"INIT:CONT OFF")
    'Single sweep mode
CALL InstrWrite(analyzer,"SYST:DISP:UPD ON")
    'Screen display on
'----- Measurement settings -----
CALL InstrWrite(analyzer,"FREQ:CENT 100MHz;SPAN 10MHz")
    'Frequency setting
CALL InstrWrite(analyzer,"DISP:TRAC:Y:RLEV -10dBm")
    'Reference level
CALL InstrWrite(analyzer,"INIT;*WAI")      'Perform measurement
'----- Querying the available output devices -----
CALL InstrWrite(analyzer,"SYST:COMM:PRIN:ENUM:FIRSt?")
    'Read out and display first output device
CALL InstrRead(analyzer,Devices$(0), 50, retCount)
Debug.Print "Printer 0: "+Devices$(0)
For i = 1 to 99
    CALL InstrWrite(analyzer,"SYST:COMM:PRIN:ENUM:NEXT?")
        'Read out next printer name
    CALL InstrRead(analyzer,Devices$(i)
    IF Left$(Devices$(i),2) = "" THEN GOTO SelectDevice
        'Stop at end of list
    Debug.Print "Printer"+Str$(i)+" : " Devices$(i)
        'Display printer name
NEXT i
SelectDevice:
'---- Selection of output device, printer language and output interface ----
CALL InstrWrite(analyzer,"SYST:COMM:PRIN:SEL "+ Devices(6))
    'Printer selection #6
CALL InstrWrite(analyzer,"HCOP:DEST 'SYST:COMM:PRIN'")
    'Configuration: "Printout to
    'printer interface"
CALL InstrWrite(analyzer,"HCOP:DEV:LANG GDI")
    'Printers require printer language 'GDI'
'----- Selection of orientation (portrait/landscape) and colour/BW -----
CALL InstrWrite(analyzer,"HCOP:PAGE:ORI PORT")
    'Portrait orientation
CALL InstrWrite(analyzer,"HCOP:DEV:COL OFF")
    'Black-and-white printout
'----- Configuring and starting the printout -----
CALL InstrWrite(analyzer,"HCOP:ITEM:ALL")
    'All screen contents
'CALL InstrWrite(analyzer,"HCOP:ITEM:TRAC:STAT ON")
    'Alternative: only traces
CALL InstrWrite(analyzer,"*CLS")      'Reset status registers
CALL viEnableEvent(vi, VI_EVENT_SERVICE_REQ, VI_QUEUE, 0)
    'Enable the event for service request

```

```

CALL InstrWrite(analyzer,"HCOP;*OPC")
  'Start printout
SRQWaitTimeout = 5000      'Allow 5s for completion
  'Now wait for the service request
statusSRQ = viWaitOnEvent(vi, VI_EVENT_SERVICE_REQ, SRQWaitTimeout, _
  eventType, eventVi)
CALL viClose(eventVi)      'Close the context before continuing
CALL viDisableEvent(vi, VI_EVENT_SERVICE_REQ, VI_QUEUE)
  'Disable subsequent events
IF NOT(statusSRQ = 0) THEN CALL Srq      'If SRQ not detected =>
  'Subroutine for evaluation
'---- Printout in WMF format (BMP format) to file -----
CALL InstrWrite(analyzer,"HCOP:DEST 'MMEM'")
  'Configuration: "Printout to file"
CALL InstrWrite(analyzer,"HCOP:DEV:LANG WMF")
  'WMF file format
'CALL InstrWrite(analyzer,"HCOP:DEV:LANG BMP")
  'BMP file format
CALL InstrWrite(analyzer,"MMEM:NAME 'C:\R_S\Instr\user\PRINT1.WMF'")
  'Define file name
CALL InstrWrite(analyzer,"*CLS")      'Reset Status registers
CALL viEnableEvent(vi, VI_EVENT_SERVICE_REQ, VI_QUEUE, 0)
  'Enable the event for service request
CALL InstrWrite(analyzer,"HCOP:IMMEDIATE;*OPC")
  'Start printout
SRQWaitTimeout = 5000      'Allow 5s for completion
  ' Now wait for the service request
statusSRQ = viWaitOnEvent(vi, VI_EVENT_SERVICE_REQ, SRQWaitTimeout, _
  eventType, eventVi)
CALL viClose(eventVi)      'Close the context before continuing
CALL viDisableEvent(vi, VI_EVENT_SERVICE_REQ, VI_QUEUE)
  'Disable subsequent events
IF NOT(statusSRQ = 0) THEN CALL Srq      'If SRQ not detected =>
  'Subroutine for evaluation
END SUB
REM *****

```

8.4 Remote Control Interfaces and Protocols

The instrument supports different interfaces and protocols for remote control. The following table gives an overview.

Table 8-1: Remote control interfaces and protocols

Inter- face	Protocols, VISA ^{*)} address string	Remarks
Local Area Network (LAN)	<ul style="list-style-type: none"> • HiSLIP High-Speed LAN Instrument Protocol (IVI-6.1) TCPIP::host address::hislip0[::INSTR] • VXI-11 TCPIP::host address::inst0[::INSTR] Library: VISA 	<p>The interface is based on TCP/IP and supports various protocols.</p> <p>For a description of the protocols refer to:</p> <p>8.4.1.1 VXI-11 Protocol 8.4.1.2 HiSLIP Protocol</p>
<p>^{*)} VISA is a standardized software interface library providing input and output functions to communicate with instruments. A VISA installation on the controller is a prerequisite for remote control using the indicated interfaces.</p>		

8.4.1 LAN Interface

For remote control via a network, the PC and the instrument must be connected via the LAN interface to a common network with TCP/IP network protocol. They are connected using a commercial RJ45 cable (shielded or unshielded twisted pair category 5). The TCP/IP network protocol and the associated network services are preconfigured on the instrument. Software for instrument control and the VISA program library must be installed on the controller.

VISA library

IP address

Only the IP address or a valid DNS host name is required to set up the connection. The host address is part of the "VISA resource string" used by the programs to identify and control the instrument.

The VISA resource string has the form:

```
TCPIP::host address[::LAN device name][::INSTR]
```

where:

- **TCPIP** designates the network protocol used
- **host address** is the IP address or host name of the device
- **LAN device name** defines the protocol and the instance number of a sub-instrument;

- `inst0` selects the VXI-11 protocol (default)
- `hislip0` selects the newer HiSLIP protocol
- **INSTR** indicates the instrument resource class (optional)

Example:

- Instrument has the IP address `192.1.2.3`; the valid resource string using VXI-11 protocol is:
`TCPIP::192.1.2.3::INSTR`

**Identifying instruments in a network**

If several instruments are connected to the network, each instrument has its own IP address and associated resource string. The controller identifies these instruments by means of the resource string.

- [VXI-11 Protocol](#)..... 163
- [HiSLIP Protocol](#)..... 163

8.4.1.1 VXI-11 Protocol

The VXI-11 standard is based on the ONC RPC (Open Network Computing Remote Procedure Call) protocol which in turn relies on TCP/IP as the network/transport layer. The TCP/IP network protocol and the associated network services are preconfigured. TCP/IP ensures connection-oriented communication, where the order of the exchanged messages is adhered to and interrupted links are identified. With this protocol, messages cannot be lost.

8.4.1.2 HiSLIP Protocol

The HiSLIP (**H**igh **S**peed **L**AN **I**nstrument **P**rotocol) is the successor protocol for VXI-11 for TCP-based instruments specified by the IVI foundation. The protocol uses two TCP sockets for a single connection - one for fast data transfer, the other for non-sequential control commands (e.g. `Device Clear` or `SRQ`).

HiSLIP has the following characteristics:

- High performance as with raw socket network connections
- Compatible IEEE 488.2 support for Message Exchange Protocol, Device Clear, Serial Poll, Remote/Local, Trigger, and Service Request

- Uses a single IANA registered port (4880), which simplifies the configuration of firewalls
- Supports simultaneous access of multiple users by providing versatile locking mechanisms
- Usable for IPv6 or IPv4 networks



Using VXI-11, each operation is blocked until a VXI-11 device handshake returns. However, using HiSLIP, data is sent to the device using the "fire and forget" method with immediate return. Thus, a successful return of a VISA operation such as `viWrite()` does not guarantee that the instrument has finished or started the requested command, but is delivered to the TCP/IP buffers.

For more information see also the application note:

[1MA208: Fast Remote Instrument Control with HiSLIP](#)

8.5 Configuring the GPIB Interface

A GPIB interface is integrated on the rear panel of the instrument. You can set the GPIB address and the ID response string. The GPIB language is set as SCPI by default and cannot be changed for the R&S FSVA/FSV.

For details on the GPIB interface see [Chapter 3.2.1.7, "GPIB interface"](#), on page 28).

Displaying the GPIB submenu

1. Press the SETUP key.
2. Press the "General Setup" softkey.
3. Press the "GPIB" softkey.

The submenu for setting the parameters of the remote control interface is displayed.

Setting the GPIB address

- ▶ In the "GPIB" menu, press the "GPIB Address" softkey.

The edit dialog box for the GPIB address is displayed. The setting range is from 0 to 30. If SCPI is selected as the GPIB language, the default address is 20.

Remote command:

```
SYST:COMM:GPIB:ADDR 20
```

Setting the default ID response string

- ▶ In the "GPIB" menu, press the "ID String Factory" softkey to select the default response to the *IDN? command.

Setting a user-defined ID response string

- ▶ In the "GPIB" menu, press the "ID String User" softkey to enter a user-defined response to the *IDN? command. The maximum length of the output string is 36 characters.

8.6 Setting Up a Network (LAN) Connection

A LAN connection is the prerequisite for all network operations. The LAN connection settings can be configured directly in the Windows operating system, or with LXI (LAN eXtension for Instruments).

The R&S FSVA/FSV is equipped with a network interface and can be connected to an Ethernet LAN (local area network). Provided the network administrator has assigned you the appropriate rights and adapted the Windows firewall configuration, you can use the interface, for example:

- To transfer data between a controlling device and the test device, e.g. to run a remote control program.
See chapter "Remote Control" in the R&S FSVA/FSV user manual.
- To access or control the measurement from a remote computer using the "Remote Desktop" application (or a similar tool)
- To connect external network devices (e.g. printers)
- To transfer data from a remote computer and back, e.g. using network folders

This section describes how to configure the LAN interface. It includes the following topics:

- [Chapter 8.6.1, "Connecting the Instrument to the Network"](#), on page 166

- [Chapter 8.6.2, "Assigning the IP Address"](#), on page 167

Note that only user accounts with administrator rights can configure LAN networks.



LXI

The R&S FSVA/FSV supports the LXI core features. LXI gives you direct access to the LAN settings described below.

For further information on the LXI interface, refer to the "LXI Configuration".

8.6.1 Connecting the Instrument to the Network

There are two methods to establish a LAN connection to the instrument:

- A non-dedicated network (Ethernet) connection from the instrument to an existing network made with an ordinary RJ-45 network cable. The instrument is assigned an IP address and can coexist with a computer and with other hosts on the same network.
- A dedicated network connection (Point-to-point connection) between the instrument and a single computer made with a (crossover) RJ-45 network cable. The computer must be equipped with a network adapter and is directly connected to the instrument. The use of hubs, switches, or gateways is not required, however, data transfer is still performed using the TCP/IP protocol. You must assign an IP address to the instrument and the computer, see [Chapter 8.6.2, "Assigning the IP Address"](#), on page 167.

Note: As the R&S FSVA/FSV uses a 1 GBit LAN, a crossover cable is not necessary (due to Auto-MDI(X) functionality).

NOTICE**Risk of network failure**

Consult your network administrator before performing the following tasks:

- Connecting the instrument to the network
- Configuring the network
- Changing IP addresses
- Exchanging hardware

Errors can affect the entire network.

- ▶ To establish a non-dedicated network connection, connect a commercial RJ-45 cable to one of the LAN ports.
To establish a dedicated connection, connect a (crossover) RJ-45 cable between the instrument and a single PC.

If the instrument is connected to the LAN, Windows automatically detects the network connection and activates the required drivers.

The network card can be operated with a 1 GBit Ethernet IEEE 802.3u interface.

8.6.2 Assigning the IP Address

Depending on the network capacities, the TCP/IP address information for the instrument can be obtained in different ways.

- If the network supports dynamic TCP/IP configuration using the Dynamic Host Configuration Protocol (DHCP), all address information can be assigned automatically.
- If the network does not support DHCP, or if the instrument is set to use alternate TCP/IP configuration, the addresses must be set manually.

By default, the instrument is configured to use dynamic TCP/IP configuration and obtain all address information automatically. This means that it is safe to establish a physical connection to the LAN without any previous instrument configuration.

NOTICE**Risk of network errors**

Connection errors can affect the entire network. If your network does not support DHCP, or if you choose to disable dynamic TCP/IP configuration, you must assign valid address information before connecting the instrument to the LAN. Contact your network administrator to obtain a valid IP address.

Assigning the IP address on the instrument

1. Press the SETUP key.
2. Press the "General Setup" softkey.
3. Press the "Network Address" softkey.
The submenu is displayed.
4. Toggle the "DHCP On/Off" softkey to the required mode.
If DHCP is "Off", you must enter the IP address manually, as described in the following steps.
Note: When DHCP is changed from "On" to "Off", the previously set IP address and subnet mask are retrieved.
If DHCP is "On", the IP address of the DHCP server is obtained automatically. The configuration is saved, and you are prompted to restart the instrument. You can skip the remaining steps.
Note: When a DHCP server is used, a new IP address may be assigned each time the instrument is restarted. This address must first be determined on the instrument itself. Thus, when using a DHCP server, it is recommended that you use the permanent computer name, which determines the address via the DNS server (see [Chapter 8.6.3, "Using Computer Names"](#), on page 170).
5. Press the "IP Address" softkey and enter the IP address, for example *192.0.2.0*. The IP address consists of four number blocks separated by dots. Every block contains a maximum of 3 numbers.
6. Press the "Subnet Mask" softkey and enter the subnet mask, for example *255.255.255.0*. The subnet mask consists of four number blocks separated by dots. Every block contains a maximum of 3 numbers.
If you have entered an invalid IP address or subnet mask, the message "out of range" is displayed in the status line. The "Edit" dialog box remains open, and you can start again. If the settings are correct, the configuration is saved, and you are prompted to restart the instrument.

7. Confirm the displayed message ("Yes" button) to restart the instrument.

Using a DNS server to determine the IP address

If a DNS server is configured on the R&S FSVA/FSV, the server can determine the current IP address for the connection using the permanent computer name.

1. Obtain the name of your DNS domain and the IP addresses of the DNS and WINS servers on your network.
2. Press the "Windows" key on the external keyboard or the CTRL + ESC key combination on your keyboard to access the operating system.
3. Select "Start > Settings > Network & Internet > Ethernet > Network and Sharing Center > Connections: Ethernet".

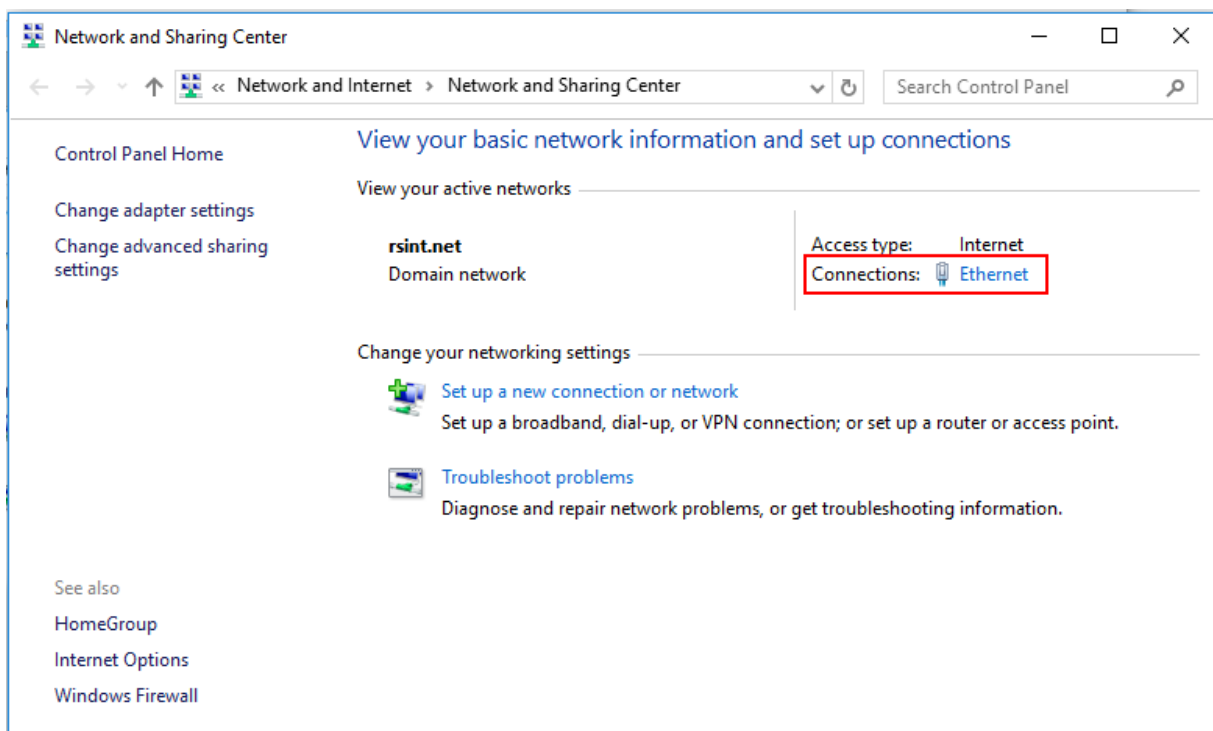

4. In the "Ethernet Status" dialog box, select the "Properties" button.
The items used by the LAN connection are displayed.

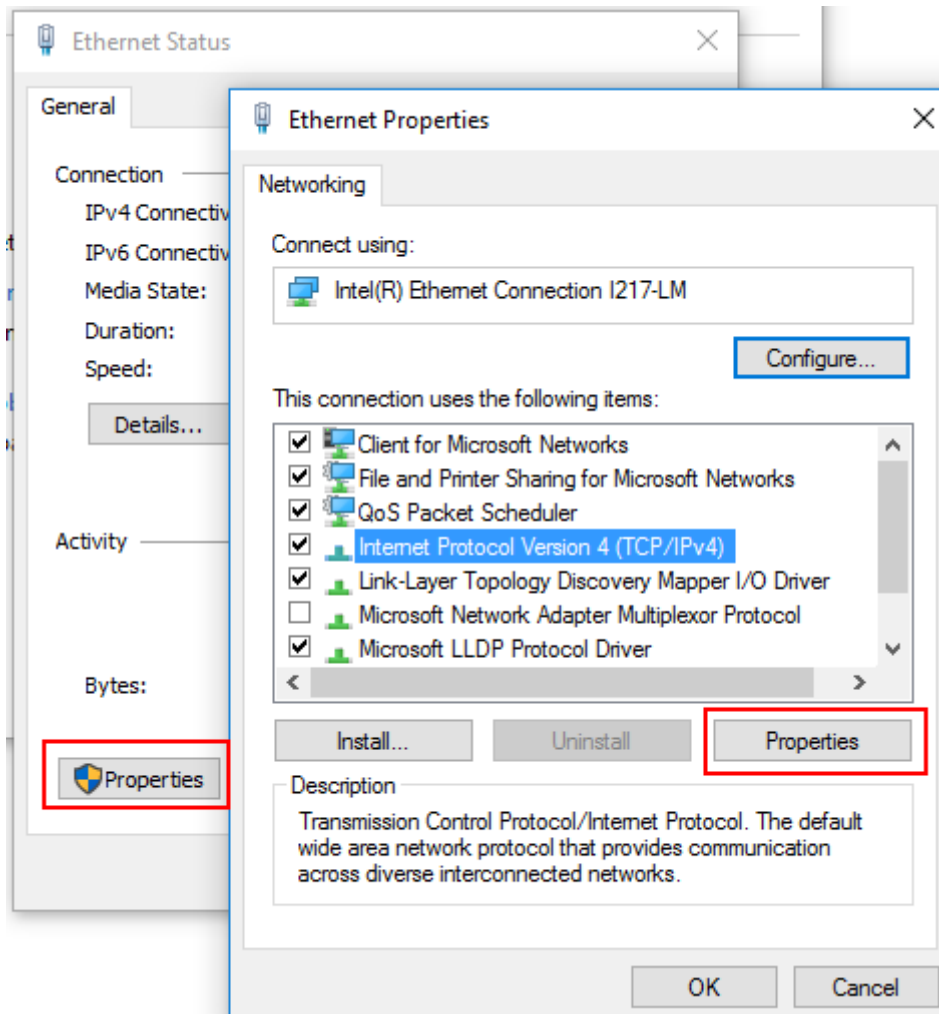

5. Tap the entry named "Internet Protocol Version 4 (TCP/IPv4)" to highlight it.
6. Select the "Properties" button.
7. On the "General" tab, select "Use the following DNS server addresses" and enter your own DNS addresses.

For more information, refer to the Windows operating system help.

8.6.3 Using Computer Names

In a LAN that uses a DNS server (Domain Name System server), each PC or instrument connected in the LAN can be accessed via an unambiguous computer name instead of the IP address. The DNS server translates the host name to the IP address. This is especially useful when a DHCP server is used, as a new IP address may be assigned each time the instrument is restarted.

Each instrument is delivered with an assigned computer name, but this name can be changed.

The default instrument name is a non-case-sensitive string with the following syntax:

<Type><variant>-<serial_number>

The serial number can be found on the rear panel of the instrument. It is the third part of the device ID printed on the bar code sticker:



For example, FSV4-123456

To change the computer name

1. Press the SETUP key and select "General setup" > "Computer name".
The current computer name is displayed here.
2. Enter the new computer name.
3. Confirm the entry.

8.6.4 Changing the Windows Firewall Settings

A firewall protects an instrument by preventing unauthorized users from gaining access to it through a network. Rohde & Schwarz highly recommends the use of the firewall on your instrument. Rohde & Schwarz instruments are shipped with the Windows firewall enabled and preconfigured in such a way that all ports and connections for remote control are enabled.

For more details on firewall configuration, see the following Rohde & Schwarz White Paper:

- [1EF96: Malware Protection Windows 10](#)

Note that changing firewall settings requires administrator rights.

8.7 How to Configure the LAN Using the LXI Web Browser Interface

The instrument's LXI browser interface works correctly with all W3C compliant browsers.

- In the web browser, open the `http://<instrument-hostname>` or `http://<instrument-ip-address>` page, e.g. `http://10.113.10.203`. The default password to change LAN configurations is *LxiWebIfc*. The "Instrument Home Page" (welcome page) opens.

The screenshot shows a web browser window titled "Instrument Home Page" with the address bar displaying `/web/html/ihp.php?mID=10`. The page features the Rohde & Schwarz logo and the LXI interface. A left-hand navigation menu includes sections for LXI (Home, Lan Configuration, Status, Utilities), Instrument Control (VNC Control), License Manager (Manage Licenses), and Help (Glossary, www.rohde-schwarz.com). The main content area is titled "Instrument Properties" and displays the following information:

Instrument Model	R&S FSV Spectrum Analyzer
Manufacturer	Rohde & Schwarz GmbH & Co. KG
Serial Number	[REDACTED]
Description	R&S FSV [REDACTED]
LXI Version	1.4 LXI Core 2011
LXI Extended Features	LXI HISLIP
DNS Host Name(s)	[REDACTED]
MAC Address	[REDACTED]
IP Address	[REDACTED]
Firmware Revision	3.20
Current Time	Friday, 2017/03/10, 12:08:01
Current Time source	Operating System
VISA resource string	TCPIP:: [REDACTED] :inst0::INSTR TCPIP:: [REDACTED] :hislip0::INSTR
Device Indicator	<input type="button" value="INACTIVE (press to toggle)"/>

How to Configure the LAN Using the LXI Web Browser Interface

The instrument home page displays the device information required by the LXI standard including the VISA resource string in read-only format.



- ▶ Press the "Device Indicator" button on the "Instrument Home Page" to activate or deactivate the LXI status icon on the status bar of the R&S FSVA/FSV. A green LXI status symbol indicates that a LAN connection has been established; a red symbol indicates an error, for example, that no LAN cable is connected. When a device is connecting to the instrument, the LXI logo blinks. The "Device Indicator" setting is not password-protected.

The most important control elements in the navigation pane of the browser interface are the following:

- "LAN Configuration" opens the menu with configuration pages.
- "Status" displays information about the LXI status of the instrument.
- "Help > Glossary" opens a document with a glossary of terms related to the LXI standard.

8.7.1 LAN Configuration

The LAN configuration consists of three parts:

- "IP configuration" provides all mandatory LAN parameters.
- "Advanced LAN Configuration" provides LAN settings that are not declared mandatory by the LXI standard.
- "Ping Client" provides the ping utility to verify the connection between the instrument and other devices.

8.7.1.1 IP Configuration

The "LAN Configuration > IP configuration" web page displays all mandatory LAN parameters and allows their modification.

The "TCP/IP Mode" configuration field controls how the IP address for the instrument gets assigned (see also [Chapter 8.6.2, "Assigning the IP Address"](#), on page 167).

For the manual configuration mode, the static IP address, subnet mask, and default gateway are used to configure the LAN. The automatic configuration

mode uses DHCP server or Dynamic Link Local Addressing (Automatic IP) to obtain the instrument IP address.



Changing the LAN configuration is password-protected. The default password is *LxiWebIfc* (notice upper and lower case characters).

8.7.1.2 Advanced LAN Configuration

The "LAN Configuration > Advanced LAN Configuration" parameters are used as follows:

- The "Negotiation" configuration field provides different Ethernet speed and duplex mode settings. In general, the "Auto Detect" mode is sufficient.
- "ICMP Ping" must be enabled to use the ping utility.
- "VXI-11" is the protocol that is used to detect the instrument in the LAN. According to the standard, LXI devices must use VXI-11 to provide a detection mechanism; other additional detection mechanisms are permitted.
- mDNS and DNS-SD are two additional protocols: Multicast DNS and DNS Service Discovery. They are used for device communication in zero configuration networks working without DNS and DHCP

8.7.1.3 Ping Client

Ping is a utility that verifies the connection between the LXI-compliant instrument and another device. The ping command uses the `ICMP` echo request and echo reply packets to determine whether the LAN connection is functional. Ping is useful for diagnosing IP network or router failures. The ping utility is not password-protected.

To initiate a ping between the LXI-compliant instrument and a second connected device:

1. Enable "ICMP Ping" on the "Advanced LAN Configuration" page (enabled after an LCI).
2. Enter the IP address of the second device **without the ping command and without any further parameters** into the "Destination Address" field (e.g. *10.113.10.203*).

3. Select "Submit".

8.8 Configuring the Network

After network support has been installed, data can be exchanged between the instrument and other computers, and network printers can be used.

Network operation is only possible if you are authorized to access network resources. Typical resources are file directories of other computers or even central printers. Authorization is assigned by the network or server administrator.

WARNING

Connection to networks

Before connecting the instrument to the network or configuring the network, consult your network administrator, particularly for large LAN installations. Errors may affect the entire network.

Never connect your analyzer to a network unprotected against virus infection because this may cause damage to the instrument software.

To integrate the instrument into your network, you can change the following system properties:

- Computer name
- Domain
- Workgroup

Operation on the network includes the following administrative tasks:

- [Operating the Instrument Without a Network](#)..... 175
- [Creating Users](#)..... 176
- [Changing the User Password](#)..... 176
- [Mapping Network Drives](#)..... 177
- [Sharing Directories \(only with Microsoft Networks\)](#)..... 179

8.8.1 Operating the Instrument Without a Network

To operate the instrument without a network connection either temporarily or permanently, no special measures are necessary. Windows automatically detects

the interruption of the network connection and does not set up the connection when the instrument is switched on.

If you are not prompted to enter the user name and password, see [Chapter 4.5.3.1, "Automatic Login Function"](#), on page 59.

8.8.2 Creating Users

After the software for the network has been installed, the instrument issues an error message the next time it is switched on because there is no user named "instrument" (= user ID for Windows automatic login) in the network. Thus, a matching user must be created in Windows and in the network, the password must be adapted to the network password, and the automatic login mechanism must then be deactivated.

The network administrator is responsible for creating new users in the network.

1. Press the "Windows" key on the external keyboard or the CTRL + ESC key combination on your keyboard to access the operating system.
2. Select "Start > Settings > Accounts > Other users".
3. Select "Add someone else to this PC".
4. In the "Microsoft account" dialog box, enter the new user name and password.
5. Select "OK".
6. Select "Finish".
The new user is created.

8.8.3 Changing the User Password

After the new user has been created on the instrument, the password must be adapted to the network password.

1. Press the "Windows" key on the external keyboard or the CTRL + ESC key combination on your keyboard to access the operating system.
2. Press CTRL + ALT + DELETE, then select "Change a password".
3. Enter the user account name.
4. Enter the old password.

5. Enter the new password in the upper text line and repeat it in the following line.
6. Press ENTER.
The new password is now active.



Logging on to the Network

At the same time you log on to the operating system, you are automatically logged on to the network (see [Chapter 4.5.3.1, "Automatic Login Function"](#), on page 59). As a prerequisite, the user name and the password must be identical under Windows and on the network.

8.8.4 Mapping Network Drives

1. Press the SAVE/ RCL key on the front panel of the R&S FSVA/FSV.
2. Press the "File Manager" softkey.
3. Press the "More" softkey.
4. Press the "Network Drive" softkey.
The "Map Network Drive" dialog box is displayed.

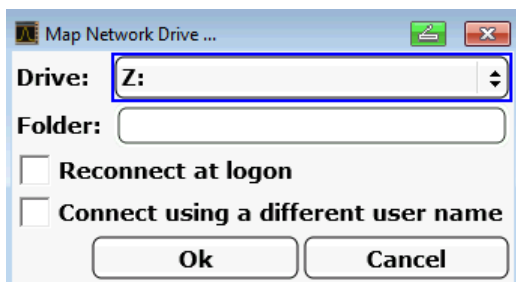

5. Press the "Drive" list to open the network drive list and select the drive you want to map.
Alternatively:
 - Press the "Map Network Drive" softkey to set the focus on the "Drive" list.
 - Press ENTER to open the network drive list and select the drive you want to map using the arrow keys.
6. To have the connection set up automatically each time the instrument is started, in the "Map Network Drive" dialog box, activate the "Reconnect at logon" option.

- To connect using a different user name, activate the "Connect using a different user name" option.

The "Map Network Drive" dialog box is extended by the "User name" and "Password" fields.

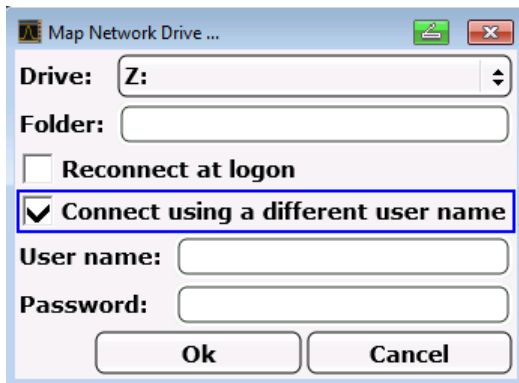

- Enter your user name and password.
- Confirm with "OK".
The drive is displayed in the Explorer.

Note: Only networks that you authorized to access are connected.

Disconnecting network drives

- Press the SAVE/ RCL key on the front panel of the R&S FSVA/FSV.
- Press the "File Manager" softkey.
- Press the "More" softkey.
- Press the "Network Drive" softkey.
- Press the "Disconnect Network Drive" softkey.
The "Disconnect Network Drive" dialog box is displayed.
- In the "Drive" list, select the drive you want to disconnect.
- Confirm with "OK".

8.8.5 Sharing Directories (only with Microsoft Networks)

Sharing directories makes data available for other users. This is only possible in Microsoft networks. Sharing is a property of a file or directory.

1. Press the "Windows" key on the external keyboard or the CTRL + ESC key combination on your keyboard to access the operating system.
2. Open the "Windows Explorer".
3. Select the desired folder with the right mouse button.
4. In the context menu, select "Share with > Specific people".
5. Select the users on your network you want to allow access to the directory to.
6. Select "Share" to confirm the settings.
7. Select "Done" to close the dialog box.
The drive is shared and can be accessed by the selected users.

Index

Symbols

75 Ω (enhancement label) 69

A

AC supply fuse 37

Administrator rights 62

Aligning

 Touchscreen 49

Alphanumeric parameters 84

AP (trace information) 69

Application cards 14

Application notes 14

AQT (hardware setting) 68

Arrow Keys 79

Att (hardware setting) 67

Automatic loading

 Settings 129

AUX PORT

 Connector 29

AV (trace information) 70

B

Brochures 13

C

CA (trace information) 70

Canceling entry 77

Channel 66

Channel bar

 Information 68

CLRWR (trace information) 70

CNT (marker functions) 70

Colors

 Screen 50

Compatible mode (hardware setting) 67

Computer name

 Changing 170

Concluding entry 77

Connector

 AC power supply 26

 AF output 22

 AUX PORT 29

 EXT TRIGGER / GATE IN 27

 External mixer 23

 GPIB interface 28

 IF/VIDEO 28

 LAN 27

 MONITOR (VGA) 27

 Noise source control 21

 OCXO 30

 Power Sensor 22

 Probe power 22

 REF IN 27

 REF OUT 28

 RF Input 50Ω 21

 Tracking generator 23

 TRIGGER OUTPUT 28

 Ultra high precision reference 30

 USB 21, 28

Connectors

 Front panel 21

D

Data sheets 13

Date

 Setting 48

DBW (hardware setting) 68

DC power supply

 Option B30 38

DHCP 167

DHCP server

 LAN configuration 170

Diagram area

 Enhancement labels 68

 Hardware settings 67

 Status display 71

 Trace information 69

Dialog boxes

 Working with 82

Dig Out (hardware setting) 68

Digital Baseband Interface (B17) 31

Display

 Enlarging 93

 maximized 89

 split 89

 Split screen 89

 Table 89

 Update Rate 97

DNS server

 LAN configuration 170

E

Edit dialog box 82

- Electrostatic discharge 33
- Enhancement labels 68
- Entry
 - Canceling 77
 - Concluding 77
- Error messages
 - see User Manual 72
- ESD 33
- EXREF (status display) 73
- Ext 72
- EXT TRIGGER
 - Connector 27
- External mixer
 - Connector 23
- F**
- Firmware
 - Options 63
 - Update 62
- Focus
 - Changing 89
- Frequency
 - Reference 47
- Frq (enhancement label) 69
- Full screen
 - see Display, maximized 89
- Fuse 37
- FXD (marker functions) 70
- G**
- GAT (enhancement label) 68
- GATE IN
 - Connector 27
- Getting started 12
- GPIB interface
 - Configuring 164
 - Connector 28
- H**
- Hardware settings
 - Display 67
- HiSLIP 162
 - Protocol 163
 - Resource string 162
- I**
- Icons
 - Toolbar 74
- IF/VIDEO
 - Connector 28
- IFOVL (status display) 73
- Interfaces
 - LAN 162
- IP address 162
 - Changing 167
- IP configuration
 - LXI 173
- K**
- Key
 - Alphanumeric 77
 - BACK 77
 - Decimal point 77
 - DNARROW 79
 - ENTER 77
 - ESC/CANCEL 77
 - GHz/dBm 77
 - HOME 80
 - Hz/-dB 77
 - kHz/dB 77
 - LEFTARROW 79
 - REDO 79
 - RIGHTARROW 79
 - Sign 77
 - UNDO 79
 - Unit 77
 - UPARROW 79
- Keyboard
 - On-screen 76
- Keys
 - SPLIT/MAXIMIZE key 89
- L**
- LAN
 - Configuration 165
 - Configuring 172
 - Connector 27
 - Interface 162
 - IP address 162
 - Remote control interface 161
 - VISA 162
 - VXI protocol 163
- Language
 - Changing 47
- Loading
 - Instrument configuration 128
 - Measurement data 128
- Login
 - Operating system 58
- LOUNL (status display) 73

- LXI
- Browser interface 172
 - LAN configuration 173
 - Ping 174
- M**
- MAXH (trace information) 70
- Measurement data
- Loading 128
 - Storing 128
- Measurement example
- AF of AM-modulated signal 114
 - AF of FM-modulated signal 123
 - AM modulation 112
 - First and second harmonic 104
 - Level and frequency 100
 - Power of burst signals 115
 - Separating signals 108
 - Signal frequency using frequency counter 103
 - Signal-to-noise ratio 120
- MI (trace information) 70
- MINH (trace information) 70
- Mini Front Panel 90
- MOD (marker functions) 70
- Mode (hardware setting) 67
- Modulation mode (hardware setting) 67
- MONITOR (VGA)
- Connector 27
- More
- Softkey 80
- Multiple signals measurement 108
- N**
- NCor (enhancement label) 69
- Network 175
- Changing user passwords 176
 - Connecting drives 177
 - Creating users 176
 - Disconnecting drives 177
 - Setting up 130
 - Sharing directories 179
- NOI (marker functions) 70
- Noise source control
- Connector 21
- Numeric parameters 83
- O**
- OCXO 42
- Connector 30
- Offset (hardware setting) 67
- On-screen keyboard 76
- Online help
- Working with 7
- Operating system 56
- Login 58
 - service packs 57
- Options
- Activating 63
 - B30 38
 - Licenses 63
- OVEN (status display) 73
- OVLN (status display) 72
- P**
- Pa (enhancement label) 68
- Parameters
- Entering 83, 84
- Passwords
- Changing 176
- PHN (marker functions) 70
- Ping 174
- PK (trace information) 69
- Power supply
- Connector 26
 - Switching on 42
- Printers
- Selecting 54
- Probe power
- Connector 22
- Protocol
- VXI 163
- Q**
- QP (trace information) 70
- R**
- RA (trace information) 70
- Rackmounting 36
- RBW (hardware setting) 67
- Ref (hardware setting) 67
- REF IN
- Connector 27
- REF OUT
- Connector 28
- Reference
- External 47
 - Internal 47

Reference frequency		
OCXO	30	
Ultra high precision (option B14)	30	
Release notes	14	
Remote control		
Command synchronization	146	
Configuration	130	
Deactivating the instrument	137	
Display power save	144	
Ending session	135	
Global variables	142	
Improving performance	97	
Initialization	142	
Instrument settings	145	
Interfaces	161	
Library	139	
Protocols	161	
Sending commands	144	
Setting up a connection	135	
Switching screen display on and off ..	143	
Using markers	145	
VNC	137	
Remote control programming example		
Changing default settings	147	
Printout	159	
Reading out trace data	155	
Storing and loading settings	157	
Using markers and delta markers	150	
Remote operation		
Setting up	130	
RM (trace information)	70	
Rotary knob	78	
S		
SA (trace information)	70	
Safety instructions	13	
Screen		
Colors	50	
Service manual	13	
Service packs	57	
Settings		
Automatic loading	129	
Loading	128	
Storing	127	
Sgl (enhancement label)	68	
Sinusoidal signal measurements	99	
Harmonics	104	
Soft Front Panel	90	
mini	90	
Softkey	79	
Softkeys		
Firmware Update	62	
More	80	
Up	80	
SPLIT/MAXIMIZE		
Key	89	
Stand-alone operation	175	
Status display	71	
Storing		
Instrument configuration	127	
Measurement data	128	
SWT (hardware setting)	67	
T		
Tdf (enhancement label)	68	
Themes		
Display	96	
Time		
Setting	48	
Toggle		
Span values	77	
TOI (marker functions)	70	
Toolbar		
Icon	74	
Toggle	74	
Touchscreen		
Aligning	49	
Display	20	
Trace information		
Detector type	69	
Trace number	69	
Traces		
Loading	128	
Storing	128	
Tracking generator		
Connector	23	
TRG (enhancement label)	68	
TRIGGER OUTPUT		
Connector	28	
TRK (marker functions)	70	
Troubleshooting		
see User Manual	72	
U		
Ultra high precision reference		
Connector	30	
UNCAL (status display)	72	
Up		
Softkey	80	

Update rate	
Display	97
Updates	62
USB	
Connector	28
User account	62
V	
VBW (hardware setting)	67
Virus protection	57
VISA	162
Resource string	162
VNC	137
VXI protocol	163
W	
Web browser	
Configuration interface	172
White papers	14
Windows 10	56
Access	60
Z	
Zero span measurements	115