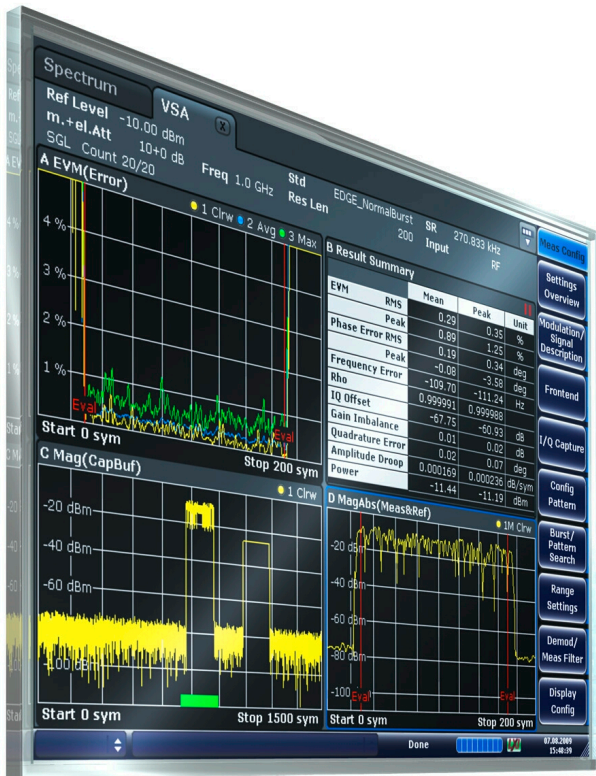


# R&S® FSV-K70

## Vector Signal Analysis

### Operating Manual



1176.7578.02 – 09

This manual describes the following R&S®FSV/FSVA options:

- R&S FSV-K70 (1310.8455.02)

This manual describes the following R&S FSVA/FSV models with firmware version 3.30 and higher:

- R&S®FSVA4 (1321.3008K05)
- R&S®FSVA7 (1321.3008K08)
- R&S®FSVA13 (1321.3008K14)
- R&S®FSVA30 (1321.3008K31)
- R&S®FSVA40 (1321.3008K41)
- R&S®FSV4 (1321.3008K04)
- R&S®FSV7 (1321.3008K07)
- R&S®FSV13 (1321.3008K13)
- R&S®FSV30 (1321.3008K30)
- R&S®FSV40 (1321.3008K39/1321.3008K40)

It also applies to the following R&S®FSV models. However, note the differences described in [Chapter 1.4, "Notes for Users of R&S FSV 1307.9002Kxx Models"](#), on page 9.

- R&S®FSV3 (1307.9002K03)
- R&S®FSV7 (1307.9002K07)
- R&S®FSV13 (1307.9002K13)
- R&S®FSV30 (1307.9002K30)
- R&S®FSV40 (1307.9002K39/1307.9002K40)

© 2017 Rohde & Schwarz GmbH & Co. KG  
Mühldorfstr. 15, 81671 München, Germany  
Phone: +49 89 41 29 - 0  
Fax: +49 89 41 29 12 164  
Email: [info@rohde-schwarz.com](mailto:info@rohde-schwarz.com)  
Internet: [www.rohde-schwarz.com](http://www.rohde-schwarz.com)

Subject to change – Data without tolerance limits is not binding.

R&S® is a registered trademark of Rohde & Schwarz GmbH & Co. KG.

Trade names are trademarks of their owners.

The following abbreviations are used throughout this manual: R&S®FSV/FSVA is abbreviated as R&S FSV/FSVA.

# Contents

<b>1</b>	<b>Preface</b> .....	<b>5</b>
1.1	Documentation Overview.....	5
1.2	Conventions Used in the Documentation.....	7
1.3	How to Use the Help System.....	8
1.4	Notes for Users of R&S FSV 1307.9002Kxx Models.....	9
<b>2</b>	<b>Brief Description of Vector Signal Analysis</b> .....	<b>10</b>
2.1	Block Diagram of Digital Signal Processing Hardware for I/Q Data.....	10
2.2	Filters and Bandwidths During Signal Processing.....	11
2.3	Symbol Mapping.....	21
2.4	Demodulation Overview.....	42
2.5	Signal Model, Estimation and Modulation Errors.....	50
<b>3</b>	<b>Instrument Functions for Vector Signal Analysis</b> .....	<b>67</b>
3.1	Measurement Result Display.....	69
3.2	Softkeys and Menu Overview for Vector Signal Analysis (R&S FSV-K70).....	107
3.3	Configuring VSA Measurements.....	141
3.4	Further Information.....	201
<b>4</b>	<b>Remote Control Commands - R&amp;S FSV-K70</b> .....	<b>204</b>
4.1	Notation.....	204
4.2	ABORt Subsystem.....	207
4.3	CALCulate subsystem.....	207
4.4	DISPlay subsystem.....	257
4.5	FORMat subsystem.....	267
4.6	INITiate Subsystem.....	268
4.7	INPut Subsystem.....	270
4.8	INSTrument Subsystem.....	277
4.9	MMEMory Subsystem.....	277
4.10	OUTPut Subsystem.....	280
4.11	SENSe subsystem.....	281
4.12	STATus:QUEStionable Subsystem.....	318
4.13	SYSTem Subsystem.....	325

4.14	TRACe subsystem.....	325
4.15	TRIGger subsystem.....	328
<b>5</b>	<b>Status Reporting System (Option R&amp;S FSV-K70).....</b>	<b>332</b>
5.1	STATus:QUESTionable Register.....	334
5.2	STATus:QUESTionable:SYNC<n> Register.....	335
5.3	STATus:QUESTionable:MODulation<n> Register.....	335
5.4	STATus:QUESTionable:MODulation<n>:EVM Register.....	336
5.5	STATus:QUESTionable:MODulation<n>:PHASe Register.....	336
5.6	STATus:QUESTionable:MODulation<n>:MAGnitude Register.....	337
5.7	STATus:QUESTionable:MODulation<n>:CFRequency Register.....	337
5.8	STATus:QUESTionable:MODulation<n>:IQRHO Register.....	337
5.9	STATus:QUESTionable:MODulation<n>:FSK Register.....	338
<b>6</b>	<b>Support.....</b>	<b>339</b>
6.1	Explanation of Error Messages.....	339
6.2	Flow Chart for Troubleshooting.....	348
6.3	Frequently Asked Questions.....	350
	<b>Annex.....</b>	<b>359</b>
<b>A</b>	<b>Formulae and Abbreviations.....</b>	<b>359</b>
A.1	Formulae.....	359
A.2	Abbreviations.....	373
<b>B</b>	<b>Predefined Standards and Settings.....</b>	<b>375</b>
	<b>List of Commands.....</b>	<b>381</b>
	<b>Index.....</b>	<b>388</b>

# 1 Preface

When equipped with application firmware R&S FSV-K70, the analyzer performs vector measurements on digitally modulated signals in the time domain. Based on the vector measurements, further evaluations, e.g. statistical evaluations, can be performed.

This document contains all information required for operation of an R&S FSVA/FSV equipped with Application Firmware R&S FSV-K70. It describes the menus and remote-control commands for vector signal analysis, as well as some common measurements.

## 1.1 Documentation Overview

This section provides an overview of the R&S FSVA/FSV user documentation. Unless specified otherwise, you find the documents on the R&S FSVA/FSV product page at: [www.rohde-schwarz.com/manual/FSVA](http://www.rohde-schwarz.com/manual/FSVA)

### 1.1.1 Quick Start Guide

Introduces the R&S FSVA/FSV and describes how to set up and start working with the product. Includes basic operations, typical measurement examples, and general information, e.g. safety instructions, etc. A printed version is delivered with the instrument. A PDF version is available for download on the Internet.

### 1.1.2 Operating Manuals and Help

Separate operating manuals are provided for the base unit and the software options:

- Base unit manual  
Contains the description of all instrument modes and functions. It also provides an introduction to remote control, a complete description of the remote control commands with programming examples, and information on maintenance, instrument interfaces and error messages. Includes the contents of the getting started manual.
- Software option manual  
Contains the description of the specific functions of an option. Basic information on operating the R&S FSVA/FSV is not included.

The contents of the operating manuals are available as help in the R&S FSVA/FSV. The help offers quick, context-sensitive access to the complete information for the base unit and the software options.

All operating manuals are also available for download or for immediate display on the Internet.

### 1.1.3 Service Manual

Describes the performance test for checking the rated specifications, module replacement and repair, firmware update, troubleshooting and fault elimination, and contains mechanical drawings and spare part lists.

The service manual is available for registered users on the global Rohde & Schwarz information system (GLORIS, <https://gloris.rohde-schwarz.com>).

### 1.1.4 Instrument Security Procedures

Deals with security issues when working with the R&S FSVA/FSV in secure areas. It is available for download on the Internet.

### 1.1.5 Basic Safety Instructions

Contains safety instructions, operating conditions and further important information. The printed document is delivered with the instrument.

### 1.1.6 Data Sheets and Brochures

The data sheet contains the technical specifications of the R&S FSVA/FSV. It also lists the options and their order numbers as well as optional accessories.

The brochure provides an overview of the instrument and deals with the specific characteristics.

See [www.rohde-schwarz.com/brochure-datasheet/FSV](http://www.rohde-schwarz.com/brochure-datasheet/FSV)

### 1.1.7 Release Notes and Open Source Acknowledgment (OSA)

The release notes list new features, improvements and known issues of the current firmware version, and describe the firmware installation.

The open source acknowledgment document provides verbatim license texts of the used open source software.

See [www.rohde-schwarz.com/firmware/FSV](http://www.rohde-schwarz.com/firmware/FSV)

### 1.1.8 Application Notes, Application Cards, White Papers, etc.

These documents deal with special applications or background information on particular topics.

See [www.rohde-schwarz.com/application/FSV](http://www.rohde-schwarz.com/application/FSV)

## 1.2 Conventions Used in the Documentation

### 1.2.1 Typographical Conventions

The following text markers are used throughout this documentation:

Convention	Description
"Graphical user interface elements"	All names of graphical user interface elements on the screen, such as dialog boxes, menus, options, buttons, and softkeys are enclosed by quotation marks.
KEYS	Key names are written in capital letters.
File names, commands, program code	File names, commands, coding samples and screen output are distinguished by their font.
<i>Input</i>	Input to be entered by the user is displayed in italics.
<a href="#">Links</a>	Links that you can click are displayed in blue font.
"References"	References to other parts of the documentation are enclosed by quotation marks.

### 1.2.2 Conventions for Procedure Descriptions

When operating the instrument, several alternative methods may be available to perform the same task. In this case, the procedure using the touchscreen is described. Any elements that can be activated by touching can also be clicked using an additionally connected mouse. The alternative procedure using the keys on the instrument or the on-screen keyboard is only described if it deviates from the standard operating procedures.

The term "select" may refer to any of the described methods, i.e. using a finger on the touchscreen, a mouse pointer in the display, or a key on the instrument or on a keyboard.

### 1.2.3 Notes on Screenshots

When describing the functions of the product, we use sample screenshots. These screenshots are meant to illustrate as much as possible of the provided functions and possible interdependencies between parameters. The shown values may not represent realistic usage scenarios.

The screenshots usually show a fully equipped product, that is: with all options installed. Thus, some functions shown in the screenshots may not be available in your particular product configuration.

## 1.3 How to Use the Help System

### Calling context-sensitive and general help

- ▶ To display the general help dialog box, press the HELP key on the front panel.  
The help dialog box "View" tab is displayed. A topic containing information about the current menu or the currently opened dialog box and its function is displayed.



For standard Windows dialog boxes (e.g. File Properties, Print dialog etc.), no context-sensitive help is available.

---

- ▶ If the help is already displayed, press the softkey for which you want to display help.  
A topic containing information about the softkey and its function is displayed.



If a softkey opens a submenu and you press the softkey a second time, the submenu of the softkey is displayed.

---

### Contents of the help dialog box

The help dialog box contains four tabs:

- "Contents" - contains a table of help contents
- "View" - contains a specific help topic
- "Index" - contains index entries to search for help topics
- "Zoom" - contains zoom functions for the help display

To change between these tabs, press the tab on the touchscreen.

### Navigating in the table of contents

- To move through the displayed contents entries, use the UP ARROW and DOWN ARROW keys. Entries that contain further entries are marked with a plus sign.
- To display a help topic, press the ENTER key. The "View" tab with the corresponding help topic is displayed.
- To change to the next tab, press the tab on the touchscreen.

### Navigating in the help topics

- To scroll through a page, use the rotary knob or the UP ARROW and DOWN ARROW keys.
- To jump to the linked topic, press the link text on the touchscreen.

### Searching for a topic

1. Change to the "Index" tab.



2. Enter the first characters of the topic you are interested in. The entries starting with these characters are displayed.
3. Change the focus by pressing the ENTER key.
4. Select the suitable keyword by using the UP ARROW or DOWN ARROW keys or the rotary knob.
5. Press the ENTER key to display the help topic.

The "View" tab with the corresponding help topic is displayed.

### Changing the zoom

1. Change to the "Zoom" tab.
2. Set the zoom using the rotary knob. Four settings are available: 1-4. The smallest size is selected by number 1, the largest size is selected by number 4.

### Closing the help window

- ▶ Press the ESC key or a function key on the front panel.

## 1.4 Notes for Users of R&S FSV 1307.9002Kxx Models

Users of R&S FSV 1307.9002Kxx models should consider the following differences to the description of the newer R&S FSVA/FSV 1321.3008Kxx models:

- Functions that are based on the Windows 10 operating system (e.g. printing or setting up networks) may have a slightly different appearance or require different settings on the Windows XP based models. For such functions, refer to the Windows documentation or the documentation originally provided with the R&S FSV instrument.
- The R&S FSV 1307.9002K03 model is restricted to a maximum frequency of 3 GHz, whereas the R&S FSVA/FSV1321.3008K04 model has a maximum frequency of 4 GHz.
- The bandwidth extension option R&S FSV-B160 (1311.2015.xx) is not available for the R&S FSV 1307.9002Kxx models. The maximum usable I/Q analysis bandwidth for these models is 28 MHz, or with option R&S FSV-B70, 40 MHz.

## 2 Brief Description of Vector Signal Analysis

The "Vector Signal Analysis" software option R&S FSV-K70 performs vector and scalar measurements on digitally modulated single-carrier signals. To perform the measurements it converts RF signals into the complex baseband. It can also use the optional Digital Baseband interface (R&S FSV-B17 option) to analyze I/Q signals already delivered to the complex baseband.

For details on the Digital Baseband interface (R&S FSV-B17 option), see the base unit description.

The following sections describe the digital signal processing hardware, the interplay of analog and digital filters for bandwidth limiting, modulation and demodulation filters, as well as the algorithms used by the measurement demodulator. The implemented modulation modes and the associated predefined symbol mappings are also listed.

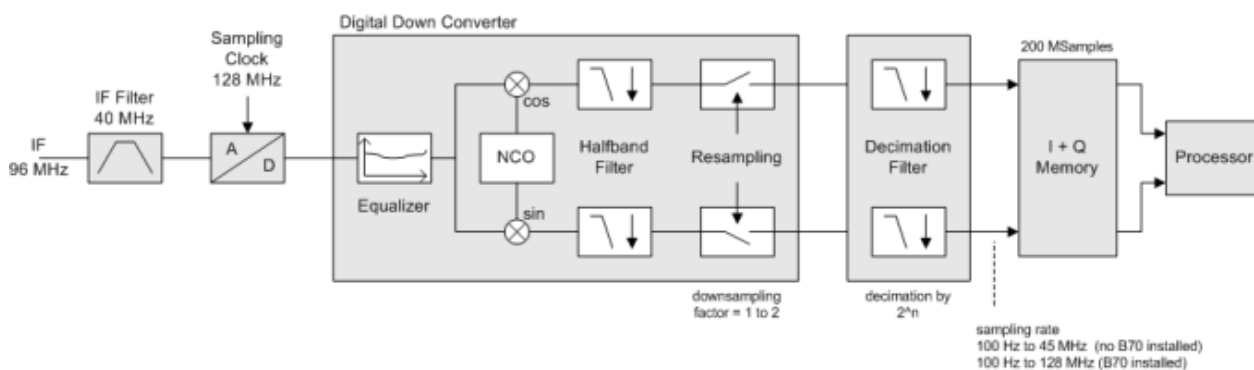
The last part of this chapter deals with vector and scalar modulation errors.

### 2.1 Block Diagram of Digital Signal Processing Hardware for I/Q Data

The following sections describe the digital hardware used to capture I/Q data for vector signal analysis with the R&S FSV-K70.

#### 2.1.1 Block Diagram for RF Input

The following block diagram provides an overview on how RF input is processed in the R&S FSV-K70 option.



**Figure 2-1: Block diagram of digital hardware for RF input in vector signal analysis**

After having passed several RF, IF and filter stages, the RF input signal is converted to an IF of 96 MHz and applied to an A/D converter with a sample frequency of exactly 128 MHz.

The digitized signal is then routed through two ICs for resampling (conversion of sample rate by a real factor) and for filtering and decimation (reduction of sample rate by

an integral factor). An **equalizer filter** before the **resampler** compensates for the frequency response of the analyzer's analog filter stages which would otherwise add to the modulation errors.

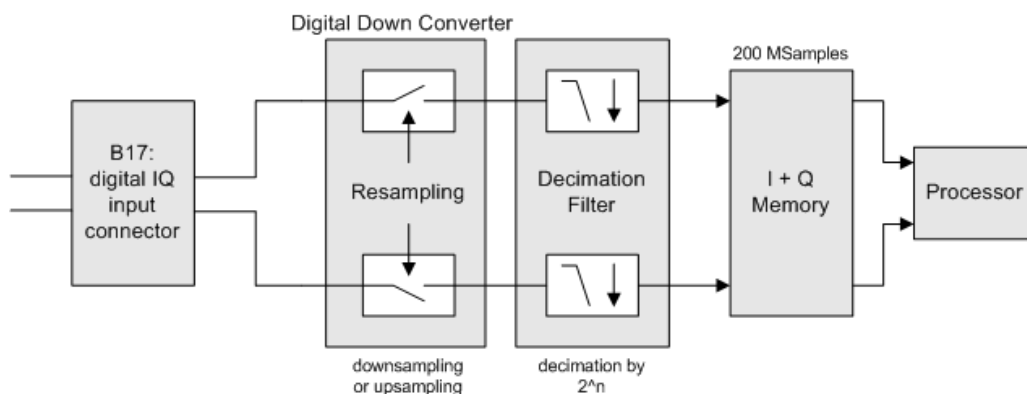
During operation, the filters and decimation factors of the instrument are set so that a sample frequency is obtained at the output of the **decimation** stage, which exactly corresponds to the following equation:

Sample rate = Symbol rate \* Capture Oversampling (see "[Capture Oversampling](#)" on page 154)

The complex output signal of the **decimation** stage is stored in the I/Q memory (**record buffer**) and forwarded to a signal processor (DSP) for further processing.

### 2.1.2 Block Diagram for Digital Baseband Input

The following block diagram provides an overview on how digital baseband input is processed in the R&S FSV-K70 option. The digital baseband input requires option R&S FSV-B17.



**Figure 2-2: Block diagram of digital hardware for digital baseband input (B17) in vector signal analysis**

The digital I/Q data stream is fed into the analyzer via the connector of the digital baseband interface (R&S FSV-B17 option). There is no need to equalize any IF filter or mix the signal into the complex baseband. The digital hardware just has to ensure that the final I/Q data stored in the record buffer has the correct sample rate; therefore, the signal is resampled and filtered.

## 2.2 Filters and Bandwidths During Signal Processing

This section describes the used filters in vector signal analysis with an R&S FSVA/FSV, as well as the bandwidth after each filter.

The relevant filters for vector signal analysis are shown in [Figure 2-3](#).

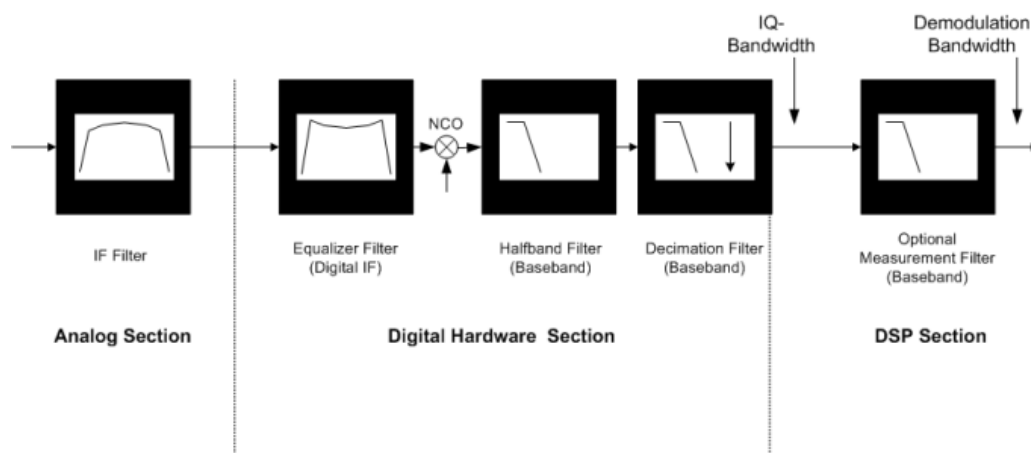


Figure 2-3: Block diagram of bandwidth-relevant filters for vector signal analysis

- After the IF Filter (only for RF input operation): bandwidth = 40 MHz.
- After the digital hardware section:  
The phase and amplitude distortions of the IF filter have been compensated for. Usually, the I/Q data has a usable bandwidth of about:  
 $0.8 * \text{sample rate} = 0.8 * \text{symbol rate} * \text{"Capture Oversampling"}$   
For details refer to [Chapter 2.2.1, "I/Q Bandwidth"](#), on page 13.  
The I/Q data's sample rate and bandwidth automatically scale themselves with the set symbol rate. For most modulated signals even the smallest allowed value for "Capture Oversampling" leads to a sufficient I/Q data bandwidth. The whole spectrum of the input signal is captured, but most adjacent channels and interferers are effectively suppressed. Only for very wide signals (FSK, no TX-filter used) it can be necessary to try higher values for "Capture Oversampling" (see ["Capture Oversampling"](#) on page 154), increasing the I/Q bandwidth. The I/Q data delivered to the DSP section has no considerable amplitude or phase distortion and a suitable bandwidth.



The "I/Q Capture" dialog of the vector signal analysis shows the sample rate and the usable I/Q bandwidth achieved for the current settings (see ["I/Q Capture"](#) on page 152).

- After the optional measurement filter:  
The measurement signal and the reference signal can be filtered by various measurement filters which have different bandwidths.

The filters described above are the ones that directly affect the bandwidth of the captured I/Q data and the final measurement signal and reference signal. Note, however, that several other filters are also involved in the DSP section but are not mentioned above:

- Receive filter to prevent ISI (intersymbol-interference)
- filters necessary for various estimators
- others

### 2.2.1 I/Q Bandwidth

The bandwidth of the I/Q data used as input for the vector signal analysis is filtered as described in [Chapter 2.2, "Filters and Bandwidths During Signal Processing"](#), on page 11. Its flat, usable bandwidth (no considerable amplitude or phase distortion) depends on:

- the used sample rate, which depends on the
  - defined "Symbol Rate" (see ["Symbol Rate"](#) on page 145)
  - defined "Capture Oversampling" (see ["Capture Oversampling"](#) on page 154)
- the type of input used (digital baseband input, RF input, etc)

The sample rate of the I/Q input data is:

Sample rate = Symbol rate \* Capture Oversampling

**Table 2-1: Value range for sample rate and symbol rate**

Model/option	Max. sample rate	Min. symbol rate	Max. symbol rate (= max. sample rate / capt. oversampling)
R&S FSVA/FSV without bandwidth extension option	45 MHz	25 Hz	11 MHz
with bandwidth extension option R&S FSV-B70/ R&S FSVA-B40	128 MHz	25 Hz	32 MHz
R&S FSVA/FSV with (active) bandwidth extension option B160	1.28 GHz	25 Hz	restricted to 160 MHz
1307.9002K39	12.5 MHz	25 Hz	3.125 MHz

Using this sample rate, the resulting I/Q data bandwidth can be determined from the figure "Relation between maximum usable bandwidth and sample rate (RF input)" in the base unit description (section "Working with I/Q data") for RF input operation or the figure "Bandwidths depending on sample rate for active digital input" in the description of the Digital Baseband interface (R&S FSV option B17).



The sample rate and the usable I/Q bandwidth achieved for the current settings is displayed in the "I/Q Capture Settings" dialog, see ["I/Q Capture"](#) on page 152.

### 2.2.2 Bandwidth Extension Option R&S FSV-B160

The bandwidth extension option R&S FSV-B160 provides additional hardware, which makes a maximum usable I/Q bandwidth of 160 MHz possible. As opposed to the R&S FSVA/FSV base unit, the R&S FSV-K70 application uses a software resampler which allows for a maximum sample rate up to 1.28 GHz.

Usage of the optional hardware can be deactivated, if necessary, for example to reduce possible spurious effects.

### 2.2.2.1 Restrictions

The optional bandwidth extension R&S FSV-B160 can not be activated if any of the following conditions apply:

- R&S FSV firmware versions previous to 2.0
- R&S FSV models 1307.9002Kx
- For R&S FSV models 1321.3008K13/30/39/40: For center frequencies larger than 7 GHz
- For sample rates < 32 MHz
- With any trigger except for an external trigger

### 2.2.3 Demodulation Bandwidth (Measurement Bandwidth)

Some modulation systems do not use a receive filter. In these cases special care should be taken that no interference or adjacent channels occur within the demodulation bandwidth. The "Capture Oversampling" parameter should be set to a low value (see "[Capture Oversampling](#)" on page 154).



Typical communication systems demand special receive or measurement filters (e.g. root-raised cosine receive filter or EDGE measurement filter).

If no such filtering is performed, care should be taken that neither interfering signals nor adjacent channels fall within the demodulation bandwidth.

### 2.2.4 Modulation and Demodulation Filters

Sample points are required for demodulation in the analyzer, where only information of the current symbol and none of neighbouring symbols is present (symbol points). These points are also called ISI-free points (ISI = intersymbol interference). If the transmitter does not provide an ISI-free signal after the transmit filter (**TX filter**), this condition can be fulfilled by signal-specific filtering of the analyzer input signal (**receive filter** or **Rx filter**). If an RRC (root-raised cosine) filter is used in the transmitter, an RRC filter is also required in the analyzer to obtain ISI-free points.

In many PSK systems, RRC filters are used as transmit, ISI and measurement filters. To determine the I/Q modulation error, the measurement signal must be compared with the corresponding ideal signal. For this purpose a **reference filter** is required which is calculated by the analyzer by convolving the coefficient of the transmit filter (**Tx filter**) and the **meas filter** (see [Figure 2-4](#)).

If unfiltered signals have to be measured as well (e.g. to determine nonlinear signal distortions), no measurement filter is switched into the signal path and the **reference filter** is identical to the **Transmit filter** (see [Figure 2-4](#)).

In the baseband block diagrams (see [Figure 2-4](#)), the system-theoretical transmitter and analyzer filters are shown for PSK and QAM demodulation. For the sake of clearness, RF stages, IF filters and the filter stages of the **digital hardware section** are not shown.

For a correct demodulation, the following filters have to be accurately specified for the analyzer:

- Transmit filter: filter characteristic of transmitter
- Meas filter:
  - PSK, QAM, UserQAM, MSK:  
The I and the Q part of the measurement and the reference signal are filtered with this filter.
  - FSK:  
The instantaneous frequency of the measurement reference signal are filtered.

In many applications, this filter is identical with the ISI filter.

The receive filter (ISI filter) is configured internally depending on the Transmit filter. The goal is to produce intersymbol-interference-free points for the demodulation.

The reference filter synthesizes the ideal transmitted signal (after meas filtering). It is calculated by the analyzer from the above filters (convolution operation **Transmit filter \* Meas Filter**).

**Table 2-2: Typical combinations of Tx and Meas filters**

Transmit filter	Measurement filter (analyzer)	Remarks
RC (raised cosine)	-	filter combination without intersymbol interference (ISI)
RRC (root raised cosine)	RRC	filter combination without ISI
GMSK	-	filter combination with low ISI
Linearized GMSK	EDGE NSR	standard specific filter; filter combination with ISI
Gauss	-	filter combination with low ISI
Rectangular	-	filter combination without ISI
Half Sine	-	filter combination without ISI
CDMA2000 1X FORWARD	Low ISI Meas Filter	filter combination without ISI
CDMA2000 1X REVERSE	Low ISI Meas Filter	filter combination without ISI
APCO25 C4FM	Rectangular	filter combination without ISI
APCO25 H-CPM	Rectangular	filter combination without ISI
APCO25 H-DQPSK	Low ISI Meas Filter	filter combination without ISI
APCO25 H-D8PSK Narrow	Low ISI Meas Filter	filter combination without ISI
APCO25 H-D8PSK Wide	Low ISI Meas Filter	filter combination without ISI
EDGE Narrow Pulse Shape	EDGE HSR (Narrow Pulse)	standard specific filter; filter combination with ISI

Transmit filter	Measurement filter (analyzer)	Remarks
EDGE Wide Pulse Shape	EDGE HSR (Wide Pulse)	standard specific filter; filter combination with ISI
User	Low ISI Meas Filter	filter combination with low ISI

Typical combinations of Tx and Meas filters are shown in the table above; they can be set in the R&S FSVA/FSV using "Meas filter = AUTO" (see "Auto" on page 175). If RC (raised cosine), RRC (root-raised cosine) and Gaussian filters are used, the Alpha (RC, RRC filters) or BT (Gaussian filters) parameters must be set in addition to the filter characteristic (roll-off factor). Typically the Alpha/BT value of the measurement filter should be the same as that of the transmission filter.

For FSK, the measurement filter filters the instantaneous frequency of the signal, not the I/Q signal.

For MSK, the measurement filter filters the I and Q parts of the measurement signal and the reference signal (i.e. not the instantaneous frequency or magnitude of the MSK signal).

## 2.2.5 Transmit filters

The transmit filters required for common standards are provided by the R&S FSV-K70.

**Table 2-3: Overview of predefined Transmit filters**

RC	Raised cosine
RRC	Root raised cosine
Gauss	Gauss filter
GMSK	Gauss filter convolved with a rectangular filter; typically used for MSK
Linearized GMSK	Standard-specific filter for GSM EDGE (3GPP TS 45.004), normal symbol rate
EDGE Narrow Pulse Shape	Standard-specific filter for GSM EDGE (higher symbol rate)
EDGE Wide Pulse Shape	Standard-specific filter for GSM EDGE (higher symbol rate)
Half Sine	Half Sine filter
APCO25 C4FM	Filter for the APCO25 C4FM standard.
APCO25 H-CPM	Filter for the APCO25 Phase 2 standard.
APCO25 H-DQPSK	Filter for the APCO25 Phase 2 standard.
APCO25 H-D8PSK Narrow	Filter for the APCO25 Phase 2 standard.
APCO25 H-D8PSK Wide	Filter for the APCO25 Phase 2 standard.
CDMA2000 1X Forward	Filter for CDMA ONE forward link (TIA/EIA/IS-95-A May 1995) and CDMA2000 1X forward link ( <a href="http://www.3gpp2.org/Public_html/specs/C.S0002-C_v1.0.pdf">http://www.3gpp2.org/Public_html/specs/C.S0002-C_v1.0.pdf</a> 28/05/2002)



CDMA2000 1X Reverse	Filter for CDMA ONE forward link (TIA/EIA/IS-95-A May 1995) and CDMA2000 1X reverse link ( <a href="http://www.3gpp2.org/Public_html/specs/C.S0002-C_v1.0.pdf">http://www.3gpp2.org/Public_html/specs/C.S0002-C_v1.0.pdf</a> 28/05/2002)
Rectangular	Rectangular filter in the time domain with a length of 1 symbol period
None	No filter is used.
USER	User-defined filter. Define the filter using the <code>[SENSe:]DDEMod:TFILter:USER</code> command.

### 2.2.6 Measurement Filters

The measurement filter can be used to filter the following two signals in the same way:

- the measurement signal (after coarse frequency, phase and timing synchronization have been achieved)
- the reference signal, i.e the I/Q symbols that have been determined in the demodulator and have already been filtered with the Transmit filter;

For MSK, PSK, QAM and User QAM the measurement filter filters the real part and imaginary part of these signals. For FSK, the measurement filter filters the instantaneous frequency of these signals.

The R&S FSV-K70 defines the error signal as the difference between the reference signal and the measurement signal. Thus, the measurement filter also shapes the spectrum of the error signal, which is used to calculate the EVM, for example.

In many applications the measurement filter is the same as the RX filter. However, unlike the measurement filter, the RX filter is not relevant for the measurement, but is only required to create the reference signal optimally.

The RX filter and the Transmit filter are usually chosen such that their combination results in an Inter-Symbol Interference (ISI) free system (see [Figure 2-4](#) and [Figure 2-5](#)).

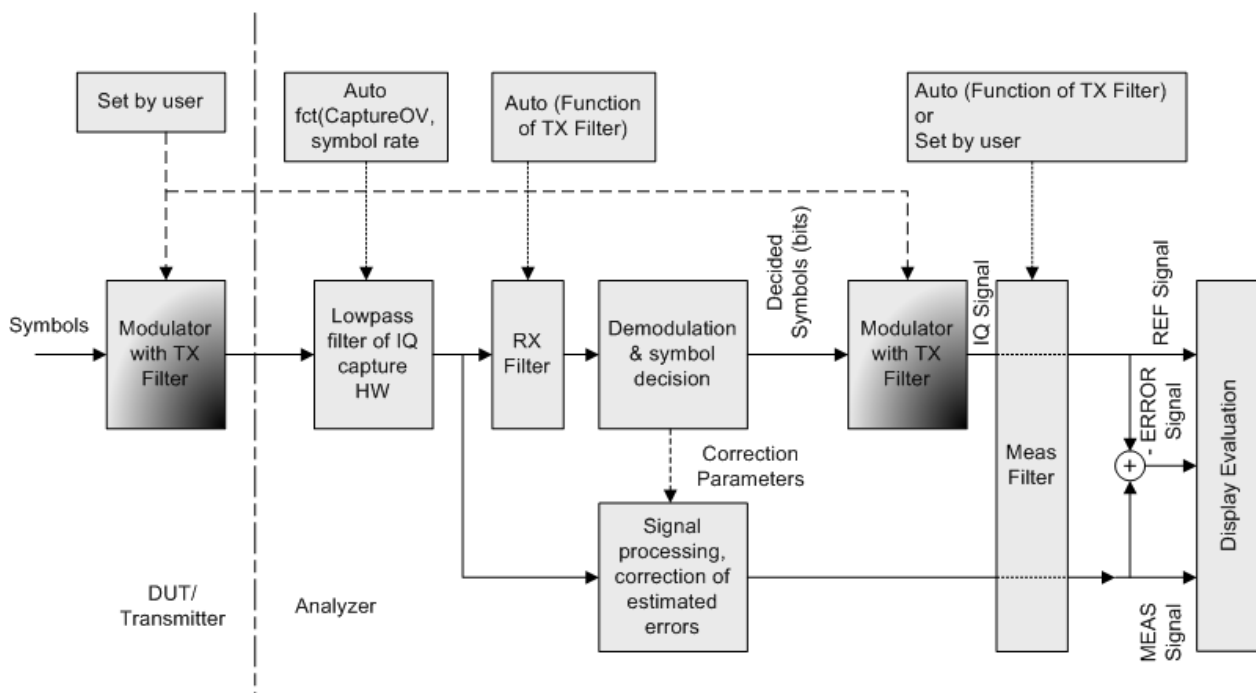


Figure 2-4: Measurement filter in the block diagram (MSK, PSK, QAM and UserQAM)

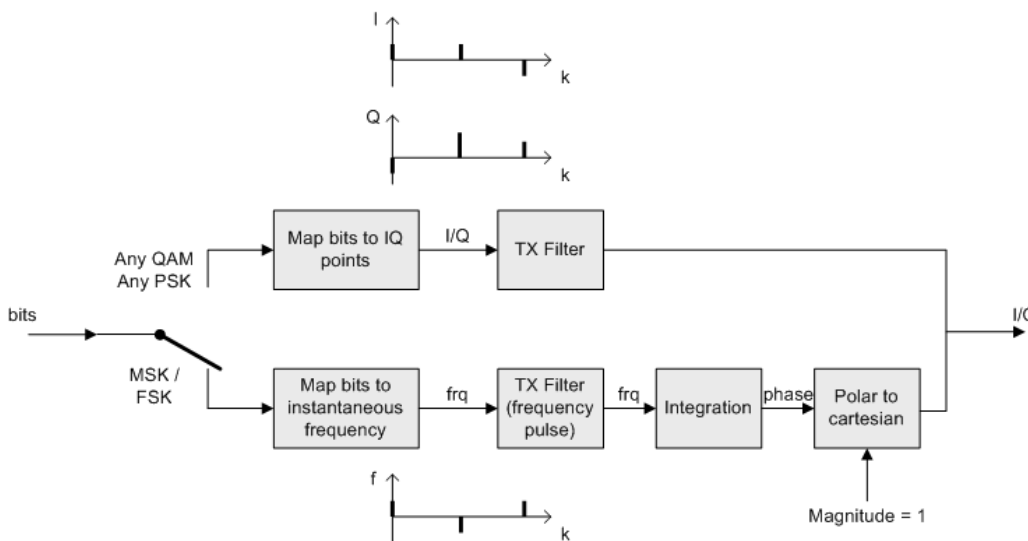


Figure 2-5: Modulator with Transmit filter in detail

As the measurement filters of the R&S FSV-K70 have low-pass characteristics, they suppress high frequency distortion components in the Meas/Ref/Error signal. The errors are weighted spectrally. Thus, turning off the measurement filter can have an influence on the numeric and graphical error values. However, the measurement filter should be switched off if non-linear distortions have to be measured (they usually produce high frequency components).

### Predefined measurement filters

The most frequently required measurement filters are provided by the R&S FSV-K70.

**Table 2-4: Overview of predefined measurement filters**

EDGE NSR	Measurement filter required for the "EDGE, Normal Symbol Rate" standard. (see 3GPP TS 45.005, chapter 4.6 Modulation Accuracy). The resulting system is NOT inter-symbol interference free.
EDGE HSR (Narrow Pulse)	Measurement filter required for the "EDGE, High Symbol Rate, Narrow Pulse" standard.
EDGE HSR (Wide Pulse)	Measurement filter required for the "EDGE, High Symbol Rate, Wide Pulse" standard.
Gauss	Classic Gauss filter with an adjustable BT
Low ISI Meas Filter	Measurement filter implemented to retain a low intersymbol interference. Best suited for eye diagrams or I/Q vector diagrams. Not necessarily suited for EVM evaluation due to amplification in the pass band.
Low Pass (Narrow)	Pass band up to $F_{\text{symbol}}/2$ Stop band starts at $F_{\text{symbol}}$ (-40dB)
Low Pass (Wide)	Pass band up to $F_{\text{symbol}}$ Stop band starts at $1.5 \cdot F_{\text{symbol}}$ (-40dB)
Rectangular	Rectangular filter in the time domain with a length of 1 symbol period; integrate and dump effect
RRC	Root Raised Cosine Filter. The roll-off parameter "Alpha" is set according to the Transmit filter if the "Auto (according to Transmit filter)" option is enabled (see "Auto" on page 175). Otherwise it must be set manually.  If the Transmit filter is also a Root Raised Cosine filter with the same roll-off parameter, the resulting system is inter-symbol interference free.
USER	User-defined filter.  Define the filter using the "Load User Filter" on page 175 function or the <code>[SENSe:]DDEMod:MFILter:USER</code> command.  For details see <a href="#">Chapter 2.2.7, "Customized Filters"</a> , on page 19.
NONE	No measurement filter is used.

The frequency response of the available standard-specific measurement filters is shown in [Chapter A.1.6.2, "Measurement Filter"](#), on page 367.

## 2.2.7 Customized Filters

The analytical filter types RC (raised cosine), RRC (root-raised cosine) and GAUSSIAN as well as the most important standard-specific filters are already integrated in the R&S FSV-K70. In addition, it is possible to use user-defined measurement and Transmit filters. Customized filters may be useful for the following purposes:

- Development of new networks and modulation methods for which no filters are defined yet.
- Measurements of transmitter characteristics with slightly modified (e.g. shortened) transmitter filters.

An external program ("FILTWIZ") is offered to convert user-defined filters. This program generates filter files (\*.vaf) which can be transferred to the analyzer with a USB device, for example. The program can be downloaded together with a detailed description as a precompiled MATLAB® file (MATLAB pcode) on the Internet, at <http://www.rohde-schwarz.com> (search term "FILTWIZ").

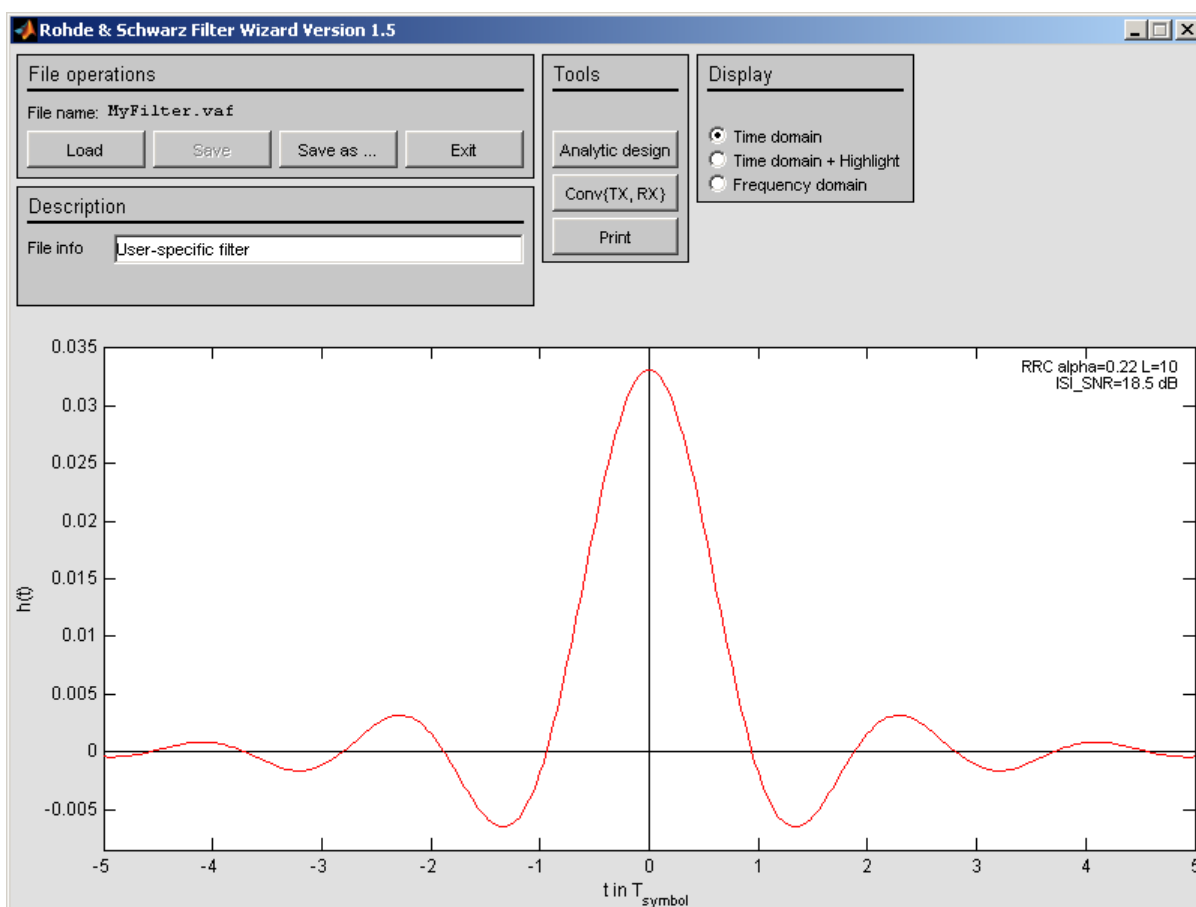


Figure 2-6: FILTWIZ - filter tool for the R&S FSV-K70

It is possible to load customized transmit filters and customized measurement filters. If a customized transmit filter is selected, the internal receive filter coefficients are calculated automatically on the fly.



Note that this is different to the R&S FSQ-K70, where it is necessary to also transfer a user receive filter.

If you upload a customized transmit filter and leave the measurement filter set to "automatic", the internally calculated receive filter will be used as measurement filter. Note that this filter is not necessarily suitable for your specific signal. The filter is optimized

such that the intersymbol interference is low. Hence, you will probably be able to see a clear eye diagram and an Vector I/Q diagram with a recognizable constellation. However, a filter that has low intersymbol interference *might* lead to noise enhancement, which is commonly undesirable for a measurement filter. In order to avoid noise enhancement, it is recommended that you:

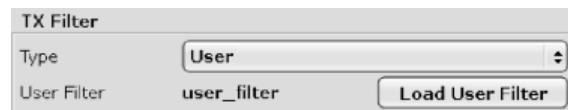
- a) design your own measurement filter and upload it as a user filter
- b) select a suitable measurement filter from the list

### Transferring filter files to the R&S FSVA/FSV

You can transfer the (.vaf) filter files to the R&S FSVA/FSV using a USB memory device.

#### To load a user transmit (TX) filter

1. 1. Open the "Modulation" tab of the "Modulation & Signal Description" dialog.
2. Select "Transmit filter Type": *User*.



3. Select "Load User Filter".
4. Load your .vaf file from the USB stick.

#### To load a user measurement filter

1. Open the "Measurement Filter" tab of the "Demodulation & Measurement Filter" dialog.
2. Select "Meas Filter Type": *User*.



3. Select "Load User Filter".
4. Load your .vaf file from the USB stick.

## 2.3 Symbol Mapping

Mapping or symbol mapping means that symbol numbers are assigned to points or transitions in the I/Q plane (e.g. PSK and QAM).

In the analyzer, the mapping is required to decode the transmitted symbols from the sampled I/Q or frequency/time data records.

The mappings for all standards used in the analyzer and for all employed modulation modes are described in the following. Unless characterized otherwise, symbol numbers are specified in hexadecimal form (MSB at the left).

### 2.3.1 Phase Shift Keying (PSK)

With this type of modulation, the information is represented by the absolute phase position of the received signal at the decision points. All transitions in the I/Q diagram are possible. The complex constellation diagram is shown. The symbol numbers are entered in the diagram according to the mapping rule.

#### BPSK (NATURAL)

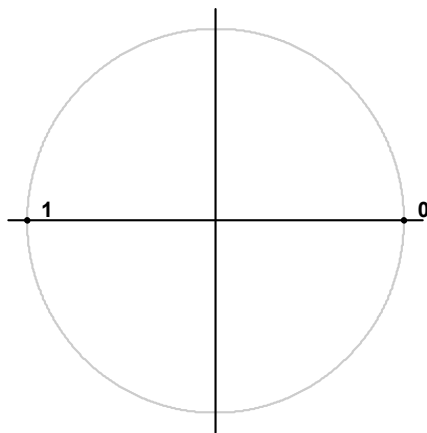


Figure 2-7: Constellation diagram for BPSK including the symbol mapping

#### QPSK

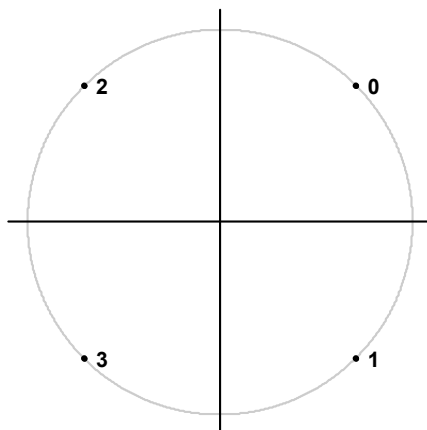


Figure 2-8: Constellation diagram for QPSK including the symbol mapping for CDMA2000 FWD and DVB S2

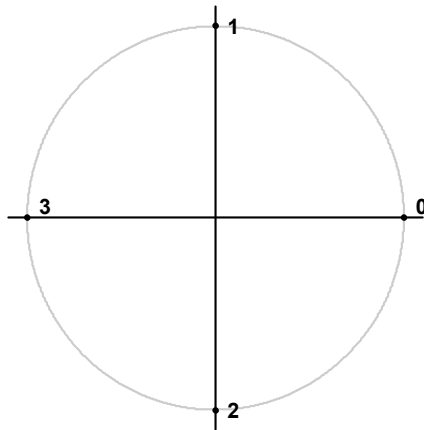


Figure 2-9: Constellation diagram for QPSK (GRAY) including the symbol mapping

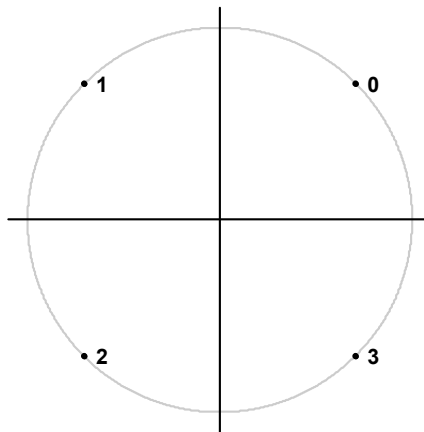


Figure 2-10: Constellation diagram for QPSK (NATURAL) including the symbol mapping

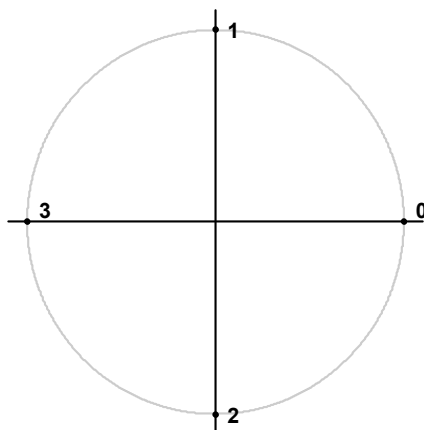


Figure 2-11: Constellation diagram for QPSK including the symbol mapping for WCDMA

## 8PSK

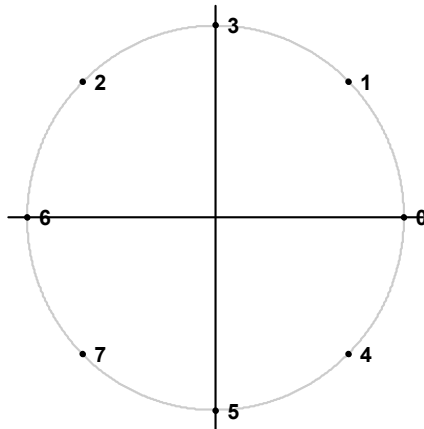


Figure 2-12: Constellation diagram for 8PSK (GRAY) including the symbol mapping

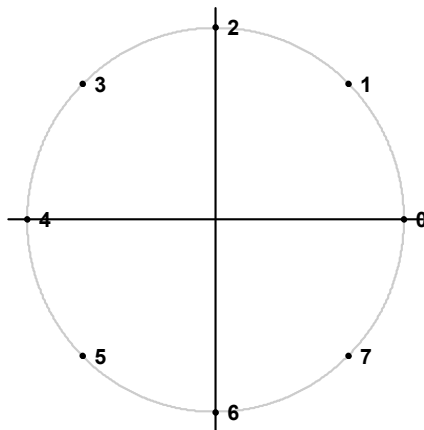


Figure 2-13: Constellation diagram for 8PSK (NATURAL) including the symbol mapping

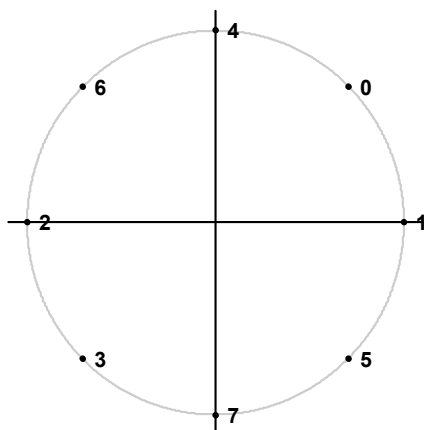


Figure 2-14: Constellation diagram for 8PSK including the symbol mapping for DVB S2



### 2.3.2 Rotating PSK

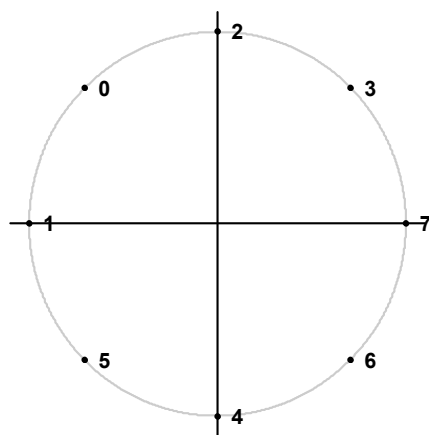
A rotating PSK modulation is basically a PSK modulation in which additional phase shifts occur. These phase shifts depend on the symbol number, e.g. for a  $\pi/4$ -QPSK, the third symbol has an additional phase offset of  $(3-1)*\pi/4$ . This offset has the same effect as a rotation of the basic system of coordinates by the offset angle after each symbol.

The method is highly important in practical applications because it prevents signal transitions through the zeros in the I/Q plane. This reduces the dynamic range of the modulated signal and the linearity requirements for the amplifier.

In practice, the method is used for  $3\pi/8$ -8PSK, for example, and (in conjunction with phase-differential coding) for  $\pi/4$ -DQPSK.

#### Symbol mapping

The logical constellation diagram for  $3\pi/8$ -8PSK comprises 8 points that correspond to the modulation level (see [Figure 2-15](#)). A counter-clockwise offset (rotation) of  $3\pi/8$  is inserted after each symbol transition.



*Figure 2-15: Constellation diagram for  $3\pi/8$  8PSK before rotation including the symbol mapping for EDGE*

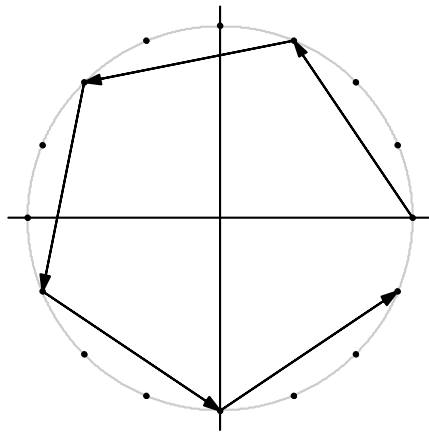


Figure 2-16: I/Q symbol stream after  $3\pi/8$  rotation in I/Q plane if the symbol number "7" is transmitted six times in a row

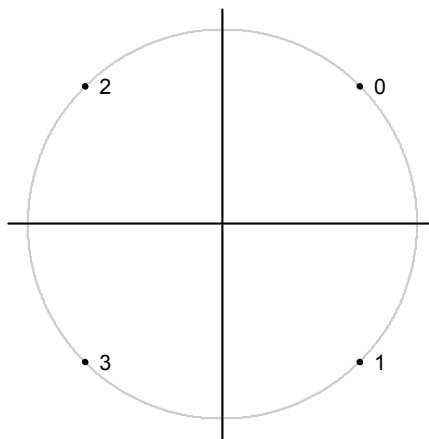


Figure 2-17: Constellation diagram for  $3\pi/4$  QPSK including the symbol mapping for EDGE

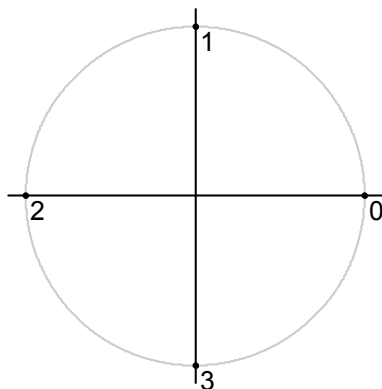


Figure 2-18: Constellation diagram for  $\pi/4$  QPSK (Natural) including the symbol mapping

### 2.3.3 Differential PSK

With differential PSK, the information is represented in the phase shift between two consecutive decision points. The absolute position of the complex sample value at the decision point does not carry information.

In the physical constellation diagram, the constellation points at the symbol decision points obtained after ISI-free demodulation are shown (as with common PSK methods). This diagram corresponds to the display on the analyzer. The position of the constellation points is standard-specific. For example, some QPSK standards define the constellation points on the diagonals, while other standards define the coordinate axes.

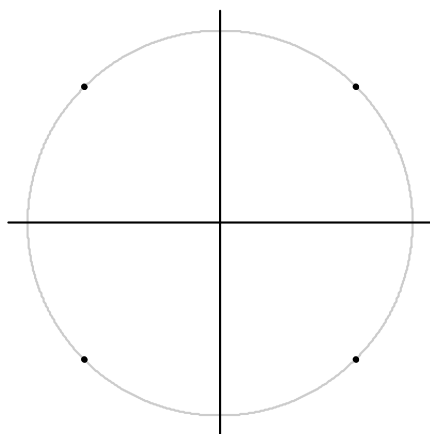
In [Table 2-5](#), the symbols are assigned to phase shifts. The QPSK (INMARSAT) mapping corresponds to simple QPSK with phase-differential coding.

Tables [Table 2-6](#) and [Table 2-7](#) show two types of differential 8PSK modulation.

Another type of differential PSK modulation is shown in [Table 2-6](#).

Differential coding according to VDL is shown in [Table 2-8](#). It can be used for modulation types with 3 bits/symbol, e.g. 8PSK.

Other types of modulation using differential coding method are described in [Chapter 2.3.4, "Rotating Differential PSK Modulation"](#), on page 28.



**Figure 2-19: Constellation diagram for DQPSK (INMARSAT and NATURAL) including the symbol mapping**

**Table 2-5: DQPSK (INMARSAT)**

Logical symbol mapping				
Modulation symbol (binary indication: MSB, LSB)	00	01	10	11
Phase shift	0°	-90°	+90°	180°

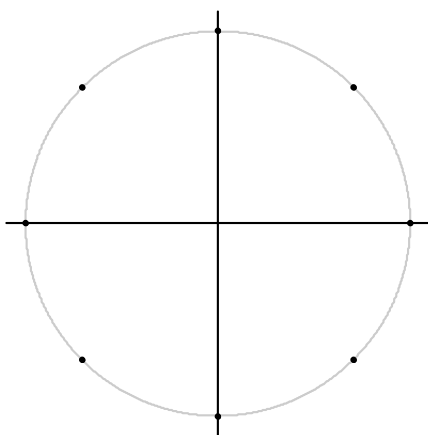


Figure 2-20: Constellation diagram for D8PSK including the symbol mapping for APCO25, APCO25 Phase 2, GRAY, NATURAL and TETRA

Table 2-6: D8PSK (NATURAL)

Logical symbol mapping								
Modulation symbol (binary indication: MSB, LSB)	000	001	010	011	100	101	110	111
Phase shift	0°	45°	90°	135°	180°	225°	270°	315°

Table 2-7: D8PSK (GRAY)

Logical symbol mapping								
Modulation symbol (binary indication: MSB, LSB)	000	001	010	011	100	101	110	111
Phase shift	0°	45°	135°	90°	270°	315°	225°	180°

Table 2-8: D8PSK (VDL)

Logical symbol mapping								
Modulation symbol (binary indication: MSB, LSB)	000	001	010	011	100	101	110	111
Phase shift	0°	45°	135°	90°	315°	270°	180°	225°

### 2.3.4 Rotating Differential PSK Modulation

Phase-differential modulation is frequently combined with an additional phase shift (e.g.  $\pi/4$  DQPSK =  $\pi/4$  phase shift modulation + differential modulated 4PSK).

The logical mapping diagram corresponds to the diagram for DPSK.

The physical constellation diagram shows the symbol decision points obtained after ISI-free demodulation.

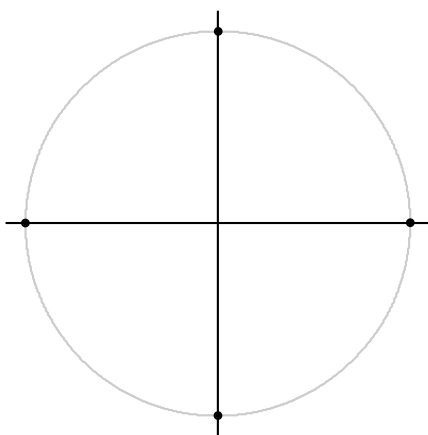


Figure 2-21: Constellation diagram for  $\pi/4$  DQPSK including the symbol mapping for APCO25 Phase 2, NADC, NATURAL, PDC, PHS, TETRA and TFTS; the  $\pi/4$  rotation is already compensated for

Table 2-9:  $\pi/4$  DQPSK (NADC, PDC, PHS, TETRA)

Logical symbol mapping				
Modulation symbol (binary indication: MSB, LSB)	00	01	10	11
Phase shift	$0^\circ+45^\circ$	$90^\circ+45^\circ$	$-90^\circ+45^\circ$	$-180^\circ+45^\circ$

Table 2-10:  $\pi/4$  DQPSK (TFTS)

Logical symbol mapping				
Modulation symbol (binary indication: MSB, LSB)	00	01	10	11
Phase shift	$-180^\circ+45^\circ$	$90^\circ+45^\circ$	$-90^\circ+45^\circ$	$0^\circ+45^\circ$

Table 2-11:  $\pi/4$  DQPSK (Natural)

Logical symbol mapping				
Modulation symbol (binary indication: MSB, LSB)	00	01	10	11
Phase shift	$0^\circ+45^\circ$	$90^\circ+45^\circ$	$-180^\circ+45^\circ$	$-90^\circ+45^\circ$

Table 2-12:  $\pi/4$  DQPSK (APCO25 and APCO25Phase2)

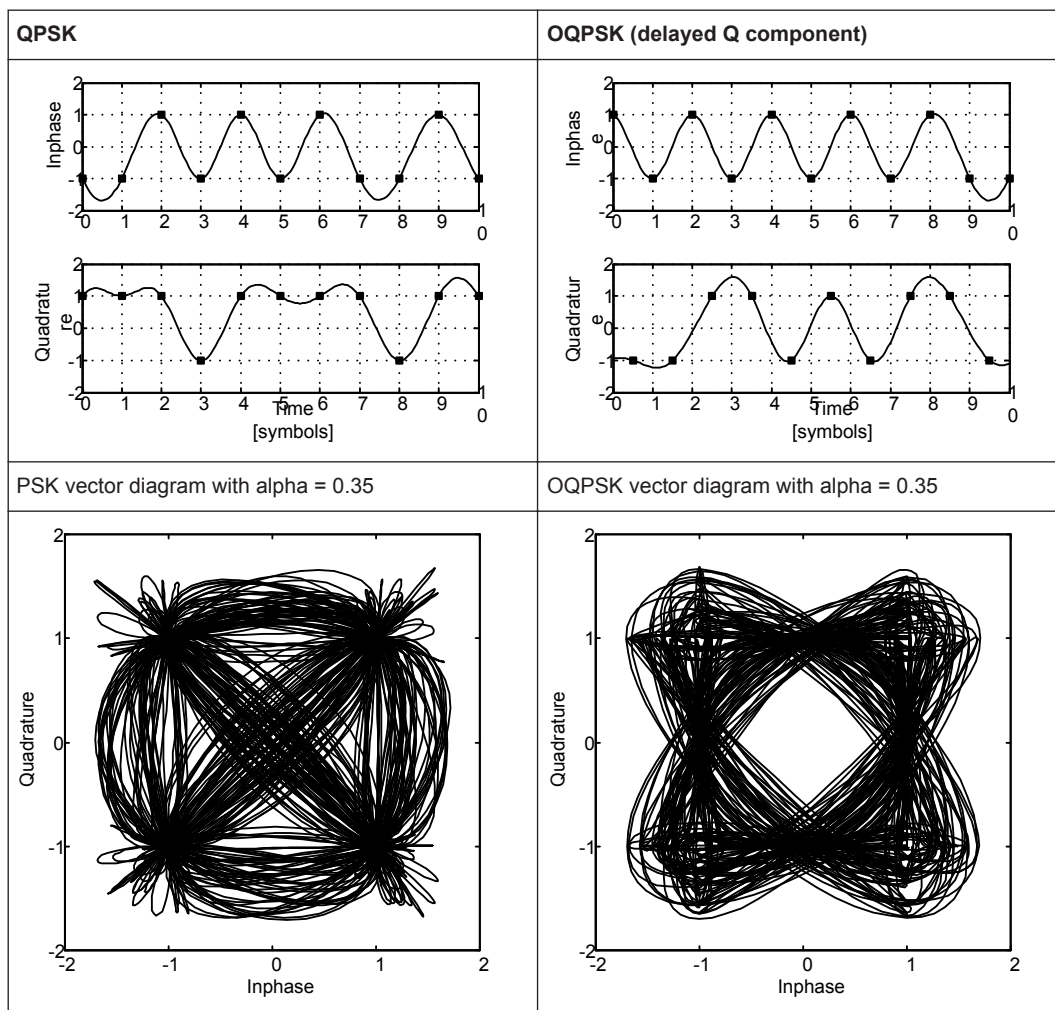
Logical symbol mapping				
Modulation symbol (binary indication: MSB, LSB)	00	01	10	11
Phase shift	$0^\circ+45^\circ$	$90^\circ+45^\circ$	$-90^\circ+45^\circ$	$-180^\circ+45^\circ$

### 2.3.5 Offset QPSK

Offset QPSK differs from "normal" QPSK in the fact that the Q component is delayed by half a symbol period against the I component in the time domain. Hence, the symbol time instants of the I and the Q component do not coincide. The concept of Offset QPSK is illustrated in the diagrams below.

Derivation of OQPSK

Table 2-13: I/Q diagram and constellation diagram



Offset QPSK reduces the dynamic range of the modulated signal (with respect to "normal" QPSK) and, therefore, the demands on amplifier linearity by avoiding zero crossings.

A distinction is made in the analyzer display:

In the Vector I/Q result display of the measurement (or reference) signal, the time delay is not compensated for. The display corresponds to the physical diagram shown in (Table 2-13)

In the Constellation I/Q result display of the measurement (or reference) signal, the time delay is compensated for. The display corresponds to the logical mapping as in Figure 2-22.

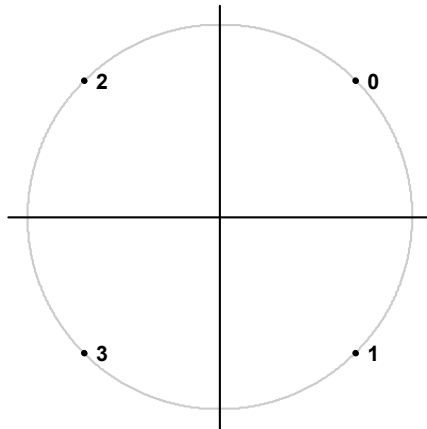
**OQPSK**

Figure 2-22: Constellation diagram for OQSK (GRAY) including the symbol mapping

### 2.3.6 Frequency Shift Keying (FSK)

To illustrate symbol mappings for FSK modulations, the symbol numbers are marked in the logical mapping diagram versus the instantaneous frequency. An instantaneous frequency of zero in the baseband corresponds to the input frequency of the analyzer.

#### 2FSK (NATURAL)

With 2FSK, the symbol decision is made by a simple frequency discriminator:

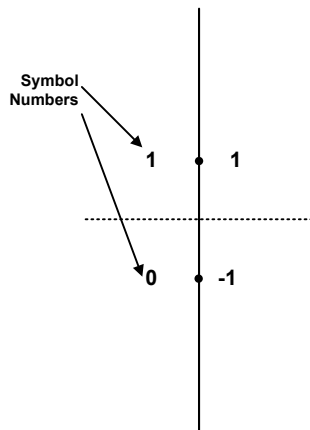


Figure 2-23: Constellation diagram for 2FSK (NATURAL) including the logical symbol mapping

#### 4FSK

With 4FSK, the symbol decision is made by a frequency discriminator with 3 decision thresholds ( $-2/3$ ;  $0$ ;  $+2/3$ ) normalized to the FSK reference deviation.

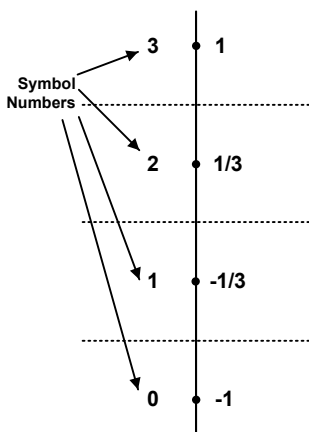


Figure 2-24: Constellation diagram for 4FSK (NATURAL) including the logical symbol mapping

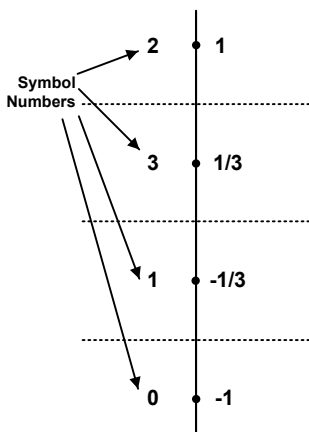


Figure 2-25: Constellation diagram for 4FSK (GRAY) including the logical symbol mapping

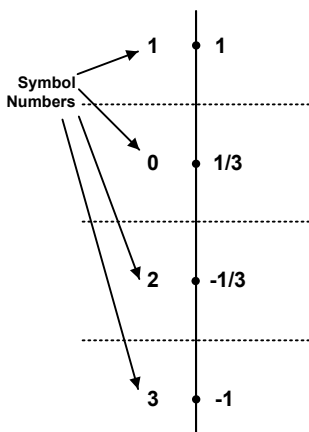


Figure 2-26: Constellation diagram for 4FSK for APCO C4FM and APCO Phase 2 including the logical symbol mapping



8FSK (NATURAL)

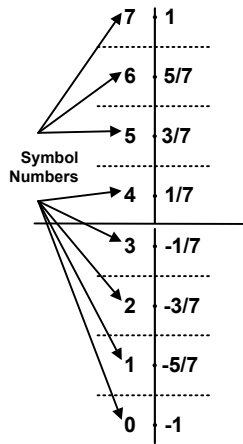


Figure 2-27: Constellation diagram for 8FSK (NATURAL) including the logical symbol mapping

16 FSK

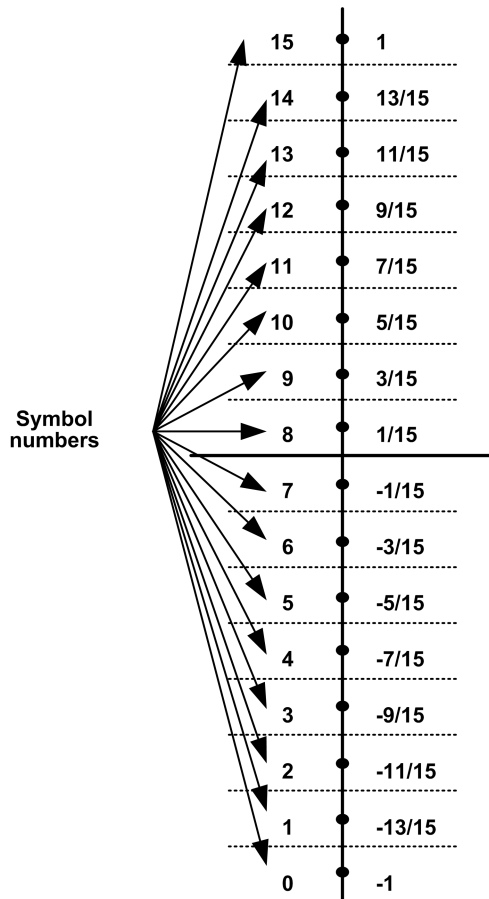


Figure 2-28: Constellation diagram for 16FSK including the logical symbol mapping

### 2.3.7 Minimum Shift Keying (MSK)

MSK modulation causes modulation-dependent phase shifts of  $\pm 90^\circ$  which can be shown in an Constellation I/Q diagram. As with PSK, demodulation is performed by evaluation of the phase positions.

Table 2-14: MSK (NATURAL)

Logical symbol mapping		
Modulation symbol (binary indication: MSB, LSB)	0	1
Phase shift	$-90^\circ$	$+90^\circ$

Table 2-15: MSK (GSM)

Logical symbol mapping		
Modulation symbol (binary indication: MSB, LSB)	0	1
Phase shift	$+90^\circ$	$-90^\circ$

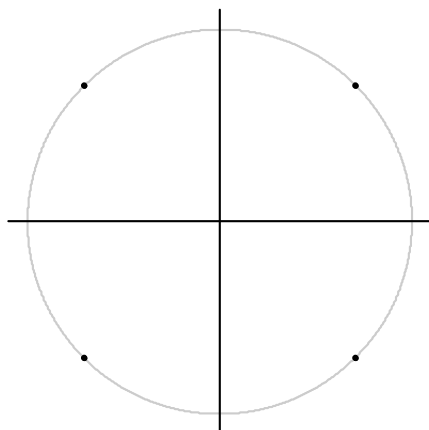


Figure 2-29: MSK (for GSM and NATURAL) and DMSK Constellation Diagram including the symbol mapping

Similar to PSK, differential coding can also be used with MSK. In this case, too, the information is represented by the transition of two consecutive symbols. The block diagram of the coder is shown below.

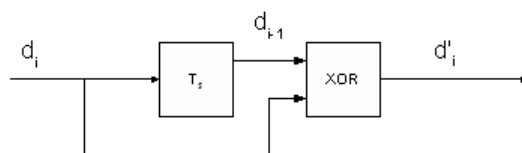


Figure 2-30: DMSK: differential encoder in the transmitter

$d_i$  input symbol  $\{0;1\}$  of differential encoder

$d_{i-1}$  input symbol delayed by the symbol period  $T_s$

$d'_i$ : output symbol {0;1} of differential encoder

The logical symbol mapping is then performed on the XOR-coded bitstream  $d'$ .

### 2.3.8 Quadrature Amplitude Modulation (QAM)

In the case of QAM the information is represented by the signal amplitude and phase.

The symbols are arranged in a square constellation in the I/Q plane.



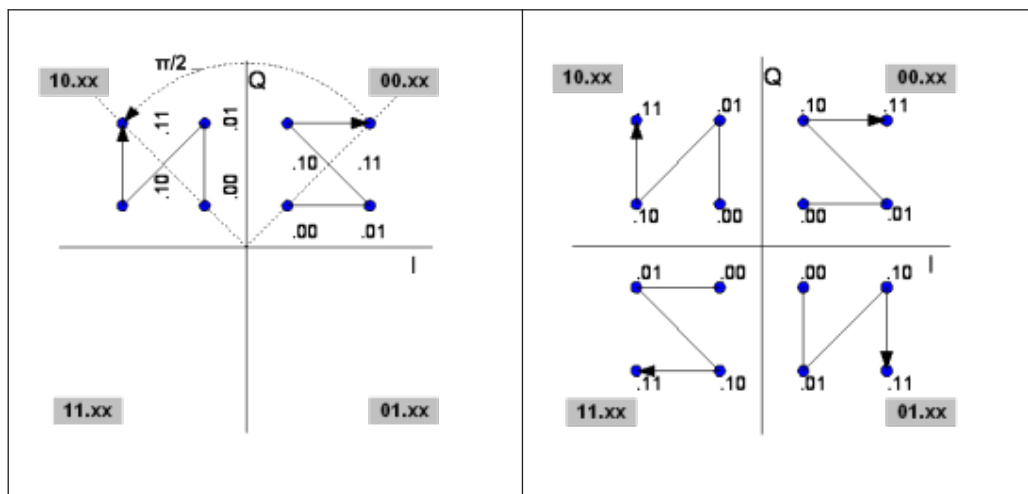
To ensure reliable demodulation, symbol numbers should be distributed evenly with respect to the symbol alphabet.

As a rule of thumb, the **result length** should correspond to at least 8 times the modulation order. For example, with 64 QAM, a result length of at least  $8 \cdot 64 = 512$  symbols should be used.

#### QAM Mappings

The following QAM mappings are obtained from the mapping of the 1st quadrant, which is always rotated by  $\pi/2$  for the subsequent quadrants and supplemented by a (GRAY-coded) prefix for each quadrant.

Table 2-16: Derivation of QAM mappings



In the following diagrams, the symbol mappings are indicated in hexadecimal and binary form.

• 0	• 1	• 3	• 2	• 0000	• 0001	• 0011	• 0010
• 4	• 5	• 7	• 6	• 0100	• 0101	• 0111	• 0110
• C	• D	• F	• E	• 1100	• 1101	• 1111	• 1110
• 8	• 9	• B	• A	• 1000	• 1001	• 1011	• 1010

Figure 2-31: Constellation diagram for 16QAM (GRAY) including the logical symbol mapping (hexadecimal and binary)

• B	• 9	• 1	• 3	• 1011	• 1001	• 0001	• 0011
• A	• 8	• 0	• 2	• 1010	• 1000	• 0000	• 0010
• E	• C	• 4	• 6	• 1110	• 1100	• 0100	• 0110
• F	• D	• 5	• 7	• 1111	• 1101	• 0101	• 0111

Figure 2-32: Constellation diagram for 16QAM including the logical symbol mapping for EDGE (hexadecimal and binary)

• B	• 9	• 2	• 3	• 1011	• 1001	• 0010	• 0011
• A	• 8	• 0	• 1	• 1010	• 1000	• 0000	• 0001
• D	• C	• 4	• 6	• 1101	• 1100	• 0100	• 0110
• F	• E	• 5	• 7	• 1111	• 1110	• 0101	• 0111

Figure 2-33: Constellation diagram for 16QAM including the logical symbol mapping for DVB-C (hexadecimal and binary)



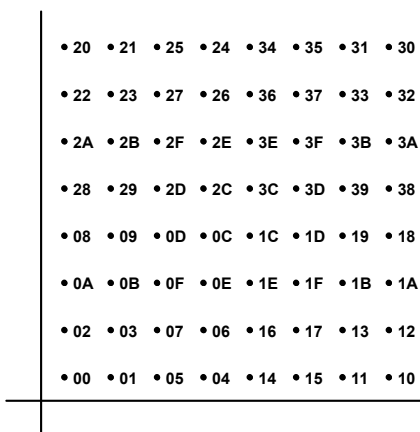


Figure 2-37: Constellation diagram for 256QAM including the logical symbol mapping (hexadecimal); the figure shows the upper right section of the diagram only

### 2.3.9 User QAM

In the case of a User QAM modulation, the information can be represented by the signal amplitude and/or the signal phase.

#### 16APSK

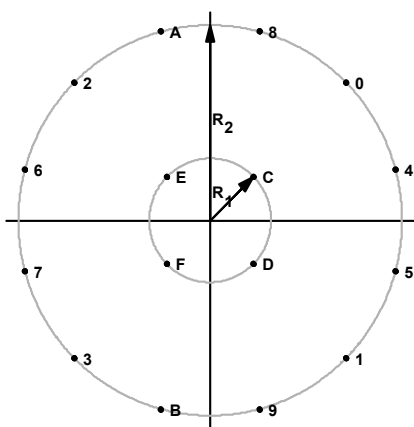


Figure 2-38: Constellation diagram for 16APSK including the logical symbol mapping for DVB-S2

For DVB-S2 16APSK mappings, the ratio of the outer circle radius to the inner circle radius ( $\gamma = R2/R1$ ) depends on the utilized code rate and complies with Table 2-17.

Table 2-17: Optimum constellation radius ratio  $\gamma$  (linear channel) for 16APSK

Code Rate	Modulation / coding spectral efficiency	$\gamma$
2/3	2.66	3.15
3/4	2.99	2.85
4/5	3.19	2.75

Code Rate	Modulation / coding spectral efficiency	$\gamma$
5/6	3.32	2.70
8/9	3.55	2.60
9/10	3.59	2.57

### 32APSK

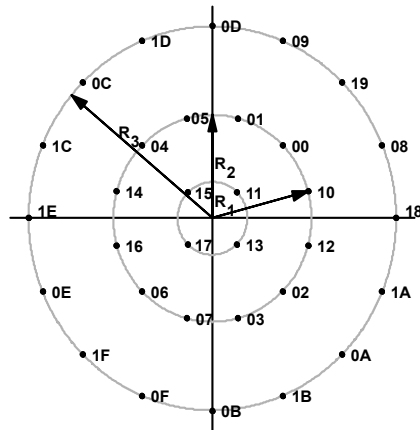


Figure 2-39: Constellation diagram for 32APSK including the logical symbol mapping for DVB-S2

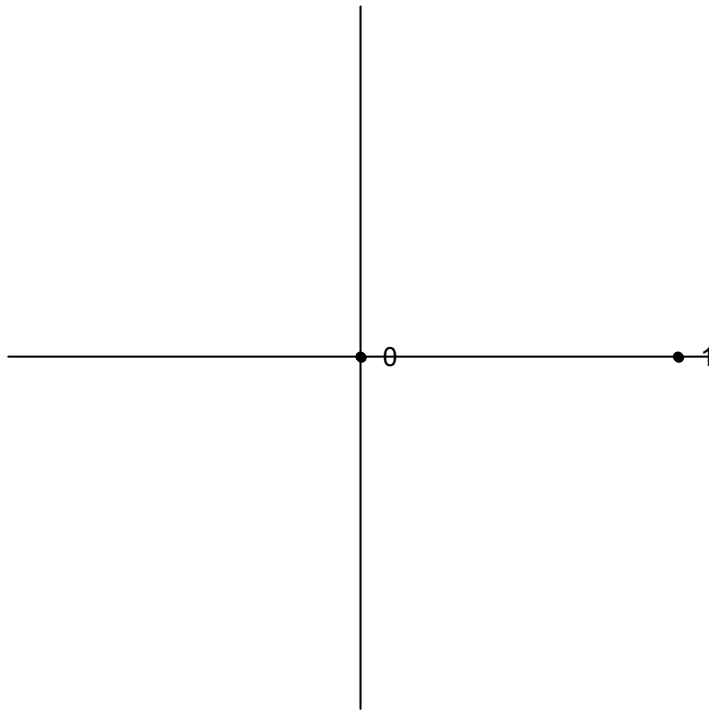
For DVB-S2 32APSK mappings, the ratio of the middle circle radius to the inner circle radius ( $\gamma_1 = R_2/R_1$ ) and the ratio of the outer circle radius to the inner circle radius ( $\gamma_2$ ) depend on the utilized code rate and comply with [Table 2-18](#).

Table 2-18: Optimum constellation radius ratios  $\gamma_1$  and  $\gamma_2$  (linear channel) for 32APSK

Code Rate	Modulation / coding spectral efficiency	$\gamma_1$	$\gamma_2$
2/3	3.74	2.84	5.27
3/4	3.99	2.72	4.87
4/5	4.15	2.64	4.64
5/6	4.43	2.54	4.33
8/9	4.49	2.53	4.30

### OOK

OOK stands for "On Off Keying" and is often also referred to as (binary) Amplitude Shift Keying (ASK). With this type of modulation, the information is solely represented by the absolute amplitude of the received signal at the decision points.

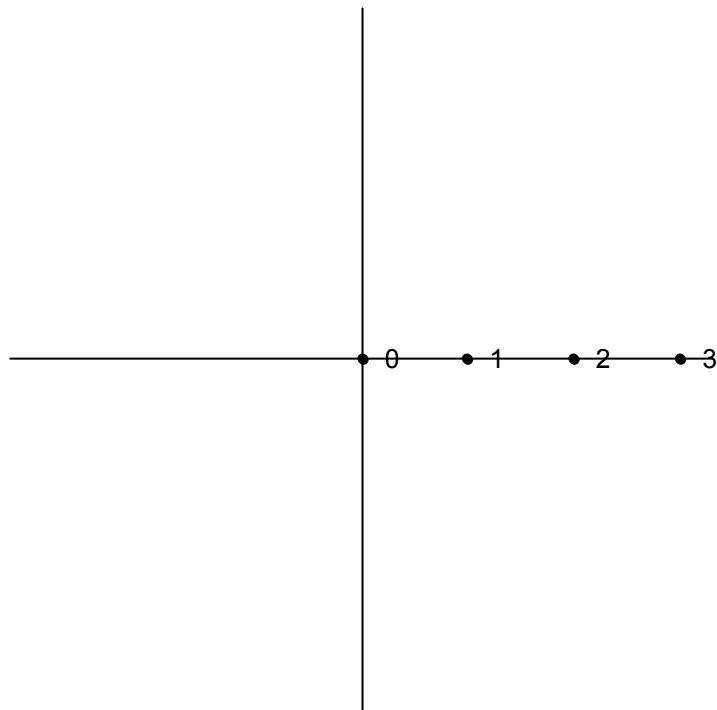


*Figure 2-40: Constellation diagram for OOK*

#### **4ASK**

4ASK is a 4-ary Amplitude Shift Keying mapping type. With this type of modulation, the information is solely represented by the absolute amplitude of the received signal at the decision points.





*Figure 2-41: Constellation diagram for 4ASK*

## 2.4 Demodulation Overview

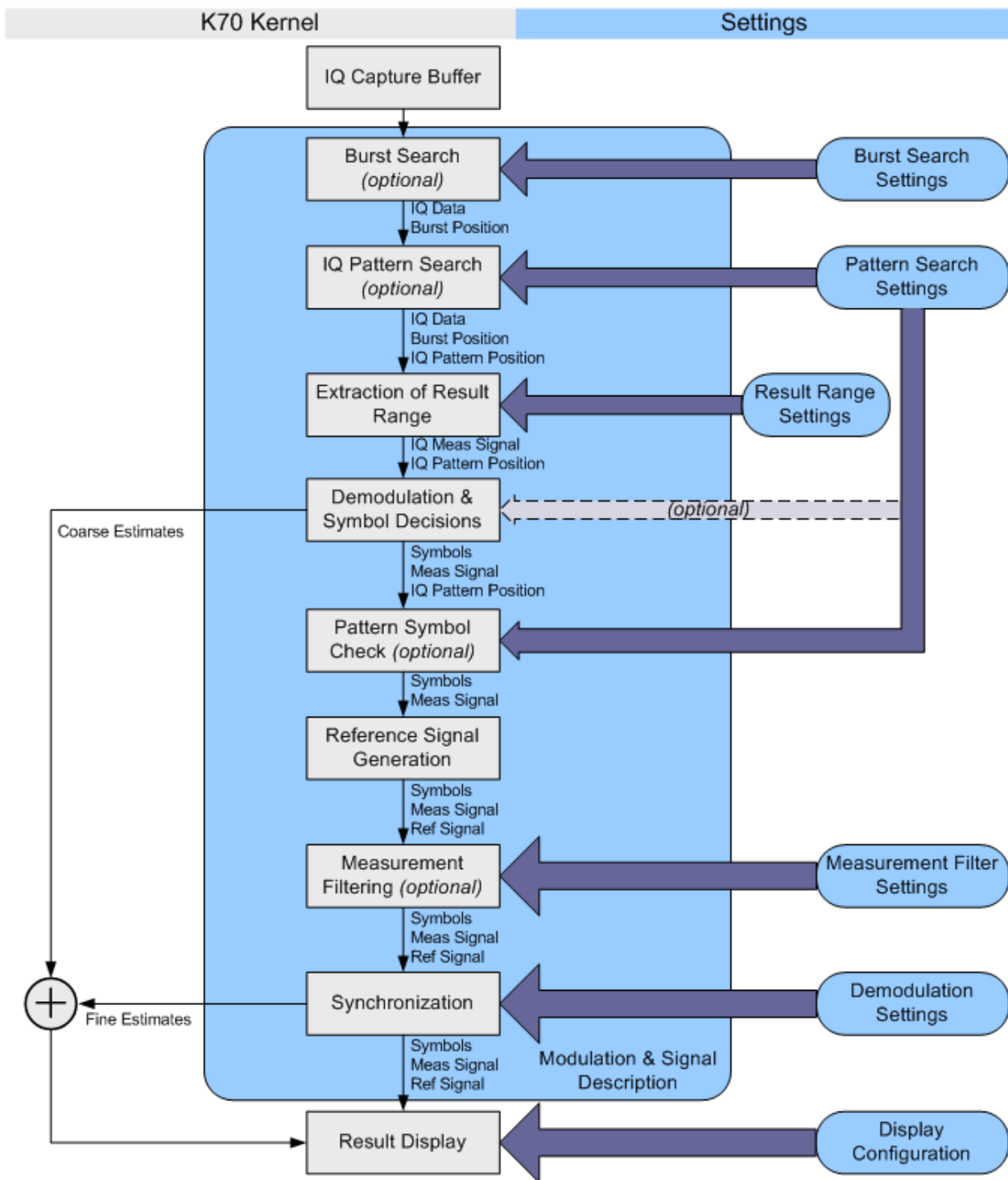


Figure 2-42: Demodulation stages of the vector signal analysis option

The [Figure 2-42](#) provides an overview of the demodulation stages of the vector signal analysis option. The function blocks of the signal processing kernel can be found at the left (in grey) and their appropriate settings at the right (in blue).

### Burst Search

In this stage, the Capture Buffer is searched for bursts that comply with the signal description. The search itself can be switched on or off via the "Burst Search" dialog (see ["Burst Search"](#) on page 158). A list of the detected bursts is passed on to the next processing stage.

### IQ Pattern Search

The "IQ Pattern Search" is performed on the Capture Buffer. This means the R&S FSV-K70 option modulates the selected pattern according to the transmit filter (Tx filter) and the modulation scheme. Subsequently, it searches the Capture Buffer for this IQ pattern, i.e. the IQ waveform of the pattern. It is assumed that patterns can only appear within bursts, i.e. the IQ pattern search range is limited to the bursts detected by the Burst Search stage. If the burst search is switched off, the whole Capture Buffer is searched for the IQ pattern. A list of all detected IQ patterns is passed on to the next processing stage. It is important to note that the R&S FSV-K70 option can only search for one pattern at a time.

The pattern search can be switched on or off via the "Pattern Search" dialog (see ["Pattern Search"](#) on page 160).

### Extraction of Result Range

The Result Range can be aligned to a burst, a pattern or simply the start of the Capture Buffer (see ["Result Range"](#) on page 165). Within this stage, the Result Range is cut from the Capture Buffer starting at a point that is specified by the user, e.g. the start of a detected burst. The R&S FSV-K70 option automatically takes into account filter settling times by making the internal buffers sufficiently longer than the selected Result Range.

### Demodulation & Symbol Decisions

This stage operates on the extracted Result Range and aims at making the correct symbol decisions. Within this stage, a coarse synchronization of the carrier frequency offset, the carrier phase, the scaling and the timing takes place. Furthermore, an automatically selected internal receive filter (Rx filter) is used in order to remove the inter-symbol interference as effectively as possible. The outputs of this stage are the (coarsely) synchronized measurement signal and the symbol decisions (bits). The symbol decisions are later used for the "Pattern Symbol Check" stage and for the "Reference Signal Generation" stage.

### Pattern Symbol Check

The "IQ Pattern Search" stage can only detect whether the similarity between the IQ pattern and the Capture Buffer exceeds a certain threshold and, in this way, find the most likely positions where a pattern can be found.

Within this stage, the R&S FSV-K70 checks whether the pattern symbols (bits) really coincide with the symbol decisions at the pre-detected position. E.g. if one out of 20 symbols does not coincide, the "IQ Pattern Search" stage might detect this IQ pattern, but the "Pattern Symbol Check" stage will decline it.

Note that this stage is only active if the pattern search is switched on.

### Reference Signal Generation

The ideal reference signal is generated based on the detected symbols and the specifications of the signal model, i.e. the modulation scheme and the transmit filter (Tx filter).

### Measurement Filtering

Both the measurement signal and the reference signal are filtered with the specified measurement filter.

### Synchronization

In this stage, the measurement signal and the reference signal are correlated. For PSK, QAM and MSK modulated signals, an estimation algorithm is used in order to obtain estimates for the signal amplitude, signal timing, carrier frequency error, phase error, IQ offset, gain imbalance, quadrature error and the amplitude droop. Alternatively, it is possible to disable the estimation algorithm.

For FSK modulated signals, estimates for the signal amplitude, signal timing, carrier frequency error, FSK deviation error and the carrier frequency drift are calculated. The measurement signal is subsequently corrected with these estimates. Compensation for FSK deviation error and carrier frequency drift can be enabled or disabled.

For more information on synchronization see

- [Chapter 2.5.1.2, "Estimation"](#), on page 52
- ["Demodulation"](#) on page 169

### Result Display

The selected measurement results are displayed on the screen(s). Configuration of the screens can be performed via the "Display Configuration" dialog (see [Chapter 3.3.1.6, "Display Configuration"](#), on page 175).

A more detailed description of the most important stages is given in the following sections.

## 2.4.1 Burst Search

The burst search is performed only if it is switched on. Otherwise, this stage is skipped. It is recommended that you switch the burst search on if the signal is bursted. This ensures that all internal estimators are operated in time ranges where the burst power ramping is up.

In order to eliminate amplitude variations caused by noise or the modulation itself, the instantaneous power of the whole capture buffer is computed and then a moving aver-

age filter is applied. The length of this filter is automatically determined with the help of the user settings.

The filtered power of the capture buffer is subsequently compared to an automatically chosen threshold and the rising and falling edges of bursts are identified. With the help of the detected edges and some further processing, it is possible to decide whether the burst "candidates" comply with the user settings.

All bursts must have a length between ("Min Burst Length" – "Search Tolerance") and ("Max Burst Length" + "Search Tolerance") to be accepted. See "[Continuous Signal / Burst Signal](#)" on page 147 and "[Search Tolerance](#)" on page 159 for a more detailed description of these parameters.

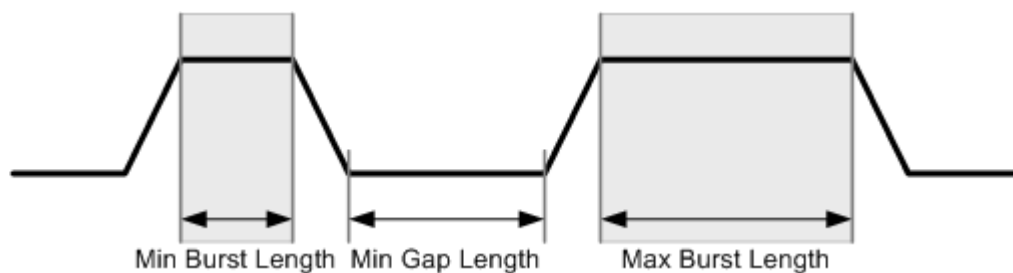


Figure 2-43: Burst Search parameters



You can influence the robustness of the burst search directly by entering the correct minimum gap length (see "[Min Gap Length](#)" on page 159), minimum burst length and maximum burst length. Refer to [Figure 2-43](#) for an illustration of the three parameters.

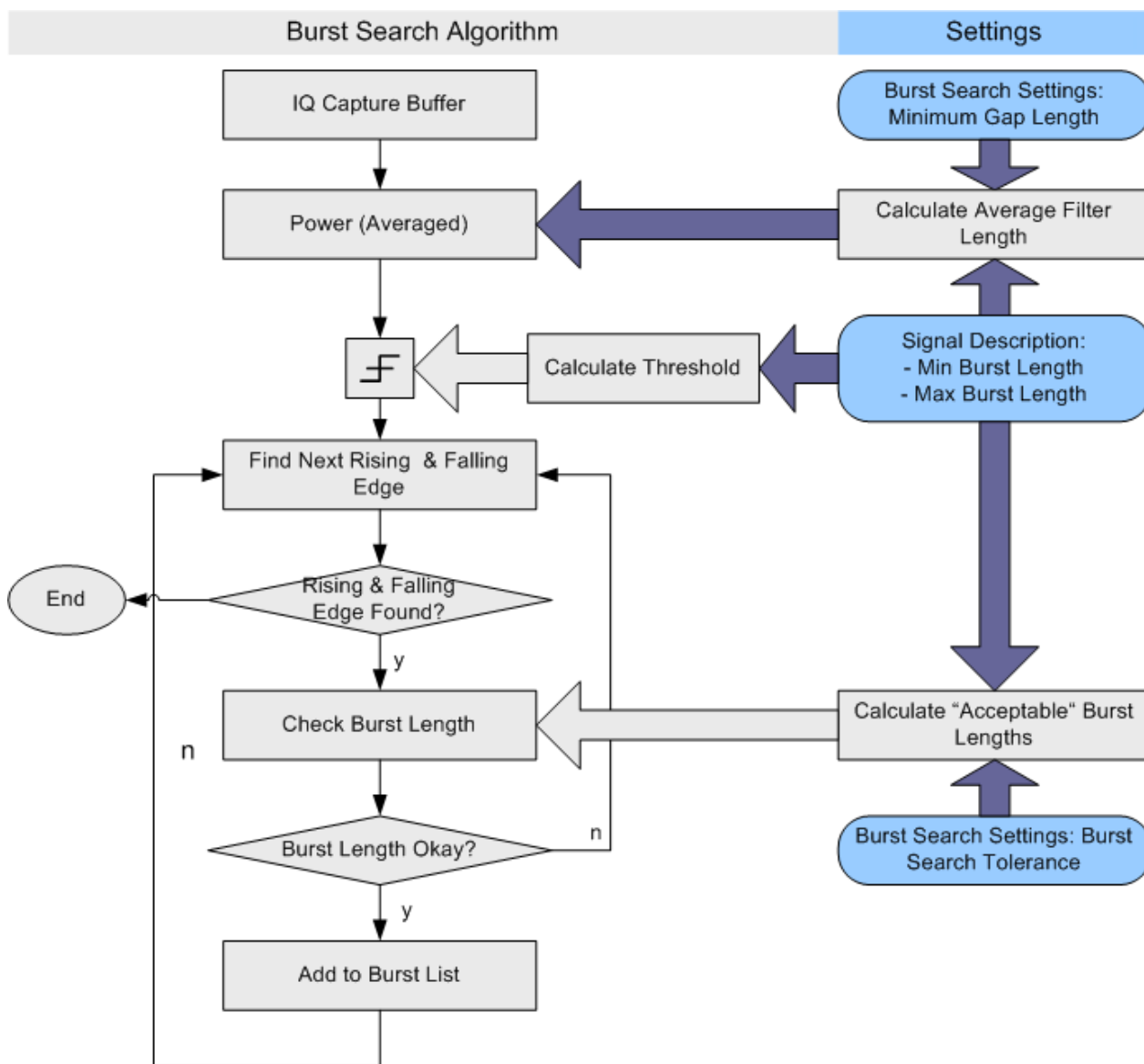


Figure 2-44: Burst search algorithm

### 2.4.2 I/Q Pattern Search

The I/Q pattern search is performed only if it is switched on. Otherwise, this stage is skipped. The main benefit of the I/Q pattern search is that it enables an alignment of the result range to the pattern. Furthermore, this stage can function as a filter: If the burst search and I/Q pattern search are switched on, and the parameter "Meas Only If Pattern Symbols Correct" is set to true, only bursts with the correct pattern are demodulated (see "Meas only if pattern symbols correct" on page 161).

During the I/Q pattern search stage, the capture buffer is searched for an I/Q pattern by trying different time and frequency hypotheses. The IQ pattern is generated internally, based on the specified symbol number of the pattern and the signal description

(i.e. modulation scheme and transmit filter). The IQ pattern search can also be referred to as the I/Q waveform. An I/Q pattern is considered detected if the correlation metric, i.e. the correlation value between the ideal IQ pattern and capture buffer, exceeds a specified "I/Q Correlation Threshold" (see "[I/Q Correlation Threshold](#)" on page 161.)

If the burst search is switched on, the I/Q pattern search only searches the I/Q pattern in bursts previously detected by the burst search. Furthermore, it only finds the first I/Q pattern within each burst. If the burst search is switched off, the I/Q pattern search searches for the I/Q pattern in the entire capture buffer.

### 2.4.3 Demodulation and Symbol Decisions

This stage operates on the Result Range and aims to make the correct symbol decisions. The algorithm is illustrated in [Figure 2-45](#) using the example of a QPSK modulation. After timing and scaling recovery, a frequency offset and phase offset estimator is employed.

After this coarse synchronization, the R&S FSV-K70 option makes symbol decisions, i.e. recovers which symbols were transmitted by the device under test (DUT).

Typically, the employed estimators are "non-data-aided" (NDA) estimators. This means that they operate on an unknown data sequence. Since the local oscillators (LO) of the transmitter (device under test) and the receiver (R&S FSVA/FSV) are normally not coupled, their phase offset with respect to each other is unknown. The unknown transmission delay between DUT and R&S FSVA/FSV adds a further unknown phase offset.

Due to this unknown phase offset, the result of the demodulation can be ambiguous with respect to the absolute phase position because of the rotational symmetry of e.g. a PSK constellation. For example, in the case of non-differential QPSK modulation, the measurement signal, the reference signal and the decided IQ symbols may have a constant phase offset of  $\{0, \pi/2, \pi, \text{ or } 3\pi/2\}$ . This offset can only be detected and eliminated if a pattern was successfully detected at symbol level (see also [Chapter 2.4.4, "Pattern Symbol Check"](#), on page 49).

If modulation types are used where the information is represented by the phase transition, e.g. differential PSK or MSK, the absolute phase position is not an issue. Thus, the ambiguity of the starting phase does not have an influence on the symbol decisions.

If the measurement signal contains a known pattern, it is also possible to use a "data-aided" (DA) estimator at this stage. This means that the estimator operates on a known data sequence, i.e. the pattern. If the signal contains a pattern, it is possible to choose between the above-described non-data-aided estimator and the data-aided estimator with the setting "[Coarse Synchronization: Pattern](#)". If the data-aided estimator is employed, the phase ambiguity can be resolved at this stage.

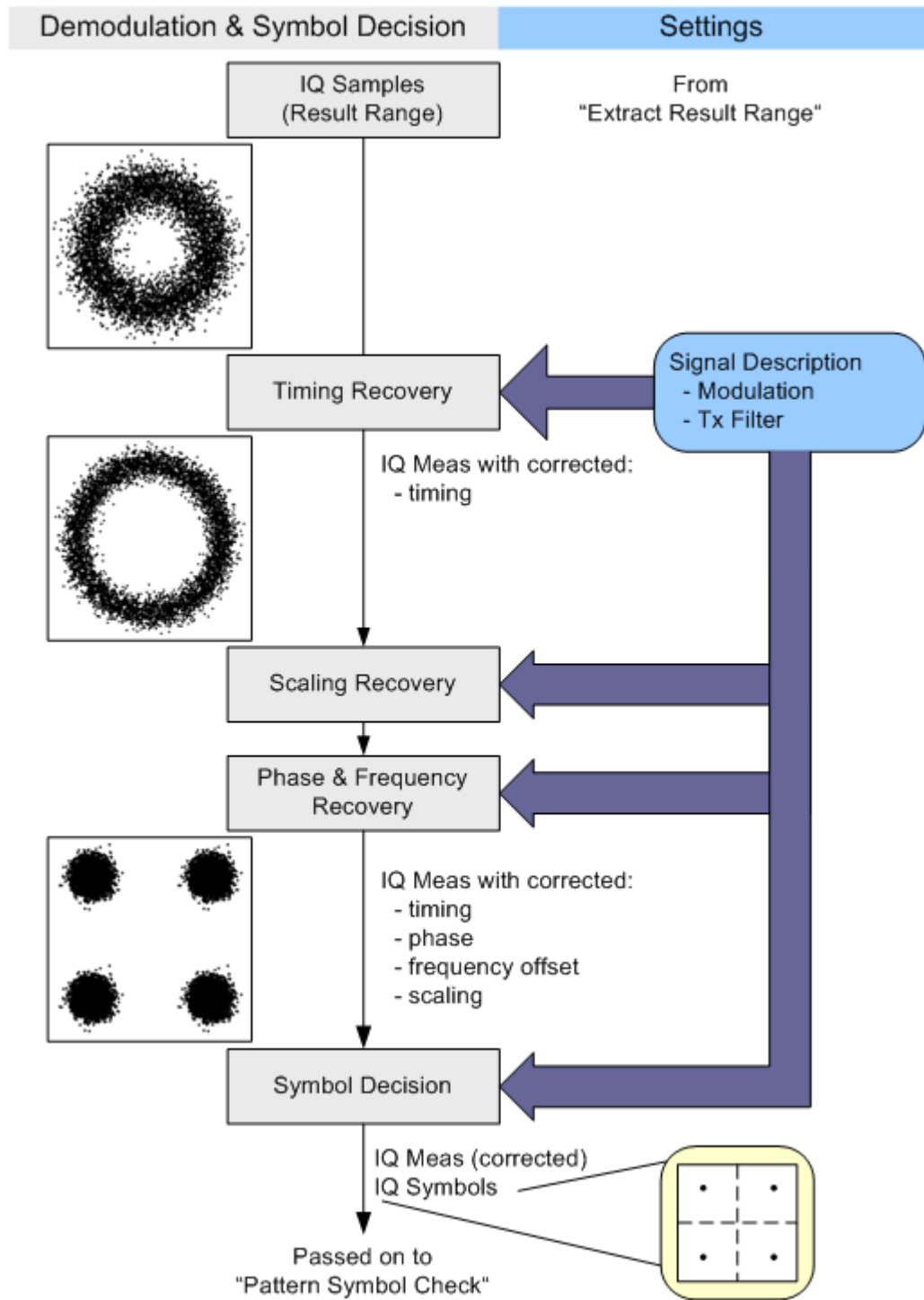


Figure 2-45: Demodulation and Symbol Decision algorithm



#### 2.4.4 Pattern Symbol Check

This stage performs a bit-by-bit comparison between the selected pattern and the demodulated bits. It is important to note that this comparison is only performed at positions that have been identified by the IQ pattern search as possible pattern positions. The algorithm and a simple example are illustrated in [Figure 2-46](#).

First, the pattern candidate bits are extracted from the whole bitstream calculated by the "Demodulation & Symbol Decisions" stage. This means that the symbol stream is cut at the position that has been detected by the [I/Q Pattern Search](#) as the start of the pattern. The extracted sequence is then compared to the selected pattern.

If the demodulation has been ambiguous with respect to the absolute phase position, the extracted sequence needs to be compared to all possible rotated versions of the selected pattern. For example, in the case of QPSK modulation, the rotational symmetry has the order four, i.e. there are four pattern hypotheses. If the extracted sequence coincides with one of the hypotheses, the pattern is declared as "found" and the absolute phase corresponding to the appropriate hypothesis is passed on. Both the symbol decisions and the IQ measurement signal are then rotated with this pattern phase (for the whole result range), thus resolving the phase ambiguity.

For more information refer to:

- [Chapter 2.4.3, "Demodulation and Symbol Decisions"](#), on page 47
- [Chapter 2.4.2, "I/Q Pattern Search"](#), on page 46

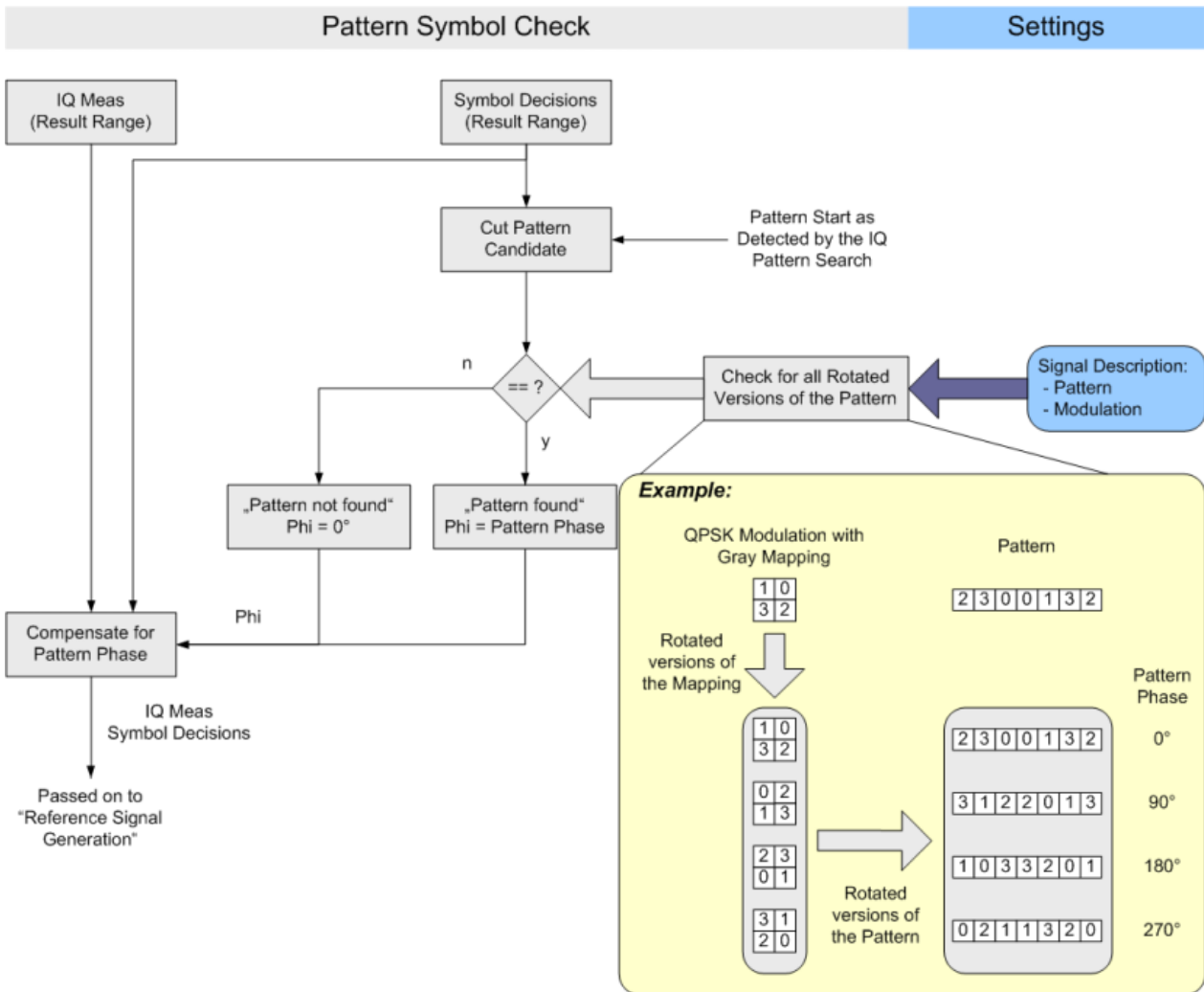


Figure 2-46: Pattern Symbol Check algorithm

## 2.5 Signal Model, Estimation and Modulation Errors

This section describes the signal and error models used within the R&S FSV-K70 VSA option. The estimation algorithms used to quantify specific modulation errors are then outlined. The chapter is divided into two parts:

2.5.1	PSK, QAM and MSK Modulation.....	51
2.5.1.1	Error Model.....	51
2.5.1.2	Estimation.....	52
2.5.1.3	Modulation Errors.....	53
2.5.2	FSK Modulation.....	60

2.5.2.1 Error Model..... 62  
 2.5.2.2 Estimation..... 63  
 2.5.2.3 Modulation Errors..... 64

2.5.1 PSK, QAM and MSK Modulation

2.5.1.1 Error Model

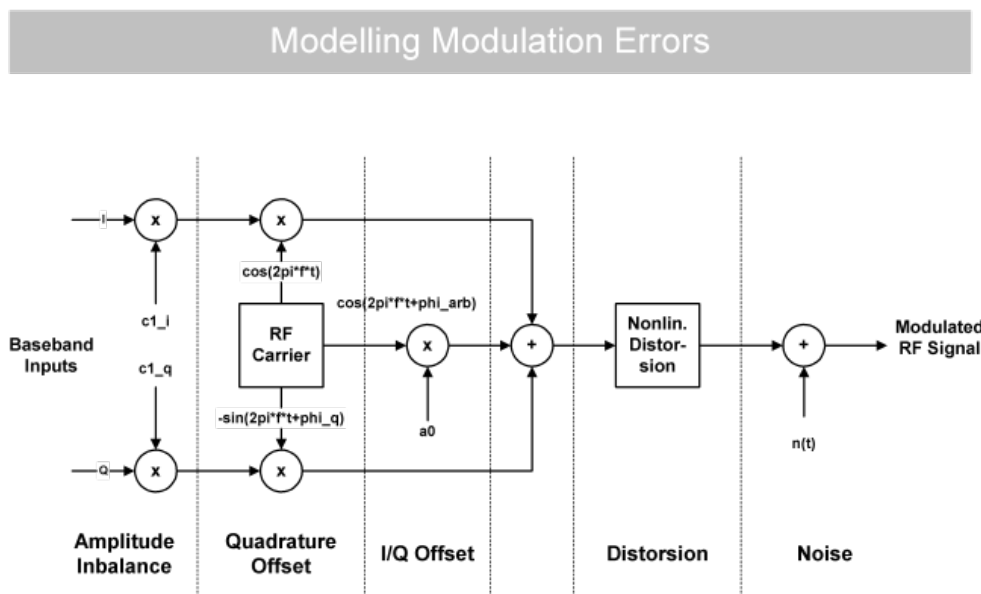


Figure 2-47: Modelling Modulation Errors

The measured signal model for PSK, QAM and MSK modulation is depicted in Figure 2-47 and can be expressed as

$$MEAS(t) = (g_I \cdot REF_I(t - \tau) + c_I + j \cdot (g_Q \cdot REF_Q(t - \tau) + c_Q)) e^{j\vartheta} e^{j(2\pi f_0 t + \varphi) - \alpha t} + n(t)$$

where:

REF<sub>I</sub>(t) and REF<sub>Q</sub>(t): the inphase and quadrature component of the reference signal

g<sub>I</sub> and g<sub>Q</sub>: the effects of the gain imbalance

c<sub>I</sub> and c<sub>Q</sub>: the effects of an IQ offset

ϑ: the quadrature error

α: the amplitude droop

f<sub>0</sub>: the carrier frequency offset

φ: the carrier phase offset

$\tau$ : the timing offset

$n(t)$ : a disturbing additive noise process of unknown power

### 2.5.1.2 Estimation

The R&S FSV-K70 option includes two synchronization stages. The first stage has already been described in the context of the "Demodulation & Symbol Decisions" block (see [Chapter 2.4.3, "Demodulation and Symbol Decisions"](#), on page 47).

The second stage is realized within the "Synchronization" block. Here, the measurement signal is matched to the reference signal by minimizing the mean square of the error vector magnitude. This is done by selecting the optimum parameter vector  $\hat{x}$ :

$$\hat{x} = \arg \min_{\tilde{x}} \left\{ \sum_t |MEAS(t) - REF(t, \tilde{x})|^2 \right\}$$

The minimization takes place at the sample instants specified by the [Estimation Points/Sym](#) parameter, i.e.

$$t = n \cdot T_E$$

with  $T_E$ : the sampling period used for estimation

Details on the estimation model and also the parameter vector can be found in [Chapter 2.5, "Signal Model, Estimation and Modulation Errors"](#), on page 50.

Subsequently, the measurement signal is corrected with the determined parameter vector. Note that with a subset of the parameters, you can enable or disable correction (see ["Demodulation"](#) on page 169).

#### Estimation ranges

The "estimation ranges" are determined internally according to the signal description:

- For continuous signals, the estimation range corresponds to the entire result range, since it can then be assumed that the signal consists of valid modulated symbols at all time instants.
- For bursted signals, the estimation range corresponds to the overlapping area of the detected burst and the "Result Range". Furthermore, the Run-In/Run-Out ranges (see ["Continuous Signal / Burst Signal"](#) on page 147) are explicitly excluded from the estimation range.

In the special case that the signal is indicated as a "burst signal", but is so highly distorted that the burst search cannot detect a burst, the estimation range corresponds to the pattern and (if an offset of the pattern is indicated) the useful part of the burst from its start to the pattern start.

### 2.5.1.3 Modulation Errors

#### Error vector (EV)

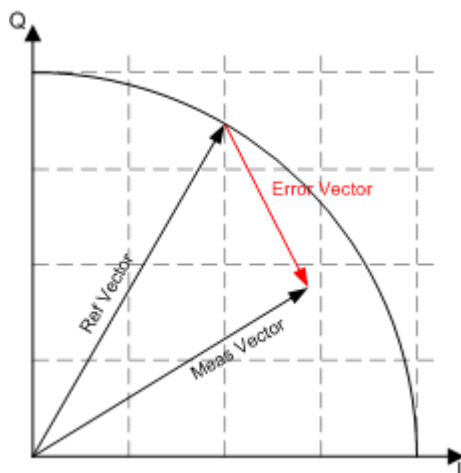


Figure 2-48: Modulation error: error vector

The error vector is the difference between the measurement signal vector (Meas vector) and the reference signal vector (Ref vector).

#### Error Vector Magnitude (EVM)

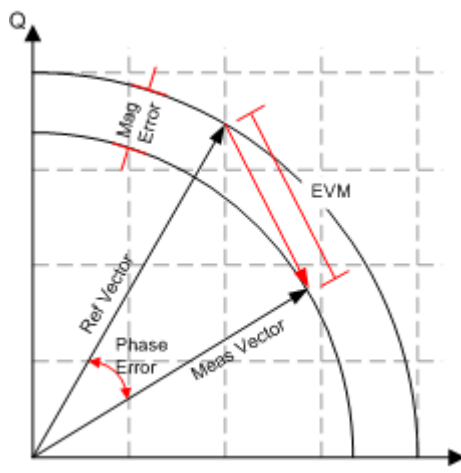


Figure 2-49: Modulation error: EVM, magnitude error, phase error

The magnitude of the error vector in the diagram is specified as the error vector magnitude (EVM). It is commonly normalized to the mean reference power. The EVM should not be confused with the magnitude error, see below.

#### Magnitude Error

The magnitude error is defined as the difference between the measurement vector magnitude and the reference vector magnitude (see [Figure 2-49](#)).

### Phase Error

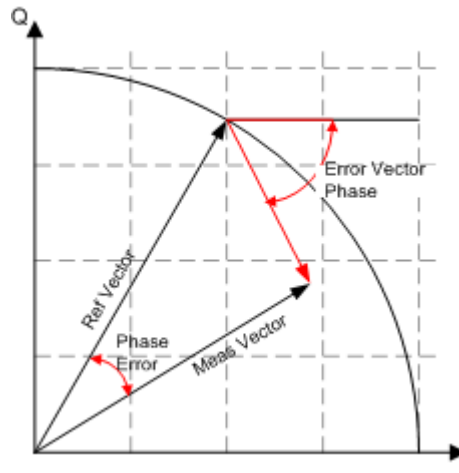


Figure 2-50: Modulation error: Phase error, error vector phase

The phase error is the phase difference between the measurement vector and the reference vector.

$$PHASE\_ERR(t) = PHASE_{MEAS}(t) - PHASE_{REF}(t)$$

This measurement parameter is of great importance for MSK modulation measurements.

The phase error should not be confused with the error vector phase. The error vector phase is the absolute phase of the error vector (see [Figure 2-50](#)).

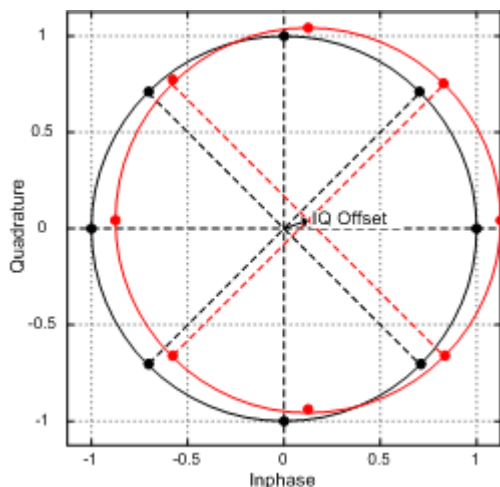
The effects of the different modulation errors in the transmitter on the result display of the analyzer are described on the next pages. All diagrams show the equivalent, complex baseband signal.

### Modulation Error Ratio (MER)

The modulation error ratio (MER) is closely related to EVM:

$$MER = -20 \cdot \log_{10}(EVM)$$

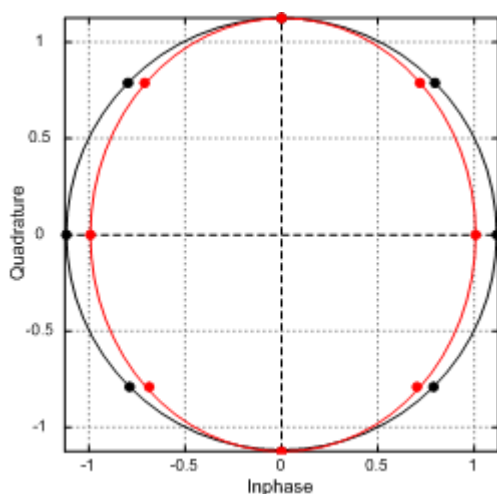
where the EVM is normalized to the mean reference power.

**I/Q Offset (Origin Offset)**

*Figure 2-51: Effect of an I/Q or origin offset after demodulation and error compensation*

Figure 2-51 shows the effect of an I/Q offset in the transmitter.

The I/Q offset can be compensated for if the corresponding option is selected in the demodulation settings. In this case, the offset does not affect the EVM.

**Gain Imbalance**

*Figure 2-52: Effect of gain imbalance*

The gain difference in the I and Q channels during signal generation in the transmitter is referred to as gain imbalance. The effect of this error on the constellation diagram and the unit circle are shown in Figure 2-52. In the example, the gain in the I channel is slightly reduced which causes a distortion of coordinates in the I direction. The unit circle of the ideal constellation points has an elliptic shape.

The gain imbalance can be compensated for if the corresponding option is selected in the demodulation settings. In this case, the imbalance does not affect the EVM.

Note that the gain imbalance is not estimated (and cannot be compensated for) in a BPSK signal.



### Preconditions for Gain Imbalance and Quadrature Error measurements

The distortions "gain imbalance" and "quadrature error" can only be measured without ambiguity, if the following two conditions are fulfilled:

- a pattern is detected
- the modulation is a non-differential, non-rotating QAM or PSK

Otherwise, only the measurement parameter "IQ Imbalance", which is a combination of the gain imbalance and the quadrature error, is significant.

### Quadrature Error

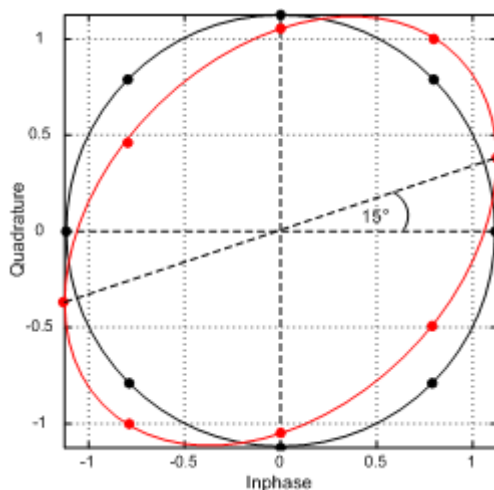


Figure 2-53: Effect of Quadrature Error

The quadrature error is another modulation error which is shown in figure [Figure 2-53](#).

In this diagram, the I and Q components of the modulated carrier are of identical amplitude but the phase between the two components deviates from 90°.

This error also distorts the coordinates. In the example in figure [Figure 2-53](#) the Q axis is shifted.

Note that the quadrature error is not estimated (and cannot be compensated for) in a BPSK signal.

### I/Q Imbalance

The effect of quadrature error and gain imbalance are combined to form the error parameter I/Q imbalance.

$$B_{[in]} = \frac{|g_I - g_Q \cdot e^{j\theta}|}{|g_I + g_Q \cdot e^{j\theta}|}$$



where  $g_I$  and  $g_Q$  are the gain of the inphase and the quadrature component and  $\theta$  represents the quadrature error.

The I/Q imbalance can be compensated for if the corresponding option is selected in the demodulation settings. In this case, the I/Q imbalance does not affect the EVM.

Note that the I/Q imbalance is not estimated (and cannot be compensated for) in a BPSK signal.

### Amplitude Droop

The decrease of the signal power over time in the transmitter is referred to amplitude droop.

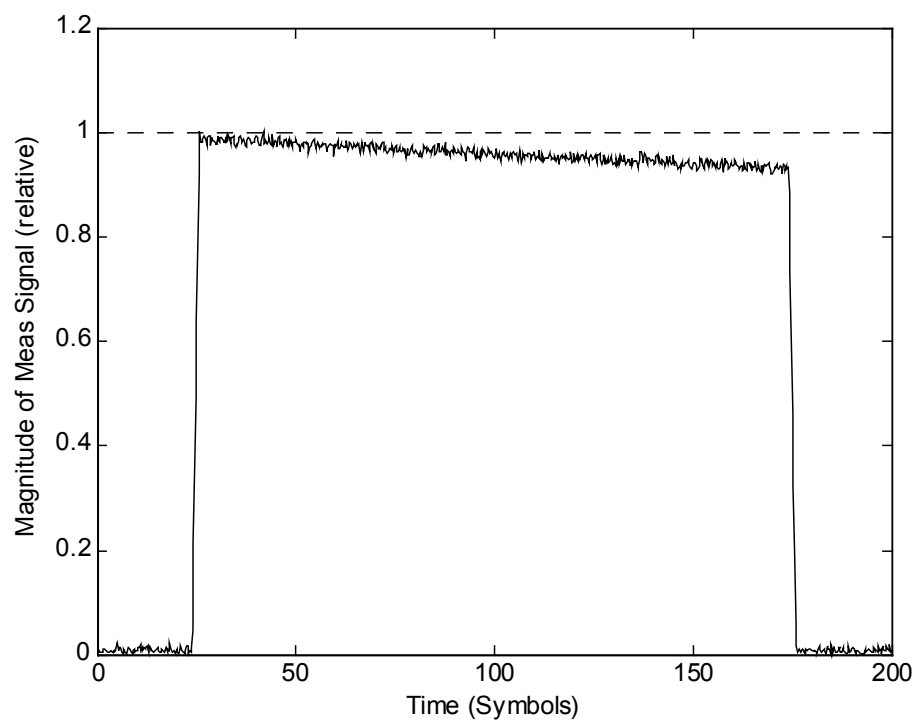
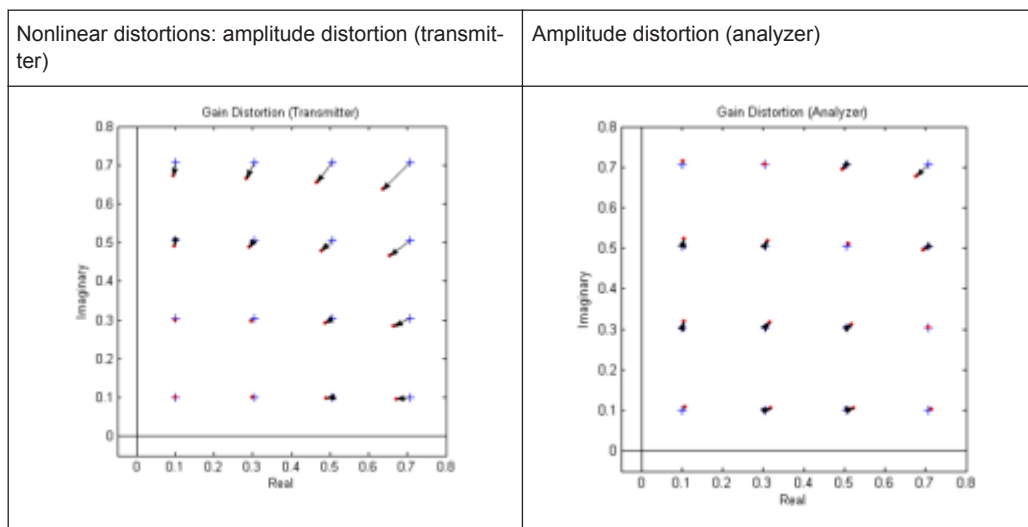


Figure 2-54: Effect of amplitude droop

**Gain Distortion**

**Table 2-19: Effect of nonlinear amplitude distortions**



The Table 2-19 illustrates the effect of nonlinear amplitude distortions on a 64QAM signal (only the 1st quadrant is shown). The transfer function is level-dependent: the highest effects occur at high input levels while low signal levels are hardly affected. The signal is scaled in the analyzer so that the average square magnitude of the error vector is minimized. The Table 2-19 shows the signal after scaling.

**Table 2-20: Amplitude transfer functions**

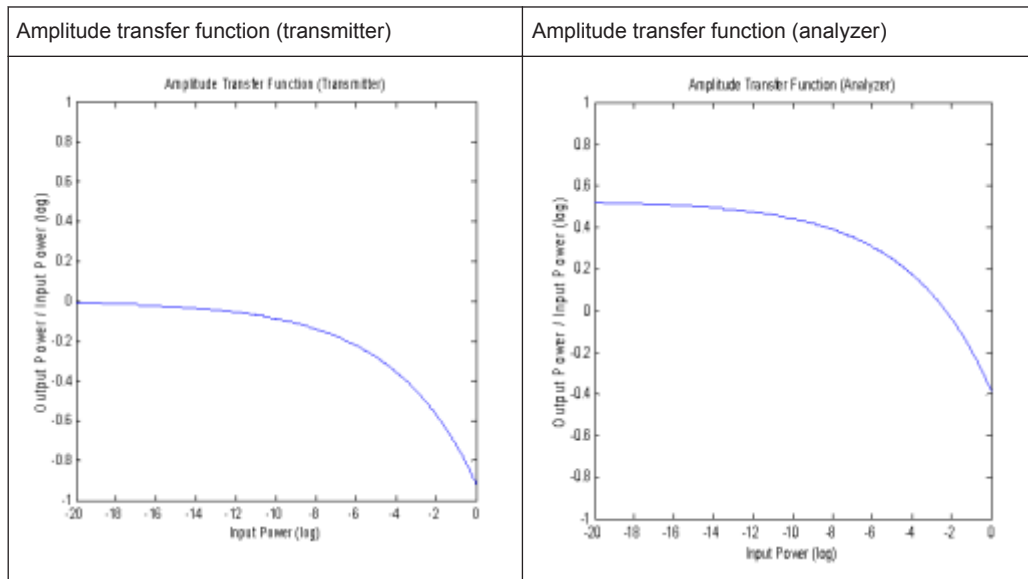
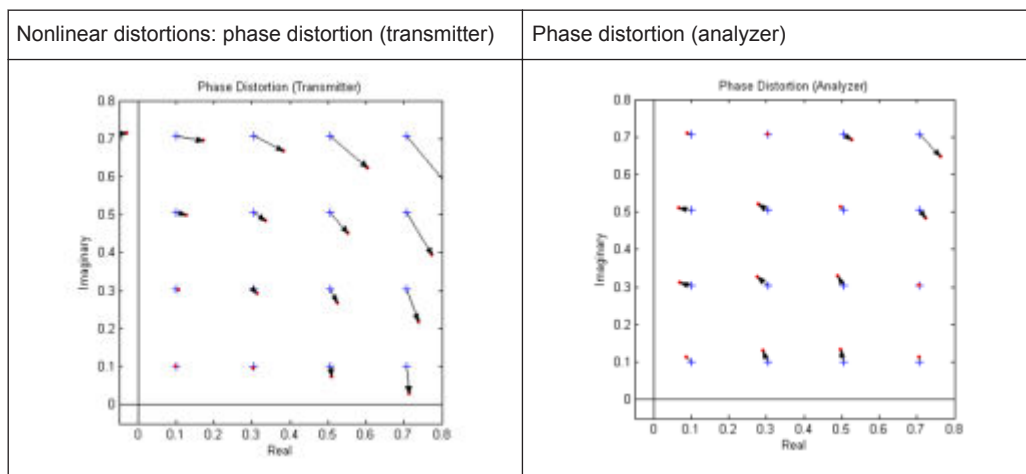


Table 2-20 shows a logarithmic display of the amplitude transfer functions. The analyzer trace is shifted against the transmitter trace by this scale factor.

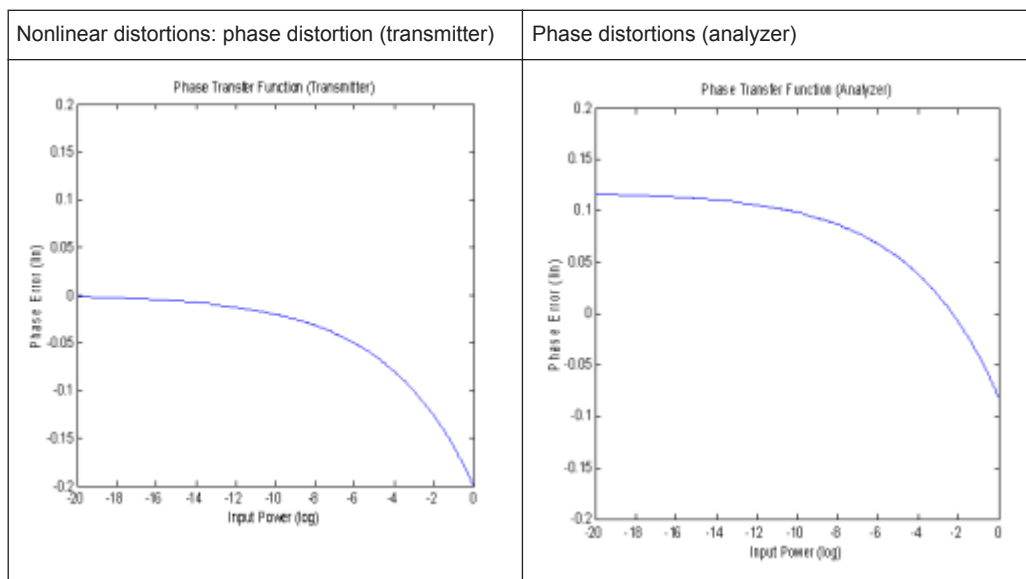
**Phase Distortion**

**Table 2-21: Effect of nonlinear phase distortions**



The [Table 2-21](#) illustrates the effect of nonlinear phase distortions on a 64QAM signal (only the 1st quadrant is shown). The transfer function is level-dependent: the highest effects occur at high input levels while low signal levels are hardly affected. These effects are caused, for instance, by saturation in the transmitter output stages. The signal is scaled in the analyzer so that the average square magnitude of the error vector is minimized. The [Table 2-21](#) shows the signal after scaling.

**Table 2-22: Phase transfer functions**



[Table 2-22](#) show a logarithmic display of the phase transfer functions. The analyzer trace is shifted by the phase described above as against the transmitter trace.

## Noise

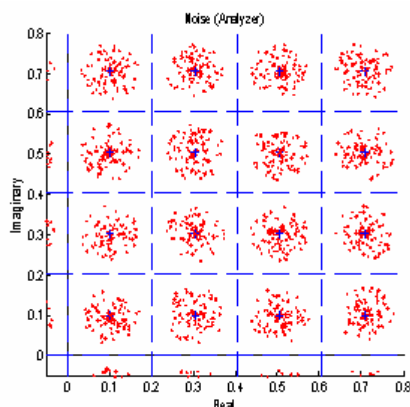


Figure 2-55: Additive noise

The Figure 2-55 shows a 64QAM signal (only the 1st quadrant is shown) with additive noise. The symbol decision thresholds are also shown.

The noise signal forms a "cloud" around the ideal symbol point in the constellation diagram. Exceeding the symbol decision boundaries leads to wrong symbol decisions and increases the bit error rate.

Similar displays are obtained in case of incorrect transmitter filter settings. When an incorrect filter is selected, crosstalk occurs between neighbouring symbol decision points instead of the ISI-free points. The effect increases the more the filtering deviates from actual requirements.

The two effects described cannot be distinguished in the Constellation I/Q diagram but in statistical and spectral analyses of the error signal.

## 2.5.2 FSK Modulation

### Signal Model

Frequency shift keying (FSK) involves the encoding of information in the frequency of a transmitted signal. As opposed to other modulation formats such as PSK and QAM, the FSK process is a non-linear transform of the transmitted data into the transmitted waveform.

A sequence of symbols  $\{s_i\}$  are modulated using a "frequency pulse"  $g(t)$  to form the instantaneous frequency of the transmitted complex baseband waveform, denoted by  $f_{REF}(t)$  and defined as:

$$f_{REF}(t) = h \cdot \sum_i s_i g(t - i \cdot T)$$

where  $f_{Symb} = 1/T$  is the symbol rate and  $h$  is a scaling factor, termed the modulation index. The transmitted (or reference) FSK signal is formed by frequency modulation of the instantaneous frequency:

$$REF(t) = e^{j \cdot 2 \cdot \pi \cdot \int_{-\infty}^t f_{REF}(u) du} = e^{j \cdot \phi_{REF}(t)}$$

where  $\phi_{REF}(t)$  denotes the phase of the transmitted waveform. In the R&S FSVA/FSV-K70 a continuous phase FSK signal is assumed, which is ensured by the integral in the expression for  $REF(t)$ . A graphical depiction of the reference waveform generation is shown below in Figure [Figure 2-56](#).

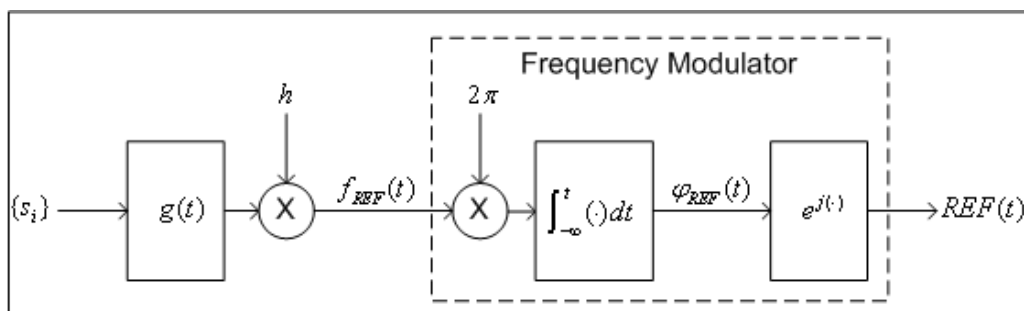


Figure 2-56: Reference complex baseband FSK signal generation

### Reference Deviation

The transmitted symbols  $\{s_i\}$  are assumed to be chosen from a finite and real-valued constellation of  $M$  values;  $\{\zeta_1, \zeta_2, \dots, \zeta_M\}$ . The maximum absolute constellation point is denoted by  $\zeta_{MAX}$ . The maximum phase contribution of a data symbol is given by:

$$\phi_{MAX} = 2 \cdot \pi \cdot h \cdot \zeta_{MAX} \int_{-\infty}^{\infty} g(t) \cdot dt$$

The reference deviation of the FSK signal is defined as:

$$\Lambda_{REF} = \frac{\phi_{MAX}}{2 \cdot \pi \cdot T} = \frac{1}{T} h \cdot \zeta_{MAX} \int_{-\infty}^{\infty} g(t) \cdot dt$$

In the R&S FSV-K70 the frequency pulse filter is normalized such that

$$\int_{-\infty}^{\infty} g(t) \cdot dt = \frac{1}{2}$$

and the constellation for  $M$  FSK is assumed to be  $\{\pm 1, \pm 3, \dots, \pm(M-1)\}$ , which implies . The expression for the [reference deviation](#) in terms of the modulation index is therefore given by:

$$\Lambda_{REF} = \frac{1}{2} \cdot h \cdot (M - 1) \cdot f_{Symb}$$

The above formula provides the necessary calculation for measurement of an FSK signal with known symbol rate and modulation index.

### Calculation examples:

The GSM standard describes the transmission of binary data using MSK (i.e. 2FSK) modulation with a modulation index of  $h=1/2$  at a symbol rate of 270.8333 KHz. The reference deviation is therefore given by:

$$\Lambda_{REF} = \frac{1}{2} \cdot \left(\frac{1}{2}\right) \cdot (2 - 1) \cdot (270.8333 \text{ kHz}) = 67.7083 \text{ kHz}$$

The APCO Project 25 standard (phase 2) defines a H-CPM signal (i.e. 4FSK) with a modulation index of  $h=1/3$  and a symbol rate of 6 KHz. The reference deviation is:

$$\Lambda_{REF} = \frac{1}{2} \cdot \left(\frac{1}{3}\right) \cdot (4 - 1) \cdot (6 \text{ kHz}) = 3 \text{ kHz}$$

### 2.5.2.1 Error Model

The FSK measurement model used assumes that signal distortions in both the magnitude and phase/frequency are present, as well as additive noise. The measured signal model is expressed as:

$$MEAS(t) = A_{DIST}(t) \cdot e^{j\varphi_{DIST}(t)} + n(t)$$

with

$n(t)$  is a disturbing additive noise process of unknown power,

$A_{DIST}(t)$  is the distorted magnitude model and

$\varphi^{DIST(t)}$  is the distorted phase model.

The magnitude model is given by:

$$A_{DIST}(t) = K \cdot e^{-\alpha t}$$

with

$K$  is a constant scaling factor which can be interpreted as the system gain and

$\alpha$  is the amplitude droop in Nepers per second.

The phase model is given by:

$$\varphi_{DIST}(t) = B \cdot \varphi_{REF}(t - \tau) + C \cdot t + \frac{1}{2} D \cdot t^2 + \phi$$

with

$B$  is a scaling factor which results in a reference deviation error,

$C$  is a carrier frequency offset in radians per second,

$D$  is a frequency drift in radians per second per second,

$\tau$  is a timing offset in seconds and

$\phi$  is a phase offset in radians.

For the above phase model, an equivalent frequency distortion model may be expressed as:

$$f_{DIST}(t) = B \cdot f_{REF}(t - \tau) + f_0 + f_d \cdot t$$

with

$B$  is the scaling factor which results in a reference deviation error,

$f_0 = C / (2 \cdot \pi)$  is a carrier frequency offset in Hz,

$f_d = D / (2 \cdot \pi)$  is a frequency drift in Hz per second and

$\tau$  is the timing offset in seconds.

The measured signal model in terms of the instantaneous frequency and all distortion parameters is given by:

$$MEAS(t) = K \cdot e^{-\alpha t} \cdot e^{j\phi} \cdot e^{j2\pi \left[ B \cdot \int_{-\infty}^t f_{REF}(u - \tau) du + f_0 t + \frac{1}{2} f_d t^2 \right]} + n(t)$$

### 2.5.2.2 Estimation

The estimation of the distortion parameters listed previously is performed separately for the magnitude and phase/frequency distortions, as illustrated in Figure 2-57. It is noted that the estimation of the timing offset is performed only on the frequency of the signal, as the reference magnitude is assumed to be constant over the estimation range. For details on the estimation range, see Chapter 2.5.1.2, "Estimation", on page 52.

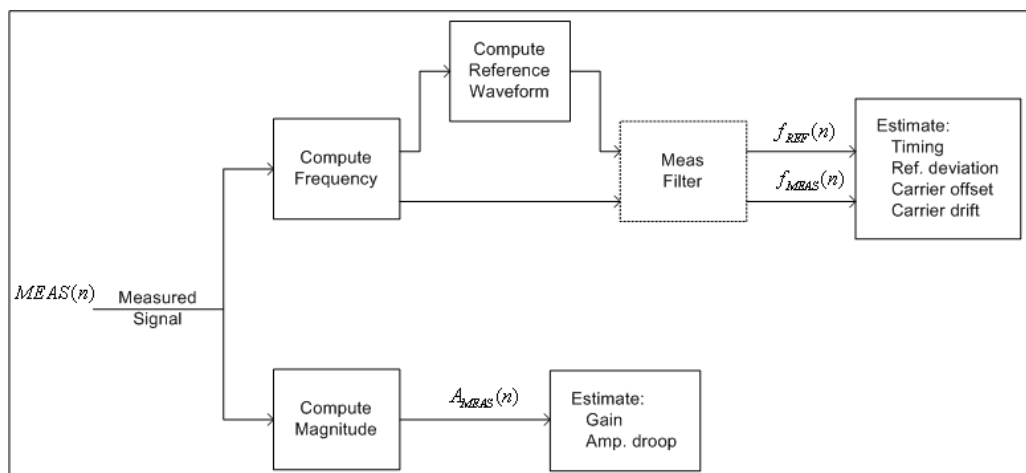


Figure 2-57: FSK Estimation Strategy

In Figure 2-57  $MEAS(n)$  denotes the sampled (complex baseband) measured signal waveform. The magnitude samples are denoted  $A_{MEAS}(n)$ , while the instantaneous frequency samples of the measured and reference signals are denoted by  $f_{MEAS}(n)$  and  $f_{REF}(n)$  respectively. The dashed outline of the "Meas Filter" block indicates that this

operation is optionally (de-) activated based on the corresponding user settings (see ["Measurement Filter"](#) on page 174 ).

For the estimation of the magnitude parameters, the following least-squares criterion is minimized:

$$C_{MAG}(K, \alpha) = \sum_n |A_{MEAS}(n) - K \cdot e^{-\alpha \cdot n \cdot T_E}|^2$$

with respect to the model parameters  $K$  and  $\alpha$ , where  $T_E$  denotes the sampling period used for estimation (see ["Estimation Points/Sym"](#) on page 172).

For estimation of the frequency parameters, the following least-squares criterion is minimized:

$$C_{FREQ}(B, f_0, f_d, \tau) = \sum_n |f_{MEAS}(n) - [B \cdot f_{REF}(n, \tau) + f_0 + f_d \cdot n \cdot T_E]|^2$$

with respect to the model parameters  $B$ ,  $f_0$ ,  $f_d$  and  $\tau$ . The term denotes the reference instantaneous frequency with a (possibly fractional) delay of samples.



For FSK modulation the default sampling period used for estimation is the capture sampling period.

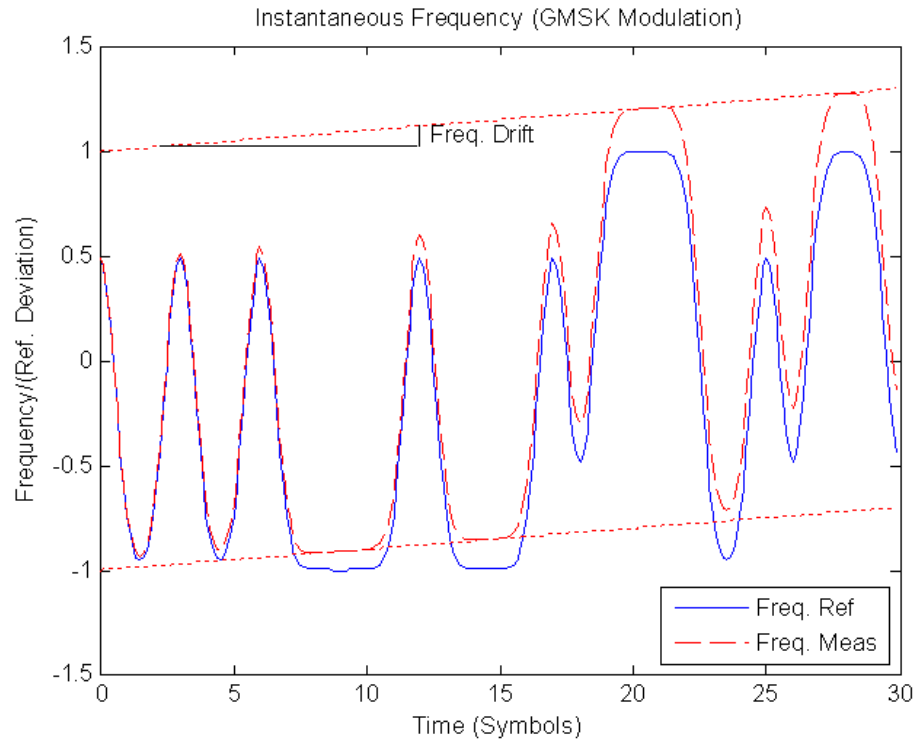
### 2.5.2.3 Modulation Errors

A 2FSK signal is generated using a GMSK frequency pulse. Examples of carrier drift and reference deviation are shown in [Figure 2-58](#) and [Figure 2-59](#) respectively.

#### Carrier frequency drift

A carrier frequency drift is modeled as a linear change in the carrier frequency with respect to time. The effect of carrier drift on the instantaneous frequency of an FSK signal is illustrated in [Figure 2-58](#).

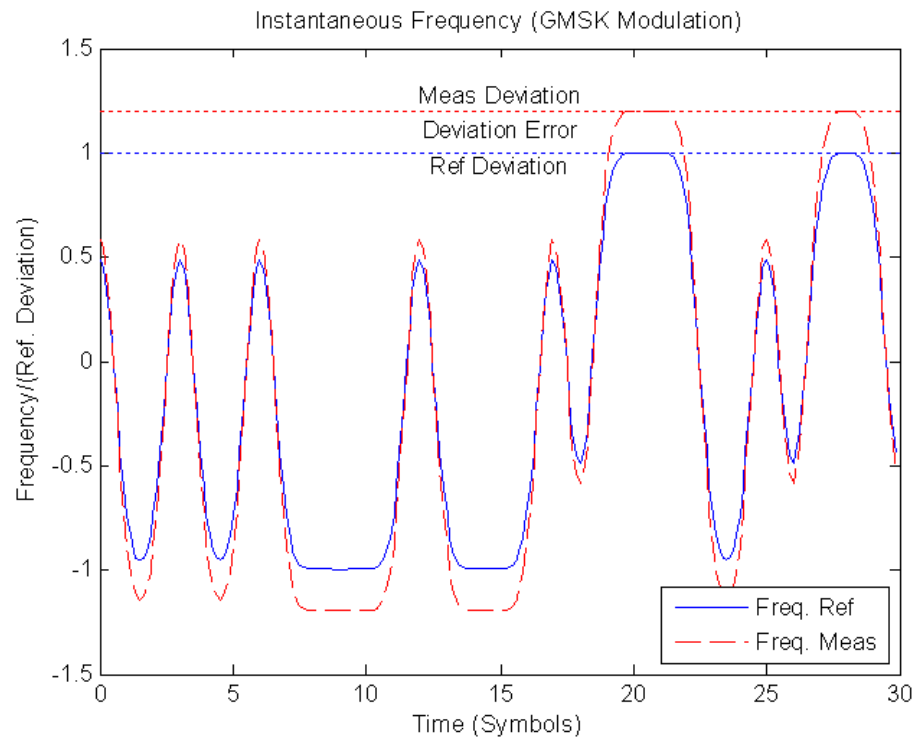




**Figure 2-58:** The reference and distorted instantaneous frequency of a GMSK signal with a carrier frequency drift

### FSK deviation error

The FSK deviation error is the difference between the measured frequency deviation and the reference frequency deviation as entered by the user (see "FSK Ref Deviation" on page 145). The evidence of a deviation error in the instantaneous frequency of an FSK signal is demonstrated in [Figure 2-59](#).



**Figure 2-59:** The reference and measured instantaneous frequency of a GMSK signal with reference deviation error

## 3 Instrument Functions for Vector Signal Analysis

### To open the VSA menu

If the "Vector Signal Analysis" (VSA) mode is not the active measurement mode, press the MODE key and select the "VSA" softkey.

If the "VSA" mode is already active, press the HOME key. The "VSA" menu is displayed.

After activation, the contents of the menus are adapted to the functions of the VSA option. The menus of the option are described in [Chapter 3.2, "Softkeys and Menu Overview for Vector Signal Analysis \(R&S FSV-K70\)"](#), on page 107

SCPI command: `INSTRument:SElect` on page 277

### Menu and Softkey Description

Apart from the "Span", "Bandwidth" and "Marker Functions" menus, which are not available in the "VSA" mode, all menus not mentioned below are provided as described for the base unit.

The MEAS key opens a submenu identical to the "VSA" menu, and additionally displays the [Chapter 3.3.1.6, "Display Configuration"](#), on page 175 dialog box when pressed.

### Measurement Result Display

Various different result displays for VSA measurements are available. The different display types are described in [Chapter 3.1, "Measurement Result Display"](#), on page 69.



### Importing and Exporting I/Q Data

As of firmware version 1.60, I/Q data can be imported from a file for processing in R&S FSV-K70, and captured I/Q data can be stored to a file ("IQ Import"/"IQ Export" softkeys in the "Save/Rcl" menu). For details see the base unit description.

### Further Information

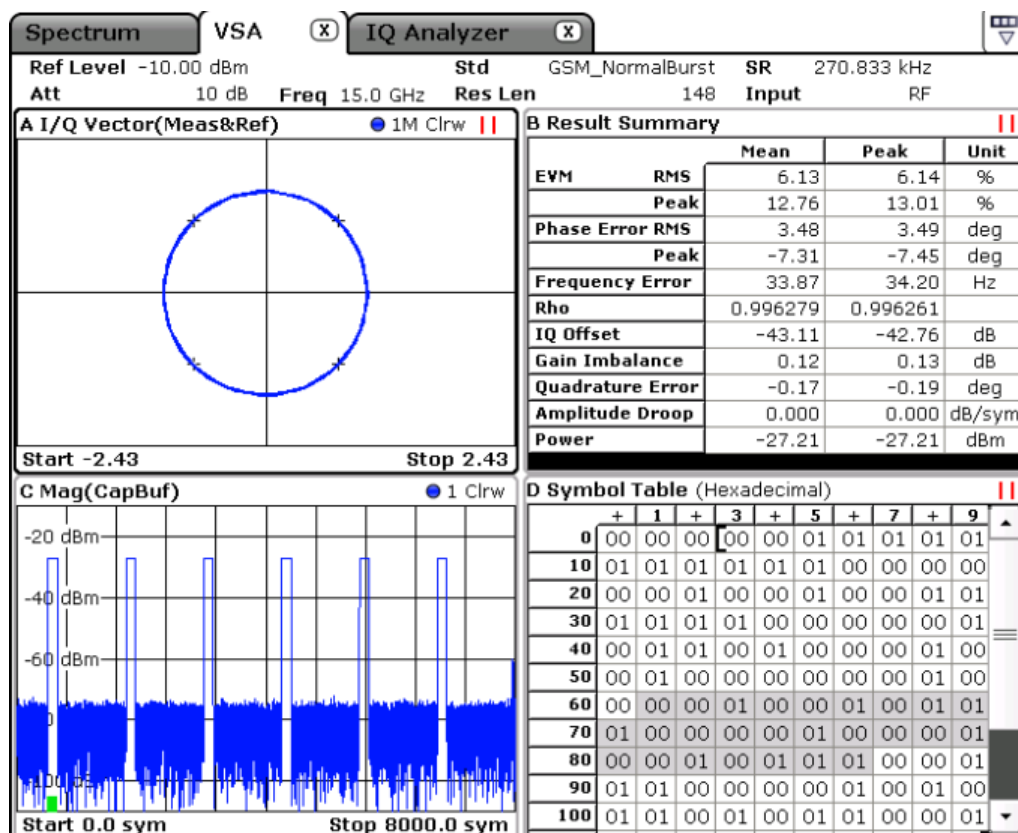
- [Chapter 3.4.1, "Trace Mode Overview"](#), on page 201
- [Chapter 3.4.2, "ASCII File Export Format for VSA Data"](#), on page 203

<b>3.1 Measurement Result Display</b> .....	<b>69</b>
3.1.1 Result types.....	70
3.1.2 Normal (Time/Symbol) Displays.....	96
3.1.3 Spectral Displays.....	97
3.1.4 Statistical Displays.....	100
3.1.5 Displayed Measurement Settings.....	102

3.1.6	Result Ranges and Evaluation Ranges.....	103
3.1.7	Saving Measurement Results.....	105
<b>3.2</b>	<b>Softkeys and Menu Overview for Vector Signal Analysis (R&amp;S FSV-K70).....</b>	<b>107</b>
3.2.1	Softkeys of the VSA menu (R&S FSV-K70).....	107
3.2.2	Softkeys of the Frequency Menu (R&S FSV-K70) .....	110
3.2.3	Softkeys of the Amplitude Menu (R&S FSV-K70) .....	110
3.2.4	Softkeys of the Auto Set Menu (R&S FSV-K70).....	116
3.2.5	Softkeys of the Sweep Menu (R&S FSV-K70).....	118
3.2.6	Softkeys of the Trace Menu (R&S FSV-K70).....	120
3.2.7	Softkeys of the Trigger Menu (R&S FSV-K70).....	124
3.2.8	Softkeys of the Meas Config Menu (R&S FSV-K70).....	126
3.2.9	Softkeys of the Marker Menu (R&S FSV-K70).....	128
3.2.10	Softkeys of the Marker To Menu (R&S FSV-K70).....	130
3.2.11	Softkeys of the Lines Menu.....	132
3.2.12	Softkeys of the Input/Output menu (R&S FSV-K70).....	136
3.2.13	Softkeys of the Save/Recall Menu (R&S FSV-K70).....	139
3.2.14	Available Context Menus.....	140
<b>3.3</b>	<b>Configuring VSA Measurements.....</b>	<b>141</b>
3.3.1	Settings Overview.....	141
3.3.2	Defining the Result Range.....	181
3.3.3	Changing the Display Scaling.....	184
3.3.4	Managing standard settings files.....	187
3.3.5	Working with Pattern Searches.....	189
3.3.6	Managing patterns.....	191
3.3.7	Working With Known Data Files.....	194
3.3.8	Working with Limits for Modulation Accuracy Measurements.....	199
3.3.9	Measuring the Size of an Eye.....	200
<b>3.4</b>	<b>Further Information.....</b>	<b>201</b>
3.4.1	Trace Mode Overview.....	201
3.4.2	ASCII File Export Format for VSA Data.....	203

### 3.1 Measurement Result Display

Various different result displays for VSA measurements are available. You select the display using the "Display Config" softkey in the "VSA" menu (see [Chapter 3.3.1.6, "Display Configuration"](#), on page 175), or by pressing the MEAS key. Which result types are available depends on the selected data source. Furthermore, for some result types, you can display either spectral, statistical, or time domain results. You can define which part of the signal is to be evaluated and configure the alignment of the result range (see [Chapter 3.3.1.4, "Result Range and Evaluation Range Settings"](#), on page 165). You can also define how detailed the trace is displayed ([Display Points/Sym](#) parameter in the "Display Configuration" dialog).



#### Distinction between Source, Result type and Result type transformation

The "Display Config" dialog provides the following settings:

- **Source**  
Here you can choose the data source for which you want to display the results.
- **Result type**  
Here you can specify the way you want to look at the "Source". For example, select "Magnitude Absolute" to see the magnitude of your measurement signal. The available choices depend on the selected source. For example, an eye diagram of the inphase component can only be selected if the source for the current screen is "Meas & Ref Signal".
- **Result type transformation**

For certain result types it is not only possible to see the common "over time" representation of the measurement, but also the spectrum or the statistics (in form of a histogram). Furthermore, it is possible to specify how many points (i.e. samples) per symbol should be displayed. For example, it might make sense for certain measurement results to only display the symbol instants. In this case, the parameter "Display Points/Sym" should be set to 1.

• Result types.....	70
• Normal (Time/Symbol) Displays.....	96
• Spectral Displays.....	97
• Statistical Displays.....	100
• Displayed Measurement Settings.....	102
• Result Ranges and Evaluation Ranges.....	103
• Saving Measurement Results.....	105

### 3.1.1 Result types

The following result types are available, depending on the source type:

• Magnitude Absolute.....	70
• Magnitude Relative.....	71
• Phase Wrap.....	72
• Phase Unwrap.....	73
• Frequency Absolute.....	74
• Frequency Relative.....	75
• Real/Imag (I/Q).....	76
• Eye Diagram Real (I).....	77
• Eye Diagram Imag (Q).....	78
• Eye Diagram Frequency.....	79
• Constellation I/Q.....	80
• Constellation I/Q (Rotated).....	80
• Vector I/Q.....	81
• Constellation Frequency.....	82
• Vector Frequency.....	83
• Symbol Table.....	83
• Error Vector Magnitude (EVM).....	84
• Magnitude Error.....	85
• Phase Error.....	86
• Frequency Error Absolute.....	87
• Frequency Error Relative.....	88
• Result Summary.....	89
• Bit Error Rate (BER).....	95

#### 3.1.1.1 Magnitude Absolute

Magnitude of the source signal; the actual signal amplitude is displayed

$$Mag_{MEAS}(t) = |MEAS(t)|$$

with  $t=n \cdot T_D$  and  $T_D$ =the duration of one sampling period at the sample rate defined by the display points per symbol parameter (see "Display Points/Sym" on page 179).

Available for source types:

- Capture Buffer
- Meas & Ref Signal

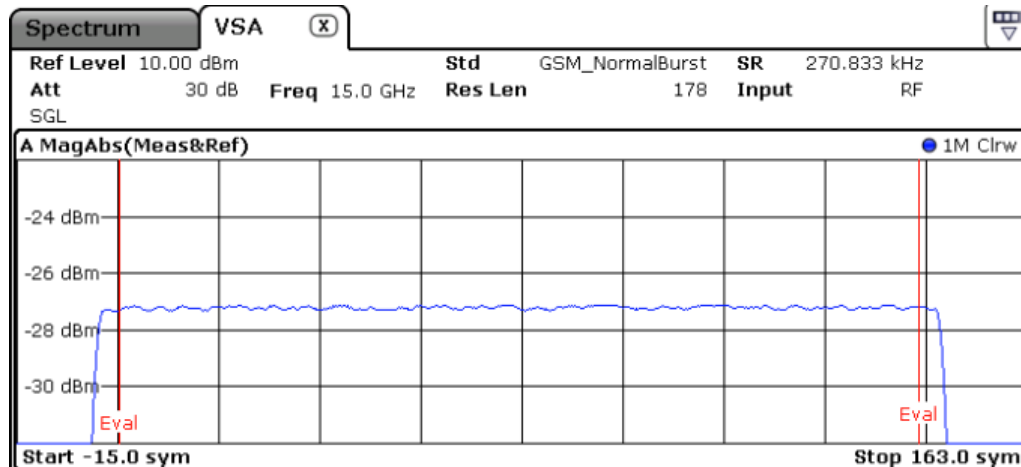


Figure 3-1: Result display "Magnitude Absolute" in normal mode

#### SCPI commands:

```
CALC:FEED 'XTIM:DDEM:MEAS'
```

to define the required source type (see [CALCulate<n>:FEED](#) on page 247)

```
CALC:FORM MAGN
```

to define the result type (see [CALCulate<n>:FORMat](#) on page 247)

```
TRAC:DATA
```

to query the trace results (see [TRACe<n>\[:DATA\]](#) on page 325)

#### 3.1.1.2 Magnitude Relative

Magnitude of the source signal; the signal amplitude is scaled to the ideal reference signal

Available for source types:

- Meas & Ref Signal

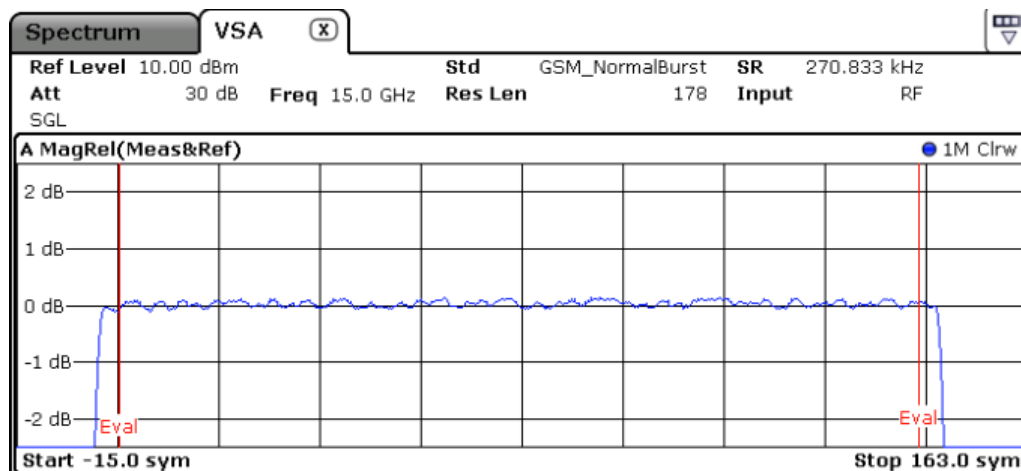


Figure 3-2: Result display "Magnitude Relative" in normal mode

#### SCPI commands:

```
CALC:FEED 'XTIM:DDEM:MEAS'
```

to define the required source type (see [CALCulate<n>:FEED](#) on page 247)

```
CALC:FORM MAGN
```

to define the result type (see [CALCulate<n>:FORMat](#) on page 247)

```
DISP:TRAC:Y:MODE REL
```

to define relative values (see [DISPlay\[:WINDow<n>\]:TRACe<t>:Y\[:SCALE\]:MODE](#) on page 263)

```
TRAC:DATA TRACE1
```

to query the trace results (see [TRACe<n>\[:DATA\]](#) on page 325)

#### 3.1.1.3 Phase Wrap

The phase or argument of the signal; the display is limited to the phase value range of  $[-180^\circ, 180^\circ]$

$$Phase_{MEAS}(t) = \angle(MEAS(t))$$

with  $t=n \cdot T_D$  and  $T_D$ =the duration of one sampling period at the sample rate defined by the display points per symbol parameter (see ["Display Points/Sym"](#) on page 179).

Available for source types:

- Meas & Ref Signal



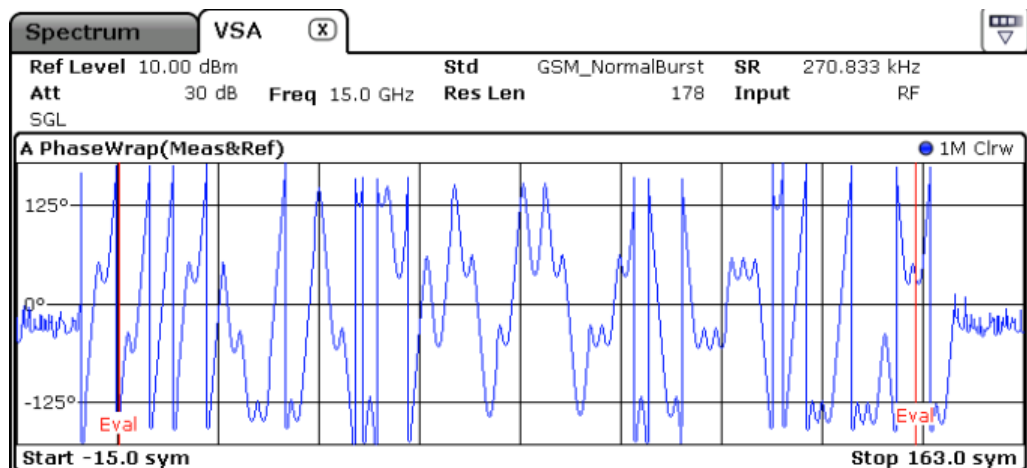


Figure 3-3: Result display "Phase Wrap" in normal mode

#### SCPI commands:

```
CALC:FEED 'XTIM:DDEM:MEAS'
```

to define the required source type (see [CALCulate<n>:FEED](#) on page 247)

```
CALC:FORM PHASe
```

to define the result type (see [CALCulate<n>:FORMat](#) on page 247)

```
TRAC:DATA TRACE1
```

to query the trace results (see [TRACe<n>\[:DATA\]](#) on page 325)

#### 3.1.1.4 Phase Unwrap

The phase of the signal; the display is not limited to  $[-180^\circ, 180^\circ]$ .

Available for source types:

- Meas & Ref Signal

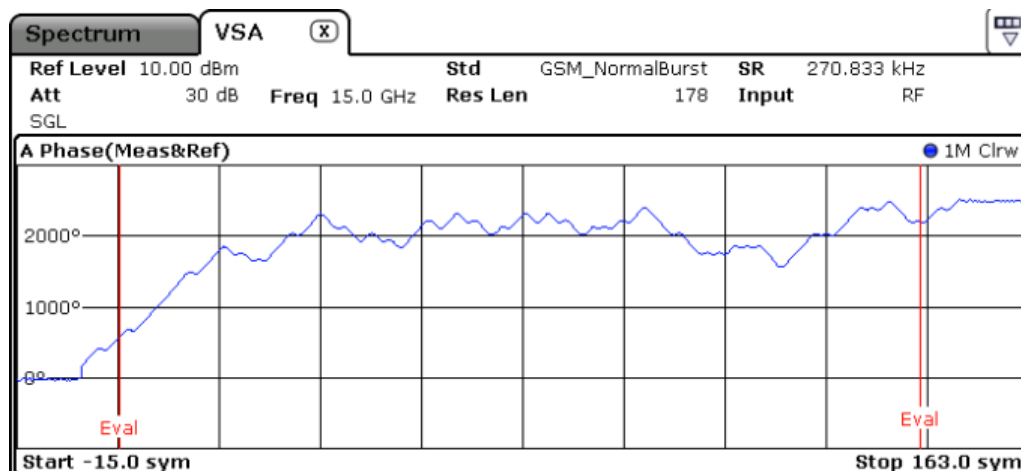


Figure 3-4: Result display "Phase Unwrap" in normal mode

#### SCPI commands:

```
CALC:FEED 'XTIM:DDEM:MEAS'
```

to define the required source type (see [CALCulate<n>:FEED](#) on page 247)

```
CALC:FORM UPhase
```

to define the result type (see [CALCulate<n>:FORMat](#) on page 247)

```
TRAC:DATA TRACE1
```

to query the trace results (see [TRACe<n>\[:DATA\]](#) on page 325)

#### 3.1.1.5 Frequency Absolute

The instantaneous frequency of the signal source; the absolute value is displayed in Hz.

Available for source types:

- Meas & Ref Signal
- Capture Buffer

##### Meas&Ref signal:

$$FREQ_{MEAS}(t) = \frac{1}{2 \cdot \pi} \frac{d}{dt} \angle MEAS(t)$$

with  $t = n \cdot T_D$  and  $T_D$  = the duration of one sampling period at the sample rate defined by the display points per symbol parameter (see "[Display Points/Sym](#)" on page 179).

##### Capture buffer:

$$FREQ_{CAPT.}(t) = \frac{1}{2 \cdot \pi} \frac{d}{dt} \angle Capt(t)$$

When evaluating the capture buffer, the absolute frequency is derived from the measured phase, with  $T_D$  = the duration of one sampling period at the sample rate defined by the capture oversampling parameter (see "Capture Oversampling" on page 154).



This measurement is mainly of interest when using the MSK or FSK modulation, but can also be used for the PSK/QAM modulations. However, since these modulations can have transitions through zero in the I/Q plane, in this case you might notice uncritical spikes. This is due to the fact that the phase of zero (or a complex value close to zero) is of limited significance, but still influences the result of the instantaneous frequency measurement.

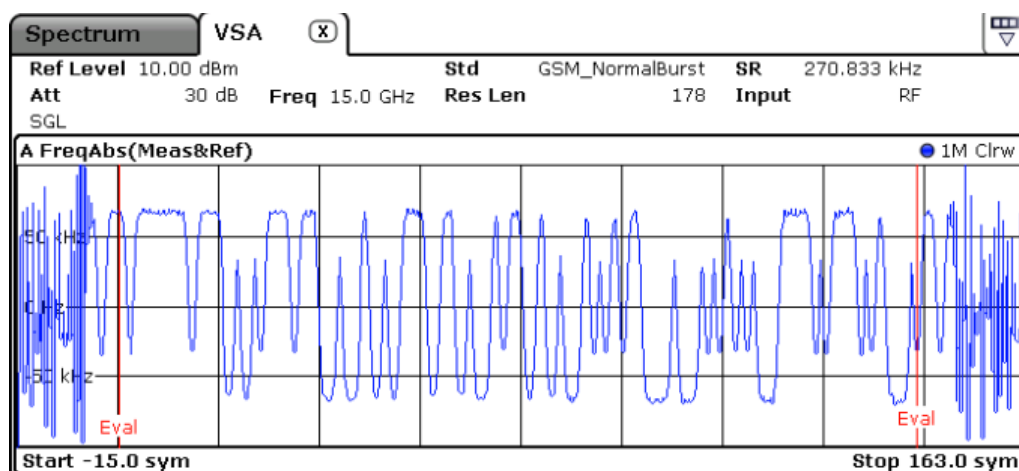


Figure 3-5: Result display "Frequency Absolute" in normal mode

#### SCPI commands:

```
CALC:FEED 'XTIM:DDEM:MEAS'
```

to define the required source type (see [CALCulate<n>:FEED](#) on page 247)

```
CALC:FORM FREQ
```

to define the result type (see [CALCulate<n>:FORMat](#) on page 247)

```
TRAC:DATA TRACE1
```

to query the trace results (see [TRACe<n>\[:DATA\]](#) on page 325)

#### 3.1.1.6 Frequency Relative

The instantaneous frequency of the signal source.

The results are normalized to the symbol rate (PSK and QAM modulated signals), the estimated FSK deviation (FSK modulated signals) or one quarter of the symbol rate (MSK modulated signals).

$$FREQ_{MEAS}(t) = \frac{1}{2 \cdot \pi} \frac{d}{dt} \angle MEAS(t)$$

with  $t=n \cdot T_D$  and  $T_D$ =the duration of one sampling period at the sample rate defined by the display points per symbol parameter (see "Display Points/Sym" on page 179).



This measurement is mainly of interest when using the MSK or FSK modulation, but can also be used for the PSK/QAM modulations. See also the note for [Frequency Absolute](#).

Available for source types:

- Meas & Ref Signal

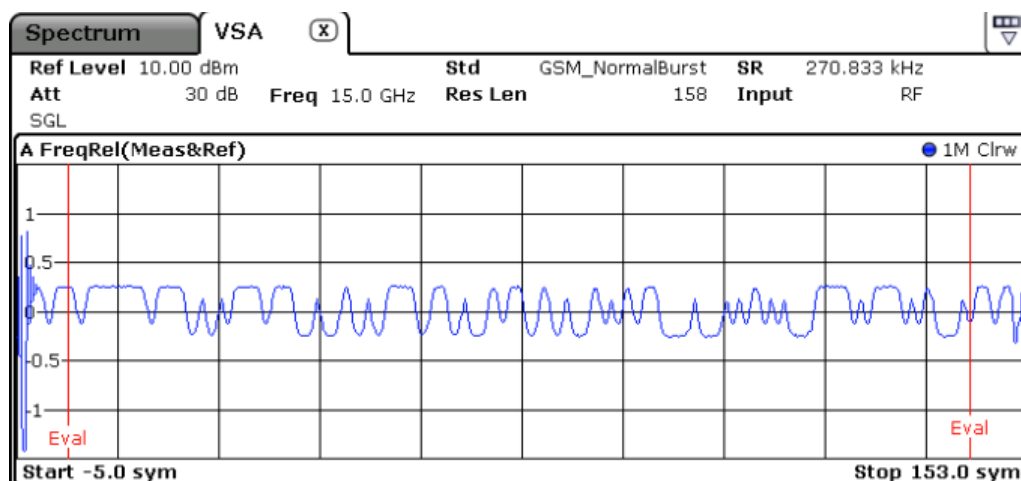


Figure 3-6: Result display "Frequency Relative" in normal mode

#### SCPI commands:

```
CALC:FEED 'XTIM:DDEM:MEAS'
```

to define the required source type (see [CALCulate<n>:FEED](#) on page 247)

```
CALC:FORM FREQ
```

to define the result type (see [CALCulate<n>:FORMat](#) on page 247)

```
DISP:TRAC:Y:MODE REL
```

to define relative values (see [DISPlay\[:WINDow<n>\]:TRACe<t>:Y\[:SCALE\]:MODE](#) on page 263)

```
TRAC:DATA TRACE1
```

to query the trace results (see [TRACe<n>\[:DATA\]](#) on page 325)

#### 3.1.1.7 Real/Imag (I/Q)

Real and imaginary part of the measurement or reference signal in separate measurement diagrams; the x-axis (scaled in time units or symbols) is identical for both diagrams

The scaling of the capture buffer is

- relative to the current reference level if you are using the RF input and
- relative to the full scale level if you are using the I/Q input

Available for source types:

- Capture Buffer
- Meas & Ref Signal
- Error Vector

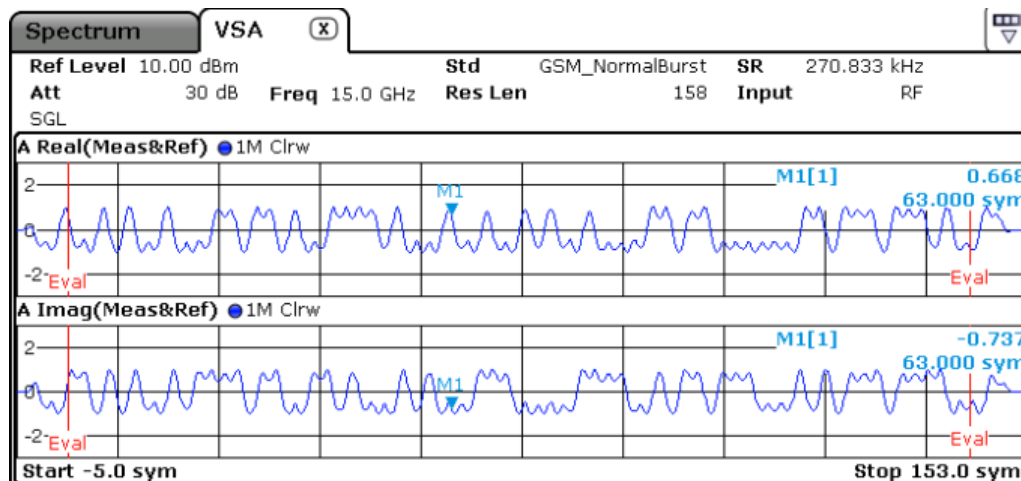


Figure 3-7: Result display "Real/Imag (I/Q)" in normal mode

#### SCPI commands:

```
CALC:FEED 'XTIM:DDEM:MEAS'
```

to define the required source type (see [CALCulate<n>:FEED](#) on page 247)

```
CALC:FORM RIMag
```

to define the result type (see [CALCulate<n>:FORMat](#) on page 247)

```
TRAC:DATA TRACE1
```

to query the trace results (see [TRACe<n>\[:DATA\]](#) on page 325)

#### 3.1.1.8 Eye Diagram Real (I)

The eye pattern of the inphase (I) channel; the x-axis value range is from -1 to +1 symbols (MSK: -2 to +2)

Available for source types:

- Meas & Ref Signal



Display lines are available in eye diagrams which allow you to determine the size of the eye, see also [Chapter 3.3.9, "Measuring the Size of an Eye"](#), on page 200.

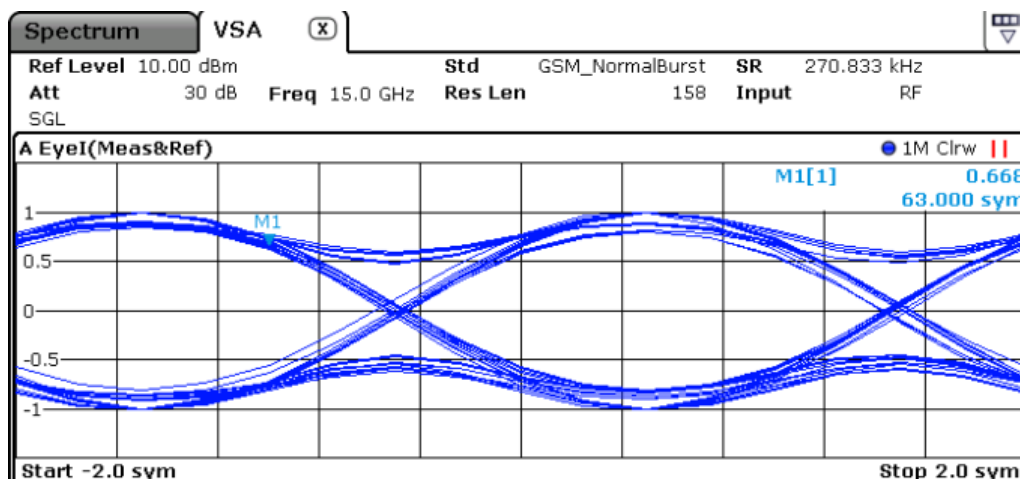


Figure 3-8: Result display "Eye Diagram Real (I)" in normal mode

#### SCPI commands:

```
CALC:FEED 'XTIM:DDEM:MEAS'
```

to define the required source type (see [CALCulate<n>:FEED](#) on page 247)

```
CALC:FORM IEYE
```

to define the result type (see [CALCulate<n>:FORMat](#) on page 247)

```
TRAC:DATA TRACE1
```

to query the trace results (see [TRACe<n>\[:DATA\]](#) on page 325)

#### 3.1.1.9 Eye Diagram Imag (Q)

The eye pattern of the quadrature (Q) channel; the x-axis range is from -1 to +1 symbols (MSK: -2 to +2)

Available for source types:

- Meas & Ref Signal



Display lines are available in eye diagrams which allow you to determine the size of the eye, see also [Chapter 3.3.9, "Measuring the Size of an Eye"](#), on page 200.

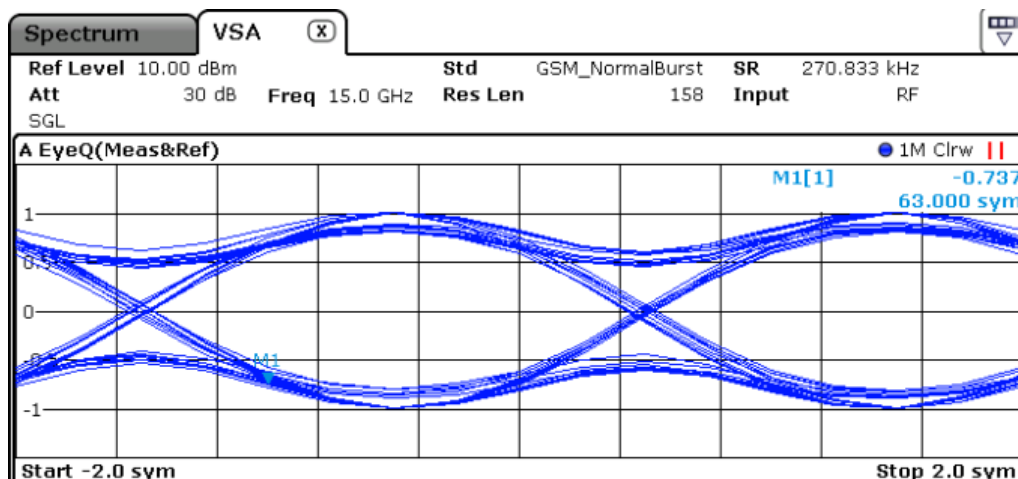


Figure 3-9: Result display "Eye Diagram Imag (Q)" in normal mode

#### SCPI commands:

```
CALC:FEED 'XTIM:DDEM:MEAS'
```

to define the required source type (see [CALCulate<n>:FEED](#) on page 247)

```
CALC:FORM QEYE
```

to define the result type (see [CALCulate<n>:FORMat](#) on page 247)

```
TRAC:DATA TRACE1
```

to query the trace results (see [TRACe<n>\[:DATA\]](#) on page 325)

#### 3.1.1.10 Eye Diagram Frequency

Shows the eye diagram of the currently measured frequencies and/or the reference signal. The time span of the data depends on the evaluation range (capture buffer).

Available for source types:

- Meas & Ref Signal



Display lines are available in eye diagrams which allow you to determine the size of the eye, see also [Chapter 3.3.9, "Measuring the Size of an Eye"](#), on page 200.

#### SCPI commands:

```
CALC:FEED 'XTIM:DDEM:MEAS'
```

to define the required source type (see [CALCulate<n>:FEED](#) on page 247)

```
CALC:FORM FEYE
```

to define the result type (see [CALCulate<n>:FORMat](#) on page 247)

```
TRAC:DATA TRACE1
```

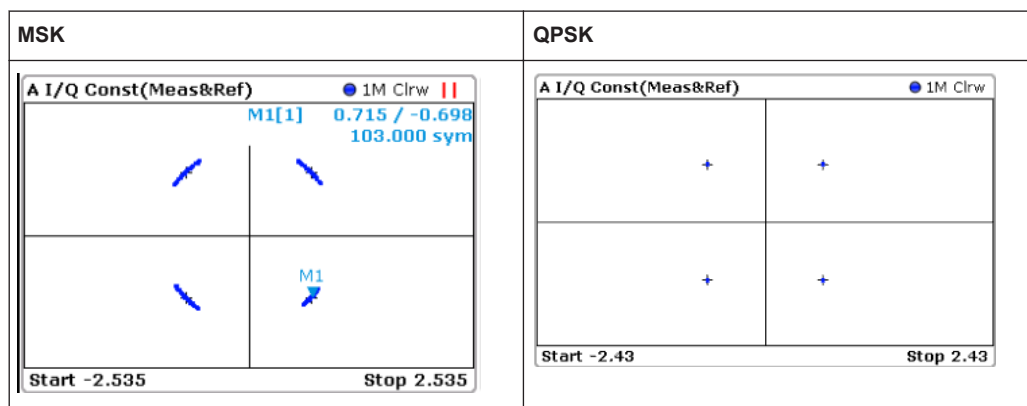
to query the trace results (see [TRACe<n>\[:DATA\]](#) on page 325)

### 3.1.1.11 Constellation I/Q

The complex source signal (without inter-symbol interference) as an X/Y plot; only the (de-rotated) symbol decision instants are drawn and not connected

Available for source types:

- Meas & Ref Signal



#### SCPI commands:

```
CALC:FEED 'XTIM:DDEM:MEAS'
```

to define the required source type (see [CALCulate<n>:FEED](#) on page 247)

```
CALC:FORM CONS
```

to define the result type (see [CALCulate<n>:FORMat](#) on page 247)

```
TRAC:DATA TRACE1
```

to query the trace results (see [TRACe<n>\[:DATA\]](#) on page 325)

### 3.1.1.12 Constellation I/Q (Rotated)

The complex source signal as an X/Y plot; As opposed to the common Constellation I/Q display, the symbol decision instants, *including the rotated ones*, are drawn and not connected

Available for source types:

- Meas & Ref Signal  
This result type is only available for signals with a rotating modulation.



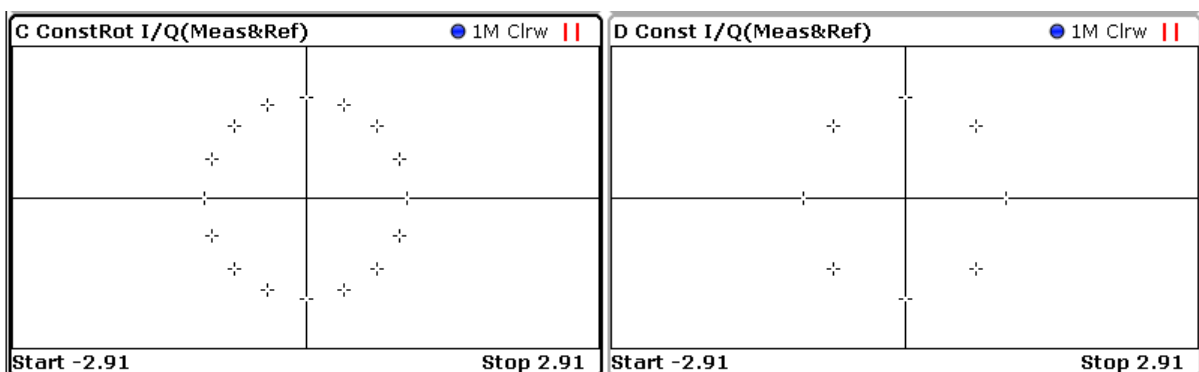


Figure 3-10: Result display "Constellation I/Q (Rotated)" vs. common "Constellation I/Q" for 8PSK modulation

#### SCPI commands:

```
CALC:FEED 'XTIM:DDEM:MEAS'
```

to define the required source type (see [CALCulate<n>:FEED](#) on page 247)

```
CALC:FORM RCON
```

to define the result type (see [CALCulate<n>:FORMat](#) on page 247)

```
TRAC:DATA TRACE1
```

to query the trace results (see [TRACe<n>\[:DATA\]](#) on page 325)

#### 3.1.1.13 Vector I/Q

The complex source signal as an X/Y plot; all available samples (as defined by the display points per symbol parameter, see "Display Points/Sym" on page 179) are drawn and connected.

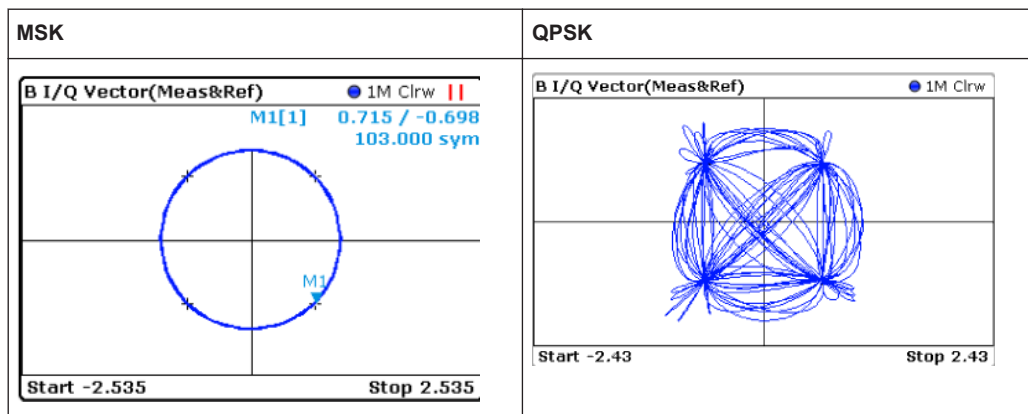


The scaling of the capture buffer is:

- relative to the current reference level if you are using the RF input
- relative to the full scale level if you are using the I/Q input

Available for source types:

- Capture Buffer
- Meas & Ref Signal
- Error Vector



**SCPI commands:**

CALC:FEED 'XTIM:DDEM:MEAS'

to define the required source type (see CALCulate<n>:FEED on page 247)

CALC:FORM COMP

to define the result type (see CALCulate<n>:FORMat on page 247)

TRAC:DATA TRACE1

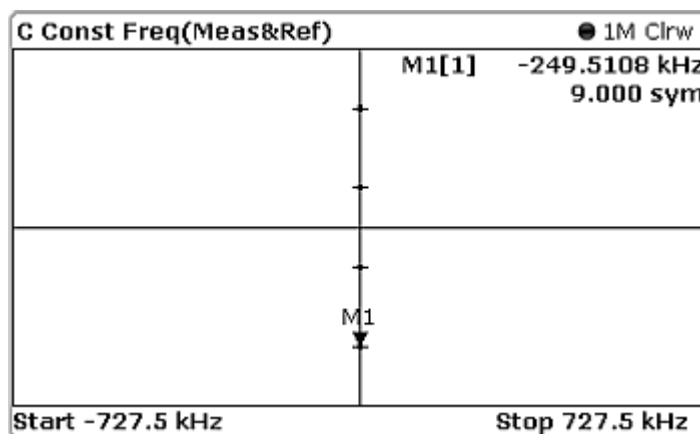
to query the trace results (see TRACe<n>[:DATA] on page 325)

**3.1.1.14 Constellation Frequency**

The instantaneous frequency of the source signal (without inter-symbol interference) as an X/Y plot; only the symbol decision instants are drawn and not connected.

Available for source types:

- Meas & Ref Signal



**SCPI commands:**

CALC:FEED 'XTIM:DDEM:MEAS'

to define the required source type (see `CALCulate<n>:FEED` on page 247)

```
CALC:FORM CONF
```

to define the result type (see `CALCulate<n>:FORMat` on page 247)

```
TRAC:DATA TRACE1
```

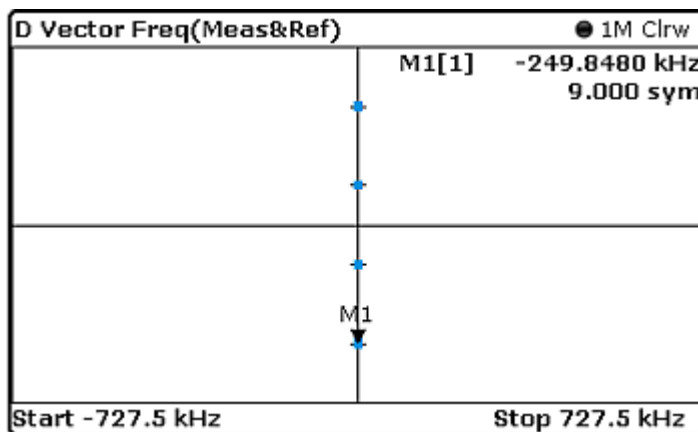
to query the trace results (see `TRACe<n>[:DATA]` on page 325)

### 3.1.1.15 Vector Frequency

The instantaneous frequency of the source signal as an X/Y plot; all available samples (as defined by the display points per symbol parameter (see "Display Points/Sym" on page 179)) are drawn and connected.

Available for source types:

- Meas & Ref Signal



#### SCPI commands:

```
CALC:FEED 'XTIM:DDEM:MEAS'
```

to define the required source type (see `CALCulate<n>:FEED` on page 247)

```
CALC:FORM COVF
```

to define the result type (see `CALCulate<n>:FORMat` on page 247)

```
TRAC:DATA TRACE1
```

to query the trace results (see `TRACe<n>[:DATA]` on page 325)

### 3.1.1.16 Symbol Table

Symbol numbers are displayed as a table. Each symbol is represented by an entry in the table. The symbols can be displayed in binary, octal, hexadecimal or decimal format.

**Example:**

A Symbol Table (Binary)																									
	+	1	+	3	+	5	+	7	+	9	+	11	+	13	+	15	+	17	+	19	+	21	+	23	+
0	01	01	00	01	00	10	00	01	10	01	11	00	00	10	11	11	01	10	11	00	11	01	00	00	11
25	10	11	11	00	00	11	11	11	11	10	00	00	11	11	01	11	11	00	01	01	11	00	11	00	10
50	00	00	10	01	01	00	11	10	11	01	00	01	11	10	01	11	11	00	11	01	10	00	10	10	10
75	01	00	01	11	00	01	10	11	01	01	01	11	00	01	00	11	00	01	00	01	00	00	00	00	10

Figure 3-11: Result display for "Symbols" in binary mode

If a pattern search is active, a found pattern is indicated in the symbol table, as well.

**SCPI commands:**

```
CALC:FEED 'XTIM:DDEM:SYMB'
```

to define the required source type (see `CALCulate<n>:FEED` on page 247)

```
TRAC:DATA TRACE1
```

to query the trace results (see `TRACe<n>[:DATA]` on page 325)

**3.1.1.17 Error Vector Magnitude (EVM)**

Displays the error vector magnitude as a function of symbols or time.

$$EVM(t) = \frac{|EV(t)|}{C}$$

with  $t=n \cdot T_D$  and  $T_D$ =the duration of one sampling period at the sample rate defined by the display points per symbol parameter (see "Display Points/Sym" on page 179).

The normalization constant  $C$  is chosen according to the EVM normalization. By default  $C^2$  is the mean power of the reference signal.

$$C = \sqrt{\frac{1}{K} \sum_k |REF(k \cdot T)|^2}$$

and

$T$  = duration of symbol periods

Note that  $k=0.5 \cdot n \cdot T$  for Offset QPSK with inactive Offset EVM.

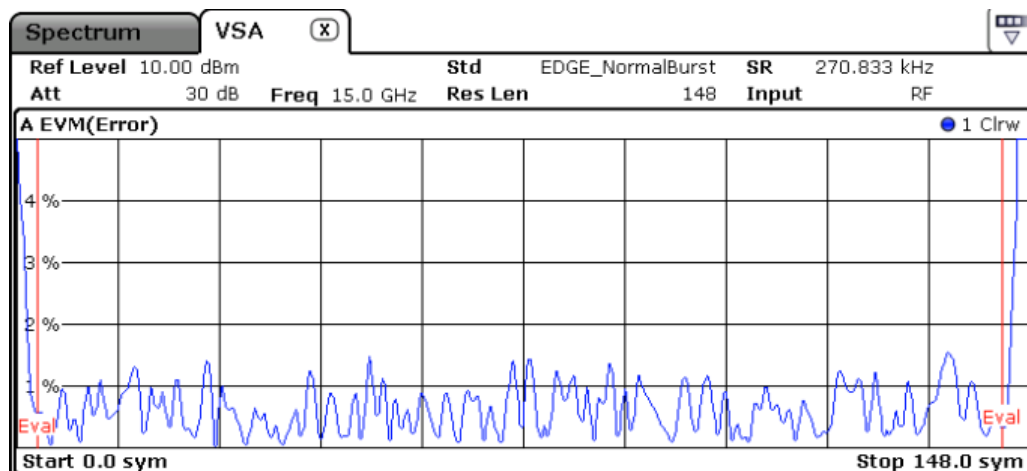


Figure 3-12: Result display "Error Vector Magnitude" in normal mode

Available for source types:

- Error Vector

#### SCPI commands:

```
CALC:FEED 'XTIM:DDEM:ERR:VECT'
```

to define the required source type (see [CALCulate<n>:FEED](#) on page 247)

```
CALC:FORM MAGN
```

to define the result type (see [CALCulate<n>:FORMat](#) on page 247)

```
TRAC:DATA TRACE1
```

to query the trace results (see [TRACe<n>\[:DATA\]](#) on page 325)

#### 3.1.1.18 Magnitude Error

Displays the magnitude error of the measurement signal with respect to the reference signal (as a function of symbols over time)

$$MAG\_ERR(t) = MAG_{MEAS}(t) - MAG_{REF}(t)$$

with  $t = n \cdot T_D$  and  $T_D$  = the duration of one sampling period at the sample rate defined by the display points per symbol parameter (see ["Display Points/Sym"](#) on page 179).

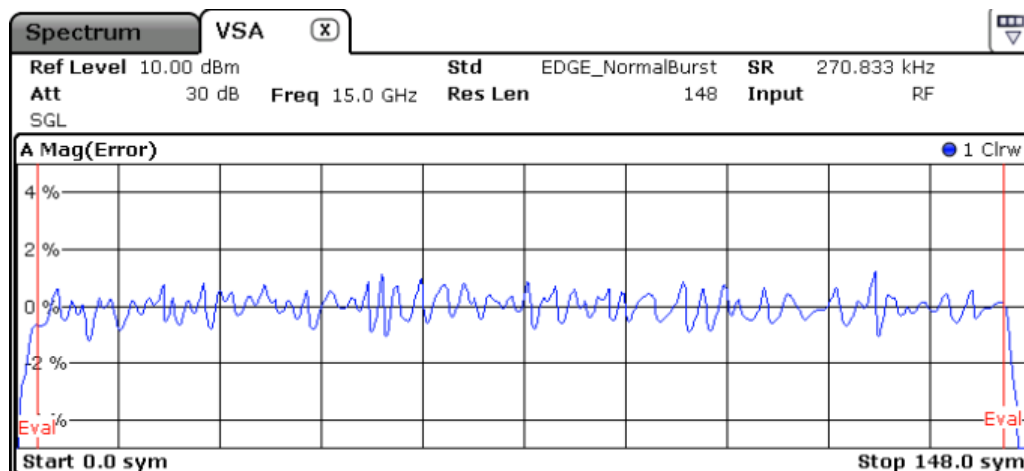


Figure 3-13: Result display "Magnitude Error" in normal mode

Available for source types:

- Modulation Errors

#### SCPI commands:

```
CALC:FEED 'XTIM:DDEM:ERR:MPH'
```

to define the required source type (see [CALCulate<n>:FEED](#) on page 247)

```
CALC:FORM MAGN
```

to define the result type (see [CALCulate<n>:FORMat](#) on page 247)

```
TRAC:DATA TRACE1
```

to query the trace results (see [TRACe<n>\[:DATA\]](#) on page 325)

#### 3.1.1.19 Phase Error

Displays the phase error of the measurement signal with respect to the reference signal as a function of symbols over time.

$$PHASE\_ERR(t) = PHASE_{MEAS}(t) - PHASE_{REF}(t)$$

with  $t = n \cdot T_D$  and  $T_D$  = the duration of one sampling period at the sample rate defined by the display points per symbol parameter (see ["Display Points/Sym"](#) on page 179).

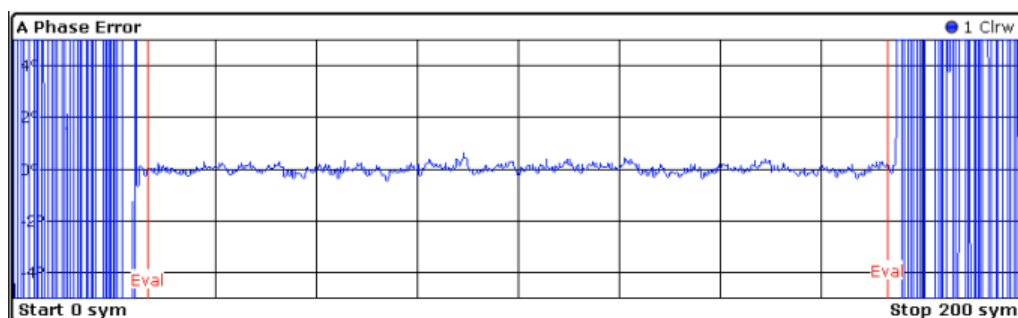


Figure 3-14: Result display "Phase Error" in normal mode

Available for source types:

- Modulation Errors

#### SCPI commands:

```
CALC:FEED 'XTIM:DDEM:ERR:MPH'
```

to define the required source type (see [CALCulate<n>:FEED](#) on page 247)

```
CALC:FORM PHAS
```

to define the result type (see [CALCulate<n>:FORMat](#) on page 247)

```
TRAC:DATA TRACE1
```

to query the trace results (see [TRACe<n>\[:DATA\]](#) on page 325)

#### 3.1.1.20 Frequency Error Absolute

Displays the error of the instantaneous frequency in Hz of the measurement signal with respect to the reference signal as a function of symbols over time.

$$FREQ\_ERR(t) = FREQ_{MEAS}(t) - FREQ_{REF}(t)$$

with  $t = n \cdot T_D$  and  $T_D$  = the duration of one sampling period at the sample rate defined by the display points per symbol parameter (see ["Display Points/Sym"](#) on page 179).

Note that this measurement does not consider a possible carrier frequency offset. This has already been compensated for in the measurement signal.



This measurement is mainly of interest when using the MSK or FSK modulation, but can also be used for the PSK/QAM modulations. However, since these modulations can have transitions through zero in the I/Q plane, in this case you might notice uncritical spikes. This is due to the fact that the phase of zero (or a complex value close to zero) has in fact limited significance, but still influences the result of the current frequency measurement.

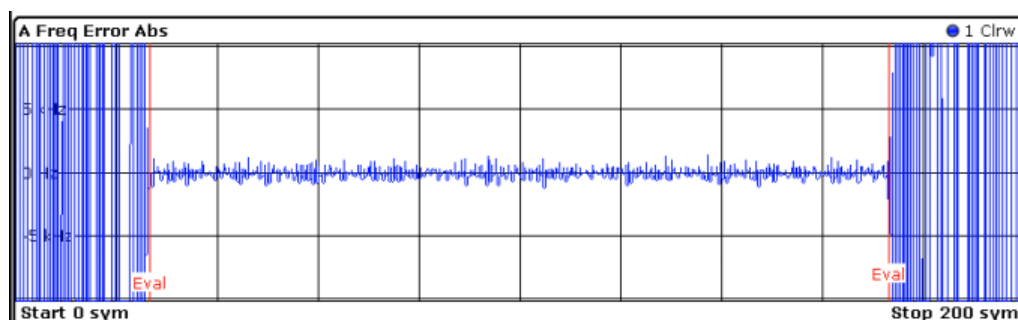


Figure 3-15: Result display "Frequency Error Absolute" in normal mode

Available for source types:

- Modulation Errors

#### SCPI commands:

```
CALC:FEED 'XTIM:DDEM:ERR:MPH'
```

to define the required source type (see [CALCulate<n>:FEED](#) on page 247)

```
CALC:FORM FREQ
```

to define the result type (see [CALCulate<n>:FORMat](#) on page 247)

```
TRAC:DATA TRACE1
```

to query the trace results (see [TRACe<n>\[:DATA\]](#) on page 325)

#### 3.1.1.21 Frequency Error Relative

Displays the error of the instantaneous frequency of the measurement signal with respect to the reference signal as a function of symbols over time.

The results are normalized to the symbol rate (PSK and QAM modulated signals), the estimated FSK deviation (FSK modulated signals) or one quarter of the symbol rate (MSK modulated signals).

$$FREQ\_ERR(t) = FREQ_{MEAS}(t) - FREQ_{REF}(t)$$

with  $t = n \cdot T_D$  and  $T_D$  = the duration of one sampling period at the sample rate defined by the display points per symbol parameter (see ["Display Points/Sym"](#) on page 179).



This measurement is mainly of interest when using the MSK or FSK modulation, but can also be used for the PSK/QAM modulations. See also the note for [Frequency Error Absolute](#).



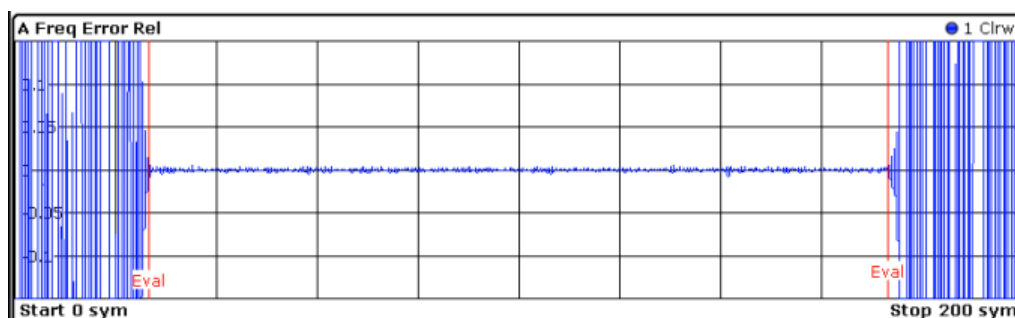


Figure 3-16: Result display "Frequency Error Relative" in normal mode

Available for source types:

- Modulation Errors

#### SCPI commands:

```
CALC:FEED 'XTIM:DDEM:ERR:MPH'
```

to define the required source type (see [CALCulate<n>:FEED](#) on page 247)

```
CALC:FORM FREQ
```

to define the result type (see [CALCulate<n>:FORMat](#) on page 247)

```
DISP:TRAC:Y:MODE REL
```

to define relative values (see [DISPlay\[:WINDow<n>\]:TRACe<t>:Y\[:SCALE\]:MODE](#) on page 263)

```
TRAC:DATA TRACE1
```

to query the trace results (see [TRACe<n>\[:DATA\]](#) on page 325)

#### 3.1.1.22 Result Summary

Shows the Modulation Accuracy results in a table.

Depending on the modulation type you are using, the result summary shows different measurement results.

Details concerning the specific measurement results can be found in [Chapter A.1, "Formulae"](#), on page 359.

## PSK, QAM and MSK modulation

Spectrum		VSA					
Ref Level	-10.00 dBm	Std	EDGE_8PSK	SR	270.833 kHz		
Att	10 dB	Freq	1.0 GHz	Res Len	148		
SGL ResRange Count 109 BURST PATTERN							
B Result Summary							
		Current	Mean	Peak	StdDev	95%ile	Unit
EVM	RMS	0.20	0.21	0.28	0.02	0.23	%
	Peak	0.47	0.59	1.00	0.09	0.73	%
MER	RMS	53.96	53.76	51.09	-75.63	52.65	dB
	Peak	46.57	44.65	40.00	-60.63	42.72	dB
Phase Error	RMS	0.13	0.18	0.62	0.07	0.32	deg
	Peak	0.60	-0.70	-7.25	1.50	3.29	deg
Magnitude Error	RMS	0.10	0.11	0.14	0.01	0.12	%
	Peak	0.31	0.13	0.49	0.28	0.38	%
Carrier Frequency Error		-145.37	-144.88	-148.25	1.45	-142.49	Hz
Rho		0.999996	0.999996	0.999992	0.000001	0.999995	
IQ Offset		-51.27	-50.81	-49.40	-59.25	-49.79	dB
IQ Imbalance		-64.16	-62.28	-69.54	-75.79	-59.96	dB
Gain Imbalance		0.01	0.01	0.02	-69.63	0.02	dB
Quadrature Error		0.01	0.02	0.06	0.01	0.04	deg
Amplitude Droop		0.000016	0.000011	0.000071	-110.597191	0.000055	dB/sym
Power		-6.91	-6.71	-6.33	-19.32	-6.38	dBm

Figure 3-17: Result summary display for "Modulation Accuracy"



If the result summary display is not given the entire screen width or height, only the information indicated by an \*) below is displayed (see also [Chapter 3.3.1.6, "Display Configuration"](#), on page 175). If the result summary is queried using remote commands, all available information is provided.

For more information see [Chapter A.1.2.1, "PSK, QAM and MSK Modulation"](#), on page 362.

The following results are displayed:

- \*) **EVM** (Error Vector Magnitude) - RMS/Peak  
SCPI command: `CALCulate<n>:MARKer<m>:FUNCTION:DDEMod:STATistic:EVM?` on page 224
- **MER** (Modulation Error Ratio) - RMS/Peak  
SCPI command: `CALCulate<n>:MARKer<m>:FUNCTION:DDEMod:STATistic:SNR?` on page 234
- \*) **Phase Error** - RMS/Peak  
SCPI command: `CALCulate<n>:MARKer<m>:FUNCTION:DDEMod:STATistic:PERRor?` on page 232
- **Magnitude Error** - RMS/Peak  
SCPI command: `CALCulate<n>:MARKer<m>:FUNCTION:DDEMod:STATistic:MERRor?` on page 230
- \*) **Carrier Frequency Error**  
SCPI command: `CALCulate<n>:MARKer<m>:FUNCTION:DDEMod:STATistic:CFERror?` on page 223

- **\*) Rho**  
SCPI command: `CALCulate<n>:MARKer<m>:FUNction:DDEMod:STATistic:RHO?` on page 233
- **\*) I/Q Offset**  
SCPI command: `CALCulate<n>:MARKer<m>:FUNction:DDEMod:STATistic:OOFfset?` on page 231
- **I/Q Imbalance**  
Not for BPSK.  
SCPI command: `CALCulate<n>:MARKer<m>:FUNction:DDEMod:STATistic:IQIMbalance?` on page 229
- **\*) Gain Imbalance**  
Not for BPSK.  
SCPI command: `CALCulate<n>:MARKer<m>:FUNction:DDEMod:STATistic:GIMBalance?` on page 229
- **\*) Quadrature Error**  
Not for BPSK.  
SCPI command: `CALCulate<n>:MARKer<m>:FUNction:DDEMod:STATistic:QERRor?` on page 232
- **\*) Amplitude Droop**  
SCPI command: `CALCulate<n>:MARKer<m>:FUNction:DDEMod:STATistic:ADRoop?` on page 222
- **\*) Power**  
SCPI command: `CALCulate<n>:MARKer<m>:FUNction:DDEMod:STATistic:MPOWer?` on page 230

For each result, the R&S FSVA/FSV calculates and shows various statistical values:

- Current value
- **\*) Mean value**  
To calculate the mean value, the R&S FSVA/FSV averages the number of results defined by the [Statistics Count](#).
- **\*) Peak value**
- StdDev (standard deviation)
- 95%ile (95 percentile; only for continuous sweep or sweep count > 1)  
Compared to the mean value, the 95%ile is a result of all measurement results since the last start of a single or continuous sweep, or of all measurements since the last change of a measurement parameter.
- **\*) Unit**

## FSK modulation

A Result Summary							
		Current	Mean	Peak	StdDev	95%ile	Unit
Frequency Error	RMS	92.01	92.01	92.01	0.00	---	%
	Peak	-230.75	-230.75	-230.75	0.00	---	%
Magnitude Error	RMS	40.93	40.93	40.93	0.00	---	%
	Peak	-97.27	-97.27	-97.27	0.00	---	%
FSK Deviation Error		-447050.28	-447050.28	-447050.28	0.00	---	Hz
FSK Meas Deviation		352950	352950	352950	0.00	---	Hz
FSK Ref Deviation		800000	800000	800000	0	---	Hz
Carrier Frequency Error		137573.84	137573.84	137573.84	0.00	---	Hz
Carrier Frequency Drift		-1483.23	-1483.23	-1483.23	0.00	---	Hz/sym
Power		-80.72	-80.72	-80.72	0.00	---	dBm

- Frequency Error - RMS/Peak**  
 Shows the average (RMS) and peak frequency error in %. The frequency error is the difference of the measured frequency and the reference frequency. The frequency error is normalized to the estimated FSK deviation.  
 SCPI command: `CALCulate<n>:MARKer<m>:FUNction:DDEMod:STATistic:FSK:DERror?` on page 226
- Magnitude Error - RMS/Peak**  
 Shows the average (RMS) and peak magnitude error in %. The magnitude error is the difference of the measured magnitude to the magnitude of the reference signal. The magnitude error is normalized to the mean magnitude of the reference signal.  
 SCPI command: `CALCulate<n>:MARKer<m>:FUNction:DDEMod:STATistic:MERRor?` on page 230
- FSK Deviation Error**  
 Shows the deviation error of FSK modulated signals in Hz. The FSK deviation error is the difference of the FSK deviation of the measured signal and the FSK reference deviation you have set.  
 SCPI command: `CALCulate<n>:MARKer<m>:FUNction:DDEMod:STATistic:FDERRor?` on page 225
- FSK Meas Deviation**  
 Shows the estimated deviation of FSK modulated signals in Hz.  
 SCPI command: `CALCulate<n>:MARKer<m>:FUNction:DDEMod:STATistic:FSK:MDEVIation?` on page 227
- FSK Ref Deviation**  
 Shows the reference deviation you have set in Hz.  
 SCPI command: `CALCulate<n>:MARKer<m>:FUNction:DDEMod:STATistic:FSK:RDEVIation?` on page 228
- Carrier Frequency Error**  
 Shows the mean carrier frequency offset in Hz.  
 SCPI command: `CALCulate<n>:MARKer<m>:FUNction:DDEMod:STATistic:CFERRor?` on page 223
- Carrier Frequency Drift**  
 Shows the mean carrier frequency drift in Hz per symbol.  
 SCPI command: `CALCulate<n>:MARKer<m>:FUNction:DDEMod:STATistic:FSK:CFDRift?` on page 226
- Power**  
 Shows the power of the measured signal.

SCPI command: `CALCulate<n>:MARKer<m>:FUNction:DDEMod:STATistic:MPOWER?` on page 230

### Basis of evaluation

The majority of the values that are displayed in the Result Summary are calculated over the "Evaluation Range" (see "Evaluation Range" on page 167). They are evaluated according to the setting of the `Display Points/Sym` parameter. For example, if "Display Points/Symbol" is "1", only the symbol instants contribute to the result displayed in the result summary.

**Table 3-1: Results calculated over the evaluation range**

PSK, MSK, QAM	FSK
EVM	Frequency Error
MER	Magnitude Error
Phase Error	Power
Magnitude Error	
Rho	
Power	

The following results that are based on internal estimation algorithms (see Chapter 2.5, "Signal Model, Estimation and Modulation Errors", on page 50) are calculated over the "Estimation range" (see also Chapter 2.5.1.2, "Estimation", on page 52).

**Table 3-2: Results calculated over the estimation range**

PSK, MSK, QAM	FSK
Carrier Frequency Error	FSK Deviation Error
I/Q Offset	FSK Measurement Deviation
I/Q Imbalance	Carrier Frequency Error
Gain Imbalance	Carrier Frequency Drift
Quadrature Error	
Amplitude Droop	

### Current value

In the "Current" column, the value evaluation for the current evaluation is displayed. For example, the EVM Peak value in the current sweep corresponds to the peak of the trace values within the evaluation range for the current sweep (as indicated by marker 1 in Figure 3-18).

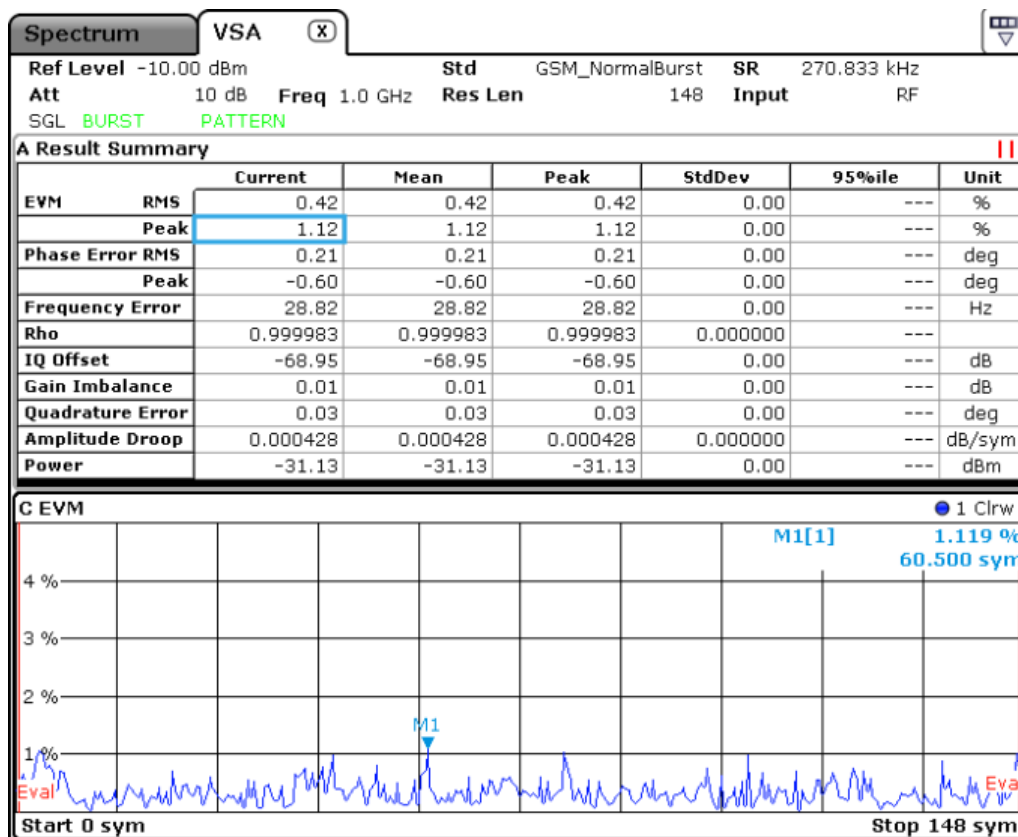


Figure 3-18: Example for result summary with current EVM peak value marked

If you want to compare the trace values to the results of the Result Summary, make sure to match the displayed points per symbol of the trace and of the Result Summary. Refer to "Display Points/Sym" on page 179 for details.

### Mean value

In the "Mean" column, the linear mean of the values that are in the "Current" column is displayed. Note that if the values are in a logarithmic representation, e.g. the I/Q Offset, the linear values are averaged.

### Peak value

In the "Peak" column, the maximum value that occurred during several evaluations is displayed. Note that when the value can be positive and negative, e.g. the phase error, the maximum absolute value (maintaining its sign) is displayed. The peak value of Rho is handled differently, since its minimum value represents the worst case. In that case, the minimum value is displayed.

### Standard Deviation

The value for the standard deviation is calculated on the linear values and then converted to the displayed unit.

### 95-percentile

The 95-percentile value is based on the distribution of the current values. Since the phase error and the magnitude error can usually be assumed to be distributed around zero, the 95-Percentile for these values is calculated based on their absolute values. Again, the Rho value is handled differently. Here, the 5-Percentile is displayed, since the lowest Rho value represents the worst case.

### SCPI commands:

```
CALC:FEED 'TCAP'
```

to define the required source type (see [CALCulate<n>:FEED](#) on page 247)

```
TRAC:DATA
```

to query the trace results (see [TRACe<n>\[:DATA\]](#) on page 325)

#### 3.1.1.23 Bit Error Rate (BER)

A bit error rate (BER) measurement compares the transmitted bits with the determined symbol decision bits:

BER = error bits / number of analyzed bits

As a prerequisite for this measurement, the R&S FSV-K70 application must know which bit sequences are correct, i.e. which bit sequences may occur. This knowledge must be provided as a list of possible data sequences in xml format, which is loaded in the R&S FSV-K70 (see [Chapter 3.3.7, "Working With Known Data Files"](#), on page 194).

If such a file is loaded in the application, the BER result display is available.

Available for source types:

- Modulation Accuracy



Note that this measurement may take some time, as each symbol decision must be compared to the possible data sequences one by one.

The BER measurement is an indicator for the quality of the demodulated signal. High BER values indicate problems such as:

- inadequate demodulation settings
- poor quality in the source data
- false or missing sequences in the Known Data file
- result range alignment leads to a mismatch of the input data with the defined sequences

A BER value of 0.5 means that for at least one measurement no matching sequence was found.

See also [Chapter 3.3.7.1, "Dependencies and Restrictions when Using Known Data"](#), on page 194

B Bit Error Rate				
	Current	Minimum	Maximum	Accumulative
Bit Error Rate	0.000 000 000	0.000 000 000	0.461 711 705	0.003 577 107
Total # of Errors	0	0	205	216
Total # of Bits	444	444	444	59940

The following information is provided in the BER result display (in full view):

- **Bit Error Rate:** error bits / number of analyzed bits
- **Total # of Errors:** number of detected bit errors (known data compared to symbol decisions)
- **Total # of Bits:** number of analyzed bits

For each of these results, the following values are provided:

BER Result	Description
Current	Value for current result range
Minimum	Minimum "Current" value during the current measurement
Maximum	Maximum "Current" value during the current measurement
Accumulative	Total value over several measurements; for BER: Total # of Errors / Total # of Bits (similar to average function)

#### SCPI commands:

```
CALC:FEED 'XTIM:DDEM:MACC'
```

to define the required source type (see [CALCulate<n>:FEED](#) on page 247)

```
CALC:FORM BER
```

to define the result type (see [CALCulate<n>:FORMat](#) on page 247)

```
CALC:BER?
```

to query the results (see [CALCulate<n>:BERate](#) on page 243)

### 3.1.2 Normal (Time/Symbol) Displays

Normal displays show the results in the time domain or as symbols.

*Table 3-3: Available time/symbol displays depending on source type*

Source Type	Result Type
Capture Buffer	Magnitude Absolute
	Real/Imag (I/Q)
	Frequency Absolute
	Vector I/Q
Meas & Ref Signal	Magnitude Absolute
	Magnitude Relative



Source Type	Result Type
	Phase Wrap
	Phase Unwrap
	Frequency Absolute
	Frequency Relative
	Real/Imag (I/Q)
	Eye Diagram Real (I)
	Eye Diagram Imag (Q)
	Eye Diagram Frequency
	Constellation I/Q
	Constellation I/Q (Rotated)
	Vector I/Q
	Constellation Frequency
	Vector Frequency
Symbols	Binary
	Octal
	Decimal
	Hexadecimal
Error Vector	EVM
	Real/Imag (I/Q)
	Vector I/Q
Modulation Errors	Magnitude Error
	Phase Error
	Frequency Error Absolute
	Frequency Error Relative
Modulation Accuracy	Result Summary
	Bit Error Rate (BER)

### 3.1.3 Spectral Displays

Spectral evaluations can be carried out for all result displays that show the time or symbols on the x-axis.



Note that the spectrum is only calculated over the evaluation range.

**Table 3-4: Available spectral displays depending on source type**

Source Type	Result Type
Capture Buffer	Magnitude Absolute
	Real/Imag (I/Q)
Meas & Ref Signal	Magnitude Absolute
	Magnitude Relative
	Phase Wrap
	Phase Unwrap
	Frequency Absolute
	Frequency Relative
	Real/Imag (I/Q)
Error Vector	EVM
	Real/Imag (I/Q)
Modulation Errors	Magnitude Error
	Phase Error
	Frequency Error Absolute
	Frequency Error Relative

For real input signals, the spectrum between the frequencies 0 and  $(\text{symbol rate} \times \text{capture oversampling}/2)$  is displayed; for complex input signals (REAL/IMAG and Error REAL/IMAG), the spectrum between  $\pm (\text{symbol rate} \times \text{capture oversampling}/2)$  is displayed.

The input signal is subjected to a fast Fourier transformation (FFT) with 4096 points, and the magnitude is calculated and displayed. If the basic result display is too long, the total length is divided into several subblocks of 4096 points each and the results are averaged. The subblocks overlap each other by 25% of the block length. In addition, the input signal or the subblocks are evaluated with a FLATTOP window.

If the valuation range is active, the FLATTOP window is also restricted to the area inside the evaluation lines. Following the FFT, the spectrum magnitude is calculated and displayed. [Figure 3-19](#) and [Figure 3-20](#) show examples of such spectral evaluations. The upper trace shows the basic diagram in each case, while the lower trace shows the associated spectral evaluations.

The top part of [Figure 3-19](#) shows EVM versus time; the spectrum of the EVM signal is shown at the bottom. In [Figure 3-20](#), the FFT is applied to the complex signal (REAL/IMAG, top). The bottom diagram shows the spectrum. Since the input signal is complex, a two-sided spectrum is shown. In both cases, the time range for the FFT is restricted by the activated evaluation lines so that, for example, burst edges are not included.

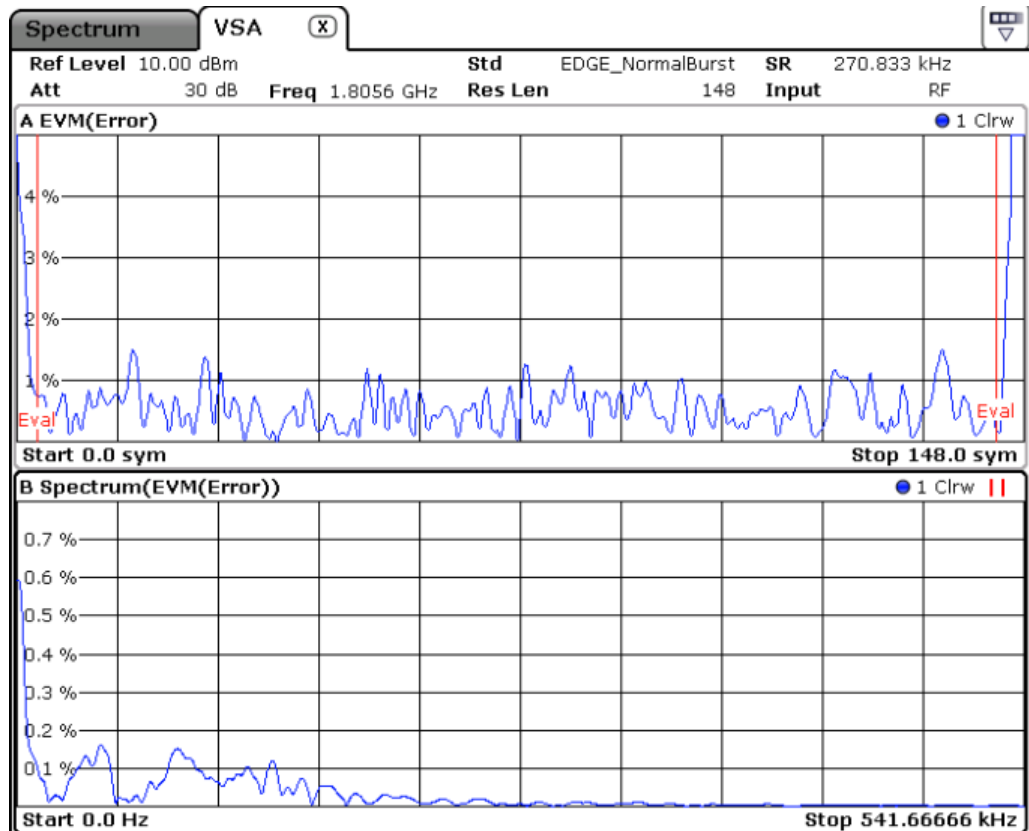


Figure 3-19: Spectrum diagram: Single-sided display for real input signals

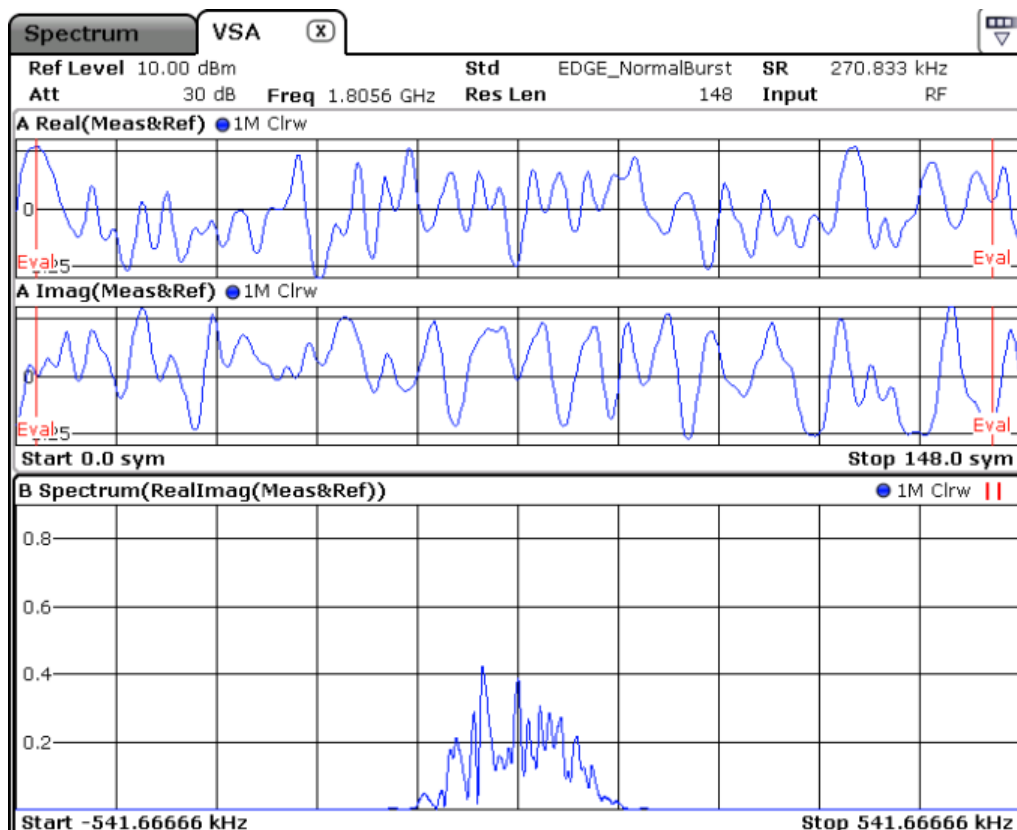


Figure 3-20: Spectrum diagram: Two-sided display for complex input signals

### 3.1.4 Statistical Displays

Statistical evaluations can be carried out for all result displays that show the time or symbols on the x-axis. They show the distribution (i.e. probabilities of occurrence) of the values as a set of bars.



Note that only samples within the evaluation range contribute to the statistic measurement.

In all statistical displays a vertical line shows the value of the 95% percentile.

Table 3-5: Available statistical displays depending on source type

Source Type	Result Type
Capture Buffer	Magnitude Absolute
	Real/Imag (I/Q)
Meas & Ref Signal	Magnitude Absolute
	Magnitude Relative
	Phase Wrap

Source Type	Result Type
	Phase Unwrap
	Frequency Absolute
	Frequency Relative
	Real/Imag (I/Q)
Error Vector	EVM
	Real/Imag (I/Q)
Modulation Errors	Magnitude Error
	Phase Error
	Frequency Error Absolute
	Frequency Error Relative

For complex displays (REAL/IMAG and Error REAL/IMAG), a separate statistics diagram is calculated for the real and imaginary parts.

The input signal of the basic display is quantized and the probability of occurrence is shown by a bargraph. The quantization can be set via the number of bars in the display area by using the "Range > X-Axis Quantize" parameter (see "[Ranges \(statistic measurements\)](#)" on page 112). In the basic setting, 101 bars are used.

The [Figure 3-21](#) shows an example of a statistical evaluation. The lower window (C) shows the basic diagram (EVM), while the upper window (A) shows the associated distribution of the EVM.

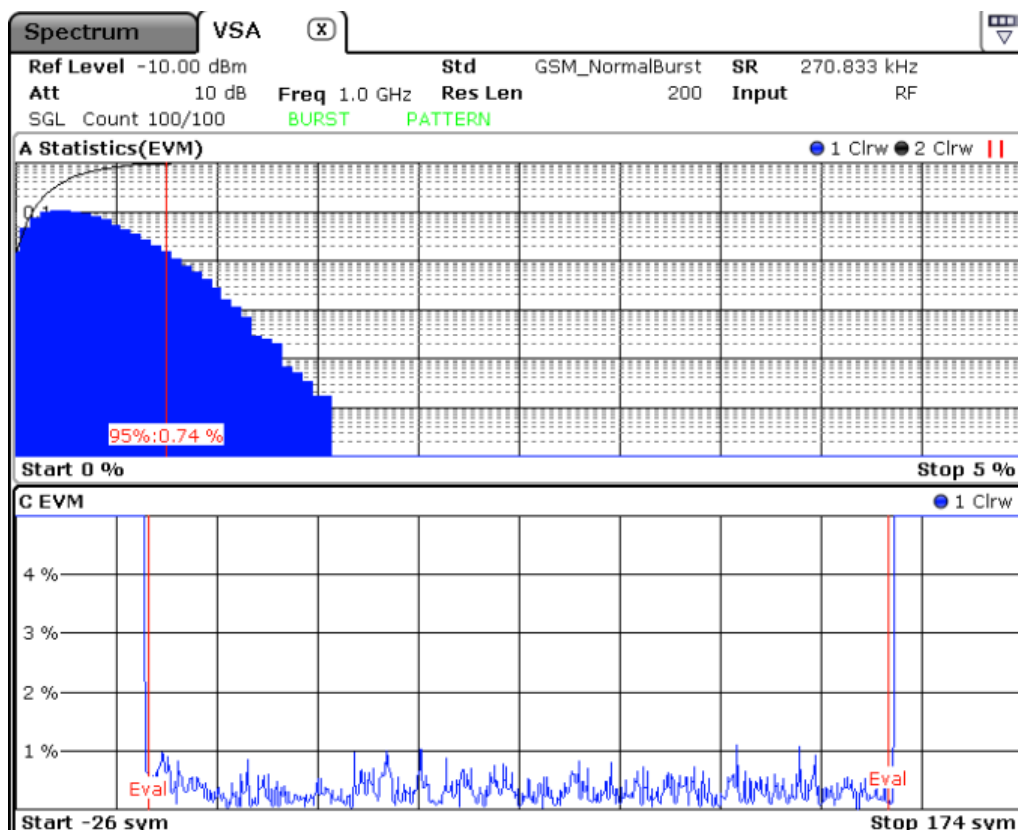


Figure 3-21: Error vector magnitude (bottom), EVM distribution (top)

### 3.1.5 Displayed Measurement Settings

The channel bar above the result screens displays the most important measurement settings. Depending on the result type, the following information may be displayed in the channel bar:



#### Editing settings in the channel bar

Some settings that are displayed in the channel bar can easily be edited by touching the setting in the display (with a finger or mouse pointer). The corresponding (edit) dialog box is displayed in which you can edit the setting. For some settings, a context-sensitive menu is also available, see [Chapter 3.2.14, "Available Context Menus"](#), on page 140.

Label	Description
Ref Level	Reference level, see <a href="#">"Reference Level"</a> on page 111
Offset	Reference level offset, if defined, see <a href="#">"Ref Level Offset"</a> on page 116
Att	Attenuation, see <a href="#">Chapter 3.2.3, "Softkeys of the Amplitude Menu (R&amp;S FSV-K70)"</a> , on page 110
Freq	Frequency, see <a href="#">"Center"</a> on page 110
Std	Digital standard, see <a href="#">"Digital Standards"</a> on page 108
Mod	Modulation type, if no standard is active (or default standard is changed), see <a href="#">"Modulation Type"</a> on page 143
Res Len	Result Length, see <a href="#">"Result Length"</a> on page 166
Cap Len	Capture Length (instead of result length for capture buffer display), see <a href="#">"Capture Length"</a> on page 154
SR	Symbol Rate, see <a href="#">"Symbol Rate"</a> on page 145
Input	Input type of the signal source, see <a href="#">Chapter 3.2.12, "Softkeys of the Input/Output menu (R&amp;S FSV-K70)"</a> , on page 136
SGL	Single sweep mode; cannot be edited directly
Burst	Burst search active (see <a href="#">"Auto/On/Off"</a> on page 159)
Pattern	Pattern search active (see <a href="#">"Auto/On/Off"</a> on page 161)
Stat Count	Statistics count for averaging and other statistical operations, see <a href="#">"Statistics Count"</a> on page 119; cannot be edited directly
Capt Count	Capture count; the current number of captures performed if several captures are necessary to obtain the number of results defined by "Statistics Count"; cannot be edited directly

For more information on general measurement settings displayed in the channel bar, see the description of basic operations in the base unit.

### 3.1.6 Result Ranges and Evaluation Ranges

The defined result and evaluation ranges are included in the result displays (where useful) to visualize the basis of the displayed values and traces.

#### Result ranges

In some cases, the data in the capture buffer contains parts that are not relevant for the evaluation task at hand. For example, bursted signals have intervals between the bursts that are not of interest when analyzing peaks or overshoots. Thus, you can exclude them from the result range (see [Chapter 3.3.2, "Defining the Result Range"](#), on page 181).

The result ranges are indicated by green bars along the time axis of the capture buffer result diagrams.

Depending on the type of signal and your result range definition, the result ranges may be continuous or discrete. Bursted signals commonly have several discrete result ranges at the bursts, with intervals during the noise periods which should not be included in the results.

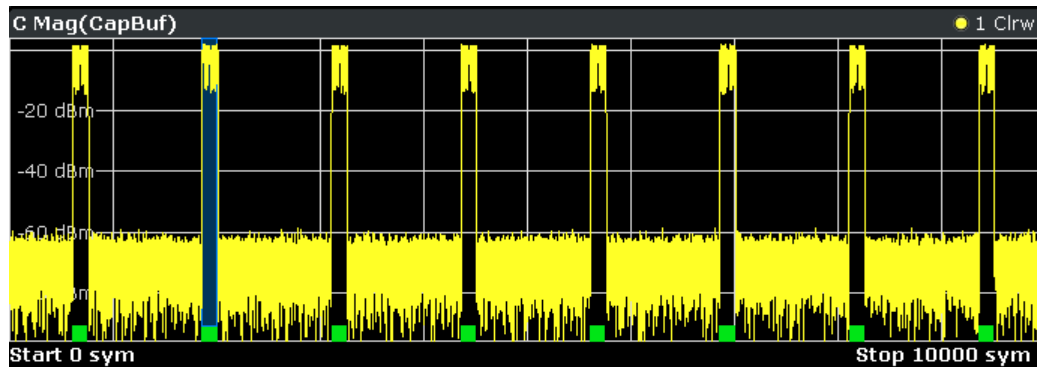


Figure 3-22: Result ranges for a burst signal

Continuous signals, on the other hand, have result ranges that cover the entire or a specific part of the capture buffer without intervals.

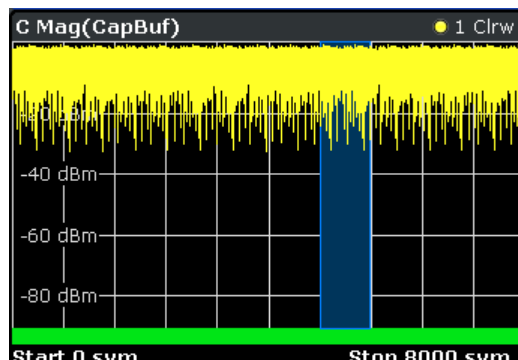


Figure 3-23: Result ranges for a continuous signal

Result displays whose source is not the capture buffer are based on a single result range, such as the EVM vs. Time display or the data in the "Current" column of the Result Summary. In this case, you can use the capture buffer display to navigate through the available result ranges ([Select Result Rng](#) softkey), and analyze the individual result ranges in another window. The currently displayed result range is indicated by a blue bar in the capture buffer display.

### Evaluation ranges

The result range in turn may contain more data than is necessary to calculate characteristic values.

For example, while you may want to display the ramps of a burst and thus include them in the result range, they do not contribute to the error vectors or power levels. Thus, you would not include them in the evaluation range.

In all displays over time, except for capture buffer displays, the evaluation range is indicated by red lines.



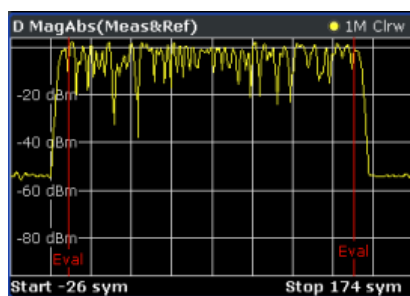


Figure 3-24: Evaluation lines in absolute magnitude diagram

In symbol tables, the evaluated symbols are indicated by red square brackets.

D Symbol Table (Hexadecimal)										
	+	1	+	3	+	5	+	7	+	9
0	1E	1E	0E	0E	05	15	1E	15	08	02
10	12	17	12	1D	18	03	13	14	13	1A
20	1D	08	12	03	07	01	0F	0D	13	08
30	0E	1E	03	1F	18	07	17	18	17	06
40	08	04	14	1D	14	0F	07	19	16	05
50	09	03	11	16	15	18	13	02	04	00
60	08	08	18	09	19	0A	18	0D	1D	06
70	1C	11	08	00	12	00	12	12	00	00
80	00	12	12	12	00	00	12	00	00	12
90	12	00	12	00	00	00	00	00	00	00
100	12	00	12	12	0A	1A	0F	1B	04	..

In other result displays that are based on the evaluation range only, two red vertical lines are displayed in the diagram header to indicate a limited evaluation basis.

B Result Summary

### 3.1.7 Saving Measurement Results

After a data acquisition or measurement, you may like to save the results for further evaluation or documentation purposes. You can save a screenshot of the display to a file or print it, and you can export the trace data in ASCII format.

#### To print or store a screenshot

1. Press the PRINT key.
2. Press the "Device Setup" softkey.
3. To copy the screenshot to the clipboard or print it on a printer, select the corresponding option. Before you print to a printer, make sure a printer is installed (see the description in the base unit manual).  
To save the screenshot to a file, select the file format for your screenshot (e.g. JPEG) and then select the "Print to file" option.
4. Close the "Hardcopy Setup" dialog.
5. Press the "Colors" softkey and then "Select Print Color Set".

6. If you want the colors of your screenshot to be as they appear on the screen, select "Screen Colors (Hardcopy)".
7. Press the PRINT key again and then press the "Print Screen" softkey.
8. If you selected "Print to file", a file selection dialog box is opened. Specify the file location for your screenshot and press "Save".

#### To store a screenshot via remote control

HCOP: DEV: LANG BMP

Selects the data format.

HCOP: DEST 'MMEM'

Directs the hardcopy to a file.

MMEM: NAME 'C: \R\_S\instr\user\Print.bmp'

Selects the file name. If the file `Print.bmp` already exists, it is replaced.

HCOP

Saves the hardcopy output into the file `Print.bmp`.

#### To save the I/Q data to a file and reload it

You can store the captured I/Q data to a file and reload it on the instrument again later.

1. Select a window that displays I/Q data.
2. Press the SAVE/RCL hardkey and then the "Save" softkey.
3. Define a file name for the data file.
4. Select "IQ Data" from the list of items to be stored.
5. Press "Save" to close the dialog and store the data to the file.
6. To load the data again later, press the SAVE/RCL hardkey and then the "Load" softkey. Select the file name with the stored data (`.df1` extension).

#### To export the trace data in ASCII format

The R&S FSVA/FSV can save your results as plain text in a text file.

1. Close all screens that are not relevant for your measurement results by disabling the "Screen X active" option in the "Display Config" dialog (see also ["Screen X active"](#) on page 176).
2. Press the TRACE key.
3. Press the "ASCII Trace Export" softkey.
4. Specify the file location to store the data to.
5. Select the "Mode": *Trace*.  
If you only want to save the I/Q samples of your capture buffer, select *RAW*.

6. To include all your parameter settings select "Header": *On*.
7. Select the format of the "Decimal Separator" (3.1416 or 3,1416).
8. Press "Save".

#### To export the data via remote control

[TRACe<n>\[:DATA\]](#) on page 325

#### Example:

```
:SENSe1:DDEMod:PRESet 'GSM_NB'
```

Load GSM Normal Burst Standard.

```
:INITiate1:CONTinuous OFF
```

Switch to single sweep mode.

```
:INITiate1:IMMediate
```

Perform single sweep.

```
:TRACe4? TRACe1
```

Query the result symbols in screen D.

## 3.2 Softkeys and Menu Overview for Vector Signal Analysis (R&S FSV-K70)

This chapter describes the softkeys available for the R&S FSV-K70 option.

• <a href="#">Softkeys of the VSA menu (R&amp;S FSV-K70)</a> .....	107
• <a href="#">Softkeys of the Frequency Menu (R&amp;S FSV-K70)</a> .....	110
• <a href="#">Softkeys of the Amplitude Menu (R&amp;S FSV-K70)</a> .....	110
• <a href="#">Softkeys of the Auto Set Menu (R&amp;S FSV-K70)</a> .....	116
• <a href="#">Softkeys of the Sweep Menu (R&amp;S FSV-K70)</a> .....	118
• <a href="#">Softkeys of the Trace Menu (R&amp;S FSV-K70)</a> .....	120
• <a href="#">Softkeys of the Trigger Menu (R&amp;S FSV-K70)</a> .....	124
• <a href="#">Softkeys of the Meas Config Menu (R&amp;S FSV-K70)</a> .....	126
• <a href="#">Softkeys of the Marker Menu (R&amp;S FSV-K70)</a> .....	128
• <a href="#">Softkeys of the Marker To Menu (R&amp;S FSV-K70)</a> .....	130
• <a href="#">Softkeys of the Lines Menu</a> .....	132
• <a href="#">Softkeys of the Input/Output menu (R&amp;S FSV-K70)</a> .....	136
• <a href="#">Softkeys of the Save/Recall Menu (R&amp;S FSV-K70)</a> .....	139
• <a href="#">Available Context Menus</a> .....	140

### 3.2.1 Softkeys of the VSA menu (R&S FSV-K70)

The VSA menu provides basic functions for vector signal analysis. For information on configuring VSA measurements, see [Chapter 3.3, "Configuring VSA Measurements"](#), on page 141.

The following softkeys are available in the "VSA" and "MEAS" menus:

Settings Overview.....	108
Digital Standards.....	108
L Load Standard.....	108
L Save As Standard.....	108
L Delete Standard.....	109
L Standard Defaults.....	109
L Restore Standard Files.....	109
L New Folder.....	109
Display Config.....	109
Restore Factory Settings.....	109
L Restore Standard Files.....	109
L Restore Pattern Files.....	109

### Settings Overview

Displays the main settings overview that visualizes the data flow of the Vector Signal Analyzer and summarizes the current settings. In addition, the "Settings Overview" dialog box provides access to the individual settings dialog boxes and allows you to restore default values.

For details on configuring the measurement and a description of the individual dialog boxes, see [Chapter 3.3.1, "Settings Overview"](#), on page 141.

### Digital Standards

Opens a submenu and a file selection dialog to manage predefined measurement settings for conventional mobile radio standards. See [Managing standard settings files](#) for details.

For an overview of predefined standards and settings see [Chapter B, "Predefined Standards and Settings"](#), on page 375.

### Load Standard ← Digital Standards

Opens a file selection dialog to load a measurement settings file for a specific standard.

See [Managing standard settings files](#) for details.

**Note:** When you load a standard, the usage of a known data file, if available, is automatically deactivated.

Remote command:

[SENSe:] DDEMod: PRESet [:STANdard] on page 296

### Save As Standard ← Digital Standards

Opens a file selection dialog to save the current measurement settings as a file for a specific standard.

Remote command:

[SENSe:] DDEMod: STANdard: SAVE on page 313

**Delete Standard ← Digital Standards**

Deletes the selected standard. Standards predefined by Rohde & Schwarz can also be deleted. A confirmation query is displayed to avoid unintentional deletion of the standard.

**Note:** Restoring predefined standard files. The standards predefined by Rohde & Schwarz available at the time of delivery can be restored using the "Restore Standards" softkey.

Remote command:

[SENSe:] DDEMod:STANdard:DELeTe on page 312

**Standard Defaults ← Digital Standards**

Resets the instrument to the default settings of the currently used standard. If no standard is currently active, the previously active standard is used.

Remote command:

[SENSe:] DDEMod:STANdard:PREset[:VALue] on page 313

**Restore Standard Files ← Digital Standards**

Restores the standards predefined by Rohde & Schwarz available at the time of delivery.

Remote command:

[SENSe:] DDEMod:FACTory[:VALue] on page 286

**New Folder ← Digital Standards**

Creates a new folder in the file system in which you can save the settings file.

This function is only available if the "Save Current Settings as Standard" dialog box is open.

**Display Config**

Opens the "Display Configuration" dialog box to configure the measurement results display. See [Chapter 3.3.1.6, "Display Configuration"](#), on page 175.

**Restore Factory Settings**

Opens a submenu that allows you to restore all standards and pattern settings on the instrument to the values predefined by Rohde & Schwarz available at the time of delivery.

**Restore Standard Files ← Restore Factory Settings**

Restores the standards predefined by Rohde & Schwarz available at the time of delivery.

Remote command:

[SENSe:] DDEMod:FACTory[:VALue] on page 286

**Restore Pattern Files ← Restore Factory Settings**

Restores the pattern files predefined by Rohde&Schwarz available at the time of delivery.

Remote command:

[SENSe:] DDEMod:FACTory[:VALue] on page 286

### 3.2.2 Softkeys of the Frequency Menu (R&S FSV-K70)

The **FREQ** key opens the "RF Settings" tab of the "Frontend & I/Q Capture Settings" dialog box and displays the "Frequency" menu, which contains the following softkeys.

Center.....	110
Stepsize Auto/Man.....	110
CF Stepsize.....	110
Frequency Offset.....	110

#### Center

Opens an edit dialog box to enter the center frequency.

Remote command:

[SENSe:] FREQuency:CENTer on page 316

#### Stepsize Auto/Man

Toggles between automatic step size or a fixed (manually defined) step size (**CF Stepsize**) for the center frequency.

Remote command:

[SENSe:] FREQuency:CENTer:STEP:AUTO on page 317

#### CF Stepsize

Opens an edit dialog box to define the fixed step size for the center frequency. The softkey indicates the current setting.

This function is only available if "**Stepsize Auto/Man**" on page 110 is set to "Man".

Remote command:

[SENSe:] FREQuency:CENTer:STEP on page 316

#### Frequency Offset

Opens an edit dialog box to enter a frequency offset that shifts the displayed frequency range by the specified offset.

The softkey indicates the current frequency offset. The allowed values range from -100 GHz to 100 GHz. The default setting is 0 Hz.

Remote command:

[SENSe:] FREQuency:OFFSet on page 317

### 3.2.3 Softkeys of the Amplitude Menu (R&S FSV-K70)

When you click the **AMPT** key, the "Amplitude" menu is displayed, which provides the following softkeys.

Reference Level.....	111
Ranges.....	111
└ Y-Axis Range.....	111
└ Y-Axis Reference Value.....	112
└ Y-Axis Reference Position.....	112
└ Y-Axis Autorange.....	112
Ranges (statistic measurements).....	112

L X-Axis Quantize.....	112
L X-Axis Reference Value.....	112
L X-Axis Range.....	112
L y-Axis Max Value.....	113
L y-Axis Min Value.....	113
L y-Unit % / Abs.....	113
L Default Settings.....	113
L Adjust Settings.....	113
Ranges (Symbol Table).....	113
L Binary.....	113
L Octal.....	113
L Decimal.....	113
L Hexadecimal.....	114
Units.....	114
L X-Axis Unit.....	114
L Y-Axis Unit.....	114
L Capture Unit.....	114
Preamp On/Off.....	114
RF Atten Manual/Mech Att Manual.....	114
RF Atten Auto/Mech Att Auto.....	115
EI Atten On/Off.....	115
EI Atten Mode (Auto/Man).....	115
Ref Level Offset.....	116
Input (AC/DC).....	116
(Bypassing the )YIG Filter.....	116

### Reference Level

Defines the reference level in dBm.

The reference level value is the maximum value the AD converter can handle without distortion of the measured value. Signal levels above this value will not be measured correctly, which is indicated by the "IFOVL" status display.

To get an ideal reference level, use Auto Level function. For more information, see

- "Auto Level" on page 117

Remote command:

`DISPlay[:WINDow<n>]:TRACe<t>:Y[:SCALe]:RLEVel` on page 264

### Ranges

Opens a submenu to define the display range for normal or spectral displays (see "Result Type Transformation" on page 178). For details on scaling see Chapter 3.3.3, "Changing the Display Scaling", on page 184.

### Y-Axis Range ← Ranges

Opens an edit dialog field to define the y-axis range.

Remote command:

`DISPlay[:WINDow<n>]:TRACe<t>:Y[:SCALe]` on page 262

**Y-Axis Reference Value ← Ranges**

Opens an edit dialog field to define a reference value for the y-axis in the current unit. The y-axis is adapted so that the reference value is displayed at the [Y-Axis Reference Position](#).

**Note:** The y-axis reference value is maintained even if the [Y-Axis Range](#) is changed. For details see [Chapter 3.3.3, "Changing the Display Scaling"](#), on page 184.

Remote command:

[DISPlay\[:WINDow<n>\]:TRACe<t>:Y\[:SCALe\]:RVALue](#) on page 266

**Y-Axis Reference Position ← Ranges**

Opens an edit dialog field to define a reference position for the y-axis as a percentage value, where 0 % refers to the bottom edge, 100 % refers to the top edge of the screen. The y-axis is adapted so that the [Y-Axis Reference Value](#) is displayed at the reference position.

For details see [Chapter 3.3.3, "Changing the Display Scaling"](#), on page 184.

Remote command:

[DISPlay\[:WINDow<n>\]:TRACe<t>:Y\[:SCALe\]:RPOSition](#) on page 265

**Y-Axis Autorange ← Ranges**

Adapts the y-axis to the current measurement results (only once, not dynamically) in the focussed window.

To adapt the range of all screens together, use the Y-Axis Auto Range All Screens function. For more information, see

- ["Y-Axis Auto Range All Screens"](#) on page 118

Remote command:

[DISPlay\[:WINDow<n>\]:TRACe<t>:Y\[:SCALe\]:AUTO\[:VALue\]](#) on page 263

**Ranges (statistic measurements)**

Opens a submenu to define the display range for statistic displays (see ["Result Type Transformation"](#) on page 178).

**X-Axis Quantize ← Ranges (statistic measurements)**

Defines the number of bars to be displayed in the graph, i.e. the granularity of classifications.

Remote command:

[CALCulate<n>:STATistics:SCALe:X:BCOunt](#) on page 251

**X-Axis Reference Value ← Ranges (statistic measurements)**

Opens an edit dialog field to define a reference value for the x-axis in the current unit.

Remote command:

[DISPlay\[:WINDow<n>\]:TRACe<t>:X\[:SCALe\]:RVALue](#) on page 261

**X-Axis Range ← Ranges (statistic measurements)**

Opens an edit dialog field to define the x-axis range in the current unit.

Remote command:

[DISPlay\[:WINDow<n>\]:TRACe<t>:X\[:SCALe\]:PDIVision](#) on page 260



**y-Axis Max Value ← Ranges (statistic measurements)**

Opens an edit dialog box to define the upper limit of the displayed probability range. Values on the y-axis are normalized which means that the maximum value is 1.0. The y-axis scaling is defined via the **y-Unit % / Abs** softkey. The distance between max and min value must be at least one decade.

Remote command:

`CALCulate<n>:STATistics:SCALE:Y:UPPer` on page 252

**y-Axis Min Value ← Ranges (statistic measurements)**

Opens an edit dialog box to define the lower limit of the displayed probability range. Values in the range  $1e^{-9} < value < 0.1$  are allowed. The y-axis scaling is defined via the **y-Unit % / Abs** softkey. The distance between max and min value must be at least one decade.

Remote command:

`CALCulate<n>:STATistics:SCALE:Y:LOWer` on page 252

**y-Unit % / Abs ← Ranges (statistic measurements)**

Defines the scaling type of the y-axis. The default value is absolute scaling.

Remote command:

`CALCulate<n>:STATistics:SCALE:Y:UNIT` on page 252

**Default Settings ← Ranges (statistic measurements)**

Resets the x- and y-axis scalings to their preset values for the current measurement window.

Remote command:

`CALCulate<n>:STATistics:PRESet` on page 251

**Adjust Settings ← Ranges (statistic measurements)**

Adjusts the x-axis scaling to the occurring statistical values.

Remote command:

`CALCulate<n>:STATistics:SCALE:AUTO` on page 251

**Ranges (Symbol Table)**

Opens a submenu to define the display mode for the symbol table.

**Binary ← Ranges (Symbol Table)**

Sets the symbol display to binary mode. This setting also affects the number of symbols displayed in each row.

**Octal ← Ranges (Symbol Table)**

Sets the symbol display to octal mode. This setting also affects the number of symbols displayed in each row.

**Decimal ← Ranges (Symbol Table)**

Sets the symbol display to decimal mode. This setting also affects the number of symbols displayed in each row.

**Hexadecimal ← Ranges (Symbol Table)**

Sets the symbol display to hexadecimal mode. This setting also affects the number of symbols displayed in each row.

**Units**

Opens a submenu to define the units for the x- and y-axis.

**X-Axis Unit ← Units**

Opens an edit dialog field to define the x-axis unit as seconds or symbols.

Remote command:

`CALCulate<n>:X:UNIT:TIME` on page 257

**Y-Axis Unit ← Units**

Opens an edit dialog field to define the y-axis unit according to the displayed measurement type.

Remote command:

`DISPlay[:WINDow<n>]:TRACe<t>:Y:SPACing` on page 266

**Capture Unit ← Units**

Defines the unit in which the data is captured: seconds or signals. The unit is also applied to the trigger offset and the grids of all active measurements.

Remote command:

`CALCulate<n>:X:UNIT:TIME` on page 257

**Preamp On/Off**

Switches the preamplifier on and off.

If option R&S FSV-B22 is installed, the preamplifier is only active below 7 GHz.

If option R&S FSV-B24 is installed, the preamplifier is active for all frequencies.

This function is not available for input from the R&S Digital I/Q Interface (option R&S FSV-B17).

Remote command:

`INPut:GAIN:STATe` on page 276

**RF Atten Manual/Mech Att Manual**

Opens an edit dialog box to enter the attenuation, irrespective of the reference level. If electronic attenuation is activated (option R&S FSV-B25 only; "EI Atten Mode Auto" softkey), this setting defines the mechanical attenuation.

The mechanical attenuation can be set in 10 dB steps.

The RF attenuation can be set in 5 dB steps (R&S FSV with option R&S FSV-B25 or R&S FSVA: 1 dB steps). The range is specified in the data sheet. If the current reference level cannot be set for the set RF attenuation, the reference level is adjusted accordingly.

This function is not available for input from the R&S Digital I/Q Interface (option R&S FSV-B17).

The RF attenuation defines the level at the input mixer according to the formula:

$$\text{level}_{\text{mixer}} = \text{level}_{\text{input}} - \text{RF attenuation}$$

**Note:** As of firmware version 1.61, the maximum mixer level allowed is **0 dBm**. Mixer levels above this value may lead to incorrect measurement results, which are indicated by the "OVLd" status display. The increased mixer level allows for an improved signal, but also increases the risk of overloading the instrument!

Remote command:

[INPut:ATTenuation](#) on page 271

#### **RF Atten Auto/Mech Att Auto**

Sets the RF attenuation automatically as a function of the selected reference level. This ensures that the optimum RF attenuation is always used. It is the default setting.

This function is not available for input from the R&S Digital I/Q Interface (option R&S FSV-B17).

Remote command:

[INPut:ATTenuation:AUTO](#) on page 271

#### **EI Atten On/Off**

This softkey switches the electronic attenuator on or off. This softkey is only available with option R&S FSV-B25.

When the electronic attenuator is activated, the mechanical and electronic attenuation can be defined separately. Note however, that both parts must be defined in the same mode, i.e. either both manually, or both automatically.

This function is not available for input from the R&S Digital I/Q Interface (option R&S FSV-B17).

- To define the mechanical attenuation, use the [RF Atten Manual/Mech Att Manual](#) or [RF Atten Auto/Mech Att Auto](#) softkeys.
- To define the electronic attenuation, use the [EI Atten Mode \(Auto/Man\)](#) softkey.

**Note:** This function is not available for stop frequencies (or center frequencies in zero span) >7 GHz. In this case, the electronic and mechanical attenuation are summarized and the electronic attenuation can no longer be defined individually. As soon as the stop or center frequency is reduced below 7 GHz, this function is available again. When the electronic attenuator is switched off, the corresponding RF attenuation mode (auto/manual) is automatically activated.

Remote command:

[INPut:EATT:AUTO](#) on page 275

#### **EI Atten Mode (Auto/Man)**

This softkey defines whether the electronic attenuator value is to be set automatically or manually. If manual mode is selected, an edit dialog box is opened to enter the value. This softkey is only available with option R&S FSV-B25, and only if the electronic attenuator has been activated via the [EI Atten On/Off](#) softkey.

**Note:** This function is not available for stop frequencies (or center frequencies in zero span) >7 GHz. In this case, the electronic and mechanical attenuation are summarized and the electronic attenuation can no longer be defined individually. As soon as the stop or center frequency is reduced below 7 GHz, electronic attenuation is available again. If the electronic attenuation was defined manually, it must be re-defined.

The attenuation can be varied in 1 dB steps from 0 to 30 dB. Other entries are rounded to the next lower integer value.

To re-open the edit dialog box for manual value definition, select the "Man" mode again.

If the defined reference level cannot be set for the given RF attenuation, the reference level is adjusted accordingly and the warning "Limit reached" is output.

Remote command:

`INPut:EATT:AUTO` on page 275

`INPut:EATT` on page 275

#### Ref Level Offset

Opens an edit dialog box to enter the arithmetic level offset. This offset is added to the measured level irrespective of the selected unit. The setting range is  $\pm 200$  dB in 0.1 dB steps.

Remote command:

`DISPlay[:WINDow<n>]:TRACe<t>:Y[:SCALe]:RLEVel:OFFSet` on page 265

#### Input (AC/DC)

Toggles the RF input of the R&S FSVA/FSV between AC and DC coupling.

This function is not available for input from the R&S Digital I/Q Interface (option R&S FSV-B17).

Remote command:

`INPut:COUPling` on page 271

#### (Bypassing the )YIG Filter

If the option R&S FSVA-B11 is installed, the YIG preselector can be bypassed.

This function is only available for R&S FSVA instruments.

If the YIG preselector at the input of the R&S FSVA is removed from the signal path, you can use the maximum bandwidth for signal analysis. However, image-frequency rejection is no longer ensured.

Note that the YIG preselector is active only on frequencies greater than 7 GHz. Therefore, switching the YIG preselector on and off has no effect if the frequency is below that value.

#### Note:

For the following measurements, the YIG preselector is off by default (if available).

- I/Q Analyzer
- GSM
- VSA

`INPut:FILTer:YIG[:STATe]` on page 276

### 3.2.4 Softkeys of the Auto Set Menu (R&S FSV-K70)

The AUTO SET displays the "Auto Set" menu, which contains the following softkeys.

Auto Level.....	117
Settings.....	117
└ Meas Time Manual.....	117
└ Meas Time Auto.....	117

L Upper Level Hysteresis.....	117
L Lower Level Hysteresis.....	117
Y-Axis Autorange.....	117
Y-Axis Auto Range All Screens.....	118

### Auto Level

Defines the optimal reference level for the current measurement automatically.

The measurement time for automatic leveling can be defined using the [Settings](#) softkey.

Remote command:

[SENSe:]ADJust:LEVel on page 284

### Settings

Opens a submenu to define settings for automatic leveling.

Possible settings are:

- "Meas Time Manual" on page 117
- "Meas Time Auto" on page 117

### Meas Time Manual ← Settings

Opens an edit dialog box to enter the duration of the level measurement in seconds. The level measurement is used to determine the optimal reference level automatically (see the "Auto Level" softkey, "Auto Level" on page 117). The default value is 1 ms.

Remote command:

[SENSe:]ADJust:CONFigure:LEVel:DURation on page 284

### Meas Time Auto ← Settings

The level measurement is used to determine the optimal reference level automatically (see the [Auto Level](#) softkey).

This softkey resets the level measurement duration for automatic leveling to the default value depending on the signal description (see "[Signal Description](#)" on page 146).

### Upper Level Hysteresis ← Settings

Defines an upper threshold the signal must exceed before the reference level is automatically adjusted when the "Auto Level" function is performed.

Remote command:

[SENSe:]ADJust:CONFigure:HYSTeresis:UPPer on page 283

### Lower Level Hysteresis ← Settings

Defines a lower threshold the signal must exceed before the reference level is automatically adjusted when the "Auto Level" function is performed.

Remote command:

[SENSe:]ADJust:CONFigure:HYSTeresis:LOWer on page 283

### Y-Axis Autorange

Adapts the y-axis to the current measurement results (only once, not dynamically) in the focussed window.

To adapt the range of all screens together, use the Y-Axis Auto Range All Screens function. For more information, see

- "Y-Axis Auto Range All Screens" on page 118

Remote command:

`DISPlay[:WINDow<n>]:TRACe<t>:Y[:SCALe]:AUTO[:VALue]` on page 263

#### Y-Axis Auto Range All Screens

Adapts the y-axis to the current measurement values (only once, not dynamically) in all measurement windows.

Remote command:

`DISPlay[:WINDow<n>]:TRACe<t>:Y[:SCALe]:AUTO:ALL` on page 263

### 3.2.5 Softkeys of the Sweep Menu (R&S FSV-K70)

The SWEEP key displays the "Sweep" menu, which contains the following softkeys.

Continuous Sweep.....	118
Single Sweep.....	118
Continue Single Sweep.....	118
Refresh.....	119
Statistics Count.....	119
Select Result Rng.....	119

#### Continuous Sweep

Sets the continuous sweep mode: the sweep takes place continuously according to the trigger settings. This is the default setting.

The trace averaging is determined by the [Statistic Count](#).

Remote command:

`INIT:CONT ON`, see `INITiate<n>:CONTinuous` on page 269

#### Single Sweep

Sets the single sweep mode: after triggering, starts the number of sweeps that are defined by using the [Statistic Count](#) softkey. The measurement stops after the defined number of sweeps has been performed.

Remote command:

`INIT:CONT OFF`, see `INITiate<n>:CONTinuous` on page 269

#### Continue Single Sweep

Repeats the number of sweeps set by using the [Statistic Count](#) softkey, without deleting the trace of the last measurement.

This is particularly of interest when using the trace configurations "Average" or "Max Hold" to take previously recorded measurements into account for averaging/maximum search.

Remote command:

`INITiate<n>:CONMeas` on page 268

**Refresh**

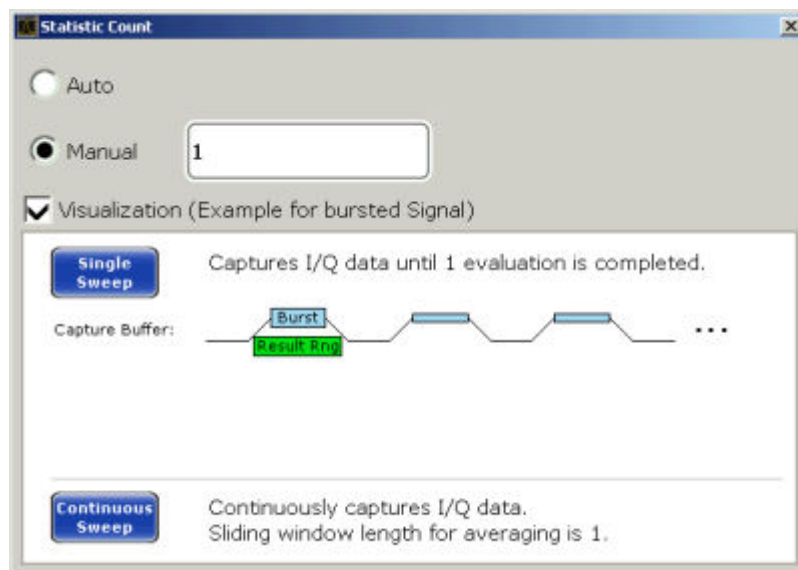
Repeats the evaluation of the data currently in the capture buffer without capturing new data. This is useful after changing settings, for example filters, patterns or evaluation ranges.

Remote command:

[INITiate:REFMeas](#) on page 270

**Statistics Count**

Opens a dialog box to define sweep characteristics. The behavior depends on whether you have set the R&S FSVA/FSV to single sweep mode or continuous sweep mode.



Activate "Description" to display a visualization of the behavior of the current settings.

- |          |  |
|----------|--|
| "Auto"   | In single sweep mode: captures the I/Q data once and evaluates it<br>In continuous sweep mode: captures I/Q data continuously; for each evaluation, the average is calculated over the last 10 capture sets (moving average)   |
| "Manual" | In single sweep mode: captures I/Q data until the defined number of evaluations have been performed<br>In continuous sweep mode: captures I/Q data continuously; if trace averaging is selected, the average is calculated over the defined number of capture sets (moving average);<br>Note: If the "Statistic Count" is set to 1, trace averaging is not performed (Max Hold and Min Hold, however, remain active, unlike in "Spectrum" mode). |

Remote command:

[\[SENSe:\] SWEep:COUNT \[:VALue\]](#) on page 317

**Select Result Rng**

Opens an input field to select the result range you want to analyze.

By default, the R&S FSVA/FSV shows the results over all result ranges that have been captured in the data capturing process and are in the R&S FSVA/FSV's memory. By selecting a range number, you can analyze a specific result range, e.g. a particular burst.

The range depends on the number of result ranges you have captured previously.

A selection of the result range is possible in single sweep mode only.

For more information refer also to

- "Capture Length" on page 154
- "Result Length" on page 166
- "Statistics Count" on page 119

Remote command:

[SENSe:] DDEMod: SEARch: MBURst: CALC on page 304

### 3.2.6 Softkeys of the Trace Menu (R&S FSV-K70)

The TRACE key displays the "Trace" menu, which contains the following softkeys.



#### Context-sensitive menus for traces

Traces have context-sensitive menus. If you right-click on a trace in the display or a trace setting in the information channel bar (or touch it for about 1 second), a menu is displayed which corresponds to the softkey functions available for traces.

Trace 1/Trace 2/Trace 3/Trace 4/Trace 5/Trace 6.....	120
L Clear Write.....	121
L Max Hold.....	121
L Min Hold.....	121
L Average.....	121
L View.....	121
L Blank.....	122
L Evaluation (Meas/Ref).....	122
Trace Wizard.....	122
L Trace Mode.....	122
L Evaluation.....	123
L Preset All Traces.....	123
L Select Max   Avg   Min.....	123
L Select Max   ClrWrite   Min.....	123
ASCII Trace Export.....	123

#### Trace 1/Trace 2/Trace 3/Trace 4/Trace 5/Trace 6

Selects the active trace (1, 2, 3, 4, 5, 6) and opens the "Trace Mode" submenu for the selected trace. The default setting is trace 1 in the overwrite mode, the other traces are switched off ("Blank" mode). Not all measurement functions support all 6 traces.

For details see [Chapter 3.4.1, "Trace Mode Overview"](#), on page 201.

**Tip:** To configure several traces in one step, press the "Trace Wizard" softkey to open a trace configuration dialog. See also ["Trace Wizard"](#) on page 122.



Remote command:

`DISPlay[:WINDow<n>]:TRACe<t>[:STATe]` on page 260

#### **Clear Write** ← Trace 1/Trace 2/Trace 3/Trace 4/Trace 5/Trace 6

Overwrite mode: the trace is overwritten by each sweep. This is the default setting.

Remote command:

`DISP:TRAC:MODE WRIT`, see `DISPlay[:WINDow<n>]:TRACe<t>:MODE` on page 259

#### **Max Hold** ← Trace 1/Trace 2/Trace 3/Trace 4/Trace 5/Trace 6

The maximum value is determined over several sweeps and displayed. The R&S FSVA/FSV saves the sweep result in the trace memory only if the new value is greater than the previous one.

This mode is especially useful with modulated or pulsed signals. The signal spectrum is filled up upon each sweep until all signal components are detected in a kind of envelope.

This mode is not available for statistics measurements.

Remote command:

`DISP:TRAC:MODE MAXH`, see `DISPlay[:WINDow<n>]:TRACe<t>:MODE` on page 259

#### **Min Hold** ← Trace 1/Trace 2/Trace 3/Trace 4/Trace 5/Trace 6

The minimum value is determined from several measurements and displayed. The R&S FSVA/FSV saves the smallest of the previously stored/currently measured values in the trace memory.

This mode is useful e.g. for making an unmodulated carrier in a composite signal visible. Noise, interference signals or modulated signals are suppressed whereas a CW signal is recognized by its constant level.

This mode is not available for statistics measurements.

Remote command:

`DISP:TRAC:MODE MINH`, see `DISPlay[:WINDow<n>]:TRACe<t>:MODE` on page 259

#### **Average** ← Trace 1/Trace 2/Trace 3/Trace 4/Trace 5/Trace 6

The average is formed over several sweeps. The [Statistics Count](#) determines the number of averaging procedures.

This mode is not available for statistics measurements.


Remote command:

`DISP:TRAC:MODE AVER`, see `DISPlay[:WINDow<n>]:TRACe<t>:MODE` on page 259

#### **View** ← Trace 1/Trace 2/Trace 3/Trace 4/Trace 5/Trace 6

The current contents of the trace memory are frozen and displayed.

**Note:** If a trace is frozen, the instrument settings, apart from level range and reference level (see below), can be changed without impact on the displayed trace. The fact that

the displayed trace no longer matches the current instrument setting is indicated by the  icon on the tab label.

If the level range or reference level is changed, the R&S FSVA/FSV automatically adapts the measured data to the changed display range. This allows an amplitude zoom to be made after the measurement in order to show details of the trace.

Remote command:

DISP:TRAC:MODE VIEW, see [DISPlay\[:WINDow<n>\]:TRACe<t>:MODE](#) on page 259

#### **Blank** ← Trace 1/Trace 2/Trace 3/Trace 4/Trace 5/Trace 6

Hides the selected trace.

Remote command:

DISP:TRAC OFF, see [DISPlay\[:WINDow<n>\]:TRACe<t>\[:STATe\]](#) on page 260

#### **Evaluation (Meas/Ref)** ← Trace 1/Trace 2/Trace 3/Trace 4/Trace 5/Trace 6

Defines whether the trace displays the evaluation of the measured signal or the reference signal (if "Meas & Ref Signal" is used as the signal source, see ["Source"](#) on page 177).

Remote command:

[CALCulate<n>:TRACe<t>\[:VALue\]](#) on page 256

#### **Trace Wizard**

Opens the "Trace Wizard" dialog. For each trace you can define a "Trace Mode" and an "Evaluation" type. Alternatively, you can configure several traces in one step using the predefined settings.



#### **Trace Mode** ← Trace Wizard

Defines the type of display and the evaluation of the trace.

- Clear Write
- Max Hold
- Min Hold
- Average
- View
- Blank

For details see [Chapter 3.4.1, "Trace Mode Overview"](#), on page 201

Remote command:

`DISPlay[:WINDow<n>]:TRACe<t>:MODE` on page 259

#### **Evaluation ← Trace Wizard**

Defines whether the trace displays the evaluation of the measured signal or the reference signal (if "Meas & Ref Signal" is used as the signal source, see ["Source"](#) on page 177).

Remote command:

`CALCulate<n>:FEED` on page 247

#### **Preset All Traces ← Trace Wizard**

Configures several traces to predefined display modes in one step:

Trace 1: "Clear Write"

Trace 2-6: Blank

For details see ([Chapter 3.4.1, "Trace Mode Overview"](#), on page 201).

#### **Select Max | Avg | Min ← Trace Wizard**

Configures several traces to predefined display modes in one step:

Trace 1: "Max Hold"

Trace 2: "Average"

Trace 3: "Min Hold"

Trace 4-6: Blank

For details see ([Chapter 3.4.1, "Trace Mode Overview"](#), on page 201).

#### **Select Max | ClrWrite | Min ← Trace Wizard**

Configures several traces to predefined display modes in one step:

Trace 1: "Max Hold"

Trace 2: "Clear Write"

Trace 3: "Min Hold"

Trace 4-6: Blank

For details see ([Chapter 3.4.1, "Trace Mode Overview"](#), on page 201).

#### **ASCII Trace Export**

Opens the "ASCII Trace Export" dialog box and saves the active trace in ASCII format to the specified file and directory. Various options are available to configure the stored data.

- "Mode"  
Stores raw I/Q data or trace data

- "Header"  
Includes a header with scaling information etc.
- "Decimal Separator"  
Defines the separator for decimal values as point or comma

Remote command:

FORMat:DEXPort:DSEParator on page 267

FORMat:DEXPort:HEADer on page 268

FORMat:DEXPort:MODE on page 268

MMEMory:STORe<n>:TRACe on page 279

### 3.2.7 Softkeys of the Trigger Menu (R&S FSV-K70)

The TRIG key opens the "I/Q Capture" tab of the "Frontend & I/Q Capture Settings" dialog box (see [Chapter 3.3.1.2, "Frontend and I/Q Capture Settings"](#), on page 149) and displays the "Trigger" menu, which contains the following softkeys.

Free Run.....	124
External.....	124
IF Power/ Baseband Power.....	124
Trigger Level.....	125
Trigger Polarity.....	125
Trigger Offset.....	125
Trigger Offset Unit.....	126

#### Free Run

The start of a sweep is not triggered. Once a measurement is completed, another is started immediately.

Remote command:

TRIG:SOUR IMM, see [TRIGger<n>\[:SEQUence\]:SOURce](#) on page 331

#### External

Defines triggering via a TTL signal at the "EXT TRIG/GATE IN" input connector on the rear panel.

Remote command:

TRIG:SOUR EXT, see [TRIGger<n>\[:SEQUence\]:SOURce](#) on page 331

#### IF Power/ Baseband Power

Defines triggering of the measurement using the second intermediate frequency.

For this purpose, the R&S FSVA/FSV uses a level detector at the second intermediate frequency.

The available trigger levels depend on the RF attenuation and preamplification. A reference level offset, if defined, is also considered.

For details on available trigger levels and trigger bandwidths see the data sheet.

The bandwidth at the intermediate frequency depends on the RBW and sweep type:

Sweep mode:

- RBW > 500 kHz: 40 MHz, nominal

- RBW  $\leq$  500 kHz: 6 MHz, nominal

FFT mode:

- RBW > 20 kHz: 40 MHz, nominal
- RBW  $\leq$  20 kHz: 6 MHz, nominal

**Note:** Be aware that in auto sweep type mode, due to a possible change in sweep types, the bandwidth may vary considerably for the same RBW setting.

The R&S FSVA/FSV is triggered as soon as the trigger level is exceeded around the selected frequency (= start frequency in the frequency sweep).

For digital input via the Digital Baseband Interface (R&S FSV-B17), the baseband power ("BB Power") is used as the trigger source.

Remote command:

TRIG:SOUR IFP, see [TRIGger<n>\[:SEquence\]:SOURce](#) on page 331

TRIG:SOUR BBP for digital input

### Trigger Level

Defines the trigger level as a numeric value.

Remote command:

[TRIGger<n>\[:SEquence\]:LEVel:IFPower](#) on page 329

For digital input via the R&S Digital I/Q Interface, R&S FSV-B17:

[TRIGger<n>\[:SEquence\]:LEVel:BBPower](#) on page 328

### Trigger Polarity

Sets the polarity of the trigger source.

The sweep starts after a positive or negative edge of the trigger signal. The default setting is "Pos". The setting applies to all modes with the exception of the "Free Run" and "Time" mode.

"Pos"                      Level triggering: the sweep is stopped by the logic "0" signal and restarted by the logical "1" signal after the gate delay time has elapsed.

"Neg"                      Edge triggering: the sweep is continued on a "0" to "1" transition for the gate length duration after the gate delay time has elapsed.

Remote command:

[TRIGger<n>\[:SEquence\]:SLOPe](#) on page 330

### Trigger Offset

Opens an edit dialog box to enter the time offset between the trigger signal and the start of the sweep.

The time may be entered in s or in symbols.

offset > 0:	Start of the sweep is delayed
offset < 0:	<p>Sweep starts earlier (pre-trigger)</p> <p>Only possible for span = 0 (e.g. I/Q Analyzer mode) and gated trigger switched off</p> <p>Maximum allowed range limited by the sweep time:  <math>\text{pretrigger}_{\text{max}} = \text{sweep time}</math></p> <p>When using the R&amp;S Digital I/Q Interface (R&amp;S FSV-B17) with I/Q Analyzer mode, the maximum range is limited by the number of pretrigger samples.</p> <p>See the R&amp;S Digital I/Q Interface(R&amp;S FSV-B17) description in the base unit.</p>

In the "External" or "IF Power" trigger mode, a common input signal is used for both trigger and gate. Therefore, changes to the gate delay will affect the trigger delay (trigger offset) as well.

Remote command:

[TRIGger<n>\[:SEQUENCE\]:HOLDoff\[:TIME\]](#) on page 330

#### Trigger Offset Unit

Toggles between symbols and seconds as the trigger offset unit.

### 3.2.8 Softkeys of the Meas Config Menu (R&S FSV-K70)

The "Meas Config" menu provides functions for measurement configuration.

<a href="#">Settings Overview</a> .....	126
<a href="#">Modulation/Signal Description</a> .....	126
<a href="#">Frontend</a> .....	127
<a href="#">I/Q Capture</a> .....	127
<a href="#">Config Pattern</a> .....	127
<a href="#">Burst/Pattern Search</a> .....	127
<a href="#">Range Settings</a> .....	127
<a href="#">Demod/ Meas Filter</a> .....	128
<a href="#">Display Config</a> .....	128

#### Settings Overview

Displays the main settings overview that visualizes the data flow of the Vector Signal Analyzer and summarizes the current settings. In addition, the "Settings Overview" dialog box provides access to the individual settings dialog boxes and allows you to restore default values.

For details on configuring the measurement and a description of the individual dialog boxes, see [Chapter 3.3.1, "Settings Overview"](#), on page 141.

#### Modulation/Signal Description

Opens the "Modulation/Signal Description" dialog box.

The signal description of the expected input signal determines the available configuration settings and the available burst or pattern settings. You can define a pattern to which the result range can be aligned (see ["Pattern"](#) on page 147).

A schematic preview of the current signal description is displayed in the preview area at the bottom of the dialog box. The preview area is not editable directly.

The "Modulation" tab contains modulation and Transmit filter settings. A live preview of the Constellation I/Q trace using the currently defined settings is displayed at the bottom of the dialog box to visualize the changes to the settings.

For details on the available settings see ["Modulation"](#) on page 143 and ["Signal Description"](#) on page 146.

### Frontend

Displays the "Frontend" tab of the "Frontend & I/Q Capture Settings" dialog box.

A live preview of the signal with the current settings is displayed in the preview area at the bottom of the dialog box. The preview area is not editable directly.

Note that this works only in continuous sweep mode.

For details on the available settings see ["Frontend"](#) on page 149

### I/Q Capture

Displays the "I/Q Capture" tab of the "Frontend & I/Q Capture Settings" dialog box.

A live preview of the signal in the capture buffer with the current settings is displayed in the preview area at the bottom of the dialog box. The preview area is not editable directly.

Note that this works only in continuous sweep mode.

For details on the available settings see ["I/Q Capture"](#) on page 152

### Config Pattern

Displays the "Advanced Pattern Settings" dialog box (see ["Advanced Settings"](#) on page 162).

### Burst/Pattern Search

Displays the "Burst/Pattern Search" dialog box.

The "Burst Search" tab contains the settings for burst searches.

A live preview of the capture buffer with the current settings is displayed in the preview area at the bottom of the dialog box. The green bar below the trace indicates the defined evaluation ranges (see ["Evaluation Range"](#) on page 167). The preview area is not editable directly.

The "Pattern Search" tab contains the settings for pattern searches.

For details on the available settings see ["Burst Search"](#) on page 158 and ["Pattern Search"](#) on page 160.

### Range Settings

Displays the "Result Range" tab of the "Result Range/Evaluation Range" dialog box.

A preview of the result display with the current settings is displayed in the visualization area at the bottom of the dialog box.

For details on the available settings see ["Result Range"](#) on page 165 and ["Evaluation Range"](#) on page 167

#### Demod/ Meas Filter

Displays the "Demodulation & Measurement Filter" dialog box.

The "Demodulation" tab contains the settings for the demodulation.

The "Measurement Filter" tab contains the settings for the measurement filter.

A live preview of the Constellation I/Q trace with the current settings is displayed in the preview area at the bottom of the dialog box. The preview area is not editable directly.

For details on the available settings see ["Measurement Filter"](#) on page 174 and ["Demodulation"](#) on page 169.

#### Display Config

Opens the "Display Configuration" dialog box to configure the measurement results display. See [Chapter 3.3.1.6, "Display Configuration"](#), on page 175.

### 3.2.9 Softkeys of the Marker Menu (R&S FSV-K70)

The MARKER key displays the "Marker" menu, which contains the following softkeys.

<a href="#">Marker 1/2/3/4</a> .....	128
<a href="#">Marker Norm/Delta</a> .....	128
<a href="#">Couple Screens (On/Off)</a> .....	129
<a href="#">Link Mkr1 and Delta1</a> .....	129
<a href="#">Marker to Trace</a> .....	130
<a href="#">All Marker Off</a> .....	130

#### Marker 1/2/3/4

Selects the corresponding marker and activates it.

Marker 1 is always a normal marker. After Marker 2 to 4 have been switched on, they are delta markers that are referenced to Marker 1. These markers can be converted into markers with absolute value displays using the "Marker Norm/Delta" softkey.

When Marker 1 is the active marker, pressing the "Marker Norm/Delta" softkey switches on an additional delta marker. Pressing the "Marker 1" to "Marker 4" softkey again switches the corresponding marker off.

Remote command:

[CALCulate<n>:MARKer<m>\[:STATe\]](#) on page 238

[CALCulate<n>:MARKer<m>:X](#) on page 239

[CALCulate<n>:MARKer<m>:Y?](#) on page 241

[CALCulate<n>:DELTamarker<m>\[:STATe\]](#) on page 211

[CALCulate<n>:DELTamarker<m>:X](#) on page 212

[CALCulate<n>:DELTamarker<m>:Y?](#) on page 213

#### Marker Norm/Delta

Changes the active marker to a normal (norm) or delta marker (with respect to marker 1).



Remote command:

[CALCulate<n>:MARKer<m>\[:STATe\]](#) on page 238

[CALCulate<n>:DELTAmarker<m>\[:STATe\]](#) on page 211

### Couple Screens (On/Off)

Markers in all diagrams with the same (time or symbols) x-axis have coupled x-values (except for capture buffer display), i.e. if you move the marker in one diagram, it is moved in all coupled diagrams.

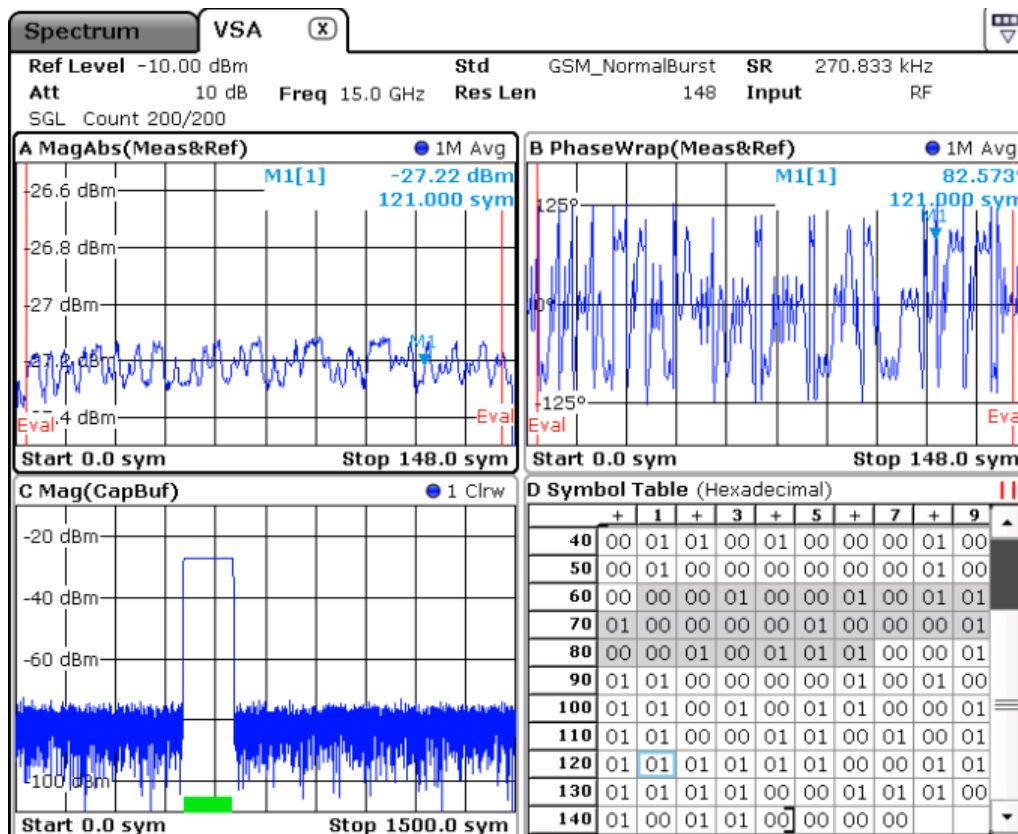


Figure 3-25: Coupled markers in screens A, B and D

Remote command:

[CALCulate<n>:MARKer<m>:LINK](#) on page 234

### Link Mkr1 and Delta1

The delta marker 1 is linked to marker 1, so if the x-axis value of the marker 1 is changed, the delta marker 1 will follow on the same x-position. The link is off by default.

You can set the two markers on different traces to measure the difference (e.g. between a max hold trace and a min hold trace or between a measurement and a reference trace).

Remote command:

[CALCulate<n>:DELTAmarker<m>:LINK](#) on page 208

**Marker to Trace**

Opens an edit dialog box to enter the number of the trace on which the marker is to be placed.

Remote command:

`CALCulate<n>:MARKer<m>:TRACe` on page 239

**All Marker Off**

Switches all markers off. It also switches off all functions and displays that are associated with the markers/delta markers.

Remote command:

`CALCulate<n>:MARKer<m>:AOFF` on page 222

**3.2.10 Softkeys of the Marker To Menu (R&S FSV-K70)**

The MARKER -> key displays the "Marker To" menu, which contains the following softkeys.

Select 1/2/3/4/Δ.....	130
Select Mkr and Trace.....	130
L Marker.....	130
L Move Marker to Trace.....	131
Search Settings.....	131
L Search Direction.....	131
L Marker Real / Marker Imag.....	131
L Search Limits.....	131
Peak.....	131
Next Peak.....	131
Max  Peak .....	132
Min.....	132
Next Min.....	132

**Select 1/2/3/4/Δ**

Selects the normal marker or the delta marker and activates the marker. "Δ" stands for delta marker 1.

`CALCulate<n>:MARKer<m>[:STATe]` on page 238

`CALCulate<n>:MARKer<m>:X` on page 239

`CALCulate<n>:MARKer<m>:Y?` on page 241

**Select Mkr and Trace**

Opens the "Select Marker and Trace" tab of the "Marker To Settings" dialog box.

**Marker ← Select Mkr and Trace**

Enables and defines the setting for the individual markers. The marker value is defined in the x-axis unit. The selected marker can be moved to a specific trace using the [Move Marker to Trace](#) function.

Remote command:

`CALCulate<n>:MARKer<m>[:STATe]` on page 238

**Move Marker to Trace ← Select Mkr and Trace**

Moves the marker selected under [Marker](#) to the trace selected here. The marker changes to the selected trace, but remains on the previous symbol.

Remote command:

[CALCulate<n>:MARKer<m>:TRACe](#) on page 239

**Search Settings**

Opens the "Search Settings" tab of the "Marker To Settings" dialog box.

**Search Direction ← Search Settings**

Defines whether the absolute values are searched, or the values to the left (smaller) or to the right (greater).

Remote command:

[CALCulate<n>:MARKer<m>:MAXimum\[:PEAK\]](#) on page 236

[CALCulate<n>:MARKer<m>:MAXimum:LEFT](#) on page 235

[CALCulate<n>:MARKer<m>:MAXimum:RIGHT](#) on page 236

**Marker Real / Marker Imag ← Search Settings**

Defines whether marker search functions are performed on the real or imaginary trace of the "Real/Imag" measurement.

Remote command:

[CALCulate<n>:MARKer<m>:SEARch](#) on page 238

**Search Limits ← Search Settings**

If enabled, defines the limits of the search.

"Left Limit"      Lowest symbol number for which the search is performed.

"Right Limit"     Highest symbol number for which the search is performed.

"Use Zoom  
Limits"            Restricts the marker search to the zoomed area.

Remote command:

[CALCulate<n>:MARKer<m>:X:SLIMits:ZOOM](#) on page 241

[CALCulate<n>:MARKer<m>:X:SLIMits:LEFT](#) on page 240

[CALCulate<n>:MARKer<m>:X:SLIMits:RIGHT](#) on page 241

**Peak**

Sets the active marker/delta marker to the highest maximum of the trace.

Remote command:

[CALCulate<n>:MARKer<m>:MAXimum\[:PEAK\]](#) on page 236

**Next Peak**

Sets the active marker/delta marker to the next maximum of the selected trace.

Remote command:

[CALCulate<n>:MARKer<m>:MAXimum:NEXT](#) on page 235

[CALCulate<n>:DELTAmarker<m>:MAXimum:NEXT](#) on page 209

**Max |Peak|**

Sets the active marker/delta marker to the largest absolute peak value (maximum or minimum) of the selected trace.

Remote command:

[CALCulate<n>:MARKer<m>:MAXimum:APEak](#) on page 235

**Min**

Sets the active marker/delta marker to the minimum of the selected trace.

Remote command:

[CALCulate<n>:MARKer<m>:MINimum\[:PEAK\]](#) on page 237

**Next Min**

Sets the active marker/delta marker to the next minimum of the selected trace.

Remote command:

[CALCulate<n>:MARKer<m>:MINimum:NEXT](#) on page 237

[CALCulate<n>:DELTamarker<m>:MINimum:NEXT](#) on page 210

### 3.2.11 Softkeys of the Lines Menu

The following table shows all softkeys available in the "Limits" menu which is displayed when you press the LINES key.

**Tasks**

- [Chapter 3.3.8, "Working with Limits for Modulation Accuracy Measurements"](#), on page 199

<a href="#">Vertical Line</a> .....	132
<a href="#">Horizontal Line</a> .....	133
<a href="#">ModAcc Limits</a> .....	133
<a href="#">Config ModAcc Limits</a> .....	133
L <a href="#">Limit Checking</a> .....	134
L <a href="#">Set to Default</a> .....	134
L <a href="#">Current/Mean/Peak</a> .....	134
L <a href="#">Limit Value</a> .....	135
L <a href="#">Check</a> .....	135

**Vertical Line**

Displays an absolute or relative vertical line in an eye diagram (see [Chapter 3.1.1, "Result types"](#), on page 70). A relative line is only available if an absolute vertical line is already displayed.

The position of the lines can be defined numerically or by dragging the line to a new position in the diagram.

The absolute x-value of the eye diagram at the position of the first line is indicated in the diagram. The relative x-value of the eye diagram at the position of the second line, in relation to the x-value at the first line, is also indicated. The unit of the vertical lines depends on the unit of the x-axis in the diagram.

If you position the lines at the left and right edges of the eye, the relative line value represents the width of the eye (see also [Chapter 3.3.9, "Measuring the Size of an Eye"](#), on page 200).

Remote command:

[CALCulate<n>:TLABs:STATe](#) on page 252

[CALCulate<n>:TLABs\[:VALue\]](#) on page 253

[CALCulate<n>:TLRel:STATe](#) on page 253

[CALCulate<n>:TLRel\[:VALue\]](#) on page 254

### Horizontal Line

Displays an absolute or relative horizontal line in an eye diagram (see [Chapter 3.1.1, "Result types"](#), on page 70). A relative line is only available if an absolute horizontal line is already displayed.

The position of the lines can be defined numerically or by dragging the line to a new position in the diagram.

The absolute y-value of the eye diagram at the position of the first line is indicated in the diagram. The relative y-value of the eye diagram at the position of the second line, in relation to the y-value at the first line, is also indicated. The unit of the vertical lines depends on the unit of the y-axis in the diagram.

If you position the lines at the top and the bottom of the eye, the relative line value represents the height of the eye (see also [Chapter 3.3.9, "Measuring the Size of an Eye"](#), on page 200).

Remote command:

[CALCulate<n>:DLABs:STATe](#) on page 244

[CALCulate<n>:DLABs\[:VALue\]](#) on page 244

[CALCulate<n>:DLRel:STATe](#) on page 245

[CALCulate<n>:DLRel\[:VALue\]](#) on page 245

### ModAcc Limits

Activates or deactivates evaluation of modulation accuracy limits in the result summary.

If limit check is activated and the measured values exceed the limits, those values are indicated in red in the result summary table. If limit check is activated and no values exceed the limits, the checked values are indicated in green.

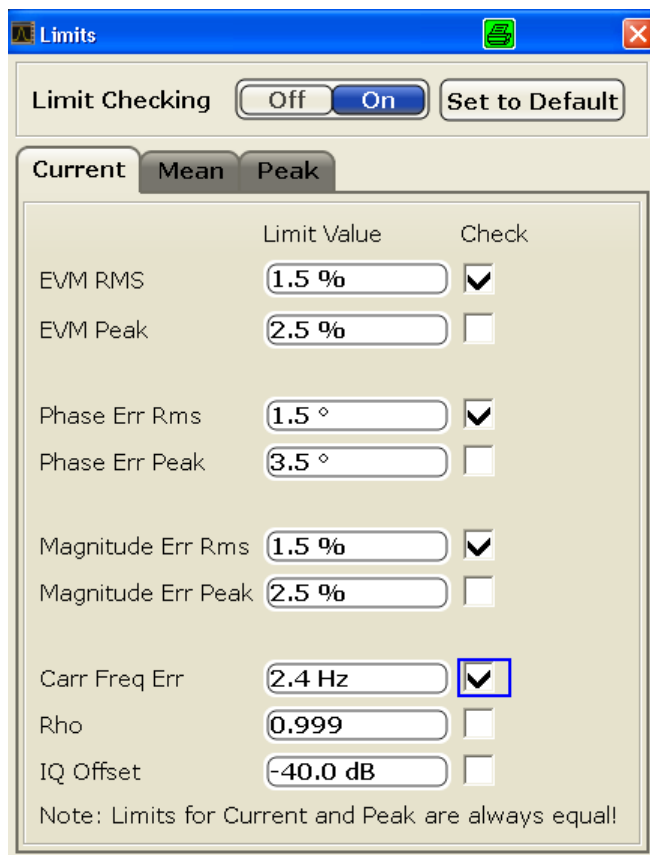
For details on working with limits see [Chapter 3.3.8, "Working with Limits for Modulation Accuracy Measurements"](#), on page 199.

Remote command:

[CALCulate<n>:LIMit:MACCuracy:STATe](#) on page 215

### Config ModAcc Limits

Opens a dialog to configure modulation accuracy limits for the result summary.



**Note:** The dialog box differs depending on the modulation type. For FSK modulation, different result types are available.

For details on configuring limits see [Chapter 3.3.8, "Working with Limits for Modulation Accuracy Measurements"](#), on page 199.

#### Limit Checking ← Config ModAcc Limits

Activates or deactivates a limit check on the subsequent measurements.

Remote command:

`CALCulate<n>:LIMit:MACCuracy:STATe` on page 215

#### Set to Default ← Config ModAcc Limits

Restores the default limits and deactivates all checks.

Remote command:

`CALCulate<n>:LIMit:MACCuracy:DEFault` on page 214

#### Current/Mean/Peak ← Config ModAcc Limits

Define and activate the limits for the currently measured value, the mean and the peak value on separate tabs. Note that the limits for the current and peak values are always the same.

**Limit Value ← Current/Mean/Peak ← Config ModAcc Limits**

Define the limit with which the currently measured, mean or peak value is to be compared. A different limit value can be defined for each result type. Depending on the modulation type, different result types are available.

Result type	Remote command
<b>PSK, MSK, QAM:</b>	
EVM RMS	<code>CALCulate&lt;n&gt;:LIMit:MACCuracy:EVM:RCURrent:VALue</code> on page 218
EVM Peak	<code>CALCulate&lt;n&gt;:LIMit:MACCuracy:EVM:PCURrent:VALue</code> on page 218
Phase Err Rms	<code>CALCulate&lt;n&gt;:LIMit:MACCuracy:PERRor:RCURrent:VALue</code> on page 220
Phase Err Peak	<code>CALCulate&lt;n&gt;:LIMit:MACCuracy:PERRor:PCURrent:VALue</code> on page 220
Magnitude Err Rms	<code>CALCulate&lt;n&gt;:LIMit:MACCuracy:MERRor:RCURrent:VALue</code> on page 219
Magnitude Err Peak	<code>CALCulate&lt;n&gt;:LIMit:MACCuracy:MERRor:PCURrent:VALue</code> on page 219
Carr Freq Err	<code>CALCulate&lt;n&gt;:LIMit:MACCuracy:CFERRor:CURRent:VALue</code> on page 217
Rho	<code>CALCulate&lt;n&gt;:LIMit:MACCuracy:RHO:CURRent:VALue</code> on page 221
IQ Offset	<code>CALCulate&lt;n&gt;:LIMit:MACCuracy:OOFset:CURRent:VALue</code> on page 220
<b>FSK modulation only:</b>	
Freq Err Rms	<code>CALCulate&lt;n&gt;:LIMit:MACCuracy:FERRor:RCURrent:VALue</code> on page 219
Freq Err Peak	<code>CALCulate&lt;n&gt;:LIMit:MACCuracy:FERRor:PCURrent:VALue</code> on page 219
Magnitude Err Rms	<code>CALCulate&lt;n&gt;:LIMit:MACCuracy:MERRor:RCURrent:VALue</code> on page 219
Magnitude Err Peak	<code>CALCulate&lt;n&gt;:LIMit:MACCuracy:MERRor:PCURrent:VALue</code> on page 219
FSK Dev Err	<code>CALCulate&lt;n&gt;:LIMit:MACCuracy:FERRor:PCURrent:VALue</code> on page 219
Carr Freq Err	<code>CALCulate&lt;n&gt;:LIMit:MACCuracy:CFERRor:CURRent:VALue</code> on page 217

**Check ← Current/Mean/Peak ← Config ModAcc Limits**

Considers the defined limit value in the limit check, if checking is activated.

Remote command:

`CALCulate<n>:LIMit:MACCuracy:<ResultType>:<LimitType>:STATe`  
on page 215

### 3.2.12 Softkeys of the Input/Output menu (R&S FSV-K70)

The INPUT/OUTPUT key displays the "In-/Output" menu, which contains the following softkeys.

Signal Source.....	136
L Input Path.....	136
L Connected Device.....	136
L Input Sample Rate.....	136
L Full Scale Level.....	137
L Level Unit.....	137
L Adjust Reference Level to Full Scale Level.....	137
EXIQ.....	137
L TX Settings.....	137
L RX Settings.....	137
L Send To.....	137
L Firmware Update.....	138
L R&S Support.....	138
L DigIConf.....	138
Input (AC/DC).....	138
Digital IQ Info.....	139

#### Signal Source

Opens a dialog box to select the signal source.

For "Digital Baseband (I/Q)", the source can also be configured here.

#### Input Path ← Signal Source

Defines whether the "RF Radio Frequency" or the "Digital IQ" input path is used for measurements. "Digital IQ" is only available if option R&S FSV-B17 (R&S Digital I/Q Interface) is installed.

**Note:** Note that the input path defines the characteristics of the signal, which differ significantly between the RF input and digital input.

Remote command:

`INPut:SElect` on page 277

#### Connected Device ← Signal Source

Displays the name of the device connected to the optional R&S Digital I/Q Interface (R&S FSV-B17) to provide Digital IQ input. The device name cannot be changed here.

The device name is unknown.

Remote command:

`INPut:DIQ:CDEvice` on page 272

#### Input Sample Rate ← Signal Source

Defines the sample rate of the digital I/Q signal source. This sample rate must correspond with the sample rate provided by the connected device, e.g. a generator.

Remote command:

`INPut:DIQ:SRATe` on page 274



**Full Scale Level ← Signal Source**

The "Full Scale Level" defines the level that should correspond to an I/Q sample with the magnitude "1".

The level can be defined either in dBm or Volt.

Remote command:

`INPut:DIQ:RANGe[:UPPer]` on page 273

**Level Unit ← Signal Source**

Defines the unit used for the full scale level.

Remote command:

`INPut:DIQ:RANGe[:UPPer]:UNIT` on page 274

**Adjust Reference Level to Full Scale Level ← Signal Source**

If enabled, the reference level is adjusted to the full scale level automatically if any change occurs.

Remote command:

`INPut:DIQ:RANGe:COUPling` on page 273

**EXIQ**

Opens a configuration dialog box for an optionally connected R&S EX-IQ-BOX and a submenu to access the main settings quickly.

**Note:** The EX-IQ-Box functionality is not supported for R&S FSV models 1307.9002Kxx.

If the optional R&S DigIConf software is installed, the submenu consists only of one key to access the software. **Note that R&S DigIConf requires a USB connection (not LAN!) from the R&S FSVA/FSV to the R&S EX-IQ-BOX in addition to the R&S Digital I/Q Interface connection. R&S DigIConf version 2.10 or higher is required.**

For typical applications of the R&S EX-IQ-BOX see also the description of the R&S Digital I/Q Interface (R&S FSV-B17) in the base unit manual.

For details on configuration see the "R&S®Ex I/Q Box - External Signal Interface Module Manual".

For details on installation and operation of the R&S DigIConf software, see the "R&S®EX-IQ-BOX Digital Interface Module R&S®DigIConf Software Operating Manual".

**TX Settings ← EXIQ**

Opens the "EX-IQ-BOX Settings" dialog box to configure the R&S FSVA/FSV for digital output to a connected device ("Transmitter" Type).

**RX Settings ← EXIQ**

Opens the "EX-IQ-BOX Settings" dialog box to configure the R&S FSVA/FSV for digital input from a connected device ("Receiver" Type).

**Send To ← EXIQ**

The configuration settings defined in the dialog box are transferred to the R&S EX-IQ-BOX.

**Firmware Update ← EXIQ**

If a firmware update for the R&S EX-IQ-BOX is delivered with the R&S FSVA/FSV firmware, this function is available. In this case, when you select the softkey, the firmware update is performed.

**R&S Support ← EXIQ**

Stores useful information for troubleshooting in case of errors.

This data is stored in the `C:\R_S\Instr\user\Support` directory on the instrument.

The `SupportSave.dfl` file contains the instrument settings and input data and can be loaded to the instrument again for inspection later. (Remember to set the sweep mode to "Single Sweep" beforehand, as "Continuous Sweep" would immediately overwrite the loaded input data.)

If you contact the Rohde&Schwarz support to get help for a certain problem, send these files to the support in order to identify and solve the problem faster.

**DigIConf ← EXIQ**

Starts the optional R&S DigIConf application. This softkey is only available if the optional software is installed.

To return to the R&S FSVA/FSV application, press any key on the front panel. The application is displayed with the "EXIQ" menu, regardless of which key was pressed.

For details on the R&S DigIConf application, see the "R&S®EX-IQ-BOX Digital Interface Module R&S®DigIConf Software Operating Manual".

**Note:** If you close the R&S DigIConf window using the "Close" icon, the window is minimized, not closed.

If you select the "File > Exit" menu item in the R&S DigIConf window, the application is closed. Note that in this case the settings are lost and the EX-IQ-BOX functionality is no longer available until you restart the application using the "DigIConf" softkey in the R&S FSVA/FSV once again.

Remote command:

Remote commands for the R&S DigIConf software always begin with `SOURce:EBOX`. Such commands are passed on from the R&S FSVA/FSV to the R&S DigIConf automatically which then configures the R&S EX-IQ-BOX via the USB connection.

All remote commands available for configuration via the R&S DigIConf software are described in the "R&S®EX-IQ-BOX Digital Interface Module R&S®DigIConf Software Operating Manual".

**Example 1:**

```
SOURce:EBOX:*RST
SOURce:EBOX:*IDN?
```

Result:

```
"Rohde&Schwarz,DigIConf,02.05.436 Build 47"
```

**Example 2:**

```
SOURce:EBOX:USER:CLOCK:REFERENCE:FREQUENCY 5MHZ
```

Defines the frequency value of the reference clock.

**Input (AC/DC)**

Toggles the RF input of the R&S FSVA/FSV between AC and DC coupling.

This function is not available for input from the R&S Digital I/Q Interface (option R&S FSV-B17).

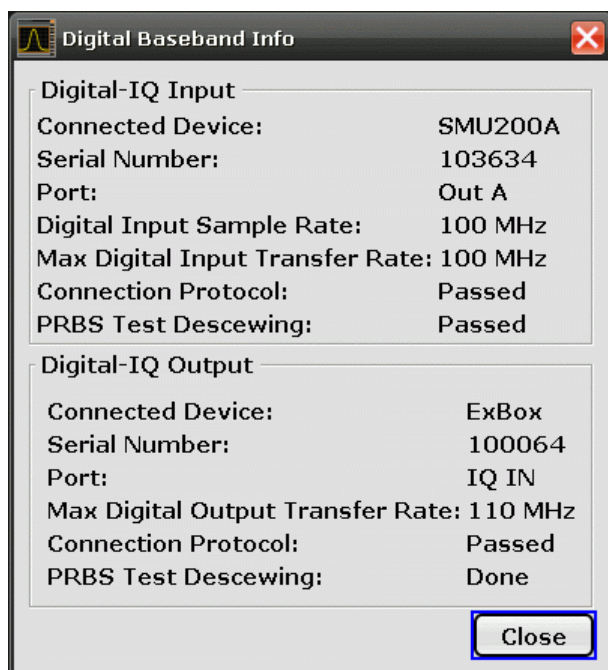
Remote command:

[INPut:COUPling](#) on page 271

**Digital IQ Info**

Displays a dialog box with information on the digital I/Q input and output connection via the optional R&S Digital I/Q Interface (R&S FSV-B17), if available. The information includes:

- Device identification
- Used port
- (Maximum) digital input/output sample rates and maximum digital input/output transfer rates
- Status of the connection protocol
- Status of the PRBS descewing test



For details see "Interface Status Information" in "Instrument Functions - R&S Digital I/Q Interface (Option R&S FSV-B17)" in the description of the base unit.

Remote command:

[INPut:DIQ:CDEvice](#) on page 272

**3.2.13 Softkeys of the Save/Recall Menu (R&S FSV-K70)**

The "Save/Recall" menu contains the same functions as for the base unit, except for the "Export" submenu:

[Export](#)..... 140

L ASCII Trace Export.....	140
L IQ Export.....	140
L R&S Support.....	140

### Export

Opens a dialog box to configure exports of trace data.

#### ASCII Trace Export ← Export

Opens the "ASCII Trace Export" dialog box and saves the active trace in ASCII format to the specified file and directory. Various options are available to configure the stored data.

- "Mode"  
Stores raw I/Q data or trace data
- "Header"  
Includes a header with scaling information etc.
- "Decimal Separator"  
Defines the separator for decimal values as point or comma

Remote command:

[FORMat:DEXPort:DSEParator](#) on page 267

[FORMat:DEXPort:HEADer](#) on page 268

[FORMat:DEXPort:MODE](#) on page 268

[MMEMory:STORe<n>:TRACe](#) on page 279

#### IQ Export ← Export

Opens a file selection dialog box to select an export file to which the IQ data will be stored. This function is only available in single sweep mode.

For details see the description in the base unit ("Importing and Exporting I/Q Data").

Remote command:

[MMEMory:STORe:IQ:STATe](#) on page 278

[MMEMory:STORe:IQ:COMM](#) on page 278

#### R&S Support ← Export

Stores useful information for troubleshooting in case of errors.

This data is stored in the `C:\R_S\Instr\user\Support` directory on the instrument.

The `SupportSave.dfl` file contains the instrument settings and input data and can be loaded to the instrument again for inspection later. (Remember to set the sweep mode to "Single Sweep" beforehand, as "Continuous Sweep" would immediately overwrite the loaded input data.)

If you contact the Rohde&Schwarz support to get help for a certain problem, send these files to the support in order to identify and solve the problem faster.

### 3.2.14 Available Context Menus

For many objects on the screen, context-sensitive menus are available that provide helpful functions for the specific object, e.g. an edit dialog box for a specific setting.

Thus, you don't have to navigate through various softkey levels or dialog boxes to quickly change a setting.

There are two ways to access the context menus:

- Right-click the object to display the menu temporarily and select the required function directly.
- Double-click the object to display a context-sensitive softkey menu that remains visible until you click a hardkey with its own menu.

**Example:**

For example, the context-sensitive menu for the symbol rate display in the information bar at the top of the screen provides a function to change the symbol rate directly. Alternatively, you could select "Home > Modulation" and then the "Symbol Rate" input field.

### 3.3 Configuring VSA Measurements

Using the VSA option you can perform vector signal analysis measurements using pre-defined standard setting files, or independently of digital standards using user-defined measurement settings. Such settings can be stored for recurrent use.

Thus, configuring VSA measurements requires one of the following tasks:

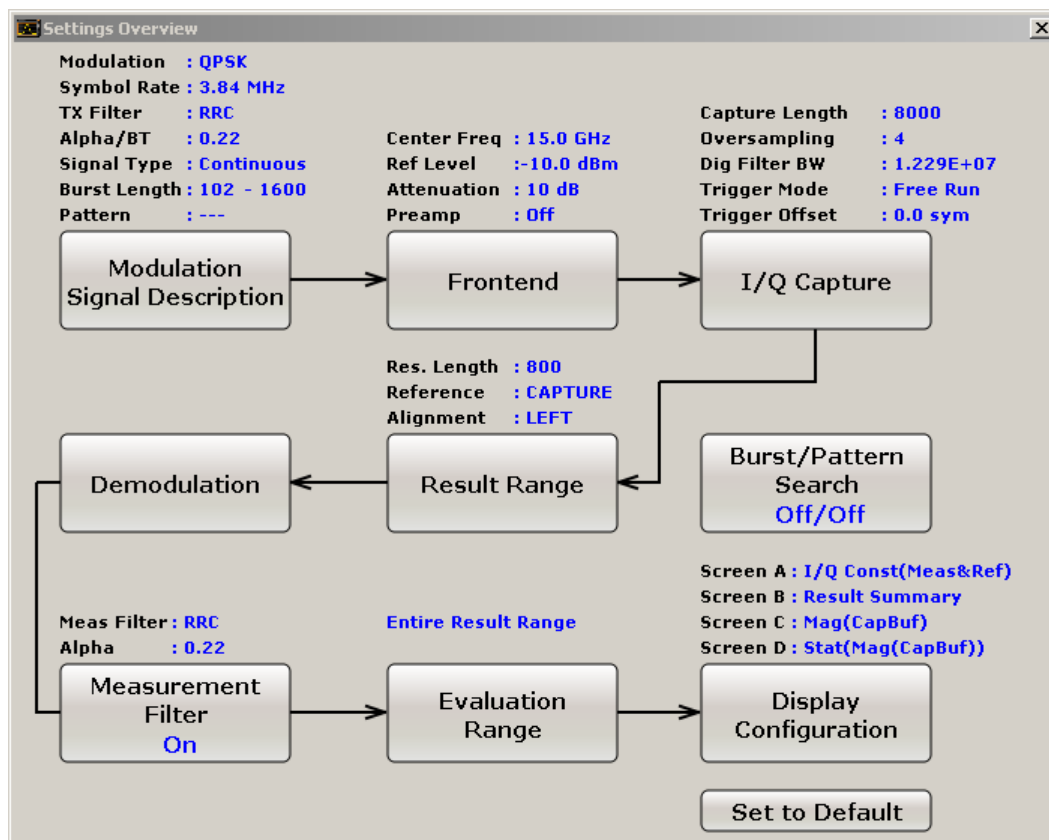
- Selecting an existing standard settings file and, if necessary, adapting the measurement settings to your specific requirements.
- Configuring the measurement settings and, if necessary, storing the settings in a file.
- [Settings Overview](#)..... 141
- [Defining the Result Range](#)..... 181
- [Changing the Display Scaling](#)..... 184
- [Managing standard settings files](#)..... 187
- [Working with Pattern Searches](#)..... 189
- [Managing patterns](#)..... 191
- [Working With Known Data Files](#)..... 194
- [Working with Limits for Modulation Accuracy Measurements](#)..... 199
- [Measuring the Size of an Eye](#)..... 200

#### 3.3.1 Settings Overview

An overview of the current and required settings is available using the "Settings Overview" softkey in the "VSA" menu (see "[Settings Overview](#)" on page 108).

The overview visualizes the data flow in the Vector Signal Analyzer, summarizes the current settings and provides a convenient way to configure all measurement settings. From the overview you can access the individual settings dialog boxes by clicking the required topic. For details on the displayed information, see the description of the individual dialog boxes below.

To reset the instrument to the default settings of the default standard, click "Set to Default".



- [Modulation and Signal Description Settings](#)..... 142
- [Frontend and I/Q Capture Settings](#)..... 149
- [Burst and Pattern Search Settings](#)..... 158
- [Result Range and Evaluation Range Settings](#)..... 165
- [Demodulation and Measurement Filter Settings](#)..... 169
- [Display Configuration](#)..... 175

### 3.3.1.1 Modulation and Signal Description Settings

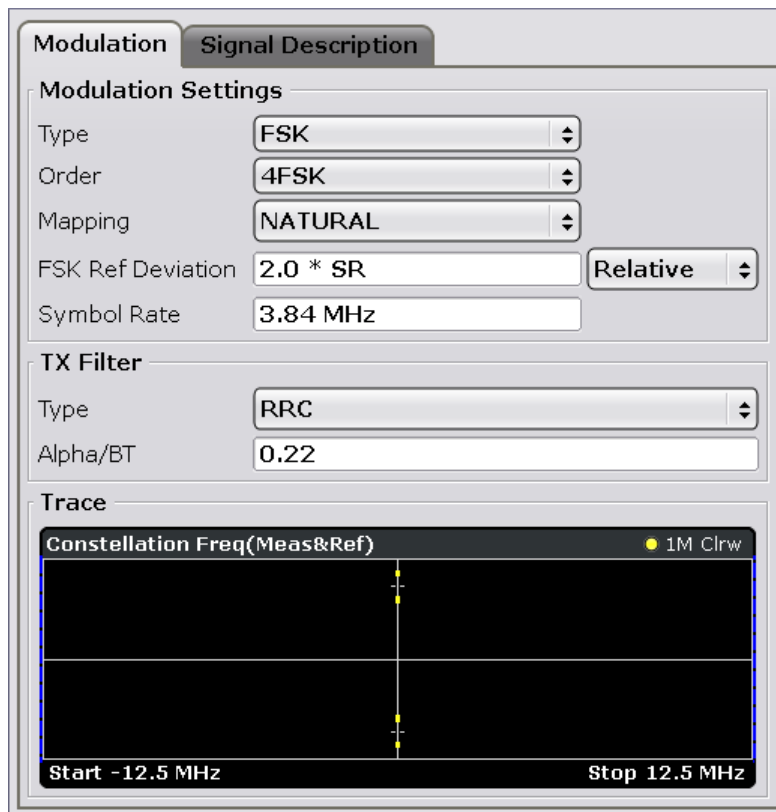
You describe the properties of the signal to be measured in the "Modulation and Signal Description Settings" dialog box. This dialog box is displayed when you select "Modulation / Signal Description" in the "Settings Overview".

The dialog box contains the following tabs:

- "Modulation" on page 143
- "Signal Description" on page 146
- "Known Data" on page 148

**Modulation**

The "Modulation" tab of the "Modulation & Signal Description" dialog box contains modulation and Transmit filter settings. A live preview of the Constellation I/Qtrace using the currently defined settings is displayed at the bottom of the dialog box to visualize the changes to the settings. The preview area is not editable directly.



Modulation Type.....143  
 Modulation Order.....144  
 FSK Ref Deviation.....145  
 Modulation Mapping.....145  
 Symbol Rate.....145  
 Transmit filter Type.....145  
     └ Load User Filter.....145  
 Alpha/BT.....146

**Modulation Type**

Defines the modulation type of the vector signal. The following types are available:

- PSK
- MSK
- QAM
- FSK
- UserQAM

Remote command:

[SENSe:] DDEMod: FORMat on page 287

**Modulation Order**

Depending on the [Modulation Type](#), various orders of modulation are available:

Type	Available orders
PSK	BPSK
	QPSK
	Offset QPSK
	DQPSK
	3Pi/4-QPSK
	Pi/4-DQPSK
	8PSK
	D8PSK
	3Pi/8-8PSK
	Pi/8-D8PSK
	Pi/4-QPSK
MSK	MSK
	DMSK
QAM	16QAM
	Pi/4-16QAM
	32QAM
	-Pi/4-32QAM
	64QAM
	128QAM
	256QAM
FSK	2FSK
	4FSK
	8FSK
	16FSK
UserQAM	2ary
	4ary
	16ary
	32ary

Remote command:

[\[SENSe:\] DDEMod:PSK:FORMat](#) on page 297

[\[SENSe:\] DDEMod:QPSK:FORMat](#) on page 299

[\[SENSe:\] DDEMod:MSK:FORMat](#) on page 292



[\[SENSe:\] DDEMod:QAM:FORMat](#) on page 298

[\[SENSe:\] DDEMod:FSK:NState](#) on page 287

### FSK Ref Deviation

The FSK Reference Deviation sets the deviation to the reference frequency.

In case of 2FSK, it indicates the distance from the reference frequency to the positive / negative deviation frequency and in case of 4FSK, the distance to the outer positive/ negative deviation frequency.

Select "Relative" from the dropdown menu next to the input field to set the deviation as a multiple of the symbol rate ( $x \cdot SR$ ). If you want to set the deviation as an absolute value in Hz, select "Absolute" from the dropdown menu.

Note that this parameter is available only in combination with FSK modulated signals.

Remote command:

[CALCulate<n>:FSK:DEVIation:REFerence\[:VALue\]](#) on page 249

[CALCulate<n>:FSK:DEVIation:REFerence:RELative](#) on page 249

### Modulation Mapping

The available mapping types depend on the [Modulation Type](#) and [Modulation Order](#).

For more information on the modulation mapping, refer to

- [Chapter 2.3, "Symbol Mapping"](#), on page 21

Remote command:

[\[SENSe:\] DDEMod:MAPPING\[:VALue\]](#) on page 290

[\[SENSe:\] DDEMod:MAPPING:CATalog?](#) on page 290

### Symbol Rate

The symbol rate also determines the I/Q bandwidth of the data recording and demodulation. You can change the default rate by entering a value in Hz.

For details on the possible values see [Table 2-1](#).

Remote command:

[\[SENSe:\] DDEMod:SRATe](#) on page 312

### Transmit filter Type

Defines the type of transmit filter

An overview of available Transmit filters is provided in [Table 2-3](#).

Remote command:

[\[SENSe:\] DDEMod:TFILter:NAME](#) on page 314

To define the name of the Transmit filter to be used.

[\[SENSe:\] DDEMod:TFILter\[:STATe\]](#) on page 314

To switch off the Transmit filter.

### Load User Filter ← Transmit filter Type

Opens a file-selection dialog box to select the user-defined Transmit filter to be used.

**Note:** If a user-defined Transmit filter is selected and the measurement filter is defined automatically (see ["Auto"](#) on page 175), a Low-ISI measurement filter according to the selected user filter is calculated and used.

For details see [Chapter 2.2.7, "Customized Filters"](#), on page 19.

Remote command:

`[SENSe:]DDEMod:TFILter:NAME` on page 314

### Alpha/BT

Defines the roll-off factor (Alpha) or the filter bandwidth (BT).

The roll-off factor and filter bandwidth for Transmit filter is available for RC, RRC, Gauss and GMSK filter.

The roll-off factor and filter bandwidth for measurement filter is available for RRC filter.

Remote command:

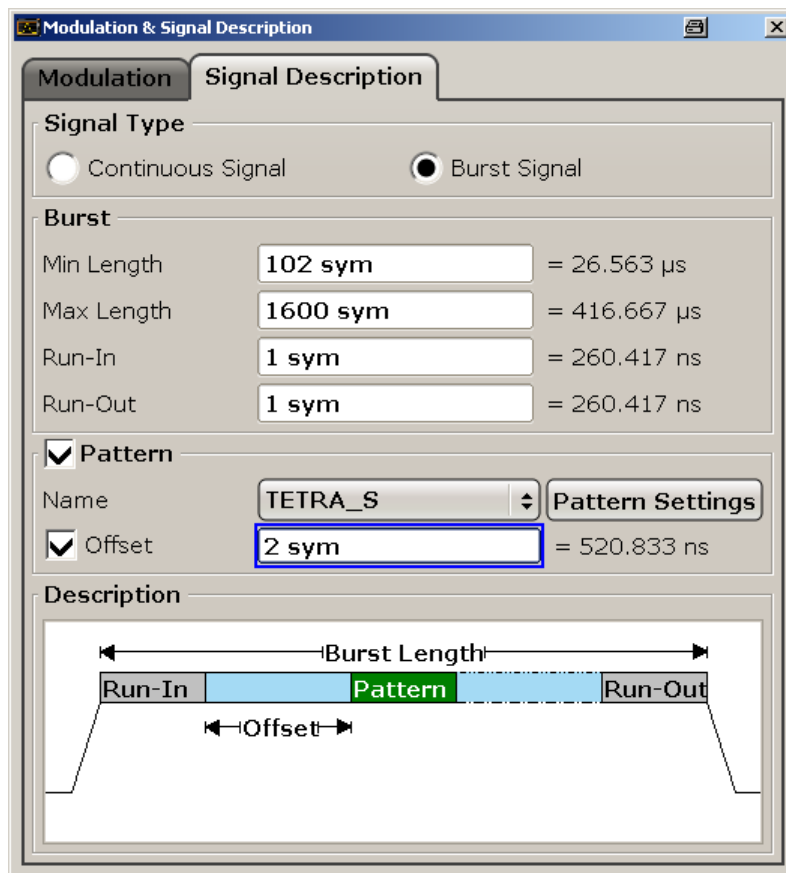
Transmit filter: `[SENSe]:DDEMod:FILTer:ALPHa` on page 286

Measurement filter: `[SENSe]:DDEMod:MFILter:ALPHa` on page 291

### Signal Description

The settings in the "Signal Description" tab of the "Modulation & Signal Description" dialog box describe the expected input signal and determine which settings are available for configuration. You can define a [Pattern](#) to which the instrument can be synchronized, thus adapting the result range.

A graphical preview of the current Signal Description configuration is displayed in the preview area at the bottom of the dialog box. The preview area is not editable directly.



Continuous Signal / Burst Signal.....	147
Pattern.....	147
Pattern Settings.....	147
Offset.....	148

### Continuous Signal / Burst Signal

Determines whether the signal is continuous or contains bursts. For bursts, further settings are available.

Parameter	Description
Min Length	Shortest expected burst length in symbols
Max Length	Longest expected burst length in symbols ( $\leq 15000$ )
Run-In	The number of symbols before the signal is assumed to have valid modulated symbols
Run-Out	The number of symbols before the falling edge that do not necessarily need to have a valid modulation

#### Note:

The burst excluding its Run-In/-Out areas is sometimes referred to as the "useful part". The minimum length of the useful part (= Min Length - Run-In - Run-Out) must be  $\geq 10$ .

The parameter Run-In/-Out can be used to influence the range over which the EVM is minimized. The (internal) synchronization range is the overlapping area of the result range and the burst excluding its Run-In/-Out areas. Hence, this parameter also allows for demodulation of bursts with mixed modulations, e.g. Bluetooth, because it can be used to explicitly exclude symbols from influencing the synchronization.

Remote command:

`[SENSe:] DDEMod: SIGNAL [:VALue]` on page 312

### Pattern

If enabled, the instrument expects the signal to contain a pattern.

**Note:** The pattern search itself must be enabled separately in the "Pattern Search Settings", see "Auto/On/Off" on page 161. By default, the pattern search is active if the signal description contains a pattern.

This function cannot be enabled if the signal description does not contain a pattern.

Select the pattern from the selection list. To change the pattern settings, press "Advanced Settings" on page 162. For details on working with pattern searches, see Chapter 3.3.5, "Working with Pattern Searches", on page 189

Further pattern settings are located in the "Pattern Search" on page 160 dialog box (see Chapter 3.3.1.3, "Burst and Pattern Search Settings", on page 158).

Remote command:

`[SENSe:] DDEMod: SIGNAL : PATTern` on page 311

### Pattern Settings

Displays the "Advanced Pattern Settings" dialog box (see "Advanced Settings" on page 162).

**Offset**

The offset of the pattern is defined with respect to the start of the useful part of the burst (see also the note in "Continuous Signal / Burst Signal" on page 147). If the position of the pattern within the burst is known, it is recommended that you define the offset. That will accelerate the pattern search and enhance the accuracy of the burst search.

Remote command:

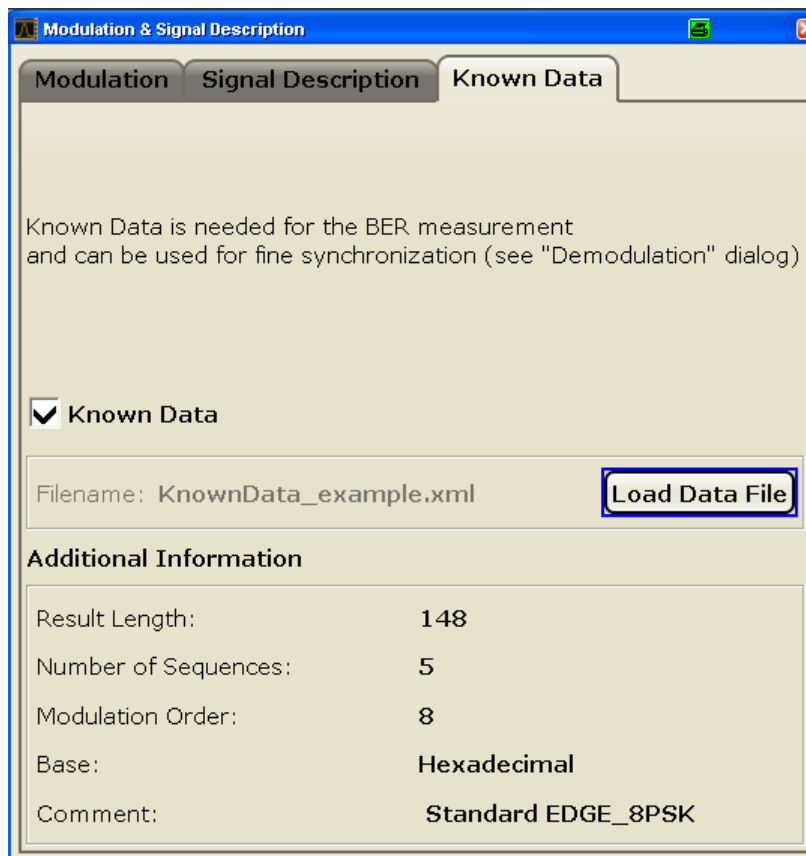
[SENSe:] DDEMod:STANdard:SYNC:OFFSet:STATe on page 313

[SENSe:] DDEMod:STANdard:SYNC:OFFSet[:VALue] on page 314

**Known Data**

In the "Known Data" tab of the "Modulation & Signal Description" dialog box you can load a file that describes the possible data sequences in the input signal (see Chapter 3.3.7, "Working With Known Data Files", on page 194).

Additional information provided by the loaded file is displayed at the bottom of the dialog box. This information is not editable directly.



[Known Data](#)..... 149

[Load Data File](#)..... 149

**Known Data**

Activates or deactivates the use of the loaded data file (if available). When deactivated, the additional information from the previously loaded data file is removed. Any references to the known data in the "Demodulation" dialog box are replaced by the default parameter values (see "Demodulation" on page 169).

**Note:** When a standard is loaded, the use of a Known Data file is automatically deactivated.

Remote command:

[SENSe:] DDEMod:KDATA:STATE on page 290

**Load Data File**

If [Known Data](#) is activated, this function displays a file selection dialog box to select the xml file that contains the known data. Once a file has been selected, any additional information provided by the file is displayed at the bottom of the dialog box.

Remote command:

[SENSe:] DDEMod:KDATA[:NAME] on page 290

**3.3.1.2 Frontend and I/Q Capture Settings**

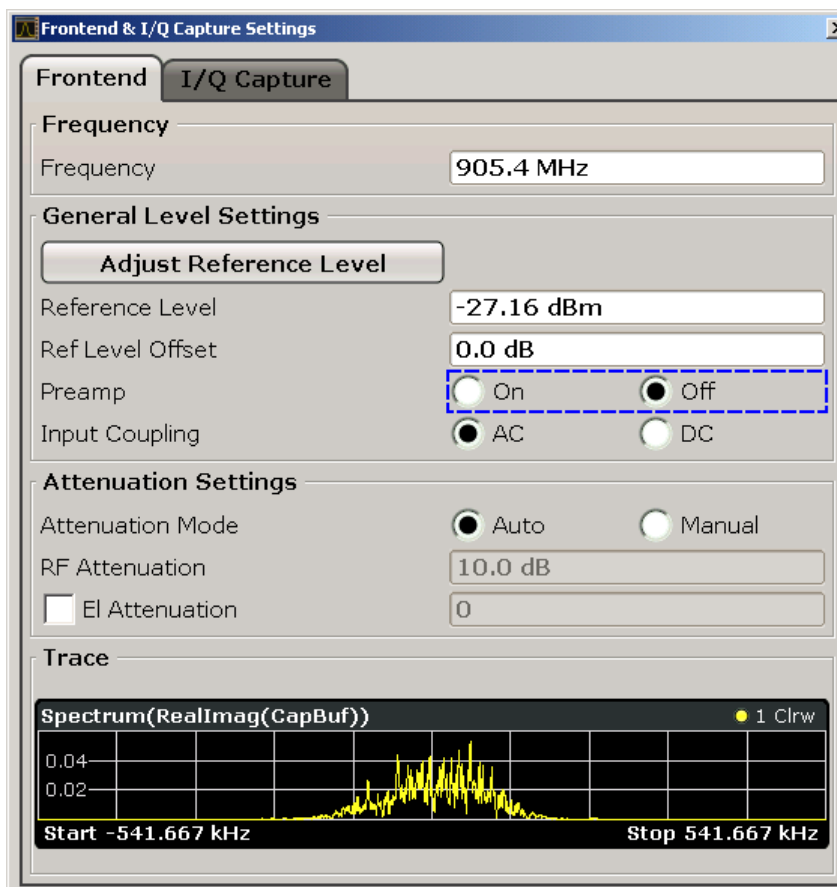
You configure the measurement of the actual input signal in the "Frontend and I/Q Capture Settings" dialog box. This dialog box contains the following tabs:

- "Frontend" on page 149
- "I/Q Capture" on page 152

**Frontend**

The "Frontend" tab contains the frontend settings of the instrument.

A live preview of the signal with the current settings is displayed in the preview area at the bottom of the dialog box. The preview area is not editable directly.



Frequency..... 150  
 Reference Level..... 150  
 Ref Level Offset..... 151  
 Preamp On/Off..... 151  
 Input Coupling..... 151  
 (Bypassing the )YIG Filter..... 151  
 Attenuation Mode..... 152  
 RF Attenuation..... 152  
 EI Attenuation ON/OFF..... 152

**Frequency**

Defines the center frequency. The allowed range of values for the center frequency depends on the frequency span.

$$\text{span} > 0: \text{span}_{\text{min}}/2 \leq f_{\text{center}} \leq f_{\text{max}} - \text{span}_{\text{min}}/2$$

$$\text{span} = 0: 0 \text{ Hz} \leq f_{\text{center}} \leq f_{\text{max}}$$

$f_{\text{max}}$  and  $\text{span}_{\text{min}}$  are specified in the data sheet.

Remote command:

[SENSe:] FREQuency:CENTer on page 316

**Reference Level**

Defines the reference level in dBm.

The reference level value is the maximum value the AD converter can handle without distortion of the measured value. Signal levels above this value will not be measured correctly, which is indicated by the "IFOVL" status display.

To get an ideal reference level, use Auto Level function. For more information, see

- "Auto Level" on page 117

Remote command:

`DISPlay[:WINDow<n>]:TRACe<t>:Y[:SCALe]:RLEVel` on page 264

### Ref Level Offset

Defines the arithmetic level offset. This offset is added to the measured level irrespective of the selected unit. Where necessary, the scaling of the y-axis is changed accordingly. The setting range is  $\pm 200$  dB in 0.1 dB steps.

Remote command:

`DISPlay[:WINDow<n>]:TRACe<t>:Y[:SCALe]:RLEVel:OFFSet` on page 265

### Preamp On/Off

Switches the preamplifier on and off.

If option R&S FSV-B22 is installed, the preamplifier is only active below 7 GHz.

If option R&S FSV-B24 is installed, the preamplifier is active for all frequencies.

This function is not available for input from the R&S Digital I/Q Interface (option R&S FSV-B17).

Remote command:

`INPut:GAIN:STATe` on page 276

### Input Coupling

Toggles the RF input of the R&S FSVA/FSV between AC and DC coupling.

Remote command:

`INPut:COUPling` on page 271

### (Bypassing the )YIG Filter

If the option R&S FSVA-B11 is installed, the YIG preselector can be bypassed.

This function is only available for R&S FSVA instruments.

If the YIG preselector at the input of the R&S FSVA is removed from the signal path, you can use the maximum bandwidth for signal analysis. However, image-frequency rejection is no longer ensured.

Note that the YIG preselector is active only on frequencies greater than 7 GHz. Therefore, switching the YIG preselector on and off has no effect if the frequency is below that value.

#### Note:

For the following measurements, the YIG preselector is off by default (if available).

- I/Q Analyzer
- GSM
- VSA

`INPut:FILTer:YIG[:STATe]` on page 276

**Attenuation Mode**

Toggles the attenuation mode. In automatic mode, the RF attenuation is automatically set as a function of the selected reference level. This ensures that the optimum RF attenuation is always used. It is the default setting.

In manual mode, the specified RF attenuation is used irrespective of the reference level (see "RF Attenuation" on page 152).

Remote command:

`INPut:ATTenuation:AUTO` on page 271

**RF Attenuation**

For **Attenuation Mode** = "Manual", this value defines the attenuation irrespective of the reference level. If electronic attenuation is enabled (option R&S FSV-B25 only; **Attenuation Mode** = "Auto"), this setting defines the mechanical attenuation.

The mechanical attenuation can be set in 10 dB steps.

The RF attenuation can be set in 5 dB steps (with option R&S FSV-B25: 1 dB steps). The range is specified in the data sheet. If the defined reference level cannot be set for the set RF attenuation, the reference level is adjusted accordingly.

**Note:** Values under 10 dB can only be entered via the numeric keypad or via remote control command in order to protect the input mixer against overload.

The RF attenuation defines the level at the input mixer according to the formula:

$$\text{level}_{\text{mixer}} = \text{level}_{\text{input}} - \text{RF attenuation}$$

The maximum mixer level allowed is -10 dBm. Mixer levels above this value may lead to incorrect measurement results, which are indicated by the "OVLD" status display.

Remote command:

`INPut:ATTenuation` on page 271

**EI Attenuation ON/OFF**

Enables and defines the electric attenuation. The attenuation can be varied in 1 dB steps from 0 to 30 dB. Other entries are rounded to the next lower integer value.

If the defined reference level cannot be set for the given RF attenuation, the reference level is adjusted accordingly and the warning "Limit reached" is output.

Remote command:

`INPut:EATT:STATe` on page 275

`INPut:EATT` on page 275

**I/Q Capture**

The "I/Q Capture" tab contains the settings for the measured I/Q data.

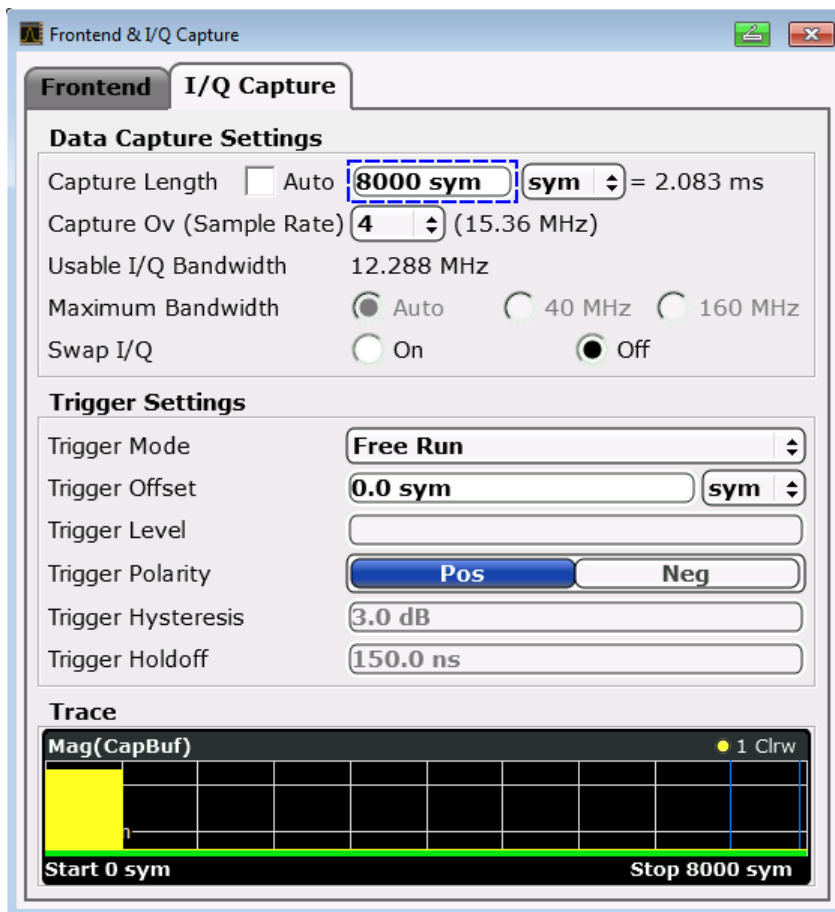
Note that the maximum usable I/Q bandwidth for the R&S FSVA/FSV40 with the order number 1307.9002K39 is 10 MHz. Therefore the maximum symbol rate for this model is restricted, depending on the selected capture oversampling value:

Capture oversampling	Max. symbol rate
4	3.125 MHz
8	1.5625 MHz



Capture oversampling	Max. symbol rate
16	0.78125 MHz
32	0.390625 MHz

A live preview of the signal in the capture buffer with the current settings is displayed in the preview area at the bottom of the dialog box. The preview area is not editable directly.



- Capture Length Auto..... 154
- Capture Length..... 154
- Capture Oversampling..... 154
- Sample Rate..... 154
- Usable I/Q Bandwidth..... 155
- Maximum Bandwidth..... 155
- Swap I/Q..... 155
- Trigger Mode..... 155
- Trigger Offset..... 156
- Trigger Level..... 157
- Trigger Polarity..... 157
- Trigger Hysteresis..... 157
- Trigger Holdoff..... 157

**Capture Length Auto**

Defines the Capture Length automatically according to the burst and pattern length settings and the statistics count (see "Signal Description" on page 146). Thus, a minimal Capture Length is used, which improves performance.

Remote command:

[SENSe:] DDEMod: RLENgth: AUTO on page 300

**Capture Length**

Defines the capture length in symbols or seconds, if not defined automatically (Capture Length Auto).

The sample rate and the usable I/Q bandwidth are displayed for reference only.

Remote command:

[SENSe:] DDEMod: RLENgth[:VALue] on page 300

**Capture Oversampling**

Sets the oversampling rate, i.e the number of captured points per symbol. The default value is 4.

This parameter affects the demodulation bandwidth. If the bandwidth is too narrow, the signal is not displayed completely. If the bandwidth is too wide, interference from outside the actual signal to be measured can distort the result. Thus, for signals with a large frequency spectrum (e.g. FSK modulated signals), a higher capture oversampling rate may be necessary.

For an indication of the required capture oversampling value, view the "Real/Imag (I/Q)" display of the Capture Buffer with a "Spectrum" transformation. If the complete signal is displayed and fills the width of the display, the selected value is suitable. If the signal is cut off, increase the oversampling rate; if it is too small, decrease the oversampling value.

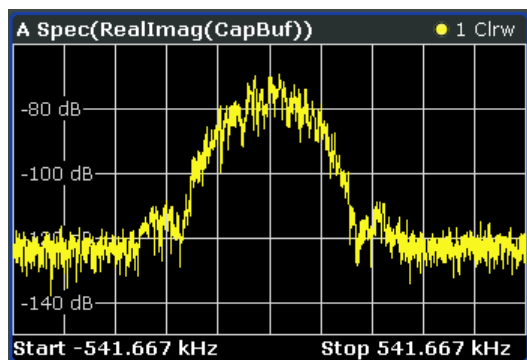


Figure 3-26: Determining the I/Q bandwidth: Real/Imag (I/Q) display of the Capture Buffer with a Spectrum transformation

For further details, see Chapter 2.2, "Filters and Bandwidths During Signal Processing", on page 11.

Remote command:

[SENSe:] DDEMod: PRATe on page 295

**Sample Rate**

Shows the current sample rate.

Note that this is a read only field.

#### Usable I/Q Bandwidth

Shows the usable I/Q bandwidth.

Note that this is a read only field.

#### Maximum Bandwidth

Defines the maximum bandwidth to be used by the R&S FSVA/FSV for I/Q data acquisition

This function is only available if the bandwidth extension option R&S FSV-B160 is installed and no other restrictions for its use apply (see [Chapter 2.2.2.1, "Restrictions"](#), on page 14).

For details on the maximum bandwidth see [Chapter 2.2, "Filters and Bandwidths During Signal Processing"](#), on page 11.

"Auto"	(Default) The maximum available bandwidth is used for all sample rates. If the bandwidth extension option R&S FSV-B160 is installed, it is activated for bandwidths as of 64 MHz (if no other restrictions for its use apply, see <a href="#">Chapter 2.2.2.1, "Restrictions"</a> , on page 14). Thus, sample rates up to 1.28 GHz and an I/Q bandwidth up to 160 MHz are possible. Note that using the bandwidth extension may cause more spurious effects.
"40 MHz"	Deactivates use of the bandwidth extension option R&S FSV-B160, thus reducing possible spurious effects, while restricting the analysis bandwidth to 40 MHz. Sample rates higher than 128 MHz can only be achieved using the bandwidth extension.
"160 MHz"	The bandwidth extension option R&S FSV-B160 is always used (if no other restrictions for its use apply, see <a href="#">Chapter 2.2.2.1, "Restrictions"</a> , on page 14), thus raising the minimum possible sample rate to 32 MHz.

Remote command:

[TRACe: IQ:WBANd \[ :STATe\]](#) on page 327

To query the currently used bandwidth:

[TRACe<n>: IQ:BWIDth](#) on page 327

#### Swap I/Q

Swaps the I and Q values of the signal. Swapping I and Q inverts the sideband.

"ON" I and Q are exchanged, inverted sideband,  $Q+j*I$

"OFF" Normal sideband,  $I+j*Q$

Remote command:

[\[SENSe:\] DDEMod: SBANd](#) on page 300

#### Trigger Mode

Defines the trigger mode.

- "External" Defines triggering via a TTL signal at the "EXT TRIG/GATE IN" input connector on the rear panel.
- "IF Power" Defines triggering of the measurement using the second intermediate frequency.  
 For this purpose, the R&S FSVA/FSV uses a level detector at the second intermediate frequency.  
 The available trigger levels depend on the RF attenuation and preamplification. A reference level offset, if defined, is also considered.  
 For details on available trigger levels and trigger bandwidths see the data sheet.  
 The bandwidth at the intermediate frequency depends on the RBW and sweep type:  
 Sweep mode:  
 • RBW > 500 kHz: 40 MHz, nominal  
 • RBW ≤ 500 kHz: 6 MHz, nominal  
 FFT mode:  
 • RBW > 20 kHz: 40 MHz, nominal  
 • RBW ≤ 20 kHz: 6 MHz, nominal  
**Note:** Be aware that in auto sweep type mode, due to a possible change in sweep types, the bandwidth may vary considerably for the same RBW setting.  
 The R&S FSVA/FSV is triggered as soon as the trigger level is exceeded around the selected frequency (= start frequency in the frequency sweep).
- "Free Run" The start of a sweep is not triggered. Once a measurement is completed, another is started immediately.

Remote command:

[TRIGger<n>\[:SEQuence\]:SOURce](#) on page 331

[TRIGger<n>\[:SEQuence\]:LEVel:IFPower](#) on page 329

For digital input: [TRIGger<n>\[:SEQuence\]:LEVel:BBPower](#) on page 328

### Trigger Offset

Opens an edit dialog box to enter the time offset between the trigger signal and the start of the sweep.

The time may be entered in s or in symbols.

offset > 0:	Start of the sweep is delayed
offset < 0:	<p>Sweep starts earlier (pre-trigger)</p> <p>Only possible for span = 0 (e.g. I/Q Analyzer mode) and gated trigger switched off</p> <p>Maximum allowed range limited by the sweep time:  <math>\text{pretrigger}_{\text{max}} = \text{sweep time}</math></p> <p>When using the R&amp;S Digital I/Q Interface (R&amp;S FSV-B17) with I/Q Analyzer mode, the maximum range is limited by the number of pretrigger samples.</p> <p>See the R&amp;S Digital I/Q Interface(R&amp;S FSV-B17) description in the base unit.</p>

In the "External" or "IF Power" trigger mode, a common input signal is used for both trigger and gate. Therefore, changes to the gate delay will affect the trigger delay (trigger offset) as well.

Remote command:

`TRIGger<n>[:SEquence]:HOLDoff[:TIME]` on page 330

### Trigger Level

Defines the trigger level as a numeric value.

Remote command:

`TRIGger<n>[:SEquence]:LEVel:IFPower` on page 329

For digital input via the R&S Digital I/Q Interface, R&S FSV-B17:

`TRIGger<n>[:SEquence]:LEVel:BBPower` on page 328

### Trigger Polarity

Sets the polarity of the trigger source.

The sweep starts after a positive or negative edge of the trigger signal. The default setting is "Pos". The setting applies to all modes with the exception of the "Free Run" and "Time" mode.

"Pos"                      Level triggering: the sweep is stopped by the logic "0" signal and restarted by the logical "1" signal after the gate delay time has elapsed.

"Neg"                      Edge triggering: the sweep is continued on a "0" to "1" transition for the gate length duration after the gate delay time has elapsed.

Remote command:

`TRIGger<n>[:SEquence]:SLOPe` on page 330

### Trigger Hysteresis

Defines the value for the trigger hysteresis for "IF power" or "RF Power" trigger sources. The hysteresis in dB is the value the input signal must stay below the power trigger level in order to allow a trigger to start the measurement. The range of the value is between 3 dB and 50 dB with a step width of 1 dB.

Remote command:

`TRIGger<n>[:SEquence]:IFPower:HYSteresis` on page 330

### Trigger Holdoff

Defines the value for the trigger holdoff. The holdoff value in s is the time which must pass before triggering, in case another trigger event happens.

This softkey is only available if "IFPower", "RF Power" or "BBPower" is the selected trigger source.

Remote command:

`TRIGger<n>[:SEquence]:IFPower:HOLDoff` on page 329

For digital input via the R&S Digital I/Q Interface, R&S FSV-B17:

`TRIGger<n>[:SEquence]:BBPower:HOLDoff` on page 329

### 3.3.1.3 Burst and Pattern Search Settings

You configure burst and pattern searches in the "Burst & Pattern Settings" dialog. This dialog box contains the following tabs:

- [Burst Search](#)
- [Pattern Search](#)

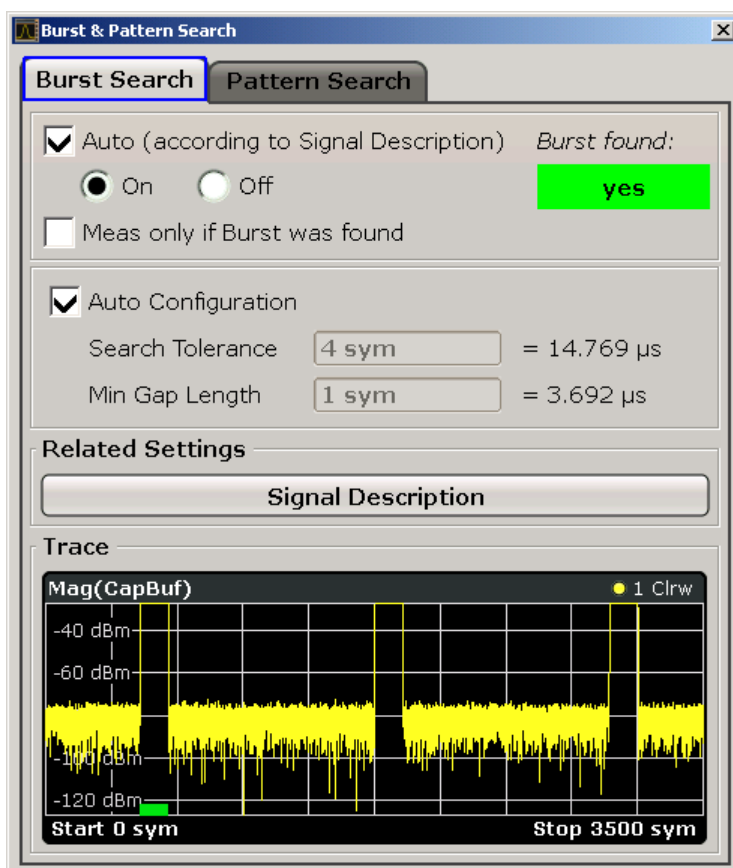
#### Burst Search

The "Burst Search" tab contains the settings for burst searches. In addition, it contains a link to the "Signal Description" settings (see "[Signal Description](#)" on page 146).

A live preview of the capture buffer with the current settings is displayed in the preview area at the bottom of the dialog box. The green bar below the trace indicates the defined evaluation range (see "[Evaluation Range](#)" on page 167). The preview area is not editable directly.



The "Burst Search" tab is also displayed when you select the "Burst Search" softkey in the "Meas Config" menu (see "[Burst/Pattern Search](#)" on page 127).



Auto/On/Off.....	159
Meas only if burst was found.....	159
Auto Configuration.....	159
L Search Tolerance.....	159
L Min Gap Length.....	159

**Auto/On/Off**

Enables or disables burst searches. If "Auto" is selected, burst search is enabled only if "Burst Signal" is selected in the "Signal Description" tab of the "Modulation & Signal Description" dialog box (see "Continuous Signal / Burst Signal" on page 147).

Remote command:

[SENSe:] DDEMod:SEARCh:BURSt:AUTO on page 301

**Meas only if burst was found**

If enabled, measurement results are only displayed (and are only averaged) if a valid burst has been found. For measurements of burst signals that are averaged over several sweeps, this option should be enabled so that erroneous measurements do not affect the result of averaging.

Remote command:

[SENSe:] DDEMod:SEARCh:BURSt:MODE on page 302

**Auto Configuration**

Configures the burst search automatically. If enabled, the [Search Tolerance](#) and [Min Gap Length](#) settings are not available.

Remote command:

[SENSe:] DDEMod:SEARCh:BURSt:CONFIgure:AUTO on page 301

**Search Tolerance ← Auto Configuration**

Defines the number of symbols that may differ from the burst length without influencing the burst detection. A search tolerance of 5, for example, with a minimum and maximum burst length of 100, will detect bursts that are 95 to 100 symbols long.

Note that due to the fact that the VSA does not have knowledge of the ramp length, there is an uncertainty in the burst search algorithm. Thus, setting this parameter to "0" will result in a failed burst search for most signals.

Remote command:

[SENSe:] DDEMod:SEARCh:BURSt:TOLerance on page 304

**Min Gap Length ← Auto Configuration**

Represents the minimum distance (in symbols) between adjacent bursts. The default value is 1 symbol in order to make sure that the burst search finds bursts that are very close to each other. However, in case the capture buffer does not contain bursts that are narrowly Modulation Orderd, it is recommended to increase the value. This makes the burst search faster and also more robust for highly distorted signals.

Note that this parameter only influences the robustness of the burst search. It should not be used to explicitly exclude certain bursts from the measurement. For example, setting the minimum gap length to 100 symbols does not ensure that the burst search does not find bursts that are more narrowly Modulation Orderd.

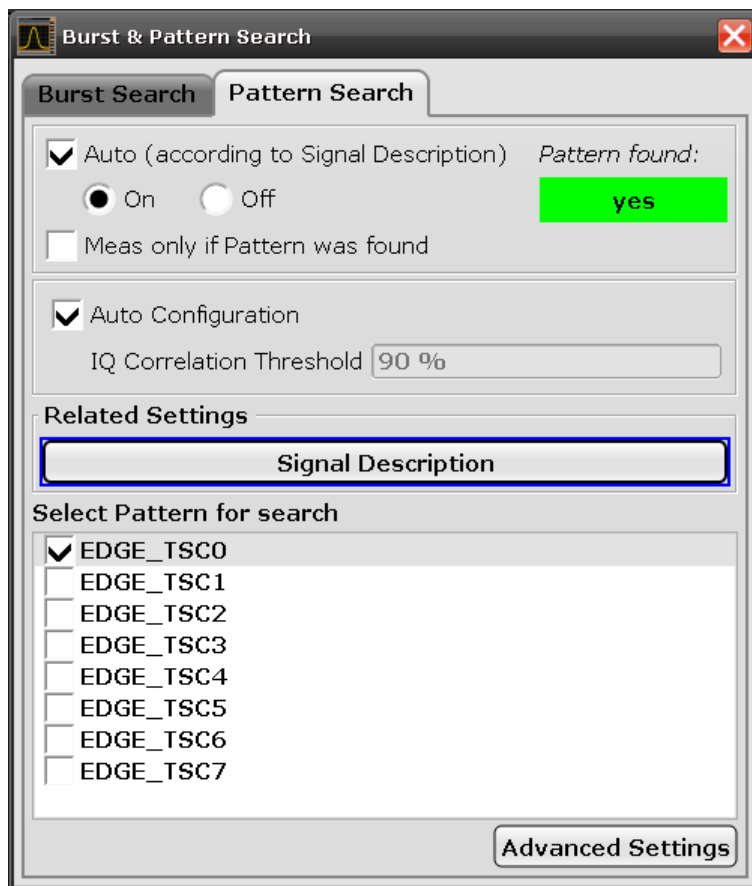
Remote command:

[SENSe:] DDEMod:SEARCh:BURSt:GLENgth[:MINimum] on page 301

**Pattern Search**

The "Pattern Search" tab contains the settings for pattern searches. In addition, it contains a link to the "Signal Description" settings (see "Signal Description" on page 146).

For details on pattern searches, see Chapter 3.3.5, "Working with Pattern Searches", on page 189.



Auto/On/Off..... 161

Meas only if pattern symbols correct..... 161

Auto Configuration..... 161

    L I/Q Correlation Threshold..... 161

Select Pattern for Search..... 161

Advanced Settings..... 162

    L Prefix..... 162

    L Show Compatible..... 162

    L Show All..... 162

    L Pattern Search On..... 162

    L Meas only if pattern symbols correct..... 163

    L Add to Standard..... 163

    L Remove from Standard..... 163



L Edit.....	163
L New.....	163
L Delete.....	163

**Auto/On/Off**

Enables or disables pattern searches. If "Auto" is selected, pattern search is enabled automatically if "Pattern" is selected in the "Signal Description" tab of the "Modulation & Signal Description" dialog box (see "Pattern" on page 147).

Remote command:

[SENSe:] DDEMod: SEARCh: SYNC: MODE on page 309

[SENSe:] DDEMod: SEARCh: SYNC: AUTO on page 306

**Meas only if pattern symbols correct**

If enabled, measurement results are only displayed (and averaged) if a valid pattern has been found. For measurements of signals with patterns that are averaged over several sweeps, this option should be enabled so that erroneous measurements do not affect the result of averaging.

Remote command:

[SENSe:] DDEMod: SEARCh: SYNC: MODE on page 309

**Auto Configuration**

Configures the pattern search automatically. If enabled, the [I/Q Correlation Threshold](#) setting is not available.

Remote command:

[SENSe:] DDEMod: SEARCh: PATtern: CONFigure: AUTO on page 305

**I/Q Correlation Threshold ← Auto Configuration**

The I/Q correlation threshold decides whether a match is accepted or not during a pattern search (see also [Chapter 3.3.5, "Working with Pattern Searches"](#), on page 189). If the parameter is set to 100%, only I/Q patterns that match totally with the input signal are found. This is only the case for infinite SNR.

The default value is 90%. As long as the pattern is found, there is no need to change this parameter. However, if the pattern is very short (approximately < 10 symbols) or if the signal is highly distorted, tuning this parameter helps the pattern search to succeed.

Remote command:

[SENSe:] DDEMod: SEARCh: SYNC: IQCThreshold on page 308

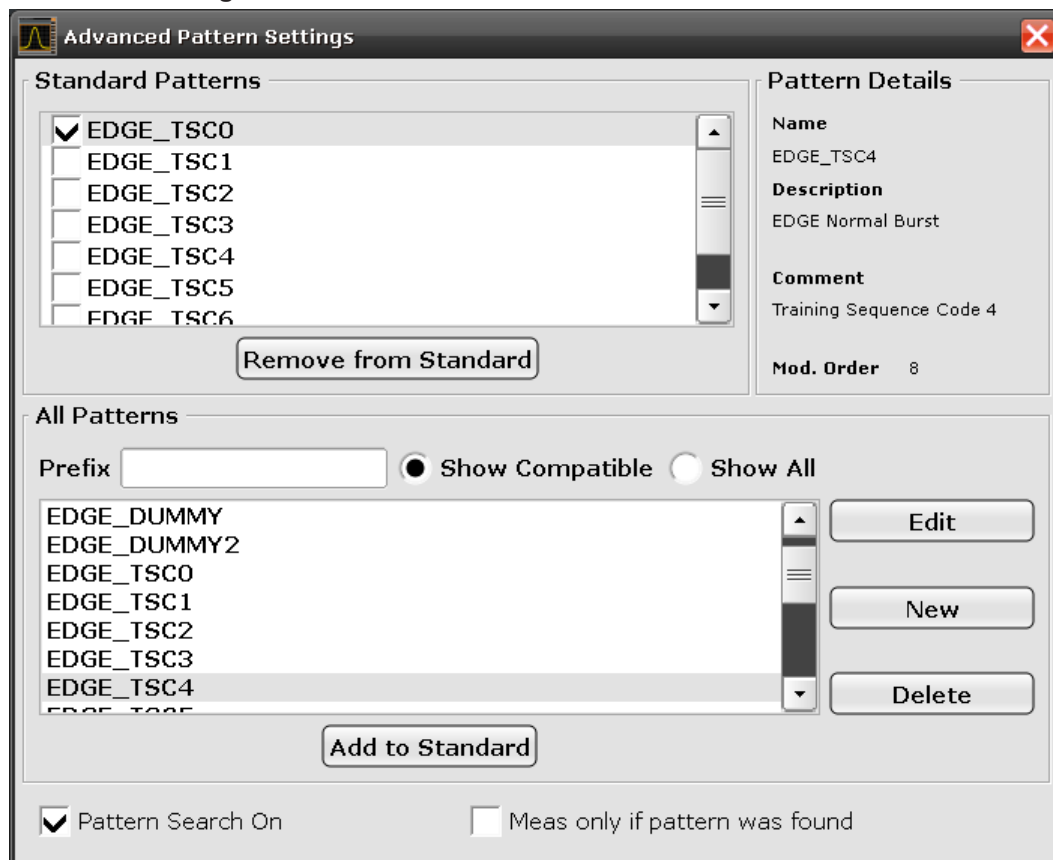
**Select Pattern for Search**

Determines which of the patterns that are assigned to the current standard is to be searched for. Only one pattern can be selected at a time. However, to check for several patterns in the same captured signal, select the single sweep mode (Statistic Count = 0 or 1) and change the pattern. The measurement is updated.

Remote command:

[SENSe:] DDEMod: SEARCh: SYNC: SElect on page 310

## Advanced Settings



The "Advanced Pattern Settings" dialog box lists the patterns assigned to the currently selected standard. You can add existing patterns to the standard, remove patterns already assigned to the standard, edit existing or define new patterns. For details on managing standard patterns, see [Chapter 3.3.6, "Managing patterns"](#), on page 191.

**Note:** Pattern details. Pattern details for the currently focussed pattern are displayed at the upper right-hand side of the dialog box. You can refer to these details, for example, when you want to add a new pattern to the standard and want to make sure you have selected the correct one.

**Prefix ← Advanced Settings**

Shows only patterns that contain the specified prefix.

**Show Compatible ← Advanced Settings**

Shows only patterns that are compatible to the selected modulation mode.

**Show All ← Advanced Settings**

Shows all patterns, regardless of the selected standard.

**Pattern Search On ← Advanced Settings**

If enabled, the instrument can adapt its result range to the selected pattern.

Remote command:

[SENSe:] DDEMod:SEARCH:SYNC:STATe on page 311

**Meas only if pattern symbols correct ← Advanced Settings**

If enabled, measurement results are only displayed (and averaged) if a valid pattern has been found. For measurements of signals with patterns that are averaged over several sweeps, this option should be enabled so that erroneous measurements do not affect the result of averaging.

Remote command:

[SENSe:] DDEMod: SEARCh: SYNC: MODE on page 309

**Add to Standard ← Advanced Settings**

Adds the selected patterns to the list of available patterns ("Standard Patterns").

For details see ["To add a predefined pattern to a standard"](#) on page 191.

Remote command:

[SENSe:] DDEMod: SEARCh: SYNC: PATTErn: ADD on page 310

**Remove from Standard ← Advanced Settings**

Removes the assignment of the selected patterns to the standard. The patterns are removed from the "Standard Patterns" list, but not deleted.

Remote command:

[SENSe:] DDEMod: SEARCh: SYNC: PATTErn: REMove on page 310

**Edit ← Advanced Settings**

Opens the "Edit Pattern" dialog box to edit the pattern definition. See ["Pattern Definition"](#) on page 164.

For details on defining a pattern, see [Example "Defining a pattern"](#) on page 192.

Remote command:

[SENSe:] DDEMod: SEARCh: SYNC: NAME on page 309

[SENSe:] DDEMod: SEARCh: SYNC: COMMEnt on page 306

[SENSe:] DDEMod: SEARCh: SYNC: DATA on page 307

[SENSe:] DDEMod: SEARCh: SYNC: TEXT on page 311

**New ← Advanced Settings**

Opens the "Pattern" dialog box to create a new pattern definition. See ["Pattern Definition"](#) on page 164.

For details on defining a pattern, see [Example "Defining a pattern"](#) on page 192.

Remote command:

[SENSe:] DDEMod: SEARCh: SYNC: NAME on page 309

[SENSe:] DDEMod: SEARCh: SYNC: COMMEnt on page 306

[SENSe:] DDEMod: SEARCh: SYNC: DATA on page 307

[SENSe:] DDEMod: SEARCh: SYNC: TEXT on page 311

**Delete ← Advanced Settings**

Deletes the selected patterns. Any existing assignments to other standards are removed.

Remote command:

[SENSe:] DDEMod: SEARCh: SYNC: DELEte on page 308

**Pattern Definition**

The settings in the "Pattern" dialog box define the pattern.

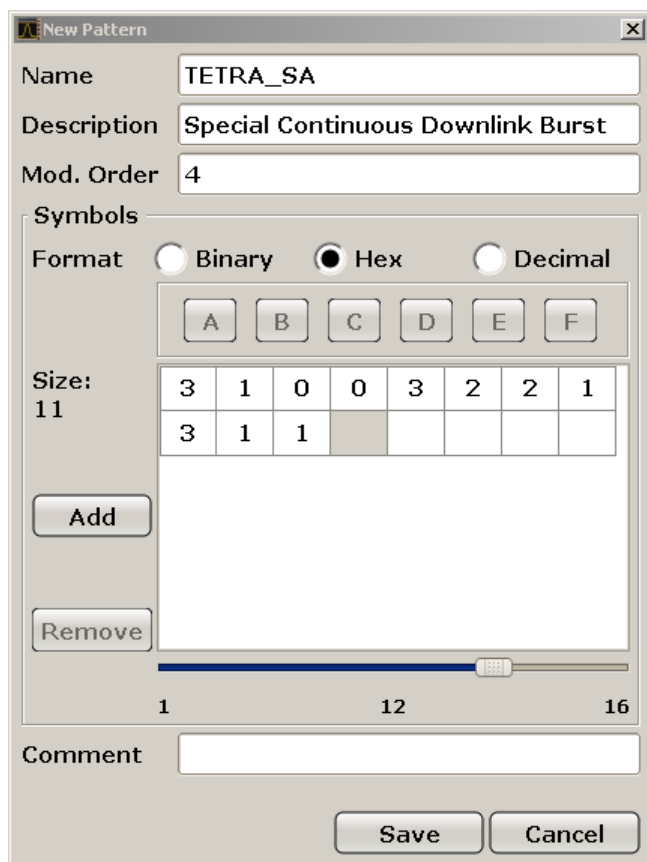


Figure 3-27: Pattern definition

For details on defining a pattern, see [Example "Defining a pattern"](#) on page 192.

Name..... 164  
 Description..... 164  
 Mod. order..... 165  
 Symbol format..... 165  
 Symbols..... 165  
 Comment..... 165

**Name**

Pattern name that will be displayed in selection list

Remote command:

[\[SENSe:\] DDEMod: SEARCh: SYNC: NAME](#) on page 309

**Description**

Optional description of the pattern which is displayed in the pattern details

Remote command:

[\[SENSe:\] DDEMod: SEARCh: SYNC: TEXT](#) on page 311

**Mod. order**

The order of modulation, e.g. 8 for an 8-PSK.

Remote command:

[\[SENSe:\] DDEMod:SEARCh:SYNC:NState](#) on page 309

**Symbol format**

Hexadecimal, decimal or binary format

**Symbols**

Pattern definition, consisting of one or more symbols

Remote command:

[\[SENSe:\] DDEMod:SEARCh:SYNC:DATA](#) on page 307

**Comment**

Optional comment for the pattern, displayed in the pattern details (kept for compatibility with FSQ)

Remote command:

[\[SENSe:\] DDEMod:SEARCh:SYNC:COMment](#) on page 306

### 3.3.1.4 Result Range and Evaluation Range Settings

You configure the result range and evaluation range settings in the "Result Range Alignment and Evaluation Range" dialog box. This dialog box contains the following tabs:

- ["Result Range"](#) on page 165
- ["Evaluation Range"](#) on page 167

**Result Range**

The "Result Range" tab contains the settings for the result range. The result range determines which part of the capture buffer, burst or pattern is displayed. For more information, see [Chapter 3.3.2, "Defining the Result Range"](#), on page 181 .

A preview of the result display with the current settings is displayed in the visualization area at the bottom of the dialog box.



The "Result Range" tab is also displayed when you select the "Range Settings" softkey in the "Meas Config" menu (see ["Range Settings"](#) on page 127).

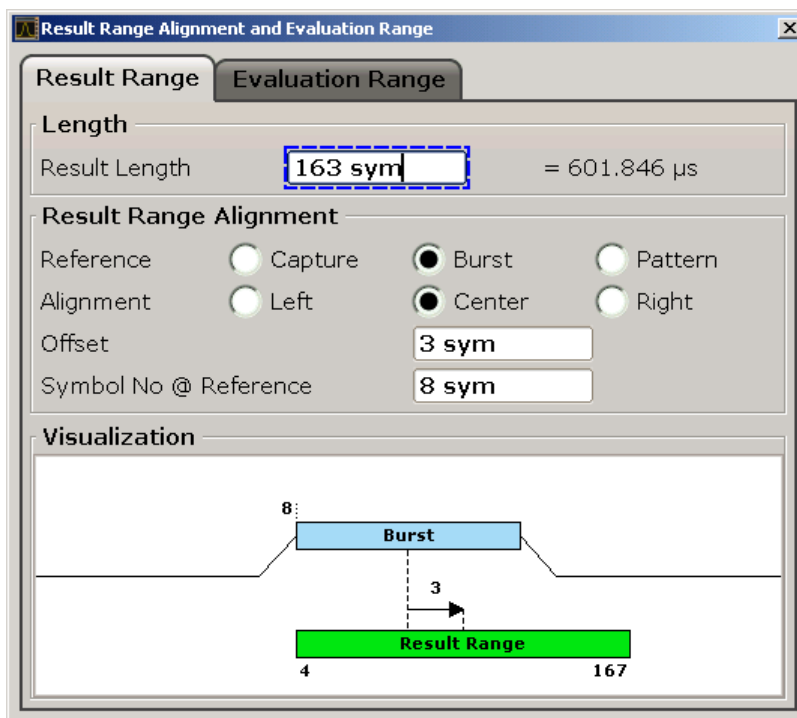


Figure 3-28: Result Range Alignment

Result Length..... 166  
 Reference..... 166  
 Alignment..... 167  
 Offset..... 167  
 Symbol Number at <Reference> start..... 167

**Result Length**

Defines the number of symbols that are to be demodulated. All traces over time are displayed over the result range. For example, if you have a burst of 100 symbols and you define the result length as 200 symbols, you can examine the burst ramps in detail (by selecting the alignment "Burst - Center").

The maximum result length depends on the CPU board (indicated in "SETUP > System Info > Hardware Info"):

FMR-7: 10000 symbols

others: 20000 symbols

Remote command:

[SENSe:] DDEMod: TIME on page 315

**Reference**

Defines the reference for the result range alignment.

The result of the current setting is displayed in the visualization area of the dialog box.

- "Capture" the capture buffer
- "Burst" the detected burst
- "Pattern" the detected pattern

Remote command:

`CALCulate<n>:TRACe<t>:ADJust[:VALue]` on page 255

### Alignment

Defines the type of alignment of the result range to the reference source. The result of the current setting is displayed in the visualization area of the dialog box.

Remote command:

`CALCulate<n>:TRACe<t>:ADJust:ALIGnment[:DEFault]` on page 255

### Offset

Defines the offset of the result range to the alignment reference. The result of the current setting is displayed in the visualization area of the dialog box.

**Note:** Note the following restrictions to this parameter:

- An offset < 0 is not possible if you align the result range to the left border of the capture buffer.
- An offset that moves the pattern outside the result range is not allowed. For example, if you align the result to the left border of the pattern, only offsets  $\leq 0$  are allowed. Otherwise, you would never be able to find the pattern within the result range.

Remote command:

`CALCulate<n>:TRACe<t>:ADJust:ALIGnment:OFFSet` on page 254

### Symbol Number at <Reference> start

Defines the number of the symbol which marks the beginning of the alignment reference source (burst, capture or pattern).

In effect, this setting defines an offset of the x-axis (in addition to the one defined for the Signal Description, see "Offset" on page 148).

For example, if you align the result to the center of the pattern and set the "Symbol Number at &lt;Reference&gt; start" to "0", you can easily find the pattern start in the EVM measurement simply by moving a marker to the symbol number "0".

**Note:** If you define an offset of the pattern with respect to the useful part of the burst in the signal description (see "Offset" on page 148) and align the result to the pattern, the Symbol Number at &lt;Reference&gt; start refers to the first symbol of the useful part of the burst, not the first symbol of the pattern.

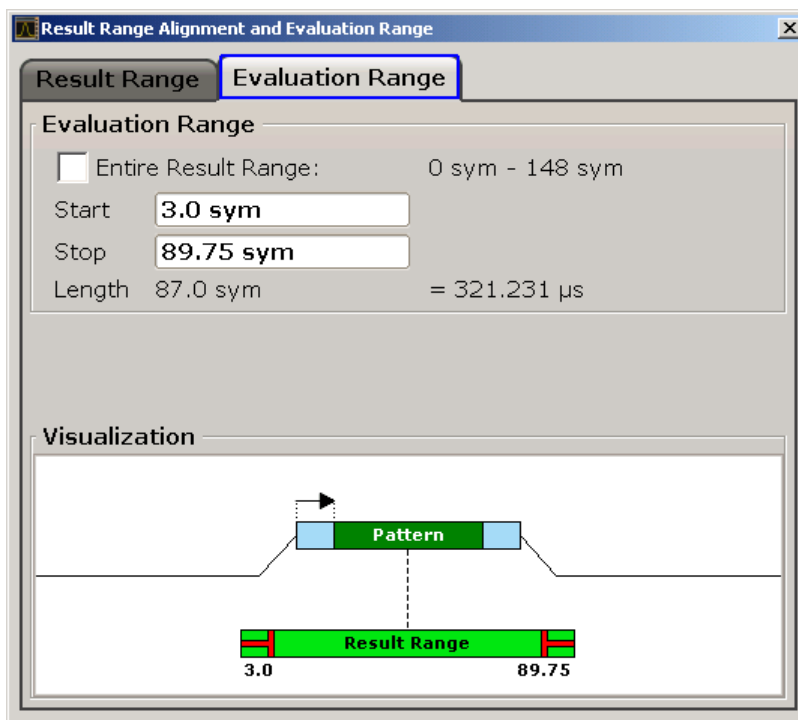
Remote command:

`DISPlay[:WINDow<n>]:TRACe<t>:X[:SCALE]:VOFFset` on page 262

### Evaluation Range

In the "Evaluation Range" tab you define which range of the result is to be evaluated - either the entire result range or only a specified part of it. The calculated length of the specified range is indicated beneath the entries. The selected evaluation range is displayed in the visualization area.

A preview of the result display with the current settings is displayed in the visualization area at the bottom of the dialog box.



Entire Result Range..... 168  
 Start..... 168  
 Stop..... 168

**Entire Result Range**

If enabled, the entire result range is evaluated.

Remote command:

CALCulate<n>:ELIN<startstop>:STATE on page 246

**Start**

Defines the symbol in the result range at which evaluation is started. The start symbol itself is included in the evaluation range.

**Note:** Note that the start value is defined with respect to the x-axis including an optional offset defined via the [Symbol Number at <Reference> start](#) parameter.

Remote command:

CALCulate<n>:ELIN<startstop>[:VALue] on page 246

**Stop**

Defines the symbol in the result range at which evaluation is stopped. The stop symbol itself is included in the evaluation range.

**Note:** Note that the stop value is defined with respect to the x-axis including an optional offset defined via the [Symbol Number at <Reference> start](#) parameter.

Remote command:

CALCulate<n>:ELIN<startstop>[:VALue] on page 246



### 3.3.1.5 Demodulation and Measurement Filter Settings

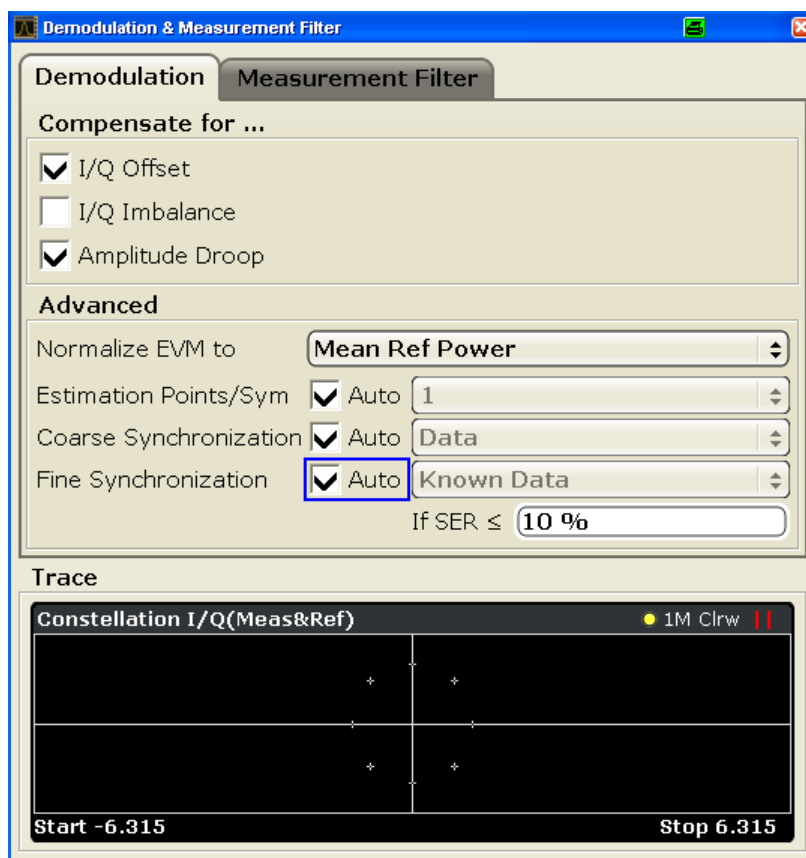
You configure the demodulation and measurement filter settings in the "Demodulation & Measurement Filter" dialog box. This dialog box contains the following tabs:

- "Demodulation" on page 169
- "Measurement Filter" on page 174

#### Demodulation

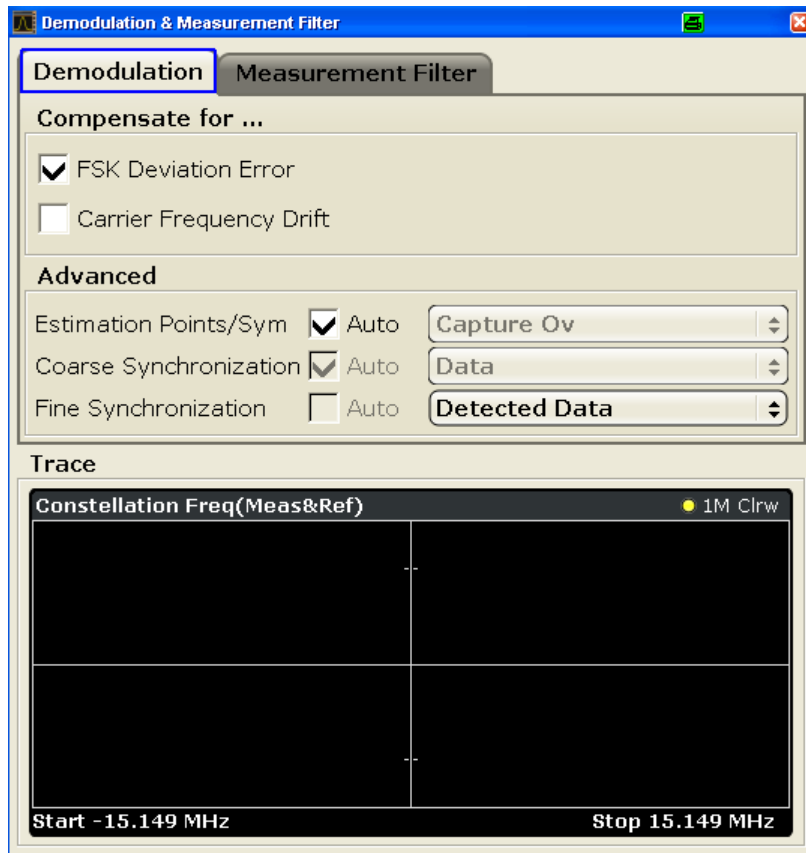
The "Demodulation" tab contains the settings for the demodulation.

A live preview of the trace with the current settings is displayed in the preview area at the bottom of the dialog box. The preview area is not editable directly.





For FSK modulation, the dialog has slightly different options.



Compensate for..... 170  
 Normalize EVM to..... 171  
 Offset EVM..... 171  
 Estimation Points/Sym..... 172  
 Coarse Synchronization..... 172  
 Fine Synchronization..... 173  
 If SER ≤..... 173

**Compensate for...**

If enabled, compensation for various effects is taken into consideration during demodulation.

**Note:** Note that compensation for all the listed distortions can result in lower EVM values.

For PSK, QAM, MSK modulation:

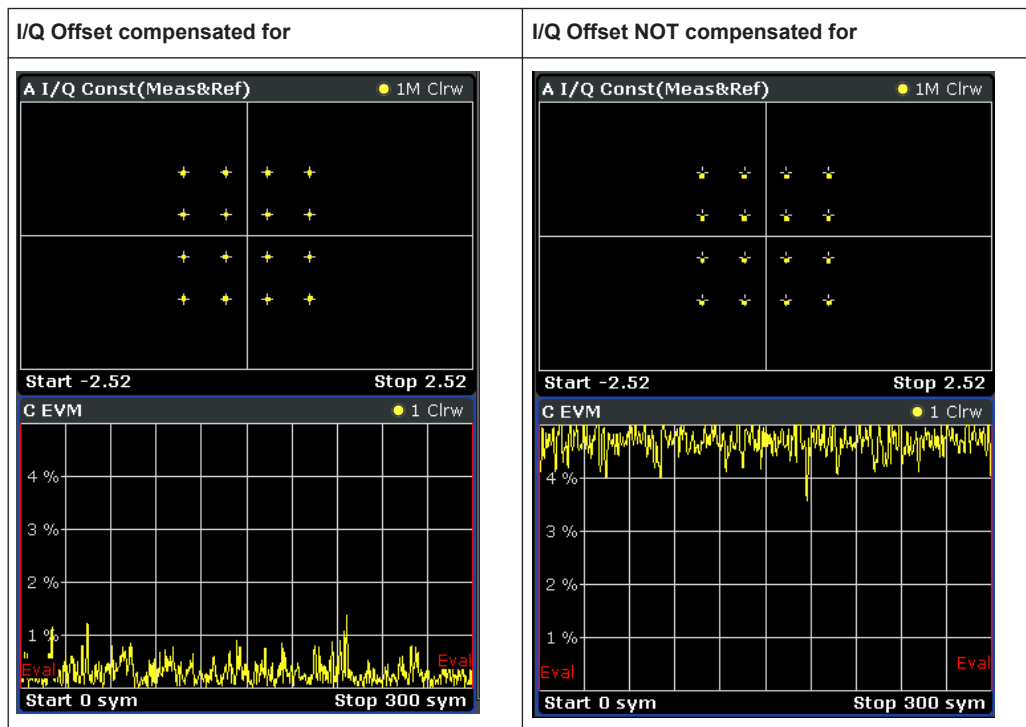
- "I/Q Offset"
- "I/Q Imbalance"
- "Amplitude Droop"

For FSK modulation:

- "FSK Deviation Error"
- "Carrier Frequency Drift"

**Example:**

The following figures compare the results for a compensated I/Q offset of 2.5% and a non-compensated offset.



Remote command:

[\[SENSe:\] DDEMod:NORMalize:ADRoop](#) on page 293

[\[SENSe:\] DDEMod:NORMalize:IQIMbalance](#) on page 294

[\[SENSe:\] DDEMod:NORMalize:IQOffset](#) on page 294

[\[SENSe:\] DDEMod:NORMalize:CFDRift](#) on page 293

[\[SENSe:\] DDEMod:NORMalize:FDERror](#) on page 293

**Normalize EVM to**

Normalizes the EVM to the specified power value.

This setting is not available for MSK or FSK modulation.

- **Max Ref Power**  
Maximum power of the reference signal at the symbol instants.
- **Mean Ref Power**  
mean power of the reference signal at the symbol instants.
- **Mean Constellation Power**  
Mean expected power of the measurement signal at the symbol instants
- **Max Constellation Power**  
The maximum expected power of the measurement signal at the symbol instants

Remote command:

[\[SENSe:\] DDEMod:ECALc\[:MODE\]](#) on page 285

**Offset EVM**

The offset EVM is only available for Offset QPSK modulated signals.

Unlike QPSK modulation, the Q component of Offset QPSK modulation is delayed by half a symbol period against the I component in the time domain. The symbol time instants of the I and the Q component therefore do not coincide.

The offset EVM controls the calculation of all results that are based on the error vector. It affects the EVM, Real/Imag and Vector I/Q result displays as well as the EVM results in the Result Summary (EVM and MER).

You can select the way the R&S FSVA/FSV calculates the error vector results.

If "Offset EVM" is inactive, the R&S FSVA/FSV subtracts the measured signal from the reference signal to calculate the error vector. This method results in the fact that the error vector contains two symbol instants per symbol period: one that corresponds to the I component and one that corresponds to the Q component.

If "Offset EVM" is active however, the R&S FSVA/FSV compensates the delay of the Q component with respect to the I component in the measurement signal as well as the reference signal **before** calculating the error vector. That means that the error vector contains only one symbol instant per symbol period.

Remote command:

[SENSe:] DDEMod:ECALc:OFFSet on page 285

### Estimation Points/Sym

The estimation points per symbol affect and control synchronization of the signal. You can set the estimation points manually or let the R&S FSVA/FSV decide which estimation points to use.

If you define the estimation points manually, you can set the estimation points to 1 or 2 per symbol or the value of the [Capture Oversampling](#) per symbol. Setting the estimation points to "1" means that the estimation algorithm takes only the symbol time instants into account, while setting the estimation points to "Capture Oversampling" means that all sample time instants are weighted equally.

If you select the automatic routine, the R&S FSVA/FSV uses 2 estimation points per symbol for Offset QPSK modulation and 1 estimation point per symbol for other PSK and QAM modulated signals. For MSK and FSK modulated signals the estimation points correspond to the capture oversampling.

Remote command:

[SENSe:] DDEMod:EPRate:AUTO on page 285

[SENSe:] DDEMod:EPRate[:VALue] on page 286

### Coarse Synchronization

It is not only possible to check whether the pattern is part of the signal, but also to use the pattern for synchronization, in order to obtain the correct reference signal. Depending on the signal, making use of the pattern for synchronization speeds up your measurement considerably and makes it more robust against high carrier frequency offsets. However, in case the parameter is set to "Pattern", you should make sure that the pattern is suitable for synchronization, e.g. a pattern that was made for synchronization purposes like in GSM. In case the pattern is short or the pattern does not have good synchronization properties, e.g. a pattern that consists of only one symbol that is repeated, this parameter should be set to "Data".

**Note:** In previous versions of the R&S FSV-K70 application this setting was referred to as "Use Pattern For Sync". The former setting "True" corresponds to the new setting "Pattern". The former setting "False" corresponds to the new setting "Data".

If "Auto" mode is selected, the detected data is used.

"Data" (Default): the detected data is used for synchronization, i.e. unknown symbols

"Pattern" Known symbols from a defined pattern are used for synchronization

Remote command:

[\[SENSe:\] DDEMod:SEARCh:PATTErn:SYNC:AUTO](#) on page 305

[\[SENSe:\] DDEMod:SEARCh:PATTErn:SYNC\[:STATe\]](#) on page 305

### Fine Synchronization

In addition to the coarse synchronization used for symbol decisions, a fine synchronization is available to calculate various results from the reference signal, e.g. the EVM. However, when the signal is known to have a poor transmission quality or has a high noise level, false symbol decisions are more frequent, which may cause spikes in the EVM results. To improve these calculations the reference signal can be estimated from a smaller area that includes a known symbol sequence in the input signal. In this case, the results for the limited reference area are more precise, at the cost of less accurate results outside this area. Thus, the result range should be set to the length of the reference area. The reference area can be defined either using a pattern or using a known data sequence from a Known Data file. If no predefined data sequences are available for the signal, the detected data is used by default.

If "Auto" mode is selected and a Known Data file has been loaded and activated for use, the known data sequences are used. Otherwise, the detected data is used.

**Note:** You can define a maximum symbol error rate (SER) for the known data in reference to the analyzed data. If the SER of the known data exceeds this limit, the default synchronization using the detected data is performed.

"Known Data" The reference signal is defined as the data sequence from the loaded Known Data file that most closely matches the measured data.

"Pattern" The reference signal is estimated from the defined pattern.

"Detected Data" (Default) The reference signal is estimated from the detected data.

Remote command:

[\[SENSe:\] DDEMod:FSYNc:AUTO](#) on page 288

[\[SENSe:\] DDEMod:FSYNc\[:MODE\]](#) on page 289

[\[SENSe:\] DDEMod:FSYNc:RESult?](#) on page 289

### If $SER \leq$

This setting is only available if "Known Data" is selected for "Fine Synchronization". You can define a maximum symbol error rate for the known data in reference to the analyzed data. Thus, if a wrong file was mistakenly loaded or the file proves to be unsuitable, it is not used for synchronization. Otherwise the results would be strongly distorted. If the SER of the known data exceeds this limit, the default synchronization using the detected data is performed.

Remote command:

[SENSe:] DDEMod:FSYNc:LEVel on page 288

**Measurement Filter**

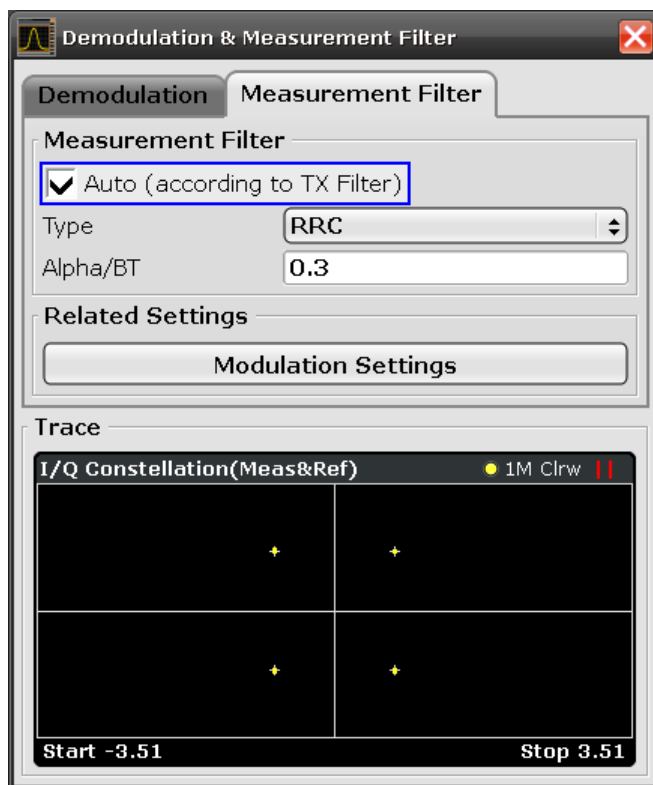
The "Measurement Filter" tab contains the settings for the measurement filter. In addition, a link to the "Modulation Settings" tab of the "Modulation and Signal Description Settings" dialog box is provided (see "Modulation" on page 143).

A live preview of the trace with the current settings is displayed in the preview area at the bottom of the dialog box. The preview area is not editable directly.

For details on measurement filters see Chapter 2.2.6, "Measurement Filters", on page 17.



The "Measurement Filter" tab is also displayed when you select the "Demod/ Meas Filter" softkey in the "Meas Config" menu (see "Demod/ Meas Filter" on page 128).



Auto..... 175  
 Type..... 175  
     └ Load User Filter..... 175  
 Alpha/BT..... 175

**Auto**

The measurement filter is defined automatically depending on the Transmit filter specified in the "Modulation" tab of the "Modulation & Signal Description" dialog box (see ["Transmit filter Type"](#) on page 145).

**Note:** If a user-defined Transmit filter is selected and the measurement filter is defined automatically, a Low-ISI measurement filter according to the selected user filter is calculated and used.

Remote command:

`[SENSe:] DDEMod:MFILter:AUTO` on page 291

**Type**

Defines the measurement filter type, if the [Auto](#) setting is not enabled.

An overview of available measurement filters is provided in [Table 2-4](#).

Remote command:

`[SENSe:] DDEMod:MFILter[:STATe]` on page 292

To turn off the measurement filter.

`[SENSe:] DDEMod:MFILter:NAME` on page 291

To define the name of the measurement filter.

**Load User Filter ← Type**

Opens a file-selection dialog box to select the user-defined measurement filter to be used.

For details see [Chapter 2.2.7, "Customized Filters"](#), on page 19.

Remote command:

`[SENSe:] DDEMod:MFILter:NAME` on page 291

**Alpha/BT**

Defines the roll-off factor (Alpha) or the filter bandwidth (BT).

The roll-off factor and filter bandwidth for Transmit filter is available for RC, RRC, Gauss and GMSK filter.

The roll-off factor and filter bandwidth for measurement filter is available for RRC filter.

Remote command:

Transmit filter: `[SENSe:] DDEMod:FILTer:ALPHa` on page 286

Measurement filter: `[SENSe:] DDEMod:MFILter:ALPHa` on page 291

**3.3.1.6 Display Configuration**

You configure the display for the results in the "Display Configuration" dialog box. This dialog box contains the following tabs:

- "Screen A-D": a separate tab for each of the four available screens
- "Predefined": for predefined display configurations

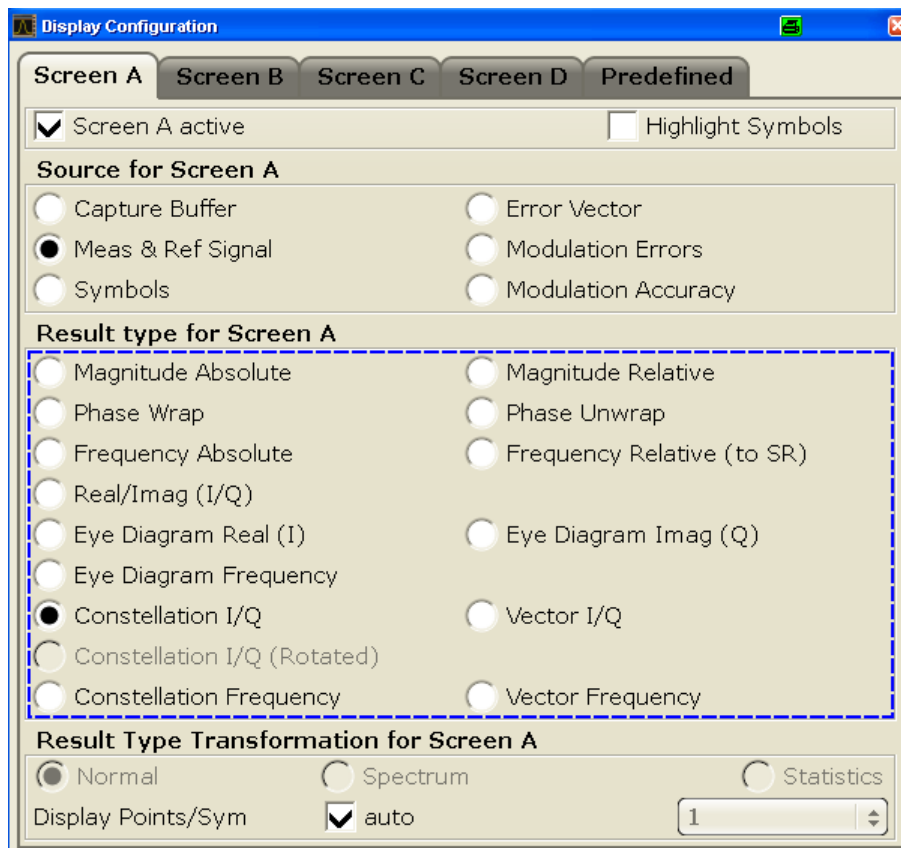
For more information, see [Chapter 3.1, "Measurement Result Display"](#), on page 69.



The "Display Configuration" tab is also displayed when you select the MEAS key.

**Screen A-D**

For each of the four available screens you can configure what is to be displayed.



Screen X active..... 176  
 Highlight Symbols..... 176  
 Source..... 177  
 Result Type..... 177  
 Result Type Transformation..... 178  
 Display Points/Sym..... 179  
 Oversampling..... 180

**Screen X active**

If enabled, the screen the tab corresponds to is displayed. If fewer than 4 screens are enabled, the remaining screens are enlarged to make best use of the available display.

Remote command:

DISPlay[:WINDow<n>]:STATe on page 259

**Highlight Symbols**

If enabled, the symbol instants are highlighted as squares in the screen for measured and reference signals in time (normal) display, as well as error displays.



Not all measurements support this function.

Remote command:

[DISPlay\[:WINDow<n>\]:TRACe<t>:SYMBOL](#) on page 260

### Source

You can choose which signal source is to be displayed from the following options:

Source	Description
Capture Buffer	The captured I/Q data
Meas & Ref	The measurement signal or the ideal reference signal (or both)
Symbols	The detected symbols (i.e. the detected bits)
Error Vector	The difference between the complex measurement signal and the complex reference signal: Modulation (measurement signal - reference signal) For example: $EVM = \text{Mag}(\text{meas} - \text{ref})$
Modulation Errors	Modulation errors due to different complex samples in the measurement and the reference signal: Modulation (measurement signal) - Modulation (reference signal) For example: $\text{Magnitude Error} = \text{Mag}(\text{meas}) - \text{Mag}(\text{ref})$
Modulation Accuracy	Category for measurements that provide a summary on the modulation accuracy (e.g. the Result Summary)

Remote command:

[CALCulate<n>:FEED](#) on page 247

### Result Type

Defines how the signal source is evaluated and which result is displayed. The available result types depend on the selected source type.

For more information, see [Chapter 3.1.1, "Result types"](#), on page 70.

**Table 3-6: Available result types depending on source type**

Source Type	Result Type
Capture Buffer	Magnitude Absolute
	Real/Imag (I/Q)
	Frequency Absolute
	Vector I/Q
Meas & Ref Signal	Magnitude Absolute
	Magnitude Relative
	Phase Wrap
	Phase Unwrap
	Frequency Absolute
	Frequency Relative

Source Type	Result Type
	Real/Imag (I/Q)
	Eye Diagram Real (I)
	Eye Diagram Imag (Q)
	Eye Diagram Frequency
	Constellation I/Q
	Vector I/Q
	Constellation Frequency
	Vector Frequency
Symbols	Binary
	Octal
	Decimal
	Hexadecimal
Error Vector	EVM
	Real/Imag (I/Q)
	Vector I/Q
Modulation Errors	Magnitude Error
	Phase Error
	Frequency Error Absolute
	Frequency Error Relative
Modulation Accuracy	Result Summary

Remote command:

[CALCulate<n>:FORMat](#) on page 247

### Result Type Transformation

The result type transformation parameters set the evaluation method of the measurement results.

These settings are not available for the following source types (see "[Source](#)" on page 177):

- Symbols
- Modulation Accuracy

For more information, see [Chapter 3.1, "Measurement Result Display"](#), on page 69.

"Normal" X-axis displays time values.

"Spectrum" X-axis displays frequency values.

- "Statistics" X-axis displays former y-values. Y-axis displays statistical information:
- Trace 1: the probability of occurrence of a certain value is plotted against the value
  - Trace 2: the cumulated probability of occurrence is plotted against the value.

Remote command:

`CALCulate<n>:DDEM:SPECTrum[:STATe]` on page 243

`CALCulate<n>:STATistics:CCDF[:STATe]` on page 250

### Display Points/Sym

Sets the number of display points that are displayed per symbol. If more points per symbol are selected than the given [Capture Oversampling](#) rate, the additional points are interpolated for the display. The more points are displayed per symbol, the more detailed the trace becomes.

**Note:** If the Capture Buffer is used as the signal source, the [Capture Oversampling](#) rate defines the number of displayed points per symbol; the "Display Points/Sym" parameter is not available.

If "Auto" is enabled, the [Capture Oversampling](#) value is used.

Alternatively, select the number of points to be displayed per symbol manually. The available values depend on the source type.

For the Result Summary, the number of display points corresponds to the [Estimation Points/Sym](#). (By default, 1 for QAM and PSK modulated signals and the capture oversampling rate for MSK and FSK modulated signals.) This value also controls which samples are considered for the Peak and RMS values and the Power result.

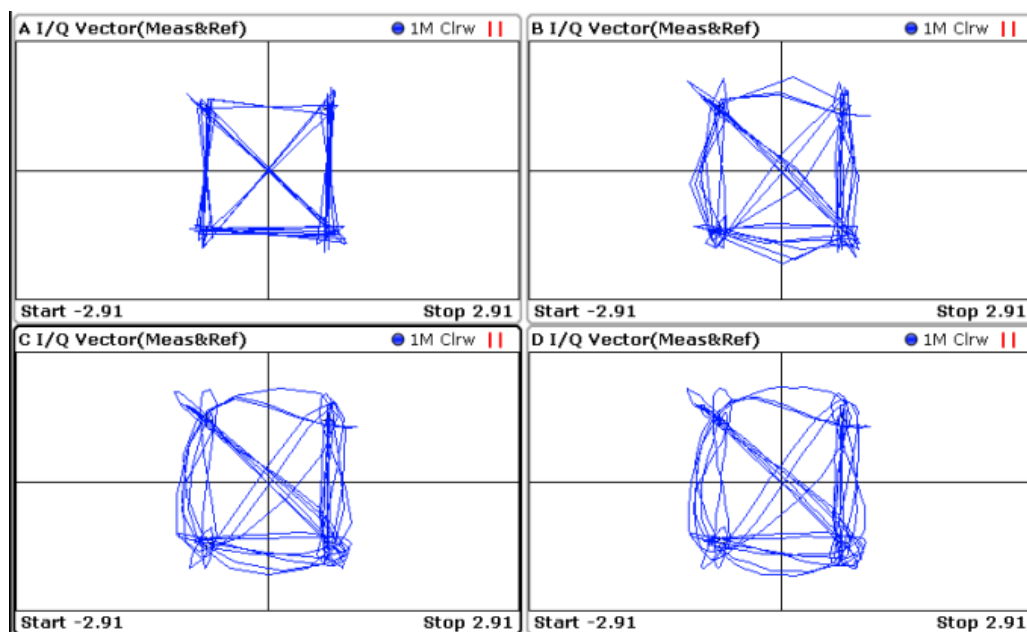


Figure 3-29: Result display with different numbers of points per symbol: Screen A = 1; Screen B = 2; Screen C = 4; Screen D = 16;

Remote command:

`DISPlay[:WINDow<n>]:PRATe[:VALue]` on page 258

`DISPlay[:WINDow<n>]:PRATe:AUTO` on page 258

### Oversampling

Defines the sample basis for statistical evaluation. This setting is only available for the Result Type Transformation "Statistics".

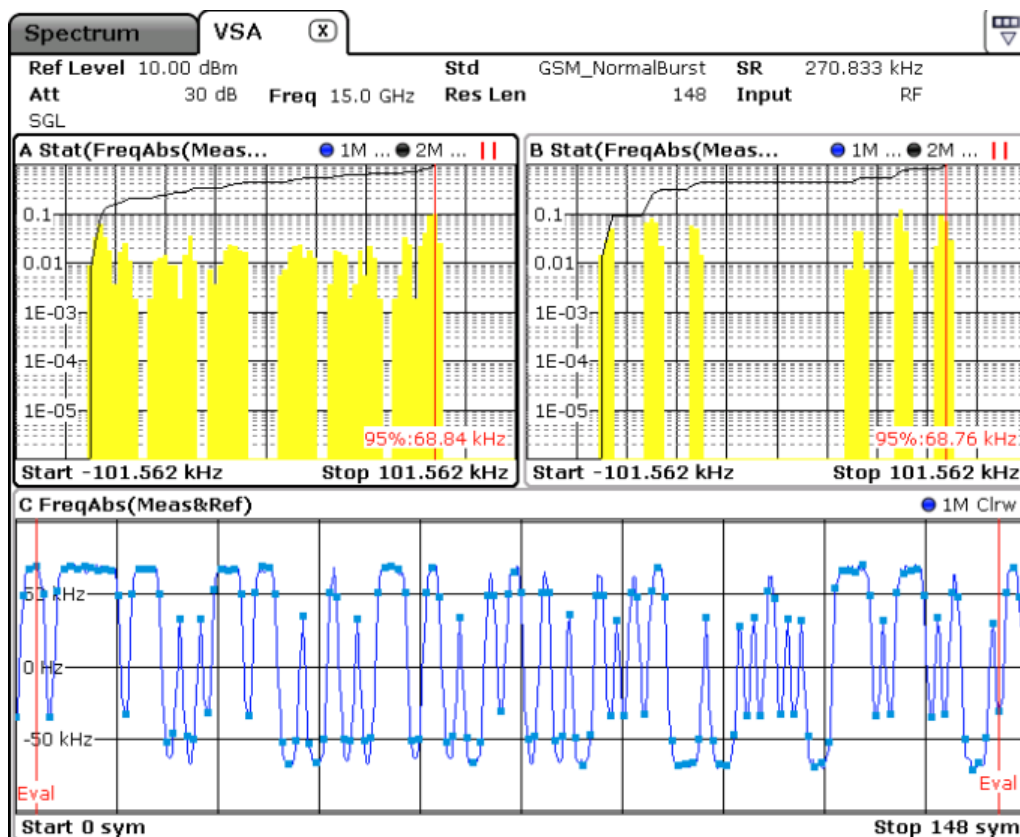


Figure 3-30: Statistics measurement: Screen C: measured signal (symbols highlighted); Screen A: statistics for all trace points; Screen B: statistics for symbol instants only

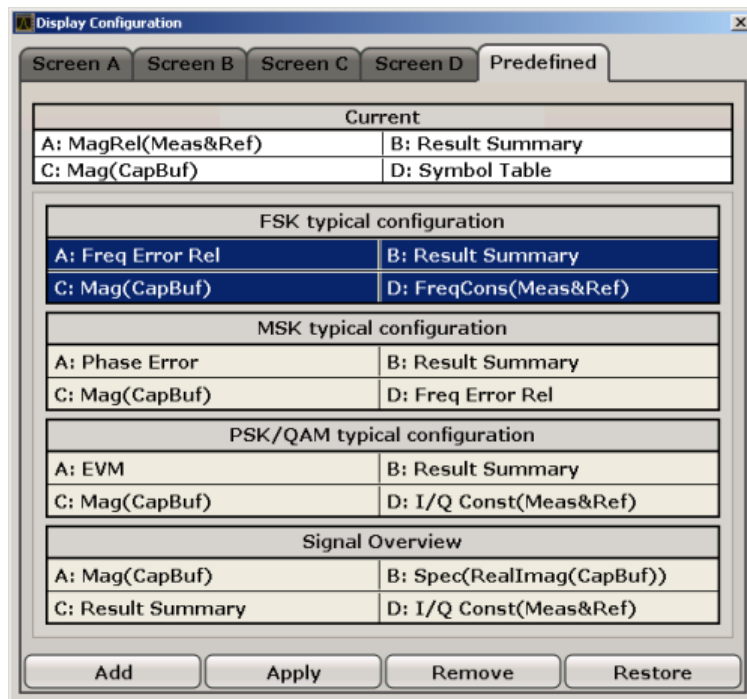
- "Symbols only" Statistics are calculated for symbol instants only  
See screen B in [Statistics measurement: Screen C: measured signal \(symbols highlighted\)](#); Screen A: statistics for all trace points; Screen B: statistics for symbol instants only.
- "Infinite" Statistics are calculated for all trace points (symbol instants and intermediate times)  
See screen A in [Statistics measurement: Screen C: measured signal \(symbols highlighted\)](#); Screen A: statistics for all trace points; Screen B: statistics for symbol instants only.
- "auto" currently not used

Remote command:

`CALCulate<n>:STATistics:MODE` on page 250

**Predefined**

You can store and load predefined screen configurations. All available configurations are displayed in the "Predefined" tab. The current screen configuration is indicated under "Current" at the top of the list.



Add..... 181  
 Apply..... 181  
 Remove..... 181  
 Restore..... 181

**Add**

Opens an edit dialog box to enter a name for the current screen configuration. The configuration is then stored and added to the list.

**Apply**

Applies the currently selected configuration from the list to the current display.

**Remove**

Removes the currently selected configuration from the list.

**Restore**

Restores the default Display Configuration. Existing settings with the default names are replaced.

**3.3.2 Defining the Result Range**

You can define which part of the source signal is analyzed ("Result Range") with reference to the captured data, a found burst or a found pattern.

You configure the result range and evaluation range settings in the "Result Range and Evaluation Range" dialog box in the "Settings Overview" (see also [Chapter 3.3.1.4, "Result Range and Evaluation Range Settings"](#), on page 165).

1. Define the "Result Length", i.e. the number of symbols from the result that are to be analyzed (see ["Result Length"](#) on page 166).  
Note that when you use Known Data files as a reference, the "Result Length" specified here must be identical to the length of the specified symbol sequences in the xml file (<ResultLength> element). See [Chapter 3.3.7.1, "Dependencies and Restrictions when Using Known Data"](#), on page 194.
2. Define the "Reference" for the result range, i.e. the source to which the result will be aligned (see ["Reference"](#) on page 166). The reference can be the captured data, a detected burst or a detected pattern.
3. Define the "Alignment" of the result range to the reference source, i.e. whether the result starts at the beginning of the reference source, ends with the reference source, or is centered with the reference source (see ["Alignment"](#) on page 167).
4. Optionally, define an offset of the result range to the reference source, e.g. to ignore the first few symbols of the captured data (see ["Offset"](#) on page 167).
5. Optionally, define the number of the symbol which marks the beginning of the reference source to change the scaling of the x-axis (see ["Symbol Number at <Reference> start"](#) on page 167). This offset is added to the one defined for the signal description, see ["Offset"](#) on page 148).

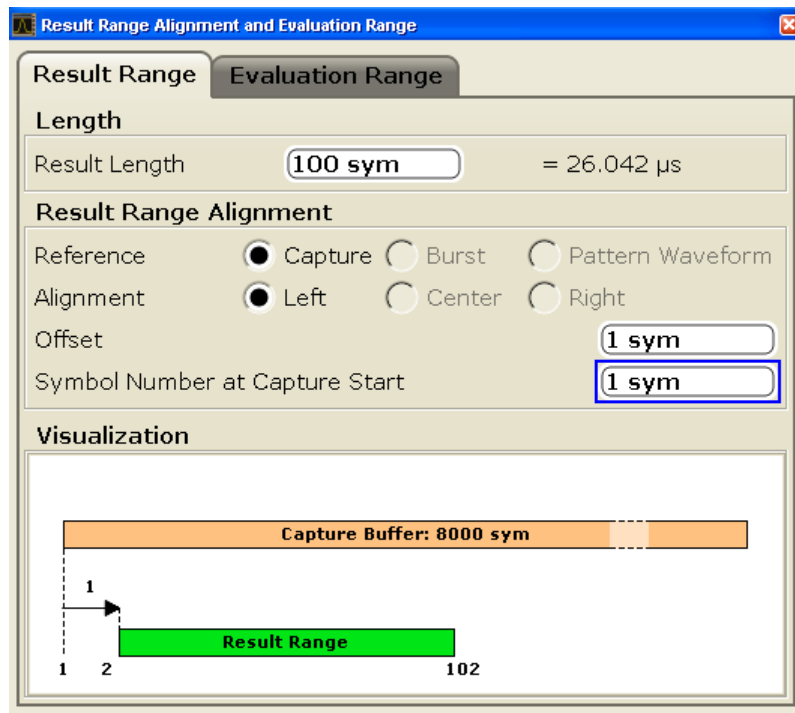
**Example: Defining the result range**

Figure 3-31: Example: Defining the Result Range

In [Figure 3-31](#), a result range will be defined for the first 100 symbols of the capture buffer, starting at the second symbol, which has the symbol number 1 (the capture buffer starts at symbol number 1, the first symbol to be displayed is the second symbol due to the offset:  $1+1=2$ ).



The result range is indicated by a green bar along the time axis in capture buffer result displays, see [Chapter 3.1.6, "Result Ranges and Evaluation Ranges"](#), on page 103.

**Defining an Evaluation Range**

By default, the entire result range is used for evaluation. If necessary, you can define an evaluation range that differs from the result range. For example, you can exclude the ramps of a burst for evaluation. The used evaluation range is indicated in the result display. For details see ["Evaluation Range"](#) on page 167.

**Remote control**

In order to define the result range via remote control, use the following commands:

```
[SENSe]:DDEMod:TIME 100
```

//Defines the result length as 100 symbols.

```
CALC:TRAC:ADJ TRIG
```

//Defines the capture buffer as the reference for the result range

```
CALC:TRAC:ADJ:ALIG LEFT
//Aligns the result range to the left edge of the capture buffer
CALC:TRAC:ADJ:ALIG:OFFS 1
//Defines an offset of 1 symbol from the capture buffer start
DISP:TRAC:X:VOFF 1
//Defines the symbol number 1 as the capture buffer start
```

### 3.3.3 Changing the Display Scaling

Depending on the type of display (time, spectrum or statistics), various scaling functions are available to adapt the result display to the current data. Scaling functions are located in the "Ranges" submenu of the "Amplitude" menu (see [Chapter 3.2.3, "Soft-keys of the Amplitude Menu \(R&S FSV-K70\)"](#), on page 110).

#### 3.3.3.1 Scaling Time and Spectrum Diagrams

The range of the displayed y-axis for time and spectral diagrams can be defined in the following ways:

- manually, by defining the range size, reference values and positions
- automatically, according to the current results

##### To define the scaling manually using a reference point

With this method, you define a reference value and a position at which this value is to be displayed on the y-axis.

1. Focus the result screen.
2. Select "AMPT > Ranges > Y-Axis Reference Value" (see ["Y-Axis Reference Value"](#) on page 112).
3. Enter a reference value for the y-axis in the current unit.
4. Select "AMPT > Ranges > Y-Axis Reference Position" (see ["Y-Axis Reference Position"](#) on page 112).
5. Enter the position at which this value is to be displayed on the y-axis. The position is a percentage of the entire length, where 100 % refers to the top edge.
6. Select "AMPT > Ranges > Y-Axis Range" (see ["Y-Axis Range"](#) on page 111).



**Example:**

If you want to analyze errors greater than 95%, you can define the y-axis range as 5 % and position the y-axis to start at 95%. To do so, enter the reference value 95 % and the reference position 0%.

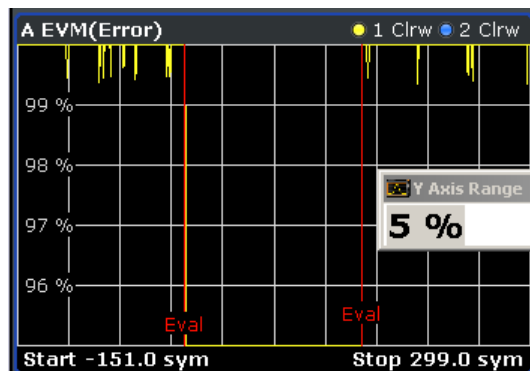


Figure 3-32: Defining the y-axis scaling using a reference point

**To define the scaling automatically**

1. Focus the result screen.
2. Select "AMPT > Ranges > Y-Axis Autorange" (see [Chapter 3.2.3, "Softkeys of the Amplitude Menu \(R&S FSV-K70\)"](#), on page 110).

The y-axis is adapted to display the current results optimally (only once, not dynamically).

**3.3.3.2 Scaling Statistics Diagrams**

Statistic diagrams show the distribution (i.e. probabilities of occurrence) of the values as a set of bars. You can define the number of bars to be displayed, i.e. the granularity of classifications. Additionally, you can specify whether absolute or percentage values are displayed. For statistics measurements, both the x-axis and the y-axis can be scaled to optimize the display.

The range of the displayed x-axis for statistics diagrams can be defined in the following ways:

- manually, by defining a range in dB
- manually, by defining reference values and positions
- automatically, according to the current results

The range of the displayed y-axis can be defined in the following ways:

- manually, by defining the minimum and maximum values to be displayed
- automatically, according to the current results

After changing the scaling you can restore the default settings.

**To define the number of bars**

1. Focus the result screen.
2. Select "AMPT > Ranges > X-Axis Quantize" (see "X-Axis Quantize" on page 112).
3. Enter the number of bars to be displayed.

The diagram is adapted to display the specified number of bars.

**To define the scaling manually using a reference point**

With this method, you define a reference value on the x-axis. The y-axis is adapted so that it crosses the x-axis at the reference value.

1. Focus the result screen.
2. Select "AMPT > Ranges > X-Axis Reference Value" (see "X-Axis Reference Value" on page 112).
3. Enter a reference value on the x-axis in the current unit.

The y-axis is adapted so that it crosses the x-axis at the reference value.

**Example:**

If you want to analyze the probabilities of occurrence for errors greater than 95 %, enter the reference value 95 %.

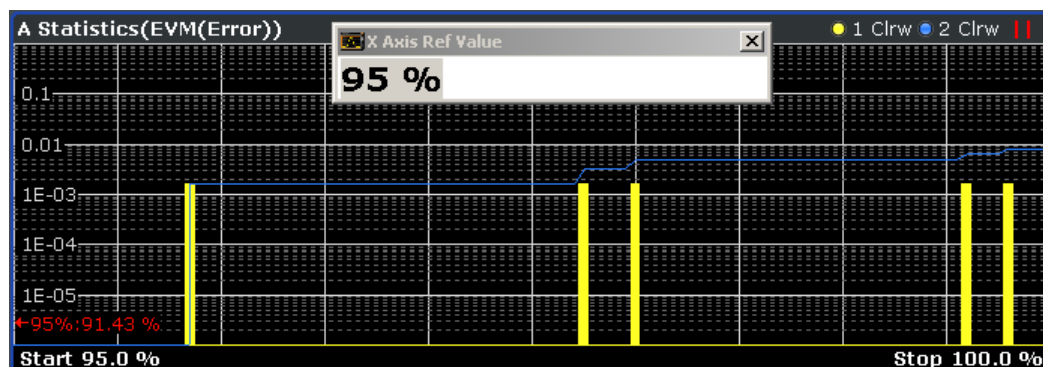


Figure 3-33: Defining the x-axis scaling using a reference point

**To define the x-axis range manually**

1. Focus the result screen.
2. Select "AMPT > Ranges > X-Axis Range" (see "X-Axis Range" on page 112).
3. Enter the range in the current unit.

The diagram is adapted to display the probabilities for the specified range.

**To define the scaling automatically**

1. Focus the result screen.

2. Select "AMPT > Ranges > Adjust Settings" (see ["Adjust Settings"](#) on page 113).

The x-axis is adapted to display the current results optimally (only once, not dynamically).

#### To define the y-axis range manually

With this method, you define the upper and lower limits of the displayed probability range. Values on the y-axis are normalized which means that the maximum value is 1.0. The y-axis scaling is defined via the "y-Unit %/Abs" softkey (see ["y-Unit % / Abs"](#) on page 113). If the y-axis has logarithmic scale, the distance between max and min value must be at least one decade.

1. Focus the result screen.
2. Select "AMPT > Ranges > Y-Axis Min Value" (see ["y-Axis Min Value"](#) on page 113).
3. Enter the lower limit in the current unit.
4. Select "AMPT > Ranges > Y-Axis Max Value" (see ["y-Axis Max Value"](#) on page 113).
5. Enter the upper limit in the current unit.

The y-axis is adapted to display the specified range. Probabilities of occurrence located outside the display area are applied to the bars at the left or right borders of the display.

#### To restore the default scaling settings

1. Focus the result screen.
2. Select "AMPT > Ranges > Default Settings" (see ["Default Settings"](#) on page 113).

The x- and y-axis scalings are reset to their default values.

### 3.3.4 Managing standard settings files

Various predefined settings files for common digital standards are provided for use with the VSA option. In addition, you can create your own settings files for user-specific measurements.

For an overview of predefined standards and settings see [Chapter B, "Predefined Standards and Settings"](#), on page 375.

#### To load predefined settings files

1. In the "VSA > Digital Standards" menu, select "Load Standard".
2. In the file selection dialog box, select the standard whose settings you want to load.

To change the path, press the arrow icons at the right end of the "Path" field and select the required folder from the file system.

3. Press the "Select" button.

The dialog box is closed and the instrument is adjusted to the stored settings for the selected standard.

#### To store settings as a standard file



This task can also be performed by remote control (see [\[SENSe:\] DDEMod: STANdard:SAVE](#) on page 313).

1. Configure the measurement as required. See [Settings Overview](#) for help.
2. In the "VSA > Digital Standards" menu, select "Save As Standard".
3. In the "File Name" field, enter the name of the standard for which you want to store settings.  
To change the path, press the arrow icons at the right end of the "Path" field and select the required folder from the file system.  
To insert a new folder, click the "New Folder" softkey and enter a name in the "New Folder" dialog box.
4. Press the "Save" button.  
The dialog box is closed and the current measurement settings are stored in a standard file.

#### To delete standard files

1. In the "Digital Standards" file selection dialog box, select the standard whose settings file you want to delete. Standards predefined by Rohde & Schwarz can also be deleted.  
To change the path, press the arrow icons at the right end of the "Path" field and select the required folder from the file system.
2. Press the "Select" button.
3. Confirm the message to avoid unintentionally deleting a standard.  
The standard file is removed from the folder.

#### To restore standard files

- ▶ In the "VSA > Digital Standards" menu, select "Restore Standard Files".  
The standards predefined by Rohde & Schwarz available at the time of delivery are restored to the `Standards` folder.

#### To restore default standard settings

If you change predefined standard settings for a specific measurement, you may want to return to the default settings later.



This task can also be performed by remote control (see [SENSe:]DDEMod:STANdard:PREset[:VALue] on page 313).

- ▶ In the "VSA > Digital Standards" menu, select "Standard Defaults".  
The instrument is reset to the default settings of the standard last used.

### 3.3.5 Working with Pattern Searches

Patterns provide a fixed sequence of symbols at a defined point in time in the symbol stream. They are used in many digital mobile radio systems to evaluate the channel impulse response and to facilitate a demodulation in the receiver.

The pattern search is performed on the I/Q capture buffer. The R&S FSV-K70 takes the symbol numbers of the pattern, modulates the pattern according to the Transmit filter and the modulation and, subsequently, searches the I/Q capture buffer for this I/Q pattern. The K70 option can then adapt its result range to this pattern.

#### Predefined Patterns

Common standards usually have predefined pattern lists with standard specific patterns. Patterns required for the current measurement can be selected from this list. This list can be extended by patterns that are already available in the instrument. Newly created patterns can also be added to the list.

#### Pattern Settings

##### To configure a pattern search

Configuring a pattern search requires the following steps:

1. [Selecting a pattern](#)  
This may require further subtasks:
  - a) [Changing the display for the list of patterns](#)
  - b) [Adding a pattern to a standard](#)
  - c) [Creating a new pattern](#)
  - d) [Editing a pattern](#)
2. [Enabling pattern search](#) (if "Auto" mode is disabled)
3. Optionally, [defining the offset of the pattern with respect to the useful part of the burst](#). The specified number of symbols in the signal are ignored during the pattern search.

##### To add a pattern to the signal description

1. In the "VSA > Settings Overview" dialog box, select "Signal Description".
2. Select the "Pattern" option.

### To select a predefined pattern for a search



This task can also be performed by remote control, see [\[SENSe:\]DDEMod:SEARCh:SYNC:CATalog](#) on page 306 and [\[SENSe:\]DDEMod:SEARCh:SYNC:SElect](#) on page 310.

Depending on whether a dialog box is already displayed, there are different ways to select a pattern:

1. If the "Settings Overview" dialog box is displayed, select "Signal Description". From the "Name" selection list, select a pattern that is assigned to the currently defined standard.
2. If the "Burst & Pattern Settings" dialog box is displayed, select the "Pattern Search" tab and select the pattern from the list of assigned patterns.
3. If the "Advanced Pattern Settings" dialog box is displayed, select the required pattern from the "Standard Patterns" list.
4. Otherwise, from the "VSA" menu, select "Signal Description". From the "Name" selection list, select a pattern that is assigned to the currently defined standard.

If the pattern you require is not available, see ["To add a predefined pattern to a standard"](#) on page 191.

### To enable a pattern search



This task can also be performed by remote control, see [\[SENSe:\]DDEMod:SEARCh:SYNC:STATe](#) on page 311.

1. If the "Advanced Pattern Settings" dialog box is already displayed, select the "Pattern Search On" option. Otherwise, in the "VSA > Settings Overview" dialog box, select "Pattern Search".
2. Select "On" to enable the search globally, or "Auto" to enable a search if a pattern is part of the signal description (see ["To add a pattern to the signal description"](#) on page 189).  
The selected pattern is used for a pattern search.
3. Optionally, select the "Meas only if pattern symbols correct" option. In this case, measurement results are only displayed if a valid pattern has been found. See also ["Meas only if pattern symbols correct"](#) on page 161.

### To define an offset for the pattern search

1. In the "VSA > Settings Overview" dialog box, select "Signal Description".
2. Select the "Offset" option and enter the number of symbols to be used as an offset.

### 3.3.6 Managing patterns

The available patterns and those assigned to the current standard are listed in the "Pattern Settings" dialog box. In addition, details for the currently focussed pattern are displayed in the upper right-hand part of the dialog box. To show the details for a specific pattern, simply click on it.

#### To add a predefined pattern to a standard

1. In the "VSA > Settings Overview" dialog box, select "Signal Description".
2. Press "Pattern Settings".
3. In the list of "All Patterns", select the required pattern.  
If the required pattern is not displayed, see ["To change the display for the list of patterns"](#) on page 191.
4. Press "Add to Standard".  
The selected pattern is inserted in the list of "Standard Patterns".

#### To change the display for the list of patterns

1. In the "VSA > Settings Overview" dialog box, select "Signal Description".
2. Press "Pattern Settings".
3. To display all available patterns, select "Show All".  
To display all patterns that are compatible to the defined standard, select "Show Compatible".  
To display only patterns that contain a specific prefix, enter the "Prefix" in the edit field.

#### To create a new pattern

1. In the "VSA > Settings Overview" dialog box, select "Signal Description".
2. Press "Pattern Settings".
3. Press "New Pattern".  
The pattern definition dialog box is displayed.
4. Define the following pattern settings:

Setting	Description
Name	Pattern name that will be displayed in selection list
Description	Optional description of the pattern which is displayed in the pattern details
Modulation order	Number of values each symbol can represent (order of modulation)
Symbol format	Hexadecimal or decimal format
Symbols	Pattern definition, consisting of one or more symbols
Comment	Optional comment for the pattern, displayed in the pattern details (kept for compatibility with FSQ)

To define the pattern, proceed as follows:

- a) If necessary, add a new symbol field by pressing "Add".
  - b) Select the symbol field you want to define.
  - c) Enter a value using the keyboard. Depending on the "Modulation Order", the value can be in the range 0 to n-1, where n is the "Modulation Order", e.g. 8 for 8-PSK.
  - d) Select the next symbol field, or insert a new one, and continue to define the other symbols. To scroll through the fields for long patterns, use the scrollbar beneath the input area. The number beneath the scrollbar at the right end indicates the sequential number of the last symbol field, the number in the center indicates the sequential number of the currently selected symbol field.
- To remove a symbol field, select it and press "Remove".

#### Example: Defining a pattern

The screenshot shows the 'New Pattern' dialog box with the following configuration:

- Name:** TETRA\_SA
- Description:** Special Continuous Downlink Burst
- Mod. Order:** 4
- Symbols:**
  - Format:** Hex (selected)
  - Buttons:** A, B, C, D, E, F
  - Size:** 11
  - Symbol Grid:**

3	1	0	0	3	2	2	1
3	1	1					
  - Buttons:** Add, Remove
  - Scrollbar:** Range 1 to 16, current position at 12.
- Comment:** (empty)
- Buttons:** Save, Cancel

Figure 3-34: Pattern definition





This task can also be performed by remote control.

**Example:**

`SENS:DDEM:SEAR:SYNC:NAME 'TETRA_SA'`, see [\[SENSe:\]DDEMod:SEARch:SYNC:NAME](#) on page 309

`SENS:DDEM:SEAR:SYNC:NST 4`, see [\[SENSe:\]DDEMod:SEARch:SYNC:NState](#) on page 309

`SENS:DDEM:SEAR:SYNC:DATA '00030001000000000003000200020001000300010001'`, see [\[SENSe:\]DDEMod:SEARch:SYNC:DATA](#) on page 307

`SENS:DDEM:SEAR:SYNC:COMM ''`, see [\[SENSe:\]DDEMod:SEARch:SYNC:COMMENT](#) on page 306

`SENS:DDEM:SEAR:SYNC:TEXT 'Special Continuous Downlink Burst'`, see [\[SENSe:\]DDEMod:SEARch:SYNC:TEXT](#) on page 311

**To edit a predefined pattern**

1. In the "VSA > Settings Overview" dialog box, select "Signal Description".
2. Press "Pattern Settings".
3. Select the pattern from the list of "All Patterns".
4. Press "Edit Pattern".
5. Change the settings as required as described in ["To create a new pattern"](#) on page 191.

**To delete a predefined pattern**

1. In the "VSA > Settings Overview" dialog box, select "Signal Description".
2. Press "Pattern Settings".
3. Select the pattern from the list of "All Patterns".
4. Press "Delete Pattern".

The pattern is removed from the list of available patterns and can no longer be assigned to any standard. Any existing assignments to other standards are removed, as well.

**To remove a predefined pattern from a standard**

1. In the "VSA > Settings Overview" menu, select "Signal Description".
2. Press "Pattern Settings".
3. Select the pattern from the list of "Standard Patterns".

4. Press "Remove from Standard".

The pattern is deleted and removed from the list of "Standard Patterns", but is still available for assignment from the list of "All Patterns".

### 3.3.7 Working With Known Data Files

For various vector signal analysis functions the measured signal is compared to a defined ideal reference signal. The more precise the reference signal, the more precise the results become. In the best case, the possible data sequences within the signal to analyze are known in advance and can be used to compare the measured data to. This is similar to defining a pattern for the entire result range. Thus, a falsely estimated reference signal (due to false symbol decisions) is avoided and does not influence the error calculation.

As of firmware version R&S FSVA/FSV 1.70, you can load xml files containing the possible sequences to the R&S FSV-K70 application and use them to compare the measured data to. In particular, you can use known data for the following functions:

- Fine synchronization during the demodulation process (see [Figure 2-42](#) and "[Demodulation](#)" on page 169)
- Calculation of the Bit Error Rate (BER), see [Chapter 3.1.1.23, "Bit Error Rate \(BER\)"](#), on page 95

#### 3.3.7.1 Dependencies and Restrictions when Using Known Data

When you use Known Data files as a reference, some dependencies to other settings and restrictions for other functions apply.

##### Modulation Order

The "Modulation Order" selected in the "Modulation" settings in the R&S FSV-K70 application must correspond to the modulation order value specified in the xml file (<ModulationOrder> element).

##### Demodulation

Demodulation using synchronization to the Known Data may increase the measurement duration, as each detected symbol must be compared to each possible sequence in the data file.

##### Result Length

The "Result Length" specified in the "Result Range" dialog box in the R&S FSV-K70 application must be identical to the length of the specified symbol sequences in the xml file (<ResultLength> element).

##### Result Range Alignment

- **Burst signals**

When you align the result range to a bursted signal, due to the uncertainty of the burst search, the determined result range might start up to 2 symbols before or after the actual burst. However, an offset of only one symbol has the effect that none of the predefined symbol sequences in the Known Data file will be found. To avoid this, try one of the following:

- Align the result range to a pattern instead of the burst.
  - Use a precise external trigger and align the result range to the capture buffer. This requires a very precise trigger timing, otherwise the result range start may be incorrect again.
- **Continuous signals**  
For continuous signals without a pattern, the result range is aligned randomly. Thus, a very large number of possible sequences must be predefined. Use a precise external trigger and align the result range to the capture buffer. This requires a very precise trigger timing, otherwise the result range start may be incorrect again.

### 3.3.7.2 How to Load Known Data Files

Known Data files are loaded in the "Modulation & Signal Description" settings.

#### To load an existing Known Data file

1. In the "Settings Overview", select "Modulation / Signal Description".
2. Switch to the "Known Data" tab.
3. Activate the usage of a Known Data file by selecting the "Known Data" option. This enables the "Load Data File" function.
4. Select the "Load Data File" button.  
A file selection dialog box is displayed.
5. Select the xml file which contains the possible data sequences of the input signal. The file must comply with the syntax described in [Chapter 3.3.7.4, "Reference: Known Data File Syntax Description"](#), on page 197.

The header information of the xml file is displayed in the dialog box.

Once a Known Data file has been loaded, the Bit Error Rate result display becomes available.

If the "Fine Synchronization" setting in the "Demodulation" dialog box is set to "Auto" mode, the known data is also used for synchronization. Otherwise it can be selected manually. Defining a maximum symbol error rate for the known data in reference to the analyzed data avoids using a falsely selected or unsuitable file for synchronization (see also "If  $SER \leq$ " on page 173).

### 3.3.7.3 How to Create Known Data Files

You must create the Known Data files yourself according to the possible data sequences of the input signal. Use any xml editing tool you like, following the rules described in [Chapter 3.3.7.4, "Reference: Known Data File Syntax Description"](#), on page 197.

Before loading the file to the R&S FSV-K70 application, make sure the syntax of your file is valid.



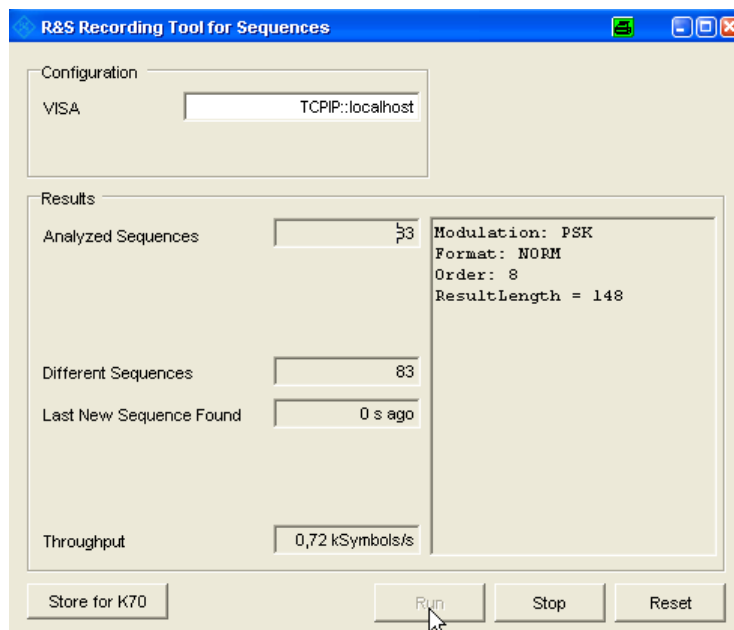
### Auxiliary tool to create Known Data files

An auxiliary tool to create Known Data files from data that is already available in the R&S FSV-K70 application is provided on the instrument free of charge.

#### To create a Known Data file using the recording tool for sequences

1. Import or apply input data for which stable demodulation results are available to the R&S FSV-K70 application. If necessary, adapt the demodulation settings until the requested results are obtained.
2. Execute the file `RecordingToolforSequences.EXE` from the installation directory on the instrument.

The "R&S Recording Tool for Sequences" window is displayed.



3. Start a measurement in the R&S FSV-K70 application.
4. In the tool window, select "Run".  
The tool records the demodulated data sequences. The following result information is provided by the tool during recording:
  - **Analyzed Sequences:** number of data sequences analyzed since the tool was started
  - **Different Sequences:** number of unique sequences detected in the measured data
  - **Last New Sequence Found:** time that has passed since the most recent unique sequence was found
  - **Throughput:** current data processing speed of the tool

Note that while the tool is running, the R&S FSV/FVA is set to remote mode, i.e. the manual interface is not available. As soon as the tool is closed, the remote mode is automatically deactivated.

5. When all known possible sequences have been found, or when a significantly large amount of time has passed so as to assume no more sequences will be found, stop the tool by selecting "Stop".
6.
  - If the results are acceptable, select "Store for K70" to store a valid xml file with the recorded data sequences on the instrument.  
A file selection dialog box is displayed in which you can select the storage location and file name.  
You can also add an optional comment to the file.
  - Otherwise, reset the tool to start a new recording, possibly after changing the demodulation settings or input data.
7. Close the tool window to return to normal operation of the R&S FSV-K70 application.

The created xml file can now be loaded in the R&S FSV-K70 application as described in [Chapter 3.3.7.2, "How to Load Known Data Files"](#), on page 195.

#### 3.3.7.4 Reference: Known Data File Syntax Description

When you load a Known Data file, the R&S FSV-K70 application checks whether the file complies with the following syntax:

**Table 3-7: Known Data File Syntax**

Syntax	Possible Values	Description
<RS_VSA_KNOWN_DATA_FILE Version="01.00">	as specified	File Header
<Comment></Comment>	arbitrary	Optional file description
<Base></Base>	2   16	The base used to specify the <Data> values (binary or hexadecimal) For <ModulationOrder> values ≥32, use binary (2).
<ModulationOrder></Modulation- Order>	2   4   8   16   32   64   128   256	Number of values each symbol can represent (order of modulation), e.g. 8 for 8-PSK For <ModulationOrder> values ≥32, use <Base> = 2.
<ResultLength></ResultLength>	1 ... up to 2000 <sup>*)</sup>	Number of symbols in each <Data> element The number must be identical to the "Result Length" setting in the "Result Range" dialog box, i.e. the number of symbols to be demodulated.
*) the exact number also depends on available memory space		

Syntax	Possible Values	Description
<Data></Data>	One character per symbol in the sequence Possible characters are: 0 to n-1, where n is the <ModulationOrder> Spaces, tabs and line breaks are ignored	One possible sequence of symbols that can be demodulated from the input signal Up to 6000 <sup>*)</sup> different sequences, i.e. <Data>-elements, can be defined in total
</RS_VSA_KNOWN_DATA_FILE>	as specified	File End
*) the exact number also depends on available memory space		

### Sample xml file for known data

```
<RS_VSA_KNOWN_DATA_FILE Version="01.00">

  <Comment> Standard EDGE_8PSK </Comment>
  <Base>          16 </Base>
  <ModulationOrder> 8 </ModulationOrder>
  <ResultLength> 148 </ResultLength>

  <Data> 777 511 727 242 206 341 366 632 073 607
        770 173 705 631 011 235 507 476 330 522
        177 177 171 117 777 177 717 717 111 615
        527 046 104 004 106 047 125 415 723 344
        241 264 773 111 337 446 514 600 677 7 </Data>

  <Data> 77 511 727 242 206 341 366 632 073 607
        770 173 705 631 011 235 507 476 330 522
        177 177 171 117 777 177 717 717 111 615
        527 046 104 004 106 047 125 415 723 344
        241 264 773 111 337 446 514 600 677 7 7 </Data>

  <Data> 7 511 727 242 206 341 366 632 073 607
        770 173 705 631 011 235 507 476 330 522
        177 177 171 117 777 177 717 717 111 615
        527 046 104 004 106 047 125 415 723 344
        241 264 773 111 337 446 514 600 677 7 77 </Data>

  <Data> 7 777 511 727 242 206 341 366 632 073 607
        770 173 705 631 011 235 507 476 330 522
        177 177 171 117 777 177 717 717 111 615
        527 046 104 004 106 047 125 415 723 344
        241 264 773 111 337 446 514 600 677 </Data>

  <Data> 77 777 511 727 242 206 341 366 632 073 607
        770 173 705 631 011 235 507 476 330 522
        177 177 171 117 777 177 717 717 111 615
        527 046 104 004 106 047 125 415 723 344
```

```
241 264 773 111 337 446 514 600 67          </Data>
</RS_VSA_KNOWN_DATA_FILE>
```

### 3.3.8 Working with Limits for Modulation Accuracy Measurements

The results of a modulation accuracy measurement can be checked for violation of defined limits automatically. If limit check is activated and the measured values exceed the limits, those values are indicated in red in the result summary table. If limit check is activated and no values exceed the limits, the checked values are indicated in green.

B Result Summary							
		Current	Mean	Peak	StdDev	95%ile	Unit
*EVM	RMS	100.00*	100.00	100.00	0.00	100.00	%
	Peak	100.00	100.00	100.00	0.00	100.00	%
Phase Error	RMS	0.00	0.00	0.00	0.00	0.00	deg
	Peak	0.00	0.00	0.00	0.00	0.00	deg
Carrier Frequency Error		-0.00	-0.00	-0.00	0.00	-0.00	Hz
Rho		1.000 000	1.000 000	1.000 000	0.000 000	1.000 000	
IQ Offset		---	---	---	---	---	dB
Gain Imbalance		0.00	0.00	0.00	-193.01	0.00	dB
Quadrature Error		0.00	0.00	0.00	0.00	0.00	deg
Amplitude Droop		0.000 000	0.000 000	0.000 000	-193.010300	0.000 000	dB/sym
Power		-200.00	-200.00	-200.00	-200.00	-200.00	dBm

Limits and the limit check are configured in the "Limits" dialog box that is displayed when you press the "Config ModAcc Limits" softkey in the "Lines" menu (see ["Config ModAcc Limits"](#) on page 133).

#### To define a limit check

1. Configure a measurement with "Modulation Accuracy" as the "Source" (in the [Display Config](#) dialog box).
2. Press the LINES key on the front panel.
3. Press the "Config ModAcc Limits" softkey in the "Limits" menu.
4. In the "Current" tab, define limits that the current value should not exceed for any or all of the result types.  
Note: the limits for the current value are automatically also defined for the peak value and vice versa. However, the limit check can be activated individually for current or peak values.
5. Select the "Check" option for each result type to be included in the limit check.
6. If necessary, define limits and activate the limit check for the mean values of the different result types on the "Mean" tab.
7. If necessary, activate the limit check for the peak values of the different result types on the "Peak" tab.
8. To reset the limits to their default values, press "Set to Default".

9. Select the "Limit Checking On" option, or press the "ModAcc Limits On" softkey in the "Limits" menu.

The limit check is performed immediately on the current modulation accuracy measurement results and for all subsequent measurements until it is deactivated. The results of the limit check are indicated by red or green values in the result summary.

### 3.3.9 Measuring the Size of an Eye

Display lines are available for eye diagrams, which allow you to determine the size of the eye.

1. Configure a measurement with "Meas & Ref" as the "Source" and an eye diagram as the "Result type" (in the [Display Config](#) dialog box).
2. Press the LINES key on the front panel.
3. Select the "Vertical Line Absolute" softkey.
4. Move the line to the left edge of the eye.
5. Select the "Vertical Line Rel" softkey.
6. Move the line to the right edge of the eye.  
The relative position of the line is indicated in the diagram, which corresponds to the width of the eye (see [Figure 3-35](#)).
7. Select the "Horizontal Line Absolute" softkey.
8. Move the line to the top of the eye.
9. Select the "Horizontal Line Rel" softkey.
10. Move the line to the bottom of the eye.

The relative position of the line is indicated in the diagram, which corresponds to the height of the eye (see [Figure 3-35](#)).



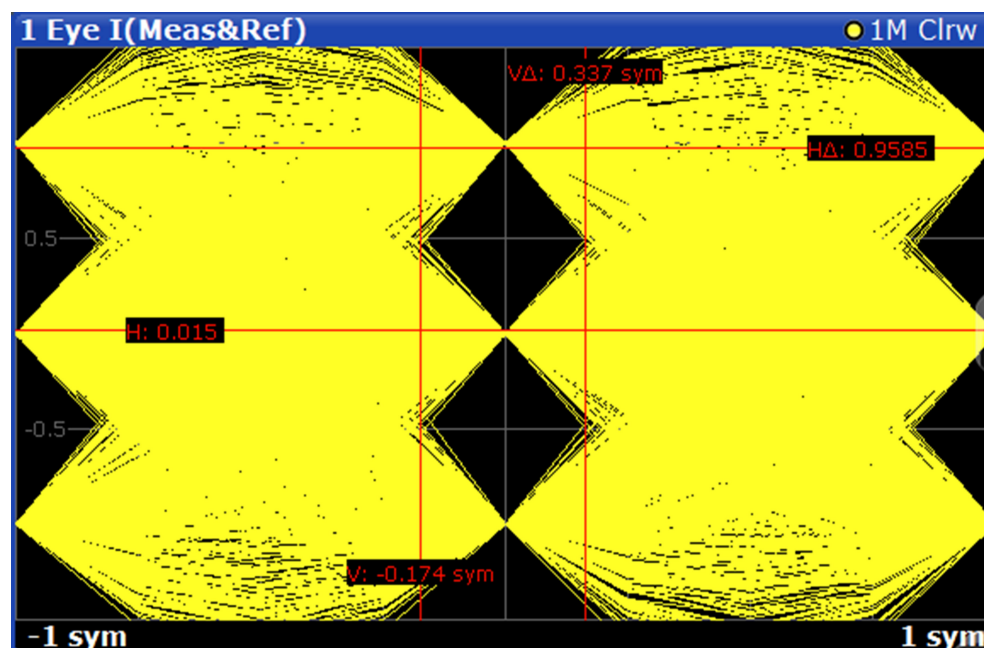


Figure 3-35: Size of an eye, calculated using display lines

## 3.4 Further Information

3.4.1	Trace Mode Overview.....	201
3.4.2	ASCII File Export Format for VSA Data.....	203

### 3.4.1 Trace Mode Overview

The traces can be activated individually for a measurement or frozen after completion of a measurement. Traces that are not activated are hidden. Each time the trace mode is changed, the selected trace memory is cleared.

The R&S FSVA/FSV provides the following different trace modes:

#### Clear Write

Overwrite mode: the trace is overwritten by each sweep. This is the default setting.

Remote command:

DISP:TRAC:MODE WRIT, see [DISPlay\[:WINDow<n>\]:TRACe<t>:MODE](#)  
on page 259

#### Max Hold

The maximum value is determined over several sweeps and displayed. The R&S FSVA/FSV saves the sweep result in the trace memory only if the new value is greater than the previous one.

This mode is especially useful with modulated or pulsed signals. The signal spectrum is filled up upon each sweep until all signal components are detected in a kind of envelope.

This mode is not available for statistics measurements.

Remote command:

DISP:TRAC:MODE MAXH, see [DISPlay\[:WINDow<n>\]:TRACe<t>:MODE](#) on page 259

### Min Hold

The minimum value is determined from several measurements and displayed. The R&S FSVA/FSV saves the smallest of the previously stored/currently measured values in the trace memory.

This mode is useful e.g. for making an unmodulated carrier in a composite signal visible. Noise, interference signals or modulated signals are suppressed whereas a CW signal is recognized by its constant level.

This mode is not available for statistics measurements.

Remote command:

DISP:TRAC:MODE MINH, see [DISPlay\[:WINDow<n>\]:TRACe<t>:MODE](#) on page 259

### Average

The average is formed over several sweeps. The [Statistics Count](#) determines the number of averaging procedures.


This mode is not available for statistics measurements.

Remote command:

DISP:TRAC:MODE AVER, see [DISPlay\[:WINDow<n>\]:TRACe<t>:MODE](#) on page 259

### View

The current contents of the trace memory are frozen and displayed.

**Note:** If a trace is frozen, the instrument settings, apart from level range and reference level (see below), can be changed without impact on the displayed trace. The fact that the displayed trace no longer matches the current instrument setting is indicated by the  icon on the tab label.

If the level range or reference level is changed, the R&S FSVA/FSV automatically adapts the measured data to the changed display range. This allows an amplitude zoom to be made after the measurement in order to show details of the trace.

Remote command:

DISP:TRAC:MODE VIEW, see [DISPlay\[:WINDow<n>\]:TRACe<t>:MODE](#) on page 259

### Blank

Hides the selected trace.

Remote command:

DISP:TRAC OFF, see [DISPlay\[:WINDow<n>\]:TRACe<t>\[:STATe\]](#) on page 260

### 3.4.2 ASCII File Export Format for VSA Data

The data of the file header consist of three columns, each separated by a semicolon: parameter name; numeric value; basic unit. The data section starts with the keyword "Trace <n>" (<n> = number of stored trace), followed by the measured data in one or several columns (depending on measurement) which are also separated by a semicolon.

**Table 3-8: ASCII file format for VSA trace data export**

File contents	Description
<b>Header</b>	
Type;FSV;	Instrument model
Version;1.45;	Firmware version
Date;01.Apr 2010;	Date of data set storage
Screen;A;	Instrument mode
Points per Symbol;4;	Points per symbol
x Axis Start;-13;sym;	Start value of the x axis
x Axis Stop;135;sym;	Stop value of the x axis
Ref value y axis;-10.00;dBm;	Y axis reference value
Ref value position;100;%;	Y axis reference position
<b>Data section</b>	
Trace;1;	Trace number
Meas;Result;	Result type
Meas Signal;Magnitude;	Result display
Demodulator;Offset QPSK;	Demodulation type
ResultMode;Trace;	Result mode
x unit;sym;	Unit of the x axis
y unit;dBm;	Unit of the y axis
Trace Mode;Clear Write;	Trace mode
Values;691;	Number of measurement points
10000;-10.3;-15.7 10130;-11.5;-16.9 10360;-12.0;-17.4 ...;...;	Measured values: <x value>, <y1>, <y2>; <y2> being available only with detector AUTOPEAK and containing in this case the smallest of the two measured values for a measurement point.

## 4 Remote Control Commands - R&S FSV-K70

This chapter lists and describes all remote control commands specific to this software application.

For further information on analyzer or basic settings commands, refer to the corresponding subsystem in the base unit description.

<b>4.1</b>	<b>Notation</b> .....	<b>204</b>
<b>4.2</b>	<b>ABORt Subsystem</b> .....	<b>207</b>
<b>4.3</b>	<b>CALCulate subsystem</b> .....	<b>207</b>
4.3.1	CALCulate:DELtmarker subsystem.....	207
4.3.2	CALCulate:LIMit:MACCuracy subsystem.....	213
4.3.3	CALCulate:MARKer subsystem.....	221
4.3.4	Other CALCulate commands.....	242
<b>4.4</b>	<b>DISPlay subsystem</b> .....	<b>257</b>
<b>4.5</b>	<b>FORMat subsystem</b> .....	<b>267</b>
<b>4.6</b>	<b>INITiate Subsystem</b> .....	<b>268</b>
<b>4.7</b>	<b>INPUt Subsystem</b> .....	<b>270</b>
<b>4.8</b>	<b>INSTRument Subsystem</b> .....	<b>277</b>
<b>4.9</b>	<b>MMEMory Subsystem</b> .....	<b>277</b>
<b>4.10</b>	<b>OUTPUt Subsystem</b> .....	<b>280</b>
<b>4.11</b>	<b>SENSE subsystem</b> .....	<b>281</b>
<b>4.12</b>	<b>STATus:QUESTionable Subsystem</b> .....	<b>318</b>
<b>4.13</b>	<b>SYSTem Subsystem</b> .....	<b>325</b>
<b>4.14</b>	<b>TRACe subsystem</b> .....	<b>325</b>
<b>4.15</b>	<b>TRIGGer subsystem</b> .....	<b>328</b>

### 4.1 Notation

In the following sections, all commands implemented in the instrument are first listed and then described in detail, arranged according to the command subsystems. The notation is adapted to the SCPI standard. The SCPI conformity information is included in the individual description of the commands.

### Individual Description

The individual description contains the complete notation of the command. An example for each command, the \*RST value and the SCPI information are included as well.

The options and operating modes for which a command can be used are indicated by the following abbreviations:

Abbreviation	Description
A	spectrum analysis
A-F	spectrum analysis – span > 0 only (frequency mode)
A-T	spectrum analysis – zero span only (time mode)
ADEMOD	analog demodulation (option R&S FSV-K7)
BT	Bluetooth (option R&S FSV-K8)
CDMA	CDMA 2000 base station measurements (option R&S FSV-K82)
EVDO	1xEV-DO base station analysis (option R&S FSV-K84)
GSM	GSM/Edge measurements (option R&S FSV-K10)
IQ	IQ Analyzer mode
OFDM	WiMAX IEEE 802.16 OFDM measurements (option R&S FSV-K93)
OFDMA/WiBro	WiMAX IEEE 802.16e OFDMA/WiBro measurements (option R&S FSV-K93)
NF	Noise Figure measurements (R&S FSV-K30)
PHN	Phase Noise measurements (R&S FSV-K40)
PSM	Power Sensor measurements (option R&S FSV-K9)
SFM	Stereo FM measurements (option R&S FSV-K7S)
SPECM	Spectrogram mode (option R&S FSV-K14)
TDS	TD-SCDMA base station / UE measurements (option R&S FSV-K76/K77)
VSA	Vector Signal Analysis (option R&S FSV-K70)
WCDMA	3GPP Base Station measurements (option R&S FSV-K72), 3GPP UE measurements (option R&S FSV-K73)
WLAN	WLAN TX measurements (option R&S FSV-K91)



The spectrum analysis mode is implemented in the basic unit. For the other modes, the corresponding options are required.

### Upper/Lower Case Notation

Upper/lower case letters are used to mark the long or short form of the key words of a command in the description. The instrument itself does not distinguish between upper and lower case letters.

## Special Characters

	A selection of key words with an identical effect exists for several commands. These keywords are indicated in the same line; they are separated by a vertical stroke. Only one of these keywords needs to be included in the header of the command. The effect of the command is independent of which of the keywords is used.
--	---

Example:

```
SENSe:FREQuency:CW|:FIXed
```

The two following commands with identical meaning can be created. They set the frequency of the fixed frequency signal to 1 kHz:

```
SENSe:FREQuency:CW 1E3
```

```
SENSe:FREQuency:FIXed 1E3
```

A vertical stroke in parameter indications marks alternative possibilities in the sense of "or". The effect of the command differs, depending on which parameter is used.

Example: Selection of the parameters for the command

```
[SENSe<1...4>:]AVERage<1...4>:TYPE VIDEo | LINear
```

[]	Key words in square brackets can be omitted when composing the header. The full command length must be accepted by the instrument for reasons of compatibility with the SCPI standards. Parameters in square brackets can be incorporated optionally in the command or omitted as well.
----	---

{}	Parameters in braces can be incorporated optionally in the command, either not at all, once or several times.
----	---

## Description of Parameters

Due to the standardization, the parameter section of SCPI commands consists always of the same syntactical elements. SCPI has therefore specified a series of definitions, which are used in the tables of commands. In the tables, these established definitions are indicated in angled brackets (<...>) and is briefly explained in the following.

For details see the chapter "SCPI Command Structure" in the base unit description.

### <Boolean>

This keyword refers to parameters which can adopt two states, "on" and "off". The "off" state may either be indicated by the keyword OFF or by the numeric value 0, the "on" state is indicated by ON or any numeric value other than zero. Parameter queries are always returned the numeric value 0 or 1.

### <numeric\_value> <num>

These keywords mark parameters which may be entered as numeric values or be set using specific keywords (character data). The following keywords given below are permitted:

- **MAXimum**: This keyword sets the parameter to the largest possible value.

- **MINimum:** This keyword sets the parameter to the smallest possible value.
- **DEFault:** This keyword is used to reset the parameter to its default value.
- **UP:** This keyword increments the parameter value.
- **DOWN:** This keyword decrements the parameter value.

The numeric values associated to MAXimum/MINimum/DEFault can be queried by adding the corresponding keywords to the command. They must be entered following the quotation mark.

Example:

```
SENSe:FREQuency:CENTer? MAXimum
```

Returns the maximum possible numeric value of the center frequency as result.

#### <arbitrary block program data>

This keyword is provided for commands the parameters of which consist of a binary data block.

## 4.2 ABORt Subsystem

### ABORt

This command aborts a current measurement and resets the trigger system.

**Example:** ABOR; INIT: IMM

**Mode:** all

## 4.3 CALCulate subsystem

4.3.1	CALCulate:DELTamarker subsystem.....	207
4.3.2	CALCulate:LIMit:MACCuracy subsystem.....	213
4.3.3	CALCulate:MARKer subsystem.....	221
4.3.4	Other CALCulate commands.....	242

### 4.3.1 CALCulate:DELTamarker subsystem

CALCulate<n>:DELTamarker<m>:AOFF.....	208
CALCulate<n>:DELTamarker<m>:LINK.....	208
CALCulate<n>:DELTamarker<m>:MAXimum:APEak.....	208
CALCulate<n>:DELTamarker<m>:MAXimum:LEFT.....	209
CALCulate<n>:DELTamarker<m>:MAXimum:NEXT.....	209
CALCulate<n>:DELTamarker<m>:MAXimum[:PEAK].....	209
CALCulate<n>:DELTamarker<m>:MAXimum:RIGHT.....	210

CALCulate<n>:DELTaMarker<m>:MINimum:LEFT.....	210
CALCulate<n>:DELTaMarker<m>:MINimum:NEXT.....	210
CALCulate<n>:DELTaMarker<m>:MINimum[:PEAK].....	211
CALCulate<n>:DELTaMarker<m>:MINimum:RIGHT.....	211
CALCulate<n>:DELTaMarker<m>[:STATe].....	211
CALCulate<n>:DELTaMarker<m>:TRACe.....	212
CALCulate<n>:DELTaMarker<m>:X.....	212
CALCulate<n>:DELTaMarker<m>:X:ABSolute?.....	212
CALCulate<n>:DELTaMarker<m>:X:RELative?.....	213
CALCulate<n>:DELTaMarker<m>:Y?.....	213

---

### CALCulate<n>:DELTaMarker<m>:AOFF

This command turns all active delta markers off.

#### Suffix:

<n>	Selects the measurement window.
<m>	Selects the marker.

#### Example:

CALC:DELT:AOFF  
Switches off all delta markers.

---

### CALCulate<n>:DELTaMarker<m>:LINK <State>

This command links delta marker 1 to marker 1.

If you change the horizontal position of the marker, so does the delta marker.

#### Suffix:

<n>	Selects the measurement window.
<m>	1 irrelevant

#### Parameters:

<State>	ON   OFF
*RST:	OFF

#### Example:

CALC:DELT:LINK ON

**Manual operation:** See "[Link Mkr1 and Delta1](#)" on page 129

---

### CALCulate<n>:DELTaMarker<m>:MAXimum:APEak

This command positions the active marker or deltamarker on the largest absolute peak value (maximum or minimum) of the selected trace.

#### Suffix:

<n>	1..4
<m>	1..4

**Usage:** Event



**Mode:** all

---

#### **CALCulate<n>:DELTamarker<m>:MAXimum:LEFT**

This command positions the delta marker to the next smaller trace maximum on the left of the current value (i.e. descending X values). The corresponding delta marker is activated first, if necessary.

If no next higher minimum value is found on the trace (level spacing to adjacent values < peak excursion), an execution error (error code: -200) is produced.

**Suffix:**

<n> Selects the measurement window.

<m> Selects the marker.

**Example:**

`CALC:DELT:MAX:LEFT`

Sets delta marker 1 to the next smaller maximum value to the left of the current value.

---

#### **CALCulate<n>:DELTamarker<m>:MAXimum:NEXT**

This command positions the delta marker to the next smaller trace maximum. The corresponding delta marker is activated first, if necessary.

If no next higher minimum value is found on the trace (level spacing to adjacent values < peak excursion), an execution error (error code: -200) is produced.

**Suffix:**

<n> Selects the measurement window.

<m> Selects the marker.

**Example:**

`CALC:DELT2:MAX:NEXT`

Sets delta marker 2 to the next smaller maximum value.

**Manual operation:** See ["Next Peak"](#) on page 131

---

#### **CALCulate<n>:DELTamarker<m>:MAXimum[:PEAK]**

This command positions the delta marker to the current trace maximum. If necessary, the corresponding delta marker is activated first.

**Suffix:**

<n> Selects the measurement window.

<m> Selects the marker.

**Example:**

`CALC:DELT3:MAX`

Sets delta marker 3 to the maximum value of the associated trace.

**CALCulate<n>:DELTamarker<m>:MAXimum:RIGHT**

This command positions the delta marker to the next smaller trace maximum on the right of the current value (i.e. ascending X values). The corresponding delta marker is activated first, if necessary.

If no next higher minimum value is found on the trace (level spacing to adjacent values < peak excursion), an execution error (error code: -200) is produced.

**Suffix:**

<n> Selects the measurement window.

<m> Selects the marker.

**Example:**

```
CALC:DELT:MAX:RIGH
```

Sets delta marker 1 to the next smaller maximum value to the right of the current value.

**CALCulate<n>:DELTamarker<m>:MINimum:LEFT**

This command positions the delta marker to the next higher trace minimum on the left of the current value (i.e. descending X values). The corresponding delta marker is activated first, if necessary.

If no next higher minimum value is found on the trace (level spacing to adjacent values < peak excursion), an execution error (error code: -200) is produced.

**Suffix:**

<n> Selects the measurement window.

<m> Selects the marker.

**Example:**

```
CALC:DELT:MIN:LEFT
```

Sets delta marker 1 to the next higher minimum to the left of the current value.

**CALCulate<n>:DELTamarker<m>:MINimum:NEXT**

This command positions the delta marker to the next higher trace minimum. The corresponding delta marker is activated first, if necessary.

If no next higher minimum value is found on the trace (level spacing to adjacent values < peak excursion), an execution error (error code: -200) is produced.

**Suffix:**

<n> Selects the measurement window.

<m> Selects the marker.

**Example:**

```
CALC:DELT2:MIN:NEXT
```

Sets delta marker 2 to the next higher minimum value.

**Manual operation:** See "Next Min" on page 132

**CALCulate<n>:DELTamarker<m>:MINimum[:PEAK]**

This command positions the delta marker to the current trace minimum. The corresponding delta marker is activated first, if necessary.

**Suffix:**

<n> Selects the measurement window.

<m> Selects the marker.

**Example:**

```
CALC:DELT3:MIN
```

Sets delta marker 3 to the minimum value of the associated trace.

**CALCulate<n>:DELTamarker<m>:MINimum:RIGHT**

This command positions the delta marker to the next higher trace minimum on the right of the current value (i.e. ascending X values). The corresponding delta marker is activated first, if necessary.

If no next higher minimum value is found on the trace (level spacing to adjacent values < peak excursion), an execution error (error code: -200) is produced.

**Suffix:**

<n> Selects the measurement window.

<m> Selects the marker.

**Example:**

```
CALC:DELT:MIN:RIGH
```

Sets delta marker 1 to the next higher minimum value to the right of the current value.

**CALCulate<n>:DELTamarker<m>[:STATE] <State>**

This command turns delta markers on and off.

If the corresponding marker was a normal marker, it is turned into a delta marker.

No suffix at DELTmarker turns on delta marker 1.

**Suffix:**

<n> Selects the measurement window.

<m> Selects the marker.

**Parameters:**

<State> ON | OFF

\*RST: OFF

**Example:**

```
CALC:DELT1 ON
```

Switches marker 1 to delta marker mode.

**Manual operation:**

See "[Marker 1/2/3/4](#)" on page 128

See "[Marker Norm/Delta](#)" on page 128

**CALCulate<n>:DELTamarker<m>:TRACe <TraceNumber>**

This command selects the trace a delta marker is positioned on.

The corresponding trace must have a trace mode other than "Blank".

**Suffix:**

<n> Selects the measurement window.

<m> Selects the marker.

**Parameters:**

<TraceNumber> **1 ... 6**  
Trace number the marker is positioned on.

**Example:**

`CALC:DELT3:TRAC 2`  
Assigns delta marker 3 to trace 2.

**CALCulate<n>:DELTamarker<m>:X <Position>**

This command positions a delta marker on a particular coordinate on the x-axis.

The position is an absolute value.

**Suffix:**

<n> Selects the measurement window.

<m> Selects the marker.

**Parameters:**

<Position> Depends on the measurement and scale of the horizontal axis

**Example:**

`CALC:DELT:X?`  
Outputs the absolute frequency/time of delta marker 1.

**Manual operation:** See "[Marker 1/2/3/4](#)" on page 128

**CALCulate<n>:DELTamarker<m>:X:ABSolute?**

This command queries the absolute x-value of the selected delta marker in the specified window. The command activates the corresponding delta marker, if necessary.

**Suffix:**

<n> 1..4  
window; For applications that do not have more than 1 measurement window, the suffix <n> is irrelevant.

<m> 1..4  
marker number

**Usage:** Query only

**Mode:** all

**CALCulate<n>:DELTamarker<m>:X:RELative?**

This command queries the x-value of the selected delta marker relative to marker 1 or to the reference position (for `CALC:DELT:FUNC:FIX:STAT ON`). The command activates the corresponding delta marker, if necessary.

**Suffix:**

<n> Selects the measurement window.  
 <m> Selects the marker.

**Example:**

```
CALC:DELT3:X:REL?
```

Outputs the frequency of delta marker 3 relative to marker 1 or relative to the reference position.

**Usage:** Query only

**CALCulate<n>:DELTamarker<m>:Y?**

This command queries the measured value of a delta marker. The corresponding delta marker is activated, if necessary. The output is always a relative value referred to marker 1 or to the reference position (reference fixed active).

To obtain a correct query result, a complete sweep with synchronization to the sweep end must be performed between the activation of the delta marker and the query of the y value. This is only possible in single sweep mode.

Depending on the unit defined with `CALC:UNIT:POW` or on the activated measuring functions, the query result is output in the units below:

**Suffix:**

<n> Selects the measurement window.  
 <m> Selects the marker.

**Example:**

```
INIT:CONT OFF
```

Switches to single sweep mode.

```
INIT;*WAI
```

Starts a sweep and waits for its end.

```
CALC:DELT2 ON
```

Switches on delta marker 2.

```
CALC:DELT2:Y?
```

Outputs measurement value of delta marker 2.

**Usage:** Query only

**Manual operation:** See "[Marker 1/2/3/4](#)" on page 128

**4.3.2 CALCulate:LIMit:MACCuracy subsystem**

<a href="#">CALCulate&lt;n&gt;:LIMit:MACCuracy:DEFault.....</a>	214
<a href="#">CALCulate&lt;n&gt;:LIMit:MACCuracy:STATe.....</a>	215
<a href="#">CALCulate&lt;n&gt;:LIMit:MACCuracy:&lt;ResultType&gt;:&lt;LimitType&gt;:STATe.....</a>	215
<a href="#">CALCulate&lt;n&gt;:LIMit:MACCuracy:&lt;ResultType&gt;:&lt;LimitType&gt;[:RESUlt]?.....</a>	216

CALCulate<n>:LIMit:MACCuracy:CFERror:CURRent:VALue.....	217
CALCulate<n>:LIMit:MACCuracy:CFERror:MEAN:VALue.....	217
CALCulate<n>:LIMit:MACCuracy:CFERror:PEAK:VALue.....	217
CALCulate<n>:LIMit:MACCuracy:EVM:PCURrent:VALue.....	218
CALCulate<n>:LIMit:MACCuracy:EVM:PMEan:VALue.....	218
CALCulate<n>:LIMit:MACCuracy:EVM:PPEak:VALue.....	218
CALCulate<n>:LIMit:MACCuracy:EVM:RCURrent:VALue.....	218
CALCulate<n>:LIMit:MACCuracy:EVM:RMEan:VALue.....	218
CALCulate<n>:LIMit:MACCuracy:EVM:RPEak:VALue.....	218
CALCulate<n>:LIMit:MACCuracy:FDERror:CURRent:VALue.....	218
CALCulate<n>:LIMit:MACCuracy:FDERror:MEAN:VALue.....	218
CALCulate<n>:LIMit:MACCuracy:FDERror:PEAK:VALue.....	218
CALCulate<n>:LIMit:MACCuracy:FERRor:PCURrent:VALue.....	219
CALCulate<n>:LIMit:MACCuracy:FERRor:PMEan:VALue.....	219
CALCulate<n>:LIMit:MACCuracy:FERRor:PPEak:VALue.....	219
CALCulate<n>:LIMit:MACCuracy:FERRor:RCURrent:VALue.....	219
CALCulate<n>:LIMit:MACCuracy:FERRor:RMEan:VALue.....	219
CALCulate<n>:LIMit:MACCuracy:FERRor:RPEak:VALue.....	219
CALCulate<n>:LIMit:MACCuracy:MERRor:PCURrent:VALue.....	219
CALCulate<n>:LIMit:MACCuracy:MERRor:PMEan:VALue.....	219
CALCulate<n>:LIMit:MACCuracy:MERRor:PPEak:VALue.....	219
CALCulate<n>:LIMit:MACCuracy:MERRor:RCURrent:VALue.....	219
CALCulate<n>:LIMit:MACCuracy:MERRor:RMEan:VALue.....	219
CALCulate<n>:LIMit:MACCuracy:MERRor:RPEak:VALue.....	219
CALCulate<n>:LIMit:MACCuracy:OOFfset:CURRent:VALue.....	220
CALCulate<n>:LIMit:MACCuracy:OOFfset:MEAN:VALue.....	220
CALCulate<n>:LIMit:MACCuracy:OOFfset:PEAK:VALue.....	220
CALCulate<n>:LIMit:MACCuracy:PERRor:PCURrent:VALue.....	220
CALCulate<n>:LIMit:MACCuracy:PERRor:PMEan:VALue.....	220
CALCulate<n>:LIMit:MACCuracy:PERRor:PPEak:VALue.....	220
CALCulate<n>:LIMit:MACCuracy:PERRor:RCURrent:VALue.....	220
CALCulate<n>:LIMit:MACCuracy:PERRor:RMEan:VALue.....	220
CALCulate<n>:LIMit:MACCuracy:PERRor:RPEak:VALue.....	220
CALCulate<n>:LIMit:MACCuracy:RHO:CURRent:VALue.....	221
CALCulate<n>:LIMit:MACCuracy:RHO:MEAN:VALue.....	221
CALCulate<n>:LIMit:MACCuracy:RHO:PEAK:VALue.....	221

---

### CALCulate<n>:LIMit:MACCuracy:DEFault

Restores the default limits and deactivates all checks in all windows.

#### Suffix:

<n>                    1..4  
                          irrelevant

**Usage:**             Event

**Mode:**              VSA

**Manual operation:** See "Set to Default" on page 134

**CALCulate<n>:LIMit:MACCuracy:STATe <LimitState>****Suffix:**

&lt;n&gt; 1..4

**Setting parameters:**

&lt;LimitState&gt; ON | OFF

\*RST: OFF

**Mode:** VSA**Manual operation:** See "ModAcc Limits" on page 133  
See "Limit Checking" on page 134**CALCulate<n>:LIMit:MACCuracy:<ResultType>:<LimitType>:STATe <LimitState>**

This command switches the limit check for the selected result type and limit type on or off.

**Suffix:**<n> 1..4  
window<ResultType> CFERror | EVM | FDERror | FERRor | MERRor | OOFFset |  
PERRor | RHO

CFERror = Carrier Frequency Error

EVM = Error Vector Magnitude

FERRor = Frequency error (FSK only)

FDERror = Frequency deviation error (FSK only)

MERRor = Magnitude Error

OOFFset = I/Q Offset

PERRor = Phase Error

RHO = Rho

<LimitType> CURRent | MEAN | PEAK | PCURRent | PMEan | PPEak |  
RCURRent | RMEan | RPEak**For CFERror, OOFFset, RHO:**

CURRent

MEAN

PEAK

**For EVM, FERRor, MERRor, PERRor:**

PCURRent = Peak current value

PMEan = Peak mean value

PPEak = Peak peak value

RCURRent = RMS current value

RMEan = RMS mean value

RPEak = RMS peak value

**Setting parameters:**

&lt;LimitState&gt; ON | OFF

Activates a limit check for the selected result and limit type.

\*RST: OFF

**Example:**            `CALC2:FEED 'XTIM:DDEM:MACC'`  
                           switch on result summary in screen 2  
                           `CALC2:LIM:MACC:CFER:CURR:VAL 100 Hz`  
                           define a limit of [-100;100]  
                           `CALC2:LIM:MACC:CFER:CURR:STAT ON`  
                           switch limit check ON

**Mode:**                VSA

**Manual operation:** See "Check" on page 135

---

**CALCulate<n>:LIMit:MACCuracy:<ResultType>:<LimitType>[:RESUlt]?<LimitResult>**

This command queries whether the limit for the specified result type and limit type was violated.

**Suffix:**

<n>                      1..4  
                           window

<ResultType>            CFERror | EVM | FDERror | FERRor | MERRor | OOFFset |  
                           PERRor | RHO  
                           CFERror = Carrier Frequency Error  
                           EVM = Error Vector Magnitude  
                           FDERror = Frequency deviation error (FSK only)  
                           FERRor = Frequency error (FSK only)  
                           MERRor = Magnitude Error  
                           OOFFset = I/Q Offset  
                           PERRor = Phase Error  
                           RHO = Rho

<LimitType>             CURRent | MEAN | PEAK | PCURRent | PMEan | PPEak |  
                           RCURRent | RMEan | RPEak  
                           **For CFERror, OOFFset, RHO:**  
                           CURRent  
                           MEAN  
                           PEAK  
                           **For EVM, FDERror, FERRor, MERRor, PERRor:**  
                           PCURRent = Peak current value  
                           PMEan = Peak mean value  
                           PPEak = Peak peak value  
                           RCURRent = RMS current value  
                           RMEan = RMS mean value  
                           RPEak = RMS peak value



**Query parameters:**

<LimitResult> NONE | PASS | FAIL | MARGIN

**NONE**  
No limit check result available yet.

**PASS**  
All values have passed the limit check.

**FAIL**  
At least one value has exceeded the limit.

**MARGIN**  
currently not used

\*RST: NONE

**Example:**

```
CALC2:FEED 'XTIM:DDEM:MACC'
switch on result summary in screen 2
CALC2:LIM:MACC:CFER:CURR:VAL 100 Hz
define a limit of [-100;100]
CALC2:LIM:MACC:CFER:CURR:STAT ON
switch limit check ON
INIT:IMM;*WAI
do single measurement
CALC2:LIM:MACC:CFER:CURR:RESULT?
query result
```

**Usage:** Query only

**Mode:** VSA

---

**CALCulate<n>:LIMit:MACCuracy:CFERror:CURRent:VALue <LimitValue>**

**CALCulate<n>:LIMit:MACCuracy:CFERror:MEAN:VALue <LimitValue>**

**CALCulate<n>:LIMit:MACCuracy:CFERror:PEAK:VALue <LimitValue>**

This command defines the limit for the current, peak or mean center frequency error limit. Note that the limits for the current and the peak value are always kept identical.

**Suffix:**

<n> 1..4  
window

**Setting parameters:**

<LimitValue> numeric value  
the value x (x>0) defines the interval [-x; x]

Range: 0.0 to 1000000  
\*RST: 1000.0 (mean: 750.0)  
Default unit: Hz

**Example:**

```
CALC2:FEED 'XTIM:DDEM:MACC'
switch on result summary in screen 2
CALC2:LIM:MACC:CFER:PEAK:VAL 100 Hz
define a limit of [-100;100]
```

**Mode:** VSA

---

```

CALCulate<n>:LIMit:MACCuracy:EVM:PCURrent:VALue <LimitValue>
CALCulate<n>:LIMit:MACCuracy:EVM:PMEan:VALue <LimitValue>
CALCulate<n>:LIMit:MACCuracy:EVM:PPEak:VALue <LimitValue>
CALCulate<n>:LIMit:MACCuracy:EVM:RCURrent:VALue <LimitValue>
CALCulate<n>:LIMit:MACCuracy:EVM:RMEan:VALue <LimitValue>
CALCulate<n>:LIMit:MACCuracy:EVM:RPEak:VALue <LimitValue>

```

This command defines the value for the current, peak or mean EVM (peak or RMS) limit. Note that the limits for the current and the peak value are always kept identical.

**Suffix:**

```

<n>          1..4
              window

```

**Setting parameters:**

```

<LimitValue> numeric value
              Range:    0.0 to 100
              *RST:    1.5
              Default unit: %

```

**Example:**

```

CALC2:FEED 'XTIM:DDEM:MACC'
switch on result summary in screen 2
CALC2:LIM:MACC:EVM:RPE:VAL 2
define a limit of 2%

```

**Mode:** VSA

---

```

CALCulate<n>:LIMit:MACCuracy:FDERror:CURRent:VALue <LimitValue>
CALCulate<n>:LIMit:MACCuracy:FDERror:MEAN:VALue <LimitValue>
CALCulate<n>:LIMit:MACCuracy:FDERror:PEAK:VALue <LimitValue>

```

This command defines the lower limit for the current, peak or mean center frequency deviation error. Note that the limits for the current and the peak value are always kept identical.

This command is available for FSK modulation only.

**Suffix:**

```

<n>          1..4
              window

```

**Setting parameters:**

```

<LimitValue> numeric value
              Range:    0.0 to 1000000
              *RST:    1 kHz
              Default unit: Hz

```

**Example:**

```

CALC2:FEED 'XTIM:DDEM:MACC'
switch on result summary in screen 2
CALC2:LIM:MACC:FDER:PEAK:VAL 1050
define a limit of 1050 Hz

```

**Mode:** VSA

---

```

CALCulate<n>:LIMit:MACCuracy:FERRor:PCURrent:VALue <LimitValue>
CALCulate<n>:LIMit:MACCuracy:FERRor:PMEan:VALue <LimitValue>
CALCulate<n>:LIMit:MACCuracy:FERRor:PPEak:VALue <LimitValue>
CALCulate<n>:LIMit:MACCuracy:FERRor:RCURrent:VALue <LimitValue>
CALCulate<n>:LIMit:MACCuracy:FERRor:RMEan:VALue <LimitValue>
CALCulate<n>:LIMit:MACCuracy:FERRor:RPEak:VALue <LimitValue>

```

This command defines the value for the current, peak or mean frequency error (peak or RMS) limit. Note that the limits for the current and the peak value are always kept identical.

This command is available for FSK modulation only.

**Suffix:**

<n>                    1..4  
                         window

**Setting parameters:**

<LimitValue>        numeric value  
                         the value x (x>0) defines the interval [-x; x]  
                         Range:        0.0 to 100  
                         \*RST:        1.5 (mean: 1.0)  
                         Default unit: Hz

**Example:**

```

CALC2:FEED 'XTIM:DDEM:MACC'
switch on result summary in screen 2
CALC2:LIM:MACC:FERR:RPE:VAL 15
define a limit of [-15;15] Hz

```

**Mode:**                VSA

---

```

CALCulate<n>:LIMit:MACCuracy:MERRor:PCURrent:VALue <LimitValue>
CALCulate<n>:LIMit:MACCuracy:MERRor:PMEan:VALue <LimitValue>
CALCulate<n>:LIMit:MACCuracy:MERRor:PPEak:VALue <LimitValue>
CALCulate<n>:LIMit:MACCuracy:MERRor:RCURrent:VALue <LimitValue>
CALCulate<n>:LIMit:MACCuracy:MERRor:RMEan:VALue <LimitValue>
CALCulate<n>:LIMit:MACCuracy:MERRor:RPEak:VALue <LimitValue>

```

This command defines the value for the current, peak or mean magnitude error (peak or RMS) limit. Note that the limits for the current and the peak value are always kept identical.

**Suffix:**

<n>                    1..4  
                         window

**Setting parameters:**

<LimitValue>        numeric value  
                         the value x (x>0) defines the interval [-x; x]  
                         Range:        0.0 to 100  
                         \*RST:        1.5  
                         Default unit: %

**Example:**            `CALC2:FEED 'XTIM:DDEM:MACC'`  
                           switch on result summary in screen 2  
                           `CALC2:LIM:MACC:MERR:RPE:VAL 2.4%`  
                           define a limit of 2.4%

**Mode:**                VSA

**CALCulate<n>:LIMit:MACCuracy:OOFset:CURRent:VALue <LimitValue>**  
**CALCulate<n>:LIMit:MACCuracy:OOFset:MEAN:VALue <LimitValue>**  
**CALCulate<n>:LIMit:MACCuracy:OOFset:PEAK:VALue <LimitValue>**

This command defines the upper limit for the current, peak or mean I/Q offset. Note that the limits for the current and the peak value are always kept identical.

**Suffix:**

<n>                    1..4  
                           window

**Setting parameters:**

<LimitValue>        numeric value  
                           Range:        -200.0 to 0.0  
                           \*RST:        -40.0 (mean: -45.0)  
                           Default unit: dB

**Example:**            `CALC2:FEED 'XTIM:DDEM:MACC'`  
                           switch on result summary in screen 2  
                           `CALC2:LIM:MACC:OOF:PEAK:VAL -50dB`  
                           define a limit of -50 dB

**Mode:**                VSA

**CALCulate<n>:LIMit:MACCuracy:PERRor:PCURrent:VALue <LimitValue>**  
**CALCulate<n>:LIMit:MACCuracy:PERRor:PMEan:VALue <LimitValue>**  
**CALCulate<n>:LIMit:MACCuracy:PERRor:PPEak:VALue <LimitValue>**  
**CALCulate<n>:LIMit:MACCuracy:PERRor:RCURrent:VALue <LimitValue>**  
**CALCulate<n>:LIMit:MACCuracy:PERRor:RMEan:VALue <LimitValue>**  
**CALCulate<n>:LIMit:MACCuracy:PERRor:RPEak:VALue <LimitValue>**

This command defines the value for the current, peak or mean phase error (peak or RMS) limit. Note that the limits for the current and the peak value are always kept identical.

**Suffix:**

<n>                    1..4  
                           window

**Setting parameters:**

<LimitValue>        numeric value  
                           the value x (x>0) defines the interval [-x; x]  
                           Range:        0.0 to 360  
                           \*RST:        3.5 (RMS: 1.5)  
                           Default unit: deg

**Example:**            `CALC2:FEED 'XTIM:DDEM:MACC'`  
                           switch on result summary in screen 2  
                           `CALC2:LIM:MACC:PERR:RPE:VAL 1.9deg`  
                           define a limit of 1.9 deg

**Mode:**                VSA

---

**CALCulate<n>:LIMit:MACCuracy:RHO:CURRent:VALue <LimitValue>**  
**CALCulate<n>:LIMit:MACCuracy:RHO:MEAN:VALue <LimitValue>**  
**CALCulate<n>:LIMit:MACCuracy:RHO:PEAK:VALue <LimitValue>**

This command defines the lower limit for the current, peak or mean Rho limit. Note that the limits for the current and the peak value are always kept identical.

**Suffix:**

<n>                    1..4  
                           window

**Setting parameters:**

<LimitValue>        numeric value  
                           Range:        0.0 to 1.0  
                           \*RST:        0.999 (mean: 0.9995)  
                           Default unit: NONE

**Example:**            `CALC2:FEED 'XTIM:DDEM:MACC'`  
                           switch on result summary in screen 2  
                           `CALC2:LIM:MACC:RHO:PEAK:VAL 0.995`  
                           define a limit of 0.995

**Mode:**                VSA

### 4.3.3 CALCulate:MARKer subsystem

<code>CALCulate&lt;n&gt;:MARKer&lt;m&gt;:AOFF</code> .....	222
<code>CALCulate&lt;n&gt;:MARKer&lt;m&gt;:FUNctio:n:DDEMod:STATistic:ADRooP?</code> .....	222
<code>CALCulate&lt;n&gt;:MARKer&lt;m&gt;:FUNctio:n:DDEMod:STATistic:ALL?</code> .....	223
<code>CALCulate&lt;n&gt;:MARKer&lt;m&gt;:FUNctio:n:DDEMod:STATistic:CFERror?</code> .....	223
<code>CALCulate&lt;n&gt;:MARKer&lt;m&gt;:FUNctio:n:DDEMod:STATistic:EVM?</code> .....	224
<code>CALCulate&lt;n&gt;:MARKer&lt;m&gt;:FUNctio:n:DDEMod:STATistic:FDERror?</code> .....	225
<code>CALCulate&lt;n&gt;:MARKer&lt;m&gt;:FUNctio:n:DDEMod:STATistic:FSK:CFDRift?</code> .....	226
<code>CALCulate&lt;n&gt;:MARKer&lt;m&gt;:FUNctio:n:DDEMod:STATistic:FSK:DERror?</code> .....	226
<code>CALCulate&lt;n&gt;:MARKer&lt;m&gt;:FUNctio:n:DDEMod:STATistic:FSK:MDEViatio:n?</code> .....	227
<code>CALCulate&lt;n&gt;:MARKer&lt;m&gt;:FUNctio:n:DDEMod:STATistic:FSK:RDEViatio:n?</code> .....	228
<code>CALCulate&lt;n&gt;:MARKer&lt;m&gt;:FUNctio:n:DDEMod:STATistic:GIMBalance?</code> .....	229
<code>CALCulate&lt;n&gt;:MARKer&lt;m&gt;:FUNctio:n:DDEMod:STATistic:IQIMbalance?</code> .....	229
<code>CALCulate&lt;n&gt;:MARKer&lt;m&gt;:FUNctio:n:DDEMod:STATistic:MERRor?</code> .....	230
<code>CALCulate&lt;n&gt;:MARKer&lt;m&gt;:FUNctio:n:DDEMod:STATistic:MPower?</code> .....	230
<code>CALCulate&lt;n&gt;:MARKer&lt;m&gt;:FUNctio:n:DDEMod:STATistic:OOFFset?</code> .....	231
<code>CALCulate&lt;n&gt;:MARKer&lt;m&gt;:FUNctio:n:DDEMod:STATistic:PERror?</code> .....	232
<code>CALCulate&lt;n&gt;:MARKer&lt;m&gt;:FUNctio:n:DDEMod:STATistic:QERRor?</code> .....	232
<code>CALCulate&lt;n&gt;:MARKer&lt;m&gt;:FUNctio:n:DDEMod:STATistic:RHO?</code> .....	233

CALCulate<n>:MARKer<m>:FUNCTION:DDEMod:STATistic:SNR?	234
CALCulate<n>:MARKer<m>:LINK	234
CALCulate<n>:MARKer<m>:MAXimum:APEak	235
CALCulate<n>:MARKer<m>:MAXimum:LEFT	235
CALCulate<n>:MARKer<m>:MAXimum:NEXT	235
CALCulate<n>:MARKer<m>:MAXimum:RIGHT	236
CALCulate<n>:MARKer<m>:MAXimum[:PEAK]	236
CALCulate<n>:MARKer<m>:MINimum:LEFT	237
CALCulate<n>:MARKer<m>:MINimum:NEXT	237
CALCulate<n>:MARKer<m>:MINimum[:PEAK]	237
CALCulate<n>:MARKer<m>:MINimum:RIGHT	238
CALCulate<n>:MARKer<m>:SEARCH	238
CALCulate<n>:MARKer<m>[:STATE]	238
CALCulate<n>:MARKer<m>:TRACE	239
CALCulate<n>:MARKer<m>:X	239
CALCulate<n>:MARKer<m>:X:SLIMits[:STATE]	240
CALCulate<n>:MARKer<m>:X:SLIMits:LEFT	240
CALCulate<n>:MARKer<m>:X:SLIMits:RIGHT	241
CALCulate<n>:MARKer<m>:X:SLIMits:ZOOM	241
CALCulate<n>:MARKer<m>:Y?	241

---

#### CALCulate<n>:MARKer<m>:AOFF

This command all markers off, including delta markers and marker measurement functions.

**Suffix:**

<n>	Selects the measurement window.
<m>	depends on mode irrelevant

**Example:**

CALC:MARK:AOFF  
Switches off all markers.

**Usage:**

Event

**Manual operation:** See "All Marker Off" on page 130

---

#### CALCulate<n>:MARKer<m>:FUNCTION:DDEMod:STATistic:ADRoop? <type>

This command queries the results of the amplitude droop error measurement performed for digital demodulation. The output values are the same as those provided in the Modulation Accuracy table (see [Chapter 3.1.1.22, "Result Summary"](#), on page 89).

**Suffix:**

<n>	1..4 screen number
<m>	1..4 irrelevant

**Query parameters:**

<b>&lt;type&gt;</b>	<b>&lt;none&gt;</b> Amplitude droop in dB/symbol (for current sweep)
	<b>AVG</b> Amplitude droop in dB/symbol, evaluating the linear average value over several sweeps
	<b>RPE</b> Peak value for amplitude droop over several sweeps
	<b>SDEV</b> Standard deviation of amplitude droop
	<b>PCTL</b> 95 percentile value of amplitude droop
	*RST:       PEAK
<b>Usage:</b>	Query only
<b>Mode:</b>	VSA

**CALCulate<n>:MARKer<m>:FUNCTION:DDEMod:STATistic:ALL?**

This command queries all results of the result summary as shown on the screen.

**Suffix:**

<b>&lt;n&gt;</b>	1..4 screen number
<b>&lt;m&gt;</b>	irrelevant
<b>Usage:</b>	Query only
<b>Mode:</b>	VSA

**CALCulate<n>:MARKer<m>:FUNCTION:DDEMod:STATistic:CFERror? <type>**

This command queries the results of the carrier frequency error measurement performed for digital demodulation.

The output values are the same as those provided in the Modulation Accuracy table .

**Suffix:**

<b>&lt;n&gt;</b>	1..4 screen number
<b>&lt;m&gt;</b>	1..4 irrelevant

**Query parameters:**

<b>&lt;type&gt;</b>	<b>&lt;none&gt;</b> Carrier frequency error for current sweep
	<b>AVG</b> Average carrier frequency error (over several sweeps)
	<b>RPE</b> Peak carrier frequency error (over several sweeps)
	<b>SDEV</b> Standard deviation of frequency error
	<b>PCTL</b> 95 percentile value of frequency error
	*RST:      PEAK
<b>Usage:</b>	Query only
<b>Mode:</b>	VSA

**CALCulate<n>:MARKer<m>:FUNCtion:DDEMod:STATistic:EVM? <type>**

This command queries the results of the error vector magnitude measurement of digital demodulation. The output values are the same as those provided in the Modulation Accuracy table .

**Suffix:**

<b>&lt;n&gt;</b>	1..4 screen number
<b>&lt;m&gt;</b>	1..4 irrelevant



**Query parameters:**

<type>	<p><b>&lt;none&gt;</b> Average EVM value of current sweep</p> <p><b>AVG</b> RMS average EVM value (over several sweeps)</p> <p><b>RPE</b> Peak value of EVM (over several sweeps)</p> <p><b>SDEV</b> Standard deviation of EVM values over several sweeps</p> <p><b>PCTL</b> 95% percentile of RMS value (over several sweeps)</p> <p><b>PEAK</b> Maximum EVM over all symbols of current sweep</p> <p><b>PAVG</b> Average of maximum EVM values over several sweeps</p> <p><b>TPEA</b> Maximum EVM over all symbols over several sweeps</p> <p><b>PSD</b> Standard deviation of maximum EVM values over several sweeps</p> <p><b>PPCT</b> 95% percentile of maximum RMS values over several sweeps</p> <p>*RST:      PEAK</p>
<b>Usage:</b>	Query only
<b>Mode:</b>	VSA

**CALCulate<n>:MARKer<m>:FUNctIon:DDEMod:STATistic:FDERror? <type>**

This command queries the results of the FSK deviation error of FSK modulated signals.

**Suffix:**

<n>	1..4 screen number
<m>	1..4 irrelevant

**Query parameters:**

<b>&lt;type&gt;</b>	<b>&lt;none&gt;</b> Deviation error for current sweep.
	<b>AVG</b> Average FSK deviation error.
	<b>RPE</b> Peak FSK deviation error.
	<b>SDEV</b> Standard deviation of FSK deviation error.
	<b>PCTL</b> 95 percentile value of FSK deviation error.
	*RST:      PEAK
<b>Usage:</b>	Query only
<b>Mode:</b>	VSA

**CALCulate<n>:MARKer<m>:FUNCTION:DDEMod:STATistic:FSK:CFDRift? <type>**

This command queries the results of the carrier frequency drift for FSK modulated signals.

**Suffix:**

<b>&lt;n&gt;</b>	1..4 screen number
<b>&lt;m&gt;</b>	1..4 irrelevant

**Query parameters:**

<b>&lt;type&gt;</b>	<b>&lt;none&gt;</b> Carrier frequency drift for current sweep.
	<b>AVG</b> Average FSK carrier frequency drift.
	<b>RPE</b> Peak FSK carrier frequency drift.
	<b>SDEV</b> Standard deviation of FSK carrier frequency drift.
	<b>PCTL</b> 95 percentile value of FSK carrier frequency drift.
	*RST:      PEAK
<b>Usage:</b>	Query only
<b>Mode:</b>	VSA

**CALCulate<n>:MARKer<m>:FUNCTION:DDEMod:STATistic:FSK:DERRor? <type>**

This command queries the results of the frequency error of FSK modulated signals.

**Suffix:**

<n> 1..4  
screen number

<m> 1..4  
irrelevant

**Query parameters:**

<type> **<none>**  
Frequency error for current sweep.

**AVG**  
Average frequency error (over several sweeps).

**RPE**  
Frequency error (over several sweeps).

**SDEV**  
Standard deviation of frequency error.

**PCTL**  
95 percentile value of frequency error.

**PEAK**  
Maximum frequency error over all symbols of current sweep.

**PAVG**  
Average of maximum frequency error values over several sweeps.

**TPE**  
Maximum frequency error over all symbols over several sweeps.

**PSD**  
Standard deviation of maximum frequency error values over several sweeps.

**PPCT**  
95% percentile of maximum RMS values over several sweeps.

\*RST: PEAK

**Usage:** Query only

**Mode:** VSA

---

**CALCulate<n>:MARKer<m>:FUNCTion:DDEMod:STATistic:FSK:MDEVIation?**  
<type>

This command queries the results of the measurement deviation of FSK modulated signals.

**Suffix:**

<n> 1..4  
screen number

<m> 1..4  
irrelevant

**Query parameters:**

<type>	<b>&lt;none&gt;</b> Measurement deviation for current sweep.
	<b>AVG</b> Average FSK measurement deviation.
	<b>RPE</b> Peak FSK measurement deviation.
	<b>SDEV</b> Standard deviation of FSK measurement deviation.
	<b>PCTL</b> 95 percentile value of FSK measurement deviation.
	*RST:      PEAK

**Usage:** Query only

**Mode:** VSA

**CALCulate<n>:MARKer<m>:FUNction:DDEMod:STATistic:FSK:RDEVIation?**  
<type>

This command queries the results of the reference deviation of FSK modulated signals.

**Suffix:**

<n>	1..4 screen number
<m>	1..4 irrelevant

**Query parameters:**

<type>	<b>&lt;none&gt;</b> Measurement deviation for current sweep.
	<b>AVG</b> Average FSK measurement deviation.
	<b>RPE</b> Peak FSK measurement deviation.
	<b>SDEV</b> Standard deviation of FSK measurement deviation.
	<b>PCTL</b> 95 percentile value of FSK measurement deviation.
	*RST:      PEAK

**Usage:** Query only

**Mode:** VSA

---

**CALCulate<n>:MARKer<m>:FUNction:DDEMod:STATistic:GIMBalance? <type>**

This command queries the results of the Gain Imbalance error measurement of digital demodulation. The output values are the same as those provided in the Modulation Accuracy table .

**Suffix:**

<n> 1..4  
screen number

<m> 1..4  
irrelevant

**Query parameters:**

<type> **<none>**  
Gain imbalance error for current sweep

**AVG**  
Average gain imbalance error (over several sweeps)

**RPE**  
Peak gain imbalance error (over several sweeps)

**SDEV**  
Standard deviation of gain imbalance error

**PCTL**  
95 percentile value of gain imbalance error

\*RST: PEAK

**Usage:** Query only

**Mode:** VSA

---

**CALCulate<n>:MARKer<m>:FUNction:DDEMod:STATistic:IQIMBalance? <type>**

This command queries the results of the I/Q imbalance error measurement of digital demodulation.

**Suffix:**

<n> 1..4  
screen number

<m> 1..4  
irrelevant

**Query parameters:**

<type>                    <none>  
 I/Q imbalance error (for current sweep)

**AVG**  
 Average I/Q imbalance error (over several sweeps)

**RPE**  
 Peak I/Q imbalance error (over several sweeps)

**SDEV**  
 Standard deviation of I/Q imbalance error

**PCTL**  
 95 percentile value of I/Q imbalance error

\*RST:            PEAK

**Usage:**                    Query only

**Mode:**                    VSA

**CALCulate<n>:MARKer<m>:FUNCTION:DDEMod:STATistic:MERRor? <type>**

This command queries the results of the magnitude error measurement of digital demodulation.

**Suffix:**

<n>                    1..4  
 screen number

<m>                    1..4  
 irrelevant

**Query parameters:**

<type>                    <none>  
 magnitude error for current sweep

**AVG**  
 Average magnitude error (over several sweeps)

**RPE**  
 Peak magnitude error (over several sweeps)

**SDEV**  
 Standard deviation of magnitude error

**PCTL**  
 95 percentile value of magnitude error

\*RST:            PEAK

**Usage:**                    Query only

**Mode:**                    VSA

**CALCulate<n>:MARKer<m>:FUNCTION:DDEMod:STATistic:MPOWER? <type>**

This command queries the results of the power measurement of digital demodulation.

**Suffix:**

<n> 1..4  
screen number

<m> 1..4  
irrelevant

**Query parameters:**

<type> **<none>**  
power measurement (for current sweep)

**AVG**  
Average of power measurement (over several sweeps)

**RPE**  
Peak of power measurement (over several sweeps)

**SDEV**  
Standard deviation of power measurement

**PCTL**  
95 percentile value of power measurement

\*RST: PEAK

**Usage:** Query only

**Mode:** VSA

**CALCulate<n>:MARKer<m>:FUNCTION:DDEMod:STATistic:OOffset? <type>**

This command queries the results of the I/Q offset measurement performed for digital demodulation.

**Suffix:**

<n> 1..4  
screen number

<m> 1..4  
irrelevant

**Query parameters:**

<type> **<none>**  
Origin offset error (for current sweep)

**AVG**  
Average origin offset error (over several sweeps)

**RPE**  
Peak origin offset error (over several sweeps)

**SDEV**  
Standard deviation of origin offset error

**PCTL**  
95 percentile value of origin offset error

\*RST: PEAK

**Usage:** Query only

**Mode:** VSA

---

**CALCulate<n>:MARKer<m>:FUNCTION:DDEMod:STATistic:PERRor? <type>**

This command queries the results of the phase error measurement performed for digital demodulation.

**Suffix:**

<n> 1..4  
screen number

<m> 1..4  
irrelevant

**Query parameters:**

<type> **<none>**  
Phase error in degree

**AVG**  
RMS phase error value (over several sweeps)

**RPE**  
Peak value of phase error (over several sweeps)

**SDEV**  
Standard deviation of phase error values over several sweeps

**PCTL**  
95% percentile of RMS value (over several sweeps)

**PEAK**  
Maximum phase error of current sweep

**PAVG**  
Average of maximum phase error values over several sweeps

**TPE**  
Maximum phase error over several sweeps

**PSD**  
Standard deviation of maximum phase error values over several sweeps

**PPCT**  
95% percentile of maximum RMS values over several sweeps

\*RST: PEAK

**Usage:** Query only

**Mode:** VSA

---

**CALCulate<n>:MARKer<m>:FUNCTION:DDEMod:STATistic:QERRor? <type>**

This command queries the results of the Quadratur error measurement performed for digital demodulation.



**Suffix:**

<n>	1..4 screen number
<m>	1..4 irrelevant

**Query parameters:**

<type>	<b>&lt;none&gt;</b> quadrature error (for current sweep)
	<b>AVG</b> Average quadrature error (over several sweeps)
	<b>RPE</b> Peak quadrature error (over several sweeps)
	<b>SDEV</b> Standard deviation of quadrature error
	<b>PCTL</b> 95 percentile value of quadrature error
	*RST:      PEAK

**Usage:** Query only

**Mode:** VSA

**CALCulate<n>:MARKer<m>:FUNCTION:DDEMod:STATistic:RHO? <type>**

This command queries the results of the Rho factor measurement performed for digital demodulation.

**Suffix:**

<n>	1..4 screen number
<m>	1..4 irrelevant

**Query parameters:**

<type>	<b>&lt;none&gt;</b> Rho factor (for current sweep)
	<b>AVG</b> Average rho factor (over several sweeps)
	<b>RPE</b> Peak rho factor (over several sweeps)
	<b>SDEV</b> Standard deviation of rho factor
	<b>PCTL</b> 95 percentile value of rho factor
	*RST:      PEAK

**Usage:** Query only

**Mode:** VSA

---

**CALCulate<n>:MARKer<m>:FUNCTION:DDEMod:STATistic:SNR? <type>**

This command queries the results of the SNR error measurement performed for digital demodulation.

**Suffix:**

<n> 1..4  
screen number

<m> 1..4  
irrelevant

**Query parameters:**

<type> **<none>**  
Average SNR value of current sweep

**AVG**  
RMS Average SNR value (over several sweeps)

**RPE**  
Peak value of SNR (over several sweeps)

**SDEV**  
Standard deviation of SNR values over several sweeps

**PCTL**  
95% percentile of RMS value (over several sweeps)

**PEAK**  
Maximum SNR over all symbols of current sweep

**PAVG**  
Average of maximum SNR values over several sweeps

**TPE**  
Maximum SNR over all symbols over several sweeps

**PSD**  
Standard deviation of maximum SNR values over several sweeps

**PPCT**  
95% percentile of maximum RMS values over several sweeps

\*RST: PEAK

**Usage:** Query only

**Mode:** VSA

---

**CALCulate<n>:MARKer<m>:LINK <MarkerCoupling>**

With this command markers between several screens can be coupled, i.e. use the same stimulus. All screens can be linked with an X-axis scaled in symbols or time, except those showing the capture buffer. If several capture buffer measurements are visible, their markers are coupled, too.

**Suffix:**

&lt;n&gt; 1..4

&lt;m&gt; 1..4

**Setting parameters:**

&lt;MarkerCoupling&gt; ON | OFF

\*RST: OFF

**Mode:** VSA**Manual operation:** See "[Couple Screens \(On/Off\)](#)" on page 129**CALCulate<n>:MARKer<m>:MAXimum:APEak**

This command positions the active marker or deltamarker on the largest absolute peak value (maximum or minimum) of the selected trace.

**Suffix:**

&lt;n&gt; 1..4

&lt;m&gt; 1..4

**Usage:** Event**Mode:** VSA**Manual operation:** See "[Max |Peak|](#)" on page 132**CALCulate<n>:MARKer<m>:MAXimum:LEFT**

This command positions a marker to the next smaller trace maximum on the left of the current position (i.e. in descending X values).

If no next smaller maximum value is found on the trace (level spacing to adjacent values < peak excursion), an execution error (error code: -200) is produced.

**Suffix:**

&lt;n&gt; Selects the measurement window.

&lt;m&gt; Selects the marker.

**Example:**

CALC:MARK2:MAX:LEFT

Positions marker 2 to the next lower maximum value to the left of the current value.

**Usage:** Event**Manual operation:** See "[Search Direction](#)" on page 131**CALCulate<n>:MARKer<m>:MAXimum:NEXT**

This command positions the marker to the next smaller trace maximum.

If no next smaller maximum value is found on the trace (level spacing to adjacent values < peak excursion), an execution error (error code: -200) is produced.

**Suffix:**  
 <n> Selects the measurement window.  
 <m> Selects the marker.  
**Example:** `CALC:MARK2:MAX:NEXT`  
 Positions marker 2 to the next lower maximum value.  
**Usage:** Event  
**Manual operation:** See "[Next Peak](#)" on page 131

#### **CALCulate<n>:MARKer<m>:MAXimum:RIGHT**

This command positions a marker to the next smaller trace maximum on the right of the current value (i.e. in ascending X values).

If no next smaller maximum value is found on the trace (level spacing to adjacent values < peak excursion), an execution error (error code: -200) is produced.

**Suffix:**  
 <n> Selects the measurement window.  
 <m> Selects the marker.  
**Example:** `CALC:MARK2:MAX:RIGHT`  
 Positions marker 2 to the next lower maximum value to the right of the current value.  
**Usage:** Event  
**Manual operation:** See "[Search Direction](#)" on page 131

#### **CALCulate<n>:MARKer<m>:MAXimum[:PEAK]**

This command positions the marker on the current trace maximum.

The corresponding marker is activated first or switched to the marker mode.

If no maximum value is found on the trace (level spacing to adjacent values < peak excursion), an execution error (error code: -200) is produced.

**Suffix:**  
 <n> Selects the measurement window.  
 <m> depends on mode  
 Selects the marker.  
**Example:** `CALC:MARK2:MAX`  
 Positions marker 2 to the maximum value of the trace.  
**Usage:** Event  
**Manual operation:** See "[Search Direction](#)" on page 131  
 See "[Peak](#)" on page 131

**CALCulate<n>:MARKer<m>:MINimum:LEFT**

This command positions a marker to the next higher trace minimum on the left of the current value (i.e. in descending X direction).

If no next higher minimum value is found on the trace (level spacing to adjacent values < peak excursion), an execution error (error code: -200) is produced.

**Suffix:**

<n> Selects the measurement window.

<m> Selects the marker.

**Example:**

`CALC:MARK2:MIN`

Positions marker 2 to the minimum value of the trace.

`CALC:MARK2:MIN:LEFT`

Positions marker 2 to the next higher minimum value to the left of the current value.

**Usage:** Event

**CALCulate<n>:MARKer<m>:MINimum:NEXT**

This command positions a marker to the next higher trace minimum.

If no next higher minimum value is found on the trace (level spacing to adjacent values < peak excursion), an execution error (error code: -200) is produced.

**Suffix:**

<n> Selects the measurement window.

<m> Selects the marker.

**Example:**

`CALC:MARK2:MIN`

Positions marker 2 to the minimum value of the trace.

`CALC:MARK2:MIN:NEXT`

Positions marker 2 to the next higher maximum value.

**Usage:** Event

**Manual operation:** See "[Next Min](#)" on page 132

**CALCulate<n>:MARKer<m>:MINimum[:PEAK]**

This command positions the marker on the current trace minimum.

The corresponding marker is activated first or switched to marker mode, if necessary.

If no minimum value is found on the trace (level spacing to adjacent values < peak excursion), an execution error (error code: -200) is produced.

**Suffix:**

<n> Selects the measurement window.

<m> depends on mode  
Selects the marker.

**Example:** `CALC:MARK2:MIN`  
Positions marker 2 to the minimum value of the trace.

**Usage:** Event

**Manual operation:** See "[Min](#)" on page 132

#### **CALCulate<n>:MARKer<m>:MINimum:RIGHT**

This command positions a marker to the next higher trace minimum on the right of the current value (i.e. in ascending X direction).

If no next higher minimum value is found on the trace (level spacing to adjacent values < peak excursion), an execution error (error code: -200) is produced.

**Suffix:**

<n> Selects the measurement window.

<m> Selects the marker.

**Example:** `CALC:MARK2:MIN`  
Positions marker 2 to the minimum value of the trace.  
`CALC:MARK2:MIN:RIGHT`  
Positions marker 2 to the next higher minimum value to the right of the current value.

**Usage:** Event

#### **CALCulate<n>:MARKer<m>:SEARch <MarkReallmag>**

This command specifies whether the marker search works on the real or the imag trace.

**Suffix:**

<n> 1..4

<m> 1..4  
irrelevant

**Setting parameters:**

<MarkReallmag> REAL | IMAG  
\*RST: REAL

**Example:** `CALC4:MARK:SEAR IMAG`

**Mode:** VSA

**Manual operation:** See "[Marker Real / Marker Imag](#)" on page 131

#### **CALCulate<n>:MARKer<m>[:STATe] <State>**

This command turns markers on and off.

If the corresponding marker number is currently active as a deltamarker, it is turned into a normal marker.

**Suffix:**

<n> Selects the measurement window.  
 <m> depends on mode  
 Selects the marker.

**Parameters:**

<State> ON | OFF  
 \*RST: OFF

**Example:**

CALC:MARK3 ON  
 Switches on marker 3 or switches to marker mode.

**Manual operation:** See "[Marker 1/2/3/4](#)" on page 128  
 See "[Marker Norm/Delta](#)" on page 128  
 See "[Select 1/2/3/4/Δ](#)" on page 130  
 See "[Marker](#)" on page 130

**CALCulate<n>:MARKer<m>:TRACe <Trace>**

This command selects the trace a marker is positioned on.  
 The corresponding trace must have a trace mode other than "Blank".  
 If necessary, the corresponding marker is switched on prior to the assignment.

**Suffix:**

<n> Selects the measurement window.  
 <m> depends on mode  
 Selects the marker.

**Parameters:**

<Trace> 1 ... 6  
 Trace number the marker is positioned on.

**Example:**

CALC:MARK3:TRAC 2  
 Assigns marker 3 to trace 2.

**Manual operation:** See "[Marker to Trace](#)" on page 130  
 See "[Move Marker to Trace](#)" on page 131

**CALCulate<n>:MARKer<m>:X <Position>**

This command positions a marker on a particular coordinate on the x-axis.

**Suffix:**

<n> Selects the measurement window.  
 <m> Selects the marker.

**Parameters:**

<Position> Numeric value that defines the marker position on the x-axis. The unit is either Hz (frequency domain) or s (time domain) or dB (statistics).  
 Range: The range depends on the current x-axis range.

**Example:**

CALC:MARK2:X 1.7MHz  
 Positions marker 2 to frequency 1.7 MHz.

**Manual operation:**

See "Marker 1/2/3/4" on page 128  
 See "Select 1/2/3/4/Δ" on page 130

**CALCulate<n>:MARKer<m>:X:SLIMits[:STATe] <State>**

This command turns marker search limits on and off.

If the power measurement in zero span is active, this command limits the evaluation range on the trace.

**Suffix:**

<n> Selects the measurement window.  
 <m> marker

**Parameters:**

<State> ON | OFF  
 \*RST: OFF

**Example:**

CALC:MARK:X:SLIM ON  
 Switches on search limitation.

**CALCulate<n>:MARKer<m>:X:SLIMits:LEFT <Limit>**

This command sets the left limit of the marker search range.

If the power measurement in zero span is active, this command limits the evaluation range to the trace.

**Note:** The function is only available if the search limit for marker and delta marker is switched on (see [CALCulate<n>:MARKer<m>:X:SLIMits\[:STATe\]](#)).

**Suffix:**

<n> Selects the measurement window.  
 <m> irrelevant

**Parameters:**

<Limit> Range: -1e9 to 1e9  
 \*RST: 0.0

**Example:**

CALC:MARK:X:SLIM ON  
 Switches the search limit function on.  
 CALC:MARK:X:SLIM:LEFT 10MHz  
 Sets the left limit of the search range to 10 MHz.



**Manual operation:** See "Search Limits" on page 131

---

#### CALCulate<n>:MARKer<m>:X:SLIMits:RIGHT <Limit>

This command sets the right limit of the marker search range.

If the power measurement in zero span is active, this command limits the evaluation range to the trace.

**Note:** The function is only available if the search limit for marker and delta marker is switched on ( `CALCulate<n>:MARKer<m>:X:SLIMits[:STATe]` ).

##### Suffix:

<n>                      Selects the measurement window.

<m>                      irrelevant

##### Parameters:

<Limit>                Range:        -1e9 to 1e9  
                              \*RST:        800.0

##### Example:

```
CALC:MARK:X:SLIM ON
Switches the search limit function on.
CALC:MARK:X:SLIM:RIGH 20MHz
Sets the right limit of the search range to 20 MHz.
```

**Manual operation:** See "Search Limits" on page 131

---

#### CALCulate<n>:MARKer<m>:X:SLIMits:ZOOM <State>

This command sets the limits of the marker search range to the zoom area.

**Note:** The function is only available if the search limit for marker and delta marker is switched on (see `CALCulate<n>:MARKer<m>:X:SLIMits[:STATe]` ).

##### Suffix:

<n>                      irrelevant

<m>                      irrelevant

##### Parameters:

<State>                ON | OFF  
                              \*RST:        OFF

##### Example:

```
CALC:MARK:X:SLIM:ZOOM ON
Switches the search limit function on.
CALC:MARK:X:SLIM:RIGH 20MHz
Sets the right limit of the search range to 20 MHz.
```

**Manual operation:** See "Search Limits" on page 131

---

#### CALCulate<n>:MARKer<m>:Y?

This command queries the measured value of a marker.

The corresponding marker is activated before or switched to marker mode, if necessary.

To get a valid result, you have to perform a complete measurement with synchronization to the end of the measurement before reading out the result. This is only possible for single sweeps.

**Suffix:**

<n> Selects the measurement window.

<m> Selects the marker.

**Return values:**

<Result> The measured value of the selected marker is returned.

**Example:**

```
INIT:CONT OFF
```

Switches to single sweep mode.

```
CALC:MARK2 ON
```

Switches marker 2.

```
INIT;*WAI
```

Starts a sweep and waits for the end.

```
CALC:MARK2:Y?
```

Outputs the measured value of marker 2.

**Usage:** Query only

**Manual operation:** See "[Marker 1/2/3/4](#)" on page 128

See "[Select 1/2/3/4/Δ](#)" on page 130

#### 4.3.4 Other CALCulate commands

CALCulate<n>:BERate.....	243
CALCulate<n>:DDEM:SPECTrum[:STATe].....	243
CALCulate<n>:DLABs:STATe.....	244
CALCulate<n>:DLABs[:VALue].....	244
CALCulate<n>:DLRel:STATe.....	245
CALCulate<n>:DLRel[:VALue].....	245
CALCulate<n>:ELIN<startstop>:STATe.....	246
CALCulate<n>:ELIN<startstop>[:VALue].....	246
CALCulate<n>:FEED.....	247
CALCulate<n>:FORMat.....	247
CALCulate<n>:FSK:DEViation:COMPensation.....	249
CALCulate<n>:FSK:DEViation:REFerence:RELative.....	249
CALCulate<n>:FSK:DEViation:REFerence[:VALue].....	249
CALCulate<n>:STATistics:CCDF[:STATe].....	250
CALCulate<n>:STATistics:MODE.....	250
CALCulate<n>:STATistics:PRESet.....	251
CALCulate<n>:STATistics:SCALE:AUTO.....	251
CALCulate<n>:STATistics:SCALE:X:BCOunt.....	251
CALCulate<n>:STATistics:SCALE:Y:LOWer.....	252
CALCulate<n>:STATistics:SCALE:Y:UNIT.....	252
CALCulate<n>:STATistics:SCALE:Y:UPPer.....	252

CALCulate<n>:TLABs:STATe..... 252  
 CALCulate<n>:TLABs:VALue]..... 253  
 CALCulate<n>:TLRel:STATe..... 253  
 CALCulate<n>:TLRel:VALue]..... 254  
 CALCulate<n>:TRACe<t>:ADJust:ALIGnment:OFFSet..... 254  
 CALCulate<n>:TRACe<t>:ADJust:ALIGnment[:DEFault]..... 255  
 CALCulate<n>:TRACe<t>:ADJust[:VALue]..... 255  
 CALCulate<n>:TRACe<t>[:VALue]..... 256  
 CALCulate<n>:UNIT:ANGLE..... 256  
 CALCulate<n>:X:UNIT:TIME..... 257

**CALCulate<n>:BERate <Format>**

Queries the Bit Error Rate results. The available results are described in [Chapter 3.1.1.23, "Bit Error Rate \(BER\)"](#), on page 95.

**Suffix:**

<n> 1..4

**Return values:**

<Format> Specifies a particular BER result to be queried. if no parameter is specified, the current bit error rate is returned. The parameters for these results are listed in [Table 4-1](#).

**Mode:** VSA

*Table 4-1: Parameters for BER result values*

Result	Current	Min	Max	Acc
Bit Error Rate	CURRent	MIN	MAX	TOTal
Total # of Errors	TECurent	TEMIN	TEMAX	TETotal
Total # of Bits	TCURrent	TMIN	TMAX	TTOTal

**CALCulate<n>:DDEM:SPECTrum[:STATe] <AddEvaluation>**

This command switches the result display to spectrum mode. Spectral evaluation is available for the following result parameters:

- MAGNitude
- PHASe/UPHase
- FREQUency
- Real/Imag (RIMAG)

The result parameters are defined using the CALC:FORM command (see [CALCulate<n>:FORMat](#) on page 247).

**Suffix:**

<n> 1..4

**Setting parameters:**

<AddEvaluation> ON | OFF  
 \*RST: Off

**Example:**            `CALC:FEED 'XTIM:DDEM:MEAS'`  
 Selects the measurement signal for display.  
`CALC:FORM PHAS`  
 Selects the phase as the result parameter.  
`CALC:DDEM:SPEC:STAT ON`  
 Selects spectral display of the phase.

**Mode:**                VSA

**Manual operation:** See ["Result Type Transformation"](#) on page 178

#### **CALCulate<n>:DLABs:STATe <State>**

Displays an absolute horizontal line in the specified window. This command is only available for eye diagrams.

##### **Parameters:**

<State>                ON | OFF  
 \*RST:                OFF

**Example:**            Display eye diagram in window 2.  
`LAY:ADD? '1',BEL,MEAS`  
`CALC2:FORM QEYE`  
 Display absolute horizontal line.  
`CALC2:DLAB:STAT ON`  
 Query y-value of absolute horizontal line.  
`CALC2:DLAB:VAL?`

**Manual operation:** See ["Horizontal Line"](#) on page 133

#### **CALCulate<n>:DLABs[:VALue] <HorAbsPos>**

Defines value of horizontal absolute line

##### **Setting parameters:**

<HorAbsPos>        numeric value  
 Y-value of the absolute horizontal line.  
 Range:            -1e9 to 1e9  
 \*RST:            0  
 Default unit: NONE

**Example:**            Display eye diagram in window 2.  
`LAY:ADD? '1',BEL,MEAS`  
`CALC2:FORM QEYE`  
 Display absolute horizontal line.  
`CALC2:DLAB:STAT ON`  
 Query y-value of absolute horizontal line.  
`CALC2:DLAB:VAL?`

**Manual operation:** See ["Horizontal Line"](#) on page 133

**CALCulate<n>:DLRel:STATe <State>**

Displays a relative horizontal line in the specified window. This command is only available for eye diagrams, and only if an absolute horizontal line is already available in the same diagram (see [CALCulate<n>:DLABs:STATe](#) on page 244).

**Parameters:**

<State> ON | OFF  
\*RST: OFF

**Example:**

Display eye diagram in window 2.  
LAY:ADD? '1',BEL,MEAS  
CALC2:FORM QEYE  
Display absolute horizontal line.  
CALC2:DLAB:STAT ON  
Display relative horizontal line.  
CALC2:DLR:STAT:ON  
Query y-value of relative horizontal line.  
CALC2:DLR:VAL?

**Manual operation:** See "[Horizontal Line](#)" on page 133

**CALCulate<n>:DLRel[:VALue] <LineRelPosRel>**

Defines or queries the y-value of the relative horizontal line in the specified window. This command is only available for eye diagrams, and only if an absolute horizontal line and a relative horizontal line are already available in the same diagram (see [CALCulate<n>:DLABs:STATe](#) on page 244 and [CALCulate<n>:DLRel:STATe](#) on page 245).

**Setting parameters:**

<LineRelPosRel> numeric value  
Relative distance of the second horizontal line to the first (absolute) horizontal line.  
Range: -1e9 to 1e9  
\*RST: 0  
Default unit: NONE

**Example:**

Display eye diagram in window 2.  
LAY:ADD? '1',BEL,MEAS  
CALC2:FORM QEYE  
Display absolute horizontal line.  
CALC2:DLAB:STAT ON  
Display relative horizontal line.  
CALC2:DLR:STAT:ON  
Query y-value of relative horizontal line.  
CALC2:DLR:VAL?

**Manual operation:** See "[Horizontal Line](#)" on page 133

**CALCulate<n>:ELIN<startstop>:STATe <Auto>**

This command restricts the evaluation range. The evaluation range is considered for the following display types:

- eye diagrams
- constellation diagrams
- modulation accuracy
- statistic displays
- spectrum displays

**Suffix:**

<n>	1..4
<startstop>	1..2 Irrelevant.

**Setting parameters:**

<Auto> ON | OFF

**ON**

The evaluation range extends from the start value defined by CALC:ELIN1:VAL to the stop value defined by CALC:ELIN2:VAL (see [CALCulate<n>:ELIN<startstop>\[:VALue\]](#) on page 246).

**OFF**

The complete result area is evaluated.

\*RST: OFF

**Mode:** VSA

**Manual operation:** See ["Entire Result Range"](#) on page 168

**CALCulate<n>:ELIN<startstop>[:VALue] <LeftDisp>**

Defines the start and stop values for the evaluation range (see [CALCulate<n>:ELIN<startstop>:STATe](#) on page 246).

**Suffix:**

<n>	1..4
<startstop>	1..2 1: start value, 2: stop value

**Setting parameters:**

<LeftDisp> numeric value  
 Range: 0 to 1000000  
 \*RST: 0  
 Default unit: SYM

**Mode:** VSA

**Manual operation:** See ["Start"](#) on page 168  
 See ["Stop"](#) on page 168

**CALCulate<n>:FEED <Feed>**

Selects the signal source to be displayed.

**Suffix:**

<n> 1..4

**Setting parameters:**

<Feed> 'XTIM:DDEM:MEAS' | 'XTIM:DDEM:REF' |  
'XTIM:DDEM:ERR:MPH' | 'XTIM:DDEM:ERR:VECT' |  
'XTIM:DDEM:MACC' | 'XTIM:DDEM:SYMB' | 'TCAP'

**'XTIM:DDEM:MEAS'**

Measured signal

**'XTIM:DDEM:REF'**

Reference signal

**'XTIM:DDEM:ERR:VECT'**

Error vector

**'XTIM:DDEM:ERR:MPH'**

Modulation errors

**'XTIM:DDEM:MACC'**

Modulation accuracy

**'XTIM:DDEM:SYMB'**

Symbol table

**'TCAP'**

Capture Buffer

**Example:**

Switch to EVM:

```
CALC:FEED 'XTIM:DDEM:ERR:VECT'
```

```
CALC:FORM MAGN
```

Switch to Meas Signal, Frequency Relative

```
CALC:FEED 'XTIM:DDEM:MEAS'
```

```
CALC:FORM FREQ
```

```
DISP:WIND1:TRAC1:Y:SCAL:MODE REL
```

**Mode:**

VSA

**Manual operation:** See "Evaluation" on page 123

See "Source" on page 177

**CALCulate<n>:FORMat <Format>**

This command defines the result type of the traces. Which parameters are available depends on the setting for CALC:FEED (see CALCulate<n>:FEED on page 247).

**Table 4-2: Available result types depending on source type**

Source Type	Result Type	Parameter
Capture Buffer	Magnitude Absolute	MAGNitude
	Real/Imag (I/Q)	RIMag
	Frequency Absolute	FREQuency

Source Type	Result Type	Parameter
	Vector I/Q	COMP
Meas & Ref Signal	Magnitude Absolute	MAGNitude
	Magnitude Relative	MAGNitude
	Phase Wrap	PHASe
	Phase Unwrap	UPHase
	Frequency Absolute	FREQuency
	Frequency Relative	FREQuency
	Real/Imag (I/Q)	RIMag
	Eye Diagram Real (I)	IEYE
	Eye Diagram Imag (Q)	QEYE
	Eye Diagram Frequency	FEYE
	Constellation I/Q	CONS
	Constellation I/Q (Rotated)	RCON
	Vector I/Q	COMP
	Constellation Frequency	CONF
	Vector Frequency	COVF
Symbols	Binary	BIN
	Octal	OCT
	Decimal	DEC
	Hexadecimal	HEX
Error Vector	EVM	MAGNitude
	Real/Imag (I/Q)	RIMag
	Vector I/Q	COMP
Modulation Errors	Magnitude Error	MAGNitude
	Phase Error	PHASe
	Frequency Error Absolute	FREQuency
	Frequency Error Relative	FREQuency
Modulation Accuracy	Bit Error Rate	BERate

Whether the result type shows absolute or relative values is defined using the `DISP:WIND:TRAC:Y:MODE` command (see `DISPlay[:WINDow<n>]:TRACe<t>:Y[:SCALE]:MODE` on page 263).

**Suffix:**

<n> 1..4



**Setting parameters:**

<Format>           MAGNitude | PHASe | UPHase | RIMag | FREQuency | COMP |  
 CONS | IEYE | QEYE | FEYE | CONF | COVF | IQCorr |  
 RCONstellation | RSUMmary | BERate | NONE

**Example:**

CALC:FEED 'XTIM:DDEM:MEAS'  
 Selects the measurement signal  
 CALC:FORM PHAS  
 Selects the phase measurement  
 CALC:DDEM:SPEC:STAT ON  
 Selects the spectral evaluation

**Mode:**           VSA

**Manual operation:** See "[Result Type](#)" on page 177

**CALCulate<n>:FSK:DEVIation:COMPensation <RefDevCompensation>**

This command selects the method for calculating the frequency error for FSK modulation.

**Suffix:**

<n>                   1..4

**Setting parameters:**

<RefDevCompensation> ON | OFF  
 \*RST:           ON

**Mode:**           VSA

**CALCulate<n>:FSK:DEVIation:REFerence:RELative <FSKRefDev>**

This command sets the relative reference value of the frequency deviation for FSK modulation. The reference is in relation to the symbol rate.

**Suffix:**

<n>                   1..4

**Setting parameters:**

<FSKRefDev>       numeric value  
 Range:           0.1 to 15  
 \*RST:           1  
 Default unit: NONE

**Mode:**           VSA

**Manual operation:** See "[FSK Ref Deviation](#)" on page 145

**CALCulate<n>:FSK:DEVIation:REFerence[:VALue] <FSKRefDevAbsResult>**

This command sets the absolute reference value of the frequency deviation for FSK modulation.

**Suffix:**

&lt;n&gt; 1..4

**Setting parameters:**

&lt;FSKRefDevAbsResult&gt; numeric value

Range: The range depends on the symbol rate and has to be between 0.1 to 15 times the symbol rate.

\*RST: 100e3

Default unit: Hz

**Mode:** VSA**Manual operation:** See "[FSK Ref Deviation](#)" on page 145**CALCulate<n>:STATistics:CCDF[:STATe] <AddEvaluation>**

This command switches the calculation of the statistical distribution of magnitude, phase or frequency values on or off.

**Suffix:**

&lt;n&gt; 1..4

**Setting parameters:**

&lt;AddEvaluation&gt; ON | OFF

\*RST: OFF

**Example:**

CALC:STAT:CCDF ON

Switches the statistic measurements on.

**Mode:** VSA**Manual operation:** See "[Result Type Transformation](#)" on page 178**CALCulate<n>:STATistics:MODE <StatisticMode>**

This command defines whether only the symbol points or all points are considered for the statistical calculations.

**Suffix:**

&lt;n&gt; 1..4

**Setting parameters:**

&lt;StatisticMode&gt; SONLy | INFinite

**SONLy**

Symbol points only

**INFinite**

All points are used

\*RST: SONLy

**Example:**

CALC1:STAT:MODE SONL

**Mode:** VSA**Manual operation:** See "[Oversampling](#)" on page 180

**CALCulate<n>:STATistics:PRESet**

This command sets both axis of the statistics measurement to measurement dependent default values.

**Suffix:**

<n> 1..4

**Example:**

CALC:STAT:PRES

**Usage:**

Event

**Mode:**

VSA

**Manual operation:** See "[Default Settings](#)" on page 113

**CALCulate<n>:STATistics:SCALE:AUTO <AutoMode>**

Sets the x-axis of the statistics measurement depending on the measured values.

**Suffix:**

<n> 1..4

**Setting parameters:**

<AutoMode> ONCE

**Example:**

CALC3:STAT:SCAL:AUTO ONCE

**Usage:**

Setting only

**Mode:**

VSA

**Manual operation:** See "[Adjust Settings](#)" on page 113

**CALCulate<n>:STATistics:SCALE:X:BCOunt <StatisticsNofColumns>**

This command defines the number of columns for the statistical distribution.

**Suffix:**

<n> 1..4

**Setting parameters:**

<StatisticsNofColumns> numeric value

Range: 2 to 1024

\*RST: 101

Default unit: NONE

**Example:**

CALC:STAT:SCAL:X:BCO 10

Sets the number of columns to 10.

**Mode:**

VSA

**Manual operation:** See "[X-Axis Quantize](#)" on page 112

**CALCulate<n>:STATistics:SCALE:Y:LOWer <Value>**

This command defines the lower limit for the y-axis of the diagram in statistical measurements. Since probabilities are specified on the y-axis, the entered numeric values are dimensionless.

**Suffix:**

<n> selects the screen

**Parameters:**

<Value> 1E-9 to 0.1

\*RST: 1E-6

**Example:** CALC:STAT:SCAL:Y:LOW 0.001

**Manual operation:** See ["y-Axis Min Value"](#) on page 113

**CALCulate<n>:STATistics:SCALE:Y:UNIT <Unit>**

This command defines the scaling type of the y-axis.

**Suffix:**

<n> selects the screen

**Parameters:**

<Unit> PCT | ABS

\*RST: ABS

**Example:** CALC:STAT:SCAL:Y:UNIT PCT  
Sets the percentage scale.

**Manual operation:** See ["y-Unit % / Abs"](#) on page 113

**CALCulate<n>:STATistics:SCALE:Y:UPPer <Value>**

This command defines the upper limit for the y-axis of the diagram in statistical measurements. Since probabilities are specified on the y-axis, the entered numeric values are dimensionless.

**Suffix:**

<n> irrelevant

**Parameters:**

<Value> 1E-8 to 1.0

\*RST: 1.0

**Example:** CALC:STAT:SCAL:Y:UPP 0.01

**Manual operation:** See ["y-Axis Max Value"](#) on page 113

**CALCulate<n>:TLABs:STATe <LineAbsState>**

Displays an absolute vertical line in the specified window. This command is only available for eye diagrams.

**Parameters:**

<State> ON | OFF  
 \*RST: OFF

**Example:**

Display eye diagram in window 2.

LAY:ADD? '1',BEL,MEAS

CALC2:FORM QEYE

Display absolute vertical line.

CALC2:TLAB:STAT ON

Query y-value of absolute vertical line.

CALC2:TLAB:VAL?

**Manual operation:** See "[Vertical Line](#)" on page 132

**CALCulate<n>:TLABs[:VALue] <VertAbsPos>**

Defines or queries the x-value of the absolute vertical line in the specified window. This command is only available for eye diagrams, and only if an absolute vertical line is already available in the diagram (see [CALCulate<n>:TLABs:STATe](#) on page 252).

**Setting parameters:**

<VertAbsPos> numeric value  
 X-value of the absolute vertical line.  
 Range: -1e9 to 1e9  
 \*RST: 0  
 Default unit: SYM

**Example:**

Display eye diagram in window 2.

LAY:ADD? '1',BEL,MEAS

CALC2:FORM QEYE

Display absolute vertical line.

CALC2:TLAB:STAT ON

Query y-value of absolute vertical line.

CALC2:TLAB:VAL?

**Manual operation:** See "[Vertical Line](#)" on page 132

**CALCulate<n>:TLRel:STATe <LineRelState>**

Displays a relative vertical line in the specified window. This command is only available for eye diagrams, and only if an absolute vertical line is already available in the same diagram (see [CALCulate<n>:TLABs:STATe](#) on page 252).

**Parameters:**

<State> ON | OFF  
 \*RST: OFF

**Example:** Display eye diagram in window 2.  
 LAY:ADD? '1',BEL,MEAS  
 CALC2:FORM QEYE  
 Display absolute vertical line.  
 CALC2:TLAB:STAT ON  
 Display relative vertical line.  
 CALC2:TLR:STAT:ON  
 Query x-value of relative vertical line.  
 CALC2:TLR:VAL?

**Manual operation:** See "[Vertical Line](#)" on page 132

### CALCulate<n>:TLRel[:VALue] <LineRelPosRel>

Defines or queries the x-value of the relative vertical line in the specified window. This command is only available for eye diagrams, and only if an absolute vertical line and a relative vertical line are already available in the same diagram (see [CALCulate<n>:TLABs:STATe](#) on page 252 and [CALCulate<n>:TLRel:STATe](#) on page 253).

#### Setting parameters:

<LineRelPosRel> numeric value  
 Relative distance of the second vertical line to the first (absolute) vertical line.  
 Range: -1e9 to 1e9  
 \*RST: 0  
 Default unit: SYM

**Example:** Display eye diagram in window 2.  
 LAY:ADD? '1',BEL,MEAS  
 CALC2:FORM QEYE  
 Display absolute vertical line.  
 CALC2:TLAB:STAT ON  
 Display relative vertical line.  
 CALC2:TLR:STAT:ON  
 Query x-value of relative vertical line.  
 CALC2:TLR:VAL?

**Manual operation:** See "[Vertical Line](#)" on page 132

### CALCulate<n>:TRACe<t>:ADJJust:ALIGNment:OFFSet <FitOffset>

This command shifts the display range (relative to the reference time) by the number of given symbols. The resolution is 1 symbol. A value >0 results in a shift towards the right, and a value <0 results in a shift towards the left.

#### Suffix:

<n> 1..4  
 irrelevant  
 <t> 1..6  
 irrelevant

**Setting parameters:**

<FitOffset> numeric value  
 Range: -8000 to 8000  
 \*RST: 0  
 Default unit: SYM

**Example:**

CALC:TRAC:ADJ:ALIG:OFFS 5

The display range is shifted by 5 symbols towards the right.

**Mode:**

VSA

**Manual operation:** See "Offset" on page 167

**CALCulate<n>:TRACe<t>:ADJJust:ALIGNment[:DEFault] <Alignment>**

This command defines where the relevant event (reference point) is to appear in the result range.

**Suffix:**

<n> 1..4  
 irrelevant

<t> 1..6  
 irrelevant

**Setting parameters:**

<Alignment> LEFT | CENTer | RIGHT

**LEFT**

The reference point is displayed at the left edge of the result range.

**CENTER**

The reference point is displayed in the middle of the result range.

**RIGHT**

The reference point is displayed at the right edge of the result range.

\*RST: LEFT

**Example:**

CALC:TRAC:ADJ:ALIG LEFT

The reference point is displayed at the left edge.

**Mode:**

VSA

**Manual operation:** See "Alignment" on page 167

**CALCulate<n>:TRACe<t>:ADJJust[:VALue] <Reference>**

This command defines the reference point for the display.

**Suffix:**

<n> 1..4  
 irrelevant

<t> 1..6  
irrelevant

**Setting parameters:**

<Reference> TRIGger | BURSt | PATtern

**TRIGger**

The reference point is the start of the capture buffer.

**BURSt**

The reference point is the burst.

**PATtern**

The instrument selects the reference point and the alignment.

\*RST: TRIGger

**Example:**

:CALC:TRAC:ADJ BURSt

Defines the reference point as the burst.

**Mode:**

VSA

**Manual operation:** See ["Reference"](#) on page 166

**CALCulate<n>:TRACe<t>[:VALue] <TrRefType>**

This commands selects the meas or the ref signal for a trace.

**Suffix:**

<n> 1..4

<t> 1..6

**Setting parameters:**

<TrRefType> MEAS | REF

\*RST: The default for trace 1 is always the measurement signal (MEAS). For all other traces, the default signal type depends on the current measurement.

**Example:**

CALC2:TRAC5 MEAS

Sets the measurement signal for trace 5.

**Usage:**

SCPI confirmed

**Mode:**

VSA

**Manual operation:** See ["Evaluation \(Meas/Ref\)"](#) on page 122

**CALCulate<n>:UNIT:ANGLE <Unit>**

This command selects the default unit for angles.

**Suffix:**

<n> 1..4

**Setting parameters:**

<Unit> DEG | RAD

\*RST: RAD



**Example:**            CALC:UNIT:ANGLE DEG  
                          Selects degrees as the default unit.

**Mode:**                VSA

#### **CALCulate<n>:X:UNIT:TIME <Unit>**

This command selects the unit (symbols or seconds) for the x axis.

**Suffix:**  
<n>                    1..4

**Setting parameters:**  
<Unit>                S | SYM  
                          \*RST:        SYM

**Example:**            CALC:X:UNIT:TIME S  
                          Sets the unit to seconds.

**Mode:**                VSA

**Manual operation:** See "X-Axis Unit" on page 114  
                          See "Capture Unit" on page 114

## 4.4 DISPlay subsystem

DISPlay[:WINDow<n>]:PRATe:AUTO.....	258
DISPlay[:WINDow<n>]:PRATe[:VALue].....	258
DISPlay[:WINDow<n>]:SIZE.....	258
DISPlay[:WINDow<n>]:STATe.....	259
DISPlay[:WINDow<n>]:TRACe<t>:MODE.....	259
DISPlay[:WINDow<n>]:TRACe<t>[:STATe].....	260
DISPlay[:WINDow<n>]:TRACe<t>:SYMBol.....	260
DISPlay[:WINDow<n>]:TRACe<t>:X[:SCALE]:PDIVision.....	260
DISPlay[:WINDow<n>]:TRACe<t>:X[:SCALE]:RPOSITion.....	261
DISPlay[:WINDow<n>]:TRACe<t>:X[:SCALE]:RVALue.....	261
DISPlay[:WINDow<n>]:TRACe<t>:X[:SCALE]:START?.....	262
DISPlay[:WINDow<n>]:TRACe<t>:X[:SCALE]:VOFFset.....	262
DISPlay[:WINDow<n>]:TRACe<t>:Y[:SCALE].....	262
DISPlay[:WINDow<n>]:TRACe<t>:Y[:SCALE]:AUTO[:VALue].....	263
DISPlay[:WINDow<n>]:TRACe<t>:Y[:SCALE]:AUTO:ALL.....	263
DISPlay[:WINDow<n>]:TRACe<t>:Y[:SCALE]:MODE.....	263
DISPlay[:WINDow<n>]:TRACe<t>:Y[:SCALE]:PDIVision.....	264
DISPlay[:WINDow<n>]:TRACe<t>:Y[:SCALE]:RLEVel.....	264
DISPlay[:WINDow<n>]:TRACe<t>:Y[:SCALE]:RLEVel:OFFSet.....	265
DISPlay[:WINDow<n>]:TRACe<t>:Y[:SCALE]:RPOSITion.....	265
DISPlay[:WINDow<n>]:TRACe<t>:Y[:SCALE]:RVALue.....	266
DISPlay[:WINDow<n>]:TRACe<t>:Y:SPACing.....	266
DISPlay[:WINDow<n>]:ZOOM:STATe.....	266
DISPlay[:WINDow<n>]:ZOOM:AREA.....	267

**DISPlay[:WINDow<n>]:PRATe:AUTO** <DisplayPPSMoDe>

This command turns auto mode of points per symbol on or off. If "Auto" is enabled, most measurements use the current "Capture Oversampling" (see [SENSe:]DDEMod:PRATe on page 295). Alternatively, select the number of points to be displayed per symbol manually (see DISPlay[:WINDow<n>]:PRATe[:VALue] on page 258).

**Suffix:**

<n> 1..4

**Setting parameters:**

<DisplayPPSMoDe> AUTO | MANual  
\*RST: AUTO

**Example:**

DISP:WIND2:PRAT:AUTO?  
Queries the points per symbol mode.

**Mode:** VSA

**Manual operation:** See "Display Points/Sym" on page 179

**DISPlay[:WINDow<n>]:PRATe[:VALue]** <DisplayPPS>

This command determines the number of points to be displayed per symbol if manual mode is selected (see DISPlay[:WINDow<n>]:PRATe:AUTO on page 258).

**Suffix:**

<n> 1..4

**Setting parameters:**

<DisplayPPS> 1, 2, 4, 8, 16 or 32  
\*RST: 4

**Example:**

DDEM:PRAT 8  
Sets 8 points per symbol.

**Mode:** VSA

**Manual operation:** See "Display Points/Sym" on page 179

**DISPlay[:WINDow<n>]:SIZE** <Size>

This command configures the measurement display.

**Suffix:**

<n> 1..4

**Setting parameters:**

<Size> SMALI | LARGe  
**LARGe**  
diagram in full screen  
**SMALI**  
split screen (diagram and table)

**Mode:** VSA

---

**DISPlay[:WINDow<n>]:STATe <Active>**

Activates/deactivates the window specified by the suffix <1...4>.

**Suffix:**

<n> 1..4

**Setting parameters:**

<Active> ON | OFF  
\*RST: ON

**Example:** DISP:WIND1:STAT ON  
Activates window 1.

**Mode:** VSA

**Manual operation:** See "[Screen X active](#)" on page 176

---

**DISPlay[:WINDow<n>]:TRACe<t>:MODE <Mode>**

This command defines the type of display and the evaluation of the traces. WRITE corresponds to the Clr/Write mode of manual operation. The trace is switched off (= BLANK in manual operation) with `DISPlay[:WINDow<n>]:TRACe<t>[:STATe]`.

The number of measurements for AVERage, MAXHold and MINHold is defined with the `[SENSe:]SWEep:COUNT[:VALue]` on page 317 command. Note that synchronization to the end of the indicated number of measurements is only possible in single sweep mode.

**Suffix:**

<n> window; For applications that do not have more than 1 measurement window, the suffix <n> is irrelevant.

<t> trace

**Parameters:**

<Mode> WRITe | VIEW | AVERage | MAXHold | MINHold | BLANK

\*RST: WRITe for TRACe1, STATe OFF for  
TRACe2/3/4/5/6

For details on trace modes refer to [Chapter 3.4.1, "Trace Mode Overview"](#), on page 201.

**Example:**

INIT:CONT OFF

Switching to single sweep mode.

SWE:COUN 16

Sets the number of measurements to 16.

DISP:TRAC3:MODE MAXH

Switches on the calculation of the maximum peak for trace 3.

INIT;\*WAI

Starts the measurement and waits for the end of the 16 sweeps.

**Manual operation:** See ["Clear Write"](#) on page 121  
 See ["Max Hold"](#) on page 121  
 See ["Min Hold"](#) on page 121  
 See ["Average"](#) on page 121  
 See ["View"](#) on page 121  
 See ["Trace Mode"](#) on page 122

#### DISPlay[:WINDow<n>]:TRACe<t>[:STATe] <State>

This command switches on or off the display of the corresponding trace. The other measurements are not aborted but continue running in the background.

**Suffix:**

<n> window; For applications that do not have more than 1 measurement window, the suffix <n> is irrelevant.

<t> trace

**Parameters:**

<State> ON | OFF

\*RST: ON for TRACe1, OFF for TRACe2 to 6

**Example:** DISP:TRAC3 ON

**Manual operation:** See ["Trace 1/Trace 2/Trace 3/Trace 4/Trace 5/Trace 6"](#) on page 120  
 See ["Blank"](#) on page 122

#### DISPlay[:WINDow<n>]:TRACe<t>:SYMBol

This command defines the display of the decision instants (time when the signals occurred) on the trace.

**Suffix:**

<n> 1..4

<t> 1..6

**Example:** DISP:WIND1:TRAC:SYMB ON

Defines that the decision instants are displayed in the form of dots.

**Mode:** VSA

**Manual operation:** See ["Highlight Symbols"](#) on page 176

#### DISPlay[:WINDow<n>]:TRACe<t>:X[:SCALe]:PDIVision <PDiv>

This command defines the scaling of the X axis.

Setting the scale of the horizontal axis is possible only for statistical result displays. All other result displays support the query only.

**Suffix:**

&lt;n&gt; 1..4

&lt;t&gt; 1..6

**Setting parameters:**<PDiv> numeric value  
numeric value**Example:** DISP:TRAC:X:PDIV 20  
Sets the scaling of the Y axis to 20 DIV.**Mode:** VSA**Manual operation:** See "X-Axis Range" on page 112**DISPlay[:WINDow<n>]:TRACe<t>:X[:SCALe]:RPOsition <RPos>**

This command defines the position of the reference value for the X axis.

Setting the position of the reference value is possible only for statistical result displays. All other result displays support the query only.

**Suffix:**

&lt;n&gt; 1..4

&lt;t&gt; 1..6

**Setting parameters:**<RPos> numeric value  
<numeric\_value>**Example:** DISP:TRAC:X:RPOS 30 PCT  
The reference value is shifted by 30% towards the left.**Mode:** VSA**DISPlay[:WINDow<n>]:TRACe<t>:X[:SCALe]:RVALue <RVal>**

This command defines the reference value for the X axis of the measurement diagram.

Setting the reference value of the x axis is possible only for statistical result displays. All other result displays support the query only.

**Suffix:**

&lt;n&gt; 1..4

&lt;t&gt; 1..6

**Setting parameters:**<RVal> numeric value  
Reference value for the X axis**Example:** DISP:TRAC:X:RVAL 20  
Sets the reference value to 20.**Mode:** VSA

**Manual operation:** See ["X-Axis Reference Value"](#) on page 112

---

### DISPlay[:WINDow<n>]:TRACe<t>:X[:SCALe]:STARt?

This command queries the first value of the x-axis in symbols or time, depending on the unit setting for the x-axis.

**Note:** In the "Result Range Alignment And Evaluation Range" dialog (or using the CALC:TRAC:ALIG commands), the burst on the screen is shifted; the x-axis thus no longer begins on the left at 0 symbols but at a selectable value.

**Suffix:**

<n> 1..4

<t> 1..6

**Example:**

CALC:TRAC:ADJ BURS

Defines the burst as the reference for the screen display.

CALC:TRAC:ADJ:ALIG CENT

Position the burst at the center of the screen.

DISP:TRAC:X:STAR?

Queries the start value of the X axis.

**Usage:** Query only

**Mode:** VSA

---

### DISPlay[:WINDow<n>]:TRACe<t>:X[:SCALe]:VOFFset <VOffset>

This command adds an offset to the symbols shown in the result display.

The offset is available for all result displays except the capture buffer.

**Suffix:**

<n> 1..4

<t> 1..6

**Setting parameters:**

<VOffset> numeric value

Range: -100000 to 100000

\*RST: 0

Default unit: NONE

**Example:**

DISP:TRAC:X:VOFF 20

Adds an offset of 20 to the number of symbols.

**Mode:** VSA

**Manual operation:** See ["Symbol Number at <Reference> start"](#) on page 167

---

### DISPlay[:WINDow<n>]:TRACe<t>:Y[:SCALe] <Range>

This command defines the display range of the y-axis with logarithmic scaling.

The command works only for a logarithmic scaling. You can select the scaling with [DISPlay\[:WINDow<n>\]:TRACe<t>:Y:SPACing](#) on page 266.

**Suffix:**

<n> window; For applications that do not have more than 1 measurement window, the suffix <n> is irrelevant.

<t> irrelevant

**Parameters:**

<Range> Range: 10 to 200  
\*RST: 100  
Default unit: dB

**Example:** DISP:TRAC:Y 110dB

**Manual operation:** See "[Y-Axis Range](#)" on page 111

**DISPlay[:WINDow<n>]:TRACe<t>:Y[:SCALe]:AUTO[:VALue]**

This command automatically scales the vertical axis of the specified screen.

**Suffix:**

<n> 1..4

<t> 1..6

**Example:** DISP:WIND2:TRAC:Y:SCAL:AUTO  
Auto scaling for screen B

**Usage:** Event

**Mode:** VSA

**Manual operation:** See "[Y-Axis Autorange](#)" on page 112

**DISPlay[:WINDow<n>]:TRACe<t>:Y[:SCALe]:AUTO:ALL**

This command automatically scales the vertical axis of all screens.

**Suffix:**

<n> 1..4

<t> 1..6

**Example:** DISP:WIND2:TRAC:Y:SCAL:AUTO:ALL

**Usage:** Event

**Mode:** VSA

**Manual operation:** See "[Y-Axis Auto Range All Screens](#)" on page 118

**DISPlay[:WINDow<n>]:TRACe<t>:Y[:SCALe]:MODE <Mode>**

This command selects the type of scaling of the y-axis.

When `SYSTem:DISPlay:UPDate` is turned off, this command has no immediate effect on the screen.

**Suffix:**

<n> window; For applications that do not have more than 1 measurement window, the suffix <n> is irrelevant.

<t> irrelevant

**Parameters:**

<Mode> **ABSolute**  
absolute scaling of the y-axis

**RELative**  
relative scaling of the y-axis

\*RST: ABS

**Example:** `DISP:TRAC:Y:MODE REL`

**DISPlay[:WINDow<n>]:TRACe<t>:Y[:SCALe][:PDIVision] <Range>**

This remote command determines the grid spacing on the Y axis for all diagrams, where possible

**Suffix:**

<n> 1..4

<t> 1..6  
irrelevant

**Setting parameters:**

<Range> numeric value  
Range: 1 to 1000000  
\*RST: 100  
Default unit: NONE

**Example:** `DISP:TRAC1:Y:PDIV 2 dB`

**Mode:** VSA

**DISPlay[:WINDow<n>]:TRACe<t>:Y[:SCALe]:RLEVel <ReferenceLevel>**

This command defines the reference level.

With the reference level offset  $\neq 0$ , the value range of the reference level is modified by the offset.

**Suffix:**

<n> irrelevant.

<t> irrelevant



**Parameters:**

<ReferenceLevel> The unit is variable.  
 Range: see datasheet  
 \*RST: -10dBm

**Example:** DISP:TRAC:Y:RLEV -60dBm

**Manual operation:** See ["Reference Level"](#) on page 111

**DISPlay[:WINDow<n>]:TRACe<t>:Y[:SCALe]:RLEVel:OFFSet <Value>**

This command defines a reference level offset.

**Suffix:**

<n> irrelevant.  
 <t> irrelevant

**Parameters:**

<Value> Range: -200 to 200  
 \*RST: 0  
 Default unit: dB

**Example:** DISP:TRAC:Y:RLEV:OFFS -10dB

**Manual operation:** See ["Ref Level Offset"](#) on page 116  
 See ["Ref Level Offset"](#) on page 151

**DISPlay[:WINDow<n>]:TRACe<t>:Y[:SCALe]:RPOStion <Position>**

This command defines the position of the reference level on the display grid..

When using a tracking generator (only with option R&S FSV-B9 or -B10, requires active normalization), and in Bluetooth mode (option R&S FSV-K8) this command defines the position of the reference value for all windows.

**Suffix:**

<n> Selects the measurement window.  
 <t> irrelevant

**Parameters:**

<Position> 0 PCT corresponds to the lower display border, 100% corresponds to the upper display border.  
 Range: 0 to 100  
 \*RST: Spectrum mode: 100 PCT, with tracking generator or time display: 50 PCT  
 Default unit: PCT

**Example:** DISP:TRAC:Y:RPOS 50PCT

**Manual operation:** See ["Y-Axis Reference Position"](#) on page 112

**DISPlay[:WINDow<n>]:TRACe<t>:Y[:SCALe]:RVALue <Value>**

The command defines the power value assigned to the reference position in the grid.  
When using a tracking generator, this command requires active normalization.

**Suffix:**

<n> irrelevant

<t> irrelevant

**Parameters:**

<Value> \*RST: 0 dB, coupled to reference level

**Example:**

DISP:TRAC:Y:RVAL -20dBm

Defines a reference position of -20 dBm.

**Manual operation:** See "[Y-Axis Reference Value](#)" on page 112

**DISPlay[:WINDow<n>]:TRACe<t>:Y:SPACing <ScalingType>**

This command selects the scaling of the y-axis.

**Suffix:**

<n> Selects the measurement window.

<t> irrelevant

**Parameters:**

<ScalingType>

**LOGarithmic**

Logarithmic scaling.

**LINear**

Linear scaling in %.

**LDB**

Linear scaling in dB.

\*RST: LOGarithmic

**Example:**

DISP:TRAC:Y:SPAC LIN

Select a linear scale.

**Manual operation:** See "[Y-Axis Unit](#)" on page 114

**DISPlay[:WINDow<n>]:ZOOM:STATe <State>**

This command turns the zoom on and off.

**Suffix:**

<n> Selects the measurement window.

**Parameters:**

<State> ON | OFF

\*RST: OFF

**Example:**

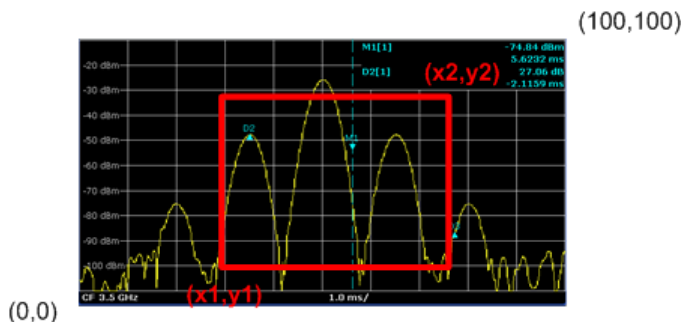
DISP:ZOOM ON

Activates the zoom mode.

**DISPlay[:WINDow<n>]:ZOOM:AREA <x1>, <y1>, <x2>, <y2>**

This command defines the zoom area.

Before you can define a zoom area, you first have to turn the zoom on.



**Suffix:**

<n> window; For applications that do not have more than 1 measurement window, the suffix <n> is irrelevant.

**Parameters:**

<x1>, <y1>, <x2>, <y2> Diagram coordinates in % of the complete diagram that define the zoom area. The lower left corner is the origin of coordinate system. The upper right corner is the end point of the system.  
 Range: 0 to 100  
 Default unit: PCT

**Example:**

```
DISP:ZOOM ON
Activates the zoom mode.
DISP:ZOOM:AREA 5,30,20,100
Enlarges the display of the measurement results in the area defined by the coordinates (5,30) and (20,100).
```

## 4.5 FORMat subsystem

FORMat:DEXPort:DSEParator.....	267
FORMat:DEXPort:HEADer.....	268
FORMat:DEXPort:MODE.....	268

**FORMat:DEXPort:DSEParator <Separator>**

This command defines which decimal separator (decimal point or comma) is to be used for outputting measurement data to the file in ASCII format. Different languages of evaluation programs (e.g. MS-Excel) can thus be supported.

**Parameters:**

<Separator> POINT | COMMA  
 \*RST: (factory setting is POINT; \*RST does not affect setting)

**Example:** `FORM:DEXP:DSEP POIN`  
Sets the decimal point as separator.

**Manual operation:** See ["ASCII Trace Export"](#) on page 123

#### **FORMat:DEXPort:HEADer <Header>**

This command defines if an extended file header (including start frequency, sweep time, detector, etc.) is created or not. A short header with the instrument model, the version and the date is always transferred.

##### **Setting parameters:**

<Header> ON | OFF  
\*RST: OFF

**Example:** `FORM:DEXP:HEAD OFF`  
Only a short file header is transferred.

**Mode:** VSA

**Manual operation:** See ["ASCII Trace Export"](#) on page 123

#### **FORMat:DEXPort:MODE <Mode>**

This command defines whether raw I/Q data or trace data is transferred.

##### **Setting parameters:**

<Mode> RAW | TRACe  
\*RST: TRACe

**Example:** `FORM:DEXP:MODE RAW`  
Raw measurement data is transferred.

**Mode:** VSA

**Manual operation:** See ["ASCII Trace Export"](#) on page 123

## 4.6 INITiate Subsystem

<a href="#">INITiate&lt;n&gt;:CONMeas</a> .....	268
<a href="#">INITiate&lt;n&gt;:CONTinuous</a> .....	269
<a href="#">INITiate&lt;n&gt;[:IMMEDIATE]</a> .....	269
<a href="#">INITiate:REFMeas</a> .....	270

#### **INITiate<n>:CONMeas**

This command restarts a measurement that has been stopped in single sweep mode.

The measurement is restarted at the first sweep point.

As opposed to `INITiate<n>[:IMMEDIATE]`, this command does not reset traces in maxhold, minhold or average mode. Therefore it can be used to continue measurements using max hold or averaging functions.

In single sweep mode, you can synchronize to the end of the measurement with `*OPC`, `*OPC?` or `*WAI`. In continuous sweep mode, synchronization to the end of the measurement is not possible. Thus, it is not recommended that you use continuous sweep mode in remote control, as results like trace data or markers are only valid after a single sweep end synchronization.

**Suffix:**

<n> irrelevant

**Example:**

```
INIT:CONT OFF
```

Switches to single sweep mode.

```
DISP:WIND:TRAC:MODE AVER
```

Switches on trace averaging.

```
SWE:COUN 20
```

Setting the sweep counter to 20 sweeps.

```
INIT;*WAI
```

Starts the measurement and waits for the end of the 20 sweeps.

```
INIT:CONM;*WAI
```

Continues the measurement (next 20 sequences) and waits for the end.

**Manual operation:** See "[Continue Single Sweep](#)" on page 118

**INITiate<n>:CONTinuous <State>**

This command determines whether the trigger system is continuously initiated (continuous) or performs single measurements (single).

The sweep is started immediately.

**Suffix:**

<n> irrelevant

**Parameters:**

<State> ON | OFF

```
*RST: ON
```

**Example:**

```
INIT:CONT OFF
```

Switches the sequence to single sweep.

```
INIT:CONT ON
```

Switches the sequence to continuous sweep.

**Mode:**

all

**Manual operation:** See "[Continuous Sweep](#)" on page 118

See "[Single Sweep](#)" on page 118

**INITiate<n>[:IMMEDIATE]**

The command initiates a new measurement sequence.

With sweep count > 0 or average count > 0, this means a restart of the indicated number of measurements. With trace functions MAXHold, MINHold and AVERage, the previous results are reset on restarting the measurement.

In single sweep mode, you can synchronize to the end of the measurement with \*OPC, \*OPC? or \*WAI. In continuous sweep mode, synchronization to the end of the measurement is not possible. Thus, it is not recommended that you use continuous sweep mode in remote control, as results like trace data or markers are only valid after a single sweep end synchronization.

**Suffix:**

<n> irrelevant

**Example:**

```
INIT:CONT OFF
```

Switches to single sweep mode.

```
DISP:WIND:TRAC:MODE AVER
```

Switches on trace averaging.

```
SWE:COUN 20
```

Setting the sweep counter to 20 sweeps.

```
INIT;*WAI
```

Starts the measurement and waits for the end of the 20 sweeps.

**Mode:** all

**INITiate:REFMeas**

Repeats the evaluation of the data currently in the capture buffer without capturing new data. This is useful after changing settings, for example filters, patterns or evaluation ranges.

**Usage:** Event

**Mode:** VSA

**Manual operation:** See "Refresh" on page 119

## 4.7 INPut Subsystem

INPut:ATTenuation.....	271
INPut:ATTenuation:AUTO.....	271
INPut:COUPling.....	271
INPut:DIQ:CDEVIce.....	272
INPut:DIQ:RANGe:COUPling.....	273
INPut:DIQ:RANGe:UPPer].....	273
INPut:DIQ:RANGe:UPPer]:UNIT.....	274
INPut:DIQ:SRATe.....	274
INPut:EATT.....	275
INPut:EATT:AUTO.....	275
INPut:EATT:STATe.....	275

INPut:FiLTeR:YIG[:STATe].....	276
INPut:GAIn:STATe .....	276
INPut:SELeCt.....	277

---

### INPut:ATTenuation <Value>

This command programs the input attenuator. To protect the input mixer against damage from overloads, the setting 0 dB can be obtained by entering numerals, not by using the DOWN command.

The RF attenuation can be set in 5 dB steps (R&S FSV with option R&S FSV-B25 or R&S FSVA: 1 dB steps). The range is specified in the data sheet. If the current reference level cannot be set for the set RF attenuation, the reference level is adjusted accordingly.

In the default state with "Spectrum" mode, the attenuation set on the step attenuator is coupled to the reference level of the instrument. If the attenuation is programmed directly, the coupling to the reference level is switched off.

This function is not available if the R&S Digital I/Q Interface (R&S FSV-B17) is active.

#### Parameters:

<Value>                    \*RST:        10 dB (AUTO is set to ON)

#### Example:

INP:ATT 30dB

Sets the attenuation on the attenuator to 30 dB and switches off the coupling to the reference level.

**Mode:**                    all

**Manual operation:**    See "RF Atten Manual/Mech Att Manual" on page 114  
                                   See "RF Attenuation" on page 152

---

### INPut:ATTenuation:AUTO <State>

This command automatically couples the input attenuation to the reference level (state ON) or switches the input attenuation to manual entry (state OFF).

This function is not available if the R&S Digital I/Q Interface (R&S FSV-B17) is active.

#### Parameters:

<State>                    ON | OFF  
                                   \*RST:        ON

#### Example:

INP:ATT:AUTO ON

Couples the attenuation set on the attenuator to the reference level.

**Manual operation:**    See "RF Atten Auto/Mech Att Auto" on page 115  
                                   See "Attenuation Mode" on page 152

---

### INPut:COUPling <CouplingType>

Toggles the RF input of the R&S FSVA/FSV between AC and DC coupling.

This function is not available if the R&S Digital I/Q Interface (R&S FSV-B17) is active.

**Parameters:**

<CouplingType> AC | DC  
\*RST: AC

**Example:** INP:COUP DC

**Manual operation:** See "Input (AC/DC)" on page 116  
See "Input Coupling" on page 151

**INPut:DIQ:CDEvice**

This command queries the current configuration and the status of the digital baseband input from the optional R&S Digital I/Q Interface (option R&S FSV-B17).

For details see the section "Interface Status Information" for the R&S Digital I/Q Interface (R&S FSV-B17) in the description of the base unit.

**Return values:**

<ConnState> Defines whether a device is connected or not.  
**0**  
No device is connected.  
**1**  
A device is connected.

<DeviceName> Device ID of the connected device

<SerialNumber> Serial number of the connected device

<PortName> Port name used by the connected device

<SampleRate> Maximum or currently used sampling rate of the connected device in Hz (depends on the used connection protocol version; indicated by <SampleRateType> parameter)

<MaxTransferRate> Maximum data transfer rate of the connected device in Hz

<ConnProtState> State of the connection protocol which is used to identify the connected device.  
**Not Started**  
**Has to be Started**  
**Started**  
**Passed**  
**Failed**  
**Done**



<PRBSTestState>	State of the PRBS test. <b>Not Started</b> <b>Has to be Started</b> <b>Started</b> <b>Passed</b> <b>Failed</b> <b>Done</b>
<SampleRateType>	<b>0</b> Maximum sampling rate is displayed <b>1</b> Current sampling rate is displayed
<Placeholder>	for future use; currently "0"
<b>Example:</b>	INP:DIQ:CDEV? Result: 1, SMU200A, 103634, Out A, 70000000, 100000000, Passed, Not Started, 0, 0
<b>Mode:</b>	IQ, VSA, EVDO, CDMA, WCDMA, GSM, ADEMOD, TDS
<b>Manual operation:</b>	See <a href="#">"Connected Device"</a> on page 136 See <a href="#">"Digital IQ Info"</a> on page 139

---

#### INPut:DIQ:RANGe:COUPling <State>

If enabled, the reference level for digital input is adjusted to the full scale level automatically if the fullscale level changes.

This command is only available if the optional R&S Digital I/Q Interface (option R&S FSV-B17) is installed.

For details see the R&S Digital I/Q Interface (R&S FSV-B17) description of the base unit.

#### Parameters:

<State> ON | OFF  
\*RST: OFF

**Example:** INP:DIQ:RANG:COUP OFF

**Mode:** IQ, VSA, EVDO, CDMA, WCDMA, GSM, ADEMOD, TDS

**Manual operation:** See ["Adjust Reference Level to Full Scale Level"](#) on page 137

---

#### INPut:DIQ:RANGe[:UPPer] <Level>

Defines or queries the "Full Scale Level", i.e. the level that should correspond to an I/Q sample with the magnitude "1".

It can be defined either in dBm or Volt (see ["Full Scale Level"](#) on page 137).

This command is only available if the optional R&S Digital I/Q Interface (option R&S FSV-B17) is installed.

For details see the R&S Digital I/Q Interface (R&S FSV-B17) description of the base unit.

**Parameters:**

<Level> <numeric value>  
 Range: 70.711 nV to 7.071 V  
 \*RST: 1 V

**Example:** INP:DIQ:RANG 1V

**Mode:** A, IQ, NF, TDS, VSA, CDMA, EVDO, WCDMA, ADEMOD, GSM, OFDM, OFDMA/WiBro, WLAN

**Manual operation:** See "[Full Scale Level](#)" on page 137

**INPut:DIQ:RANGe[:UPPer]:UNIT <Unit>**

Defines the unit of the full scale level (see "[Level Unit](#)" on page 137). The availability of units depends on the measurement application you are using.

This command is only available if the optional R&S Digital I/Q Interface (option R&S FSV-B17) is installed.

For details see the R&S Digital I/Q Interface (R&S FSV-B17) description of the base unit.

**Parameters:**

<Level> V | dBm | dBpW | W | dBmV | dBuV | dBuA | A  
 \*RST: Volt

**Example:** INP:DIQ:RANG:UNIT A

**Mode:** IQ, VSA, EVDO, CDMA, WCDMA, GSM, ADEMOD, TDS

**Manual operation:** See "[Level Unit](#)" on page 137

**INPut:DIQ:SRATe <SampleRate>**

This command specifies or queries the sample rate of the input signal from the R&S Digital I/Q Interface (see "[Input Sample Rate](#)" on page 136).

This command is only available if the optional R&S Digital I/Q Interface (option R&S FSV-B17) is installed.

For details see the R&S Digital I/Q Interface (R&S FSV-B17) description of the base unit.

**Parameters:**

<SampleRate> Range: 1 Hz to 10 GHz  
 \*RST: 32 MHz

**Example:** INP:DIQ:SRAT 200 MHz

**Mode:** A, IQ, NF, TDS, VSA, CDMA, EVDO, WCDMA, ADEMOD, GSM, OFDM, OFDMA/WiBro, WLAN

**Manual operation:** See ["Input Sample Rate"](#) on page 136

#### INPut:EATT <Attenuation>

This command defines the electronic attenuation.

If necessary, the command also turns the electronic attenuator on.

This command is only available with option R&S FSV-B25, but not if R&S FSV-B17 is active.

The attenuation can be varied in 1 dB steps from 0 to 25 dB. Other entries are rounded to the next lower integer value.

If the defined reference level cannot be set for the given RF attenuation, the reference level is adjusted accordingly and the warning "Limit reached" is output.

#### Parameters:

<Attenuation> 0...25  
\*RST: 0 dB (OFF)

**Example:** INP1:EATT 10 dB

**Mode:** all

**Manual operation:** See ["EI Atten Mode \(Auto/Man\)"](#) on page 115  
See ["EI Attenuation ON/OFF"](#) on page 152

#### INPut:EATT:AUTO <State>

This command switches the automatic behaviour of the electronic attenuator on or off. If activated, electronic attenuation is used to reduce the operation of the mechanical attenuation whenever possible.

This command is only available with option R&S FSV-B25, but not if R&S FSV-B17 is active.

#### Parameters:

<State> ON | OFF  
\*RST: ON

**Example:** INP1:EATT:AUTO OFF

**Mode:** all

**Manual operation:** See ["EI Atten On/Off"](#) on page 115  
See ["EI Atten Mode \(Auto/Man\)"](#) on page 115

#### INPut:EATT:STATe <State>

This command turns the electronic attenuator on or off.

This command is only available with option R&S FSV-B25, but not if R&S FSV-B17 is active.

**Parameters:**

<State> ON | OFF  
\*RST: OFF

**Example:**

INP:EATT:STAT ON  
Switches the electronic attenuator into the signal path.

**Manual operation:** See "[EI Attenuation ON/OFF](#)" on page 152

**INPut:FILTer:YIG[:STATe] <State>**

If the option R&S FSVA-B11 is installed, the YIG preselector can be bypassed.

This function is only available for R&S FSVA instruments.

If the YIG preselector at the input of the R&S FSVA is removed from the signal path, you can use the maximum bandwidth for signal analysis. However, image-frequency rejection is no longer ensured.

Note that the YIG preselector is active only on frequencies greater than 7 GHz. Therefore, switching the YIG preselector on and off has no effect if the frequency is below that value.

**Parameters:**

<State> ON | OFF | 0 | 1  
\*RST: 1 (0 for I/Q Analyzer, GSM, VSA measurements)

**Example:**

INP:FILT:YIG OFF  
Deactivates the YIG preselector.

**Manual operation:** See "[\(Bypassing the \)YIG Filter](#)" on page 116

**INPut:GAIN:STATe <State>**

This command turns the preamplifier on and off. (For the exact amplification value, see the data sheet).

With option R&S FSV-B22, the preamplifier only has an effect below 7 GHz.

With option R&S FSV-B24, the amplifier applies to the entire frequency range.

This command is not available when using R&S Digital I/Q Interface (R&S FSV-B17).

**Parameters:**

<State> ON | OFF  
\*RST: OFF

**Example:**

INP:GAIN:STAT ON  
Turns the preamplifier on.

**Manual operation:** See "[Preamp On/Off](#)" on page 114

---

**INPut:SElect** <Source>

This command selects the signal source for measurements.

**Parameters:**

<Source>	<b>RF</b> Radio Frequency ("RF INPUT" connector)
	<b>DIQ</b> Digital IQ (only available with R&S Digital I/Q Interface, option R&S FSV-B17)
	*RST: RF

**Example:** INP:SEL RF

**Mode:** A, IQ, NF, TDS, VSA, CDMA, EVDO, WCDMA, ADEMOD, GSM, OFDM, OFDMA/WiBro, WLAN

**Manual operation:** See "[Input Path](#)" on page 136

## 4.8 INSTRument Subsystem

---

**INSTrument:SElect** <Mode>

This command switches the instrument to VSA mode.

**Parameters:**

<Mode>	<b>DDEM</b> VSA mode
--------	-------------------------

**Example:** INST:SEL DDEM

**Mode:** VSA

---

**INSTrument:NSElect** <Mode>

This command switches the instrument to VSA mode.

**Parameters:**

<Mode>	<b>2</b> VSA mode
--------	----------------------

**Example:** INST:NSEL 2

**Mode:** VSA

## 4.9 MMEMory Subsystem

---

**MMEMory:LOAD:IQ:STATe** 1, <FileName>

This command loads the I/Q data from the specified `.iq.tar` file.

**Note:** switch to single sweep mode (`INIT:CONT OFF`) before importing I/Q data as otherwise the instrument will continue to measure data and display the current results rather than the imported data.

**Parameters:**

<FileName> Complete file name including the path

**Example:**

```
MMEM:LOAD:IQ:STAT 1, 'C:
\R_S\Instr\user\data.iq.tar'
```

Loads I/Q data from the specified file.

**Usage:**

Setting only

**MMEMory:SElect:ITEM:VIQData <Mode>**

If enabled, the captured I/Q data is included in the save set when instrument data is stored (single sweep mode only).

**Parameters:**

<Mode> ON | OFF

**Mode:**

VSA

**MMEMory:STORe:IQ:STATe 1, <FileName>**

This command stores the complex I/Q data to the specified `.iq.tar` file in 32-bit floating point format.

**Parameters:**

<FileName> Complete file name including the path

**Example:**

```
MMEM:STOR:IQ:STAT 1, 'C:
\R_S\Instr\user\data.iq.tar'
```

Stores I/Q data to the specified file.

**Manual operation:** See ["IQ Export"](#) on page 140

**MMEMory:STORe:IQ:COMM <Description>**

Defines a description of the export file which is stored with the data and also displayed in the file selection dialog box for I/Q data import and export.

**Parameters:**

<Description>

**Example:**

```
MMEM:STOR:IQ:COMM 'Device test 1b'
```

Creates a description for the export file.

```
MMEM:STOR:IQ:STAT 1, 'C:
\R_S\Instr\user\data.iq.tar'
```

Stores I/Q data and the comment to the specified file.

**Manual operation:** See ["IQ Export"](#) on page 140

**MMEMory:STORe:IQ:FORMat** <Format>, <DataFormat>

This command defines the format of the I/Q data to be stored.

**Parameters:**

<Format>	FLOat32   INT32 Defines the format of the complex or real data. *RST: FLOat32
<DataFormat>	COMPLex   REAL Defines whether complex or real data is exported. *RST: COMPLex

**Example:**

```
MMEM:STOR:IQ:FORM INT,REAL
```

Stores real I/Q data as integer values to the specified file (see [MMEMory:STORe:IQ:STATe](#) on page 278).

**Mode:** A, CDMA, EVDO, IQ, TDS, VSA, WCDMA

**MMEMory:STORe<n>:TRACe** <Trace>, <Path>

This command stores the selected trace in the specified window in a file with ASCII format. The file format is described in [Chapter 3.4.2, "ASCII File Export Format for VSA Data"](#), on page 203.

The decimal separator (decimal point or comma) for floating-point numerals contained in the file is defined with the `FORMat:DEXPort:DSEParator` command (see [FORMat:DEXPort:DSEParator](#) on page 267).

**Suffix:**

<n> window; For applications that do not have more than 1 measurement window, the suffix <n> is irrelevant.

**Setting parameters:**

<Trace>	1 to 6 selected measurement trace
<Path>	DOS file name The file name includes indication of the path and the drive name. Indication of the path complies with DOS conventions.

**Example:**

```
MMEM:STOR:TRAC 3, 'TEST.ASC'
```

Stores trace 3 in the file TEST.ASC.

**Usage:** Setting only

**Mode:** VSA

**Manual operation:** See ["ASCII Trace Export"](#) on page 123

## 4.10 OUTPut Subsystem

### OUTPut:DIQ <State>

If enabled, the captured IQ data is output to the R&S Digital I/Q Interface in a continuous stream. This function requires the LVDS interface option (R&S FSV-B17).

Digital input and digital output cannot be used simultaneously.

#### Parameters:

<State>                    **ON | OFF**  
                               \*RST:        OFF

**Example:**                OUTP:DIQ ON

**Mode:**                    ADEMODO, IQ, VSA

### OUTPut:DIQ:CDEvice

This command queries the current configuration and the status of the digital baseband output to the optional R&S Digital I/Q Interface (option R&S FSV-B17).

For details see the R&S Digital I/Q Interface description for the base unit.

#### Return values:

<ConnState>                Defines whether a device is connected or not.  
                               **0**  
                               No device is connected.  
                               **1**  
                               A device is connected.

<DeviceName>              Device ID of the connected device

<SerialNumber>             Serial number of the connected device

<PortName>                Port name used by the connected device

<NotUsed>                 to be ignored

<MaxTransferRate>        Maximum data transfer rate of the connected device in Hz

<ConnProtState>          State of the connection protocol which is used to identify the connected device.  
                               **Not Started**  
                               **Has to be Started**  
                               **Started**  
                               **Passed**  
                               **Failed**  
                               **Done**



<PRBSTestState>	State of the PRBS test. <b>Not Started</b> <b>Has to be Started</b> <b>Started</b> <b>Passed</b> <b>Failed</b> <b>Done</b>
<NotUsed>	to be ignored
<Placeholder>	for future use; currently "0"
<b>Example:</b>	OUTP:DIQ:CDEV? Result: 1, SMU200A, 103634, Out A, 70000000, 100000000, Passed, Not Started, 0, 0
<b>Mode:</b>	IQ, VSA

## 4.11 SENSe subsystem

[SENSe:]ADJust:CONFIguration:HYSTerisis:LOWer.....	283
[SENSe:]ADJust:CONFIguration:HYSTerisis:UPPer.....	283
[SENSe:]ADJust:CONFIgure:LEVel:DURation.....	284
[SENSe:]ADJust:CONFIgure:LEVel:DURation:MODE.....	284
[SENSe:]ADJust:LEVel.....	284
[SENSe:]DDEMod:ECALc:OFFSet.....	285
[SENSe:]DDEMod:ECALc:MODE].....	285
[SENSe:]DDEMod:EPRate:AUTO.....	285
[SENSe:]DDEMod:EPRate[:VALue].....	286
[SENSe:]DDEMod:FACTory[:VALue].....	286
[SENSe:]DDEMod:FILTer:ALPHa.....	286
[SENSe:]DDEMod:FILTer[:STATe].....	287
[SENSe:]DDEMod:FORMat.....	287
[SENSe:]DDEMod:FSK:NState.....	287
[SENSe:]DDEMod:FSYNc:AUTO.....	288
[SENSe:]DDEMod:FSYNc:LEVel.....	288
[SENSe:]DDEMod:FSYNc:RESult?.....	289
[SENSe:]DDEMod:FSYNc:MODE].....	289
[SENSe:]DDEMod:KDATA:STATe.....	290
[SENSe:]DDEMod:KDATA[:NAME].....	290
[SENSe:]DDEMod:MAPPing:CATalog?.....	290
[SENSe:]DDEMod:MAPPing[:VALue].....	290
[SENSe:]DDEMod:MFILTer:ALPHa.....	291
[SENSe:]DDEMod:MFILTer:AUTO.....	291
[SENSe:]DDEMod:MFILTer:NAME.....	291
[SENSe:]DDEMod:MFILTer[:STATe].....	292
[SENSe:]DDEMod:MFILTer:USER.....	292

[SENSe:]DDEMod:MSK:FORMat.....	292
[SENSe:]DDEMod:NORMalize:ADRoop.....	293
[SENSe:]DDEMod:NORMalize:CFDRift.....	293
[SENSe:]DDEMod:NORMalize:FDERror.....	293
[SENSe:]DDEMod:NORMalize:IQIMbalance.....	294
[SENSe:]DDEMod:NORMalize:IQOffset.....	294
[SENSe:]DDEMod:NORMalize[:VALue].....	294
[SENSe:]DDEMod:PRATe.....	295
[SENSe:]DDEMod:PRESet:CALC.....	295
[SENSe:]DDEMod:PRESet:RLEVel.....	295
[SENSe:]DDEMod:PRESet[:STANdard].....	296
[SENSe:]DDEMod:PSK:FORMat.....	297
[SENSe:]DDEMod:PSK:NSTate.....	298
[SENSe:]DDEMod:QAM:FORMat.....	298
[SENSe:]DDEMod:QAM:NSTate.....	299
[SENSe:]DDEMod:QPSK:FORMat.....	299
[SENSe:]DDEMod:RENgth:AUTO.....	300
[SENSe:]DDEMod:RENgth[:VALue].....	300
[SENSe:]DDEMod:SBANd.....	300
[SENSe:]DDEMod:SEARch:BURSt:AUTO.....	301
[SENSe:]DDEMod:SEARch:BURSt:CONFigure:AUTO.....	301
[SENSe:]DDEMod:SEARch:BURSt:GLENgth[:MINimum].....	301
[SENSe:]DDEMod:SEARch:BURSt:LENgth:MAXimum.....	302
[SENSe:]DDEMod:SEARch:BURSt:LENgth[:MINimum].....	302
[SENSe:]DDEMod:SEARch:BURSt:MODE.....	302
[SENSe:]DDEMod:SEARch:BURSt:SKIP:FALLing.....	303
[SENSe:]DDEMod:SEARch:BURSt:SKIP:RISing.....	303
[SENSe:]DDEMod:SEARch:BURSt:STATe.....	303
[SENSe:]DDEMod:SEARch:BURSt:TOLerance.....	304
[SENSe:]DDEMod:SEARch:MBURst:CALC.....	304
[SENSe:]DDEMod:SEARch:MBURst:STARt?.....	304
[SENSe:]DDEMod:SEARch:PATTErn:CONFigure:AUTO.....	305
[SENSe:]DDEMod:SEARch:PATTErn:SYNC[:STATe].....	305
[SENSe:]DDEMod:SEARch:PATTErn:SYNC:AUTO.....	305
[SENSe:]DDEMod:SEARch:SYNC:AUTO.....	306
[SENSe:]DDEMod:SEARch:SYNC:CATalog.....	306
[SENSe:]DDEMod:SEARch:SYNC:COMMEnt.....	306
[SENSe:]DDEMod:SEARch:SYNC:COpy.....	307
[SENSe:]DDEMod:SEARch:SYNC:DATA.....	307
[SENSe:]DDEMod:SEARch:SYNC:DELeTe.....	308
[SENSe:]DDEMod:SEARch:SYNC:FOUNd.....	308
[SENSe:]DDEMod:SEARch:SYNC:IQCThreshold.....	308
[SENSe:]DDEMod:SEARch:SYNC:MODE.....	309
[SENSe:]DDEMod:SEARch:SYNC:NAME.....	309
[SENSe:]DDEMod:SEARch:SYNC:NSTate.....	309
[SENSe:]DDEMod:SEARch:SYNC:PATTErn:ADD.....	310
[SENSe:]DDEMod:SEARch:SYNC:PATTErn:REMOve.....	310
[SENSe:]DDEMod:SEARch:SYNC:SELeCt.....	310
[SENSe:]DDEMod:SEARch:SYNC:STATe.....	311
[SENSe:]DDEMod:SEARch:SYNC:TEXT.....	311

[SENSe:]DDEMod:SIGNal:PATtern.....	311
[SENSe:]DDEMod:SIGNal[:VALue].....	312
[SENSe:]DDEMod:SRATe.....	312
[SENSe:]DDEMod:STANdard:COMMeNt.....	312
[SENSe:]DDEMod:STANdard:DELeTe.....	312
[SENSe:]DDEMod:STANdard:PRESet[:VALue].....	313
[SENSe:]DDEMod:STANdard:SAVE.....	313
[SENSe:]DDEMod:STANdard:SYNC:OFFSet:STATe.....	313
[SENSe:]DDEMod:STANdard:SYNC:OFFSet[:VALue].....	314
[SENSe:]DDEMod:TfILTer:ALPHa.....	314
[SENSe:]DDEMod:TfILTer:NAME.....	314
[SENSe:]DDEMod:TfILTer[:STATe].....	314
[SENSe:]DDEMod:TfILTer:USER.....	315
[SENSe:]DDEMod:TIME.....	315
[SENSe:]DDEMod:UQAM:FORMat.....	316
[SENSe:]DDEMod:UQAM:NStAtE?.....	316
[SENSe:]FREQuency:CENTer.....	316
[SENSe:]FREQuency:CENTer:STEP.....	316
[SENSe:]FREQuency:CENTer:STEP:AUTO.....	317
[SENSe:]FREQuency:OFFSet.....	317
[SENSe:]SWEEp:COUNt[:VALue].....	317
[SENSe:]SWEEp:COUNt:CURRent.....	318

---

#### [SENSe:]ADJJust:CONFIguration:HYSTerEsis:LOWer <Threshold>

This command defines a lower threshold the signal must drop below before the reference level is automatically adjusted when the "Auto Level" function is performed.

(See [SENSe:]ADJJust:LEVel on page 284).

##### Parameters:

<Threshold>            Range:     0 to 200  
                          \*RST:     +1 dB  
                          Default unit: dB

**Example:**            SENS:ADJ:CONF:HYST:LOW 2

**Example:**            For an input signal level of currently 20 dBm, the reference level will only be adjusted when the signal level falls below 18 dBm.

**Manual operation:**   See "Lower Level Hysteresis" on page 117

---

#### [SENSe:]ADJJust:CONFIguration:HYSTerEsis:UPPer <Threshold>

This command defines an upper threshold the signal must exceed before the reference level is automatically adjusted when the "Auto Level" function is performed.

(See [SENSe:]ADJJust:LEVel on page 284).

##### Parameters:

<Threshold>            Range:     0 to 200  
                          \*RST:     +1 dB  
                          Default unit: dB

**Example:**                   SENS:ADJ:CONF:HYST:UPP 2  
For an input signal level of currently 20 dBm, the reference level will only be adjusted when the signal level rises above 22 dBm.

**Manual operation:** See "[Upper Level Hysteresis](#)" on page 117

#### [SENSe:]ADJust:CONFigure:LEVel:DURation <Duration>

This command defines the duration of the level measurement used to determine the optimal reference level automatically (for SENS:ADJ:LEV ON).

##### Parameters:

<Duration>                   <numeric value> in seconds  
Range:                   0.001 to 16000.0  
\*RST:                   0.001  
Default unit: s

**Example:**                   ADJ:CONF:LEV:DUR:5

**Manual operation:** See "[Meas Time Manual](#)" on page 117

#### [SENSe:]ADJust:CONFigure:LEVel:DURation:MODE <Mode>

This command selects the way the R&S FSVA/FSV determines the length of the measurement that is performed while determining the ideal reference level.

##### Parameters:

<Mode>                   **AUTO**  
Automatically determines the measurement length.  
**MANual**  
Manual definition of the measurement length.  
\*RST:                   AUTO

**Example:**                   ADJ:CONF:LEV:DUR:MODE MAN  
Specifies manual definition of the measurement duration.  
ADJ:CONF:LEV:DUR:5  
Specifies the duration manually.

#### [SENSe:]ADJust:LEVel

This command initiates automatic setting of the RF attenuation to the level of the applied signal.

**Note:** The following command must be synchronized to the end of the autorange process using \*WAI, \*OPC oder \*OPC?, because otherwise the autorange process will be stopped.

**Example:**                   ADJ:LEV  
Adjusts the reference level to the current measurement.

**Usage:**                   Event

**Mode:**                   VSA

**Manual operation:** See ["Auto Level"](#) on page 117

---

**[SENSe:]DDEMod:ECALc:OFFSet** <EVMOffsetState>

The command activates and deactivates an offset for the calculation of the EVM for OQPSK modulated signals.

**Setting parameters:**

<EVMOffsetState> ON | OFF  
 \*RST: ON

**Mode:** VSA

**Manual operation:** See ["Offset EVM"](#) on page 171

---

**[SENSe:]DDEMod:ECALc[:MODE]** <EvmCalc>

This command defines the calculation formula for EVM.

**Setting parameters:**

<EvmCalc> SIGNal | SYMBol | MECPower | MACPower

**SIGNal**

Calculation normalized to the mean power of the reference signal at the symbol instants.

**SYMBol**

Calculation normalized to the maximum power of the reference signal at the symbol instants.

**MECPower**

Calculation normalized to the mean expected power of the measurement signal at the symbol instants

**MACPower**

Calculation normalized to the maximum expected power of the measurement signal at the symbol instants

\*RST: SIGNal

**Example:** DDEMod:ECALc:MODE SIGN  
 EVM is normalized to the average power.

**Mode:** VSA

**Manual operation:** See ["Normalize EVM to"](#) on page 171

---

**[SENSe:]DDEMod:EPRate:AUTO** <LinkMode>

This command activates and deactivates automatic estimation oversampling for the modulation accuracy table.

**Setting parameters:**

<LinkMode> ON | OFF  
 \*RST: ON

**Mode:** VSA

**Manual operation:** See ["Estimation Points/Sym"](#) on page 172

**[SENSe:]DDEMod:EPRate[:VALue]** <EstimationOverSampling>

This command determines the number of estimation points per symbol for the modulation accuracy table.

**Setting parameters:**

<EstimationOverSampling> numeric value

\*RST: 1

**Mode:** VSA

**Manual operation:** See ["Estimation Points/Sym"](#) on page 172

**[SENSe:]DDEMod:FACTory[:VALue]** <Factory>

This command restores the factory settings of standards or patterns for the R&S FSV-K70 option.

**Setting parameters:**

<Factory> ALL | STANdard | PATTeRn

**ALL**

Restores both standards and patterns.

\*RST: ALL

**Usage:** Setting only

**Mode:** VSA

**Manual operation:** See ["Restore Standard Files"](#) on page 109  
See ["Restore Pattern Files"](#) on page 109

**[SENSe:]DDEMod:FILTer:ALPHa** <MeasFilterAlphaBT>

This command determines the filter characteristic (ALPHA/BT). The resolution is 0.01.

**Setting parameters:**

<MeasFilterAlphaBT> numeric value

Range: 0.05 to 1.0

\*RST: 0.22

Default unit: NONE

**Example:** DDEM:FILT:ALPH 0.5  
Sets ALPHA/BT to 0.5

**Mode:** VSA

**Manual operation:** See ["Alpha/BT"](#) on page 146

---

**[SENSe:]DDEMod:FILTer[:STATe] <MeasFilterState>**

This command defines whether the input signal that is evaluated is filtered by the measurement filter. This command has no effect on the Transmit filter.

**Setting parameters:**

<MeasFilterState> ON | OFF

**ON**

[SENSe:]DDEMod:MFILTer:AUTO is activated.

**OFF**

The input signal is not filtered. [SENSe:]DDEMod:MFILTer:AUTO is deactivated.

\*RST: ON

**Example:**

DDEM:FILT OFF

The input signal is not filtered.

**Mode:**

VSA

---

**[SENSe:]DDEMod:FORMat <Group>**

This command selects the digital demodulation mode.

**Setting parameters:**

<Group> MSK | PSK | QAM | QPSK | FSK | UQAM

**QPSK**

Quad Phase Shift Key

**PSK**

Phase Shift Key

**MSK**

Minimum Shift Key

**QAM**

Quadrature Amplitude Modulation

\*RST: PSK

**Example:**

SENS:DDEM:FORM QAM

Selects QAM modulation.

**Mode:**

VSA

**Manual operation:** See "[Modulation Type](#)" on page 143

---

**[SENSe:]DDEMod:FSK:NState <FSKNstate>**

This command defines the demodulation of the FSK modulation scheme.

**Setting parameters:**

<FSKNstate>     **2**  
                   2FSK  
                   **4**  
                   4FSK  
                   **8**  
                   8FSK  
                   **16**  
                   16FSK  
                   \*RST:     2

**Example:**           DDEM:FSK:NST 8

**Mode:**             VSA

**Manual operation:** See "[Modulation Order](#)" on page 144

**[SENSe:]DDEMod:FSYNc:AUTO <FineSyncAuto>**

If "Auto" mode is selected and a Known Data file has been loaded and activated for use, the known data sequences are used. Otherwise, the detected data is used.

**Setting parameters:**

<FineSyncAuto>    ON | OFF  
                   \*RST:     ON

**Mode:**             VSA

**Manual operation:** See "[Fine Synchronization](#)" on page 173

**[SENSe:]DDEMod:FSYNc:LEVel <SERLevel>**

This command is only available if [[SENSe :](#)] [DDEMod:FSYNc \[ :MODE \]](#) KDAT was performed.

It defines a maximum symbol error rate for the known data in reference to the analyzed data. If the SER of the measured data exceeds this limit, the default synchronization using the detected data is performed.

A maximum SER level of 0 means that the file is only used if the measured data is identical to one of the specified data sequences.

**Setting parameters:**

<SERLevel>        numeric value  
                   Range:     0.0 to 100.0  
                   \*RST:     10.0  
                   Default unit: PCT

**Mode:**             VSA

**Manual operation:** See "[If SER ≤](#)" on page 173



**[SENSe:]DDEMod:FSYNc:RESult?**

This command queries whether a loaded Known Data file was used for fine synchronization or not. If a maximum symbol error rate was specified (using the [\[SENSe:\]DDEMod:FSYNc:LEVel](#) command) and exceeded, the file is not used.

**Return values:**

<Usage> 0 | 1  
**0**  
 The Known Data file was not used do to the exceeded SER.  
**1**  
 The Known Data file was used.

**Usage:** Query only

**Mode:** VSA

**Manual operation:** See "[Fine Synchronization](#)" on page 173

**[SENSe:]DDEMod:FSYNc[:MODE] <FineSync>**

This command defines the fine synchronization mode used to calculate results, e.g. the bit error rate.

**Note:** You can define a maximum symbol error rate (SER) for the known data in reference to the analyzed data. If the SER of the known data exceeds this limit, the default synchronization using the detected data is performed. See [\[SENSe:\]DDEMod:FSYNc:LEVel](#) on page 288.

**Setting parameters:**

<FineSync> KDATa | PATTErn | DDATa  
**KDATa**  
 The reference signal is defined as the data sequence from the loaded Known Data file that most closely matches the measured data.  
**PATTErn**  
 The reference signal is estimated from the defined pattern. This setting requires an activated pattern search, see [\[SENSe:\]DDEMod:SEARCh:SYNC:STATe](#) on page 311.  
**DDATa**  
 (Default) The reference signal is estimated from the detected data.  
 \*RST: DDATa

**Example:** SENS:DDEM:FSYN:MODE KDATa

**Mode:** VSA

**Manual operation:** See "[Fine Synchronization](#)" on page 173

---

**[SENSe:]DDEMod:KDATa:STATe** <KnownDataState>

This command activates the usage of known data. The usage of known data is a prerequisite for the BER measurement and can also be used for the fine synchronization. See [Chapter 3.3.7, "Working With Known Data Files"](#), on page 194 for details.

**Setting parameters:**

<KnownDataState> ON | OFF  
\*RST: OFF

**Mode:** VSA

**Manual operation:** See "[Known Data](#)" on page 149

---

**[SENSe:]DDEMod:KDATa[:NAME]** <FileName>

This command selects the Known Data file.

**Setting parameters:**

<FileName> string  
the path and file name of the xml file containing known data sequences.

**Example:** SENS:DDEM:KDAT:NAME 'D:\\MyData.xml'

**Mode:** VSA

**Manual operation:** See "[Load Data File](#)" on page 149

---

**[SENSe:]DDEMod:MAPPING:CATalog?**

This command queries the names of all mappings that are available for the current modulation type and order. A mapping describes the assignment of constellation points to symbols.

**Example:** DDEM:MAPP:CAT?  
Queries the list of mappings.

**Usage:** Query only

**Mode:** VSA

**Manual operation:** See "[Modulation Mapping](#)" on page 145

---

**[SENSe:]DDEMod:MAPPING[:VALue]** <Mapping>

This command selects the mapping designated by <mapping\_name> for the digital demodulation. The mapping describes the assignment of constellation points to symbols.

**Setting parameters:**

<Mapping> string  
<string>

**Example:**           SENS:DDEM:MAPP 'GSM'  
Sets mapping to GSM.

**Mode:**             VSA

**Manual operation:** See "[Modulation Mapping](#)" on page 145

#### [SENSe]:DDEMod:MFILter:ALPHa <MeasFilterAlphaBT>

This command sets the alpha value of the measurement filter.

##### Setting parameters:

<MeasFilterAlphaBT> numeric value

Range:       0.05 to 1.0

\*RST:       0.22

Default unit: NONE

**Example:**           SENS:DDEM:MFIL:ALPH 0.8  
Sets alpha to 0.8

**Mode:**             VSA

**Manual operation:** See "[Alpha/BT](#)" on page 146

#### [SENSe:]DDEMod:MFILter:AUTO <MeasFilterAuto>

If this command is set to "ON", the measurement filter is defined automatically depending on the Transmit filter.

##### Setting parameters:

<MeasFilterAuto>   ON | OFF

\*RST:       ON

**Example:**           SENS:DDEM:MFIL:AUTO ON

**Mode:**             VSA

**Manual operation:** See "[Auto](#)" on page 175

#### [SENSe:]DDEMod:MFILter:NAME <Name>

This command selects a measurement filter and automatically switches it on.

For more information on measurement filters, refer to [Chapter 2.2.6, "Measurement Filters"](#), on page 17.

##### Setting parameters:

<Name>             Name of the measurement filter or 'User' for a user-defined filter. An overview of available measurement filters is provided in [Table 2-4](#).

**Example:**           SENS:DDEM:MFIL:NAME 'RRC'  
Selects the RRC measurement filter.

**Mode:**             VSA

**Manual operation:** See "Type" on page 175  
See "Load User Filter" on page 175

---

**[SENSe:]DDEMod:MFILter[:STATe] <MeasFilterState>**

Use this command to switch the measurement filter off. To switch a measurement filter on, use the [SENSe:]DDEMod:MFILter:NAME command.

**Setting parameters:**

<MeasFilterState> ON | OFF

**OFF**

Switches the measurement filter off.

**ON**

Switches the measurement filter specified by [SENSe:]DDEMod:MFILter:NAME on. However, this command is not necessary, as the [SENSe:]DDEMod:MFILter:NAME command automatically switches the selected filter on.

\*RST: ON

**Example:** SENS:DDEM:MFIL:STAT OFF  
Deactivates the measurement filter.

**Mode:** VSA

**Manual operation:** See "Type" on page 175

---

**[SENSe:]DDEMod:MFILter:USER <FilterName>**

This command selects the user-defined measurement filter.

For details on creating user-defined filters, see [Chapter 2.2.7, "Customized Filters"](#), on page 19.

**Setting parameters:**

<FilterName> Name of the user-defined filter

**Example:** SENS:DDEM:MFIL:NAME 'USER'  
Selects user filter mode for the meas filter  
SENS:DDEM:MFIL:USER 'D:\MyMeasFilter'  
Selects the user-defined meas filter

**Mode:** VSA

---

**[SENSe:]DDEMod:MSK:FORMat <Name>**

This command defines the specific demodulation mode for MSK.

**Setting parameters:**

<Name> TYPE1 | TYPE2 | NORMal | DIFFerential  
**TYPE1 | NORMal**  
 MSK  
**TYPE2 | DIFFerential**  
 DMSK  
 \*RST: QPSK

**Example:**

DDEM:FORM MSK  
 Switches MSK demodulation on.  
 DDEM:MSK:FORM TYPE2  
 Switches DMSK demodulation on.

**Mode:** VSA

**Manual operation:** See "[Modulation Order](#)" on page 144

**[SENSe:]DDEMod:NORMalize:ADRoop** <CompAmptDroop>

This command switches the compensation of the amplitude droop on or off.

**Setting parameters:**

<CompAmptDroop> ON | OFF  
 \*RST: ON

**Example:**

DDEM:NORM:ADR ON  
 Switches the compensation on.

**Mode:** VSA

**Manual operation:** See "[Compensate for...](#)" on page 170

**[SENSe:]DDEMod:NORMalize:CFDRift** <CarrierFreqDrift>

This command activates or deactivates compensation of the carrier frequency drift.

**Setting parameters:**

<CarrierFreqDrift> ON | OFF  
 \*RST: OFF

**Mode:** VSA

**Manual operation:** See "[Compensate for...](#)" on page 170

**[SENSe:]DDEMod:NORMalize:FDERror** <RefDevCompensation>

This command selects the method for calculating the frequency error if you are using FSK modulation.

**Setting parameters:**

&lt;RefDevCompensation&gt; ON | OFF

**ON**

Scales the reference signal to the current deviation of the measurement signal

**OFF**

Uses the nominal deviation you have set for the reference signal

\*RST: ON

**Mode:** VSA**Manual operation:** See "[Compensate for...](#)" on page 170**[SENSe:]DDEMod:NORMalize:IQIMbalance** <ComplQImbalance>

This command switches the compensation of the IQ imbalance on or off.

**Setting parameters:**

&lt;ComplQImbalance&gt; ON | OFF

\*RST: OFF

**Example:** DDEM:NORM:IQIM OFF  
Switches the compensation off.**Mode:** VSA**Manual operation:** See "[Compensate for...](#)" on page 170**[SENSe:]DDEMod:NORMalize:IQOffset** <ComplQOffset>

This command switches the compensation of the IQ offset on or off.

**Setting parameters:**

&lt;ComplQOffset&gt; ON | OFF

\*RST: ON

**Example:** DDEM:NORM:IQOF OFF  
Switches the compensation off.**Mode:** VSA**Manual operation:** See "[Compensate for...](#)" on page 170**[SENSe:]DDEMod:NORMalize[:VALue]** <Normalize>

This command switches the compensation of the I/Q offset and the compensation of amplitude droop on or off. When queried, the command returns 1 if both are ON and 0 if both are off. Otherwise, an error is returned.

The command is kept because of compatibility to the R&S FSQ and won't be supported in later versions. Instead, use the new command ([\[SENSe:\]DDEMod:NORMalize:IQOffset](#) on page 294)

**Setting parameters:**

<Normalize> ON | OFF  
 \*RST: ON

**Example:**

SENS : DDEM : NORM ON  
 Turn on IQ offset compensation and amplitude droop compensation

**Mode:** VSA

**[SENSe:]DDEMod:PRATe <CaptOverSampling>**

This command determines the number of captured points per symbol.

**Setting parameters:**

<CaptOverSampling> 4, 8, 16, 32  
 \*RST: 4

**Example:**

DDEM : PRAT 8  
 Sets 8 points per symbol.

**Mode:** VSA

**Manual operation:** See "[Capture Oversampling](#)" on page 154

**[SENSe:]DDEMod:PRESet:CALC**

This command selects the Signal Overview from the predefined tab of the display overview dialog box.

**Example:**

SENS : DDEM : PRES : CALC  
 Resets the screen display to the presetting.

**Usage:** Event

**Mode:** VSA

**[SENSe:]DDEMod:PRESet:RLEVel**

This command initiates automatic setting of the RF attenuation and IF gain to the level of the applied signal.

**Note:** The following command must be synchronized to the end of the autorange process using \*WAI, \*OPC or \*OPC?, because otherwise the autorange process will be stopped.

**Example:**

SENS : DDEM : PRES : RLEV ; \*WAI  
 Performs automatic level setting

**Usage:** Event

**Mode:** VSA

**[SENSe:]DDEMod:PRESet[:STANdard]** <Standard>

This command selects an automatic setting of all modulation parameters according to a standardized transmission method or a user-defined transmission method. The standardized transmission methods are available in the instrument as predefined standards.

**Setting parameters:**

<Standard>                      string

Specifies the file name that contains the transmission method without the extension. For user-defined standards, the file path must be included. Default standards predefined by Rohde&Schwarz do not require a path definition. A list of short forms for predefined standards is provided below.

**Example:**

```
DDEM:PRES 'TETRA_NDDOWN'
```

Switches the predefined digital standard "TETRA\_DiscontinuousDownlink" on.

```
DDEM:PRES 'C:\R_S\Instr\usr\standards\USER_GSM'
```

Switches the user-defined digital standard "USER\_GSM" on.

**Mode:**                              VSA

**Manual operation:**    See "[Load Standard](#)" on page 108

For predefined standards, the following short forms can be used:

```
3G_WCDMA_FWD = 3G_WCDMA
3G_WCDMA_REV = 3G_WCDMA
APCO25_C4FM
APCO25_CQPSK
Bluetooth_DH1
Bluetooth_DH3
Bluetooth_DH5
CDMA2K_1X_FWD = F1CD
CDMA2K_1X_REV = R1CD
DECT_P32_FixedPart = DECT_FP
DECT_P32_PortablePart
DVB_S2_16APSK
DVB_S2_32APSK
DVB_S2_8PSK
DVB_S2_QPSK
EDGE_NB = EDGE_8PSK
EDGE_NormalBurst = EDGE_8PSK
```



EDGE\_16QAM  
 EDGE\_32QAM  
 F1CD = CDMA2K\_1X\_FWD  
 GSM\_AB = GSM\_AccessBurst  
 GSM\_FB = GSM\_FrequencyBurst  
 GSM = GSM\_NormalBurst  
 GSM\_AB = GSM\_AccessBurst  
 GSM\_FB = GSM\_FrequencyBurst  
 GSM\_NB = GSM\_NormalBurst  
 GSM\_SB = GSM\_SynchronisationBurst  
 TETRA\_NCDOWN = TETRA\_ContinuousDownlink  
 TETRA\_NDDOWN = TETRA\_DiscontinuousDownlink  
 ZIGBEE\_BPSK\_868M\_300K  
 ZIGBEE\_BPSK\_915M\_600K  
 ZIGBEE\_OQPSK\_2450M\_1M

---

**[SENSe:]DDEMod:PSK:FORMat <Name>**

Together with `DDEMod:PSK:NST`, this command defines the demodulation order for PSK (see also [\[SENSe:\]DDEMod:PSK:NSTate](#) on page 298). Depending on the demodulation format and state, the following orders are available:

NSTate	Format	Order
2	any	BPSK -Pi/2-BPSK
8	NORMal	8PSK
8	DIFFerential	D8PSK
8	N3Pi8	3pi/8-8PSK (EDGE)
8	PI8D8PSK	Pi/8-D8PSK

**Setting parameters:**

<Name>                    NORMal | DIFFerential | N3Pi8 | PI8D8PSK  
 \*RST:                    QPSK

**Example:**

```
DDEMod:FORM PSK
Switches PSK demodulation on.
DDEMod:PSK:NST 8
DDEMod:PSK:FORM DIFF
Switches D8PSK demodulation on.
```

**Mode:** VSA

**Manual operation:** See "[Modulation Order](#)" on page 144

---

**[SENSe:]DDEMod:PSK:NState <PSKNstate>**

Together with `DDEMod:PSK:FORMat`, this command defines the demodulation order for PSK (see also [\[SENSe:\]DDEMod:PSK:FORMat](#) on page 297). Depending on the demodulation format and state, the following orders are available:

NState	FORMat	Order
2	any	BPSK
8	NORMal	8PSK
8	DIFFerential	D8PSK
8	N3Pi8	3pi/8-8PSK (EDGE)
8	PI8D8PSK	Pi/8-D8PSK

**Setting parameters:**

<PSKNstate> numeric value  
 \*RST: 2

**Example:** `DDEM:FORM PSK`  
 Switches PSK demodulation on.  
`DDEMod:PSK:NSt 8`  
`DDEM:PSK:FORM DIFF`  
 Switches D8PSK demodulation on.

**Mode:** VSA

---

**[SENSe:]DDEMod:QAM:FORMat <Name>**

This command defines the specific demodulation mode for QAM.

The current firmware release of the R&S FSV-K70 does not support Differential QAM.

**Setting parameters:**

<Name> NORMal | DIFFerential | NPI4 | MNPI4  
 \*RST: QPSK

**Example:** `DDEM:FORM QAM`  
 Switches QAM demodulation on.  
`DDEM:QAM:FORM NPI4`  
 Switches Pi/4-16QAM demodulation on.

**Mode:** VSA

**Manual operation:** See "[Modulation Order](#)" on page 144

**[SENSe:]DDEMod:QAM:NState <QAMNState>**

This command defines the demodulation order for QAM.

NState	Order
16	16QAM
16	Pi/4-16QAM
32	32QAM
32	Pi/4-32QAM
64	64QAM
128	128QAM
256	256QAM

**Setting parameters:**

<QAMNState>      numeric value  
 \*RST:            16

**Example:**

DDEM:FORM QAM  
 Switches QAM demodulation on.  
 DDEM:QAM:NST 64  
 Switches 64QAM demodulation on.

**Mode:**            VSA

**[SENSe:]DDEMod:QPSK:FORMat <Name>**

This command defines the demodulation order for QPSK.

FORMat	Order
NORMal	QPSK
DIFFerential	DQPSK
OFFSet	OQPSK
DPI4	PI/4 DQPSK

**Setting parameters:**

<Name>            NORMAL | DIFFerential | DPI4 | OFFSet  
 \*RST:            NORMAL

**Example:**

DDEM:FORM QPSK  
 Switches QPSK demodulation on.  
 DDEM:QPSK:FORM DPI4  
 Switches pi/4 DQPSK demodulation on.

**Mode:**            VSA

**Manual operation:** See "[Modulation Order](#)" on page 144

**[SENSe:]DDEMod:RLENgth:AUTO** <RecLengthAuto>

This command switches the automatic adaptation of the capture length on or off. The automatic adaptation is performed so that a sufficient capture length is set as a function of result length, burst and pattern search and network-specific characteristics (e.g. burst and frame structure).

**Setting parameters:**

<RecLengthAuto> ON | OFF  
\*RST: ON

**Example:** DDEMod:RLEN:AUTO OFF  
Does not set "RLENgth" automatically.

**Mode:** VSA

**Manual operation:** See "[Capture Length Auto](#)" on page 154

**[SENSe:]DDEMod:RLENgth[:VALue]** <RecordLength>

This command defines the capture length for further processing, e.g. for burst search. The "RLENgth" is given in time (S) or symbols (SYM). As a result of a query, the value is given in time.

Note that the maximum record length depends on the capture oversampling rate (see "[Capture Oversampling](#)" on page 154). For the default value =4, the maximum is 50.000. For larger oversample rates, the maximum record length can be calculated as:

$$\text{Recordlength}_{\text{MAX}} = 200.000 / \text{<Capture oversampling>}$$

**Setting parameters:**

<RecordLength> numeric value  
Range: 100 symbols = 26.042 us to 50000 symbols = 13.021 ms  
\*RST: 8000 symbols = 2.083 ms  
Default unit: S

**Example:** DDEMod:RLEN 1000SYM  
Sets a capture length of 1000 symbols.

**Mode:** VSA

**Manual operation:** See "[Capture Length](#)" on page 154

**[SENSe:]DDEMod:SBANd** <SidebandPos>

This command selects the sideband for the demodulation.

**Setting parameters:**

<SidebandPos> NORMal | INVerse  
**NORMal**  
 Normal (non-inverted) position  
**INVerse**  
 Inverted position  
 \*RST: NORMal

**Example:**

DDEM:SBAN INV  
 Selects the inverted position.

**Mode:** VSA

**Manual operation:** See "[Swap I/Q](#)" on page 155

**[SENSe:]DDEMod:SEARch:BURSt:AUTO <AutoBurstSearch>**

This command links the burst search to the type of signal. When a signal is marked as bursted, burst search is switched on automatically (see also "[Auto/On/Off](#)" on page 159).

**Setting parameters:**

<AutoBurstSearch> AUTO | MANual  
 \*RST: AUTO

**Example:**

:DDEM:SEAR:BURS:AUTO AUTO  
 Enables auto burst search.

**Mode:** VSA

**Manual operation:** See "[Auto/On/Off](#)" on page 159

**[SENSe:]DDEMod:SEARch:BURSt:CONFIgure:AUTO <AutoConfigure>**

This command sets the search tolerance and the min gap length to their default values.

**Setting parameters:**

<AutoConfigure> ON | OFF  
 \*RST: ON

**Example:**

SENS:DDEM:SEAR:BURS:CONF:AUTO ON

**Mode:** VSA

**Manual operation:** See "[Auto Configuration](#)" on page 159

**[SENSe:]DDEMod:SEARch:BURSt:GLEnGth[:MINimum] <MinGapLength>**

This command defines the minimum time between two bursts. A minimum time with decreased level must occur between two bursts. The default unit is a symbol. The value can also be given in seconds.

**Setting parameters:**

<MinGapLength> numeric value  
 Range: 1 to 15000  
 \*RST: 1  
 Default unit: SYM

**Example:** DDEM:SEAR:BURSt:GLEn 3US

**Mode:** VSA

**Manual operation:** See "[Min Gap Length](#)" on page 159

**[SENSe:]DDEMod:SEARch:BURSt:LENGth:MAXimum <MaxLength>**

This command defines the maximum length of a burst. Only those bursts will be recognized that fall below this length. The default unit is symbols. The value can also be given in seconds.

**Setting parameters:**

<MaxLength> numeric value  
 Range: 0 to 15000  
 \*RST: 1600  
 Default unit: SYM

**Example:** DDEM:SEAR:BURSt:LENG:MAX 156 us  
 The maximum burst length is 156  $\mu$ s.

**Mode:** VSA

**[SENSe:]DDEMod:SEARch:BURSt:LENGth[:MINimum] <UsefulLength>**

This command defines the minimum length of a burst. Only those bursts will be recognized that exceed this length. The default unit is symbols. The value can also be given in seconds.

**Setting parameters:**

<UsefulLength> numeric value  
 Range: 10 to 15000  
 \*RST: 98  
 Default unit: SYM

**Example:** DDEM:SEAR:BURSt:LENG 140 us  
 The minimum burst length is 140 us.

**Mode:** VSA

**[SENSe:]DDEMod:SEARch:BURSt:MODE <MeasOnlyOnBurst>**

This command sets the vector analyzer so that a measurement is performed only if a burst is found ("BURSt"). The command is available only if the burst search is activated beforehand using the DDEM:SEARch:BURSt:STATe = ON command (see [\[SENSe:\]DDEMod:SEARch:BURSt:STATe](#) on page 303).

**Setting parameters:**

<MeasOnlyOnBurst> MEAS | BURS  
 \*RST: MEAS

**Example:**

DDEM:SEAR:BURS:MODE BURS  
 Measurement is performed only if burst is found.

**Mode:** VSA

**Manual operation:** See "[Meas only if burst was found](#)" on page 159

**[SENSe:]DDEMod:SEARch:BURSt:SKIP:FALLing <RunOut>**

This command defines the length of the falling burst edge which is not considered when evaluating the result.

The default unit is symbols. The value can also be given in seconds.

**Setting parameters:**

<RunOut> numeric value  
 Range: 0 to 15000  
 \*RST: 1  
 Default unit: SYM

**Example:**

DDEM:SEAR:BURS:SKIP:FALL 5US  
 5 µs of the rising burst edge are not considered

**Mode:** VSA

**[SENSe:]DDEMod:SEARch:BURSt:SKIP:RISing <RunIn>**

This command defines the length of the rising burst edge which is not considered when evaluating the result. The default unit is symbols. The value can also be given in seconds.

**Setting parameters:**

<RunIn> numeric value  
 Range: 0 to 15000  
 \*RST: 1  
 Default unit: SYM

**Example:**

DDEM:SEAR:BURS:SKIP:RIS 5US  
 5 us of the rising burst edge are not considered

**Mode:** VSA

**[SENSe:]DDEMod:SEARch:BURSt:STATe <SearchState>**

This command switches the search for a signal burst on or off.

**Setting parameters:**

<SearchState> ON | OFF  
 \*RST: OFF

**Example:** DDEM:SEAR:BURS OFF  
Switches burst search off.

**Mode:** VSA

**[SENSe:]DDEMod:SEARch:BURSt:TOLerance <SearchTolerance>**

This command controls burst search tolerance.

**Setting parameters:**

<SearchTolerance> numeric value  
Range: 0 to 100000  
\*RST: 4  
Default unit: SYM

**Example:** :DDEM:SEAR:BURS:TOL 1  
Sets the burst tolerance to 1

**Mode:** VSA

**Manual operation:** See "[Search Tolerance](#)" on page 159

**[SENSe:]DDEMod:SEARch:MBURst:CALC <SelectResRangeNr>**

Sets the result range to be displayed after a single sweep.

**Setting parameters:**

<SelectResRangeNr> numeric value  
Range: 1 to 1000000  
\*RST: 1  
Default unit: NONE

**Mode:** VSA

**Manual operation:** See "[Select Result Rng](#)" on page 119

**[SENSe:]DDEMod:SEARch:MBURst:STARt?**

This command queries the start of the current result range within the capture buffer.

**Return values:**

<StartValue> Symbol or time at which x-axis starts



**Example:**

```

INIT:CONT OFF
//switch to single sweep mode
INIT;*WAI
//perform single sweep
SENS:DDEM:SEAR:MBUR:CALC 1
//switch to first result range
SENS:DDEM:SEAR:MBUR:START?
//query start of current (=first) result range
// in the capture buffer
SENS:DDEM:SEAR:MBUR:CALC 2
//switch to second result range
SENS:DDEM:SEAR:MBUR:START?
//query start of current (=second) result range
// in the capture buffer

```

**Usage:** Query only

**[SENSe:]DDEMod:SEARch:PATtern:CONFigure:AUTO <AutoConfigure>**

This command sets the IQ correlation threshold to its default value.

**Setting parameters:**

<AutoConfigure> ON | OFF  
\*RST: ON

**Example:** SENS:DDEM:SEAR:PATT:CONF:AUTO ON

**Mode:** VSA

**Manual operation:** See "[Auto Configuration](#)" on page 161

**[SENSe:]DDEMod:SEARch:PATtern:SYNC[:STATe] <FastSync>**

Switches fast synchronization on and off, if you manually synchronize with a waveform pattern.

**Setting parameters:**

<FastSync> ON | OFF  
\*RST: OFF

**Mode:** VSA

**Manual operation:** See "[Coarse Synchronization](#)" on page 172

**[SENSe:]DDEMod:SEARch:PATtern:SYNC:AUTO <UseWfmForSync>**

This command selects manual or automatic synchronization with a pattern waveform to speed up measurements.

**Setting parameters:**

<UseWfmForSync> AUTO | MANual  
\*RST: AUTO

**Mode:** VSA

**Manual operation:** See "[Coarse Synchronization](#)" on page 172

**[SENSe:]DDEMod:SEARch:SYNC:AUTO** <AutoPatternSearch>

This command links the pattern search to the type of signal. When a signal is marked as patterned, pattern search is switched on automatically.

**Setting parameters:**

<AutoPatternSearch> AUTO | MANual

\*RST: AUTO

**Example:** :DDEM:SEAR:SYNC AUTO  
Enables auto pattern search

**Mode:** VSA

**Manual operation:** See "[Auto/On/Off](#)" on page 161

**[SENSe:]DDEMod:SEARch:SYNC:CATalog** <Patterns>

This command reads the names of all patterns stored on the hard disk.

**Setting parameters:**

<Patterns> CURRent | ALL

**CURRent**

Only patterns that belong to the current standard

**ALL**

All patterns

\*RST: ALL

**Example:** :DDEM:PRES 'GSM\_AB'  
Selects the digital standard "GSM Access Burst".  
:DDEM:SEAR:SYNC:PATT:ADD 'GSM\_TSC1'  
Adds "GSM\_TSC1" to standard.  
:DDEM:SEAR:SYNC:CAT? CURR  
Reads out all patterns that belong to the standard.

**Mode:** VSA

**[SENSe:]DDEMod:SEARch:SYNC:COMMent** <Comment>

This command defines a comment to a sync pattern. The pattern must have been selected before using the `DDEM:SEARch:SYNC:NAME` command (see [\[SENSe:\]DDEMod:SEARch:SYNC:NAME](#) on page 309).

**Setting parameters:**

<Comment> string

**Example:**                   : DDEM:SEAR:SYNC:NAME 'GSM\_TSC0'  
                                   Name of pattern.  
                                   : DDEM:SEAR:SYNC:DATA '0001000000000001'  
                                   Data of pattern.  
                                   : DDEM:SEAR:SYNC:COMM 'PATTERN FOR PPSK'  
                                   Comment.

**Mode:**                    VSA

**Manual operation:**    See "Edit" on page 163  
                                   See "New" on page 163  
                                   See "Comment" on page 165

---

#### [SENSe:]DDEMod:SEARch:SYNC:COPY <Pattern>

This command copies a pattern file. The pattern to be copied must have been selected before using the `DDEM:SEARch:SYNC:NAME` command (see [\[SENSe:\]DDEMod:SEARch:SYNC:NAME](#) on page 309).

**Tip:** In manual operation, a pattern can be copied in the editor by storing it under a new name.

#### Setting parameters:

<Pattern>                   string

**Example:**                   : DDEM:SEAR:SYNC:NAME 'GSM\_TSC0'  
                                   Selects the pattern.  
                                   : DDEM:SEAR:SYNC:COPY 'GSM\_PATT'  
                                   Copies "GSM\_TSC0" to GSM\_PATT.

**Usage:**                    Setting only

**Mode:**                    VSA

---

#### [SENSe:]DDEMod:SEARch:SYNC:DATA <Data>

This command defines the sync sequence of a sync pattern. The pattern must have been selected before using the `DDEM:SEARch:SYNC:NAME` command (see [\[SENSe:\]DDEMod:SEARch:SYNC:NAME](#) on page 309).

**Important:** The value range of a symbol depends on the degree of modulation, e.g. for an 8PSK modulation the value range is from 0 to 7. The degree of modulation belongs to the pattern and is set using the `DDEM:SEAR:SYNC:NST` command (see [\[SENSe:\]DDEMod:SEARch:SYNC:NSTate](#) on page 309).

For details on defining patterns, see ["To create a new pattern"](#) on page 191.

**Setting parameters:**

&lt;Data&gt; string

Four values represent a symbol (hexadecimal format). The value range of a symbol depends on the degree of modulation. With a degree of modulation of 4, all symbols have a value range of: 0000, 0001, 0002, 0003; with a degree of modulation of 8: 0000, 0001, 0002, 0003, 0004, 0005, 0006, 0007.

**Mode:** VSA

**Manual operation:** See "Edit" on page 163  
 See "New" on page 163  
 See "Symbols" on page 165

**[SENSe:]DDEMod:SEARch:SYNC:DELeTe**

This command deletes a sync sequence. The sync sequence to be deleted must have been selected before using the `DDEMod:SEARch:SYNC:NAME` command (see [\[SENSe:\]DDEMod:SEARch:SYNC:NAME](#) on page 309).

**Example:** `:DDEMod:SEAR:SYNC:NAME 'GSM_TSC0'`  
 Selects the pattern.  
`:DDEMod:SEAR:SYNC:DEL`  
 Deletes GSM\_TSC0 pattern.

**Usage:** Event**Mode:** VSA**Manual operation:** See "Delete" on page 163**[SENSe:]DDEMod:SEARch:SYNC:FOUNd <Name>**

This command returns the name of the pattern that was found.

**Setting parameters:**

&lt;Name&gt; string

**Example:** `DDEMod:SEAR:SYNC:FOUN?`**[SENSe:]DDEMod:SEARch:SYNC:IQCThreshold <CorrelationLev>**

This command sets the IQ correlation threshold for pattern matching in percent. A high level means stricter matching. See "[I/Q Correlation Threshold](#)" on page 161 for details.

**Setting parameters:**

<CorrelationLev> numeric value  
 Range: 10.0 to 100.0  
 \*RST: 90.0  
 Default unit: PCT

**Example:** `SENS:DDEMod:SEAR:SYNC:IQCT 85.5`

**Mode:** VSA

**Manual operation:** See "[I/Q Correlation Threshold](#)" on page 161

#### [SENSe:]DDEMod:SEARch:SYNC:MODE <MeasOnlyOnPattern>

This command sets the vector analyzer so that the measurement is performed only if the measurement was synchronous to the selected sync pattern (SYNC). The measured values are displayed and considered in the error evaluation only if the set sync pattern was found. Bursts with a wrong sync pattern (sync not found) are ignored. If an invalid or no sync pattern is found, the measurement waits and resumes running only when a valid sync pattern is found. The command is available only if the sync sequence search is activated using the `DDEMod:SEARch:BURSt:STATe = ON` command (see [[SENSe:](#)] `DDEMod:SEARch:BURSt:STATe` on page 303). With "MEAS" selected, the measurement is performed independently of successful synchronization.

#### Setting parameters:

<MeasOnlyOnPattern>MEAS | SYNC

\*RST: MEAS

**Example:** :DDEMod:SEAR:SYNC:MODE SYNC

The measurement is performed only with successful synchronization.

**Mode:** VSA

**Manual operation:** See "[Auto/On/Off](#)" on page 161  
See "[Meas only if pattern symbols correct](#)" on page 161

#### [SENSe:]DDEMod:SEARch:SYNC:NAME <Name>

This command selects a sync pattern for editing or for a new entry.

#### Setting parameters:

<Name> string

**Example:** :DDEMod:SEAR:SYNC:NAME 'GSM\_TSC0'

Selects the pattern GSM\_TSC0.

**Mode:** VSA

**Manual operation:** See "[Edit](#)" on page 163  
See "[New](#)" on page 163  
See "[Name](#)" on page 164

#### [SENSe:]DDEMod:SEARch:SYNC:NState <NState>

This command selects the degree of modulation (number of permitted states). The pattern must have been selected before using the `DDEMod:SEARch:SYNC:NAME` command (see [[SENSe:](#)] `DDEMod:SEARch:SYNC:NAME` on page 309).

The number of permitted states depends on the modulation mode.

**Setting parameters:****<NState>** numeric value**Example:**

:DDEM:SEAR:SYNC:NAME 'GSM\_TSC0'

Selects the GSM\_TSC0 pattern.

:DDEM:SEAR:SYNC:DATA '00010001'

Enters 00010001 as data.

:DDEM:SEAR:SYNC:NST 4

Sets the degree of modulation.

**Mode:** VSA**Manual operation:** See "[Mod. order](#)" on page 165**[SENSe:]DDEMod:SEARch:SYNC:PATtern:ADD <AddPattern>**

This command adds a pattern to the current standard. Using the `DDEM:SEAR:SYNC:SEL` command, only those patterns can be selected which belong to the current standard (see [\[SENSe:\]DDEMod:SEARch:SYNC:SElect](#) on page 310).

**Setting parameters:****<AddPattern>** string**Example:**

DDEM:PRES 'TETRA\_NCDOWN'

Selects the standard "TETRA\_NCDOWN".

DDEM:SEAR:SYNC:PATT:ADD 'TETRA\_S1'

Adds the pattern "TETRA\_S1" to the standard.

**Usage:** Setting only**Mode:** VSA**Manual operation:** See "[Add to Standard](#)" on page 163**[SENSe:]DDEMod:SEARch:SYNC:PATtern:REMOve**

This command deletes one or all patterns from the current standard.

**Example:**

DDEM:PRES 'TETRA\_NCDOWN'

Selects the digital standard "Tetra".

DDEM:SEAR:SYNC:PATT:REM 'pattern'

Removes the pattern "pattern" from the "Tetra" standard.

**Usage:** Setting only**Mode:** VSA**Manual operation:** See "[Remove from Standard](#)" on page 163**[SENSe:]DDEMod:SEARch:SYNC:SElect <Select>**

This command selects a predefined sync pattern file.

**Setting parameters:**

<Select> string

**Example:** DDEM:SEAR:SYNC:SEL 'GSM\_TSC0'

**Mode:** VSA

**Manual operation:** See ["Select Pattern for Search"](#) on page 161

**[SENSe:]DDEMod:SEARch:SYNC:STATe <PatternSearch>**

This command switches the search for a sync sequence on or off.

**Setting parameters:**

<PatternSearch> ON | OFF

\*RST: OFF

**Example:** DDEM:SEAR:SYNC ON  
Switches the sync search on.

**Mode:** VSA

**Manual operation:** See ["Pattern Search On"](#) on page 162

**[SENSe:]DDEMod:SEARch:SYNC:TEXT <Text>**

This command defines a text to explain the pattern. The text is displayed only in the selection menu (manual control). This text should be short and concise. Detailed information about the pattern is given in the comment (see [\[SENSe:\]DDEMod:SEARch:SYNC:COMMeNt](#) on page 306).

**Setting parameters:**

<Text> string

**Example:** SENS:DDEM:SEAR:SYNC:NAME 'GSM\_1'  
Selects the "GSM\_1" pattern.  
:DDEM:SEAR:SYNC:DATA '1001'  
Enter pattern "1001".  
:DDEM:SEAR:SYNC:TEXT 'TEST S25'  
Enter text for the "GSM\_1" pattern.

**Mode:** VSA

**Manual operation:** See ["Edit"](#) on page 163  
See ["New"](#) on page 163  
See ["Description"](#) on page 164

**[SENSe:]DDEMod:SIGNAL:PATTERn <PatternedSignal>**

This command specifies whether the signal contains a pattern or not.

**Setting parameters:**

<PatternedSignal> ON | OFF

\*RST: OFF

**Mode:** VSA

**Manual operation:** See "[Pattern](#)" on page 147

**[SENSe:]DDEMod:SIGNal[:VALue]** <SignalType>

This command specifies whether the signal is bursted or continuous.

**Setting parameters:**

<SignalType> CONTInuous | BURSted  
\*RST: CONTInuous

**Mode:** VSA

**Manual operation:** See "[Continuous Signal / Burst Signal](#)" on page 147

**[SENSe:]DDEMod:SRATe** <SymbolRate>

This command defines the symbol rate.

**Setting parameters:**

<SymbolRate> numeric value  
For details on the possible values see [Table 2-1](#).  
\*RST: 3.84e6  
Default unit: Hz

**Mode:** VSA

**Manual operation:** See "[Symbol Rate](#)" on page 145

**[SENSe:]DDEMod:STANdard:COMMeNt** <Comment>

This command enters the comment for a new standard. The comment is stored with the standard and is only displayed in the selection menu (manual operation). When remote control is used, the string is deleted after the standard has been stored, allowing a new comment to be entered for the next standard. In this case a blank string is returned when a query is made.

**Setting parameters:**

<Comment> string

**Mode:** VSA

**[SENSe:]DDEMod:STANdard:DELeTe** <FileName>

This command deletes a specified digital standard file in the vector signal analysis. The file name includes the path. If the file does not exist, an error message is displayed.

**Setting parameters:**

<FileName> string  
File name including the path for the digital standard file



**Example:** SENS:DDEM:STAN:DEL 'C:\path\standardname'  
**Usage:** Setting only  
**Mode:** VSA  
**Manual operation:** See ["Delete Standard"](#) on page 109

#### [SENSe:]DDEMod:STANdard:PREset[:VALue]

This command restores the default settings of the currently selected standard.

**Usage:** Event  
**Mode:** VSA  
**Manual operation:** See ["Standard Defaults"](#) on page 109

#### [SENSe:]DDEMod:STANdard:SAVE <FileName>

This command stores the current settings of the vector signal analysis as a new user-defined digital standard. If the name of the digital standard is already in use, an error message is output and a new name has to be selected. It is recommended that you define a comment before storing the standard.

##### Setting parameters:

<FileName> string  
 The path and file name to which the settings are stored.

**Example:** DDEM:STAN:COMM 'GSM\_AccessBurst with Pattern'  
 Defines a comment for the settings.  
 DDEM:STAN:SAVE 'C:  
 \R\_S\Instr\usr\standards\USER\_GSM'  
 Stores the settings in the user-defined digital standard  
 "USER\_GSM".

**Usage:** Setting only  
**Mode:** VSA  
**Manual operation:** See ["Save As Standard"](#) on page 108

#### [SENSe:]DDEMod:STANdard:SYNC:OFFSet:STATe <PatternOffsState>

This command (de)activates the pattern offset.

##### Setting parameters:

<PatternOffsState> ON | OFF  
 \*RST: OFF

**Mode:** VSA  
**Manual operation:** See ["Offset"](#) on page 148

---

**[SENSe:]DDEMod:STANdard:SYNC:OFFSet[:VALue] <PatternOffset>**

This command defines a number of symbols which are ignored before the comparison with the pattern starts.

**Setting parameters:**

<PatternOffset>      numeric value  
                          Range:      0 to 15000  
                          \*RST:      0  
                          Default unit: SYM

**Mode:**                      VSA

**Manual operation:**    See "Offset" on page 148

---

**[SENSe:]DDEMod:TFILter:ALPHa <Alpha>**

This command determines the filter characteristic (ALPHA/BT). The resolution is 0.01.

**Setting parameters:**

<Alpha>                    numeric value  
                          Range:      0.05 to 1.0  
                          \*RST:      0.22  
                          Default unit: NONE

**Mode:**                      VSA

---

**[SENSe:]DDEMod:TFILter:NAME <Name>**

This command selects a transmit filter and automatically switches it on.

For more information on Transmit filters, refer to [Chapter 2.2.4, "Modulation and Demodulation Filters"](#), on page 14.

**Parameters:**

<Name>                    Name of the Transmit filter; an overview of available Transmit filters is provided in [Table 2-3](#).

**Example:**                    SENS:DDEM:TFIL:NAME 'RRC'  
                          Selects the RRC filter.

**Mode:**                      VSA

**Manual operation:**    See "Transmit filter Type" on page 145  
                          See "Load User Filter" on page 145

---

**[SENSe:]DDEMod:TFILter[:STATe] <TXFilterState>**

Use this command to switch the Transmit filter off. To switch a Transmit filter on, use the `[SENSe:]DDEMod:TFILter:NAME` command.

**Setting parameters:**

<TXFilterState> ON | OFF

**OFF**  
Switches the Transmit filter off.

**ON**  
Switches the Transmit filter specified by [SENSe:]DDEMod:TFILter:NAME on. However, this command is not necessary, as the [SENSe:]DDEMod:TFILter:NAME command automatically switches the filter on.

\*RST: ON

**Example:** SENS:DDEM:TFIL:STAT OFF

**Mode:** VSA

**Manual operation:** See "Transmit filter Type" on page 145

**[SENSe:]DDEMod:TFILter:USER <FilterName>**

This command selects a user-defined Transmit filter file.

**Setting parameters:**

<FilterName> The name of the Transmit filter file.

**Example:** SENS:DDEM:TFIL:NAME 'USER'  
Defines the use of a user-defined Transmit filter.  
SENS:DDEM:TFIL:USER 'D:\MyTXFilter'  
Selects the user-defined filter "MyTXFilter"

**Mode:** VSA

**[SENSe:]DDEMod:TIME <ResultLength>**

The command determines the number of displayed symbols (result length).

**Setting parameters:**

<ResultLength> numeric value

Range: 10 to 10000 (FMR-7) / 20000 (others), depending on CPU board; indicated in "SETUP > System Info > Hardware Info"

\*RST: 800

Default unit: SYM

**Example:** DDEM:TIME 80  
Sets result length to 80 symbols.

**Mode:** VSA

**Manual operation:** See "Result Length" on page 166

---

**[SENSe:]DDEMod:UQAM:FORMat <Name>**

This command selects the type of UserQAM demodulation.

**Setting parameters:**

<Name>                    string  
Name of the UserQAM demodulation

**Example:**                DDEM:FORM UQAM  
Selects user QAM demodulation.  
DDEM:UQAM:FORM '32ary'  
Selects 32ary user QAM name.  
DDEM:MAPP 'DVB\_S2\_32APSK\_34'  
Selects the mapping DVB\_S2\_32APSK\_34.

**Mode:**                    VSA

---

**[SENSe:]DDEMod:UQAM:NState?**

This command returns the order of the active UserQAM.

**Usage:**                    Query only

**Mode:**                    VSA

---

**[SENSe:]FREQuency:CENTer <Frequency>**

This command defines the center frequency (frequency domain) or measuring frequency (time domain).

**Parameters:**

<Frequency>                Range:        0 to fmax  
                              \*RST:        fmax/2  
                              Default unit: Hz  
                               $f_{max}$  is specified in the data sheet. min span is 10 Hz

**Example:**                FREQ:CENT 100 MHz

**Manual operation:**    See "[Center](#)" on page 110  
                              See "[Frequency](#)" on page 150

---

**[SENSe:]FREQuency:CENTer:STEP <StepSize>**

This command defines the center frequency step size.

**Parameters:**

<StepSize>                Range:        1 to fmax  
                              \*RST:        0.1 x <span value>  
                              Default unit: Hz

**Example:**                FREQ:CENT:STEP 120 MHz

**Manual operation:**    See "[CF Stepsize](#)" on page 110

**[SENSe:]FREQuency:CENTer:STEP:AUTO <State>**

This command links the step width to the current standard (ON) or sets the step width entered using the `FREQ:CENT:STEP` command (OFF) (see [\[SENSe:\]FREQuency:CENTer:STEP](#) on page 316).

**Parameters:**

<State> ON | OFF  
\*RST: ON

**Example:**

`FREQ:CENT:STEP:AUTO ON`  
Activates the coupling of the step size to the span.

**Manual operation:** See ["Stepsize Auto/Man"](#) on page 110

**[SENSe:]FREQuency:OFFSet <Offset>**

This command defines the frequency offset.

**Parameters:**

<Offset> Range: -100 GHz to 100 GHz  
\*RST: 0 Hz  
Default unit: Hz

**Example:**

`FREQ:OFFS 1GHZ`

**Manual operation:** See ["Frequency Offset"](#) on page 110

**[SENSe:]SWEep:COUNT[:VALue] <SweepCount>**

This command sets the statistics count. Entering 0 as a parameter activates "Auto" mode. Entering a number greater than 0 activates "Manual" mode and sets the statistics count to the corresponding number.

For more information see

- ["Statistics Count"](#) on page 119

**Setting parameters:**

<SweepCount> numeric value  
Range: 0 to 32767  
\*RST: 0  
Default unit: NONE

**Example:**

`INIT:CONT ON`  
Activates continuous sweep mode.  
`SWE:COUN 0`  
Records the I/Q data continuously and uses a sliding window length for averaging of 10.  
`INIT:CONT OFF`  
Activates single sweep mode  
`SWE 5`  
Records I/Q data until 5 evaluations have finished.

**Usage:** SCPI confirmed  
**Mode:** VSA  
**Manual operation:** See "[Statistics Count](#)" on page 119

---

**[SENSe:]SWEep:COUNT:CURRent <Counter>**

This command queries the current statistics counter value which indicates how many result ranges have been evaluated. For results that use the capture buffer as a source, the number of used capture buffers can be queried.

**Setting parameters:**

<Counter> CAPTure | STATistics

**STATistics**

Returns the number of result ranges that have been evaluated.

**CAPTure**

Returns the number of used capture buffers evaluated.

\*RST: STATistics

**Mode:** VSA

## 4.12 STATus:QUEStionable Subsystem

The following commands can be used to query the contents of the status registers specific to the R&S FSV-K70 option.

For details see [Chapter 5, "Status Reporting System \(Option R&S FSV-K70\)"](#), on page 332.

<a href="#">STATus:QUEStionable:CONDition</a> .....	319
<a href="#">STATus:QUEStionable[:EVENTj]?</a> .....	319
<a href="#">STATus:QUEStionable:MODulation&lt;n&gt;:ENABLE</a> .....	319
<a href="#">STATus:QUEStionable:MODulation&lt;n&gt;:CONDition?</a> .....	319
<a href="#">STATus:QUEStionable:MODulation&lt;n&gt;[:EVENTj]?</a> .....	320
<a href="#">STATus:QUEStionable:MODulation&lt;n&gt;:NTRansition</a> .....	320
<a href="#">STATus:QUEStionable:MODulation&lt;n&gt;:PTRansition</a> .....	320
<a href="#">STATus:QUEStionable:MODulation&lt;n&gt;:&lt;ResultType&gt;[:EVENTj]?</a> .....	321
<a href="#">STATus:QUEStionable:MODulation&lt;n&gt;:&lt;ResultType&gt;:CONDition?</a> .....	321
<a href="#">STATus:QUEStionable:MODulation&lt;n&gt;:&lt;ResultType&gt;:ENABLE?</a> .....	322
<a href="#">STATus:QUEStionable:MODulation&lt;n&gt;:&lt;ResultType&gt;:NTRansition?</a> .....	322
<a href="#">STATus:QUEStionable:MODulation&lt;n&gt;:&lt;ResultType&gt;:PTRansition?</a> .....	323
<a href="#">STATus:QUEStionable:SYNC:CONDition?</a> .....	323
<a href="#">STATus:QUEStionable:SYNC:ENABLE</a> .....	324
<a href="#">STATus:QUEStionable:SYNC:NTRansition</a> .....	324
<a href="#">STATus:QUEStionable:SYNC:PTRansition</a> .....	324
<a href="#">STATus:QUEStionable:SYNC[:EVENTj]?</a> .....	324

---

**STATus:QUEStionable:CONDition**

This command queries the CONDition part of the "STATus:QUEStionable" register. This part contains the sum bit of the next lower register. This register part can only be read, but not written into or cleared. Readout does not delete the contents of the CONDition part.

**Example:** STAT:QUES:COND?

**Mode:** all

---

**STATus:QUEStionable[:EVENT]?**

This command queries the contents of the EVENT part of the STATus:QUEStionable register. The EVENT part indicates whether an event has occurred since the last reading, it is the "memory" of the condition part. It only indicates events passed on by the transition filters. It is permanently updated by the instrument. This part can only be read by the user. Reading the register clears it.

**Example:** STAT:QUES?

**Usage:** Query only

**Mode:** all

---

**STATus:QUEStionable:MODulation<n>:ENABLE <Enable>**

Determines whether the EVENT bit of the STATus:QUEStionable:MODulation<n> register contributes to the sum bit of the STATus:QUEStionable register.

**Suffix:**

<n> 1..4

**Setting parameters:**

<Enable> **0**  
the associated EVENT bit does not contribute to the sum bit  
**1**  
if the associated EVENT bit is "1", the sum bit is set to "1" as well

**Usage:** SCPI confirmed

**Mode:** all

---

**STATus:QUEStionable:MODulation<n>:CONDition?**

Contains the sum bit of the next lower register (STATus:QUEStionable:MODulation<n>:<ResultType>). Its contents reflect the evaluation status. This register part can only be read, but not written into or cleared. Its contents are not affected by reading.

**Suffix:**

<n> 1..4

**Usage:** Query only  
SCPI confirmed

**Mode:** VSA

#### **STATus:QUEStionable:MODulation<n>[:EVENT]?**

The EVENT part indicates whether an event has occurred since the last reading, it is the "memory" of the condition part. It only indicates events passed on by the transition filters. It is permanently updated by the instrument. This part can only be read by the user. Reading the register clears it.

Possible events (limit violations) are described in [Chapter 5.3, "STATus:QUEStionable:MODulation<n> Register"](#), on page 335.

**Suffix:**  
<n> 1..4

**Usage:** Query only  
SCPI confirmed

**Mode:** VSA

#### **STATus:QUEStionable:MODulation<n>:NTRansition <NTransition>**

This bit acts as a transition filter. When a bit of the CONDition part of the STATus:QUEStionable:MODulation<n> register is changed from 1 to 0, the NTR bit decides whether the EVENT bit is set to 1.

**Suffix:**  
<n> 1..4

**Setting parameters:**  
<NTransition> **0**  
the EVENT bit is not set  
**1**  
the EVENT bit is set

**Usage:** SCPI confirmed

**Mode:** VSA

#### **STATus:QUEStionable:MODulation<n>:PTRansition <PTransition>**

This bit acts as a transition filter. When a bit of the CONDition part of the STATus:QUEStionable:MODulation<n> register is changed from 0 to 1, the NTR bit decides whether the EVENT bit is set to 1.

**Suffix:**  
<n> 1..4



**Setting parameters:**

<PTransition>           **0**  
                                   the EVENT bit is not set

**1**  
                                   the EVENT bit is set

**Usage:**                   SCPI confirmed

**Mode:**                   VSA

**STATus:QUEStionable:MODulation<n>:<ResultType>[:EVENT]?**

The EVENT part indicates whether an event has occurred in the evaluation of the selected result type since the last reading. It only indicates events passed on by the transition filters. It is permanently updated by the instrument. This part can only be read by the user. Reading the register clears it.

Possible events (limit violations) are described for the individual result types in [Chapter 5, "Status Reporting System \(Option R&S FSV-K70\)"](#), on page 332.

**Suffix:**

<n>                           1..4

<ResultType>           CFRequency | EVM | FSK | IQRHo | MAGNitude | PHASe  
 CFRequency = limit violations in Carrier Frequency evaluation  
 EVM = limit violations in EVM evaluation  
 FSK = limit violations in FSK evaluation  
 IQRHo = limit violations in I/Q-Offset and RHO evaluation  
 MAGNitude = limit violations in Magnitude Error evaluation  
 PHASe = limit violations in Phase Error evaluation

**Usage:**                   Query only  
                                   SCPI confirmed

**Mode:**                   VSA

**STATus:QUEStionable:MODulation<n>:<ResultType>:CONDition?**

Contains the result of the limit check during evaluation. This register part can only be read, but not written into or cleared. Readout does not delete the contents of the CONDition section.

**Suffix:**

<n>                           1..4

<ResultType>           CFRequency | EVM | FSK | IQRHo | MAGNitude | PHASe  
 CFRequency = limit violations in Carrier Frequency evaluation  
 EVM = limit violations in EVM evaluation  
 FSK = limit violations in FSK evaluation  
 IQRHo = limit violations in I/Q-Offset and RHO evaluation  
 MAGNitude = limit violations in Magnitude Error evaluation  
 PHASe = limit violations in Phase Error evaluation

**Usage:** Query only  
SCPI confirmed

**Mode:** VSA

#### STATus:QUESTionable:MODulation<n>:<ResultType>:ENABLE? <Mode>

Determines whether the `EVENTt` bit of the associated status register for the result type contributes to the sum bit of the `STATus:QUESTionable:MODulation` register.

Each bit of the `EVENTt` part is "ANDed" with the associated `ENABLE` bit. The results of all logical operations of this part are passed on to the event sum bit via an "OR" function.

**Suffix:**

<n> 1..4

<ResultType> CFRequency | EVM | FSK | IQRHo | MAGNitude | PHASe  
 CFRequency = limit violations in Carrier Frequency evaluation  
 EVM = limit violations in EVM evaluation  
 FSK = limit violations in FSK evaluation  
 IQRHo = limit violations in I/Q-Offset and RHO evaluation  
 MAGNitude = limit violations in Magnitude Error evaluation  
 PHASe = limit violations in Phase Error evaluation

**Setting parameters:**

<Mode> **0**  
the associated `EVENTt` bit does not contribute to the sum bit  
**1**  
if the associated `EVENTt` bit is "1", the sum bit is set to "1" as well

**Usage:** Query only  
SCPI confirmed

**Mode:** VSA

#### STATus:QUESTionable:MODulation<n>:<ResultType>:NTRansition? <Mode>

This bit acts as a transition filter. When a bit of the `CONDition` part of the associated status register for the result type is changed from 1 to 0, the `NTR` bit decides whether the `EVENTt` bit is set to 1.

**Suffix:**

<n> 1..4

<ResultType> CFRequency | EVM | FSK | IQRHo | MAGNitude | PHASe  
 CFRequency = limit violations in Carrier Frequency evaluation  
 EVM = limit violations in EVM evaluation  
 FSK = limit violations in FSK evaluation  
 IQRHo = limit violations in I/Q-Offset and RHO evaluation  
 MAGNitude = limit violations in Magnitude Error evaluation  
 PHASe = limit violations in Phase Error evaluation

**Setting parameters:**

<Enable>           **0**  
the EVENT bit is not set

**1**  
the EVENT bit is set

**Usage:**            Query only  
                          SCPI confirmed

**Mode:**             VSA

**STATus:QUEStionable:MODulation<n>:<ResultType>:PTRansition? <Mode>**

This bit acts as a transition filter. When a bit of the CONDition part of the associated status register for the result type is changed from 0 to 1, the PTR bit decides whether the EVENT bit is set to 1.

**Suffix:**

<n>                    1..4

<ResultType>        CFRequency | EVM | FSK | IQRHo | MAGNitude | PHASe  
CFRequency = limit violations in Carrier Frequency evaluation  
EVM = limit violations in EVM evaluation  
FSK = limit violations in FSK evaluation  
IQRHo = limit violations in I/Q-Offset and RHO evaluation  
MAGNitude = limit violations in Magnitude Error evaluation  
PHASe = limit violations in Phase Error evaluation

**Setting parameters:**

<Enable>            **0**  
the EVENT bit is not set

**1**  
the EVENT bit is set

**Usage:**            Query only  
                          SCPI confirmed

**Mode:**             VSA

**STATus:QUEStionable:SYNC:CONDition? <ChannelName>**

This command reads out the CONDition section of the status register.

The command does not delete the contents of the EVENT section.

**Query parameters:**

<ChannelName>      String containing the name of the channel.  
The parameter is optional. If you omit it, the command works for the currently active channel.

**Usage:**            Query only

---

**STATus:QUEStionable:SYNC:ENABLE** <SumBit>,<ChannelName>

This command controls the ENABle part of a register.

The ENABle part allows true conditions in the EVENt part of the status register to be reported in the summary bit. If a bit is 1 in the enable register and its associated event bit transitions to true, a positive transition will occur in the summary bit reported to the next higher level.

**Parameters:**

<SumBit>	Range: 0 to 65535
<ChannelName>	String containing the name of the channel. The parameter is optional. If you omit it, the command works for the currently active channel.

---

**STATus:QUEStionable:SYNC:NTRansition** <SumBit>,<ChannelName>

This command controls the Negative TRansition part of a register.

Setting a bit causes a 1 to 0 transition in the corresponding bit of the associated register. The transition also writes a 1 into the associated bit of the corresponding EVENt register.

**Parameters:**

<SumBit>	Range: 0 to 65535
<ChannelName>	String containing the name of the channel. The parameter is optional. If you omit it, the command works for the currently active channel.

---

**STATus:QUEStionable:SYNC:PTRansition** <SumBit>,<ChannelName>

These commands control the Positive TRansition part of a register.

Setting a bit causes a 0 to 1 transition in the corresponding bit of the associated register. The transition also writes a 1 into the associated bit of the corresponding EVENt register.

**Parameters:**

<SumBit>	Range: 0 to 65535
<ChannelName>	String containing the name of the channel. The parameter is optional. If you omit it, the command works for the currently active channel.

---

**STATus:QUEStionable:SYNC[:EVENT]?** <ChannelName>

This command reads out the EVENt section of the status register.

The command also deletes the contents of the EVENt section.

**Query parameters:**

<ChannelName> String containing the name of the channel.  
The parameter is optional. If you omit it, the command works for the currently active channel.

**Usage:** Query only

## 4.13 SYSTem Subsystem

---

### SYSTem:DISPlay:UPDate <State>

In remote control mode, this command switches on or off the instrument display. If switched on, only the diagrams, traces and display fields are displayed and updated.

The best performance is obtained if the display output is switched off during remote control.

**Parameters:**

<State> ON | OFF  
\*RST: OFF

**Example:** SYST:DISP:UPD ON

## 4.14 TRACe subsystem

TRACe<n>[:DATA].....	325
TRACe<n>:IQ:BWIDth.....	327
TRACe:IQ:WBAND[:STATe].....	327

---

### TRACe<n>[:DATA] <Trace>

This command queries the trace data.

The data the R&S FSVA/FSV returns for each result display is as follows:

- **Capture Buffer**  
For the Capture Buffer result display, the command returns the y-axis values of the data that is stored in the capture buffer. The number of returned values depends on the size of the capture buffer and the oversampling rate. For example, a capture buffer of 500 in combination with an oversampling rate of 4 would return 2000 level values. The unit is dBm.
- **Cartesian diagrams**  
For cartesian diagrams, the command returns the Y values of the trace only (magnitude, phase, frequency, real/imag, eye diagrams). The number of returned values is the product of the Result Length and the Points per Symbol. The unit depends on the unit you have set previously. You can query the x value that relates to the first value of the y-axis with `DISPlay[:WINDow<n>]:TRACe<t>:X[:SCALE]:START?` on page 262.

When querying the results for eye diagrams, the results are merely superimposed in the display. This means that the eye diagram result displays are the same as the real/imag result display.

- **Polar diagrams**  
For polar diagrams, the command returns a pair of values for each trace point. The first value is the real part, the second value the imaginary part. The number of returned value pairs is the product of evaluation range length and points per symbol for the Vector I/Q result display and the evaluation range length for the Constellation I/Q result display.  
The Constellation Frequency and Vector Frequency result display return one value for each trace point on the y-axis.
- **Symbols**  
For the symbol table result diagrams, the command returns one value for each number in the table. The number of returned values depends on the modulation scheme you have selected.  
If no parameter is specified, the command always returns the values in the decimal format. If the parameter STRace is used, the format depends on the currently defined symbol format (see [CALCulate<n>:FORMat](#) on page 247).
- **Eye diagram**
- For eye diagrams, the command returns one value for each sample. The number of returned values is the product of evaluation range length and points per symbol.
- **Result Summary**  
For the Result Summary, the command returns all values listed in the result table from top to bottom. The order of the results is as follows:  
<result1\_current>, <result1\_mean>, <result1\_peak>, <result1\_stddev>,  
<result1\_95%ile>, <result2\_current>, <result2\_mean>, (...)  
Empty cells in the table return nothing. The number of returned values depends on the modulation scheme you have selected. PSK, MSK and QAM modulation returns 53 values, FSK modulation returns 42 values. The unit of each value depends on the particular result.

**Suffix:**

<n>                    1..4  
                          screen number

**Setting parameters:**

&lt;Trace&gt;

**TRACe1/2/3/4/5/6**

The complete data from the corresponding trace.

**TRACe1R/TRACe2R/TRACe3R**

The real data from the corresponding trace. The parameters are available for the Real/Imaginary result types.

**TRACe1I/TRACe2I/TRACe3I**

The imaginary data from the corresponding trace. The parameters are available for the Real/Imaginary result types.

**STRace**The symbols are returned in the currently defined symbol format (see [CALCulate<n>:FORMat](#) on page 247. (If no parameter is specified, the command always returns the values in the decimal format.)

Note that no leading zeros are returned (see example below).

**Example:**

TRAC? TRACE1

Queries data from trace 1.

**Example:**

```
calc4:form BINary
trace4:data? strace
//Queries data from symbol table in binary format
//Result (no leading zeros!):
1,1110,11,10,100,111,1101,1,1010,101,10,10,100,1111,...
```

**Mode:**

VSA

**TRACe<n>:IQ:BWIDth**

This command queries the flat, usable filter bandwidth of the final I/Q data.

**Suffix:**

&lt;n&gt; irrelevant

**Example:**

TRAC:IQ:BWID?

**Manual operation:** See "[Maximum Bandwidth](#)" on page 155**TRACe:IQ:WBAND[:STATe] <State>**

Activates or deactivates the bandwidth extension option R&amp;S FSV-B160, if installed.

Sample rates higher than 128 MHz can only be achieved using the bandwidth extension.

**Parameters:**

&lt;State&gt;

ON | OFF | FORCe160

**ON**

(Default) The maximum available bandwidth is used for all sample rates.

If the bandwidth extension option R&S FSV-B160 is installed, it is activated for bandwidths as of 64 MHz (if no other restrictions for its use apply, see [Chapter 2.2.2.1, "Restrictions"](#), on page 14).

Thus, sample rates up to 1.28 GHz and an I/Q bandwidth up to 160 MHz are possible.

Note that using the bandwidth extension may cause more spurious effects.

**OFF**

Deactivates use of the bandwidth extension option R&S FSV-B160, thus reducing possible spurious effects, while restricting the analysis bandwidth to 40 MHz.

**FORCe160**

The bandwidth extension option R&S FSV-B160 is always used (if no other restrictions for its use apply, see [Chapter 2.2.2.1, "Restrictions"](#), on page 14), thus raising the minimum possible sample rate to 32 MHz.

\*RST: ON

**Manual operation:** See "[Maximum Bandwidth](#)" on page 155

## 4.15 TRIGger subsystem

TRIGger<n>[:SEQuence]:LEVel:BBPower.....	328
TRIGger<n>[:SEQuence]:BBPower:HOLDoff.....	329
TRIGger<n>[:SEQuence]:LEVel:IFPower.....	329
TRIGger<n>[:SEQuence]:IFPower:HOLDoff.....	329
TRIGger<n>[:SEQuence]:IFPower:HYSTeresis.....	330
TRIGger<n>[:SEQuence]:HOLDoff[:TIME].....	330
TRIGger<n>[:SEQuence]:SLOPe.....	330
TRIGger<n>[:SEQuence]:SOURce.....	331

---

### TRIGger<n>[:SEQuence]:LEVel:BBPower <Level>

This command sets the level of the baseband power trigger source (for digital input via the R&S Digital I/Q Interface, R&S FSV-B17).

**Suffix:**

<n> irrelevant

**Parameters:**

&lt;Level&gt;

Range: -50 dBm to +20 dBm

\*RST: -20 DBM



**Example:** TRIG:LEV:BB -30DBM

**Mode:** All

**Manual operation:** See "Trigger Level" on page 125  
See "Trigger Mode" on page 155

#### TRIGger<n>[:SEQUENCE]:BBPower:HOLDoff <Value>

This command sets the holding time before the next BB power trigger event (for digital input via the R&S Digital I/Q Interface, R&S FSV-B17).

**Suffix:**  
<n> irrelevant

**Parameters:**  
<Value> \*RST: 150 ns

**Example:** TRIG:SOUR BBP  
Sets the baseband power trigger source.  
TRIG:BBP:HOLD 200 ns  
Sets the holding time to 200 ns.

**Mode:** all

**Manual operation:** See "Trigger Holdoff" on page 157

#### TRIGger<n>[:SEQUENCE]:LEVel:IFPower <TriggerLevel>

This command defines the power level at the third intermediate frequency that must be exceeded to cause a trigger event. Note that any RF attenuation or preamplification is considered when the trigger level is analyzed. If defined, a reference level offset is also considered.

**Suffix:**  
<n> irrelevant

**Parameters:**  
<TriggerLevel> \*RST: -20 dBm

**Example:** TRIG:LEV:IFP -30DBM

**Manual operation:** See "Trigger Level" on page 125  
See "Trigger Mode" on page 155

#### TRIGger<n>[:SEQUENCE]:IFPower:HOLDoff <Value>

This command sets the holding time before the next IF power trigger event.

**Suffix:**  
<n> irrelevant

**Parameters:**  
<Value> \*RST: 150 ns

**Example:** TRIG:SOUR IFP  
Sets the IF power trigger source.  
TRIG:IFP:HOLD 200 ns  
Sets the holding time to 200 ns.

**Manual operation:** See "[Trigger Holdoff](#)" on page 157

#### TRIGger<n>[:SEQUENCE]:IFPower:HYSteresis <Value>

This command sets the limit that the hysteresis value for the IF power trigger has to fall below in order to trigger the next measurement.

**Suffix:**  
<n> irrelevant

**Parameters:**  
<Value> \*RST: 3 dB

**Example:** TRIG:SOUR IFP  
Sets the IF power trigger source.  
TRIG:IFP:HYST 10DB  
Sets the hysteresis limit value.

**Manual operation:** See "[Trigger Hysteresis](#)" on page 157

#### TRIGger<n>[:SEQUENCE]:HOLDoff[:TIME] <Delay>

This command defines the length of the trigger delay.

A negative delay time (pretrigger) can be set in zero span only.

**Suffix:**  
<n> irrelevant

**Parameters:**  
<Delay> Range: zero span: -sweptime (see data sheet) to 30 s;  
span: 0 to 30 s  
\*RST: 0 s

**Example:** TRIG:HOLD 500us

**Manual operation:** See "[Trigger Offset](#)" on page 125

#### TRIGger<n>[:SEQUENCE]:SLOPe <Type>

This command selects the slope of the trigger signal. The selected trigger slope applies to all trigger signal sources.

**Suffix:**  
<n> irrelevant

**Parameters:**  
<Type> POSitive | NEGative  
\*RST: POSitive

**Example:** TRIG:SLOP NEG

**Manual operation:** See ["Trigger Polarity"](#) on page 125

**TRIGger<n>[:SEQuence]:SOURce <Source>**

This command selects the trigger source.

IF power and RF power triggers are not available together with the bandwidth extension option R&S FSV-B160.

For details on trigger modes refer to the "Trg/Gate Source" softkey in the base unit description.

**Suffix:**

<n> irrelevant

**Parameters:**

<Source>

**IMMediate**

Free Run

**EXtern**

External trigger

**IFPower**

Power trigger at the second intermediate frequency

**BBPower**

Baseband power (for digital input via the R&S Digital I/Q Interface, R&S FSV-B17)

\*RST: IMMediate

**Example:**

TRIG:SOUR EXT

Selects the external trigger input as source of the trigger signal

**Manual operation:**

See ["Free Run"](#) on page 124

See ["External"](#) on page 124

See ["IF Power/ Baseband Power"](#) on page 124

See ["Trigger Mode"](#) on page 155

## 5 Status Reporting System (Option R&S FSV-K70)

The status reporting system stores all information on the current operating state of the instrument, e.g. information on errors or limit violations which have occurred. This information is stored in the status registers and in the error queue. The status registers and the error queue can be queried via IEC bus.

In this section, only the new and altered status registers/bits for the VSA option (R&S FSV-K70) are described. Detailed information on the status registers of the base system is given in the section "Status Reporting System" in chapter 5 of the Operating Manual on CD.

### Description of the Status Registers

In addition to the registers provided by the base system, the following registers are used in the VSA option (R&S FSV-K70):

- `STATUS:QUESTIONable:SYNC<n>` - contains application-specific information about synchronization errors or errors during burst detection
- `STATUS:QUESTIONable:MODulation<n>` – provides information on any limit violations that occur after demodulation in one of the 4 windows
- `STATUS:QUESTIONable:MODulation<n>:EVM` - limit violations in EVM evaluation
- `STATUS:QUESTIONable:MODulation<n>:PHASe` - limit violations in Phase Error evaluation
- `STATUS:QUESTIONable:MODulation<n>:MAGnitude` - limit violations in Magnitude Error evaluation
- `STATUS:QUESTIONable:MODulation<n>:CFRequency` - limit violations in Carrier Frequency evaluation
- `STATUS:QUESTIONable:MODulation<n>:IQRHO` - limit violations in I/Q-Offset and RHO evaluation
- `STATUS:QUESTIONable:MODulation<n>:FSK` - limit violations in FSK evaluation



The status of the `STATUS:QUESTIONable:MODulation` register is indicated in bit 7 of the "STATUS:QUESTIONable" register. It can be queried using the `STATUS:QUESTIONable[:EVENT]?` command.

---

The commands to query the contents of the following status registers are described in Chapter 4.12, "STATUS:QUESTIONable Subsystem", on page 318.

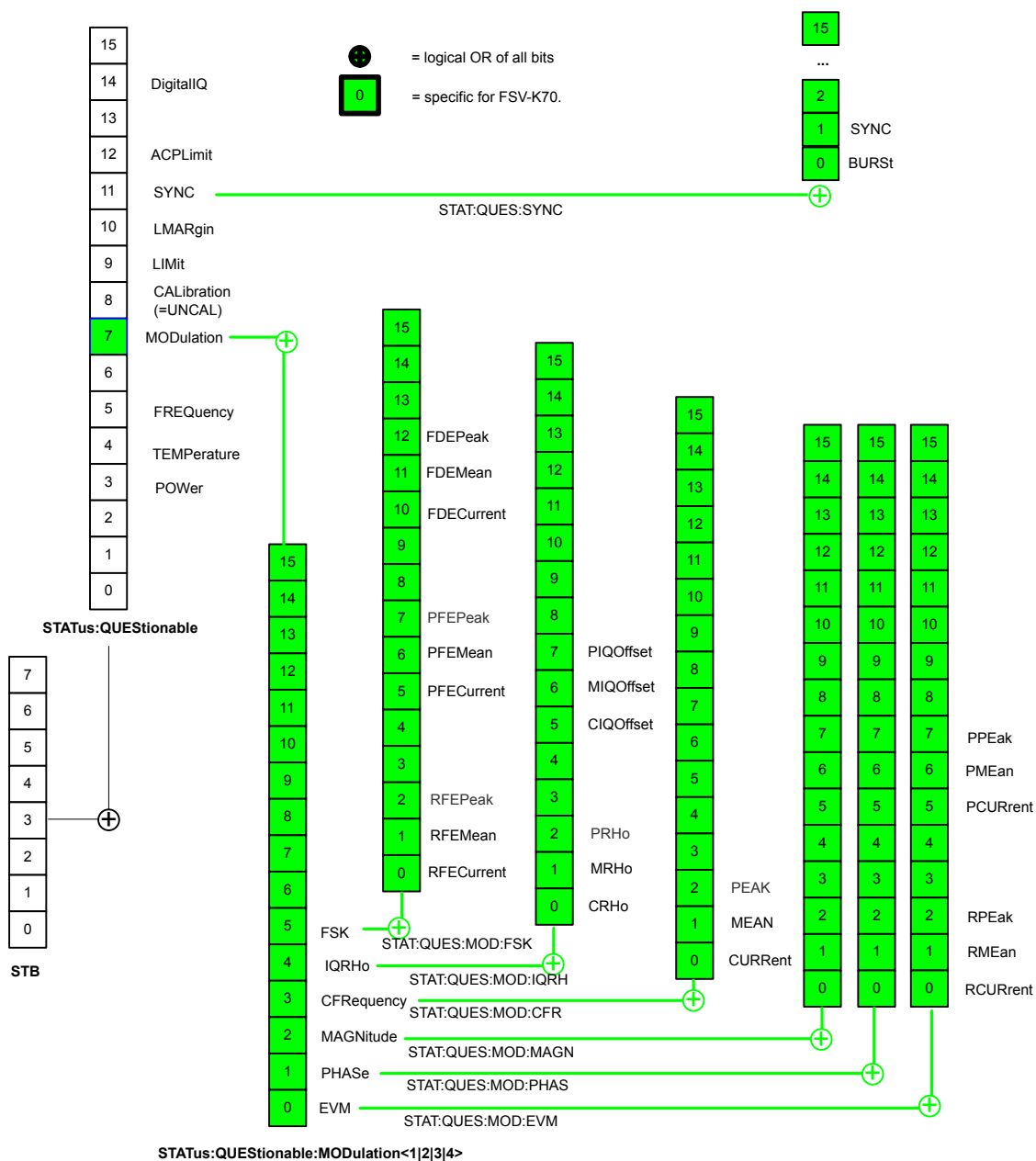


Figure 5-1: Overview of VSA-specific status registers

5.1 STATUS:QUESTIONable Register..... 334

5.2 STATUS:QUESTIONable:SYNC<n> Register..... 335

5.3 STATUS:QUESTIONable:MODulation<n> Register..... 335

5.4 STATUS:QUESTIONable:MODulation<n>:EVM Register..... 336

5.5 STATUS:QUESTIONable:MODulation<n>:PHASe Register..... 336

5.6 STATUS:QUESTIONable:MODulation<n>:MAGNitude Register..... 337

5.7	STATus:QUESTionable:MODulation<n>:CFRequency Register.....	337
5.8	STATus:QUESTionable:MODulation<n>:IQRHO Register.....	337
5.9	STATus:QUESTionable:MODulation<n>:FSK Register.....	338

## 5.1 STATus:QUESTionable Register

This register contains information about indefinite states which may occur if the instrument is operated without meeting the specifications or defined limits. It can be read using the commands `STATus:QUESTionable:CONDition` and `STATus:QUESTionable[:EVENT]?`.

**Table 5-1: Meaning of the bits used in the STATus:QUESTionable register**

Bit No.	Meaning
0 to 2	These bits are not used
3	POWer This bit is set if a questionable power occurs (see <code>STATus:QUESTionable:POWer</code> register).
4	TEMPerature This bit is set if a questionable temperature occurs.
5	FREQuency The bit is set if a frequency is questionable (see <code>STATus:QUESTionable:FREQuency</code> register).
6	Not used
7	MODulation The bit is set if a limit violation occurs after demodulation (see <code>STATus:QUESTionable:MODulation&lt;n&gt;</code> Register)
8	CALibration The bit is set if a measurement is performed unaligned ("UNCAL" display)
9	LIMit (device-specific) This bit is set if a limit value is violated (see <code>STATus:QUESTionable:LIMit</code> register)
10	LMARgin (device-specific) This bit is set if a margin is violated (see <code>STATus:QUESTionable:LMARgin</code> register)
11	SYNC (device-specific) This bit is set if, in measurements or pre-measurements, synchronization to midamble fails or no burst is found. This bit is also set if, in pre-measurements mode, the result differs too strongly from the expected value.
12	ACPLimit (device-specific) This bit is set if a limit for the adjacent channel power measurement is violated (see <code>STATus:QUESTionable:ACPLimit</code> register)
13	Not used

Bit No.	Meaning
14	Digital I/Q (device-specific) This bit is set if a connection error occurs at the R&S Digital I/Q Interface (R&S FSV-B17 option), see STATUs:QUEStionable:DIQ register
15	This bit is always 0.

## 5.2 STATUs:QUEStionable:SYNC<n> Register

This register contains application-specific information about synchronization errors or errors during burst detection for each window in each VSA channel. It can be queried with commands [STATUs:QUEStionable:SYNC:CONDition?](#) on page 323 and [STATUs:QUEStionable:SYNC\[:EVENT\]?](#) on page 324.

*Table 5-2: Status error bits in STATUs:QUEStionable:SYNC register for R&S FSV-K70*

Bit	Definition
0	Burst not found. This bit is set if a burst could not be detected.
1	Sync not found This bit is set if the sync sequence (pattern) of the midamble could not be detected.
2 to 14	Not used.
15	This bit is always 0.

## 5.3 STATUs:QUEStionable:MODulation<n> Register

This register comprises information about any limit violations that may occur after demodulation in any of the four windows. It can be queried with commands [STATUs:QUEStionable:MODulation<n>:CONDition?](#) on page 319 and [STATUs:QUEStionable:MODulation<n>\[:EVENT\]?](#) on page 320.

Bit No	Meaning
0	Error in EVM evaluation
1	Error in Phase Error evaluation
2	Error in Magnitude Error evaluation
3	Error in Carrier Frequency evaluation
4	Error in I/Q offset or RHO evaluation
5	Error in FSK evaluation
6-15	These bits are not used

## 5.4 STATus:QUESTionable:MODulation<n>:EVM Register

This register comprises information about limit violations in EVM evaluation. It can be queried with commands

STATus:QUESTionable:MODulation<n>:EVM:CONDition and  
STATus:QUESTionable:MODulation<n>:EVM[:EVENT].

Bit No	Meaning
0	Error in current RMS value
1	Error in mean RMS value
2	Error in peak RMS value
3-4	These bits are not used
5	Error in current peak value
6	Error in mean peak value
7	Error in peak peak value
8-15	These bits are not used

## 5.5 STATus:QUESTionable:MODulation<n>:PHASe Register

This register comprises information about limit violations in Phase Error evaluation. It can be queried with commands

STATus:QUESTionable:MODulation<n>:PHASe:CONDition and  
STATus:QUESTionable:MODulation<n>:PHASe[:EVENT].

Bit No	Meaning
0	Error in current RMS value
1	Error in mean RMS value
2	Error in peak RMS value
3-4	These bits are not used
5	Error in current peak value
6	Error in mean peak value
7	Error in peak peak value
8-15	These bits are not used



## 5.6 STATus:QUESTionable:MODulation<n>:MAGNitude Register

This register comprises information about limit violations in Magnitude Error evaluation. It can be queried with commands

STATus:QUESTionable:MODulation<n>:MAGNitude:CONDition and  
STATus:QUESTionable:MODulation<n>:MAGNitude[:EVENT].

Bit No	Meaning
0	Error in current RMS value
1	Error in mean RMS value
2	Error in peak RMS value
3-4	These bits are not used
5	Error in current peak value
6	Error in mean peak value
7	Error in peak peak value
8-15	These bits are not used

## 5.7 STATus:QUESTionable:MODulation<n>:CFRequency Register

This register comprises information about limit violations in Carrier Frequency evaluation. It can be queried with commands

STATus:QUESTionable:MODulation<n>:CFREquency:CONDition and  
STATus:QUESTionable:MODulation<n>:CFREquency[:EVENT].

Bit No	Meaning
0	Error in current value
1	Error in mean value
2	Error in peak value
3-15	These bits are not used

## 5.8 STATus:QUESTionable:MODulation<n>:IQRHO Register

This register comprises information about limit violations in I/Q offset or RHO evaluation. It can be queried with commands

STATus:QUESTionable:MODulation<n>:IQRHO:CONDition and  
 STATus:QUESTionable:MODulation<n>:IQRHO[:EVENT].

Bit No	Meaning
0	Error in current RHO value
1	Error in mean RHO value
2	Error in peak RHO value
3-4	These bits are not used
5	Error in current I/Q offset value
6	Error in mean I/Q offset value
7	Error in peak I/Q offset value
8-15	These bits are not used

## 5.9 STATus:QUESTionable:MODulation<n>:FSK Register

This register comprises information about limit violations in FSK evaluation. It can be queried with commands

STATus:QUESTionable:MODulation<n>:FSK:CONDition and  
 STATus:QUESTionable:MODulation<n>:FSK[:EVENT].

Bit No	Meaning
0	Error in current Frequency Error RMS value
1	Error in mean Frequency Error RMS value
2	Error in peak Frequency Error RMS value
3-4	These bits are not used
5	Error in current Frequency Error peak value
6	Error in mean Frequency Error peak value
7	Error in peak Frequency Error peak value
8-9	These bits are not used
10	Error in current Frequency Deviation value
11	Error in mean Frequency Deviation value
12	Error in peak Frequency Deviation value
13-15	These bits are not used

## 6 Support

The "R&S Support" softkey in the SAVE/RCL > "Export" menu stores useful information for troubleshooting in case of errors.

This data is stored in the `C:\R_S\Instr\user\Support` directory on the instrument.

The `SupportSave.dfl` file contains the instrument settings and input data and can be loaded to the instrument again for inspection later. (Remember to set the sweep mode to "Single Sweep" beforehand, as "Continuous Sweep" would immediately overwrite the loaded input data.)

If you contact the Rohde&Schwarz support to get help for a certain problem, send these files to the support in order to identify and solve the problem faster.

### 6.1 Explanation of Error Messages

The following section describes error messages and possible causes.

Message: Burst Not Found.....	339
Message: Pattern Not Found.....	342
Message: Sync failed. Check for all zero signal.....	343
Message: Result Alignment Failed.....	343
Message: Pattern Search On, But No Pattern Selected.....	345
Message: Pattern Not (Entirely) Within Result Range.....	345
Message: Short Pattern: Pattern Search Might Fail.....	345
Message: Sync Prefers More Valid Symbols.....	346
Message: Sync Prefers Longer Pattern.....	347
Message: Result Ranges Overlap.....	348

#### Message: Burst Not Found

The "Burst Not Found" error message can have several causes:

- **Burst search is active, but the signal is not bursted**

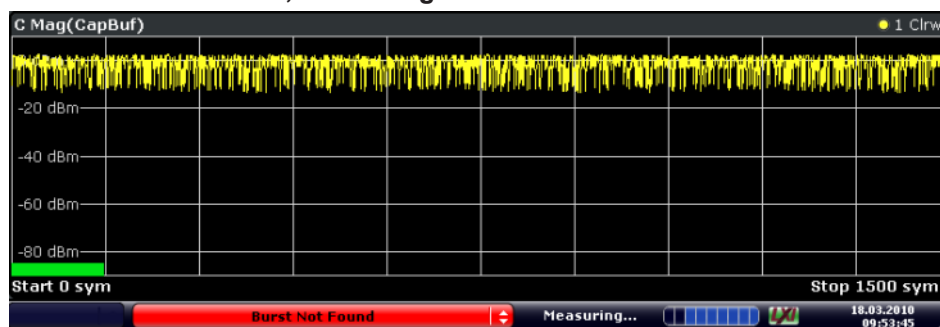


Figure 6-1: Example for active burst search with continuous signal

Solution: Select "Continuous Signal" as the signal type.

For more information, see

- "Signal Description" on page 146.

- **Signal is bursted, but bursts have not been captured completely**  
The burst search can only find bursts that start and end within the capture buffer. It ignores bursts that are cut off.



Figure 6-2: Example for incomplete burst capture

Solution: Change the trigger settings and/or enlarge the capture length.

For more information, see

– ["/Q Capture"](#) on page 152

- **The current measurement is being performed on a burst that has not been captured completely.**

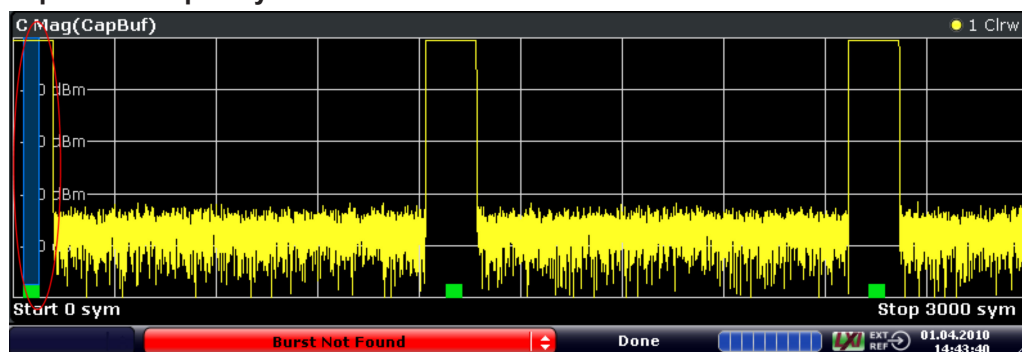


Figure 6-3: Example for measurement on incomplete burst capture

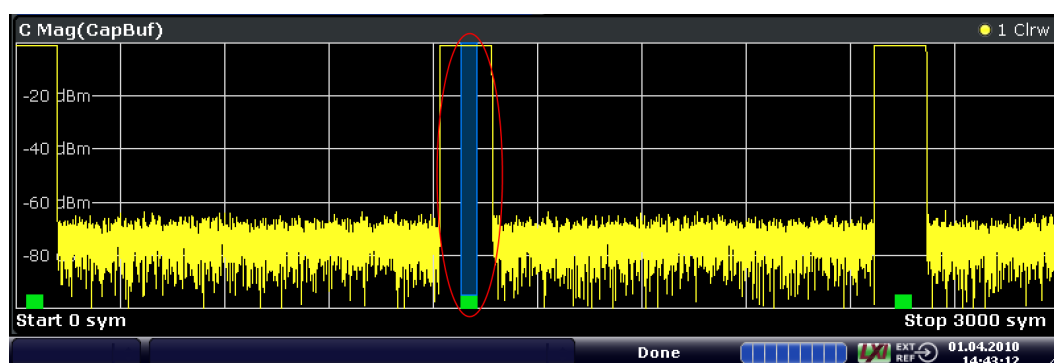


Figure 6-4: Example for measurement on complete burst capture

Solution:

Change the trigger settings or increase the result length.

Note, however, that in this case, the results are actually correct and the message can be ignored.

- **The settings do not match the signal**

In order to allow you to select certain bursts, the burst search only searches for bursts that have a length between "Min Length" and "Max Length" (plus a tolerance that you can set in the "Burst Search" Dialog). In case the burst is, e.g. shorter than the "Burst Min Length", the burst search fails.

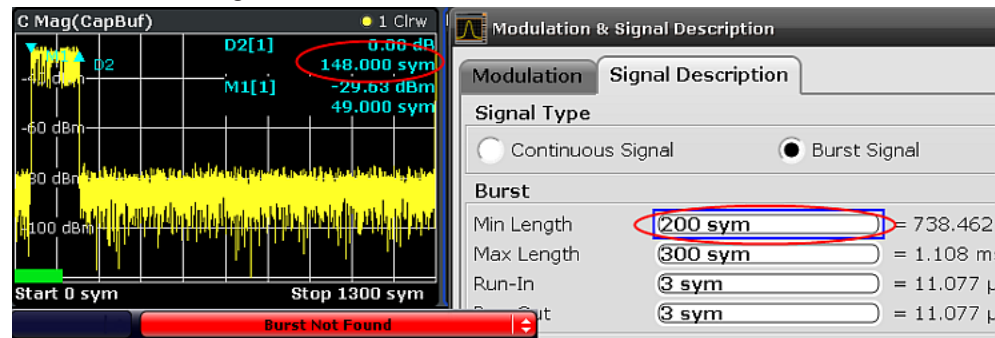


Figure 6-5: Example for a failed burst search due too a burst that is too short

Solution: try one of the following:

- Switch on the Magnitude (Capture Buffer) result display. Move a marker to the start of the burst. Move a delta marker to the end of the burst and compare the burst length to the settings in the "Signal Description" dialog.
- Increase the search tolerance in the "Burst Search" dialog. Keep an eye on the green/red field. If the burst search succeeds, you can see the length of the found bursts.
- Set the minimum burst length to 50 and the maximum burst length to 5000.

For more information, see:

- ["Signal Description"](#) on page 146
- [Chapter 3.2.9, "Softkeys of the Marker Menu \(R&S FSV-K70\)"](#), on page 128
- ["Burst Search"](#) on page 158

- **The signal is highly distorted and/or has modulation noise**

One possibility to enhance the robustness of the burst search is to increase the minimum gap length. If the bursts within your capture buffer are not closely spaced, it makes sense to increase the value of this parameter.

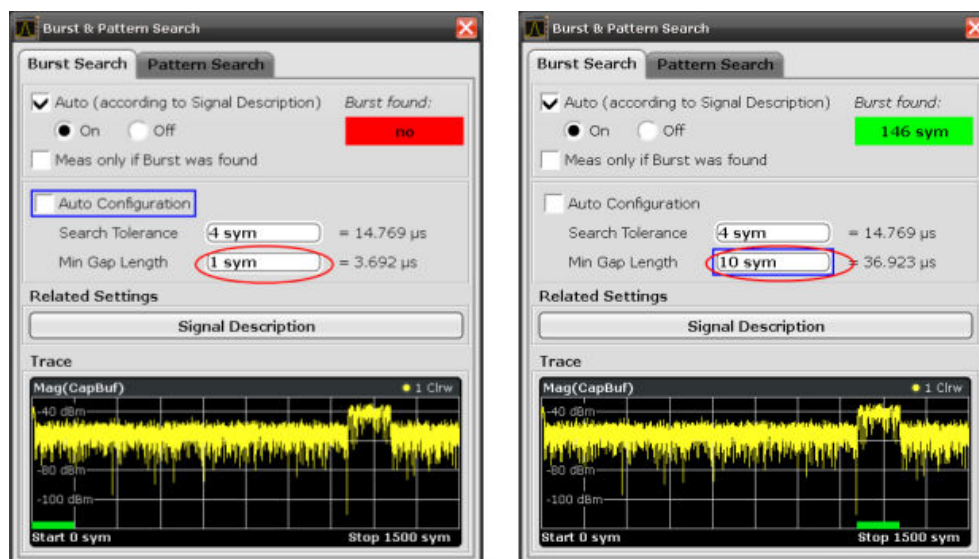


Figure 6-6: Example for adjusting the minimum gap length

For more information, see  
["Burst Search"](#) on page 158

- **The pattern search is switched on, fails and the alignment is with reference to the pattern.**

In case the pattern search is switched on and the reference for the alignment is the pattern (and not the burst), a non-detected pattern causes the result range to be positioned at the beginning of the capture buffer. Hence, if a the burst does not start right at the beginning of the capture buffer, you will see a "Burst Not Found" Message.

Solution:

- Refer to ["Message: Pattern Not Found"](#) on page 342
- Switch the pattern search off.
- Choose "Burst" as the reference for the result range alignment.

#### Message: Pattern Not Found

The "Pattern Not Found" error message can have several causes:

- **The burst search has failed**

If burst and pattern search are active, the application looks for patterns only within the found bursts. Hence, in case the burst search fails, the pattern search will also fail.

Solution: Try one of the following:

- Make sure the burst search is successful.
- Deactivate the burst search but keep the pattern search active.

For more information, see

- ["Message: Burst Not Found"](#) on page 339
- ["Burst Search"](#) on page 158

- **The offset of the pattern within the burst is incorrectly set**

It is possible to set a pattern offset to speed up the pattern search. The offset of the pattern would be the offset of the pattern start with respect to the start of the useful part of the burst. However, if the entered offset is not correct (within about 4 symbols of tolerance), the pattern will not be found.

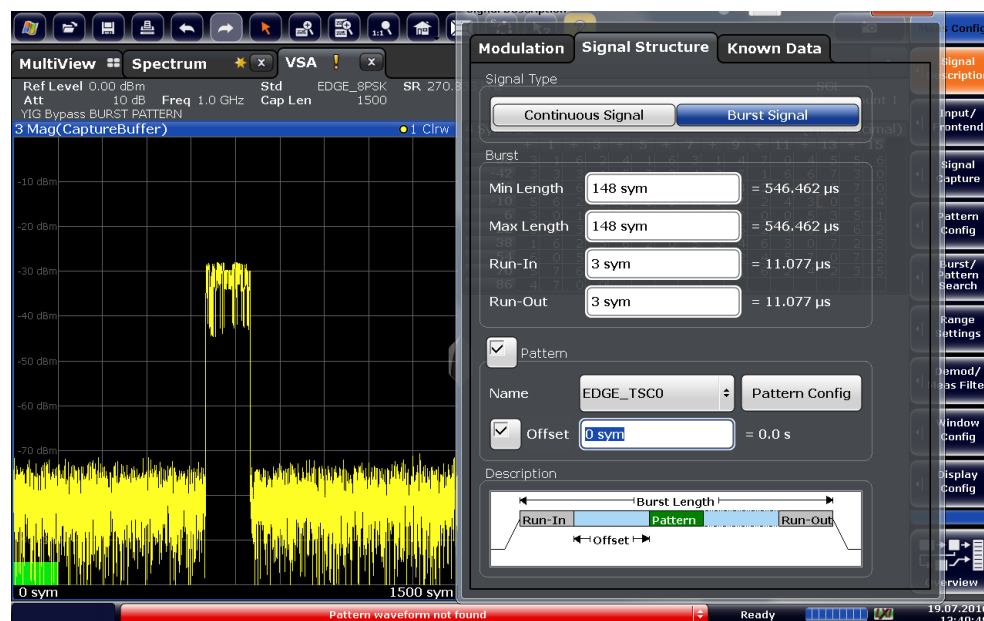


Figure 6-7: GSM EDGE burst; Pattern is actually located in the middle of the burst. The correct value for "Offset" here would be 58.

Solution: Try one of the following:

- Remove the offset ('unknown').
- Enter the correct offset (within about 4 symbols of tolerance).

For more information, see

- ["Signal Description"](#) on page 146

- The specified pattern does not coincide with the pattern in your signal: In the R&S FSQ-K70 it is possible to search for multiple patterns at the same time. For example, in a GSM measurement, the capture buffer can be checked for all TSCs simultaneously. This is not possible in the R&S FSV-K70.

Solution:

Make sure that the correct pattern is specified in the "Signal Description" dialog.

For more information, see

- ["Signal Description"](#) on page 146

#### Message: Sync failed. Check for all zero signal.

A prerequisite for correct synchronization is a random data sequence of an adequate size.

Solution: Make sure the input signal contains an adequate number of uncorrelated (random!) bits. (Not 0 0 0 0 0, 1 1 1 1 1, or 01 01 01 01 01, for example.)

For QAM modulation, the result length (the data on which synchronization is based) should correspond to at least 8 times the modulation order (see ["Result Length"](#) on page 166).

#### Message: Result Alignment Failed

The result range alignment is not possible for the particular capture buffer. The result range needs I/Q data that has not been captured.

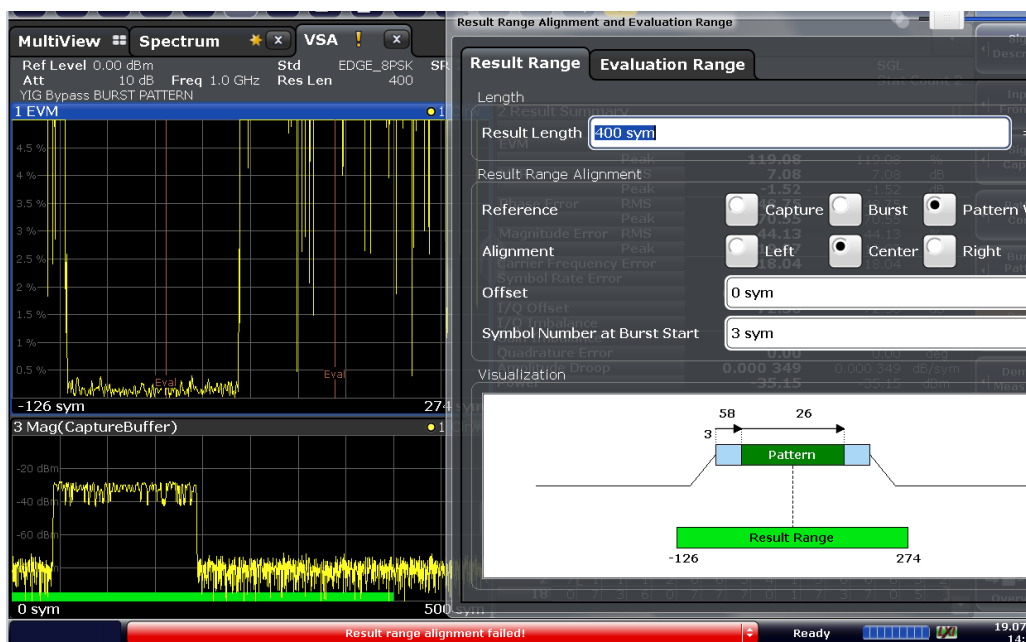


Figure 6-8: Example for failed alignment

In this screenshot, the alignment of the long result range to the burst center is not possible because there are not enough samples in the capture buffer before the burst starts. In this scenario, the trigger settings should be changed such that the burst is in the middle of the capture buffer.

Solution: Change the trigger settings and/or enlarge the capture length.

For more information, see:

- ["I/Q Capture"](#) on page 152



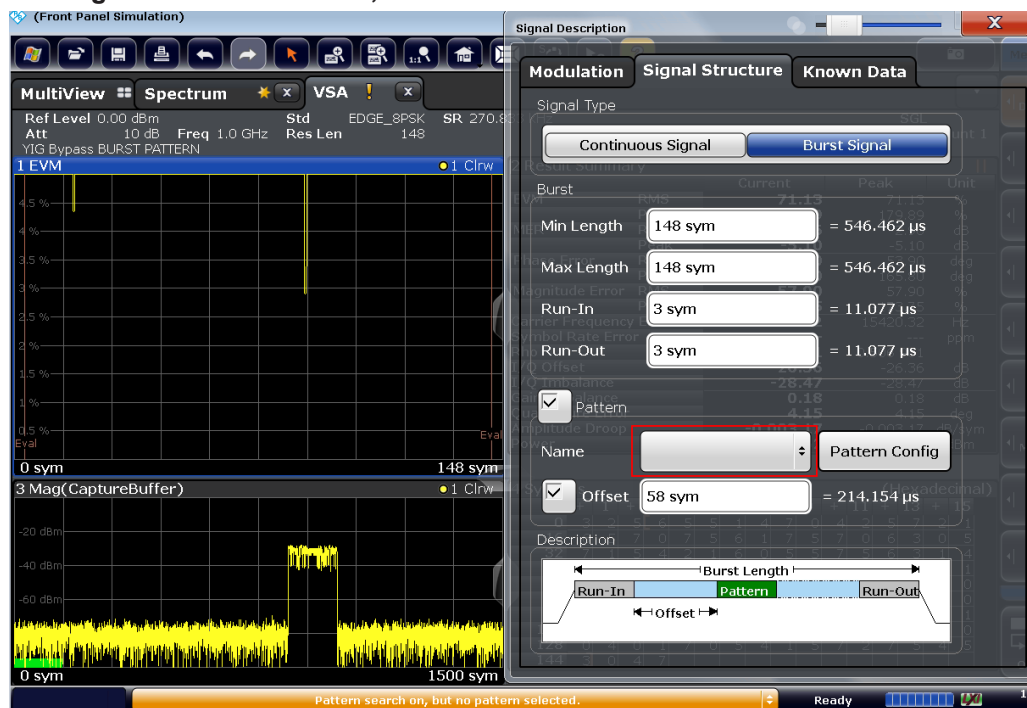
**Message: Pattern Search On, But No Pattern Selected**

Figure 6-9: The red circle shows the place where you can specify a pattern

Solution: Select an existing pattern (or create a new pattern) that you expect to be within the signal.

For more information, see

- "Signal Description" on page 146
- Chapter 3.3.5, "Working with Pattern Searches", on page 189

**Message: Pattern Not (Entirely) Within Result Range**

A pattern can only be found, if it is entirely within the result range. Therefore, this error message always occurs with a "Pattern Not Found" error.

Solution: Choose the pattern as reference of your result range alignment. Then, the pattern will be forcefully part of your result range and the pattern search can succeed.

For more information, see

- "Result Range" on page 165
- Chapter 3.3.2, "Defining the Result Range", on page 181

**Message: Short Pattern: Pattern Search Might Fail**

The R&S FSVA/FSV performs the pattern search in two stages.

- Stage 1 involves the generation of an I/Q pattern waveform by modulating the pattern symbol sequence. The I/Q pattern is then correlated with the measured signal. At positions where the correlation metric exceeds the "I/Q Correlation Threshold" the I/Q pattern is found.
- Stage 2 demodulates the measured signal at the I/Q pattern location and the transmitted symbols are checked for correctness against the pattern symbol sequence.

In case of a very short pattern, i.e. a pattern length in the order of the inter-symbol interference (ISI) duration, a number of issues can arise:

- False positive  
The I/Q pattern is found at positions where the transmitted symbols differ from the pattern symbols.  
Solution: Try one of the following:
  - Activate "Meas only if Pattern Symbols Correct".
  - Increase the "I/Q Correlation Threshold"  
(see ["I/Q Correlation Threshold"](#) on page 161).
- False negative  
The I/Q pattern search misses a position where transmitted symbols match the pattern symbols.  
Solution:
  - Decrease the "I/Q Correlation Threshold"  
(see ["I/Q Correlation Threshold"](#) on page 161).

In case of bursted signals the pattern search finds only the first occurrence of the I/Q pattern within each burst. If a false positive occurs in this situation (cf. case 1.) the use of "Meas only if pattern symbols correct" will not provide a satisfactory solution.

In this case do the following:

- Increase the "I/Q Correlation Threshold".
- Specify the expected position of the pattern within the burst by adjusting the "Offset" parameter.

### Message: Sync Prefers More Valid Symbols

**Note:** Note that this message does not necessarily indicate a problem. Its purpose is to inform you that you might have the opportunity to get a more stable demodulation and/or better measurement results by improving your setup.

Synchronization in the R&S FSV-K70 is performed in two stages: coarse synchronization that precedes the reference signal generation and fine synchronization based on the reference signal.

- The coarse synchronization stage can work data-aided (i.e. based on a known pattern) or non-data-aided (i.e. based on the unknown data symbols). The default is a non-data-aided coarse synchronization. In the case that a pattern is part of signal, the user can switch to data-aided synchronization.
- The fine synchronization stage always works data-aided.

'Sync Prefers More Valid Symbols' indicates that one of the synchronization stages has too few symbols to ensure that the synchronization is robust.

The message is given if

- Coarse Synchronization = Non-Data-Aided (User Pattern for Sync = Off):  
Estimation range shorter than 40 symbols  
(see [Chapter 2.5.1.2, "Estimation"](#), on page 52)
- Fine Synchronization:  
Estimation range shorter than 10 symbols  
(see [Chapter 2.5.1.2, "Estimation"](#), on page 52)

Solution:

- If the signal contains a pattern, set "Coarse Synchronization: Pattern".  
(see ["Coarse Synchronization"](#) on page 172).

Example: measurement of a GSM EDGE pattern that has a length of 26 symbols.

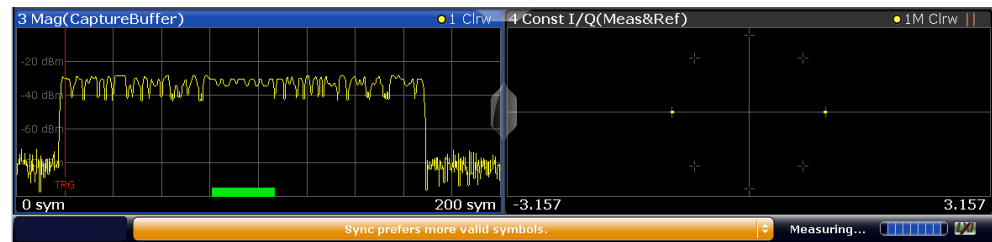


Figure 6-10: User Pattern for Sync = Off

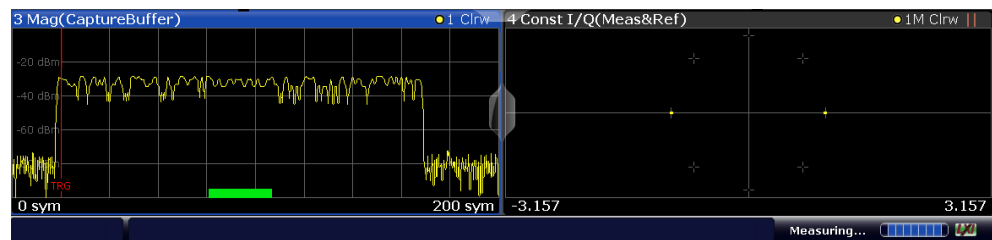


Figure 6-11: User Pattern for Sync = On

- Choose a longer "Result Range".
- If the signal is bursted and the bursts are short:
  - Make sure your "Result Range" comprises the entire burst.
  - Make sure that "Run-In/Out" is not chosen too large, since the "Run-In/Out" ranges are excluded from the synchronization.
- If the signal is bursted and contains a pattern:
 

Only switch off the burst search if absolutely necessary. If you need to switch it off, align your "Result Range" to the pattern, make sure it does not exceed the burst ramps and choose "Continuous Signal" as the "Signal Type" in the "Signal Description" dialog.

For more information, see

- [Chapter 2.4, "Demodulation Overview"](#), on page 42

#### Message: Sync Prefers Longer Pattern

This message can only occur if the coarse synchronization is data-aided, i.e. is based on a known pattern. In case the pattern is very short, pattern-based coarse synchronization might be unstable. If demodulation is stable, e.g. you get a reasonable EVM, there is no need to change anything. Otherwise, you have two options:

- Switch to the non-pattern-based mode by setting the parameter "Coarse Synchronization: Data " (see ["Coarse Synchronization"](#) on page 172)
- If possible, use a longer pattern.

For more information, see

- [Chapter 2.4, "Demodulation Overview"](#), on page 42

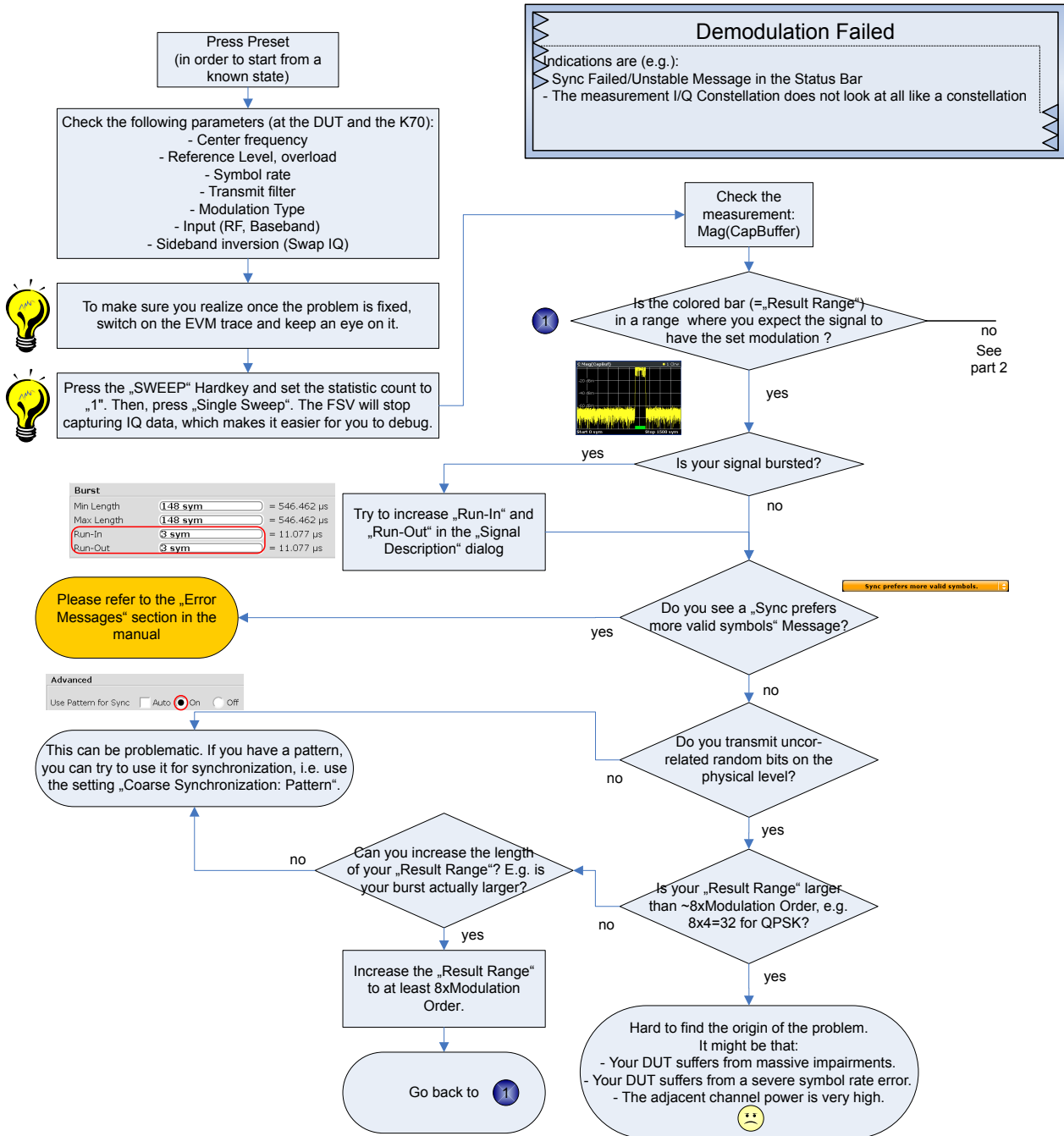
**Message: Result Ranges Overlap**

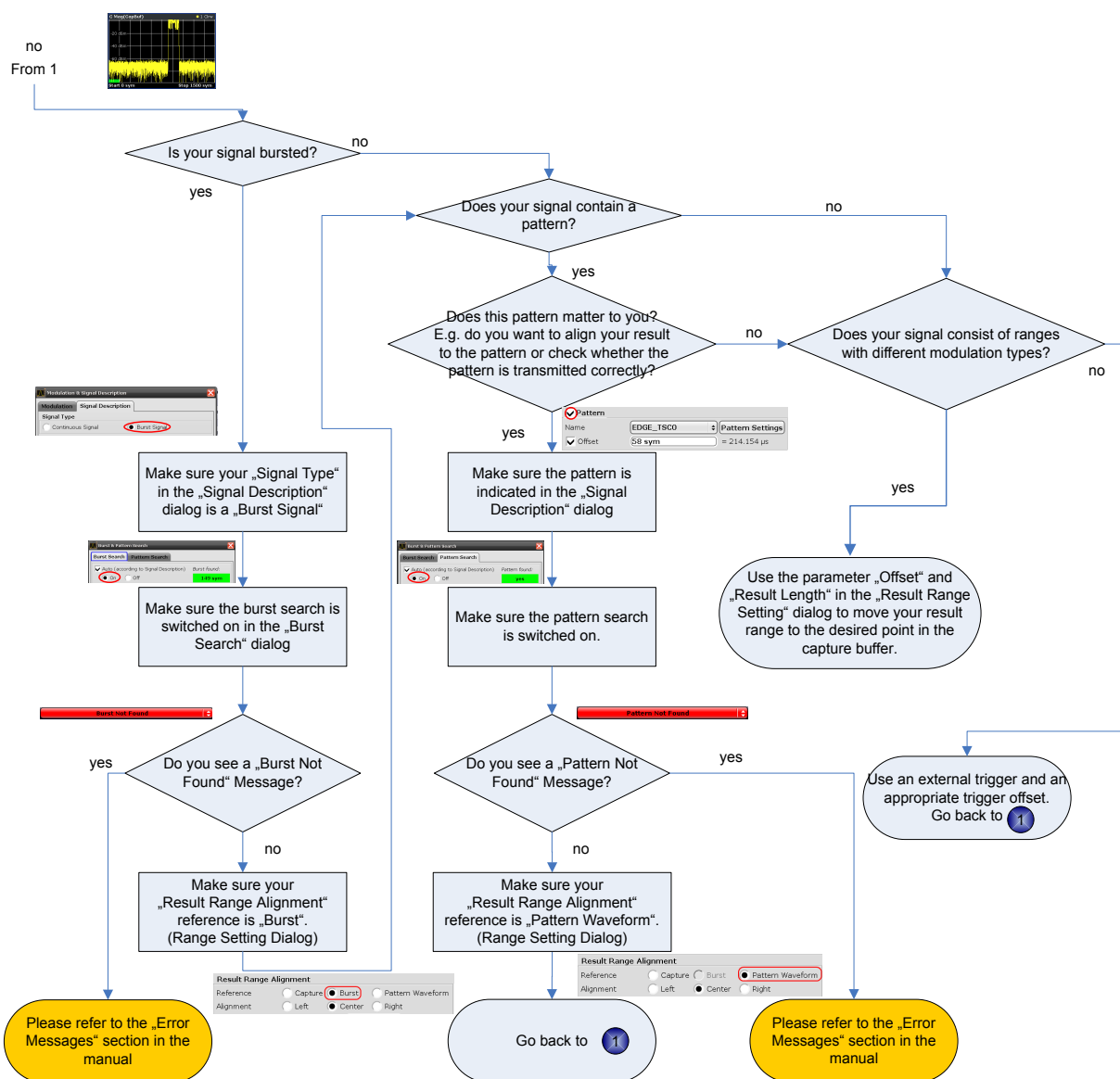
This message does not indicate an error. It is merely displayed to inform you that the defined result ranges in the capture buffer overlap. Thus, some captured data is evaluated more than once. For example, the same peak value may be listed several times if it is included in several result ranges, and averaging is performed on (partially) duplicate values. However, a negative influence on the measurement results is not to be expected.

## 6.2 Flow Chart for Troubleshooting

If you experience a concrete measurement problem, you might want to try solving it with the help of the flow-chart.

Troubleshooting Overview





## 6.3 Frequently Asked Questions

Problem: Synchronization fails despite correct settings..... 351

Problem: Synchronization seems to fail for all zero/all one/ 0 1 0 1 0 1... bit sequence  
..... 351

Problem: The trace is not entirely visible within the measurement screen..... 351

Problem: The trace of the measurement signal is visible in the measurement screen;  
the trace of the reference signal is not..... 351

Problem: The measurement screen does not show average results..... 352

Problem: The spectrum is not displayed in the logarithmic domain..... 352

Problem: The Vector I/Q result display and the Constellation I/Q result display look dif-  
ferent..... 353

Problem: The Constellation I/Q measurement result display has a different number of constellation points in the R&S FSQ-K70 and the R&S FSV-K70.....	353
Problem: the MSK/FSK signal demodulates on the R&S FSQ-K70, but not on the R&S FSV-K70 or: Why do I have to choose different transmit filters in the R&S FSQ-K70 and the R&S FSV-K70?.....	354
Problem: The EVM trace looks okay, but the EVM in the result summary is significantly different.....	354
Question: Why isn't the FSK Deviation Error in R&S FSV-K70 identical to the FSK DEV ERROR in R&S FSQ-K70?.....	356
Problem: The PSK/QAM Signal shows spikes in the Frequency Error result display.	357
Question: The y-axis unit for the spectrum of the measurement signal can be chosen to be "dB". What level is this relative to?.....	357
Question: How can I get the demodulated symbols of all my GSM bursts in the capture buffer in remote control?.....	357
Question: Why do the EVM results for my FSK-modulated signal look wrong?.....	358

**Problem: Synchronization fails despite correct settings**

A prerequisite for correct synchronization is a random data sequence of an adequate size.

Solution:

Make sure the input signal contains an adequate number of uncorrelated (random!) bits. (Not 0 0 0 0 0, 1 1 1 1 1, or 01 01 01 01 01, for example.)

For QAM modulation, the result length (the data on which synchronization is based) should correspond to at least 8 times the modulation order (see "Result Length" on page 166).


For more solutions, see [Chapter 6.2, "Flow Chart for Troubleshooting"](#), on page 348.

**Problem: Synchronization seems to fail for all zero/all one/ 0 1 0 1 0 1... bit sequence**

See "[Problem: Synchronization fails despite correct settings](#)" on page 351.


**Problem: The trace is not entirely visible within the measurement screen**

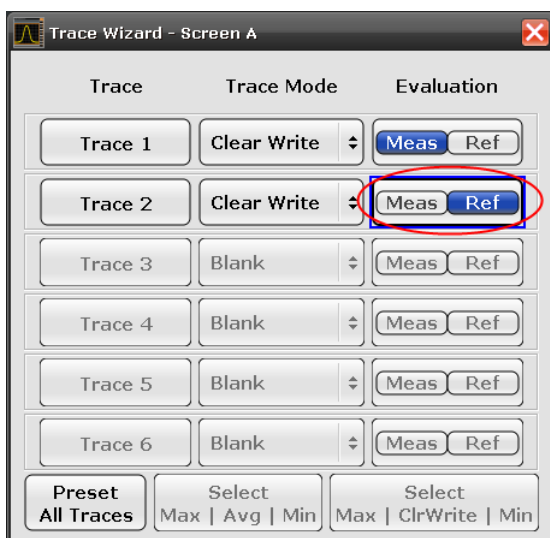
Solution:

- 1. Press the  key to select the measurement screen.
- 2. Press the AUTO key.
- 3. Press the "Y-Axis Auto Range" softkey.

**Problem: The trace of the measurement signal is visible in the measurement screen; the trace of the reference signal is not**

Solution:

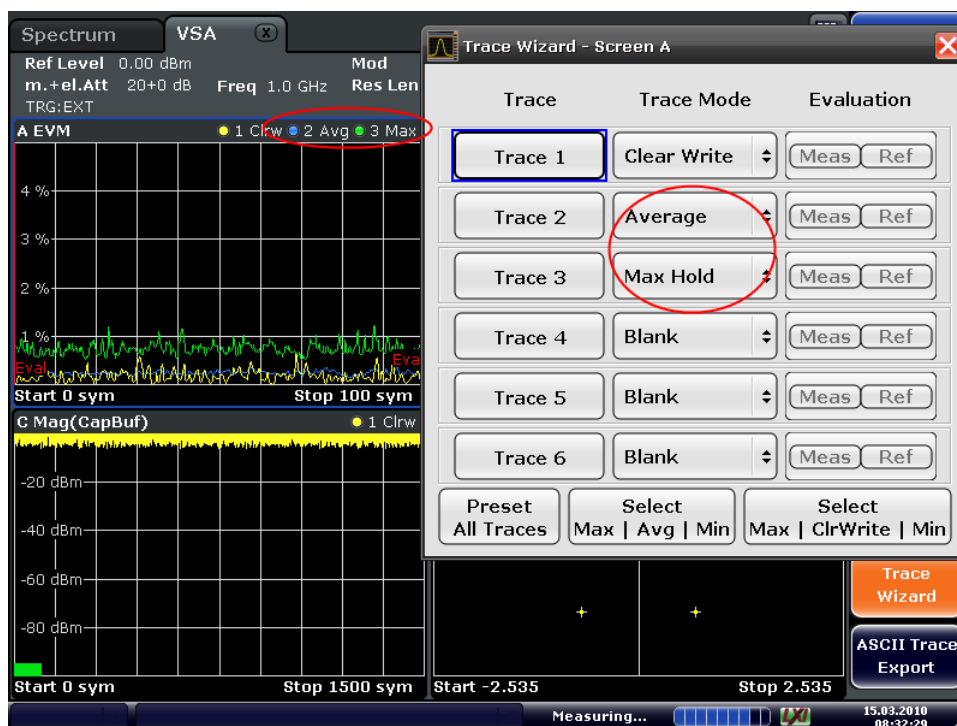
- 1. Press the  key to select the measurement screen.
- 2. Press the TRACE key.
- 3. Press the "Trace Wizard" softkey.
- 4. Select a second trace, choose "Clear Write" as "Trace Mode" and toggle to "Ref" in the "Evaluation" column.



**Problem: The measurement screen does not show average results**

Solution:

- 1. Press the key to select the measurement screen.
- 2. Press the TRACE key.
- 3. Press the "Trace Wizard" softkey.
- 4. Select a second trace and choose the preferred "Trace Mode", e.g. "Max Hold" or "Average".



**Problem: The spectrum is not displayed in the logarithmic domain**

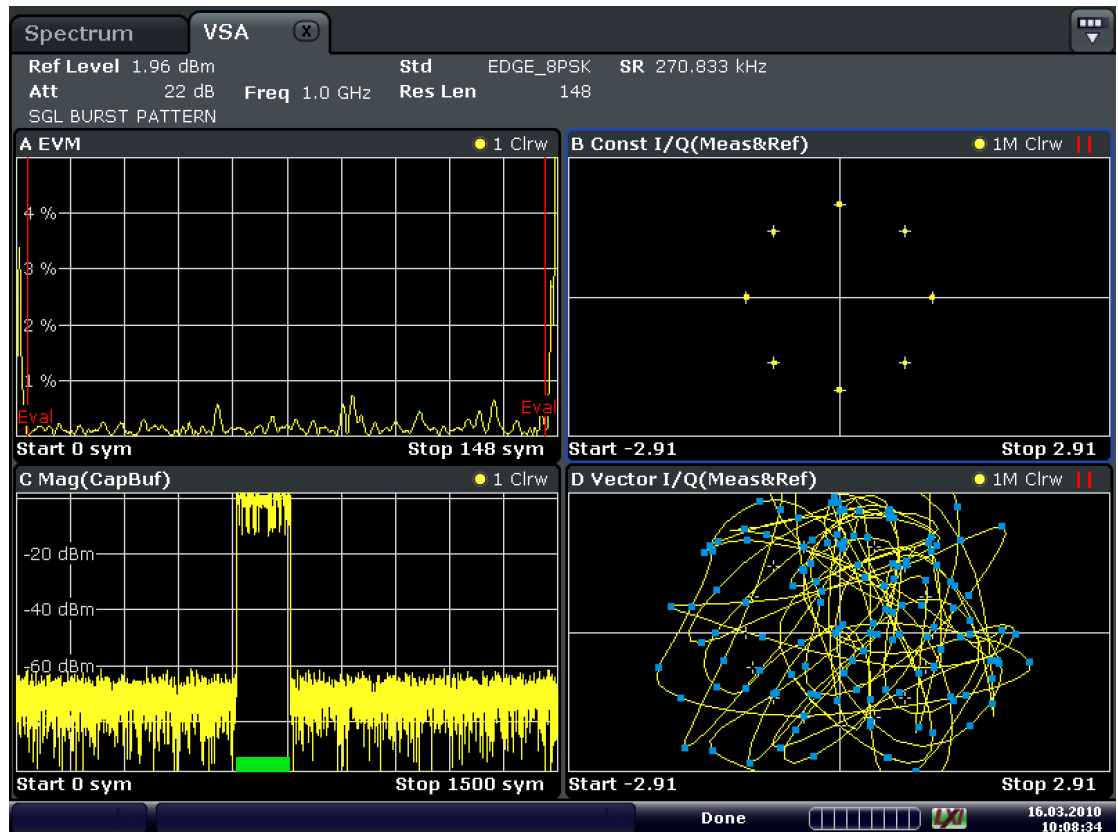
Solution:

- 1. Press the key to select the measurement screen.



- 2. Press the AMPT key.
- 3. Press the "Unit" softkey.
- 4. Press the "Y-Axis Unit" softkey.
- 5. Select dB.

**Problem: The Vector I/Q result display and the Constellation I/Q result display look different**



Date: 16.MAR.2010 10:08:34

**Reason:**

- The Vector I/Q diagram shows the measurement signal after the measurement filter and synchronization.
- The Constellation I/Q diagram shows the de-rotated constellation (i.e. for a  $\pi/4$ -DQPSK, 4 instead of 8 points are displayed). The inter-symbol interference has been removed.

In case the measurement filter does not remove the inter-symbol interference, the screens show measurements that are significantly different.

**Problem: The Constellation I/Q measurement result display has a different number of constellation points in the R&S FSQ-K70 and the R&S FSV-K70**

**Reason:**

In the FSQ-K70, the Constellation I/Q measurement displays the symbol instants of the Vector I/Q measurement. Hence, this is a rotated constellation, e.g. for a  $\pi/4$ -DQPSK, 8 points are displayed.

In the R&S FSV-K70, the Constellation I/Q diagram shows the de-rotated constellation (i.e. for a  $\pi/4$ -DQPSK, 4 instead of 8 points are displayed). The inter-symbol interference has been removed.

**Note:** As of firmware version R&S FSVA/FSV 1.70, a new result display ("I/Q Constellation (Rotated)") is available that displays the rotated constellation, as the FSQ-K70 does.

For details on the Constellation I/Q diagram in the R&S FSV-K70, see [Chapter 3.1.1.11, "Constellation I/Q"](#), on page 80.

**Table 6-1: Constellation I/Q and Vector I/Q for  $\pi/4$ -DQPSK modulation**

<p>The screenshot shows the Constellation I/Q diagram for the R&amp;S FSQ-K70. The plot displays a de-rotated constellation with 4 points. The axes are labeled 'I' and 'Q'. The plot is titled 'Constellation I/Q (Meas&amp;Ref)'. The parameters shown are: Ref: -20 dBm, SR: 18 kHz, CF: 1 GHz, TETRA_MCQUN, Meas_Signal1, Const10Map. The plot shows a clear constellation with 4 points.</p>	<p>The screenshot shows the Constellation I/Q diagram for the R&amp;S FSV-K70. The plot displays a rotated constellation with 8 points. The axes are labeled 'I' and 'Q'. The plot is titled 'Constellation I/Q (Meas&amp;Ref)'. The parameters shown are: Ref Level: 3.28 dBm, Att: 23 dB, Freq: 1.0 GHz, Res Len: 255, TETRA_ContinuousDownlink, SR: 18.0 kHz. The plot shows a clear constellation with 8 points.</p>
R&S FSQ-K70	R&S FSV-K70

**Problem: the MSK/FSK signal demodulates on the R&S FSQ-K70, but not on the R&S FSV-K70 or: Why do I have to choose different transmit filters in the R&S FSQ-K70 and the R&S FSV-K70?**

When generating an MSK/FSK reference signal, the R&S FSQ-K70 automatically replaces the Dirac pulses generated by the frequency mapper with square pulses with the length of one symbol. In the R&S FSV-K70, however, this "replacement" is part of the transmit filter routine. Thus, the R&S FSQ and the R&S FSV require different transmit filters for measuring the same FSK/MSK signal.

**Example:**

- If your transmit filter for the R&S FSQ-K70 was "NONE", you need to choose "Rectangular" as the transmit filter type in the R&S FSV.
- If your transmit filter for the R&S FSQ-K70 was "GAUSS", you need to choose "GMSK" as the transmit filter type in the R&S FSV.

**Problem: The EVM trace looks okay, but the EVM in the result summary is significantly different**

**Solution:**

- Make sure that the position of the "Evaluation Lines" is reasonable. The Result Summary only evaluates sample instants that are within the evaluation lines. Hence, in the case the "Result Range" covers the burst ramps, it is important to adjust the "Evaluation Range" appropriately.

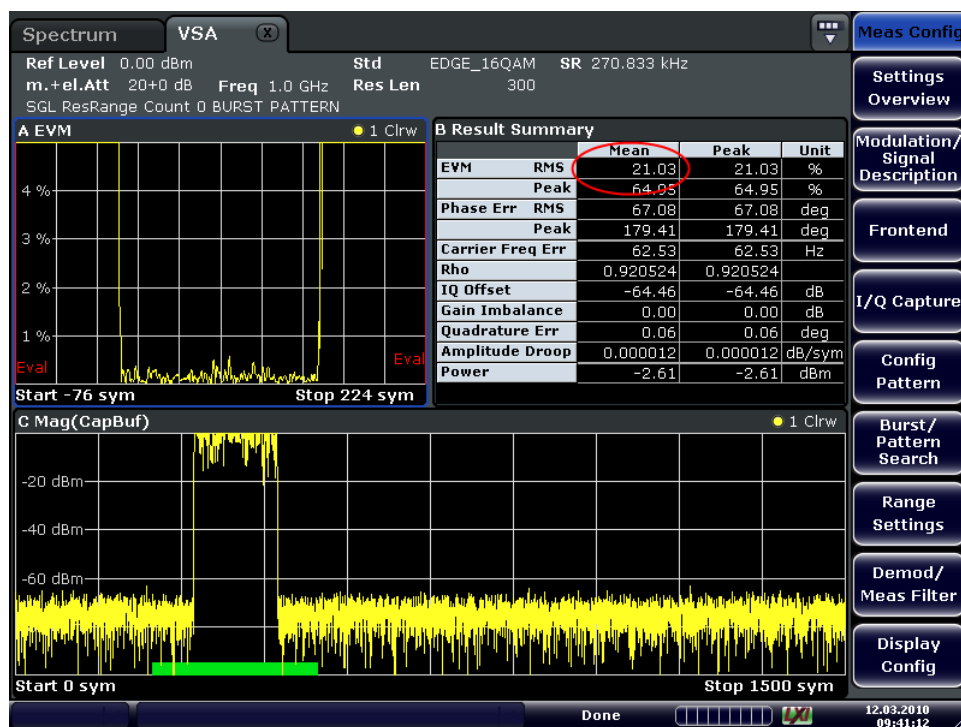


Figure 6-12: Problem: EVM in result summary does not correspond with trace display

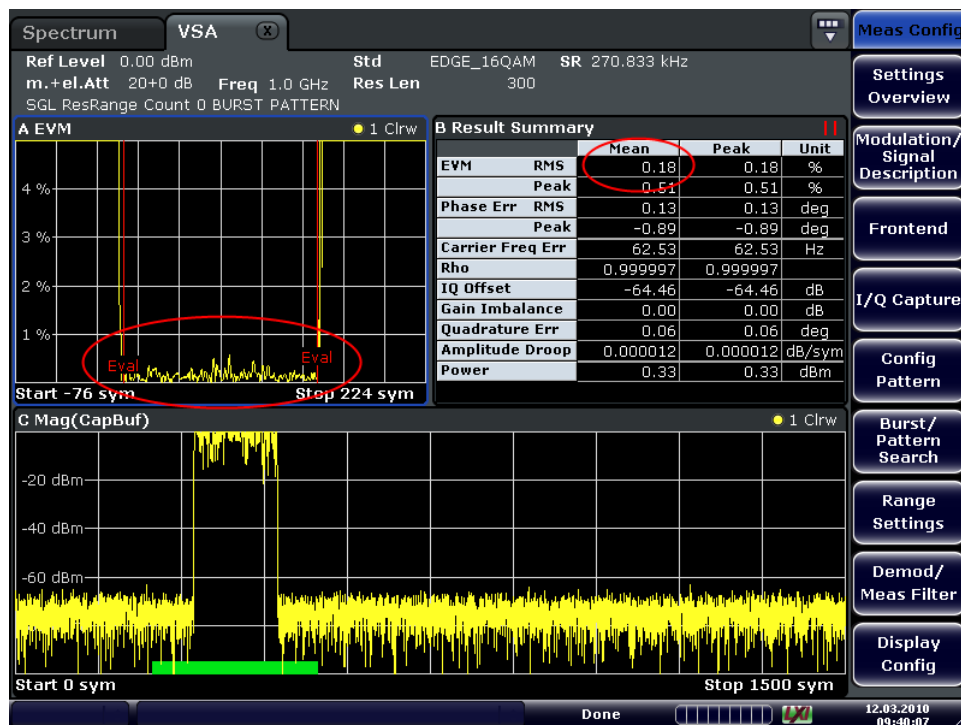
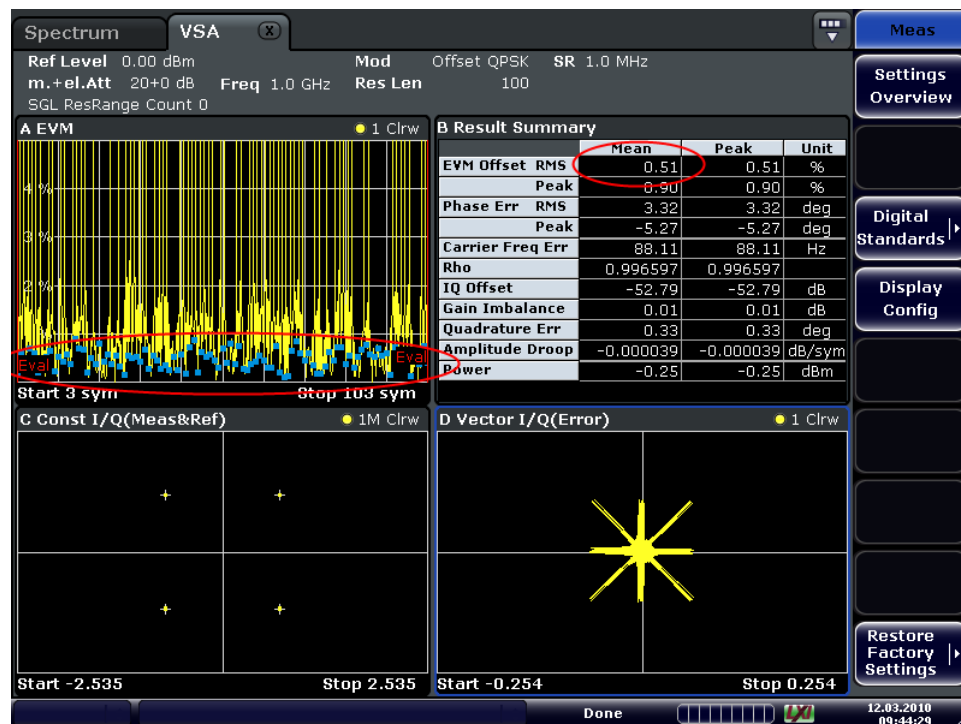


Figure 6-13: Solution: Result Summary with correct evaluation range setting

- Make sure that the same samples are evaluated. The EVM trace displays (as default) all sample instants, e.g. if the "Capture Oversampling" is 4, the EVM trace shows 4 samples per symbol. The Result Summary does not forcefully evaluate all

sample instants. E.g. for a PSK modulation, as default only symbol instants contribute to the EVM result.

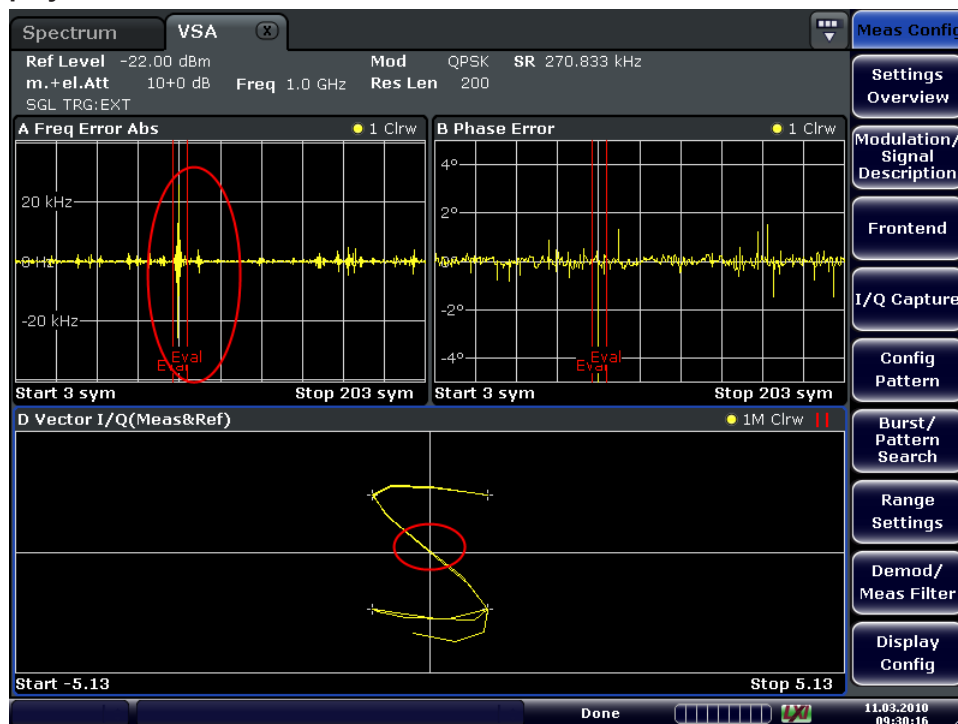


#### Question: Why isn't the FSK Deviation Error in R&S FSV-K70 identical to the FSK DEV ERROR in R&S FSQ-K70?

Solution:

The FSK deviation error in the R&S FSV-K70 is calculated as the difference between the measured frequency deviation and the reference frequency deviation as entered by the user (see "FSK Ref Deviation" on page 145). What is referred to as the "FSK DEV ERROR" in the R&S FSQ-K70 is calculated differently (see the R&S FSQ-K70 Software Manual) and is comparable to the "Freq Err RMS" in the R&S FSV-K70. However, while the "FSK DEV ERROR" in the R&S FSQ-K70 is given in Hz, the "Freq Err RMS" in the R&S FSV-K70 is given in percent, i.e. relative to the "FSK Meas Deviation".

### Problem: The PSK/QAM Signal shows spikes in the Frequency Error result display



Solution:

These spikes are usually uncritical and are caused by zero-transitions in the I/Q Plane.

**Question: The y-axis unit for the spectrum of the measurement signal can be chosen to be "dB". What level is this relative to?**

Answer:

Spectrum (Reallmag, Meas&Ref) calculates the FFT of the result Reallmag(Meas&Ref). Reallmag(Meas&Ref) has the unit "none". In this case, "none" means the measured signal has been scaled such that it matches the ideal corresponding reference signal as well as possible. The reference signal in turn is scaled such that  $\max(\text{abs}(a \text{ at symbol instants})) = 1.0$ .

**Question: How can I get the demodulated symbols of all my GSM bursts in the capture buffer in remote control?**

Answer:

Use the following remote commands:

```
:SENSe1:DDEMod:PRESet 'GSM_NB'
```

Load the GSM standard.

```
:SENSe1:DDEMod:RLENgth 10000 SYM
```

Enlarge the capture buffer length such that all the bursts you want to demodulate can be seen within the capture buffer.

```
:INITiate1:CONTinuous OFF
```

Go to single sweep mode.

```
:SENSe1:SWEEp:COUNT 0
```

Set the "Statistic Count" to "Auto" mode.

```
:INITiate1:IMMediate
```

Do single sweep.

```
:SENSe1:SWEEp:COUNT:CURRENT?
```

Query the number of demodulated bursts within the capture buffer.

```
For n = 1:NumberOfBursts
```

```
    :SENSe1:DDEMod:SEARch:MBURst:CALC n
```

```
    :TRACe4? TRACe1 'Query the result symbols in screen D
```

```
End
```

Step through all bursts and query the demodulated symbols.

**Question: Why do the EVM results for my FSK-modulated signal look wrong?**

Answer:

For an FSK-modulated signal, the signal processing differs to an PSK/QAM/MSK-modulated signal. The estimation model does not minimize the EVM but the error of the instantaneous frequency (see [Chapter 2.5.2.1, "Error Model"](#), on page 62). Therefore, the measurement value that corresponds to the EVM value for FSK is the the Frequency Error (Absolute/Relative). (Source Type: Modulation Error; Result Type: Frequency Error (Absolute/Relative))

# Annex

## A Formulae and Abbreviations

The following sections are provided for reference purposes and include detailed formulae and abbreviations

- [Formulae](#)..... 359
- [Abbreviations](#)..... 373

### A.1 Formulae

- [Trace-based Evaluations](#)..... 359
- [Result Summary Evaluations](#)..... 361
- [Statistical Evaluations for the Result Summary](#)..... 364
- [Trace Averaging](#)..... 365
- [Analytically Calculated Filters](#)..... 365
- [Standard-Specific Filters](#)..... 366

#### A.1.1 Trace-based Evaluations

The trace-based evaluations all take place at the sample rate defined by the "Display Points Per Symbol" parameter (see "Display Points/Sym" on page 179). The sampling instants at this rate are referred to as "t" here, i.e.

$$t = n \cdot T_D$$

where  $T_D$  equals the duration of one sampling period at the sample rate defined by the "Display Points Per Symbol" parameter.

Test parameter	Formula
Error vector	$EV(t) = MEAS(t) - REF(t)$
Error Vector Magnitude (EVM)	$EVM(t) = \frac{ EV(t) }{C}$ <p>with the normalization constant C depends on your setting. By default <math>C^2</math> is the mean power of the reference signal.</p> $C = \sqrt{\frac{1}{K} \sum_k  REF(k \cdot T) ^2}$ <p><math>T</math> = duration of symbol periods</p>

Test parameter	Formula
Magnitude	$Mag_{MEAS}(t) =  MEAS(t) $ $Mag_{REF}(t) =  REF(t) $
Phase	$Phase_{MEAS}(t) = \angle(MEAS(t))$ $Phase_{REF}(t) = \angle(REF(t))$
Frequency	$FREQ_{MEAS}(t) = \frac{1}{2 \cdot \pi} \frac{d}{dt} \angle MEAS(t)$ $FREQ_{REF}(t) = \frac{1}{2 \cdot \pi} \frac{d}{dt} \angle REF(t)$
Magnitude error	$MAG\_ERR(t) = MAG_{MEAS}(t) - MAG_{REF}(t)$
Phase error	$PHASE\_ERR(t) = PHASE_{MEAS}(t) - PHASE_{REF}(t)$
Frequency error	$FREQ\_ERR(t) = FREQ_{MEAS}(t) - FREQ_{REF}(t)$

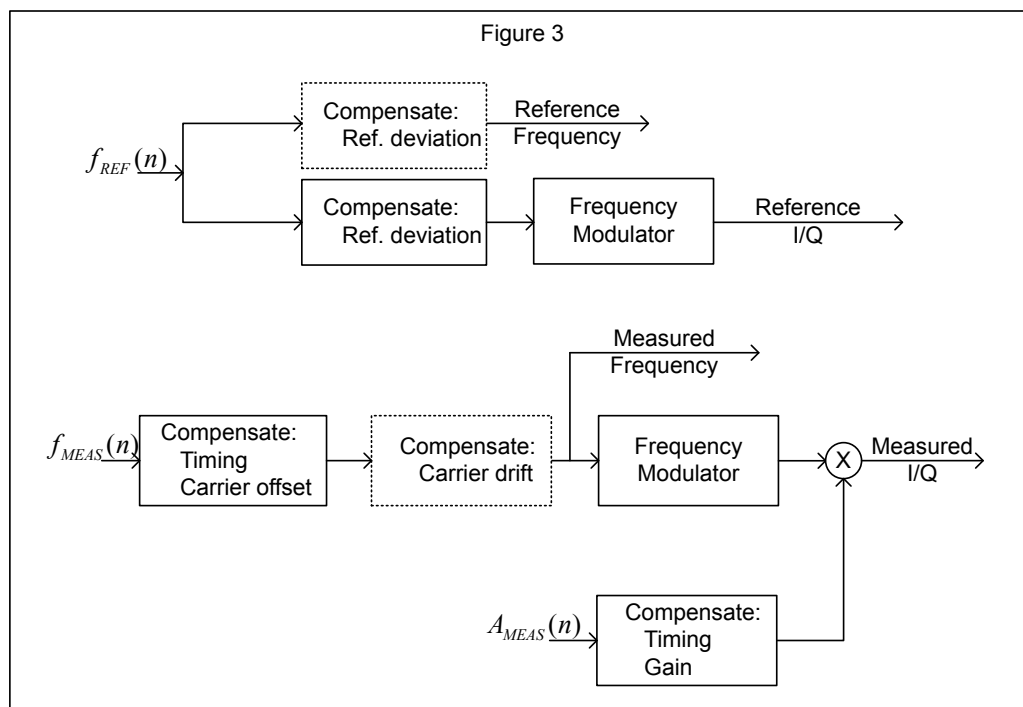
### FSK Modulation

The trace based results for FSK signals are the same as those available for linear modulation types. However, as the signal processing for FSK signals is performed on the magnitude and instantaneous frequency, the I/Q based results first require a reconstruction of the reference and measured I/Q waveforms, as illustrated in [Reconstruction of the reference and measured I/Q waveforms for FSK modulation](#).

The dashed outline of the "compensate" blocks indicate that these operations are optionally (de-)activated depending on the corresponding user settings. With respect to FSK measurements, the optional compensation parameters are:

- [FSK Reference deviation](#)
- [Carrier frequency drift](#)





**Figure A-1: Reconstruction of the reference and measured I/Q waveforms for FSK modulation**

Note that a reference deviation error is corrected in the reference frequency trace. This ensures that the frequency deviation in the measured frequency trace corresponds to that of the originally measured signal. With respect to the I/Q reconstruction, the measured magnitude is timing compensated using the timing offset estimated from the measured instantaneous frequency. This ensures that the measured magnitude and frequency remain synchronized in the reconstructed I/Q waveform.

### A.1.2 Result Summary Evaluations

The evaluations for the result summary take place at the sample rate defined by the "Display Points Per Symbol" parameter (see "Display Points/Sym" on page 179). This value can be one of the following:

- "1": only the symbol instant contributes to the result
- "2": two samples per symbol instant contribute to the result
- the "Capture Oversampling" rate (see "Capture Oversampling" on page 154): all samples contribute to the result equally

The results are determined by the evaluation range.

The sampling instants at this rate are referred to as "t" here, i.e.

$$t = n \cdot T_D$$

where  $T_D$  equals the duration of one sampling period at the sample rate defined by the "Display Points Per Symbol" parameter

### A.1.2.1 PSK, QAM and MSK Modulation

For PSK, QAM and MSK modulation the estimation model is described in detail in chapter [Chapter 2.5.1, "PSK, QAM and MSK Modulation"](#), on page 51. The parameters of the PSK, QAM and MSK-specific result summary table can be related to the distortion model parameters as follows:

**Table A-1: Evaluation of results in the PSK, QAM and MSK result summary**

EVM	RMS	$\sqrt{\frac{1}{N} \sum_n EVM(n \cdot T_D)^2}$
	Peak	$\max(EVM(n \cdot T_D))$
Modulation error	RMS	$-20 \cdot \log_{10} \left( \frac{\sqrt{\frac{1}{N} \sum_n  EV(n \cdot T_D) ^2}}{\sqrt{\frac{1}{K} \sum_k  REF(k \cdot T) ^2}} \right)$
	Peak	$\min(MER(n \cdot T_D))$  $\text{with } MER(n \cdot T_D) = -20 \cdot \log_{10} \left( \frac{\sqrt{\frac{1}{N} \sum_n  EV(n \cdot T_D) ^2}}{\sqrt{\frac{1}{K} \sum_k  REF(k \cdot T) ^2}} \right)$
Magnitude error	RMS	$\sqrt{\frac{1}{N} \sum_n  MAG\_ERR(n \cdot T_D) ^2}$
	Peak	$\max(MAG\_ERR(n \cdot T_D))$
Phase error	RMS	$\sqrt{\frac{1}{N} \sum_n  PHASE\_ERR(n \cdot T_D) ^2}$
	Peak	$\max(PHASE\_ERR(n \cdot T_D))$
RHO (correlation coefficient)		$\rho = \frac{\left  \sum_n REF^*(n) \cdot MEAS(n) \right ^2}{\sum_n  REF(n) ^2 \cdot \sum_n  MEAS(n) ^2} = \frac{ KKF(MEAS, REF) ^2}{AKF(REF) \cdot AKF(MEAS)}$

IQ Offset C		$C_{[lin]} = \frac{\left(\frac{c_I}{g_I}\right)^2 + \left(\frac{c_Q}{g_Q}\right)^2}{\frac{1}{K} \sum_k  REF(k \cdot T) ^2}$ $C = 10 \cdot \log_{10}(C_{[lin]}) [\text{dB}]$
IQ Imbalance B		$B_{[lin]} = \frac{ g_I - g_Q \cdot e^{j\theta} }{ g_I + g_Q \cdot e^{j\theta} }$ $B = 20 \cdot \log_{10}(B_{[lin]}) [\text{dB}]$
Gain Imbalance G		$G_{[lin]} = \frac{g_Q}{g_I}$ $G = 20 \cdot \log_{10}(G_{[lin]}) [\text{dB}]$
Quadrature Error $\Theta$		$\theta_{[lin]} = \vartheta / \pi \cdot 180^\circ$ $\theta = \theta_{[lin]} [\text{deg}]$
Amplitude Droop A		$A_{[lin]} = e^{-\alpha T}$ $A = 20 \cdot \log_{10}(A_{[lin]}) [\text{dB}/\text{Sym}]$

### A.1.2.2 FSK Modulation

For FSK modulation the estimation model is described in detail in section [Chapter 2.5.2, "FSK Modulation"](#), on page 60. The parameters of the FSK-specific result summary table can be related to the distortion model parameters as follows:

**Table A-2: Evaluation of results in the FSK result summary**

Frequency Error	RMS	$\sqrt{\frac{1}{N} \sum_n  FREQ\_ERR(n \cdot T_D) ^2}$
	Peak	$\max(FREQ\_ERR(n \cdot T_D))$
Magnitude Error	RMS	$\sqrt{\frac{1}{N} \sum_n  MAG\_ERR(n \cdot T_D) ^2}$
	Peak	$\max(MAG\_ERR(n \cdot T_D))$

FSK Deviation Error $\Lambda_{ERR}$		$\Lambda_{ERR} = \Lambda_{MEAS} - \Lambda_{REF} = (B - 1) \cdot \Lambda_{REF}$ Estimated FSK deviation error [Hz].
FSK Measurement Deviation $\Lambda_{MEAS}$		$\Lambda_{MEAS} = B \cdot \Lambda_{REF}$ Estimated FSK deviation of the meas signal [Hz].
FSK Reference Deviation $\Lambda_{REF}$		FSK reference deviation as entered by the user [Hz].
Carrier Frequency Error $f_0$		$f_0 = \frac{C}{2 \cdot \pi}$ The carrier frequency error of the measured signal [Hz].
Carrier Frequency Drift $f_d$		$f_d = \frac{D}{2 \cdot \pi \cdot T}$ The drift in the carrier frequency of the measured signal [Hz/Sym].

### A.1.3 Statistical Evaluations for the Result Summary

The statistical evaluations in the result summary are based on the measurement results that are displayed in the "Current" column. Hence, the index "m" here represents the current evaluation, "M" is the total number of evaluations. In single sweep mode, M corresponds to the statistics count.

If the measurement values are represented in the logarithmic domain, the linear values are averaged. The result is then subsequently converted back into logarithmic domain. The linear values are indicated by the subscript [lin] in [Table A-1](#).

	Mathematical expression	Calculation in R&S FSVA/FSV
Mean $\hat{x}_M$	$\bar{x}_M = \frac{1}{M} \sum_m x_m$	$\bar{x}_M = \frac{(M-1) \cdot \bar{x}_{M-1} + x_M}{M}$ with $\bar{x}_0 = 0$
Peak $\hat{x}_M$	$\hat{x}_M = x_{idx}$ with $idx = \arg \max_m  x_m $	$\hat{x}_M = x_M$ if $ x_M  >  \hat{x}_{M-1} $ $\hat{x}_M = x_{M-1}$ if $ x_M  \leq  \hat{x}_{M-1} $ with $\bar{x}_0 = 0$

	Mathematical expression	Calculation in R&S FSVA/FSV
StdDev $\sigma_M$	$\sigma_M = \sqrt{\frac{1}{M} \sum_m (x_m - \bar{x}_M)^2}$ <p>with</p> $\bar{x}_M = \frac{1}{M} \sum_m x_m$	$\sigma_M = \sqrt{\frac{(M-1) \cdot \sigma_{M-1}^2 + \frac{M}{M-1} (x_M - \bar{x}_M)^2}{M}}$ <p>with</p> $\sigma_0 = 0$
95%ile $x_{95,M}$	$x_{95,M} = \{x   \Pr(x_m \leq x) = 0.95\}$ <p>Pr() denotes the probability</p>	Sorting the values and giving the 95%ile.

#### A.1.4 Trace Averaging

The index "m" represents the current evaluation, "M" is the total number of evaluations. In single sweep mode, M corresponds to the statistics count. The index "s" represents the s<sup>th</sup> sample within the trace.

If the measurement results are represented in logarithmic domain, the average operation is performed on the linear values. The result is then subsequently converted back into logarithmic domain.

	Measurements	Calculation in R&S FSVA/FSV
RMS Average $\bar{x}_{s,M}$	<ul style="list-style-type: none"> <li>Error Vector Magnitude (EVM)</li> <li>Meas/Ref magnitude</li> <li>Capture Buffer magnitude</li> </ul>	$\bar{x}_{s,M} = \sqrt{\frac{(M-1) \cdot \bar{x}_{s,M-1}^2 + x_{s,M}^2}{M}}$
Linear Average $\bar{x}_{s,M}$	All measurements where trace averaging is possible <b>except for</b> the measurements listed for RMS averaging	$\bar{x}_{s,M} = \frac{(M-1) \cdot \bar{x}_{s,M-1} + x_{s,M}}{M}$

#### A.1.5 Analytically Calculated Filters

The following filters are calculated during runtime of the unit and as a function of the operating parameter Alpha or BT.

Filter Type	Setting Parameter	Impulse Response
Raised cosine (RC)	Alpha ( $\alpha$ )	$h(t) = \frac{\sin\left(\frac{\pi}{T}\right) \cdot \cos\left(\frac{\pi\alpha t}{T}\right)}{\left(\frac{\pi}{T}\right) \cdot 1 - 4\left(\frac{\alpha t}{T}\right)^2}$
Root raised cosine (RRC)	Alpha ( $\alpha$ )	$h(t) = 4\alpha \frac{\cos((1+\alpha)\pi/T) + \frac{\sin((1-\alpha)\pi/T)}{4\alpha/T}}{\pi\sqrt{T}\left(1 - (4\alpha t/T)^2\right)}$
Gaussian filter (Gauss) ETSI TS 100 959 (V8.3.0)	BT	$h(t) = \frac{\exp\left(\frac{-t^2}{2\rho^2 T^2}\right)}{\sqrt{(2\pi) \cdot \rho T}}$ <p>with</p> $\rho = \frac{\sqrt{\ln 2}}{2\pi BT}$

## A.1.6 Standard-Specific Filters

### A.1.6.1 Transmit filter

#### EDGE Tx filter ETSI TS 300 959 (V8.1.2) (Linearized GMSK)

$$c_0(t) = \begin{cases} \prod_{i=0}^3 S(t+iT) & \text{for } 0 \leq t \leq 5T \\ 0 & \text{else} \end{cases}$$

$$S(t) = \begin{cases} \sin\left(\pi \int_0^t g(t') dt'\right) & \text{for } 0 \leq t \leq 4T \\ \sin\left(\frac{\pi}{2} - \pi \int_0^{t-4T} g(t') dt'\right) & \text{for } 4T < t \leq 8T \\ 0 & \text{else} \end{cases}$$

$$g(t) = \frac{1}{2T} \left( Q\left(2\pi \cdot 0.3 \frac{t-5T/2}{T\sqrt{\ln(2)}}\right) - Q\left(2\pi \cdot 0.3 \frac{t-3T/2}{T\sqrt{\ln(2)}}\right) \right)$$

$$Q(t) = \frac{1}{\sqrt{2\pi}} \int_t^{\infty} e^{-\frac{\tau^2}{2}} d\tau$$

$c_0(t)$  is the impulse response of the EDGE transmit filter

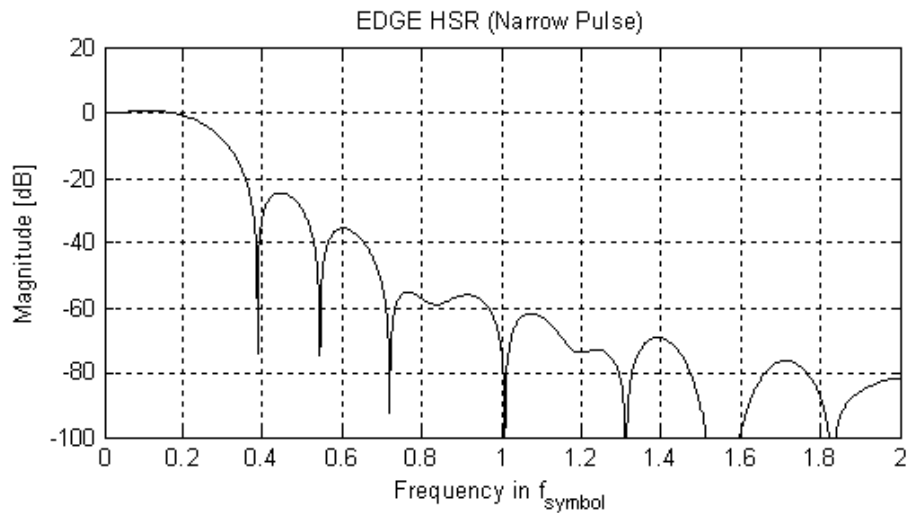
### A.1.6.2 Measurement Filter

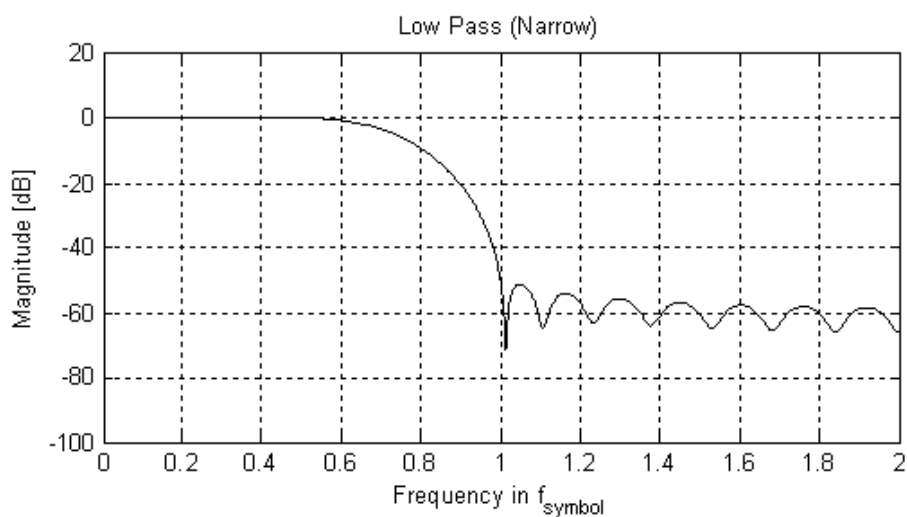
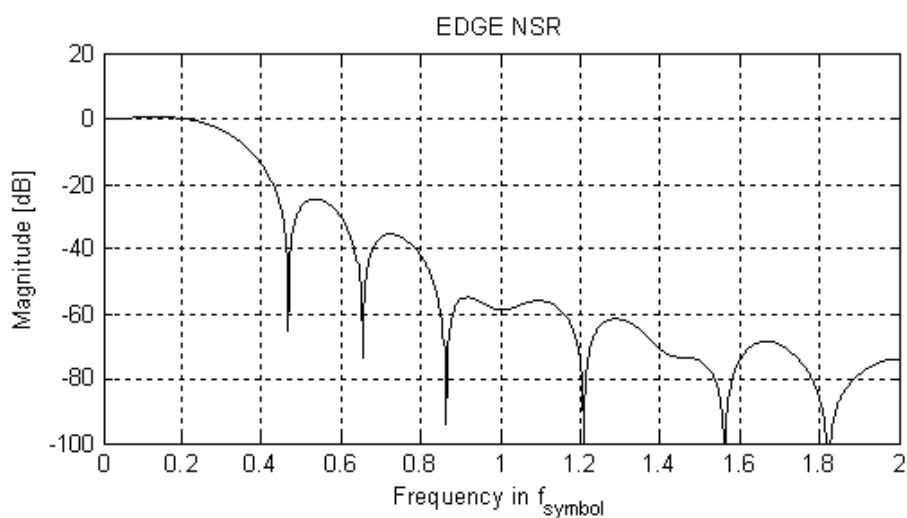
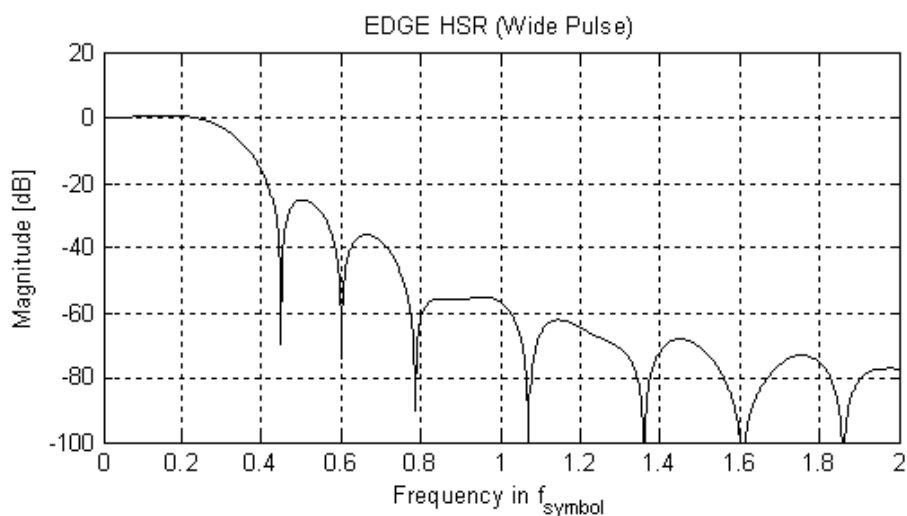
#### EDGE Measurement filters

RC filter, Alpha = 0.25, single-side-band 6 dB bandwidth = 90 kHz Windowing by multiplying the impulse response according to the following equation:

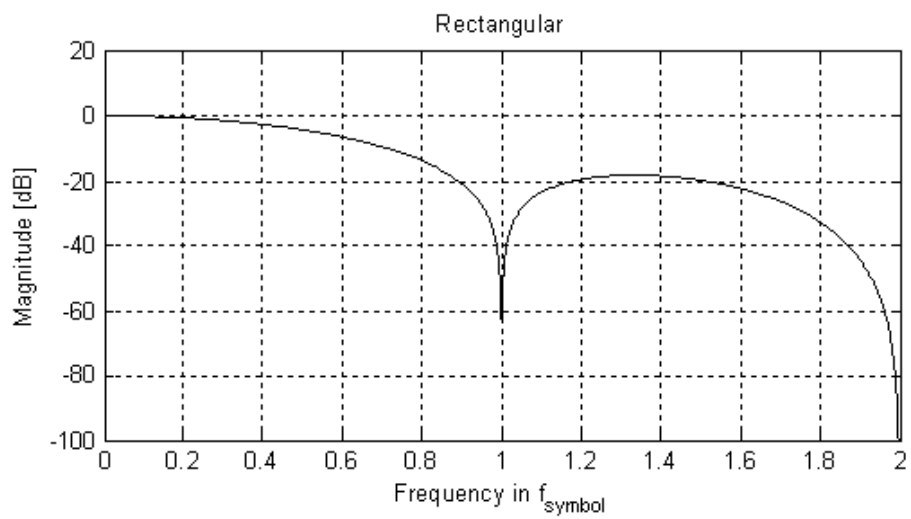
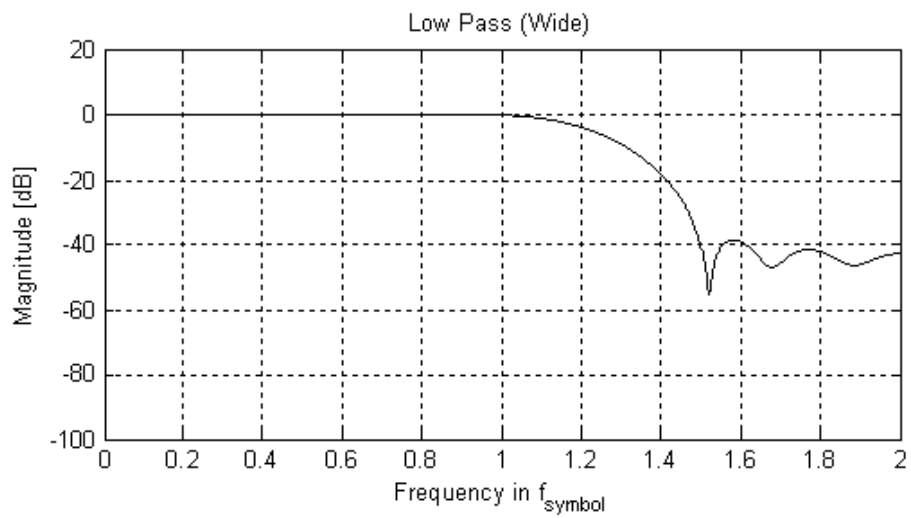
$$w(t) = \begin{cases} 1, & 0 \leq |t| \leq 1.5T \\ 0.5(1 + \cos[\pi(|t| - 1.5T)/2.25T]) & 1.5T < |t| < 3.75T \\ 0, & |t| \geq 3.75T \end{cases}$$

The following figure shows the frequency response of the standard-specific measurement filters.



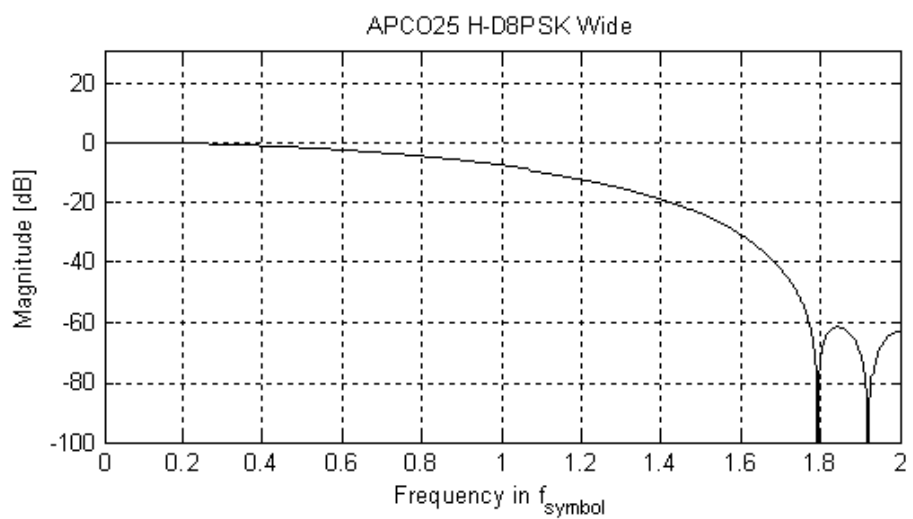
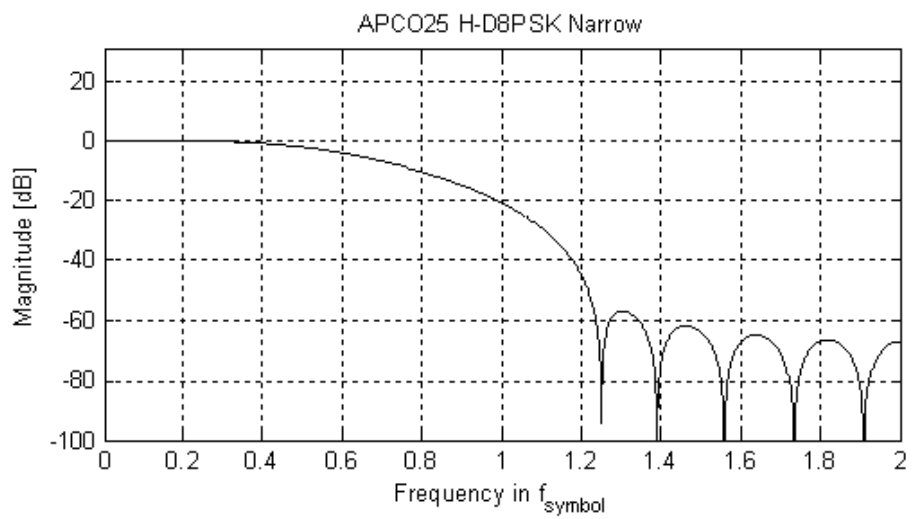
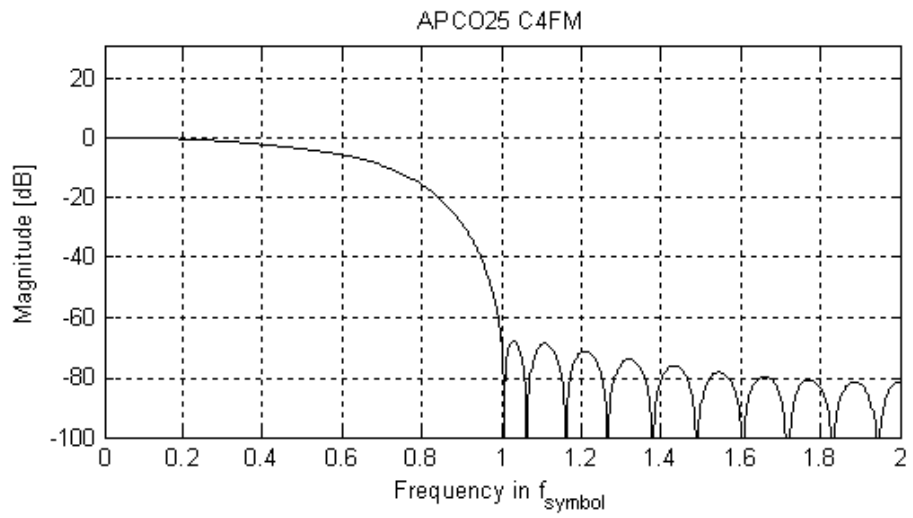


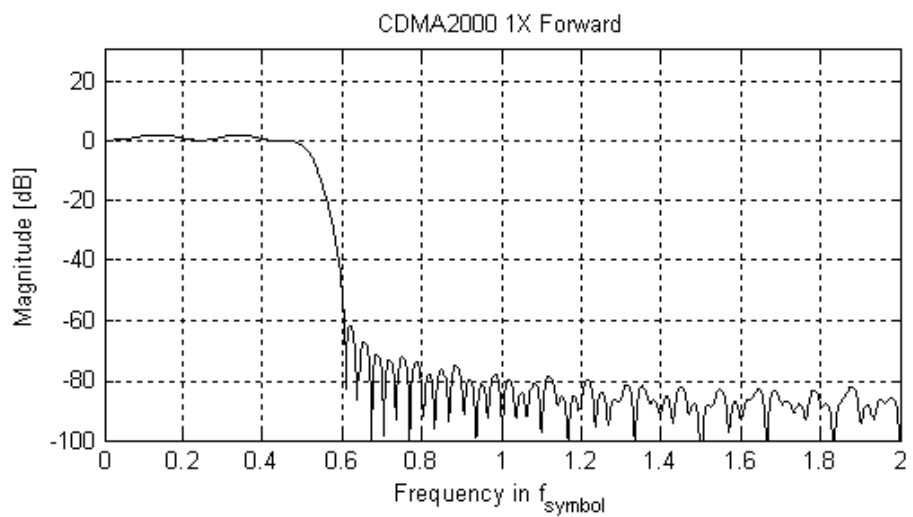
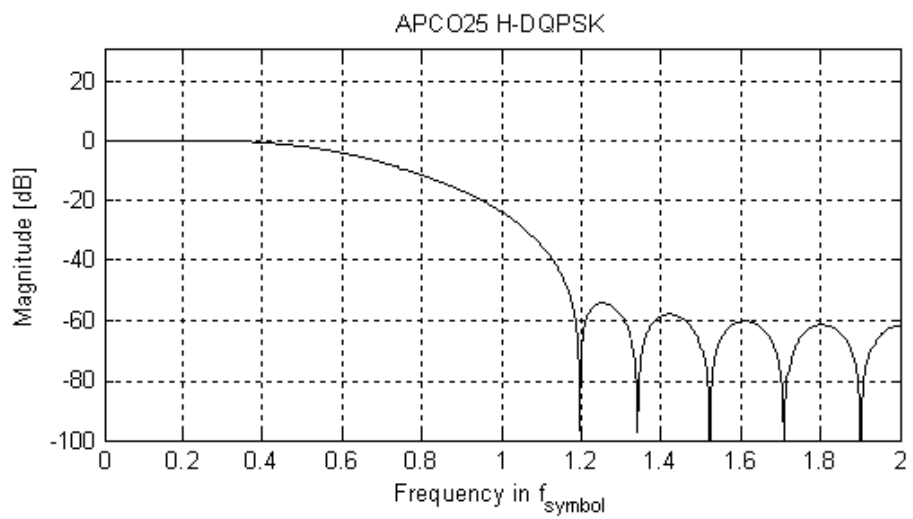
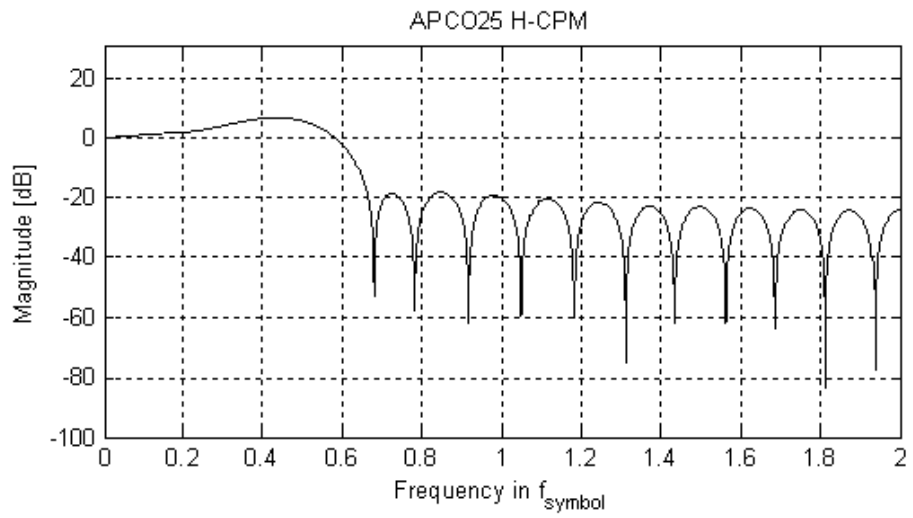


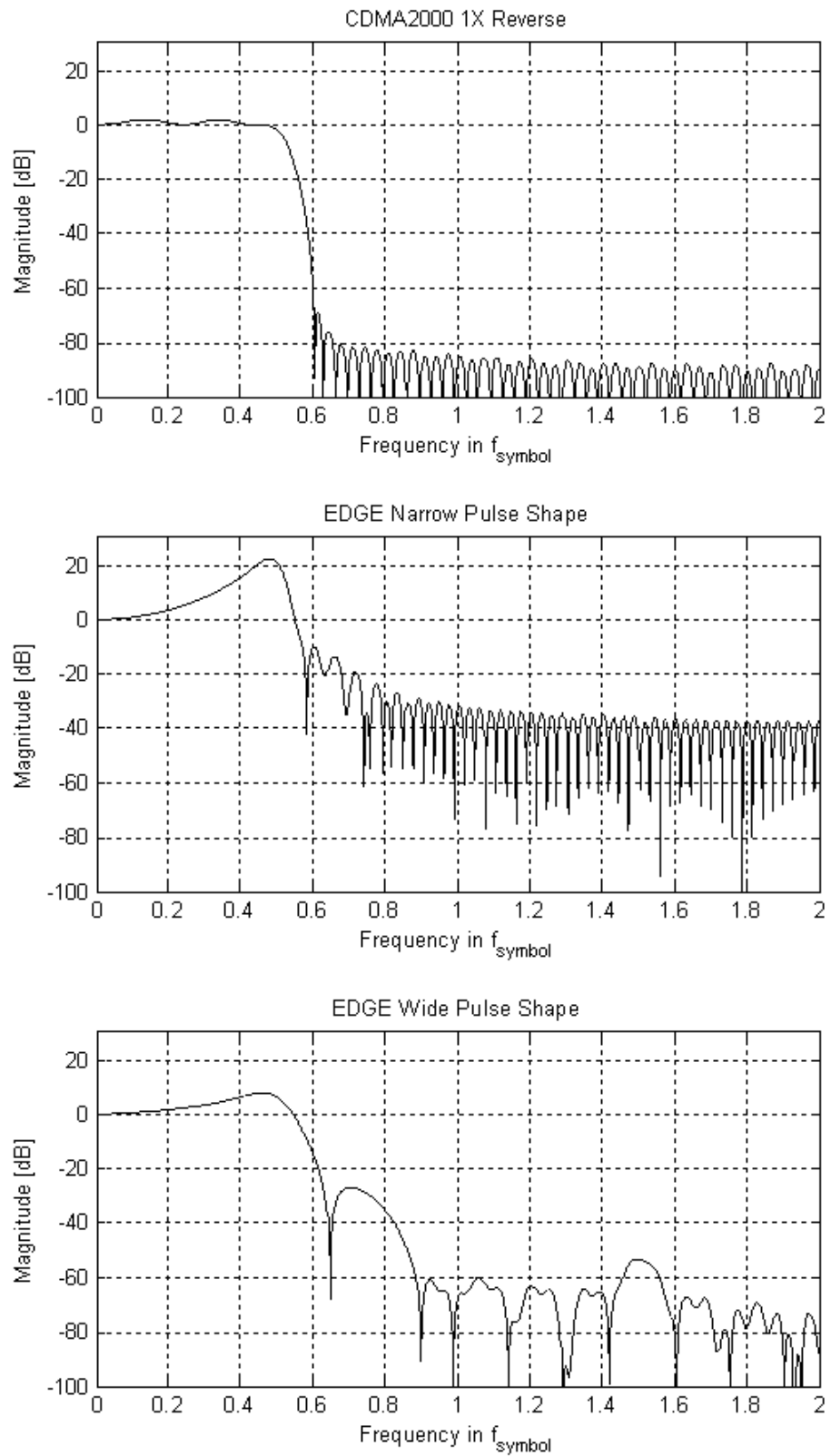


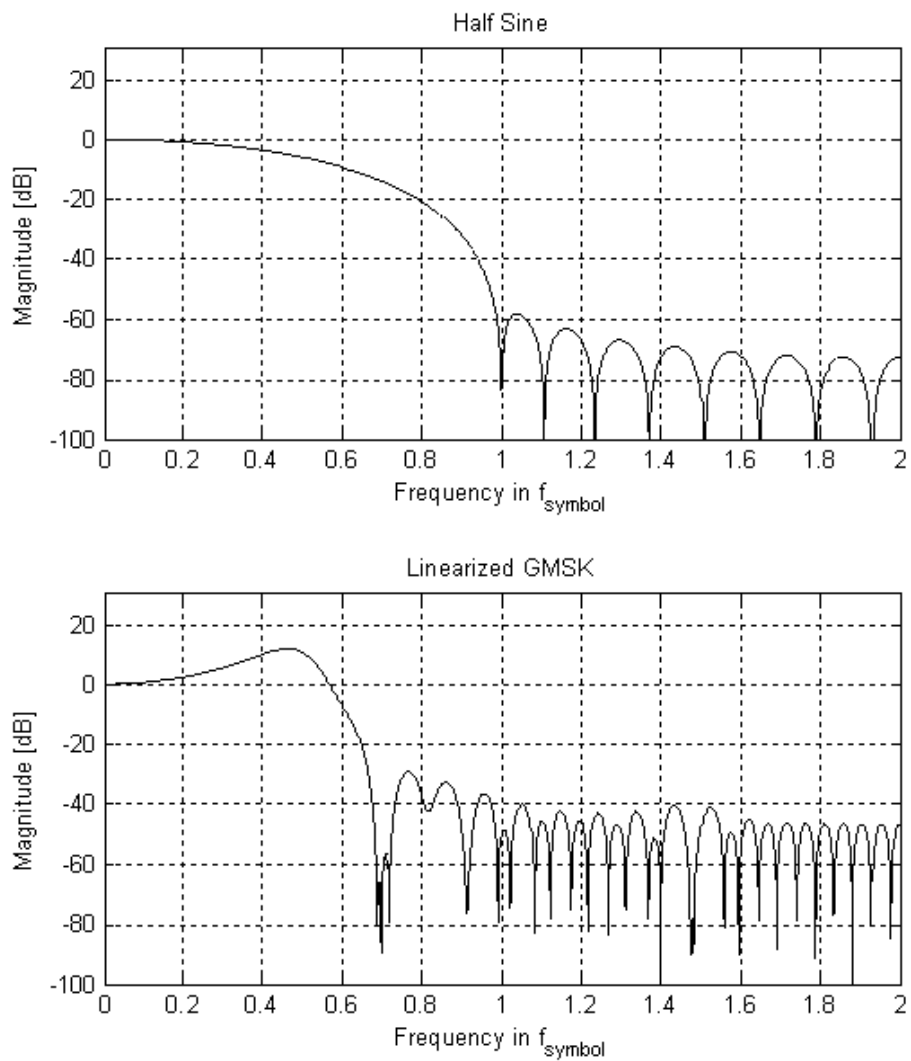
### Low-ISI Filters

The following frequency responses are obtained when using a low-ISI measurement filter and the Transmit filter indicated in the title of each diagram.









## A.2 Abbreviations

The following abbreviations are commonly used in the description of the R&S FSV-K70 option.

Abbreviation	Meaning	See section
FSK	Frequency Shift Keying Modulation mode for which the information is encrypted in the frequency.	Frequency Shift Keying (FSK)
ISI	Inter-symbol Interference	

Abbreviation	Meaning	See section
ISI-free demodulation	Demodulation structure in which the signal is no longer influenced by adjacent symbols at the decision instants after signal-adapted filtering.	System-Theoretical Modulation and Demodulation Filters
MEAS filter	Measurement Filter Weighting filter for the measurement.	System-Theoretical Modulation and Demodulation Filters
MSK	Minimum Shift Keying Modulation mode.	Minimum Shift Keying (MSK)
NDA Demodulator	Non Data Aided Demodulator Demodulation without any knowledge of the sent data contents.	Demodulation and Algorithms
PSK	Phase Shift Keying Modulation mode for which the information lies within the phase or within the phase transitions.	Phase Shift Keying (PSK)
QAM	Quadrature Amplitude Modulation Modulation mode for which the information is encrypted both in the amplitude and phase.	Quadrature Amplitude Modulation (QAM)
RMS	Root Mean Square	Averaging RMS Quantities
RX filter	Receive Filter Baseband filter in analyzer used for signal-adapted filtering.	System-Theoretical Modulation and Demodulation Filters
Transmit filter	Transmitter Filter Digital impulse shaping filter in signal processing unit of transmitter.	System-Theoretical Modulation and Demodulation Filters
VSA	Vector Signal Analysis Measurement at complex modulated RF carriers.	

## B Predefined Standards and Settings

In the "Digital Standards" menu, predefined basic settings for standards can be selected and user-defined standards stored (see "[Digital Standards](#)" on page 108).

The most common measurements are predefined as standard settings for a large number of mobile radio networks. The instrument comes prepared with the following settings for those standards:

- Capture length and result length
- Signal description
- Modulation
- Transmit filter and measurement filter
- Burst/Pattern search configuration
- Result range alignment
- Evaluation range settings
- Display configuration

The standard settings are grouped in folders to facilitate selecting a standard.

Table B-1: List of predefined standards and settings

Folder	Standard	Modulation Mapping	Symbol rate	Transmit Filter	Alpha/BT	Search for Burst	Search for Pattern	Pattern	Result length	Alignment	Evaluation Range
GSM	GSM_Nor- malBurst	DMSK GSM	270.83333 kHz	GMSK NONE	0.3	✓	✓	GSM_TSC0 (...) GSM_TSC7	148	Pattern to Center	0.5 - 147.25
	GSM_Syn- chroniza- tionBurst	DMSK GSM	270.83333 kHz	GMSK NONE	0.3	✓	✓	GSM_SB0 (...) GSM_SB2	148	Pattern to Center	3 - 144
	GSM_Fre- quency- Burst	DMSK GSM	270.83333 kHz	GMSK NONE	0.3	✓	✓	GSM_FB0 GSM_FB01	148	Pattern to Center	3 - 144
	GSM_Ac- cessBurst	DMSK GSM	270.83333 kHz	GMSK NONE	0.3	✓	✓	GSM_AB0 (...) GSM_AB2	88	Pattern to Center	8 - 85
	EDGE_8PS K	3π/8-8PSK EDGE	270.833 kHz	Linearized GMSK EDGE_NSR	-	✓	✓	EDGE_TSC0 (...) EDGE_TS7	148	Pattern to Center	3-144.75
	EDGE_16Q AM	π/4-16QAM EDGE	270.833 kHz	Linearized GMSK EDGE_NSR	-	✓	✓	16QAM_EDGE _TSC0 (...) 16QAM_EDGE _TS7	148	Pattern to Center	3-144.75
	EDGE_32Q AM	π/4-32QAM EDGE	270.833 kHz	Linearized GMSK EDGE_NSR	-	✓	✓	32QAM_EDGE _TSC0 (...) 32QAM_EDGE _TS7	148	Pattern to Center	3-144.75



Folder	Standard	Modulation Mapping	Symbol rate	Transmit Filter Meas.Filter	Alpha/BT	Search for Burst	Search for Pattern	Pattern	Result length	Alignment	Evaluation Range
	EDGE_QP SK_HSR_N arrowPulse	$3\pi/4$ -QPSK EDGE	325 kHz	EDGE Nar- row Pulse Shape EDGE HSR (Narrow Pulse)	-	✓	✓	EDGE_HSR_Q PSK_TSC0 (...) EDGE_HSR_Q PSK_TSC1..7	177	Pattern to Center	4- 172.75
	EDGE_QP SK_HSR_ WidePulse	$3\pi/4$ -QPSK EDGE	325 kHz	EDGE Wide Pulse Shape EDGE HSR (Wide Pulse)	-	✓	✓	EDGE_HSR_Q PSK_TSC0 (...) EDGE_HSR_Q PSK_TSC1..7	177	Pattern to Center	4- 172.75
	EDGE_16Q AM_HSR_ Narrow- Pulse	$\pi/4$ -16QAM EDGE	325 kHz	EDGE Nar- row Pulse Shape EDGE HSR (Narrow Pulse)	-	✓	✓	EDGE_HSR_1 6QAM_TSC0 (...) EDGE_HSR_1 6QAM_TSC1.. 7	177	Pattern to Center	4- 172.75
	EDGE_16Q AM_HSR_ WidePulse	$\pi/4$ -16QAM EDGE	325 kHz	EDGE Wide Pulse Shape EDGE HSR (Wide Pulse)	-	✓	✓	EDGE_HSR_1 6QAM_TSC0 (...) EDGE_HSR_1 6QAM_TSC1.. 7	177	Pattern to Center	4- 172.75
	EDGE_32Q AM_HSR_ Narrow- Pulse	$-\pi/4$ -32QAM EDGE	325 kHz	EDGE Nar- row Pulse Shape EDGE HSR (Narrow Pulse)	-	✓	✓	EDGE_HSR_3 2QAM_TSC0 (...) EDGE_HSR_3 2QAM_TSC1.. 7	177	Pattern to Center	4- 172.75

Folder	Standard	Modulation Mapping	Symbol rate	Transmit Filter Meas.Filter	Alpha/BT	Search for Burst	Search for Pattern	Pattern	Result length	Alignment	Evaluation Range
	EDGE_32Q AM_HSR_ WidePulse	$-\pi/4$ -32QAM EDGE	325 kHz	EDGE Wide Pulse Shape EDGE HSR (Wide Pulse)	-	✓	✓	EDGE_HSR_3 2QAM_TSC0 (...) EDGE_HSR_3 2QAM_TSC1.. 7	177	Pattern to Center	4 - 172.75
TETRA	TETRA_Dis continuous- Downlink	$\pi/4$ -DQPSK TETRA	18 kHz	RRC RRC	0.35	✓	-	TETRA_S1 ... TETRA_S3	246	Burst to Center	0 - 244
	TETRA_Co ntinuous- Downlink	$\pi/4$ -DQPSK TETRA	18 kHz	RRC RRC	0.35	✓	-	TETRA_E TETRA_S	255	Burst to Center	0 - 244
3GPP	3G_WCDMA A	QPSK WCDMA	3.84 MHz	RRC RRC	0.22	-	-	-	800	Capture/ Left	-
CDMA	CDMA2000 _1X_FWD	QPSK CDMA2K_F WD	1.2288 MHz	CDMA 2000 1X FWD Low ISI Meas Filter	-	-	-	-	800	Capture/ Left	-
	CDMA2000 _1X_REV	Offset QPSK Gray	1.2288 MHz	CDMA 2000 1X Reverse Low ISI Meas Filter	-	-	-	-	800	Capture / Left	-
APCO25	APCO25_C QPSK	$\pi/4$ DQPSK APCO25	4.8 kHz	RC NONE	0.2 -	-	-	-	200	Capture/ Left	-
	APCO25_C 4FM	4FSK APCO25	4.8 kHz	APCO25 C4FM Rectangular	-	-	-	-	200	Capture Left	-
Bluetooth	Blue- tooth_DH1	2FSK Natural	1 MHz	GMSK None	0.5	✓	-	-	366	Burst to Center	2 - 363.75

Folder	Standard	Modulation Mapping	Symbol rate	Transmit Filter Meas.Filter	Alpha/BT	Search for Burst	Search for Pattern	Pattern	Result length	Alignment	Evaluation Range
	Blue-tooth_DH3	2FSK Natural	1 MHz	GMSK None	0.5	✓	-	-	1622	Burst to Center	2 - 1619.75
	Blue-tooth_DH5	2FSK Natural	1 MHz	GMSK None	0.5	✓	-	-	2870	Burst to Center	2 - 2867.75
	Blue-tooth_Low Energy	2FSK Natural	1 MHz	GMSK None	0.5	✓	-	-	376	Burst to Center	60 - 347.75
	Blue-tooth_2_DH 1	$\pi/4$ -DQPSK BT_EDR2	1 MHz	RRC RRC	0.4	✓	✓	Blue-tooth_EDR_Sy nc_2-DHx	242	Pattern / Left	-
	Blue-tooth_2_DH 3	$\pi/4$ -DQPSK BT_EDR2	1 MHz	RRC RRC	0.4	✓	✓	Blue-tooth_EDR_Sy nc_2-DHx	1494	Pattern / Left	-
	Blue-tooth_2_DH 5	$\pi/4$ -DQPSK BT_EDR2	1 MHz	RRC RRC	0.4	✓	✓	Blue-tooth_EDR_Sy nc_2-DHx	2742	Pattern / Left	-
	Blue-tooth_3_DH 1	$\pi/4$ -DQPSK BT_EDR3	1 MHz	RRC RRC	0.4	✓	✓	Blue-tooth_EDR_Sy nc_3-DHx	242	Pattern / Left	-
	Blue-tooth_3_DH 3	$\pi/4$ -DQPSK BT_EDR3	1 MHz	RRC RRC	0.4	✓	✓	Blue-tooth_EDR_Sy nc_3-DHx	1494	Pattern / Left	-
	Blue-tooth_3_DH 5	$\pi/4$ -DQPSK BT_EDR3	1 MHz	RRC RRC	0.4	✓	✓	Blue-tooth_EDR_Sy nc_3-DHx	2742	Pattern / Left	-
DECT	DECT_P32_FixedPart	2FSK Natural	1.152 MHz	GMSK None	0.5	✓	✓	DECT_PP DECT_PP_Pro longed	424	Capture Left	0 - 799.75
	DECT_P32_Portable-Part	2FSK Natural	1.152 MHz	GMSK None	0.5	✓	✓	DECT_FP DECT_FP_Pro longed	424	Capture Left	-

Folder	Standard	Modulation Mapping	Symbol rate	Transmit Filter Meas.Filter	Alpha/BT	Search for Burst	Search for Pattern	Pattern	Result length	Alignment	Evaluation Range
DVB-S2	DVB_S2_8_PSK	8PSK DVB_S2_8P SK	20 MHz	RRC RRC	0.35	-	-	-	90	Capture Left	-
	DVB_s2_16_APSK	UserQAM 16ary DVB_S2_16 APSK_34	20 MHz	RRC RRC	0.35	-	-	-	180	Capture Left	-
	DVB_S2_3_2APSK	UserQAM 32ary DVB_S2_32 APSK_34	20 MHz	RRC RRC	0.35	-	-	-	270	Capture Left	-
	DVB_S2_Q_PSK	QPSK DVB_S2_Q PSK	20 MHz	RRC RRC	0.35	-	-	-	90	Capture Left	-
ZIGBEE	ZIG-BEE_BPSK_868M_300K	BPSK Natural	300 kHz	RC None	1.0	✓	-	-	1000	Burst to Center	-
	ZIG-BEE_BPSK_915M_600K	BPSK Natural	600 kHz	RC None	1.0	✓	-	-	1000	Burst to Center	-
	ZIG-BEE_OQP_SK_2450M_1M	Offset- QPSK Gray	1 MHz	Half Sine -	-	✓	-	-	1000	Burst to Center	-

## List of Commands

[SENSe:]ADJust:CONFIguration:HYSTeresis:LOWer.....	283
[SENSe:]ADJust:CONFIguration:HYSTeresis:UPPer.....	283
[SENSe:]ADJust:CONFIgure:LEVel:DURation.....	284
[SENSe:]ADJust:CONFIgure:LEVel:DURation:MODE.....	284
[SENSe:]ADJust:LEVel.....	284
[SENSe:]DDEMod:ECALc:OFFSet.....	285
[SENSe:]DDEMod:ECALc[:MODE].....	285
[SENSe:]DDEMod:EPRate:AUTO.....	285
[SENSe:]DDEMod:EPRate[:VALue].....	286
[SENSe:]DDEMod:FACTory[:VALue].....	286
[SENSe:]DDEMod:FILTer[:STATe].....	287
[SENSe:]DDEMod:FORMat.....	287
[SENSe:]DDEMod:FSK:NSTate.....	287
[SENSe:]DDEMod:FSYNc:AUTO.....	288
[SENSe:]DDEMod:FSYNc:LEVel.....	288
[SENSe:]DDEMod:FSYNc:RESult?.....	289
[SENSe:]DDEMod:FSYNc[:MODE].....	289
[SENSe:]DDEMod:KDAta:STATe.....	290
[SENSe:]DDEMod:KDAta[:NAME].....	290
[SENSe:]DDEMod:MAPPING:CATalog?.....	290
[SENSe:]DDEMod:MAPPING[:VALue].....	290
[SENSe:]DDEMod:MFILter:AUTO.....	291
[SENSe:]DDEMod:MFILter:NAME.....	291
[SENSe:]DDEMod:MFILter:USER.....	292
[SENSe:]DDEMod:MFILter[:STATe].....	292
[SENSe:]DDEMod:MSK:FORMat.....	292
[SENSe:]DDEMod:NORMalize:ADRoop.....	293
[SENSe:]DDEMod:NORMalize:CFDRift.....	293
[SENSe:]DDEMod:NORMalize:FDERror.....	293
[SENSe:]DDEMod:NORMalize:IQIMbalance.....	294
[SENSe:]DDEMod:NORMalize:IQOFset.....	294
[SENSe:]DDEMod:NORMalize[:VALue].....	294
[SENSe:]DDEMod:PRATe.....	295
[SENSe:]DDEMod:PRESet:CALC.....	295
[SENSe:]DDEMod:PRESet:RLEVel.....	295
[SENSe:]DDEMod:PRESet[:STANdard].....	296
[SENSe:]DDEMod:PSK:FORMat.....	297
[SENSe:]DDEMod:PSK:NSTate.....	298
[SENSe:]DDEMod:QAM:FORMat.....	298
[SENSe:]DDEMod:QAM:NSTate.....	299
[SENSe:]DDEMod:QPSK:FORMat.....	299
[SENSe:]DDEMod:RLENgth:AUTO.....	300
[SENSe:]DDEMod:RLENgth[:VALue].....	300
[SENSe:]DDEMod:SBANd.....	300
[SENSe:]DDEMod:SEARch:BURSt:AUTO.....	301
[SENSe:]DDEMod:SEARch:BURSt:CONFIgure:AUTO.....	301
[SENSe:]DDEMod:SEARch:BURSt:GLENgth[:MINimum].....	301

[SENSe:]DDEMod:SEARch:BURSt:LENGth:MAXimum.....	302
[SENSe:]DDEMod:SEARch:BURSt:LENGth[:MINimum].....	302
[SENSe:]DDEMod:SEARch:BURSt:MODE.....	302
[SENSe:]DDEMod:SEARch:BURSt:SKIP:FALLing.....	303
[SENSe:]DDEMod:SEARch:BURSt:SKIP:RISing.....	303
[SENSe:]DDEMod:SEARch:BURSt:STATe.....	303
[SENSe:]DDEMod:SEARch:BURSt:TOLerance.....	304
[SENSe:]DDEMod:SEARch:MBURst:CALC.....	304
[SENSe:]DDEMod:SEARch:MBURst:START?.....	304
[SENSe:]DDEMod:SEARch:PATtern:CONFigure:AUTO.....	305
[SENSe:]DDEMod:SEARch:PATtern:SYNC:AUTO.....	305
[SENSe:]DDEMod:SEARch:PATtern:SYNC[:STATe].....	305
[SENSe:]DDEMod:SEARch:SYNC:AUTO.....	306
[SENSe:]DDEMod:SEARch:SYNC:CATalog.....	306
[SENSe:]DDEMod:SEARch:SYNC:COMMeNt.....	306
[SENSe:]DDEMod:SEARch:SYNC:COpy.....	307
[SENSe:]DDEMod:SEARch:SYNC:DATA.....	307
[SENSe:]DDEMod:SEARch:SYNC:DELeTe.....	308
[SENSe:]DDEMod:SEARch:SYNC:FOUNd.....	308
[SENSe:]DDEMod:SEARch:SYNC:IQCThreshold.....	308
[SENSe:]DDEMod:SEARch:SYNC:MODE.....	309
[SENSe:]DDEMod:SEARch:SYNC:NAME.....	309
[SENSe:]DDEMod:SEARch:SYNC:NState.....	309
[SENSe:]DDEMod:SEARch:SYNC:PATtern:ADD.....	310
[SENSe:]DDEMod:SEARch:SYNC:PATtern:REMOve.....	310
[SENSe:]DDEMod:SEARch:SYNC:SELeCt.....	310
[SENSe:]DDEMod:SEARch:SYNC:STATe.....	311
[SENSe:]DDEMod:SEARch:SYNC:TEXT.....	311
[SENSe:]DDEMod:SIGNal:PATtern.....	311
[SENSe:]DDEMod:SIGNal[:VALue].....	312
[SENSe:]DDEMod:SRATe.....	312
[SENSe:]DDEMod:STANdard:COMMeNt.....	312
[SENSe:]DDEMod:STANdard:DELeTe.....	312
[SENSe:]DDEMod:STANdard:PREset[:VALue].....	313
[SENSe:]DDEMod:STANdard:SAVE.....	313
[SENSe:]DDEMod:STANdard:SYNC:OFFSet:STATe.....	313
[SENSe:]DDEMod:STANdard:SYNC:OFFSet[:VALue].....	314
[SENSe:]DDEMod:TFILter:NAME.....	314
[SENSe:]DDEMod:TFILter:USER.....	315
[SENSe:]DDEMod:TFILter[:STATe].....	314
[SENSe:]DDEMod:TIME.....	315
[SENSe:]DDEMod:UQAM:FORMat.....	316
[SENSe:]DDEMod:UQAM:NState?.....	316
[SENSe:]FREQuency:CENTer.....	316
[SENSe:]FREQuency:CENTer:STEP.....	316
[SENSe:]FREQuency:CENTer:STEP:AUTO.....	317
[SENSe:]FREQuency:OFFSet.....	317
[SENSe:]SWEep:COUNt:CURRent.....	318
[SENSe:]SWEep:COUNt[:VALue].....	317
[SENSe:]DDEMod:FILTer:ALPHa.....	286

[SENSe]:DDEMod:MFILter:ALPHA.....	291
[SENSe]:DDEMod:TFILter:ALPHA.....	314
ABORT.....	207
CALCulate<n>:BERate.....	243
CALCulate<n>:DDEM:SPECTrum[:STATe].....	243
CALCulate<n>:DELTamarker<m>:AOFF.....	208
CALCulate<n>:DELTamarker<m>:LINK.....	208
CALCulate<n>:DELTamarker<m>:MAXimum:APEak.....	208
CALCulate<n>:DELTamarker<m>:MAXimum:LEFT.....	209
CALCulate<n>:DELTamarker<m>:MAXimum:NEXT.....	209
CALCulate<n>:DELTamarker<m>:MAXimum:RIGHT.....	210
CALCulate<n>:DELTamarker<m>:MAXimum[:PEAK].....	209
CALCulate<n>:DELTamarker<m>:MINimum:LEFT.....	210
CALCulate<n>:DELTamarker<m>:MINimum:NEXT.....	210
CALCulate<n>:DELTamarker<m>:MINimum:RIGHT.....	211
CALCulate<n>:DELTamarker<m>:MINimum[:PEAK].....	211
CALCulate<n>:DELTamarker<m>:TRACe.....	212
CALCulate<n>:DELTamarker<m>:X.....	212
CALCulate<n>:DELTamarker<m>:X:ABSolute?.....	212
CALCulate<n>:DELTamarker<m>:X:RELative?.....	213
CALCulate<n>:DELTamarker<m>:Y?.....	213
CALCulate<n>:DELTamarker<m>[:STATe].....	211
CALCulate<n>:DLABs:STATe.....	244
CALCulate<n>:DLABs[:VALue].....	244
CALCulate<n>:DLRel:STATe.....	245
CALCulate<n>:DLRel[:VALue].....	245
CALCulate<n>:ELIN<startstop>:STATe.....	246
CALCulate<n>:ELIN<startstop>[:VALue].....	246
CALCulate<n>:FEED.....	247
CALCulate<n>:FORMat.....	247
CALCulate<n>:FSK:DEVIation:COMPensation.....	249
CALCulate<n>:FSK:DEVIation:REFerence:RELative.....	249
CALCulate<n>:FSK:DEVIation:REFerence[:VALue].....	249
CALCulate<n>:LIMit:MACCuracy:<ResultType>:<LimitType>:STATe.....	215
CALCulate<n>:LIMit:MACCuracy:<ResultType>:<LimitType>[:RESUlt]?.....	216
CALCulate<n>:LIMit:MACCuracy:CFERror:CURRent:VALue.....	217
CALCulate<n>:LIMit:MACCuracy:CFERror:MEAN:VALue.....	217
CALCulate<n>:LIMit:MACCuracy:CFERror:PEAK:VALue.....	217
CALCulate<n>:LIMit:MACCuracy:DEFault.....	214
CALCulate<n>:LIMit:MACCuracy:EVM:PCURRent:VALue.....	218
CALCulate<n>:LIMit:MACCuracy:EVM:PMEan:VALue.....	218
CALCulate<n>:LIMit:MACCuracy:EVM:PPEak:VALue.....	218
CALCulate<n>:LIMit:MACCuracy:EVM:RCURRent:VALue.....	218
CALCulate<n>:LIMit:MACCuracy:EVM:RMEan:VALue.....	218
CALCulate<n>:LIMit:MACCuracy:EVM:RPEak:VALue.....	218
CALCulate<n>:LIMit:MACCuracy:FDERror:CURRent:VALue.....	218
CALCulate<n>:LIMit:MACCuracy:FDERror:MEAN:VALue.....	218
CALCulate<n>:LIMit:MACCuracy:FDERror:PEAK:VALue.....	218
CALCulate<n>:LIMit:MACCuracy:FERRor:PCURRent:VALue.....	219
CALCulate<n>:LIMit:MACCuracy:FERRor:PMEan:VALue.....	219

CALCulate<n>:LIMit:MACCuracy:FERRor:PPEak:VALue.....	219
CALCulate<n>:LIMit:MACCuracy:FERRor:RCURrent:VALue.....	219
CALCulate<n>:LIMit:MACCuracy:FERRor:RMEan:VALue.....	219
CALCulate<n>:LIMit:MACCuracy:FERRor:RPEak:VALue.....	219
CALCulate<n>:LIMit:MACCuracy:MERRor:PCURrent:VALue.....	219
CALCulate<n>:LIMit:MACCuracy:MERRor:PMEan:VALue.....	219
CALCulate<n>:LIMit:MACCuracy:MERRor:PPEak:VALue.....	219
CALCulate<n>:LIMit:MACCuracy:MERRor:RCURrent:VALue.....	219
CALCulate<n>:LIMit:MACCuracy:MERRor:RMEan:VALue.....	219
CALCulate<n>:LIMit:MACCuracy:MERRor:RPEak:VALue.....	219
CALCulate<n>:LIMit:MACCuracy:OOFfset:CURRent:VALue.....	220
CALCulate<n>:LIMit:MACCuracy:OOFfset:MEAN:VALue.....	220
CALCulate<n>:LIMit:MACCuracy:OOFfset:PEAK:VALue.....	220
CALCulate<n>:LIMit:MACCuracy:PERRor:PCURrent:VALue.....	220
CALCulate<n>:LIMit:MACCuracy:PERRor:PMEan:VALue.....	220
CALCulate<n>:LIMit:MACCuracy:PERRor:PPEak:VALue.....	220
CALCulate<n>:LIMit:MACCuracy:PERRor:RCURrent:VALue.....	220
CALCulate<n>:LIMit:MACCuracy:PERRor:RMEan:VALue.....	220
CALCulate<n>:LIMit:MACCuracy:PERRor:RPEak:VALue.....	220
CALCulate<n>:LIMit:MACCuracy:RHO:CURRent:VALue.....	221
CALCulate<n>:LIMit:MACCuracy:RHO:MEAN:VALue.....	221
CALCulate<n>:LIMit:MACCuracy:RHO:PEAK:VALue.....	221
CALCulate<n>:LIMit:MACCuracy:STATE.....	215
CALCulate<n>:MARKer<m>:AOFF.....	222
CALCulate<n>:MARKer<m>:FUNction:DDEMod:STATistic:ADRoop?.....	222
CALCulate<n>:MARKer<m>:FUNction:DDEMod:STATistic:ALL?.....	223
CALCulate<n>:MARKer<m>:FUNction:DDEMod:STATistic:CFERror?.....	223
CALCulate<n>:MARKer<m>:FUNction:DDEMod:STATistic:EVM?.....	224
CALCulate<n>:MARKer<m>:FUNction:DDEMod:STATistic:FDERror?.....	225
CALCulate<n>:MARKer<m>:FUNction:DDEMod:STATistic:FSK:CFDRift?.....	226
CALCulate<n>:MARKer<m>:FUNction:DDEMod:STATistic:FSK:DERRor?.....	226
CALCulate<n>:MARKer<m>:FUNction:DDEMod:STATistic:FSK:MDEviation?.....	227
CALCulate<n>:MARKer<m>:FUNction:DDEMod:STATistic:FSK:RDEviation?.....	228
CALCulate<n>:MARKer<m>:FUNction:DDEMod:STATistic:GIMBalance?.....	229
CALCulate<n>:MARKer<m>:FUNction:DDEMod:STATistic:IQIMbalance?.....	229
CALCulate<n>:MARKer<m>:FUNction:DDEMod:STATistic:MERRor?.....	230
CALCulate<n>:MARKer<m>:FUNction:DDEMod:STATistic:MPOWer?.....	230
CALCulate<n>:MARKer<m>:FUNction:DDEMod:STATistic:OOFfset?.....	231
CALCulate<n>:MARKer<m>:FUNction:DDEMod:STATistic:PERRor?.....	232
CALCulate<n>:MARKer<m>:FUNction:DDEMod:STATistic:QERRor?.....	232
CALCulate<n>:MARKer<m>:FUNction:DDEMod:STATistic:RHO?.....	233
CALCulate<n>:MARKer<m>:FUNction:DDEMod:STATistic:SNR?.....	234
CALCulate<n>:MARKer<m>:LINK.....	234
CALCulate<n>:MARKer<m>:MAXimum:APEak.....	235
CALCulate<n>:MARKer<m>:MAXimum:LEFT.....	235
CALCulate<n>:MARKer<m>:MAXimum:NEXT.....	235
CALCulate<n>:MARKer<m>:MAXimum:RIGHT.....	236
CALCulate<n>:MARKer<m>:MAXimum[:PEAK].....	236
CALCulate<n>:MARKer<m>:MINimum:LEFT.....	237
CALCulate<n>:MARKer<m>:MINimum:NEXT.....	237



CALCulate<n>:MARKer<m>:MINimum:RIGHT.....	238
CALCulate<n>:MARKer<m>:MINimum[:PEAK].....	237
CALCulate<n>:MARKer<m>:SEARCh.....	238
CALCulate<n>:MARKer<m>:TRACe.....	239
CALCulate<n>:MARKer<m>:X.....	239
CALCulate<n>:MARKer<m>:X:SLIMits:LEFT.....	240
CALCulate<n>:MARKer<m>:X:SLIMits:RIGHT.....	241
CALCulate<n>:MARKer<m>:X:SLIMits:ZOOM.....	241
CALCulate<n>:MARKer<m>:X:SLIMits[:STATe].....	240
CALCulate<n>:MARKer<m>:Y?.....	241
CALCulate<n>:MARKer<m>[:STATe].....	238
CALCulate<n>:STATistics:CCDF[:STATe].....	250
CALCulate<n>:STATistics:MODE.....	250
CALCulate<n>:STATistics:PRESet.....	251
CALCulate<n>:STATistics:SCALe:AUTO.....	251
CALCulate<n>:STATistics:SCALe:X:BCOunt.....	251
CALCulate<n>:STATistics:SCALe:Y:LOWer.....	252
CALCulate<n>:STATistics:SCALe:Y:UNIT.....	252
CALCulate<n>:STATistics:SCALe:Y:UPPer.....	252
CALCulate<n>:TLABs:STATe.....	252
CALCulate<n>:TLABs[:VALue].....	253
CALCulate<n>:TLRel:STATe.....	253
CALCulate<n>:TLRel[:VALue].....	254
CALCulate<n>:TRACe<t>:ADJust:ALIGnment:OFFSet.....	254
CALCulate<n>:TRACe<t>:ADJust:ALIGnment[:DEFault].....	255
CALCulate<n>:TRACe<t>:ADJust[:VALue].....	255
CALCulate<n>:TRACe<t>[:VALue].....	256
CALCulate<n>:UNIT:ANGLE.....	256
CALCulate<n>:X:UNIT:TIME.....	257
DISPlay[:WINDow<n>]:PRATe:AUTO.....	258
DISPlay[:WINDow<n>]:PRATe[:VALue].....	258
DISPlay[:WINDow<n>]:SIZE.....	258
DISPlay[:WINDow<n>]:STATe.....	259
DISPlay[:WINDow<n>]:TRACe<t>:MODE.....	259
DISPlay[:WINDow<n>]:TRACe<t>:SYMBol.....	260
DISPlay[:WINDow<n>]:TRACe<t>:X[:SCALe]:PDIVision.....	260
DISPlay[:WINDow<n>]:TRACe<t>:X[:SCALe]:RPOStion.....	261
DISPlay[:WINDow<n>]:TRACe<t>:X[:SCALe]:RVALue.....	261
DISPlay[:WINDow<n>]:TRACe<t>:X[:SCALe]:STARt?.....	262
DISPlay[:WINDow<n>]:TRACe<t>:X[:SCALe]:VOFFSet.....	262
DISPlay[:WINDow<n>]:TRACe<t>:Y:SPACing.....	266
DISPlay[:WINDow<n>]:TRACe<t>:Y[:SCALe].....	262
DISPlay[:WINDow<n>]:TRACe<t>:Y[:SCALe]:AUTO:ALL.....	263
DISPlay[:WINDow<n>]:TRACe<t>:Y[:SCALe]:AUTO[:VALue].....	263
DISPlay[:WINDow<n>]:TRACe<t>:Y[:SCALe]:MODE.....	263
DISPlay[:WINDow<n>]:TRACe<t>:Y[:SCALe]:RLEVel.....	264
DISPlay[:WINDow<n>]:TRACe<t>:Y[:SCALe]:RLEVel:OFFSet.....	265
DISPlay[:WINDow<n>]:TRACe<t>:Y[:SCALe]:RPOStion.....	265
DISPlay[:WINDow<n>]:TRACe<t>:Y[:SCALe]:RVALue.....	266
DISPlay[:WINDow<n>]:TRACe<t>:Y[:SCALe]:PDIVision].....	264

DISPlay[:WINDow<n>]:TRACe<t>[:STATe].....	260
DISPlay[:WINDow<n>]:ZOOM:AREA.....	267
DISPlay[:WINDow<n>]:ZOOM:STATe.....	266
FORMat:DEXPort:DSEParator.....	267
FORMat:DEXPort:HEADer.....	268
FORMat:DEXPort:MODE.....	268
INITiate:REFMeas.....	270
INITiate<n>:CONMeas.....	268
INITiate<n>:CONTInuous.....	269
INITiate<n>[:IMMediate].....	269
INPut:ATTenuation.....	271
INPut:ATTenuation:AUTO.....	271
INPut:COUPling.....	271
INPut:DIQ:CDEVice.....	272
INPut:DIQ:RANGe:COUPling.....	273
INPut:DIQ:RANGe[:UPPer].....	273
INPut:DIQ:RANGe[:UPPer]:UNIT.....	274
INPut:DIQ:SRATe.....	274
INPut:EATT.....	275
INPut:EATT:AUTO.....	275
INPut:EATT:STATe.....	275
INPut:FILTer:YIG[:STATe].....	276
INPut:GAIN:STATe.....	276
INPut:SElect.....	277
INSTrument:NSElect.....	277
INSTrument:SElect.....	277
MMEMory:LOAD:IQ:STATe.....	277
MMEMory:SElect:ITEM:VIQData.....	278
MMEMory:STORe:IQ:COMM.....	278
MMEMory:STORe:IQ:FORMat.....	279
MMEMory:STORe:IQ:STATe.....	278
MMEMory:STORe<n>:TRACe.....	279
OUTPut:DIQ.....	280
OUTPut:DIQ:CDEVice.....	280
STATus:QUEStionable:CONDition.....	319
STATus:QUEStionable:MODulation<n>:<ResultType>:CONDition?.....	321
STATus:QUEStionable:MODulation<n>:<ResultType>:ENABLE?.....	322
STATus:QUEStionable:MODulation<n>:<ResultType>:NTRansition?.....	322
STATus:QUEStionable:MODulation<n>:<ResultType>:PTRansition?.....	323
STATus:QUEStionable:MODulation<n>:<ResultType>[:EVENT]?.....	321
STATus:QUEStionable:MODulation<n>:CONDition?.....	319
STATus:QUEStionable:MODulation<n>:ENABLE.....	319
STATus:QUEStionable:MODulation<n>:NTRansition.....	320
STATus:QUEStionable:MODulation<n>:PTRansition.....	320
STATus:QUEStionable:MODulation<n>[:EVENT]?.....	320
STATus:QUEStionable:SYNC:CONDition?.....	323
STATus:QUEStionable:SYNC:ENABLE.....	324
STATus:QUEStionable:SYNC:NTRansition.....	324
STATus:QUEStionable:SYNC:PTRansition.....	324
STATus:QUEStionable:SYNC[:EVENT]?.....	324

STATus:QUEStionable[:EVENT]?	319
SYSTem:DISPlay:UPDate	325
TRACe:IQ:WBAND[:STATe]	327
TRACe<n>:IQ:BWIDth	327
TRACe<n>[:DATA]	325
TRIGger<n>[:SEQuence]:BBPower:HOLDoff	329
TRIGger<n>[:SEQuence]:HOLDoff[:TIME]	330
TRIGger<n>[:SEQuence]:IFPower:HOLDoff	329
TRIGger<n>[:SEQuence]:IFPower:HYSTeresis	330
TRIGger<n>[:SEQuence]:LEVel:BBPower	328
TRIGger<n>[:SEQuence]:LEVel:IFPower	329
TRIGger<n>[:SEQuence]:SLOPe	330
TRIGger<n>[:SEQuence]:SOURce	331

# Index

## A

Activating the option .....	67
Adjust Settings	
Softkey .....	113
Alignment	
Result range .....	167
Alpha/BT .....	146, 175
Amplitude Droop	
Compensation .....	170
Application cards .....	6
Application notes .....	6
ASCII Trace export .....	203
ASCII Trace Export	
Softkey .....	123, 140
attenuation	
(option B25) .....	115
Attenuation	
(option B25) .....	115
Automatic .....	115
Manual .....	114, 271
Option B25 .....	114
Attenuation Mode	
RF Settings .....	152
Auto level	
Hysteresis .....	117
Average trace mode .....	121, 202

## B

Bandwidth	
Extension .....	155
Maximum .....	155
Bandwidth extension	
Option B160 .....	13
Restrictions for use .....	14
BER	
see Bit error rate .....	95
Binary	
Softkey .....	113
Bit error rate	
Result type .....	95
Blank trace mode .....	122, 202
Block diagram	
I/Q data .....	10
Brochures .....	6
Burst Search .....	44
Activating (remote control) .....	303
Auto configuration .....	159
Enabling .....	159
Falling edge (remote control) .....	303
Gap length .....	159
Minimum gap (remote control) .....	301
Rising edge (remote control) .....	303
Softkey .....	127
Tolerance .....	159
Tolerance (remote control) .....	304
Burst Signal .....	147
Bursts	
Length (remote control) .....	302
Useful length .....	147

## C

Capture Length	
I/Q Capture .....	154
I/Q Capture (remote control) .....	300
Capture Oversampling .....	154
Remote control .....	295
Capture Unit	
Softkey .....	114
Carrier Frequency Drift	
Compensation .....	170
Center frequency .....	110
CF Stepsize .....	110
Characters	
Special .....	206
Clear Write trace mode .....	121, 201
Coarse Synchronization .....	172
Commands	
Description .....	204
Compensation	
Demodulation .....	170
Config ModAcc Limits	
Softkey .....	133
Config Pattern	
Softkey .....	127
Constellation I/Q	
Result type .....	80
Rotated, Result type .....	80
Continuous Signal .....	147
Continuous sweep .....	118
Couple Screens (On/Off)	
Remote control .....	234
Softkey .....	129

## D

Data sheets .....	6
Decimal	
Softkey .....	113
Default Settings	
Softkey .....	113
Delete Standard	
softkey .....	109
Demod Meas Filter	
Softkey .....	128
Demodulation	
Bandwidth .....	14
Coarse Synchronization .....	172
Compensation .....	170
Estimation Points per Symbol .....	172
Fine Synchronization .....	173
Mode (remote control) .....	298, 299
Normalization .....	171
Offset EVM .....	171
Order (remote control) .....	299
Demodulation order	
Remote control .....	297, 298
Differential PSK (DPSK) .....	27
DigiConf	
Softkey .....	138
Digital Baseband Info	
Remote control .....	280

- Digital IQ data
  - device ..... 136
- Digital IQ Info
  - Remote control ..... 272
  - Softkey ..... 139
- Digital Standards
  - Softkey ..... 108
- Display Configuration
  - Result Type ..... 177
  - Result Type Transformation ..... 178
  - Softkey ..... 109, 128
  - Source ..... 177
- Display Points/Symbol ..... 179
  - remote control ..... 258
- Display range
  - Frequency ..... 110
- E**
- EDGE filters
  - Frequency response ..... 367
- EI Attenuation
  - RF Settings ..... 152
- Electronic input attenuation
  - FSV-B25 ..... 275
- Error model
  - FSK ..... 62
- Error Vector Magnitude (EVM)
  - Result type ..... 84
- Estimation ..... 52
  - FSK ..... 63
  - Points per Symbol ..... 172
  - Ranges ..... 52
- Evaluation
  - Range ..... 168
  - Range (remote control) ..... 246
  - Range display ..... 104
  - Refreshing ..... 119
  - Traces ..... 123
- Evaluation (Meas/Ref)
  - Remote control ..... 256
  - Softkey ..... 122
- EVM
  - Result Summary ..... 90
- EX-IQ-BOX ..... 137
  - DigiConf ..... 138
- Export
  - I/Q data (remote) ..... 278
  - Softkey ..... 140
- export format ..... 203
- Exporting
  - I/Q data (remote) ..... 278
  - I/Q data format (remote) ..... 279
- External
  - Softkey ..... 124
- Eye diagram
  - Measuring eye size ..... 200
- Eye Diagram Frequency
  - Result type ..... 79
- Eye Diagram Imag (Q)
  - Result type ..... 78
- Eye Diagram Real (I)
  - Result type ..... 77
- F**
- Filter bandwidth
  - Digital I/Q (remote control) ..... 327
- Filters
  - Activating (remote control) ..... 287, 292, 314
  - Alpha/BT (remote control) ..... 314
  - Customized ..... 19
  - Selecting (remote control) ..... 314
- Fine Synchronization ..... 173
- Folders
  - New ..... 109
- Free Run
  - Softkey ..... 124
- frequency
  - offset ..... 110
- Frequency
  - Center ..... 110
  - RF Settings ..... 150
- Frequency Absolute
  - Result type ..... 74
- Frequency Error Absolute
  - Result type ..... 87
- Frequency Error Relative
  - Result type ..... 88
- Frequency Relative
  - Result type ..... 75
- Frequency response
  - EDGE filters ..... 367
  - Low-ISI filters ..... 369
- Frequency shift keying (FSK) ..... 31
- Frontend
  - Softkey ..... 127
- FSK Deviation Error
  - Compensation ..... 170
- Full Scale Level
  - Digital I/Q Interface (remote control) ..... 273
  - Digital IQ ..... 137
- G**
- Getting started ..... 5
- H**
- Hexadecimal
  - Softkey ..... 114
- Horizontal line
  - Eye diagram ..... 133
- Hysteresis
  - Lower (Auto level) ..... 117
  - Upper (Auto level) ..... 117
- I**
- I/Q bandwidth ..... 13
- I/Q Capture
  - Capture Length ..... 154
  - Capture Length (remote control) ..... 300
  - Capture Length Auto ..... 154
  - Capture Oversampling ..... 154
  - Sample Rate ..... 154
  - Softkey ..... 127
  - Trigger Mode ..... 155
  - Usable I/Q Bandwidth ..... 155

- I/Q data
  - Block diagram ..... 10
  - Export (remote control) ..... 278
  - Export format (remote control) ..... 279
  - Import (remote control) ..... 277
  - Saving ..... 105
- I/Q Imbalance
  - Compensation ..... 170
- I/Q Offset
  - Compensation ..... 170
- I/Q pattern search ..... 46
- IEC/IEEE bus
  - Command description ..... 204
- IF Power
  - Softkey ..... 124
- IF WIDE OUTPUT
  - Connector ..... 155
- Importing
  - I/Q data (remote) ..... 277
- Input Coupling
  - RF Settings ..... 151
- Input sample rate
  - Digital IQ ..... 136
- Intersymbol interference ..... 14
- IQ Export
  - Softkey ..... 140
- ISI
  - Filter ..... 15
  - Intersymbol interference ..... 14
- K**
- Known data
  - Creating files ..... 195
  - File syntax ..... 197
  - Recording tool ..... 196
- Known Data
  - Files ..... 194
  - Working with ..... 194
- L**
- Level Unit
  - Digital I/Q Interface (remote control) ..... 274
  - Digital IQ ..... 137
- Limits
  - Configuring ..... 199
  - Modulation Accuracy ..... 133, 199
- Lines
  - Horizontal ..... 133
  - Menu ..... 132
  - Vertical ..... 132
- Load Standard
  - Softkey ..... 108
- Low-ISI filters
  - Frequency response ..... 369
- Lower Level Hysteresis
  - Softkey ..... 117
- Lower-case (commands) ..... 205
- M**
- Magnitude Absolute
  - Result type ..... 70
- Magnitude Error
  - Result type ..... 86
- Magnitude Relative
  - Result type ..... 71
- Mapping ..... 21, 145
- marker
  - peak ..... 131
- Markers
  - Coupling ..... 129
  - Coupling (remote control) ..... 234
  - Selecting ..... 130
  - Set to trace ..... 130
  - Setting to Trace ..... 131
  - Settings ..... 130, 131
- Matched filter ..... 14
- Max Hold trace mode ..... 121, 201
- Max Peak
  - softkey ..... 132
- maximum search ..... 131
- MEAS filter ..... 15
- MEAS key ..... 67
- Meas only if burst was found ..... 159
- Measurement bandwidth ..... 14
- Measurement filters ..... 17
  - Deactivating (remote control) ..... 292
  - Enabling ..... 175
  - Predefined ..... 19
  - Type ..... 175
  - User-defined ..... 175
- Measurement result display ..... 69
- Menu
  - Lines ..... 132
  - Measurement ..... 107
  - VSA ..... 107
- Min Hold trace mode ..... 121, 202
- minimum search ..... 132
- Minimum shift keying (MSK) ..... 34
- ModAcc Limits
  - Softkey ..... 133
- Modulation
  - Errors, FSK ..... 64
  - Mapping ..... 145
  - Order ..... 144
  - Symbol Rate ..... 145
  - Type ..... 143
- Modulation Accuracy
  - Limits ..... 133, 199
- N**
- New Folder
  - Softkey ..... 109
- Normalization
  - Demodulation ..... 171
- O**
- Octal
  - Softkey ..... 113
- offset
  - frequency ..... 110
- Offset
  - EVM ..... 171
  - Pattern ..... 148
  - QPSK ..... 29
  - Reference level ..... 116
  - Result range ..... 167
  - Trigger ..... 125, 156

- Online help
  - Working with ..... 8
- Options
  - B160 ..... 155
  - B160 (Bandwidth extension) ..... 13
  - Bandwidth extension ..... 155
  - FSV-B25 ..... 114, 275
  - RF Preamplifier (B22) ..... 114, 151
- Order
  - Demodulation (remote control) ..... 297, 299
  - Demodulation (Remote control) ..... 298
- Oversampling
  - Statistics ..... 180
- Overwrite mode ..... 121, 201
- P**
- Pattern Search
  - Activating (remote control) ..... 306, 311
  - Auto configuration ..... 161
  - Enabling ..... 161
  - I/Q Correlation Threshold ..... 161
- Patterns ..... 147
  - Adding to standard ..... 163
  - Assigning to standard (remote control) ..... 310
  - Comment, remote control ..... 306
  - Copying (remote control) ..... 307
  - Creating ..... 163
  - Defining ..... 164
  - Defining (remote control) ..... 307
  - Deleting ..... 163
  - Deleting (remote control) ..... 308
  - Editing ..... 163
  - Enabling ..... 161, 162, 163
  - List ..... 162
  - Managing ..... 191
  - Offset ..... 148
  - Offset (remote control) ..... 313
  - Removing from standard ..... 163
  - Removing from standard (remote control) ..... 310
  - Restoring ..... 109
  - Selecting (remote control) ..... 309, 310
  - Settings ..... 162
  - Text, remote control ..... 311
  - Working with ..... 189
- PEAKSEARCH ..... 131
- Phase Error
  - Result type ..... 87
- Phase shift keying (PSK) ..... 22
- Phase Unwrap
  - Result type ..... 73
- Phase Wrap
  - Result type ..... 72
- polarity
  - external trigger ..... 125, 157
  - trigger edge ..... 125, 157
- pre-trigger ..... 126, 156
- Preamplifier (B22) ..... 114, 151
- Printing
  - Results ..... 105
  - Screenshots ..... 105
- PSK mixed forms ..... 28
- R**
- R&S Digital I/Q Interface (B17) ..... 139, 272, 280
- R&S Support
  - softkey ..... 138, 140
- Range Settings
  - Softkey ..... 127
- Ranges
  - Softkey ..... 111
  - Softkey (statistic measurements) ..... 112
  - Softkey (Symbol Table) ..... 113
- Real/Imag (I/Q)
  - Result type ..... 76
- Receive filter ..... 15
- Recording tool
  - Known data ..... 196
- Reference
  - Result range ..... 166
- Reference filter ..... 15
- Reference level
  - Offset ..... 116
  - Offset (RF Settings) ..... 151
- Reference Level
  - Digital IQ ..... 137
  - RF Settings ..... 111, 150
- Release notes ..... 6
- Restore Factory Settings
  - Softkey ..... 109
- Restore Pattern Files
  - Softkey ..... 109
- Restore Standard Files
  - softkey ..... 109
- Result ranges
  - Alignment ..... 167
  - Defining ..... 181
  - Display ..... 103
  - Length ..... 166
  - Offset ..... 167
  - Overlapping ..... 348
  - Reference ..... 166
  - Selecting ..... 119
- Result Summary
  - Result type ..... 89
- Result type ..... 69
- Result type transformation ..... 69
- Result types
  - Display Configuration ..... 177
  - Overview ..... 70
  - Transformation ..... 178
- Results
  - Saving ..... 105
- RF Attenuation
  - RF Settings ..... 152
- RF Preamplifier (B22) ..... 114, 151
- RF Settings
  - Attenuation Mode ..... 152
  - EL Attenuation ..... 152
  - Frequency ..... 150
  - Input Coupling ..... 151
  - Ref Level Offset ..... 151
  - Reference Level ..... 111, 150
  - RF Attenuation ..... 152
- Rotating PSK ..... 25
- RRC filter ..... 14
- RX Settings
  - softkey ..... 137
- S**
- Safety instructions ..... 6

Sample rate		
Digital I/Q Interface (remote control)	274	
Digital IQ	136	
Save As Standard		
Softkey	108	
Saving		
I/Q data	105	
Results	105	
Screenshots	105	
scaling		
x-axis	185	
y-axis	184, 185	
SCPI		
Conformity information	205	
Screens		
Display Configuration	176	
Screenshots		
Printing	105	
search		
minimum	132	
peak	131	
Search		
Direction	131	
Direction (Real or Imag)	131	
Limits	131	
Tolerance (Burst Search)	159	
Service manual	6	
Settings Overview		
softkey	108, 126	
Signal Description		
Continuous/Burst Signal	147	
Pattern	147	
Softkey	126	
Signal Mapping	145	
Signal Source		
I/Q Analyzer	136	
Remote control	277	
Softkey	136	
softkey		
All Marker Off	130	
CF Stepsize (remote control)	316	
Cont Meas (remote control)	269	
Continue Single Sweep (remote control)	268, 269	
Continuous Sweep (remote control)	269	
Default Settings (remote control)	252	
Deviation Lin/Log (remote control)	266	
El Atten Mode (Auto/Man)	115	
Export (remote control)	279	
Frequency Offset	110	
Grid Abs/Rel (remote control)	263	
Left Limit (remote control)	240	
Limits On/Off (remote control)	240	
Link Mkr1 and Delta1	129	
Link Mrk1 and Delta1 (remote control)	208	
Manual (remote control)	316	
Marker 1 (remote control)	211	
Marker 1 to 4 (remote control)	212, 213, 238, 239	
Marker 2 (remote control)	211	
Marker 3 (remote control)	211	
Marker 4 (remote control)	211	
Marker Norm/Delta	128	
Marker Norm/Delta (remote control)	211	
Marker to Trace (remote control)	212	
Meas Time Auto	117, 284	
Meas Time Manual	117, 284	
Min	132	
Min (remote control)	211, 237	
Next Min	132	
Next Min (remote control)	210, 237, 238	
Next Peak	131	
Next Peak (remote control)	209, 210, 211, 235, 236, 237, 238	
Peak	131	
Peak (remote control)	209, 236	
R&S Support	138, 140	
Range Lin. Unit (remote control)	266	
Range Linear % (remote control)	266	
Range Log (remote control)	262, 266	
Ref Level Offset (remote control)	265	
Ref Level Position (remote control)	265	
Ref Value (remote control)	266	
Ref Value Position (remote control)	265	
Reference Position (remote control)	265	
Right Limit (remote control)	241	
Search Lim Off (remote control)	240	
Search Limits (remote control)	240	
Select 1 2 3 4 (remote control)	238	
Select 1/2/3/4	130	
Settings	117	
Single Meas (remote control)	269	
Single Sweep (remote control)	269	
Trace 1 2 3 4 5 6 (remote control)	260	
Trace Mode (remote control)	263	
Trg/Gate Polarity Pos/Neg (remote control)	330	
Trigger Holdoff (remote control)	330	
Trigger Polarity	125, 157	
Use Zoom Limits (remote control)	241	
y-Axis Max Value	113	
y-Axis Max Value (remote control)	252	
y-Axis Min Value	113	
y-Unit %/Abs	113	
y-Unit %/Abs (remote control)	252	
Softkey		
Auto Level	117	
Average	121, 202	
BB Power Retrigger Holdoff (remote control)	329	
Blank	122, 202	
Center	110	
Center (remote control)	316	
Clear Write	121, 201	
Config ModAcc Limits	133	
Cont Meas (remote control)	269	
Continue Single Sweep	118	
Continuous Sweep	118	
Continuous Sweep (remote control)	269	
Decim Sep (remote control)	267	
DiglConf	138	
Display Config	109, 128	
EL Atten (remote control)	275	
EL Atten Mode (Auto/Man) (remote control)	275	
El Atten On/Off	115	
EX-IQ-BOX	137	
Export (remote control)	278	
Frequency Offset (remote control)	317	
IF Power Retrigger Holdoff (remote control)	329	
IF Power Retrigger Hysteresis (remote control)	330	
Import (remote control)	277	
Input (AC/DC)	116, 138	
Input (AC/DC)(remote control)	271	
IQ Export	140	
Load Standard	108	
Marker 1 to 4 (remote control)	213, 241	
Marker 1/2/3/4	128	
Marker to Trace	130	



- Marker to Trace (remote control) ..... 239
- Max Hold ..... 121, 201
- Mech Atten Auto ..... 115
- Mech Atten Auto (remote control) ..... 271
- Mech Atten Manual ..... 114
- Mech Atten Manual (remote control) ..... 271
- Min Hold ..... 121, 202
- ModAcc Limits ..... 133
- Preamplifier On/Off ..... 114, 151
- Preamplifier On/Off (remote control) ..... 276
- Ref Level (remote control) ..... 264
- Ref Level Offset ..... 116
- RF Atten Auto ..... 115
- RF Atten Auto (remote control) ..... 271
- RF Atten Manual ..... 114
- RF Atten Manual (remote control) ..... 271
- Select 1 2 3 4 (remote control) ..... 241
- Single Meas (remote control) ..... 269
- Single Sweep ..... 118
- Single Sweep (remote control) ..... 269
- Trace Mode (remote control) ..... 259
- Trg/Gate Source (remote control) ..... 328, 329, 331
- Trigger Holdoff ..... 157
- Trigger Hysteresis ..... 157
- Trigger Offset ..... 125, 156
- View ..... 121, 202
- Softkeys
  - Lower Level Hysteresis ..... 117
  - Upper Level Hysteresis ..... 117
- Source ..... 69
- Special characters ..... 206
- Spectral display ..... 97
- Standard Defaults
  - softkey ..... 109
- Standards
  - Predefined ..... 375
  - Saving ..... 108
  - Saving (remote control) ..... 313
- Statistical display ..... 100
- Statistics count ..... 119
- Status registers
  - STATus:QUEStionable ..... 334
- Status reporting system ..... 332
- Swap I/Q ..... 155
- Sweep
  - Continue single sweep ..... 118
  - Continuous ..... 118
  - Single ..... 118
- Switching on the option ..... 67
- Symbol mapping ..... 21
- Symbol rate ..... 145
  - Remote control ..... 312
- Symbol tables
  - Result type ..... 83
- Symbols
  - Display Configuration ..... 176
- Synchronization
  - Fails, troubleshooting ..... 351
- Syntax
  - Known data files ..... 197
- T**
- Trace
  - Clear Write ..... 121, 201
- Trace mode ..... 122
  - Average ..... 121, 202
  - Blank ..... 122, 202
  - Clear Write ..... 121, 201
  - Max Hold ..... 121, 201
  - Min Hold ..... 121, 202
  - View ..... 121, 202
- Trace Wizard ..... 122
- Traces
  - Configuring ..... 123
- Transmit filter ..... 15
  - Alpha/BT ..... 146, 175
  - Deactivating (remote control) ..... 314
  - Predefined ..... 16
  - Type ..... 145
  - User-defined ..... 145
- trigger
  - slope ..... 125, 157
- Trigger
  - Holdoff ..... 157
  - Hysteresis ..... 157
  - Level ..... 125, 157
  - Offset ..... 125, 156
- Trigger Mode
  - I/Q Capture ..... 155
- Trigger Offset Unit
  - Softkey ..... 126
- TX Settings
  - EX-IQ-BOX ..... 137
- U**
- Units
  - Softkey ..... 114
- Upper Level Hysteresis
  - Softkey ..... 117
- Upper-case (commands) ..... 205
- Useful length
  - Bursts ..... 147
  - Bursts (remote control) ..... 302
- V**
- Vector I/Q
  - Result type ..... 81
- Vertical line
  - Eye diagram ..... 132
- View trace mode ..... 121, 202
- VSA menu ..... 107
- W**
- White papers ..... 6
- X**
- X-Axis Quantize
  - Softkey ..... 112
- X-Axis Range
  - Softkey ..... 112, 186
- X-Axis Reference Value
  - Softkey ..... 112
- X-Axis Unit
  - Softkey ..... 114

**Y**

Y-Axis Auto Range All Screens	
Softkey .....	118
Y-Axis Autorange	
Softkey .....	112, 117, 185, 186
Y-Axis Range	
Softkey .....	111, 187
Y-Axis Reference Position	
Softkey .....	112, 184, 186
Y-Axis Reference Value	
Softkey .....	112, 184, 186
Y-Axis Unit	
Softkey .....	114
YIG filter	
see YIG preselector .....	116, 151
YIG preselector	
Activating/Deactivating .....	116, 151, 276

**Z**

zoom	
area (remote control) .....	267
remote control .....	266
Zoom	
Amplitude .....	121, 202