

3GPP FDD incl. enhanced MS/BS tests, HSDPA, HSUPA, HSPA+ R&S[®]SMBV-K42/-K43/-K45/-K59 Operating Manual



1178976102



ROHDE & SCHWARZ

Operating Manual

Version 25

This document describes the following software options:

- R&S®SMBV-K42/-K43/-K45/-K59
1415.8048.xx, 1415.8054.xx, 1415.8077.xx, 1415.8219.xx

This manual describes firmware version 4.70.108.xx and later of the R&S®SMBV100A.

© 2020 Rohde & Schwarz GmbH & Co. KG

Mühlhofstr. 15, 81671 München, Germany

Phone: +49 89 41 29 - 0

Fax: +49 89 41 29 12 164

Email: info@rohde-schwarz.com

Internet: www.rohde-schwarz.com

Subject to change – Data without tolerance limits is not binding.

R&S® is a registered trademark of Rohde & Schwarz GmbH & Co. KG.

Trade names are trademarks of the owners.

1178.9761.02 | Version 25 | 3GPP FDD incl. enhanced MS/BS tests, HSDPA, HSUPA, HSPA+

The following abbreviations are used throughout this manual: R&S®SMBV is abbreviated as R&S SMBV, R&S®WinIQSIM2™ is abbreviated as R&S WinIQSIM2

Contents

1	Preface	11
1.1	About this Manual	11
1.2	Documentation Overview	11
1.2.1	Quick Start Guide Manual.....	12
1.2.2	Operating Manual and Help.....	12
1.2.3	Service Manual.....	12
1.2.4	Instrument Security Procedures.....	12
1.2.5	Basic Safety Instructions.....	12
1.2.6	Data Sheets and Brochures.....	13
1.2.7	Release Notes and Open Source Acknowledgment (OSA).....	13
1.2.8	Application Notes, Application Cards, White Papers, etc.....	13
2	Welcome to the 3GPP FDD Options	14
2.1	Accessing the 3GPP FDD Dialog	15
2.2	Scope	16
2.3	Notes on Screenshots	16
3	About the 3GPP FDD Options	17
3.1	Required Options	17
3.2	Major 3GPP Parameters Overview	17
3.3	Modulation System 3GPP FDD	18
3.3.1	Scrambling Code Generator.....	19
3.3.1.1	Downlink Scrambling Code Generator.....	19
3.3.1.2	Uplink Scrambling Code Generator.....	20
3.3.2	Scrambling Unit.....	22
3.3.3	Channelization Code Generator.....	23
3.3.4	Data Source.....	23
3.3.5	Slot and Frame Builder.....	23
3.3.6	Timing Offset.....	24
3.3.7	Demultiplexer.....	25
3.3.8	Power Control.....	25
3.3.9	Summation and Filtering.....	26
3.3.10	Multicode.....	26

3.3.11	Orthogonal Channel Noise (OCNS).....	27
3.3.11.1	Standard, HSDPA and HSDPA2 modes.....	27
3.3.11.2	3i OCNS mode.....	28
3.3.12	HS-SCCH Less Operation.....	30
3.3.12.1	HS-SCCH Type 2.....	30
3.3.12.2	HS-SCCH Type Two Fixed Reference Channel: H-Set 7.....	31
3.3.13	Higher Order Modulation.....	31
3.3.13.1	64QAM in downlink.....	31
3.3.13.2	64QAM Fixed Reference Channel: H-Set 8.....	32
3.3.13.3	16QAM in uplink.....	32
3.3.13.4	16QAM Fixed Reference Channel: FRC 8.....	32
3.3.14	MIMO in HSPA+.....	33
3.3.14.1	D-TxAA Feedback signaling: PCI and CQI.....	33
3.3.14.2	MIMO downlink control channel Support.....	34
3.3.14.3	Redundancy Version.....	35
3.3.14.4	HARQ Processes.....	35
3.3.14.5	MIMO uplink control channel Support.....	36
3.3.14.6	CQI Reports: Type A and Type B.....	37
3.3.14.7	PCI Reports.....	37
3.3.14.8	MIMO Fixed Reference Channels: H-Set 9 and H-Set 11.....	38
3.3.15	Dual Cell HSDPA (DC-HSDPA).....	38
3.3.15.1	DC-HSDPA Data Acknowledgement (non-MIMO mode).....	39
	CQI Reports: CQI1 and CQI2.....	41
3.3.15.2	DC-HSDPA + MIMO.....	41
3.3.15.3	Dual Cell HSDPA (DC-HSDPA) Fixed Reference Channel: H-Set 12.....	41
3.3.16	HS-DPCCH Extension for 4C-HSDPA and 8C-HSDPA.....	42
3.3.17	Dual Cell HSUPA (Dual Cell E-DCH).....	42
3.3.18	UE Capabilities.....	42
3.3.18.1	MIMO and 64QAM UE Capabilities.....	42
3.3.18.2	UL 16QAM UE Capabilities.....	43
3.3.18.3	MIMO and DC-HSDPA Operation UE Capabilities.....	43
3.3.18.4	Dual Cell E-DCH Operation UE Capabilities.....	43
3.3.19	Uplink Discontinuous transmission (UL DTX).....	43

4	User Interface.....	46
4.1	General Settings for 3GPP FDD Signals.....	47
4.2	Configure Base Stations or UE.....	52
4.2.1	Orthogonal Channel Noise (OCNS) Settings.....	52
4.2.2	Common Configuration Settings.....	53
4.2.3	General Power Settings.....	56
4.3	Filtering, Clipping, ARB Settings.....	58
4.3.1	Filter Settings.....	58
4.3.2	Clipping Settings.....	59
4.3.3	ARB Settings.....	61
4.4	Trigger/Marker/Clock Settings.....	61
4.4.1	Trigger In.....	63
4.4.2	Marker Mode.....	66
4.4.3	Marker Delay.....	67
4.4.4	Clock Settings.....	68
4.4.5	Global Settings.....	69
4.5	Test Setups/Models.....	69
4.6	Predefined Settings - Downlink.....	73
4.7	Additional User Equipment - Uplink.....	74
4.8	Base Station Settings.....	76
4.8.1	Common Settings.....	77
4.8.2	Channel Table.....	80
4.9	Compressed Mode.....	85
4.9.1	Compressed Mode General Settings.....	86
4.9.2	Compressed Mode Configuration Graph.....	89
4.9.2.1	Transmission Gaps.....	89
4.9.2.2	Compressed Ranges.....	90
4.9.2.3	Non-compressed ranges.....	90
4.10	Code Domain Graph - BS.....	91
4.11	Channel Graph - BS.....	93
4.12	HSDPA Settings - BS.....	94
4.12.1	Enhanced HSDPA Mode Settings.....	95
4.12.2	MIMO Configuration.....	97

4.13	HSDPA H-Set Mode Settings - BS	97
4.13.1	HSDPA H-Set General Settings.....	99
4.13.2	H-Set Configuration Common Settings.....	100
4.13.3	MIMO Settings.....	103
4.13.4	Global Settings.....	104
4.13.5	Coding Configuration.....	106
4.13.6	Signal Structure.....	108
4.13.7	HARQ Simulation.....	110
4.13.8	Error Insertion.....	111
4.13.9	Randomly Varying Modulation and Number of Codes (Type 3i) Settings.....	112
4.14	Enhanced Settings for P-CPICH - BS1	113
4.15	Enhanced Settings for P-CCPCH - BS1	114
4.15.1	Channel Number and State.....	114
4.15.2	Channel Coding - Enhanced P-CCPCH BS1.....	115
4.16	Enhanced Settings for DPCHs - BS1	116
4.16.1	Channel Number and State.....	117
4.16.2	Channel Coding.....	118
4.16.3	Transport Channel - Enhanced DPCHs BS1.....	121
4.16.4	Error Insertion - Enhanced DPCHs BS1.....	124
4.16.5	Dynamic Power Control - Enhanced DPCHs BS1.....	125
4.17	S-CCPCH Settings - BS Channel Table	130
4.18	Config AICH/AP-AICH - BS Channel Table	131
4.19	DPCCH Settings - BS Channel Table	132
4.19.1	Common Slot Structure (DPCCH).....	133
4.19.2	TPC Settings.....	134
4.19.3	DPCCH Power Offset.....	136
4.20	Config E-AGCH - BS Channel Table	137
4.21	Config E-RGCH/E-HICH - BS Channel Table	139
4.22	Config F-DPCH - BS Channel Table	140
4.22.1	Common Settings.....	141
4.22.2	TPC Settings.....	141
4.23	Multi Channel Assistant - BS	144
4.24	User Equipment Configuration (UE)	147

4.24.1	General Settings.....	149
4.25	Code Domain Graph - UE.....	151
4.26	Dynamic Power Control - UE.....	152
4.27	UL-DTX/User Scheduling - UE.....	157
4.28	PRACH Settings - UE.....	160
4.28.1	Graphical Display.....	162
4.28.2	Preamble Settings.....	166
4.28.3	Message Part Settings.....	167
4.28.4	Channel Coding State.....	168
4.29	PCPCH Settings - UE.....	170
4.29.1	Graphical Display.....	172
4.29.2	Preamble Settings.....	175
4.29.3	Message Part Settings.....	177
4.29.4	Channel Coding Settings.....	180
4.30	DPCCH Settings - UE.....	181
4.31	E-DPCCH Settings - UE.....	188
4.32	HS-DPCCH Settings - UE.....	189
4.32.1	About HS-DPCCH.....	190
4.32.2	HS-DPCCH Common Settings.....	192
4.32.3	HS-DPCCH Scheduling Table (Release 8 and Later/RT).....	195
4.32.4	HS-DPCCH Settings for Normal Operation (Up to Release 7).....	204
4.32.5	MIMO Settings HS-DPCCH (Up to Release 7).....	206
4.33	DPDCH Settings - UE.....	210
4.33.1	DPDCH Common Settings.....	211
4.33.2	Channel Table.....	212
4.34	E-DPDCH Settings - UE.....	214
4.34.1	E-DPDCH Common Settings.....	215
4.34.2	Channel Table.....	216
4.35	E-DCH Scheduling - UE.....	218
4.36	Scheduling List.....	221
4.37	HSUPA FRC Settings - UE.....	223
4.37.1	FRC General Settings.....	223
4.37.2	Coding and Physical Channels Settings.....	224

4.37.3	DTX Mode Settings.....	227
4.37.4	HARQ Simulation Settings.....	228
4.37.5	Bit and Block Error Insertion Settings.....	230
4.38	Global Enhanced Channel Settings - UE1.....	231
4.38.1	Enhanced Channels State.....	231
4.38.2	Channel Coding.....	232
4.38.3	Transport Channel.....	235
4.38.4	Error Insertion.....	238
5	How to Work with the 3GPP FDD Option.....	240
5.1	Resolving Domain Conflicts.....	240
5.2	Using the DL-UL Timing Offset Settings.....	241
5.3	Configuring UL-DTX Transmission and Visualizing the Scheduling.....	242
5.4	How to Configure the HS-DPCCH Settings for 4C-HSDPA Tests.....	244
6	Application Sheets.....	246
6.1	Uplink Dual Cell HSDPA Test Signal Generation.....	246
6.1.1	Options and Equipment Required.....	246
6.1.2	Test Setup.....	246
6.1.3	Generating an uplink DC-HSDPA Test Signal (Non-MIMO Mode).....	247
6.1.4	Generating an Uplink Test Signal for Simultaneous Dual Cell and MIMO Operation..	249
7	Remote-Control Commands.....	250
7.1	General Commands.....	251
7.2	Filter/Clipping Settings.....	257
7.3	Trigger Settings.....	262
7.4	Marker Settings.....	266
7.5	Clock Settings.....	268
7.6	Test Models and Predefined Settings.....	270
7.7	Setting Base Stations.....	275
7.8	Enhanced Channels of Base Station 1.....	322
7.8.1	General Settings.....	323
7.8.2	Channel Coding.....	324
7.8.3	Dynamic Power Control Settings.....	335
7.8.4	Error Insertion.....	338

7.9 User Equipment Settings.....	342
7.9.1 General Settings.....	343
7.9.2 Compressed Mode Settings.....	347
7.9.3 DPCCH Settings.....	349
7.9.4 HS-DPCCH Settings.....	356
7.9.4.1 Common Settings.....	356
7.9.4.2 Up to Release 7 Settings.....	359
7.9.4.3 Release 8 and Later (RT) Settings.....	367
7.9.5 DPDCH Settings.....	375
7.9.6 PCPCH Settings.....	379
7.9.7 PRACH Settings.....	390
7.9.8 HSUPA Settings.....	399
7.9.9 UL-DTX and Uplink Scheduling Settings.....	417
7.9.10 Dynamic Power Control Settings.....	421
7.10 Enhanced Channels of the User Equipment.....	424
Annex.....	437
A Reference.....	437
List of Commands.....	444
Index.....	454

1 Preface

1.1 About this Manual

This operating manual provides all the information **specific to the digital standard 3GPP FDD**.

The main focus in this manual is on the provided settings and the tasks required to generate a signal. The following topics are included:

- **Welcome to the 3GPP FDD options R&S SMBV-K42/-K83**
Introduction to and getting familiar with the option
- **About the 3GPP FDD and Basics**
Background information on basic terms and principles in the context of the signal generation
- **3GPP FDD Configuration and Settings**
A concise description of all functions and settings available to configure signal generation with their corresponding remote control commands
- **How to generate a Signal with the 3GPP FDD Options**
The basic procedure to perform signal generation tasks and step-by-step instructions for more complex tasks or alternative methods
As well as detailed examples to guide you through typical signal generation scenarios and allow you to try out the application immediately
- **Application Examples**
Example signal generation scenarios in which the option is frequently used.
- **Remote Control Commands**
Remote commands required to configure and perform signal generation in a remote environment, sorted by tasks
Programming examples demonstrate the use of many commands and can usually be executed directly for test purposes
- **Annex**
Reference material, such as extensive lists
- **List of remote commands**
Alphabetical list of all remote commands described in the manual
- **Index**

1.2 Documentation Overview

This section provides an overview of the R&S SMBV user documentation. Unless specified otherwise, you find the documents on the R&S SMBV product page at:

www.rohde-schwarz.com/manual/smbv100a

1.2.1 Quick Start Guide Manual

Introduces the R&S SMBV and describes how to set up and start working with the product. Includes basic operations, typical measurement examples, and general information, e.g. safety instructions, etc. A printed version is delivered with the instrument.

1.2.2 Operating Manual and Help

Separate manuals for the base unit and the software options are provided for download:

- Base unit manual
Contains the description of all instrument modes and functions. It also provides an introduction to remote control, a complete description of the remote control commands with programming examples, and information on maintenance, instrument interfaces and error messages. Includes the contents of the quick start guide manual.
- Software option manual
Contains the description of the specific functions of an option. Basic information on operating the R&S SMBV is not included.

The contents of the user manuals are available as help in the R&S SMBV. The help offers quick, context-sensitive access to the complete information for the base unit and the software options.

All user manuals are also available for download or for immediate display on the Internet.

1.2.3 Service Manual

Describes the performance test for checking the rated specifications, module replacement and repair, firmware update, troubleshooting and fault elimination, and contains mechanical drawings and spare part lists.

The service manual is available for registered users on the global Rohde & Schwarz information system (GLORIS, <https://gloris.rohde-schwarz.com>).

1.2.4 Instrument Security Procedures

Deals with security issues when working with the R&S SMBV in secure areas. It is available for download on the Internet.

1.2.5 Basic Safety Instructions

Contains safety instructions, operating conditions and further important information. The printed document is delivered with the instrument.

1.2.6 Data Sheets and Brochures

The data sheet contains the technical specifications of the R&S SMBV. It also lists the options and their order numbers and optional accessories.

The brochure provides an overview of the instrument and deals with the specific characteristics.

See www.rohde-schwarz.com/brochure-datasheet/smbv100a

1.2.7 Release Notes and Open Source Acknowledgment (OSA)

The release notes list new features, improvements and known issues of the current firmware version, and describe the firmware installation.

The open source acknowledgment document provides verbatim license texts of the used open source software.

See www.rohde-schwarz.com/firmware/smbv100a

1.2.8 Application Notes, Application Cards, White Papers, etc.

These documents deal with special applications or background information on particular topics.

See www.rohde-schwarz.com/application/smbv100a.

2 Welcome to the 3GPP FDD Options

The R&S SMBV provides you with the ability to generate signals in accordance with the WCDMA standard 3GPP FDD.

WCDMA (Wideband CDMA) describes a group of mobile radiocommunication technologies, the details of which differ greatly. The R&S SMBV supports the 3GPP FDD standard developed by the 3GPP (3rd Generation Partnership Project) standardization committee.

The R&S SMBV generates the 3GPP FDD signals in a combination of realtime mode (enhanced channels) and arbitrary waveform mode. Channel coding and simulation of bit and block errors can be activated for the enhanced channels of Release 99 and for H-Sets 1 to 5 generated in real time. Channel coding can also be activated for HSDPA/HSPA+ H-Sets and all HSUPA/HSPA+ FRC channels which are generated in arbitrary wave mode. Data lists can also be used for the data and TPC fields. The enhanced state of realtime channels can be switched off to generate specific test scenarios. In arbitrary waveform mode, the signal is first calculated and then output.

The R&S SMBV simulates 3GPP FDD at the physical channel level and also at the transport layer level for all channels for which channel coding can be activated.

The following list gives an overview of the functions provided by the R&S SMBV for generating a 3GPP FDD signal (option R&S SMBV-K42):

- Configuration of up to four base stations and four user equipment.
- Combination of realtime mode (enhanced channels) and arbitrary waveform mode
- All special channels and up to 512 channels on the downlink, except HSDPA, HSUPA and HSPA+
- Various test models and pre-defined settings for the uplink and the downlink
- Modulation 16QAM and 64QAM (downlink) for configuring high-speed channels in continuous mode (test model 5&6, HSDPA)
- Clipping for reducing the crest factor
- Misuse TPC" parameter for varying the original normal transmit power over time
- Simulation of up to 128 additional user equipment

The following functions are provided specifically for the receiver test:

- Realtime generation of up to four code channels with the option of using data lists for the data and TPC fields
- Channel coding of the reference measurement channels, AMR and BCH in real time
- Feeding through of bit errors (to test a BER tester) and block errors (to test a BLER tester)
- Simulation of orthogonal channel noise (OCNS in accordance with TS 25.101)
- Presettings in accordance with 3GPP specifications
- HSDPA Downlink in continuous mode (test model 5&6 for TX tests)

The following functions are provided by extension R&S SMBV-K43 enhanced BS/MS tests including HSDPA:

- HSDPA uplink
- HSDPA downlink (packet mode and H-Set mode without CPC, 64QAM and MIMO)
- Dynamic Power Control
- Predefined and user-definable H-Sets
- Assistance in the setting of the appropriate sequence length for arbitrary waveform mode

The following functions are provided by extension R&S SMBV-K45 3GPP FDD HSUPA:

- HSUPA Downlink (RX measurements on 3GPP FDD UEs with correct timing)
- HSUPA Uplink (RX measurements on 3GPP FDD node BS supporting HSUPA)
- HSUPA HARQ Feedback support

The following functions are provided by extension R&S SMBV-K59 3GPP FDD HSPA+:

- Downlink 64QAM with channel coding
- Uplink 16QAM (4PAM)
- Downlink MIMO
- Uplink ACK/PCI/CQI feedback for downlink MIMO and/or Dual Cell HSDPA
- CPC in downlink (HS-SCCH less operation, enhanced F-DPCH) and uplink (UL-DTX, Uplink DPCCH slot format 4)
- Support for the generation of 3i OCNS and for randomly varying modulation and the number of HS-PDSCH channels in H-Set over time (type 3i enhanced performance requirements tests).

This operating manual contains a description of the functionality that the application provides, including remote control operation.

All functions not discussed in this manual are the same as in the base unit and are described in the R&S SMBV operating manual. The latest version is available at:

www.rohde-schwarz.com/manual/SMBV100A

2.1 Accessing the 3GPP FDD Dialog

To open the dialog with 3GPP FDD settings

- ▶ In the block diagram of the R&S SMBV, select "Baseband > 3GPP FDD".

A dialog box opens that display the provided general settings.

The signal generation is not started immediately. To start signal generation with the default settings, select "State > On".

2.2 Scope



Tasks (in manual or remote operation) that are also performed in the base unit in the same way are not described here.

In particular, it includes:

- Managing settings and data lists, like storing and loading settings, creating and accessing data lists, or accessing files in a particular directory.
- Information on regular trigger, marker and clock signals and filter settings, if appropriate.
- General instrument configuration, such as configuring networks and remote operation
- Using the common status registers

For a description of such tasks, see the R&S SMBV operating manual.

2.3 Notes on Screenshots

When describing the functions of the product, we use sample screenshots. These screenshots are meant to illustrate as many as possible of the provided functions and possible interdependencies between parameters. The shown values may not represent realistic usage scenarios.

The screenshots usually show a fully equipped product, that is: with all options installed. Thus, some functions shown in the screenshots may not be available in your particular product configuration.

3 About the 3GPP FDD Options

Some background knowledge on basic terms and principles used in the 3GPP FDD modulation system is provided here for better understanding of the required configuration settings.

3.1 Required Options

The basic equipment layout for generating 3GPP FDD signals includes the:

- Base unit
- Digital standard 3GPP FDD (R&S SMBV-K42)

The following options are required to **support all 3GPP-related settings** described in this operating manual:

- Option digital standard 3GPP FDD (R&S SMBV-K42)
- Options 3GPP HSDPA, FDD HSUPA and FDD HSPA+ (R&S SMBV-K43/-K45/-K59)

For more information, see data sheet.

3.2 Major 3GPP Parameters Overview

[Table 3-1](#) gives an overview of parameters of the modulation system 3GPP FDD.

Table 3-1: Parameters of the modulation system

Parameter	Value
Chip rate	3.84 Mcps
Channel types	<p>Downlink:</p> <ul style="list-style-type: none"> • Primary Common Pilot Channel (P-CPICH) • Secondary Common Pilot Channel (S-CPICH) • Primary Sync Channel (P-SCH) • Secondary Sync Channel (S-SCH) • Primary Common Control Phys. Channel (P-CCPCH) • Secondary Common Control Phys. Channel (S-CCPCH) • Page Indication Channel (PICH) • Acquisition Indication Channel (AICH) • Access Preamble Acquisition Indication Channel (AP-AICH) • Collision Detection Acquisition Indication Channel (CD-AICH) • Phys. Downlink Shared Channel (PDSCH) • Dedicated Physical Control Channel (DL-DPCCH) • Dedicated Phys. Channel (DPCH) • High-Speed Shared Control Channel (HS-SCCH) • High-Speed Physical Downlink Shared Channel (HS-PDSCH), Modulation QPSK, 16 QAM or 64QAM • HSUPA channels (E-AGCH, E-RGCH, E-HICH, F-DPCH) <p>Uplink:</p> <ul style="list-style-type: none"> • Phys. Random Access Channel (PRACH) • Phys. Common Packet Channel (PCPCH) • Dedicated Physical Control Channel (DPCCH) • Dedicated Physical Data Channel (DPDCH) • High Speed Dedicated Physical Control Channel (HS-DPCCH) • E-DCH Dedicated Physical Control Channel (E-DPCCH) • E-DCH dedicated physical data channel (E-DPDCH)
Symbol rates	<p>7.5 ksps, 15 ksps, 30 ksps to 960 ksps depending on the channel type (downlink)</p> <p>15 ksps, 30 ksps, 60 ksps to 1920 ksps depending on the channel type (uplink)</p>
Channel count	<p>In downlink 4 base stations each with up to 128 DPCHs and 11 special channels.</p> <p>In uplink 4 user equipment either with PRACH or PCPCH or a combination of DPCCH, up to 6 DPDCH, HS-DPCCH, E-DPCCH and up to 4 E-DPDCH channels.</p>
Frame structure	<p>Timeslot: 0.667 ms,</p> <p>Subframe: 3 timeslots = 2 ms</p> <p>Radio frame: 15 timeslots = 10 ms</p> <p>The frame structure in symbols depends on the symbol rate.</p>
Scrambling code	<p>Downlink: 18-bit M sequence</p> <p>Uplink: 25-bit M sequence in long mode and 8-bit M sequence in short mode</p>
Channelization code for most of the channel types	"Orthogonal Variable Spreading Factor Code (OVSF)" square matrix of dimension chip rate/symbol rate

3.3 Modulation System 3GPP FDD

The following block diagram shows the components of the 3GPP FDD transmission system.

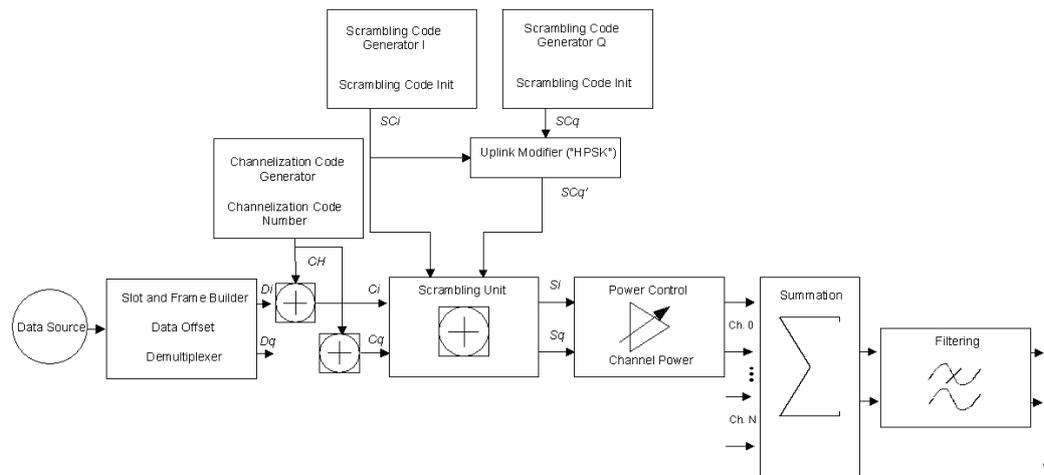

Figure 3-1: Components of the 3GPP FDD transmission system

3.3.1 Scrambling Code Generator

The scrambling code generator (previously called long code generator) is used to scramble the chip sequence as a function of the transmitter.

Depending on the link direction and mode (long or short), the structure and initialization regulation of the generator are different.

3.3.1.1 Downlink Scrambling Code Generator

This generator consists of a pair of shift registers from which the binary sequences for in-phase and orthogonal component of the scrambling code are determined. The [Figure 3-2](#) shows that the I component is produced as EXOR operation of the LSB outputs. However the register contents are first masked and read out for the Q component and then EXORed.

Table 3-2: Generator polynomials of the downlink scrambling code generators

Shift register 1	$x^{18}+x^7+1$
Shift register 2	$x^{18}+x^{10}+x^7+x^5+1$

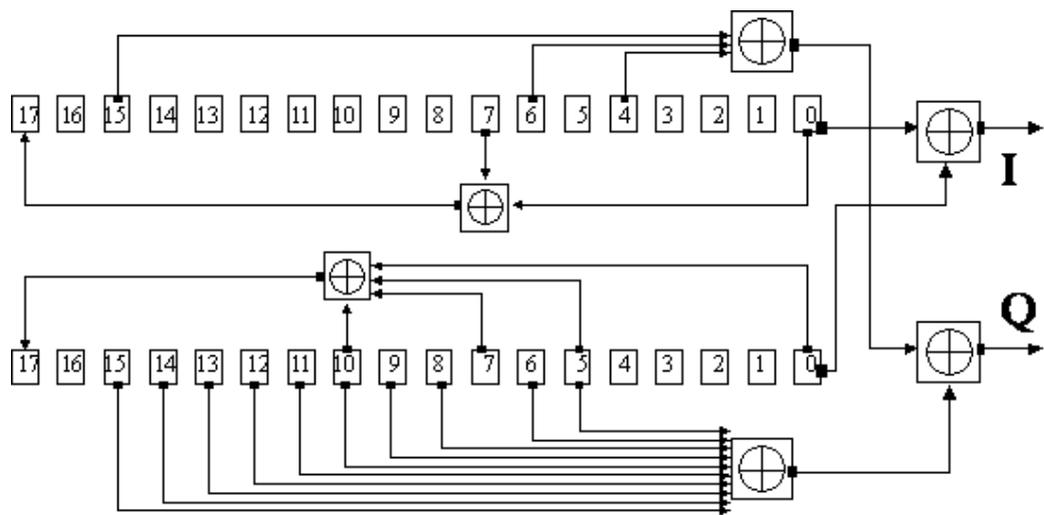

Figure 3-2: Structure of downlink scrambling code generator

The shift registers are initialized by loading shift register 1 with "0...01" and shift register 2 completely with "1". In addition, shift register 1 is wound forward by n cycles, n being the scrambling code number or scrambling code (SC) for short.

After a cycle time of one radio frame the generators are reset, i.e. the above initialization is carried out again.

3.3.1.2 Uplink Scrambling Code Generator

In the uplink, a differentiation is made between two SC modes. The long SC can be used for all types of channel. The short SC can be used as an alternative to the long SC for all channels except PRACH and PCPCH.

Uplink long scrambling code

Principally, the code generator of the long SC in the uplink is of the same structure as the SC in the downlink. However, the generator polynomials of the shift registers and the type of initialization are different.

Table 3-3: Generator polynomials of the uplink long scrambling code generator

Shift register 1	$x^{25}+x^3+1$
Shift register 2	$x^{25}+x^3+x^2+x+1$

The shift registers are initialized by allocating 1 to shift register 1-bit number 24 and the binary form of the scrambling code number n to bits 23 to 0. Shift register 2 is loaded with "1".

The read-out positions for the Q component are defined such that they correspond to an IQ offset of 16.777.232 cycles.

After a cycle time of one radio frame the generators are reset, i.e. the above initialization is carried out again.

Uplink short scrambling code

The code generator of the short SC in the uplink consists of a total of three coupled shift registers.

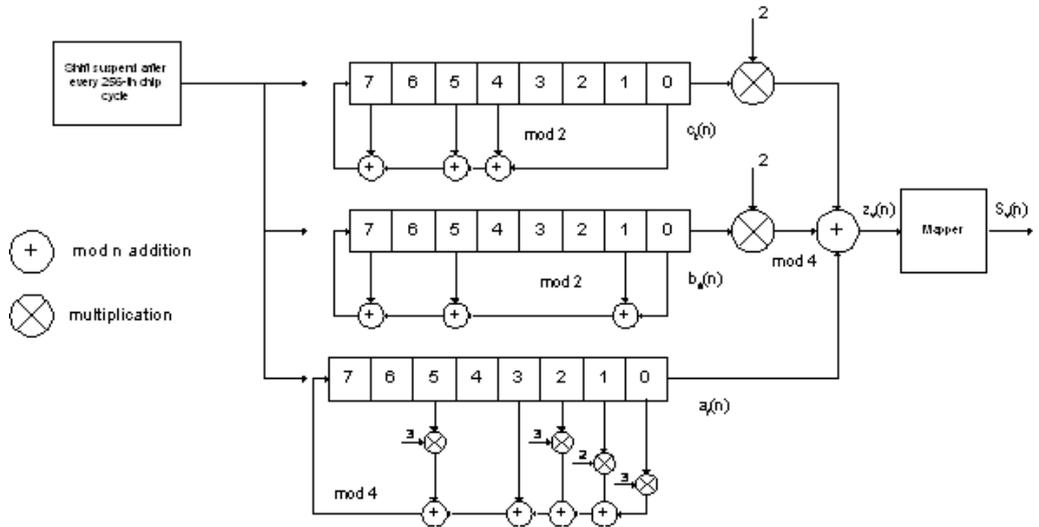

Figure 3-3: Structure of uplink short scrambling code generator

Table 3-4: Generator polynomials of uplink short scrambling code generator

Shift register 1 (binary)	$x^8+x^7+x^5+x^4+1$
Shift register 2 (binary)	$x^8+x^7+x^5+x+1$
Shift register 3 (quaternary)	$x^8+x^5+3x^3+x^2+2x+1$

The output sequences of the two binary shift registers are weighted with factor 2 and added to the output sequence of the quaternary shift register. The resulting quaternary output sequence is mapped into the binary complex level by the mapper block.

For initialization, of the three 8-bit shift registers (in a modified way) the binary form of the 24-bit short SC number n is used. For details see 3GPP TS 25 213, "Spreading and Modulation".

Table 3-5: Mapping of the quaternary output sequence into the binary IQ level

$z_v(n)$	$S_v(n)$
0	+1 + j1
1	-1 + j1
2	-1 - j1
3	+1 - j1

Preamble scrambling code generator

When generating the preambles of the PRACH and PCPCH, a special SC is used. It is based on the Long SC described under a), however only the I component is taken and subsequently a pointer ($e^{j(\pi/4 + \pi/4 * k)}$, $k=0$ to 4095) modulated upon it.

Modification of the long and short scrambling code output sequence

The scrambling code sequence of the Q component is modified as standard to reduce the crest factor of the signal. Zero-crossings can thus be avoided for every second cycle. (This method is often called "HPSK").

For details see 3GPP TS 25 213, "Spreading and Modulation". The R&S SMBV uses a decimation factor of 2.

3.3.2 Scrambling Unit

In the scrambling unit, the output of the scrambling code generator is linked with spread symbols.

The input signal and the scrambling code signal are interpreted as complex signal:

$$(C_i, C_q, SC_i, SC_q' \in \{-1, +1\})$$

The output signal is a complex multiplication of two signals:

$$S_i + j S_q = (C_i + j C_q) * (SC_i + j SC_q')$$

The following equations apply:

$$S_i = C_i SC_i - C_q SC_q'$$

$$S_q = C_i SC_q' + C_q SC_i$$

The signal thus obtained can be interpreted as a QPSK signal with the following constellation diagram:

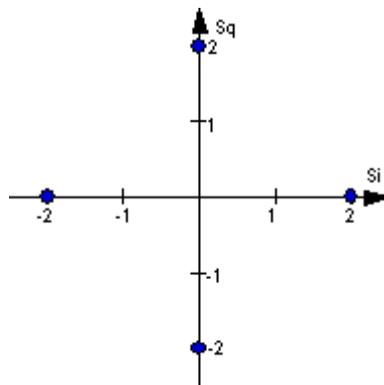

Figure 3-4: Constellation diagram of a channel with 0 dB power



There are auxiliary conditions for some types of channels that can result in different constellation diagrams. If, for instance, symbols of the SCH are coded, a BPSK constellation is obtained without the scrambling unit.

Furthermore, with HSDPA and HSPA+, the higher order modulations 4PAM, 16QAM and 64QAM were introduced.

3.3.3 Channelization Code Generator

The channelization code generator cyclically outputs a channel-specific bit pattern. The length of the cycle corresponds to the period of the source symbol to be spread, i.e. the number of bits corresponds to the spread factor. The spreading sequence for the I and Q branch is identical (real value). Spreading is a simple EXOR operation.

Two different channelization code generators are used depending on the type of channel:

Channelization code generator for all channels except SCH

Due to this channelization code, the channel separation takes place in the sum signal. The channelization code number is the line of an orthogonal spreading matrix which is generated according to an iterative scheme ("OVSF").

Channelization code generator SCH

This generator replaces the one described above if the synchronization code symbol of the SCH channels is spread.

The spreading matrix is replaced by a method that forms the spreading sequence. For details, see 3GPP TS 25 213.

3.3.4 Data Source

The data and TPC fields of the enhanced channels (realtime channels) can be filled from data lists containing user-defined data. This allows user information from the physical layer or from higher layers such as the transport layer to be introduced into the signal generation process.

The choice of data sources is crucially important for the signal characteristics. The constellation diagram and the crest factor in particular are modeled to a great extent by a suitable choice of data.

3.3.5 Slot and Frame Builder

The bits from the data source are first entered into a frame structure. The frames are made up of three hierarchical levels:

Table 3-6: Hierarchical structure of 3GPP FDD frames

Hierarchy	Length in ms	Remarks
Timeslot	0.667	
Subframe	2 ms	One subframe consists of 3 timeslots.
Radio frame	10	After a radio frame, pilot symbols are repeated. One radio frame consists of 15 timeslots. A frame is also the length of a scrambling code cycle. Frames are the basic unit. The sequence length is stated in radio frames.

The configuration of the timeslots depends on the channel type and symbol rate. The following components are distinguished:

- **Pilot sequence**
The pilot sequence characterizes the timeslot position within the radio frame and also depends on the symbol rate, transmit diversity and the pilot length parameter. Channel types DPCH, S-CCPCH, DL-DPCCH, DPCCH, PRACH and PCPCH have a pilot sequence.
- **Synchronization code symbol**
The synchronization code symbol is the only symbol of the SCH.
- **TPC symbol**
This symbol is used to control the transmit power. It is used in DPCH, DL-DPCCH and DPCCH.
A bit pattern for the sequence of TPC symbols can be indicated as a channel-specific pattern.
- **Data symbols**
These symbols carry the user information and are fed from the data source. They are used in DPCH, P-CCPCH, S-CCPCH, PDSCH, E-AGCH, E-RGCH, E-HICH, DPDCH, PRACH, PCPCH, HS-PDSCH and E-DPDCH.
- **Signature**
The signature is used in PRACH and PCPCH. 16 fixed bit patterns are defined.
- **TFCI (transport format combination indicator)**
If enabled, the TFCI is used in DPCH/DPCCH. In this case, a code sequence with the length of 30 is defined using this value and distributed among 15 subsequent timeslots. In PRACH and PCPCH, the TFCI field is provided as standard.
- **FBI**
Feedback indication bits are only used in DPCCH and PCPCH.

3.3.6 Timing Offset

The symbol stream can be shifted in time relative to the other channels. For this purpose, a timing offset can be entered into the channel table, stating the range of shifting in multiples of 256 chips. Since the generator does not generate infinite symbol streams like a real-time system, this offset is implemented as a rotation.

Example:

DPCH 30 ksps, 1 timeslot, timing offset = 2;

2×256 chips = 512 chip offset;

4 data symbols shifting at a symbol rate of 30 ksps (1 symbol corresponds to 3.84 Mcps / 30 ksps = 128 chips).

Previously:

11	11	11	11	00	01	10	11	00	10	01	11	11	01	00	01	10	11	01	00
----	----	----	----	----	----	----	----	----	----	----	----	----	----	----	----	----	----	----	----

Afterwards:

10	11	01	00	11	11	11	11	00	01	10	11	00	10	01	11	11	01	00	01
----	----	----	----	----	----	----	----	----	----	----	----	----	----	----	----	----	----	----	----

The use of the timing offset usually causes a reduction of the crest factor of the total signal. This is based on the fact that the spreading chips SC_i and scramble chips SC'_q that are applied to the pilot sequences of the channels are not always the same.

3.3.7 Demultiplexer

In the downlink, the symbol stream is divided into 2-bit streams D_i and D_q before processing in the spreading unit.

For example, if QPSK modulation is used for a channel, the symbol stream is processed as follows:

- It is divided by allocating bits 1, 3, 5, to $2n-1$ to the in-phase bitstream D_i
- It is divided by allocating bits 2, 4, 6, $2n$ to the quadrature bitstream D_q .

For the above example with timing offset:

$D_i = 1\ 1\ 0\ 0\ 1\ 1\ 1\ 1\ 0\ 0\ 1\ 1\ 0\ 1\ 0\ 1\ 1\ 0\ 0\ 0$

$D_q = 0\ 1\ 1\ 0\ 1\ 1\ 1\ 1\ 0\ 1\ 0\ 1\ 0\ 0\ 1\ 1\ 1\ 1\ 0\ 1$

(left-hand bit is always the first one in the time sequence)

In the uplink, independent data are used for the two paths.

PRACH/PCPCH:	Preamble : signature parallel to I and Q
	Message part : data to I, pilot, TPC and TFCI to Q
DPCCH/E-DPCCH:	all bits to I, Q always unused
DPDCH/HS-DPCCH/E-DPDCH:	all bits are always to I or Q (dependent on channel number), the other path is unused.

3.3.8 Power Control

After spreading and scrambling, a channel-specific power factor p is applied to the signal. A value of -6 dB therefore results in half the level (or $\frac{1}{4}$ power) and the following diagram (DPCH):

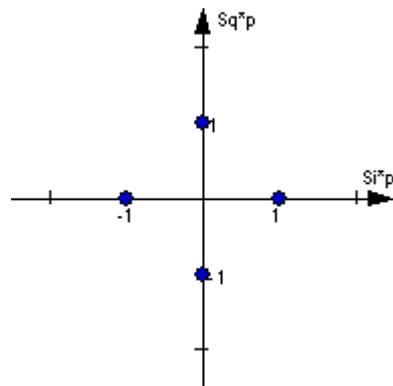

Figure 3-5: Constellation diagram of a channel with -6 dB power

3.3.9 Summation and Filtering

After application of the channel power, the components of the individual channels are summed up.

The constellation diagram of the sum signal is obtained by superposition of the diagrams of the individual channels. If the signal consists of two channels with power of -6 dB and -12 dB and each channel contains independent source data (DPCH), the following constellation diagram is obtained:

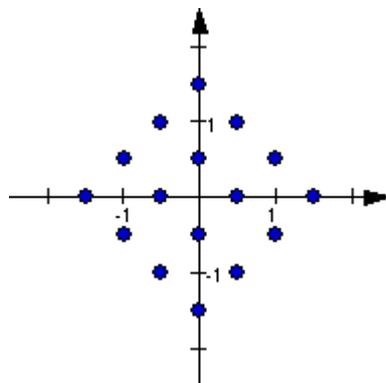

Figure 3-6: Constellation diagram of a 3GPP WCDMA signal with two DPCH channels

3.3.10 Multicode

3GPP FDD supports multicode transmission for downlink-dedicated physical channels (DPCH).

This form of transmission is used for channels intended for the same receiver, i.e. those receivers that belong to a radio link. The first channel of this group is used as a master channel.

Shared parts (pilot, TPC and TCFI) are spread for all channels using the spreading code of the master channel.



Instead of changing the spreading code within a slot several times, the master code rather than the shared parts can be sent at higher power. Then blank out the other channels correspondingly.

3.3.11 Orthogonal Channel Noise (OCNS)

With orthogonal channel noise, a practical downlink signal is generated to test the maximum input levels of user equipment in accordance with standard specifications. This simulates the data and control signals of the other orthogonal channels in the downlink. 3GPP TS 25.101 contains a precise definition of the required appearance of the OCNS signal.

Four different OCNS scenarios are defined in the standard. One standard scenario, two scenarios for HSDPA test cases and one scenario for type 3i enhanced performance requirements tests according to 3GPP TS34.121-1.

When activating OCNS and depending on the selected OCNS mode, different channel groups with different presetting are assigned as in the following tables. These channels cannot be edited in the channel table.

3.3.11.1 Standard, HSDPA and HSDPA2 modes

For the "Standard", "HSDPA" and "HSDPA2" modes, the OCNS channels are all normal DPCHs. The symbol rate is set at 30 ksps and the pilot length to 8 bits.

The powers of the OCNS channel outputs are relative. In the R&S SMBV, the power of the OCNS component is set so that OCNS channels supplement the remaining channels in BS1 to make total power of 0 dB (linear 1).

It is not possible to adapt the OCNS power if the linear power of the remaining channels is >1, this produces an error message. The OCNS channels are then given the maximum power (all -80 dB).

The "Total Power" display is updated after automatic calculation of the output; it is not possible to use "Adjust Total Power" to make the setting.

Table 3-7: Defined settings for the OCNS signal in base station 1 in Standard mode

Chan. code	Timing offset (x256Tchip)	Level setting (dB)	Channel type	Symbol rate	Pilot length
2	86	-1	DPCH	30 ksps	8 bit
11	134	-3	DPCH	30 ksps	8 bit
17	52	-3	DPCH	30 ksps	8 bit
23	45	-5	DPCH	30 ksps	8 bit
31	143	-2	DPCH	30 ksps	8 bit
38	112	-4	DPCH	30 ksps	8 bit
47	59	-8	DPCH	30 ksps	8 bit
55	23	-7	DPCH	30 ksps	8 bit

Chan. code	Timing offset (x256Tchip)	Level setting (dB)	Channel type	Symbol rate	Pilot length
62	1	-4	DPCH	30 ksps	8 bit
69	88	-6	DPCH	30 ksps	8 bit
78	30	-5	DPCH	30 ksps	8 bit
85	18	-9	DPCH	30 ksps	8 bit
94	30	-10	DPCH	30 ksps	8 bit
125	61	-8	DPCH	30 ksps	8 bit
113	128	-6	DPCH	30 ksps	8 bit
119	143	0	DPCH	30 ksps	8 bit

Table 3-8: Defined settings for the OCNS signal in base station 1 in HSDPA mode

Channelization code at SF=128	Relative Level setting (dB)	Channel type	Symbol rate	Pilot length
122	0	DPCH	30 ksps	8 bit
123	-2	DPCH	30 ksps	8 bit
124	-2	DPCH	30 ksps	8 bit
125	-4	DPCH	30 ksps	8 bit
126	-1	DPCH	30 ksps	8 bit
127	-3	DPCH	30 ksps	8 bit

Table 3-9: Defined settings for the OCNS signal in base station 1 in HSDPA2 mode

Channelization code at SF=128	Relative Level setting (dB)	Channel type	Symbol rate	Pilot length
4	0	DPCH	30 ksps	8 bit
5	-2	DPCH	30 ksps	8 bit
6	-4	DPCH	30 ksps	8 bit
7	-1	DPCH	30 ksps	8 bit

3.3.11.2 3i OCNS mode

(Requires options R&S SMx/AMU-K43 and -K59)

In the "3i" OCNS mode, 16 DPCH channels are inserted in the BS 1 channel according to 3GPP TS34.121-1, chapter E.5E.

According to 3GPP TS34.121-1, table E.5E.1.3, the channelization code of each of these channels changes randomly on a symbol-by-symbol basis between two possible values.

23	DPCH (OCNS)		10	30	2	-1.70	PN 9
24						108	
25	DPCH (OCNS)		10	30	3	-2.70	PN 9
26						103	
27	DPCH (OCNS)		10	30	5	-3.50	PN 9
28						109	

Figure 3-7: Channel table (first three DPCHs only)

The power control sequence modeling according to 3GPP TS34.121-1, chapter E.5E.3 is applied to these channels. The power relationship between these channels is according to 3GPP TS34.121-1, table E.5E.1.3 only during the first slot. It can deviate in the subsequent slots up to a certain range, but the total power of these channels is maintained constant (by normalization).



If the "3i" OCNS mode is activated, the OCNS channels are automatically leveled to have total power of 0 dB for all channels of BS 1.

Table 3-10: Defined settings for the OCNS signal in base station 1 in 3i mode

Slot format	Symbol Rate, kbps	First Ch. code of the channel	Second Ch. code of the channel	Relative Power, dB (before the 0 dB adjustment)
10	30	2	108	-1.7
10	30	3	103	-2.7
10	30	5	109	-3.5
10	30	6	118	-0.8
10	30	90	4	-6.2
10	30	94	123	-4.6
10	30	96	111	-2.3
10	30	98	106	-4.1
10	30	99	100	-3.1
10	30	101	113	-5.1
12	60	52	44	0.0
10	30	110	124	-4.6
10	30	114	115	-4.8
10	30	116	126	-4.8
12	60	60	46	-1.1
10	30	125	95	-4.1



Refer to [Chapter 4.13.9, "Randomly Varying Modulation and Number of Codes \(Type 3i\) Settings"](#), on page 112 for description of the further settings required for the 3i enhanced performance requirements tests according to 3GPP TS 34.121-1.

3.3.12 HS-SCCH Less Operation

HS-SCCH less operation is a special HSDPA mode of operation which reduces the HS-SCCH overhead and reduces UE battery consumption. It changes the conventional structure of HSDPA data reception. In HSDPA as defined from 3GPP release 5 onwards, UE is supposed to read continuously HS-SCCH where data allocations are being signaled. The UE is being addressed via a UE-specific identity (16-bit H-RNTI / HSDPA radio network temporary identifier) on HS-SCCH. As soon as the UE detects relevant control information on HS-SCCH, it switches to the associated HS-PDSCH resources and receives the data packet.

This scheme is fundamentally changed in HS-SCCH less operation and HS-SCCH less operation is optimized for services with relatively small packets, e.g. VoIP.

In HS-SCCH less operation mode, the base station can decide for each packet again whether to apply HS-SCCH less operation or not, i.e. conventional operation is always possible.

The first transmission of a data packet on HS-DSCH is done without an associated HS-SCCH. The first transmission always uses QPSK and redundancy version of 0. Only four pre-defined transport formats can be used so the UE can blindly detect the correct format. The four possible transport formats are configured by higher layers. Only pre-defined channelization codes can be used for this operation mode and are configured per UE by higher layers: the parameter HS-PDSCH code index provides the index of the first HS-PDSCH code to use. For each of the transport formats, it is configured whether one or two channelization codes are required.

In order to allow detection of the packets on HS-DSCH, the HS-DSCH CRC (Cyclic Redundancy Check) becomes UE specific based on the 16-bit HRNTI. This is called CRC attachment method 2 (CRC attachment method 1 is conventional as of 3GPP release 5).

In case of successful reception of the packet, the UE sends an ACK on HS-DPCCH. If the packet was not received correctly, the UE sends nothing.

If the packet is not received in the initial transmission, the base station retransmits it. The number of retransmissions is limited to two in HS-SCCH less operation.

In contrast to the initial transmission, the retransmissions are using HS-SCCH signaling. However, the coding of the HS-SCCH deviates from release 5, since the bits on HS-SCCH are reinterpreted. This is called HS-SCCH type 2. The conventional HS-SCCH as of 3GPP release 5 is called HS-SCCH type 1.

3.3.12.1 HS-SCCH Type 2

The table below gives a comparison of the HS-SCCH Type 1 (normal operation) and HS-SCCH Type 2 (less operation) formats.

Table 3-11: Comparison of HS-SCCH Type 1 and Type 2

HS-SCCH Type 1 (normal operation)	HS-SCCH Type 2 (less operation)
Channelization code set information (7 bits)	Channelization code set information (7 bits)
Modulation scheme information (1 bit)	Modulation scheme information (1 bit)
Transport block size information (6 bits)	Special information type (6 bits)
HARQ process information (3 bits)	Special information (7 bits)
Redundancy and constellation version (3 bits)	UE identity (16 bits)
New data indicator (1 bit)	
UE identity (16 bits)	

The special information type on HS-SCCH type 2 must be set to 111110 to indicate HS-SCCH less operation. The 7 bits special information then contains:

- 2-bit transport block size information (one of the four possible transport block sizes as configured by higher layers)
- 3-bit pointer to the previous transmission of the same transport block (to allow soft combining with the initial transmission)
- 1-bit indicator for the second or third transmission
- 1 bit reserved.

QPSK is also used for the retransmissions. The redundancy version for the second and third transmissions are equal to 3 and 4, respectively.

For the retransmissions, also HS-DSCH CRC attachment method 2 is used.

ACK or NACK is reported by the UE for the retransmitted packets.

3.3.12.2 HS-SCCH Type Two Fixed Reference Channel: H-Set 7

In order to support HS-SCCH Type 2 (less operation) testing, a fixed reference channel has been introduced. H-Set 7 is specified as reference test channel for HSDPA test cases.

The H-Set 7 consists of one HS-PDSCH and its parameterization and coding chain is based on one code with QPSK modulation and one HARQ process.

3.3.13 Higher Order Modulation

3.3.13.1 64QAM in downlink

With the possibility to use 64QAM in downlink, HSPA+ can achieve downlink data rates of 21 Mbps. This theoretical peak data rate (physical channel bit rate) with 64QAM is calculated as follows:

$$\text{Peak data rate (64QAM)} = 15 [\text{codes}] * 2880 \text{ bits} / 2 \text{ ms [subframe]} = 21.6 \text{ MBps}$$

3.3.13.2 64QAM Fixed Reference Channel: H-Set 8

In order to support 64QAM testing, a fixed reference channel has been introduced. H-Set 8 is specified as reference test channel for HSPA+ test cases.

The H-Set 8 parameterization and coding chain is based on 15 codes with 64QAM modulation. Six hybrid ARQ processes are used, and HS-DSCH is continuously transmitted.

3.3.13.3 16QAM in uplink

With the possibility to use 16QAM on E-DCH (enhanced dedicated channel) in uplink, HSPA+ can achieve uplink peak data rates of 11.5 Mbps. A new uplink UE category 7 has been introduced which supports 16QAM in addition to BSPK.

Uplink transmission in HSPA+ is based on IQ multiplexing of E-DPDCH (enhanced dedicated physical data channel) physical channels as in HSUPA of 3GPP release 6. In fact, the 16QAM constellation is made up of two orthogonal 4PAM (pulse amplitude modulation) constellations. In case of 4PAM modulation, a set of two consecutive binary symbols n_k and n_{k+1} is converted to a real valued sequence following the mapping described in the table below.

Table 3-12: Mapping of E-DPDCH with 4PAM modulation

n_k, n_{k+1}	00	01	10	11
Mapped real value	0.4472	1.3416	-0.4477	-1.3416

This results in the following symbol mapping:



An E-DPDCH uses BPSK or 4PAM modulation symbols.

3.3.13.4 16QAM Fixed Reference Channel: FRC 8

To support 16QAM (4PAM) testing in the uplink, an E-DPDCH fixed reference channel (FRC 8) has been introduced.

The FRC 8 parameterization and channel coding is based on the following:

- Four physical channel codes (2xSF2 and 2xSF4) with overall symbol rate of 2x960 + 2x1920 ksps
- 4PAM modulation
- E-DCH TTI of 2 ms
- Eight hybrid ARQ processes

3.3.14 MIMO in HSPA+

HSPA+ uses full MIMO approach including spatial multiplexing. The approach is called D-TxAA (double transmit antenna array). It is only applicable for the high-speed down-link shared channel, the HS-DSCH.

The figure below shows the basic principle of the 2x2 approach. The figure is taken from 3GPP TS 25.214.

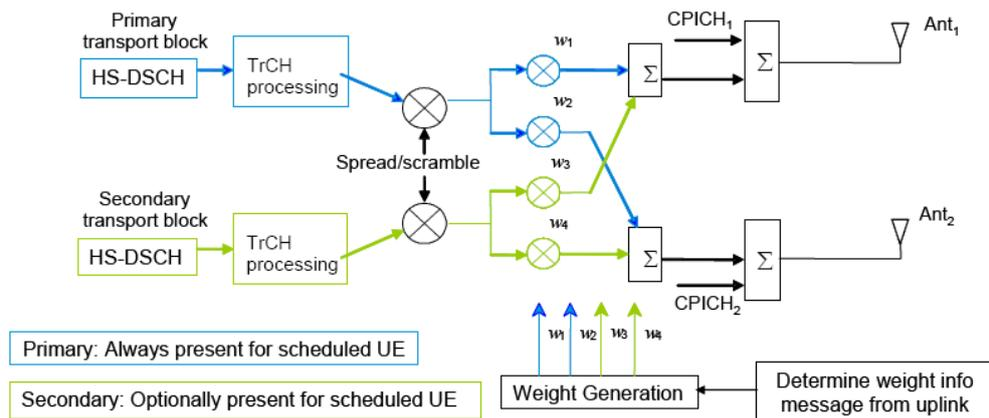

Figure 3-8: MIMO for HSPA+

With D-TxAA, two independent data streams (transport blocks) can be transmitted simultaneously over the radio channel over the same WCDMA channelization codes. Each transport block is processed and channel coded separately. After spreading and scrambling, **precoding** based on weight factors is applied to optimize the signal for transmission over the mobile radio channel.

Four precoding weights w_1 - w_4 are available. The first stream is multiplied with w_1 and w_2 , the second stream is multiplied with w_3 and w_4 . The weights can take the following values:

$$w_3 = w_1 = 1/\sqrt{2},$$

$$w_4 = -w_2,$$

$$w_2 \in \left\{ \frac{1+j}{2}, \frac{1-j}{2}, \frac{-1+j}{2}, \frac{-1-j}{2} \right\}$$

Precoding weight w_1 is always fixed, and only w_2 can be selected by the base station. Weights w_3 and w_4 are automatically derived from w_1 and w_2 , because they have to be orthogonal.

3.3.14.1 D-TxAA Feedback signaling: PCI and CQI

D-TxAA requires a **feedback signaling** from the UE to assist the base station in taking the right decision in terms of modulation and coding scheme and precoding weight selection. The UE has to determine the preferred primary precoding vector for transport block 1 consisting of w_1 and w_2 . Since w_1 is fixed, the feedback message only

consists of a proposed value for w_2 . This feedback is called **precoding control information (PCI)**. The UE also recommends whether one or two streams can be supported in the current channel situation. If dual stream transmission is used, the secondary precoding vector consists of the weights w_3 and w_4 . It is inferred in the base station, because it has to be orthogonal to the first precoding vector with w_1 and w_2 . Thus, the UE does not have to report it explicitly. The UE also indicates the optimum modulation and coding scheme for each stream. This report is called **channel quality indicator (CQI)**.

Based on the composite PCI/CQI reports, the base station scheduler decides whether to schedule one or two data streams to the UE. It also decides what packet sizes (transport block sizes) and modulation schemes to use for each stream.

3.3.14.2 MIMO downlink control channel Support

In order to support MIMO operation, changes to the HSDPA downlink control channel have become necessary, i.e. the HS-SCCH.

There is a new **HS-SCCH Type 3** for MIMO operation defined. The table below gives a comparison of the HS-SCCH Type 1 and Type 3 formats.

HS-SCCH Type 1	HS-SCCH Type 3	MIMO
(normal operation)	One transport block	Two transports blocks
Channelization code set information (7 bits)	Channelization code set information (7 bits)	Channelization code set information (7 bits)
Modulation scheme information (1 bit)	Modulation scheme and number of transport blocks information (3 bits)	Modulation scheme and number of transport blocks information (3 bits)
Transport block size information (6 bits)	Precoding weight information (2 bits)	Precoding weight information for primary transport block (2 bits)
HARQ process information (3 bits)	Transport block size information (6 bits)	Transport block size information for primary transport block (6 bits)
Redundancy and constellation version (3 bits)	HARQ process information (4 bits)	Transport block size information for secondary transport block (6 bits)
New data indicator (1 bit)	Redundancy and constellation version (2 bits)	HARQ process information (4 bits)
UE identity (16 bits)	UE identity (16 bits)	Redundancy and constellation version for primary transport block (2 bits)
		Redundancy and constellation version for secondary transport block (2 bits)
		UE identity (16 bits)

The "Precoding weight info for the primary transport block" contains the information on weight factor w_2 as described above. Weight factors w_1 , w_3 , and w_4 are derived accordingly. The number of transport blocks transmitted and the modulation scheme information are jointly coded as shown in [Table 3-13](#).

Table 3-13: Interpretation of "Modulation scheme and number of transport blocks info" sent on HS-SCCH

Modulation scheme + number of transport blocks info (3 bits)	Modulation for primary transport block	Modulation for secondary transport block	Number of transport blocks
111	16QAM	16QAM	2
110	16QAM	QPSK	2
101	64QAM	n.a.	1
	64QAM	QPSK	2
100	16QAM	n.a.	1
011	QPSK	QPSK	2
010	64QAM	64QAM	2
001	64QAM	16QAM	2
000	QPSK	n.a.	1

3.3.14.3 Redundancy Version

Redundancy versions for the primary transport block and for the secondary transport block are signaled. Four redundancy version values are possible (unlike HSDPA in 3GPP release 5 where eight values for the redundancy version could be signaled).

3.3.14.4 HARQ Processes

Also the signaling of the HARQ processes differs from HSDPA in 3GPP release 5. In 3GPP release 5, up to eight HARQ processes can be signaled. Configure a minimum of six HARQ processes to achieve continuous data transmission. Similarly, in MIMO with dual stream transmission, a minimum of 12 HARQ processes would be needed to achieve continuous data transmission.

Each HARQ process has independent acknowledgements and retransmissions. In theory, HARQ processes on both streams can run independently from one another. Independent HARQ processes, however, increases the signaling overhead to 8 bits.

To save signaling overhead, a restriction is introduced: HARQ processes are only signaled for the primary transport block within 4 bits, the HARQ process for the secondary transport block is derived from that according to a fixed rule. According to 3GPP TS 25.212. Thus, there is a one-to-one mapping between the HARQ process used for the primary transport block and the HARQ process used for the secondary transport block. The relation is shown in the table below for the example of 12 HARQ processes configured.

Table 3-14: Combinations of HARQ process numbers for dual stream transmission (12 HARQ processes configured)

HARQ process number on primary stream	0	1	2	3	4	5	6	7	8	9	10	11
HARQ process number on secondary stream	6	7	8	9	10	11	0	1	2	3	4	5



Only an even number of HARQ processes is allowed to be configured with MIMO operation.

3.3.14.5 MIMO uplink control channel Support

Also the uplink control channel for HSDPA operation is affected by MIMO, i.e. the HS-DPCCH (high-speed dedicated physical control channel). In addition to CQI reporting as already defined from 3GPP release 5 onwards, PCI reporting for precoding feedback is introduced. Channel coding is done separately for the composite precoding control indication (PCI) / channel quality indication (CQI) and for HARQ-ACK (acknowledgement or negative acknowledgement information). The figure below shows the principle.

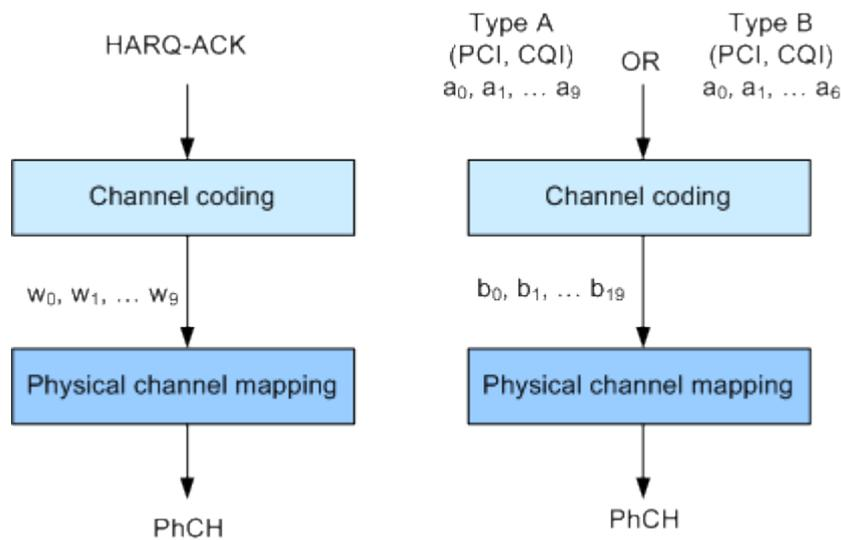

Figure 3-9: Channel coding for HS-DPCCH (MIMO mode)

The 10 bits of the HARQ-ACK messages are interpreted according to 3GPP TS 25.212 (see table below). ACK/NACK information is provided for the primary and for the secondary transport block.

Table 3-15: Interpretation of HARQ-ACK in MIMO operation (non-DC-HSDPA case)

HARQ-ACK message to be transmitted		w ₀	w ₁	w ₂	w ₃	w ₄	w ₅	w ₆	w ₇	w ₈	w ₉
HARQ-ACK in response to a single scheduled transport block											
ACK		1	1	1	1	1	1	1	1	1	1
NACK		0	0	0	0	0	0	0	0	0	0
HARQ-ACK in response to two scheduled transport blocks											
Response to primary transport block	Response to secondary transport block										
ACK	ACK	1	0	1	0	1	1	1	1	0	1
ACK	NACK	1	1	0	1	0	1	0	1	1	1

NACK	ACK	0	1	1	1	1	0	1	0	1	1
NACK	NACK	1	0	0	1	0	0	1	0	0	0
PRE/POST indication											
PRE		0	0	1	0	0	1	0	0	1	0
POST		0	1	0	0	1	0	0	1	0	0

3.3.14.6 CQI Reports: Type A and Type B

In MIMO case, two types of CQI reports are supported:

- **Type A CQI reports** can indicate the supported transport formats for the number of transport blocks that the UE prefers. Single and dual stream transmissions are supported.
- **Type B CQI reports** are used for single stream transmission according to what has been defined from 3GPP release 5 onwards.

For type A CQI reports, the UE selects the CQI1 and CQI2 values for each transport block in dual stream transmission, or the CQIS value in single stream transmission. Then it creates the CQI value to report on HS-DPCCH as follows:

$$CQI = \begin{cases} 15 * CQI_1 + CQI_2 + 31 & \text{when 2 transport blocks are preferred by the UE} \\ CQIs & \text{when 1 transport block is preferred by the UE} \end{cases}$$

For dual stream transmission, new CQI tables are specified in 3GPP TS25.214 for correct interpretation of transport formats based on CQI1 and CQI2.

3.3.14.7 PCI Reports

The PCI value to report in the uplink is created in the UE according to the preferred precoding weight w_2 according to the table below.

Table 3-16: Mapping of preferred precoding weight to PCI values

w_2^{pref}	$\frac{1+j}{2}$	$\frac{1-j}{2}$	$\frac{-1+j}{2}$	$\frac{-1-j}{2}$
PCI value	0	1	2	3

The PCI value is transmitted together with the CQI value as a composite PCI/CQI value. The figure below shows how the composite PCI/CQI report is created.

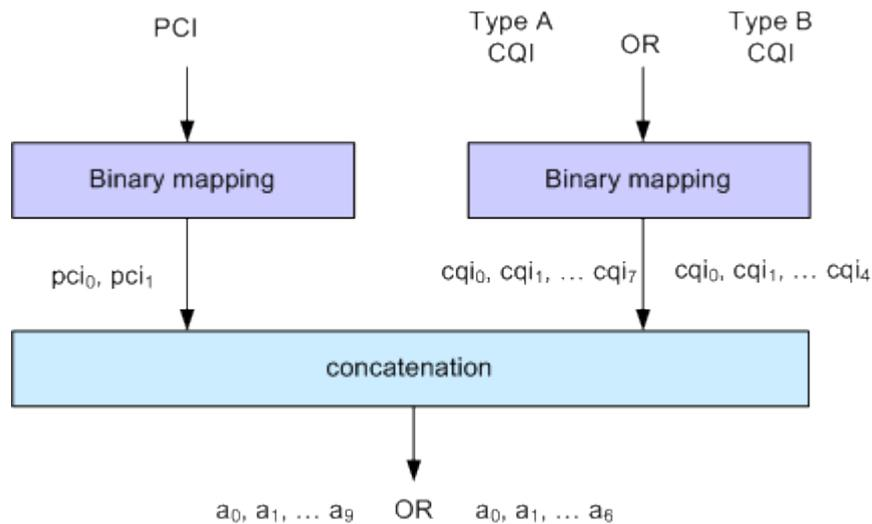

Figure 3-10: Composite PCI/CQI information (MIMO mode)

3.3.14.8 MIMO Fixed Reference Channels: H-Set 9 and H-Set 11

In order to support MIMO testing, two fixed reference channels have been introduced. H-Set 9 and H-Set 11 are specified as reference test channel for HSPA+ test cases.

The H-Set 9 parameterization and coding chain is based on 15 codes with two different modulations, 16QAM and QPSK, for the primary and secondary transport blocks respectively. Six HARQ processes are used, and HS-DSCH is continuously transmitted.

The H-Set 11 parameterization and coding chain is also based on 15 codes and uses two different modulations, six HARQ processes and HS-DSCH is continuously transmitted. The modulation schemes specified for the H-Set 11 are however **64QAM** and **16QAM** for the primary and secondary transport blocks respectively.

3.3.15 Dual Cell HSDPA (DC-HSDPA)

Within 3GPP Release 7 the peak user throughput was enhanced (MIMO, higher order modulation).

In DC-HSDPA operation, the UE is configured with secondary serving HS-DSCH cell. With one HS-SCCH in each of the two cells scheduling flexibility to have different transport formats depending on CQI feedback on each carrier is maintained.

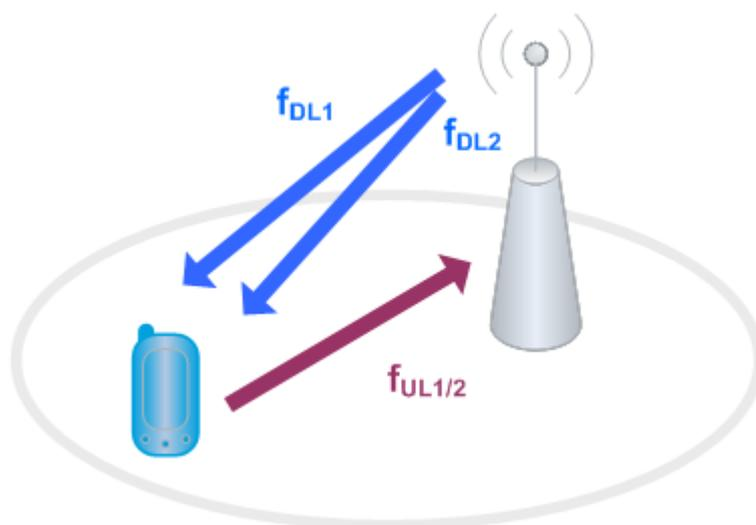

Figure 3-11: Dual-cell HSDPA operation

The following restrictions apply in case of DC-HSDPA operation:

- The dual cell transmission only applies to HSDPA physical channels
- The two cells belong to the same Node-B
- In Release 8, it is required that the two cells are on adjacent carriers; from Release 9 onwards the paired cells can operate on two different frequency bands.
- The two cells use MIMO to serve UEs configured for dual cell operation

3.3.15.1 DC-HSDPA Data Acknowledgement (non-MIMO mode)

When the UE is configured to work in DC-HSDPA non-MIMO mode, the coding of the HS-DPCCH is performed according to the general coding flow. The HARQ-ACK and the CQI are coded in parallel. The figure below shows the principle.

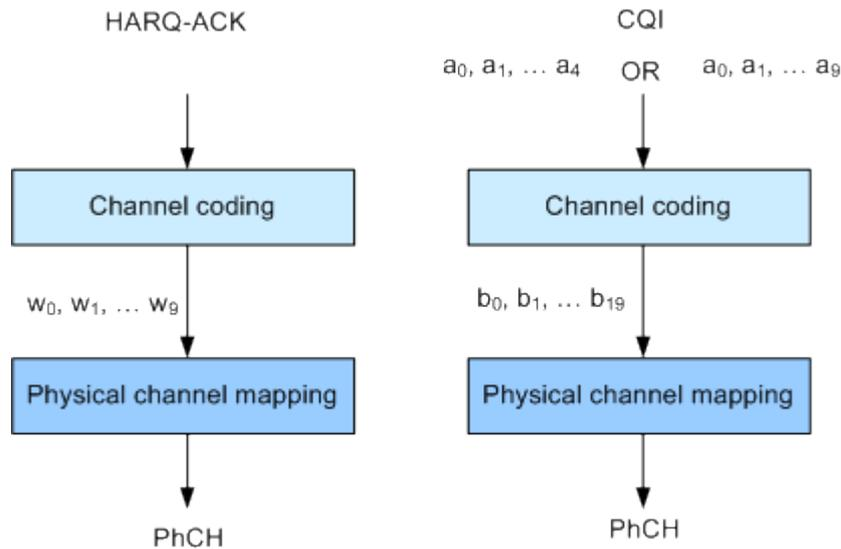

Figure 3-12: Channel coding for HS-DPCCH (non-MIMO mode)

The 10 bits of the HARQ-ACK messages are interpreted according to 3GPP TS 25.212 (see the table below). ACK/NACK information is provided for the transport block of the serving and secondary serving HS-DSCH cells.

Table 3-17: Interpretation of HARQ-ACK in DC-HSDPA non-MIMO operation

HARQ-ACK message to be transmitted	w ₀	w ₁	w ₂	w ₃	w ₄	w ₅	w ₆	w ₇	w ₈	w ₉
HARQ-ACK in response to a single scheduled transport block, detected on the serving HS-DSCH cell										
ACK	1	1	1	1	1	1	1	1	1	1
NACK	0	0	0	0	0	0	0	0	0	0
HARQ-ACK in response to a single scheduled transport block, detected on the secondary serving HS-DSCH cell										
ACK	1	1	1	1	1	0	0	0	0	0
NACK	0	0	0	0	0	1	1	1	1	1
HARQ-ACK in response to a single scheduled transport block, detected on each of the serving and secondary serving HS-DSCH cells										
Response to transport block from serving HS-DSCH cell	Response to transport block from secondary serving HS-DSCH cell									
ACK	ACK	1	0	1	0	1	0	1	0	1
ACK	NACK	1	1	0	0	1	1	0	0	1
NACK	ACK	0	0	1	1	0	0	1	1	0
NACK	NACK	0	1	0	1	0	1	0	1	0
PRE/POST indication										

PRE		0	0	1	0	0	1	0	0	1	0
POST		0	1	0	0	1	0	0	1	0	0

CQI Reports: CQI1 and CQI2

Two individual CQI reports CQI1 and CQI2 are concatenated to form the composite channel quality information. CQI1 corresponds to the serving HS-DSCH cell and CQI2 to the secondary serving cell respectively. The figure below show how the CQI report is constructed.

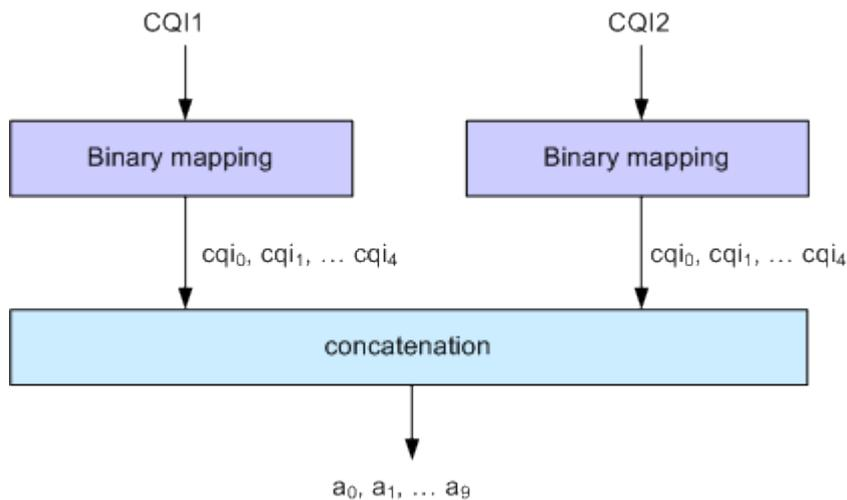

Figure 3-13: Composite CQI information (DC-HSDPA operation, non-MIMO mode)

3.3.15.2 DC-HSDPA + MIMO

Channel coding is done separately for the composite PCI/CQI and for HARQ-ACK information.

The principle is shown on figure [Figure 3-9](#).

The composite PCI/CQI report is created as illustrated on figure [Figure 3-10](#).

The HARQ-ACK message is coded to 10 bits according to 3GPP TS 25.212. The standard defines the HARQ-ACK coding for the feedback of the serving and secondary serving HS-DSCH cells for normal and dual stream transmission.

3.3.15.3 Dual Cell HSDPA (DC-HSDPA) Fixed Reference Channel: H-Set 12

In order to support DC-HSDPA testing, a fixed reference channel has been introduced. H-Set 12 is specified as reference test channel for HSDPA test cases.

The H-Set 12 parameterization and coding chain is based on 1 code with QPSK modulation. Six hybrid ARQ processes are used, and HS-DSCH is continuously transmitted.

3.3.16 HS-DPCCH Extension for 4C-HSDPA and 8C-HSDPA

The 3GPP Release 11 extends the dual cell HSDPA (DC-HSDPA) transmission up to 8 cells HSDPA (8C-HSDPA). This extension enables the simultaneous scheduling of HSDPA transmission over four or eight cells, one serving and up to three or up to seven secondary serving cells. The transmissions on the serving cells are independent and are dynamically activated and deactivated.

For each of the cells, MIMO can be enabled. The channel coding of the feedback data transmitted via the HS-DPCCH is based on the same principle as in MIMO single cell transmission.

For detailed description on the channel coding, refer to the 3GPP specification TS 25.212.

The related instrument settings are described in [Chapter 4.32, "HS-DPCCH Settings - UE"](#), on page 189.

3.3.17 Dual Cell HSUPA (Dual Cell E-DCH)

The Dual-Cell HSUPA employs carrier aggregation in the uplink. The DC-HSUPA operation is available only in combination with the DC-HSDPA. This operation uses two independent carriers, each assigned to one of the DC-HSDPA "cells".

3.3.18 UE Capabilities

MIMO, 64QAM and DC-HSDPA operation in downlink as well as 16QAM in uplink are UE capability, i.e. not all UEs have to support them.

Several UE categories have been introduced to provide:

- DL MIMO support and support of 64QAM in addition to 16QAM and QPSK in downlink
- 16QAM support in uplink
- Support of dual cell operation and MIMO

The R&S SMBV supports all UE categories.

3.3.18.1 MIMO and 64QAM UE Capabilities

According to 3GPP TS25.306 V8.4.0, the following release 8 HS-DSCH categories with MIMO and 64QAM support are defined:

- Categories 13 and 14:
 - Support of 64QAM
 - No support of MIMO
 - Maximum data rate of category 14 is 21 Mbps
- Categories 15 and 16:
 - Support of MIMO with modulation schemes QPSK and 16QAM
 - No support of 64QAM
 - Maximum data rate of category 16 is 27.6 Mbps

- Categories 17 and 18:
Support of MIMO with modulation schemes QPSK and 16QAM
Support of 64QAM and MIMO, but not simultaneously
Maximum data rate of category 18 is 27.6 Mbps when MIMO is used and 21 Mbps when 64QAM is used
- Categories 19 and 20:
Simultaneous support of MIMO and all modulation schemes (QPSK, 16QAM and 64QAM)
Maximum data rate of category 20 is 42.1 Mbps

3.3.18.2 UL 16QAM UE Capabilities

According to 3GPP TS25.306 V9.5.0, the following release 8 E-DCH categories with 16QAM uplink support are defined:

- Category 7 and 9:
Support of 16QAM in addition to BPSK

3.3.18.3 MIMO and DC-HSDPA Operation UE Capabilities

According to 3GPP TS25.306 V9.0.0, the following release 9 HS-DSCH categories with MIMO and dual cell operation support are defined:

- Categories 21, 22, 23 and 24:
Support of QPSK, 16QAM and for categories 23 and 24 also 64QAM
Support of dual cell operation, but without MIMO
- Categories 25, 26, 27 and 28:
Support of QPSK, 16QAM and for categories 27 and 28 also 64QAM
Simultaneous support of MIMO and dual cell operation

3.3.18.4 Dual Cell E-DCH Operation UE Capabilities

According to 3GPP TS25.306 V9.5.0, the following release 9 E-DCH categories with Dual-Cell E-DCH support are defined:

- Category 8:
Supports only QPSK in Dual-Cell E-DCH operation
- Category 9:
Supports QPSK and 16QAM in Dual-Cell E-DCH operation

3.3.19 Uplink Discontinuous transmission (UL DTX)

Uplink discontinuous transmission (UL DTX) is one of the features of the continuous packet connectivity (CPC) provided to reduce the uplink control channel overhead. UL DTX allows the UE to stop transmission of uplink DPCCCH in case there is no transmission activity on E-DCH or HS-DPCCH. This is sometimes also called uplink DPCCCH gating.

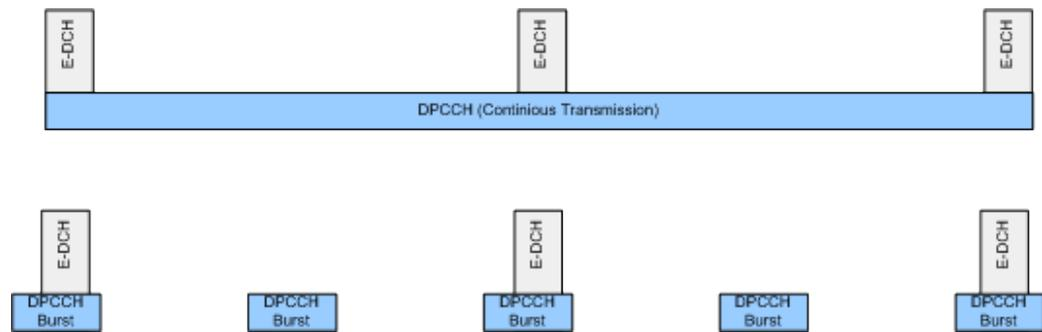

Figure 3-14: Principle of UL-DTX

Uplink DPCCH is not transmitted continuously any more, but it is transmitted from time to time according to a known activity pattern (UE-DTX cycle). This regular activity is needed in order to maintain synchronization and power control loop. Gating is only active if there is no uplink data transmission on E-DCH or HS-DPCCH transmission ongoing. In case E-DCH or HS-DPCCH is used, the uplink DPCCH is transmitted in parallel.

The 3GPP specifications define two patterns that can be applied to adapt the DTX cycle to the traffic conditions, the UE-DTX cycle 1 and the UE-DTX cycle 2 (see also [Chapter 5.3, "Configuring UL-DTX Transmission and Visualizing the Scheduling"](#), on page 242). The UE-DTX cycle 1 is applied depending on the duration of E-DCH inactivity. The UE-DTX cycle 2 has less frequent DPCCH transmission instants and is applied whenever there is no uplink data transmission. The switching from UE-DTX cycle 1 to UE-DTX cycle 2 is determined by a configurable period of inactivity.

The transmission of control signaling on the HS-DPCCH is not affected by the UL-DTX pattern. With enabled UL-DTX, the HARQ-ACK messages and the CQI reporting remain unchanged and the UE transmits acknowledgment according to the HARQ-ACK pattern, regardless of the UL-DTX cycle. Transmission of control signals does not cause switching from UE-DTX cycle 2 to UE-DTX cycle 1.

A preamble and postamble are added to the DPCCH burst for synchronization reasons. The length of the uplink DPCCH preamble and postamble depend whether the DPCCH burst transmission is caused by user-data transmission on the E-DCH or control signaling on the HS-DPCCH.

- For the E-DCH transmission
During the UE-DTX cycle 1, the DPCCH transmission starts two slots before the start of E-DPDCH and terminates one slot after it. For the UE-DTX cycle 2, an extended preamble of up to 15 slots is applied.
- For the HS-DPCCH transmission
The preamble length depends whether an HARQ-ACK or CQI report is transmitted. Two slots are applied for the HARQ-ACK case (unless an HARQ preamble PRE is transmitted) and three in case of CQI reporting. For the latter case, an extended preamble is applied too.
The DPCCH transmission terminates at the end of the first full DPCCH slot after the end of the HARQ-ACK/CQI field.

An instrument equipped with the required options provided an UL-DTX functionality, that is fully compliant with 3GPP TS 25.214. All dependencies from E-DCH transmis-

sions, HARQ-ACK transmissions or CQI transmissions on the DPCCH are respected. The corresponding settings are described in [Chapter 4.27, "UL-DTX/User Scheduling - UE"](#), on page 157.



Use the [Scheduling List](#) to display the UL-DTX burst pattern and transmissions of E-DCH and HS-DPCCH, as well as the impact on the UL-DPCCH transmissions or the configured uplink user scheduling.

Refer to [Chapter 5.3, "Configuring UL-DTX Transmission and Visualizing the Scheduling"](#), on page 242 for an example on how to use the UL-DTX function.

4 User Interface

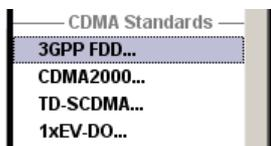

- ▶ To access the dialog for setting the 3GPP FDD digital standard, select "Baseband > 3GPP FDD".

The dialog is split into several sections for configuring the standard. The choice of transmission direction determines which displays and parameters are made available in the lower section.

The upper section of the dialog is where the 3GPP FDD digital standard is enabled, the default settings are called and the transmission direction selected. Button "Test Case Wizard" opens a configuration menu with a selection of predefined settings according to test cases in TS 25.141. The valid 3GPP version and the chip rate in use are displayed. Many of the buttons lead to submenus for loading and saving the 3GPP FDD configuration and for setting the filter, trigger and clock parameters.

The lower dialog section is where either the base station signal or the user equipment signal is configured, depending on the transmission direction selected.

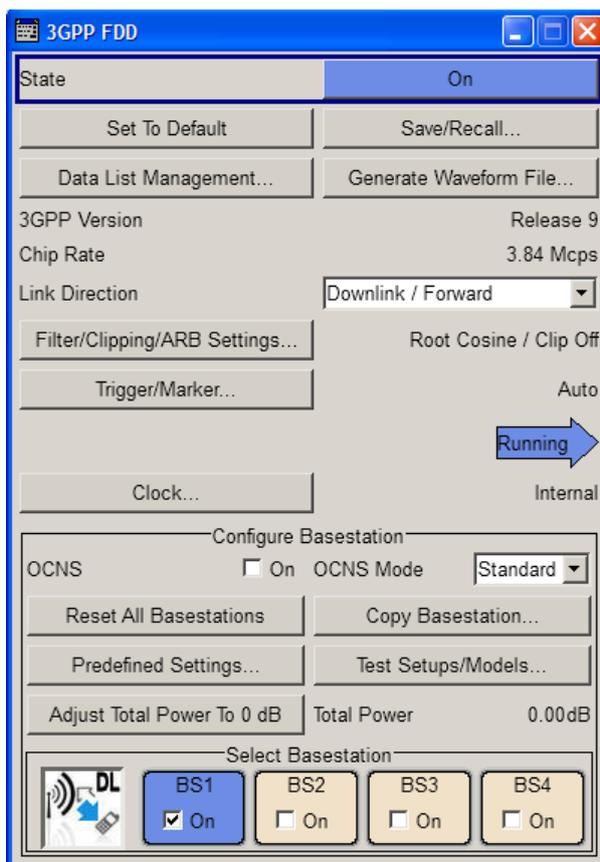

The dialog is comprehensive, so a small list of contents is added here to make orientation easier.

The headings are always given a short form of the "dialog path" and the header also shows you your current location in the dialog.

• General Settings for 3GPP FDD Signals.....	47
• Configure Base Stations or UE.....	52
• Filtering, Clipping, ARB Settings.....	58
• Trigger/Marker/Clock Settings.....	61
• Test Setups/Models.....	69
• Predefined Settings - Downlink.....	73
• Additional User Equipment - Uplink.....	74
• Base Station Settings.....	76
• Compressed Mode.....	85
• Code Domain Graph - BS.....	91
• Channel Graph - BS.....	93
• HSDPA Settings - BS.....	94
• HSDPA H-Set Mode Settings - BS.....	97
• Enhanced Settings for P-CPICH - BS1.....	113
• Enhanced Settings for P-CCPCH - BS1.....	114
• Enhanced Settings for DPCHs - BS1.....	116
• S-CCPCH Settings - BS Channel Table.....	130
• Config AICH/AP-AICH - BS Channel Table.....	131
• DPCCH Settings - BS Channel Table.....	132
• Config E-AGCH - BS Channel Table.....	137
• Config E-RGCH/E-HICH - BS Channel Table.....	139
• Config F-DPCH - BS Channel Table.....	140
• Multi Channel Assistant - BS.....	144
• User Equipment Configuration (UE).....	147
• Code Domain Graph - UE.....	151
• Dynamic Power Control - UE.....	152
• UL-DTX/User Scheduling - UE.....	157
• PRACH Settings - UE.....	160
• PCPCH Settings - UE.....	170
• DPCCH Settings - UE.....	181
• E-DPCCH Settings - UE.....	188
• HS-DPCCH Settings - UE.....	189
• DPDCH Settings - UE.....	210
• E-DPDCH Settings - UE.....	214
• E-DCH Scheduling - UE.....	218
• Scheduling List.....	221
• HSUPA FRC Settings - UE.....	223
• Global Enhanced Channel Settings - UE1.....	231

4.1 General Settings for 3GPP FDD Signals

The upper menu section is where the 3GPP FDD digital standard is enabled and reset and where all the settings valid for the signal in both transmission directions are made.

State.....	48
Set to default.....	48
Save/Recall.....	48
Data List Management.....	49
Generate Waveform.....	50
3GPP Version.....	50
Chip Rate.....	51
Link Direction.....	51
Filtering/Clipping/ARB Settings.....	51
Trigger/Marker.....	51
Execute Trigger.....	51
Clock.....	51

State

Activates the standard and deactivates all the other digital standards and digital modulation modes in the same path.

The instrument generates the 3GPP FDD signal as a combination of realtime mode (enhanced channels) and arbitrary waveform mode (all the other channels). The following is a more detailed list of the channels generated in **real time**:

- *Downlink channels*: P-CCPCH and up to three DPCHs of base station 1 and H-Sets 1 to 5.
- *Uplink channels*: DPCCH and one DPDCH of user equipment 1.
Depending on the actual configurations, other channels of user equipment 1 can also be generated in real time.

Generated in **arbitrary waveform mode** and added to the realtime signal are: PRACH and PCPCH channels and the channels of the other user equipment.

Remote command:

[:SOURce<hw>] :BB:W3GPP:STATe on page 254

Set to default

Calls the default settings. Test Model 1 (64 channels) is preset.

The parameter "State" is not affected.

Remote command:

[:SOURce<hw>] :BB:W3GPP:PRESet on page 252

Save/Recall

Calls the "Save/Recall" menu.

"From the Save/Recall menu," the "File Select" windows for saving and recalling 3GPP FDD configurations and the "File Manager" can be called.



3GPP FDD configurations are stored as files with the predefined file extension *.3g. The filename and the directory they, are user-definable.

The complete settings in the "3GPP FDD" dialog and all subdialogs are saved and recalled.

"Recall 3GPP FDD setting"	<p>Opens the "File Select" window for loading a saved 3GPP FDD configuration.</p> <p>The configuration of the selected (highlighted) file is loaded by pressing the "Select" button.</p>
"Save 3GPP FDD setting"	<p>Opens the "File Select" window for saving the current 3GPP FDD signal configuration.</p> <p>The name of the file is specified in the "File name" entry field, the directory selected in the "save into" field. The file is saved by pressing the "Save" button.</p> <p>The "Fast Save" function determines whether the instrument performs an absolute or a differential storing of the settings. Enable this function to accelerate the saving process by saving only the settings with values different to the default ones. "Fast Save" is not affected by the "Preset" function.</p>
"File Manager"	<p>Calls the "File Manager".</p> <p>The "File Manager" is used to copy, delete and rename files and to create directories.</p>

Remote command:

[:SOURce<hw>] :BB:W3GPp:SETTing:CATalog? on page 252

[:SOURce<hw>] :BB:W3GPp:SETTing:LOAD on page 253

[:SOURce<hw>] :BB:W3GPp:SETTing:STORe on page 253

[:SOURce<hw>] :BB:W3GPp:SETTing:STORe:FAST on page 253

[:SOURce<hw>] :BB:W3GPp:SETTing:DELeTe on page 252

Data List Management

Calls the "Data List Management" menu. This menu is used to create and edit a data list.



All data lists are stored as files with the predefined file extension *.dm_iqd. The file-name and the directory are user-definable.

The data lists must be selected as a data source for the corresponding individual function, e.g. in the channel table of the base stations.

Note: All data lists are generated and edited with the `SOURce:BB:DM` subsystem commands. Files containing data lists are recognized by the file extension *.dm_iqd. The data lists are selected as a data source for a specific function in the individual subsystems of the digital standard.

Creating and editing the data list

```
SOUR:BB:DM:DLIS:SEL "3gpp"
```

```
SOUR:BB:DM:DLIS:DATA 1,1,0,1,0,1,0,1,1,1,1,0,0,0
```

```
SOUR:BB:DM:DLIS:DATA:APP 1,1,0,1,0,1,0,1,1,1,1,0,0
```

Remote command:

[:SOURce<hw>] :BB:W3GPp:BSTation<st>:CHANnel<ch0>:DATA on page 279

[:SOURce<hw>] :BB:W3GPp:BSTation<st>:CHANnel<ch0>:DATA:DSElect on page 279

[:SOURce<hw>] :BB:W3GPp:BSTation<st>:CHANnel<ch0>:DPCCh:TPC:DATA on page 283

[:SOURce<hw>] :BB:W3GPp:BSTation<st>:CHANnel<ch0>:DPCCh:TPC:DATA:DSElect on page 284

[:SOURce<hw>] :BB:W3GPp:BSTation:ENHanced:CHANnel<ch0>:DPCH:TCHannel<di0>:DATA on page 330

[:SOURce<hw>] :BB:W3GPp:BSTation:ENHanced:CHANnel<ch0>:DPCH:TCHannel<di0>:DATA:DSElect on page 331

[:SOURce<hw>] :BB:W3GPp:MSTation<st>:CHANnel<ch>:DPDCh:DATA on page 375

[:SOURce<hw>] :BB:W3GPp:MSTation<st>:CHANnel<ch>:DPDCh:DATA:DSElect on page 376

[:SOURce<hw>] :BB:W3GPp:MSTation:ENHanced:DPDCh:TCHannel<di0>:DATA on page 433

[:SOURce<hw>] :BB:W3GPp:MSTation:ENHanced:DPDCh:TCHannel<di0>:DATA:DSElect on page 434

[:SOURce<hw>] :BB:W3GPp:MSTation<st>:DPCCh:TPC:DATA on page 353

[:SOURce<hw>] :BB:W3GPp:MSTation<st>:DPCCh:TPC:DATA:DSElect on page 353

[:SOURce<hw>] :BB:W3GPp:MSTation<st>:PCPCh:DATA on page 380

[:SOURce<hw>] :BB:W3GPp:MSTation<st>:PCPCh:DATA:DSElect on page 381

[:SOURce<hw>] :BB:W3GPp:MSTation<st>:PCPCh:TPC:DATA on page 388

[:SOURce<hw>] :BB:W3GPp:MSTation<st>:PCPCh:TPC:DATA:DSElect on page 388

[:SOURce<hw>] :BB:W3GPp:MSTation<st>:PRACH:DATA on page 391

[:SOURce<hw>] :BB:W3GPp:MSTation<st>:PRACH:DATA:DSElect on page 392

Generate Waveform

With enabled signal generation, triggers the instrument to store the current settings as an ARB signal in a waveform file. Waveform files can be further processed by the ARB and/or as a multi-carrier or a multi-segment signal.

The filename and the directory it is stored in are user-definable; the predefined file extension for waveform files is *.wv.

Remote command:

[:SOURce<hw>] :BB:W3GPp:WAVEform:CREate on page 254

3GPP Version

Displays the current implemented version of the 3GPP FDD standard.

The default settings and parameters provided are oriented towards the specifications of the version displayed.

Remote command:

[:SOURce] :BB:W3GPp:GPP3:VERSion? on page 255

Chip Rate

Displays the system chip rate, fixed at 3.84 Mcps.

To vary the output chip rate, use the parameters in the "Filter/Clipping/ARB Settings" dialog

See [Chapter 4.3, "Filtering, Clipping, ARB Settings"](#), on page 58.

Remote command:

[:SOURce<hw>] :BB:W3GPP:CRATe? on page 259

Link Direction

Selects the transmission direction. Further provided settings are in accordance with this selection.

"Downlink/ Forward Link" The transmission direction selected is base station to user equipment. The signal corresponds to that of a base station.

"Uplink/ Reverse Link" The transmission direction selected is user equipment to base station. The signal corresponds to that of user equipment.

Remote command:

[:SOURce<hw>] :BB:W3GPP:LINK on page 257

Filtering/Clipping/ARB Settings

Access a dialog for setting baseband filtering, clipping and the sequence length of the arbitrary waveform component. An indication of the key parameters values is provided.

See [Chapter 4.3, "Filtering, Clipping, ARB Settings"](#), on page 58 for detailed description.

Remote command:

n.a.

Trigger/Marker

Calls the menu for selecting the trigger source, for configuring the marker signals and for setting the time delay of an external trigger signal (see [Chapter 4.4, "Trigger/Marker/Clock Settings"](#), on page 61).

The currently selected trigger source is displayed to the right of the button.

Remote command:

n.a.

Execute Trigger

Executes trigger manually.

A manual trigger can be executed only when an internal trigger source and a trigger mode other than "Auto" have been selected.

Remote command:

[:SOURce<hw>] :BB:W3GPP:TRIGger:EXECute on page 263

Clock

Calls the menu for selecting the clock source and for setting a delay (see [Chapter 4.4.4, "Clock Settings"](#), on page 68).

Remote command:

n.a.

4.2 Configure Base Stations or UE

Depending on the transmission direction selection, the central section of the dialog provides the "Configure Base Station" section or the "Configure User Equipment" section.

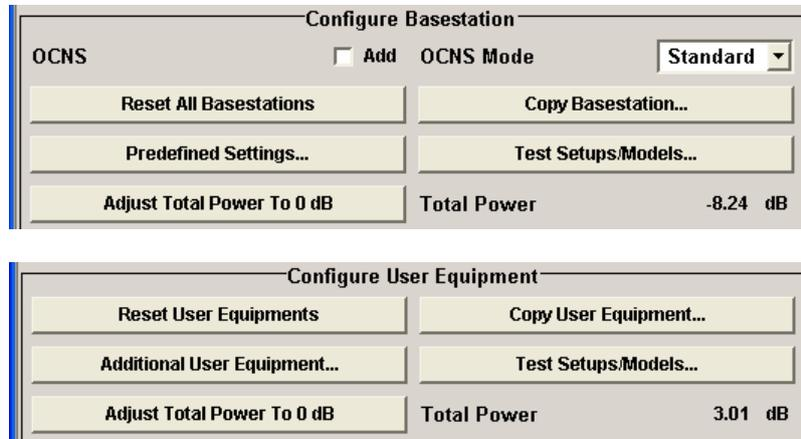

4.2.1 Orthogonal Channel Noise (OCNS) Settings

With Orthogonal Channel Noise, a practical downlink signal is generated to test the maximum input levels of user equipment in accordance with standard specifications. This simulates the data and control signals of the other orthogonal channels in the downlink. 3GPP TS 25.101 contains a precise definition of the required appearance of the OCNS signal.

This section describes the provided settings. For detailed information, see [Chapter 3.3.11, "Orthogonal Channel Noise \(OCNS\)"](#), on page 27.

OCNS On

In BS1, activates OCNS channels according to the definition in the 3GPP standard.

The 3GPP specification defines different OCNS scenarios. Select the OCNS scenario with the parameter [OCNS Mode](#).

When activating OCNS and depending on the selected OCNS mode, different channel groups with different presetting are assigned, see tables in [Chapter 3.3.11, "Orthogonal Channel Noise \(OCNS\)"](#), on page 27. These channels cannot be edited in the channel table.

Remote command:

`[:SOURCE<hw>] :BB:W3GPP:BSTation:OCNS:STATE` on page 275

OCNS Mode

Selects the scenario for activating OCNS channels. To activate the selected OCNS scenario, set the check box [OCNS > On](#).

Four different OCNS scenarios are defined in the 3GPP standard; one "standard" scenario, two scenarios for HSDPA test cases and one scenario for type 3i enhanced performance requirements tests according to 3GPP TS34.121-1 ("other user's channels"). For an overview of the provided scenarios and their settings, refer to [Chapter 3.3.11, "Orthogonal Channel Noise \(OCNS\)"](#), on page 27.

Note: If the "3i" OCNS mode is activated and the "3GPP FDD > State > On", the OCNS channels are automatically leveled in order to have total power of 0 dB for all channels of BS 1.

Remote command:

`[:SOURCE<hw>] :BB:W3GPP:BSTation:OCNS:MODE` on page 275

OCNS Seed

In "OCNS mode > 3i", sets the seed for both the random processes, the power control simulation process and the process controlling the switch over of the channelization codes.

Remote command:

`[:SOURCE<hw>] :BB:W3GPP:BSTation:OCNS:SEED` on page 276

4.2.2 Common Configuration Settings

The central "Configure Basestations / User Equipments" section in the lower part of the dialog, covers the general parameters for configuring the respective transmission direction.

Reset all Base Stations

Resets all base stations to the predefined settings. The preset value for each parameter is specified in the description of the remote-control commands.

Table 4-1: Overview of the base station predefined settings

Parameter	Value
State	Off
State (all channels)	Off
Scrambling Code	0
Slot Format DPCH	8
Symbol Rate DPCH	30 ksps
Channelization Code (all channels)	0
Data Source (all channels)	PN9
Timing Offset (all channels)	0
Multi-Code State (all channels)	Off

Remote command:

`[:SOURCE<hw>] :BB:W3GPP:BSTation:PRESet` on page 255

Reset User Equipment

Resets all user equipment to the predefined settings. The preset value for each parameter is specified in the description of the remote-control commands.

Table 4-2: Overview of the user equipment predefined settings

Parameter	Value
State	Off
Mode	DPCCH + DPDCH
Scrambling Code (hex)	0
DPCCH Settings	
Power	0 dB
DPDCH Settings	
DPDCH State	On
HS-DPCCH, E-DPCCH and E-DPDCH State	Off
Channel Power	0 dB
Overall Symbol Rate	60 ksps

Remote command:

`[:SOURCE<hw>] :BB:W3GPp:MSTation:PRESet` on page 345

Copy Basestation/Copy User Equipment...

Copies the settings of a base station or user equipment to a second base or user equipment. A dialog opens for creating the destination station.

Downlink / Forward link direction

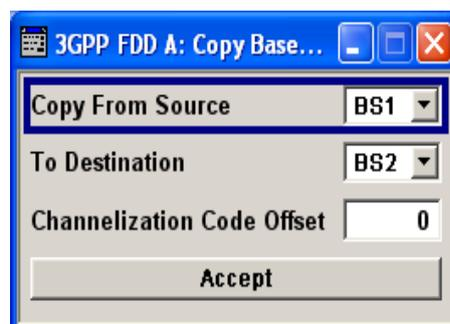

Uplink / Reverse link direction

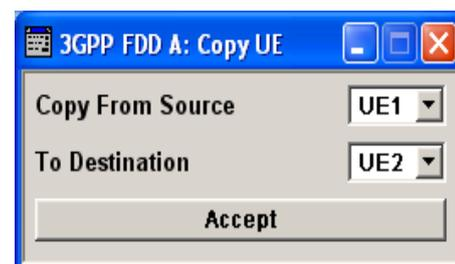

"Copy from Source"

Selects the base station or user equipment whose settings are to be copied.

Remote command:

`[:SOURCE<hw>] :BB:W3GPp:COPY:SOURCE` on page 256

"To Destination"

Selects the base station or user equipment whose settings are to be overwritten.

Remote command:

`[:SOURCE<hw>] :BB:W3GPP:COPY:DESTINATION` on page 255

"Channelization Code Offset (Base Station only)"

Enters the offset to be applied when copying the base station to the channelization codes of the destination base station. The minimum value is 0 (channelization codes are identical), the maximum value is 511.

Remote command:

`[:SOURCE<hw>] :BB:W3GPP:COPY:COFFSET` on page 255

"Accept" Starts the copy process.

Remote command:

`[:SOURCE<hw>] :BB:W3GPP:COPY:EXECUTE` on page 256

Test Setups/Models

Provides access to the test models defined in the 3GPP standard and further test setups, see [Chapter 4.5, "Test Setups/Models"](#), on page 69.

Remote command:

n.a.

Predefined Settings

Access a dialog for setting predefined configurations, see [Chapter 4.6, "Predefined Settings - Downlink"](#), on page 73.

Remote command:

n.a.

Additional User Equipment

Access a dialog for simulating up to 128 additional user equipment, see [Chapter 4.7, "Additional User Equipment - Uplink"](#), on page 74.

Remote command:

n.a.

Select Basestation/User Equipment

Selects the base station or user equipment by pressing the accompanying block.

A dialog for editing the selected basestation or user equipment opens (see [Chapter 4.8, "Base Station Settings"](#), on page 76 and [Chapter 4.24, "User Equipment Configuration \(UE\)"](#), on page 147).

To activate a base station or user equipment, enable its state.



Remote command:

(the base station or user equipment is selected by the keyword index
 BStation<[1] | 2 | 3 | 4> or MStation<i>)

[\[:SOURCE<hw>\]:BB:W3GPP:BSTation<st>:STATe](#) on page 321

[\[:SOURCE<hw>\]:BB:W3GPP:MSTation<st>:STATe](#) on page 347

4.2.3 General Power Settings

The power settings are enabled for "3GPP FDD > State = On".

Adjust Total Power to 0dB

Sets the power of the enabled channels so that the total power of all the active channels is 0 dB. This does not change the power ratio among the individual channels.

Remote command:

[\[:SOURCE<hw>\]:BB:W3GPP:POWER:ADJUST](#) on page 257

Total Power

Displays the total power of the active channels.

The total power is calculated from the power ratio of the powered up code channels with modulation on. If the value is not equal to 0 dB, the individual code channels are internally adapted so that the "Total Power" for achieving the set output level is 0 dB. The power ratios are maintained.

Remote command:

[\[:SOURCE<hw>\]:BB:W3GPP:POWER\[:TOTAl\]?](#) on page 257

Power Reference

Determines the power reference for the leveling of the output signal in uplink direction.

Parameter	Power leveling performed during	Power displayed in "Status bar > Level" is equal to	"Mode" of the first active UE
"RMS Power"	Complete signal	Output signal's mean power	<ul style="list-style-type: none"> • PRACH Standard • PRACH Preamble only • DPCCH+DPDCH and UL-DTX Off • PCPCH Standard • PCPCH Preamble only
"First DPCCH" "First E-DCH" "First HARQ-ACK" "First PCI/CQI"	First slot in which a DPCCH, an E-DCH, an HARQ-ACK or a PCI/CQI is transmitted in the first active UE	Output signal's mean power during the first active DPCCH Note: if there are other UEs or channels active during the reference slot, the total power is used as a reference, not only the DPCCH power. This mode is required if the UL-DTX is enabled, due to the long signal parts of inactivity.	<ul style="list-style-type: none"> • DPCCH+DPDCH and UL-DTX On • DPCCH+DPDCH and UL-DTX Off
"PRACH Message Part"	PRACH message part of the first active UE	Output signal's mean power during the PRACH message part	PRACH Standard
"Last PRACH Preamble"	Last PRACH preamble of the first active UE	Output signal's mean power during the last PRACH preamble	<ul style="list-style-type: none"> • PRACH Standard • PRACH Preamble only

Example:

- "RF Level" = -10 dBm (value displayed in the status bar of the instrument)
- DPCCH is activated
- E-DPCCH and one E-DPDCH are activated in the first subframe of each frame

The [Figure 4-1](#) displays the power versus time for "Power Reference = First DPCCH": the signal level in the first subframe is -10 dBm; the RMS power of the signal is -13.3 dBm.

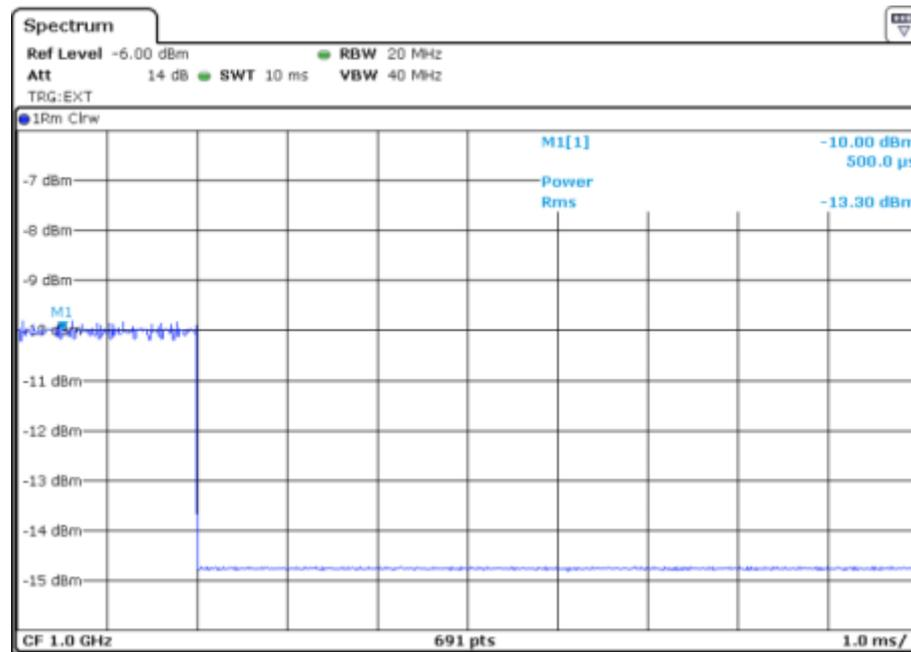

Figure 4-1: Example: Power Reference = First DPCCH

The [Figure 4-2](#) displays the power versus time for "Power Reference = RMS": the RMS power of the signal is -10 dBm; the signal level in the first subframe is -6.7 dBm.

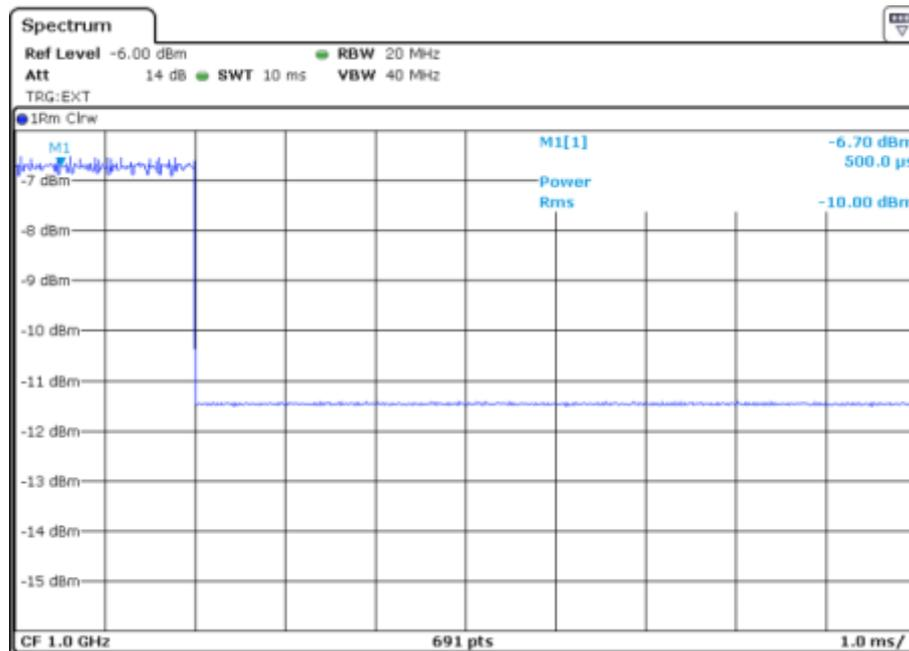

Figure 4-2: Example: Level Reference = RMS

Remote command:

`[:SOURce<hw>] :BB:W3GPP:LREference` on page 347

4.3 Filtering, Clipping, ARB Settings

Access:

- ▶ Select "3GPP FDD > Main dialog > Filter/Clipping/ARB Settings".

The dialog comprises the settings, necessary to configure the baseband filter, to enable clipping and adjust the sequence length of the arbitrary waveform component.

4.3.1 Filter Settings

Settings:

Filter

Selects the baseband filter.

Remote command:

`[:SOURce<hw>] :BB:W3GPP:FILTer:TYPE` on page 262

Roll Off Factor or BxT

Sets the filter parameter.

The filter parameter offered ("Roll Off Factor" or "BxT") depends on the currently selected filter type. This parameter is preset to the default for each of the predefined filters.

Remote command:

[\[:SOURCE<hw>\]:BB:W3GPP:FILTER:PARAMETER:APCO25](#) on page 259

[\[:SOURCE<hw>\]:BB:W3GPP:FILTER:PARAMETER:COSine](#) on page 260

[\[:SOURCE<hw>\]:BB:W3GPP:FILTER:PARAMETER:GAUSS](#) on page 260

[\[:SOURCE<hw>\]:BB:W3GPP:FILTER:PARAMETER:RCOSine](#) on page 261

[\[:SOURCE<hw>\]:BB:W3GPP:FILTER:PARAMETER:SPHase](#) on page 261

Cut Off Frequency Factor

Sets the value for the cut-off frequency factor. The cut-off frequency of the filter can be adjusted to reach spectrum mask requirements.

Remote command:

[\[:SOURCE<hw>\]:BB:W3GPP:FILTER:PARAMETER:LPASs](#) on page 260

[\[:SOURCE<hw>\]:BB:W3GPP:FILTER:PARAMETER:LPASSEVM](#) on page 261

Chip Rate Variation

Enters the chip rate. The default settings for the chip rate are 3.84 Mcps.

The chip rate entry changes the output clock and the modulation bandwidth, as well as the synchronization signals that are output. It does not affect the calculated chip sequence.

Remote command:

[\[:SOURCE<hw>\]:BB:W3GPP:CRATE:VARiation](#) on page 259

4.3.2 Clipping Settings

Provided are the following settings:

Clipping State

Switches baseband clipping on and off.

Baseband clipping is a simple and effective way of reducing the crest factor of the WCDMA signal.

WCDMA signals can have high crest factors particularly with many channels and unfavorable timing offsets. High crest factors entail two basic problems:

- The nonlinearity of the power amplifier (compression) causes intermodulation which expands the spectrum (spectral regrowth).
- Since the level in the D/A converter is relative to the maximum value, the average value is converted with a relatively low resolution. This results in a high quantization noise.

Both effects increase the adjacent-channel power.

With baseband clipping, all the levels are limited to a settable value ("Clipping Level"). This level is specified as a percentage of the highest peak value. Since clipping is done before filtering, the procedure does not influence the spectrum. The EVM however increases.

Since clipping the signal not only changes the peak value but also the average value, the effect on the crest factor is unpredictable. The following example shows the effect of the "Clipping" on the crest factor for typical scenarios.

Example: Clipping effect on the crest factor

The [Table 4-3](#) shows changing the crest factor by clipping (vector mode $|I+q|$) for signal configurations with different output crest factors.

100% clipping levels mean that clipping does not take place.

Table 4-3: Crest factor values as function of the vector clipping

Clipping level	Downlink: 10 DPCHs "Minimum Crest" 30 ksps	Downlink: 10 DPCHs "Worst Crest" 30 ksps	Downlink: 10 DPCHs "Average Crest" 30 ksps	Downlink: 128 DPCHs "Average Crest" 30 ksps
100%	9.89 dB	14.7 dB	10.9 dB	21.7 dB
80%	8.86 dB	12.9 dB	9.39 dB	20.2 dB
50%	7.50 dB	10.1 dB	8.29 dB	16.9 dB
20%	5.50 dB	6.47 dB	6.23 dB	12.5 dB
10%	5.34 dB	6.06 dB	5.80 dB	9.57 dB
5%	5.34 dB	6.06 dB	5.80 dB	8.17 dB

The pictures in the following table demonstrate the effect of clipping with vector mode ($|I+q|$), using a signal configuration with 4 DPCH as an example.

The arrows and the circle in the upper illustration show how the levels are mapped during subsequent clipping in vector mode ($|I+q|$).

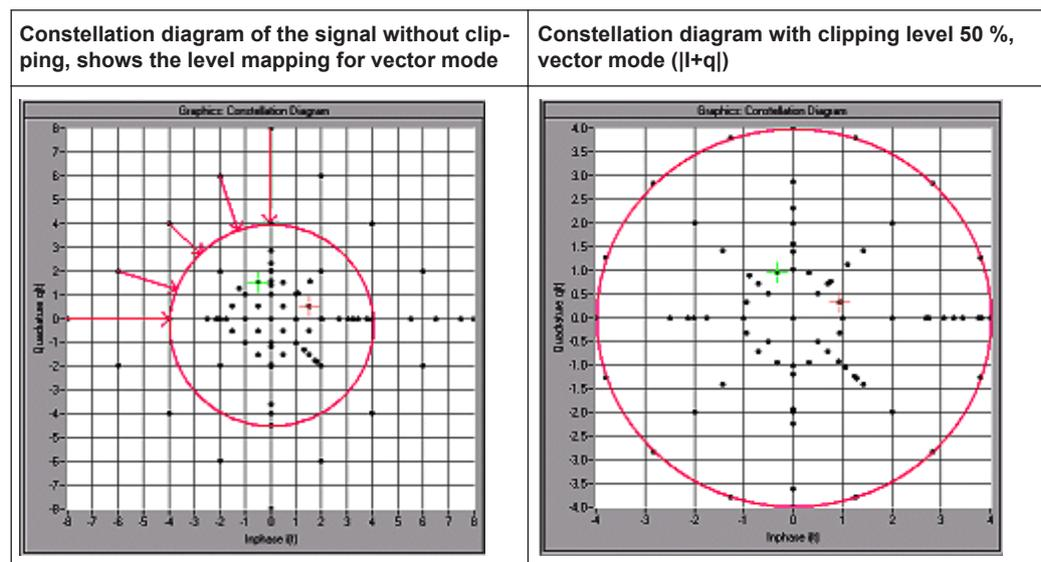

Remote command:

[\[:SOURCE<hw>\]:BB:W3GPP:CLIPPING:STATE](#) on page 259

Clipping Level

Sets the limit for clipping.

This value indicates at what point the signal is clipped. It is specified as a percentage, relative to the highest level. 100% indicates that clipping does not take place.

Remote command:

[\[:SOURCE<hw>\]:BB:W3GPP:CLIPPING:LEVEL](#) on page 258

Clipping Mode

Selects the clipping method. The dialog displays a graphical illustration on how this two methods work.

- "Vector $|i + jq|$ "
The limit is related to the amplitude $|i + q|$. The I and Q components are mapped together, the angle is retained.
- "Scalar $|i|, |q|$ "
The limit is related to the absolute maximum of all the I and Q values $|i| + |q|$. The I and Q components are mapped separately, the angle changes.

Remote command:

[\[:SOURCE<hw>\]:BB:W3GPP:CLIPPING:MODE](#) on page 258

4.3.3 ARB Settings

Provided are the following settings:

Sequence Length ARB

Changes the sequence length of the arbitrary waveform component of the signal. This component is calculated in advance and output in the arbitrary waveform generator. It is added to the realtime signal components.

The maximum number of frames is calculated as follows:

Max. No. of Frames = Arbitrary waveform memory size / (3.84 Mcps x 10 ms).

Tip: In pure amplifier tests with several channels and no enhanced channels, it is possible to improve the statistical properties of the signal by increasing the sequence length.

Remote command:

[\[:SOURCE<hw>\]:BB:W3GPP:SELENGTH](#) on page 254

4.4 Trigger/Marker/Clock Settings

To access this dialog, select "Main Menu > Trigger/Marker".

The "Trigger In" section is where the trigger for the signal is set. Various parameters are provided for the settings, depending on which trigger source - internal or external -

is selected. The status of signal generation ("Running" or "Stopped") is indicated for all trigger modes.

The "Marker Mode" section is where the marker signals at the [Marker] output connectors are configured.

The "Marker Delay" section is where a marker signal delay can be defined.

The "Clock Settings" section is where the clock source is selected and - in the case of an external source - the clock type.

The buttons in the last section lead to submenu for general trigger, clock and mapping settings.

4.4.1 Trigger In



The trigger functions are available for R&S SMx and R&S AMU instruments only.

The "Trigger In" section is where the trigger for the signal is set. Various parameters are provided for the settings, depending on which trigger source - internal or external - is selected. The status of signal generation ("Running" or "Stopped") is indicated for all trigger modes.

Trigger Mode

Selects trigger mode, i.e. determines the effect of a trigger event on the signal generation.

- "Auto"
The signal is generated continuously.
- "Retrigger"
The signal is generated continuously. A trigger event (internal or external) causes a restart.
- "Armed Auto"
The signal is generated only when a trigger event occurs. Then the signal is generated continuously.
An "Arm" stops the signal generation. A subsequent trigger event (internal or external) causes a restart.
- "Armed Retrigger"
The signal is generated only when a trigger event occurs. Then the signal is generated continuously. Every subsequent trigger event causes a restart.
An "Arm" stops signal generation. A subsequent trigger event (internal or external) causes a restart.
- "Single"
The signal is generated only when a trigger event occurs. Then the signal is generated once to the length specified at "Signal Duration".
Every subsequent trigger event (internal or external) causes a restart.

Remote command:

`[:SOURce<hw>] :BB:W3GPp [:TRIGger] :SEQuence` on page 263

Signal Duration Unit

Defines the unit for describing the length of the signal sequence to be output in the "Single" trigger mode.

Remote command:

`[:SOURce<hw>] :BB:W3GPp:TRIGger:SLUNit` on page 264

Signal Duration

Enters the length of the signal sequence to be output in the "Single" trigger mode.

Use this parameter to output part of the signal deliberately, an exact sequence of the signal, or a defined number of repetitions of the signal.

Remote command:

[:SOURce<hw>] :BB:W3GPp:TRIGger:SLENgth on page 264

Running/Stopped

With enabled modulation, displays the status of signal generation for all trigger modes.

- "Running"
The signal is generated; a trigger was (internally or externally) initiated in triggered mode.
- "Stopped"
The signal is not generated and the instrument waits for a trigger event.

Remote command:

[:SOURce<hw>] :BB:W3GPp:TRIGger:RMODe? on page 264

Arm

Stops the signal generation until subsequent trigger event occurs.

Remote command:

[:SOURce<hw>] :BB:W3GPp:TRIGger:ARM:EXECute on page 263

Execute Trigger

Executes trigger manually.

A manual trigger can be executed only when an internal trigger source and a trigger mode other than "Auto" have been selected.

Remote command:

[:SOURce<hw>] :BB:W3GPp:TRIGger:EXECute on page 263

Trigger Source

Selects trigger source. This setting is effective when a trigger mode other than "Auto" has been selected.

- "Internal"
The trigger event is executed by "Execute Trigger".
- "External"
The trigger event is the active edge of an external trigger signal, supplied at the TRIGGER connector.
Use the "Global Trigger/Clock Settings" dialog to define the polarity, the trigger threshold and the input impedance of the trigger signal.

Remote command:

[:SOURce<hw>] :BB:W3GPp:TRIGger:SOURce on page 263

Sync. Output to External Trigger

(for "Trigger Source > External")

Enables/disables output of the signal synchronous to the external trigger event.

For two or more R&S SMBVs that work in a master-slave mode, configure this parameter depending on the provided system trigger event and the properties of the output signal. See the table below for an overview of the required settings.

Table 4-4: Typical applications

System trigger	Application	"Sync. Output to External Trigger"
Common External Trigger event for the master and the slave instruments	All instruments are synchronous to the external trigger event	On
	All instruments are synchronous among themselves but starting the signal from first symbol is more important than synchronicity with external trigger event	Off
Internal trigger signal of the master R&S SMBV for the slave instruments	All instruments are synchronous among themselves	Off

"On"

Corresponds to the default state of this parameter.

The signal calculation starts simultaneously with the external trigger event but because of the instrument's processing time the first samples are cut off and no signal is outputted. After elapsing of the internal processing time, the output signal is synchronous to the trigger event.

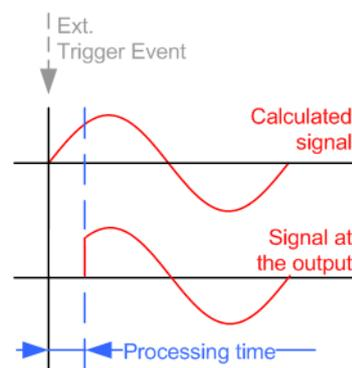

"Off"

The signal output begins after elapsing of the processing time and starts with sample 0, i.e. the complete signal is output.

This mode is recommended for triggering of short signal sequences with signal duration comparable with the processing time of the instrument.

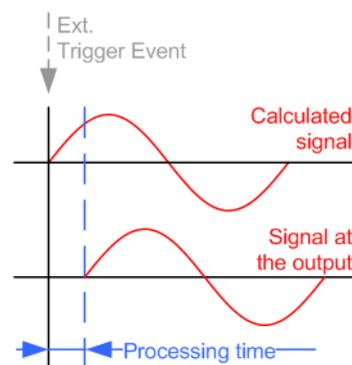

Remote command:

`[:SOURce<hw>] :BB:W3GPp:TRIGger:EXTernal:SYNChronize:OUTPut`
on page 264

Trigger Delay

Delays the trigger event of the signal from:

- The external trigger source

Use this setting to:

- Synchronize the instrument with the device under test (DUT) or other external devices

Remote command:

`[:SOURce<hw>] :BB:W3GPp:TRIGger [:EXTernal<ch>] :DELay` on page 265

Trigger Inhibit

Sets the duration for inhibiting a new trigger event subsequent to triggering. The input is to be expressed in samples.

In the "Retrigger" mode, every trigger signal causes signal generation to restart. This restart is inhibited for the specified number of samples.

This parameter is only available on external triggering.

Remote command:

`[:SOURce<hw>] :BB:W3GPp:TRIGger [:EXTernal<ch>] :INHibit` on page 265

4.4.2 Marker Mode

The marker output signal for synchronizing external instruments is configured in the marker settings section "Marker Mode".



The R&S SMBV supports only two markers.

Marker Mode

Selects a marker signal for the associated [Marker] output.

- | | |
|-------------------------------------|---|
| "Slot" | A marker signal is generated at the start of each slot (every 2560 chips or 0.667 ms). |
| "Radio Frame" | A marker signal is generated at the start of each frame (every 38400 chips or 10 ms). |
| "Chip Sequence Period (ARB)" | A marker signal is generated at the start of every arbitrary waveform sequence (depending on the setting for the arbitrary waveform sequence length). If the signal does not contain an arbitrary waveform component, a radio frame trigger is generated. |
| "System Frame Number (SFN) Restart" | A marker signal is generated at the start of every SFN period (every 4096 frames). |

"ON/OFF Ratio" A regular marker signal that is defined by an on/off ratio is generated. A period lasts one on and off cycle.



Remote command:

`[:SOURCE<hw>] :BB:W3GPp:TRIGger:OUTPut<ch>:ONTime` on page 267

`[:SOURCE<hw>] :BB:W3GPp:TRIGger:OUTPut<ch>:OFFTime` on page 267

"User Period" A marker signal is generated at the beginning of every user-defined period. The period is defined in Period. This can be used, for instance, to generate a pulse at the start of each transport block (e.g. TTI 20 ms or 40 ms).

Remote command:

`[:SOURCE<hw>] :BB:W3GPp:TRIGger:OUTPut<ch>:PERiod` on page 267

Remote command:

`[:SOURCE<hw>] :BB:W3GPp:TRIGger:OUTPut<ch>:MODE` on page 266

4.4.3 Marker Delay

The delay of the signals on the [MARKER] outputs is set in the "Marker Delay" section. The R&S SMBV supports only two markers.

Marker x Delay

Enters the delay between the marker signal at the marker outputs and the start of the frame or slot.

The input is expressed as a number of symbols/samples. If the setting "Fix marker delay to dynamic range" is enabled, the setting range is restricted to the dynamic range. In this range, the delay of the marker signals can be set without restarting the marker and signal.

Remote command:

`[:SOURCE<hw>] :BB:W3GPp:TRIGger:OUTPut<ch>:DELay` on page 267

Current Range without Recalculation

Displays the dynamic range within which the delay of the marker signals can be set without restarting the marker and signal.

The delay can be defined by moving the setting mark.

Remote command:

`[:SOURCE<hw>] :BB:W3GPp:TRIGger:OUTPut<ch>:DELay:MAXimum?`
on page 268

`[:SOURCE<hw>] :BB:W3GPp:TRIGger:OUTPut<ch>:DELay:MINimum?`
on page 268

Fix marker delay to current range

Restricts the marker delay setting range to the dynamic range. In this range, the delay can be set without restarting the marker and signal.

Remote command:

[:SOURce<hw>] :BB:W3GPp:TRIGger:OUTPut:DELaY:FIXed on page 267

4.4.4 Clock Settings

The Clock Settings is used to set the clock source and a delay if necessary.

Sync. Mode

(for R&S SMBV only)

Selects the synchronization mode.

This parameter is used to enable generation of precise synchronous signal of several connected R&S SMBVs.

Note: If several instruments are connected, the connecting cables from the master instrument to the slave one and between each two consecutive slave instruments must have the same length and type.

Avoid unnecessary cable length and branching points.

"None" The instrument is working in standalone mode.

"Sync. Master" The instrument provides all connected instrument with its synchronization (including the trigger signal) and reference clock signal.



"Sync. Slave" The instrument receives the synchronization and reference clock signal from another instrument working in a master mode.

Remote command:

[:SOURce<hw>] :BB:W3GPp:CLOCK:SYNChronization:MODE on page 269

Set Synchronization Settings

(for R&S SMBV only)

Performs automatically adjustment of the instrument's settings required for the synchronization mode, selected with the parameter [Sync. Mode](#).

Remote command:

[:SOURce<hw>] :BB:W3GPp:CLOCK:SYNChronization:EXECute on page 269

Clock Source

Selects the clock source.

"Internal" The internal clock reference is used to generate the chip clock.

"External" The external clock reference is fed in as the chip clock or multiple thereof via the [Clock] connector.

The chip rate must be correctly set to accuracy of (2 % (see data sheet).

The polarity of the clock input can be changed with the aid of "Global Trigger/Clock Settings".

Remote command:

[:SOURce<hw>] :BB:W3GPp:CLOCK:SOURce on page 269

Clock Mode

Enters the type of externally supplied clock.

- "Chip" A chip clock is supplied via the [CLOCK] connector.
- "Multiple Chip" A multiple of the chip clock is supplied via the [CLOCK] connector; the chip clock is derived internally from this. The Multiplier window provided allows the multiplication factor to be entered.

Remote command:

`[:SOURCE<hw>] :BB:W3GPP:CLOCK:MODE` on page 268

Chip Clock Multiplier

Enters the multiplication factor for clock type multiple.

Remote command:

`[:SOURCE<hw>] :BB:W3GPP:CLOCK:MULTIPLIER` on page 268

Measured External Clock

Provided for permanent monitoring of the enabled and externally supplied clock signal.

Remote command:

`CLOCK:INPUT:FREQUENCY?`

4.4.5 Global Settings

This section provides access general trigger, clock and mapping settings.

Global Trigger/Clock Settings

Accesses the "Global Trigger/Clock/Input Settings" dialog.

This dialog is to set the trigger threshold, the input impedance and the polarity of the clock and trigger inputs.

The parameters in this dialog affect all digital modulations and standards, and are described in chapter "Global Trigger/Clock/Input Settings" in the operating manual.

4.5 Test Setups/Models

Access:

- ▶ Select "3GPP FFD > Basestation/User Equipment > Test Setup/Models"

The dialog offers various test models, depending on the selected transmission direction. The presetting is defined in the 3GPP standard TS 25.141.

Test Models Downlink

Access a list of test models in accordance with the 3GPP standard TS 25.141.

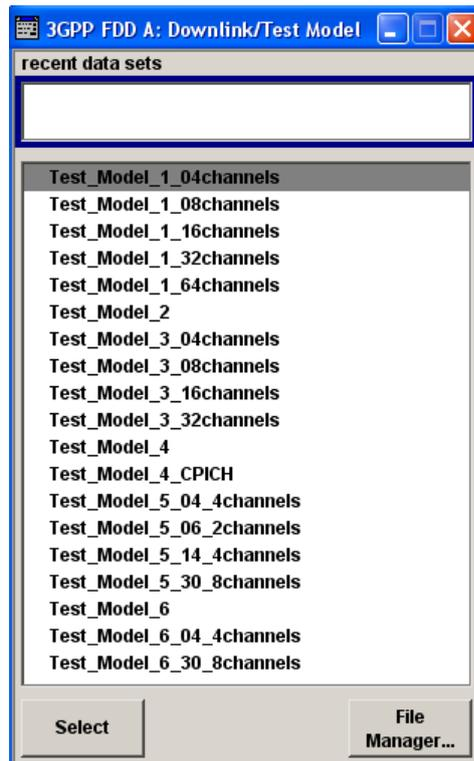

Selecting a test model for an active base station immediately generates the selected signal configuration.

The [Table 4-5](#) gives an overview of the available test models.

Table 4-5: Test Models Downlink

Test Model	Description
"Test Model 1 (4/8 channels)"	Test models for Home BS <ul style="list-style-type: none"> • Spectrum emission mask • ACLR • Spurious emissions • Transmit intermodulation • Modulation accuracy • Peak code domain error
"Test Model 1 (16/32/64 channels)"	<ul style="list-style-type: none"> • Spectrum emission mask • ACLR • Spurious emissions • Transmit intermodulation • Modulation accuracy • Peak code domain error
"Test Model 2"	Output power dynamics
"Test Model 3 (4/8 channels)"	Peak code domain error test models for Home BS
"Test Model 3 (16/32 channels)"	Peak code domain error
"Test Model 4"	Error Vector Magnitude, optional P-CPICH is not active
"Test Model 4 (CPICH)"	Error Vector Magnitude, optional P-CPICH is active.

Test Model	Description
"Test Model 5 (4 HS-PDSCH + 4 DPCH)"	Error Vector Magnitude test models for Home BS at base stations that support high-speed physical down-link shared channels with 16 QAM
"Test Model 5 (8 HS-PDSCH + 30 DPCH)" "Test Model 5 (4 HS-PDSCH + 14 DPCH)" "Test Model 5 (2 HS-PDSCH + 6 DPCH)"	Error Vector Magnitude at base stations that support high-speed physical down-link shared channels with 16 QAM
"Test Model 6_04_4channels"	Relative Code Domain Error test models for Home BS only applicable for 64QAM modulated codes.
"Test Model 6_30_8channels"	Relative Code Domain Error only applicable for 64QAM modulated codes.

Remote command:

[\[:SOURCE<hw>\]:BB:W3GPP:SETTING:TModel:BSTation:CATalog?](#)
on page 273

[\[:SOURCE<hw>\]:BB:W3GPP:SETTING:TModel:BSTation](#) on page 273

Test Models Uplink

Access the predefined test signals.

The 3GPP has not defined any test models for the Uplink transmission direction. This implementation however, provides a list of useful test signals and enables you to generate an uplink signal quickly.

This instrument generates the Uplink test models in the enhanced state of user equipment 1. An exception is the test models for the E-DPCCH and E-DPDCH, these channels are not calculated in real time. The sequence length is not changed.

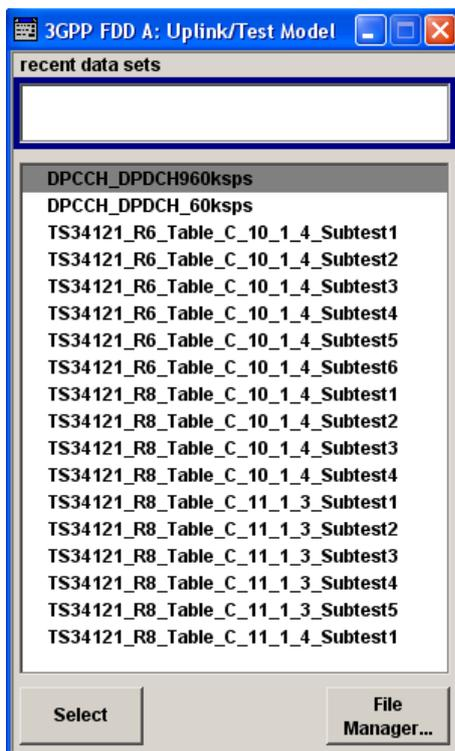

The following table lists some examples of configurations available for selection.

Table 4-6: Test Models Uplink

Test Model	Description
"DPCCH + DPDCH 60 kspS"	User equipment 1 is activated in DPCCH + DPDCH mode. 60 kspS is selected as the overall symbol rate. All the other settings correspond to the preset setting.
"DPCCH + DPDCH 960 kspS"	User equipment 1 is activated in DPCCH + DPDCH mode. 960 kspS is selected as the overall symbol rate. All the other settings correspond to the preset setting.
"TS34121_R6_Table_C_10_1_4_Subset1 .. 6"	Uplink test model according to 3GPP TS 34.121 Release 6, Table C.10.1.4.
"TS34121_R8_Table_C_10_1_4_Subset1 .. 4"	Uplink test models for transmitter characteristics tests with HS-DPCCH according to 3GPP TS 34.121 Release 8, Table C.10.1.4.
"TS34121_R8_Table_C_11_1_3_Subset1 .. 5"	Uplink test models for transmitter characteristics tests with HS-DPCCH and E-DCH according to 3GPP TS 34.121 Release 8, Table C.11.1.3.
"TS34121_R8_Table_C_11_1_4_Subset1"	Uplink test model for transmitter characteristics tests with HS-DPCCH and E-DCH with 16QAM according to 3GPP TS 34.121 Release 8, Table C.11.1.4.

Remote command:

`[:SOURCE<hw>] :BB:W3GPp:SETTING:TMODeL:MSTation:CATalog?`

on page 274

`[:SOURCE<hw>] :BB:W3GPp:SETTING:TMODeL:MSTation` on page 274

4.6 Predefined Settings - Downlink

With the "Predefined Settings" function, it is possible to create highly complex scenarios with just a few modifications. This function is of use if, say, just the envelope of the signal is of interest.

Access:

1. Select "3GPP FDD > Link Direction > Downlink".
2. Select "Basestation > Predefined Settings".

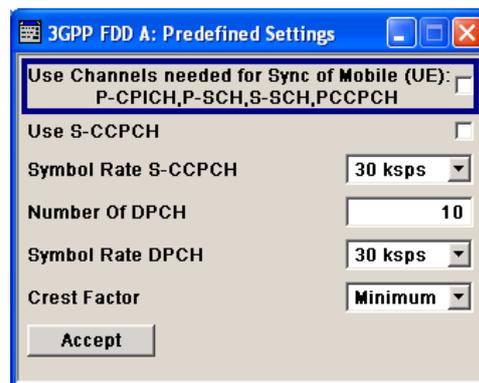

The channel table of base station 1 is filled (preset) with the set parameters. The sequence length of the generated signal is 1 frame.

Use Channels

Selects whether P-CPICH, P-SCH, S-SCH and PCCPCH are used in the scenario or not. These "special channels" are required by user equipment for synchronization.

Remote command:

[\[:SOURCE<hw>\]:BB:W3GPP:PPARAMETER:SCHANNELS](#) on page 273

Use S-CCPCH

Selects if S-CCPCH is used in the scenario or not.

Remote command:

[\[:SOURCE<hw>\]:BB:W3GPP:PPARAMETER:SCCPCH:STATE](#) on page 273

Symbol Rate S-CCPCH

Sets the symbol rate of S-CCPCH.

Remote command:

[\[:SOURCE<hw>\]:BB:W3GPP:PPARAMETER:SCCPCH:SRATE](#) on page 272

Number of DPCH

Sets the number of activated DPCHs.

The maximum number is the ratio of the chip rate and the symbol rate (maximum 512 at the lowest symbol rate of 7.5 ksps).

Remote command:

[\[:SOURCE<hw>\]:BB:W3GPP:PPARAMETER:DPCH:COUNT](#) on page 271

Symbol Rate DPCH

Sets the symbol rate of all DPCHs.

Remote command:

[:SOURCE<hw>] :BB:W3GPP:PPARameter:DPCH:SRATe on page 272

Crest Factor

Selects desired range for the crest factor of the test scenario. The crest factor of the signal is kept in the desired range by automatically setting appropriate channelization codes and timing offsets.

"Minimum"	The crest factor is minimized. The channelization codes are distributed uniformly over the code domain. The timing offsets are increased by 3 per channel.
"Average"	An average crest factor is set. The channelization codes are distributed uniformly over the code domain. The timing offsets are all set to 0.
"Worst"	The crest factor is set to an unfavorable value (i.e. maximum). The channelization codes are assigned in ascending order. The timing offsets are all set to 0.

Remote command:

[:SOURCE<hw>] :BB:W3GPP:PPARameter:CRESt on page 271

Accept

Presets the channel table of basestation 1 with the parameters defined in the Predefined Settings menu. Scrambling Code 0 is automatically selected (as defined in the 3GPP test models).

Remote command:

[:SOURCE<hw>] :BB:W3GPP:PPARameter:EXECute on page 272

4.7 Additional User Equipment - Uplink

Access:

1. Select "3GPP FDD > Link Direction > Uplink".
2. In the "User Equipment" tab , select "Additional User Equipment".

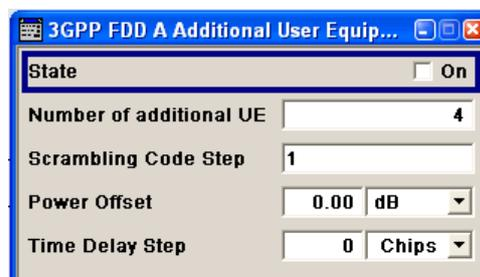

The dialog allows you to simulate up to 128 additional user equipment and thus to generate a signal that corresponds to the received signal for a base station with high capacity utilization.

The fourth user equipment (UE4) serves as a template for all other stations.

The following parameters are the only ones modified for the additional user equipment:

- Scrambling code (different for all stations)
- Power (different to UE4, but identical among themselves)

State

Enables/disables all additional user equipment.

Remote command:

`[:SOURCE<hw>] :BB:W3GPp:MSTation:ADDITIONAL:STATE` on page 344

Number of Additional UE

Sets the amount of additional user equipment. As many as 128 additional user equipment can be simulated.

Remote command:

`[:SOURCE<hw>] :BB:W3GPp:MSTation:ADDITIONAL:COUNT` on page 343

Scrambling Code Step

Enters the step width for increasing the scrambling code of the additional user equipment. The start value is the scrambling code of UE4.

Remote command:

`[:SOURCE<hw>] :BB:W3GPp:MSTation:ADDITIONAL:SCODE:STEP` on page 344

Power Offset

Sets the power offset of the active channels of the additional user equipment to the power outputs of the active channels of UE4.

The resultant power must fall within the range 0 dB to - 80 dB. If the value is above or below this range, it is limited automatically.

Remote command:

`[:SOURCE<hw>] :BB:W3GPp:MSTation:ADDITIONAL:POWER:OFFSET`
on page 344

Time Delay Step

Enters the step width for the time delay of the additional user equipment to one another. The start value returns the time delay of UE4. Entry is made in chips and can be a maximum of one frame.

The time delay allows user equipment to be simulated even if the arrival of their signals is not synchronized at the base station.

Remote command:

`[:SOURCE<hw>] :BB:W3GPp:MSTation:ADDITIONAL:TDELAY:STEP` on page 344

4.8 Base Station Settings

Base stations can be configured independently of one another. Base station 1 (BS1) also includes enhanced channels (Enhanced Channels, Realtime).

Access:

1. Select "3GPP FDD > Link Direction > Downlink / Forward".
2. Select "Base Station > BS 1/2/3/4".

	Channel Type	Enh / HSDPA Settings	Slot Fmt	Symb Rate /kps	Ch Code	Power /dB	Data	DList / Pattern	T Offs	DPCCH Settings	State	Dom Conf
6	PICH			15	0	0.00	PN 9		0		Off	
7	AICH			15	0	0.00				Config...	Off	
8	AP-AICH			15	0	0.00				Config...	Off	
9	PDSCH		0	15	0	0.00	PN 9				Off	
10	DL-DPCCH		0	7.5	0	0.00				Config...	Off	
11	DPCH	Config...	8	30	0	0.00	PN 9		0	Config...	Off	
12	HS-SCCH	Config...		30	5	-10.00	H-Set				On	
13	HS-PDS.QPSK			240	8	-20.00	PN 9				On	
14	HS-PDS.QPSK			240	9	-20.00	PN 9				On	
15	HS-PDS.QPSK			240	10	-20.00	PN 9				On	
16	HS-PDS.QPSK			240	11	-20.00	PN 9				On	
17	HS-PDS.QPSK			240	12	-20.00	PN 9				On	
18	DPCH		8	30	0	0.00	PN 9		0	Config...	Off	
19	DPCH		8	30	0	0.00	PN 9		0	Config...	Off	
20	DPCH		8	30	0	0.00	PN 9		0	Config...	Off	
21	DPCH		8	30	0	0.00	PN 9		0	Config...	Off	
22	DPCH		8	30	0	0.00	PN 9		0	Config...	Off	
23	DPCH (OCNS)		10	30	4	0.00	PN 9		0	Config...	On	
24	DPCH (OCNS)		10	30	5	-2.00	PN 9		0	Config...	On	
25	DPCH (OCNS)		10	30	6	-4.00	PN 9		0	Config...	On	
26	DPCH (OCNS)		10	30	7	-1.00	PN 9		0	Config...	On	

The dialog comprises the following sections:

- "Common Settings" section, in which the general parameters of the base station are set
- A row containing the buttons "Multichannel Assistant", "Code Domain" and "Channel Graph", which call the appropriate submenus graphics
- The channel table with graphical display of the structure of the channel being edited.

4.8.1 Common Settings

The following general parameters of the base station are provided:

State

Activates or deactivates the selected base station.

Remote command:

`[:SOURCE<hw>] :BB:W3GPp:BSTation<st>:STATE` on page 321

2nd Search Code Group

Displays the second search code group.

This parameter is specified in the table defined by the 3GPP standard. This table assigns a specific spreading code to the synchronization code symbol for every slot in the frame. The value is calculated from the scrambling code.

Remote command:

`[:SOURCE<hw>] :BB:W3GPp:BSTation<st>:SSCG?` on page 321

Scrambling Code On

Activates the scrambling code, selected with the parameter [Scrambling Code \(hex\)](#).

The scrambling code can be deactivated for test purposes.

Remote command:

`[:SOURCE<hw>] :BB:W3GPp:BSTation<st>:SCODE:STATE` on page 320

Scrambling Code (hex)

Sets the scrambling code and thus the base station identification.

This value is also the initial value of the scrambling code generator, see [Chapter 3.3.1, "Scrambling Code Generator"](#), on page 19.

To activate the scrambling code, set the check box to [On](#).

Remote command:

`[:SOURCE<hw>] :BB:W3GPp:BSTation<st>:SCODE` on page 320

Page Indicators/Frame

Enters the number of page indicators (PI) per frame in the page indicator channel (PICH).

Remote command:

`[:SOURCE<hw>] :BB:W3GPp:BSTation<st>:PINDicator:COUNT` on page 320

Time Delay

For basestation BS2/3/4, sets the time delay of the signal of the selected base station compared to the signal of base station 1.

Remote command:

`[:SOURCE<hw>] :BB:W3GPp:BSTation<st>:TDELay` on page 321

Diversity / MIMO

Selects the antenna and the antenna configuration to be simulated.

The R&S SMBV supports two antenna configurations: a single-antenna system and a two-antenna system. Thus, an instrument equipped with two paths can simulate simultaneously the signals of both antennas of one two-antenna system. Moreover, for this two-antenna system, transmit diversity can be additionally activated or deactivated.

To simulate transmit diversity, a two-antenna system has to be selected and "Open Loop Transmit Diversity" has to be activated.

To configure HS-PDSCH MIMO channels, a two-antenna system has to be selected.

"Single Antenna"

The signal of single-antenna system is calculated and applied.

"Antenna 1 of 2"

Calculates and applies the output signal for antenna 1 of a two-antenna system.

"Antenna 2 of 2"

Calculates and applies the output signal for antenna 2 of a two-antenna system.

Remote command:

`[:SOURce<hw>] :BB:W3GPP:BSTation<st>:TDIVersity` on page 322

S-CPICH As Phase Reference

Activates or deactivates the use of S-CPICH as reference phase.

If activated the phase of S-CPICH and the phase of all DPCHs is 180 degrees offset from the phase of P-CPICH.

Remote command:

`[:SOURce<hw>] :BB:W3GPP:BSTation<st>:SCPich:PREference [:STATe]`
on page 320

Open Loop Transmit Diversity

(Enabled for two-antenna system only)

Activates/deactivates open loop transmit diversity. The antenna whose signal is to be simulated is selected with the parameter "Diversity/MIMO".

Various forms of transmit diversity are described in the 3GPP standard. Different coding is used to divide the signal between the two antennas. As a result, the receiver can decode the traffic signal from the two input signals and is less liable to fading and other interferences.

A fixed diversity scheme is assigned to each channel type:

- TSTD (time switched transmit diversity for SCH) for P-SCH, S-SCH
- STTD (space time block coding transmit antenna diversity) for all other channels, except HS-PDSCH MIMO.

The HS-PDSCH MIMO channels are precoded as described in [Chapter 3.3.14, "MIMO in HSPA+"](#), on page 33.

These two schemes are described in detail in TS 25.211.

Remote command:

`[:SOURce<hw>] :BB:W3GPP:BSTation<st>:TDIVersity` on page 322

`[:SOURce<hw>] :BB:W3GPP:BSTation<st>:OLTDiversity` on page 319

Compressed Mode State

Activates compressed mode.

The compressed mode is configured in [Chapter 4.9, "Compressed Mode"](#), on page 85.

To access the dialog, use the "Compressed Mode" button.

Remote command:

`[:SOURce<hw>] :BB:W3GPp:BSTation<st>:CMODE:STATe` on page 318

`[:SOURce<hw>] :BB:W3GPp:MSTation<st>:CMODE:STATe` on page 349

Compressed Mode...

(This feature is enabled for BS 2...4 only.)

Calls the menu for configuring the compressed mode, see [Chapter 4.9, "Compressed Mode"](#), on page 85.

Remote command:

n.a.

Reset All Channels

Calls the default settings for the channel table.

Remote command:

`[:SOURce<hw>] :BB:W3GPp:BSTation<st>:CHANnel:PRESet` on page 277

Preset HSDPA H-Set

(This feature is available for BS 1 only.)

Calls the default settings of the channel table for the HSDPA H-Set mode.

Channels 12 to 17 are preset for HSDPA H-Set 1.

Remote command:

`[:SOURce<hw>] :BB:W3GPp:BSTation<st>:CHANnel:HSDPa:HSET:PRESet`
on page 276

Multi Channel Assistant

Accesses a dialog for configuring several DPCH channels simultaneously, see [Chapter 4.23, "Multi Channel Assistant - BS"](#), on page 144.

Remote command:

n.a.

Code Domain...

Accesses a graphical display of the assigned code domain, see [Chapter 4.10, "Code Domain Graph - BS"](#), on page 91.

Remote command:

n.a.

Channel Graph...

Access a channel graph display to check the configured signal visually, see [Chapter 4.11, "Channel Graph - BS"](#), on page 93.

Remote command:

n.a.

4.8.2 Channel Table

The channel table allows you to configure the individual channel parameters. The structure of the currently selected channel is displayed graphically in the table header.

TFCI 8		Data 296										Pilot 16	
	Channel Type	Enhanced/HSDPA Settings	Slot Fmt	Symb Rate /ksp	Ch Code	Power /dB	Data	DLList / Pattern	T Offs	DPCCH Settings	State	Do Conf	
0	P-CPICH	Config...		15	0	0.00					Off		
1	S-CPICH			15	0	0.00					Off		
2	P-SCH			15		0.00					Off		
3	S-SCH			15		0.00					Off		
4	P-CCPCH	Config...		15	1	0.00	PN 9				Off		
5	S-CCPCH		13	240	0	0.00	PN 9		10	Config...	On		
6	PICH			15	16	0.00	PN 9		0		On		
7	AICH			15	0	0.00				Config...	Off		
8	AP-AICH			15	0	0.00				Config...	Off		
9	PDSCH		0	15	0	0.00	PN 9			Config...	Off		
10	DL-DPCCH		0	7.5	0	0.00				Config...	Off		
11	HS-PDS.MIMO	Config...		240	2	0.00	PN 9				On		
12	HS-SCCH	Config...		30	9	0.00	H-Set				On		
13	HS-PDS.QPSK			240	3	0.00	PN 9				On		
14	HS-PDS.QPSK			240	4	0.00	PN 9				On		
15	HS-PDS.QPSK			240	5	0.00	PN 9				On		
16	HS-PDS.QPSK			240	6	0.00	PN 9				On		
17	HS-PDS.QPSK			240	7	0.00	PN 9				On		

The "Channel table" is located in the lower part of the menu.

139 channels are available for each base station. Channels 0 to 10 are assigned to the special channels, with the allocation of channels 0 to 8 being fixed. Channels 9 and 10 can be assigned a PDSCH, a DL-DPCCH, an HS-SCCH, an E-AGCH, an E-RGCH, or an E-HICH.

Code channels 11 to 138 can be assigned a DPCH, an HS-SCCH, an HS-PDSCH (QPSK/16QAM/64QAM), an HS-PDSCH (MIMO), an E-AGCH, an E-RGCH, an E-HICH, or an F-DPCH. This makes it possible to simulate the signal of a base station that supports high-speed channels. See also [Table A-1](#)

Channels 4 and 11 to 13 of base station 1 can be generated in realtime (enhanced channels) and are highlighted in color. User-definable channel coding can be activated for these channels. Bit and block errors can be simulated. Data can be added to the data and TPC fields from data lists either at the physical level or in the transport layer.

At the physical level, a downlink DPCH consists of the DPDCH (Dedicated Physical Data Channel) and the DPCCH (Dedicated Physical Control Channel). The channel characteristics are defined by the symbol rate. The DPDCH transports the user data that is fed directly into the data field.

The DPCCH transports the control fields, i.e. TFCI (Transport Format Combination Indicator), TPC (Transmit Power Control) and Pilot field. DPDCH is grouped with DPCCH using time division multiplexing in accordance with 3GPP TS 25.211 (see [Figure 4-3](#)). The formation of a downlink reference measurement channel is described in [Chapter 4.16, "Enhanced Settings for DPCHs - BS1"](#), on page 116.

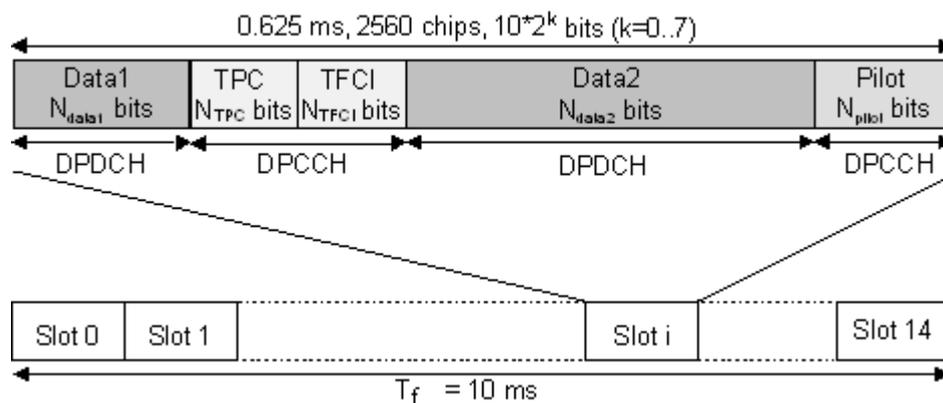

Figure 4-3: Structure of a downlink DPCH in the time domain

Channel Number

Displays the consecutive channel numbers from 0 to 138.

All the rows are always displayed, even if the channels are inactive. They are switched on and off by the "On/Off" button in the "State" column.

Remote command:

n.a.

(selected via the suffix to the keyword :CHANnel<n>)

Channel Type

Selects channel type.

The channel type is fixed for channel numbers 0...8; for the remaining channel numbers, the choice lays between the relevant standard channels and the high-speed channels.

The first 11 channels are reserved for special channels.

Remote command:

[:SOURCE<hw>] :BB:W3GPp:BSTation<st>:CHANnel<ch0>:TYPE on page 309

Enhanced Settings / HSDPA Settings

(Enhanced Settings are available for BS1 only.)

Accesses the dialog for configuring the enhanced channels of BS1 or the dialog for configuring the high-speed channels for all base stations.

- **Enhanced Settings**

The channel state, "Enhanced On/Off", is displayed in different colors.

Enhanced channels are generated in real time. Channel coding in accordance with the 'Reference Measurement Channels' definition in TS 25.101, TS 25.104 and TS 25.141 can be activated. Any other user-defined coding can also be configured and stored.

If data lists are used as the data sources for data fields and TPC fields, it is possible to load external data. You can load, for example:

- User information from a higher layer
- TPC lists and use them to generate longer, non-repetitive power profiles

- Data lists with artificial bit errors or block errors to the CRC checksum to test the BER/BLER testers that are integrated in the BS.

The enhanced settings dialog is different for the P-CCPCH and the DPCHs (see [Chapter 4.16, "Enhanced Settings for DPCHs - BS1"](#), on page 116 and [Chapter 4.15, "Enhanced Settings for P-CCPCH - BS1"](#), on page 114).

- **HSDPA Settings**

The available settings and indications of the HSDPA settings dialog depend on the selected high-speed channel type HS-SCCH, HS-PDSCH (QPSK), HS-PDSCH (QAM) or HS-PDSCH (MIMO).

See [Chapter 4.12, "HSDPA Settings - BS"](#), on page 94.

Remote command:

n.a.

Slot Format

Enters the slot formats for the selected channel.

The range of values depends on the channel selected. For DPCH channels, for example, the slot formats are 0 to 16.

For F-DPCH channels, the slot formats 1 to 9 are enabled only for instruments equipped with additional option R&S SMBV-K59. The difference between the F-DPCH slot formats is the position of the 2 bits TPC field.

A slot format defines the complete structure of a slot made of data and control fields and includes the symbol rate.

Parameters set via the slot format can subsequently be changed individually.

The structure of the channel currently selected is displayed in a graphic above the channel table (slot structure).

Remote command:

`[:SOURCE<hw>] :BB:W3GPP:BSTation<st>:CHANnel<ch0>:SFORmat`
on page 308

Symbol Rate

Sets the symbol rate of the selected channel. The range of values depends on the channel selected.

A change in the symbol rate can lead to a change in the slot format and vice versa.

Remote command:

`[:SOURCE<hw>] :BB:W3GPP:BSTation<st>:CHANnel<ch0>:SRATE` on page 308

Channelization Code

Enters the channelization code (formerly the spreading code number).

The code channel is spread with the set channelization code (spreading code). The range of values of the channelization code depends on the symbol rate of the channel.

The standard assigns a fixed channelization code to some channels (P-CPICH, for example, always uses channelization code 0).

The range of values runs from 0 to $((\text{Chip Rate}/\text{Symbol Rate}) - 1)$, where the Chip Rate is 3.84Mcps.

Remote command:

[:SOURce<hw>] :BB:W3GPp:BSTation<st>:CHANnel<ch0>:CCODE on page 278

Power

Sets the channel power in dB.

The power entered is relative to the powers of the other channels. If "3GPP > Adjust Total Power to 0 dB" is executed, all the power data is relative to 0 dB.

The set "Power" value is also the start power of the channel for "Misuse TPC", "Dynamic Power Control" and the power control sequence simulation of the OCNS mode 3i channels.

Note: The maximum channel power of 0 dB applies to non-blanked channels (duty cycle 100%).

With blanked channels, the maximum value can be increased to values greater than 0 dB. Where the maximum value is calculated as:

$$10 * \log_{10} 1 / \text{duty_cycle}$$

Remote command:

[:SOURce<hw>] :BB:W3GPp:BSTation<st>:CHANnel<ch0>:POWer on page 307

Data

Selects data source.

The following standard data sources are available:

- "All 0, All 1"
An internally generated sequence containing 0 data or 1 data.
- "PNxx"
An internally generated pseudo-random noise sequence.
- "Pattern"
An internally generated sequence according to a bit pattern.
Use the "Pattern" box to define the bit pattern.
- "Data List/Select DList"
A binary data from a data list, internally or externally generated.
Select "Select DList" to access the standard "Select List" dialog.
 - Select the "Select Data List > navigate to the list file *.dm_iqd > Select" to select an existing data list.
 - Use the "New" and "Edit" functions to create internally new data list or to edit an existing one.
 - Use the standard "File Manager" function to transfer external data lists to the instrument.

See also "Main Dialog > Data List Management".

Remote command:

[:SOURce<hw>] :BB:W3GPp:BSTation<st>:CHANnel<ch0>:DATA on page 279

[:SOURce<hw>] :BB:W3GPp:BSTation<st>:CHANnel<ch0>:DATA:PATtern
on page 280

[:SOURce<hw>] :BB:W3GPp:BSTation<st>:CHANnel<ch0>:DATA:DSElect
on page 279

Data Config

(This feature is available for BS1 with active channel coding only.)

Accesses a dialog for configuring the data sources of subchannels in the transport layer, see [Chapter 4.16, "Enhanced Settings for DPCHs - BS1"](#), on page 116.

Remote command:

n.a.

Timing Offset

Sets the timing offset (T_{Offset}).

The timing offset determines the shift of the source symbols before interleaving.

The absolute starting time of the frame (slot 0) is shifted relative to the start of the scrambling code sequence by the `timing offset * 256 chips`. This means that whatever the symbol rate, the resolution of the timing offset is always 256 chips.

This procedure is used to reduce the crest factor. To obtain a lower crest factor, for example, a good offset from channel to channel is 1. For example, for DPCH11 a timing offset 0, for DPCH12 a timing offset 1, for DPCH13 a timing offset 2.

The illustration below shows the effect of the timing offset parameter. For various scenarios, the scrambling code sequence is shown in time relation to the data slots and to a reference time t_0 . The reference time t_0 is the starting time from that the signal is calculated in the instrument.

- Timing offset is not used ($T_{\text{Offset}} = 0$).
The beginning of the frame (slot 0) and the beginning of the scrambling code period are synchronous with starting point t_0 .
- Timing offset is used ($T_{\text{Offset}} > 0$).
The absolute starting time of the frames (slot 0) is shifted relative to the reference time t_0 by $T_{\text{Offset}} * 256$ chips. The beginning of the scrambling code sequence is still synchronous with reference time t_0 . The beginning of the scrambling code period and the frame (slot 0) are no longer synchronous.

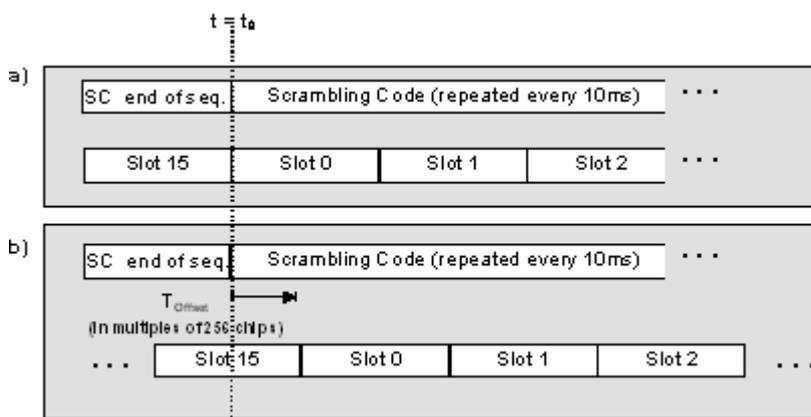

Remote command:

`[:SOURCE<hw>] :BB:W3Gpp:BSTation<st>:CHANnel<ch0>:TOFFset`
on page 309

DPCCH Settings

Access a dialog for configuring the control fields of the selected channel, see [Chapter 4.19, "DPCCH Settings - BS Channel Table"](#), on page 132

The selected slot format predetermines the setting of the control fields. So a change is also made to the control fields by changing the slot format and vice versa.

Remote command:

n.a.

Channel State

Activates or deactivates the channel.

Remote command:

`[:SOURce<hw>] :BB:W3GPP:BSTation<st>:CHANnel<ch0>:STATe` on page 309

Domain Conflict, Resolving Domain Conflicts

Displays whether the channel has a code domain conflict with one of the channels lying above it (with a lower channel number). A special symbol marks a conflict and the column is colored soft orange. If there is no conflict, the column is colored soft blue.

The instrument helps you to resolve code domain conflicts by automatically adapting the channelization code of the channels involved.

To access the required function, in the "3GPP FDD > Base station > Channel Table" select the conflict symbol and trigger "Resolve Domain Conflicts".



Tip: Use the "Code Domain" to visualize the graphical display of code domain assignment by all the active code channels (see [Chapter 4.10, "Code Domain Graph - BS"](#), on page 91).

Refer to [Chapter 5, "How to Work with the 3GPP FDD Option"](#), on page 240 for step-by-step description.

Remote command:

`[:SOURce<hw>] :BB:W3GPP:BSTation<st>:DCONflict [:STATe] ?` on page 319

`[:SOURce<hw>] :BB:W3GPP:BSTation<st>:DCONflict:RESolve` on page 318

4.9 Compressed Mode

(This feature is available for BS 2...4 and UE 2...4 only.)

To enable handover of a mobile station from a 3GPP FDD base station/user equipment to another base station/user equipment, (3GPP FDD, 3GPP TDD, GSM or E-UTRA) at a different frequency, transmission and reception of the 3GPP FDD signal must be interrupted for a short time. During this time, the mobile station changes to the frequency of the new base station, for example to measure the receive level of this station or read system information.

To transmit a consistently high data volume also in the remaining (shorter) period of time, the data is compressed. This can be done by halving the spreading factor (SF/2 method) or reducing error protection (puncturing method). In both cases, transmit power in the ranges concerned is increased to maintain adequate signal quality.

Apart from these two methods, there is also the method of "higher layer scheduling". With this method, transmission of the data stream is stopped during the transmission gap. This method is suitable for packet-oriented services; it involves no power increase (power offset) in the active ranges.

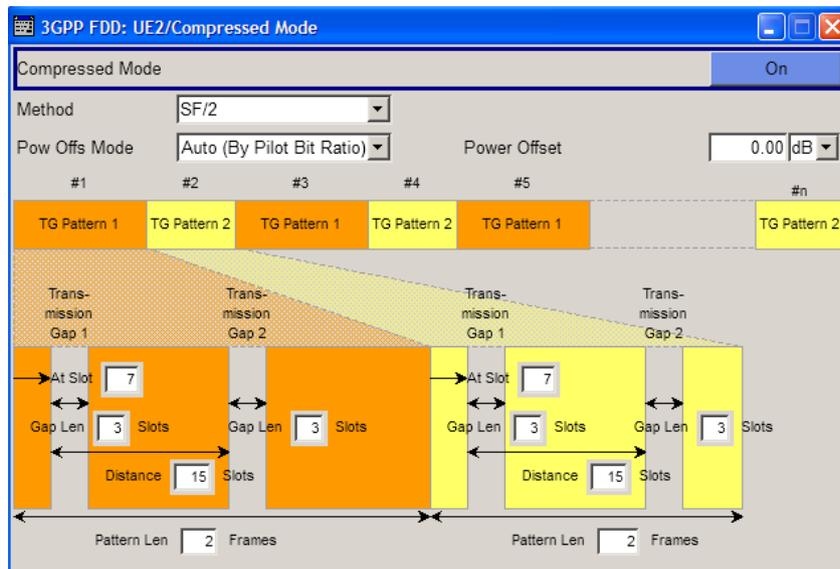
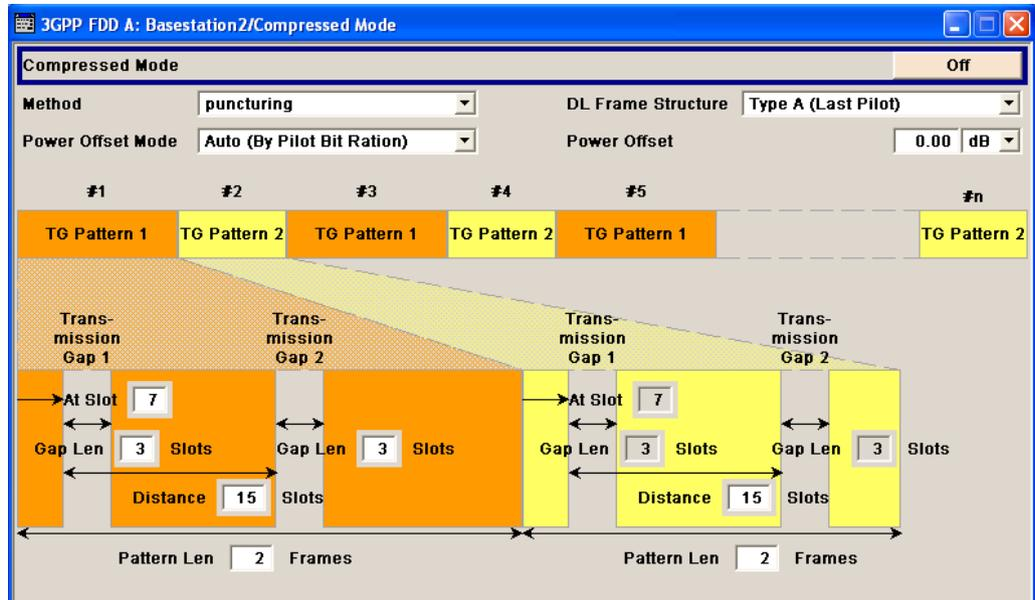

4.9.1 Compressed Mode General Settings

Compressed Mode State

Activates compressed mode.

The compressed mode is configured in [Chapter 4.9, "Compressed Mode"](#), on page 85.

To access the dialog, use the "Compressed Mode" button.

Remote command:

`[:SOURCE<hw>] :BB:W3GPp:BSTation<st>:CMODE:STATE` on page 318

`[:SOURCE<hw>] :BB:W3GPp:MSTation<st>:CMODE:STATE` on page 349

Compressed Mode Method - UE

Selects compressed mode method.

"Higher layer scheduling" The data is compressed by stopping the transmission of the data stream during the transmission gap.

"SF/2" The data is compressed by halving the spreading factor.

Remote command:

`[:SOURCE<hw>] :BB:W3GPp:MSTation<st>:CMODE:METHod` on page 348

Compressed Mode Method - BS

Selects compressed mode method.

"Puncturing" The data is compressed by reducing error protection.

"Higher layer scheduling" The data is compressed by stopping the transmission of the data stream during the transmission gap.

"SF/2" The data is compressed by halving the spreading factor. This method can be demonstrated in the code domain graph. The graph is split into two windows. The upper window shows the code domain assignment with non-compressed slots, the lower window with compressed slots. It can be recognized clearly that the DPCH bars in the lower window are wider, which is due to the reduction of the spreading factor of these channels. The other channels (e.g. CPICH) have the same width in both halves.

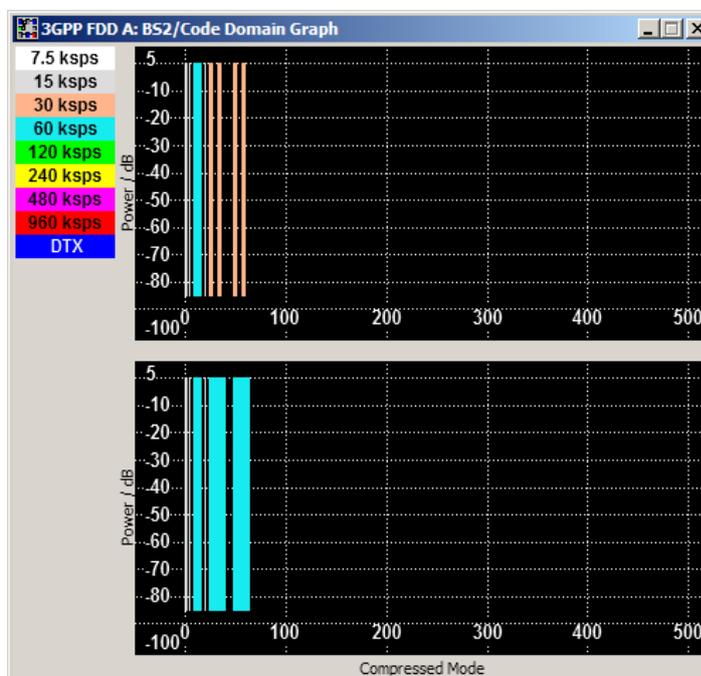

Remote command:

`[:SOURCE<hw>] :BB:W3GPp:BSTation<st>:CMODE:METHod` on page 316

DL Frame Structure - BS

Selects frame structure. The frame structure determines the transmission of TPC and pilot field in the transmission gaps.

For 3GPP FDD radio communication to operate, the mobile station receiver requires information in the pilot field for synchronization and channel estimation and in the power control field TPC for control of the mobile station transmit power.

To keep the period during which no channel estimation takes place as short as possible, the pilot is sent in the last slot of each transmission gap.



Optionally, the first TPC field of the transmission gap can be sent in addition.



"Type A (Last Pilot)" The pilot field is sent in the last slot of each transmission gap.

"Type B (First TPC, Last Pilot)" The pilot field is sent in the last slot of each transmission gap. The first TPC field of the transmission gap is sent in addition.

Remote command:

[\[:SOURCE<hw>\]:BB:W3GPP:BSTation<st>:CMODE:DLFStructure](#) on page 315

Power Offset Mode

Selects power offset mode.

The compressed slots can be sent with a power offset, i.e. at an increased power level.

"Auto (By Pilot Bit Ratio)" The power offset is obtained as the relation between the Number of pilots bits of non-compressed slots and the Number of pilot bits by compressed slots.

"User" The power offset is defined manually. The value is input in entry field Power offset.

Remote command:

[\[:SOURCE<hw>\]:BB:W3GPP:BSTation<st>|MSTation<st>:CMODE:POMode](#) on page 318

Power Offset

Defines power offset. The entered value is only valid for "Power Offset Mode User".

Remote command:

[\[:SOURCE<hw>\]:BB:W3GPP:BSTation<st>|MSTation<st>:CMODE:POFFset](#) on page 317

4.9.2 Compressed Mode Configuration Graph

The remaining parameters of the compressed mode are set in the configuration graph. The graph displays the distribution of transmission gaps in a compressed mode signal.

The signal generated can be divided into three subranges.

4.9.2.1 Transmission Gaps

A transmission gap has a maximum length of 14 slots. Since at least eight active slots must be sent per frame, gaps comprising seven slots and more have to be distributed over two neighboring frames.

The transmitted signal consists of max. two patterns that are sent alternately. Each pattern comprises two transmission gaps.

The graph includes all parameters necessary to define the transmission gaps in the signal.



The settings in the graph are also valid for the compressed mode graph of the user equipment with the same number. For example, setting a distance of 9 slots for base station 4 also sets the distance to 9 slots for user equipment 4.

The parameters below are interrelated in many ways. For example, the transmission gap distance must be selected so that no frame contains more than one gap. In the event of an invalid entry, the next valid value is automatically set. If the entry is valid but changes the valid range for another parameter, the setting of the parameter is adapted.

At Slot:

Transmission gap slot number.

Remote command:

```
[ :SOURCE<hw> ] :BB:W3GPp:BSTation<st>:CMODE:Pattern<ch>:TGSN  
on page 317
```

```
[ :SOURCE<hw> ] :BB:W3GPp:MSTation<st>:CMODE:Pattern<ch>:TGSN  
on page 349
```

Gap Len:

Transmission gap lengths.

Remote command:

```
[ :SOURCE<hw> ] :BB:W3GPp:BSTation<st>:CMODE:Pattern<ch>:TGL<di>  
on page 316
```

```
[ :SOURCE<hw> ] :BB:W3GPp:MSTation<st>:CMODE:Pattern<ch>:TGL<di>  
on page 348
```

Distance

Transmission gap distance.

Remote command:

```
[ :SOURCE<hw> ] :BB:W3GPp:BSTation<st>:CMODE:PATtern<ch>:TGD
```

on page 316

```
[ :SOURCE<hw> ] :BB:W3GPp:MSTation<st>:CMODE:PATtern<ch>:TGD
```

on page 348

Pattern Len:

Transmission gap pattern length. The input range is 1 ... 100 frames for pattern 1 and 0 ... 100 frames for pattern 2. Thus, it is possible to configure transmission gap pattern with only one pattern.

Remote command:

```
[ :SOURCE<hw> ] :BB:W3GPp:BSTation<st>:CMODE:PATtern<ch>:TGPL
```

on page 317

```
[ :SOURCE<hw> ] :BB:W3GPp:MSTation<st>:CMODE:PATtern<ch>:TGPL
```

on page 349

4.9.2.2 Compressed Ranges

All slots of a frame that are not blanked are compressed. If the transmission gap is transmitted within one frame (single-frame method), an envelope as shown by the diagram on [Figure 4-4](#) is obtained:

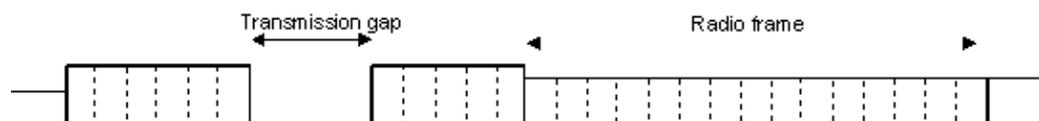

Figure 4-4: Envelope of compressed mode signal with single-frame method

If the transmission gap is distributed over two neighboring frames, all slots of the two frames that are not blanked are compressed (see [Figure 4-5](#)):



Figure 4-5: Envelope of compressed mode signal with double-frame method

A different slot format, usually with a higher number of pilot bits, is used in the compressed ranges.

The transmit power can be increased ("Power Offset Mode") automatically or manually by defining a power offset.

4.9.2.3 Non-compressed ranges

Frames containing no transmission gaps are sent with the same slot format and the same power as in the non-compressed mode.

4.10 Code Domain Graph - BS

The channelization codes are taken from a code tree of hierarchical structure (see [Figure 4-6](#)).

The higher the spreading factor, the smaller the symbol rate and vice versa. The product of the spreading factor and symbol rate is constant and always yields the chip rate.

The outer branches of the tree (right-most position in the figure) indicate the channelization codes for the smallest symbol rate (and thus the highest spreading factor). Channelization codes with smaller spreading factor are contained in the codes with larger spreading factor in the same code branch. When using such competitive channelization codes at the same time, the signals of associated code channels are mixed such that they can no longer be separated in the receiver. Orthogonality is then lost.

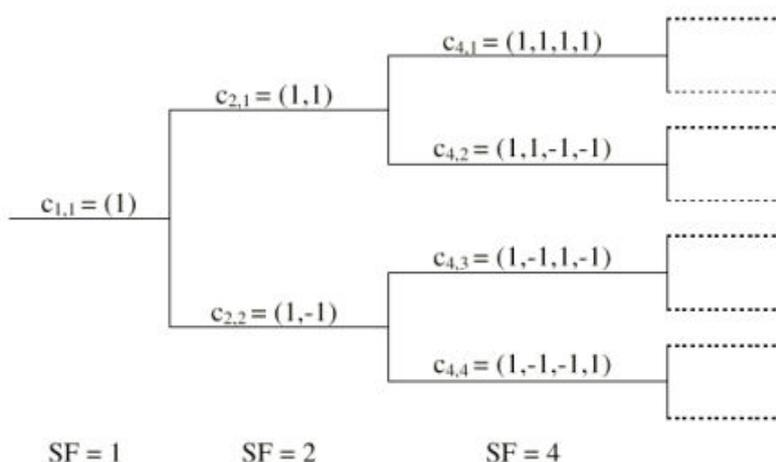

Figure 4-6: Code tree of channelization codes

Example:

If code $c_{2,1}$ is being used, the remaining branch with $c_{4,1}$ and $c_{4,2}$ is blocked.

The domain of a certain channelization code is the outer branch range (with minimum symbol rate and max. spreading factor). It is based on the channelization code selected in the code tree. Using a spreading code means that its entire domain is used.

At a chip rate of 3.84 Mcps, the domain ranges from 0 to 511

$$= \frac{\text{Chip_rate}}{\text{min_Symbol_rate}} - 1 = \frac{3.84 \text{ Mcps}}{7.5 \text{ ksp/s}} - 1$$

Understanding the displayed information

The "Code Domain" display indicates the assigned code domain. The channelization code is plotted at the X-axis, the colored bars indicate coherent code channels. The colors are assigned to fixed symbol rates, the allocation is shown below the graph. The relative power can be taken from the height of the bar.

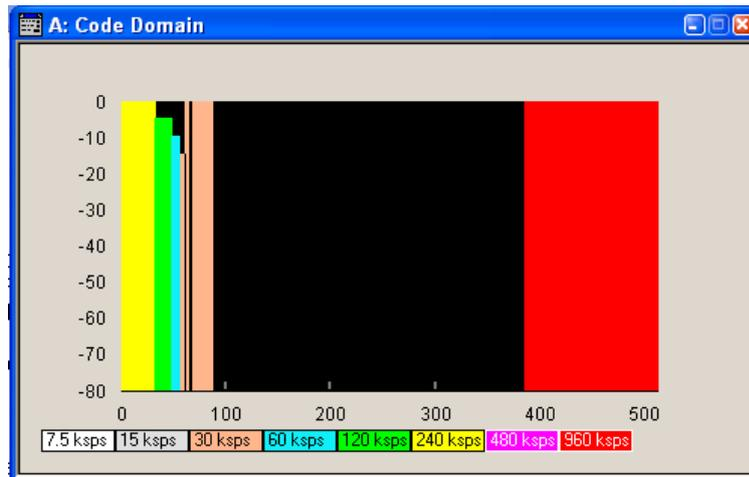

If the current settings result in a code domain conflict where the code domains of the active channels intersect, the code domain conflict is indicated by overlapping bars.

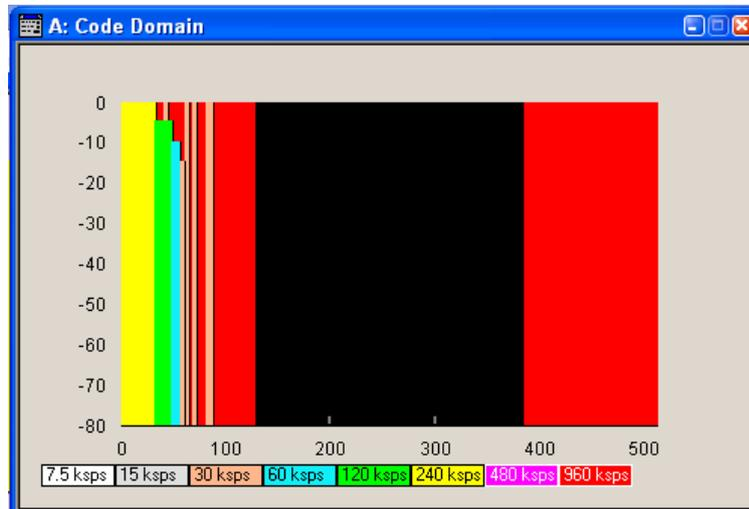

The occupied code domain of a channel is calculated as follows:

$$\text{Domain_Factor} = \frac{\text{current_symbol_rate}}{\text{min_symbol_rate}(=7.5\text{kps})}$$

As follows:

"Lower domain limit" = current channelization code number * domain factor

"Upper domain limit" = lower domain limit + domain_factor - 1.

Example:

Channel with symbol rate 30 ksps and channelization code 10:

Domain factor = $30/7.5 = 4$,

Lower domain limit = $10 \times 4 = 40$,

Upper domain limit = $40 + 4 - 1 = 43$.

The channel occupies the code domain 40 to 43.



Refer to [Chapter 5.1, "Resolving Domain Conflicts"](#), on page 240 for step-by-step description.

4.11 Channel Graph - BS

The channel graph display shows the active code channels.

1. To access the base station channel graph, select "3GPP FDD > Link Direction > Downlink / Forward".
2. Select "Basestation > BS 1/2/3/4".
3. Select "Channel Graph".

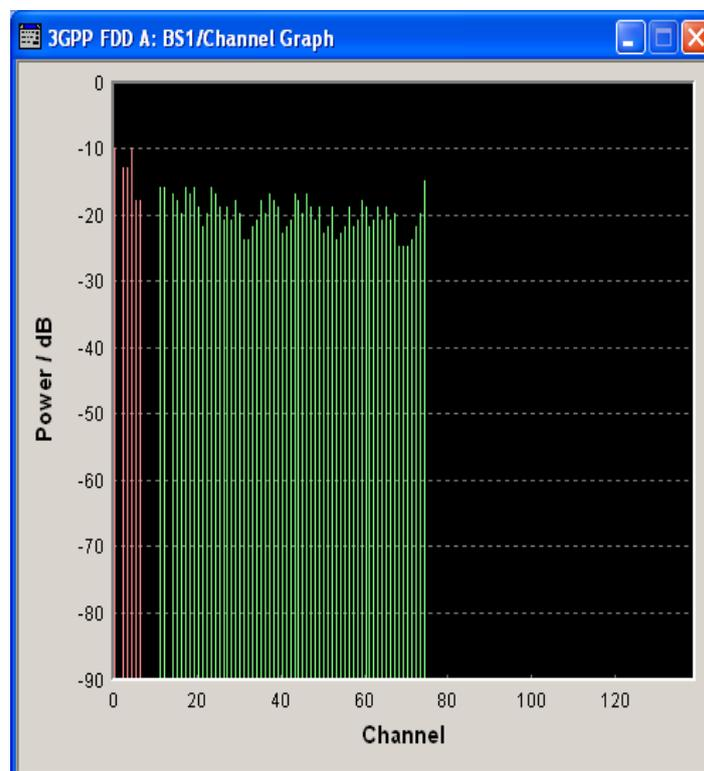

The channel number is plotted on the X-axis. The red bars represent the special channels (P-CPICH to DL-DPCCH), the green bars the other channels. The height of the bars shows the relative power of the channel

The graph is calculated from the settings that have been made.

4.12 HSDPA Settings - BS

The "MIMO Settings" are only available for enabled two-antenna system (see "[Diversity / MIMO](#)" on page 77) and selected HS-PDSCH MIMO channel.

- ▶ To access "Enhanced HSDPA Mode" dialog, select "Baseband > 3GPP FDD > BS > Channel Table > HSDPA Settings > Config".

The available settings and indications in this dialog depend on the selected HSDPA mode and channel type.

3GPP FDD A: BS1/Enhanced19 HSDPA Mode

HSDPA-Mode: Subframe 1

Burst-Mode: On

Inter TTI Distance: 5

Constellation Version Parameter - b: 0

MIMO Settings

Precoding Weight Pattern (w2): 0,1,2

Stream 2 Active Pattern: 1111 1111

Modulation And Constellation Version

	Stream 1:	Stream 2:
Modulation	64 QAM	QPSK
Constellation Version Parameter - b	1	

Generation modes of the high-speed channels

The high-speed channels can be generated either *continuously* as defined in test model 5, in packet mode or in H-Set mode according to TS 25.101, annex A.7.

In *packet mode*, the start of the channel and the distance between the HSDPA packets can be set. The packet transmissions can start in one of the first five subframes (0 to 4). A subframe has the same length as a packet and is three slots long. An HS-SCCH starts at the beginning of the selected subframe, an HS-PDSCH starts with an offset of two slots to the selected subframe. The active parts of the HS-SCCH and the HS-PDSCH for a specific subframe setting differ by the slot offset of the HS-PDSCH.

Example:

Setting subframe 1

HS-SCCH: slot 3 to 5 active

HS-PDSCH: slot 5 to 7 active.

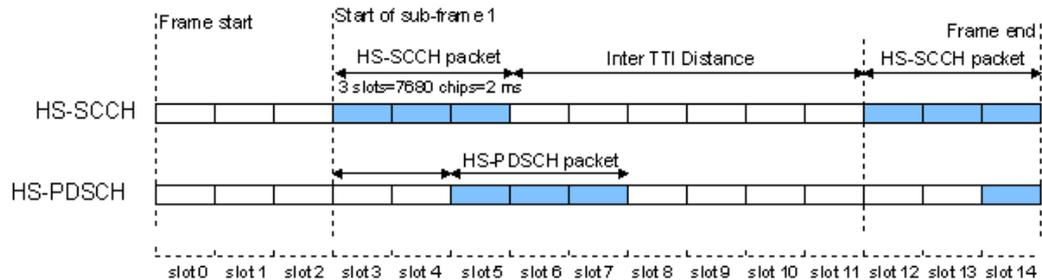

Figure 4-7: Timing diagram for the HS-SCCH and the associated HS-PDSCH, packet subframe 1 mode and inter-TTI distance = 3

In *H-Set mode*, the first packet is sent in the HS-SCCH subframe 0. Up to 15 HSDPA channels are coupled to be used in the fixed reference channels. The number of coupled channels depends on the selected H-Set. Channel coding is always performed over a certain number of bits. The resulting packets are distributed evenly over one subframe of all HS-PDSCH channelization codes. Therefore, the data stream is not assigned to a defined channel but to all coupled channels.

4.12.1 Enhanced HSDPA Mode Settings

Provided are the following settings:

HSDPA Mode

Selects the HSDPA mode.

- "Continuous" The high-speed channel is generated continuously. This mode is used in test model 5 and 6.
- "Subframe 0 | 1 | 2 | 3 | 4" The high-speed channel is generated in packet mode. The start of the channel is set by selecting the subframe in which the first packet is sent. The distance between subsequent packets is set with parameter "Inter TTI Distance".
- "H-Set" (Available for BS1 and HS-SCCH only.) The high-speed channel is generated in packet mode. The first packet is sent in the HS-SCCH subframe 0. The number of the coupled channel in the H-Set can be changed with the parameter "Number of HS-PDSCH Channel Codes".

Remote command:

```
[ :SOURCE<hw> ] :BB:W3GPp:BSTation<st>:CHANnel<ch0>:HSDPa:MODE
```

on page 307

Burst Mode

Activates/deactivates burst mode. The signal is bursted when on, otherwise dummy data are sent during transmission brakes.

Remote command:

[:SOURCE<hw>] :BB:W3GPP:BSTation<st>:CHANnel<ch0>:HSDPa:BMODE [:STATE] on page 289

Inter TTI Distance (H-Set)

(Available for "subframe x")

Selects the distance between two packets in HSDPA packet mode.

The distance is set in number of sub-frames (3 slots = 2 ms). An "Inter TTI Distance" of 1 means continuous generation.

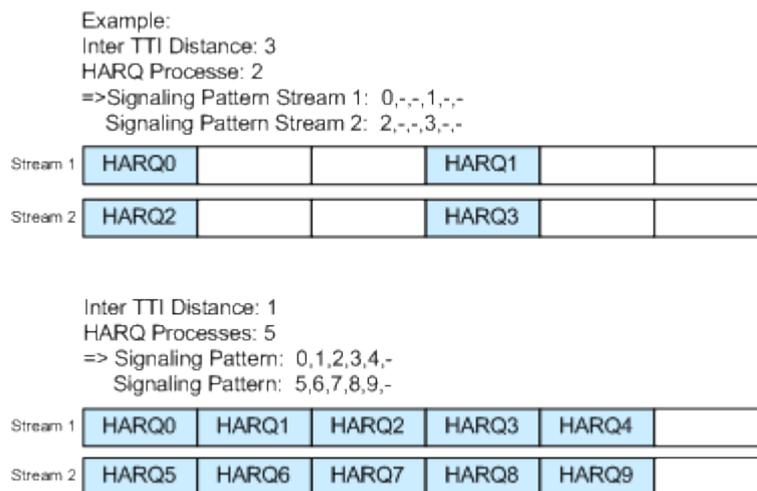

Figure 4-8: Example: Inter TTI Distance in HSDPA H-Set Mode

Remote command:

[:SOURCE<hw>] :BB:W3GPP:BSTation<st>:CHANnel<ch0>:HSDPa:TTIDistance on page 307

Constellation Version Parameter b - BS

(Available for "HS-PDSCH 16QAM" and "64QAM" only)

Switches the order of the constellation points of the 16QAM or 64QAM mapping.

The rearrangement is done according to 3GPP TS25.212.

Remote command:

[:SOURCE<hw>] :BB:W3GPP:BSTation<st>:CHANnel<ch0>:HSDPa:CVPB on page 289

4.12.2 MIMO Configuration



The parameters in this section are available for instruments equipped with option R&S SMBV-K59, BS1 and Channel Type HS-PDSCH (MIMO) only (see ["Diversity / MIMO"](#) on page 77).

Precoding Weight Pattern (w2)

Sets the precoding weight parameter w2 for MIMO precoding.

The values of the weight parameters w1, w3 and w4 are calculated based on the value for w2 (see [Chapter 3.3.14, "MIMO in HSPA+"](#), on page 33).

Remote command:

```
[ :SOURCE<hw> ] :BB:W3GPp:BSTation<st>:CHANnel<ch0>:HSDPa:MIMO:
PWPattern on page 306
```

Stream 2 Active Pattern

Enables/disables a temporal deactivation of stream 2 per TTI in form of sending pattern.

The stream 2 sending pattern is a sequence of max 16 values of "1" (enables stream 2 for that TTI) and "-" (disabled stream 2 for that TTI).

Remote command:

```
[ :SOURCE<hw> ] :BB:W3GPp:BSTation<st>:CHANnel<ch0>:HSDPa:MIMO:
STAPattern on page 306
```

Modulation Stream 1/2 (HS-PDSCH MIMO)

Sets the modulation for stream 1 and respectively stream 2 to QPSK, 16QAM or 64QAM.

Remote command:

```
[ :SOURCE<hw> ] :BB:W3GPp:BSTation<st>:CHANnel<ch0>:HSDPa:MIMO:
MODulation<di> on page 306
```

Constellation Version Parameter b Stream 1/2 - BS

Switches the order of the constellation points of the 16QAM or 64QAM mapping.

The rearrangement is done according to 3GPP TS25.212.

Remote command:

```
[ :SOURCE<hw> ] :BB:W3GPp:BSTation<st>:CHANnel<ch0>:HSDPa:MIMO:
CVPB<di> on page 305
```

4.13 HSDPA H-Set Mode Settings - BS



The enhanced HSDPA H-Set mode settings are available for BS1, HS-SCCH and HSDPA Mode set to H-Set only.

Compared to previous releases of the instrument's firmware, much more flexibility in the configuration of H-Sets is provided now. Several former fixed parameters are now configurable, e.g.:

- The channelization codes used for the physical channels are not any more fixed
- A redundancy version sequence can be selected, i.e. varying the RV is possible in case HARQ mode constant NACK is configured.



To let the instrument generate a signal equal to the one generated by an instrument equipped with older firmware, perform the following:

- Set the same "Channelization Codes" as the codes used for your physical channels.
- Set the "HARQ Mode" to "Constant ACK".

A configuration according to an H-Set defined in TS 25.101 can be easily accomplished by selecting one of the predefined H-Sets in the "Enhanced HSDPA H-Set Mode" dialog.

3GPP FDD A: BS1/Enhanced13 HSDPA Mode

HSDPA-Mode: H-Set

Burst-Mode: On

H-Set Configuration

Predefined H-Set: 9 (16QAM/QPSK)

Advanced Mode (requires ARB): On

Suggested ARB Seq. Length: 6 Current ARB Seq. Length: 12 **Adjust**

Combined Nominal Average Information Bitrate /kbps: 13 652

UE Category: 15

HS-SCCH Type: Type 3 (MIMO)

MIMO Settings

Precoding Weight Pattern (w2): 0

Stream 2 Active Pattern: 1

Global Settings

Data Source (HS-PDSCH): PN 9

UEID (H-RNTI): 0

Channelization Code HS-SCCH (SF128): 5

Number Of HS-PDSCH Channelization Codes: 15

Start Channelization Code HS-PDSCH (SF16): 1

Total HS-PDSCH Power: -13.24 dB

Coding Configuration		
	Stream 1:	Stream 2:
HS-PDSCH Modulation	16QAM	QPSK
Binary Channel Bits Per TTI (Physical Layer)	28 800	14 400
Transport Block Size Table	Table 1	Table 1
Transport Block Size Index	37	42
Information Bit Payload (TB-Size)	17 568	9 736
Coding Rate	0.610	0.676
Virtual IR Buffer Size (per HARQ Process)	28 800	28 800

Signal Structure	
Inter TTI Distance	2
Number Of HARQ Processes Per Stream	2
Signalling Pattern Stream 1	0,1,1,1
Signalling Pattern Stream 2	2,3,3,3

HARQ Simulation	
HARQ Mode	Constant NACK
Redundancy Version Sequence Stream 1	0,3,3
Redundancy Version Sequence Stream 2	0

Randomly Varying Modulation And Number Of Codes	
State	<input type="checkbox"/> On
Alternative HS-PDSCH Modulation	16QAM
Alternative Number Of HS-PDSCH Channelization Codes	1
Random Seed	0

Bit Error Insertion	
State	<input type="checkbox"/> On
Bit Error Rate	0.001 000 0
Insert Errors On	Physical Layer

Block Error Insertion	
State	<input type="checkbox"/> On
Block Error Rate	0.100 0

4.13.1 HSDPA H-Set General Settings

Provided are the following settings:

HSDPA Mode

Selects the HSDPA mode.

"Continuous"	The high-speed channel is generated continuously. This mode is used in test model 5 and 6.
"Subframe 0 1 2 3 4"	The high-speed channel is generated in packet mode. The start of the channel is set by selecting the subframe in which the first packet is sent. The distance between subsequent packets is set with parameter "Inter TTI Distance".
"H-Set"	(Available for BS1 and HS-SCCH only.) The high-speed channel is generated in packet mode. The first packet is sent in the HS-SCCH subframe 0. The number of the coupled channel in the H-Set can be changed with the parameter "Number of HS-PDSCH Channel Codes".

Remote command:

```
[ :SOURCE<hw> ] :BB:W3GPp:BSTation<st>:CHANnel<ch0>:HSDPa:MODE
```

on page 307

Burst Mode

Activates/deactivates burst mode. The signal is bursted when on, otherwise dummy data are sent during transmission brakes.

Remote command:

```
[ :SOURCE<hw> ] :BB:W3GPp:BSTation<st>:CHANnel<ch0>:HSDPa:BMODE [ :STATE ]
```

on page 289

4.13.2 H-Set Configuration Common Settings



The parameters in this section are available for BS1 and HSDPA H-Set Mode only.

Predefined H-Set

Selects the H-Set and the modulation according to TS 25.101, annex A.7 .

Table 4-7: Following combinations are possible:

H-Set	Modulation
1, 2, 3, 6, 10	QPSK 16QAM
4, 5, 7, 12	QPSK
8	64QAM
9	16QAM (stream 1) QPSK (stream 2)
11	64QAM (stream 1) 16QAM (stream 2)
User	-

Note: H-Sets 7 to 9 and H-Set 11 are enabled for instruments equipped with option R&S SMBV-K59 only. H-Set 9 and H-Set 11 are available only for enabled two-antenna system (see "Diversity / MIMO" on page 77).

Several parameters are automatically set, depending on the selection made for the parameter "H-Set". However, it is also possible to change these parameters. In this case, the value of the parameter "H-Set" is automatically set to User.

Note: Use the predefined settings to let the instrument generate a signal equal to the one generated by an instrument equipped with older firmware.

Remote command:

```
[ :SOURce<hw> ] :BB:W3GPp:BSTation<st>:CHANnel<ch0>:HSDPa:HSET:
PREDeFined on page 296
```

Advanced Mode (requires ARB)

Activates/deactivates the advanced mode in which the H-Set is generated by the ARB. The parameter can be configured only for H-Sets 1 - 5. For H-Sets 6 to 12 and User, it is always enabled.

For an H-Set calculated in arbitrary waveform mode, it is critical to set an appropriate "Current ARB Sequence Length". An appropriate sequence length is required for the generation of signals without unwanted artifacts when pre-calculated sequences are repeated cyclically. In particular, the HARQ cycles have to terminate completely before restarting the signal.

Assistance in setting an appropriate sequence length is provided by the parameter "Suggested ARB Sequence Length" and the "Adjust" button. When working in Advanced Mode, it is recommended to adjust the current ARB sequence length to the suggested one.

Remote command:

```
[ :SOURce<hw> ] :BB:W3GPp:BSTation<st>:CHANnel<ch0>:HSDPa:HSET:
AMODE on page 289
[ :SOURce<hw> ] :BB:W3GPp:BSTation<st>:CHANnel<ch0>:HSDPa:HSET:
SLENgth? on page 300
```

Suggested ARB sequence length

Displays the suggested ARB sequence length.

The "Suggested ARB Sequence Length" is the calculated minimum length that depends on several parameters: TTI distance, number of HARQ processes, HARQ cycles, HARQ mode, RV parameter sequence, HS-SCCH Type, precoding weight pattern and stream 2 active pattern.

When working in "Advanced Mode", it is recommended to adjust the current ARB sequence length to the suggested one.

It is recommended that you set this suggested ARB sequence length in the instrument.

Remote command:

```
[ :SOURce<hw> ] :BB:W3GPp:BSTation<st>:CHANnel<ch0>:HSDPa:HSET:
SLENgth? on page 300
```

Current ARB sequence length

Displays the current ARB sequence length or the adjusted ARB sequence length, set after pressing the button "Adjust".

When working in "Advanced Mode", it is recommended to adjust the current ARB sequence length to the suggested one.

It is recommended that you set this suggested ARB sequence length in the instrument.

Remote command:

`[:SOURce<hw>] :BB:W3GPP:SLENgth` on page 254

Adjust

Sets the current ARB sequence length to the suggested value.

When working in "[Advanced Mode](#)", it is recommended to adjust the current ARB sequence length to the suggested one.

Remote command:

`[:SOURce<hw>] :BB:W3GPP:BSTation<st>:CHANnel<ch0>:HSDPa:HSET:SLENgth:ADJust` on page 300

Nominal Average Information Bit Rate

Indicates the average data rate on the transport layer. In case of MIMO, the parameter indicates the combined nominal average information bit rate.

The "Nominal Average Information Bit Rate" is calculated for the ideal case of infinite sequence and with regard of the stream 2 active pattern.

Remote command:

`[:SOURce<hw>] :BB:W3GPP:BSTation<st>:CHANnel<ch0>:HSDPa:HSET:NAIBitrate?` on page 295

UE Category

Displays the UE category that is minimum required to receive the selected H-Set (see also [Chapter 3.3.18, "UE Capabilities"](#), on page 42).

Remote command:

`[:SOURce<hw>] :BB:W3GPP:BSTation<st>:CHANnel<ch0>:HSDPa:HSET:UECategory?` on page 304

HS-SCCH Type

Sets the HS-SCCH type.

"Type 1 (normal)" Normal operation mode.

"Type 2 (HS-SCCH less)" (Available for instruments equipped with option R&S SMBV-K59 only)
HS-SCCH less operation mode (see also [Chapter 3.3.12, "HS-SCCH Less Operation"](#), on page 30.

"Type 3
(MIMO)"

(Available for instruments equipped with option R&S SMBV-K59 and enabled two-antenna system only)

HS-SCCH Type 3 mode is defined for MIMO operation (see also [Chapter 3.3.14.2, "MIMO downlink control channel Support"](#), on page 34.

Enabling this operation mode, enables the parameters in section "MIMO Settings" and the stream 2 parameters in sections "HARQ Simulation, Signal Structure" and "Coding Configuration".

While working in HS-SCCH Type 3 mode and simulating Antenna 2 of one two-antenna system without transmit diversity, no control channel is sent. However, the HS-SCCH is displayed as an active in the channel table. To prove, that there is no control channel transmission, consult the "Code Domain Graph".

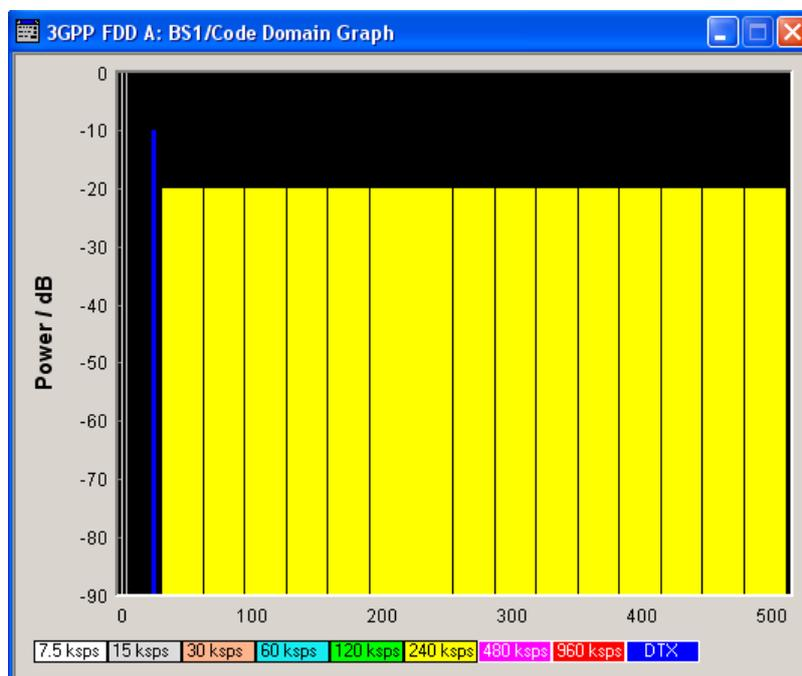

The HS-SCCH channel is displayed as DTX.

Remote command:

```
[ :SOURCE<hw> ] :BB:W3Gpp:BSStation<st>:CHANnel<ch0>:HSDPa:HSET:TYPE
on page 303
```

4.13.3 MIMO Settings



The parameters in this section are available for instruments equipped with option R&S SMBV-K59, BS1, HSDPA H-Set Mode, and for HS-SCCH Type 3 (MIMO) only.

Precoding Weight Pattern (w2)

Selects the sequence for the MIMO precoding weight parameter w2.

The values of the weight parameters w_1 , w_3 and w_4 are calculated based on the value for w_2 (see [Chapter 3.3.14, "MIMO in HSPA+"](#), on page 33).

Remote command:

```
[ :SOURCE<hw> ] :BB:W3GPp:BSTation<st>:CHANnel<ch0>:HSDPa:HSET:
PWPattern on page 296
```

Stream 2 Active Pattern

Enables/disables a temporal deactivation of stream 2 per TTI in form of sending pattern.

The stream 2 sending pattern is a sequence of max 16 values of "1" (enables stream 2 for that TTI) and "-" (disabled stream 2 for that TTI).

Remote command:

```
[ :SOURCE<hw> ] :BB:W3GPp:BSTation<st>:CHANnel<ch0>:HSDPa:HSET:
STAPattern on page 301
```

4.13.4 Global Settings



The parameters in this section are available for BS1 and HSDPA H-Set Mode only.

Data Source (HS-DSCH)

Selects the data source for the transport channel.

New data is retrieved from the data source each time an initial transmission is performed within one TTI. An initial transmission is performed in case of "HARQ Mode > Constant ACK" or by each new beginning of the "Redundancy Version Sequence".

The following standard data sources are available:

- "All 0, All 1"
An internally generated sequence containing 0 data or 1 data.
- "PNxx"
An internally generated pseudo-random noise sequence.
- "Pattern"
An internally generated sequence according to a bit pattern.
Use the "Pattern" box to define the bit pattern.
- "Data List/Select DList"
A binary data from a data list, internally or externally generated.
Select "Select DList" to access the standard "Select List" dialog.
 - Select the "Select Data List > navigate to the list file *.dm_iqd > Select" to select an existing data list.
 - Use the "New" and "Edit" functions to create internally new data list or to edit an existing one.
 - Use the standard "File Manager" function to transfer external data lists to the instrument.

See also "Main Dialog > Data List Management".

Remote command:

`[:SOURCE<hw>] :BB:W3GPp:BSTation<st>:CHANnel<ch0>:HSDPa:HSET:DATA`
on page 292

`[:SOURCE<hw>] :BB:W3GPp:BSTation<st>:CHANnel<ch0>:HSDPa:HSET:`
`DATA:PATtern` on page 293

`[:SOURCE<hw>] :BB:W3GPp:BSTation<st>:CHANnel<ch0>:HSDPa:HSET:`
`DATA:DSElect` on page 293

UEID (H-RNTI)

Enters the UE identity which is the HS-DSCH Radio Network Identifier (H-RNTI) defined in 3GPP TS 25.331: "Radio Resource Control (RRC); Protocol Specification".

Remote command:

`[:SOURCE<hw>] :BB:W3GPp:BSTation<st>:CHANnel<ch0>:HSDPa:HSET:UEID`
on page 304

Channelization Code HS-SCCH (SF128)

Sets the channelization code of the HS-SCCH.

Note: To let the instrument generate a signal equal to the signal generated by an instrument equipped with older firmware, set the same "Channelization Codes" as the codes used for your physical channels.

Remote command:

`[:SOURCE<hw>] :BB:W3GPp:BSTation<st>:CHANnel<ch0>:HSDPa:HSET:`
`HSCCode` on page 295

Number of HS-PDSCH Channelization Codes

Sets the number of physical HS-PDSCH data channels assigned to the HS-SCCH.

The maximum number of channels assigned to the H-Set depends on the "HS-SCCH Type" and the channel number of the first HS-PDSCH channel in the H-Set.

For HS-SCCH Type 2 (less operation), maximum of two channels can be assigned.

For HS-SCCH Type 1 (normal operation) and Type 3 (MIMO), the maximum number of assigned channels is 15.

Remote command:

`[:SOURCE<hw>] :BB:W3GPp:BSTation<st>:CHANnel<ch0>:HSDPa:HSET:`
`CLENgth` on page 292

Start Channelization Code HS-PDSCH (SF16)

Sets the channelization code of the first HS-PDSCH channel in the H-Set.

The channelization codes of the rest of the HS-PDSCHs in the H-Set are set automatically.

Note: To let the instrument generate a signal equal to the signal generated by an instrument equipped with older firmware, set the same "Channelization Codes" as the codes used for your physical channels.

Remote command:

`[:SOURCE<hw>] :BB:W3GPp:BSTation<st>:CHANnel<ch0>:HSDPa:HSET:`
`SCCode` on page 299

Total HS-PDSCH Power

Sets the total HS-PDSCH power, i.e. sets the total power of all HS-PDSCH channels in the H-Set.

Note: In the 3GPP test specification, e.g. 3GPP TS34.121-1, the HS-PDSCH power is typically given as total power of all HS-PDSCH channels. Use this parameter to set the HS-PDSCH power level directly as given in the 3GPP test specification.

There are two possibilities to set the power of an H-Set:

- Select "BS1 > Channel Table > HS-PDSCH Channel > Power" and set the power of the individual channels.

The total power of all HS-PDSCH channels of the H-Set depends on the [Number of HS-PDSCH Channelization Codes](#) and is calculated as follows:

$$TotalPower_{All\ HS-PDSCHs} = Power_{HS-PDSCH\ Channel} + 10 * \log_{10}(NumberOfHS-PDSCHChannelizationCodes)$$

The calculated total power is displayed with the parameter "Total HS-PDSCH Power"

- Set directly the total power of the H-Set, i.e set the parameter "Total HS-PDSCH Power"

The individual power levels of the HS-PDSCHs are calculated automatically and displayed in the "BS1 > Channel Table > HS-PDSCH Channel > Power".

Example:

Select "BS1 > HSDPA H-Set".

The default H-Set with five channelization codes ("BS1 > Channel table > HSDPA Settings > Config > Enhanced HSDPA Mode > Number of HS-PDSCH Channelization Codes") is configured.

The default individual power levels of the HS-PDSCH channels are -20 dB. The "Total HS-PDSCH Power" is -13.01 dB.

Set the "Total HS-PDSCH Power" to -10 dB. The individual power levels of the HS-PDSCH channels are -16.99 dB.

Remote command:

```
[ :SOURCE<hw> ] :BB:W3GPP:BSTation<st>:CHANnel<ch0>:HSDPa:HSET:
TPower on page 301
```

4.13.5 Coding Configuration

The parameters in this section are available for BS1 and HSDPA H-Set Mode only. The parameters for stream 2 are available for instruments equipped with option R&S SMBV-K59 and for HS-SCCH Type 3 only.

HS-PDSCH Modulation Stream1/2

Sets the HS-PDSCH modulation for stream 1 and stream 2 to QPSK, 16QAM or 64QAM.

Note: The modulation 64QAM is available for instruments equipped with option R&S SMBV-K59 only.

For HS-SCCH Type 2, the available modulation scheme is QPSK only.

For HS-SCCH Type 3 (MIMO), the modulation selected for stream 1 has to be the higher-order one, i.e. combination 16QAM/64QAM is not allowed.

Remote command:

```
[ :SOURce<hw> ] :BB:W3GPp:BSTation<st>:CHANnel<ch0>:HSDPa:HSET:
MODulation<di> on page 295
```

UE Supports 64QAM

(Available for BS1, "HSDPA H-Set Mode", "HS-SCCH Type 1" and "16QAM" only)

Enables/disables UE support of 64QAM.

In case this parameter is disabled, i.e. the UE does not support 64QAM, the 7 bit is used for channelization information.

Remote command:

```
[ :SOURce<hw> ] :BB:W3GPp:BSTation<st>:CHANnel<ch0>:HSDPa:HSET:
S64Qam on page 299
```

Binary Channel Bits per TTI (Physical Layer) Stream1/2

Displays the coded binary channel bits per TTI and per stream.

The value displayed is calculated upon the values and selections for the parameters "HS-PDSCH Modulation", "Symbol Rate" and "Number of HS-PDSCH Channel Codes".

Remote command:

```
[ :SOURce<hw> ] :BB:W3GPp:BSTation<st>:CHANnel<ch0>:HSDPa:HSET:
BCBTti<di>? on page 291
```

Transport Block Size Table Stream1/2

Selects Table 0 or Table 1 as described in 3GPP TS 25.321.

For "HS-PDSCH Modulation" set to 64QAM, only Table 1 is available.

Remote command:

```
[ :SOURce<hw> ] :BB:W3GPp:BSTation<st>:CHANnel<ch0>:HSDPa:HSET:TBS:
TABLE<di> on page 303
```

Transport Block Size Index Stream1/2

Selects the index k_i for the corresponding table and stream, as described in 3GPP TS 25.321.

Remote command:

```
[ :SOURce<hw> ] :BB:W3GPp:BSTation<st>:CHANnel<ch0>:HSDPa:HSET:TBS:
INDEX<di> on page 302
```

Transport Block Size Reference Stream1/2

(Available for BS1, HSDPA H-Set Mode and HS-SCCH Type 2 only)

While working in less operation mode, this parameter is signaled instead of the parameter "Transport Block Size Index".

Remote command:

[:SOURce<hw>] :BB:W3GPp:BSTation<st>:CHANnel<ch0>:HSDPa:HSET:TBS:REFeRence on page 302

Information Bit Payload (TB-Size) Stream 1/2

Displays the payload of the information bit. This value determines the number of transport layer bits sent in each TTI before coding.

Remote command:

[:SOURce<hw>] :BB:W3GPp:BSTation<st>:CHANnel<ch0>:HSDPa:HSET:BPAYload<di>? on page 291

Coding Rate Stream 1/2

Displays the resulting coding rate per stream.

The coding rate is calculated as a relation between the "Information Bit Payload" and "Binary Channel Bits per TTI".

Remote command:

[:SOURce<hw>] :BB:W3GPp:BSTation<st>:CHANnel<ch0>:HSDPa:HSET:CRATe<di>? on page 292

Virtual IR Buffer Size (per HARQ Process) Stream1/2

Sets the size of the virtual IR buffer (number of SMLs per HARQ process) per stream.

Remote command:

[:SOURce<hw>] :BB:W3GPp:BSTation<st>:CHANnel<ch0>:HSDPa:HSET:VIBSize<di> on page 305

4.13.6 Signal Structure



The parameters in this section are available for BS1 and HSDPA H-Set Mode only. The parameters for stream 2 are available for instruments equipped with option R&S SMBV-K59 and for HS-SCCH Type 3 only.

Inter TTI Distance (H-Set)

(Available for "subframe x")

Selects the distance between two packets in HSDPA packet mode.

The distance is set in number of sub-frames (3 slots = 2 ms). An "Inter TTI Distance" of 1 means continuous generation.

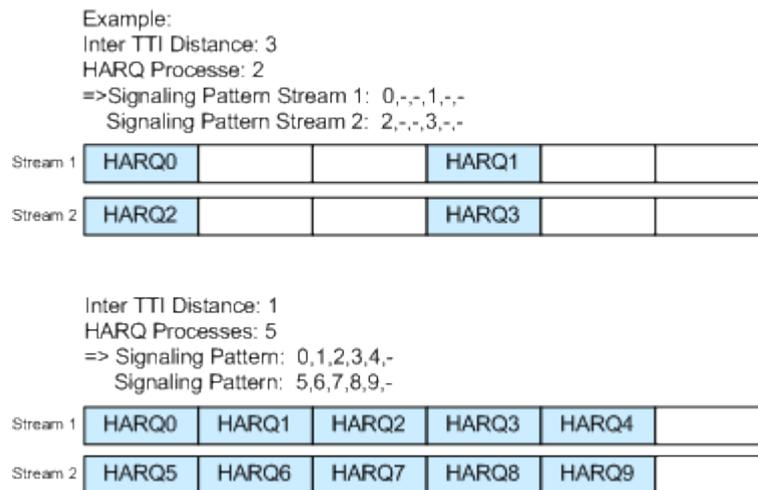

Figure 4-9: Example: Inter TTI Distance in HSDPA H-Set Mode

Remote command:

```
[ :SOURCE<hw> ] :BB:W3GPp:BSTation<st>:CHANnel<ch0>:HSDPa:
TTIDistance on page 307
```

Number of HARQ Processes per Stream

Sets the number of HARQ processes. This value determines the distribution of the payload in the subframes and depends on the Inter "TTI Distance" (see figure).

A minimum of six HARQ Processes are required to achieve continuous data transmission.

Remote command:

```
[ :SOURCE<hw> ] :BB:W3GPp:BSTation<st>:CHANnel<ch0>:HSDPa:HSET:
HARQ:LENGTH on page 294
```

Signaling Pattern Stream1/2

Displays the distribution of packets over time. The "Signaling Pattern" displays a HARQ-Process cycle and is a sequence of HARQ-IDs and "-". An HARQ-ID indicates a packet, a "-" indicates no packet (see figure). The signaling pattern is cyclically repeated.

Long signaling patterns with regular repeating groups of HARQ-ID and "-" are not displayed completely. The signaling pattern is shortened and ". . ." is displayed but the scheduling is performed according to the selected "Inter TTI Distance". Long signaling patterns with irregularity in the HARQ-ID and "-" groups are displayed completely.

Depending on the selected "Burst Mode", a dummy TTI is sent within the no packet subframes.

Remote command:

```
[ :SOURCE<hw> ] :BB:W3GPp:BSTation<st>:CHANnel<ch0>:HSDPa:HSET:
SPATtern<di>? on page 300
```

4.13.7 HARQ Simulation



The parameters in this section are available for BS1 and HSDPA H-Set Mode only. The parameters for stream 2 are available for instruments equipped with option R&S SMBV-K59 and for HS-SCCH Type 3 only.

Mode (HARQ Simulation)

Sets the HARQ simulation mode.

Note: To let the instrument generate a signal equal to the one generated by an instrument equipped with older firmware, set the "HARQ Mode" to "Constant ACK".

"Constant ACK"

New data is used for each new TTI. This mode is used to simulate maximum throughput transmission.

"Constant NACK"

(enabled in "Advanced Mode" only)

Enables NACK simulation, i.e. depending on the sequence selected with parameter "Redundancy Version Parameter Sequence" packets are retransmitted. This mode is used for testing with varying redundancy version.

Remote command:

`[:SOURCE<hw>] :BB:W3GPp:BSTation<st>:CHANnel<ch0>:HSDPa:HSET:HARQ:MODE` on page 294

Redundancy Version Stream1/2

The parameter is enabled for "HARQ Simulation Mode > Constant ACK".

Enters the redundancy version per stream. This value determines the processing of the Forward Error Correction and constellation arrangement (16/64QAM modulation), see TS 25.212 4.6.2.

For HS-SCCH Type 2 (less operation), the redundancy version is always 0.

Remote command:

`[:SOURCE<hw>] :BB:W3GPp:BSTation<st>:CHANnel<ch0>:HSDPa:HSET:RVParameter<di>` on page 297

Redundancy Version Sequence Stream 1/2

The parameter is enabled for "HARQ Simulation Mode > Constant NACK".

Enters a sequence of redundancy version per stream. The value of the RV parameter determines the processing of the Forward Error Correction and constellation arrangement (16/64QAM modulation), see TS 25.212 4.6.2.

The sequence has a length of maximum 30 values. The sequence length determines the maximum number of retransmissions. New data is retrieved from the data source after reaching the end of the sequence.

For HS-SCCH Type 2 (less operation), the redundancy version sequence is always "0, 3, 4".

Remote command:

```
[ :SOURce<hw> ] :BB:W3GPP:BSTation<st>:CHANnel<ch0>:HSDPa:HSET:
RVPSequenCe<di> on page 297
```

4.13.8 Error Insertion



The parameters in this section are available for BS1, HSDPA H-Set Mode and disabled Advanced Mode only.

In the "Bit/Block Error Insertion" sections, errors can be inserted into the data source and into the CRC checksum. This can be used for example to test the bit and block error rate testers.

Bit Error State (HSDPA H-Set)

Activates or deactivates bit error generation.

Bit errors are inserted into the data stream of the coupled HS-PDSCHs. It is possible to select the layer in which the errors are inserted (physical or transport layer).

When the data source is read out, bits are deliberately inverted at random points in the data bitstream at the specified error rate so that an invalid signal is simulated.

Remote command:

```
[ :SOURce<hw> ] :BB:W3GPP:BSTation[:ENHanced]:CHANnel<ch0>:HSDPa:
DERRor:BIT:STATe on page 341
```

Bit Error Rate (HSDPA H-Set)

Sets the bit error rate.

Remote command:

```
[ :SOURce<hw> ] :BB:W3GPP:BSTation[:ENHanced]:CHANnel<ch0>:HSDPa:
DERRor:BIT:RATE on page 341
```

Insert Errors On (HSDPA H-Set)

Selects the layer at which bit errors are inserted.

"Transport layer"

Bit errors are inserted in the transport layer.

"Physical layer"

Bit errors are inserted in the physical layer.

Remote command:

```
[ :SOURce<hw> ] :BB:W3GPP:BSTation[:ENHanced]:CHANnel<ch0>:HSDPa:
DERRor:BIT:LAYer on page 341
```

Block Error State (HSDPA H-Set)

Activates or deactivates block error generation.

The CRC checksum is determined and then the last bit is inverted at the specified error probability in order to simulate an invalid signal.

Remote command:

```
[ :SOURce<hw> ] :BB:W3GPp:BSTation [ :ENHanced ] :CHANnel<ch0>:HSDPa:
DERRor:BLOCK:STATE on page 342
```

Block Error Rate (HSDPA H-Set)

Sets the block error rate.

Remote command:

```
[ :SOURce<hw> ] :BB:W3GPp:BSTation [ :ENHanced ] :CHANnel<ch0>:HSDPa:
DERRor:BLOCK:RATE on page 342
```

4.13.9 Randomly Varying Modulation and Number of Codes (Type 3i) Settings

(Available for enabled [Advanced Mode](#), HS-SCCH Type 1 and for instruments equipped with option R&S SMBV-K59)

The used modulation and number of HS-PDSCH codes in an H-Set is randomly selected every HSDPA TTI among four options with equal probability (see [Table 4-8](#)).

Table 4-8: Used modulation and number of HS-PDSCH codes

Option	Modulation	Number of HS-PDSCH codes
1	HS-PDSCH Modulation	Alternative Number of HS-PDSCH Channelization Codes
2	"Alternative HS-PDSCH Modulation" on page 113	Alternative Number of HS-PDSCH Channelization Codes
3	HS-PDSCH Modulation	Number of HS-PDSCH Channelization Codes
4	"Alternative HS-PDSCH Modulation" on page 113	Number of HS-PDSCH Channelization Codes



Although the number of active HS-PDSCH channels varies over time, the overall power of the HS-PDSCH channels in the H-Set stays constant. This is because the power of the individual HS-PDSCH channels is raised when the number is reduced. The channel powers displayed in the "BS > Channel Table" are the channel powers during the TTIs in which the [Number of HS-PDSCH Channelization Codes](#) is applied.

The ARB sequence length suggestion does not consider the statistical process of the selection among the four options. It can be necessary that you further increase the ARB sequence length to achieve the desired statistical properties.

See [Suggested ARB sequence length](#) .



To generate a signal without unwanted artifacts, select "3GPP FDD > Filter/Clipping/ARB Settings" and set the parameter [Sequence Length ARB](#) to a multiple of the suggested length.

The configured transport block size table and transport block size index are used in all TTIs, no matter which of the four options is used. The payload size can vary over time and can deviate from the value displayed with the parameter [Information Bit Payload \(TB-Size\) Stream 1/2](#).

Randomly Varying Modulation And Number Of Codes

Enables/disables the random variation of the modulation and codes.

Remote command:

```
[ :SOURCE<hw> ] :BB:W3GPP:BSTation<st>:CHANnel<ch0>:HSDPa:HSET:RVState on page 298
```

Alternative HS-PDSCH Modulation

Sets the alternative modulation (see [Table 4-8](#)).

Remote command:

```
[ :SOURCE<hw> ] :BB:W3GPP:BSTation<st>:CHANnel<ch0>:HSDPa:HSET:ALTModulation on page 290
```

Alternative Number of HS-PDSCH Channelization Codes

Sets the alternative number of HS-PDSCH channelization codes (see [Table 4-8](#)).

Remote command:

```
[ :SOURCE<hw> ] :BB:W3GPP:BSTation<st>:CHANnel<ch0>:HSDPa:HSET:ACLlength on page 290
```

Random Seed

Sets the seed for the random process deciding between the four options (see [Table 4-8](#)).

Remote command:

```
[ :SOURCE<hw> ] :BB:W3GPP:BSTation<st>:CHANnel<ch0>:HSDPa:HSET:SEED on page 298
```

4.14 Enhanced Settings for P-CPICH - BS1

Access:

- ▶ Select "3GPP FDD > BS > Channel Table > P-CPICH > Enhanced Settings > Config".

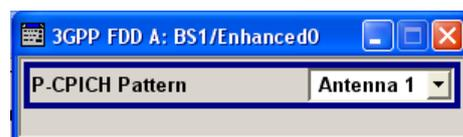

P-CPICH Pattern

Sets the P-CPICH pattern (channel 0).

Remote command:

[:SOURce<hw>] :BB:W3GPp:BSTation<st>:ENHanced:PCPich:PATtern
on page 323

4.15 Enhanced Settings for P-CCPCH - BS1

Access:

- ▶ Select "3GPP FDD > BS1 > Channel Table > P-CCPCH > Enhanced Settings > Config".

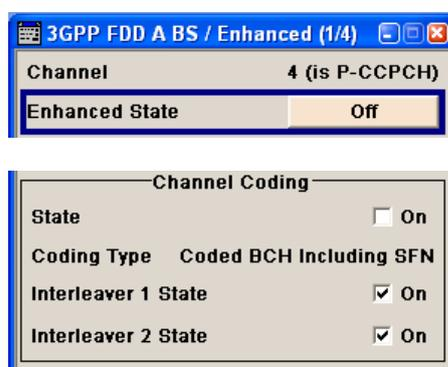

The dialog comprises the settings for configuring the enhanced state of this displayed channel and the channel coding settings. Interleaver states 1 and 2 can be activated separately.

The settings for the enhanced P-CCPCH channel and the enhanced DPCH channels are different (see [Chapter 4.16, "Enhanced Settings for DPCHs - BS1"](#), on page 116).

4.15.1 Channel Number and State

Channel Number (Enhanced P-CCPCH)

Displays the channel number and the channel type.

Remote command:

n.a.

State (Enhanced P-CCPCH)

Switches the P-CCPCH (Primary Common Control Phys. Channel) to the enhanced state. The channel signal is generated in real time.

Remote command:

[:SOURce<hw>] :BB:W3GPp:BSTation:ENHanced:PCCPch:STATe on page 323

4.15.2 Channel Coding - Enhanced P-CCPCH BS1

The "Channel Coding" section is where the channel coding settings are made.

The channel-coded P-CCPCH (Broadcast Channel BCH) with System Frame Number is generated according to the following principle.

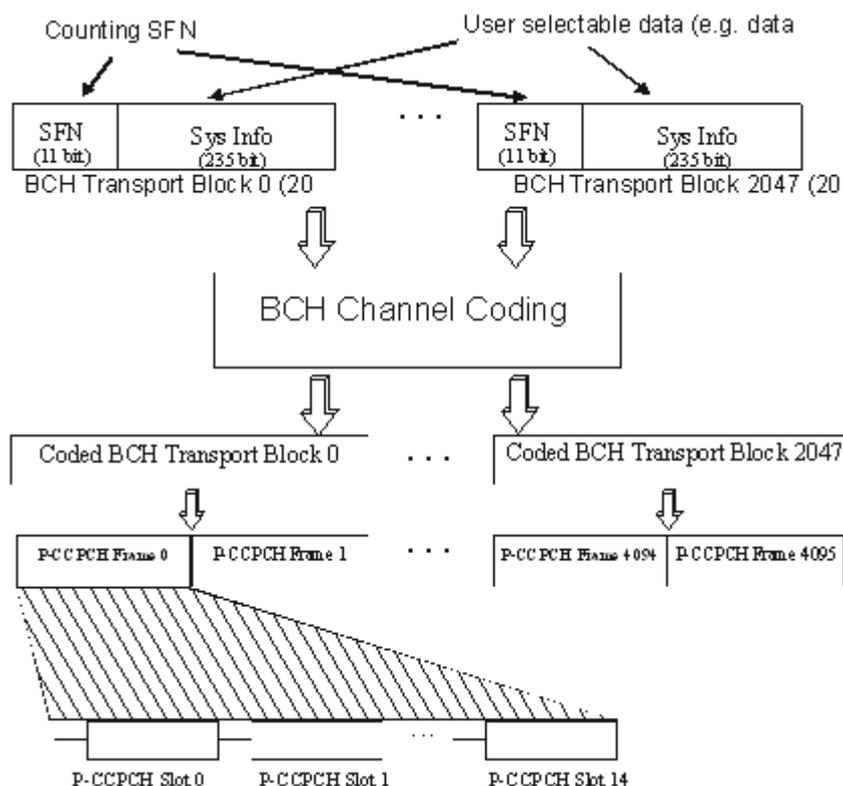

Figure 4-10: Generation of a channel coded P-CCPCH/BCH

The data blocks of the BCH at transport-channel level comprise data determined for 20 ms of the P-CCPCH (i.e. 2 frames) after channel coding. The first field of such a data block is an 11-bit long field for the system frame number (SFN). The SFN is automatically incremented by 1 (as stipulated in the standard) from transport block to transport block. This is equivalent to a step width of 2 frames due to the transport time interval length of 20 ms. After 2048 transport blocks (equivalent to 4096 frames), the SFN is reset and starts again at 0 (SFN restart). An output trigger indicating the SFN restart can be generated.

The SFN format is defined in the standard; it is MSB-first coded.

The remaining system information (a 235-bit long field per block) is filled from the data source selected for the P-CCPCH.

A data list can be used to transmit further specific system information in addition to the SFN. If only the SFN is required, "ALL 0" is recommended as data source for P-CCPCH.

The BCH transport blocks are then channel-coded. A coded transport block comprises the data sequence for two P-CCPCH frames.

Channel Coding State

Activates or deactivates channel coding.

The coding scheme is displayed in the field below.

Remote command:

`[:SOURCE<hw>] :BB:W3GPP:BSTation:ENHanced:PCCPch:CCODing:STATE`
on page 335

Channel Coding Type

Displays the coding scheme.

The coding scheme of P-CCPCH (BCH) is specified in the standard. The channel is generated automatically with the counting system frame number (SFN). The system information after the SFN field is completed from the selected data source.

Remote command:

`[:SOURCE<hw>] :BB:W3GPP:BSTation:ENHanced:PCCPch:CCODing:TYPE?`
on page 335

Interleaver

Activates or deactivates channel coding interleaver states 1 and 2.

Note: The interleaver states do not cause the symbol rate to change

Remote command:

`[:SOURCE<hw>] :BB:W3GPP:BSTation:ENHanced:PCCPch:CCODing:INTerleaver<di>` on page 334

4.16 Enhanced Settings for DPCHs - BS1

Access:

- ▶ Select "3GPP FDD > BS1 > Channel Table > DPCH > Enhanced/HSDPA Settings > Config...".

The "Enhanced Channel" dialog comprises information on the selected channel and settings for activating the enhanced state of this channel.

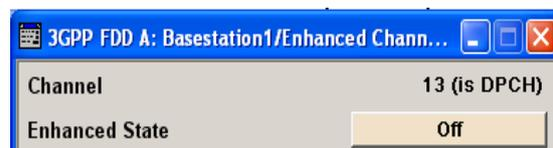

The "Channel Coding" section comprises the settings to enable the channel coding, select the coding type or display more information, like details on the transport channel.

Channel Coding	
State	<input type="checkbox"/> On
Coding Type	RMC (12.2 kbps)
Show Details >>>	

Available are settings to enable and configure "Bit/Block Error Insertion".

Bit Error Insertion	
State	<input type="checkbox"/> On
Bit Error Rate	0.001 000 0
Insert Errors On	Physical Layer

Block Error Insertion	
State	<input type="checkbox"/> On
Block Error Rate	0.100 0

The "Dynamic Power Control" section comprises the settings necessary to configure the power of the selected enhanced channel and to increase or decrease it within the predefined dynamic range ("Up Range + Down Range") and with the predefined step size ("Power Step").

Dynamic Power Control	
State	<input type="checkbox"/> On
Mode	External
Direction	Up
Power Step	1.00 dB
Up Range	10.00 dB
Down Range	10.00 dB

The settings for the enhanced P-CCPCH channel (see [Chapter 4.15, "Enhanced Settings for P-CCPCH - BS1"](#), on page 114) and the enhanced DPCH channels are different. This section describes the settings for the enhanced DPCH channels (channels#11 to 13). The channels can be configured independently.



Use the [HSDPA Settings - BS](#) dialog to configure the high-speed channels.

4.16.1 Channel Number and State

Provided are the following settings:

Enhanced State

Switches the DPCH channel to the enhanced state.

In the enhanced state, the modulation signal of the selected channel is generated in real time. It is possible to activate channel coding and simulate bit and block errors or use dynamic power control. Data lists, for example with user data for the transport layer, can be used as the data source.

Remote command:

`[:SOURCE<hw>] :BB:W3Gpp:BSTation:ENHanced:CHANnel<ch0>:DPCH:STATE`
 on page 323

4.16.2 Channel Coding

The "Channel Coding" section is where the channel coding settings are made. You can choose between a reduced display and the detailed setting options display. With the reduced display, it is only possible to select the coding scheme and this selection sets the associated parameters to the presetting prescribed in the standard. The "Transport Channel" section for detailed setting and for defining a user coding can be revealed with the "Show Details" button and hidden with the "Hide Details" button.

According to 3GPP TS 25.101, a downlink reference measurement channel is generated when the transport channels DTCH and DCCH are mapped to a DPCH with a different data rate after channel coding and multiplexing. The figure below is taken from the standard (TS 25.101). It illustrates the generation of a 12.2 kbps reference measurement channel from the DTCH and DCCH transport channels (see standard for figures and tables of other reference measurement channels).

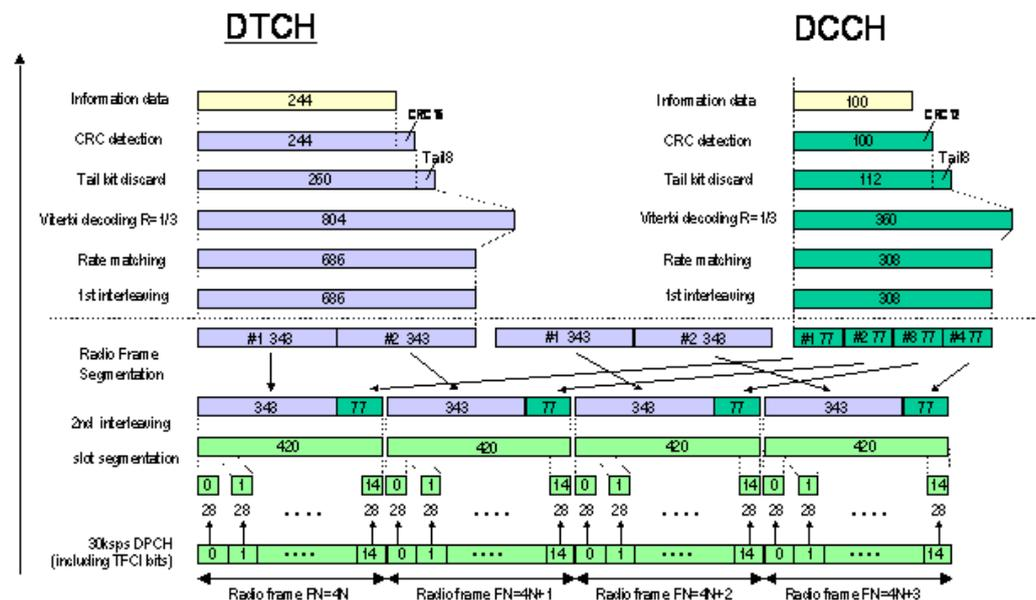

Figure 4-11: Channel coding of the 12.2 kbps reference measurement channel (downlink)

The Table 4-9 shows a summary of the transport channel parameters of the 12.2 kbps reference measurement channel

Table 4-9: Transport channel parameters (12.2 kbps reference measurement channel)

Parameter	DCCH	DTCH
Data Source	All 0	All 0
Transport Block Size	100	244
Transmission Time Interval	40 ms	20 ms
Type of Error Protection	Convolution Coding	Convolution Coding
Coding Rate	1/3	1/3
Rate Matching attribute	256	256
Size of CRC	12	16
Interleaver 1/2	On	On

Channel Coding State

Activates or deactivates channel coding.

Channel-coded measurement channels - so-called "reference measurement channels" - are required for many test procedures specified by the standard.

When channel coding is activated, the slot format, the symbol rate, the pilot length and the TFCI state are predetermined. The corresponding parameters in the channel table are disabled.

Remote command:

`[:SOURCE<hw>] :BB:W3GPP:BSTation:ENHanced:CHANnel<ch0>:DPCH:CCODing:STATE` on page 326

Channel Coding Type

Selects channel coding.

The 3GPP specification defines 4 reference measurement channel coding types, which differ in the input data bit rate bit to be processed (12.2, 64, 144 and 384 kbps). The additional AMR CODER coding scheme generates the coding of a voice channel.

The BTFD coding types with different data rates are also defined in the 3GPP specification (TS 34.121). They are used for the receiver quality test Blind Transport Format Detection. DTX (discontinuous transmission) bits are included in the data stream between rate matching and interleaving 1.

User coding can be defined as required in the detailed coding settings menu section revealed with button "Show Details". They can be stored and loaded in the "User Coding" submenu. Selection User is indicated as soon as a coding parameter is modified after selecting a predefined coding type.

The input data bits are taken for channel coding from the data source specified in the "Transport Channel" dialog section. The bits are available with a higher rate at the channel coding output. The allocations between the measurement input data bit rate and the output symbol rate are fixed, that is to say, the symbol rate is adjusted automatically.

The following are available for selection:

"RMC 12.2 12.2 kbps measurement channel kbps"

"RMC 64 kbps" 64 kbps measurement channel
 "RMC 144 kbps" 144 kbps measurement channel
 "RMC 384 kbps" 384 kbps measurement channel
 "AMR 12.2 kbps" Channel coding for the AMR coder
 "BTDF Rate 1 12.2ksp" Blind Transport Format Detection Rate 1 (12.2 kbps)
 "BTDF Rate 2 7.95ksp" Blind Transport Format Detection Rate 2 (7.95 kbps)
 "BTDF Rate 3 1.95ksp" Blind Transport Format Detection Rate 3 (1.95 kbps)

Remote command:

[:SOURce<hw>] :BB:W3GPP:BSTation:ENHanced:CHANnel<ch0>:DPCH:CCODing:TYPE on page 327

Show Details

Reveals the detailed setting options for channel coding.

Once the details are revealed, the labeling on the button changes to "Hide Details". Use this to hide the detailed setting options display again.

The screenshot shows a configuration window with a button labeled '<<< Hide Details'. Below it is a 'User Coding...' button. The main area contains the following settings:

- Slot Format: 10
- Symbol Rate: 30 ksp
- Bits per Frame (DPDCH): 450

A table titled 'Transport Channel' is displayed:

DTCH 1	DTCH 2	DTCH 3	DTCH 4	DTCH 5	DTCH 6	DCCH
244	100	100	100	100	100	100
PN 9	PN 9	PN 9	PN 9	PN 9	PN 9	PN 9
<input checked="" type="checkbox"/> On	<input type="checkbox"/> On	<input type="checkbox"/> On	<input type="checkbox"/> On	<input type="checkbox"/> On	<input type="checkbox"/> On	<input checked="" type="checkbox"/> On

Below the table are several settings:

- Data Source: PN 9
- Transport Time Intervall: 20 ms
- Transport Blocks: 1
- Transport Block Size: 244
- Size Of CRC: 16
- Rate Matching Attribute: 256
- DTX Indication Bits: 0
- Error Protection: Conv 1/3
- Interleaver 1 State: On
- Interleaver 2 State: On

Remote command:
n.a.

User Coding

Calls the "User Coding" menu.

From the "User Coding" menu, the "File Select" windows for saving and recalling user-defined channel coding and the "File Manager" can be called.

Files with user coding are files with the predefined file extension *.3g_ccod_dl. The filename and the directory they are stored in are user-definable; the file extension is assigned automatically.

The complete channel coding settings are saved and recalled.

Remote command:

```
[ :SOURCE<hw> ] :BB:W3GPp:BSTation:ENHanced:CHANnel:DPCH:CCODing:
USER:CATalog? on page 328
```

```
[ :SOURCE<hw> ] :BB:W3GPp:BSTation:ENHanced:CHANnel<ch0>:DPCH:
CCODing:USER:STORe on page 329
```

```
[ :SOURCE<hw> ] :BB:W3GPp:BSTation:ENHanced:CHANnel<ch0>:DPCH:
CCODing:USER:LOAD on page 328
```

Slot Format (DPDCH)

Enters the slot format. The slot format (and thus the symbol rate, the pilot length and the TFCl state) depends on the coding type selected.

Remote command:

```
[ :SOURCE<hw> ] :BB:W3GPp:BSTation:ENHanced:CHANnel<ch0>:DPCH:
CCODing:SFORmat on page 325
```

Symbol Rate (DPDCH)

Displays the symbol rate.

The symbol rate is determined by the slot format set.

Remote command:

```
[ :SOURCE<hw> ] :BB:W3GPp:BSTation:ENHanced:CHANnel<ch0>:DPCH:
CCODing:SRATe? on page 326
```

Bits per Frame (DPDCH)

Displays the data bits in the DPDCH component of the DPCH frame at physical level. The value depends on the slot format.

Remote command:

```
[ :SOURCE<hw> ] :BB:W3GPp:BSTation:ENHanced:CHANnel<ch0>:DPCH:
CCODing:BPFRame? on page 325
```

4.16.3 Transport Channel - Enhanced DPCHs BS1

In the "Transport Channel" section, up to seven transport channels (TCHs) can be configured. The first one is always a DCCH; the other six are DTCHs (DTCH1 to 6). The most important parameters of the TCH are displayed (data source and transport block

size). The associated parameters shown in the section below depend on which TCH is selected.

A wide arrow beneath the block indicates which TCH is selected.

Transport Channel						
DTCH 1 244 PN 9 <input checked="" type="checkbox"/> On	DTCH 2 100 PN 9 <input type="checkbox"/> On	DTCH 3 100 PN 9 <input type="checkbox"/> On	DTCH 4 100 PN 9 <input type="checkbox"/> On	DTCH 5 100 PN 9 <input type="checkbox"/> On	DTCH 6 100 PN 9 <input type="checkbox"/> On	DCCH 100 PN 9 <input checked="" type="checkbox"/> On
Data Source					PN 9	
Transport Time Intervall					20 ms	
Transport Blocks					1	
Transport Block Size					244	
Size Of CRC					16	
Rate Matching Attribute					256	
DTX Indication Bits					0	
Error Protection					Conv 1/3	
Interleaver 1 State					<input checked="" type="checkbox"/> On	
Interleaver 2 State					<input checked="" type="checkbox"/> On	

Transport Channel State

Activates or deactivates the transport channel.

Remote command:

`[:SOURce<hw>] :BB:W3Gpp:BSTation:ENHanced:CHANnel<ch0>:DPCH: TCHannel<di0>:STATE` on page 333

In case of remote control, DCCH corresponds to :TCHannel0, DTCH1 to :TCHannel1, etc.

Data Source

Selects the data source for the transport channel.

The following standard data sources are available:

- "All 0, All 1"
An internally generated sequence containing 0 data or 1 data.
- "PNxx"
An internally generated pseudo-random noise sequence.
- "Pattern"
An internally generated sequence according to a bit pattern.
Use the "Pattern" box to define the bit pattern.
- "Data List/Select DList"
A binary data from a data list, internally or externally generated.
Select "Select DList" to access the standard "Select List" dialog.
 - Select the "Select Data List > navigate to the list file *.dm_iqd > Select" to select an existing data list.
 - Use the "New" and "Edit" functions to create internally new data list or to edit an existing one.

- Use the standard "File Manager" function to transfer external data lists to the instrument.

See also "Main Dialog > Data List Management".

Remote command:

```
[ :SOURce<hw> ] :BB:W3GPp:BSTation:ENHanced:CHANnel<ch0>:DPCH:
TCHannel<di0>:DATA on page 330
```

```
[ :SOURce<hw> ] :BB:W3GPp:BSTation:ENHanced:CHANnel<ch0>:DPCH:
TCHannel<di0>:DATA:PATtern on page 331
```

```
[ :SOURce<hw> ] :BB:W3GPp:BSTation:ENHanced:CHANnel<ch0>:DPCH:
TCHannel<di0>:DATA:DSElect on page 331
```

Transport Time Interval

Sets the number of frames into which a TCH is divided. This setting also defines the interleaver depth.

Remote command:

```
[ :SOURce<hw> ] :BB:W3GPp:BSTation:ENHanced:CHANnel<ch0>:DPCH:
TCHannel<di0>:TTINterval on page 334
```

Transport Block

Sets the number of transport blocks for the TCH.

Remote command:

```
[ :SOURce<hw> ] :BB:W3GPp:BSTation:ENHanced:CHANnel<ch0>:DPCH:
TCHannel<di0>:TBCount on page 333
```

Transport Block Size

Sets the size of the transport block at the channel coding input.

Remote command:

```
[ :SOURce<hw> ] :BB:W3GPp:BSTation:ENHanced:CHANnel<ch0>:DPCH:
TCHannel<di0>:TBSize on page 334
```

Size of CRC

Defines the type (length) of the CRC. Checksum determination can also be deactivated (setting "None").

Remote command:

```
[ :SOURce<hw> ] :BB:W3GPp:BSTation:ENHanced:CHANnel<ch0>:DPCH:
TCHannel<di0>:CRCSize on page 330
```

Rate Matching Attribute

Sets data rate matching.

Remote command:

```
[ :SOURce<hw> ] :BB:W3GPp:BSTation:ENHanced:CHANnel<ch0>:DPCH:
TCHannel<di0>:RMATtribute on page 333
```

DTX Indication Bits

Sets the number of DTX (discontinuous transmission) bits. These bits are entered in the data stream between rate matching and interleaver 1. Channel coding of BTFD reference measurement channels Rate 2 and Rate 3 includes DTX267 and DTX644, respectively (see 3GPP TS 34.121).

Remote command:

```
[ :SOURCE<hw> ] :BB:W3GPP:BSTation:ENHanced:CHANnel<ch0>:DPCH:
TCHannel<di0>:DTX on page 332
```

Error Protection

Selects error protection.

"None"	No error protection
"Turbo 1/3"	Turbo coder of rate 1/3 in accordance with the 3GPP specifications.
"Conv 1/2 1/3"	Convolution coder of rate 1/2 or 1/3 with generator polynomials defined by 3GPP.

Remote command:

```
[ :SOURCE<hw> ] :BB:W3GPP:BSTation:ENHanced:CHANnel<ch0>:DPCH:
TCHannel<di0>:EPRotectio on page 332
```

Interleaver 1 State

Activates or deactivates channel coding interleaver state 1 of the transport channel. Interleaver state 1 can be set independently in each TCH. Activation does not change the symbol rate.

Remote command:

```
[ :SOURCE<hw> ] :BB:W3GPP:BSTation:ENHanced:CHANnel<ch0>:DPCH:
TCHannel<di0>:INTerleaver on page 332
```

Interleaver 2 State

Activates or deactivates channel coding interleaver state 2 of all the transport channels. Interleaver state 2 can only be set for all the TCHs together. Activation does not change the symbol rate.

Remote command:

```
[ :SOURCE<hw> ] :BB:W3GPP:BSTation:ENHanced:CHANnel<ch0>:DPCH:
INTerleaver2 on page 329
```

4.16.4 Error Insertion - Enhanced DPCHs BS1

In the "Bit/Block Error Insertion" sections, errors can be inserted into the data source and into the CRC checksum, for example, to check the bit and block error rate testers.

Bit Error State (Enhanced DPCHs)

Activates or deactivates bit error generation.

Bit errors are inserted into the data fields of the enhanced channels. When channel coding is active, it is possible to select the layer in which the errors are inserted (physical or transport layer).

When the data source is read out, individual bits are deliberately inverted at random points in the data bitstream at the specified error rate so that invalid signal is simulated.

Remote command:

```
[ :SOURCE<hw> ] :BB:W3GPP:BSTation:ENHanced:CHANnel<ch0>:DPCH:
DERRor:BIT:STATE on page 339
```

Bit Error Rate

Sets the bit error rate.

Remote command:

```
[ :SOURCE<hw> ] :BB:W3GPP:BSTation:ENHanced:CHANnel<ch0>:DPCH:
DERRor:BIT:RATE on page 339
```

Insert Errors On

Selects the layer in the coding process at which bit errors are inserted.

"Transport layer" Bit errors are inserted in the transport layer.
This selection is only available when channel coding is active.

"Physical layer" Bit errors are inserted in the physical layer.

Remote command:

```
[ :SOURCE<hw> ] :BB:W3GPP:BSTation:ENHanced:CHANnel<ch0>:DPCH:
DERRor:BIT:LAYer on page 339
```

Block Error State

Activates or deactivates block error generation.

The CRC checksum is determined and then the last bit is inverted at the specified error probability in order to simulate an invalid signal.

Remote command:

```
[ :SOURCE<hw> ] :BB:W3GPP:BSTation:ENHanced:CHANnel<ch0>:DPCH:
DERRor:BLOCK:STATE on page 340
```

Block Error Rate

Sets block error rate.

Remote command:

```
[ :SOURCE<hw> ] :BB:W3GPP:BSTation:ENHanced:CHANnel<ch0>:DPCH:
DERRor:BLOCK:RATE on page 340
```

4.16.5 Dynamic Power Control - Enhanced DPCHs BS1

The "Dynamic Power Control" section comprises the settings necessary to configure the power of the selected enhanced channel. Power can be increased or decreased within the predefined dynamic range ("Up Range + Down Range") and with the predefined step size ("Power Step") depending on a control signal.

The control signal can be provided:

- Internally (TPC pattern)
- Manually

See [Mode](#) .

The "Dynamic Power Control" is suitable for testing of closed (inner) loop Power Control in two test constellations:

- To test whether the DUT (receiver) correctly performs the SIR (signal to interference ratio) measurement and inserts the corresponding bits into the TPC field of its transmitting signal.
The TPC control information is provided by an external "Dynamic Power Control" signal.
- To test whether the DUT (transmitter) responds with the correct output power to received TPC bits.
To perform this test, use a data list adapted to the test condition as TPC data source. The TPC pattern is defined in the channel table.

The power change of the channels is performed by a switchover of a mapping table, controlled by the "Dynamic Power Control" signal. This signal is queried at the beginning of the pilot field. The limited number of mappings restricts the maximum dynamic range to 30 dB and the step width to min. 0.5 dB. The output power of each channel is thus limited to the dynamic range around the channel-specific start power.



Obtaining optimum signal quality

Do not set the "Power Up Range" higher than necessary because the mapping of the I/Q level in this range must be maintained as a level margin.

Example: Principle of the downlink dynamic power control

"Power Up Range = Power Down Range"

Channel#11/13, "Direction > Up"

Channel#12, "Direction > Down"

External control signal is provided

The [Figure 4-12](#) illustrates the adjustment in the channel power of these three enhanced channels.

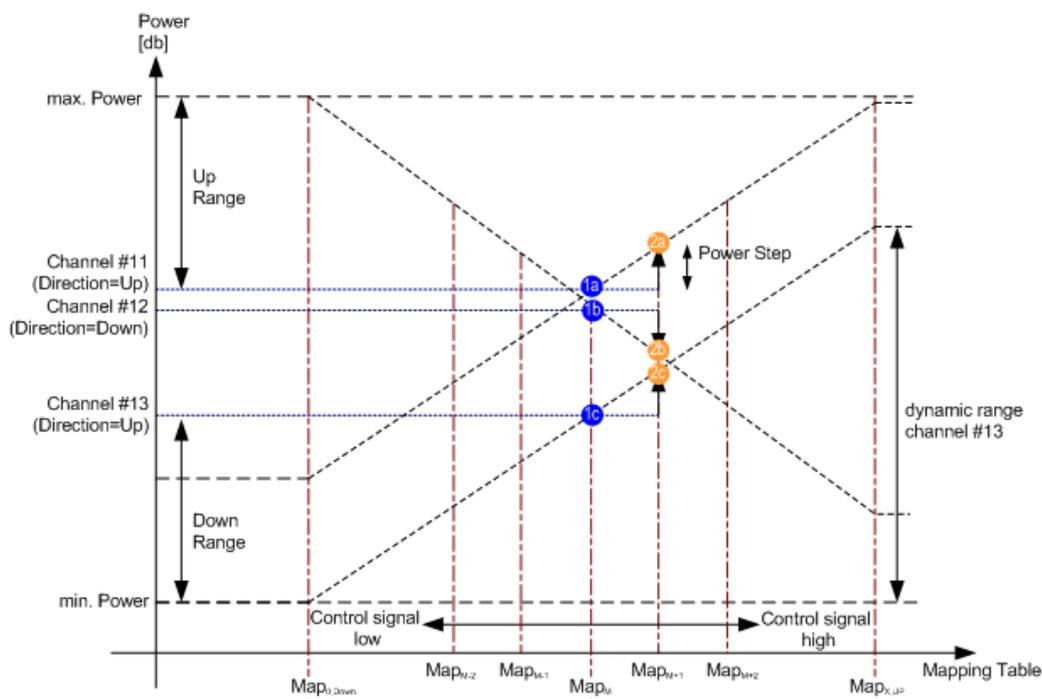

Figure 4-12: Dynamic Power Control (downlink)

- 1a, 1b, 1c = Start power of the corresponding channel#11 to 13
- 2a, 2b, 2c = Resulting channel power of channel#11 to 13 at high level of the control signal at the beginning of the pilot field.

The available mappings are shown on the X-axis with Map_M being the starting point. In this point, all channels have the start power as selected in the channel table.

At the beginning of the pilot field, the provided control signal is queried in each time-slot. Receiving of a logical "1" results in a switchover to the right mapping Map_{M+1} . This means an increase of the output power by "Power Step" for all channels with "Power Control Mode Up". In this example, the power of channel 12 is decreased by the same value (see Figure 4-12).

Receiving of a logical "0" results in a switchover to the left mapping Map_{M-1} . This means a reduction of the output power by "Power Step" for all channels with "Power Control Mode Down". The power of channel 12 is increased by the same value.

The "Dynamic Power Control" settings are performed in the "Enhanced Settings" menu of the channel table.

Dynamic Power Control State

Activates or deactivates the "Dynamic Power Control" for the selected enhanced channel.

With activated Dynamic Power Control, the power of the enhanced channel can be increased or decreased within the predefined dynamic range ("Up Range" + "Down Range"). The power is varied with the predefined step size ("Power Step").

The "Direction" settings determine if the channel power is increased or decreased by a high level of the control signal.

Remote command:

```
[ :SOURCE<hw> ] :BB:W3GPP:BSTation:ENHanced:CHANnel<ch0>:DPCH:
DPControl:STATE on page 337
```

Mode

Selects the control signal for Dynamic Power Control.

- | | |
|----------|---|
| "TPC" | The TPC pattern is used for Dynamic Power Control. This selection corresponds to selection mis-use TPC for not enhanced DPCHs. |
| "Manual" | The control signal is manually produced by selecting one of the buttons 0 or 1. Button 1 corresponds to a positive control signal, button 0 to a negative control signal.
The channel power is increased or decreased depending on the "Direction" setting by the selected power step. |

Remote command:

```
[ :SOURCE<hw> ] :BB:W3GPP:BSTation:ENHanced:CHANnel<ch0>:DPCH:
DPControl:MODE on page 336
[ :SOURCE<hw> ] :BB:W3GPP:BSTation:ENHanced:CHANnel<ch0>:DPCH:
DPControl:STEP:MANual on page 337
```

Direction

Determines whether the channel power is increased or decreased by a high level of the control signal (see [Figure 4-12](#)).

- | | |
|--------|---|
| "Up" | A high level of the control signal leads to an increase of channel power. |
| "Down" | A high level of the control signal leads to a decrease of channel power. |

Remote command:

```
[ :SOURce<hw> ] :BB:W3GPP:BSTation:ENHanced:CHANnel<ch0>:DPCH:
DPControl:DIRection on page 336
```

Power Step

Sets step width by which the channel power of the selected enhanced channel in the timeslot grid is increased or decreased. The variation applies to the set dynamic range ("Up Range + Down Range") and if "Dynamic Power Control" is enabled.

The start power of the channel is set in the "Power" column of the channel table.

Remote command:

```
[ :SOURce<hw> ] :BB:W3GPP:BSTation:ENHanced:CHANnel<ch0>:DPCH:
DPControl:STEP [ :EXTernal ] on page 338
```

Up Range / Down Range

Sets dynamic range by which – with "Dynamic Power Control" switched on – the channel powers of the enhanced channels can be increased. The resulting "Dynamic Power Control" dynamic range ("Up Range" + "Down Range") depends on the selected "Power Step" and is as follow:

- For "Power Step" < 1 dB, the dynamic range ("Up Range" + "Down Range") <= 30 dB
- For "Power Step" => 1 dB, the dynamic range ("Up Range" + "Down Range") <= 60 dB

Remote command:

```
[ :SOURce<hw> ] :BB:W3GPP:BSTation<st>:ENHanced:CHANnel<ch0>:DPCH:
DPControl:RANGE:UP on page 337
[ :SOURce<hw> ] :BB:W3GPP:BSTation:ENHanced:CHANnel<ch0>:DPCH:
DPControl:RANGE:DOWN on page 337
```

Power Control Graph

Indicates the deviation of the channel power (delta POW) from the set power start value of the corresponding enhanced channels.

The graph is automatically displayed with "Dynamic Power Control" switched on.

Note: A realtime update of the display in the timeslot (= 0.667 ms) is not possible and is performed in a coarser time interval. The power control graph does not display fast channel power changes. The settled state of the control loop is however easy to recognize.

Remote command:

```
[ :SOURce<hw> ] :BB:W3GPP:BSTation:ENHanced:CHANnel<ch0>:DPCH:
DPControl [ :POWER ] ? on page 338
```

4.17 S-CCPCH Settings - BS Channel Table

Access:

- ▶ Select "3GPP FDD > BS > Channel Table > Channel type > S-CCPCH > DPCCH Settings > Config...".

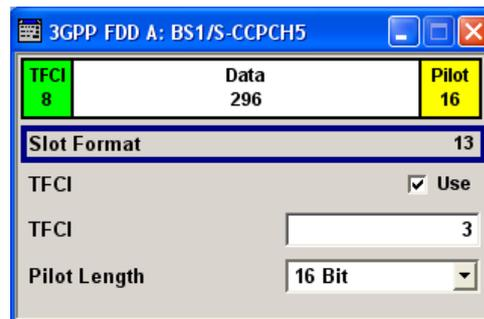

The selected slot format determines the provided settings. Whenever the "TFCI State" and [Pilot Length] settings are changed, the slot format is adjusted accordingly.

Slot Structure (S-CCPCH)

Displays the slot structure.

TFCI	Data	Pilot
8	296	16

The structure of the slot depends on the selected slot format (see also 3GPP TS 25.211, Table 18: Secondary CCPCH fields)

Slot Format (S-CCPCH)

Displays the slot format.

The slot format displayed changes when a change is made to the TFCI and Pilot control field settings.

Remote command:
n.a.

Use TFCI

Activates TFCI field usage.

Remote command:

`[:SOURCE<hw>] :BB:W3Gpp:BSStation<st>:CHANnel<ch0>:DPCCh:TFCI:STATE` on page 282

The remote-control command is not valid for multi channel mode.

TFCI Value

Enters the value of the TFCI field (Transport Format Combination Indicator) . This value is used to select a combination of 30 bits, which is divided into two groups of 15 successive slots.

Remote command:

[\[:SOURCE<hw>\]:BB:W3GPP:BSTation<st>:CHANnel<ch0>:DPCCh:TFCI](#)

on page 282

The remote-control command is not valid for multi channel mode.

Pilot Length

Sets the length of the pilot fields.

The range of values for this parameter depends on the channel type and the symbol rate.

To achieve a constant slot length, the data fields are lengthened or shortened depending on the pilot length, as defined in the standard.

Note: The pilot fields of all active power-controlled DPCHs must be of the same length if [Dynamic Power Control State](#) with external control signal is active.

Remote command:

[\[:SOURCE<hw>\]:BB:W3GPP:BSTation<st>:CHANnel<ch0>:DPCCh:PLENgtH](#)

on page 281

The remote-control command is not valid for multi channel mode.

4.18 Config AICH/AP-AICH - BS Channel Table

Access:

- ▶ Select "3GPP FDD > BS > Channel Table > AICH/AP-AICH > DPCCH Sett > Config...".

The dialog comprises the parameters for configuring the signature pattern and selecting the slot.

Signature ACK/NACK Pattern

Enters the 16-bit pattern for the ACK/NACK field.

This field is used by the base station to acknowledge, refuse or ignore requests of up to 16 user equipment.

Note: Pattern + is entered using the numeric key 1. Pattern - is entered via the numeric key +/-.

""+" = ACK"	The ACK is sent. Transmission was successful and correct.
""-" = NACK"	The NACK is sent. Transmission was not correct.
""0" = DTX"	Nothing is sent. Transmission is interrupted (Discontinuous Transmission (DTX)).

Remote command:

[\[:SOURCE<hw>\]:BB:W3GPP:BSTation<st>:CHANnel<ch0>:AICH:SAPattern](#)

on page 277

[\[:SOURCE<hw>\]:BB:W3GPP:BSTation<st>:CHANnel<ch0>:APAIch:](#)

[SAPattern](#) on page 278

Access Slot

Selects the slot in which the burst is transmitted.

Remote command:

`[:SOURCE<hw>] :BB:W3GPP:BSTation<st>:CHANNEL<ch0>:AICH:ASLOT`
on page 277

`[:SOURCE<hw>] :BB:W3GPP:BSTation<st>:CHANNEL<ch0>:APAIch:ASLOT`
on page 277

4.19 DPCCH Settings - BS Channel Table

- To access the dialog for configuring the fields of the dedicated physical control channel, select "3GPP FDD > BS > Channel Table > DPCH > DPCCH Settings > Config...".

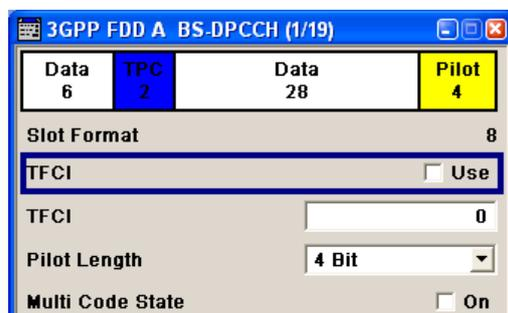

The selected slot format determines the provided settings. Whenever the "TFCI State" and "Pilot Length" settings are changed, the slot format is adjusted accordingly.

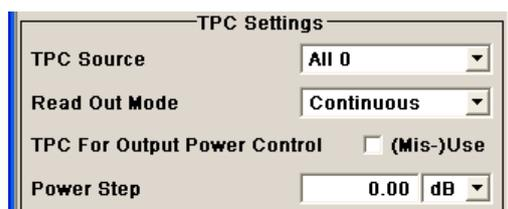

The "TPC Settings" section is where the TPC field is set.

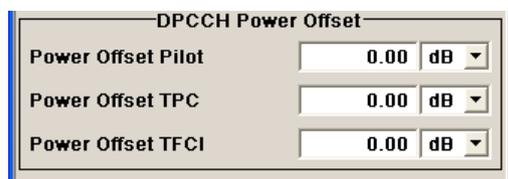

The "DPCCH Power Offset" section is where the power offset of the control fields to the set channel power is set.

4.19.1 Common Slot Structure (DPCCH)

Data 6	TPC 2	Data 28	Pilot 4
-----------	----------	------------	------------

The upper section of the dialog shows the structure. It depends on the slot format selected (see also 3GPP TS 25.211, Table 11: DPDCH and DPCCH fields)

Slot Format (DPCCH)

Displays the slot format.

The slot format displayed changes when a change is made to the TFCI and Pilot control field settings.

Remote command:

n.a.

Use TFCI

Activates TFCI field usage.

Remote command:

`[:SOURCE<hw>] :BB:W3GPP:BSTation<st>:CHANnel<ch0>:DPCCh:TFCI:STATE` on page 282

The remote-control command is not valid for multi channel mode.

TFCI Value

Enters the value of the TFCI field (Transport Format Combination Indicator) . This value is used to select a combination of 30 bits, which is divided into two groups of 15 successive slots.

Remote command:

`[:SOURCE<hw>] :BB:W3GPP:BSTation<st>:CHANnel<ch0>:DPCCh:TFCI` on page 282

The remote-control command is not valid for multi channel mode.

Pilot Length

Sets the length of the pilot fields.

The range of values for this parameter depends on the channel type and the symbol rate.

To achieve a constant slot length, the data fields are lengthened or shortened depending on the pilot length, as defined in the standard.

Note: The pilot fields of all active power-controlled DPCHs must be of the same length if [Dynamic Power Control State](#) with external control signal is active.

Remote command:

`[:SOURCE<hw>] :BB:W3GPP:BSTation<st>:CHANnel<ch0>:DPCCh:PLENght` on page 281

The remote-control command is not valid for multi channel mode.

Multicode State (DPCCH)

Activates multicode transmission.

Multicode transmission can be activated for a group of channels destined for the same receiver that is to say, belonging to a radio link. The first channel of this group is used as the master channel.

With multicode transmission, the common components (Pilot, TPC and TCFI) for all the channels are spread using the spreading code of the master channel.

This parameter is only available for the DPCHs.

Note: The remote-control command is not valid for multichannel mode.

Remote command:

`[:SOURCE<hw>] :BB:W3GPp:BSTation<st>:CHANnel<ch0>:DPCCh:MCODE`
on page 280

4.19.2 TPC Settings

Access:

1. Select "3GPP FDD > BS > Channel Table > DPCH > DPCCH Settings > Config...".
2. Select "TPC Settings".

The "TPC Settings" section is where the TPC data source and read out mode are set.

TPC Data Source (DPCCH)

Selects the data source for the TPC field (Transmit Power Control). This field is used to control the transmit power.

The following standard data sources are available:

- "All 0, All 1"
An internally generated sequence containing 0 data or 1 data.
- "Pattern"
An internally generated sequence according to a bit pattern.
Use the "Pattern" box to define the bit pattern.
- "Data List / Select TPC List"
A binary data from a data list, internally or externally generated.
Select "Select TPC List" to access the standard "Select List" dialog.
See also "Main Dialog > Data List Management".

Remote command:

`[:SOURCE<hw>] :BB:W3GPp:BSTation<st>:CHANnel<ch0>:DPCCh:TPC:DATA`
on page 283

`[:SOURCE<hw>] :BB:W3GPp:BSTation<st>:CHANnel<ch0>:DPCCh:TPC:DATA: PATTern`
on page 284

`[:SOURCE<hw>] :BB:W3GPP:BSTation<st>:CHANnel<ch0>:DPCCh:TPC:DATA:DSElect` on page 284

The remote-control command is not valid for multichannel mode.

TPC Read Out Mode (DPCCH)

Defines TPC data usage.

The TPC bits are used to signal the increase or reduction in transmit power to the called station. For all read out modes, 1 bit is taken from the data stream for the TPC field for each slot. The bit is entered into the bitstream several times, depending on the symbol rate. The difference between the modes lies in the usage of the TPC bits.

The different modes can be used to set a specific output power and then let the power oscillate around this value. For example, if the power is the pattern 11111, the power can be varied with "Single + alt. 01" and "Single + alt. 10". Thus, power measurements can be carried out at quasi-constant power.

- "Continuous:"
The TPC bits are used cyclically.
- "Single + All 0"
The TPC bits are used once, and then the TPC sequence is continued with 0 bits.
- "Single + All 1"
The TPC bits are used once, and then the TPC sequence is continued with 1 bit.
- "Single + alt. 01"
The TPC bits are used once and then the TPC sequence is continued with 0 bits and 1 bit alternately. Bits are appended in multiples, depending on the symbol rate, for example, 00001111.
- "Single + alt. 10"
The TPC bits are used once and then the TPC sequence is continued with 1 bit and 0 bits alternately. Bits are appended in multiples, depending on the symbol rate, for example, 11110000.

Use the parameter "Read Out Mode" together with the option "TPC For Output Power Control (Mis-) Use" to generate various output power profiles.

Remote command:

`[:SOURCE<hw>] :BB:W3GPP:BSTation<st>:CHANnel<ch0>:DPCCh:TPC:READ` on page 285

The remote-control commands are not valid for multichannel mode.

Misuse TPC for Output Power Control (DPCCH)

Defines "mis-" use of the TPC data.

The TPC bits are used to signal the increase or reduction in transmit power to the called station.

If "(Mis-) use TPC for output power control" is activated, the specified pattern is used to vary the intrinsic transmit power over time. A bit of this pattern is removed for each slot in order to increase (bit = "1") or reduce (bit = "0") the channel power by the specified power step ("Power Step"). The upper limit is 0 dB and the lower limit -60 dB.

The following envelope is produced with the settings:

- Channel power = 0 dB
- Power step = 1.0 dB
- Pattern = "001110100000011"

- "TPC Read Out Mode = Continuous"

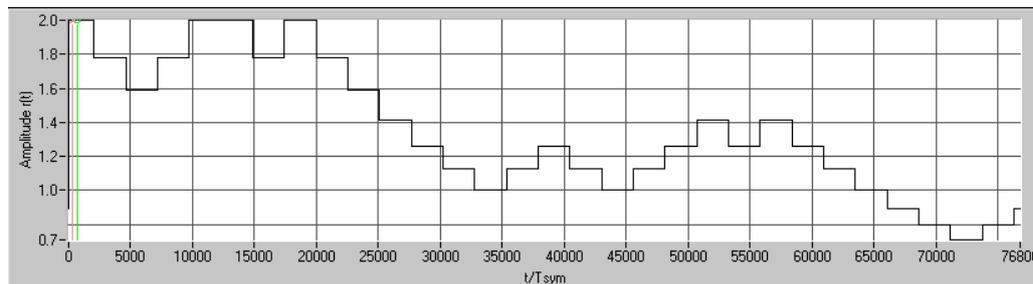

Figure 4-13: Dynamic change of channel power (continuous)

Note: The change in power is always carried out (as stipulated in the standard) at the start of the slot pilot field. Misuse TPC for Output Power Control is not available for enhanced DPCHs. Power Control via TPC pattern for enhanced channels can be selected for active Dynamic Power Control (see [Chapter 4.16.5, "Dynamic Power Control - Enhanced DPCHs BS1"](#), on page 125).

Remote command:

```
[ :SOURCE<hw> ] :BB:W3GPp:BSTation<st>:CHANnel<ch0>:DPCCh:TPC:
MISuse on page 284
```

The remote-control command is not valid for multichannel mode.

TPC Power Step (DPCCH)

Sets the step width of the power change in dB for "(Mis-) use TPC for output power control".

Note: Misuse TPC for Output Power Control is not available for enhanced DPCHs. Power Control via TPC pattern for enhanced channels can be selected for active Dynamic Power Control (see [Chapter 4.16.5, "Dynamic Power Control - Enhanced DPCHs BS1"](#), on page 125).

Remote command:

```
[ :SOURCE<hw> ] :BB:W3GPp:BSTation<st>:CHANnel<ch0>:DPCCh:TPC:PSTep
on page 285
```

The remote-control command is not valid for multichannel mode.

4.19.3 DPCCH Power Offset

DPCCH Power Offset	
Power Offset Pilot	0.00 dB
Power Offset TPC	0.00 dB
Power Offset TFCI	0.00 dB

This section provides the parameters for configuring power offsets of the control fields to the channel power.

Power Offset Pilot (DPCCH)

Sets the power offset of the pilot field to the channel power in dB.

Remote command:

`[:SOURCE<hw>] :BB:W3GPP:BSTation<st>:CHANnel<ch0>:DPCCh:POFFset:PILOt` on page 281

The remote-control command is not valid for multichannel mode.

Power Offset TPC (DPCCH)

Sets the power offset of the TPC field to the channel power in dB.

Remote command:

`[:SOURCE<hw>] :BB:W3GPP:BSTation<st>:CHANnel<ch0>:DPCCh:POFFset:TPC` on page 282

The remote-control command is not valid for multichannel mode.

Power Offset TFCI (DPCCH)

Sets the power offset of the TFCI field to the channel power in dB.

Remote command:

`[:SOURCE<hw>] :BB:W3GPP:BSTation<st>:CHANnel<ch0>:DPCCh:POFFset:TFCI` on page 281

The remote-control command is not valid for multichannel mode.

4.20 Config E-AGCH - BS Channel Table

Access:

- ▶ Select "3GPP FDD > BS > Channel Table > E-AGCH > DPCCH Settings > Config...".

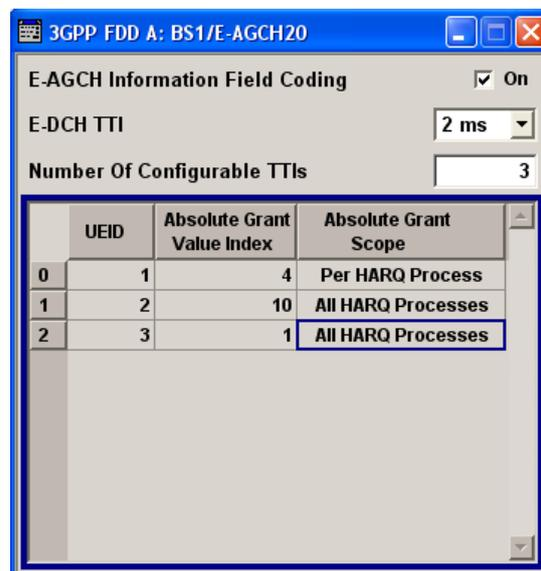

The dialog provides the parameter required to configure the HSUPA control channels.

E-AGCH Information Field Coding

Enables/disables the information coding. Disabling this parameter corresponds to a standard operation, i.e. no coding is performed and the data is sent uncoded. Enabling this parameter allows you to configure the way the data is coded.

Remote command:

```
[ :SOURCE<hw> ] :BB:W3GPp:BSTation<st>:CHANnel<ch0> [ :HSUPa ] :EAGCh:IFCoding on page 310
```

E-DCH TTI

Switches between 2 ms and 10 ms. The processing duration also influences the number of used slots.

Remote command:

```
[ :SOURCE<hw> ] :BB:W3GPp:BSTation<st>:CHANnel<ch0> [ :HSUPa ] :EAGCh:TTIEdch on page 311
```

Number of Configurable TTIs

Sets the number of configurable TTIs.

Remote command:

```
[ :SOURCE<hw> ] :BB:W3GPp:BSTation<st>:CHANnel<ch0> [ :HSUPa ] :EAGCh:TTICount on page 311
```

E-AGCH Table

Comprises the parameters provided for an E-AGCH channel.

UEID (A-GCH) ← E-AGCH Table

Sets the UE Id for the selected TTI.

Remote command:

```
[ :SOURCE<hw> ] :BB:W3GPp:BSTation<st>:CHANnel<ch0> [ :HSUPa ] :EAGCh:TTI<di0>:UEID on page 311
```

Absolute Grant Value Index ← E-AGCH Table

Sets the Index for the selected TTI. According to the TS 25.212 (4.10.1 A.1), there is a cross-reference between the grant index and the grant value. The TTI configuration of the table is used cyclically. Depending on the selection made for the parameter "E-DCH TTI", each table row corresponds to a 2ms TTI or to a 10ms TTI.

Remote command:

```
[ :SOURCE<hw> ] :BB:W3GPp:BSTation<st>:CHANnel<ch0> [ :HSUPa ] :EAGCh:TTI<di0>:AGVIndex on page 311
```

Absolute Grant Scope ← E-AGCH Table

Sets the scope of the selected grant. According to the TS 25.321, the impact of each grant on the UE depends on this parameter.

For E-DCH TTI = 10ms, the "Absolute Grant Scope" is always All HARQ Processes.

Remote command:

```
[ :SOURCE<hw> ] :BB:W3GPp:BSTation<st>:CHANnel<ch0> [ :HSUPa ] :EAGCh:TTI<di0>:AGScope on page 310
```

4.21 Config E-RGCH/E-HICH - BS Channel Table

Access:

- ▶ Select "3GPP FDD > BS > Channel Table > E-RGCH/E-HICH > DPCCH Settings > Config...".

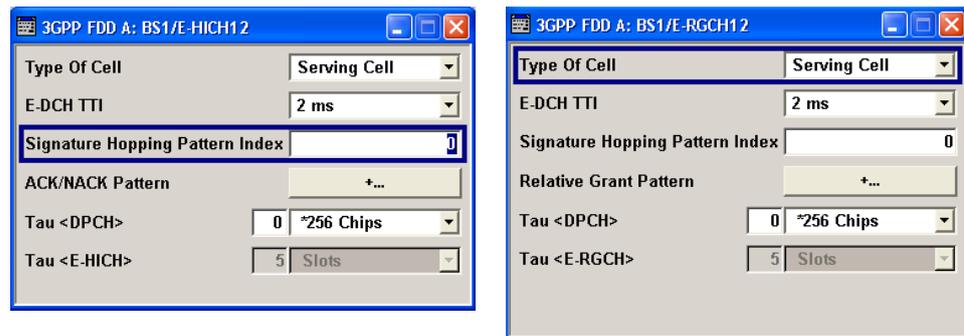

The dialogs provide the parameters for configuring the corresponding HSUPA control channels.

Type of Cell

Switches between Serving Cell and Non-Serving Cell. The cell type determines the number of used slots.

Remote command:

```
[ :SOURCE<hw> ] :BB:W3GPp:BSTation<st>:CHANnel<ch0> [ :HSUPa ] :ERGCh:CTYPe on page 314
```

```
[ :SOURCE<hw> ] :BB:W3GPp:BSTation<st>:CHANnel<ch0> [ :HSUPa ] :EHICH:CTYPe on page 312
```

E-DCH TTI

Switches between 2 ms and 10 ms. The processing duration also influences the number of used slots.

Remote command:

```
[ :SOURCE<hw> ] :BB:W3GPp:BSTation<st>:CHANnel<ch0> [ :HSUPa ] :ERGCh:TTIEdch on page 315
```

```
[ :SOURCE<hw> ] :BB:W3GPp:BSTation<st>:CHANnel<ch0> [ :HSUPa ] :EHICH:TTIEdch on page 314
```

Signature Hopping Pattern Index – HSUPA BS

Enters a value that identifies the user equipment. The values are defined in TS 25.211.

Remote command:

```
[ :SOURCE<hw> ] :BB:W3GPp:BSTation<st>:CHANnel<ch0> [ :HSUPa ] :ERGCh:SSINdex on page 315
```

```
[ :SOURCE<hw> ] :BB:W3GPp:BSTation<st>:CHANnel<ch0> [ :HSUPa ] :EHICH:SSINdex on page 313
```

Relative Grant Pattern

(This feature is available for E-RGCH only.)

Enters a pattern: 0 = Hold, + = Up, - = Down.

Note: Pattern + is entered using the numeric key 1. Pattern - is entered via the numeric key +/-.

For Non-Serving Cell, "1" is not allowed.

Remote command:

`[:SOURCE<hw>] :BB:W3GPp:BSTation<st>:CHANnel<ch0> [:HSUPa] :ERGCh:RGPattern` on page 315

ACK/NACK Pattern

(This feature is available for E-HICH only.)

Enters the pattern for the ACK/NACK field.

For Non-Serving Cell, only "+" (ACK) and "0" (no signal) is allowed. For Serving Cells only "+" (ACK) and "-" (NACK) is allowed.

Note: Pattern + is entered using the numeric key 1. Pattern - is entered via the numeric key +/-.

Remote command:

`[:SOURCE<hw>] :BB:W3GPp:BSTation<st>:CHANnel<ch0> [:HSUPa] :EHICH:RGPattern` on page 313

Tau DPCH

Enters the offset of the downlink dedicated offset channels.

Remote command:

`[:SOURCE<hw>] :BB:W3GPp:BSTation<st>:CHANnel<ch0> [:HSUPa] :EHICH:DTAU` on page 312

`[:SOURCE<hw>] :BB:W3GPp:BSTation<st>:CHANnel<ch0> [:HSUPa] :ERGCh:DTAU` on page 314

Tau E-RGCH/E-HICH

Displays the offset of the P-CCPCH frame boundary.

Remote command:

`[:SOURCE<hw>] :BB:W3GPp:BSTation<st>:CHANnel<ch0> [:HSUPa] :EHICH:ETAU?` on page 313

`[:SOURCE<hw>] :BB:W3GPp:BSTation<st>:CHANnel<ch0> [:HSUPa] :ERGCh:ETAU?` on page 314

4.22 Config F-DPCH - BS Channel Table

This section provides the description of the setting parameters for the fractional dedicated physical control channel.

- ▶ To access the dialog, select "3GPP FDD > BS > Channel Table > F-DPCCH > DPCCH Settings > Config".

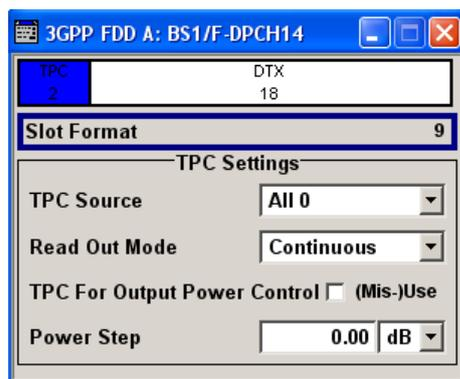

4.22.1 Common Settings

The upper section of the dialog shows the slot structure and format.

Slot Format (F-DPCH)

Displays the slot format as selected with the parameter "Slot Format" in the Channel Table.

The corresponding slot structure is displayed above the parameter.

DTX 2	TPC 2	DTX 16
----------	----------	-----------

Slot formats 1 .. 9 are enabled only for instruments equipped with option R&S SMBV-K59.

The difference between the F-DPCH slot formats is the position of the 2 bits TPC field.

Remote command:

n.a.

4.22.2 TPC Settings

The TPC settings in the lower section contain the parameters for configuring TPC data source and read out mode.

TPC Source

Selects the data source for the F-DPCH channel.

The following standard data sources are available:

- "All 0, All 1"
An internally generated sequence containing 0 data or 1 data.
- "PNxx"
An internally generated pseudo-random noise sequence.
- "Pattern"
An internally generated sequence according to a bit pattern.
Use the "Pattern" box to define the bit pattern.
- "Data List/Select DList"
A binary data from a data list, internally or externally generated.

Select "Select DList" to access the standard "Select List" dialog.

- Select the "Select Data List > navigate to the list file *.dm_iqd > Select" to select an existing data list.
- Use the "New" and "Edit" functions to create internally new data list or to edit an existing one.
- Use the standard "File Manager" function to transfer external data lists to the instrument.

See also "Main Dialog > Data List Management".

Remote command:

`[:SOURce<hw>] :BB:W3GPp:BSTation<st>:CHANnel<ch0>:FDPCh:DPCh:TPC:DATA` on page 286

`[:SOURce<hw>] :BB:W3GPp:BSTation<st>:CHANnel<ch0>:FDPCh:DPCh:TPC:DATA:DSElect` on page 286

`[:SOURce<hw>] :BB:W3GPp:BSTation<st>:CHANnel<ch0>:FDPCh:DPCh:TPC:DATA:PATtern` on page 287

TPC Read Out Mode (F-DPCH)

Defines TPC data usage.

The TPC bits are used to signal the increase or reduction in transmit power to the called station. For all read out modes, 1 bit is taken from the data stream for the TPC field for each slot. The bit is entered into the bitstream several times, depending on the symbol rate. The difference between the modes lies in the usage of the TPC bits.

The different modes can be used to set a specific output power and then let the power oscillate around this value. For example, if the power is the pattern 11111, the power can be varied with "Single + alt. 01" and "Single + alt. 10". Thus, power measurements can be carried out at quasi-constant power.

- "Continuous:"
The TPC bits are used cyclically.
- "Single + All 0"
The TPC bits are used once, and then the TPC sequence is continued with 0 bits.
- "Single + All 1"
The TPC bits are used once, and then the TPC sequence is continued with 1 bit.
- "Single + alt. 01"
The TPC bits are used once and then the TPC sequence is continued with 0 bits and 1 bit alternately. Bits as appended in multiples, depending on the symbol rate, for example, 00001111.
- "Single + alt. 10"
The TPC bits are used once and then the TPC sequence is continued with 1 bit and 0 bits alternately. Bits as appended in multiples, depending on by the symbol rate, for example, 11110000.

Use the parameter "Read Out Mode" together with the option "TPC For Output Power Control (Mis-) Use" to generate various output power profiles.

Remote command:

`[:SOURce<hw>] :BB:W3GPp:BSTation<st>:CHANnel<ch0>:FDPCh:DPCh:TPC:READ` on page 288

TPC For Output Power Control (Mis-) Use

Defines "mis-" use of the TPC data.

The TPC bits are used to signal the increase or reduction in transmit power to the called station.

If "(Mis-) use TPC for output power control" is activated, the specified pattern is used to vary the intrinsic transmit power over time. A bit of this pattern is removed for each slot in order to increase (bit = "1") or reduce (bit = "0") the channel power by the specified power step ("Power Step"). The upper limit is 0 dB and the lower limit -60 dB.

The following envelope is produced with the settings:

- Channel power = 0 dB
- Power step = 1.0 dB
- Pattern = "0011110100000011"
- "TPC Read Out Mode = Continuous"

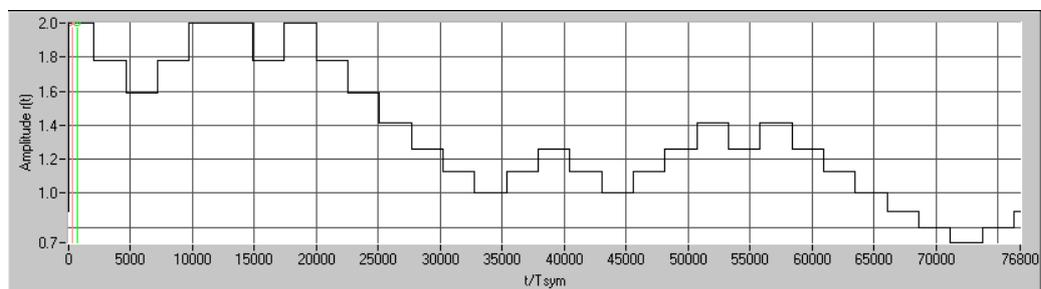

Remote command:

```
[ :SOURce<hw> ] :BB:W3GPp:BSTation<st>:CHANnel<ch0>:FDPCh:DPCh:
TPC:MIUse on page 287
```

TPC Power Step (F-DPCH)

Sets the step width of the power change in dB for "(Mis-) use TPC for output power control".

Remote command:

```
[ :SOURce<hw> ] :BB:W3GPp:BSTation<st>:CHANnel<ch0>:FDPCh:DPCh:
TPC:PSTep on page 288
```

4.23 Multi Channel Assistant - BS

Access:

- ▶ Select "3GPP FDD > BS > Channel Table > Multi Channel Assistant".

The screenshot shows a dialog box titled "3GPP FDD A Basestation 1 Multi Channel Assistant". It contains the following fields and controls:

- Start Channel Number (DPCH): 11
- Stop Channel Number (DPCH): 21
- Channel Type: DPCH (dropdown)
- Slot Format #: 8
- Symbol Rate: 30 ksps (dropdown)
- Channelization Code: 0
- Channelization Code Step: 0
- Power: -30.00 dB (dropdown)
- Power Step: 0.00 dB (dropdown)
- Data Source (DPDCH): PN 9 (dropdown)
- Pattern: 0... (dropdown)
- Select Data List... button
- None (text)
- DPCCH Settings... button (highlighted with a red box)
- Timing Offset: 0
- Timing Offset Step: 0
- Channel State: On
- Accept button

The "Multi Channel Assistant" allows several channels to be set simultaneously and is only available for the channel types DPCH, HS-SCCH, HS QPSK, HS 16QAM and HS 64QAM.

Enhanced state is automatically deactivated. The channel table is only filled with new values when the "Accept" button is pressed.

Start Channel Number

Enters the index for the start channel of the channel range that is set jointly.

Remote command:

n.a.

Stop Channel Number

Enters the index for the stop channel of the channel range that is set jointly.

Remote command:

n.a.

Channel Type

Enters the channel type for the channel range that is set jointly. Available for selection are DPCH, HS-SCCH, HS QPSK, HS 16QAM, or HS 64QAM.

Remote command:

n.a.

Channelization Code

Sets the channelization code for the start channel.

The channel is spread with the specified channelization code (spreading code).

The range of values of the channelization code depends on the symbol rate of the channel.

The range of values runs from 0 to $(\text{chip_rate}/\text{symbol_rate}) - 1$

Remote command:

n.a.

Channelization Code Step

Sets the step width for the channelization code from channel to channel.

The valid range of values for the channelization code of an individual channel must not be exceeded. If the range of values is exceeded, the channelization code is limited automatically.

Remote command:

n.a.

Power

Sets the channel power of the start channel in dB.

The power entered is relative to the powers of the other channels and does not initially relate to the "Level" power display. If [Adjust Total Power to 0dB](#) is executed (top level of the 3GPP dialog), all the power data is relative to 0 dB.

Note: The maximum channel power of 0 dB applies to non-blanked channels (duty cycle 100%). With blanked channels, the maximum value can be increased to values greater than 0 dB .

To increase the value, use the parameter "Adjust Total Power" where the maximum value is calculated as $10 \cdot \log_{10}(1/\text{duty_cycle})$.

The "Power" value is also the starting power of the channel for "Misuse TPC" and "Dynamic Power Control".

Remote command:

n.a.

Power Step

Enters the step width for the change of channel power from channel to channel.

The valid range of values must not be exceeded. If the range of values is exceeded, the power is automatically limited to the permissible of -80 dB to 0 dB.

Remote command:

n.a.

Data Source

Selects data source.

The following standard data sources are available:

- "All 0, All 1"
An internally generated sequence containing 0 data or 1 data.
- "PNxx"
An internally generated pseudo-random noise sequence.
- "Pattern"
An internally generated sequence according to a bit pattern.

Use the "Pattern" box to define the bit pattern.

- "Data List/Select DList"

A binary data from a data list, internally or externally generated.

Select "Select DList" to access the standard "Select List" dialog.

- Select the "Select Data List > navigate to the list file *.dm_iqd > Select" to select an existing data list.
- Use the "New" and "Edit" functions to create internally new data list or to edit an existing one.
- Use the standard "File Manager" function to transfer external data lists to the instrument.

See also "Main Dialog > Data List Management".

Remote command:

n.a.

Channel State

Activates or deactivates all the channels in the set channel range.

Remote command:

n.a.

Accept

Executes automatic completion of the channel table in accordance with the parameters set.

Remote command:

n.a.

DPCH

Access:

Select "3GPP FDD > BS > Channel Table > Multi Channel Assistant > DPCH"

Slot Format ← DPCH

Enters the slot format.

For DPCH channels, the slot formats are 0 to 16.

A slot format defines the structure of a slot made of data and control fields and includes the symbol rate.

The individual parameters of a slot can later be changed, with the slot format being adjusted, if necessary.

This parameter is not available for high-speed channels.

Note: For the "DPCCH Settings", this value is read-only.

Remote command:

n.a.

Symbol Rate ← DPCH

Sets the symbol rate. The range of values depends on the channel selected.

The symbol rate is determined by the slot format set. A change in the symbol rate leads automatically to an adjustment of the slot format.

Remote command:
n.a.

DPCCH Settings ← DPCH

Accesses the dialog for configuring DPCCH channels, see [Chapter 4.19, "DPCCH Settings - BS Channel Table"](#), on page 132.

Remote command:
n.a.

In contrast to setting a single channel, the remote control commands are not available.

Timing Offset ← DPCH

Sets the timing offset for the start channel.

The timing offset determines the shift of the source symbols before interleaving.

The absolute starting time of the frame (slot 0) is shifted relative to the start of the scrambling code sequence by the `timing offset * 256 chips`. This means that whatever the symbol rate, the resolution of the timing offset is always 256 chips.

This procedure is used to reduce the crest factor. A good way to obtain a lower crest factor is to use an offset of 1 from channel to channel, for example.

Remote command:
n.a.

Timing Offset Step ← DPCH

Sets the step width for the timing offset from channel to channel.

The valid range of values must not be exceeded. If the range of values is exceeded, the timing offset is automatically limited to the permissible range.

Remote command:
n.a.

4.24 User Equipment Configuration (UE)



In the standard, the term "Mobile Station" has been replaced by the term "User Equipment". This is done to account the fact that there is a great variety of mobile terminal equipment available to users, with functionality that is constantly being enhanced.

Access:

1. Select "3GPP FFD > Link Direction > Uplink".

2. Select "3GPP FDD > User Equipment > UE 1/2/3/4".

The screenshot shows the configuration window for '3GPP FDD A: User Equipment1'. It is organized into several sections:

- Common Settings:** State is 'On', Mode is 'DPCCH + DPDCH', Scrambling Code (hex) is '0000 00', Scrambling Mode is 'Long Scrambling Code', Time Delay is '0 Chips', and buttons for 'Dynamic Power Control...' and 'Code Domain...' are present.
- DPCCH Settings:** Pilot is 6, TFCI is 2, TPC is 2, and Power is 0.00 dB. A 'Show Details >>>' button is available.
- DPDCH Settings:** Data is 40, State is checked 'On', and Channel Power is 0.00 dB. A 'Show Details >>>' button is available.
- HS-DPCCH Settings:** HARQ-ACK (Slots) is 1, CQI (Slots) is 2, State is unchecked 'On', and Power is 0.00 dB. A 'Show Details >>>' button is available.
- E-DPCCH Settings:** Happy Bit is 1, Retrans Sequence Number is 2, E-TFCI Information is 7, State is unchecked 'On', and Power is 0.00 dB. A 'Show Details >>>' button is available.
- E-DPDCH Settings:** Data is 1280, and State is unchecked 'On'. A 'Show Details >>>' button is available.
- E-DCH Scheduling:** E-DCH TTI is 2 ms, Number Of Table Rows is 1, E-DCH Schedule Repeats After is 1 TTIs, and a 'Scheduling List...' button is at the bottom.

A user equipment has a maximum of 6 DPDCHs, with parameters largely prescribed by the 3GPP specification TS 25.211. To simplify operation, the settings are grouped into three modes with following main differences:

- With the "DPCCH + DPDCH" mode, the HSDPA channel HS-DPCCH and the HSUPA channels E-DPCCH and E-DPDCH can be activated.
- With the "PRACH only" and "PCPCH only" modes, there is also a choice between "Standard" (all parameters can be set) and "Preamble only" (only the preamble can be set).

The dialog of each particular mode only displays the parameters that are relevant.

The DPCCH and one DPDCH of user equipment 1 are generated in realtime (enhanced mode). Depending on the actual configurations, other channels of user equipment 1 can also be generated in real time. The PRACH and PCPCH channels are not generated in real time.

The dialog comprises an upper section "Common Settings", with central sections depending on the set mode, e.g. "PRACH Settings" or "DPCCH Settings". When "DPCCH + DPDCH" modes are selected, only the channel structure, the state and the channel power are indicated. The "E-DCH Scheduling" section also appears below.

The section for detailed setting and the channel tables (for DPDCH and E-DPDCH channels) can be revealed with the "Show Details" button and hidden with the "Hide Details" button.

In the menu for user equipment 1, under "DPDCH settings", there is a button for accessing the dialog for setting the enhanced channel parameters. When "PRACH Standard" or "PCPCH Standard" mode is selected, the "Channel Coding" section also appears below.

In the menus for user equipment 2, 3 and 4, the compressed mode can be activated and configured ("Compressed Mode").

4.24.1 General Settings

The "Common Settings" section is where the general settings for the selected user equipment are made.

State

Activates or deactivates the selected user equipment. The number of the selected user equipment is specified in the menu header.

Remote command:

`[:SOURCE<hw>] :BB:W3Gpp:MSTation<st>:STATE` on page 347

Mode

Selects the mode in which the user equipment is to work. The lower part of the menu changes in accordance with the mode. The following modes are available:

"PRACH only - Standard"

In this mode, the instrument generates a single physical random access channel (PRACH). This channel is needed to set up the connection between the user equipment and the base station. All the PRACH parameters can be set in the PRACH Settings section (see [Chapter 4.28, "PRACH Settings - UE"](#), on page 160).

"PRACH only - Preamble only"

In this mode, the instrument only generates the preamble of a physical random access channel (PRACH). Only the PRACH preamble parameters can be set in the PRACH Settings section. This mode is needed for test case 8.8, according to 3GPP TS 25.141.

"PCPCH only - Standard"

In this mode, the instrument generates a single physical common packet channel (PCPCH). This channel is used to transmit packet-oriented services (e.g. SMS). The specific PCPCH parameters can be set in the PCPCH Settings section (see [Chapter 4.29, "PCPCH Settings - UE"](#), on page 170).

"PCPCH only - Preamble only"

In this mode, the instrument only generates the preamble of a physical common packet channel (PCPCH). Only the PRACH preamble parameters can be set in the PCPCH Settings section. This mode is needed for test case 8.9, according to 3GPP TS 25.141.

"DPCCH + DPDCH"

In this mode, the instrument generates a control channel (DPCCH) and up to six data channels (DPDCH). This mode corresponds to the standard mode of user equipment during voice and data transmission.

In addition, the HS-DPCCH, E-DPCCH and E-DPDCH channels can be activated.

Channel-specific parameters can be set in the section of the individual channels.

The DPCCH and one DPDCH of user equipment 1 are generated in realtime (enhanced mode). Depending on the actual configurations, other channels of user equipment 1 can also be generated in real time.

Remote command:

`[:SOURCE<hw>] :BB:W3GPP:MSTation<st>:MODE` on page 345

Scrambling Code (hex)

Sets the scrambling code.

The scrambling code is used to distinguish the transmitter (UE) by transmitter-dependent scrambling. Hexadecimal values are entered. Long or short scrambling codes can be generated (see also [Chapter 3.3.1, "Scrambling Code Generator"](#), on page 19).

Remote command:

`[:SOURCE<hw>] :BB:W3GPP:MSTation<st>:SCODE` on page 346

Scrambling Mode

Sets the type of scrambling code.

With scrambling code, a distinction is made between long and short scrambling code (see also Section [Scrambling Code Generator](#)).

"Off" Disables scrambling code for test purposes.

"Long Scrambling Code" Sets the long scrambling code.

"Short Scrambling Code" (only modes "DPCCH + DPDCH" and "PCPCH only") Sets short scrambling code.

The short scrambling code is only standardized for DPCCH and DPDCH channels. But it can also be generated for the PCPCH channel for test purposes.

Remote command:

`[:SOURCE<hw>] :BB:W3GPP:MSTation<st>:SCODE:MODE` on page 346

Time Delay

Enters the time delay of the signal of the selected user equipment compared to the signal of user equipment 1.

Remote command:

`[:SOURCE<hw>] :BB:W3GPP:MSTation<st>:TDELAY` on page 347

Compressed Mode

(This feature is available for UE 2...4 and "DPCCH+DPDCH" Mode only.)

Opens the "Compressed Mode" dialog, see [Chapter 4.9, "Compressed Mode"](#), on page 85.

Remote command:
n.a.

UL-DTX .../ User Scheduling

(for instruments equipped with option R&S SMBV-K45 and R&S SMBV-K59, UE 1 and DPCCH+DPDCH mode only)

Accesses the dialog for configuring an uplink discontinuous transmission (UL-DTX) or applying user scheduling, see [Chapter 4.27, "UL-DTX/User Scheduling - UE"](#), on page 157.

Remote command:
n.a.

Dynamic Power Control

(for UE 1 and DPCCH+DPDCH mode only)

Accesses the dialog for configuring the "Dynamic Power Control" settings, see [Chapter 4.26, "Dynamic Power Control - UE"](#), on page 152.

Remote command:
n.a.

4.25 Code Domain Graph - UE

Access:

- ▶ Select "3GPP FDD > User Equipment > UE > Code Domain".

The "Code Domain" dialog enables you to check the uplink signal visually.

Understanding the display information

The "Code Domain" display indicates the assigned code domain. The channelization code is plotted at the X axis; the colored bars indicate coherent code channels. The colors are assigned to fixed symbol rates; the allocation is shown below the graph. The relative power can be taken from the height of the bar. The symbols on so-called I- and Q-branches are spread independently. The channelization codes are fixed for the channels.

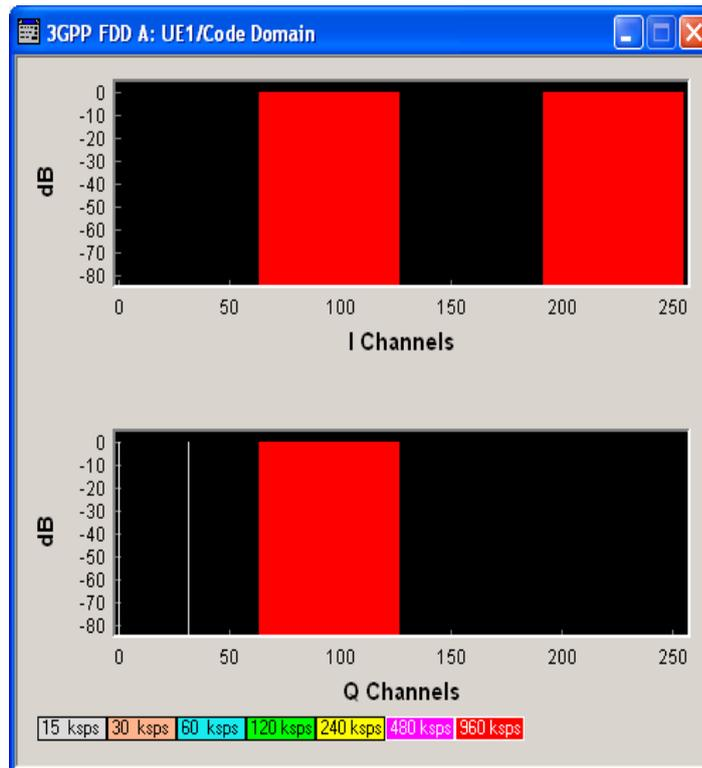

Use the code domain graph to evaluate whether there is a code domain conflict or not; a domain conflict arises when the code domains of the active channels intersect. A code domain conflict is indicated by overlapping bars.

A conflict can occur only when the parameter "Force Channelization Code to I/Q" is activated.

4.26 Dynamic Power Control - UE

In the "Dynamic Power Control" dialog, the power of the enhanced channels can be changed within the predefined dynamic range. The dynamic range is set as the sum of the parameters "Up Range" and "Down Range". The power is varied with the predefined step size ("Power Step") and with an external, internal or manual control signal.

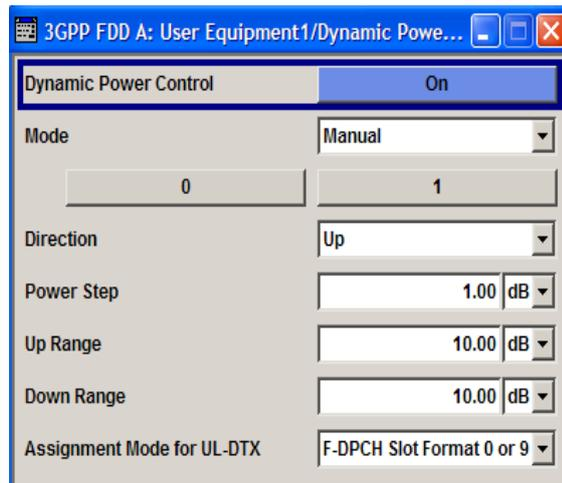

Dynamic Power Control State

Activates or deactivates the "Dynamic Power Control".

With activated "Dynamic Power Control", the power of the enhanced channels can be increased or decreased within the predefined dynamic range. The dynamic range is set as the sum of the parameters "Up Range" and "Down Range".

The power is varied with the predefined step size ("Power Step") and with an internal or manual control signal.

Supply the external control signal via the LEVATT input of the AUX I/O connector.

Remote command:

```
[ :SOURCE<hw> ] :BB:W3GPp:MSTation [ :ENHanced:DPDCh ] :DPControl:STATE
on page 423
```

Mode

Selects the control signal for "Dynamic Power Control".

"By TPC Pattern"

The TPC pattern is used for "Dynamic Power Control". This selection corresponds to selection "(Mis) Use TPC" for not enhanced channels.

"Manual"

The control signal is manually produced by pushing one of the buttons 0 or 1.

The channel power is increased or decreased depending on the "Direction" setting by the set power step.

Remote command:

```
[ :SOURCE<hw> ] :BB:W3GPp:MSTation [ :ENHanced:DPDCh ] :DPControl:MODE
on page 422
[ :SOURCE<hw> ] :BB:W3GPp:MSTation [ :ENHanced:DPDCh ] :DPControl:STEP:
MANual on page 424
```

Direction

Selects the Dynamic Power Control mode.

"Up"

A high level of the control signal leads to an increase of channel power.

"Down" A high level of the control signal leads to a decrease of channel power.

Remote command:

```
[ :SOURCE<hw> ] :BB:W3GPP:MSTation [ :ENHanced:DPDCh ] :DPControl:
DIRrection on page 422
```

Power Step

If "Dynamic Power Control > On", sets the step width by which the channel powers of the enhanced channels in the timeslot grid are changed within the set dynamic range. The dynamic range is set as the sum of "Up Range" and "Down Range".

The start power of the channel is set in the "Channel Power" entry field of the menu.

Remote command:

```
[ :SOURCE<hw> ] :BB:W3GPP:MSTation [ :ENHanced:DPDCh ] :DPControl:
STEP [ :EXTernal ] on page 424
```

Up Range / Down Range

Sets dynamic range by which – with "Dynamic Power Control" switched on – the channel powers of the enhanced channels can be increased. The resulting "Dynamic Power Control" dynamic range ("Up Range" + "Down Range") depends on the selected "Power Step" and is as follow:

- For "Power Step" < 1 dB, the dynamic range ("Up Range" + "Down Range") <= 30 dB
- For "Power Step" => 1 dB, the dynamic range ("Up Range" + "Down Range") <= 60 dB

Remote command:

```
[ :SOURCE<hw> ] :BB:W3GPP:MSTation [ :ENHanced:DPDCh ] :DPControl:
RANGE:UP on page 423
[ :SOURCE<hw> ] :BB:W3GPP:MSTation [ :ENHanced:DPDCh ] :DPControl:
RANGE:DOWN on page 423
```

Power Control Graph

Indicates the deviation of the channel power (delta POW) from the set power start value of the enhanced channels.

The graph is automatically displayed if "Dynamic Power Control > State > On".

Note: Since a realtime update of the window in the timeslot (= 0.667 ms) is not possible for reasons of speed, an update can be performed in a coarser time interval. Fast channel power changes are not displayed but the settled state of the control loop can be recognized easily.

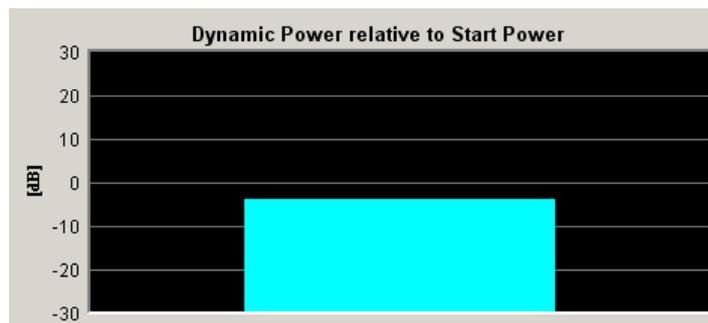

Remote command:

```
[ :SOURCE<hw> ] :BB:W3Gpp:MSTation [ :ENHanced:DPDCh ] :DPControl [ :
POWER ] ? on page 423
```

Assignment Mode for UL-DTX

The parameter is enabled only for activated [UL-DTX... / User Scheduling State](#).

The power control recognizes the UL-DPCCH gaps according to 3GPP TS 25.214. Some of the TPC commands sent to the instrument over the external line or by the TPC pattern are ignored, whereas others are summed up and applied later. The processing of the TPC commands depends only on whether the BS sends the TPC bits on the F-DPCH with slot format 0/ slot format 9 or not. It is not necessary to distinguish between the cases „DL-DPCH“ and „F-DPCH Slot format different than 9 and 0“. In both of these cases, the downlink TPC commands are sent (to a real UE via the air interface) later than in the first 512 chips of the downlink slot. Thus, the treatment of the TPC commands by the UE is identical.

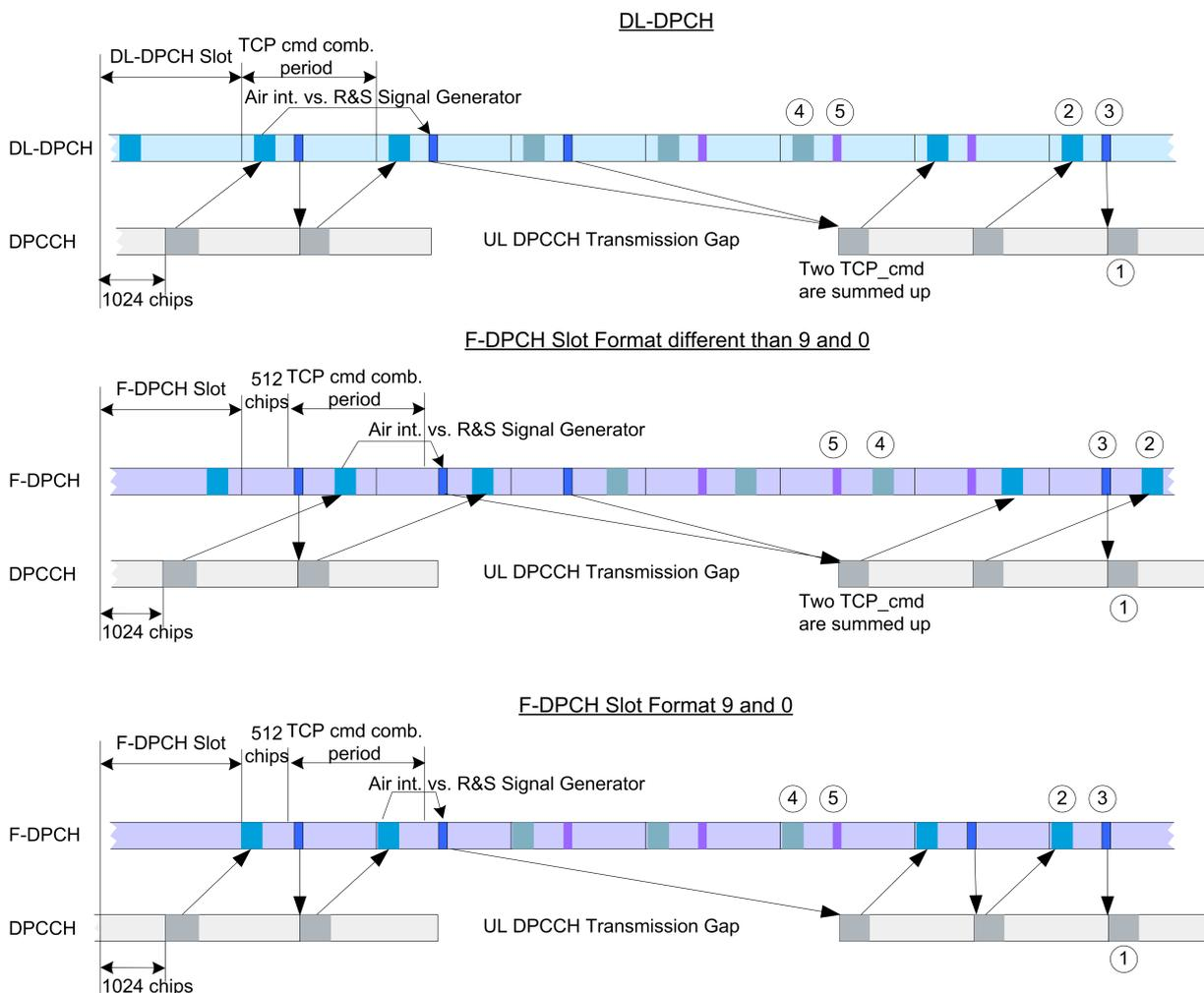

Figure 4-14: Timing diagram - Power Control with UL-DTX

- 1 = Uplink pilot
- 2 = TPC bits via air interface
- 3 = TPC command via binary feedback
- 4 = No need to send TPC bits via air interface; UE ignores any TPC bits
- 5 = No need to send TPC commands via binary feedback line; R&S SMBV ignores any TPC commands

The feedback sent to the instrument corresponds to the parameter „TPC_cmd“ defined in the 3GPP standard. It represents the TPC information of the last (already completed) „TPC command combining period“. This is true even if the TPC information of the ongoing „TPC command combining period“ is already known by the BS before the feedback transmission over the binary feedback line.

Note: The provided external binary feedback has to be stable at least between 0.1 ms before and after the UL DPCCH slot boundary.

Remote command:

```
[ :SOURce<hw> ] :BB:W3Gpp:MSTation [:ENHanced:DPDCh] :DPControl:
ASSignment on page 422
```

4.27 UL-DTX/User Scheduling - UE



Option: R&S SMBV-K45 and -K59.

1. To access the "**UL-DTX**" settings, select "3GPP FDD > Link Direction > Uplink / Reverse > User Equipments > UE".
2. Select "Mode > DPCCH + DPDCH".
3. Select "UL-DTX / User Scheduling..."
4. Select "Mode > UL-DTX".

UL-DTX / User Scheduling	
Mode	UL-DTX
Scheduling	
E-DCH TTI	2 ms
Offset	3 Subframes
Inactivity Threshold for Cycle 2	8 TTIs
Long Preamble Length	4 Slots
Cycle 1 Configuration	
DTX Cycle 1	4 Subframes
DPCCH Burst Length 1	1 Subframes
Preamble Length 1	2 Slots
Postamble Length 1	1 Slot
Cycle 2 Configuration	
DTX Cycle 2	8 Subframes
DPCCH Burst Length 2	1 Subframes
Preamble Length 2	2 Slots
Postamble Length 2	1 Slot

The "UE /UL-DTX" contains the parameters for adjusting the UL-DTX settings. The provided UL-DTX functionality is fully compliant with 3GPP TS 25.214. All dependencies from E-DCH transmissions, HARQ-ACK transmissions or CQI transmissions on the DPCCH are respected.

For UL-DTX, the dialog provides settings to configure the start offset, the threshold time for switching to UE-DTX cycle 2 and the DPCCH activity patterns for UE-DTX cycle 1/2. You can set the frequentness of the DPCCH bursts, the DPCCH bursts length (without pre- and postamble) and configure the length of the longer preamble for the UE-DTX cycle 2.



In this instrument, the signal generation starts with UE-DTX cycle 2. To trigger a switching to a UE-DTX cycle 1, activate the channels E-DPCCH/E-DPDCH and configure the "E-DCH Scheduling" parameters.



Use the [Scheduling List](#) to display the UL-DTX burst pattern and transmissions of E-DCH and HS-DPCCH, as well as the impact on the UL-DPCCH transmissions or the configured uplink user scheduling.

Detailed information

For detailed information on the provided functions, like explanation of the UL-DTX principle, description of the user scheduling file format, possible interdependencies, refer to:

- [Chapter 3.3.19, "Uplink Discontinuous transmission \(UL DTX\)"](#), on page 43

For an example on how to use these functions, refer to:

- [Chapter 5.3, "Configuring UL-DTX Transmission and Visualizing the Scheduling"](#), on page 242

UL-DTX... / User Scheduling State

Depending on the selected "Mode", enables/disables:

- Uplink discontinuous transmission (UL-DTX), i.e. uplink DPCCH gating
Enabling the UL-DTX deactivates the DPDCH and the HSUPA FRC.

Remote command:

`[:SOURCE<hw>] :BB:W3GPP:MSTation:UDTX:STATE` on page 418

Mode

The parameter is fixed to "UL-DTX".

Remote command:

`[:SOURCE<hw>] :BB:W3GPP:MSTation:UDTX:MODE` on page 417

Scheduling

This section comprises the common settings for both UL-DTX cycles.

E-DCH TTI ← Scheduling

Sets the duration of a E-DCH TTI.

By enabled UL-DTX, the value configured with this parameter sets the value for the parameter "E-DCH TTI" in the "UE1 > E-DCH Scheduling" dialog.

Remote command:

`[:SOURCE<hw>] :BB:W3GPP:MSTation:UDTX:TTIEdch` on page 418

Offset ← Scheduling

Sets the parameter UE_DTX_DRX_Offset and determines the start offset in subframes of the first uplink DPCCH burst (after the preamble). The offset is applied only for bursts belonging to the DPCCH burst pattern; HS-DPCCH or E-DCH transmissions are not affected.

The parameter UE_DTX_DRX_Offset is used to calculate the first subframe in each UL DPCCH burst pattern.

- For DTX cycle 1:
(5*CFN-UE_DTX_DRX_Offset+Subframe#) MOD UE_DTX_Cycle_1 = 0
- For DTX cycle 2:
(5*CFN-UE_DTX_DRX_Offset+Subframe#) MOD UE_DTX_Cycle_2 = 0

The offset is used to shift the DPCCH burst pattern of the different UEs so that they have the DPCCH transmission phase in their DTX cycles at different times.

Remote command:

[:SOURCE<hw>] :BB:W3GPP:MSTation:UDTX:OFFSet on page 418

Inactivity Threshold for Cycle 2 ← Scheduling

Defines the number of consecutive E-DCH TTIs without an E-DCH transmission, after which the UE moves immediately from UE-DTX cycle 1 to using UE-DTX cycle 2 (see [Figure 5-2](#)).

Note: In this implementation, the signal generation starts with UE-DTX cycle 2. To trigger a switching to a UE-DTX cycle 1, activate the channels E-DPCCH/E-DPDCH and configure the "E-DCH Scheduling" parameters.

Remote command:

[:SOURCE<hw>] :BB:W3GPP:MSTation:UDTX:ITHReshold on page 419

Long Preamble Length ← Scheduling

Determines the length in slots of the preamble associated with the UE-DTX cycle 2.

Remote command:

[:SOURCE<hw>] :BB:W3GPP:MSTation:UDTX:LPLength on page 419

Cycle 1 / Cycle 2 Configuration

Comprises the settings for configuring the frequentness of the DPCCH bursts and the DPCCH bursts length (without pre- and postamble).

DTX Cycle 1 / DTX Cycle 2 ← Cycle 1 / Cycle 2 Configuration

Sets the offset in subframe between two consecutive DPCCH bursts within the corresponding UE-DTX cycle, i.e. determines how often the DPCCH bursts are transmitted (see [Figure 5-2](#)).

The UE-DTX cycle 2 is an integer multiple of the UE-DTX cycle 1, i.e. has less frequent DPCCH transmission instants.

Remote command:

[:SOURCE<hw>] :BB:W3GPP:MSTation:UDTX:CYCLE<ch> on page 419

DPCCH Burst Length 1 / DPCCH Burst Length 2 ← Cycle 1 / Cycle 2 Configuration

Determines the uplink DPCCH burst length in subframes without the preamble and postamble, when the corresponding UE-DTX cycle is applied.

Remote command:

[:SOURCE<hw>] :BB:W3GPP:MSTation:UDTX:BURSt<ch> on page 420

Preamble Length 1 / Preamble Length 2 ← Cycle 1 / Cycle 2 Configuration

Displays the preamble length in slots, when the corresponding UE-DTX cycle is applied.

The preamble length is fixed to two slots.

Remote command:

`[:SOURCE<hw>] :BB:W3GPP:MSTation:UDTX:PREamble<ch>?` on page 420

Postamble Length 1 / Postamble Length 2 ← Cycle 1 / Cycle 2 Configuration

Displays the postamble length in slots, when the corresponding UE-DTX cycle is applied.

The postamble length is fixed to one slot.

Remote command:

`[:SOURCE<hw>] :BB:W3GPP:MSTation:UDTX:POSTamble<ch>?` on page 420

4.28 PRACH Settings - UE

Access:

1. Select "3GPP FDD > Link Direction > Uplink / Reverse > User Equipments > UE 1".
2. Select "Mode > PRACH Standard/PRACH Preamble Only".

The PRACH settings are available in two modes:

- In "Standard" mode, the instrument generates a single physical random access channel (PRACH). This channel is used during the connection set up between the user equipment and the base station.
- In "Preamble only" mode, the instrument only generates the preamble of a physical random access channel (PRACH). This mode is required for test case 8.8, according to 3GPP TS 25.141.

In this mode, only the preamble parameters are available.

The screenshot shows the '3GPP FDD A: User Equipment1' window. The 'Common Settings' section includes: State (On), Mode (PRACH Standard), Scrambling Code (hex) (0000 00), Scrambling Mode (Long Scrambling Code), and Time Delay (0 Chips). The 'PRACH Settings' section features a diagram of the PRACH structure with callouts: 1a (Preamble Power Step: 1.00 dB), 1b (Delta Power (Preamble): 2.78 dB), 2 (Delta Power (Message Part): 5.79 dB), 2a (Data: 2.78 dB), 2b (Control: 2.78 dB), 3a (Structure Length: 17 Slots), 3b (Repeat Structure After: 20 Acc. Slots), and 4 (ARB Sequence Length: 60 Slots). Below the diagram are 'Repeat Structure After ARB Sequence Length' (On) and 'Repeat Structure After' (20 Acc. Slots). The 'Preamble Settings' section includes: Preamble Power (0.00 dB), Preamble Power Step (1.00 dB), Preamble Repetition (1), and Signature (0). The 'Message Part' section includes: Data Power (0.00 dB), Control Power (0.00 dB), Message Length (1 Frames), Slot Format # (1), Symbol Rate (30 ksps), TFCI (0), and Data Source (PN 9). The 'Channel Coding' section includes: Coding State (On) and Coding Type (RACH RMC (TB size 168 bit)). A 'Show Coding >>>' button is also present.

Figure 4-15: Standard PRACH Structure: Understanding the displayed information

- 1a = "Preamble Power Step"; subtract this value from 1b to calculate the power of the other preambles
- 1b = "Delta Power (Preamble)", i.e. correction value for the last preamble before the message part
- 2 = "Delta Power (Message Part)", i.e. correction value for the message part overall
- 2a, 2b = Correction values for the data and control part of the message part
- 3a = Current "Structure Length"
- 3b = User-defined repetition of the PRACH structure, i.e. the same structure is repeated three times within the current ARB sequence length
- 4 = Current ARB sequence length (in slots); set with the parameter [Sequence Length ARB](#)

The dialog comprises a graphical representation of the PRACH structure, including the timing parameters, the "Preamble Settings" and "Message Part" sections. The last sections comprise the preamble settings for the parameters of the data part of the channel. Some settings are made directly in the input fields of the graphical display.

In the "Channel Coding" section, channel coding can be activated.

Power settings and power calculation

- Calculating the power of the preamble
The correction value for the last preamble before the message part (indication in the preamble block) is indicated in the graphical display of the PRACH structure. The power of the other preambles is calculated by subtracting the selected "Preamble Power Step".
- Calculating the power of the message part
The correction values for the message part overall and separately for data and control part (indications in the message part block) are also indicated. For one active UE and if the "Level Reference" is set to "RMS Power", the RF power of the message part is calculated as:
"Message Part Power" = "RF Level" + "Delta Power Message Part"

Example: Calculating the power of the message part

- "3GPP > User Equipment > Level Reference > RMS Power"
- "Level = 5 dBm"
- "Delta Power Message Part = 5.79 dB"

The resulting "Message Part Power" = 5 + 5.79 = 10.79 dBm

4.28.1 Graphical Display

The graphical display shows either the complete PRACH including the message part or only the preamble depending on the selected mode.

PRACH standard

1. To access these settings, select "3GPP FDD > Link Direction > Uplink / Reverse > User Equipments > UE 1".
2. Select "Mode > PRACH Standard".

PRACH Preamble Only

- ▶ Select "Mode > PRACH Preamble Only".

The screenshot displays the 'PRACH Settings' window. At the top, 'Preamble Power Step' is set to 1.00 dB, and the power level is 15.74 dB. The 'Start Offset #' is 0 Acc. Slots. A diagram shows three preamble pulses with a 'Time Pre->Pre' interval of 1 Acc. Slots. The 'Structure Length' is 2 Slots, and the 'ARB Sequence Length' is 60 Slots. The 'Repeat Structure After ARB Sequence Length' checkbox is checked 'On', with a value of 10 Acc. Slots. The 'Preamble Settings' section at the bottom shows 'Preamble Power' at 0.00 dB, 'Preamble Power Step' at 1.00 dB, 'Preamble Repetition' at 1, and 'Signature' at 0.

Figure 4-16: PRACH mode preamble-only

Some of the parameter values can be input directly in the input fields of the graphical display. The indicated structure length and the power correction values match the real settings; the number of preambles, however, is shown as an example, to explain the parameter function.

Use the power correction values to calculate the correct settings for the desired RF level, see "[Power settings and power calculation](#)" on page 162.

Delta Power (Preamble)

Indicates the level correction value for the last preamble before the message part.

The level of the other preambles can be calculated by subtracting the set "Preamble Power Step".

Remote command:

`[:SOURCE<hw>] :BB:W3GPp:MSTation<st>:PRACH:TIMing:DPOWER:PREamble?` on page 397

Delta Power (Message Part)

Indicates the level correction value for the message part, together with the power offsets of the data and control part.

The indication of the total value is important for measurements where just the envelope of the signal is of interest whereas the separate indication is useful for receiver tests.

See also "[Power settings and power calculation](#)" on page 162.

Remote command:

`[:SOURCE<hw>] :BB:W3GPp:MSTation<st>:PRACH:TIMing:DPOWer:MPART?`
on page 396

`[:SOURCE<hw>] :BB:W3GPp:MSTation<st>:PRACH:TIMing:DPOWer:MPART:DATA?` on page 397

`[:SOURCE<hw>] :BB:W3GPp:MSTation<st>:PRACH:TIMing:DPOWer:MPART:CONTrol?` on page 397

Start Offset

Enters the start offset of the PRACH in access slots or slots.

The starting time delay in timeslots is then equal to 2*"Start Offset #"

Remote command:

`[:SOURCE<hw>] :BB:W3GPp:MSTation<st>:PRACH:TIMing:SOFFset`
on page 398

Time Pre->Pre

Enters the time difference between two successive preambles in access slots.

Remote command:

`[:SOURCE<hw>] :BB:W3GPp:MSTation<st>:PRACH:TIMing:TIME:PREPre`
on page 399

Time Pre->MP

Enters the time difference between the last preamble and the message part in access slots.

Two modes are defined in the standard. In mode 0, the preamble to message part difference is 3 access slots, in mode 1 it is 4 access slots.

Remote command:

`[:SOURCE<hw>] :BB:W3GPp:MSTation<st>:PRACH:TIMing:TIME:PREMp`
on page 398

Structure Length

Indicates the structure length:

- In "PRACH only - Preamble" mode, the structure length is defined as:
"Structure Length" = "Start Offset (Slots)" + "Preamble Repetition"*"Time Pre->Pre"

Example: Calculating the structure length in PRACH preamble only mode

"Start Offset # = 1 Access Slots", i.e. two slots

"Preamble Repetition = 2"

"Time Pre->Pre = 2 Access Slots", i.e. four slots

"Structure Length" = 2 Slots + 2 x 4 Slots = 10 Slots

- In "PRACH only - Standard" mode, the structure length is defined as:
"Structure Length" = "Start Offset (Slots)" + "Preamble Repetition"*"Time Pre->Pre" + "Time Pre->MP" + 15*"Message Part Length (Frames)"

Example: Calculating the structure length in PRACH Standard mode

- "Start Offset # = 2 Access Slots", i.e. four slots
- "Preamble Repetition = 3"
- "Time Pre->Pre = Time Pre->MP = 3 Access Slots", i.e. six slots
- "Message Part Length = 2 Frames"
- "Structure Length" = 4 Slots + 2 x 6 Slots + 6 Slots + 15 x 2 = 52 Slots

See also "[Repeat Structure After ARB Sequence Length](#)" on page 165.

Remote command:

```
[ :SOURce<hw> ] :BB:W3GPp:MSTation<st>:PRACH:TIMing:SPERiod?
on page 398
```

ARB Sequence Length

Indicates the ARB sequence length.

Note: A caution message is displayed, if the structure length is longer than the selected ARB sequence length.

The change the ARB sequence length, use the parameter [Sequence Length ARB](#).

Remote command:

```
[ :SOURce<hw> ] :BB:W3GPp:SEnGth on page 254
```

Repeat Structure After ARB Sequence Length

Enables/disables repeating the selected PRACH structure during one ARB sequence.

"On" Within one ARB sequence, the selected PRACH structure is repeated once.

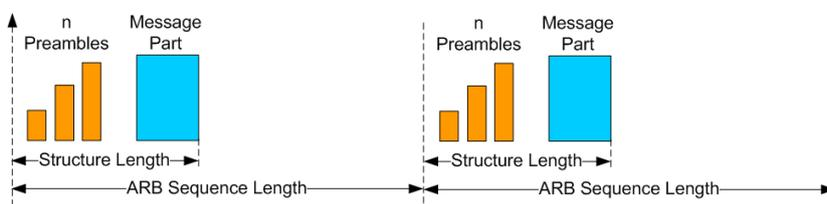

Figure 4-17: "Repeat Structure after ARB sequence length = On"

"Off" The selected PRACH structure can be repeated several times, depending on the structure length and the [Repeat Structure After \(x Acc. Slots\)](#).

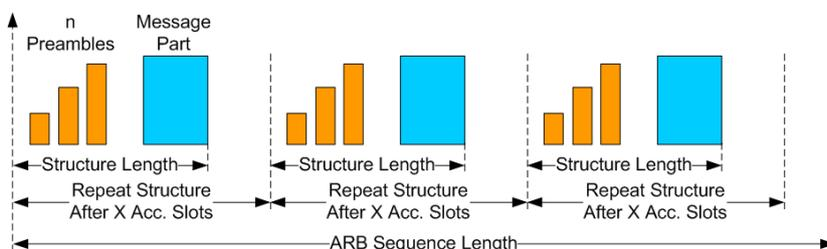

Figure 4-18: "Repeat Structure after ARB sequence length = Off"

Remote command:

`[:SOURCE<hw>] :BB:W3GPP:MSTation<st>:PRACH:RARB` on page 394

Repeat Structure After (x Acc. Slots)

If "Repeat Structure After ARB Sequence Length > Off", sets the number of access slots after that the selected PRACH structure is repeated, see [Figure 4-18](#).

Remote command:

`[:SOURCE<hw>] :BB:W3GPP:MSTation<st>:PRACH:RAFTER` on page 394

4.28.2 Preamble Settings

1. To access these settings, select "3GPP FDD > Link Direction > Uplink / Reverse > User Equipments > UE 1".
2. Select "Mode > PRACH Standard/PRACH Preamble Only".

The "Preamble Settings" section provides the parameters for configuring the PRACH preamble.

Preamble Power

Sets the power of the preamble component of the PRACH channel.

Remote command:

`[:SOURCE<hw>] :BB:W3GPP:MSTation<st>:PRACH:PPower` on page 393

Preamble Power Step

Sets the power by which the preamble is increased from repetition to repetition. The power set with the parameter [Preamble Power](#) is the "target power", used during the last repetition of the preamble.

Example:

"Preamble Power = 0 dB"

"Preamble Repetition = 3"

"Preamble Power Step = 3 dB"



Figure 4-19: Generated power sequence

Remote command:

`[:SOURCE<hw>] :BB:W3GPP:MSTation<st>:PRACH:PPower:STEP` on page 393

Preamble Repetition

Sets the preamble count.

Remote command:

`[:SOURCE<hw>] :BB:W3GPP:MSTation<st>:PRACH:PREpetition` on page 394

Signature

Selects the signature to be used for the PRACH channel.

The signature defines the code domain for the channelization code being used. 16 fixed bit patterns are defined.

Remote command:

`[:SOURce<hw>] :BB:W3GPp:MSTation<st>:PRACH:SIGNature` on page 395

4.28.3 Message Part Settings

Access:

1. Select "3GPP FDD > Link Direction > Uplink / Reverse > User Equipments > UE 1".
2. Select "Mode > PRACH Standard".

The "Message Part" section comprises the settings for the data part of the PRACH.

Data Power

Sets the power of the data component of the PRACH channel.

Remote command:

`[:SOURce<hw>] :BB:W3GPp:MSTation<st>:PRACH:DPOWER` on page 392

Control Power

Sets the power of the control component of the PRACH channel.

Remote command:

`[:SOURce<hw>] :BB:W3GPp:MSTation<st>:PRACH:CPOWER` on page 391

Message Length

Sets the length of the message component of the PRACH channel in frames.

Remote command:

`[:SOURce<hw>] :BB:W3GPp:MSTation<st>:PRACH:MLENgtH` on page 393

Slot Format

Selects the slot format.

Slot formats 0 to 3 are available for the PRACH channel. The slot format defines the symbol rate of the message component.

Remote command:

`[:SOURce<hw>] :BB:W3GPp:MSTation<st>:PRACH:SFORmat` on page 395

Symbol Rate

Sets the symbol rate of the PRACH channel.

The symbol rate is determined by the slot format set. A change in the symbol rate leads automatically to an adjustment of the slot format.

Remote command:

`[:SOURce<hw>] :BB:W3GPp:MSTation<st>:PRACH:SRATe` on page 395

TFCI

Enters the value of the TFCI field (transport format combination indicator) in the control component of the PRACH channel.

Remote command:

[\[:SOURCE<hw>\]:BB:W3GPP:MSTation<st>:PRACH:TFCI](#) on page 396

Data Source

Selects the data source for the data component of the PRACH channel.

The following standard data sources are available:

- "All 0, All 1"
An internally generated sequence containing 0 data or 1 data.
- "PNxx"
An internally generated pseudo-random noise sequence.
- "Pattern"
An internally generated sequence according to a bit pattern.
Use the "Pattern" box to define the bit pattern.
- "Data List/Select DList"
A binary data from a data list, internally or externally generated.
Select "Select DList" to access the standard "Select List" dialog.
 - Select the "Select Data List > navigate to the list file *.dm_iqd > Select" to select an existing data list.
 - Use the "New" and "Edit" functions to create internally new data list or to edit an existing one.
 - Use the standard "File Manager" function to transfer external data lists to the instrument.

See also "Main Dialog > Data List Management".

Remote command:

[\[:SOURCE<hw>\]:BB:W3GPP:MSTation<st>:PRACH:DATA](#) on page 391

[\[:SOURCE<hw>\]:BB:W3GPP:MSTation<st>:PRACH:DATA:PATtern](#) on page 392

[\[:SOURCE<hw>\]:BB:W3GPP:MSTation<st>:PRACH:DATA:DSElect](#) on page 392

4.28.4 Channel Coding State

Channel coding of PRACH is possible for all UEs.

1. To access these settings, select "3GPP FDD > Link Direction > Uplink / Reverse > User Equipments > UE 1".

2. Select "Mode > PRACH Standard".

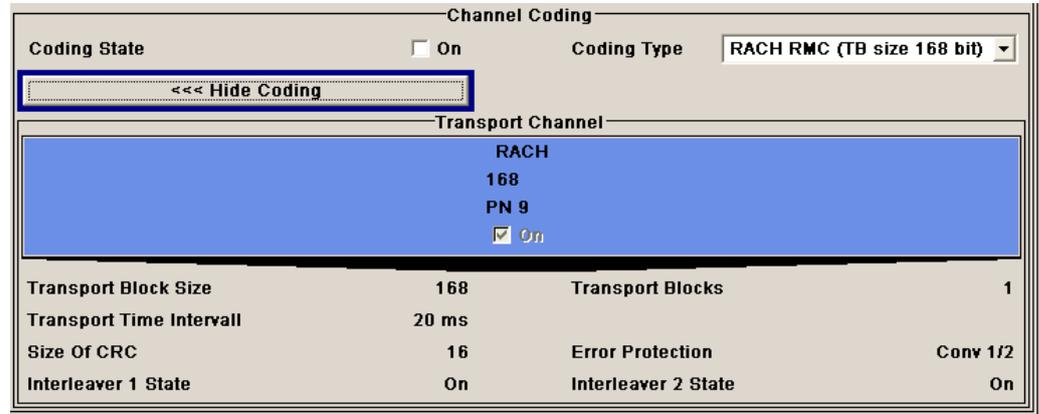

Channel Coding			
Coding State	<input type="checkbox"/> On	Coding Type	RACH RMC (TB size 168 bit)
<<< Hide Coding			
Transport Channel			
RACH			
168			
PN 9			
<input checked="" type="checkbox"/> On			
Transport Block Size	168	Transport Blocks	1
Transport Time Interval	20 ms		
Size Of CRC	16	Error Protection	Conv 1/2
Interleaver 1 State	On	Interleaver 2 State	On

The "Channel Coding" section is where the channel coding for the PRACH channel is activated and deactivated and the coding type is defined. The fixed settings for the channel coding parameters are displayed.

Coding State

Activates or deactivates channel coding for the PRACH channel.

If enabled, the "Message Part Length" automatically is set to 2. It cannot be changed.

Remote command:

`[:SOURCE<hw>] :BB:W3GPP:MSTation<st>:ENHanced:PRACH:CCODing:STATE`
on page 436

Coding Type

Selects the predefined reference measurement channel coding types for the PRACH channel.

"RACH RMC (TB size 168 bit)"

Reference Measurements Channel Coding with transport block size of 168 bit.

"RACH RMC (TB size 360 bit)"

Reference Measurements Channel Coding with transport block size of 360 bit.

Remote command:

`[:SOURCE<hw>] :BB:W3GPP:MSTation<st>:ENHanced:PRACH:CCODing:TYPE`
on page 436

Show Coding

Calls the menu for displaying the channel coding settings. The reference measurement channel parameters are set to fixed values.

The following parameters are displayed:

"Data Source" The data source is displayed in the transport channel graphical display.

"Transport Block Size"

Size of the transport block at the channel coding input.

"Transport Block"	Transport block count.
"Transport Time Interval"	Number of frames into which a TCH is divided.
"Size of CRC"	CRC type (length).
"Error Protection"	Error protection.
"Interleaver 1 / 2 State"	Channel coding interleaver state
Remote command:	n.a.

4.29 PCPCH Settings - UE

Access:

1. Select "3GPP FDD > Link Direction > Uplink / Reverse > User Equipments > UE 1".
2. Select "Mode > PCPCH Standard/PCPCH Preamble Only".

The PCPCH settings are available in two modes:

- In "PCPCH Standard" mode, the instrument generates a single physical common packet channel (PCPCH). This channel is used to transmit packet-oriented services (e.g. SMS).
- In "PCPCH Preamble only" mode, the instrument only generates the preamble of a physical common packet channel (PCPCH). This mode is needed for test case 8.9, according to 3GPP TS 25.141.

In this mode, only the preamble parameters are available.

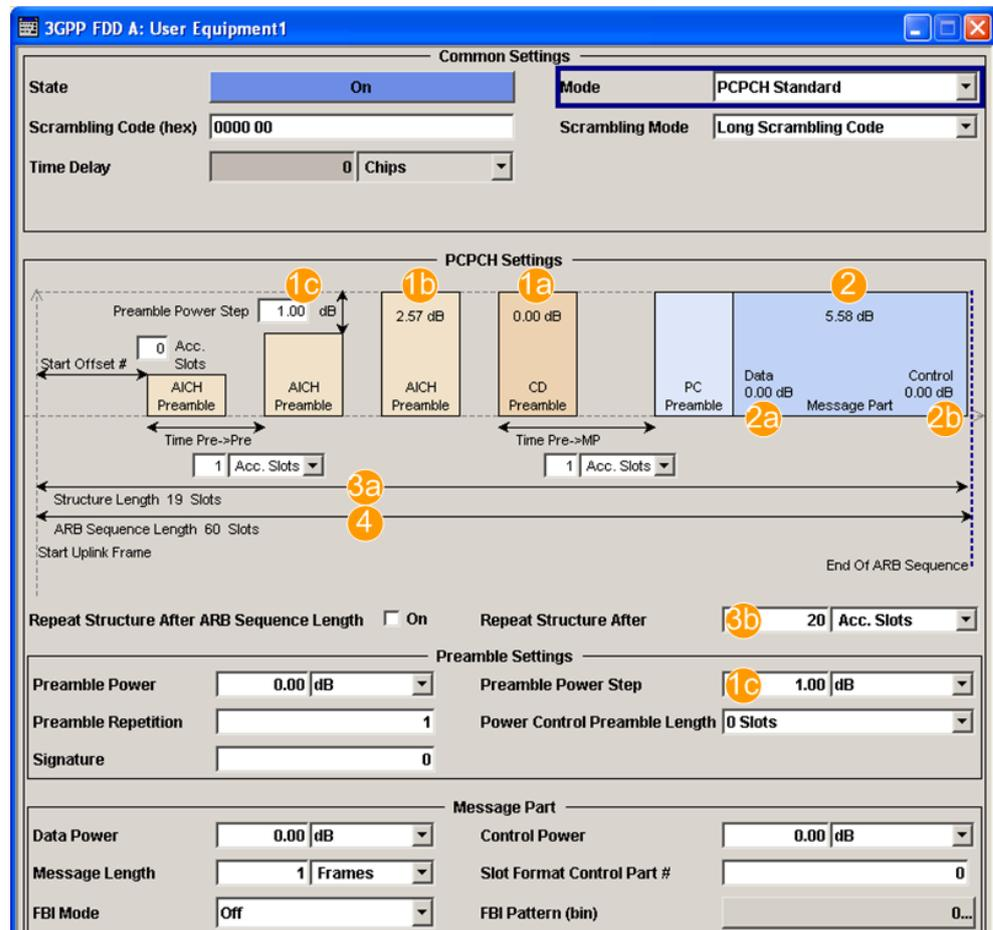

Figure 4-20: Standard PCPCH Structure: Understanding the displayed information

- 1a, 1b = "Delta Power (Preamble)", i.e. correction values for the last AICH preamble before the message part and the CD Preamble
- 1c = "Preamble Power Step"; subtract this value from 1b to calculate the power of the other preambles
- 2 = "Delta Power (Message Part)", i.e. correction value for the message part overall
- 2a, 2b = Correction values for the data and control part of the message part
- 3a = Current "Structure Length"
- 3b = User-defined repetition of the PCPCH structure, i.e. the same structure is repeated three times within the current ARB sequence length
- 4 = Current ARB sequence length (in slots); set with the parameter [Sequence Length ARB](#)

The dialog comprises a graphical display of the PCPCH structure including the timing parameters, the "Preamble Settings" and "Message Part" sections. The last sections comprise the preamble settings and the parameters for the data part of the channel. Some settings are made directly in the input fields of the graphical display.

The "Channel Coding" settings for activating channel coding are available for UE1.

Power settings and power calculation

- Calculating the power of the preamble

The graphical display of the PCPCH structure indicates:

- The correction value for the last AICH preamble before the message part
- The CD Preamble (indication in the AICH and CD Preamble block)

The power of the other preambles is calculated by subtracting the selected "Preamble Power Step".

- Calculating the power of the message part
The power correction value of the message part is indicated in the message part settings.
For one active UE, the RF power of the message part is calculated as:
"Message Part Power" = "RF Level" + "Delta Power Message Part"
For PCPCH, the parameter "Level Reference" is always "RMS Power".

Example: Calculating the power of the message part

- "Level = 5 dBm"
- "Delta Power Message Part = 5.58 dB"

The resulting "Message Part Power" = 5 + 5.58 = 10.58 dBm

4.29.1 Graphical Display

The graphical display shows either the complete PCPCH including the message part or only the preamble depending on the selected mode.

PCPCH Standard

1. To access these settings, select "3GPP FDD > Link Direction > Uplink / Reverse > User Equipments > UE 1".
2. Select "Mode > PCPCH Standard"

PCPCH preamble-only

- ▶ Select "Mode > PCPCH Preamble Only".

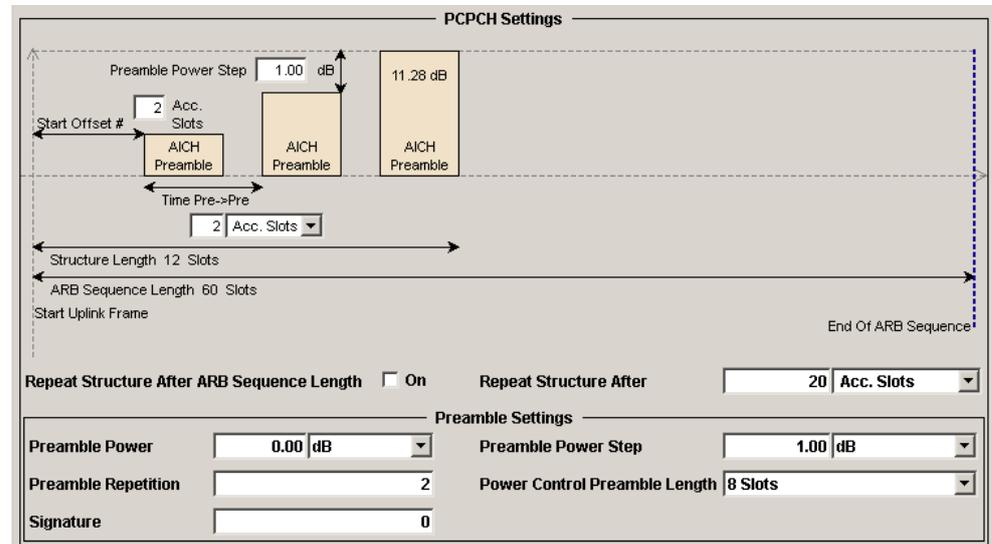

Figure 4-21: PCPCH Structure in "Mode > PCPCH preamble-only"

Some of the parameter values can be input directly in the input fields of the graphical display. The indicated structure length and the power correction values match the real settings; the number of preambles, however, is shown as an example, to explain the parameter function.

Use the power correction values to calculate the correct settings for the desired RF level (see "[Power settings and power calculation](#)" on page 171).

Delta Power (Preamble)

Indication of the level correction value for the last AICH preamble before the message part. This value is identical to the correction value for the CD preamble.

The level of the other preambles can be calculated by subtracting the set "Preamble Power Step".

Remote command:

```
[ :SOURCE<hw> ] :BB:W3GPp:MSTation<st>:PCPCh:TIMing:DPOWer:PREAmble? on page 386
```

Delta Power (Message Part)

Indicates the level correction value for the message part, together with the power offsets of the data and control part.

See also [Example "Calculating the power of the message part"](#) on page 172.

Remote command:

```
[ :SOURCE<hw> ] :BB:W3GPp:MSTation<st>:PCPCh:TIMing:DPOWer:MPART? on page 386
```

Start Offset #

Enters the start offset of the PCPCH in access slots.

Note: The PCPCH only transmitted once, at the start of the sequence.

The starting time delay in timeslots is calculated according to TS 25 211, chapter 7.3 PCPCH/AICH timing relation and is $2 \times \text{Start Offset \#}$.

Remote command:

`[:SOURCE<hw>] :BB:W3GPP:MSTation<st>:PCPCh:TIMing:SOFFset`
on page 387

Transmission Timing (Preamble)

Enters the time difference between two successive preambles in access slots.

Remote command:

`[:SOURCE<hw>] :BB:W3GPP:MSTation<st>:PCPCh:TIMing:TIME:PREPre`
on page 388

Transmission Timing (Message Part)

Enters the time difference between the last preamble and the message part in access slots.

Two modes are defined in the standard. In mode AICH transmission timing 0, the preamble to message part difference is three access slots. In mode AICH transmission timing 1, it is four access slots.

Remote command:

`[:SOURCE<hw>] :BB:W3GPP:MSTation<st>:PCPCh:TIMing:TIME:PREMp`
on page 387

Structure Length

Indicates the structure length:

- In "PCPCH only - Preamble" mode, the structure length is defined as:
"Structure Length" = "Start Offset (Slots)" + "Preamble Repetition" * "Time Pre->Pre"

Example: Calculating the structure length in PCPCH preamble-only mode

"Start Offset # = 2 access slots", i.e. = 4 slots

"Preamble Repetition = 2"

"Time Pre->Pre = 2 access slots", i.e. = 4 slots

"Structure Length" = 4 slots + 2 x 4 slots = 12 slots

- In "PCPCH only - Standard" mode, the structure length is defined as:
"Structure Length" = "Start Offset (Slots)" + "Preamble Repetition" * "Time Pre->Pre" + "Time Pre->MP" + "Power Control Preamble Length" + 15 * "Message Part Length (Frames)"
In PCPCH mode, the CD preamble has to be accounted. Therefore, preamble repetition instead of (preamble repetition - 1) is used.

Example: Calculating the structure length in PCPCH Standard mode

"Start Offset = 2 access slots", i.e. four slots

"Preamble Repetition = 3"

"Time Pre - Pre = Time Pre - MP = 3 access slots", i.e. six slots

"Power Control Preamble Length = 8 slots"

"Message Part Length = 2 frames"

"Structure Length" = 4 slots + 3 x 6 slots + 6 slots + 8 + 15 x 2 = 66 slots

Remote command:

```
[ :SOURCE<hw> ] :BB:W3GPp:MSTation<st>:PCPCh:TIMing:SPERiod?
```

on page 387

ARB Sequence Length

Indication of the ARB sequence length.

Note: A caution message is displayed, if the structure length is longer than the selected ARB sequence length.

To change the ARB sequence length, use the parameter [Sequence Length ARB](#).

Remote command:

```
[ :SOURCE<hw> ] :BB:W3GPp:SLENgth on page 254
```

Repeat Structure After ARB Sequence Length

Enables/disables repeating the selected PCPCH structure during one ARB sequence.

"On" Within one ARB sequence, the selected PCPCH structure is repeated once.

See [Figure 4-17](#) for illustration of the principle.

"Off" The selected PCPCH structure can be repeated several times, depending on the structure length and the [Repeat Structure After \(x Acc. Slots\)](#).

See [Figure 4-18](#) for illustration of the principle.

Remote command:

```
[ :SOURCE<hw> ] :BB:W3GPp:MSTation<st>:PCPCh:RARB on page 384
```

Repeat Structure After (x Acc. Slots)

If "Repeat Structure After ARB Sequence Length > Off", sets the number of access slots after that the selected PCPCH structure is repeated, see [Figure 4-18](#).

Remote command:

```
[ :SOURCE<hw> ] :BB:W3GPp:MSTation<st>:PCPCh:RAFTer on page 384
```

4.29.2 Preamble Settings

1. To access these settings, select "3GPP FDD > Link Direction > Uplink / Reverse > User Equipments > UE 1".

- Select "Mode > PCPCH Standard/PCPCH Preamble Only".

The "Preamble Settings" section provides the parameters for configuring the PCPCH preamble.

Preamble Power

Sets the power of the preamble component of the PCPCH channel.

Remote command:

`[:SOURce<hw>] :BB:W3GPp:MSTation<st>:PCPCh:PPower` on page 383

Preamble Repetition

Sets the preamble count.

Remote command:

`[:SOURce<hw>] :BB:W3GPp:MSTation<st>:PCPCh:PREpetition` on page 384

Preamble Power Step

Sets the power by which the preamble is increased from repetition to repetition. The power set under Preamble Power is the "target power", used during the last repetition of the preamble.

Example:

"Preamble Power" = 0 dB

"Preamble Repetition" = 3

"Preamble Power Step" = 3 dB

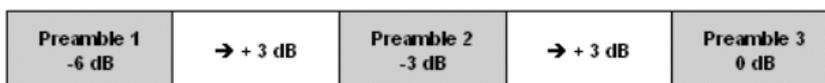

Figure 4-22: Generated power sequence

Remote command:

`[:SOURce<hw>] :BB:W3GPp:MSTation<st>:PCPCh:PPower:STEP` on page 383

Power Control Preamble Length

Sets the length of the power control preamble in slots.

Remote command:

`[:SOURce<hw>] :BB:W3GPp:MSTation<st>:PCPCh:PLENght` on page 383

Signature

Selects the signature to be used for the PCPCH channel. The signature defines the code domain for the channelization code being used.

Remote command:

`[:SOURce<hw>] :BB:W3GPp:MSTation<st>:PCPCh:SIGNature` on page 385

4.29.3 Message Part Settings

Access:

1. Select "3GPP FDD > Link Direction > Uplink / Reverse > User Equipments > UE 1".
2. Select "Mode > PCPCH Standard".

Data Part		Message Part	
Data Power	0.00 dB	Control Power	0.00 dB
Message Length	1 Frames	Slot Format Control Part #	0
FBI Mode	Off	FBI Pattern (bin)	0...
Symbol Rate	30 ksps		
Data Source	PN 9		
TFCI	0		
TPC Data Source	All 0		
Read Out Mode	Continuous		

The "Message Part" section comprises the settings for the data part of the PCPCH.

Data Power

Sets the power of the data component of the PCPCH channel.

Remote command:

[\[:SOURCE<hw>\]:BB:W3GPp:MSTation<st>:PCPCh:DPOwer](#) on page 381

Control Power

Sets the power of the control component of the PCPCH channel.

Remote command:

[\[:SOURCE<hw>\]:BB:W3GPp:MSTation<st>:PCPCh:CPOwer](#) on page 379

Message Length

Sets the length of the message component of the PCPCH channel in frames.

Remote command:

[\[:SOURCE<hw>\]:BB:W3GPp:MSTation<st>:PCPCh:MLENgt](#) on page 382

Slot Format

Selects the slot format of the control component of the PCPCH channel.

Slot formats 0 to 2 are available for the PCPCH channel. The slot format defines the structure of the control component, the FBI mode.

When channel coding is active, the FBI mode and the slot format are prescribed.

"Slot format 0" No FBI field

"Slot format 1" 1 FBI field

"Slot format 2" 2 FBI fields

Remote command:

[\[:SOURCE<hw>\]:BB:W3GPp:MSTation<st>:PCPCh:CPSFormat](#) on page 380

FBI Mode

Selects the FBI (feedback information) mode.

The FBI mode is determined by the slot format set. A change in the FBI mode leads automatically to an adjustment of the slot format.

"FBI Off" The FBI field is not in use.

"FBI On 1 Bit" The FBI field is used with a length of 1 bit.

"FBI On 2 Bits" The FBI field is used with a length of 2 bits.

Remote command:

[\[:SOURCE<hw>\]:BB:W3GPP:MSTation<st>:PCPCh:FBI:MODE](#) on page 382

FBI Pattern

Enters the bit pattern for the FBI field in the control part (of the message part) of the PCPCH.

The FBI field is filled cyclically with a pattern of up to 32 bits in length.

Remote command:

[\[:SOURCE<hw>\]:BB:W3GPP:MSTation<st>:PCPCh:FBI:PATtern](#) on page 382

Symbol Rate

Sets the symbol rate of the PCPCH channel.

The symbol rate is determined by the slot format set. A change in the symbol rate leads automatically to an adjustment of the slot format.

When channel coding is active, the symbol rate is prescribed.

Remote command:

[\[:SOURCE<hw>\]:BB:W3GPP:MSTation<st>:PCPCh:SRATe](#) on page 385

Data Source

Selects the data source for the data component of the PCPCH channel.

The following standard data sources are available:

- "All 0, All 1"
An internally generated sequence containing 0 data or 1 data.
- "PNxx"
An internally generated pseudo-random noise sequence.
- "Pattern"
An internally generated sequence according to a bit pattern.
Use the "Pattern" box to define the bit pattern.
- "Data List/Select DList"
A binary data from a data list, internally or externally generated.
Select "Select DList" to access the standard "Select List" dialog.
 - Select the "Select Data List > navigate to the list file *.dm_iqd > Select" to select an existing data list.
 - Use the "New" and "Edit" functions to create internally new data list or to edit an existing one.
 - Use the standard "File Manager" function to transfer external data lists to the instrument.

See also "Main Dialog > Data List Management".

Remote command:

`[:SOURce<hw>] :BB:W3GPp:MSTation<st>:PCPCh:DATA` on page 380

`[:SOURce<hw>] :BB:W3GPp:MSTation<st>:PCPCh:DATA:PATtern` on page 381

`[:SOURce<hw>] :BB:W3GPp:MSTation<st>:PCPCh:DATA:DSElect` on page 381

TFCI

Enters the value of the TFCI field (transport format combination indicator) in the control component of the PCPCH channel.

Remote command:

`[:SOURce<hw>] :BB:W3GPp:MSTation<st>:PCPCh:TFCI` on page 386

TPC Data Source

Defines the data source for the TPC field of the PCPCH channel.

The following standard data sources are available:

- "All 0, All 1"
An internally generated sequence containing 0 data or 1 data.
- "Pattern"
An internally generated sequence according to a bit pattern.
Use the "Pattern" box to define the bit pattern.
- "Data List/Select TPC Data List"
A binary data from a data list, internally or externally generated.
Select "Select DList" to access the standard "Select List" dialog.
 - Select the "Select Data List > navigate to the list file *.dm_iqd > Select" to select an existing data list.
 - Use the standard "File Manager" function to transfer external data lists to the instrument.

See also "Main Dialog > Data List Management".

Remote command:

`[:SOURce<hw>] :BB:W3GPp:MSTation<st>:PCPCh:TPC:DATA` on page 388

`[:SOURce<hw>] :BB:W3GPp:MSTation<st>:PCPCh:TPC:DATA:DSElect`
on page 388

`[:SOURce<hw>] :BB:W3GPp:MSTation<st>:PCPCh:TPC:DATA:PATtern`
on page 389

Read Out Mode

Defines TPC data usage.

The TPC bits are used to signal the increase or reduction in transmit power to the called station. For all read out modes, 1 bit is taken from the data stream for the TPC field for each slot. The bit is entered into the bitstream several times, depending on the symbol rate. The difference between the modes lies in the usage of the TPC bits.

The different modes can be used to set a specific output power and then let the power oscillate around this value. For example, if the power is the pattern 11111, the power can be varied with "Single + alt. 01" and "Single + alt. 10". Thus, power measurements can be carried out at quasi-constant power.

- "Continuous:"
The TPC bits are used cyclically.
- "Single + All 0"

- The TPC bits are used once, and then the TPC sequence is continued with 0 bits.
- "Single + All 1"
The TPC bits are used once, and then the TPC sequence is continued with 1 bit.
 - "Single + alt. 01"
The TPC bits are used once and then the TPC sequence is continued with 0 bits and 1 bit alternately. Bits are appended in multiples, depending on the symbol rate, for example, 00001111.
 - "Single + alt. 10"
The TPC bits are used once and then the TPC sequence is continued with 1 bit and 0 bits alternately. Bits are appended in multiples, depending on the symbol rate, for example, 11110000.

Remote command:

`[:SOURCE<hw>] :BB:W3GPP:MSTation<st>:PCPCh:TPC:READ` on page 389

4.29.4 Channel Coding Settings

Access:

1. Select "3GPP FDD > Link Direction > Uplink / Reverse > User Equipments > UE 1".
2. Select "Mode > PCPCH Standard".

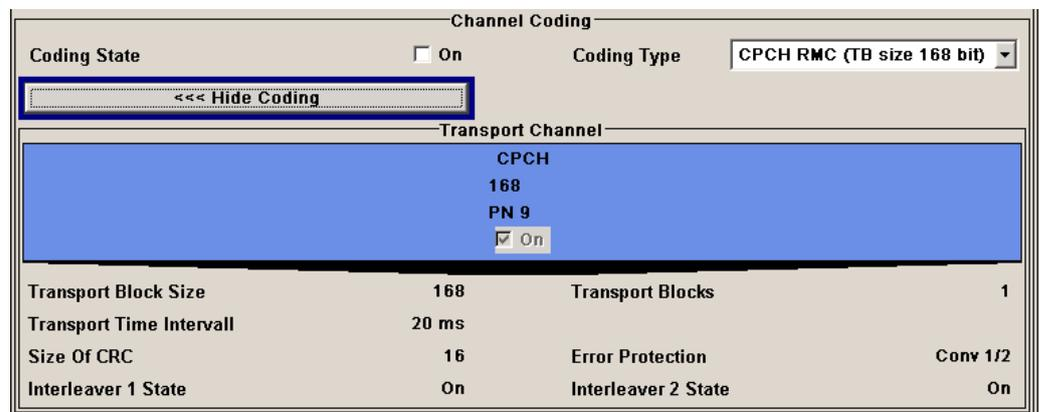

Channel Coding			
Coding State	<input type="checkbox"/> On	Coding Type	CPCH RMC (TB size 168 bit)
<<< Hide Coding			
Transport Channel			
CPCH			
168			
PN 9			
<input checked="" type="checkbox"/> On			
Transport Block Size	168	Transport Blocks	1
Transport Time Interval	20 ms		
Size Of CRC	16	Error Protection	Conv 1/2
Interleaver 1 State	On	Interleaver 2 State	On

The "Channel Coding" section is where the channel coding for the PCPCH channel is activated and deactivated and the coding type is defined. The fixed settings for the channel coding parameters are displayed.

Channel Coding State

Activates or deactivates channel coding for the PCPCH channel.

Remote command:

`[:SOURCE<hw>] :BB:W3GPP:MSTation:ENHanced:PCPCh:CCODing:STAtE`
on page 435

Channel Coding Type

Selects the predefined reference measurement channel coding types for the PCPCH channel.

"CPCH RMC (TB size 168 bit)"

Reference Measurements Channel Coding with transport block size of 168 bit.

"CPCH RMC (TB size 360 bit)"

Reference Measurements Channel Coding with transport block size of 360 bit.

Remote command:

`[:SOURCE<hw>] :BB:W3GPP:MSTation:ENHanced:PCPCh:CCODing:TYPE`
on page 436

Show Coding

Calls the menu for displaying channel coding. The reference measurement channel parameters are set to fixed values.

The following parameters are displayed:

"Data Source" The data source is displayed in the transport channel graphical display.

"Transport Block Size"

Size of the transport block at the channel coding input.

"Transport Block"

Transport blocks count.

"Transport Time Interval"

Number of frames into which a TCH is divided.

"Size of CRC" CRC type (length).

"Error Protection"

Error protection.

"Interleaver 1 / 2 State"

Channel coding interleaver state

Remote command:

n.a.

4.30 DPCCH Settings - UE

The DPCCH settings section is where the settings are made for the DPCCH channel. This section is only available if DPCCH + DPDCH mode is activated (see also [Chapter 4.33, "DPDCH Settings - UE"](#), on page 210).

In the upper section, the settings of the DPCCH parameters are made. The channel structure is displayed.

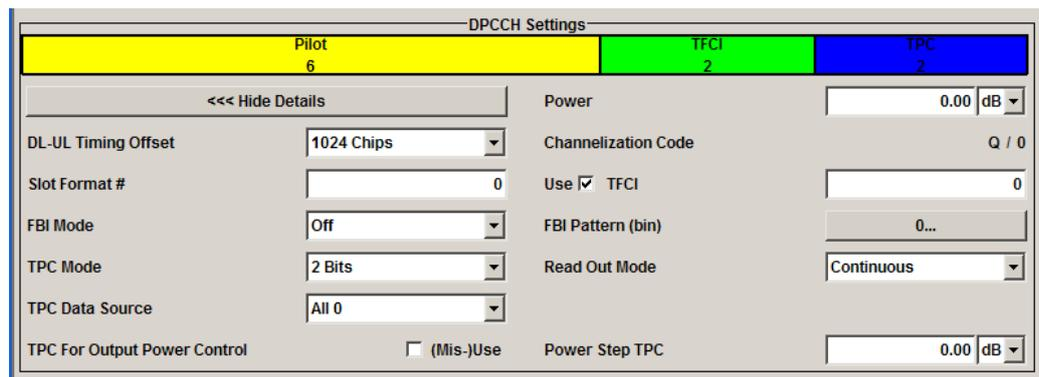

In UE1, the DPCCH is generated in real time (enhanced).

About the dedicated physical channels

At the physical level, an uplink DPCH consists of the DPDCH (Dedicated Physical Data Channel) and the DPCCH (Dedicated Physical Control Channel). The channel characteristics are defined by the symbol rate.

The DPDCH transports the user data that is fed directly into the data field. The DPCCH carries the control fields (Pilot field; TPC = Transmit Power Control, FBI (Feedback Information) and TFCI = Transport Format Combination Indicator). DPDCH is grouped with DPCCH I/Q code multiplexing in accordance with 3GPP TS 25.211, see diagram below. The generation of an uplink reference measurement channel is described in [Chapter 4.38, "Global Enhanced Channel Settings - UE1"](#), on page 231.

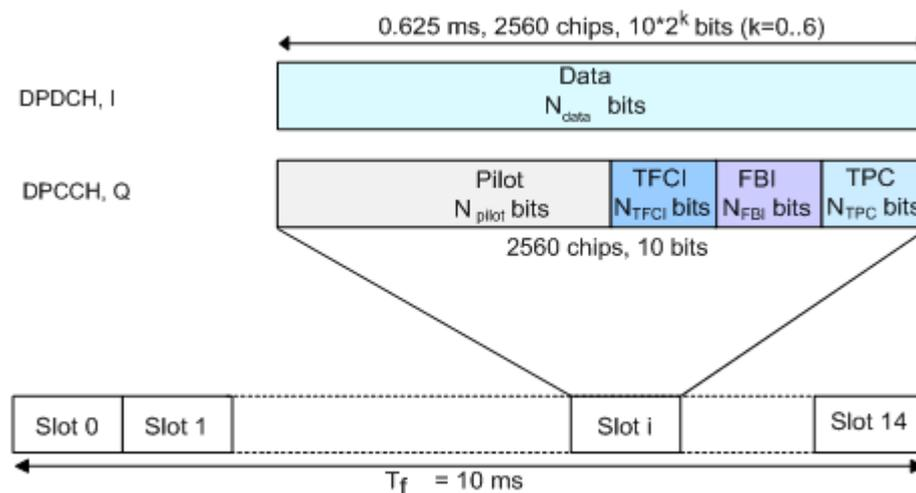

Figure 4-23: Structure of an uplink DPCH in the time domain

Channelization Code

Displays the channelization code and the modulation branch (I or Q) of the DPCCH. The code channel is spread with the set channelization code (spreading code). The standard assigns a fixed channelization code to the DPCCH.

Remote command:

[:SOURce<hw>] :BB:W3GPP:MSTation<st>:DPCCh:HS:CCODE? on page 358

Power

Sets the power of the DPCCH channel.

Test cases defined in the 3GPP standard often use notation "Signaling values for β_c and β_d ". The quantization of the gain parameters is shown in the following table which is taken from 3GPP TS 25.213 (left columns) and supplemented by the instrument-specific values (right column).

Signaling values for β_c and β_d	Quantized amplitude ratios β_c and β_d	Power to be set / dB
15	1.0	0.0
14	14/15	-0.60
13	13/15	-1.24
12	12/15	-1.94
11	11/15	-2.69
10	10/15	-3.52
9	9/15	-4.44
8	8/15	-5.46
7	7/15	-6.62
6	6/15	-7.96
5	5/15	-9.54
4	4/15	-11.48
3	3/15	-13.99
2	2/15	-17.52
1	1/15	-23.52
0	Switch off	Switch channel off or -80 dB

Remote command:

[:SOURce<hw>] :BB:W3GPP:MSTation<st>:DPCCh:POWer on page 351

DL-UL Timing Offset

Sets the timing offset between the downlink and the uplink.

The timing offset determines the time delay in chips between the downlink signal timing and transmission of the uplink signal.

Note: The signals of all UEs have the same uplink slot timing. The parameters "DL-UL Timing Offset" are coupled and by changing this parameter for one of the UEs, the values for the other UEs are automatically adjusted.

- "1024 Chips" The uplink signal is generated according to the 3GPP specification. The signal is calculated synchronously to the downlink reference timing, i.e. the first uplink frame starts at chip position 1024 of the simulated signal.
- "0 Chips" No timing offset is applied, i.e. there is no timing delay between receipt of the downlink signal and transmission of the uplink signal. See also "[To generate a continuous uplink signal composed of multiple separately generated uplink frames](#)" on page 241.

Remote command:

`[:SOURCE<hw>] :BB:W3GPP:MSTation<st>:DPCCh:TOFFset` on page 353

Slot Format

Selects the slot format.

The slot format defines the structure of the DPCCH slots and the control fields. Depending on the selected slot format, the slot structure is displayed.

Slot formats 0 to 4 are available for the DPCCH channel as defined in the 3GPP Rel. 7 specification TS 25.211.

Note: The former slot formats 4 and 5 according to 3GPP Rel. 4 specification TS 25.211 are not supported.

The slot format selection adjusts the DPCCH slot structure according to the 3GPP specification. However, it is also possible to adjust this structure by configuration of each of the control fields separately.

The table below gives an overview of the cross-reference between the slot format and the structure of the DPCCH slot.

Slot format #	Pilot, bits	NTPC, bits (TPC Mode)	NTFCI, bits (Use TFCI)	NFBI, bits (FBI Mode)
0	6	2	2	0
1	8	2	0	0
2	5	2	2	1
3	7	2	0	1
4	6	4	0	0

"Slot format 0"



"FBI Mode" = Off, i.e. no FBI field

"TFCI Mode" = 2 bits

"Use TFCI" = On, i.e. TFCI field = 2 bits

"Slot format 1"



"FBI Mode" = Off, i.e. no FBI field

"TFCI Mode" = 2 bits

"Use TFCI" = Off, i.e. no TFCI field

"Slot format 2"	
	<p>"FBI Mode" = 1 bit "TFCI Mode" = 2 bits "Use TFCI" = On, i.e. TFCI field = 2 bits</p>
"Slot format 3"	
	<p>"FBI Mode" = 1 bit "TFCI Mode" = 2 bits "Use TFCI" = Off, i.e. no TFCI field</p>
"Slot format 4"	
	<p>Option: R&S SMBV-K59 "FBI Mode" = Off, i.e. no FBI field "TFCI Mode" = 4 bits "Use TFCI" = Off, i.e. no TFCI field</p>

Remote command:

`[:SOURCE<hw>] :BB:W3GPp:MSTation<st>:DPCCh:SFORmat` on page 351

Use TFCI

Activates the TFCI (transport format combination indicator) field.

The status of the TFCI field is determined by the "Slot Format" set. A change leads automatically to an adjustment of the slot format.

Remote command:

`[:SOURCE<hw>] :BB:W3GPp:MSTation<st>:DPCCh:TFCI:STATE` on page 352

TFCI

Enters the value of the TFCI field (transport format combination indicator) of the DPCCH channel.

Remote command:

`[:SOURCE<hw>] :BB:W3GPp:MSTation<st>:DPCCh:TFCI` on page 352

FBI Mode

Selects the FBI (feedback information) mode.

The FBI mode is determined by the "Slot Format" set. A change in the FBI mode leads automatically to an adjustment of the slot format.

Note: The former 2-bits long FBI Mode according to 3GPP Rel. 4 specification TS 25.211 is not supported.

"Off" The FBI field is not in use.

"1 Bit" The FBI field with a length of 1 bit is used.

Remote command:

`[:SOURCE<hw>] :BB:W3GPp:MSTation<st>:DPCCh:FBI:MODE` on page 350

FBI Pattern (bin)

Enters the bit pattern for the FBI field.

The FBI field is filled cyclically with a pattern of up to 32 bits in length.

Remote command:

`[:SOURCE<hw>] :BB:W3GPP:MSTation<st>:DPCCh:FBI:PATtern` on page 351

TPC Mode

Selects the TPC (Transmit Power Control) mode.

The TPC mode is determined by the "Slot Format" set. A change in the TPC mode leads automatically to an adjustment of the slot format.

"2 Bits" A TPC field with a length of 2 bits is used.

"4 Bits" Option: R&S SMBV-K59

A TPC field with a length of 4 bits is used.

A 4 bits long TPC field can be selected, only for Slot Format 4 and disabled FBI and TFCI fields.

Remote command:

`[:SOURCE<hw>] :BB:W3GPP:MSTation<st>:DPCCh:TPC:MODE` on page 355

TPC Data Source

Defines the data source for the TPC field of the DPCCH channel.

The following standard data sources are available:

- "All 0, All 1"
An internally generated sequence containing 0 data or 1 data.
- "Pattern"
An internally generated sequence according to a bit pattern.
Use the "Pattern" box to define the bit pattern.
- "Data List / Select TPC Data List"
A binary data from a data list, internally or externally generated.
Select "Select TPC Data List" to access the standard "Select List" dialog.
See also "Main Dialog > Data List Management".

Remote command:

`[:SOURCE<hw>] :BB:W3GPP:MSTation<st>:DPCCh:TPC:DATA` on page 353

`[:SOURCE<hw>] :BB:W3GPP:MSTation<st>:DPCCh:TPC:DATA:PATtern`
on page 354

`[:SOURCE<hw>] :BB:W3GPP:MSTation<st>:DPCCh:TPC:DATA:DSElect`
on page 353

TPC Read Out Mode

Defines TPC data usage.

The TPC bits are used to signal the increase or reduction in transmit power to the called station. For all read out modes, 1 bit is taken from the data stream for the TPC field for each slot. The bit is entered into the bitstream several times, depending on the symbol rate. The difference between the modes lies in the usage of the TPC bits.

The different modes can be used to set a specific output power and then let the power oscillate around this value. For example, if the power is the pattern 11111, the power can be varied with "Single + alt. 01" and "Single + alt. 10". Thus, power measurements can be carried out at quasi-constant power.

- "Continuous:"
The TPC bits are used cyclically.
- "Single + All 0"

- The TPC bits are used once, and then the TPC sequence is continued with 0 bits.
- "Single + All 1"
The TPC bits are used once, and then the TPC sequence is continued with 1 bit.
 - "Single + alt. 01"
The TPC bits are used once and then the TPC sequence is continued with 0 bits and 1 bit alternately. Bits are appended in multiples, depending on the symbol rate, for example, 00001111.
 - "Single + alt. 10"
The TPC bits are used once and then the TPC sequence is continued with 1 bit and 0 bits alternately. Bits are appended in multiples, depending on the symbol rate, for example, 11110000.

Use the parameter "Read Out Mode" together with the option "TPC For Output Power Control (Mis-) Use" to generate various output power profiles.

Remote command:

`[:SOURCE<hw>] :BB:W3GPP:MSTation<st>:DPCCh:TPC:READ` on page 356

Misuse TPC for Output Power Control

(available for UE2, UE3 and UE4 only)

Defines "mis-" use of the TPC data.

The TPC bits are used to signal the increase or reduction in transmit power to the called station.

If "(Mis-) use TPC for output power control" is activated, the specified pattern is used to vary the intrinsic transmit power over time. A bit of this pattern is removed for each slot in order to increase (bit = "1") or reduce (bit = "0") the channel power by the specified power step ("Power Step"). The upper limit is 0 dB and the lower limit -60 dB.

The following envelope is produced with the settings:

- Channel power = 0 dB
- Power step = 1.0 dB
- Pattern = "001110100000011"
- "TPC Read Out Mode = Continuous"

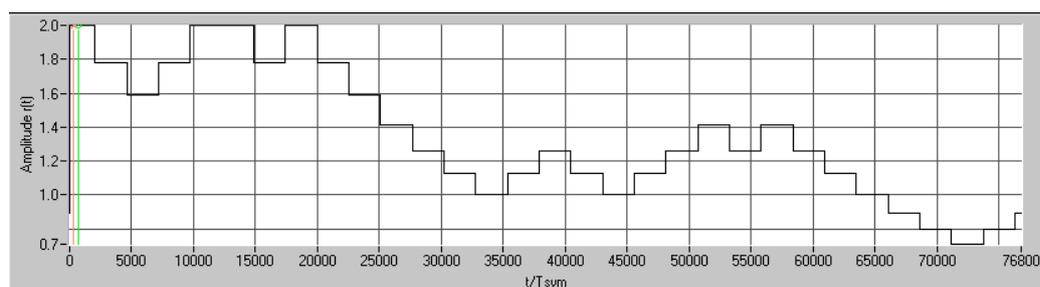

Figure 4-24: Dynamic change of channel power (continuous)

Note: Power control works both on the DPCCH and all the active DPDCHs. The change in power is always carried out (as stipulated in the standard) at the start of the slot pilot field

Remote command:

`[:SOURCE<hw>] :BB:W3GPP:MSTation<st>:DPCCh:TPC:MISuse` on page 354

TPC Power Step

(available for UE2, UE3 and UE4 only)

Sets the step width of the power change in dB for "(Mis-) use TPC for output power control".

Remote command:

`[:SOURCE<hw>] :BB:W3GPP:MSTation<st>:DPCCh:TPC:PSTep` on page 355

4.31 E-DPCCH Settings - UE

Access:

1. Select "3GPP FDD > Link Direction > Uplink / Reverse > User Equipments > UE".
2. Select "Mode > DPCCH + DPDCH".
3. Select "E-DPCCH Settings > Show Details".

The dialog displays the channel structure and the available parameters.

State (E-DPCCH)

Activates or deactivates the E-DPCCH channel.

If an FRC is set for the channel, this field is activated automatically.

Remote command:

`[:SOURCE<hw>] :BB:W3GPP:MSTation<st>[:HSUPa]:DPCCh:E:STATE`

on page 413

Power

Sets the power of the E-DPCCH channel.

The value range is -80 dB to 0 dB.

Remote command:

`[:SOURCE<hw>] :BB:W3GPP:MSTation<st>[:HSUPa]:DPCCh:E:POWER`

on page 412

Retransmission Sequence Number

Sets the retransmission sequence number.

The value range is 0 to 3.

Remote command:

```
[ :SOURCE<hw> ] :BB:W3GPp:MSTation<st> [ :HSUPa ] :DPCCh:E:RSNumber  
on page 413
```

Channelization Code

Displays the channelization code and the modulation branch (always I) of the E-DPCCH. The code channel is spread with the set channelization code (spreading code). The standard assigns a fixed channelization code to the E-DPCCH.

Remote command:

```
[ :SOURCE<hw> ] :BB:W3GPp:MSTation<st> [ :HSUPa ] :DPCCh:E:CCODE?  
on page 412
```

E-TFCI Information

Sets the value for the TFCI (Transport Format Combination Indicator) field.

The value range is 0 to 127.

Remote command:

```
[ :SOURCE<hw> ] :BB:W3GPp:MSTation<st> [ :HSUPa ] :DPCCh:E:TFCI  
on page 413
```

Happy Bit

Activating the happy bit. This bit is indicating whether the UE could use more resources (Not Happy/deactivated) or not (Happy/activated).

Remote command:

```
[ :SOURCE<hw> ] :BB:W3GPp:MSTation<st> [ :HSUPa ] :DPCCh:E:HBIT  
on page 412
```

HSUPA FRC...

For UE1, accesses the dialog for configuring the FRC (Fixed Reference Channel), see [Chapter 4.37, "HSUPA FRC Settings - UE"](#), on page 223.

Remote command:

n.a.

4.32 HS-DPCCH Settings - UE

Access:

1. Select "3GPP FDD > Link Direction > Uplink / Reverse > User Equipments > UE".

2. Select "HS-DPCCH".

HS-DPCCH Settings

HARQ-ACK (Slots) 1 **PCI/CQI (Slots) 2**

State On Power dB

<<< Hide Details

Compatibility Mode

Start Delay *256 Chips MIMO Mode On

Inter TTI Distance (Interval) Subframes **Secondary Cell Enabled**

Channelization Code Secondary Cell Active

Slot Format

HARQ - ACK

Number of Rows HARQ-ACK Repeat After Intervals

HARQ-ACK From Interval	HARQ-ACK To Interval	HS-DPCCH 1 HARQ-ACK 1	HS-DPCCH 1 HARQ-ACK 2	HS-DPCCH 2 HARQ-ACK 3	HS-DPCCH 2 HARQ-ACK 4	Pow Offs /dB
0	0	1	AA/D			0.0
1	3	3	NN/NN			0.0

PCI / CQI

Number of Rows PCI/CQI Repeat After Intervals

PCI/CQI From Interval	PCI/CQI To Interval	HS-DPCCH 1 PCI/CQI 1 Type	HS-DPCCH 1 PCI/CQI 1 Content	HS-DPCCH 1 PCI/CQI 2 Type	HS-DPCCH 1 PCI/CQI 2 Content	HS-DPCCH 2 PCI/CQI 3 Type	HS-DPCCH 2 PCI/CQI 3 Content	HS-DPCCH 2 PCI/CQI 4 Type	HS-DPCCH 2 PCI/CQI 4 Content	Pow Offs /dB
0	0	0	DTX							
1	1	1	A (Dual TB)	Config...						0.0

Suggested / Current ARB Seq. Length

The dialog contains the general parameters required for configuring the channel, and displays the channel structure.



Realtime signal generation

To enable realtime signal generation for UE1:

- Select "3GPP FDD > User Equipment > UE1> HS-DPCCH"
- Select "Compatibility Mode > Up to Release 7"

4.32.1 About HS-DPCCH

HS-DPCCH Structure

The HS-DPCCH carries uplink feedback signaling related to the accuracy and quality of downlink HS-DSCH transmission. Hybrid-ARQ Acknowledgment (HARQ-ACK) is transmitted in the first subframe slot. Channel quality Indication (CQI) and if UE configured in MIMO mode, also precoding control indication (PCI) are transmitted in the second and third subframe slot. Only one HS-DPCCH can be transmitted on each radio link. The HS-DPCCH can only exist together with an uplink DPCCH.

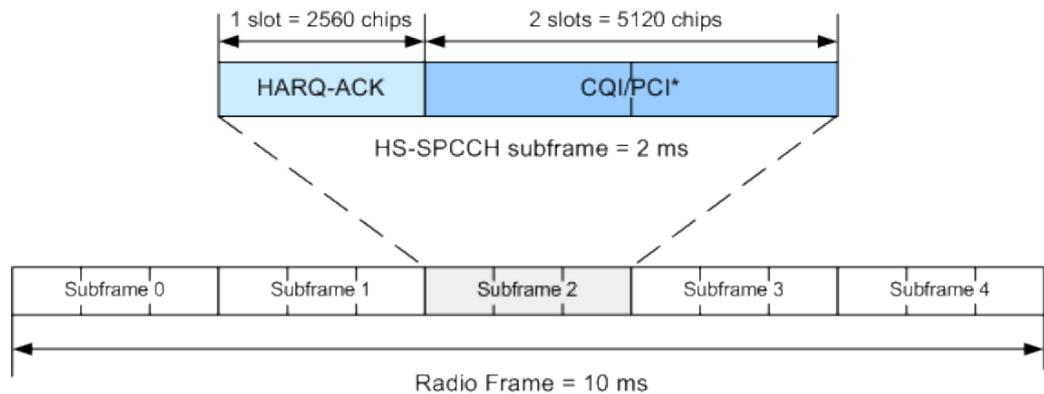

*) PCI for UE configured in MIMO mode only

Figure 4-25: Structure of an uplink HS-DPCCH in the time domain

The HS-DPCCH subframe starts $256 \times m$ chips after the start of an uplink DPCCH slot. The value m is selected such that the subframe transmission starts within the first 0 to 255 chips after 7.5 slots following the end of the received HS-PDSCH subframe.

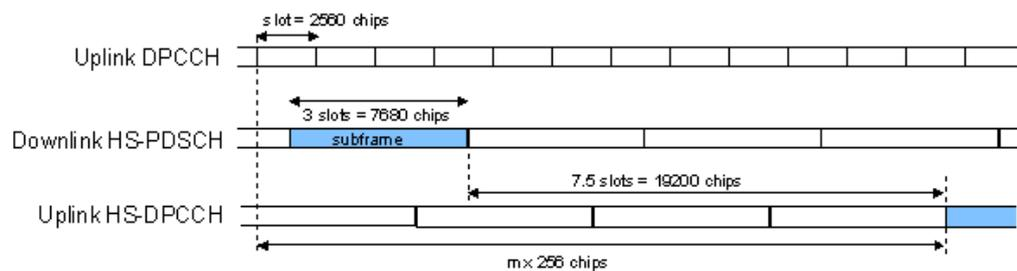

Figure 4-26: Timing offset between the uplink DPCCH, the HS-PDSCH and the HS-DPCCH at the UE

HS-DPCCH Power

According to 3GPP TS 25.214, the uplink HS-DPCCH power is estimated for each HS-DPCCH slot.

In this implementation, the channel power can be set individually for each case of feedback signaling and UE mode. The channel power is set as a combination of the CQI Power (parameter "Power") and the corresponding "Power Offset" (see Table 4-10 and Table 4-11). Since the feedback signaling can be configured per slot of TTI that carries HS-DPCCH, the channel power is also calculated on a slot basis.

Table 4-10: Calculating of the HARQ-ACK power

Mode	HARQ-ACK	Offset parameter	Resulting power
Compatibility Mode = Up to Release 7			
Normal	ACK/NACK pattern	Power Offset ACK	Power + Power Offset ACK
		Power Offset NACK	Power + Power Offset NACK
	Single ACK	Power Offset ACK	Power + Power Offset ACK

Mode	HARQ-ACK	Offset parameter	Resulting power
	Single NACK	Power Offset NACK	Power + Power Offset NACK
MIMO	TB1: ACK, TB2: ACK	Power Offset ACK/ACK	Power + Power Offset ACK/ACK
	TB1: ACK, TB2: NACK	Power Offset ACK/NACK	Power + Power Offset ACK/NACK
	TB1: NACK, TB2: ACK	Power Offset NACK/ACK	Power + Power Offset NACK/ACK
	TB1: NACK, TB2: NACK	Power Offset NACK/NACK	Power + Power Offset NACK/ NACK
Compatibility Mode = Release 8 and later (RT)			
all	HARQ-ACK	Power Offset HARQ-ACK	Power + Power Offset HARQ-ACK

Table 4-11: Calculating the PCI/CQI power

Mode	CQI	Type	CQI parameter	Offset parameter	Resulting power
Compatibility. Up to Release 7 Mode=					
Normal	-		CQI	-	Power
MIMO	CQI Type A	Single TB	CQIs	Power Offset CQI Type A	Power + Power Offset CQI Type A
		Double TB	CQI1 and CQI2		
Compatibility. Rel. 8 and later (RT) Mode=					
Normal	CQI		CQI	Power Offset PCI/CQI	Power + Power Offset PCI/CQI
DC-HSDPA non-MIMO	Comp. CQI		CQI1 and CQI2		
MIMO	CQI Type A	Single TB	CQIs		
		Double TB	CQI1 and CQI2		

4.32.2 HS-DPCCH Common Settings

The displayed channel structure depends on whether the UE is working in MIMO mode or not.

State (HS-DPCCH)

Activates or deactivates the HS-DPCCH channel.

Remote command:

[\[:SOURCE<hw>\]:BB:W3Gpp:MSTation<st>:DPCCh:HS:STATE](#) on page 357

Power (HS-DPCCH)

Sets the power in dB.

- In a "Compatibility Mode > Release 8 and Later" mode, this parameter represents the **reference power** used to calculate:
 - The power used during the HARQ-ACK slot
 - The power used during the PCI/CQI slots
- In a "Compatibility Mode > Up to Release 7" mode, this parameter represents the **CQI power of a UE** that:
 - Is configured in a normal mode
 - Is configured in MIMO mode and sending CQI Type B report.

The CQI Power is the reference power used to calculate:

- The power used during the HARQ-ACK slot
- The power used during the PCI/CQI slots of a UE configured in MIMO mode and sending CQI Type A reports.

The power entered is relative to the powers of the other channels and does not initially relate to the "Level" power display. If [Adjust Total Power to 0dB](#) is executed, all the power data is relative to the "Level" display.

Remote command:

[\[:SOURCE<hw>\]:BB:W3GPp:MSTation<st>:DPCCh:HS:POWer](#) on page 357

Compatibility Mode (HS-DPCCH)

Switches between the following modes:

"Up to Release 7"

Switches to the display of the HS-DPCCH settings provided for backwards compatibility.

"Release 8 and Later"

The concept of the graphical user interface for the configuration of HS-DPCCH has been adapted to support simultaneous DC-HSDPA and MIMO operation, as required in 3GPP Release 9 onwards.

This mode is disabled, if [Dynamic Power Control State](#) is On.

"Release 8 and Later RT"

Enables generation of the HS-DPCCH in real-time even for Release 8/9 content. Real-time signals are useful for complex HS-DPCCH scheduling and are required while using dynamic power control with the HS-DPCCH.

Remote command:

[\[:SOURCE<hw>\]:BB:W3GPp:MSTation<st>:DPCCh:HS:COMPatibility](#) on page 357

Start Delay

Sets the delay between the uplink HS-DPCCH and the frame of uplink DPCH.

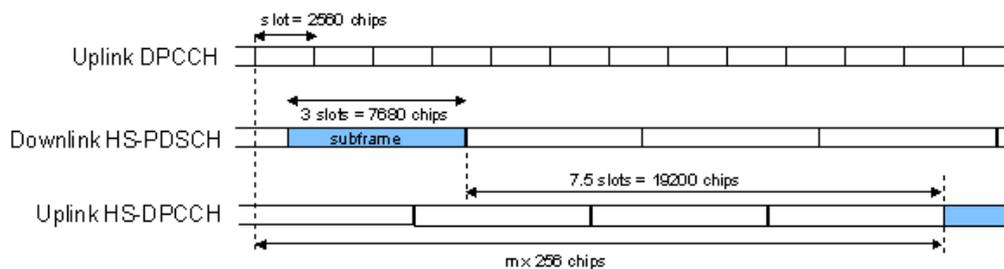

Thus, the channel can be synchronized with the associated downlink HS-PDSCH.

The delay is entered as a multiple m of 256 chips according to TS 25.211 7.7:

$$m = (T_{TX_diff} / 256) + 101$$

Where T_{TX_diff} is the difference in chips ($T_{TX_diff} = 0, 256, \dots, 38144$).

The value range of m is 0 to 250 (2 frames + 1024 chips)

Remote command:

`[:SOURCE<hw>] :BB:W3GPP:MSTation<st>:DPCCh:HS:SDElay` on page 358

Inter TTI Distance (Interval)

Selects the distance between two HSDPA packets. The distance is set in number of subframes (3 slots = 2 ms). An "Inter TTI Distance" of 1 means continuous generation.

Regarding the HS-DPCCH uplink transmission, this parameter determines where HS-DPCCH transmissions are possible in principle.

To have actual HS-DPCCH transmissions, HARQ-ACK and/or PCI/CQI transmissions have to be scheduled as described in:

- [4.32.3](#)
- [4.32.4](#)
- [4.32.5](#)

Remote command:

`[:SOURCE<hw>] :BB:W3GPP:MSTation<st>:DPCCh:HS:TTIDistance`
on page 358

Channelization Code (HS-DPCCH)

Displays the channelization code and the modulation branch (I or Q) of the HS-DPCCH.

The code channel is spread with the set channelization code (spreading code). The channelization code of the high-speed channel depends on the number of activated DPDCHs, i.e. on the overall symbol rate.

For "Secondary Cell Enabled ≥ 4 ", two HS-DPCCHs, i.e. two channelization codes are used.

Example:

Enable the following settings:

- "DPDCH State = On"
- "DPDCH Overall Symbol Rate = 60 ksps"
- "HS-DPCCH State = On"
- "Secondary Cell Enabled = 0"
The used channelization code is "HS-DPCCH > Channelization Code = Q / 64".
Open the "User Equipment > Code Domain" dialog
- Enable "Secondary Cell Enabled = 4"

Remote command:

`[:SOURce<hw>] :BB:W3GPp:MSTation<st>:DPCCh:HS:CCODE?` on page 358

Slot Format

Displays the used slot format.

The specified slot format for "Secondary Cell Enabled < 2" is "Slot Format 0 (15 ksps)". With more than 2 secondary cells or with 2 secondary cells and "MIMO Mode = On", the "Slot Format 1 (30 ksps)" is required, i.e. slot format with higher symbol rate.

Remote command:

`[:SOURce<hw>] :BB:W3GPp:MSTation<st>:DPCCh:HS:SFORmat?` on page 368

4.32.3 HS-DPCCH Scheduling Table (Release 8 and Later/RT)



These settings are available for "Compatibility Mode > Release 8 and Later/Release 8 and Later RT".

The configuration of MIMO settings and DC-HSDPA/4C-HSDPA/8C-HSDPA requires R&S SMBV-K59.

With the provided settings, you can adjust the HS-DPCCH signal of a UE configured for one of the following operations: normal operation, DC-HSDPA or 4C/8C-HSDPA operation, MIMO mode or for a simultaneous secondary cell + MIMO operation.

The HS-DPCCH structure can be configured with the parameters "Inter TTI Distance", "Number of Table Rows", "From/To" and "Repeat After". The HARQ-ACK and CQI/PCI information can be configured with the parameters of the HS-DPCCH scheduling tables. The scheduling for the HARQ-ACK and PCI/CQI reports can be performed independently; different repetition cycles can be specified.

Example: HS-DPCCH scheduling

The following is a simple example intended to explain the principle. Configured is an HS-DPCCH scheduling in "MIMO Mode = Off" and with "Secondary Cell Enabled = 0".

Parameter	Value
Start Delay	101 * 256 Chips
Compatibility Mode (HS-DPCCH)	Release 8 and later (RT)

Parameter	Value
Inter TTI Distance (Interval)	5 Subframes
HARQ-ACK scheduling	
Number of Rows	2
HARQ-ACK Repeat After	4 intervals
Row#0	
HARQ-ACK From Interval/ HARQ-ACK To Interval	from HARQ-ACK interval 0 to 1
HS-DPCCH 1/2, HARQ-ACK 1/2/3/4	A
Row#1	
HARQ-ACK From Interval/ HARQ-ACK To Interval	from HARQ-ACK interval 3 to 3
HS-DPCCH 1/2, HARQ-ACK 1/2/3/4	N
PCI/CQI scheduling	
Number of Rows	2
PCI/CQI Repeat After	3 intervals
Row#0	
PCI-CQI From Interval/ PCI-CQI To Interval	from PCI/CQI interval 0 to 0
HS-DPCCH 1/2, PCI/CQI 1/2/3/4 Type	DTX
Row#1	
PCI-CQI From Interval/ PCI-CQI To Interval	from PCI/CQI interval 1 to 1
HS-DPCCH 1/2, PCI/CQI 1/2/3/4 Type	CQI
CQI/CQI ₅ /CQI ₁ /CQI ₂	5



Use the [Scheduling List](#) to display the configured scheduling.

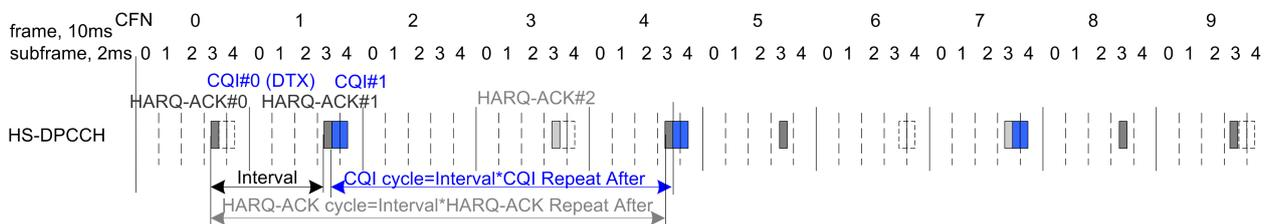

Figure 4-27: Example of HS-DPCCH Scheduling

"Inter TTI Distance (Interval)" = Five subframes
 "HARQ-ACK Cycle" = "Inter TTI Distance (Interval)"**"HARQ-ACK Repeat After = 5*4=20 Intervals"
 "CQI Cycle" = "Inter TTI Distance (Interval)"**"CQI Repeat After = 5*3=15 Intervals"

MIMO Mode

Enables/disables working in MIMO mode for the selected UE.

Remote command:

`[:SOURCE<hw>] :BB:W3GPP:MSTation<st>:DPCCh:HS:MMODE` on page 368

Secondary Cell Enabled

Enables the selected number of secondary cells for the selected UE. Secondary cells are used for working in DC-/4C/8C-HSDPA mode.

See also [Chapter 3.3.15, "Dual Cell HSDPA \(DC-HSDPA\)"](#), on page 38, [Chapter 3.3.16, "HS-DPCCH Extension for 4C-HSDPA and 8C-HSDPA"](#), on page 42 and [Chapter 5.4, "How to Configure the HS-DPCCH Settings for 4C-HSDPA Tests"](#), on page 244.

Remote command:

`[:SOURCE<hw>] :BB:W3GPP:MSTation<st>:DPCCh:HS:SC:ENABLEd`
on page 369

Secondary Cell Active

Sets the number of active secondary cells for the selected UE.

See also [Chapter 3.3.15, "Dual Cell HSDPA \(DC-HSDPA\)"](#), on page 38, [Chapter 3.3.16, "HS-DPCCH Extension for 4C-HSDPA and 8C-HSDPA"](#), on page 42 and [Chapter 5.4, "How to Configure the HS-DPCCH Settings for 4C-HSDPA Tests"](#), on page 244.

Remote command:

`[:SOURCE<hw>] :BB:W3GPP:MSTation<st>:DPCCh:HS:SC:ACTive` on page 369

HARQ-ACK

Comprises the parameters provided for the independent configuration of the HARQ-ACK scheduling.

Number of Rows ← HARQ-ACK

Determines the number of the rows in the HARQ-ACK scheduling table.

Each row represents one TTI interval, as configured with the parameter [Inter TTI Distance \(Interval\)](#). The parameters set in the table are read out cyclically.

See also [Figure 4-27](#).

Remote command:

`[:SOURCE<hw>] :BB:W3GPP:MSTation<st>:DPCCh:HS:HACK:ROWS` on page 369

HARQ-ACK Repeat After ← HARQ-ACK

Defines the cycle length after that the information in the HS-DPCCH scheduling table is read out again from the beginning.

The parameter together with the parameter [Inter TTI Distance \(Interval\)](#) defines the repetition cycle of the HARQ-ACK pattern:

HARQ-ACK cycle = [Inter TTI Distance \(Interval\)](#) * "HARQ-ACK Repeat After"

Remote command:

`[:SOURCE<hw>] :BB:W3GPP:MSTation<st>:DPCCh:HS:HACK:REPeat`
on page 374

HARQ-ACK From Interval/ HARQ-ACK To Interval ← HARQ-ACK

Defines the beginning/end of the HARQ-ACK transmissions inside the HARQ-ACK cycle (specified by [HARQ-ACK Repeat After](#)). The range is specified in multiples of intervals, determined by [Inter TTI Distance \(Interval\)](#).

See also [Figure 4-27](#).

Remote command:

`[:SOURCE<hw>] :BB:W3GPP:MSTation<st>:DPCCh:HS:ROW<ch0>:HACK:FROM`
on page 370

`[:SOURCE<hw>] :BB:W3GPP:MSTation<st>:DPCCh:HS:ROW<ch0>:HACK:TO`
on page 370

HS-DPCCH 1/2, HARQ-ACK 1/2/3/4 ← HARQ-ACK

Per HS-DPCCHs, sets the information transmitted during the HARQ-ACK slots of the TTIs during the corresponding specified "HARQ-ACK From/To" range.

Two HS-DPCCHs are transmitted, if "Secondary Cell Enabled > 3".

The number of enabled HARQ-ACKs depends on the combination of enabled and active secondary cells. In this implementation, the activated cells are mapped from left to right.

The processing of HS-DPCCH is defined for four different main cases (see [Table 4-12](#)).

Table 4-12: HS-DPCCH processing

Mode	"MIMO Mode"	"Secondary Cell Enabled"	"Secondary Cell Active"	Comment
Normal operation	Off	0	0	-
MIMO only	On	0	0	see Chapter 3.3.14.5, "MIMO uplink control channel Support" , on page 36
DC-HSDPA only 4C/8C-HSDPA only	Off	1 2 to 7	0, 1 2 to 7	see Chapter 3.3.15.1, "DC-HSDPA Data Acknowledgement (non-MIMO mode)" , on page 39 see Chapter 3.3.16, "HS-DPCCH Extension for 4C-HSDPA and 8C-HSDPA" , on page 42
DC-HSDPA +MIMO 4C/8C-HSDPA +MIMO	On	1 2 to 7	1 2 to 7	see Chapter 3.3.15.2, "DC-HSDPA + MIMO" , on page 41 see Chapter 3.3.16, "HS-DPCCH Extension for 4C-HSDPA and 8C-HSDPA" , on page 42

Meaning of the used abbreviations:

- **A** indicates an ACK response; **N** - an NACK
- **D** means no transmission (DTX), i.e. no transport block was sent on the corresponding HS-DSCH downlink transmission.
- Single letter, e.g. an **A** indicates a response to a single scheduled transport block (TB)
- A letter's couple, e.g. an **AA** indicates two MIMO streams, i.e. the response on two TBs

- / is a separation mark between the response to the serving and secondary cells, where the feedback related to the serving HS-DSCH cell is the one before the divider sign.

Example: Understanding the syntax

For better representation of the principle, the sending of ACK only messages is assumed.

HARQ-ACK value	Description
A/A/A	"MIMO Mode = Off" (single letters only) Three active cells, one serving and two secondary serving cells; one single TB transmission per cell
AA/A	"MIMO Mode = On" Two active cells, one serving with two MIMO streams and one secondary serving cell with single TB transmission
AA/AA	"MIMO Mode = On" Two active cells, each transmitting two MIMO streams
AA/AA, AA/D	"MIMO Mode = On" Three active cells, each transmitting two MIMO streams
AA/AA, AA/AA	"MIMO Mode = On" Four active cells, each transmitting two MIMO streams

"DTX" No HARQ-ACK feedback information is sent.

"A, N" Selects an ACK or NACK response to a single scheduled transport block.

"AA, AN, NA, NN"
("MIMO Mode > On", "Secondary Cell Enabled/Active = 0")
Selects the response to two scheduled transport blocks, i.e. feedback on the primary and secondary stream in a dual stream transmission.

"A/D, N/A, ... (different combinations possible)"
("MIMO Mode > Off", "Secondary Cell Enabled < 2")
Selects the response to a single scheduled transport block on each of the serving and secondary serving HS-DSCH cells.

"A/D/D, N/D/D, ... (different combinations possible)"
("MIMO Mode > Off", "Secondary Cell Enabled = 2")
Selects the response to a single scheduled transport block on each of the serving and the two secondary serving HS-DSCH cells.

"AN/NN, D/AA, ... (different combinations possible)"
("MIMO Mode > On", "Secondary Cell Active = On")
Selects the response to two scheduled transport blocks on each of the serving and secondary serving HS-DSCH cells.

"PRE, POST" PRE or POST is sent in the HARQ-ACK slots of the corresponding TTI.

Remote command:

[:SOURCE<hw>] :BB:W3GPp:MSTation<st>:DPCCh:HS:ROW<ch0>:HACK<di>
on page 370

Power Offset HARQ-ACK ← HARQ-ACK

Sets the power offset of an HARQ-ACK response relative to the "Power".

The power used during all HARQ-ACK slots during the corresponding specified "HARQ-ACK From/To" range is calculated as:

$$P_{\text{HARQ-ACK}} = \text{Power} + P_{\text{off_HARQ-ACK}}$$

The value range is -10 dB to 10 dB.

The parameter is enabled for HARQ-ACK different than DTX.

While generating the HS-DPCCH signal in real time, the HARQ-ACK power offsets of all configured HARQ-ACK responses are set to the same value.

Remote command:

[:SOURCE<hw>] :BB:W3GPp:MSTation<st>:DPCCh:HS:ROW<ch0>:POHACK
on page 371

PCI / CQI

Comprises the parameters provided for the independent configuration of the PCI/CQI reports scheduling.

Number of Rows ← PCI / CQI

This parameter determines the number of the rows in the PCI / CQI scheduling table.

Each row represents one TTI interval, as configured with the parameter [Inter TTI Distance \(Interval\)](#). The parameters set in the table are read out cyclically.

See also [Figure 4-27](#).

Remote command:

[:SOURCE<hw>] :BB:W3GPp:MSTation<st>:DPCCh:HS:PCQI:ROWS on page 369

PCI/CQI Repeat After ← PCI / CQI

Defines the cycle length after that the information in the HS-DPCCH scheduling table is read out again from the beginning.

The parameter together with the parameter [Inter TTI Distance \(Interval\)](#) defines the repetition cycle of the PCI/CQI pattern:

$$\text{PCI/CQI cycle} = \text{Inter TTI Distance (Interval)} * \text{"PCI/CQI Repeat After"}$$

Remote command:

[:SOURCE<hw>] :BB:W3GPp:MSTation<st>:DPCCh:HS:PCQI:REPEAT
on page 374

PCI-CQI From Interval/ PCI-CQI To Interval ← PCI / CQI

Defines the beginning/ end of the PCI/CQI transmissions inside the PCI/CQI cycle (specified by [PCI/CQI Repeat After](#)). The range is specified in multiples of intervals, defined by [Inter TTI Distance \(Interval\)](#).

See also [Figure 4-27](#).

Remote command:

`[:SOURCE<hw>] :BB:W3GPP:MSTation<st>:DPCCh:HS:ROW<ch0>:PCQI:FROM`
on page 372

`[:SOURCE<hw>] :BB:W3GPP:MSTation<st>:DPCCh:HS:ROW<ch0>:PCQI:TO`
on page 372

HS-DPCCH 1/2, PCI/CQI 1/2/3/4 Type ← PCI / CQI

Per HS-DPCCH, selects the type of the PCI/CQI report (see [CQI Reports: Type A and Type B](#) and [CQI Reports: CQI1 and CQI2](#)).

Two HS-DPCCHs are required, if "Secondary Cell Enabled > 3".

The number of enabled PCI/CQIs depends on the number of required HS-DPCCHs and the "Slot Format". In this implementation, the activated cells are mapped from left to right.

The available values depend on the state of the parameters "MIMO Mode", "Secondary Cell Enabled" and "Secondary Cell Active".

"DTX" No PCI/CQI feedback information is sent.

"CQI" Selects CQI report for the normal operation.

"Type A Single TB"

(MIMO Mode On)

Selects CQI Type A report with information that one transport block is preferred.

"Type A Double TB"

(MIMO Mode On)

Selects CQI Type A report with information that two transport blocks are preferred.

"Type B"

(MIMO Mode On)

Selects CQI Type B report.

"Composite CQI"

(MIMO Mode Off, "Secondary Cell Enabled = Secondary Cell Active ≤ 2")

Selects a composite CQI, constructed from the two individual reports CQI1 and CQI2 of the serving and secondary serving HS-DSCH cell.

Remote command:

`[:SOURCE<hw>] :BB:W3GPP:MSTation<st>:DPCCh:HS:ROW<ch0>:PCQI<di>:`
`TYPE` on page 372

Power Offset PCI/CQI ← PCI / CQI

Sets the power offset $P_{\text{off_PCI/CQI}}$ of all PCI/CQI slots during the corresponding specified PCI/CQI From/To range relative to the [Power](#).

The power $P_{\text{PCI/CQI}}$ used during the PCI/CQI slots is calculated as:

$$P_{\text{PCI/CQI}} = \text{Power} + P_{\text{off_PCI/CQI}}$$

The value range is -10 dB to 10 dB.

While generating the HS-DPCCH signal in real time, the PCI/CQI power offsets of all configured PCI/CQI slots are set to the same value.

Remote command:

[:SOURCE<hw>] :BB:W3GPp:MSTation<st>:DPCCh:HS:ROW<ch0>:POPCqi
on page 373

PCI/CQI 1/2/3/4 Content ← PCI / CQI

Accesses a dialog for configuring the PCI and CQI report. The provided settings depend on the selected "PCI/CQI Type".

CQI/CQI_s/CQI₁/CQI₂ ← PCI/CQI 1/2/3/4 Content ← PCI / CQI

Sets the CQI report transmitted during the PCI/CQI slots of the TTIs during the corresponding specified PCI/CQI From/To range (see [Chapter 3.3.14.6, "CQI Reports: Type A and Type B"](#), on page 37 and ["CQI Reports: CQI1 and CQI2"](#) on page 41).

"CQI"	Sets the CQI value for CQI Type B report and the CQI in normal operation.
"CQI _s "	Sets the CQI value in case a CQI Type A report when one transport block is preferred.
"CQI ₁ "	Sets the CQI ₁ value of CQI Type A report when two transport blocks are preferred or the CQI ₁ value of a composite CQI report of a dual cell only operation.
"CQI ₂ "	Sets the CQI ₂ value of CQI Type A report when two transport blocks are preferred or the CQI ₂ value of a composite CQI report of a dual cell only operation.

Remote command:

[:SOURCE<hw>] :BB:W3GPp:MSTation<st>:DPCCh:HS:ROW<ch0>:PCQI<di>:
CQI<us> on page 373

PCI ← PCI/CQI 1/2/3/4 Content ← PCI / CQI

Selects the PCI value transmitted during the PCI/CQI slots of the TTIs during the corresponding specified PCI/CQI From/To range (see [PCI Reports](#)).

Remote command:

[:SOURCE<hw>] :BB:W3GPp:MSTation<st>:DPCCh:HS:ROW<ch0>:PCQI<di>:
PCI on page 373

Suggested / Current ARB Seq. Length (HS-DPCCH)

Displays the suggested and current ARB sequence length, in case the signal is not generated in real time.

The "Suggested ARB Sequence Length" is the calculated minimum length that depends on the [Inter TTI Distance \(Interval\)](#), the [Number of Rows/Number of Rows](#), the [HARQ-ACK Repeat After](#) and the [PCI/CQI Repeat After](#). The current ARB sequence length is adjusted by pressing the button "Adjust ARB Sequence Length".

Example: Effect of the ARB sequence length

- Preset the instruments and adjust the settings as described in [Example "HS-DPCCH scheduling"](#) on page 195. Use the [Scheduling List](#) to show the HS-DPCCH scheduling (see also [Figure 4-27](#)).
- Change the [Compatibility Mode \(HS-DPCCH\)](#) to "Release 8 and Later" and compare the displayed HS-DPCCH scheduling in the "Scheduling List".

Real-time signal generation

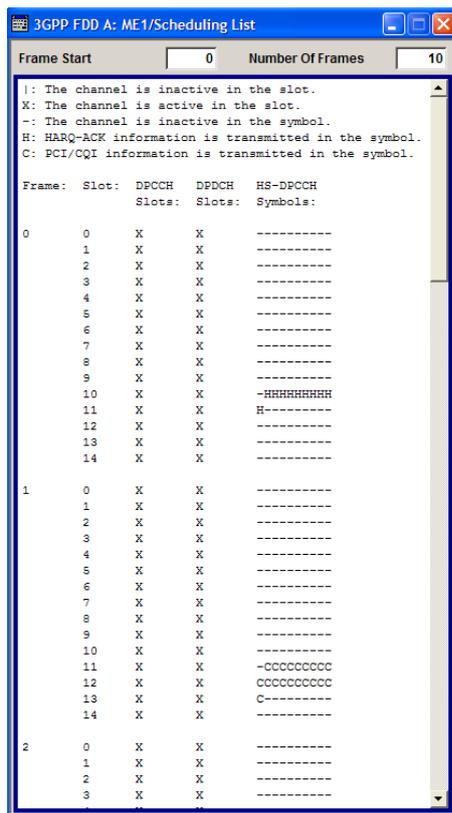

ARB signal generation with "Current ARB Seq. Length" < "Suggested ARB Seq. Length"

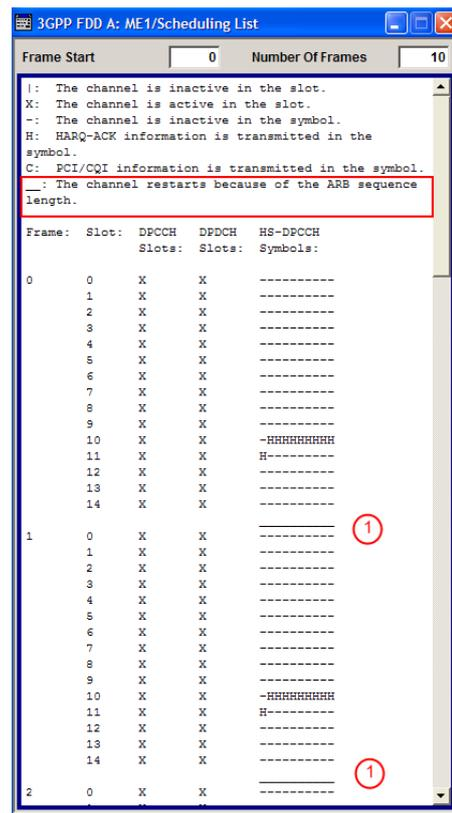

The channel restarts after 1 frame ("Current ARB Seq. Length = 1 Frame")

- The "Suggested / Current ARB Sequence Length" is 12 / 1. Press the [Adjust ARB Sequence Length \(HS-DPCCH\)](#). The "Current ARB Seq. Length" is adjusted, the channel restarts after 12 frames and the "Scheduling List" shows the HS-DPCCH scheduling in all frames as in the real-time mode.

Tip: To ensure a long enough ARB sequence, select "3GPP FDD > Filter/Clipping/ARB Settings" and adjust the [Sequence Length ARB](#) so that the ARB sequence length is multiple or equal the scheduling repetition.

Remote command:

[:SOURce<hw>] :BB:W3GPP:MSTation<st>:DPCCh:HS:SLENgth? on page 374

Adjust ARB Sequence Length (HS-DPCCH)

Sets the current ARB sequence length to the suggested value (see also [Example "Effect of the ARB sequence length"](#) on page 203).

Remote command:

`[:SOURCE<hw>] :BB:W3GPP:MSTation<st>:DPCCh:HS:SLENgth:ADJust`
on page 374

4.32.4 HS-DPCCH Settings for Normal Operation (Up to Release 7)

The R&S SMBV supports also the parameters for backward compatibility.

Access:

1. Select "3GPP FDD > Link Direction > Uplink / Reverse > User Equipments > UE"
2. Select "HS-DPCCH".
3. Select "Compatibility Mode > Up to Release 7".

The dialog contains the parameters that were available up to the selected release.

Power Offset ACK

Sets the power offset $P_{\text{off_ACK}}$ of an ACK response to a single scheduled transport block relative to the CQI Power P_{CQI} .

The power P_{ACK} used during the HARQ-ACK slot is calculated as:

$$P_{\text{ACK}} = P_{\text{CQI}} + P_{\text{off_ACK}}$$

The value range is -10 dB to 10 dB.

Remote command:

`[:SOURCE<hw>] :BB:W3GPP:MSTation<st>:DPCCh:HS:POACK` on page 359

Power Offset NACK

Sets the power offset $P_{\text{off_NACK}}$ of an NACK response to a single scheduled transport block relative to the CQI Power P_{CQI} .

The power P_{NACK} used during the HARQ-ACK slot is calculated as:

$$P_{\text{NACK}} = P_{\text{CQI}} + P_{\text{off_NACK}}$$

The value range is -10 dB to 10 dB.

Remote command:

[\[:SOURCE<hw>\]:BB:W3GPP:MSTation<st>:DPCCh:HS:PONack](#) on page 359

ACK/NACK Pattern

(for "MIMO Mode > Off")

Enters the pattern for the HARQ-ACK field (Hybrid-ARQ Acknowledgment).

After receiving a transmission packet, the user equipment returns feedback information in the HARQ-ACK field that is related to the accuracy of downlink HS-DSCH transmission.

1 bit is used per HS-DPCCH packet. The maximum length of the pattern is 32 bits.

""1" = ACK" The HARQ ACK is sent. Transmission was successful and correct.

""0" = NACK" The NACK is sent. Transmission was not correct. With an NACK, the UE requests retransmission of the incorrect data.

""-" = DTX" Nothing is sent. Transmission is interrupted (discontinuous transmission (DTX)).

Remote command:

[\[:SOURCE<hw>\]:BB:W3GPP:MSTation<st>:DPCCh:HS:HAPattern](#) on page 360

CQI Pattern Length

(for "MIMO Mode > Off")

Sets the length of the CQI sequence. The values of the CQI sequence are entered in input fields "CQI Values". The pattern is generated cyclically.

With the CQI (channel quality indicator), the user equipment informs the base station about the receive quality of the downlink HS-PDSCH.

Thus, the base station can adapt the modulation and coding scheme to improve the signal quality. The instrument supports the control of the base station HS-PDSCH by CQI sequences with a length of 1 to 10 values.

Remote command:

[\[:SOURCE<hw>\]:BB:W3GPP:MSTation<st>:DPCCh:HS:CQI:PLENgtH](#)
on page 360

CQI Values

(for "MIMO Mode > Off")

Enters the values of the CQI sequence. Value -1 means that no CQI is sent (DTX).

The length of the CQI sequence is set at input field CQI Length. The pattern is generated cyclically.

With the CQI, the user equipment informs the base station about the receive quality of the downlink HS-PDSCH. Thus, the base station can adapt the modulation and coding scheme to improve the signal quality. The instrument supports the control of the base station HS-PDSCH by CQI sequences with a length of 1 to 10 values.

Remote command:

```
[ :SOURCE<hw> ] :BB:W3GPP:MSTation<st>:DPCCh:HS:CQI<ch> [ :VALues ]
```

on page 361

MIMO Mode (Up to Release 7)

(requires R&S SMBV-K59)

Enables/disables working in MIMO mode for the selected UE.

When MIMO mode is enabled, the parameters ACK/NACK pattern, CQI pattern length and CQI values are not available. Several MIMO-specific parameters are enabled for configuration (see [Chapter 4.32.5, "MIMO Settings HS-DPCCH \(Up to Release 7\)"](#), on page 206s).

Remote command:

```
[ :SOURCE<hw> ] :BB:W3GPP:MSTation<st>:DPCCh:HS:MIMO [ :MODE ]
```

on page 361

4.32.5 MIMO Settings HS-DPCCH (Up to Release 7)



The configuration of MIMO settings requires R&S SMBV-K59 and "MIMO Mode > On".

Access:

1. Select "3GPP FDD > Link Direction > Uplink / Reverse > User Equipments > UE"
2. Select "HS-DPCCH".
3. Select "Compatibility Mode > Up to Release 7".

- Select "MIMO Mode > On".

	HARQ-ACK	PCI	CQI Type	CQI/CQIs/CQI1	CQI2
0	TB1: ACK, TB2: ACK	3	Type A Dual TB	2	5
1	Single TB: NACK	1	Type B	9	
2	Single TB: ACK	0	Type A Single TB	1	

The available settings allow you to adjust the HS-DPCCH configuration for UE configured in MIMO mode.

The HS-DPCCH structure can be configured with the parameters [Inter TTI Distance](#) and [Number of TTIs](#). The HS-DPCCH structure can also be configured by changing the HARQ-ACK and CQI/PCI information per TTI by means of the parameters of the HS-DPCCH scheduling table. Any combination of single or dual transport block [HARQ-ACK](#), [PCI value](#), [CQI Type](#) and corresponding [CQI value\(s\)](#), as well as channel power can be configured.

Power Offset ACK/ACK

Sets the power offset $P_{\text{off_ACK/ACK}}$ of an ACK/ACK response to two scheduled transport blocks relative to the CQI Power P_{CQI} .

The power $P_{\text{ACK/ACK}}$ used during the HARQ-ACK slots is calculated as:

$$P_{\text{ACK/ACK}} = P_{\text{CQI}} + P_{\text{off_ACK/ACK}}$$

The value range is -10 dB to 10 dB.

Remote command:

```
[ :SOURCE<hw> ] :BB:W3Gpp:MSTation<st>:DPCCh:HS:MIMO:POAAck
```

on page 361

Power Offset ACK/NACK

Sets the power offset $P_{\text{off_ACK/NACK}}$ of an ACK/NACK response to two scheduled transport blocks relative to the CQI Power P_{CQI} .

The power $P_{ACK/NACK}$ used during the HARQ-ACK slots is calculated as:

$$P_{ACK/NACK} = P_{CQI} + P_{off_ACK/NACK}$$

The value range is -10 dB to 10 dB.

Remote command:

`[:SOURCE<hw>] :BB:W3GPP:MSTation<st>:DPCCh:HS:MIMO:POANack`
on page 362

Power Offset NACK/ACK

Sets the power offset $P_{off_NACK/ACK}$ of an NACK/ACK response to two scheduled transport blocks relative to the CQI Power P_{CQI} .

The power $P_{NACK/ACK}$ used during the HARQ-ACK slots is calculated as:

$$P_{NACK/ACK} = P_{CQI} + P_{off_NACK/ACK}$$

The value range is -10 dB to 10 dB.

Remote command:

`[:SOURCE<hw>] :BB:W3GPP:MSTation<st>:DPCCh:HS:MIMO:PONack`
on page 362

Power Offset NACK/NACK

Sets the power offset $P_{off_NACK/NACK}$ of an NACK/NACK response to two scheduled transport blocks relative to the CQI Power P_{CQI} .

The power $P_{NACK/NACK}$ used during the HARQ-ACK slots is calculated as:

$$P_{NACK/NACK} = P_{CQI} + P_{off_NACK/NACK}$$

The value range is -10 dB to 10 dB.

Remote command:

`[:SOURCE<hw>] :BB:W3GPP:MSTation<st>:DPCCh:HS:MIMO:PONNack`
on page 363

Power Offset CQI Type A

Sets the power offset $P_{off_CQI\ Type\ A}$ of the PCI/CQI slots in case a CQI Type A report is sent relative to the CQI Power P_{CQI} .

The power $P_{CQI\ Type\ A}$ used during the PCI/CQI slots is calculated as:

$$P_{CQI\ Type\ A} = P_{CQI} + P_{off_CQI\ Type\ A}$$

Since the CQI Type B reports are used in a single stream transmission (see [Chapter 3.3.14.6, "CQI Reports: Type A and Type B"](#), on page 37), the power $P_{CQI\ Type\ B} = P_{CQI}$.

The value range is -10 dB to 10 dB.

Remote command:

`[:SOURCE<hw>] :BB:W3GPP:MSTation<st>:DPCCh:HS:MIMO:POCA` on page 364

Number of TTIs (Up to Release 7)

Selects the number of configurable TTIs.

This parameter determines the number of the rows in the HS-DPCCH scheduling table. Each row represents one TTI. The parameters set in the table are read out cyclically.

Remote command:

`[:SOURCE<hw>] :BB:W3GPP:MSTation<st>:DPCCh:HS:MIMO:TTICount`
on page 364

MIMO Settings Table

Comprises the parameters provided for active MIMO Mode.

HARQ-ACK (Up to Release 7) ← MIMO Settings Table

Selects the information transmitted during the HARQ-ACK slot of the corresponding TTI (see [Chapter 3.3.14.5, "MIMO uplink control channel Support"](#), on page 36).

"DTX" Selects discontinuous transmission (DTX) for the corresponding TTI. During that TTI, no feedback information is sent, i.e. all other parameters in the feedback signaling table are disabled.

"Single TB: ACK/Single TB: NACK" Selects an ACK or NACK response to a single scheduled transport block.

"TB1:ACK,TB2:ACK / TB1:ACK,TB2:NACK / TB1:NACK,TB2:ACK / TB1:NACK,TB2:NACK" Selects the response to two scheduled transport blocks.

Remote command:

`[:SOURCE<hw>] :BB:W3GPP:MSTation<st>:DPCCh:HS:MIMO:TTI<ch0>:HACK`
on page 365

PCI (Up to Release 7) ← MIMO Settings Table

Selects the PCI value transmitted during the PCI/CQI slots of the corresponding TTI (see [Chapter 3.3.14.7, "PCI Reports"](#), on page 37).

Remote command:

`[:SOURCE<hw>] :BB:W3GPP:MSTation<st>:DPCCh:HS:MIMO:TTI<ch0>:PCI`
on page 365

CQI Type (Up to Release 7) ← MIMO Settings Table

Selects the type of the CQI report (see [Chapter 3.3.14.6, "CQI Reports: Type A and Type B"](#), on page 37).

"Type A Single TB" Selects CQI Type A report with information that one transport block is preferred.

"Type A Double TB" Selects CQI Type A report with information that two transport blocks are preferred.

"Type B" Selects CQI Type B report.

Remote command:

`[:SOURCE<hw>] :BB:W3GPP:MSTation<st>:DPCCh:HS:MIMO:TTI<ch0>:CQIType`
on page 365

CQI/CQI_s/CQI₁/CQI₂ (Up to Release 7) ← MIMO Settings Table

Selects the CQI report transmitted during the PCI/CQI slots of the corresponding TTI (see [Chapter 3.3.14.6, "CQI Reports: Type A and Type B"](#), on page 37).

- "CQI" Sets the CQI value for CQI Type B report.
- "CQI_s" Sets the CQI value in case a CQI Type A report when one transport block is preferred.
- "CQI₁" Sets the CQI₁ value of CQI Type A report when two transport blocks are preferred.
- "CQI₂" Sets the CQI₂ value of CQI Type A report when two transport blocks are preferred.

Remote command:

```
[ :SOURce<hw> ] :BB:W3GPp:MSTation<st>:DPCCh:HS:MIMO:TTI<ch0>:
CQI<di> on page 366
```

4.33 DPDCH Settings - UE

The "DPDCH Settings" section is where the settings are made for the DPDCH channels. This section is only available if "DPCCH + DPDCH" mode is activated (see also Chapter 4.30, "DPCCH Settings - UE", on page 181).

The DPDCH is configured in form of "Channel Table". The number of active channels depends on the overall symbol rate set. The data sources for the data part of the individual channels can be selected in the channel table. The remaining parameters are only displayed and their value depends on the overall symbol rate set.

In UE1, the DPDCH is generated in real time (enhanced), if only one DPDCH is selected by the overall symbol rate setting.

The "Global Enhanced Channels" accesses a dialog for configuring the enhanced parameters.

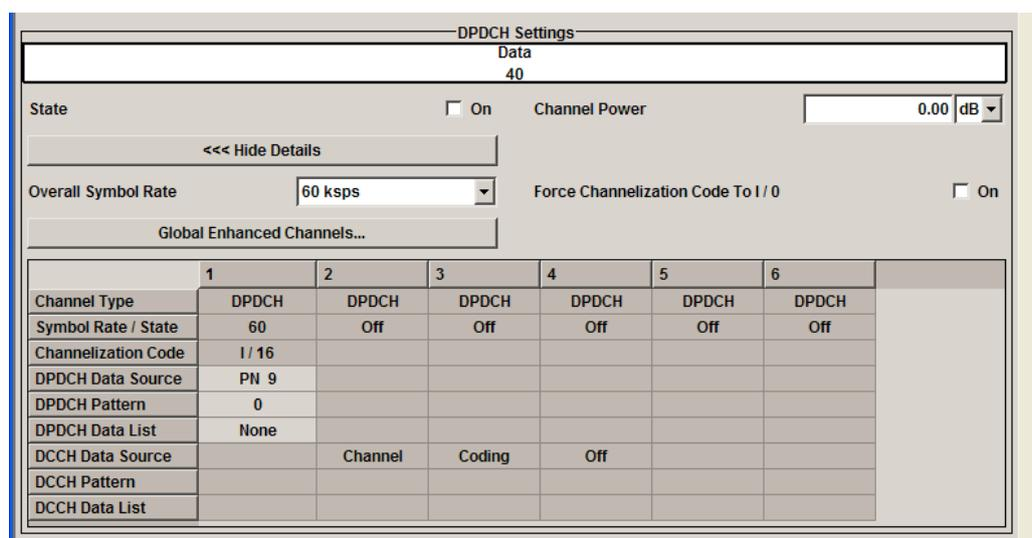

4.33.1 DPDCH Common Settings

State (DPDCH)

Activates or deactivates all the DPDCH channels.

Remote command:

`[:SOURCE<hw>] :BB:W3GPP:MSTation<st>:DPDCh:STATe` on page 378

Channel Power

Sets the channel power in dB.

The power entered is relative to the powers of the other channels and does not initially relate to the "Level" power display. If [Adjust Total Power to 0dB](#) is executed, all the power data is relative to "Level".

Note: The uplink channels are not blanked in this mode (duty cycle 100%).

Test cases defined in the 3GPP standard often use notation "Signaling values for β_c and β_d ". The quantization of the gain parameters is shown in the following table which is taken from 3GPP Spec 25.213 (left columns) and supplemented by the instrument-specific values (right column).

Signaling values for β_c and β_d	Quantized amplitude ratios β_c and β_d	Power to be set / dB
15	1.0	0.0
14	14/15	-0.60
13	13/15	-1.24
12	12/15	-1.94
11	11/15	-2.69
10	10/15	-3.52
9	9/15	-4.44
8	8/15	-5.46
7	7/15	-6.62
6	6/15	-7.96
5	5/15	-9.54
4	4/15	-11.48
3	3/15	-13.99
2	2/15	-17.52
1	1/15	-23.52
0	Switch off	Switch channel off or -80 dB

Remote command:

`[:SOURCE<hw>] :BB:W3GPP:MSTation<st>:DPDCh:POWer` on page 378

Force Channelization Code To I/Q

Sets the channelization code to I/Q.

This mode can only be activated if the "Overall Symbol Rate < 2 x 960 kbps".

It is provided for test purposes. Using an oscilloscope, the data bits of the DPDCH are visible on the I/Q signal for the following settings:

- "Force Channelization Code to I/Q > On"
- "Scrambling Code Mode > Off"
- "DPCCH Channel Power = - 80 dB"

Remote command:

`[:SOURCE<hw>] :BB:W3GPp:MSTation<st>:DPDCh:FCIO` on page 377

Overall Symbol Rate

Sets the overall symbol rate of all the DPDCH channels.

The structure of the DPDCH channel table depends on this parameter. The overall symbol rate determines which DPDCHs are active, which symbol rate they have and which channelization codes they use (see [Table A-2](#)).

DPDCHs that are not active by virtue of the overall rate are also disabled for operation.

Note: Up to an overall rate of 960 ksps, only DPDCH 1 is active, its symbol rate is the same as the overall symbol rate and the channelization code is the same as spreading factor/4 (spreading factor = chip rate / symbol rate).

With an overall symbol rate greater than 960 ksps, all the active DPDCH channels have the symbol rate 960 ksps.

Remote command:

`[:SOURCE<hw>] :BB:W3GPp:MSTation<st>:DPDCh:ORATe` on page 378

Global Enhanced Channels

Accesses the dialog for configuring all the enhanced channel settings of user equipment UE1, see [Chapter 4.38, "Global Enhanced Channel Settings - UE1"](#), on page 231.

Remote command:

n.a.

4.33.2 Channel Table

The channel table allows you to configure the individual parameters for the DPDCH channels. The structure of the currently selected channel is displayed graphically in the table header.

The number of active channels depends on the selected overall symbol rate. You can select the data sources for the individual channels. The remaining parameters are only displayed and their values depend also on the overall symbol rate. See also [Table A-2](#).

Channel Number

Displays the channel number.

Remote command:

n.a.

(the channel is selected by the suffix at keyword CHANnel<n>)

Channel Type

Displays the channel type.

Remote command:

n.a.

Symbol Rate / State

Displays the symbol rate and the state of the DCDCCH channel.

The symbol rate and the state of channel 2 to 6 are dependent on the overall symbol rate set and cannot be modified.

Remote command:

[:SOURCE<hw>] :BB:W3GPP:MSTation<st>:CHANnel<ch>:DPDCh:SRATe?
on page 377

Channelization Code

Displays the channelization code and the modulation branch (I or Q) of the DPDCH channel.

The channelization code is dependent on the overall symbol rate set and cannot be modified.

Remote command:

[:SOURCE<hw>] :BB:W3GPP:MSTation<st>:CHANnel<ch>:DPDCh:CCODE?
on page 375

DPDCH Data Source

For UE2, UE3 and UE4 and UE1 without channel coding, selects the data source for the DPDCH channel.

When channel coding is active, the data source for the DTCH1 component in the transport layer is selected here. In this situation, the display reads "DTCH data Source" and the "DCCH Data" entry field is enabled for selecting the data source of the DCCH channel. The data sources of the other DTCH channels can be set in the "Global Enhanced Channel Settings > Transport Channel" dialog, see [Chapter 4.38, "Global Enhanced Channel Settings - UE1"](#), on page 231.

The following standard data sources are available:

- "All 0, All 1"
An internally generated sequence containing 0 data or 1 data.
- "PNxx"
An internally generated pseudo-random noise sequence.
- "Pattern"
An internally generated sequence according to a bit pattern.
Use the "Pattern" box to define the bit pattern.
- "Data List/Select DList"
A binary data from a data list, internally or externally generated.
Select "Select DList" to access the standard "Select List" dialog.
 - Select the "Select Data List > navigate to the list file *.dm_iqd > Select" to select an existing data list.

- Use the "New" and "Edit" functions to create internally new data list or to edit an existing one.
- Use the standard "File Manager" function to transfer external data lists to the instrument.

See also "Main Dialog > Data List Management".

Remote command:

`[:SOURCE<hw>] :BB:W3GPP:MSTation<st>:CHANnel<ch>:DPDCh:DATA`

on page 375

`[:SOURCE<hw>] :BB:W3GPP:MSTation<st>:CHANnel<ch>:DPDCh:DATA:`

`PATtern` on page 376

`[:SOURCE<hw>] :BB:W3GPP:MSTation<st> [:HSUPa] :CHANnel<ch>:DPDCh:E:DATA:DSElect` on page 401

DCCH Data Source

For UE1 for enhanced channels with active channel coding, selects the data source for the DCCH component.

The following standard data sources are available:

- "All 0, All 1"
An internally generated sequence containing 0 data or 1 data.
- "PNxx"
An internally generated pseudo-random noise sequence.
- "Pattern"
An internally generated sequence according to a bit pattern.
Use the "Pattern" box to define the bit pattern.
- "Data List/Select DList"
A binary data from a data list, internally or externally generated.
Select "Select DList" to access the standard "Select List" dialog.
 - Select the "Select Data List > navigate to the list file *.dm_iqd > Select" to select an existing data list.
 - Use the "New" and "Edit" functions to create internally new data list or to edit an existing one.
 - Use the standard "File Manager" function to transfer external data lists to the instrument.

See also "Main Dialog > Data List Management".

4.34 E-DPDCH Settings - UE

Access:

1. Select "3GPP FDD > Link Direction > Uplink / Reverse > User Equipments > UE".
2. Select "Mode > DPCCH + DPDCH".

3. Select "E-DPDCH Settings > Show Details".

	1	2	3	4	5
Channel Type	E-DPDCH	E-DPDCH	E-DPDCH	E-DPDCH	E-DPDCH
Symbol Rate / State	480	Off	Off	Off	Off
Channelization Code	1 / 2				
Channel Power /dB	0.00				
E-DPDCH Data Source	PN 9				
E-DPDCH Pattern	0				
E-DPDCH Data List	None				

The dialog displays the channel structure and the available parameters.

The E-DPDCH channels are defined in form of a "Channel Table". The number of active channels depends on the overall symbol rate. The data sources for the data part of the individual channels can be selected in the channel table. The remaining parameters are only displayed and their value depends on the overall symbol rate.

4.34.1 E-DPDCH Common Settings

State (E-DPDCH)

Activates or deactivates all the E-DPDCH channels.

If an FRC is set for the channel, this field is activated automatically.

Remote command:

```
[ :SOURCE<hw> ] :BB:W3Gpp:MSTation<st> [ :HSUPa ] :DPDCh:E:STATE
on page 415
```

Force Channelization Code To I/O

Sets the channelization code to I/O.

This mode can only be activated if the overall symbol rate is less than 2 x 960 kbps.

It is provided for test purposes. Using an oscilloscope, the data bits of the E-DPDCH are visible on the I/Q signal if:

- "Force Channelization Code to I/O > On"
- "Scrambling Code Mode > Off"
- "DPDCH Power = - 80 dB"

Remote command:

```
[ :SOURCE<hw> ] :BB:W3Gpp:MSTation<st> [ :HSUPa ] :DPDCh:E:FCIO
on page 414
```

Overall Symbol Rate

Sets the overall symbol rate of all the E-DPDCH channels.

The structure of the E-DPDCH channel table depends on this parameter. The overall symbol rate determines which E-DPDCHs are active, which symbol rate they have and which channelization codes they use.

E-DPDCHs that are not active by virtue of the overall rate are also disabled for operation.

If an FRC is set for the channel, this field is read-only.

Note: If the [Dynamic Power Control State](#) and/or the [UL-DTX... / User Scheduling State](#) is enabled, the E-DPDCH is generated in real time. Then only the overall symbol rates with one E-DPDCH channel or those that restrict the E-DPDCHs to the I or Q branch are enabled for configuration.

To send simultaneously multiple physical E-DPDCH, set the Overall Rate to one of the predefined two-channel configurations. For some special applications, it is necessary to split up the generation of these channels to two baseband blocks. The instrument provides also special non-standard overall symbol rates, that enable the instrument to generate only the E-DPDCH channels of the I branch or of the Q branch per baseband block.

Remote command:

```
[ :SOURCE<hw> ] :BB:W3GPp:MSTation<st> [:HSUPa] :DPDCh:E:ORATe
```

on page 414

Modulation

Sets the modulation of the E-DPDCH.

There are two possible modulation schemes specified for this channel, BPSK and 4PAM (4 Pulse-Amplitude Modulation). The latter one is available only for [Overall Symbol Rates](#) using two channels, e.g 2x960 ksp/s and/or 2x1920 ksp/s.

Note: Modulation scheme 4PAM requires R&S SMBV-K59.

Remote command:

```
[ :SOURCE<hw> ] :BB:W3GPp:MSTation<st> [:HSUPa] :DPDCh:E:MODulation
```

on page 414

4.34.2 Channel Table

The channel table allows you to configure the individual parameters for the E-DPDCH channels. The structure of the currently selected channel is displayed graphically in the table header.

The number of active channels depends on the selected overall symbol rate. You can select the data sources for the individual channels. The remaining parameters are only displayed and their values depend also on the overall symbol rate. See also [Table A-3](#) and [Table A-4](#).

Channel Number

Displays the channel number.

Remote command:

n.a.

(the channel is selected by the suffix at keyword CHANnel<n>)

Channel Type

Displays the channel type.

Remote command:

n.a.

Symbol Rate / State

Displays the symbol rate and the state of the E-DPDCH channel.

The symbol rate and the state of the channels depend on the overall symbol rate and cannot be modified.

Remote command:

`[:SOURCE<hw>] :BB:W3GPP:MSTation<st> [:HSUPa] :CHANNEL<ch> :DPDCh:E:SRATE?` on page 402

Channelization Code

Displays the channelization code and the modulation branch (I or Q) of the DPDCH channel.

The channelization code depends on the overall symbol rate and cannot be modified.

Remote command:

`[:SOURCE<hw>] :BB:W3GPP:MSTation<st> [:HSUPa] :CHANNEL<ch> :DPDCh:E:CCODE?` on page 400

Channel Power / dB

Sets the power of the selected E-DPDCH channel.

The power entered is relative to the powers of the other channels and does not initially relate to the "Level" power display. If [Adjust Total Power to 0dB](#) is executed, all the power data is relative to "Level"

Remote command:

`[:SOURCE<hw>] :BB:W3GPP:MSTation<st> [:HSUPa] :CHANNEL<ch> :DPDCh:E:POWER` on page 402

E-DPDCH Data Source

Selects the data source for the E-DPDCH channel.

The data source for the DPDCH is also entered here for the enhanced channels of UE1 without channel coding.

The following standard data sources are available:

- "All 0, All 1"
An internally generated sequence containing 0 data or 1 data.
- "PNxx"
An internally generated pseudo-random noise sequence.
- "Pattern"
An internally generated sequence according to a bit pattern.
Use the "Pattern" box to define the bit pattern.
- "Data List/Select DList"
A binary data from a data list, internally or externally generated.
Select "Select DList" to access the standard "Select List" dialog.
 - Select the "Select Data List > navigate to the list file *.dm_iqd > Select" to select an existing data list.

- Use the "New" and "Edit" functions to create internally new data list or to edit an existing one.
- Use the standard "File Manager" function to transfer external data lists to the instrument.

See also "Main Dialog > Data List Management".

Remote command:

`[:SOURCE<hw>] :BB:W3GPP:MSTation<st> [:HSUPa] :CHANnel<ch> :DPDCh:E:DATA` on page 401

`[:SOURCE<hw>] :BB:W3GPP:MSTation<st> [:HSUPa] :CHANnel<ch> :DPDCh:E:DATA:PATtern` on page 402

`[:SOURCE<hw>] :BB:W3GPP:MSTation<st> [:HSUPa] :CHANnel<ch> :DPDCh:E:DATA:DSElect` on page 401

4.35 E-DCH Scheduling - UE

(requires option R&S SMBV-K45)

Access:

1. Select "3GPP FDD > User Equipment > link Direction > Uplink / Reverse > User Equipments > UE"
2. Select "E-DCH Settings > Show Details".

E-DCH Scheduling		E-DCH From TTI	E-DCH To TTI
E-DCH TTI	2 ms	0	0
Number Of Table Rows	1		
Schedule Repeats After	1 TTIs		

This dialog comprises the settings necessary to configure the common time schedule of the E-DPDCH and E-DPCCH. The settings enable you to configure single E-DCH packets or "bursts" of variable length consisting of several successive E-DCH packets and to decide upon the E-DCH packets distribution.

Use the [Scheduling List](#) to display and verify the configured uplink scheduling for every UE.



Real time vs. ARB signal generation

The E-DCH channels are generated in real time or as an ARB signal.

- If the E-DCH channels are generated as ARB signal, the ARB sequence length has to be long enough and a multiple or equal the scheduling repetition.
- The instrument generates the channels in real time if [UL-DTX... / User Scheduling State](#) and/or [Dynamic Power Control State](#) is activated.
 - During generation of E-DCH channels in real-time, channel coding (i.e. activation of FRCs) is disabled. Use pre-channel-coded data list as "Data Source" if channel coded data on the E-DCH is required.
 - The E-DPDCH can be generated in realtime only for overall symbol rates with one E-DPDCH channel or those that restrict the E-DPDCHs to the I or Q branch.

Example: E-DCH Scheduling

To configure an E-DCH transmission in TTIs 3-6, 128-156, 1003-1006, 1128-1156, etc. perform the settings listed in [Table 4-13](#).

Table 4-13: E-DCH scheduling example

Parameter	Value	Comment
Select "3GPP FDD > Filter/Clipping/ARB Settings" and adjust the Sequence Length ARB	200 frames	If the E-DCH channels are generated as ARB signal, the ARB sequence length has to be long enough and a multiple or equal the scheduling repetition.
E-DCH TTI	2 ms	
Number of Table Rows	2	two scheduled E-DCH bursts
E-DCH Schedule Repeats After	1000 TTIs	each E-DCH burst is repeated every 1000 TTIs
Row#0		E-DCH burst (4 E-DCH packets)
" E-DCH TTI From "	3	
" E-DCH TTI To "	6	
Row#1		E-DCH burst (29 E-DCH packets)
" E-DCH TTI From "	128	
" E-DCH TTI To "	156	
E-DPCCH State	On	Enables E-DPCCH
E-DPDCH State	On	Enables E-DPDCH

Open the [Scheduling List](#) to display the E-DCH scheduling.

3GPP FDD A: ME1/Scheduling List

Frame Start: 0 Number Of Frames: 10

! : The channel is inactive in the slot.
X : The channel is active in the slot.
_ : The channel restarts because of the ARB sequence length.

Frame:	Slot:	E-DCH TTI:	DPCCH Slots:	E-DPCCH Slots:	E-DPDCH Slots:
0	0	0	X		
	1		X		
	2		X		
	3	1	X		
	4		X		
	5		X		
	6	2	X		
	7		X		
	8		X		
	9	3	X	X	X
	10		X	X	X
	11		X	X	X
	12	4	X	X	X
	13		X	X	X
	14		X	X	X
1	0	5	X	X	X
	1		X	X	X
	2		X	X	X
	3	6	X	X	X
	4		X	X	X
	5		X	X	X
	6	7	X		
	7		X		
	8		X		
	9	8	X		
	10		X		
	11		X		
	12	9	X		
	13		X		
	14		X		

E-DCH TTI

Sets the size for the TTI (Transmission Time Interval).

If an [FRC](#) is set for the E-DPCCH or [UL-DTX...](#) / [User Scheduling State](#) is enabled, this field is read-only.

Remote command:

```
[ :SOURCE<hw> ] :BB:W3GPp:MSTation<st> [:HSUPa] :EDCH:TTIEdch
```

on page 415

```
[ :SOURCE<hw> ] :BB:W3GPp:MSTation<st> [:HSUPa] :DPDCh:E:TTIEdch
```

on page 415

Number of Table Rows

Sets the number of the rows in the scheduling table, i.e. determines the number of the E-DCH "bursts" enabled for configuration. An E-DCH "burst" is built of several successive E-DCH packets.

Remote command:

```
[ :SOURCE<hw> ] :BB:W3GPp:MSTation<st> [:HSUPa] :EDCH:ROWCount
```

on page 416

E-DCH Schedule Repeats After

Determine the number of TTIs after that the E-DCH scheduling is repeated.

Remote command:

```
[ :SOURCE<hw> ] :BB:W3GPP:MSTation<st> [ :HSUPa ] :EDCH:REPEAT
```

on page 416

E-DCH Scheduling Table

Enables flexible configuration of single E-DCH packets or E-DCH "bursts" of variable length consisting of several successive E-DCH packets

E-DCH TTI From ← E-DCH Scheduling Table

Determines the start TTI of the corresponding E-DCH burst.

Remote command:

```
[ :SOURCE<hw> ] :BB:W3GPP:MSTation<st> [ :HSUPa ] :EDCH:ROW<ch0>:FROM
```

on page 416

E-DCH TTI To ← E-DCH Scheduling Table

Determines the end TTI of the corresponding E-DCH burst.

Remote command:

```
[ :SOURCE<hw> ] :BB:W3GPP:MSTation<st> [ :HSUPa ] :EDCH:ROW<ch0>:TO
```

on page 416

4.36 Scheduling List

Opens a display of the current uplink scheduling per UE.

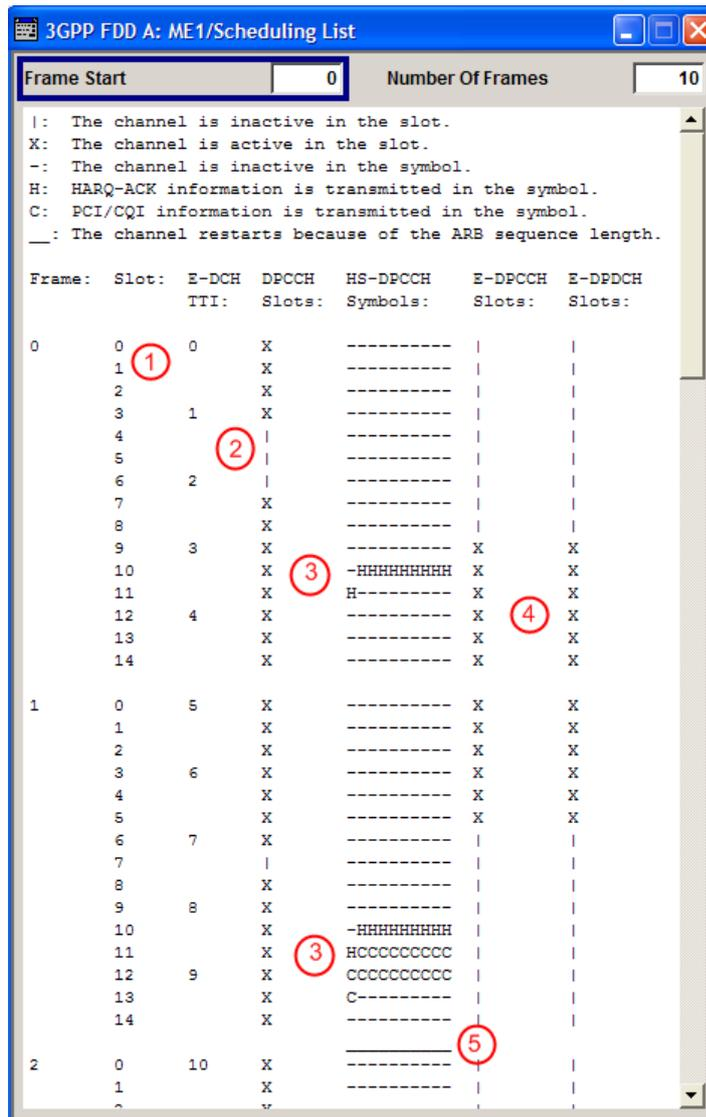

Figure 4-28: Example of Scheduling List (UE1)

- 1 = E-DCH TTI is three slots long, i.e. E-DCH TTI = 2ms
- 2 = DPCCH shows busts pattern, i.e. UL-DTX is activated
- 3 = HS-DPCCH is active and the scheduled HARQ-ACK and PCI/CQI messages have different patterns
- 4 = E-DPCCH and E-DPDCH are active; both channels have the same E-DCH scheduling
- 5 = ARB Sequence Length = 2 frames

Frame Start

Defines the start frame of the displayed UL scheduling.

Number of Frames

Defines number of frames for that the UL scheduling is displayed.

4.37 HSUPA FRC Settings - UE

The "UE HSUPA FRC" dialog provides the parameters for configuring the fixed reference channel (FRC) and the settings for the HARQ simulation.

4.37.1 FRC General Settings

Access:

1. Select "3GPP FDD > Link Direction > Uplink / Reverse > User Equipments > UE"
2. Select "E-DPCCH Settings > Show Details > HSUPA FRC..."

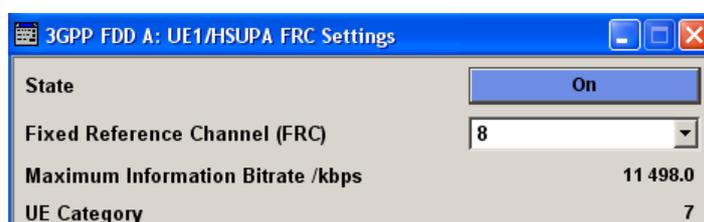

The dialog comprises the common settings for the fixed reference channel (FRC).

State (HSUPA FRC)

Activates or deactivates the FRC state for the E-DCH channels.

If FRC is activated, the channels E-DPCCH and E-DPDCH are automatically activated.

The following parameters of these channels are set automatically, depending on the configured FRC:

- For E-DPCCH:
 - "Retransmission Sequence Number" is set to 0
 - "E-TFCI"
- For E-DPDCH:
 - [Overall Symbol Rate](#) is set according to the correspondent parameter of FRC. The "Modulation" is set according to the "Modulation" used for the selected FRC.
 - The [E-DPDCH Data Source](#) is set according to the [Data Source \(E-DCH\)](#) used for the selected FRC.
- For E-DCH scheduling:
 - [E-DCH TTI](#) is set according to the [E-DCH TTI](#) of the selected FRC
 - If the "HARQ Simulation" is disabled and the state in the DTX mode section is activated, the "E-DCH Scheduling Table" is configured according to the "[DTX Pattern](#)" specified.
 - By enabled "HARQ Simulation", the settings in the "E-DCH Scheduling Table" are configured to ensure a continuous E-DCH transmission.

Note: HSUPA FRCs are disabled, if [UL-DTX... / User Scheduling State](#) or [Dynamic Power Control State](#) are activated.

Remote command:

```
[ :SOURCE<hw> ] :BB:W3GPP:MSTation<st> [ :HSUPa ] :DPCCh:E:FRC:STATE  
on page 410
```

Fixed Reference Channel (FRC)

Selects the FRC according to TS 25.141, annex A.10.

Additionally, user defined FRC can be configured.

FRC8 is available only for instruments equipped with R&S SMBV-K59.

Remote command:

```
[ :SOURCE<hw> ] :BB:W3GPP:MSTation<st> [ :HSUPa ] :DPCCh:E:FRC:CHANnel  
on page 403
```

Maximum Information Bitrate/kbps

Displays the maximum information bit rate.

Remote command:

```
[ :SOURCE<hw> ] :BB:W3GPP:MSTation<st> [ :HSUPa ] :DPCCh:E:FRC:MIBRate?  
on page 408
```

UE Category

Displays the UE category that is minimum required for the selected FRC (see also [Chapter 3.3.18.2, "UL 16QAM UE Capabilities"](#), on page 43).

Remote command:

```
[ :SOURCE<hw> ] :BB:W3GPP:MSTation<st> [ :HSUPa ] :DPCCh:E:FRC:  
UECategory? on page 412
```

4.37.2 Coding and Physical Channels Settings

Access:

1. Select "3GPP FDD > Link Direction > Uplink / Reverse > User Equipments > UE"

2. Select "E-DPCCH Settings > Show Details > HSUPA FRC... > Coding And Physical Channels".

Coding And Physical Channels	
Data Source (E-DCH)	PN 9
Overall Symbol Rate	2x960 + 2x1920 ksps
Modulation	4PAM
E-DCH TTI	2 ms
Number Of HARQ Processes	8
Binary Channel Bits / TTI (Nbin)	23 040
Transport Block Size Table	Table 3 (2ms)
Transport Block Size Index	124
Information Bit Payload (Ninf)	22 996
Coding Rate (Ninf/Nbin)	0.998

This dialog comprises the parameters required for configuring the physical channel settings and coding.

Data Source (E-DCH)

Selects the data source for the E-DCH channels, i.e. this parameter affects the corresponding parameter of the E-DPDCH.

The following standard data sources are available:

- "All 0, All 1"
An internally generated sequence containing 0 data or 1 data.
- "PNxx"
An internally generated pseudo-random noise sequence.
- "Pattern"
An internally generated sequence according to a bit pattern.
Use the "Pattern" box to define the bit pattern.
- "Data List/Select DList"
A binary data from a data list, internally or externally generated.
Select "Select DList" to access the standard "Select List" dialog.
 - Select the "Select Data List > navigate to the list file *.dm_iqd > Select" to select an existing data list.
 - Use the "New" and "Edit" functions to create internally new data list or to edit an existing one.
 - Use the standard "File Manager" function to transfer external data lists to the instrument.

See also "Main Dialog > Data List Management".

Remote command:

`[:SOURce<hw>] :BB:W3GPp:MSTation<st> [:HSUPa] :DPCCh:E:FRC:DATA`
on page 403

`[:SOURce<hw>] :BB:W3GPp:MSTation<st> [:HSUPa] :DPCCh:E:FRC:DATA: PATtern` on page 404

`[:SOURce<hw>] :BB:W3GPp:MSTation<st> [:HSUPa] :DPCCh:E:FRC:DATA: DSElect` on page 404

Overall Symbol Rate

Sets the overall symbol rate for the E-DCH channels, i.e. this parameter affects the corresponding parameter of the E-DPDCH.

Remote command:

`[:SOURCE<hw>] :BB:W3GPP:MSTation<st> [:HSUPa] :DPCCh:E:FRC:ORATE`
on page 409

Modulation

Sets the modulation of the FRC, i.e. this parameter affects the corresponding parameter of the E-DPDCH.

There are two possible modulation schemes specified, BPSK and 4PAM (4 Pulse Amplitude Modulation). The latter one is available only for the following [Overall Symbol Rates](#):

- 2x960 kbps
- 2x1920 kbps
- 2x960 + 2x1920 kbps.

Note: Modulation scheme 4PAM is available only for instruments equipped with the HSPA+ option R&S SMBV-K59.

Remote command:

`[:SOURCE<hw>] :BB:W3GPP:MSTation<st> [:HSUPa] :DPCCh:E:FRC:MODulation`
on page 409

E-DCH TTI

Sets the size of the TTI (Transmission Time Interval) for the E-DCH channels, i.e. this parameter affects the corresponding parameter of the E-DCH scheduling configuration.

Remote command:

`[:SOURCE<hw>] :BB:W3GPP:MSTation<st> [:HSUPa] :DPCCh:E:FRC:TTIEdch`
on page 411

Number Of HARQ Processes

Displays the number of HARQ (Hybrid-ARQ acknowledgement) processes. This value determines the distribution of the payload in the subframes.

Remote command:

`[:SOURCE<hw>] :BB:W3GPP:MSTation<st> [:HSUPa] :DPCCh:E:FRC:HPRocesses?`
on page 408

Binary Channel Bits / TTI (Nbin)

Displays the number of binary bits per TTI.

Transport Block Size Table

Selects the transport block size table from 3GPP TS 25.321, annex B according to that the transport block size is configured.

The transport block size is determined also by the parameter "Transport Block Size Index".

The allowed values of this parameter depend on the selected "E-DCH TTI" and "Modulation" scheme.

E-DCH TTI	Modulation	Transport block size table	Transport block size index (E-TFCI)
2 ms	BPSK	Table 0	0 .. 127
		Table 1	0 .. 125
	4PAM	Table 2	0 .. 127
		Table 3	0 .. 124
10 ms	-	Table 0	0 .. 127
		Table 1	0 .. 120

Remote command:

```
[ :SOURCE<hw> ] :BB:W3GPp:MSTation<st> [ :HSUPa ] :DPCCh:E:FRC:TBS:
TABLE on page 410
```

Transport Block Size Index (E-TFCI)

Selects the transport block size index (E-TFCI) for the corresponding table, as described in 3GPP TS 25.321, annex B.

The value range of this parameter depends on the selected "Transport Block Size Table".

Remote command:

```
[ :SOURCE<hw> ] :BB:W3GPp:MSTation<st> [ :HSUPa ] :DPCCh:E:FRC:TBS:
INDEX on page 410
```

Information Bit Payload (Ninf)

Displays the payload of the information bit. This value determines the number of transport layer bits sent in each HARQ process.

Remote command:

```
[ :SOURCE<hw> ] :BB:W3GPp:MSTation<st> [ :HSUPa ] :DPCCh:E:FRC:PAYBits?
on page 409
```

Coding Rate (Ninf/Nbin)

Displays the relation between the information bits to binary channel bits.

Remote command:

```
[ :SOURCE<hw> ] :BB:W3GPp:MSTation<st> [ :HSUPa ] :DPCCh:E:FRC:CRATE?
on page 403
```

4.37.3 DTX Mode Settings

Access:

1. Select "3GPP FDD > Link Direction > Uplink / Reverse > User Equipments > UE"

2. Select "E-DPCCH Settings > Show Details > HSUPA FRC...> DTX Mode".

This dialog comprises the parameters required for enabling and defining user data.

State (DTX)

Activates or deactivates the DTX (discontinuous transmission) mode.

Note: If activated, the "E-DCH Scheduling Table" in the "E-DPCCH Settings" dialog is configured according to the "DTX Pattern" specified.

Remote command:

```
[ :SOURCE<hw> ] :BB:W3GPP:MSTation<st>[:HSUPa]:DPCCh:E:FRC:DTX:
STATE on page 406
```

User Data (DTX Pattern)

Sets the user-definable the bit pattern for the DTX. The maximum length is 64 bits.

The following values are allowed:

- 1: Data transmission
- -: DTX

Note: If activated, this setting overwrites the "E-DCH Scheduling Table" in the "E-DPCCH Settings" dialog.

Example:

"User Data (DTX Pattern) = 1-11-" sets the "E-DCH Scheduling" settings as follow:

E-DCH TTI	E-DCH From TTI	E-DCH To TTI
0	0	0
1	2	2
2	3	3

Remote command:

```
[ :SOURCE<hw> ] :BB:W3GPP:MSTation<st>[:HSUPa]:DPCCh:E:FRC:DTX:
PATTERN on page 406
```

4.37.4 HARQ Simulation Settings

This section describes the HARQ settings. The provided settings depend on the selected "HARQ Simulation > Mode".



R&S SMBV instruments do not support "HARQ Simulation > Mode > HARQ Feedback".

Access:

1. Select "3GPP FDD > Link Direction > Uplink / Reverse > User Equipments > UE".

2. Select "E-DPCCH Settings > Show Details > HSUPA FRC...> HARQ Simulation".
3. Select "Mode > Virtual HARQ".

State (HARQ)

Activates or deactivates the HARQ simulation mode.

Remote command:

```
[ :SOURCE<hw> ] :BB:W3GPp:MSTation<st> [ :HSUPa ] :DPCCh:E:FRC:HARQ:
SIMulation[:STATe] on page 407
```

Mode (HARQ)

Selects the HARQ simulation mode.

"Virtual HARQ" This mode simulates base station feedback. For every HARQ process (either 4 or 8), a bit pattern can be defined to simulate ACKs and NACKs.

Remote command:

```
[ :SOURCE<hw> ] :BB:W3GPp:MSTation<st> [ :HSUPa ] :DPCCh:E:FRC:HARQ:
SIMulation:MODE on page 407
```

Virtual HARQ Mode

Simulates a base station feedback with the following settings:

Always Use Redundancy Version 0 (HARQ) ← Virtual HARQ Mode

If activated, the same redundancy version is sent, that is, the redundancy version is not adjusted for the next retransmission in case of a received NACK.

Remote command:

```
[ :SOURCE<hw> ] :BB:W3GPp:MSTation<st> [ :HSUPa ] :DPCCh:E:FRC:HARQ:
SIMulation:RVZero on page 407
```

HARQ1..8: ACK/NACK ← Virtual HARQ Mode

("HARQ Mode > Virtual HARQ")

Enters the pattern for the HARQ (Hybrid-ARQ acknowledgement).

The maximum length of the pattern is 32 bits.

""1" = ACK" New data is transmitted and the RSN (retransmission sequences number) is set to 0.

""0" = NACK" The data is retransmitted and the RSN is increased with 1.
The maximum value of RSN is 3, i.e. even if more than three retransmissions are configured, the RSN remains 3.

Remote command:

```
[ :SOURCE<hw> ] :BB:W3GPP:MSTation<st> [ :HSUPa ] :DPCCh:E:FRC:HARQ [ :SIMulation ] :PATtern<ch> on page 408
```

4.37.5 Bit and Block Error Insertion Settings

Access:

1. Select "3GPP FDD > Link Direction > Uplink / Reverse > User Equipments > UE"
2. Select "E-DPCCH Settings > Show Details > HSUPA FRC...> Bit/Block Error Insertion".

The dialogs provide the parameters for inserting errors into the data source and into the CRC checksum.

Bit Error State

Activates or deactivates bit error generation.

Bit errors are inserted into the data fields of the enhanced channels. It is possible to select the layer in which the errors are inserted (physical or transport layer).

When the data source is read out, bits are deliberately inverted at random points in the data bitstream at the specified error rate so that an invalid signal is simulated.

Remote command:

```
[ :SOURCE<hw> ] :BB:W3GPP:MSTation<st> [ :HSUPa ] :DPCCh:E:FRC:DERRor:BIT:STATE on page 405
```

Bit Error Rate

Sets the bit error rate. The value range is 10E-1 to 10E-7.

Remote command:

```
[ :SOURCE<hw> ] :BB:W3GPP:MSTation<st> [ :HSUPa ] :DPCCh:E:FRC:DERRor:BIT:RATE on page 405
```

Insert Errors On

Selects the layer in the coding process at which bit errors are inserted.

"Transport layer"

Bit errors are inserted in the transport layer.

"Physical layer"

Bit errors are inserted in the physical layer.

Remote command:

```
[ :SOURCE<hw> ] :BB:W3GPP:MSTation<st> [ :HSUPa ] :DPCCh:E:FRC:DERRor:BIT:LAYer on page 405
```

Block Error State

Activates or deactivates block error generation.

The CRC checksum is determined and then the last bit is inverted at the specified error probability in order to simulate an invalid signal.

Remote command:

`[:SOURCE<hw>] :BB:W3GPP:MSTation<st> [:HSUPa] :DPCCh:E:FRC:DERRor:BLOCK:STATE` on page 406

Block Error Rate

Sets block error rate.

Remote command:

`[:SOURCE<hw>] :BB:W3GPP:MSTation<st> [:HSUPa] :DPCCh:E:FRC:DERRor:BLOCK:RATE` on page 406

4.38 Global Enhanced Channel Settings - UE1



The "Global Enhanced Channel" settings are only available for user equipment 1 (UE1).

Access:

1. Select "3GPP FDD > Link Direction > Uplink / Reverse > User Equipments > UE 1".
2. Select "DPDCH Settings > Show Details > Global Enhanced Channels...".

4.38.1 Enhanced Channels State

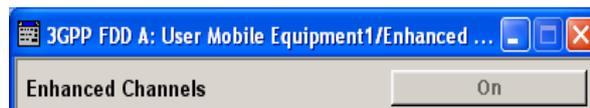

On top of the dialog, you can activate the global enhanced settings.

Enhanced Channels State

Displays the enhanced state of the station. As at least the DPCCCH of UE1 is always calculated in real time, the enhanced state is always on for UE1.

The DPCCCH and one DPDCH of user equipment 1 are generated in real time. Depending on the actual configurations, other channels of user equipment 1 can also be generated in real time.

It is possible to activate channel coding and simulate bit and block errors. Data lists, for example with user data for the transport layer, can be used as the data source.

Remote command:

[:SOURce<hw>] :BB:W3GpP:MSTation:ENHanced:DPDCh:STATe on page 431

4.38.2 Channel Coding

Access:

1. Select "3GPP FDD > Link Direction > Uplink / Reverse > User Equipments > UE 1".
2. Select "DPDCH Settings > Show Details > Global Enhanced Channels... > Show Details".

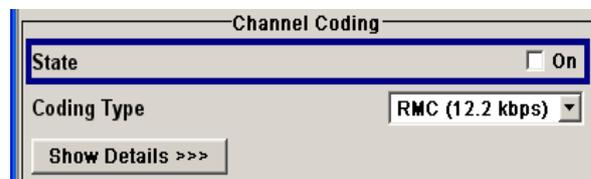

The "Channel Coding" section is where the channel coding settings are made. You can choose between a reduced display and the detailed setting options display. With the reduced display, it is only possible to select the coding scheme and this selection sets the associated parameters to the presetting prescribed in the standard. The "Transport Channel" section for detailed setting and for defining a user coding can be revealed with the "Show Details" button and hidden with the "Hide Details" button.

According to 3GPP TS 25.141, an uplink reference measurement channel is generated when the transport channels DTCH and DCCH are mapped to a DPDCH with a different data rate. The mapping is performed after channel coding and multiplexing. [Figure 4-29](#) illustrates the generation of a 12.2 kbps reference measurement channel from the DTCH and DCCH transport channels.

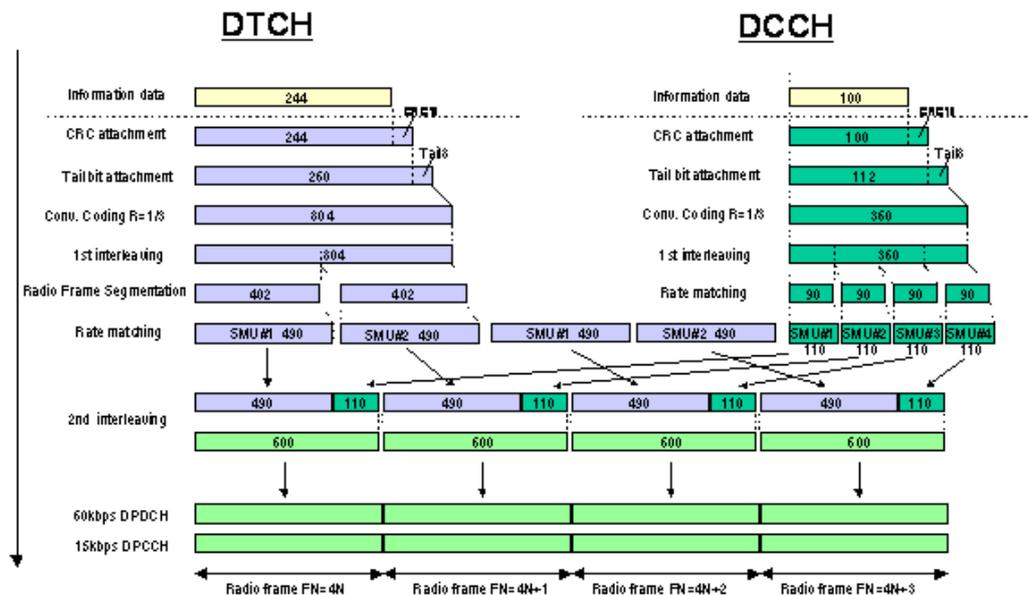

Figure 4-29: Channel coding of the 12.2 kbps reference measurement channels (uplink) [3GPP TS 25.141]

Channel Coding State

Activates or deactivates channel coding.

Note: Annex A.1, 3GPP TS 25.141, lists the recommended DPCCH-settings.

Remote command:

`[:SOURCE<hw>] :BB:W3GPP:MSTation:ENHanced:DPDCh:CCODing:STAtE`
on page 426

Coding Type

Selects channel coding.

The 3GPP specification defines 4 reference measurement channel coding types, which differ in the input data bit rate to be processed (12.2, 64, 144 and 384 kbps). The additional AMR CODER coding scheme generates the coding of a voice channel.

"User" coding can be defined as required in the detailed coding settings menu section revealed with button "Show Details". They can be stored and loaded in the "User Coding" submenu. Selection "User" is indicated as soon as a coding parameter is modified after selecting a predefined coding type.

The input data bits are taken from the data source specified for the "Transport Channels" for channel coding. The bits are available with a higher rate at the channel coding output. The allocations between the measurement input data bit rate and the output symbol rate are fixed, that is to say, the overall symbol rate is adjusted automatically.

The following are available for selection:

"RMC 12.2 12.2 kbps measurement channel
kbps"

"RMC 64 kbps" 64 kbps measurement channel

"RMC 144 144 kbps measurement channel
kbps"
 "RMC 384 384 kbps measurement channel
kbps"
 "AMR 12.2 Channel coding for the AMR coder
kbps"

Remote command:

[:SOURCE<hw>] :BB:W3GPP:MSTation:ENHanced:DPDCh:CCODing:TYPE
on page 426

Show Details

Reveals the detailed setting options for channel coding.

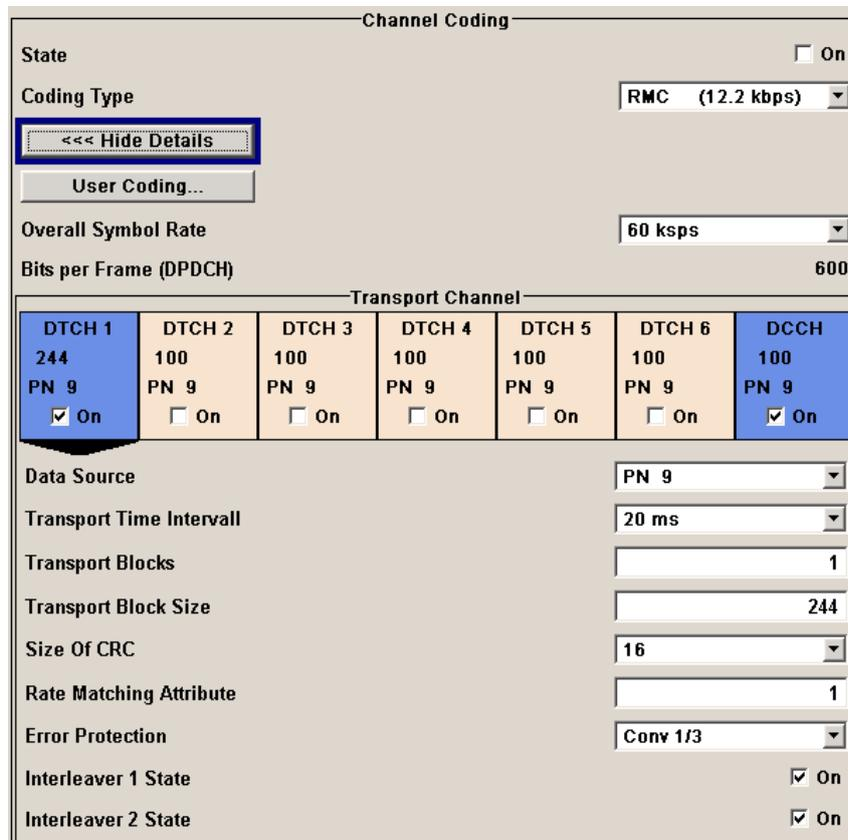

Channel Coding

State On

Coding Type **RMC (12.2 kbps)**

<<< Hide Details

User Coding...

Overall Symbol Rate **60 ksps**

Bits per Frame (DPDCH) **600**

Transport Channel						
DTCH 1	DTCH 2	DTCH 3	DTCH 4	DTCH 5	DTCH 6	DCCH
244	100	100	100	100	100	100
PN 9	PN 9	PN 9	PN 9	PN 9	PN 9	PN 9
<input checked="" type="checkbox"/> On	<input type="checkbox"/> On	<input type="checkbox"/> On	<input type="checkbox"/> On	<input type="checkbox"/> On	<input type="checkbox"/> On	<input checked="" type="checkbox"/> On

Data Source **PN 9**

Transport Time Intervall **20 ms**

Transport Blocks **1**

Transport Block Size **244**

Size Of CRC **16**

Rate Matching Attribute **1**

Error Protection **Conv 1/3**

Interleaver 1 State On

Interleaver 2 State On

Remote command:

n.a.

User Coding ...

Accesses files with user codings and the standard "File Select" function.

User codings of UE1 are stored as files with the predefined file extension *.3g_ccod_ul. The filename and the directory they are stored in are user-definable; the file extension is assigned automatically.

The complete channel coding settings are saved and recalled.

Remote command:

[:SOURce<hw>] :BB:W3GPp:MSTation:ENHanced:DPDCh:CCODing:USER:CATalog? on page 427

[:SOURce<hw>] :BB:W3GPp:MSTation:ENHanced:DPDCh:CCODing:USER:DElete on page 427

[:SOURce<hw>] :BB:W3GPp:MSTation:ENHanced:DPDCh:CCODing:USER:LOAD on page 428

[:SOURce<hw>] :BB:W3GPp:MSTation:ENHanced:DPDCh:CCODing:USER:STORE on page 428

Overall Symbol Rate

Sets the overall symbol rate of the DPDCH.

The structure of the DPDCH channel table depends on this parameter. The overall symbol rate determines which DPDCHs are active, which symbol rate they have and which channelization codes they use.

DPDCHs that are not active by virtue of the overall rate, are also disabled for operation.

Note: Up to an overall rate of 960 ksps, only DPDCH 1 is active. Its symbol rate is the same as the overall rate and the channelization code is the same as spreading factor/4 (spreading factor = chip rate / symbol rate).

With an overall symbol rate greater than 960 ksps, all the active DPDCHs have the symbol rate 960 ksps.

Remote command:

[:SOURce<hw>] :BB:W3GPp:MSTation:ENHanced:DPDCh:ORATe on page 431

Bits per Frame (DPDCH)

Displays the data bits in the DPDCH component of the frame at physical level. The value depends on the overall symbol rate.

Remote command:

[:SOURce<hw>] :BB:W3GPp:MSTation:ENHanced:DPDCh:BPFRame? on page 425

4.38.3 Transport Channel

Access:

1. Select "3GPP FDD > Link Direction > Uplink / Reverse > User Equipments > UE 1".
2. In the "DPDCH Settings" section, select "Show Details > Transport Channel".

3. Select one of the transport channels, for example "DTCH1".

Transport Channel						
DTCH 1	DTCH 2	DTCH 3	DTCH 4	DTCH 5	DTCH 6	DCCH
244	100	100	100	100	100	100
PN 9	PN 9	PN 9	PN 9	PN 9	PN 9	PN 9
<input checked="" type="checkbox"/> On	<input type="checkbox"/> On	<input type="checkbox"/> On	<input type="checkbox"/> On	<input type="checkbox"/> On	<input type="checkbox"/> On	<input checked="" type="checkbox"/> On
Data Source					PN 9	
Transport Time Intervall					20 ms	
Transport Blocks					1	
Transport Block Size					244	
Size Of CRC					16	
Rate Matching Attribute					1	
Error Protection					Conv 1/3	
Interleaver 1 State					<input checked="" type="checkbox"/> On	
Interleaver 2 State					<input checked="" type="checkbox"/> On	

The dialog provides access to the settings of up to seven transport channels (TCHs), the DTCHs (DTCH1 to 6) and the DCCH.

A wide arrow beneath the block indicates which TCH is selected.

Transport Channel State

Activates or deactivates the transport channel.

Remote command:

```
[ :SOURce<hw> ] :BB:W3Gpp:MSTation:ENHanced:DPDCh:TCHannel<di0>:
STATE on page 432
```

In case of remote control, DCCH corresponds to :TCHannel0, DTCH1 to :TCHannel1, etc.

Data Source

Selects the data source for the transport channel.

The data source for the DCCH and DTCH1 can also be selected in the main dialog in the channel table.

The following standard data sources are available:

- "All 0, All 1"
An internally generated sequence containing 0 data or 1 data.
- "PNxx"
An internally generated pseudo-random noise sequence.
- "Pattern"
An internally generated sequence according to a bit pattern.
Use the "Pattern" box to define the bit pattern.
- "Data List/Select DList"
A binary data from a data list, internally or externally generated.
Select "Select DList" to access the standard "Select List" dialog.
 - Select the "Select Data List > navigate to the list file *.dm_iqd > Select" to select an existing data list.

- Use the "New" and "Edit" functions to create internally new data list or to edit an existing one.
- Use the standard "File Manager" function to transfer external data lists to the instrument.

See also "Main Dialog > Data List Management".

Remote command:

`[:SOURCE<hw>] :BB:W3GPp:MSTation:ENHanced:DPDCh:TCHannel<di0> : DATA` on page 433

`[:SOURCE<hw>] :BB:W3GPp:MSTation:ENHanced:DPDCh:TCHannel<di0> : DATA:PATtern` on page 434

`[:SOURCE<hw>] :BB:W3GPp:MSTation:ENHanced:DPDCh:TCHannel<di0> : DATA:DSElect` on page 434

Transport Time Interval

Sets the number of frames into which a TCH is divided. This setting also defines the interleaver depth.

Remote command:

`[:SOURCE<hw>] :BB:W3GPp:MSTation:ENHanced:DPDCh:TCHannel<di0> : TTInterval` on page 432

Number of Transport Blocks

Sets the number of transport blocks for the TCH.

Remote command:

`[:SOURCE<hw>] :BB:W3GPp:MSTation:ENHanced:DPDCh:TCHannel<di0> : TBCount` on page 432

Transport Block Size

Sets the size of the transport block at the channel coding input.

Remote command:

`[:SOURCE<hw>] :BB:W3GPp:MSTation:ENHanced:DPDCh:TCHannel<di0> : TBSize` on page 432

Size of CRC

Defines the type (length) of the CRC. Checksum determination can also be deactivated (setting "None").

Remote command:

`[:SOURCE<hw>] :BB:W3GPp:MSTation:ENHanced:DPDCh:TCHannel<di0> : CRCSize` on page 433

Rate Matching Attribute

Sets data rate matching.

Remote command:

`[:SOURCE<hw>] :BB:W3GPp:MSTation:ENHanced:DPDCh:TCHannel<di0> : RMAtribute` on page 431

Error Protection

Selects error protection.

"None"	No error protection
"Turbo 1/3"	Turbo coder of rate 1/3 in accordance with the 3GPP specifications.
"Conv 1/2 1/3"	Convolution coder of rate 1/2 or 1/3 with generator polynomials defined by 3GPP.

Remote command:

```
[ :SOURce<hw> ] :BB:W3GPp:MSTation:ENHanced:DPDCh:TCHannel<di0>:
EPRotecton on page 434
```

Interleaver 1 State

Activates or deactivates channel coding interleaver state 1 of the transport channel. Interleaver state 1 can be set independently in each TCH. Activation does not change the symbol rate.

Remote command:

```
[ :SOURce<hw> ] :BB:W3GPp:MSTation:ENHanced:DPDCh:TCHannel<di0>:
INTerleaver on page 435
```

Interleaver 2 State

Activates or deactivates channel coding interleaver state 2 of all the transport channels. Interleaver state 2 can only be set for all the TCHs together. Activation does not change the symbol rate.

Remote command:

```
[ :SOURce<hw> ] :BB:W3GPp:MSTation:ENHanced:DPDCh:INTerleaver2
on page 430
```

4.38.4 Error Insertion

Access:

1. Select "3GPP FDD > Link Direction > Uplink / Reverse > User Equipments > UE 1".
2. Select "DPDCH Settings > Show Details > Global Enhanced Channels...".
3. Select "Bit Error Insertion / Block Error Insertion".

In the "Bit/Block Error Insertion" sections, errors can be inserted into the data source and into the CRC checksum.

Bit Error State

Activates or deactivates bit error generation.

Bit errors are inserted into the data fields of the enhanced channels. When channel coding is active, it is possible to select the layer in which the errors are inserted (physical or transport layer).

When the data source is read out, individual bits are deliberately inverted at random points in the data bitstream at the specified error rate so that invalid signal is simulated.

Remote command:

`[:SOURCE<hw>] :BB:W3GPP:MSTation:ENHanced:DPDCh:DERRor:BIT:STATE`
on page 429

Bit Error Rate TCH1

Sets the bit error rate.

Remote command:

`[:SOURCE<hw>] :BB:W3GPP:MSTation:ENHanced:DPDCh:DERRor:BIT:RATE`
on page 429

Insert Errors On

Selects the layer at which bit errors are inserted.

"Transport layer" Bit errors are inserted in the transport layer.
This layer is only available when channel coding is active.

"Physical layer" Bit errors are inserted in the physical layer.

Remote command:

`[:SOURCE<hw>] :BB:W3GPP:MSTation:ENHanced:DPDCh:DERRor:BIT:LAYer`
on page 428

Block Error State

Activates or deactivates block error generation.

The CRC checksum is determined and then the last bit is inverted at the specified error probability in order to simulate an invalid signal.

Block error generation is only available when channel coding is active.

Remote command:

`[:SOURCE<hw>] :BB:W3GPP:MSTation:ENHanced:DPDCh:DERRor:BIT:STATE`
on page 429

Block Error Rate

Sets the block error rate.

Remote command:

`[:SOURCE<hw>] :BB:W3GPP:MSTation:ENHanced:DPDCh:DERRor:BLOCK:RATE`
on page 430

5 How to Work with the 3GPP FDD Option

The following step-by-step instructions demonstrate how to perform some signal generation tasks with the 3GPP FDD option.

5.1 Resolving Domain Conflicts

To resolve code domain conflicts

1. To recognize a downlink domain conflict, use one of the following methods:

a) Select "3GPP FDD > Base Station > Channel Table"

A conflict symbol in the column "Dom Conf" of the channel table indicates a code domain conflict.

The term domain conflict describes that channels overlap.

16	DPCH	No	#8	30	15	0.00	PN 9		0	Config...	On	
17	DPCH	No	#16	960	3	0.00	PN 9		0	Config...	On	
18	DPCH	No	#8	30	17	0.00	PN 9		0	Config...	On	
19	DPCH	No	#8	30	10	0.00	PN 9		0	Config...	On	●
20	DPCH	No	#16	960	0	0.00	PN 9		0	Config...	On	●
21	DPCH	No	#8	30	20	0.00	PN 9		0	Config...	On	●
22	DPCH	No	#8	30	21	0.00	PN 9		0	Config...	On	●

b) Select "3GPP FDD > Base Station > Code Domain"

A code domain conflict is indicated by overlapping bars.

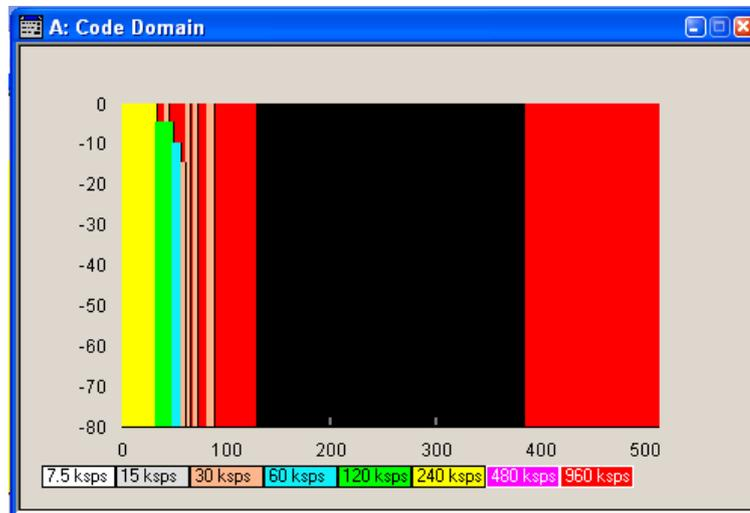

2. The instrument helps you to resolve code domain conflicts by automatically adapting the channelization code of the channels involved.

To access the required function, in the "3GPP FDD > Base Station > Channel Table" select the conflict symbol and trigger "Resolve Domain Conflicts".



Note: The HSUPA control channels E-RGCH and E-HICH use the same channelization code as long as they use different signature sequence hopping index that identifies the user equipment. The F-DPCH channels also use the same channelization code as long as they use a different timing offset or slot format.

The code domain conflict is resolved by changing the channelization codes of the affected channels.

16	DPCH	No	#8	30	79	0.00	PN 9	0	Config...	On
17	DPCH	No	#16	960	0	0.00	PN 9	0	Config...	On
18	DPCH	No	#8	30	80	0.00	PN 9	0	Config...	On
19	DPCH	No	#8	30	81	0.00	PN 9	0	Config...	On
20	DPCH	No	#16	960	1	0.00	PN 9	0	Config...	On
21	DPCH	No	#8	30	82	0.00	PN 9	0	Config...	On
22	DPCH	No	#8	30	83	0.00	PN 9	0	Config...	On

The graphs immediately display the change

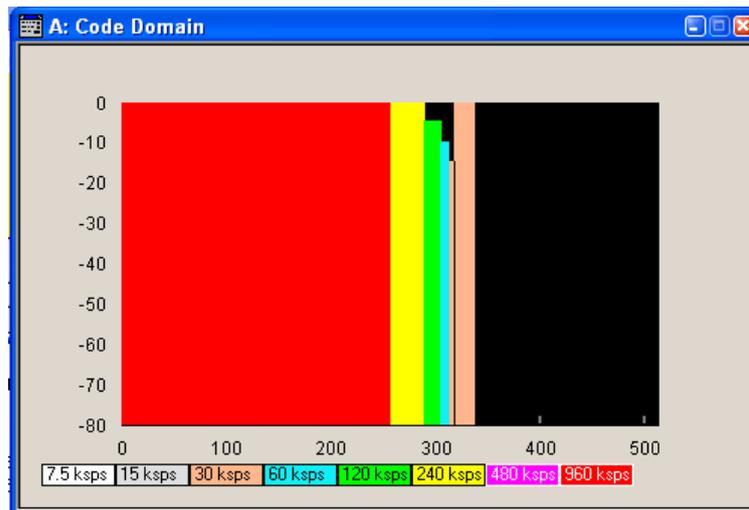

5.2 Using the DL-UL Timing Offset Settings

To generate a continuous uplink signal composed of multiple separately generated uplink frames

1. Adjust the uplink settings as required and set "User Equipment > UE > DPCCH > DL-UL Timing Offset = 0 Chips".
2. Enable generation of the 3GPP FDD signal, i.e "3GPP FDD > State > On"
3. Use the [Generate Waveform](#) function to save the current signal as an ARB signal in a waveform file.

4. Reconfigure the uplink settings
5. Save the signal as an ARB file.
6. Use the "Baseband > ARB > Multi Segment" function to assemble a common signal from the several uplink signals.
7. If necessary, readjust the "Marker" settings.
Use for example a sequence list to configure the order the waveforms are processed or to set how many times each of them is repeated.

5.3 Configuring UL-DTX Transmission and Visualizing the Scheduling

To configure the instrument to generate an UL DPCCH DTX signal

1. Enable "Baseband > 3GPP FDD > Transmission Direction > Uplink".
2. Select "User Equipment > UE1 > UL-DTX".
3. Enable "Mode > UL-DTX". Configure the following settings:

Table 5-1: UL-DTX Settings

Parameter	Value
E-DCH TTI	2 ms
Offset	2 Subframes
Inactivity Threshold for Cycle 2	8 TTIs
Long Preamble Length	4 Slots
DTX Cycle 1 / DTX Cycle 2	4 Subframes and 8 Subframes respectively
DPCCH Burst Length 1 / DPCCH Burst Length 2	1 Subframe (3 Slots)
UL-DTX... / User Scheduling State	On

The figure below shows the generated UL DPCCH DTX bursts pattern.

4. Use the [Scheduling List](#) to display the configured burst pattern.

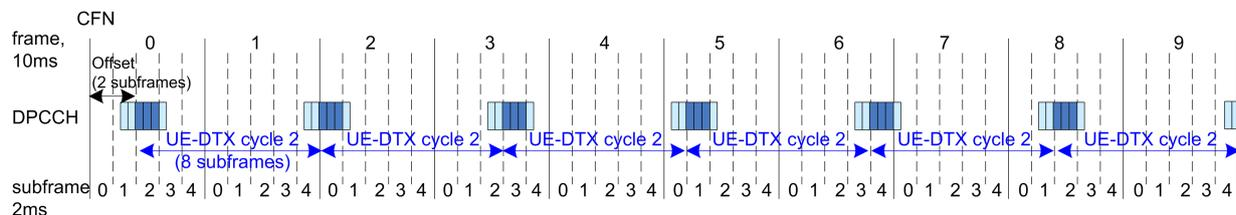

Figure 5-1: Example for UL DPCCH DTX burst pattern as generated by the R&S SMBV (E-DCH TTI=2ms, beginning at CFN0, UE_DTX_DRX_Offset=2, DTX Cycle 2=8 subframes)

Note: In this implementation, the signal generation starts with UE-DTX cycle 2.

The UL DPCCH DTX burst pattern is offset with two subframes. The burst is six slots long (2 slots Preamble + 3 slots DPCCH Burst Length 2 + 1 slot postamble). They are generated every eight subframes.

5. Select "User Equipment > UE1 > E-DCH Scheduling Settings".
6. Configure the settings as follows:

Table 5-2: E-DCH scheduling settings

Parameter	Value
Number of Table Rows	1
E-DCH Schedule Repeats After	24 TTIs
E-DCH TTI From	10
E-DCH TTI To	10

7. Select "UE1 > E-DPDCH Settings > State > On" to enable the generation of E-DPDCH.

The "UE1 > Scheduling List" shows the updated UL DPCCH DTX bursts pattern (see also Figure 5-2).

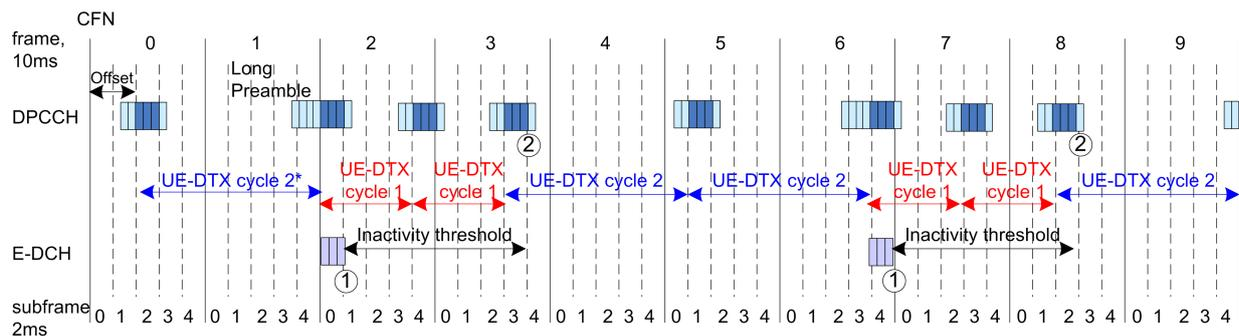

Figure 5-2: Example for UL DPCCH DTX burst pattern in case of E-DCH transmission

- 1 = Cycle 2 to Cycle 1 switch after E-DCH transmission
- 2 = Cycle 1 to Cycle 2 switch when the inactivity timer expires
- *) = In the R&S SMBV, the signal generation starts with UE-DTX cycle 2.

8. Configure the "UE1 > HS-DPCCH Settings" as follows:

Table 5-3: HS-DPCCH Settings

Parameter	Value
Compatibility Mode (HS-DPCCH)	"Release 8 and Later RT"
Inter TTI Distance (Interval)	1 subframe
Number of Rows	1
HARQ-ACK Repeat After	40 intervals
HARQ-ACK From Interval/ HARQ-ACK To Interval	20 / 20
HS-DPCCH 1/2, HARQ-ACK 1/2/3/4	A
Number of Rows	1

Parameter	Value
PCI/CQI Repeat After	40 intervals
PCI-CQI From Interval/ PCI-CQI To Interval	2 / 2
HS-DPCCH 1/2, PCI/CQI 1/2/3/4 Type	CQI
CQI/CQI _s /CQI ₁ /CQI ₂	5

- Select "UE1 > HS-DPCCH Settings > State > On" to enable the transmission of control signaling.

Figure 5-3 shows the generated UL DPCCH DTX bursts pattern.

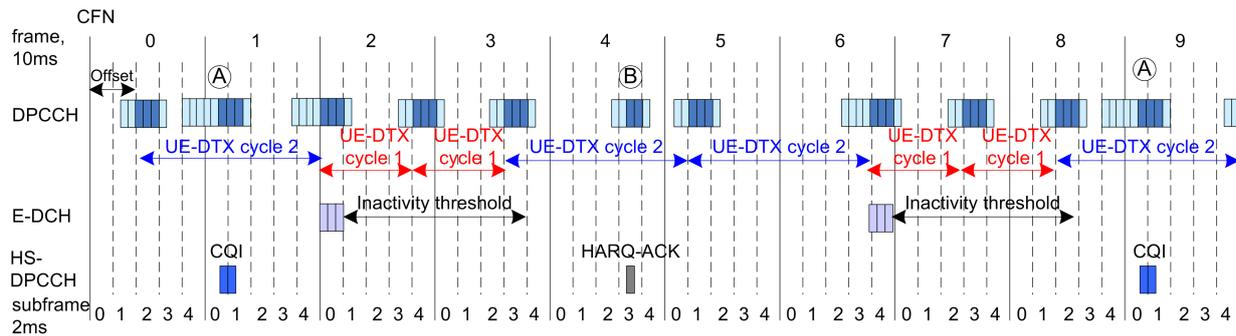

Figure 5-3: Example for UL DPCCH DTX burst pattern in case of E-DCH and HS-DPCCH transmissions

- A = DPCCH burst caused by the transmission of a CQI report
- B = DPCCH burst caused by the transmission of an HARQ-ACK message

Although there is an HS-DPCCH transmission, the UE does not switch from UE-DTX cycle 2 to UE-DTX cycle 1.

5.4 How to Configure the HS-DPCCH Settings for 4C-HSDPA Tests

The following is an example on how to use the provided settings to configure the instrument to send ACK only messages. This transmission is required in the ACK mis-detection test for 4C-HSDPA, according to 3GPP TS 25.141, section 8.11A.3 and 8.11A.4.

The example is based on the test configuration specified in 3GPP TS 25.141, annex A.9A.

Table 5-4: Required test configurations (excerpt)

Test Configuration	4/4/4	4/2/2	3/3/3	3/2/1	3/3/0
HS-DPCCH spreading factor	128	128	128	128	256
Secondary cell enabled	3	3	2	2	2

Test Configuration	4/4/4	4/2/2	3/3/3	3/2/1	3/3/0
Secondary cell active	3	1	2	1	2
Number of MIMO carriers	4	2	3	1	0

To configure the 4C-HSDPA HS-DPCCH Reference Measurement Channel

The example lists only the related setting and is based on Test Configuration = 3/3/3, see [Table 5-4](#).

1. Enable "Baseband > 3GPP FDD > Link Direction > Uplink".
2. For "User Equipment > UE1", enable "HS-DPCCH > State > On".
3. Select "HS-DPCCH > MIMO Mode > On".
4. Select "HS-DPCCH > Secondary Cell Enabled > 2".
5. Select "HS-DPCCH > Secondary Cell Active > 2".
6. Use the default values "HS-DPCCH > HARQ-ACK Scheduling > Number of Rows > 1" and "HS-DPCCH > HARQ-ACK Scheduling > HARQ-ACK Repeat After > 1".
7. Select "HS-DPCCH > HARQ-ACK Scheduling > HS-DPCCH 1 HARQ-ACK 1 > AA/AA".
8. Select "HS-DPCCH > HARQ-ACK Scheduling > HS-DPCCH 1 HARQ-ACK 2 > AA/D".

Start Delay	101	*256 Chips	MIMO Mode	<input checked="" type="checkbox"/> On			
Inter TTI Distance (Interval)	5	Subframes	Secondary Cell Enabled	2			
Channelization Code	Q / 32		Secondary Cell Active	2			
Slot Format	1 (30ksps)						
HARQ - ACK							
Number of Rows	1		HARQ-ACK Repeat After	1 Intervals			
	HARQ-ACK From Interval	HARQ-ACK To Interval	HS-DPCCH 1 HARQ-ACK 1	HS-DPCCH 1 HARQ-ACK 2	HS-DPCCH 2 HARQ-ACK 3	HS-DPCCH 2 HARQ-ACK 4	Pow Offs /dB
0	0	0	AA/AA	AA/D			0.0

6 Application Sheets

Application sheets describe short application examples for selected issues and provide related background information.

6.1 Uplink Dual Cell HSDPA Test Signal Generation

The R&S SMBV supports the generation of feedback messages for HSDPA data acknowledgment and channel quality indication as defined in the 3GPP TS 25.212 release 8 and release 9.

This application sheet describes how to configure the instrument to generate an uplink test signal for basic tests on Dual Cell HSDPA (DC-HSDPA) operation.

6.1.1 Options and Equipment Required

The following equipment is required:

- Vector Signal Generator R&S SMU, R&S AMU, R&S SMJ, R&S SMATE or R&S SMBV, equipped with:
 - Firmware version 2.15.085.47 (R&S SMBV) and 2.10.111.53 (other instruments) or later. Latest firmware version recommended.
 - One of the baseband options, e.g. R&S SMx/AMU-B10
 - One of the frequency options, e.g. R&S SMx-B103
- Option R&S SMx/AMU-K42, "Digital Standard 3GPP FDD"
- Option R&S SMx/AMU-K43, "3GPP FDD enhanced MS/BS tests incl. HSDPA"
- Option R&S SMx/AMU-K59, "Digital Standard HSPA+"

6.1.2 Test Setup



Figure 6-1: Test Setup (example with R&S SMU)

6.1.3 Generating an uplink DC-HSDPA Test Signal (Non-MIMO Mode)

To generate an uplink test signal corresponding to the signal of a UE configured to work in DC-HSDPA non-MIMO mode, configure the uplink HS-DPCCH as follows:

1. Preset the instrument to ensure a defined instrument state.
2. Open the 3GPP FDD dialog (e.g. "Baseband Block > 3GPP FDD").
Select "Link Direction > Uplink".
3. Select "UE1" and open the corresponding "User Equipment" dialog.
4. Set the "Scrambling Code" as required.
5. Navigate to the "HS-DPCCH Settings" section. Expand the display of detailed settings.
 - a) Set the "Compatibility Mode" to "Release 8 and Later".
 - b) Select the "Secondary Cell Enabled = 1" and "Secondary Cell Active = 1" to configure dual cell HSDPA mode for the selected UE.
 - c) Configure the HS-DPCCH structure with the parameters "Inter TTI Distance" and "Number of HARQ-ACK or PCI/CQI Rows". Configure the HARQ-ACK and CQI/PCI information per interval by means of the parameters in the table.
 - d) Set the parameter "HS-DPCCH 1 HARQ-ACK 1" as required to adjust the information transmitted during the HARQ-ACK slot of the corresponding TTI.
For example, an *A/N* feedback means that an ACK is sent to the serving cell and a NACK to the secondary serving cell.
 - e) To include composite CQI messages in the signal as specified in 3GPP TS 25.212:
 - Select "HS-DPCCH 1 PCI/CQI Type > Composite CQI"
 - Select "PCI/CQI 1 Content > Config".
Set the values of the parameters "CQI1" and "CQI2"
 - f) Adjust the power settings as required.
 - g) Execute "Adjust ARB Sequence Length".
 - h) Set the "HS-DPCCH > State > On".
 - i) Close the dialog.

Uplink Dual Cell HSDPA Test Signal Generation

HS-DPCCH Settings								
HARQ-ACK (Slots)			CQI (Slots)					
1			2					
State <input checked="" type="checkbox"/> On			Power 0.00 dB					
<<< Hide Details								
Compatibility Mode Release 8 and Later			MIMO Mode <input type="checkbox"/> On					
Start Delay 101 *256 Chips			Secondary Cell Enabled 1					
Inter TTI Distance (Interval) 1 Subframes			Secondary Cell Active 1					
Channelization Code Q / 64			Slot Format 0 (15ksps)					
HARQ - ACK								
Number of Rows 1			HARQ-ACK Repeat After 1 Intervals					
HARQ-ACK From Interval	HARQ-ACK To Interval	HS-DPCCH 1 HARQ-ACK	HS-DPCCH 1 HARQ-ACK	HS-DPCCH 2 HARQ-ACK	HS-DPCCH 2 HARQ-ACK	Pow Offs /dB		
0	0	0	A/N			0.0		
PCI / CQI								
Number of Rows 1			PCI/CQI Repeat After 1 Intervals					
PCI/CQI From Interval	PCI/CQI To Interval	HS-DPCCH 1 PCI/CQI 1 Type	PCI/CQI 1 Content	HS-DPCCH 1 PCI/CQI 2 Type	HS-DPCCH 2 PCI/CQI 3 Type	HS-DPCCH 2 PCI/CQI 4 Type	PCI/CQI 4 Content	Pow Offs /dB
0	0	0	Comp CQI	Config...				0.0
Suggested / Current ARB Seq. Length 1 / 1			Adjust ARB Sequence Length					

Figure 6-2: Example: R&S SMU with firmware version 2.20.360.xx

- In the "3GPP FDD > Trigger/Marker/Clock" dialog, adjust the settings as required. For example, to synchronize the instrument to the frame timing of the DUT, feed the frame marker signal of the DUT to the instrument. Enable trigger mode "Armed Auto". Select an "External Source".
- In the "3GPP FDD" dialog, set the "State > On" to enable the generation of the 3GPP FDD uplink (UL) signal.
- In the "RF > RF Frequency > Reference Frequency" dialog, adjust the settings as required. For example, if you use a common reference signal or if the DUT provides the reference frequency, connect the reference signal source to the instrument. Select "Source External". Adjust the "External Reference Frequency".
- Press the [FREQ] key. Enter the required RF frequency, e.g. 1950 MHz.
- Adjust the output signal level as required. Press the [RF ON/OFF] key to activate the RF output.

6.1.4 Generating an Uplink Test Signal for Simultaneous Dual Cell and MIMO Operation

- ▶ Perform the steps described above.
Enable the parameter "3GPP FDD > UE1 > HS-DPCCH Settings > MIMO Mode".
You are enabled to configure the HARQ-ACK feedback messages for up to four simultaneously transmitted downlink transport blocks.



For background information about the dual cell operation and processing of HARQ-ACK feedback messages, refer to [Chapter 3.3.15, "Dual Cell HSDPA \(DC-HSDPA\)"](#), on page 38.

7 Remote-Control Commands

The following commands are required to perform signal generation with the 3GPP FDD options in a remote environment. We assume that the R&S SMBV has already been set up for remote operation in a network as described in the R&S SMBV documentation. Knowledge about the remote control operation and the SCPI command syntax are assumed.



Conventions used in SCPI command descriptions

For a description of the conventions used in the remote command descriptions, see section "Remote Control Commands" in the R&S SMBV operating manual.

Common suffixes

The following common suffixes are used in remote commands:

Suffix	Value range	Description
SOURce<hw>	1	available baseband signals
OUTPut<ch>	1 .. 2	available markers
EXTernal<ch>	1	external trigger connector
BSTation<st>	1 to 4	Base station If the suffix is omitted, BS1 is selected.
CHANnel<ch>	0 to 138	channel If the suffix is omitted, Channel1 is selected.
MSTation<st>	1 to 4	user equipment. If the suffix is omitted, MS1 is selected.

Placeholder <root>

For commands that read out or save files in the default directory, the default directory is set using command `MMEM:CDIRectory`. The examples in this description use the place holder `<root>` in the syntax of the command.

- `D:\` - for selecting the internal hard disk of a Windows instrument
- `E:\` - for selecting the memory stick which is inserted at the USB interface of a Windows instrument
- `/var/user/` - for selecting the internal flash card of a Linux instrument
- `/usb/` - for selecting the memory stick which is inserted at the USB interface of a Linux instrument.

Tasks (in manual or remote operation) that are also performed in the base unit in the same way are not described here.

In particular, this includes:

- Managing settings and data lists, i.e. storing and loading settings, creating and accessing data lists, accessing files in a particular directory, etc.

- Information on regular trigger, marker and clock signals as well as filter settings, if appropriate.
- General instrument configuration, such as configuring networks and remote operation
- Using the common status registers

For a description of such tasks, see the R&S SMBV operating manual.

The commands in the `SOURce:BB:W3GPp` subsystem are described in several sections, separated into general remote commands, commands for base station settings and commands for user equipment settings.

This subsystem contains commands for the primary and general settings of the 3GPP FDD standard. These settings concern activation of the standard, setting the transmission direction, filter, clock, trigger and clipping settings, defining the chip rate and the sequence length, as well as the preset and power adjust setting.

The commands for setting the base station and the user equipment, the enhanced channels of the base and user equipment, as well as the commands for selecting the test models and the test setups, are described in separate sections. The commands are divided up in this way to make the comprehensive `SOURce:BB:W3GPp` subsystem clearer.

The following commands specific to the 3GPP FDD options are described here:

• General Commands	251
• Filter/Clipping Settings	257
• Trigger Settings	262
• Marker Settings	266
• Clock Settings	268
• Test Models and Predefined Settings	270
• Setting Base Stations	275
• Enhanced Channels of Base Station 1	322
• User Equipment Settings	342
• Enhanced Channels of the User Equipment	424

7.1 General Commands

<code>[:SOURce<hw>]:BB:W3GPp:PRESet</code>	252
<code>[:SOURce<hw>]:BB:W3GPp:SETTing:CATalog?</code>	252
<code>[:SOURce<hw>]:BB:W3GPp:SETTing:DELete</code>	252
<code>[:SOURce<hw>]:BB:W3GPp:SETTing:LOAD</code>	253
<code>[:SOURce<hw>]:BB:W3GPp:SETTing:STORe</code>	253
<code>[:SOURce<hw>]:BB:W3GPp:SETTing:STORe:FAST</code>	253
<code>[:SOURce<hw>]:BB:W3GPp:SLENgth</code>	254
<code>[:SOURce<hw>]:BB:W3GPp:STATe</code>	254
<code>[:SOURce<hw>]:BB:W3GPp:WAVeform:CREate</code>	254
<code>[:SOURce]:BB:W3GPp:GPP3:VERSion?</code>	255
<code>[:SOURce<hw>]:BB:W3GPp:BSTation:PRESet</code>	255
<code>[:SOURce<hw>]:BB:W3GPp:COpy:COFFset</code>	255

<code>[:SOURce<hw>]:BB:W3GPP:COPY:DESTination</code>	255
<code>[:SOURce<hw>]:BB:W3GPP:COPY:EXECute</code>	256
<code>[:SOURce<hw>]:BB:W3GPP:COPY:SOURce</code>	256
<code>[:SOURce<hw>]:BB:W3GPP:LINK</code>	257
<code>[:SOURce<hw>]:BB:W3GPP:POWer:ADJust</code>	257
<code>[:SOURce<hw>]:BB:W3GPP:POWer[:TOTal]?</code>	257

`[:SOURce<hw>]:BB:W3GPP:PRESet`

Sets the parameters of the digital standard to their default values (*RST values specified for the commands).

Not affected is the state set with the command `SOURce<hw>:BB:W3GPP:STATe`.

Example: `SOURce1:BB:W3GPP:PRESet`

Usage: Event

Manual operation: See "Set to default" on page 48

`[:SOURce<hw>]:BB:W3GPP:SETTing:CATalog?`

This command reads out the files with 3GPP FDD settings in the default directory. The default directory is set using command `MME:CDIRectory`. Only files with the file extension *.3g are listed.

Return values:

<Catalog> string

Example: `MME:CDIR '/var/user/temp/3gpp`

Sets the default directory.

`BB:W3GP:SETT:CAT?`

Reads out all the files with 3GPP FDD settings in the default directory.

Response: UPLINK, DOWNLINK

The files UPLINK and DOWNLINK are available.

Usage: Query only

Manual operation: See "Save/Recall" on page 48

`[:SOURce<hw>]:BB:W3GPP:SETTing:DELeTe <Filename>`

This command deletes the selected file with 3GPP FDD settings. The directory is set using command `MME:CDIRectory`. A path can also be specified, in which case the files in the specified directory are read. The file extension can be omitted. Only files with the file extension *.3g are deleted.

Setting parameters:

<Filename> <file_name>

Example: `BB:W3GP:SETT:DEL 'UPLINK'`

Deletes file UPLINK.

Usage: Setting only
Manual operation: See ["Save/Recall"](#) on page 48

[:SOURce<hw>]:BB:W3GPP:SETTING:LOAD <Filename>

This command loads the selected file with 3GPP FDD settings. The directory is set using command `MMEM:CDIRectory`. A path can also be specified, in which case the files in the specified directory are read. The file extension can be omitted. Only files with the file extension `*.3g` are loaded.

Setting parameters:

<Filename> <file_name>

Example: `BB:W3GP:SETT:LOAD 'UPLINK'`
 Loads file UPLINK.

Usage: Setting only
Manual operation: See ["Save/Recall"](#) on page 48

[:SOURce<hw>]:BB:W3GPP:SETTING:STORE <Filename>

This command stores the current 3GPP FDD settings into the selected file. The directory is set using command `MMEM:CDIRectory`. A path can also be specified, in which case the files in the specified directory are read. Only enter the file name. 3GPP FDD settings are stored as files with the specific file extensions `*.3g`.

Setting parameters:

<Filename> string

Example: `BB:W3GP:SETT:STOR 'UPLINK'`
 Stores the current 3GPP FDD settings into file UPLINK.

Usage: Setting only
Manual operation: See ["Save/Recall"](#) on page 48

[:SOURce<hw>]:BB:W3GPP:SETTING:STORE:FAST <Fast>

Determines whether the instrument performs an absolute or a differential storing of the settings.

Enable this function to accelerate the saving process by saving only the settings with values different to the default ones.

Note: This function is not affected by the "Preset" function.

Parameters:

<Fast> 0 | 1 | OFF | ON
 *RST: 1

Manual operation: See ["Save/Recall"](#) on page 48

[:SOURce<hw>]:BB:W3GPp:SLENgth <SLength>

Defines the sequence length of the arbitrary waveform component of the 3GPP signal in the number of frames. This component is calculated in advance and output in the arbitrary waveform generator. It is added to the realtime signal components (Enhanced Channels).

When working in Advanced Mode (`W3GP:BST1:CHAN:HSDP:HSET:AMOD ON`), it is recommended to adjust the current ARB sequence length to the suggested one.

Parameters:

<SLength> integer
 Range: 1 to Max. No. of Frames = Arbitrary waveform memory size/(3.84 Mcps x 10 ms).
 *RST: 1

Example: `BB:W3GP:SLEN 10`
 sets the sequence length to 10 frames.

Manual operation: See ["Sequence Length ARB"](#) on page 61

[:SOURce<hw>]:BB:W3GPp:STATe <State>

Activates the standard and deactivates all the other digital standards and digital modulation modes in the same path.

Parameters:

<State> 0 | 1 | OFF | ON
 *RST: 0

Example: `SOURce1:BB:W3GPp:STATe ON`

Manual operation: See ["State"](#) on page 48

[:SOURce<hw>]:BB:W3GPp:WAVEform:CREate <Filename>

This command creates a waveform using the current settings of the 3GPP FDD menu. The file name is entered with the command. The file is stored with the predefined file extension `*.wv`. The file name and the directory it is stored in are user-definable.

Setting parameters:

<Filename> <file_name>

Example: `M MEM:CDIR '/var/user/temp/waveform'`
 sets the default directory to `/var/user/temp/waveform`.
`BB:W3GP:WAV:CRE 'gpp3_bs'`
 creates the waveform file `gpp3_bs.wv` in the default directory.

Usage: Setting only

Manual operation: See ["Generate Waveform"](#) on page 50

[[:SOURce]:BB:W3GPp:GPP3:VERSion?

The command queries the version of the 3GPP standard underlying the definitions.

Return values:

<Version> string

Example: `BB:W3GP:GPP3:VERS?`
queries the 3GPP version.

Usage: Query only

Manual operation: See "[3GPP Version](#)" on page 50

[[:SOURce<hw>]:BB:W3GPp:BSTation:PRESet

The command produces a standardized default for all the base stations. The settings correspond to the *RST values specified for the commands.

All base station settings are preset.

Example: `BB:W3GP:BST:PRES`
resets all the base station settings to default values.

Usage: Event

Manual operation: See "[Reset all Base Stations](#)" on page 53

[[:SOURce<hw>]:BB:W3GPp:COPY:COFFset <COffset>

Sets the offset for the channelization code in the destination base station.

Parameters:

<COffset> integer
Range: 0 to 511
*RST: 0

Example: `BB:W3GP:COPY:COFF 10`
the channelization code is shifted by 10 when the source base station is copied to the destination base station.

Manual operation: See "[Copy Basestation/Copy User Equipment...](#)" on page 54

[[:SOURce<hw>]:BB:W3GPp:COPY:DESTination <Destination>

The command selects the station to which data is to be copied. Whether the data is copied to a base station or a user equipment depends on which transmission direction is selected (command `W3GPp:LINK UP | DOWN`).

Parameters:

<Destination> 1 | 2 | 3 | 4
Range: 1 to 4
*RST: 2

Example: `BB:W3GP:LINK DOWN`
 selects the downlink transmit direction (base station to user equipment).
`BB:W3GP:COPY:SOUR 1`
 selects base station 1 as the source.
`BB:W3GP:COPY:DEST 4`
 selects base station 4 as the destination.
`BB:W3GP:COPY:EXEC`
 starts copying the parameter set of base station 1 to base station 4.

Manual operation: See "[Copy Basestation/Copy User Equipment...](#)" on page 54

[:SOURce<hw>]:BB:W3GPp:COPY:EXECute

The command starts the copy process. The dataset of the source station is copied to the destination station. Whether the data is copied to a base station or a user equipment depends on which transmission direction is selected (command `W3GPp:LINK UP | DOWN`).

Example: `BB:W3GP:COPY:EXEC`
 starts copying the parameter set of the selected source station to the selected destination station.

Usage: Event

Manual operation: See "[Copy Basestation/Copy User Equipment...](#)" on page 54

[:SOURce<hw>]:BB:W3GPp:COPY:SOURce <Source>

The command selects the station that has data to be copied. Whether the station copied is a base or user equipment depends on which transmission direction is selected (command `W3GPp:LINK UP | DOWN`).

Parameters:

<Source> 1 | 2 | 3 | 4
 Range: 1 to 4
 *RST: 1

Example: `BB:W3GP:LINK UP`
 selects the uplink transmit direction (user equipment to base station).
`BB:W3GP:COPY:SOUR 1`
 selects user equipment 1 as the source.
`BB:W3GP:COPY:DEST 4`
 selects user equipment 4 as the destination.
`BB:W3GP:COPY:EXEC`
 starts copying the parameter set of user equipment 1 to user equipment 4.

Manual operation: See "[Copy Basestation/Copy User Equipment...](#)" on page 54

[:SOURce<hw>]:BB:W3GPp:LINK <Link>

The command defines the transmission direction. The signal either corresponds to that of a base station (FORWARD|DOWN) or that of a user equipment (REVERSE|UP).

Parameters:

<Link> DOWN | UP | FORWARD | REVERSE
*RST: FORWARD|DOWN

Example:

BB:W3GP:LINK DOWN
the transmission direction selected is base station to user equipment. The signal corresponds to that of a base station.

Manual operation: See "[Link Direction](#)" on page 51

[:SOURce<hw>]:BB:W3GPp:POWER:ADJUST

The command sets the power of the active channels in such a way that the total power of the active channels is 0 dB. This does not change the power ratio among the individual channels.

Example:

BB:W3GP:POW:ADJ
The total power of the active channels is set to 0 dB, the power ratio among the individual channels is unchanged.

Usage: Event

Manual operation: See "[Adjust Total Power to 0dB](#)" on page 56

[:SOURce<hw>]:BB:W3GPp:POWER[:TOTAL]?

The command queries the total power of the active channels. After "Power Adjust", this power corresponds to 0 dB.

Return values:

<Total> float

Example:

BB:W3GP:POW?
queries the total power of the active channels.
Response: -22.5
the total power is -25 dB.

Usage: Query only

Manual operation: See "[Total Power](#)" on page 56

7.2 Filter/Clipping Settings

[:SOURce<hw>]:BB:W3GPp:CLIPPING:LEVEL.....	258
[:SOURce<hw>]:BB:W3GPp:CLIPPING:MODE.....	258
[:SOURce<hw>]:BB:W3GPp:CLIPPING:STATE.....	259
[:SOURce<hw>]:BB:W3GPp:CRATE?.....	259

<code>[:SOURce<hw>]:BB:W3GPp:CRATe:VARiAtion</code>	259
<code>[:SOURce<hw>]:BB:W3GPp:FILTer:PARAmeter:APCO25</code>	259
<code>[:SOURce<hw>]:BB:W3GPp:FILTer:PARAmeter:COsine</code>	260
<code>[:SOURce<hw>]:BB:W3GPp:FILTer:PARAmeter:GAUSs</code>	260
<code>[:SOURce<hw>]:BB:W3GPp:FILTer:PARAmeter:LPASs</code>	260
<code>[:SOURce<hw>]:BB:W3GPp:FILTer:PARAmeter:LPASSEVM</code>	261
<code>[:SOURce<hw>]:BB:W3GPp:FILTer:PARAmeter:RCOSine</code>	261
<code>[:SOURce<hw>]:BB:W3GPp:FILTer:PARAmeter:SPHase</code>	261
<code>[:SOURce<hw>]:BB:W3GPp:FILTer:TYPE</code>	262

`[:SOURce<hw>]:BB:W3GPp:CLIPping:LEVel <Level>`

The command sets the limit for level clipping (Clipping). This value indicates at what point the signal is clipped. It is specified as a percentage, relative to the highest level. 100% indicates that clipping does not take place.

Level clipping is activated with the command `SOUR:BB:W3GP:CLIP:STAT ON`

Parameters:

<Level> integer
 Range: 1 to 100
 *RST: 100

Example:

```
BB:W3GP:CLIP:LEV 80PCT
sets the limit for level clipping to 80% of the maximum level.
BB:W3GP:CLIP:STAT ON
activates level clipping.
```

Manual operation: See "[Clipping Level](#)" on page 61

`[:SOURce<hw>]:BB:W3GPp:CLIPping:MODE <Mode>`

The command sets the method for level clipping (Clipping).

Parameters:

<Mode> VECTor | SCALar
VECTor
 The reference level is the amplitude $|i+jq|$
SCALar
 The reference level is the absolute maximum of the I and Q values.
 *RST: VECTor

Example:

```
BB:W3GP:CLIP:MODE SCAL
selects the absolute maximum of all the I and Q values as the
reference level.
BB:W3GP:CLIP:LEV 80PCT
sets the limit for level clipping to 80% of this maximum level.
BB:W3GP:CLIP:STAT ON
activates level clipping.
```

Manual operation: See "[Clipping Mode](#)" on page 61

[:SOURce<hw>]:BB:W3GPp:CLIPping:STATe <State>

Activates level clipping.

Parameters:

<State> 0 | 1 | OFF | ON
*RST: 0

Example: BB:W3GP:CLIP:STAT ON
activates level clipping.

Manual operation: See "[Clipping State](#)" on page 59

[:SOURce<hw>]:BB:W3GPp:CRATe?

The command queries the set system chip rate. The output chip rate can be set with the command SOUR:BB:W3GP:CRAT:VAR.

Return values:

<CRate> R3M8
*RST: R3M8

Example: BB:W3GP:CRAT?
queries the system chip rate.
Response: R3M8
the system chip rate is 3.8 Mcps.

Usage: Query only

Manual operation: See "[Chip Rate](#)" on page 51

[:SOURce<hw>]:BB:W3GPp:CRATe:VARiation <Variation>

Sets the output chip rate.

The chip rate entry changes the output clock and the modulation bandwidth, as well as the synchronization signals that are output. It does not affect the calculated chip sequence.

Parameters:

<Variation> float
Range: 400 to 5E6
Increment: 0.001
*RST: 3.84 MCps

Example: BB:W3GP:CRAT:VAR 4086001
sets the chip rate to 4.08 Mcps.

Manual operation: See "[Chip Rate Variation](#)" on page 59

[:SOURce<hw>]:BB:W3GPp:FILTer:PARAmeter:APCO25 <Apco25>

The command sets the roll-off factor for filter type APCO25.

Parameters:

<Apco25> float
 Range: 0.05 to 0.99
 Increment: 0.01
 *RST: 0.2

Example:

BB:W3GP:FILT:PAR:APCO25 0.2
 sets the roll-off factor to 0.2 for filter type APCO25.

Manual operation: See "[Roll Off Factor or BxT](#)" on page 59

[:SOURCE<hw>]:BB:W3GPp:FILT:PAR:Parameter:Cosine <Cosine>

The command sets the roll-off factor for the Cosine filter type.

Parameters:

<Cosine> float
 Range: 0 to 1
 Increment: 0.01
 *RST: 0.35

Example:

BB:W3GP:FILT:PAR:Cos 0.35
 sets the roll-off factor to 0.35 for filter type Cosine.

Manual operation: See "[Roll Off Factor or BxT](#)" on page 59

[:SOURCE<hw>]:BB:W3GPp:FILT:PAR:Parameter:GAUSSs <Gauss>

The command sets the roll-off factor for the Gauss filter type.

Parameters:

<Gauss> float
 Range: 0.15 to 2.5
 Increment: 0.01
 *RST: 0.5

Example:

BB:W3GP:FILT:PAR:GAUSS 0.5
 sets B x T to 0.5 for the Gauss filter type.

Manual operation: See "[Roll Off Factor or BxT](#)" on page 59

[:SOURCE<hw>]:BB:W3GPp:FILT:PAR:Parameter:LPASSs <LPass>

Sets the cut off frequency factor for the Lowpass (ACP opt.) filter type. The minimum/maximum values depend on the current symbol rate:

Parameters:

<LPass> float
 Range: 0.05 to 2
 Increment: 0.01
 *RST: 0.5

Example: `BB:W3GP:FILT:PAR:LPAS 0.5`
the cut of frequency factor is set to 0.5.

Manual operation: See ["Cut Off Frequency Factor"](#) on page 59

[[:SOURce<hw>]:BB:W3GPp:FILTer:PARAmeter:LPASSEVM <LPassEvm>

Sets the cut off frequency factor for the Lowpass (EVM opt.) filter type.

Parameters:

<LPassEvm> float
Range: 0.05 to 2
Increment: 0.01
*RST: 0.5

Example: `BB:W3GP:FILT:PAR:LPASSEVM 0.5`
the cut of frequency factor is set to 0.5.

Manual operation: See ["Cut Off Frequency Factor"](#) on page 59

[[:SOURce<hw>]:BB:W3GPp:FILTer:PARAmeter:RCOSine <RCosine>

The command sets the roll-off factor for the Root Cosine filter type.

Parameters:

<RCosine> float
Range: 0 to 1.0
Increment: 0.01
*RST: 0.22

Example: `BB:W3GP:FILT:PAR:RCOS 0.22`
sets the roll-off factor to 0.22 for filter type Root Cosine.

Manual operation: See ["Roll Off Factor or BxT"](#) on page 59

[[:SOURce<hw>]:BB:W3GPp:FILTer:PARAmeter:SPHase <SPHase>

The command sets B x T for the Split Phase filter type.

Parameters:

<SPHase> float
Range: 0.15 to 2.5
Increment: 0.01
*RST: 2

Example: `BB:W3GP:FILT:PAR:SPH 0.5`
sets B x T to 0.5 for the Split Phase filter type.

Manual operation: See ["Roll Off Factor or BxT"](#) on page 59

[:SOURCE<hw>]:BB:W3GPP:FILTER:TYPE <Type>

Selects the filter type.

Parameters:

<Type> RCOSine | COSine | GAUSs | LGAuss | CONE | COF705 |
COEQUALizer | COFEQUALizer | C2K3x | APCO25 | SPHase |
RECTangle | LPASs | DIRac | ENPShape | EWPSHape |
LPASSEVM | PGAuss

COSine = "Cosine" = Raised Cosine

RCOSine = "Root Cosine" = Root Raised Cosine (RRC)

*RST: RCOSine

Example:

SOURCE1:BB:W3GPP:FILTER:TYPE RCOS
Select RRC filter.

Manual operation: See "Filter" on page 58

7.3 Trigger Settings

Example: Trigger configuration

```
SOURCE1:BB:W3GPP:TRIGGER:SOURCE INTERNAL
SOURCE1:BB:W3GPP:TRIGGER:SEQUENCE ARETRIGGER
SOURCE1:BB:W3GPP:STAT ON
SOURCE1:BB:W3GPP:TRIGGER:EXECUTE
SOURCE1:BB:W3GPP:TRIGGER:ARM:EXECUTE
SOURCE1:BB:W3GPP:TRIGGER:RMODE?
// stopped
SOURCE1:BB:W3GPP:TRIGGER:EXECUTE
SOURCE1:BB:W3GPP:TRIGGER:RMODE?
// run

// SOURCE1:BB:W3GPP:TRIGGER:SEQUENCE SING
// SOURCE1:BB:W3GPP:TRIGGER:SLUNIT SEQUENCE
// SOURCE1:BB:W3GPP:TRIGGER:SLLENGTH 2

// SOURCE1:BB:W3GPP:TRIGGER:SEQUENCE AAUT
// SOURCE1:BB:W3GPP:TRIGGER:SOURCE EXT
// SOURCE1:BB:W3GPP:TRIGGER:EXTERNAL:SYNCHRONIZE:OUTPUT 1
// SOURCE1:BB:W3GPP:TRIGGER:EXTERNAL1:INHIBIT 100
// SOURCE1:BB:W3GPP:TRIGGER:EXTERNAL1:DELAY 10
```

[:SOURCE<hw>]:BB:W3GPP[:TRIGGER]:SEQUENCE.....	263
[:SOURCE<hw>]:BB:W3GPP:TRIGGER:SOURCE.....	263
[:SOURCE<hw>]:BB:W3GPP:TRIGGER:ARM:EXECUTE.....	263
[:SOURCE<hw>]:BB:W3GPP:TRIGGER:EXECUTE.....	263
[:SOURCE<hw>]:BB:W3GPP:TRIGGER:EXTERNAL:SYNCHRONIZE:OUTPUT.....	264
[:SOURCE<hw>]:BB:W3GPP:TRIGGER:RMODE?.....	264

<code>[:SOURce<hw>]:BB:W3GPP:TRIGger:SLENgth</code>	264
<code>[:SOURce<hw>]:BB:W3GPP:TRIGger:SLUNit</code>	264
<code>[:SOURce<hw>]:BB:W3GPP:TRIGger[:EXTErnal<ch>]:DELay</code>	265
<code>[:SOURce<hw>]:BB:W3GPP:TRIGger[:EXTErnal<ch>]:INHibit</code>	265

`[:SOURce<hw>]:BB:W3GPP[:TRIGger]:SEQUence <Sequence>`

Selects the trigger mode:

- `AUTO` = auto
- `RETRigger` = retrigger
- `AAUTo` = armed auto
- `ARETRigger` = armed retrigger
- `SINGLE` = single

Parameters:

`<Sequence>` `AUTO` | `RETRigger` | `AAUTo` | `ARETRigger` | `SINGLE`
`*RST:` `AUTO`

Example: See [Example "Trigger configuration"](#) on page 262

Manual operation: See ["Trigger Mode"](#) on page 63

`[:SOURce<hw>]:BB:W3GPP:TRIGger:SOURce <Source>`

Selects the trigger source:

- `INTernal`: manual trigger or `*TRG`.
- `EXTernal`: trigger signal on the TRIGGER connector.

Parameters:

`<Source>` `INTernal`|`EXTernal`
`*RST:` `INTernal`

Example: `SOURce1:BB:W3GPP:TRIGger:SOURce EXTernal`
 sets external triggering via the TRIGGER connector.

Manual operation: See ["Trigger Source"](#) on page 64

`[:SOURce<hw>]:BB:W3GPP:TRIGger:ARM:EXECute`

Stops signal generation; a subsequent trigger event restarts signal generation.

Example: See [Example "Trigger configuration"](#) on page 262

Usage: Event

Manual operation: See ["Arm"](#) on page 64

`[:SOURce<hw>]:BB:W3GPP:TRIGger:EXECute`

Executes a trigger.

Example: See [Example "Trigger configuration"](#) on page 262

Usage: Event

Manual operation: See "[Execute Trigger](#)" on page 51

[:SOURce<hw>]:BB:W3GPP:TRIGger:EXTernal:SYNChronize:OUTPut <Output>

Enables signal output synchronous to the trigger event.

Parameters:

<Output> 0 | 1 | OFF | ON
*RST: 1

Example: See [Example "Trigger configuration"](#) on page 262

Manual operation: See "[Sync. Output to External Trigger](#)" on page 64

[:SOURce<hw>]:BB:W3GPP:TRIGger:RMODE?

Queries the signal generation status.

Return values:

<RMode> STOP | RUN
*RST: STOP

Example: See [Example "Trigger configuration"](#) on page 262

Usage: Query only

Manual operation: See "[Running/Stopped](#)" on page 64

[:SOURce<hw>]:BB:W3GPP:TRIGger:SEnGth <SLength>

Defines the length of the signal sequence that is output in the `SINGLE` trigger mode.

Parameters:

<SLength> integer
Range: 1 to 4293120000
*RST: 1

Example: See [Example "Trigger configuration"](#) on page 262

Manual operation: See "[Signal Duration](#)" on page 63

[:SOURce<hw>]:BB:W3GPP:TRIGger:SLUNit <SLunit>

Defines the unit for the entry of the signal sequence length.

Parameters:

<SLunit> CHIP | FRAME | SLOT | SEQUENCE
*RST: SEQUENCE

Example: See [Example "Trigger configuration"](#) on page 262

Manual operation: See "[Signal Duration Unit](#)" on page 63

[:SOURce<hw>]:BB:W3GPp:TRIGger[:EXTErnal<ch>]:DELay <Delay>

Specifies the trigger delay (expressed as a number of chips) for external triggering.

Parameters:

<Delay>	float
Range:	0 to 65535
Increment:	0.01
*RST:	0

Example: BB:W3GP:TRIG:SOUR EXT
BB:W3GP:TRIG:DEL 50

Manual operation: See "[Trigger Delay](#)" on page 66

[:SOURce<hw>]:BB:W3GPp:TRIGger[:EXTErnal<ch>]:INHibit <Inhibit>

The command specifies the number of chips by which a restart is to be inhibited following a trigger event. This command applies only in the case of external triggering.

Parameters:

<Inhibit>	integer
Range:	0 chips to $2^{32}-1$ chips
Increment:	1 chip
*RST:	0 chips

Example: BB:W3GP:TRIG:SOUR EXT
selects an external trigger via the TRIGGER 1 connector.
BB:W3GP:TRIG:INH 200
sets a restart inhibit for 200 chips following a trigger event.

Manual operation: See "[Trigger Inhibit](#)" on page 66

7.4 Marker Settings

Example: Marker configuration

```
SOURcel:BB:W3GPp:TRIGger:OUTPut1:MODE USER
SOURcel:BB:W3GPp:TRIGger:OUTPut1:PERiod 38400
```

```
SOURcel:BB:W3GPp:TRIGger:OUTPut1:MODE RAT
SOURcel:BB:W3GPp:TRIGger:OUTPut1:ONTime 1
SOURcel:BB:W3GPp:TRIGger:OUTPut1:OFFTime 1
// defines the on/off ratio
```

```
// Marker delay configuration
SOURcel:BB:W3GPp:TRIGger:OUTPut2:DELay 1600
```

```
SOURcel:BB:W3GPp:TRIGger:OUTPut:DELay:FIXed 1
// restricts the marker signal delay
SOURcel:BB:W3GPp:TRIGger:OUTPut:DELay:MINimum?
// 0
SOURcel:BB:W3GPp:TRIGger:OUTPut:DELay:MAXimum?
// 2000
```

[:SOURce<hw>]:BB:W3GPp:TRIGger:OUTPut<ch>:MODE.....	266
[:SOURce<hw>]:BB:W3GPp:TRIGger:OUTPut<ch>:ONTime.....	267
[:SOURce<hw>]:BB:W3GPp:TRIGger:OUTPut<ch>:OFFTime.....	267
[:SOURce<hw>]:BB:W3GPp:TRIGger:OUTPut<ch>:PERiod.....	267
[:SOURce<hw>]:BB:W3GPp:TRIGger:OUTPut<ch>:DELay.....	267
[:SOURce<hw>]:BB:W3GPp:TRIGger:OUTPut:DELay:FIXed.....	267
[:SOURce<hw>]:BB:W3GPp:TRIGger:OUTPut<ch>:DELay:MINimum?.....	268
[:SOURce<hw>]:BB:W3GPp:TRIGger:OUTPut<ch>:DELay:MAXimum?.....	268

[:SOURce<hw>]:BB:W3GPp:TRIGger:OUTPut<ch>:MODE <Mode>

Defines the signal for the selected marker output.

Parameters:

<Mode> SLOt | RFRame | CSPeriod | SFNR | RATio | USER | TRIGger

SLOt = Slot

RFRame = Radio Frame

CSPeriod = Chip Sequence Period (ARB)

SFNR = System Frame Number (SFN) Restart

RATio = ON/OFF Ratio

USER = User

TRIGger

A received internal or external trigger signal is output at the marker connector.

*RST: RFRame

Example:

```
SOURcel:BB:W3GPp:TRIGger:OUTPut2:MODE SLOt
selects the slot marker for the corresponding marker signal.
```

Manual operation: See ["Marker Mode"](#) on page 66

```
[:SOURce<hw>]:BB:W3GPp:TRIGger:OUTPut<ch>:ONTime <OnTime>
[:SOURce<hw>]:BB:W3GPp:TRIGger:OUTPut<ch>:OFFTime <OffTime>
```

Sets the number of chips during which the marker output is on or off.

Parameters:

<OffTime> integer
 Range: 1 to 16777215
 *RST: 1
 Default unit: chip

Example: See [Example "Marker configuration"](#) on page 266

Manual operation: See ["Marker Mode"](#) on page 66

```
[:SOURce<hw>]:BB:W3GPp:TRIGger:OUTPut<ch>:PERiod <Period>
```

Sets the repetition rate for the signal at the marker outputs.

Parameters:

<Period> integer
 Range: 1 to $2^{32}-1$ chips
 *RST: 38400

Example: See [Example "Marker configuration"](#) on page 266.

Manual operation: See ["Marker Mode"](#) on page 66

```
[:SOURce<hw>]:BB:W3GPp:TRIGger:OUTPut<ch>:DELay <Delay>
```

Defines the delay between the signal on the marker outputs and the start of the signals.

Parameters:

<Delay> float
 Range: 0 to 16777215
 *RST: 0

Example: See [Example "Marker configuration"](#) on page 266

Manual operation: See ["Marker x Delay"](#) on page 67

```
[:SOURce<hw>]:BB:W3GPp:TRIGger:OUTPut:DELay:FIXed <Fixed>
```

Restricts the marker delay setting range to the dynamic range.

Parameters:

<Fixed> 0 | 1 | OFF | ON
 *RST: 0

Example: See [Example "Marker configuration"](#) on page 266

Manual operation: See ["Fix marker delay to current range"](#) on page 67

```
[:SOURce<hw>]:BB:W3GPp:TRIGger:OUTPut<ch>:DELay:MINimum?
[:SOURce<hw>]:BB:W3GPp:TRIGger:OUTPut<ch>:DELay:MAXimum?
```

Queries the min/max marker delay.

Return values:

<Maximum> float
Increment: 0.001

Example: See [Example "Marker configuration"](#) on page 266

Usage: Query only

Manual operation: See ["Current Range without Recalculation"](#) on page 67

7.5 Clock Settings

[:SOURce<hw>]:BB:W3GPp:CLOCK:MODE.....	268
[:SOURce<hw>]:BB:W3GPp:CLOCK:MULTiplier.....	268
[:SOURce<hw>]:BB:W3GPp:CLOCK:SOURce.....	269
[:SOURce<hw>]:BB:W3GPp:CLOCK:SYNChronization:EXECute.....	269
[:SOURce<hw>]:BB:W3GPp:CLOCK:SYNChronization:MODE.....	269

```
[:SOURce<hw>]:BB:W3GPp:CLOCK:MODE <Mode>
```

Sets the type of externally supplied clock.

Parameters:

<Mode> CHIP | MCHip
*RST: CHIP

Example: SOURce1:BB:W3GPp:CLOCK:MODE CHIP
Selects clock type chip.

Manual operation: See ["Clock Mode"](#) on page 69

```
[:SOURce<hw>]:BB:W3GPp:CLOCK:MULTiplier <Multiplier>
```

Sets the multiplier for clock type Multiplied.

Parameters:

<Multiplier> integer
Range: 1 to 64
*RST: 4

Example: `SOURce1:BB:W3GPP:CLOCK:SOURce EXT`
selects the external clock source.
`SOURce1:BB:W3GPP:CLOCK:MODE MChip`
selects clock type multiplied, i.e. the supplied clock has a rate which is a multiple of the chip rate.
`SOURce1:BB:W3GPP:CLOCK:MULTIplier 12`
the multiplier for the external clock rate is 12.

Manual operation: See "[Chip Clock Multiplier](#)" on page 69

[:SOURce<hw>]:BB:W3GPP:CLOCK:SOURce <Source>

Sets the clock source.

Parameters:

<Source> INTernal | EXTernal

INTernal
The internal clock reference is used.

EXTernal
The external clock reference is supplied to the CLOCK connector.

*RST: INTernal

Example: `BB:W3GP:CLOC:SOUR EXT`
selects an external clock reference.
`BB:W3GP:CLOC:MODE CHIP`
specifies that a chip clock is supplied via the clock connector.

Manual operation: See "[Clock Source](#)" on page 68

[:SOURce<hw>]:BB:W3GPP:CLOCK:SYNChronization:EXECute

Performs automatically adjustment of the instrument's settings required for the synchronization mode, set with the command `BB:W3GP:CLOC:SYNC:MODE`.

Example: `:BB:W3GP:CLOC:SYNC:MODE MAST`
the instrument is configured to work as a master one.
`:BB:W3GP:CLOC:SYNC:EXEC`
all synchronization's settings are adjusted accordingly.

Usage: Event

Manual operation: See "[Set Synchronization Settings](#)" on page 68

[:SOURce<hw>]:BB:W3GPP:CLOCK:SYNChronization:MODE <Mode>

Selects the synchronization mode.

This parameter is used to enable generation of precise synchronous signal of several connected R&S SMBVs.

Note: If several instruments are connected, the connecting cables from the master instrument to the slave one and between each two consecutive slave instruments must have the same length and type. This applies for all connections, the REF OUT to REF IN connection, the MARKER 1 to TRIGGER connection and the CLOCK OUT to CLOCK IN connection. Avoid unnecessary cable length and branching points.

Parameters:

<Mode> NONE | MASTer | SLAVe

NONE

The instrument is working in stand-alone mode.

MASTer

The instrument provides all connected instrument with its synchronization (including the trigger signal) and reference clock signal.

SLAVe

The instrument receives the synchronization and reference clock signal from another instrument working in a master mode.

*RST: NONE

Example:

```
:BB:W3GP:CLOC:SYNC:MODE MAST
```

The instrument is configured to work as a master one.

Manual operation: See "[Sync. Mode](#)" on page 68

7.6 Test Models and Predefined Settings

The provided commands give you the opportunity to generate standardized or predefined test settings:

- Test Models:
 - Selection of test models for the downlink in accordance with 3GPP standard 25.141.
 - Selection of non-standardized test models for the uplink.
- Predefined Settings:

Definition of Predefined Settings for base station 1 which enable the creation of highly complex scenarios for the downlink by presetting the channel table of base station 1. The settings take effect only after execution of command

```
BB:W3GPp:PPARAmeter:EXECute.
```

[:SOURce<hw>]:BB:W3GPp:PPARAmeter:CRESt	271
[:SOURce<hw>]:BB:W3GPp:PPARAmeter:DPCH:COUNt	271
[:SOURce<hw>]:BB:W3GPp:PPARAmeter:DPCH:SRATe	272
[:SOURce<hw>]:BB:W3GPp:PPARAmeter:EXECute	272
[:SOURce<hw>]:BB:W3GPp:PPARAmeter:SCCPch:SRATe	272
[:SOURce<hw>]:BB:W3GPp:PPARAmeter:SCCPch:STATe	273
[:SOURce<hw>]:BB:W3GPp:PPARAmeter:SCHannels	273
[:SOURce<hw>]:BB:W3GPp:SETTing:TMODel:BSTation	273

<code>[:SOURCE<hw>]:BB:W3GPp:SETTING:TMODeL:BSTation:CATalog?</code>	273
<code>[:SOURCE<hw>]:BB:W3GPp:SETTING:TMODeL:MSStation</code>	274
<code>[:SOURCE<hw>]:BB:W3GPp:SETTING:TMODeL:MSStation:CATalog?</code>	274

`[:SOURCE<hw>]:BB:W3GPp:PPARAmeter:CRESt <Crest>`

This command selects the desired range for the crest factor of the test scenario. The crest factor of the signal is kept in the desired range by automatically setting appropriate channelization codes and timing offsets.

The setting takes effect only after execution of command

`BB:W3GPp:PPARAmeter:EXECute`.

The settings of commands

- `BB:W3GP:BST<n>:CHAN<n>:CCODE` and
- `BB:W3GP:BST<n>:CHAN<n>:TOFFset`

Are adjusted according to the selection.

Parameters:

`<Crest>`

MINimum | AVERage | WORSt

MINimum

The crest factor is minimized. The channelization codes are distributed uniformly over the code domain. The timing offsets are increased by 3 per channel.

AVERage

An average crest factor is set. The channelization codes are distributed uniformly over the code domain. The timing offsets are all set to 0.

WORSt

The crest factor is set to an unfavorable value (i.e. maximum). The channelization codes are assigned in ascending order. The timing offsets are all set to 0.

*RST: MINimum

Example:

`BB:W3GP:PPAR:CRESt WORSt`

Sets the crest factor to an unfavorable value.

Manual operation: See "[Crest Factor](#)" on page 74

`[:SOURCE<hw>]:BB:W3GPp:PPARAmeter:DPCH:COUNT <Count>`

Sets the number of activated DPCHs. The maximum number is the ratio of the chip rate and the symbol rate (maximum 512 at the lowest symbol rate of 7.5 ksps).

Parameters:

`<Count>`

integer

Range: 0 to 512 (Max depends on other settings)

*RST: 10

Example: `BB:W3GP:PPAR:DPCH:COUN 21`
the predefined signal contains 21 DPCHs.
`BB:W3GPp:PPARameter:EXECute`

Manual operation: See " [Number of DPCH](#) " on page 73

[:SOURCE<hw>]:BB:W3GPp:PPARameter:DPCH:SRATe <SRate>

This command sets the symbol rate of DPCHs.

The setting takes effect only after execution of command

`BB:W3GPp:PPARameter:EXECute.`

Parameters:

<SRate> D7K5 | D15K | D30K | D60K | D120k | D240k | D480k | D960k
*RST: D30K

Example: `BB:W3GP:PPAR:DPCH:SRAT D240K`
sets the symbol rate of the DPCHs to 240ksps.

Manual operation: See " [Symbol Rate DPCH](#) " on page 74

[:SOURCE<hw>]:BB:W3GPp:PPARameter:EXECute

This command presets the channel table of base station 1 with the parameters defined by the PPARameter commands.

Example: `BB:W3GP:PPAR:EXEC`
configures the signal sequence as defined by the : PPARameter commands.

Usage: Event

Manual operation: See " [Accept](#) " on page 74

[:SOURCE<hw>]:BB:W3GPp:PPARameter:SCCPch:SRATe <SRate>

The command sets the symbol rate of S-CCPCH.

The setting takes effect only after execution of command

`BB:W3GPp:PPARameter:EXECute.`

Parameters:

<SRate> D15K | D30K | D60K | D120k | D240k | D480k | D960k
*RST: D30K

Example: `BB:W3GP:PPAR:SCCP:SRAT D240K`
'sets the SCCPCH to 240 ksps.

Manual operation: See " [Symbol Rate S-CCPCH](#) " on page 73

[[:SOURce<hw>]:BB:W3GPp:PPARameter:SCCPch:STATe <State>

Activates/deactivates the S-CCPCH.

Parameters:

<State> 0 | 1 | OFF | ON
 *RST: 0

Example:

```
BB:W3GP:PPAR:SCCP:STAT ON
S-CCPCH is activated.
BB:W3GPp:PPARameter:EXECute
```

Manual operation: See " [Use S-CCPCH](#) " on page 73

[[:SOURce<hw>]:BB:W3GPp:PPARameter:SCHannels <SChannels>

The command activates/deactivates the PCPICH, PSCH, SSCH and PCCPCH. These "special channels" are required by a user equipment for synchronization.

The setting takes effect only after execution of command
 BB:W3GPp:PPARameter:EXECute.

Parameters:

<SChannels> 0 | 1 | OFF | ON
 *RST: 0

Manual operation: See " [Use Channels](#) " on page 73

[[:SOURce<hw>]:BB:W3GPp:SETTing:TMODeL:BSTation <BStation>

Selects a standard test model for the downlink.

Parameters:

<BStation> string

Example:

```
SOURce1:BB:W3GPp:SETTing:TMODeL:BSTation:
CATalog?
queries the list of available test models for the downlink trans-
mission direction.
Response: Test_Model_1_16channels,...
SOURce1:BB:W3GPp:SETTing:TMODeL:BSTation:
"Test_Model_1_64channels"
selects the test model Measurement: Spectrum emission mask
ACLR; 64 Channels.
```

Manual operation: See " [Test Models Downlink](#) " on page 69

[[:SOURce<hw>]:BB:W3GPp:SETTing:TMODeL:BSTation:CATalog?

Queries the list of test models defined by the standard for the downlink.

Return values:

<Catalog> string

- Example:** see `[:SOURCE<hw>] :BB:W3GPp:SETTING:TMODeL:BSTation` on page 273
- Usage:** Query only
- Manual operation:** See "Test Models Downlink" on page 69

`[:SOURCE<hw>] :BB:W3GPp:SETTING:TMODeL:MSTation <MStation>`

The command selects a test model that is not defined by the standard for the uplink.

Parameters:

- `<MStation>` string
- DPCCH_DPDCH_60ksps**
Preset, Uplink, UE1 on, DPDCH + DPCCH, Overall symbol rate 60 ksps.
- DPCCH_DPDCH960ksps**
Preset, Uplink, UE1 on, DPDCH + DPCCH, Overall symbol rate 960 ksps
- TS34121_R6_Table_C_10_1_4_Subtest4**
Uplink test model according to 3GPP TS 34.121 Release 6, Table C.10.1.4.
- TS34121_R8_Table_C_10_1_4_Subtest3**
Uplink test models for transmitter characteristics tests with HS-DPCCH according to 3GPP TS 34.121 Release 8, Table C.10.1.4.
- TS34121_R8_Table_C_11_1_3_Subtest2**
Uplink test models for transmitter characteristics tests with HS-DPCCH and E-DCH according to 3GPP TS 34.121 Release 8, Table C.11.1.3.
- TS34121_R8_Table_C_11_1_4_Subtest1**
Uplink test model for transmitter characteristics tests with HS-DPCCH and E-DCH with 16QAM according to 3GPP TS 34.121 Release 8, Table C.11.1.4.

- Example:** `BB:W3GP:SETT:TMOD:MST 'DPCCH_DPDCH960ksps'`
selects the test model with a symbol rate of 960 ksps.

- Manual operation:** See "Test Models Uplink" on page 71

`[:SOURCE<hw>] :BB:W3GPp:SETTING:TMODeL:MSTation:CATalog?`

The command queries the list of non-standardized test models for the uplink.

Return values:

`<Catalog>` string

- Example:** `BB:W3GP:SETT:TMOD:MST:CAT?`
queries the list of available test models
Response: `DPCCH_DPDCH960ksps,DPCCH_DPDCH_60ksps`

Usage: Query only

Manual operation: See ["Test Models Uplink"](#) on page 71

7.7 Setting Base Stations

The `SOURCE:BB:W3GPP:BSTATION` system contains commands for setting base stations. The commands of this system only take effect if the 3GPP FDD standard is activated, the `DOWN` transmission direction is selected and the particular base station is enabled:

```
SOURCE:BB:W3GPP:STATE ON
SOURCE:BB:W3GPP:LINK DOWN
SOURCE:BB:W3GPP:BSTATION2:STATE ON
```

`BSTATION<st>`

The numeric suffix to `BSTATION` determines the base station. The value range is 1 .. 4. If the suffix is omitted, BS1 is selected.

`CHANNEL<ch>`



In case of remote control, suffix counting for channels corresponds to the suffix counting with 3GPP FDD (channel 0 to channel 138). SCPI prescribes that suffix 1 is the default state and used when no specific suffix is specified. Therefore, channel 1 (and not channel 0) is selected when no suffix is specified.

The commands for setting the enhanced channels of base station 1 are described in [Chapter 7.8, "Enhanced Channels of Base Station 1"](#), on page 322.

`[:SOURCE<hw>]:BB:W3GPP:BSTATION:OCNS:STATE <State>`

Activates OCNS channels according to the scenario selected with the command `[:SOURCE<hw>]:BB:W3GPP:BSTATION:OCNS:MODE`.

Parameters:

```
<State>      0 | 1 | OFF | ON
*RST:       0
```

Example: See `[:SOURCE<hw>]:BB:W3GPP:BSTATION:OCNS:MODE` on page 275.

Manual operation: See ["OCNS On"](#) on page 52

`[:SOURCE<hw>]:BB:W3GPP:BSTATION:OCNS:MODE <Mode>`

Selects the scenario for setting the OCNS channels.

To activate the selected scenario, send the command `[:SOURCE<hw>]:BB:W3GPP:BSTATION:OCNS:STATE`.

Parameters:

<Mode> STANdard | HSDPa | HSDP2 | M3I

Four different OCNS scenarios are defined in the standard; one standard scenario, two scenarios for testing HSDPA channels and one for enhanced performance type 3i tests.

*RST: STANdard

Example:

BB:W3GP:BST:OCNS:MODE HSDP

Selects the scenario for testing the high-speed channels.

BB:W3GP:BST:OCNS:STAT ON

Activates the OCNS channels with the settings defined in the standard.

Options:

M3I requires option R&S SMBV-K43 and R&S SMBV-K59

Manual operation: See " [OCNS Mode](#) " on page 52

[:SOURCE<hw>]:BB:W3GPp:BSTation:OCNS:SEED <Seed>

In "3i" OCNS mode, sets the seed for both the random processes, the power control simulation process and the process controlling the switch over of the channelization codes.

Parameters:

<Seed> integer

Range: 0 to 65535

*RST: dynamic

Options:

R&S SMx/AMU-K43 and -K59

Manual operation: See "[OCNS Seed](#)" on page 53

[:SOURCE<hw>]:BB:W3GPp:BSTation<st>:CHANnel:HSDPa:HSET:PRESet

Sets the default settings of the channel table for the HSDPA H-Set mode. Channels 12 to 17 are preset for HSDPA H-Set 1.

Example:

SOURce1:BB:W3GPp:BSTation1:CHANnel12:HSDPa:MODE
HSET

selects H-Set mode.

SOURce1:BB:W3GPp:BSTation1:CHANnel12:HSDPa:
HSET:PRES

presets the H-Set.

SOURce1:BB:W3GPp:BSTation1:CHANnel12:TYPE?

Response: HSSC

SOURce1:BB:W3GPp:BSTation1:CHANnel12:HSDPa:

HSET:PREDeFined?

Response: P1QPSK

Usage:

Event

Manual operation: See " [Preset HSDPA H-Set](#) " on page 79

[:SOURCE<hw>]:BB:W3GPP:BSTation<st>:CHANNEL:PRESet

The command calls the default settings of the channel table.

Example: BB:W3GPP:BST:CHAN:PRESet
presets all channels of the base station.

Usage: Event

Manual operation: See "[Reset All Channels](#)" on page 79

[:SOURCE<hw>]:BB:W3GPP:BSTation<st>:CHANNEL<ch0>:AICH:ASLOT <ASlot>

Selects the slot in which the burst is transmitted.

Suffix:
<ch0> 7..7

Parameters:
<ASlot> integer
Range: 0 to 15
*RST: 0

Example: SOURCE1:BB:W3GPP:BSTation1:CHANNEL7:AICH:ASLOT
5
defines the slot to transmit the burst.

Manual operation: See "[Access Slot](#)" on page 132

**[:SOURCE<hw>]:BB:W3GPP:BSTation<st>:CHANNEL<ch0>:AICH:SAPattern
<SaPattern>**

Enters the 16 bit pattern for the ACK/NACK field.

Parameters:
<SaPattern> <16 bit pattern>
*RST: +00000000000000

Example: SOURCE1:BB:W3GPP:BSTation1:CHANNEL<ch0>:AICH:
SAPattern "+00000000000000"
sets the bit pattern to "+00000000000000" (ACK).

Manual operation: See "[Signature ACK/NACK Pattern](#)" on page 131

**[:SOURCE<hw>]:BB:W3GPP:BSTation<st>:CHANNEL<ch0>:APAIch:ASLOT
<ASlot>**

Selects the slot in which the burst is transmitted.

Suffix:
<ch0> 8..8

Parameters:

<ASlot> integer
 Range: 0 to 15
 *RST: 0

Example:

SOURce1:BB:W3GPP:BSTation1:CHANnel8:APAIch:
 ASLOT 5
 defines the slot to transmit the burst.

Manual operation: See " [Access Slot](#) " on page 132

**[:SOURce<hw>]:BB:W3GPP:BSTation<st>:CHANnel<ch0>:APAIch:SAPattern
 <SaPattern>**

Enters the 16-bit pattern for the ACK/NACK field.

This field is used by the base station to acknowledge, refuse or ignore requests of up to 16 user equipment.

Parameters:

<SaPattern> <16 bit pattern>
 *RST: "+000000000000"

Example:

SOUR:BB:W3GP:BST1:CHAN8:APAI:SAP
 "+000000000000"
 Sets the bit pattern to "+" (ACK).

Manual operation: See " [Signature ACK/NACK Pattern](#) " on page 131

[:SOURce<hw>]:BB:W3GPP:BSTation<st>:CHANnel<ch0>:CCODE <CCode>

The command sets the channelization code (formerly the spreading code number). The range of values of the channelization code depends on the symbol rate of the channel. The standard assigns a fixed channelization code to some channels (P-CPICH, for example, always uses channelization code 0).

$[\text{chip-rate}(=3.84\text{Mcps}) / \text{symbol_rate}] - 1$

The slot format determines the symbol rate (and thus the range of values for the channelization code), the TFCI state and the pilot length. If the value of any one of the four parameters is changed, all the other parameters are adapted as necessary.

In the case of enhanced channels with active channel coding, the selected channel coding also affects the slot format and thus the remaining parameters. If these parameters are changed, the channel coding type is set to user.

Parameters:

<CCode> integer
 Range: 0 to 511
 Increment: 1
 *RST: depends on channel type

Example:

BB:W3GP:BST1:CHAN15:CCOD 123
 Sets channelization code 123 for channel 15 of base station 1.

Manual operation: See "[Channelization Code](#)" on page 82

[:SOURce<hw>]:BB:W3GPp:BSTation<st>:CHANnel<ch0>:DATA <Data>

The command determines the data source for the data fields of the specified channel.

For enhanced channels with channel coding, the data source is set with the command

[\[:SOURce<hw>\]:BB:W3GPp:BSTation:ENHanced:CHANnel<ch0>:DPCH: TCHannel<di0>:DATA](#) on page 330.

Parameters:

<Data> PN9 | PN11 | PN15 | PN16 | PN20 | PN21 | PN23 | DLISt | ZERO | ONE | PATTern

PNxx

The pseudo-random sequence generator is used as the data source. Different random sequence lengths can be selected.

DLISt

A data list is used. The data list is selected with the command `:BB:W3GPp:BST:CHANnel:DATA:DSElect`.

ZERO | ONE

Internal 0 and 1 data is used.

PATTern

Internal data is used. The bit pattern for the data is defined by the command `:BB:W3GPp:BST:CHANnel:DATA:PATTern`.

*RST: PN9

Example:

`BB:W3GP:BST2:CHAN13:DATA PATT`

Selects as the data source for the data fields of channel 13 of base station 2, the bit pattern defined with the following command.

`BB:W3GP:BST2:CHAN13:DATA:PATT #H3F,8`

Defines the bit pattern.

Manual operation: See "[Data List Management](#)" on page 49

[:SOURce<hw>]:BB:W3GPp:BSTation<st>:CHANnel<ch0>:DATA:DSElect <DSelect>

The command selects the data list for the DLISt data source selection.

The lists are stored as files with the fixed file extensions `*.dm_iqd` in a directory of the user's choice. The directory applicable to the following commands is defined with the command `MMEMORY:CDIR`. To access the files in this directory, you only have to give the file name, without the path and the file extension.

Parameters:

<DSelect> string

Example: `BB:W3GP:BST2:CHAN13:DATA DLIS`
 selects the Data Lists data source.
`MMEM:CDIR '/var/user/temp/IqData'`
 selects the directory for the data lists.
`BB:W3GP:BST2:CHAN13:DATA:DSEL '3gpp_list1'`
 selects file '3gpp_list1' as the data source. This file must be in the directory `/var/user/temp/IqData` and have the file extension `*.dm_iqd`.

Manual operation: See "[Data List Management](#)" on page 49

[:SOURCE<hw>]:BB:W3GPP:BSTation<st>:CHANnel<ch0>:DATA:PATtern
 <Pattern>, <BitCount>

The command determines the bit pattern for the PATtern selection. The maximum length is 64 bits.

Parameters:

<Pattern> numeric
 *RST: #H0

<BitCount> integer
 Range: 1 to 64
 *RST: 1

Example: `BB:W3GP:BST2:CHAN13:DATA:PATT #H3F,8`
 defines the bit pattern.

Manual operation: See "[Data](#)" on page 83

[:SOURCE<hw>]:BB:W3GPP:BSTation<st>:CHANnel<ch0>:DPCCh:MCODE
 <MCode>

The command activates multicode transmission for the selected channel (ON) or deactivates it (OFF). The multicode channels are destined for the same receiver, that is to say, are part of a radio link. The first channel of this group is used as the master channel. The common components (Pilot, TPC and TCFI) for all the channels are then spread using the spreading code of the master channel.

Parameters:

<MCode> 0 | 1 | OFF | ON
 *RST: 0

Example: `BB:W3GP:BST2:CHAN12:DPCC:MCOD ON`
 activates the simulation in multicode mode for channel 12 of base station 2.
`BB:W3GP:BST2:CHAN13:DPCC:MCOD ON`
 activates the simulation in multicode mode for channel 13 of base station 2. Channel 12 is the master channel.

Manual operation: See "[Multicode State \(DPCCH\)](#)" on page 133

```
[ :SOURce<hw>]:BB:W3GPp:BSTation<st>:CHANnel<ch0>:DPCCh:PLENght
<PLength>
```

Sets the length of the pilot fields.

The range of values for this parameter depends on the channel type and the symbol rate. The slot format determines the symbol rate (and thus the range of values for the channelization code), the TFCI state and the pilot length. If the value of any one of the four parameters is changed, all the other parameters are adapted as necessary.

In the case of enhanced channels with active channel coding, the selected channel coding also affects the slot format and thus the remaining parameters. If these parameters are changed, the channel coding type is set to user.

Parameters:

```
<PLength>          BIT2 | BIT4 | BIT8 | BIT16 | BIT0
                    *RST:      BIT4, bei S-CCPCH 0
```

Example:

```
SOURce1:W3GPp:BSTation1:CHANnel12:DPCCh:PLENght
BIT8
Sets the length of the pilot fields for channel 12 of base station
1.
```

Manual operation: See "[Pilot Length](#)" on page 131

```
[ :SOURce<hw>]:BB:W3GPp:BSTation<st>:CHANnel<ch0>:DPCCh:POFFset:PILot
<Pilot>
```

Sets an offset to the set channel power for the pilot field.

Parameters:

```
<Pilot>            float
                   Range:    -10 to 10
                   Increment: 0.01
                   *RST:     0
```

Example:

```
BB:W3GP:BST2:CHAN12:DPCCh:POFF:PIL -2 dB
in the pilot field, sets an offset of -2 dB relative to the channel
power.
```

Manual operation: See "[Power Offset Pilot \(DPCCH\)](#)" on page 136

```
[ :SOURce<hw>]:BB:W3GPp:BSTation<st>:CHANnel<ch0>:DPCCh:POFFset:TFCI
<Tfci>
```

The command sets an offset to the set channel power for the TFCI field.

Parameters:

```
<Tfci>            float
                   Range:    -10 to 10
                   Increment: 0.01
                   *RST:     0
```

Example: `BB:W3GP:BST2:CHAN12:DPCC:POFF:PIL -2 dB`
in the TFCI field, sets an offset of -2 dB relative to the channel power.

Manual operation: See " [Power Offset TFCI \(DPCCH\)](#) " on page 137

[:SOURCE<hw>]:BB:W3GPp:BSTation<st>:CHANnel<ch0>:DPCCh:POFFset:TPC<Tpc>

The command sets an offset to the set channel power for the TPC field.

This setting is only valid for the DPCHs.

Parameters:

<Tpc> float
Range: -10 to 10
Increment: 0.01
*RST: 0

Example: `BB:W3GP:BST2:CHAN12:DPCC:POFF:TPC -2 dB`
in the TPC field, sets an offset of -2 dB relative to the channel power.

Manual operation: See " [Power Offset TPC \(DPCCH\)](#) " on page 137

[:SOURCE<hw>]:BB:W3GPp:BSTation<st>:CHANnel<ch0>:DPCCh:TFCI <Tfci>

The command enters the value of the TFCI field (Transport Format Combination Indicator) for the selected channel of the specified base station. The TFCI field is always filled with exactly 10 bits with leading zeros.

Parameters:

<Tfci> integer
Range: 0 to 1023
*RST: 0

Example: `BB:W3GP:BST2:CHAN12:DPCC:TFCI 22`
sets the value 22 for the TFCI field of channel 12 of base station 2.

Manual operation: See " [TFCI Value](#) " on page 130

[:SOURCE<hw>]:BB:W3GPp:BSTation<st>:CHANnel<ch0>:DPCCh:TFCI:STATe<State>

The command activates the TFCI field (Transport Format Combination Identifier) for the selected channel of the specified base station.

The slot format determines the symbol rate (and thus the range of values for the channelization code), the TFCI state and the pilot length. If the value of any one of the four parameters is changed, all the other parameters are adapted as necessary.

In the case of enhanced channels with active channel coding, the selected channel coding also affects the slot format and thus the remaining parameters. If these parameters are changed, the channel coding type is set to user.

Parameters:

<State> ON | OFF
*RST: OFF

Example:

BB:W3GP:BST2:CHAN12:DPCC:TFCI:STAT OFF
Sets that the TFCI field of channel 12 of base station 2 is not used.

Manual operation: See " Use TFCI " on page 130

[:SOURce<hw>] :BB:W3GPp:BSTation<st>:CHANnel<ch0>:DPCCh:TPC:DATA
<Data>

Determines the data source for the TPC field of the channel.

Parameters:

<Data> ZERO | ONE | PATtern | DLISt

DLISt

A data list is used.

Use the command [:SOURce<hw>] :BB:W3GPp:BSTation<st>:CHANnel<ch0>:DPCCh:TPC:DATA:DSElect to define the data list file.

ZERO | ONE

Internal 0 and 1 data is used.

PATtern

Internal data is used. Use the command [:SOURce<hw>] :BB:W3GPp:BSTation<st>:CHANnel<ch0>:DPCCh:TPC:DATA:PATtern to define the bit pattern.

*RST: ZERO

Example:

SOURce1:BB:W3GPp:BSTation2:CHANnel13:DPCCh:TPC:DATA PATtern

Selects as the data source for the TPC field of channel 13 of base station 2

SOURce1:BB:W3GPp:BSTation2:CHANnel13:DPCCh:TPC:DATA:PATtern #H3F,8

Defines the bit pattern.

Example:

SOURce1:BB:W3GPp:BSTation2:CHANnel13:DPCCh:TPC:DATA DLIS

Selects the data source.

MMEM:CDIR '/var/user/IqData'

Selects the directory for the data lists.

SOURce1:BB:W3GPp:BSTation2:CHANnel13:DPCCh:TPC:DATA:DSElect 'tpc_ch4'

Selects the file tpc_ch4 as the data source.

Manual operation: See ["Data List Management"](#) on page 49

**[:SOURce<hw>]:BB:W3GPp:BSTation<st>:CHANnel<ch0>:DPCCh:TPC:DATA:
DSElect <DSelect>**

Selects the data list for the `DLIST` data source selection.

The lists are stored as files with the fixed file extensions `*.dm_iqd` in a directory of the user's choice. The directory is defined with the command `MMEMORY:CDIR`. To access the files in this directory, you only have to give the file name, without the path and the file extension.

Parameters:

<DSelect> <data list name>

Example:

see [\[:SOURce<hw>\]:BB:W3GPp:BSTation<st>:
CHANnel<ch0>:DPCCh:TPC:DATA](#) on page 283

Manual operation: See ["Data List Management"](#) on page 49

**[:SOURce<hw>]:BB:W3GPp:BSTation<st>:CHANnel<ch0>:DPCCh:TPC:DATA:
PATTern <Pattern>, <BitCount>**

Determines the bit pattern.

Parameters:

<Pattern> numeric
 *RST: #H0

<BitCount> integer
 Range: 1 to 64
 *RST: 1

Example:

see [\[:SOURce<hw>\]:BB:W3GPp:BSTation<st>:
CHANnel<ch0>:DPCCh:TPC:DATA](#) on page 283

Manual operation: See [" TPC Data Source \(DPCCH\) "](#) on page 134

**[:SOURce<hw>]:BB:W3GPp:BSTation<st>:CHANnel<ch0>:DPCCh:TPC:MISuse
<MisUse>**

The command activates "mis-" use of the TPC field (Transmit Power Control) of the selected channel for controlling the channel powers of these channels of the specified base station.

The bit pattern (see commands `:W3GPp:BSTation<n>:CHANnel<n>:DPCCh:TPC...`) of the TPC field of each channel is used to control the channel power. A "1" leads to an increase of channel powers, a "0" to a reduction of channel powers. Channel power is limited to the range 0 dB to -60 dB. The step width of the change is defined with the command [\[:SOURce<hw>\]:BB:W3GPp:BSTation<st>:CHANnel<ch0>:DPCCh:TPC:PSTep](#).

Parameters:

<MisUse> ON | OFF
 *RST: 0

Manual operation: See " [Misuse TPC for Output Power Control \(DPCCH\)](#) " on page 135

[:SOURce<hw>]:BB:W3GPp:BSTation<st>:CHANnel<ch0>:DPCCh:TPC:PSTep
 <PowerStep>

The command defines the step width for the change of channel powers in the case of "mis-" use of the TPC field.

Parameters:

<PowerStep> float
 Range: -10 to 10
 Increment: 0.01
 *RST: 0

Example: BB:W3GP:BST2:CHAN13:DPCC:TPC:PST 1 dB
 sets the step width for the change of channel powers for channel 13 of base station 2 to 1 dB.

Manual operation: See " [TPC Power Step \(DPCCH\)](#) " on page 136

[:SOURce<hw>]:BB:W3GPp:BSTation<st>:CHANnel<ch0>:DPCCh:TPC:READ
 <Read>

The command sets the read out mode for the bit pattern of the TPC field.

The bit pattern is defined with the com-

mands :BB:W3GPp:BST<i>:CHANnel<n>:DPCCh:TPC

Parameters:

<Read> CONTInuous | S0A | S1A | S01A | S10A

CONTInuous

The bit pattern is used cyclically.

S0A

The bit pattern is used once, then the TPC sequence continues with 0 bits.

S1A

The bit pattern is used once, then the TPC sequence continues with 1 bit.

S01A

The bit pattern is used once and then the TPC sequence is continued with 0 bits and 1 bit alternately (in multiples, depending on by the symbol rate, for example, 00001111).

S10A

The bit pattern is used once and then the TPC sequence is continued with 1 bit and 0 bits alternately (in multiples, depending on by the symbol rate, for example, 11110000).

*RST: CONTInuous

Example:

BB:W3GP:BST2:CHAN13:DPCC:TPC:READ S0A

The bit pattern is used once, after which a 0 sequence is generated (applies to channel 13 of base station 2).

Manual operation: See " [TPC Read Out Mode \(DPCCH\)](#) " on page 135

[:SOURce<hw>]:BB:W3GPp:BSTation<st>:CHANnel<ch0>:FDPCh:DPCCCh:TPC:DATA <Data>

The command determines the data source for the TPC field of the channel.

Parameters:

<Data>

DLISt | ZERO | ONE | PATTern

DLISt

A data list is used. The data list is selected with the command

[\[:SOURce<hw>\]:BB:W3GPp:BSTation<st>:CHANnel<ch0>:FDPCh:DPCCCh:TPC:DATA:DSElect](#)

ZERO | ONE

Internal 0 and 1 data is used.

PATTern

Internal data is used. The bit pattern for the data is defined by the command [\[:SOURce<hw>\]:BB:W3GPp:BSTation<st>:CHANnel<ch0>:FDPCh:DPCCCh:TPC:DATA:PATTern](#).

*RST: PATTern

Example:

BB:W3GP:BST1:CHAN11:FDPC:DPCC:TPC:DATA PATT

selects as the data source for the TPC field of channel 11 of base station 1, the bit pattern defined with the following command:

BB:W3GP:BST1:CHAN11:FDPC:DPCC:TPC:DATA:PATT
#H3F, 8

defines the bit pattern.

Manual operation: See " [TPC Source](#) " on page 141

[:SOURce<hw>]:BB:W3GPp:BSTation<st>:CHANnel<ch0>:FDPCh:DPCCCh:TPC:DATA:DSElect <DSelect>

The command selects the data list for the DLISt data source selection.

The lists are stored as files with the fixed file extensions *.dm_iqd in a directory of the user's choice. The directory applicable to the following commands is defined with the command `MMEMory:CDIR`. To access the files in this directory, you only have to give the file name, without the path and the file extension.

Parameters:**<DSelect>** <data list name>**Example:**

```
BB:W3GP:BST1:CHAN11:FDPC:DPCC:TPC:DATA DLIS
selects the "Data Lists" data source.
MMEM:CDIR '/var/user/temp/IqData'
selects the directory for the data lists.
BB:W3GP:BST1:CHAN11:FDPC:DPCC:TPC:DATA:DSEL
'tpc_ch4'
selects the file 'tpc_ch4' as the data source. This file must be in
the directory /var/user/temp/IqData and have the file
extension *.dm_iqd.
```

Manual operation: See " [TPC Source](#) " on page 141

[:SOURce<hw>]:BB:W3GPp:BSTation<st>:CHANnel<ch0>:FDPCh:DPCCCh:TPC:DATA:PATtern <Pattern>, <BitCount>

The command determines the bit pattern for the PATtern selection. The maximum bit pattern length is 32 bits.

Parameters:

<Pattern> numeric
 *RST: #H0

<BitCount> integer
 Range: 1 to 64
 *RST: 1

Example:

```
BB:W3GP:BST1:CHAN11:FDPC:DPCC:TPC:DATA:PATT
#H3F, 8
defines the bit pattern for the TPC field of channel 11 of base
station 1.
```

Manual operation: See " [TPC Source](#) " on page 141

[:SOURce<hw>]:BB:W3GPp:BSTation<st>:CHANnel<ch0>:FDPCh:DPCCCh:TPC:MISuse <Misuse>

The command activates "mis-" use of the TPC field (Transmit Power Control) of the selected channel for controlling the channel powers of these channels of the specified base station.

The bit pattern (see command [\[:SOURce<hw>\]:BB:W3GPp:BSTation<st>:CHANnel<ch0>:FDPCh:DPCCCh:TPC:DATA:PATtern](#)) of the TPC field of each channel is used to control the channel power. A "1" leads to an increase of channel powers, a "0" to a reduction of channel powers. Channel power is limited to the range 0 dB to -60 dB. The step width of the change is defined with the command [\[:SOURce<hw>\]:BB:W3GPp:BSTation<st>:CHANnel<ch0>:FDPCh:DPCCCh:TPC:PSTep](#).

Parameters:

<Misuse> ON | OFF
 *RST: 0

Example:

BB:W3GP:BST1:CHAN11:FDPC:DPCC:TPC:MIS ON
 activates regulation of channel power for channel 11 of base station 1 via the bit pattern of the associated TPC field.
 BB:W3GP:BST1:CHAN11:FDPC:DPCC:TPC:PST 1dB
 sets the step width for the change of channel powers for channel 11 of base station 1 to 1 dB.

Manual operation: See " [TPC For Output Power Control \(Mis-\) Use](#) " on page 143

**[:SOURce<hw>]:BB:W3GPp:BSTation<st>:CHANnel<ch0>:FDPCh:DPCCCh:TPC:
 PStep <PStep>**

The command defines the step width for the change of channel powers in the case of "mis-" use of the TPC field.

Suffix:

<ch0> 11..138

Parameters:

<PStep> float
 Range: -10.0 dB to 10.0 dB
 Increment: 0.01 dB
 *RST: 0 dB

Example:

BB:W3GP:BST1:CHAN11:FDPC:DPCC:TPC:PST 1.5dB
 sets the step width for the change of channel powers for channel 11 of base station 1 to 1.5 dB.

Manual operation: See " [TPC Power Step \(F-DPCH\)](#) " on page 143

**[:SOURce<hw>]:BB:W3GPp:BSTation<st>:CHANnel<ch0>:FDPCh:DPCCCh:TPC:
 READ <Read>**

The command sets the read out mode for the bit pattern of the TPC field.

Parameters:

<Read> CONTinuous | S0A | S1A | S01A | S10A

CONTinuous

The bit pattern is used cyclically.

S0A

The bit pattern is used once, then the TPC sequence continues with 0 bits.

S1A

The bit pattern is used once, then the TPC sequence continues with 1 bit.

S01A

The bit pattern is used once and then the TPC sequence is continued with 0 bits and 1 bit alternately (in multiples, depending on by the symbol rate, for example, 00001111).

S10A

The bit pattern is used once and then the TPC sequence is continued with 1 bit and 0 bits alternately (in multiples, depending on by the symbol rate, for example, 11110000).

*RST: CONTInuous

Example:

```
BB:W3GP:BST1:CHAN11:FDPC:DPCC:TPC:READ S0A
```

The bit pattern is used once, after which a 0 sequence is generated (applies to channel 11 of base station 1).

Manual operation: See " [TPC Read Out Mode \(F-DPCH\)](#) " on page 142

```
[:SOURce<hw>]:BB:W3GPp:BSTation<st>:CHANnel<ch0>:HSDPa:BMODE[:  
STATe] <State>
```

The command activates/deactivates burst mode. The signal is bursted when on, otherwise dummy data are sent during transmission brakes.

Parameters:

<State> ON | OFF

*RST: 1

Example:

```
BB:W3GP:BST1:CHAN12:HSDP:BMOD OFF
```

deactivates burst mode, dummy data are sent during the transmission brakes.

Manual operation: See " [Burst Mode](#) " on page 96

```
[:SOURce<hw>]:BB:W3GPp:BSTation<st>:CHANnel<ch0>:HSDPa:CVPB <Cvpb>
```

The command switches the order of the constellation points of the 16QAM and 64QAM mapping. The re-arrangement is done according to 3GPP TS25.212.

Parameters:

<Cvpb> integer

Range: 0 to 3

*RST: 0

Example:

```
BB:W3GP:BST1:CHAN12:HSDP:CVPB 1
```

selects interchange of MSBs with LSBs.

Manual operation: See " [Constellation Version Parameter b - BS](#) " on page 96

```
[:SOURce<hw>]:BB:W3GPp:BSTation<st>:CHANnel<ch0>:HSDPa:HSET:AMODE  
<AMode>
```

Activates/deactivates the advanced mode in which the H-Set is generated by the ARB.

The parameter can be configured only for H-Sets 1 - 5.

For H-Sets 6 to 12 and User, it is always enabled.

Parameters:

<AMode> ON | OFF
 *RST: OFF (H-Sets 1..5); ON (H-Sets 6..12, User);

Example:

```
BB:W3GP:BST1:CHAN12:HSDP:MODE HSET
Selects H-Set mode.
BB:W3GP:BST1:CHAN12:HSDP:HSET:PRED P1QAM16
Selects H-Set 1 (16QAM).
BB:W3GP:BST1:CHAN12:HSDP:HSET:AMOD ON
Enables advanced mode for the selected H-Set.
```

Manual operation: See "[Advanced Mode \(requires ARB\)](#)" on page 101

**[[:SOURce<hw>]:BB:W3GPp:BSTation<st>:CHANnel<ch0>:HSDPa:HSET:
 ACLength <AcLength>**

Sets the alternative number of HS-PDSCH channelization codes (see [Chapter 4.13.9, "Randomly Varying Modulation and Number of Codes \(Type 3i\) Settings"](#), on page 112).

Parameters:

<AcLength> integer
 Range: 1 to 15 (max depends on other values)
 *RST: 5

Example:

```
SOURce:BB:W3GP:BST1:CHANnel12:HSDPa:HSET:
CLEngth 8
SOURce:BB:W3GP:BST1:CHANnel12:HSDPa:HSET:
ACLength 8
```

Options: R&S SMx/AMU-K59

Manual operation: See "[Alternative Number of HS-PDSCH Channelization Codes](#)" on page 113

**[[:SOURce<hw>]:BB:W3GPp:BSTation<st>:CHANnel<ch0>:HSDPa:HSET:
 ALTModulation <ALTModulation>**

Sets the alternative modulation (see [Chapter 4.13.9, "Randomly Varying Modulation and Number of Codes \(Type 3i\) Settings"](#), on page 112).

Parameters:

<ALTModulation> QPSK | QAM16 | QAM64
 *RST: QAM16

Example:

```
:SOURce:BB:W3GPp:BSTation1:CHANnel12:HSDPa:
HSET:ALTModulation QPSK
```

Options: R&S SMx/AMU-K59

Manual operation: See ["Alternative HS-PDSCH Modulation"](#) on page 113

[:SOURCE<hw>]:BB:W3GPp:BSTation<st>:CHANnel<ch0>:HSDPa:HSET:BCBTti<di>?

Displays the binary channel bits per TTI and per stream.

The value displayed is calculated upon the values sets with the commands:

- `[:SOURCE<hw>]:BB:W3GPp:BSTation<st>:CHANnel<ch0>:HSDPa:HSET:MODulation<di>`,
- `[:SOURCE<hw>]:BB:W3GPp:BSTation<st>:CHANnel<ch0>:SRATe` and
- `[:SOURCE<hw>]:BB:W3GPp:BSTation<st>:CHANnel<ch0>:HSDPa:HSET:HSCCode`.

Return values:

<Bcbtti> float

Example:

`BB:W3GP:BST1:CHAN12:HSDP:MODE HSET`
selects H-Set mode.

`BB:W3GP:BST1:CHAN12:HSDP:HSET:TYPE MIMO`
sets the H-set type.

`BB:W3GP:BST1:CHAN12:HSDP:HSET:BCBT2?`
queries the binary channel bits per TTI for stream 2.

Response: "4800"

Usage: Query only

Manual operation: See [" Binary Channel Bits per TTI \(Physical Layer\) Stream1/2 "](#) on page 107

[:SOURCE<hw>]:BB:W3GPp:BSTation<st>:CHANnel<ch0>:HSDPa:HSET:BPAYload<di>?

The command queries the payload of the information bit. This value determines the number of transport layer bits sent in each subframe.

Return values:

<BPayload> float

Range: 1 to 5000

Example:

`BB:W3GP:BST1:CHAN12:HSDP:MODE HSET`
selects H-Set mode.

`BB:W3GP:BST1:CHAN12:HSDP:HSET:BPAY2?`
queries the payload of the information bit.

Response: "256"

Usage: Query only

Manual operation: See [" Information Bit Payload \(TB-Size\) Stream 1/2 "](#) on page 108

**[:SOURCE<hw>]:BB:W3GPp:BSTation<st>:CHANnel<ch0>:HSDPa:HSET:
CLENGTH <CLength>**

The command queries the number of physical HS-PDSCH data channels assigned to the HS-SCCH.

Parameters:

<CLength> integer
 Range: 1 to 15
 *RST: 5

Example:

BB:W3GP:BST1:CHAN12:HSDP:MODE HSET
 selects H-Set mode.
 BB:W3GP:BST1:CHAN12:HSDP:HSET:CLEN?
 queries the number of physical HS-PDSCH data channels
 assigned to the HS-SCCH.
 Response: "4"

Manual operation: See "[Number of HS-PDSCH Channelization Codes](#)"
 on page 105

**[:SOURCE<hw>]:BB:W3GPp:BSTation<st>:CHANnel<ch0>:HSDPa:HSET:
CRATe<di>?**

Queries the resulting coding rate per stream.

The coding rate is calculated as a relation between the "Information Bit Payload" and "Binary Channel Bits per TTI".

Return values:

<CRate> float

Example:

BB:W3GP:BST1:CHAN12:HSDP:MODE HSET
 selects H-Set mode.
 BB:W3GP:BST1:CHAN12:HSDP:HSET:CRAT2?
 queries the coding rate of stream 2.
 Response: "0.658"

Usage: Query only

Manual operation: See "[Coding Rate Stream 1/2](#)" on page 108

**[:SOURCE<hw>]:BB:W3GPp:BSTation<st>:CHANnel<ch0>:HSDPa:HSET:DATA
<Data>**

Selects the data source for the transport channel.

Parameters:

<Data> ZERO | ONE | PATtern | PN9 | PN11 | PN15 | PN16 | PN20 |
 PN21 | PN23 | DLISt

ZERO | ONE

Internal 0 and 1 data is used.

PATtern

Internal data is used. Use the command `[:SOURCE<hw>] :BB:W3GPp:BSTation<st>:CHANnel<ch0>:HSDPa:HSET:DATA:PATtern` to set the pattern.

DLISt

A data list is used. Use the command `[:SOURCE<hw>] :BB:W3GPp:BSTation<st>:CHANnel<ch0>:HSDPa:HSET:DATA:DSElect` to select the data list file.

*RST: PN9

Example:

BB:W3GP:BST1:CHAN11:HSDP:HSET:DATA PATT
selects as the data source for the transport channel
BB:W3GP:BST1:CHAN11:HSDP:HSET:DATA:PATT #H3F,8
defines the bit pattern.

Manual operation: See " [Data Source \(HS-DSCH\)](#) " on page 104

[:SOURCE<hw>] :BB:W3GPp:BSTation<st>:CHANnel<ch0>:HSDPa:HSET:DATA:DSElect <DSelect>

The command selects the data list for the DLISt data source selection.

The lists are stored as files with the fixed file extensions `*.dm_iqd` in a directory of the user's choice. The directory applicable to the following commands is defined with the command `MMEMoRY:CDIR`. To access the files in this directory, you only have to give the file name, without the path and the file extension.

Parameters:

<DSelect> string

Example:

BB:W3GP:BST1:CHAN11:HSDP:HSET:DATA DLIS
selects the Data Lists data source.
MMEMoRY:CDIR '/var/user/temp/H-Sets'
selects the directory for the data lists.
BB:W3GP:BST1:CHAN11:HSDP:HSET:DATA:DSEL
'hset_ch11'
selects the file `hset_ch11` as the data source. This file must be in the directory `/var/user/temp/H-Sets` and have the file extension `*.dm_iqd`.

Manual operation: See " [Data Source \(HS-DSCH\)](#) " on page 104

[:SOURCE<hw>] :BB:W3GPp:BSTation<st>:CHANnel<ch0>:HSDPa:HSET:DATA:PATtern <Pattern>, <BitCount>

Determines the bit pattern for the PATtern selection.

Parameters:

<Pattern> numeric

*RST: #H0

<BitCount> integer
 Range: 1 to 64
 *RST: 1

Example: BB:W3GP:BST1:CHAN11:HSDP:HSET:DATA PATT
 selects as the data source for the H-set
 BB:W3GP:BST1:CHAN11:HSDP:HSET:DATA:PATT #H3F, 8
 defines the bit pattern for the H-set.

Manual operation: See " [Data Source \(HS-DSCH\)](#) " on page 104

**[:SOURCE<hw>]:BB:W3GPp:BSTation<st>:CHANnel<ch0>:HSDPa:HSET:HARQ:
 LENGth <Length>**

Sets the number of HARQ processes. This value determines the distribution of the payload in the subframes.

Parameters:

<Length> integer
 Range: 1 to 6
 *RST: 0

Example: SOURCE1:BB:BB:W3GPp:BSTation1:CHANnel12:HSDPa:
 HSET:HARQ:MODE HSET
 selects H-Set mode.
 SOURCE1:BB:BB:W3GPp:BSTation1:CHANnel12:HSDPa:
 HSET:HARQ:LENGth?
 queries the number of HARQ processes.
 Response:2

Manual operation: See " [Number of HARQ Processes per Stream](#) " on page 109

**[:SOURCE<hw>]:BB:W3GPp:BSTation<st>:CHANnel<ch0>:HSDPa:HSET:HARQ:
 MODE <Mode>**

Sets the HARQ Simulation Mode.

Parameters:

<Mode> CACK | CNACK
CACK
 New data is used for each new TTI.
CNACK
 Enables NACK simulation, i.e. depending on the sequence selected for the parameter Redundancy Version Parameter Sequence packets are retransmitted.
 *RST: CACK

Example:

```
BB:W3GP:BST1:CHAN12:HSDP:MODE HSET
selects H-Set mode.
BB:W3GP:BST1:CHAN12:HSDP:HSET:AMOD ON
enables advanced mode.
BB:W3GP:BST1:CHAN12:HSDP:HSET:HARQ:MODE CNAC
sets Constant NACK HARQ Mode.
```

Manual operation: See "[Mode \(HARQ Simulation\)](#)" on page 110

**[:SOURCE<hw>]:BB:W3GPp:BSTation<st>:CHANnel<ch0>:HSDPa:HSET:
HSCCode <HsCCode>**

Sets the channelization code of the HS-SCCH.

Note: To let the instrument generate a signal equal to the one generated by an instrument equipped with older firmware, set the same Channelization Codes as the codes used for your physical channels.

Parameters:

<HsCCode> float
Range: 0 to 127

Example:

```
BB:W3GP:BST1:CHAN12:HSDP:MODE HSET
Selects H-Set mode.
BB:W3GP:BST1:CHAN12:HSDP:HSET:HSCC 10
Sets channelization code 10 for the HS-SCCH.
```

Manual operation: See "[Channelization Code HS-SCCH \(SF128\)](#)" on page 105

**[:SOURCE<hw>]:BB:W3GPp:BSTation<st>:CHANnel<ch0>:HSDPa:HSET:
MODulation<di> <Modulation>**

Sets the modulation for stream 1 and stream 2 to QPSK, 16QAM or 64QAM.

The modulation 64QAM is available for instruments equipped with option R&S SMBV-K59 only.

For HS-SCCH Type 2, the available modulation scheme is QPSK only.

Parameters:

<Modulation> QPSK | QAM16 | QAM64
*RST: QPSK

Example:

```
BB:W3GP:BST1:CHAN12:HSDP:HSET:TYPE MIMO
BB:W3GP:BST1:CHAN12:HSDP:HSET:MOD1 QAM64
```

Manual operation: See "[HS-PDSCH Modulation Stream1/2](#)" on page 106

**[:SOURCE<hw>]:BB:W3GPp:BSTation<st>:CHANnel<ch0>:HSDPa:HSET:
NAIBitrate?**

Queries the average data rate on the transport layer (Nominal Average Information Bitrate).

Return values:

<NaiBitrate> float
 Range: 1 to 5000
 Increment: 0.1
 *RST: 0

Example:

BB:W3GP:BST1:CHAN12:HSDP:MODE HSET
 selects H-Set mode.
 BB:W3GP:BST1:CHAN12:HSDP:HSET:NAIB?
 queries the average data rate on the transport layer.
 Response: "455"

Usage: Query only

Manual operation: See " [Nominal Average Information Bit Rate](#) " on page 102

**[[:SOURce<hw>]:BB:W3GPp:BSTation<st>:CHANnel<ch0>:HSDPa:HSET:
 PREDefined <Predefined>**

The command selects the H-Set and the modulation according to TS 25.101 Annex A.7.

Parameters:

<Predefined> P1QPSK | P1QAM16 | P2QPSK | P2QAM16 | P3QPSK |
 P3QAM16 | P4QPSK | P5QPSK | P6QPSK | P6QAM16 |
 P7QPSK | P8QAM64 | P9QAM16QPSK | P10QPSK |
 P10QAM16 | P11QAM64QAM16 | P12QPSK | USER
 *RST: P1QPSK

Example:

BB:W3GP:BST1:CHAN12:HSDP:MODE HSET
 selects H-Set mode.
 BB:W3GP:BST1:CHAN12:HSDP:HSET:PRE P3QPSK
 selects H-Set 3 (QPSK).

Manual operation: See " [Predefined H-Set](#) " on page 100

**[[:SOURce<hw>]:BB:W3GPp:BSTation<st>:CHANnel<ch0>:HSDPa:HSET:
 PWPattern <PwPattern>**

Sets the precoding weight parameter w2 for MIMO precoding.

The values of the weight parameters w1, w3 and w4 are calculated based on the value for w2 (see [Chapter 3.3.14, "MIMO in HSPA+"](#), on page 33).

Parameters:

<PwPattern> string
 *RST: 0

Example:

BB:W3GP:BST1:CHAN12:HSDP:HSET:PWP "0,1,3"
 selects the pattern.

Manual operation: See " [Precoding Weight Pattern \(w2\)](#) " on page 103

**[:SOURCE<hw>]:BB:W3GPp:BSTation<st>:CHANnel<ch0>:HSDPa:HSET:
RVParameter<di> <RvParameter>**

The parameter is enabled for "HARQ Simulation Mode" set to Constant ACK.

The command sets the Redundancy Version Parameter. This value determines the processing of the Forward Error Correction and Constellation Arrangement (QAM16 and 64QAM modulation), see TS 25.212 4.6.2.

For HS-SCCH Type 2 (less operation), the Redundancy Version Parameter is always 0.

Parameters:

<RvParameter> integer
 Range: 0 to 7
 *RST: 0

Example:

BB:W3GP:BST1:CHAN12:HSDP:MODE HSET
 selects H-Set mode.
 BB:W3GP:BST1:CHAN12:HSDP:HSET:HARQ:MODE CACK
 sets Constant ACK HARQ Mode.
 BB:W3GP:BST1:CHAN12:HSDP:HSET:RVP 7
 sets the Redundancy Version Parameter to 7.
 BB:W3GP:BST1:TDIV ANT1
 enables transmit diversity
 BB:W3GP:BST1:CHAN12:HSDP:HSET:TYPE MIMO
 selects HS-SCCH Type 3 (MIMO).
 BB:W3GP:BST1:CHAN12:HSDP:HSET:RVP2 4
 sets the Redundancy Version Parameter of stream 2.

Manual operation: See "[Redundancy Version Stream1/2](#)" on page 110

**[:SOURCE<hw>]:BB:W3GPp:BSTation<st>:CHANnel<ch0>:HSDPa:HSET:
RVPSequence<di> <RvpSequence>**

The parameter is enabled for "HARQ Simulation Mode" set to Constant NACK.

Enters a sequence of Redundancy Version Parameters per stream. The value of the RV parameter determines the processing of the Forward Error Correction and Constellation Arrangement (16/64QAM modulation), see TS 25.212 4.6.2.

The sequence has a length of maximum 30 values. The sequence length determines the maximum number of retransmissions. New data is used after reaching the end of the sequence.

For HS-SCCH Type 2 (less operation), the Redundancy Version Parameter Sequence is a read-only parameter.

Parameters:

<RvpSequence> string

Example:

```
BB:W3GP:BST1:CHAN12:HSDP:MODE HSET
selects H-Set mode.
BB:W3GP:BST1:CHAN12:HSDP:HSET:AMOD ON
enables advanced mode.
BB:W3GP:BST1:CHAN12:HSDP:HSET:HARQ:MODE CNAC
sets Constant NACK HARQ Mode.
BB:W3GP:BST1:TDIV ANT1
enables transmit diversity
BB:W3GP:BST1:CHAN12:HSDP:HSET:TYPE MIMO
selects HS-SCCH Type 3 (MIMO).
BB:W3GP:BST1:CHAN12:HSDP:HSET:RVPS2
'0,1,3,2,0,1,2,3'
sets the Redundancy Version Parameter sequence of stream 2.
```

Example:

```
BB:W3GP:BST1:CHAN12:HSDP:HSET:TYPE LOP
selects HS-SCCH Type 2 (less operation).
BB:W3GP:BST1:CHAN12:HSDP:HSET:RVPS?
queries the Redundancy Version Parameter sequence.
Response: 0,3,4
```

Manual operation: See "[Redundancy Version Sequence Stream 1/2](#)" on page 110

**[[:SOURCE<hw>]:BB:W3GPp:BSTation<st>:CHANnel<ch0>:HSDPa:HSET:RVState
<RvState>**

Enables/disables the random variation of the modulation and number of codes (see [Chapter 4.13.9, "Randomly Varying Modulation and Number of Codes \(Type 3i\) Settings"](#), on page 112).

Parameters:

<RvState> 0 | 1 | OFF | ON
*RST: OFF

Example:

```
SOURCE:BB:W3GPp:BST1:CHAN12:HSDPa:HSET:RVState
ON
```

Options: R&S SMx/AMU-K59

Manual operation: See "[Randomly Varying Modulation And Number Of Codes](#)" on page 113

**[[:SOURCE<hw>]:BB:W3GPp:BSTation<st>:CHANnel<ch0>:HSDPa:HSET:SEED
<Seed>**

Sets the seed for the random process deciding between the four options (see [Chapter 4.13.9, "Randomly Varying Modulation and Number of Codes \(Type 3i\) Settings"](#), on page 112).

Parameters:

<Seed> integer
Range: 0 to 65535
*RST: 0 for path A, 1 for path B

Example: `SOURce:BB:W3GPP:BST1:CHANnel12:HSDPa:HSET:SEED
5`

Options: R&S SMx/AMU-K59

Manual operation: See "[Random Seed](#)" on page 113

**[:SOURce<hw>]:BB:W3GPP:BSTation<st>:CHANnel<ch0>:HSDPa:HSET:S64Qam
<S64qam>**

Enables/disables UE support of 64QAM.

This command is enabled only for HS-SCCH Type 1 (normal operation) and 16QAM modulation.

In case this parameter is disabled, i.e. the UE does not support 64QAM, the xccs,7 bit is used for channelization information.

Parameters:

<S64qam> ON | OFF
*RST: OFF

Example: `BB:W3GP:BST1:CHAN12:HSDP:MODE HSET`
selects H-Set mode.
`BB:W3GP:BST1:CHAN12:HSDP:HSET:TYPE NORM`
selects HS-SCCH Type 1 (normal operation).
`BB:W3GP:BST1:CHAN12:HSDP:HSET:MOD QAM16`
sets 16QAM modulation.
`BB:W3GP:BST1:CHAN12:HSDP:HSET:S64Q ON`
enables UE to support 64QAM

Manual operation: See "[UE Supports 64QAM](#)" on page 107

**[:SOURce<hw>]:BB:W3GPP:BSTation<st>:CHANnel<ch0>:HSDPa:HSET:SCCode
<SCcode>**

Sets the channelization code of the first HS-PDSCH channel in the H-Set. The channelization codes of the rest of the HS-PDSCHs in this H-Set are set automatically.

Note: To let the instrument generate a signal equal to the one generated by an instrument equipped with older firmware, set the same Channelization Codes as the codes used for your physical channels.

Parameters:

<SCcode> integer
Range: 1 to 15
*RST: 8

Example: `BB:W3GP:BST1:CHAN12:HSDP:MODE HSET`
Selects H-Set mode.
`BB:W3GP:BST1:CHAN12:HSDP:HSET:SCC 10`
Sets channelization code of the first HS-PDSCH.

Manual operation: See " [Start Channelization Code HS-PDSCH \(SF16\)](#) " on page 105

[:SOURce<hw>]:BB:W3GPp:BSTation<st>:CHANnel<ch0>:HSDPa:HSET: SLENgth?

Queries the suggested ARB sequence length.

Return values:

<SLength> integer
Range: 1 to max

Example: see [\[:SOURce<hw>\]:BB:W3GPp:BSTation<st>:CHANnel<ch0>:HSDPa:HSET:SLENgth:ADJust](#) on page 300

Usage: Query only

Manual operation: See " [Advanced Mode \(requires ARB\)](#) " on page 101

[:SOURce<hw>]:BB:W3GPp:BSTation<st>:CHANnel<ch0>:HSDPa:HSET: SLENgth:ADJust

Sets the ARB sequence length to the suggested value.

Example: BB:W3GP:BST1:CHAN12:HSDP:MODE HSET
selects H-Set mode.
BB:W3GP:BST1:CHAN12:HSDP:HSET:AMOD ON
enables advanced mode.
BB:W3GP:BST1:CHAN12:HSDP:HSET:SLEN?
queries the suggested ABR sequence length.
Response: 21
BB:W3GP:SLEN?
queries the current ABR sequence length.
Response: 12
BB:W3GP:BST1:CHAN12:HSDP:HSET:SLEN:ADJ
sets the ARB sequence length to the suggested value.
BB:W3GP:SLEN?
queries the current ABR sequence length.
Response: 21

Usage: Event

Manual operation: See " [Adjust](#) " on page 102

[:SOURce<hw>]:BB:W3GPp:BSTation<st>:CHANnel<ch0>:HSDPa:HSET: SPATtern<di>?

Queries the distribution of packets over time. A "-" indicates no packet

Return values:

<SPattern> string

Example: BB:W3GP:BST1:CHAN15:HSDP:TTID 3
sets the TTI
BB:W3GP:BST1:CHAN12:HSDP:HSET:HARQ:LENG 2
sets the number of HARQ processes
BB:W3GP:BST1:CHAN12:HSDP:HSET:SPAT1?
queries the signaling pattern for stream 1
Response: 0,-,-1,-,-

Usage: Query only

Manual operation: See "[Signaling Pattern Stream1/2](#)" on page 109

[:SOURce<hw>]:BB:W3GPp:BSTation<st>:CHANnel<ch0>:HSDPa:HSET:STAPattern <StaPattern>

Enables/disables a temporal deactivation of Stream 2 per TTI in form of sending pattern.

The stream 2 sending pattern is a sequence of max 16 values of "1" (enables Stream 2 for that TTI) and "-" (disabled Stream 2 for that TTI).

Parameters:

<StaPattern> string
*RST: 1

Example: BB:W3GP:BST1:CHAN12:HSDP:HSET:STAP "11-"
selects the pattern.

Manual operation: See "[Stream 2 Active Pattern](#)" on page 104

[:SOURce<hw>]:BB:W3GPp:BSTation<st>:CHANnel<ch0>:HSDPa:HSET:TPOWer <Tpower>

Sets the total power of the HS-PDSCH channels in the H-Set.

The individual power levels of the HS-PDSCHs are calculated automatically and can be queried with the command `[:SOURce<hw>]:BB:W3GPp:BSTation<st>:CHANnel<ch0>:POWer`.

Parameters:

<Tpower> float
The min/max values depend on the number of HS-PDSCH channelization codes (`[:SOURce<hw>]:BB:W3GPp:BSTation<st>:CHANnel<ch0>:HSDPa:HSET:CLENGTH`) and are calculated as follow:
min = -80 dB + 10*log₁₀(NumberOfHS-PDSCHChannelizationCodes)
max = 0 dB + 10*log₁₀(NumberOfHS-PDSCHChannelizationCodes)
Range: dynamic to dynamic
Increment: 0.01
*RST: -13.01

Example:

```
:SOURce:BB:W3GPP:BST1:CHAN12:HSDPa:MODE HSET
:SOURce:BB:W3GPP:BST1:CHAN12:HSDPa:HSET:
CLENGTH?
Response: 5
:SOURce:BB:W3GPP:BST1:CHAN13:POWER -10
:SOURce:BB:W3GPP:BST1:CHAN12:HSDPa:HSET:TPOWER?
Response: -3.01029995663981 dB
:SOURce:BB:W3GPP:BST1:CHAN12:HSDPa:HSET:TPOWER
-5
:SOURce:BB:W3GPP:BST1:CHAN13:POWER?
Response: -11.9897000433602 dB
```

Manual operation: See "[Total HS-PDSCH Power](#)" on page 106

[:SOURce<hw>]:BB:W3GPP:BSTation<st>:CHANnel<ch0>:HSDPa:HSET:TBS:INDex<di> <Index>

Selects the Index ki for the corresponding table and stream, as described in 3GPP TS 25.321.

Parameters:

<Index> integer
Range: 0 to 62

Example:

```
BB:W3GP:BST1:CHAN12:HSDP:MODE HSET
Selects H-Set mode.
BB:W3GP:BST1:CHAN12:HSDP:HSET:TBS:TABL2 TAB0
Selects Table 0 for stream 2.
BB:W3GP:BST1:CHAN12:HSDP:HSET:TBS:IND2 25
Sets the Index ki
```

Manual operation: See "[Transport Block Size Index Stream1/2](#)" on page 107

[:SOURce<hw>]:BB:W3GPP:BSTation<st>:CHANnel<ch0>:HSDPa:HSET:TBS:REFerence <Reference>

While working in less operation mode, this command is signaled instead of the command BB:W3GP:BST:CHAN:HSDP:HSET:TBS:IND.

Parameters:

<Reference> integer
Range: 0 to 3
*RST: 0

Example:

```
BB:W3GP:BST1:CHAN12:HSDP:MODE HSET
selects H-Set mode.
BB:W3GP:BST1:CHAN12:HSDP:HSET:TYPE LOP
selects less operation mode.
BB:W3GP:BST1:CHAN12:HSDP:HSET:TBS:TABL2 TAB0
selects Table 0 for stream 2.
BB:W3GP:BST1:CHAN12:HSDP:HSET:TBS:REF 2
sets the reference.
```

Manual operation: See " [Transport Block Size Reference Stream1/2](#) " on page 107

```
[:SOURce<hw>]:BB:W3GPp:BSTation<st>:CHANnel<ch0>:HSDPa:HSET:TBS:
TABLE<di> <Table>
```

Selects Table 0 or Table 1 as described in 3GPP TS 25.321.

For HS-PDSCH Modulation set to 64QAM, only Table 1 is available.

Parameters:

<Table> TAB0 | TAB1
*RST: TAB0

Example:

```
BB:W3GP:BST1:CHAN12:HSDP:MODE HSET
Selects H-Set mode.
BB:W3GP:BST1:CHAN12:HSDP:HSET:TBS:TABL2 TAB0
Selects Table 0 for stream 2.
```

Manual operation: See " [Transport Block Size Table Stream1/2](#) " on page 107

```
[:SOURce<hw>]:BB:W3GPp:BSTation<st>:CHANnel<ch0>:HSDPa:HSET:TYPE
<Type>
```

Sets the HS-SCCH type.

Parameters:

<Type> NORMAL | LOPeration | MIMO
NORMAL
Normal operation mode.
LOPeration
HS-SCCH less operation mode.

MIMO

HS-SCCH Type 3 mode is defined for MIMO operation.

Enabling this operation mode, enables the MIMO parameters [:SOURce<hw>]:BB:W3GPP:BSTation<st>:CHANnel<ch0>:HSDPa:MIMO:CVPB<di>, [:SOURce<hw>]:BB:W3GPP:BSTation<st>:CHANnel<ch0>:HSDPa:MIMO:MODulation<di>, [:SOURce<hw>]:BB:W3GPP:BSTation<st>:CHANnel<ch0>:HSDPa:MIMO:PWPattern and [:SOURce<hw>]:BB:W3GPP:BSTation<st>:CHANnel<ch0>:HSDPa:MIMO:STAPattern and all Stream 2 parameters.

*RST: NORMal

Example:

```
BB:W3GP:BST1:TDIV ANT1
```

enables transmit diversity and antenna 1.

```
BB:W3GP:BST1:CHAN12:HSDP:HSET:TYPE MIMO
```

sets MIMO operation mode.

Manual operation: See " [HS-SCCH Type](#) " on page 102

[:SOURce<hw>]:BB:W3GPP:BSTation<st>:CHANnel<ch0>:HSDPa:HSET:UECategory?

Queries the UE category number.

Return values:

<UeCategory> integer

Range: 0 to 5000

Example:

```
BB:W3GP:BST1:CHAN12:HSDP:MODE HSET
```

selects H-Set mode.

```
BB:W3GP:BST1:CHAN12:HSDP:HSET:PRED P3QPSK
```

selects H-Set 3 (QPSK).

```
BB:W3GP:BST1:CHAN12:HSDP:HSET:UEC?
```

queries the UE Category.

Response: 5

Usage: Query only

Manual operation: See " [UE Category](#) " on page 102

[:SOURce<hw>]:BB:W3GPP:BSTation<st>:CHANnel<ch0>:HSDPa:HSET:UEID <Ueid>

The command sets the UE identity which is the HS-DSCH Radio Network Identifier (H-RNTI) defined in 3GPP TS 25.331: "Radio Resource Control (RRC); Protocol Specification".

Parameters:

<Ueid> integer
 Range: 0 to 65535
 *RST: 0

Example:

BB:W3GP:BST1:CHAN12:HSDP:MODE HSET
 selects H-Set mode.
 BB:W3GP:BST1:CHAN12:HSDP:HSET:UEID 256
 sets the UE identity.

Manual operation: See " [UEID \(H-RNTI\)](#) " on page 105

**[:SOURCE<hw>]:BB:W3GPP:BSTation<st>:CHANnel<ch0>:HSDPa:HSET:
 VIBSize<di> <VibSize>**

Sets the size of the Virtual IR Buffer (Number of SMLs per HARQ-Process) per stream.

Parameters:

<VibSize> integer
 Range: 800 to 304000
 Increment: 800
 *RST: 9600

Example:

SOURCE1:BB:W3GPP:BSTation1:TDIV ANT1
 SOURCE1:BB:W3GPP:BSTation1:CHANnel12:HSDPa:
 HSET:TYPE MIMO
 SOURCE1:BB:W3GPP:BSTation1:CHANnel12:HSDPa:
 HSET:VIBSize1?
Response: 9600
 SOURCE1:BB:W3GPP:BSTation1:CHANnel12:HSDPa:
 HSET:VIBSize1 300000
 SOURCE1:BB:W3GPP:BSTation1:CHANnel12:HSDPa:
 HSET:VIBSize2 300000

Manual operation: See " [Virtual IR Buffer Size \(per HARQ Process\) Stream1/2](#) " on page 108

**[:SOURCE<hw>]:BB:W3GPP:BSTation<st>:CHANnel<ch0>:HSDPa:MIMO:
 CVPB<di> <Cvpb>**

The command switches the order of the constellation points of the 16QAM and 64QAM mapping.

The re-arrangement is done according to 3GPP TS25.212.

Parameters:

<Cvpb> 0 | 1 | 2 | 3
 Range: 0 to 3
 *RST: 0

Example:

BB:W3GP:BST1:CHAN12:HSDP:MIMO:CVPB2 1
 selects interchange of MSBs with LSBs for stream 2.

Manual operation: See "[Constellation Version Parameter b Stream 1/2 - BS](#)" on page 97

[:SOURCE<hw>]:BB:W3GPP:BSTation<st>:CHANNEL<ch0>:HSDPa:MIMO:MODulation<di> <Modulation>

Sets the modulation for stream 1 and stream 2 to QPSK, 16QAM or 64QAM.

The modulation 64QAM is available for instruments equipped with option R&S SMBV-K59 only.

Parameters:

<Modulation> QPSK | QAM16 | QAM64
*RST: HSQP

Example: BB:W3GP:BST1:CHAN12:HSDP:MIMO:MOD1 HS64Q

Manual operation: See "[Modulation Stream 1/2 \(HS-PDSCH MIMO\)](#)" on page 97

[:SOURCE<hw>]:BB:W3GPP:BSTation<st>:CHANNEL<ch0>:HSDPa:MIMO:PWPattern <PwPattern>

Sets the precoding weight parameter w2 for MIMO precoding.

The values of the weight parameters w1, w3 and w4 are calculated based on the value for w2 (see [Chapter 3.3.14, "MIMO in HSPA+"](#), on page 33).

Parameters:

<PwPattern> string
*RST: 0

Example: BB:W3GP:BST1:CHAN12:HSDP:MIMO:PWP "0,1,3" selects the pattern.

Manual operation: See "[Precoding Weight Pattern \(w2\)](#)" on page 97

[:SOURCE<hw>]:BB:W3GPP:BSTation<st>:CHANNEL<ch0>:HSDPa:MIMO:STAPattern <StaPattern>

Enables/disables a temporal deactivation of Stream 2 per TTI in form of sending pattern.

The stream 2 sending pattern is a sequence of max 16 values of "1" (enables Stream 2 for that TTI) and "-" (disabled Stream 2 for that TTI).

Parameters:

<StaPattern> string
*RST: 1

Example: BB:W3GP:BST1:CHAN12:HSDP:MIMO:STAP "11-" selects the pattern.

Manual operation: See "[Stream 2 Active Pattern](#)" on page 97

```
[ :SOURCE<hw>]:BB:W3GPp:BSTation<st>:CHANnel<ch0>:HSDPa:MODE <Mode>
```

The command selects the HSDPA mode.

Parameters:

<Mode> CONTInuous | PSF0 | PSF1 | PSF2 | PSF3 | PSF4 | HSET

CONTInuous

The high speed channel is generated continuously. This mode is defined in test model 5.

PSFx

The high speed channel is generated in packet mode. The start of the channel is set by selecting the subframe in which the first packet is sent.

HSET

The high speed channels are preset according to TS 25.1401 Annex A.7, H-Set.

*RST: CONTInuous

Example:

```
BB:W3GP:BST1:CHAN12:HSDP:MODE PSF1
```

selects packet mode for channel 12. The first packet is sent in packet subframe 1 (PSF1).

Manual operation: See "[HSDPA Mode](#)" on page 95

```
[ :SOURCE<hw>]:BB:W3GPp:BSTation<st>:CHANnel<ch0>:HSDPa:TTIDistance
<TtiDistance>
```

The command selects the distance between two packets in HSDPA packet mode. The distance is set in number of sub-frames (3 slots = 2 ms). An "Inter TTI Distance" of 1 means continuous generation.

Parameters:

<TtiDistance> integer
 Range: 1 to 16
 *RST: 5

Example:

```
BB:W3GP:BST1:CHAN12:HSDP:TTID 2
```

selects an Inter TTI Distance of 2 subframes.

Manual operation: See "[Inter TTI Distance \(H-Set\)](#)" on page 96

```
[ :SOURCE<hw>]:BB:W3GPp:BSTation<st>:CHANnel<ch0>:POWer <Power>
```

Sets the channel power relative to the powers of the other channels. This setting also determines the starting power of the channel for Misuse TPC, Dynamic Power Control and the power control sequence simulation of OCNS mode 3i channels.

With the command `SOURCE:BB:W3GPp:POWer:ADJust`, the power of all the activated channels is adapted so that the total power corresponds to 0 dB. This does not change the power ratio among the individual channels.

Parameters:

<Power> float
 Range: -80 to 0
 Increment: 0.01
 *RST: depends on channel

Example:

BB:W3GP:BST2:CHAN12:POW -10dB
 Sets the channel power of channel 12 of base station 2 dB to -10 dB relative to the power of the other channels.

Manual operation: See "Power" on page 83

[:SOURce<hw>]:BB:W3GPp:BSTation<st>:CHANnel<ch0>:SFORmat <SFormat>

The command sets the slot format of the selected channel. The value range depends on the selected channel.

The slot format determines the symbol rate (and thus the range of values for the channelization code), the TFCI state and the pilot length. If the value of any one of the four parameters is changed, all the other parameters are adapted as necessary.

In the case of enhanced channels with active channel coding, the selected channel coding also affects the slot format and thus the remaining parameters. If these parameters are changed, the channel coding type is set to user.

Parameters:

<SFormat> integer
 Range: 0 to dynamic
 *RST: 0

Example:

BB:W3GP:BST2:CHAN12:SFOR 8
 Selects slot format 8 for channel 12 of base station 2.

Manual operation: See "Slot Format" on page 82

[:SOURce<hw>]:BB:W3GPp:BSTation<st>:CHANnel<ch0>:SRATe <SRate>

The command sets the symbol rate of the selected channel. The value range depends on the selected channel and the selected slot format.

The slot format determines the symbol rate (and thus the range of values for the channelization code), the TFCI state and the pilot length. If the value of any one of the four parameters is changed, all the other parameters are adapted as necessary.

In the case of enhanced channels with active channel coding, the selected channel coding also affects the slot format and thus the remaining parameters. If these parameters are changed, the channel coding type is set to user.

Parameters:

<SRate> D7K5 | D15K | D30K | D60K | D120k | D240k | D480k | D960k
 *RST: DPCHs D30K; CHAN1..10 D15K; DL-DPCCH (CHAN11) D7K5;

Example: `BB:W3GP:BST2:CHAN12:SRAT D120K`
Sets the symbol rate for channel 12 of base station 2 to 120 ksps.

Manual operation: See "[Symbol Rate](#)" on page 82

[:SOURCE<hw>]:BB:W3GPp:BSTation<st>:CHANnel<ch0>:STATe <State>

The command activates the selected channel.

Parameters:

<State> ON | OFF
*RST: 0

Example: `BB:W3GP:BST2:CHAN12:STAT OFF`
deactivates channel 12 of base station 2.

Manual operation: See "[Channel State](#)" on page 85

[:SOURCE<hw>]:BB:W3GPp:BSTation<st>:CHANnel<ch0>:TOFFset <TOffset>

Sets the timing offset.

Parameters:

<TOffset> integer
For F-DPCH channels, the value range is 0 to 9.
*RST: 0

Example: `BB:W3GP:BST2:CHAN12:TOFF 20`
defines a frame shift relative to the scrambling code sequence of 20*256 chips.

Manual operation: See "[Timing Offset](#)" on page 84

[:SOURCE<hw>]:BB:W3GPp:BSTation<st>:CHANnel<ch0>:TYPE <Type>

Sets the channel type.

Parameters:

<Type> PCPich | SCPich | PSCH | SSCH | PCCPch | SCCPch | PICH |
APAich | AICH | PDSCh | DPCCCh | DPCH | HSSCch | HSQPsk |
HSQam | HS64Qam | HSMimo | EAGCh | ERGCh | EHICH |
FDPCh | HS16Qam

The channels types of CHANnel10 to CHANnel18 are predefined.
For the remaining channels, you can select a channel type from
the relevant standard channels and the high-speed channels

Example: `SOURCE1:BB:W3GPp:BSTation1:CHANnel12:TYPE
HSQPsk`
selects channel type HS-PDS, QPSK for channel 12

Manual operation: See "[Channel Type](#)" on page 81

**[:SOURce<hw>]:BB:W3GPP:BSTation<st>:CHANnel<ch0>[:HSUPa]:EAGCh:
IFCoding <IfCoding>**

Enables/disables the information coding.

Parameters:

<IfCoding> 0 | 1 | OFF | ON

0|OFF

corresponds to a standard operation; no coding is performed and the data is sent uncoded.

1|ON

you can configure the way the data is coded

*RST: 0

Example:

```
SOURce1:BB:W3GPP:BSTation1:CHANnel9:HSUPa:
EAGCh:IFCoding 1
SOURce1:BB:W3GPP:BSTation1:CHANnel9:HSUPa:
EAGCh:TTIEdch 2
SOURce1:BB:W3GPP:BSTation1:CHANnel9:HSUPa:
EAGCh:TTICount 2
SOURce1:BB:W3GPP:BSTation1:CHANnel9:HSUPa:
EAGCh:TTI0:UEID 100
SOURce1:BB:W3GPP:BSTation1:CHANnel9:HSUPa:
EAGCh:TTI0:AGVIndex 20
SOURce1:BB:W3GPP:BSTation1:CHANnel9:HSUPa:
EAGCh:TTI0:AGScope PER
SOURce1:BB:W3GPP:BSTation1:CHANnel9:HSUPa:
EAGCh:TTI1:UEID 10000
SOURce1:BB:W3GPP:BSTation1:CHANnel9:HSUPa:
EAGCh:TTI1:AGVIndex 1
SOURce1:BB:W3GPP:BSTation1:CHANnel9:HSUPa:
EAGCh:TTI1:AGScope ALL
```

Manual operation: See " [E-AGCH Information Field Coding](#) " on page 138

**[:SOURce<hw>]:BB:W3GPP:BSTation<st>:CHANnel<ch0>[:HSUPa]:EAGCh:
TTI<di0>:AGScope <AGScope>**

Sets the scope of the selected grant. According to the TS 25.321, the impact of each grant on the UE depends on this parameter.

For E-DCH TTI = 10ms, the absolute grant scope is always ALL (All HARQ Processes).

Parameters:

<AGScope> ALL | PER

Example:

see [:SOURce<hw>]:BB:W3GPP:BSTation<st>:
CHANnel<ch0>[:HSUPa]:EAGCh:IFCoding on page 310

Manual operation: See " [Absolute Grant Scope](#) " on page 138

```
[:SOURCE<hw>]:BB:W3GPp:BSTation<st>:CHANnel<ch0>[:HSUPa]:EAGCh:
  TTI<di0>:AGVIndex <AgvIndex>
```

Sets the Index for the selected TTI. According to the TS 25.212 (4.10.1A.1), there is a cross-reference between the grant's index and the grant value.

Parameters:

<AgvIndex> integer
 Range: 0 to 31

Example: see [:SOURCE<hw>]:BB:W3GPp:BSTation<st>:
 CHANnel<ch0>[:HSUPa]:EAGCh:IFCoding on page 310

Manual operation: See " [Absolute Grant Value Index](#) " on page 138

```
[:SOURCE<hw>]:BB:W3GPp:BSTation<st>:CHANnel<ch0>[:HSUPa]:EAGCh:
  TTI<di0>:UEID <Ueid>
```

Sets the UE Id for the selected TTI.

Parameters:

<Ueid> integer
 Range: 0 to 65535

Example: see [:SOURCE<hw>]:BB:W3GPp:BSTation<st>:
 CHANnel<ch0>[:HSUPa]:EAGCh:IFCoding on page 310

Manual operation: See " [UEID \(A-GCH\)](#) " on page 138

```
[:SOURCE<hw>]:BB:W3GPp:BSTation<st>:CHANnel<ch0>[:HSUPa]:EAGCh:
  TTICount <TtiCount>
```

Sets the number of configurable TTIs.

Parameters:

<TtiCount> integer
 Range: 1 to 10

Example: SOURCE1:BB:W3GPp:BSTation1:CHANnel9:TYPE EAGCh
 SOURCE1:BB:W3GPp:BSTation1:CHANnel9:HSUPa:
 EAGCh:TTICount 5

Manual operation: See " [Number of Configurable TTIs](#) " on page 138

```
[:SOURCE<hw>]:BB:W3GPp:BSTation<st>:CHANnel<ch0>[:HSUPa]:EAGCh:
  TTIEDch <Ttiedch>
```

Sets the processing duration.

Parameters:

<Ttiedch> 2ms | 10ms
 *RST: 2ms

Example: see [:SOURCE<hw>]:BB:W3GPP:BSTation<st>:
CHANnel<ch0>[:HSUPa]:EAGCh:IFCoding on page 310

Manual operation: See " E-DCH TTI " on page 138

**[:SOURCE<hw>]:BB:W3GPP:BSTation<st>:CHANnel<ch0>[:HSUPa]:EHICH:
CTYPE <CType>**

Sets the cell type.

Parameters:

<CType> SERVing | NOSERVing
*RST: SERVing

Example: SOURCE1:BB:W3GPP:BSTation1:CHANnel9:TYPE EHICH
SOURCE1:BB:W3GPP:BSTation1:CHANnel9:HSUPa:
EHICH:CTYPE SERVing
SOURCE1:BB:W3GPP:BSTation1:CHANnel9:HSUPa:
EHICH:TTIEdch 2ms
SOURCE1:BB:W3GPP:BSTation1:CHANnel9:HSUPa:
EHICH:SSINDEX 2
SOURCE1:BB:W3GPP:BSTation1:CHANnel9:HSUPa:
EHICH:DTAU 2
SOURCE1:BB:W3GPP:BSTation1:CHANnel9:HSUPa:
EHICH:ETAU?
Response: 5
SOURCE1:BB:W3GPP:BSTation1:CHANnel9:HSUPa:
EHICH:RGPattern "+-+-"
SOURCE1:BB:W3GPP:BSTation1:CHANnel9:HSUPa:
EHICH:CTYPE NOSERVing
SOURCE1:BB:W3GPP:BSTation1:CHANnel9:HSUPa:
EHICH:RGPattern "+0+0"

Manual operation: See " Type of Cell " on page 139

**[:SOURCE<hw>]:BB:W3GPP:BSTation<st>:CHANnel<ch0>[:HSUPa]:EHICH:DTAU
<Dtau>**

Sets the offset of the downlink dedicated offset channels.

Suffix:

<ch0> 9..138

Parameters:

<Dtau> integer
Range: 0 to 149
*RST: 0

Example: see [:SOURCE<hw>]:BB:W3GPP:BSTation<st>:
CHANnel<ch0>[:HSUPa]:EHICH:CTYPE on page 312

Manual operation: See " Tau DPCH " on page 140

[:SOURce<hw>]:BB:W3GPP:BSTation<st>:CHANnel<ch0>[:HSUPa]:EHICH:ETAU?

Queries the offset of the P-CCPCH frame boundary.

Return values:

<EtaU> integer
Range: 0 to 149

Example: see [:SOURce<hw>]:BB:W3GPP:BSTation<st>:CHANnel<ch0>[:HSUPa]:EHICH:CTYPe on page 312

Usage: Query only

Manual operation: See " [Tau E-RGCH/E-HICH](#) " on page 140

[:SOURce<hw>]:BB:W3GPP:BSTation<st>:CHANnel<ch0>[:HSUPa]:EHICH:RGPattern <RgPattern>

Sets the bit pattern for the ACK/NACK field.

Parameters:

<RgPattern> <32-bit long pattern>
"+" (ACK) and "0" (no signal)
For the non serving cell
"+" (ACK) and "-" (NACK)
For the serving cell
*RST: +

Example: see [:SOURce<hw>]:BB:W3GPP:BSTation<st>:CHANnel<ch0>[:HSUPa]:EHICH:CTYPe on page 312

Manual operation: See " [ACK/NACK Pattern](#) " on page 140

[:SOURce<hw>]:BB:W3GPP:BSTation<st>:CHANnel<ch0>[:HSUPa]:EHICH:SSIndex <SsIndex>

Sets the value that identifies the user equipment. The values are defined in TS 25.211.

Suffix:

<ch0> 9..138

Parameters:

<SsIndex> integer
Range: 0 to 39
*RST: 0

Example: see [:SOURce<hw>]:BB:W3GPP:BSTation<st>:CHANnel<ch0>[:HSUPa]:EHICH:CTYPe on page 312

Manual operation: See " [Signature Hopping Pattern Index – HSUPA BS](#) " on page 139

```
[ :SOURce<hw>]:BB:W3GPp:BSTation<st>:CHANnel<ch0>[:HSUPa]:EHICH:
  TTIEDch <Ttiedch>
```

Sets the processing duration.

Parameters:

```
<Ttiedch>          2ms | 10ms
                    *RST:      2ms
```

Example: see [:SOURce<hw>]:BB:W3GPp:BSTation<st>:CHANnel<ch0>[:HSUPa]:EHICH:CTYPE on page 312

Manual operation: See " E-DCH TTI " on page 139

```
[ :SOURce<hw>]:BB:W3GPp:BSTation<st>:CHANnel<ch0>[:HSUPa]:ERGCh:
  CTYPE <CType>
```

Selects the cell type.

Parameters:

```
<CType>          SERVing | NOSERVing
                    *RST:      SERVing
```

Example: SOUR:BB:W3GP:BST1:CHAN9:HSUP:ERGC:CTYP SERV

Manual operation: See " Type of Cell " on page 139

```
[ :SOURce<hw>]:BB:W3GPp:BSTation<st>:CHANnel<ch0>[:HSUPa]:ERGCh:
  DTAU <Dtau>
```

Sets the offset of the downlink dedicated offset channels.

Parameters:

```
<Dtau>           integer
                  Range:    0 to 149
                  *RST:    0
```

Example: SOUR:BB:W3GP:BST1:CHAN12:HSUP:ERGC:DTAU 5

Manual operation: See " Tau DPCH " on page 140

```
[ :SOURce<hw>]:BB:W3GPp:BSTation<st>:CHANnel<ch0>[:HSUPa]:ERGCh:
  ETAU?
```

Queries the offset of the P-CCPCH frame boundary.

Return values:

```
<Etau>           integer
                  Range:    0 to 149
```

Example: SOUR:BB:W3GP:BST1:CHAN12:HSUP:ERGC:ETAU?

Usage: Query only

Manual operation: See "[Tau E-RGCH/E-HICH](#)" on page 140

**[:SOURCE<hw>]:BB:W3GPp:BSTation<st>:CHANnel<ch0>[:HSUPa]:ERGCh:
RGPAttern <RgPattern>**

Sets the bit pattern for the relative grant pattern field.

Parameters:

<RgPattern> string

Example:

SOUR:BB:W3GP:BST1:CHAN10:HSUP:ERGC:RGPA "-"
Sets the bit pattern to "-" (down).

Manual operation: See "[Relative Grant Pattern](#)" on page 140

**[:SOURCE<hw>]:BB:W3GPp:BSTation<st>:CHANnel<ch0>[:HSUPa]:ERGCh:
SSINdex <SsIndex>**

Sets the value that identifies the user equipment. The values are defined in TS 25.211.

Parameters:

<SsIndex> integer
Range: 0 to 39
*RST: 0

Example:

SOUR:BB:W3GP:BST1:CHAN9:HSUP:ERGC:SSIN 0
Sets the value to identify the user equipment.

Manual operation: See "[Signature Hopping Pattern Index – HSUPA BS](#)"
on page 139

**[:SOURCE<hw>]:BB:W3GPp:BSTation<st>:CHANnel<ch0>[:HSUPa]:ERGCh:
TTIEdch <Ttiedch>**

Sets processing duration.

Parameters:

<Ttiedch> 2ms | 10ms
*RST: 2ms

Example:

SOUR:BB:W3GP:BST1:CHAN10:HSUP:ERGC:TTIE 2ms

Manual operation: See "[E-DCH TTI](#)" on page 139

[:SOURCE<hw>]:BB:W3GPp:BSTation<st>:CMODE:DLFStructure <DlfStructure>

The command selects the frame structure. The frame structure determines the transmission of TPC and pilot field in the transmission gaps.

Parameters:

<DlfStructure> A | B

A

Type A, the pilot field is sent in the last slot of each transmission gap.

B

Type B, the pilot field is sent in the last slot of each transmission gap. The first TPC field of the transmission gap is sent in addition.

*RST: A

Example:

```
BB:W3GP:BST2:CMOD:DLFS A
selects frame structure of type A.
```

Manual operation: See "[DL Frame Structure - BS](#)" on page 88

```
[:SOURCE<hw>]:BB:W3GPP:BSTation<st>:CMODE:METHod <Method>
```

The command selects compressed mode method.

Parameters:

<Method> PUNcturing | HLScheduling | SF2

PUNcturing

The data is compressed by reducing error protection.

HLScheduling

The data is compressed by stopping the transmission of the data stream during the transmission gap.

SF2

The data is compressed by halving the spreading factor.

*RST: SF2

Example:

```
BB:W3GP:BST2:CMODE:METH HLSC
selects compressed mode method High Layer Scheduling.
```

Manual operation: See "[Compressed Mode Method - BS](#)" on page 87

```
[:SOURCE<hw>]:BB:W3GPP:BSTation<st>:CMODE:PATtern<ch>:TGD <Tgd>
```

Sets the transmission gap distances.

Parameters:

<Tgd> integer
Range: 3 to 100
*RST: 15

Example:

```
BB:W3GP:BST2:CMODE:PATT2:TGD 7
sets transmission gap distance of pattern 2 to 7 slots.
```

Manual operation: See "[Distance](#)" on page 89

```
[:SOURCE<hw>]:BB:W3GPP:BSTation<st>:CMODE:PATtern<ch>:TGL<di> <Tgl>
```

Sets the transmission gap lengths.

Parameters:

<Tgl> integer
 Range: 3 to 14
 *RST: 3

Example:

BB:W3GP:BST2:CMOD:PATT2:TGL1 4
 sets transmission gap length of gap 1 of pattern 2 to 4 slots.

Manual operation: See "[Gap Len:](#)" on page 89

[:SOURCE<hw>]:BB:W3GPP:BSTation<st>:CMODE:PATTERN<ch>:TGPL <Tgpl>

The command sets the transmission gap pattern lengths. Setting 0 is available only for pattern 2.

The transmission gap pattern length of the user equipment with the same suffix as the selected base station is set to the same value.

Parameters:

<Tgpl> integer
 Range: 0 to 100
 *RST: 2

Example:

BB:W3GP:BST2:CMOD:PATT2:TGPL 7
 sets transmission gap pattern length of pattern 2 to 7 frames.

Manual operation: See "[Pattern Len:](#)" on page 90

[:SOURCE<hw>]:BB:W3GPP:BSTation<st>:CMODE:PATTERN<ch>:TGSN <Tgsn>

Sets the transmission gap slot number of pattern 1.

Parameters:

<Tgsn> integer
 Range: 0 to 14
 *RST: 7

Example:

BB:W3GP:BST2:CMOD:PATT:TGSN 4
 sets slot number of pattern 1 to slot 4.

Manual operation: See "[At Slot:](#)" on page 89

**[:SOURCE<hw>]:BB:W3GPP:BSTation<st>|MSTation<st>:CMODE:POFFset
 <POffset>**

The command sets the power offset for mode USER.

Parameters:

<POffset> float
 Range: 0 dB to 10 dB
 Increment: 0.01 dB
 *RST: 0 dB

Example: `BB:W3GP:BST2|UE2:CMOD:POFF 4`
sets the power offset value to 4 dB.
`BB:W3GP:BST2|UE2:CMOD:POM USER`
selects power offset mode USER

Manual operation: See ["Power Offset"](#) on page 88

[:SOURCE<hw>]:BB:W3GPp:BSTation<st>|MSTation<st>:CMODE:POMode
<PoMode>

The command selects the power offset mode.

Parameters:

<PoMode> AUTO | USER

AUTO

The power offset is obtained by pilot bit ratio as follows:
Number of pilots bits of non-compressed slots / Number of pilot bits by compressed slots.

USER

The power offset is defined by command `[:SOURCE<hw>]:BB:W3GPp:BSTation<st>|MSTation<st>:CMODE:POFFset`.

*RST: AUTO

Example: `BB:W3GP:BST2|UE2:CMOD:POFF 4`
sets the power offset value to 4 dB.
`BB:W3GP:BST2|UE2:CMOD:POM USER`
selects power offset mode USER.

Manual operation: See ["Power Offset Mode"](#) on page 88

[:SOURCE<hw>]:BB:W3GPp:BSTation<st>:CMODE:STATE <State>

The command activates/deactivates the compressed mode.

Parameters:

<State> ON | OFF

*RST: 0

Example: `BB:W3GP:BST2:CMOD:STAT ON`
activates compressed mode for base station 2.

Manual operation: See ["Compressed Mode State"](#) on page 79

[:SOURCE<hw>]:BB:W3GPp:BSTation<st>:DCONflict:RESolve

The command resolves existing domain conflicts by modifying the Channelization Codes of the affected channels.

Example: `BB:W3GP:BST2:DCON:STAT?`
 queries whether a code domain conflict exists for base station 2.
 Response: 1
 there is a conflict.
`BB:W3GP:BST2:DCON:RES`
 resolves the code domain error by modifying the Channelization codes of the affected channels.

Usage: Event

Manual operation: See ["Domain Conflict, Resolving Domain Conflicts"](#) on page 85

`[:SOURce<hw>]:BB:W3GPp:BSTation<st>:DCONflict[:STATe]?`

The command queries whether there is (response 1) or is not (response 0) a conflict (overlap) in the hierarchically-structured channelization codes. The cause of a possible domain conflict can be ascertained by manual operation in the "BS > Code Domain" dialog.

Return values:

<State> 0 | 1 | OFF | ON
 *RST: 0

Example: `BB:W3GP:BST2:DCON:STAT?`
 queries whether a code domain conflict exists for base station 2.
 Response: 0
 there is no conflict.

Usage: Query only

Manual operation: See ["Domain Conflict, Resolving Domain Conflicts"](#) on page 85

`[:SOURce<hw>]:BB:W3GPp:BSTation<st>:OLTDiversity <OltDiversity>`

Activates/deactivates open loop transmit diversity.

The antenna whose signal is to be simulated is selected with the command `[:SOURce<hw>]:BB:W3GPp:BSTation<st>:TDIVersity`.

Parameters:

<OltDiversity> ON | OFF
 *RST: OFF

Example: `BB:W3GP:BST2:TDIV ANT2`
 calculates and applies the output signal for antenna 2 of one two-antenna system.
`BB:W3GP:BST2:OLTD ON`
 enables open loop transmit diversity.

Manual operation: See ["Open Loop Transmit Diversity"](#) on page 78

```
[:SOURce<hw>]:BB:W3GPp:BSTation<st>:PINDicator:COUNT <Count>
```

The command sets the number of page indicators (PI) per frame in the page indicator channel (PICH).

Parameters:

```
<Count>          D18 | D36 | D72 | D144
*RST:            D18
```

Example:

```
BB:W3GP:BST2:PIND:COUN D36
sets the number of page indicators (PI) per frame in the page
indicator channel (PICH) to 36.
```

Manual operation: See "[Page Indicators/Frame](#)" on page 77

```
[:SOURce<hw>]:BB:W3GPp:BSTation<st>:SCODE <SCode>
```

Sets the identification for the base station. This value is simultaneously the initial value of the scrambling code generator.

Parameters:

```
<SCode>          integer
Range:           #H0 to #H5FFF
*RST:            #H0
```

Example:

```
BB:W3GP:BST2:SCOD #H1FFF
sets the scrambling code
```

Manual operation: See "[Scrambling Code \(hex\)](#)" on page 77

```
[:SOURce<hw>]:BB:W3GPp:BSTation<st>:SCODE:STATE <State>
```

The command makes it possible to deactivate base station scrambling for test purposes.

Parameters:

```
<State>          ON | OFF
*RST:            ON
```

Example:

```
BB:W3GP:BST2:SCOD:STAT OFF
deactivates scrambling for base station 2.
```

Manual operation: See "[Scrambling Code On](#)" on page 77

```
[:SOURce<hw>]:BB:W3GPp:BSTation<st>:SCPich:PREference[:STATE] <State>
```

The command activates or deactivates the use of S-CPICH as reference phase.

Parameters:

```
<State>          ON | OFF
*RST:            0
```

Example: `BB:W3GP:BST2:SCP:REF ON`
activates the use of S-CPICH as reference phase for base station 2.

Manual operation: See "[S-CPICH As Phase Reference](#)" on page 78

[:SOURCE<hw>]:BB:W3GPP:BSTation<st>:SSCG?

The command queries the secondary synchronization code group. This parameter is specified in the table defined by the 3GPP standard "Allocation of SSCs for secondary SCH". This table assigns a specific spreading code to the synchronization code symbol for every slot in the frame. The value is calculated from the scrambling code.

Return values:

<Sscg> integer
Range: 0 to 63

Example: `BB:W3GP:BST2:SSCG?`
queries the 2nd search code group for base station 2.
Response: 24
the base station is part of second search group 24.

Usage: Query only

Manual operation: See "[2nd Search Code Group](#)" on page 77

[:SOURCE<hw>]:BB:W3GPP:BSTation<st>:STATE <State>

Activates and deactivates the specified base station.

Parameters:

<State> 0 | 1 | OFF | ON
*RST: 1 (BSTation1), 0 (all other)

Example: `BB:W3GP:BST2:STAT OFF`
deactivates base station 2.

Manual operation: See "[Select Basestation/User Equipment](#)" on page 55

[:SOURCE<hw>]:BB:W3GPP:BSTation<st>:TDElay <Tdelay>

Adds a time shift for the selected base station compared to base station 1.

Parameters:

<Tdelay> integer
Range: 0 to 38400
*RST: 0
Default unit: chip

Example: `BB:W3GP:BST2:TDEL 256`
shifts base station 2 by 256 chips compared to base station 1.

Manual operation: See "[Time Delay](#)" on page 77

[:SOURce<hw>]:BB:W3GPp:BSTation<st>:TDIVersity <TDiversity>

Selects the antenna and the antenna configuration to be simulated.

To simulate transmit diversity, a two-antenna system has to be selected and Open Loop Transmit Diversity has to be activated (command `BB:W3GP:BST:OLTD ON`).

Parameters:

<TDiversity> SANT | ANT1 | ANT2 | OFF
 SANT = single-antenna system
 *RST: SANT

Example:

`BB:W3GP:BST2:TDIV ANT2`
 the signal of antenna 2 of one two-antenna system is simulated.

Manual operation: See "[Diversity / MIMO](#)" on page 77

7.8 Enhanced Channels of Base Station 1

The `SOURce:BB:W3GPp:BSTation:ENHanced` subsystem contains the commands for setting the enhanced channels of base station 1. The commands of this system only take effect when the 3GPP FDD standard is activated, the downlink transmission direction is selected, base station 1 is enabled and enhanced channels are activated:

`SOURce:BB:W3GPp:STATe ON`

`SOURce:BB:W3GPp:LINK DOWN`

`SOURce:BB:W3GPp:BST1:STATe ON`

`SOURce:BB:W3GPp:BST:ENHanced:CHANnel<11...13>:DPCH:STATe ON`

Or

`SOURce:BB:W3GPp:BST:ENHanced:PCCPch:STATe ON`

BSTation<st>

The numeric suffix to `BSTation` determines the base station. Enhanced channels are enabled for base station 1 only.

CHANnel<ch0>

The value range is `CHANnel<11|12|13>` for enhanced DPCHs and `CHANnel<4>` for P-CCPCH.

TCHannel<di>

The transport channel designations for remote control are `TCHannel0` for DCCH, `TCHannel1` to `TCHannel6` for DTCH1 to DTCH6.

7.8.1 General Settings

<code>[:SOURCE<hw>]:BB:W3GPp:BSTation:ENHanced:CHANnel<ch0>:DPCH:STATE</code>	323
<code>[:SOURCE<hw>]:BB:W3GPp:BSTation:ENHanced:PCCPch:STATE</code>	323
<code>[:SOURCE<hw>]:BB:W3GPp:BSTation<st>:ENHanced:PCPich:PATtern</code>	323

`[:SOURCE<hw>]:BB:W3GPp:BSTation:ENHanced:CHANnel<ch0>:DPCH:STATE`
<State>

The command switches the selected channel to the enhanced state.

Parameters:

<State> ON | OFF
 *RST: 0

Example: `BB:W3GP:BST:ENH:CHAN13:DPCH:STAT ON`
 switches DPCH 13 to Enhanced State.

Manual operation: See " [Enhanced State](#) " on page 117

`[:SOURCE<hw>]:BB:W3GPp:BSTation:ENHanced:PCCPch:STATE` <State>

The command activates or deactivates the enhanced state of the P-CCPCH (BCH).

Parameters:

<State> ON | OFF
 *RST: OFF

Example: `BB:W3GP:BST:ENH:PCCP:STAT ON`
 switches the P-CCPCH to Enhanced State.

Manual operation: See " [State \(Enhanced P-CCPCH\)](#) " on page 114

`[:SOURCE<hw>]:BB:W3GPp:BSTation<st>:ENHanced:PCPich:PATtern` <Pattern>

Sets the P-CPICH pattern (channel 0).

Parameters:

<Pattern> ANT1 | ANT2
 *RST: ANT1

Example: `BB:W3GP:BST2:ENH:PCP:PATT ANT2`
 sets the P-CPICH Pattern to Antenna 2.

Manual operation: See " [P-CPICH Pattern](#) " on page 113

7.8.2 Channel Coding

[:SOURCE<hw>]:BB:W3GPp:BSTation:ENHanced:CHANnel:DPCH:CCODing:USER:DELeTe.....	325
[:SOURCE<hw>]:BB:W3GPp:BSTation:ENHanced:CHANnel<ch0>:DPCH:CCODing:BPFRame?.....	325
[:SOURCE<hw>]:BB:W3GPp:BSTation:ENHanced:CHANnel<ch0>:DPCH:CCODing:SFORmat.....	325
[:SOURCE<hw>]:BB:W3GPp:BSTation:ENHanced:CHANnel<ch0>:DPCH:CCODing:SRATe?.....	326
[:SOURCE<hw>]:BB:W3GPp:BSTation:ENHanced:CHANnel<ch0>:DPCH:CCODing:STATe.....	326
[:SOURCE<hw>]:BB:W3GPp:BSTation:ENHanced:CHANnel<ch0>:DPCH:CCODing:TYPE.....	327
[:SOURCE<hw>]:BB:W3GPp:BSTation:ENHanced:CHANnel:DPCH:CCODing:USER:CATalog?.....	328
[:SOURCE<hw>]:BB:W3GPp:BSTation:ENHanced:CHANnel<ch0>:DPCH:CCODing:USER:LOAD.....	328
[:SOURCE<hw>]:BB:W3GPp:BSTation:ENHanced:CHANnel<ch0>:DPCH:CCODing:USER:STORe.....	329
[:SOURCE<hw>]:BB:W3GPp:BSTation:ENHanced:CHANnel<ch0>:DPCH:INTerleaver2.....	329
[:SOURCE<hw>]:BB:W3GPp:BSTation:ENHanced:CHANnel<ch0>:DPCH:TCHannel<di0>:CRCSiZe.....	330
[:SOURCE<hw>]:BB:W3GPp:BSTation:ENHanced:CHANnel<ch0>:DPCH:TCHannel<di0>:DATA.....	330
[:SOURCE<hw>]:BB:W3GPp:BSTation:ENHanced:CHANnel<ch0>:DPCH:TCHannel<di0>:DATA:DSELeCt.....	331
[:SOURCE<hw>]:BB:W3GPp:BSTation:ENHanced:CHANnel<ch0>:DPCH:TCHannel<di0>:DATA:PATtern.....	331
[:SOURCE<hw>]:BB:W3GPp:BSTation:ENHanced:CHANnel<ch0>:DPCH:TCHannel<di0>:DTX.....	332
[:SOURCE<hw>]:BB:W3GPp:BSTation:ENHanced:CHANnel<ch0>:DPCH:TCHannel<di0>:EPROteCtion.....	332
[:SOURCE<hw>]:BB:W3GPp:BSTation:ENHanced:CHANnel<ch0>:DPCH:TCHannel<di0>:INTerleaver.....	332
[:SOURCE<hw>]:BB:W3GPp:BSTation:ENHanced:CHANnel<ch0>:DPCH:TCHannel<di0>:RMATtribute.....	333
[:SOURCE<hw>]:BB:W3GPp:BSTation:ENHanced:CHANnel<ch0>:DPCH:TCHannel<di0>:STATe.....	333
[:SOURCE<hw>]:BB:W3GPp:BSTation:ENHanced:CHANnel<ch0>:DPCH:TCHannel<di0>:TBCouNt.....	333
[:SOURCE<hw>]:BB:W3GPp:BSTation:ENHanced:CHANnel<ch0>:DPCH:TCHannel<di0>:TBSiZe.....	334
[:SOURCE<hw>]:BB:W3GPp:BSTation:ENHanced:CHANnel<ch0>:DPCH:TCHannel<di0>:TTINterval.....	334
[:SOURCE<hw>]:BB:W3GPp:BSTation:ENHanced:PCCPch:CCODing:INTerleaver<di>.....	334
[:SOURCE<hw>]:BB:W3GPp:BSTation:ENHanced:PCCPch:CCODing:STATe.....	335
[:SOURCE<hw>]:BB:W3GPp:BSTation:ENHanced:PCCPch:CCODing:TYPE?.....	335

**[:SOURCE<hw>]:BB:W3GPp:BSTation:ENHanced:CHANnel:DPCH:CCODing:
USER:DELeTe <Filename>**

Deletes the specified files with stored user channel codings.

The files are stored with the fixed file extensions *.3g_ccod_d1 in a directory of the user's choice. The directory applicable to the commands is defined with the command `MMEMory:CDIR`. To access the files in this directory, you only have to give the file name, without the path and the file extension.

Setting parameters:

<Filename> string

Example: `MMEM:CDIR '/var/user/temp/CcodDpchUser'`
selects the directory for the user channel coding files.
`BB:W3GP:BST:ENH:CHAN:DPCH:CCOD:USER:DEL`
`'user_cc1'`
deletes the specified file with user coding.

Usage: Setting only

**[:SOURCE<hw>]:BB:W3GPp:BSTation:ENHanced:CHANnel<ch0>:DPCH:
CCODing:BPFRame?**

Queries the number of data bits in the DPDCH component of the frame at the physical layer.

Return values:

<BpFrame> integer
Range: 30 to 20000
*RST: 510

Example: `BB:W3GP:BST:ENH:CHAN13:DPCH:CCOD:BPFR?`
queries the number of data bits.
Response: 1
the number of data bits is 1.

Usage: Query only

Manual operation: See "[Bits per Frame \(DPDCH\)](#)" on page 121

**[:SOURCE<hw>]:BB:W3GPp:BSTation:ENHanced:CHANnel<ch0>:DPCH:
CCODing:SFORmat <SFormat>**

The command sets the slot format for the selected enhanced DPCH of base station 1. The slot format is fixed for channel-coded measurement channels conforming to the standard - "Reference Measurement Channel". Changing the slot format automatically activates User coding (`W3GP:BST:ENH:CHAN<11...13>:DPCH:CCOD:TYPE USER`). The slot format also fixes the symbol rate, bits per frame, pilot length and TFCI state parameters.

When a channel coding type conforming to the standard is selected ([: SOURce<hw>]:BB:W3GPp:BSTation:ENHanced:CHANnel<ch0>:DPCH:CCODing:TYPE) and channel coding is activated, the slot format is ([: SOURce<hw>]:BB:W3GPp:BSTation:ENHanced:CHANnel<ch0>:DPCH:CCODing:STATe) automatically set to the associated value.

Changing the slot format automatically activates User coding (W3GP:BST:ENH:CHAN<11...13>:DPCH:CCOD:TYPE USER).

The command sets the symbol rate (W3GP:BST:ENH:CHAN:DPCH:CCOD:SRAT), the bits per frame (W3GP:BST:ENH:CHAN:DPCH:CCOD:BFFR), the pilot length (W3GP:BST1:CHAN:DPCC:PLEN), and the TFCI state (W3GP:BST1:CHAN:DPCC:TFCI STAT) to the associated values.

Parameters:

<SFormat> integer
 Range: 0 to dynamic
 *RST: 0

Example: BB:W3GP:BST:ENH:CHAN13:DPCH:CCOD:SFOR 4
 sets slot format 4 for Enhanced DPCH13.

Manual operation: See " Slot Format (DPDCH) " on page 121

[: SOURce<hw>]:BB:W3GPp:BSTation:ENHanced:CHANnel<ch0>:DPCH:CCODing:SRATe?

The command queries the symbol rate.

The symbol rate depends on the selected slot format ([: SOURce<hw>]:BB:W3GPp:BSTation:ENHanced:CHANnel<ch0>:DPCH:CCODing:SFormat), and if the slot format changes, this changes automatically as well.

Return values:

<SRate> D7K5 | D15K | D30K | D60K | D120k | D240k | D480k | D960k |
 D1920k | D2880k | D3840k | D4800k | D5760k | D2X1920K |
 D2X960K2X1920K
 *RST: D30K

Example: BB:W3GP:BST:ENH:CHAN13:DPCH:CCOD:SRAT?
 queries the symbol rate.
 Response: 'D30K'
 the symbol rate of Enhanced DPCH 13 is 30 ksp.

Usage: Query only

Manual operation: See " Symbol Rate (DPDCH) " on page 121

[: SOURce<hw>]:BB:W3GPp:BSTation:ENHanced:CHANnel<ch0>:DPCH:CCODing:STATe <State>

The command activates or deactivates channel coding for the selected enhanced DPCH.

When channel coding is activated and a channel coding type conforming to the standard is selected, (`BB:W3GP:BST:ENH:CHAN:DPCH:CCOD:TYPE`) the slot format, (`BB:W3GP:BST:ENH:CHAN:DPCH:CCOD:SFOR`) and thus the symbol rate, (`BB:W3GP:BST:ENH:CHAN:DPCH:CCOD:SRAT`) the bits per frame, (`BB:W3GP:BST:ENH:CHAN:DPCH:CCOD:BPFR`), the pilot length (`BB:W3GP:BST1:CHAN:DPCC:PLEN`) and the TFCI state (`BB:W3GP:BST1:CHAN:DPCC:TFCI STAT`) are set to the associated values.

Parameters:

<State> ON | OFF
*RST: OFF

Example:

`BB:W3GP:BST:ENH:CHAN13:DPCH:CCOD:TYPE M12K2`
selects channel coding type RMC 12.2 kbps for Enhanced DPCH 13.
`BB:W3GP:BST:ENH:CHAN13:DPCH:CCOD:STAT ON`
activates channel coding.

Manual operation: See "[Channel Coding State](#)" on page 119

[[:SOURce<hw>]:BB:W3GPp:BSTation:ENHanced:CHANnel<ch0>:DPCH:CCODing:TYPE <Type>

The command selects the channel coding scheme in accordance with the 3GPP specification.

The 3GPP specification defines 4 reference measurement channel coding types, which differ in the input data bit rate to be processed (12.2, 64, 144 and 384 kbps). The additional AMR CODER coding scheme generates the coding of a voice channel. The BTFD coding types with different data rates are also defined in the 3GPP specification (TS 34.121). They are used for the receiver quality test Blind Transport Format Detection.

When a channel coding type conforms to the standard and channel coding is activated, (`:BB:W3GP:BST:ENH:CHAN<n>:DPCH:CCOD:STAT`) the slot format (`:BB:W3GP:BST:ENH:CHAN<n>:DPCH:CCOD:SFOR`) and thus the symbol rate (`:BB:W3GP:BST:ENH:CHAN<n>:DPCH:CCOD:SRAT`), the bits per frame, (`:BB:W3GP:BST:ENH:CHAN<n>:DPCH:CCOD:BPFR`), the pilot length (`:BB:W3GP:BST1:CHAN<n>:DPCC:PLEN`) and the TFCI state (`:BB:W3GP:BST1:CHAN<n>:DPCC:TFCI:STAT`) are set to the associated values.

Parameters:

<Type> M12K2 | M64K | M144k | M384k | AMR | BTFD1 | BTFD2 | BTFD3
M12K2
Measurement channel with an input data bit rate of 12.2 kbps.
M64K
Measurement channel with an input data bit rate of 64 kbps.
M144k
Measurement channel with an input data bit rate of 144 kbps.

M384k

Measurement channel with an input data bit rate of 384 kbps.

AMR

Channel coding for the AMR Coder (coding a voice channel).

USER

This parameter cannot be set. USER is returned whenever a user-defined channel coding is active, that is to say, after a channel coding parameter has been changed or a user coding file has been loaded. The file is loaded by the command [:

`SOURce<hw>]:BB:W3GPp:BSTation:ENHanced:CHANnel<ch0>:DPCH:CCODing:USER:LOAD.`

BTFD1

Blind Transport Format Detection Rate 1 (12.2 kbps).

BTFD2

Blind Transport Format Detection Rate 2 (7.95 kbps).

BTFD3

Blind Transport Format Detection Rate 3 (1.95 kbps).

*RST: M12K2

Example:

`BB:W3GP:BST:ENH:CHAN13:DPCH:CCOD:TYPE M144`
selects channel coding scheme RMC 144 kbps.

Manual operation: See " [Channel Coding Type](#) " on page 119

[:SOURce<hw>]:BB:W3GPp:BSTation:ENHanced:CHANnel:DPCH:CCODing:USER:CATalog?

Queries existing files with stored user channel codings.

The files are stored with the fixed file extensions *.3g_ccod_d1 in a directory of the user's choice. The directory applicable to the commands is defined with the command `MMEMemory:CDIR`.

Return values:

<Catalog> string

Example:

`MME:CDIR '/var/user/temp/CcodDpchUser'`
selects the directory for the user channel coding files.
`BB:W3GP:BST:ENH:CHAN:DPCH:CCOD:USER:CAT?`
queries the existing files with user coding.
Response: user_cc1
there is one file with user coding.

Usage: Query only

Manual operation: See " [User Coding](#) " on page 121

[:SOURce<hw>]:BB:W3GPp:BSTation:ENHanced:CHANnel<ch0>:DPCH:CCODing:USER:LOAD <Filename>

The command loads the specified files with stored user channel codings.

The files are stored with the fixed file extensions `*.3g_ccod_d1` in a directory of the user's choice. The directory applicable to the commands is defined with the command `MMEMemory:CDIR`. To access the files in this directory, you only have to give the file name, without the path and the file extension.

Setting parameters:

<Filename> <user_coding>

Example:

```
MME:CDIR '/var/user/temp/CcodDpchUser'
selects the directory for the user channel coding files.
BB:W3GP:BST:ENH:CHAN13:DPCH:CCOD:USER:LOAD
'user_cc1'
loads the specified file with user coding.
```

Usage: Setting only

Manual operation: See " [User Coding](#) " on page 121

**[:SOURCE<hw>]:BB:W3GPp:BSTation:ENHanced:CHANnel<ch0>:DPCH:
CCODing:USER:STORE <Filename>**

The command saves the current settings for channel coding as user channel coding in the specified file.

The files are stored with the fixed file extensions `*.3g_ccod_d1` in a directory of the user's choice. The directory in which the file is stored is defined with the command `MMEMemory:CDIR`. To store the files in this directory, you only have to give the file name, without the path and the file extension.

Setting parameters:

<Filename> string

Example:

```
MME:CDIR '/var/user/temp/CcodDpchUser'
selects the directory for the user channel coding files.
BB:W3GP:BST:ENH:CHAN13:DPCH:CCOD:USER:STOR
'user_cc1'
saves the current channel coding setting in file user_cc1 in
directory /var/user/temp/CcodDpchUser.
```

Usage: Setting only

Manual operation: See " [User Coding](#) " on page 121

**[:SOURCE<hw>]:BB:W3GPp:BSTation:ENHanced:CHANnel<ch0>:DPCH:
INTerleaver2 <Interleaver2>**

The command activates or deactivates channel coding interleaver state 2 for the selected channel.

Interleaver state 2 is activated or deactivated for all the transport channels together. Interleaver state 1 can be activated and deactivated for each transport channel individually (command `[:SOURCE<hw>]:BB:W3GPp:BSTation:ENHanced:CHANnel<ch0>:DPCH:TCHannel<di0>:INTerleaver`).

Note: The interleaver states do not cause the symbol rate to change.

Parameters:

<Interleaver2> ON | OFF
*RST: ON

Example:

BB:W3GP:BST:ENH:CHAN13:DPCH:INT OFF
deactivates channel coding interleaver state 2 for all the TCHs of DPCH13.

Manual operation: See " [Interleaver 2 State](#) " on page 124

**[:SOURce<hw>] :BB:W3GPp:BSTation:ENHanced:CHANnel<ch0>:DPCH:
TCHannel<di0>:CRCSize <CrcSize>**

The command defines the CRC length for the selected transport channel. It is also possible to deactivate checksum determination.

Parameters:

<CrcSize> NONE | 8 | 12 | 16 | 24
*RST: 16

Example:

BB:W3GP:BST:ENH:CHAN13:DPCH:TCH0:CRCS NONE
deactivates checksum determination for the DCCH of DPCH13.

Manual operation: See " [Size of CRC](#) " on page 123

**[:SOURce<hw>] :BB:W3GPp:BSTation:ENHanced:CHANnel<ch0>:DPCH:
TCHannel<di0>:DATA <Data>**

The command determines the data source for the data fields of enhanced channels with channel coding. If channel coding is not active, the DPCH data source is used (`:SOURce:BB:W3GPp:BST:CHANnel:DATA`).

Parameters:

<Data> PN9 | PN11 | PN15 | PN16 | PN20 | PN21 | PN23 | DLISt |
ZERO | ONE | PATTErn |

PNxx

The pseudo-random sequence generator is used as the data source. Different random sequence lengths can be selected.

DLISt

A data list is used. The data list is selected with the command `[:SOURce<hw>] :BB:W3GPp:BSTation:ENHanced:CHANnel<ch0>:DPCH:TCHannel<di0>:DATA:DSElect`.

ZERO | ONE

Internal 0 and 1 data is used.

PATTErn

Internal data is used. The bit pattern for the data is defined with the command `[:SOURce<hw>] :BB:W3GPp:BSTation:ENHanced:CHANnel<ch0>:DPCH:TCHannel<di0>:DATA:PATTErn`.

*RST: PN9

Example:

BB:W3GP:BST:ENH:CHAN13:DPCH:TCH1:DATA PATT
 Selects the Pattern data source for the data fields of DTCH1 of DPCH13. The bit pattern is defined with the following command.
 BB:W3GP:BST:ENH:CHAN13:DPCH:TCH1:DATA:PATT
 #H3F, 8
 Defines the bit pattern.

Manual operation: See ["Data List Management"](#) on page 49

**[:SOURCE<hw>]:BB:W3GPp:BSTation:ENHanced:CHANnel<ch0>:DPCH:
 TCHannel<di0>:DATA:DSElect <DSelect>**

The command selects the data list for enhanced channels for the DLIS selection.

The files are stored with the fixed file extensions *.dm_iqd in a directory of the user's choice. The directory applicable to the commands is defined with the command MME-Memory:CDIR. To access the files in this directory, you only have to give the file name, without the path and the file extension.

Parameters:

<DSelect> string

Example:

BB:W3GP:BST:ENH:CHAN13:DPCH:TCH1:DATA DLIS
 selects the Data Lists data source for DTCH1 of DPCH13.
 MMEM:CDIR '/var/user/temp/IQData'
 selects the directory for the data lists.
 BB:W3GP:BST:ENH:CHAN13:DPCH:TCH1:DATA:DSEL
 'bts_tch'
 selects the file bts_tch as the data source.

Manual operation: See ["Data List Management"](#) on page 49

**[:SOURCE<hw>]:BB:W3GPp:BSTation:ENHanced:CHANnel<ch0>:DPCH:
 TCHannel<di0>:DATA:PATTern <Pattern>, <BitCount>**

The command determines the bit pattern for the PATTern selection. The maximum length is 64 bits.

Parameters:

<Pattern> numeric

*RST: #H0

<BitCount> integer

Range: 1 to 64

*RST: 1

Example:

BB:W3GP:BST:ENH:CHAN13:DPCH:TCH1:DATA:PATT
 #H3F, 8
 defines the bit pattern.

Manual operation: See ["Data Source"](#) on page 122

**[:SOURce<hw>]:BB:W3GPp:BSTation:ENHanced:CHANnel<ch0>:DPCH:
TCHannel<di0>:DTX <Dtx>**

The command sets the number of DTX (Discontinuous Transmission) bits. These bits are entered in the data stream between rate matching and interleaver 1 and used for the BTFD reference measurement channels rate 2 and rate 3.

Parameters:

<Dtx> integer
Range: 0 to 1024
*RST: 0

Example: BB:W3GP:BST:ENH:CHAN13:DPCH:TCH1:DTX 257
257 bits are entered in the data stream between rate matching and interleaver 1.

Manual operation: See " [DTX Indication Bits](#) " on page 124

**[:SOURce<hw>]:BB:W3GPp:BSTation:ENHanced:CHANnel<ch0>:DPCH:
TCHannel<di0>:EPRotecton <EProtection>**

Sets the error protection.

Parameters:

<EProtection> NONE | TURBo3 | CON2 | CON3
NONE
No error protection
TURBo3
Turbo Coder of rate 1/3 in accordance with the 3GPP specifications.
CON2 | CON3
Convolution Coder of rate 1/2 or 1/3 with generator polynomials defined by 3GPP.
*RST: CON3

Example: BB:W3GP:BST:ENH:CHAN13:DPCH:TCH1:EPR NONE
error protection for transport channel DTCH1 of DPCH13 is deactivated.

Manual operation: See " [Error Protection](#) " on page 124

**[:SOURce<hw>]:BB:W3GPp:BSTation:ENHanced:CHANnel<ch0>:DPCH:
TCHannel<di0>:INTerleaver <Interleaver>**

The command activates or deactivates channel coding interleaver state 1 for the selected channel.

Interleaver state 1 can be activated and deactivated for each transport channel individually. The channel is selected via the suffix at TCHannel.

Interleaver state 2 can only be activated or deactivated for all the transport channels together (`[:SOURCE<hw>] :BB:W3GPp:BSTation:ENHanced:CHANnel<ch0> :DPCH:INTerleaver2`).

Note: The interleaver states do not cause the symbol rate to change.

Parameters:

<Interleaver> ON | OFF
 *RST: ON

Manual operation: See "[Interleaver 1 State](#)" on page 124

The transport channel designations for remote control are TChannel0 for DCCH, TChannel1 to TChannel6 for DTCH1 to DTCH6.

`[:SOURCE<hw>] :BB:W3GPp:BSTation:ENHanced:CHANnel<ch0> :DPCH: TChannel<di0> :RMATtribute <RmAttribute>`

Sets data rate matching.

Parameters:

<RmAttribute> integer
 Range: 1 to 1024
 *RST: 256

Example: `BB:W3GP:BST:ENH:CHAN13:DPCH:TCH1:RMAT 1024`
sets the rate matching attribute for DTCH1 of DPCH13 to 1024.

Manual operation: See "[Rate Matching Attribute](#)" on page 123

`[:SOURCE<hw>] :BB:W3GPp:BSTation:ENHanced:CHANnel<ch0> :DPCH: TChannel<di0> :STATE <State>`

The command activates/deactivates the selected transport channel.

Parameters:

<State> ON | OFF
 *RST: OFF

Example: `BB:W3GP:BST:ENH:CHAN13:DPCH:TCH1:STAT ON`
activates DTCH1 of DPCH13.

Manual operation: See "[Transport Channel State](#)" on page 122

`[:SOURCE<hw>] :BB:W3GPp:BSTation:ENHanced:CHANnel<ch0> :DPCH: TChannel<di0> :TBCount <TbCount>`

Defines the number of blocks used for the selected transport channel.

Parameters:

<TbCount> integer
 Range: 1 to 24
 *RST: 1

Example: `BB:W3GP:BST:ENH:CHAN13:DPCH:TCH:TBC 4`
sets 4 transport blocks for DTCH1 of DPCH13.

Manual operation: See "[Transport Block](#)" on page 123

**[:SOURCE<hw>]:BB:W3GPp:BSTation:ENHanced:CHANnel<ch0>:DPCH:
TCHannel<di0>:TBSize <TbSize>**

Sets the size of the data blocks.

Parameters:

<TbSize> integer
Range: 0 to 4096

Example: `BB:W3GP:BST:ENH:CHAN13:DPCH:TCH:TBS 1024`
sets the length of the transport blocks for DTCH1 of DPCH13 to 1024.

Manual operation: See "[Transport Block Size](#)" on page 123

**[:SOURCE<hw>]:BB:W3GPp:BSTation:ENHanced:CHANnel<ch0>:DPCH:
TCHannel<di0>:TTINterval <TtInterval>**

Sets the number of frames into which a TCH is divided. This setting also defines the interleaver depth.

Parameters:

<TtInterval> 10MS | 20MS | 40MS

Example: `SOURCE1:BB:W3GPp:BSTation:ENHanced:CHANnel13:
DPCH:TCHannel1:TTINterval 20ms`
sets that DTCH1 of DPCH13 is divided into 2 frames.

Manual operation: See "[Transport Time Interval](#)" on page 123

**[:SOURCE<hw>]:BB:W3GPp:BSTation:ENHanced:PCCPch:CCODing:
INTerleaver<di> <Interleaver>**

The command activates or deactivates channel coding interleaver state 1 or 2 for the P-CCPCH.

Note: The interleaver states do not cause the symbol rate to change.

Parameters:

<Interleaver> ON | OFF
*RST: ON

Example: `BB:W3GP:BST:ENH:PCCP:CCOD:INT1 OFF`
deactivates channel coding interleaver state 1 for the P-CCPCH.

Manual operation: See "[Interleaver](#)" on page 116

```

// selects a dynamic range of 10 dB for ranging up the channel power
SOURCE:BB:W3GPp:BSTation:ENHanced:CHAN11:DPCH:DPControl:RANGe:UP 50 dB
// selects a dynamic range of 50 dB for ranging up the channel power
// The overall increase and decrease of channel power,
// i.e. the dynamic range is limited to 60 dB
SOURCE:BB:W3GPp:BSTation:ENHanced:CHAN11:DPCH:DPControl:MODE TPC
// selects the source of the power control signal
SOURCE:BB:W3GPp:BSTation:ENHanced:CHAN11:DPCH:DPControl:STATe ON
// activates Dynamic Power Control for DPCH 11
SOURCE:BB:W3GPp:BSTation:ENHanced:CHAN11:DPCH:DPControl:POWer?
// queries the deviation of the channel power of DPCH 11

[:SOURCE<hw>]:BB:W3GPp:BSTation:ENHanced:CHANnel<ch0>:DPCH:DPControl:
  DIRection..... 336
[:SOURCE<hw>]:BB:W3GPp:BSTation:ENHanced:CHANnel<ch0>:DPCH:DPControl:MODE. 336
[:SOURCE<hw>]:BB:W3GPp:BSTation<st>:ENHanced:CHANnel<ch0>:DPCH:
  DPControl:RANGe:UP..... 337
[:SOURCE<hw>]:BB:W3GPp:BSTation:ENHanced:CHANnel<ch0>:DPCH:DPControl:
  RANGe:DOWN..... 337
[:SOURCE<hw>]:BB:W3GPp:BSTation:ENHanced:CHANnel<ch0>:DPCH:DPControl:STATe. 337
[:SOURCE<hw>]:BB:W3GPp:BSTation:ENHanced:CHANnel<ch0>:DPCH:DPControl:
  STEP:MANual..... 337
[:SOURCE<hw>]:BB:W3GPp:BSTation:ENHanced:CHANnel<ch0>:DPCH:DPControl:
  STEP[:EXternal]..... 338
[:SOURCE<hw>]:BB:W3GPp:BSTation:ENHanced:CHANnel<ch0>:DPCH:DPControl[:
  POWer]?..... 338

```

**[:SOURCE<hw>]:BB:W3GPp:BSTation:ENHanced:CHANnel<ch0>:DPCH:
DPControl:DIRection <Direction>**

The command selects the Dynamic Power Control direction. The selected mode determines if the channel power is increased (UP) or decreased (DOWN) by a control signal with high level.

Parameters:

<Direction> UP | DOWN
*RST: UP

Example: see [Example "Configuring the Dynamic Power Control Settings"](#) on page 335

Manual operation: See "[Direction](#)" on page 128

**[:SOURCE<hw>]:BB:W3GPp:BSTation:ENHanced:CHANnel<ch0>:DPCH:
DPControl:MODE <Mode>**

Selects the control signal source for Dynamic Power Control.

Parameters:

<Mode> TPC | MANual

Example: See [Example "Configuring the Dynamic Power Control Settings"](#) on page 335.

Manual operation: See "[Mode](#)" on page 128

```
[:SOURce<hw>]:BB:W3GPp:BSTation<st>:ENHanced:CHANnel<ch0>:DPCH:
  DPControl:RANGe:UP <Up>
```

```
[:SOURce<hw>]:BB:W3GPp:BSTation:ENHanced:CHANnel<ch0>:DPCH:
  DPControl:RANGe:DOWN <Down>
```

The command selects the dynamic range for ranging down the channel power.

Parameters:

<Down> float
 Range: 0 to 60
 Increment: 0.01
 *RST: 10
 Default unit: dB

Example: see [Example "Configuring the Dynamic Power Control Settings"](#) on page 335

Manual operation: See "[Up Range / Down Range](#)" on page 129

```
[:SOURce<hw>]:BB:W3GPp:BSTation:ENHanced:CHANnel<ch0>:DPCH:
  DPControl:STATe <State>
```

The command activates/deactivates Dynamic Power Control.

Parameters:

<State> 0 | 1 | OFF | ON
 *RST: 0

Example: see [Example "Configuring the Dynamic Power Control Settings"](#) on page 335

Manual operation: See "[Dynamic Power Control State](#)" on page 128

```
[:SOURce<hw>]:BB:W3GPp:BSTation:ENHanced:CHANnel<ch0>:DPCH:
  DPControl:STEP:MANual <Manual>
```

Sets the control signal for manual mode of Dynamic Power Control.

Setting parameters:

<Manual> MAN0 | MAN1
 *RST: MAN0

Example:

```
BB:W3GP:BST:ENH:CHAN11:DPCH:DPC:MODE MAN
BB:W3GP:BST:ENH:CHAN11:DPCH:DPC:STEP 0.5 dB
BB:W3GP:BST:ENH:CHAN11:DPCH:DPC:STAT ON
BB:W3GP:BST:ENH:CHAN11:DPCH:DPC:STEP:MAN MAN0
```

Usage: Setting only

Manual operation: See " [Mode](#) " on page 128

**[:SOURce<hw>]:BB:W3GPp:BSTation:ENHanced:CHANnel<ch0>:DPCH:
DPControl:STEP[:EXTernal] <External>**

This command sets step width by which – with Dynamic Power Control being switched on - the channel power of the selected enhanced channel is increased or decreased.

Parameters:

<External> float
 Range: 0.5 to 6
 Increment: 0.01
 *RST: 1
 Default unit: dB

Example: see [Example "Configuring the Dynamic Power Control Settings"](#) on page 335

Manual operation: See " [Power Step](#) " on page 129

**[:SOURce<hw>]:BB:W3GPp:BSTation:ENHanced:CHANnel<ch0>:DPCH:
DPControl[:POWER]?**

The command queries the deviation of the channel power (delta POW) from the set power start value of the corresponding enhanced channels.

Return values:

<Power> float
 Range: -60 to 60
 Increment: 0.01
 *RST: 0

Example: see [Example "Configuring the Dynamic Power Control Settings"](#) on page 335

Usage: Query only

Manual operation: See " [Power Control Graph](#) " on page 129

7.8.4 Error Insertion

[:SOURce<hw>]:BB:W3GPp:BSTation:ENHanced:CHANnel<ch0>:DPCH:DERRor:BIT: LAYer.....	339
[:SOURce<hw>]:BB:W3GPp:BSTation:ENHanced:CHANnel<ch0>:DPCH:DERRor:BIT: RATE.....	339
[:SOURce<hw>]:BB:W3GPp:BSTation:ENHanced:CHANnel<ch0>:DPCH:DERRor:BIT: STATe.....	339
[:SOURce<hw>]:BB:W3GPp:BSTation:ENHanced:CHANnel<ch0>:DPCH:DERRor: BLOCK:RATE.....	340
[:SOURce<hw>]:BB:W3GPp:BSTation:ENHanced:CHANnel<ch0>:DPCH:DERRor: BLOCK:STATe.....	340

<code>[:SOURce<hw>]:BB:W3GPp:BSTation[:ENHanced]:CHANnel<ch0>:HSDPa:DERRor: BIT:LAYer.....</code>	341
<code>[:SOURce<hw>]:BB:W3GPp:BSTation[:ENHanced]:CHANnel<ch0>:HSDPa:DERRor: BIT:RATE.....</code>	341
<code>[:SOURce<hw>]:BB:W3GPp:BSTation[:ENHanced]:CHANnel<ch0>:HSDPa:DERRor: BIT:STATe.....</code>	341
<code>[:SOURce<hw>]:BB:W3GPp:BSTation[:ENHanced]:CHANnel<ch0>:HSDPa:DERRor: BLOCK:RATE.....</code>	342
<code>[:SOURce<hw>]:BB:W3GPp:BSTation[:ENHanced]:CHANnel<ch0>:HSDPa:DERRor: BLOCK:STATe.....</code>	342

**`[:SOURce<hw>]:BB:W3GPp:BSTation:ENHanced:CHANnel<ch0>:DPCH:DERRor:
BIT:LAYer <Layer>`**

The command selects the layer in the coding process in which bit errors are inserted.

Parameters:

<Layer> TRANsport | PHYSical

TRANsport

Transport Layer (Layer 2). This layer is only available when channel coding is active.

PHYSical

Physical layer (Layer 1).

*RST: PHYSical

Example:

`BB:W3GP:BST:ENH:CHAN13:DPCH:DERR:BIT:LAY PHYS`
selects layer 1 for entering bit errors.

Manual operation: See " [Insert Errors On](#) " on page 125

**`[:SOURce<hw>]:BB:W3GPp:BSTation:ENHanced:CHANnel<ch0>:DPCH:DERRor:
BIT:RATE <Rate>`**

The command sets the bit error rate.

Parameters:

<Rate> float
Range: 1E-7 to 0.5
Increment: 1E-7
*RST: 0.001

Example:

`BB:W3GP:BST:ENH:CHAN13:DPCH:DERR:BIT:RATE 1E-4`
sets a bit error rate of 0.0001.

Manual operation: See " [Bit Error Rate](#) " on page 125

**`[:SOURce<hw>]:BB:W3GPp:BSTation:ENHanced:CHANnel<ch0>:DPCH:DERRor:
BIT:STATe <State>`**

The command activates bit error generation or deactivates it.

Bit errors are inserted into the data fields of the enhanced channels. When channel coding is active, it is possible to select the layer in which to insert the errors (the physical or the transport layer, `[:SOURCE<hw>] :BB:W3GPp:BSTation:ENHanced:CHANnel<ch0>:DPCH:DERRor:BIT:LAYer`). When the data source is read out, individual bits are deliberately inverted at random points in the data bit stream at the specified error rate in order to simulate an invalid signal.

Parameters:

<State> ON | OFF
*RST: 0

Example:

`BB:W3GP:BST:ENH:CHAN13:DPCH:DERR:BIT:STAT ON`
activates bit error generation.

Manual operation: See "[Bit Error State \(Enhanced DPCHs\)](#)" on page 124

`[:SOURCE<hw>] :BB:W3GPp:BSTation:ENHanced:CHANnel<ch0>:DPCH:DERRor:
BLOCK:RATE <Rate>`

Sets the block error rate.

Parameters:

<Rate> float
Range: 1E-4 to 0.5
Increment: 1E-4
*RST: 0.1

Example:

`BB:W3GP:BST:ENH:CHAN13:DPCH:DERR:BLOC:RATE 1E-2`
sets the block error rate to 0.01.

Manual operation: See "[Block Error Rate](#)" on page 125

`[:SOURCE<hw>] :BB:W3GPp:BSTation:ENHanced:CHANnel<ch0>:DPCH:DERRor:
BLOCK:STATe <State>`

The command activates or deactivates block error generation. Block error generation is only possible when channel coding is activated.

During block error generation, the CRC checksum is determined and then the last bit is inverted at the specified error probability in order to simulate a defective signal.

Parameters:

<State> ON | OFF
*RST: 0

Example:

`BB:W3GP:BST:ENH:CHAN13:DPCH:CCOD:STAT ON`
activates channel coding.
`BB:W3GP:BST:ENH:CHAN13:DPCH:DERR:BLOC:RATE 5E-1`
sets the block error rate to 0.1.
`BB:W3GP:BST:ENH:CHAN13:DPCH:DERR:BLOC:STAT ON`
activates block error generation.

Manual operation: See "[Block Error State](#)" on page 125

**[:SOURCE<hw>]:BB:W3GPP:BSTation[:ENHanced]:CHANNEL<ch0>:HSDPa:
DERRor:BIT:LAYer <Layer>**

The command selects the layer in the coding process in which bit errors are inserted.

Parameters:

<Layer> TRANsport | PHYSical
TRANsport
 Transport Layer (Layer 2)
PHYSical
 Physical layer (Layer 1)
 *RST: PHYSical

Example: BB:W3GP:BST:ENH:CHAN12:HSDP:DERR:BIT:LAY PHYS
 selects layer 1 for entering bit errors.

Manual operation: See " [Insert Errors On \(HSDPA H-Set\)](#) " on page 111

**[:SOURCE<hw>]:BB:W3GPP:BSTation[:ENHanced]:CHANNEL<ch0>:HSDPa:
DERRor:BIT:RATE <Rate>**

Sets the bit error rate.

Parameters:

<Rate> float
 *RST: 1E-3

Example: BB:W3GP:BST:ENH:CHAN12:HSDP:DERR:BIT:RATE 1E-4
 sets a bit error rate of 0.0001.

Manual operation: See " [Bit Error Rate \(HSDPA H-Set\)](#) " on page 111

**[:SOURCE<hw>]:BB:W3GPP:BSTation[:ENHanced]:CHANNEL<ch0>:HSDPa:
DERRor:BIT:STATe <State>**

The command activates bit error generation or deactivates it.

Bit errors are inserted into the data stream of the coupled HS-PDSCHs. It is possible to select the layer in which the errors are inserted (physical or transport layer). When the data source is read out, individual bits are deliberately inverted at random points in the data bit stream at the specified error rate in order to simulate an invalid signal.

Parameters:

<State> ON | OFF
 *RST: 0

Example: BB:W3GP:BST:ENH:CHAN12:HSDP:DERR:BIT:STAT ON
 activates bit error generation.

Manual operation: See " [Bit Error State \(HSDPA H-Set\)](#) " on page 111

**[:SOURCE<hw>]:BB:W3GPP:BSTation[:ENHanced]:CHANNEL<ch0>:HSDPa:
DERRor:BLOCK:RATE <Rate>**

The command sets the block error rate.

Parameters:

<Rate> float
Range: 1E-4 to 5E-1
*RST: 5E-1

Example: BB:W3GP:BST:ENH:CHAN12:HSDP:DERR:BLOC:RATE 1E-2
sets the block error rate to 0.01.

Manual operation: See " [Block Error Rate \(HSDPA H-Set\)](#) " on page 112

**[:SOURCE<hw>]:BB:W3GPP:BSTation[:ENHanced]:CHANNEL<ch0>:HSDPa:
DERRor:BLOCK:STATe <State>**

The command activates or deactivates block error generation. During block error generation, the CRC checksum is determined and then the last bit is inverted at the specified error probability in order to simulate a defective signal.

Parameters:

<State> ON | OFF
*RST: 0

Example: BB:W3GP:BST:ENH:CHAN12:HSDP:DERR:BLOC:RATE 5E-1
sets the block error rate to 0.1.
BB:W3GP:BST:ENH:CHAN12:HSDP:DERR:BLOC:STAT ON
activates block error generation.

Manual operation: See " [Block Error State \(HSDPA H-Set\)](#) " on page 111

7.9 User Equipment Settings

The SOURCE:BB:W3GPP:MSTation system contains commands for setting the user equipment. The commands of this system only take effect when the 3GPP FDD standard is activated, the UP transmission direction is selected and the particular user equipment is enabled:

SOURCE:BB:W3GPP:STATE ON

SOURCE:BB:W3GPP:LINK UP

SOURCE:BB:W3GPP:MSTation2:STATE ON

MSTation<st>

The numeric suffix to MSTation determines the user equipment. The value range is 1 .. 4. If the suffix is omitted, MS1 is selected.

• General Settings.....	343
• Compressed Mode Settings.....	347
• DPCCH Settings.....	349
• HS-DPCCH Settings.....	356
• DPDCH Settings.....	375
• PCPCH Settings.....	379
• PRACH Settings.....	390
• HSUPA Settings.....	399
• UL-DTX and Uplink Scheduling Settings.....	417
• Dynamic Power Control Settings.....	421

7.9.1 General Settings

<code>[:SOURce<hw>]:BB:W3GPp:MSTation:ADDITIONal:COUNT</code>	343
<code>[:SOURce<hw>]:BB:W3GPp:MSTation:ADDITIONal:POWER:OFFSet</code>	344
<code>[:SOURce<hw>]:BB:W3GPp:MSTation:ADDITIONal:SCODE:STEP</code>	344
<code>[:SOURce<hw>]:BB:W3GPp:MSTation:ADDITIONal:STATE</code>	344
<code>[:SOURce<hw>]:BB:W3GPp:MSTation:ADDITIONal:TDElay:STEP</code>	344
<code>[:SOURce<hw>]:BB:W3GPp:MSTation:PRESet</code>	345
<code>[:SOURce<hw>]:BB:W3GPp:MSTation<st>:MODE</code>	345
<code>[:SOURce<hw>]:BB:W3GPp:MSTation<st>:SCODE</code>	346
<code>[:SOURce<hw>]:BB:W3GPp:MSTation<st>:SCODE:MODE</code>	346
<code>[:SOURce<hw>]:BB:W3GPp:MSTation<st>:STATE</code>	347
<code>[:SOURce<hw>]:BB:W3GPp:MSTation<st>:TDElay</code>	347
<code>[:SOURce<hw>]:BB:W3GPp:LREference</code>	347

`[:SOURce<hw>]:BB:W3GPp:MSTation:ADDITIONal:COUNT <Count>`

The command sets the amount of additional user equipment.

Up to 128 additional user equipment can be simulated - corresponding to a receive signal for a base station with high capacity utilization. The fourth user equipment (UE4) serves as a template for all other stations. The only parameters of the additional user equipment to be modified are the scrambling code and the power.

Parameters:

<code><Count></code>	integer
Range:	1 to 128
*RST:	4

Example:

```
BB:W3GP:MST:ADD:COUN 20
Sets 20 additional user equipment.
BB:W3GP:MST:ADD:POW:OFFS -3.0
Sets the power offset to -3 dB.
BB:W3GP:MST:ADD:SCOD:STEP 1
Sets the step width for increasing the scrambling code to 1.
BB:W3GP:MST:ADD:STAT ON
Connects the 20 user equipment to the 3GPP FDD signal.
```

Manual operation: See "[Number of Additional UE](#)" on page 75

[:SOURce<hw>]:BB:W3GPP:MSTation:ADDITIONal:POWER:OFFSet <Offset>

Sets the power offset of the active channels of the additional user equipment relative to the power of the active channels of the reference station UE4.

The offset applies to all the additional user equipment. The resultant overall power must fall within the range 0 ... - 80 dB. If the value is above or below this range, it is limited automatically.

Parameters:

<Offset> float
 Range: -80 to 0
 Increment: 0.01
 *RST: 0

Example: BB:W3GP:MST:ADD:POW:OFFS -3.0
 sets the offset to -3 dB.

Manual operation: See "[Power Offset](#)" on page 75

[:SOURce<hw>]:BB:W3GPP:MSTation:ADDITIONal:SCODE:STEP <Step>

Sets the step width for increasing the scrambling code of the additional user equipment. The start value is the scrambling code of UE4.

Parameters:

<Step> integer
 Range: 0 to #FFFFFFF

Example: BB:W3GP:MST:ADD:SCOD:STEP #H55
 sets the step width for increasing the scrambling code to #H55.

Manual operation: See "[Scrambling Code Step](#)" on page 75

[:SOURce<hw>]:BB:W3GPP:MSTation:ADDITIONal:STATE <State>

Activates additional user equipment.

Parameters:

<State> 0 | 1 | OFF | ON
 *RST: 0

Example: SOURce1:BB:W3GPP:MSTation:ADDITIONal:STATE ON
 connects the additional user equipment to the 3GPP FDD signal.

Manual operation: See "[State](#)" on page 75

[:SOURce<hw>]:BB:W3GPP:MSTation:ADDITIONal:TDElay:STEP <Step>

Sets the step width for the time delay of the additional user equipment to one another. The start value is the time delay of UE4.

Parameters:

<Step> integer
 Range: 0 to 38400 (1 frame)
 *RST: 0
 Default unit: chip

Example:

```
BB:W3GP:MST:ADD:TDEL:STEP 256
```

shifts each of the user equipment 256 chips apart, starting from the time delay of UE4.

Manual operation: See ["Time Delay Step"](#) on page 75

[:SOURCE<hw>]:BB:W3GPp:MSTation:PRESet

The command produces a standardized default for all the user equipment. The settings correspond to the *RST values specified for the commands.

All user equipment settings are preset.

Example:

```
BB:W3GP:MST:PRESet
```

resets all the user equipment settings to default values.

Usage:

Event

Manual operation: See ["Reset User Equipment"](#) on page 54

[:SOURCE<hw>]:BB:W3GPp:MSTation<st>:MODE <Mode>

The command selects the operating mode for the user equipment.

Parameters:

<Mode> PRACH | PCPCh | DPCDch | PPRach | PPCPch

PRACH

The user equipment only generates a signal with a physical random access channel (PRACH). This channel is used to set up the user equipment connection with the base station. The channel-specific parameters of the PRACH can be set with the commands `:SOURCE:BB:W3GPp:MSTation<n>:PRACH:....`

PPRACH

The user equipment only generates a signal with the preamble component of a physical random access channel (PRACH). The parameters of the PRACH preamble can be set with the commands `:SOURCE:BB:W3GPp:MSTation<n>:PRACH:....`

PCPCh

The user equipment only generates a signal with a physical common packet channel (PCPCH). This channel is used to transmit packet-oriented services (e.g. SMS). The channel-specific parameters of the PCPCH can be set with the commands `:SOURCE:BB:W3GPp:MSTation<n>:PCPCh:....`

PPCPch

The user equipment only generates a signal with the preamble component of a physical common packet channel (PCPCH). The parameters of the PCPCH preamble can be set with the commands `:SOURCE:BB:W3GPp:MSTation<n>:PCPCh:....`

DPCDch

The user equipment generates a signal with a dedicated physical control channel (DPCCH), up to 6 dedicated physical data channels (DPDCH), up to one HS-DPCCH channel, up to one E-DPCCH channel and up to four E-DPDCH channels. This signal is used for voice and data transmission.

*RST: DPCDch

Example:

`BB:W3GP:MST1:MODE DPCD`

switches the user equipment to standard mode - transmission of voice and data.

Manual operation: See ["Mode"](#) on page 149

[:SOURCE<hw>]:BB:W3GPp:MSTation<st>:SCODE <SCode>

The command sets the scrambling code. Long or short scrambling codes can be generated (command `[:SOURCE<hw>] :BB:W3GPp:MSTation<st>:SCODE:MODE`).

Parameters:

<SCode> integer
 Range: #H0 to #HFFFFFFF
 *RST: #H0

Example:

`BB:W3GP:MST2:SCOD #H12`

sets scrambling code #12.

Manual operation: See ["Scrambling Code \(hex\)"](#) on page 150

[:SOURCE<hw>]:BB:W3GPp:MSTation<st>:SCODE:MODE <Mode>

The command sets the type for the scrambling code. The scrambling code generator can also be deactivated for test purposes.

SHORT is only standardized for the selection `:BB:W3GP:MST:MODE DPCDh` and `:BB:W3GP:MST:MODE PCPCh`. But it can also be generated for the PCPCH for test purposes.

Parameters:

<Mode> LONG | SHORT | OFF
 *RST: LONG

Example:

`BB:W3GP:MST2:SCOD:MODE OFF`

deactivates the scrambling code generator.

Manual operation: See ["Scrambling Mode"](#) on page 150

[:SOURce<hw>]:BB:W3GPp:MSTation<st>:STATe <State>

The command activates and deactivates the specified user equipment.

Parameters:

<State> 0 | 1 | OFF | ON
 *RST: ON

Example: BB:W3GP:MST2:STAT OFF
 deactivates user equipment 2.

Manual operation: See " [Select Basestation/User Equipment](#) " on page 55

[:SOURce<hw>]:BB:W3GPp:MSTation<st>:TDElay <TDelay>

Adds a time shift for the selected user equipment compared to user equipment 1.

Parameters:

<TDelay> integer
 Range: 0 to 38400
 *RST: 0
 Default unit: chip

Example: BB:W3GP:MST2:TDEL 256
 shifts user equipment 2 by 256 chips compared to user equipment 1.

Manual operation: See " [Time Delay](#) " on page 150

[:SOURce<hw>]:BB:W3GPp:LREference <Reference>

Determines the power reference for the calculation of the output signal power in uplink direction.

Parameters:

<Reference> RMS | DPCC | PMP | LPP | EDCH | HACK | PCQI
 RMS = RMS Power, DPCC = First DPCC, PMP = PRACH Message Part, LPP = Last PRACH Preamble, EDCH = First E-DCH, HACK = First HARQ-ACK, PCQI = First PCI/CQI
 *RST: RMS

Example: SOURce1:BB:W3GPp:LREference RMS

Manual operation: See " [Power Reference](#) " on page 56

7.9.2 Compressed Mode Settings

[:SOURce<hw>]:BB:W3GPp:MSTation<st>:CMODE:METhod..... 348
 [:SOURce<hw>]:BB:W3GPp:MSTation<st>:CMODE:PATtern<ch>:TGD..... 348
 [:SOURce<hw>]:BB:W3GPp:MSTation<st>:CMODE:PATtern<ch>:TGL<di>..... 348

[:SOURce<hw>]:BB:W3GPp:MSTation<st>:CMODE:PATtern<ch>:TGPL.....	349
[:SOURce<hw>]:BB:W3GPp:MSTation<st>:CMODE:PATtern<ch>:TGSN.....	349
[:SOURce<hw>]:BB:W3GPp:MSTation<st>:CMODE:STATE.....	349

[:SOURce<hw>]:BB:W3GPp:MSTation<st>:CMODE:METHod <Method>

The command selects compressed mode method.

Parameters:

<Method> HLSCheduling | SF2

SF2

The data is compressed by halving the spreading factor.

HLSCheduling

The data is compressed by stopping the transmission of the data stream during the transmission gap.

*RST: SF2

Example:

BB:W3GP:MST2:CMOD:METH HLSC

selects compressed mode method High Layer Scheduling.

Manual operation: See "[Compressed Mode Method - UE](#)" on page 87

[:SOURce<hw>]:BB:W3GPp:MSTation<st>:CMODE:PATtern<ch>:TGD <Tgd>

Sets the transmission gap distances.

Parameters:

<Tgd> integer
 Range: 3 to 100
 *RST: 15

Example:

BB:W3GP:MST2:CMOD:PATT2:TGD 7

sets transmission gap distance of pattern 2 to 7 slots.

Manual operation: See "[Distance](#)" on page 89

[:SOURce<hw>]:BB:W3GPp:MSTation<st>:CMODE:PATtern<ch>:TGL<di> <Tgl>

Sets the transmission gap lengths.

Parameters:

<Tgl> integer
 Range: 3 to 14
 *RST: 3

Example:

BB:W3GP:MST2:CMOD:PATT2:TGL1 4

sets transmission gap length of gap 1 of pattern 2 to 4 slots.

Manual operation: See "[Gap Len:](#)" on page 89

[[:SOURce<hw>]:BB:W3GPp:MSTation<st>:CMODE:PATtern<ch>:TGPL <Tgpl>

The command sets the transmission gap pattern lengths. Setting 0 is available only for pattern 2.

The transmission gap pattern lengths of the base station with the same suffix as the selected user equipment is set to the same value.

Parameters:

<Tgpl> integer
 Range: 0 to 100
 *RST: 2

Example: BB:W3GP:MST2:CMOD:PATT2:TGPL 7
 sets transmission gap pattern length of pattern 2 to 7 frames.

Manual operation: See "[Pattern Len.](#)" on page 90

[[:SOURce<hw>]:BB:W3GPp:MSTation<st>:CMODE:PATtern<ch>:TGSN <Tgsn>

Sets the transmission gap slot number of pattern 1.

Parameters:

<Tgsn> integer
 Range: 0 to 14
 *RST: 7

Example: BB:W3GP:MST2:CMOD:PATT:TGSN 4
 sets slot number of pattern 1 to slot 4.

Manual operation: See "[At Slot.](#)" on page 89

[[:SOURce<hw>]:BB:W3GPp:MSTation<st>:CMODE:STATe <State>

The command activates/deactivates the compressed mode.

Parameters:

<State> ON | OFF
 *RST: 0

Example: BB:W3GP:MST2:CMOD:STAT ON
 activates compressed mode for user equipment 2.

Manual operation: See "[Compressed Mode State](#)" on page 79

7.9.3 DPCCH Settings

[:SOURce<hw>]:BB:W3GPp:MSTation<st>:DPCCh:CCODE?	350
[:SOURce<hw>]:BB:W3GPp:MSTation<st>:DPCCh:FBI:MODE	350
[:SOURce<hw>]:BB:W3GPp:MSTation<st>:DPCCh:FBI:PATtern	351
[:SOURce<hw>]:BB:W3GPp:MSTation<st>:DPCCh:POWER	351
[:SOURce<hw>]:BB:W3GPp:MSTation<st>:DPCCh:SFORmat	351

<code>[:SOURCE<hw>] : BB : W3GPp : MSTation<st> : DPCCCh : TFCI</code>	352
<code>[:SOURCE<hw>] : BB : W3GPp : MSTation<st> : DPCCCh : TFCI : STATE</code>	352
<code>[:SOURCE<hw>] : BB : W3GPp : MSTation<st> : DPCCCh : TOFFset</code>	353
<code>[:SOURCE<hw>] : BB : W3GPp : MSTation<st> : DPCCCh : TPC : DATA</code>	353
<code>[:SOURCE<hw>] : BB : W3GPp : MSTation<st> : DPCCCh : TPC : DATA : DSElect</code>	353
<code>[:SOURCE<hw>] : BB : W3GPp : MSTation<st> : DPCCCh : TPC : DATA : PATtern</code>	354
<code>[:SOURCE<hw>] : BB : W3GPp : MSTation<st> : DPCCCh : TPC : MISuse</code>	354
<code>[:SOURCE<hw>] : BB : W3GPp : MSTation<st> : DPCCCh : TPC : MODE</code>	355
<code>[:SOURCE<hw>] : BB : W3GPp : MSTation<st> : DPCCCh : TPC : PSTep</code>	355
<code>[:SOURCE<hw>] : BB : W3GPp : MSTation<st> : DPCCCh : TPC : READ</code>	356

`[:SOURCE<hw>] : BB : W3GPp : MSTation<st> : DPCCCh : CCODE?`

Queries the channelization code and the modulation branch of the specified channel. The value is fixed.

Return values:

`<CCode>` integer
Range: 0 to max

Example:

`BB : W3GP : MST1 : DPCC : CCOD?`
queries the channelization code for DPCCCH of user equipment 1.
Response: Q, 64

Usage: Query only

`[:SOURCE<hw>] : BB : W3GPp : MSTation<st> : DPCCCh : FBI : MODE <Mode>`

The command sets the number of bits for the FBI field. With OFF, the FBI field is not used.

Note: The former 2-bits long FBI Mode "D2B" according to 3GPP Release 4 specification TS 25.211 is not supported any more.

The command sets the slot format (`[:SOURCE<hw>] : BB : W3GPp : MSTation<st> : DPCCCh : SFORmat`) in conjunction with the set TFCI status (`[:SOURCE<hw>] : BB : W3GPp : MSTation<st> : DPCCCh : TFCI : STATE`) and the TPC Mode (`[:SOURCE<hw>] : BB : W3GPp : MSTation<st> : DPCCCh : TPC : MODE`) to the associated values.

Parameters:

`<Mode>` OFF | D1B
*RST: OFF

Example:

`BB : W3GP : MST1 : DPCC : FBI : MODE OFF`
an FBI field is not used.

Manual operation: See "FBI Mode" on page 185

[:SOURce<hw>]:BB:W3GPp:MSTation<st>:DPCCh:FBI:PATtern <Pattern>, <BitCount>

The command determines the bit pattern when the PATtern data source is selected for the FBI field.

Parameters:

<Pattern> numeric

The first parameter determines the bit pattern (choice of hexadecimal, octal or binary notation), the second specifies the number of bits to use.

*RST: #H0

<BitCount> integer

Range: 1 to 32

*RST: 1

Example:

BB:W3GP:MST1:DPCC:FBI:PATT #H3F,8
defines the bit pattern of the data for the FBI field.

Manual operation: See "[FBI Pattern \(bin\)](#)" on page 185

[:SOURce<hw>]:BB:W3GPp:MSTation<st>:DPCCh:POWer <Power>

The command defines the channel power for the DPCCH.

Parameters:

<Power> float

Range: -80 dB to 0 dB

Increment: 0.1 dB

*RST: 0 dB

Example:

BB:W3GP:MST1:DPCC:POW -10 dB
sets the channel power to -10 dB.

Manual operation: See "[Power](#)" on page 183

[:SOURce<hw>]:BB:W3GPp:MSTation<st>:DPCCh:SFORmat <SFormat>

The command sets the slot format for the DPCCH. The slot format defines the structure of the DPCCH slots and the control fields.

Slot Format # 4 is available only for instruments equipped with R&S SMx/AMU-K59.

Slot formats 0 to 4 are available for the DPCCH channel as defined in the 3GPP Release 7 specification TS 25.211.

Note:

The former slot formats 4 and 5 according to 3GPP Release 4 specification TS 25.211 are not supported any more.

The command sets the FBI mode (`[:SOURCE<hw>] :BB:W3GPp:MSTation<st> :DPCCh:FBI:MODE`), the TFCI status (`[:SOURCE<hw>] :BB:W3GPp:MSTation<st> :DPCCh:TFCI:STATe`) and the TPC Mode (`[:SOURCE<hw>] :BB:W3GPp:MSTation<st>:DPCCh:TPC:MODE`) to the associated values.

Parameters:

`<SFormat>` integer
 Range: 0 to 4
 *RST: 0

Example:

`BB:W3GP:MST2:DPCC:SFOR 3`
 selects slot format 3 for the DPCCH of user equipment 2.

Manual operation: See "[Slot Format #](#)" on page 184

[:SOURCE<hw>] :BB:W3GPp:MSTation<st> :DPCCh:TFCI <Tfci>

Sets the value of the TFCI (Transport Format Combination Indicator) field. This value selects a combination of 30 bits, which are divided into two groups of 15 successive slots.

Parameters:

`<Tfci>` integer
 Range: 0 to 1023
 *RST: 0

Example:

`BB:W3GP:MST1:DPCC:TFCI 21`
 sets the TFCI value to 21.

Manual operation: See "[TFCI](#)" on page 185

[:SOURCE<hw>] :BB:W3GPp:MSTation<st> :DPCCh:TFCI:STATe <State>

The command activates the TFCI (Transport Format Combination Indicator) field for the DPCCH.

The command sets the slot format (`[:SOURCE<hw>] :BB:W3GPp:MSTation<st> :DPCCh:SFormat`) in conjunction with the set FBI mode (`[:SOURCE<hw>] :BB:W3GPp:MSTation<st>:DPCCh:FBI:MODE`) and the TPC Mode (`[:SOURCE<hw>] :BB:W3GPp:MSTation<st>:DPCCh:TPC:MODE`) to the associated values.

Parameters:

`<State>` ON | OFF
 *RST: 1

Example:

`BB:W3GP:MST1:DPCC:TFCI:STAT ON`
 activates the TFCI field.

Manual operation: See "[Use TFCI](#)" on page 185

```
[:SOURce<hw>]:BB:W3GPp:MSTation<st>:DPCCh:TOFFset <TOffset>
```

Sets the timing offset.

Parameters:

```
<TOffset>          integer
                    Range:    0 to 1024
                    Increment: 1024
```

Example: `BB:W3GP:MST1:DPCC:TOFF?`
queries the timing offset.

Manual operation: See "[DL-UL Timing Offset](#)" on page 183

```
[:SOURce<hw>]:BB:W3GPp:MSTation<st>:DPCCh:TPC:DATA <Data>
```

The command determines the data source for the TPC field of the DPCCH.

Parameters:

```
<Data>             DLISt | ZERO | ONE | PATTErn |
```

DLISt

A data list is used. The data list is selected with the command
`[:SOURce<hw>]:BB:W3GPp:MSTation<st>:DPCCh:TPC:DATA:DSElect`.

ZERO | ONE

Internal 0 and 1 data is used.

PATTErn

Internal data is used. The bit pattern for the data is defined by
the command `[:SOURce<hw>]:BB:W3GPp:MSTation<st>:DPCCh:TPC:DATA:PATTErn`. The maximum length is 64 bits.

*RST: ZERO

Example: `BB:W3GP:MST2:DPCC:TPC:DATA PATT`
selects as the data source for the TPC field of user equipment 2
the bit pattern defined with the following command.
`BB:W3GP:MST2:DPCC:TPC:DATA: PATT #H48D0,16`
defines the bit pattern.

Manual operation: See "[Data List Management](#)" on page 49

```
[:SOURce<hw>]:BB:W3GPp:MSTation<st>:DPCCh:TPC:DATA:DSElect <DSelect>
```

The command selects the data list when the DLISt data source is selected for the TPC field of the DPCCH.

The files are stored with the fixed file extensions `*.dm_iqd` in a directory of the user's choice. The directory applicable to the commands is defined with the command `MMEMoRY:CDIR`. To access the files in this directory, you only have to give the file name, without the path and the file extension.

Parameters:**<DSelect>** string**Example:**

BB:W3GP:MST1:DPCC:TPC:DATA DLIS

selects the Data Lists data source.

M MEM:CDIR '/var/user/temp/IQData'

selects the directory for the data lists.

BB:W3GP:MST1:DPCC:TPC:DATA:DSEL 'dpcch_tpc_1'

selects the data list dpcch_tpc1.

Manual operation: See ["Data List Management"](#) on page 49**[:SOURce<hw>]:BB:W3GPp:MSTation<st>:DPCCh:TPC:DATA:PATtern <Pattern>, <BitCount>**

The command determines the bit pattern for the PATtern data source selection. The maximum length of the bit pattern is 64 bits.

Parameters:**<Pattern>** numeric***RST:** #H0**<BitCount>** integer**Range:** 1 to 64***RST:** 1**Example:**

BB:W3GP:MST1:DPCC:TPC:DATA:PATT #B11110000,8

defines the bit pattern of the data for the TPC field.

Manual operation: See ["TPC Data Source"](#) on page 186**[:SOURce<hw>]:BB:W3GPp:MSTation<st>:DPCCh:TPC:MIUse <MisUse>**

The command activates "mis-" use of the TPC field (Transmit Power Control) for controlling the channel power of the user equipment.

The bit pattern (see com-

mands `:SOURce:BB:W3GPp:MSTation:DPCC:TPC:DATA...`) of the TPC field of the DPCCH is used to control the channel power. A "1" leads to an increase of channel powers, a "0" to a reduction of channel powers. Channel power is limited to the range 0 dB to -60 dB. The step width for the change is defined by the command [\[:SOURce<hw>\]:BB:W3GPp:MSTation<st>:DPCCh:TPC:PSTep](#).**Note:** "Mis-"using the TPC field is available for UE2, UE3,UE4 only.**Parameters:****<MisUse>** ON | OFF***RST:** 0

Example: `BB:W3GP:MST2:DPCC:TPC:MIS ON`
 activates regulation of the channel power via the bit pattern of the TPC field.
`BB:W3GP:MST2:DPCC:TPC:PST 1 dB`
 sets the step width for the change of channel power to 1 dB.

Manual operation: See ["Misuse TPC for Output Power Control"](#) on page 187

[:SOURce<hw>]:BB:W3GPp:MSTation<st>:DPCCh:TPC:MODE <Mode>

Selects the TPC (Transmit Power Control) mode.

The command sets the slot format (`[:SOURce<hw>]:BB:W3GPp:MSTation<st>:DPCCh:SFORmat`) in conjunction with the set TFCI status (`[:SOURce<hw>]:BB:W3GPp:MSTation<st>:DPCCh:TFCI:STATe`) and the FBI Mode (`[:SOURce<hw>]:BB:W3GPp:MSTation<st>:DPCCh:FBI:MODE`) to the associated values.

Parameters:

<Mode> D2B | D4B

D2B
 A TPC field with a length of 2 bits is used.

D4B
 (enabled only for instruments equipped with R&S SMx/AMU-K59)
 A TPC field with a length of 4 bits is used.
 A 4 bits long TPC field can be selected, only for Slot Format 4 and disabled FBI and TFCI fields.

*RST: D2B

Example: `BB:W3GP:MST1:DPCC:TPC:MODE D2B`
 an TPC field with a length of 2 bits is used.

Manual operation: See ["TPC Mode"](#) on page 186

[:SOURce<hw>]:BB:W3GPp:MSTation<st>:DPCCh:TPC:PSTep <PStep>

The command sets the level of the power step in dB for controlling the transmit power via the data of the TPC field.

Parameters:

<PStep> float

Range: -10 to 10
 Increment: 0.01
 *RST: 0

Example: `BB:W3GP:MST:DPCC:TPC:MIS ON`
 activates regulation of the channel power via the bit pattern of the TPC field.
`BB:W3GP:MST:DPCC:TPC:PST 1 dB`
 sets the step width for the change of channel power to 1 dB.

Manual operation: See "TPC Power Step" on page 188

[:SOURce<hw>]:BB:W3GPp:MSTation<st>:DPCCh:TPC:READ <Read>

The command sets the read out mode for the bit pattern of the TPC field of the DPCCH.

The bit pattern is selected with the command

SOUR:BB:W3GPp:MST:DPCC:TPC:DATA:PATT.

Parameters:

<Read> CONTInuous | S0A | S1A | S01A | S10A

CONTInuous

The bit pattern is used cyclically.

S0A

The bit pattern is used once, then the TPC sequence continues with 0 bits.

S1A

The bit pattern is used once, then the TPC sequence continues with 1 bit.

S01A

The bit pattern is used once and then the TPC sequence is continued with 0 bits and 1 bit alternately (in multiples, depending on by the symbol rate, for example, 00001111).

S10A

The bit pattern is used once and then the TPC sequence is continued with 1 bit and 0 bits alternately (in multiples, depending on by the symbol rate, for example, 11110000).

*RST: CONTInuous

Example:

BB:W3GP:MST2:DPCC:TPC:READ CONT

The selected bit pattern is repeated continuously for the TPC sequence.

Manual operation: See "TPC Read Out Mode" on page 186

7.9.4 HS-DPCCH Settings

7.9.4.1 Common Settings

[:SOURce<hw>]:BB:W3GPp:MSTation<st>:DPCCh:HS:STATE.....	357
[:SOURce<hw>]:BB:W3GPp:MSTation<st>:DPCCh:HS:POWer.....	357
[:SOURce<hw>]:BB:W3GPp:MSTation<st>:DPCCh:HS:COMPatibility.....	357
[:SOURce<hw>]:BB:W3GPp:MSTation<st>:DPCCh:HS:CCODE?.....	358
[:SOURce<hw>]:BB:W3GPp:MSTation<st>:DPCCh:HS:SDELay.....	358
[:SOURce<hw>]:BB:W3GPp:MSTation<st>:DPCCh:HS:TTIDistance.....	358

```
[:SOURce<hw>]:BB:W3GPp:MSTation<st>:DPCCh:HS:STATe <State>
```

This command activates or deactivates the HS-DPCCH.

Parameters:

```
<State>          0 | 1 | OFF | ON
*RST:           0
```

Example: `BB:W3GP:MST1:DPCC:HS:STAT ON`
activates HS-DPCCH.

Manual operation: See "[State \(HS-DPCCH\)](#)" on page 192

```
[:SOURce<hw>]:BB:W3GPp:MSTation<st>:DPCCh:HS:POWer <Power>
```

Sets the channel power in dB.

The power is set relative to the powers of the other channels. If "Adjust Total Power to 0 dB" is executed (`[:SOURce<hw>] :BB:W3GPp:POWer:ADJust`), the power is normalized to total power for all channels of 0 dB. The power ratio of the individual channels remains unchanged.

Parameters:

```
<Power>         float
                Range:   -80 to 0
                Increment: 0.01
                *RST:     0
```

Example: `BB:W3GP:MST1:DPCC:HS:POW -30`
Sets the channel power to -30 dB.

Manual operation: See "[Power \(HS-DPCCH\)](#)" on page 193

```
[:SOURce<hw>]:BB:W3GPp:MSTation<st>:DPCCh:HS:COMPatibility <Compatibility>
```

The concept of the graphical user interface for the configuration of HS-DPCCH has been adapted to support simultaneous DC-HSDPA and MIMO operation, as required in 3GPP Release 9 onwards.

This command enables the configuration of the HS-DPCCH settings provided for backwards compatibility (REL7).

Parameters:

```
<Compatibility> REL7 | REL8 | REL8RT
*RST:           REL8
```

Example: `BB:W3GP:MST1:DPCC:HS:COMP REL8`
Sets the compatibility mode to Release 8 and Later.

Manual operation: See "[Compatibility Mode \(HS-DPCCH\)](#)" on page 193

[:SOURce<hw>]:BB:W3GPp:MSTation<st>:DPCCh:HS:CCODE?

Queries the channelization code and the modulation branch of the HS-DPCCH.

Return values:

<CCode> integer
 Range: 1 to 64
 *RST: 64

Example:

BB:W3GP:MST1:DPCC:HS:CCOD?
 queries the channelization code.
 Response: Q, 32
 the channelization code is 32 and the modulation branch is Q.

Usage: Query only

Manual operation: See "[Channelization Code](#)" on page 182

[:SOURce<hw>]:BB:W3GPp:MSTation<st>:DPCCh:HS:SDELay <SDelay>

Sets the delay between the uplink HS-DPCCH and the frame of uplink DPCH.

Parameters:

<SDelay> integer
 a multiple m of 256 chips according to TS 25.211 7.7
 Range: 0 to 250
 *RST: 101
 Default unit: * 256 Chips

Example:

BB:W3GP:MST1:DPCC:HS:SDEL 101
 sets a start delay of 101 x 256 chips.

Manual operation: See "[Start Delay](#)" on page 193

[:SOURce<hw>]:BB:W3GPp:MSTation<st>:DPCCh:HS:TTIDistance <TtiDistance>

Selects the distance between two packets in HSDPA packet mode.

Parameters:

<TtiDistance> integer
 Range: 1 to 16
 *RST: 5

Example:

BB:W3GP:MST1:DPCC:HS:TTID 4
 selects an Inter TTI Distance of 4 subframes.

Manual operation: See "[Inter TTI Distance \(Interval\)](#)" on page 194

7.9.4.2 Up to Release 7 Settings

[:SOURCE<hw>]:BB:W3GPp:MSTation<st>:DPCCh:HS:POACK.....	359
[:SOURCE<hw>]:BB:W3GPp:MSTation<st>:DPCCh:HS:PONACK.....	359
[:SOURCE<hw>]:BB:W3GPp:MSTation<st>:DPCCh:HS:HAPattern.....	360
[:SOURCE<hw>]:BB:W3GPp:MSTation<st>:DPCCh:HS:CQI:PLENgtH.....	360
[:SOURCE<hw>]:BB:W3GPp:MSTation<st>:DPCCh:HS:CQI<ch>[:VALues].....	361
[:SOURCE<hw>]:BB:W3GPp:MSTation<st>:DPCCh:HS:MIMO[:MODE].....	361
[:SOURCE<hw>]:BB:W3GPp:MSTation<st>:DPCCh:HS:MIMO:POAAck.....	361
[:SOURCE<hw>]:BB:W3GPp:MSTation<st>:DPCCh:HS:MIMO:POANack.....	362
[:SOURCE<hw>]:BB:W3GPp:MSTation<st>:DPCCh:HS:MIMO:PONack.....	362
[:SOURCE<hw>]:BB:W3GPp:MSTation<st>:DPCCh:HS:MIMO:PONNack.....	363
[:SOURCE<hw>]:BB:W3GPp:MSTation<st>:DPCCh:HS:MIMO:POCA.....	364
[:SOURCE<hw>]:BB:W3GPp:MSTation<st>:DPCCh:HS:MIMO:TTICount.....	364
[:SOURCE<hw>]:BB:W3GPp:MSTation<st>:DPCCh:HS:MIMO:TTI<ch0>:HACK.....	365
[:SOURCE<hw>]:BB:W3GPp:MSTation<st>:DPCCh:HS:MIMO:TTI<ch0>:PCI.....	365
[:SOURCE<hw>]:BB:W3GPp:MSTation<st>:DPCCh:HS:MIMO:TTI<ch0>:CQIType.....	365
[:SOURCE<hw>]:BB:W3GPp:MSTation<st>:DPCCh:HS:MIMO:TTI<ch0>:CQI<di>.....	366

[:SOURCE<hw>]:BB:W3GPp:MSTation<st>:DPCCh:HS:POACK <Poack>

(Up to Release 7)

Sets the channel power part of the ACK in dB.

Parameters:

<Poack>	float
	Range: -10 to 10
	Increment: 0.1
	*RST: 0

Example: BB:W3GP:MST1:DPCC:HS:POAC -2.5dB
Sets the channel power part of the ACK to 2.5 dB.

Manual operation: See "[Power Offset ACK](#)" on page 204

[:SOURCE<hw>]:BB:W3GPp:MSTation<st>:DPCCh:HS:PONACK <PoNack>

(Up to Release 7)

Sets the channel power part of the NACK in dB.

Parameters:

<PoNack>	float
	Range: -10 to 10
	Increment: 0.1
	*RST: 0

Example: BB:W3GP:MST1:DPCC:HS:PONA -2.5dB
Sets the channel power part of the NACK to 2.5 dB.

Manual operation: See "[Power Offset NACK](#)" on page 205

[:SOURce<hw>]:BB:W3GPp:MSTation<st>:DPCCh:HS:HAPattern <HaPattern>

(Up to Release 7)

The command enters the pattern for the HARQ-ACK field (Hybrid-ARQ Acknowledgement). One bit is used per HS-DPCCH packet.

Parameters:

<HaPattern>

string

The pattern is entered as string, the maximum number of entries is 32. Three different characters are permitted.

1

The HARQ ACK is sent (ACK). Transmission was successful and correct.

0

The NACK is sent (NACK). Transmission was not correct. With an NACK, the UE requests retransmission of the incorrect data.

-

Nothing is sent. Transmission is interrupted (Discontinuous Transmission, DTX).

*RST: <empty>

Example:

BB:W3GP:MST1:DPCC:HS:COMP REL7

BB:W3GP:MST1:DPCC:HS:HAP "110--110-0"

enters the pattern for the HARQ-ACK field.

Manual operation: See "[ACK/NACK Pattern](#)" on page 205

[:SOURce<hw>]:BB:W3GPp:MSTation<st>:DPCCh:HS:CQI:PLENght <PLength>

Sets the length of the CQI sequence.

The values of the CQI sequence are defined with command `[:SOURce<hw>]:BB:W3GPp:MSTation<st>:DPCCh:HS:CQI<ch>[:VALues]`. The pattern is generated cyclically.

Parameters:

<PLength>

integer

Range: 1 to 10

*RST: 1

Example:

BB:W3GP:MST1:DPCC:HS:CQI:PLEN 2

the CQI sequence length is 2 values.

BB:W3GP:MST1:DPCC:HS:CQI1 -1

the first CQI value is -1.

BB:W3GP:MST1:DPCC:HS:CQI2 2

the second CQI value is 2.

Manual operation: See "[CQI Pattern Length](#)" on page 205

[:SOURce<hw>]:BB:W3GPp:MSTation<st>:DPCCh:HS:CQI<ch>[:VALues]
 <Values>

Sets the values of the CQI sequence.

The length of the CQI sequence is defined with command `[:SOURce<hw>]:BB:W3GPp:MSTation<st>:DPCCh:HS:CQI:PLENgtH`. The pattern is generated cyclically.

Parameters:

<Values> integer
 Value -1 means that no CQI is sent (DTX - Discontinuous Transmission).
 Range: -1 to 30
 *RST: 1

Example:

BB:W3GP:MST1:DPCC:HS:CQI:PLEN 2
 the CQI sequence length is 2 values.
 BB:W3GP:MST1:DPCC:HS:CQI1 1
 the first CQI value is -1.
 BB:W3GP:MST1:DPCC:HS:CQI2 2
 the second CQI value is 2.

Manual operation: See "CQI Values" on page 205

[:SOURce<hw>]:BB:W3GPp:MSTation<st>:DPCCh:HS:MIMO[:MODE] <Mode>

Enables/disables working in MIMO mode for the selected UE.

Parameters:

<Mode> 0 | 1 | OFF | ON
 *RST: 0

Example:

BB:W3GP:MST1:DPCC:HS:MIMO:MODE ON
 Enables MIMO mode for UE 1.

Options: R&S SMBV-K59

Manual operation: See "MIMO Mode (Up to Release 7)" on page 206

[:SOURce<hw>]:BB:W3GPp:MSTation<st>:DPCCh:HS:MIMO:POAAck <PoaAck>

(up to Release 7)

Sets the power offset $P_{\text{off_ACK/ACK}}$ of an ACK/ACK response to two scheduled transport blocks relative to the CQI Power P_{CQI} (`[:SOURce<hw>]:BB:W3GPp:MSTation<st>:DPCCh:HS:POWer`).

The power P_{ACK/ACK} used during the HARQ-ACK slots is calculated as:

$$P_{\text{ACK/ACK}} = P_{\text{CQI}} + P_{\text{off_ACK/ACK}}$$

Parameters:

<PoaAck> float
 Range: -10 to 10
 Increment: 0.1
 *RST: 0

Example:

BB:W3GP:MST1:DPCC:HS:MIMO:MODE ON
 Enables MIMO mode for UE 1.
 BB:W3GP:MST1:DPCC:HS:MIMO:TTI2:HACK ACK
 Sets the HARQ-ACK to ACK/ACK.
 BB:W3GP:MST1:DPCC:HS:MIMO:POAA -2.5dB
 Sets the power offset to -2.5 dB.

Options: R&S SMBV-K59

Manual operation: See ["Power Offset ACK/ACK"](#) on page 207

[:SOURCE<hw>]:BB:W3GPP:MSTation<st>:DPCCh:HS:MIMO:POANack
 <PoaNack>

(up to Release 7)

Sets the power offset $P_{\text{off_ACK/NACK}}$ of an ACK/NACK response to two scheduled transport blocks relative to the CQI Power P_{CQI} ([\[:SOURCE<hw>\]:BB:W3GPP:MSTation<st>:DPCCh:HS:POWER](#)).

The power $P_{\text{ACK/NACK}}$ used during the HARQ-ACK slots is calculated as:

$$P_{\text{ACK/NACK}} = P_{\text{CQI}} + P_{\text{off_ACK/NACK}}$$

Parameters:

<PoaNack> float
 Range: -10 to 10
 Increment: 0.1
 *RST: 0

Example:

BB:W3GP:MST1:DPCC:HS:MIMO:MODE ON
 Enables MIMO mode for UE 1.
 BB:W3GP:MST1:DPCC:HS:MIMO:TTI2:HACK ANACK
 Sets the HARQ-ACK to ACK/NACK.
 BB:W3GP:MST1:DPCC:HS:MIMO:POAN -1.5dB
 Sets the power offset to -1.5 dB.

Options: R&S SMBV-K59

Manual operation: See ["Power Offset ACK/NACK"](#) on page 207

[:SOURCE<hw>]:BB:W3GPP:MSTation<st>:DPCCh:HS:MIMO:PONack <PoNack>

(up to Release 7)

Sets the power offset $P_{\text{off_NACK/ACK}}$ of an NACK/ACK response to two scheduled transport blocks relative to the CQI Power P_{CQI} (`[:SOURCE<hw>] :BB:W3GPp: MSTation<st>:DPCC:HS:POWER`).

The power $P_{\text{NACK/ACK}}$ used during the HARQ-ACK slots is calculated as:

$$P_{\text{NACK/ACK}} = P_{\text{CQI}} + P_{\text{off_NACK/ACK}}$$

Parameters:

<PoNack> float
 Range: -10 to 10
 Increment: 0.1
 *RST: 0

Example:

BB:W3GP:MST1:DPCC:HS:MIMO:MODE ON
 Enables MIMO mode for UE 1.
 BB:W3GP:MST1:DPCC:HS:MIMO:TTI2:HACK NACK
 Sets the HARQ-ACK to NACK/ACK.
 BB:W3GP:MST1:DPCC:HS:MIMO:PONA -1dB
 Sets the power offset to -1dB.

Options: R&S SMBV-K59

Manual operation: See ["Power Offset NACK/ACK"](#) on page 208

`[:SOURCE<hw>] :BB:W3GPp: MSTation<st>:DPCC:HS:MIMO:PONNack
 <PonNack>`

(up to Release 7)

Sets the power offset $P_{\text{off_NACK/NACK}}$ of an NACK/NACK response to two scheduled transport blocks relative to the CQI Power P_{CQI} (`[:SOURCE<hw>] :BB:W3GPp: MSTation<st>:DPCC:HS:POWER`).

The power $P_{\text{NACK/NACK}}$ used during the HARQ-ACK slots is calculated as:

$$P_{\text{NACK/NACK}} = P_{\text{CQI}} + P_{\text{off_NACK/NACK}}$$

Parameters:

<PonNack> float
 Range: -10 to 10
 Increment: 0.1
 *RST: 0

Example:

BB:W3GP:MST1:DPCC:HS:MIMO:MODE ON
 Enables MIMO mode for UE 1.
 BB:W3GP:MST1:DPCC:HS:MIMO:TTI2:HACK NNAC
 Sts the HARQ-ACK to NACK/NACK.
 BB:W3GP:MST1:DPCC:HS:MIMO:PONN -3dB
 Sets the power offset to -3dB.

Options: R&S SMBV-K59

Manual operation: See ["Power Offset NACK/NACK"](#) on page 208

[:SOURce<hw>] :BB:W3GPp:MSTation<st>:DPCCCh:HS:MIMO:POCA <Poca>

(up to Release 7)

Sets the power offset $P_{\text{off_CQI Type A}}$ of the PCI/CQI slots in case a CQI Type A report is sent relative to the CQI Power P_{CQI} (**[:SOURce<hw>] :BB:W3GPp:MSTation<st>:DPCCCh:HS:POWer**).

The power $P_{\text{CQI Type A}}$ used during the PCI/CQI slots is calculated as:

$$P_{\text{CQI Type A}} = P_{\text{CQI}} + P_{\text{off_CQI Type A}}$$

Since the CQI Type B reports are used in a single stream transmission, the power $P_{\text{CQI Type B}} = P_{\text{CQI}}$.

Parameters:

<Poca> float
 Range: -10 to 10
 Increment: 0.1
 *RST: 0

Example:

BB:W3GP:MST1:DPCC:HS:MIMO:MODE ON
 Enables MIMO mode for UE 1.
 BB:W3GP:MST1:DPCC:HS:MIMO:MODE:TT2:CQIT TADT
 Selects CQI Type A Dual TB report for TTI2.
 BB:W3GP:MST1:DPCC:HS:MIMO:POCA -4dB
 Sets the power offset to -4dB.

Options: R&S SMBV-K59

Manual operation: See ["Power Offset CQI Type A"](#) on page 208

[:SOURce<hw>] :BB:W3GPp:MSTation<st>:DPCCCh:HS:MIMO:TTICount <TtiCount>

Selects the number of configurable TTI's.

Parameters:

<TtiCount> integer
 Range: 1 to 32
 *RST: 1

Example:

BB:W3GP:MST1:DPCC:HS:MIMO:MODE ON
 Enables MIMO mode for UE 1.
 BB:W3GP:MST1:DPCC:HS:MIMO:TTIC 4
 Sets the number of configurable TTI's to 4.

Options: R&S SMBV-K59

Manual operation: See ["Number of TTIs \(Up to Release 7\)"](#) on page 208

[:SOURce<hw>]:BB:W3GPp:MSTation<st>:DPCCh:HS:MIMO:TTI<ch0>:HACK
 <Hack>

Selects the information transmitted during the HARQ-ACK slot of the corresponding TTI.

Suffix:
 <ch0> 0..Number of TTI -1

Parameters:
 <Hack> DTX | SACK | SNACK | AACK | ANACK | NACK | NNACK
 *RST: AACK (for TTI 1)

Example:
 BB:W3GP:MST1:DPCC:HS:MIMO:MODE ON
 Enables MIMO mode for UE 1.
 BB:W3GP:MST1:DPCC:HS:MIMO:TTI2:HACK SACK
 Sets the HARQ-ACK to single ACK.

Options: R&S SMBV-K59

Manual operation: See "[HARQ-ACK \(Up to Release 7\)](#)" on page 209

[:SOURce<hw>]:BB:W3GPp:MSTation<st>:DPCCh:HS:MIMO:TTI<ch0>:PCI <Pci>

Selects the PCI value transmitted during the PCI/CQI slots of the corresponding TTI.

Suffix:
 <ch0> 0 to Number of TTI -1

Parameters:
 <Pci> integer
 Range: 0 to 3
 *RST: 0

Example:
 BB:W3GP:MST1:DPCC:HS:MIMO:MODE ON
 Enables MIMO mode for UE 1.
 BB:W3GP:MST1:DPCC:HS:MIMO:TTI2:HACK SACK
 Sets the HARQ-ACK to single ACK.
 BB:W3GP:MST1:DPCC:HS:MIMO:TTI2:PCI 2
 Sets the PCI.

Options: R&S SMBV-K59

Manual operation: See "[PCI \(Up to Release 7\)](#)" on page 209

[:SOURce<hw>]:BB:W3GPp:MSTation<st>:DPCCh:HS:MIMO:TTI<ch0>:CQIType
 <CqiType>

Selects the type of the CQI report.

Suffix:
 <ch0> 0..Number of TTI -1

Parameters:

<CqiType> TAST | TADT | TB
 *RST: TADT

Example:

BB:W3GP:MST1:DPCC:HS:MIMO:MODE ON
 Enables MIMO mode for UE 1.
 BB:W3GP:MST1:DPCC:HS:MIMO:TTI2:HACK SACK
 Ssets the HARQ-ACK to single ACK.
 BB:W3GP:MST1:DPCC:HS:MIMO:TTI2:CQIT TADT
 Selects CQI Type A dual TB report for TTI2.

Options: R&S SMBV-K59

Manual operation: See "CQI Type (Up to Release 7)" on page 209

**[:SOURCE<hw>]:BB:W3GPp:MSTation<st>:DPCC:HS:MIMO:TTI<ch0>:CQI<di>
 <Cqi>**

Selects the CQI report transmitted during the PCI/CQI slots of the corresponding TTI.

For single stream transmission (BB:W3GP:MST:DPCC:HS:MIMO:TTI:CQI1), this command set the CQI values of the following cases:

- The CQI (the value for CQI Type B report)
- The CQI_s (the CQI value in case a CQI Type A report when one transport block is preferred)

For dual stream transmission (BB:W3GP:MST:DPCC:HS:MIMO:TTI:CQI2), this command sets:

- The CQI₁, the first of the two CQI values of CQI Type A report when two transport blocks are preferred
- The CQI₂, the second of the two CQI values of CQI Type A report when two transport blocks are preferred. The CQI then is calculated as follows:
 $CQI = 15 * CQI_1 + CQI_2 + 31$

Suffix:

<ch0> 0..Number of TTI -1
 TTI

<di> 1|2
 The suffix CQI<1 | 2> distinguishes between CQI/CQI_s/CQI₁ and CQI₂.

Parameters:

<Cqi> integer
 Range: 0 to 30
 *RST: 0

- Example:** `BB:W3GP:MST1:DPCC:HS:MIMO:MODE ON`
Enables MIMO mode for UE 1.
- `BB:W3GP:MST1:DPCC:HS:MIMO:TTI2:HACK SACK`
Sets the HARQ-ACK to single ACK.
- `BB:W3GP:MST1:DPCC:HS:MIMO:TTI2:CQIT TADT`
Selects CQI Type A dual TB report for TTI2.
- `BB:W3GP:MST1:DPCC:HS:MIMO:TTI2:CQI1 1.5`
Sets CQI1
- `BB:W3GP:MST1:DPCC:HS:MIMO:TTI2:CQI2 2`
Sets CQI2
- Example:** `BB:W3GP:MST1:DPCC:HS:MIMO:TTI2:CQIT TAST`
Selects CQI Type A single TB report for TTI2.
- `BB:W3GP:MST1:DPCC:HS:MIMO:TTI2:CQI1 3`
Sets CQIS
- Example:** `BB:W3GP:MST1:DPCC:HS:MIMO:TTI2:CQIT TB`
Selects CQI Type B
- `BB:W3GP:MST1:DPCC:HS:MIMO:TTI2:CQI1 0`
Sets CQI
- Options:** R&S SMBV-K59
- Manual operation:** See "[CQI/CQI_s/CQI₁/CQI₂ \(Up to Release 7\)](#)" on page 209

7.9.4.3 Release 8 and Later (RT) Settings

Example: HS-DPCCH Scheduling

The following is a simple example intended to explain the principle. Configured is an HS-DPCCH scheduling in MIMO Mode and with "Secondary Cell Enabled = 1".

```
BB:W3GP:MST1:DPCC:HS:COMP REL8
BB:W3GP:MST1:DPCC:HS:TTID 5
BB:W3GP:MST1:DPCC:HS:MMOD ON
BB:W3GP:MST1:DPCC:HS:SC:ENABled 1
BB:W3GP:MST1:DPCC:HS:SC:ACT 0
BB:W3GP:MST1:DPCC:HS:HACK:ROWS 2
BB:W3GP:MST1:DPCC:HS:HACK:REPeat 4
BB:W3GP:MST1:DPCC:HS:ROW0:HACK:FROM 0
BB:W3GP:MST1:DPCC:HS:ROW0:HACK:TO 1
BB:W3GP:MST1:DPCC:HS:ROW0:HACK1 MS_AA_D
BB:W3GP:MST1:DPCC:HS:ROW1:HACK:FROM 3
BB:W3GP:MST1:DPCC:HS:ROW1:HACK:TO 3
BB:W3GP:MST1:DPCC:HS:ROW1:HACK1 MS_NN_NN
BB:W3GP:MST1:DPCC:HS:PCQI:ROWS 2
BB:W3GP:MST1:DPCC:HS:PCQI:REPeat 3
BB:W3GP:MST1:DPCC:HS:ROW0:PCQI:FROM 0
BB:W3GP:MST1:DPCC:HS:ROW0:PCQI:TO 0
BB:W3GP:MST1:DPCC:HS:ROW1:PCQI1:TYPE DTX
BB:W3GP:MST1:DPCC:HS:ROW1:PCQI:FROM 1
```

```

BB:W3GP:MST1:DPCC:HS:ROW1:PCQI:TO 1
BB:W3GP:MST1:DPCC:HS:ROW1:PCQI1:TYPE TADT
BB:W3GP:MST1:DPCC:HS:ROW1:PCQI1:CQI1 10
BB:W3GP:MST1:DPCC:HS:ROW1:PCQI1:CQI2 20
BB:W3GP:MST1:DPCC:HS:ROW1:PCQI1:PCI 2
BB:W3GP:MST1:DPCC:HS:STAT ON

```

[:SOURce<hw>]:BB:W3GPp:MSStation<st>:DPCCh:HS:SFormat?	368
[:SOURce<hw>]:BB:W3GPp:MSStation<st>:DPCCh:HS:MMODE	368
[:SOURce<hw>]:BB:W3GPp:MSStation<st>:DPCCh:HS:SC:ENABLEd	369
[:SOURce<hw>]:BB:W3GPp:MSStation<st>:DPCCh:HS:SC:ACTive	369
[:SOURce<hw>]:BB:W3GPp:MSStation<st>:DPCCh:HS:HACK:ROWS	369
[:SOURce<hw>]:BB:W3GPp:MSStation<st>:DPCCh:HS:PCQI:ROWS	369
[:SOURce<hw>]:BB:W3GPp:MSStation<st>:DPCCh:HS:ROW<ch0>:HACK:FROM	370
[:SOURce<hw>]:BB:W3GPp:MSStation<st>:DPCCh:HS:ROW<ch0>:HACK:TO	370
[:SOURce<hw>]:BB:W3GPp:MSStation<st>:DPCCh:HS:ROW<ch0>:HACK<di>	370
[:SOURce<hw>]:BB:W3GPp:MSStation<st>:DPCCh:HS:ROW<ch0>:POHACK	371
[:SOURce<hw>]:BB:W3GPp:MSStation<st>:DPCCh:HS:ROW<ch0>:PCQI:FROM	372
[:SOURce<hw>]:BB:W3GPp:MSStation<st>:DPCCh:HS:ROW<ch0>:PCQI:TO	372
[:SOURce<hw>]:BB:W3GPp:MSStation<st>:DPCCh:HS:ROW<ch0>:PCQI<di>:TYPE	372
[:SOURce<hw>]:BB:W3GPp:MSStation<st>:DPCCh:HS:ROW<ch0>:PCQI<di>:CQI<us>	373
[:SOURce<hw>]:BB:W3GPp:MSStation<st>:DPCCh:HS:ROW<ch0>:PCQI<di>:PCI	373
[:SOURce<hw>]:BB:W3GPp:MSStation<st>:DPCCh:HS:ROW<ch0>:POPCqi	373
[:SOURce<hw>]:BB:W3GPp:MSStation<st>:DPCCh:HS:HACK:REPeat	374
[:SOURce<hw>]:BB:W3GPp:MSStation<st>:DPCCh:HS:PCQI:REPeat	374
[:SOURce<hw>]:BB:W3GPp:MSStation<st>:DPCCh:HS:SLENgth?	374
[:SOURce<hw>]:BB:W3GPp:MSStation<st>:DPCCh:HS:SLENgth:ADJust	374

[\[:SOURce<hw>\]:BB:W3GPp:MSStation<st>:DPCCh:HS:SFormat?](#)

Queries the used slot format.

Return values:

<SlotFormat> integer
 Range: 0 to 1
 *RST: 0

Usage: Query only

Options: R&S SMBV-K59

Manual operation: See "[Slot Format](#)" on page 195

[\[:SOURce<hw>\]:BB:W3GPp:MSStation<st>:DPCCh:HS:MMODE <MMode>](#)

(Release 8 and Later, Release 8 and Later (RT))

Enables/disables working in MIMO mode for the selected UE.

Parameters:

<MMode> 0 | 1 | OFF | ON
 *RST: 0

Example: see [Example "HS-DPCCH Scheduling"](#) on page 367

Options: R&S SMBV-K59

Manual operation: See ["MIMO Mode"](#) on page 197

[:SOURCE<hw>]:BB:W3GPP:MSTation<st>:DPCCh:HS:SC:ENABLED
<SecCellEnabled>

Enables the selected number of secondary cells for the selected UE.

Parameters:

<SecCellEnabled> integer
Range: 0 to 7
*RST: 0

Example: see [Example "HS-DPCCH Scheduling"](#) on page 367

Options: R&S SMBV-K59

Manual operation: See ["Secondary Cell Enabled"](#) on page 197

[:SOURCE<hw>]:BB:W3GPP:MSTation<st>:DPCCh:HS:SC:ACTIVE
<SecCellActive>

(Release 8 and Later)

Sets the number of active secondary cells for the selected UE.

Parameters:

<SecCellActive> integer
Range: 0 to 7
*RST: 0

Example: see [Example "HS-DPCCH Scheduling"](#) on page 367

Options: R&S SMBV-K59

Manual operation: See ["Secondary Cell Active"](#) on page 197

[:SOURCE<hw>]:BB:W3GPP:MSTation<st>:DPCCh:HS:HACK:ROWS <RowCount>
[:SOURCE<hw>]:BB:W3GPP:MSTation<st>:DPCCh:HS:PCQI:ROWS <RowCount>

Determines the number of the rows in the HARQ-ACK respectively in the PCI/CQI scheduling table.

Parameters:

<RowCount> integer
Range: 1 to 32
*RST: 1

Example: See [Example "HS-DPCCH Scheduling"](#) on page 367

Options: R&S SMBV-K59

Manual operation: See ["Number of Rows"](#) on page 200

[:SOURCE<hw>]:BB:W3GPp:MSTation<st>:DPCCh:HS:ROW<ch0>:HACK:FROM
<HackFrom>

[:SOURCE<hw>]:BB:W3GPp:MSTation<st>:DPCCh:HS:ROW<ch0>:HACK:TO
<HackTo>

(Release 8 and later)

Defines the beginning / end of the HARQ-ACK transmissions inside the HARQ-ACK cycle. R&S SMBVThe range is specified in multiples of intervals (Inter-TTI distance).

Suffix:

<ch0> 0 to <RowCount>

Parameters:

<HackTo> integer
Range: 0 to dynamic
*RST: row index

Example: See [Example "HS-DPCCH Scheduling"](#) on page 367

Options: R&S SMBV-K59

Manual operation: See ["HARQ-ACK From Interval/ HARQ-ACK To Interval"](#) on page 198

[:SOURCE<hw>]:BB:W3GPp:MSTation<st>:DPCCh:HS:ROW<ch0>:HACK<di>
<HarqAck>

(Release 8 and Later)

Sets the information transmitted during the HARQ-ACK slots of the TTIs during the corresponding specified HARQ-ACK From/To range.

For detailed description, see ["HS-DPCCH 1/2, HARQ-ACK 1/2/3/4"](#) on page 198. The [Table 7-1](#) provides the necessary cross-reference information.

Table 7-1: Cross-reference between the used GUI terms and abbreviations in the SCPI command

Value name	Parameter value
"DTX"	DTX D_DTX
"PRE, POST"	PRE POST
"A, N"	A N
"AA, AN, NA, NN"	M_A M_N M_AA M_AN M_NA M_NN
"A/D, N/A, ... " (different combinations possible)	S_A_D S_N_A ... (different combinations possible)

Value name	Parameter value
"A/D/D, N/D/D, ... " (different combinations possible)	S2_N_N_N S2_N_N_A ... (different combinations possible)
"AN/NN, D/AA, ... " (different combinations possible)	MS_AA_AA MS_D_AA ... (different combinations possible)

Suffix:

<ch0> 0..<RowCount>

Parameters:

<HarqAck>

DTX | PRE | POST | A | N | M_A | M_N | M_AA | M_AN | M_NA |
M_NN | S_A_D | S_N_D | S_D_A | S_D_N | S_A_A | S_A_N |
S_N_A | S_N_N | MS_A_D | MS_N_D | MS_AA_D | MS_AN_D |
MS_NA_D | MS_NN_D | MS_D_A | MS_D_N | MS_D_AA |
MS_D_AN | MS_D_NA | MS_D_NN | MS_A_A | MS_A_N |
MS_N_A | MS_N_N | MS_A_AA | MS_A_AN | MS_A_NA |
MS_A_NN | MS_N_AA | MS_N_AN | MS_N_NA | MS_N_NN |
MS_AA_A | MS_AA_N | MS_AN_A | MS_AN_N | MS_NA_A |
MS_NA_N | MS_NN_A | MS_NN_N | MS_AA_AA |
MS_AA_AN | MS_AA_NA | MS_AA_NN | MS_AN_AA |
MS_AN_AN | MS_AN_NA | MS_AN_NN | MS_NA_AA |
MS_NA_AN | MS_NA_NA | MS_NA_NN | MS_NN_AA |
MS_NN_AN | MS_NN_NA | MS_NN_NN | S2_A_D_D |
S2_N_D_D | S2_D_A_D | S2_D_N_D | S2_D_D_A |
S2_D_D_N | S2_A_A_D | S2_A_N_D | S2_N_A_D |
S2_N_N_D | S2_A_D_A | S2_A_D_N | S2_N_D_A |
S2_N_D_N | S2_D_A_A | S2_D_A_N | S2_D_N_A |
S2_D_N_N | S2_A_A_A | S2_A_A_N | S2_A_N_A |
S2_A_N_N | S2_N_A_A | S2_N_A_N | S2_N_N_A |
S2_N_N_N | D_DTX

Example: See [Example "HS-DPCCH Scheduling"](#) on page 367**Options:** R&S SMBV-K59**Manual operation:** See ["HS-DPCCH 1/2, HARQ-ACK 1/2/3/4"](#) on page 198

```
[ :SOURce<hw>]:BB:W3GPP:MSTation<st>:DPCCh:HS:ROW<ch0>:POHACK
<PoHack>
```

(Release 8 and Later)

Sets the power offset of a HARQ-ACK response relative to the [\[:SOURce<hw>\]:BB:W3GPP:MSTation<st>:DPCCh:HS:POWER](#).**Suffix:**

<ch0> 0..<RowCount>

Parameters:

<PoHack> float
 Range: -10 to 10
 Increment: 0.1
 *RST: 0

Options: R&S SMBV-K59

Manual operation: See ["Power Offset HARQ-ACK"](#) on page 200

[:SOURCE<hw>]:BB:W3GPP:MSTation<st>:DPCCh:HS:ROW<ch0>:PCQI:FROM
 <PcqiFrom>

[:SOURCE<hw>]:BB:W3GPP:MSTation<st>:DPCCh:HS:ROW<ch0>:PCQI:TO
 <PcqiTo>

(Release 8 and later)

Defines the beginning / end of the PCI/CQI transmissions inside the PCI/CQI cycle. The range is specified in multiples of intervals (Inter-TTI distance).

Suffix:

<ch0> 0 to <RowCount>

Parameters:

<PcqiTo> integer
 Range: 0 to dynamic
 *RST: row index

Example: See [Example "HS-DPCCH Scheduling"](#) on page 367

Options: R&S SMBV-K59

Manual operation: See ["PCI-CQI From Interval/ PCI-CQI To Interval"](#) on page 200

[:SOURCE<hw>]:BB:W3GPP:MSTation<st>:DPCCh:HS:ROW<ch0>:PCQI<di>:
TYPE <CqiType>

Selects the type of the PCI/CQI report.

Suffix:

<ch0> 0..<RowCount>

Parameters:

<CqiType> DTX | CQI | TAST | TADT | TB | CCQI
TAST|TADT
 Type A Single TB, Type A Double TB
TB
 Type B
CCQI
 Composite CQI

Example: see [Example "HS-DPCCH Scheduling"](#) on page 367

Options: R&S SMBV-K59

Manual operation: See ["HS-DPCCH 1/2, PCI/CQI 1/2/3/4 Type"](#) on page 201

[:SOURce<hw>]:BB:W3GPP:MSTation<st>:DPCCh:HS:ROW<ch0>:PCQI<di>:CQI<us> <Cqi>

Parameters:

<Cqi> integer
 Range: 0 to 30
 *RST: 0

Example: see [Example "HS-DPCCH Scheduling"](#) on page 367

Options: R&S SMBV-K59

Manual operation: See ["CQI/CQI₃/CQI₁/CQI₂"](#) on page 202

[:SOURce<hw>]:BB:W3GPP:MSTation<st>:DPCCh:HS:ROW<ch0>:PCQI<di>:PCI<PCI>

Suffix:

<ch0> 0..<RowCount>

Parameters:

<PCI> integer
 Range: 0 to 3
 *RST: 0

Example: see [Example "HS-DPCCH Scheduling"](#) on page 367

Manual operation: See ["PCI"](#) on page 202

[:SOURce<hw>]:BB:W3GPP:MSTation<st>:DPCCh:HS:ROW<ch0>:POPcqi<PoPcqi>

(Release 8 and Later)

Sets the power offset $P_{\text{off_PCI/CQI}}$ of all PCI/CQI slots during the corresponding specified PCI/CQI From/To range relative to the [\[:SOURce<hw>\]:BB:W3GPP:MSTation<st>:DPCCh:HS:POWER](#).

Suffix:

<ch0> 0..<RowCount>

Parameters:

<PoPcqi> float
 Range: -10 to 10
 Increment: 0.1
 *RST: 0

Options: R&S SMBV-K59

Manual operation: See ["Power Offset PCI/CQI"](#) on page 201

[:SOURce<hw>]:BB:W3GPp:MSTation<st>:DPCCh:HS:HACK:REPeat <HackRep>

Defines the cycle length after that the information in the HS-DPCCH scheduling table is read out again from the beginning.

Parameters:

<HackRep> integer
Range: 1 to dynamic

Example: see [Example "HS-DPCCH Scheduling"](#) on page 367

Manual operation: See ["HARQ-ACK Repeat After"](#) on page 197

[:SOURce<hw>]:BB:W3GPp:MSTation<st>:DPCCh:HS:PCQI:REPeat <PcqiRep>

(Release 8 and Later)

Defines the cycle length after that the information in the HS-DPCCH scheduling table is read out again from the beginning.

Parameters:

<PcqiRep> integer
Range: 1 to dynamic
*RST: 1

Example: see [Example "HS-DPCCH Scheduling"](#) on page 367

Manual operation: See ["PCI/CQI Repeat After"](#) on page 200

[:SOURce<hw>]:BB:W3GPp:MSTation<st>:DPCCh:HS:SLENgth?

(Release 8 and Later)

Queries the suggested and current ARB sequence length.

The current ARB sequence length is adjusted with the command [\[:SOURce<hw>\]:BB:W3GPp:MSTation<st>:DPCCh:HS:SLENgth:ADJust](#) on page 374.

Return values:

<SLength> float

Example: BB:W3GP:MST1:DPCC:HS:SLEN?
Queries the ARB sequence length

Usage: Query only

Options: R&S SMBV-K59

Manual operation: See ["Suggested / Current ARB Seq. Length \(HS-DPCCH\)"](#) on page 202

[:SOURce<hw>]:BB:W3GPp:MSTation<st>:DPCCh:HS:SLENgth:ADJust

(Release 8 and Later)

Sets the current ARB sequence length to the suggested value.

Example: BB:W3GP:MST1:DPCC:HS:SLen:ADJ
Adjusts the ARB sequence length

Usage: Event

Options: R&S SMBV-K59

Manual operation: See "[Adjust ARB Sequence Length \(HS-DPCCH\)](#)" on page 204

7.9.5 DPDCH Settings

[:SOURCE<hw>]:BB:W3GPp:MSTation<st>:CHANnel<ch>:DPDCh:CCODE?	375
[:SOURCE<hw>]:BB:W3GPp:MSTation<st>:CHANnel<ch>:DPDCh:DATA	375
[:SOURCE<hw>]:BB:W3GPp:MSTation<st>:CHANnel<ch>:DPDCh:DATA:DSElect	376
[:SOURCE<hw>]:BB:W3GPp:MSTation<st>:CHANnel<ch>:DPDCh:DATA:PATtern	376
[:SOURCE<hw>]:BB:W3GPp:MSTation<st>:CHANnel<ch>:DPDCh:SRate?	377
[:SOURCE<hw>]:BB:W3GPp:MSTation<st>:DPDCh:FCIO	377
[:SOURCE<hw>]:BB:W3GPp:MSTation<st>:DPDCh:ORate	378
[:SOURCE<hw>]:BB:W3GPp:MSTation<st>:DPDCh:POWER	378
[:SOURCE<hw>]:BB:W3GPp:MSTation<st>:DPDCh:STATe	378

[\[:SOURCE<hw>\]:BB:W3GPp:MSTation<st>:CHANnel<ch>:DPDCh:CCODE?](#)

The command queries the channelization code of the specified channel. The value is fixed and depends on the overall symbol rate of the user equipment.

Return values:

<CCode> float

Example: BB:W3GP:MST1:CHAN:DPDC:CCOD?
queries the channelization code for DPDCH 1 of user equipment 1.

Usage: Query only

Manual operation: See "[Channelization Code](#)" on page 213

[\[:SOURCE<hw>\]:BB:W3GPp:MSTation<st>:CHANnel<ch>:DPDCh:DATA](#) <Data>

The command determines the data source for the selected DPDCH.

For the enhanced channels of user equipment 1 (UE1), this entry is valid when channel coding is deactivated. When channel coding is active, data sources are selected for the transport channels with the com-

mands :BB:W3GPp:MST:CHANnel:DPDCh:DCCH:DATA

and :BB:W3GPp:MST:ENHanced:TCHannel:DATA.

Parameters:

<Data> PN9 | PN11 | PN15 | PN16 | PN20 | PN21 | PN23 | DLISt | ZERO | ONE | PATtern

PNxx

The pseudo-random sequence generator is used as the data source. Different random sequence lengths can be selected.

DLISt

A data list is used. The data list is selected with the command
`[:SOURce<hw>] :BB:W3GPp:MSTation<st> :
 CHANnel<ch> :DPDCh:DATA:DSElect.`

ZERO | ONE

Internal 0 and 1 data is used.

PATtern

Internal data is used. The bit pattern for the data is defined by the command
`[:SOURce<hw>] :BB:W3GPp:MSTation<st> :
 CHANnel<ch> :DPDCh:DATA:PATtern.`

*RST: PN9

Example:

`BB:W3GP:MST1:CHAN:DPDC:DATA PN11`

Selects internal PRBS data with period length $2^{11}-1$ as the data source.

Manual operation: See "[Data List Management](#)" on page 49

`[:SOURce<hw>] :BB:W3GPp:MSTation<st> :CHANnel<ch> :DPDCh:DATA:DSElect
 <DSelect>`

The command selects the data list for the DLISt data source selection.

The files are stored with the fixed file extensions `*.dm_iqd` in a directory of the user's choice. The directory applicable to the commands is defined with the command `MMEMoRY:CDIR`. To access the files in this directory, you only have to give the file name, without the path and the file extension.

Parameters:

`<DSelect>` `<data list name>`

Example:

`BB:W3GP:MST1:CHAN1:DPDC:DATA DLIS`

selects the Data Lists data source.

`MMEM:CDIR '/var/user/temp/IQData'`

selects the directory for the data lists.

`BB:W3GP:MST1:CHAN1:DPDC:DATA:DSEL 'dpdch_13'`

selects the file `dpdch_13` as the data source.

Manual operation: See "[Data List Management](#)" on page 49

`[:SOURce<hw>] :BB:W3GPp:MSTation<st> :CHANnel<ch> :DPDCh:DATA:PATtern
 <Pattern>, <BitCount>`

The command enters the bit pattern for the PATtern data source selection. The first parameter determines the bit pattern (choice of hexadecimal, octal or binary notation), the second specifies the number of bits to use.

Parameters:

<Pattern> numeric
 *RST: #H0

<BitCount> integer
 Range: 1 to 64
 *RST: 1

Example:

BB:W3GP:MST1:CHAN1:DPDC:DATA PATT
 selects the Pattern data source.
 BB:W3GP:MST1:CHAN1:DPDC:DATA:PATT #H3F, 8
 defines the bit pattern.

Manual operation: See "[DPDCH Data Source](#)" on page 213

[:SOURce<hw>]:BB:W3GPP:MSTation<st>:CHANnel<ch>:DPDCh:SRATe?

The command queries the symbol rate of the DPDCH. The symbol rate depends on the overall symbol rate set and cannot be modified.

Return values:

<SRate> D15K | D30K | D60K | D120k | D240k | D480k | D960k

Example:

BB:W3GP:MST4:CHAN2:DPDC:SRAT?
 queries the symbol rate of DPDCH 2 of user equipment 4.
 Response: 960
 the symbol rate is 960 ksps.

Note:

DPDCH 2 is only active once the overall symbol rate is 2 x 960 ksps or more. When overall symbol rates are less, the error message "???" is returned.

Usage: Query only

Manual operation: See "[Symbol Rate / State](#)" on page 213

[:SOURce<hw>]:BB:W3GPP:MSTation<st>:DPDCh:FCIO <Fcio>

The command sets the channelization code to I/O. This mode can only be activated if the overall symbol rate is < 2 x 960 kbps.

Parameters:

<Fcio> ON | OFF
 *RST: OFF

Example:

BB:W3GP:MST1:DPDC:FCIO ON
 sets the channelization code to I/O.

Manual operation: See "[Force Channelization Code To I/O](#)" on page 212

[:SOURce<hw>]:BB:W3GPp:MSTation<st>:DPDCh:ORATe <ORate>

The command sets the overall symbol rate. The overall symbol rate determines the number of DPDCHs as well as their symbol rate and channelization codes.

Parameters:

<ORate> D15K | D30K | D60K | D120k | D240k | D480k | D960k |
 D1920k | D2880k | D3840k | D4800k | D5760k
D15K ... D5760K
 15 ksps ... 6 x 960 ksps
 *RST: D60K

Example:

BB:W3GP:MST1:DPDC:ORAT D15K
 sets the overall symbol rate to 15 ksps. Only DPDCH1 is active,
 the symbol rate is 15 ksps and the channelization code is 64.

Manual operation: See "[Overall Symbol Rate](#)" on page 212

[:SOURce<hw>]:BB:W3GPp:MSTation<st>:DPDCh:POWER <Power>

Sets the channel power of the DPDCHs. The power entered is relative to the powers of the other channels. If "Adjust Total Power to 0 dB" is executed ([\[:SOURce<hw>\]:BB:W3GPp:POWER:ADJust](#)), the power is normalized to a total power for all channels of 0 dB. The power ratios of the individual channels remains unchanged.

Note: The uplink channels are not blanked in this mode (duty cycle 100%).

Parameters:

<Power> float
 Range: -80 to 0
 Increment: 0.01
 *RST: 0

Example:

BB:W3GP:MST4:DPDC:POW -60dB
 Sets the channel power for DPDCH 2 of user equipment 4 to -60
 dB. The channel power relates to the power of the other chan-
 nels.
 BB:W3GP:POW:ADJ
 The channel power relates to 0 dB.

Manual operation: See "[Channel Power](#)" on page 211

[:SOURce<hw>]:BB:W3GPp:MSTation<st>:DPDCh:STATE <State>

The command activates or deactivates DPDCHs. This always activates or deactivates all the channels. The number of channels (1...6) is determined by the overall symbol rate.

Parameters:

<State> ON | OFF
 *RST: OFF

Example: BB:W3GP:MST1:DPDC:STAT ON
activates all the DPDCHs.

Manual operation: See "State (DPDCH)" on page 211

7.9.6 PCPCH Settings

[SOURce<hw>]:BB:W3GPp:MSStation<st>:PCPCh:CPOWer.....	379
[SOURce<hw>]:BB:W3GPp:MSStation<st>:PCPCh:CPSFormat.....	380
[SOURce<hw>]:BB:W3GPp:MSStation<st>:PCPCh:DATA.....	380
[SOURce<hw>]:BB:W3GPp:MSStation<st>:PCPCh:DATA:DSElect.....	381
[SOURce<hw>]:BB:W3GPp:MSStation<st>:PCPCh:DATA:PATtern.....	381
[SOURce<hw>]:BB:W3GPp:MSStation<st>:PCPCh:DPOWer.....	381
[SOURce<hw>]:BB:W3GPp:MSStation<st>:PCPCh:FBI:MODE.....	382
[SOURce<hw>]:BB:W3GPp:MSStation<st>:PCPCh:FBI:PATtern.....	382
[SOURce<hw>]:BB:W3GPp:MSStation<st>:PCPCh:MLENgtH.....	382
[SOURce<hw>]:BB:W3GPp:MSStation<st>:PCPCh:PLENgtH.....	383
[SOURce<hw>]:BB:W3GPp:MSStation<st>:PCPCh:PPOWer.....	383
[SOURce<hw>]:BB:W3GPp:MSStation<st>:PCPCh:PPOWer:STEP.....	383
[SOURce<hw>]:BB:W3GPp:MSStation<st>:PCPCh:PREPetition.....	384
[SOURce<hw>]:BB:W3GPp:MSStation<st>:PCPCh:RAFter.....	384
[SOURce<hw>]:BB:W3GPp:MSStation<st>:PCPCh:RARB.....	384
[SOURce<hw>]:BB:W3GPp:MSStation<st>:PCPCh:SIGNature.....	385
[SOURce<hw>]:BB:W3GPp:MSStation<st>:PCPCh:SRATe.....	385
[SOURce<hw>]:BB:W3GPp:MSStation<st>:PCPCh:TFCI.....	386
[SOURce<hw>]:BB:W3GPp:MSStation<st>:PCPCh:TIMing:DPOWer:MPARt?.....	386
[SOURce<hw>]:BB:W3GPp:MSStation<st>:PCPCh:TIMing:DPOWer:PREAmble?.....	386
[SOURce<hw>]:BB:W3GPp:MSStation<st>:PCPCh:TIMing:SOFFset.....	387
[SOURce<hw>]:BB:W3GPp:MSStation<st>:PCPCh:TIMing:SPERiod?.....	387
[SOURce<hw>]:BB:W3GPp:MSStation<st>:PCPCh:TIMing:TIME:PREMp.....	387
[SOURce<hw>]:BB:W3GPp:MSStation<st>:PCPCh:TIMing:TIME:PREPre.....	388
[SOURce<hw>]:BB:W3GPp:MSStation<st>:PCPCh:TPC:DATA.....	388
[SOURce<hw>]:BB:W3GPp:MSStation<st>:PCPCh:TPC:DATA:DSElect.....	388
[SOURce<hw>]:BB:W3GPp:MSStation<st>:PCPCh:TPC:DATA:PATtern.....	389
[SOURce<hw>]:BB:W3GPp:MSStation<st>:PCPCh:TPC:READ.....	389

[SOURce<hw>]:BB:W3GPp:MSStation<st>:PCPCh:CPOWer <CPower>

Sets the power of the control component of the PCPCH.

Parameters:

<CPower> float
Range: -80 to 0
Increment: 0.01
*RST: 0

Example: BB:W3GP:MST1:PCPC:CPOW -10 dB
Sets the power to -10 dB.

Manual operation: See " Control Power " on page 177

[:SOURce<hw>]:BB:W3GPp:MSTation<st>:PCPCh:CPSFormat <CpSFormat>

The command defines the slot format of the control component of the PCPCH.

The slot format sets the associated FBI mode automatically:

- Slot format 0 = FBI OFF
- Slot format 1 = FBI 1 bit
- Slot format 2 = FBI 2 bits

Parameters:

<CpSFormat> integer
 Range: 0 to 2
 *RST: 0

Example: BB:W3GP:MST1:PCPC:CPSF 2
 sets slot format 2.

Manual operation: See " [Slot Format](#) " on page 177

[:SOURce<hw>]:BB:W3GPp:MSTation<st>:PCPCh:DATA <Data>

The command determines the data source for the PCPCH.

Parameters:

<Data> ZERO | ONE | PATtern | PN9 | PN11 | PN15 | PN16 | PN20 |
 PN21 | PN23 | DLISt

PNxx

The pseudo-random sequence generator is used as the data source. Different random sequence lengths can be selected.

DLISt

A data list is used. The data list is selected with the command

SOURce:BB:W3GPp:MST:PCPCh:DATA:DSElect [:
[SOURce<hw>\]:BB:W3GPp:MSTation<st>:PCPCh:DATA:
 DSElect.](#)

ZERO | ONE

Internal 0 and 1 data is used.

PATtern

Internal data is used. The bit pattern for the data is defined by the command [:[SOURce<hw>\]:BB:W3GPp:MSTation<st>:PCPCh:DATA:PATtern.](#)

*RST: PN9

Example: BB:W3GP:MST1:PCPC:DATA PN11
 selects internal PRBS data with period length $2^{11}-1$ as the data source.

Manual operation: See "[Data List Management](#)" on page 49

[:SOURce<hw>]:BB:W3GPp:MSTation<st>:PCPCh:DATA:DSElect <DSelect>

The command selects the data list for the DLIS data source.

The files are stored with the fixed file extensions *.dm_iqd in a directory of the user's choice. The directory applicable to the commands is defined with the command `MMEMory:CDIR`. To access the files in this directory, you only have to give the file name, without the path and the file extension.

Parameters:

<DSelect> string

Example:

```
BB:W3GP:MST1:PCPC:DATA DLIS
selects data lists as the data source.
MMEM:CDIR '/var/user/temp/IQData'
selects the directory for the data lists.
BB:W3GP:MST1:PCPC:DATA:DSEL 'pcpch_data'
selects the data list pcpch_data.
```

Manual operation: See "[Data List Management](#)" on page 49

[:SOURce<hw>]:BB:W3GPp:MSTation<st>:PCPCh:DATA:PATtern <Pattern>, <BitCount>

The command determines the bit pattern for the data component when the PATtern data source is selected. The first parameter determines the bit pattern (choice of hexadecimal, octal or binary notation), the second specifies the number of bits to use.

Parameters:

<Pattern> numeric
 *RST: #H0

<BitCount> integer
 Range: 1 to 64
 *RST: 1

Example:

```
BB:W3GP:MST:PCPC:DATA:PATT #H3F,8
defines the bit pattern of the data for the DATA component.
```

Manual operation: See "[Data Source](#)" on page 178

[:SOURce<hw>]:BB:W3GPp:MSTation<st>:PCPCh:DPOWER <DPower>

Sets the power of the data component of the PCPCH.

Parameters:

<DPower> float
 Range: -80 to 0
 Increment: 0.01
 *RST: 0

Example:

```
BB:W3GP:MST1:PCPC:DPOW -10 dB
Sets the power to -10 dB.
```

Manual operation: See " [Data Power](#) " on page 177

[[:SOURce<hw>]:BB:W3GPp:MSTation<st>:PCPCh:FBI:MODE <Mode>

The command sets the number of bits (1 or 2) for the FBI field. With OFF, the field is not used.

The FBI pattern automatically sets the associated slot format:

- FBI OFF = Slot format 0
- FBI 1 bit = Slot format 1
- FBI 2 bits = Slot format 2

Parameters:

<Mode> OFF | D1B | D2B
 *RST: OFF

Example: BB:W3GP:MST2:PCPC:FBI:MODE OFF
 the FBI field is not used.

Manual operation: See " [FBI Mode](#) " on page 178

[[:SOURce<hw>]:BB:W3GPp:MSTation<st>:PCPCh:FBI:PATtern <Pattern>, <BitCount>

The command determines the bit pattern for the FBI field when the PATtern data source is selected. The maximum length of the pattern is 32 bits. The first parameter determines the bit pattern (choice of hexadecimal, octal or binary notation), the second specifies the number of bits to use.

Parameters:

<Pattern> numeric
 *RST: #H0
 <BitCount> integer
 Range: 1 to 32
 *RST: 1

Example: BB:W3GP:MST1:PCPC:FBI:PATT #H3F,8
 defines the bit pattern of the data for the FBI field.

Manual operation: See " [FBI Pattern](#) " on page 178

[[:SOURce<hw>]:BB:W3GPp:MSTation<st>:PCPCh:MLENght <MLength>

The command sets the length of the message component as a number of frames.

Parameters:

<MLength> 1 | 2 Frames
 Range: 1 to 2
 *RST: 1 Frame

Example: `BB:W3GP:MST4:PCPC:MLEN 2`
the length of the message component is 2 frames.

Manual operation: See " [Message Length](#) " on page 177

[:SOURCE<hw>]:BB:W3GPp:MSTation<st>:PCPCh:PLENght <PLength>

The command defines the length of the power control preamble of the PCPCH as a number of slots.

Parameters:
<PLength> S0 | S8
*RST: S8

Example: `BB:W3GP:MST1:PCPC:PLEN S8`
sets a length of 8 slots for the power control preamble.

Manual operation: See " [Power Control Preamble Length](#) " on page 176

[:SOURCE<hw>]:BB:W3GPp:MSTation<st>:PCPCh:PPower <PPower>

Sets the power of the preamble component of the PCPCH. If the preamble is repeated and the power increased with each repetition, this setting specifies the power achieved during the last repetition.

Parameters:
<PPower> float
Range: -80 to 0
Increment: 0.01
*RST: 0

Example: `BB:W3GP:MST1:PCPC:PPOW -10 dB`
Sets the power to -10 dB.
`BB:W3GP:MST1:PCPC:PPOW:STEP 1 dB`
Sets an increase in power of 1 dB per preamble repetition.
`BB:W3GP:MST1:PCPC:PREP 2`
Sets a sequence of 2 preambles. The power of the first preamble is -9 dB, the power of the second, -1 dB.

Manual operation: See " [Preamble Power](#) " on page 176

[:SOURCE<hw>]:BB:W3GPp:MSTation<st>:PCPCh:PPower:STEP <Step>

The command defines the step width of the power increase, by which the preamble component of the PCPCH is increased from repetition to repetition. The power during the last repetition corresponds to the power defined by the command [:

`SOURCE<hw>]:BB:W3GPp:MSTation<st>:PCPCh:PPower.`

Parameters:

<Step> float
 Range: 0 dB to 10 dB
 Increment: 0.1 dB
 *RST: 0 dB

Example:

BB:W3GP:MST1:PCPC:PPOW:STEP 2dB
 the power of the PCPCH preamble is increased by 2 dB with every repetition.

Manual operation: See "[Preamble Power Step](#)" on page 176

[:SOURCE<hw>]:BB:W3GPp:MSTation<st>:PCPCh:PREPetition <PRepetition>

The command defines the number of PCPCH preamble components.

Parameters:

<PRepetition> integer
 Range: 1 to 10
 *RST: 1

Example:

BB:W3GP:MST1:PCPC:PREP 3
 sets three preamble components.

Manual operation: See "[Preamble Repetition](#)" on page 176

[:SOURCE<hw>]:BB:W3GPp:MSTation<st>:PCPCh:RAFTer <Repeatafter>

Sets the number of access slots after that the PCPCH structure is repeated.

Parameters:

<Repeatafter> integer
 Range: 1 to 1000
 *RST: 18

Example:

See [\[:SOURCE<hw>\]:BB:W3GPp:MSTation<st>:PCPCh:RARB](#) on page 384

Manual operation: See "[Repeat Structure After \(x Acc. Slots\)](#)" on page 175

[:SOURCE<hw>]:BB:W3GPp:MSTation<st>:PCPCh:RARB <State>

Enables/disables repeating the selected PCPCH structure during one ARB sequence.

Parameters:

<State> 0 | 1 | OFF | ON
ON
 Within one ARB sequence, the selected PCPCH structure is repeated once.

OFF

The selected PCPCH structure can be repeated several time, depending on the structure length (`[:SOURCE<hw>] :BB : W3GPP : MSTation<st> : PRACH : TIMing : SPERiod?`) and the `[:SOURCE<hw>] :BB : W3GPP : MSTation<st> : PCPCh : RAFTer`.

*RST: 1

Example:

```
SOURce1:BB:W3GPP:SLenGth 4
SOURce1:BB:W3GPP:MSTation3:PCPCh:TIMing:
SPERiod?
Response: 14
SOURce1:BB:W3GPP:MSTation1:PCPCh:RARb OFF
SOURce1:BB:W3GPP:MSTation1:PCPCh:RAFTer 20
```

Manual operation: See "[Repeat Structure After ARB Sequence Length](#)" on page 175

[:SOURCE<hw>] :BB : W3GPP : MSTation<st> : PCPCh : SIGNature <Signature>

The command selects the signature of the PCPCH (see Table 3 in 3GPP TS 25.213 Version 3.4.0 Release 1999).

Parameters:

<Signature> integer
 Range: 0 to 15
 *RST: 0

Example:

```
BB:W3GP:MST1:PCPC:SIGN 5
selects signature 5.
```

Manual operation: See "[Signature](#)" on page 176

[:SOURCE<hw>] :BB : W3GPP : MSTation<st> : PCPCh : SRATe <SRate>

The command sets the symbol rate of the PCPCH.

User Equipment 1: When channel coding is active, the symbol rate is limited to the range between 15 and 120 ksps. Values above this limit are automatically set to 120 ksps.

Parameters:

<SRate> D15K | D30K | D60K | D120k | D240k | D480k | D960k
 *RST: D30K

Example:

```
BB:W3GP:MST1:PCPC:SRAT D15K
sets the symbol rate of the PCPCH of user equipment 1 to 15
ksps.
```

Manual operation: See "[Symbol Rate](#)" on page 178

[[:SOURce<hw>]:BB:W3GPp:MSTation<st>:PCPCh:TFCI <Tfci>

Sets the value of the TFCI (Transport Format Combination Indicator) field. This value selects a combination of 30 bits, which are divided into two groups of 15 successive slots.

Parameters:

<Tfci> integer
 Range: 0 to 1023
 *RST: 0

Example: BB:W3GP:MST1:PCPC:TFCI 21
 sets the TFCI value to 21.

Manual operation: See " [TFCI](#) " on page 179

[[:SOURce<hw>]:BB:W3GPp:MSTation<st>:PCPCh:TIMing:DPOWer:MPARt?

Queries the level correction value for the message part. In case of one UE active, the power of the message part can be calculated by adding the set RF level.

Return values:

<MPart> float
 Range: -80 to 0
 Increment: 0.01
 *RST: 0

Example: BB:W3GP:MST3:PCPC:TIM:DPOW:MPAR?
 queries the level correction value for the message part.
 Response: 1.2
 the correction value is 1.2 dB.
 POW?
 queries the RF level.
 Response: 2
 the RF output level is 2 dBm. The message part power is 3.2 dBm

Usage: Query only

Manual operation: See " [Delta Power \(Message Part\)](#) " on page 173

[[:SOURce<hw>]:BB:W3GPp:MSTation<st>:PCPCh:TIMing:DPOWer:PREAmble?

Queries level correction value for the last AICH preamble before the message part. This value is identical to the correction value for the CD preamble. The level of the other preambles can be calculated by subtracting the set Preamble Power Step.

Return values:

<PREamble> float
 Range: -80 to 0
 Increment: 0.01
 *RST: 0

- Example:** `BB:W3GP:MST3:PCPC:TIM:DPOW:PRE?`
queries the level correction value for the last AICH preamble before the message part.
- Usage:** Query only
- Manual operation:** See " [Delta Power \(Preamble\)](#) " on page 173

[:SOURce<hw>]:BB:W3GPp:MSTation<st>:PCPCh:TIMing:SOFFset <SOffset>

This command defines the start offset of the PCPCH in access slots. The starting time delay in timeslots is calculated according to: 2 x Start Offset.

Parameters:

<SOffset> integer
Range: 1 to 14
*RST: 0

- Example:** `BB:W3GP:MST3:PCPC:TIM:SOFF 1`
the start offset of the PCPCH of UE 3 is 2 access slots.

Manual operation: See " [Start Offset #](#) " on page 173

[:SOURce<hw>]:BB:W3GPp:MSTation<st>:PCPCh:TIMing:SPERiod?

Queries the structure length.

Return values:

<SPeriod> float

- Example:** See `[:SOURce<hw>]:BB:W3GPp:MSTation<st>:PCPCh:RARB` on page 384

Usage: Query only

Manual operation: See " [Structure Length](#) " on page 174

[:SOURce<hw>]:BB:W3GPp:MSTation<st>:PCPCh:TIMing:TIME:PREMp <Premp>

This command defines the AICH Transmission Timing. This parameter defines the time difference between the preamble and the message part. Two modes are defined in the standard. In mode 0, the preamble to message part difference is 3 access slots, in mode 1 it is 4 access slots.

Parameters:

<Premp> integer
Range: 1 to 14
*RST: 3

- Example:** `BB:W3GP:MST3:PCPC:TIM:TIME:PREM 3`
the difference between the preamble and the message part is 3 access slots.

Manual operation: See " [Transmission Timing \(Message Part\)](#) " on page 174

[:SOURce<hw>] :BB:W3GPp:MSTation<st>:PCPCh:TIMing:TIME:PREPre <Prepre>

This command defines the time difference between two successive preambles in access slots.

Parameters:

<Prepre> integer
 Range: 1 to 14
 *RST: 3

Example:

BB:W3GP:MST3:PCPC:TIM:TIME:PREP 3
 the time difference between two successive preambles is 3 access slots.

Manual operation: See "[Transmission Timing \(Preamble\)](#)" on page 174

[:SOURce<hw>] :BB:W3GPp:MSTation<st>:PCPCh:TPC:DATA <Data>

The command determines the data source for the TPC field of the PCPCH.

Parameters:

<Data> ZERO | ONE | PATTErn | DLISt

DLISt

A data list is used. The data list is selected with the command [\[:SOURce<hw> \] :BB:W3GPp:MSTation<st>:PCPCh:TPC:DATA:DSElect](#).

ZERO | ONE

Internal 0 and 1 data is used.

PATTErn

Internal data is used. The bit pattern for the data is defined by the command [\[:SOURce<hw> \] :BB:W3GPp:MSTation<st>:PCPCh:TPC:DATA:PATTErn](#). The maximum length is 64 bits.

*RST: PATTErn

Example:

BB:W3GP:MST2:PCPC:TPC:DATA PATT
 selects as the data source for the TPC field of user equipment 2 the bit pattern defined with the following command.
 BB:W3GP:MST2:PCPC:TPC:DATA:DATA:PATTErn #H48D0,16
 defines the bit pattern.

Manual operation: See "[Data List Management](#)" on page 49

[:SOURce<hw>] :BB:W3GPp:MSTation<st>:PCPCh:TPC:DATA:DSElect <DSelect>

The command selects the data list when the DLISt data source is selected for the TPC field of the PCPCH.

The files are stored with the fixed file extensions *.dm_iqd in a directory of the user's choice. The directory applicable to the commands is defined with the command `MMEMory:CDIR`. To access the files in this directory, you only have to give the file name, without the path and the file extension.

Parameters:**<DSelect>** string**Example:**

BB:W3GP:MST1:PCPC:TPC:DATA DLIS

selects data lists as the data source.

M MEM:CDIR '/var/user/temp/IQData'

selects the directory for the data lists.

BB:W3GP:MST1:PCPC:TPC:DATA:DSEL 'dpcch_tpc_1'

selects the data list dpcch_tpc1.

Manual operation: See "[Data List Management](#)" on page 49**[:SOURce<hw>]:BB:W3GPp:MSTation<st>:PCPCh:TPC:DATA:PATtern <Pattern>, <BitCount>**

The command determines the bit pattern for the PATtern data source selection. The maximum length of the bit pattern is 64 bits.

Parameters:**<Pattern>** numeric***RST:** #H0**<BitCount>** integer**Range:** 1 to 64***RST:** 1**Example:**

BB:W3GP:MST1:PCPC:DATA:PATT #H3F,8

defines the bit pattern of the data for the FBI field.

Manual operation: See "[TPC Data Source](#)" on page 179**[:SOURce<hw>]:BB:W3GPp:MSTation<st>:PCPCh:TPC:READ <Read>**

The command sets the read out mode for the bit pattern of the TPC field of the PCPCH.

The bit pattern is selected with the command `[:SOURce<hw>]:BB:W3GPp:MSTation<st>:PCPCh:TPC:DATA`.**Parameters:****<Read>** CONTinuous | S0A | S1A | S01A | S10A**CONTinuous**

The bit pattern is used cyclically.

S0A

The bit pattern is used once, then the TPC sequence continues with 0 bits.

S1A

The bit pattern is used once, then the TPC sequence continues with 1 bits.

S01A

The bit pattern is used once and then the TPC sequence is continued with 0 and 1 bits alternately (in multiples, depending on by the symbol rate, for example, 00001111).

S10A

The bit pattern is used once and then the TPC sequence is continued with 1 and 0 bits alternately (in multiples, depending on by the symbol rate, for example, 11110000).

*RST: CONTInuous

Example:

BB:W3GP:MST2:PCPC:TPC:READ CONT

the selected bit pattern is repeated continuously for the TPC sequence.

Manual operation: See " [Read Out Mode](#) " on page 179

7.9.7 PRACH Settings

[:SOURce<hw>]:BB:W3GPp:MSTation<st>:PRACH:ATTiming.....	390
[:SOURce<hw>]:BB:W3GPp:MSTation<st>:PRACH:CPOWer.....	391
[:SOURce<hw>]:BB:W3GPp:MSTation<st>:PRACH:DATA.....	391
[:SOURce<hw>]:BB:W3GPp:MSTation<st>:PRACH:DATA:DSElect.....	392
[:SOURce<hw>]:BB:W3GPp:MSTation<st>:PRACH:DATA:PATtern.....	392
[:SOURce<hw>]:BB:W3GPp:MSTation<st>:PRACH:DPOWer.....	392
[:SOURce<hw>]:BB:W3GPp:MSTation<st>:PRACH:MLENght.....	393
[:SOURce<hw>]:BB:W3GPp:MSTation<st>:PRACH:PPOWer.....	393
[:SOURce<hw>]:BB:W3GPp:MSTation<st>:PRACH:PPOWer:STEP.....	393
[:SOURce<hw>]:BB:W3GPp:MSTation<st>:PRACH:PREPetition.....	394
[:SOURce<hw>]:BB:W3GPp:MSTation<st>:PRACH:RAFter.....	394
[:SOURce<hw>]:BB:W3GPp:MSTation<st>:PRACH:RARB.....	394
[:SOURce<hw>]:BB:W3GPp:MSTation<st>:PRACH:SFORmat.....	395
[:SOURce<hw>]:BB:W3GPp:MSTation<st>:PRACH:SIGNature.....	395
[:SOURce<hw>]:BB:W3GPp:MSTation<st>:PRACH:SRATe.....	395
[:SOURce<hw>]:BB:W3GPp:MSTation<st>:PRACH:TFCI.....	396
[:SOURce<hw>]:BB:W3GPp:MSTation<st>:PRACH:TIMing:DPOWer:MPART?.....	396
[:SOURce<hw>]:BB:W3GPp:MSTation<st>:PRACH:TIMing:DPOWer:MPART:CONTrol?.....	397
[:SOURce<hw>]:BB:W3GPp:MSTation<st>:PRACH:TIMing:DPOWer:MPART:DATA?.....	397
[:SOURce<hw>]:BB:W3GPp:MSTation<st>:PRACH:TIMing:DPOWer:PREAmble?.....	397
[:SOURce<hw>]:BB:W3GPp:MSTation<st>:PRACH:TIMing:SOFFset.....	398
[:SOURce<hw>]:BB:W3GPp:MSTation<st>:PRACH:TIMing:SPERiod?.....	398
[:SOURce<hw>]:BB:W3GPp:MSTation<st>:PRACH:TIMing:TIME:PREMp.....	398
[:SOURce<hw>]:BB:W3GPp:MSTation<st>:PRACH:TIMing:TIME:PREPre.....	399

[:SOURce<hw>]:BB:W3GPp:MSTation<st>:PRACH:ATTiming <AtTiming>

This command defines which AICH Transmission Timing, time difference between the preamble and the message part or the time difference between two successive preambles in access slots, is defined.

Parameters:

<AtTiming> ATT0 | ATT1
 *RST: ATT0

Example:

BB:W3GP:MST3:PRAC:ATT ATT1
 Selects the AICH Transmission Timing as the difference between the preamble and the message part.

[:SOURce<hw>]:BB:W3GPp:MSTation<st>:PRACH:CPOWER <CPower>

The command defines the power of the control component of the PRACH.

Parameters:

<CPower> float
 Range: -80 dB to 0 dB
 Increment: 0.1 dB
 *RST: 0 dB

Example:

BB:W3GP:MST1:PRAC:CPOW -10 dB
 sets the power to -10 dB.

Manual operation: See "[Control Power](#)" on page 167

[:SOURce<hw>]:BB:W3GPp:MSTation<st>:PRACH:DATA <Data>

The command determines the data source for the PRACH.

Parameters:

<Data> ZERO | ONE | PATtern | PN9 | PN11 | PN15 | PN16 | PN20 |
 PN21 | PN23 | DLISt

PNxx

The pseudo-random sequence generator is used as the data source. Different random sequence lengths can be selected.

DLISt

A data list is used. The data list is selected with the command [\[:SOURce<hw>\]:BB:W3GPp:MSTation<st>:PRACH:DATA:DSElect](#).

ZERO | ONE

Internal 0 and 1 data is used.

PATtern

Internal data is used. The bit pattern for the data is defined by the command [\[:SOURce<hw>\]:BB:W3GPp:MSTation<st>:PRACH:DATA:PATtern](#).

*RST: PN9

Example:

BB:W3GP:MST1:PRAC:DATA PN11
 selects internal PRBS data with period length $2^{11}-1$ as the data source.

Manual operation: See "[Data List Management](#)" on page 49

[:SOURce<hw>]:BB:W3GPp:MSTation<st>:PRACH:DATA:DSElect <DSelect>

The command selects the data list for the DLIS data source.

The files are stored with the fixed file extensions *.dm_iqd in a directory of the user's choice. The directory applicable to the commands is defined with the command `MMEMory:CDIR`. To access the files in this directory, you only have to give the file name, without the path and the file extension.

Parameters:

<DSelect> string

Example:

```
BB:W3GP:MST1:PRAC:DATA DLIS
selects data lists as the data source.
MMEM:CDIR '/var/user/temp/IQData'
selects the directory for the data lists.
BB:W3GP:MST1:PRAC:DATA:DSEL 'pcpch_data'
selects the data list pcpch_data.
```

Manual operation: See "[Data List Management](#)" on page 49

[:SOURce<hw>]:BB:W3GPp:MSTation<st>:PRACH:DATA:PATtern <Pattern>, <BitCount>

The command determines the bit pattern for the data component when the PATtern data source is selected. The first parameter determines the bit pattern (choice of hexadecimal, octal or binary notation), the second specifies the number of bits to use.

Parameters:

<Pattern> numeric
 *RST: #H0

<BitCount> integer
 Range: 1 to 64
 *RST: 1

Example:

```
BB:W3GP:MST1:PRAC:DATA:PATT #H3F,8
defines the bit pattern of the data for the DATA component.
```

Manual operation: See "[Data Source](#)" on page 168

[:SOURce<hw>]:BB:W3GPp:MSTation<st>:PRACH:DPOWER <DPower>

The command defines the power of the data component of the PRACH.

Parameters:

<DPower> float
 Range: -80 dB to 0 dB
 Increment: 0.1 dB
 *RST: 0 dB

Example:

```
BB:W3GP:MST1:PRAC:DPOW -10 dB
sets the power to -10 dB.
```

Manual operation: See " [Data Power](#) " on page 167

[:SOURce<hw>]:BB:W3GPp:MSTation<st>:PRACH:MLENgtH <MLength>

The command sets the length of the message component as a number of frames.

Parameters:

<MLength> 1 | 2 Frames
*RST: 1

Example:

BB:W3GP:MST4:PRAC:MLEN 2
the length of the message component is 2 frames.

Manual operation: See " [Message Length](#) " on page 167

[:SOURce<hw>]:BB:W3GPp:MSTation<st>:PRACH:PPower <PPower>

The command defines the power of the preamble component of the PRACH. If the preamble is repeated and the power increased with each repetition, this setting specifies the power achieved during the last repetition.

Parameters:

<PPower> float
Range: -80 dB to 0 dB
Increment: 0.1 dB
*RST: 0 dB

Example:

BB:W3GP:MST1:PRAC:PPOW -10 dB
sets the power to -10 dB.
BB:W3GP:MST1:PRAC:PPOW:STEP 1 dB
sets an increase in power of 1 dB per preamble repetition.
BB:W3GP:MST1:PRAC:PREP 2
sets a sequence of 2 preambles. The power of the first preamble is - 9 dB, the power of the second, -1 dB.

Manual operation: See " [Preamble Power](#) " on page 166

[:SOURce<hw>]:BB:W3GPp:MSTation<st>:PRACH:PPower:STEP <Step>

The command defines the step width of the power increase, by which the preamble component of the PRACH is increased from repetition to repetition. The power defined during the last repetition corresponds to the power defined by the command [:

[SOURce<hw>\]:BB:W3GPp:MSTation<st>:PRACH:PPower.](#)

Parameters:

<Step> float
Range: 0 dB to 10 dB
Increment: 0.1 dB
*RST: 0 dB

Example: BB:W3GP:MST1:PRAC:PPOW:STEP 2 dB
the power of the PRACH preamble is increased by 2 dB with every repetition.

Manual operation: See " [Preamble Power Step](#) " on page 166

[:SOURce<hw>]:BB:W3GPp:MSTation<st>:PRACH:PREPetition <PRepetition>

The command defines the number of PRACH preamble components.

Parameters:

<PRepetition> integer
Range: 1 to 10
*RST: 1

Example: BB:W3GP:MST1:PRAC:PREP 3
sets three preamble components.

Manual operation: See " [Preamble Repetition](#) " on page 166

[:SOURce<hw>]:BB:W3GPp:MSTation<st>:PRACH:RAFTer <Repeatafter>

Sets the number of access slots after that the PRACH structure is repeated.

Parameters:

<Repeatafter> integer
Range: 1 to 1000
*RST: 11

Example: See [:SOURce<hw>]:BB:W3GPp:MSTation<st>:PRACH:RARB on page 394

Manual operation: See " [Repeat Structure After \(x Acc. Slots\)](#) " on page 166

[:SOURce<hw>]:BB:W3GPp:MSTation<st>:PRACH:RARB <State>

Enables/disables repeating the selected PRACH structure during one ARB sequence.

Parameters:

<State> 0 | 1 | OFF | ON

ON

Within one ARB sequence, the selected PRACH structure is repeated once.

OFF

The selected PRACH structure can be repeated several time, depending on the structure length ([:SOURce<hw>]:BB:W3GPp:MSTation<st>:PRACH:TIMing:SPERiod?) and the [:SOURce<hw>]:BB:W3GPp:MSTation<st>:PRACH:RAFTer.

*RST: 1

Example:

```
SOURce1:BB:W3Gpp:SLENgth 4
SOURce1:BB:W3Gpp:MSTation3:PRACH:TIMing:
SPERiod?
Response: 14
SOURce1:BB:W3Gpp:MSTation1:PRACH:RARb OFF
SOURce1:BB:W3Gpp:MSTation1:PRACH:RAFTer 20
```

Manual operation: See "[Repeat Structure After ARB Sequence Length](#)" on page 165

[:SOURce<hw>]:BB:W3Gpp:MSTation<st>:PRACH:SFORmat <SFormat>

Defines the slot format of the PRACH.

A change of slot format leads to an automatic change of symbol rate [:

[SOURce<hw>\]:BB:W3Gpp:MSTation<st>:PRACH:SRATe](#)

When channel coding is active, the slot format is predetermined. So in this case, the command has no effect.

Parameters:

<SFormat> 0 | 1 | 2 | 3
*RST: 1

Example: BB:W3GP:MST:PRAC:SFOR 2
sets slot format 2.

Manual operation: See "[Slot Format](#)" on page 167

[:SOURce<hw>]:BB:W3Gpp:MSTation<st>:PRACH:SIGNature <Signature>

The command selects the signature of the PRACH (see Table 3 in 3GPP TS 25.213 Version 3.4.0 Release 1999).

Parameters:

<Signature> integer
Range: 0 to 15
*RST: 0

Example: BB:W3GP:MST1:PRAC:SIGN 5
selects signature 5.

Manual operation: See "[Signature](#)" on page 167

[:SOURce<hw>]:BB:W3Gpp:MSTation<st>:PRACH:SRATe <SRate>

The command sets the symbol rate of the PRACH.

A change of symbol rate leads to an automatic change of slot format [:

[SOURce<hw>\]:BB:W3Gpp:MSTation<st>:PRACH:SFORmat.](#)

Parameters:

<SRate> D15K | D30K | D60K | D120k
 *RST: D30K

Example:

BB:W3GP:MST1:PRAC:SRAT D15K
 sets the symbol rate of the PRACH of user equipment 1 to 15 kbps.

Manual operation: See " [Symbol Rate](#) " on page 167

[:SOURCE<hw>]:BB:W3GPp:MSTation<st>:PRACH:TFCI <Tfci>

Sets the value of the TFCI (Transport Format Combination Indicator) field. This value selects a combination of 30 bits, which are divided into two groups of 15 successive slots.

Parameters:

<Tfci> integer
 Range: 0 to 1023
 *RST: 0

Example:

BB:W3GP:MST1:PRAC:TFCI 21
 sets the TFCI value to 21.

Manual operation: See " [TFCI](#) " on page 168

[:SOURCE<hw>]:BB:W3GPp:MSTation<st>:PRACH:TIMing:DPOWer:MPARt?

Queries the level correction value for the message part. In case of one UE active and "Level Reference" set to "RMS Power", the power of the message part can be calculated by adding the set RF level.

Return values:

<MPart> float
 Range: -80 to 0
 Increment: 0.01
 *RST: 0

Example:

BB:W3GP:MST3:PRAC:TIM:DPOW:MPAR?
 queries the level correction value for the message part.
 Response: 1.2
 the correction value is 1.2 dB.
 POW?
 queries the RF level.
 Response: 2
 the RF output level is 2 dBm. The message part power is 3.2 dBm.

Usage: Query only

Manual operation: See " [Delta Power \(Message Part\)](#) " on page 163

[:SOURce<hw>]:BB:W3GPp:MSTation<st>:PRACH:TIMing:DPOWer:MPARt:CONTROL?

Queries the level correction value for the message control part.

Return values:

<Control> float
 Range: -80 to 0
 Increment: 0.01
 *RST: 0

Example:

BB:W3GP:MST3:PRAC:TIM:DPOW:MPAR:CONT?
 queries the level correction value for the message control part.
 Response: -3.24
 the correction value is -3.24 dB.

Usage: Query only

Manual operation: See "[Delta Power \(Message Part\)](#)" on page 163

[:SOURce<hw>]:BB:W3GPp:MSTation<st>:PRACH:TIMing:DPOWer:MPARt:DATA?

Queries the level correction value for the message data part.

Return values:

<Data> float
 Range: -80 to 0
 Increment: 0.01
 *RST: 0

Example:

BB:W3GP:MST3:PRAC:TIM:DPOW:MPAR:DATA?
 queries the level correction value for the message data part.
 Response: -3.24
 the correction value is -3.24 dB.

Usage: Query only

Manual operation: See "[Delta Power \(Message Part\)](#)" on page 163

[:SOURce<hw>]:BB:W3GPp:MSTation<st>:PRACH:TIMing:DPOWer:PREAmble?

Queries level correction value for the preamble before the message part.

Return values:

<Preamble> float
 Range: -80 to 0
 Increment: 0.01
 *RST: 0

Example:

BB:W3GP:MST3:PRAC:TIM:DPOW:PRE?
 queries the level correction value for the last preamble before the message part.

Usage: Query only

Manual operation: See " [Delta Power \(Preamble\)](#) " on page 163

[:SOURce<hw>]:BB:W3GPP:MSTation<st>:PRACH:TIMing:SOFFset <SOffset>

This command defines the start offset of the PRACH in access slots. The starting time delay in timeslots is calculated according to: 2 x Start Offset.

Parameters:

<SOffset> integer
 Range: 1 to 50
 *RST: 0

Example: BB:W3GP:MST3:PRAC:TIM:SOFF 1
 the start offset of the PRACH of UE 3 is 2 access slots.

Manual operation: See " [Start Offset #](#) " on page 164

[:SOURce<hw>]:BB:W3GPP:MSTation<st>:PRACH:TIMing:SPERiod?

Queries the structure length.

Return values:

<SPeriod> float

Example: see [:SOURce<hw>]:BB:W3GPP:MSTation<st>:PRACH:
[RARB](#) on page 394

Usage: Query only

Manual operation: See " [Structure Length](#) " on page 164

[:SOURce<hw>]:BB:W3GPP:MSTation<st>:PRACH:TIMing:TIME:PREMp <Premp>

This command defines the AICH Transmission Timing. This parameter defines the time difference between the preamble and the message part. Two modes are defined in the standard. In mode 0, the preamble to message part difference is 3 access slots, in mode 1 it is 4 access slots.

Parameters:

<Premp> integer
 Range: 1 to 14
 *RST: 3

Example: BB:W3GP:MST3:PRAC:TIM.TIME:PREM 3
 the difference between the preamble and the message part is 3 access slots.

Manual operation: See " [Time Pre->MP](#) " on page 164

[:SOURce<hw>]:BB:W3GPp:MSTation<st>:PRACh:TIMing:TIME:PREPre <Prepre>

This command defines the time difference between two successive preambles in access slots.

Parameters:

<Prepre> integer
 Range: 1 to 14
 *RST: 3

Example:

BB:W3GP:MST3:PRAC:TIM.TIME:PREP 3
 the time difference between two successive preambles is 3 access slots.

Manual operation: See " [Time Pre->Pre](#) " on page 164

7.9.8 HSUPA Settings

[:SOURce<hw>]:BB:W3GPp:MSTation<st>[:HSUPa]:CHANnel<ch>:DPDCh:E:CCODE?	400
[:SOURce<hw>]:BB:W3GPp:MSTation<st>[:HSUPa]:CHANnel<ch>:DPDCh:E:DATA	401
[:SOURce<hw>]:BB:W3GPp:MSTation<st>[:HSUPa]:CHANnel<ch>:DPDCh:E:DATA: DSElect	401
[:SOURce<hw>]:BB:W3GPp:MSTation<st>[:HSUPa]:CHANnel<ch>:DPDCh:E:DATA: PATtern	402
[:SOURce<hw>]:BB:W3GPp:MSTation<st>[:HSUPa]:CHANnel<ch>:DPDCh:E:POWER	402
[:SOURce<hw>]:BB:W3GPp:MSTation<st>[:HSUPa]:CHANnel<ch>:DPDCh:E:SRATE?	402
[:SOURce<hw>]:BB:W3GPp:MSTation<st>[:HSUPa]:DPCCh:E:FRC:CHANnel	403
[:SOURce<hw>]:BB:W3GPp:MSTation<st>[:HSUPa]:DPCCh:E:FRC:CRATE?	403
[:SOURce<hw>]:BB:W3GPp:MSTation<st>[:HSUPa]:DPCCh:E:FRC:DATA	403
[:SOURce<hw>]:BB:W3GPp:MSTation<st>[:HSUPa]:DPCCh:E:FRC:DATA:DSElect	404
[:SOURce<hw>]:BB:W3GPp:MSTation<st>[:HSUPa]:DPCCh:E:FRC:DATA:PATtern	404
[:SOURce<hw>]:BB:W3GPp:MSTation<st>[:HSUPa]:DPCCh:E:FRC:DERRor:BIT:LAYer	405
[:SOURce<hw>]:BB:W3GPp:MSTation<st>[:HSUPa]:DPCCh:E:FRC:DERRor:BIT:RATE	405
[:SOURce<hw>]:BB:W3GPp:MSTation<st>[:HSUPa]:DPCCh:E:FRC:DERRor:BIT:STATE	405
[:SOURce<hw>]:BB:W3GPp:MSTation<st>[:HSUPa]:DPCCh:E:FRC:DERRor:BLOCK:RATE	406
[:SOURce<hw>]:BB:W3GPp:MSTation<st>[:HSUPa]:DPCCh:E:FRC:DERRor:BLOCK: STATE	406
[:SOURce<hw>]:BB:W3GPp:MSTation<st>[:HSUPa]:DPCCh:E:FRC:DTX:PATtern	406
[:SOURce<hw>]:BB:W3GPp:MSTation<st>[:HSUPa]:DPCCh:E:FRC:DTX:STATE	406
[:SOURce<hw>]:BB:W3GPp:MSTation<st>[:HSUPa]:DPCCh:E:FRC:HARQ:SIMulation: MODE	407
[:SOURce<hw>]:BB:W3GPp:MSTation<st>[:HSUPa]:DPCCh:E:FRC:HARQ:SIMulation: RVZero	407
[:SOURce<hw>]:BB:W3GPp:MSTation<st>[:HSUPa]:DPCCh:E:FRC:HARQ:SIMulation[: STATE]	407
[:SOURce<hw>]:BB:W3GPp:MSTation<st>[:HSUPa]:DPCCh:E:FRC:HARQ: SIMulation]:PATtern<ch>	408
[:SOURce<hw>]:BB:W3GPp:MSTation<st>[:HSUPa]:DPCCh:E:FRC:HPROcesses?	408
[:SOURce<hw>]:BB:W3GPp:MSTation<st>[:HSUPa]:DPCCh:E:FRC:MIBRate?	408
[:SOURce<hw>]:BB:W3GPp:MSTation<st>[:HSUPa]:DPCCh:E:FRC:MODulation	409

[SOURce<hw>]:BB:W3GPp:MSTation<st>[:HSUPa]:DPCCh:E:FRC:ORATe.....	409
[SOURce<hw>]:BB:W3GPp:MSTation<st>[:HSUPa]:DPCCh:E:FRC:PAYBits?.....	409
[SOURce<hw>]:BB:W3GPp:MSTation<st>[:HSUPa]:DPCCh:E:FRC:STATe.....	410
[SOURce<hw>]:BB:W3GPp:MSTation<st>[:HSUPa]:DPCCh:E:FRC:TBS:INDex.....	410
[SOURce<hw>]:BB:W3GPp:MSTation<st>[:HSUPa]:DPCCh:E:FRC:TBS:TABLE.....	410
[SOURce<hw>]:BB:W3GPp:MSTation<st>[:HSUPa]:DPCCh:E:FRC:TTIBits?.....	411
[SOURce<hw>]:BB:W3GPp:MSTation<st>[:HSUPa]:DPCCh:E:FRC:TTIEdch.....	411
[SOURce<hw>]:BB:W3GPp:MSTation<st>[:HSUPa]:DPCCh:E:FRC:UECategory?.....	412
[SOURce<hw>]:BB:W3GPp:MSTation<st>[:HSUPa]:DPCCh:E:CCODE?.....	412
[SOURce<hw>]:BB:W3GPp:MSTation<st>[:HSUPa]:DPCCh:E:HBIT.....	412
[SOURce<hw>]:BB:W3GPp:MSTation<st>[:HSUPa]:DPCCh:E:POWER.....	412
[SOURce<hw>]:BB:W3GPp:MSTation<st>[:HSUPa]:DPCCh:E:RSNumber.....	413
[SOURce<hw>]:BB:W3GPp:MSTation<st>[:HSUPa]:DPCCh:E:STATe.....	413
[SOURce<hw>]:BB:W3GPp:MSTation<st>[:HSUPa]:DPCCh:E:TFCI.....	413
[SOURce<hw>]:BB:W3GPp:MSTation<st>[:HSUPa]:DPDCh:E:FCIO.....	414
[SOURce<hw>]:BB:W3GPp:MSTation<st>[:HSUPa]:DPDCh:E:MODulation.....	414
[SOURce<hw>]:BB:W3GPp:MSTation<st>[:HSUPa]:DPDCh:E:ORATe.....	414
[SOURce<hw>]:BB:W3GPp:MSTation<st>[:HSUPa]:DPDCh:E:STATe.....	415
[SOURce<hw>]:BB:W3GPp:MSTation<st>[:HSUPa]:DPDCh:E:TTIEdch.....	415
[SOURce<hw>]:BB:W3GPp:MSTation<st>[:HSUPa]:EDCH:TTIEdch.....	415
[SOURce<hw>]:BB:W3GPp:MSTation<st>[:HSUPa]:EDCH:REPeat.....	416
[SOURce<hw>]:BB:W3GPp:MSTation<st>[:HSUPa]:EDCH:ROW<ch0>:FROM.....	416
[SOURce<hw>]:BB:W3GPp:MSTation<st>[:HSUPa]:EDCH:ROW<ch0>:TO.....	416
[SOURce<hw>]:BB:W3GPp:MSTation<st>[:HSUPa]:EDCH:ROWCount.....	416

[SOURce<hw>]:BB:W3GPp:MSTation<st>[:HSUPa]:CHANnel<ch>:DPDCh:E:CCODE?

Queries the channelization code and the modulation branch (I or Q) of the E-DPDCH channel.

The channelization code is dependent on the overall symbol rate set and cannot be modified.

Return values:

<ChannelCode> integer

Example:

BB:W3GP:MST4:HSUP:CHAN1:DPDC:E:CCOD?

queries the channelization code and the modulation branch (I or Q) of E-DPDCH 1 of user equipment 4.

Response: Q, 32

Usage:

Query only

Manual operation: See " [Channelization Code](#) " on page 217

```
[:SOURce<hw>]:BB:W3GPp:MSTation<st>[:HSUPa]:CHANnel<ch>:DPDCh:E:
  DATA <Data>
```

The command selects the data source for the E-DPDCH channel.

Parameters:

<Data> ZERO | ONE | PATtern | PN9 | PN11 | PN15 | PN16 | PN20 |
PN21 | PN23 | DLISt

PNxx

The pseudo-random sequence generator is used as the data source. Different random sequence lengths can be selected.

DLISt

A data list is used. The data list is selected with the command
SOURce: [:SOURce<hw>]:BB:W3GPp:MSTation<st>[:
HSUPa]:CHANnel<ch>:DPDCh:E:DATA:DSElect.

ZERO | ONE

Internal 0 and 1 data is used.

PATtern

Internal data is used. The bit pattern for the data is defined by
the command [:SOURce<hw>]:BB:W3GPp:MSTation<st>[:
HSUPa]:CHANnel<ch>:DPDCh:E:DATA:PATtern.

*RST: PN9

Example: SOUR:BB:W3GP:MST1:HSUP:CHAN1:DPDC:E:DATA PN11
selects internal PRBS data with period length $2^{11}-1$ as the data source.

Manual operation: See "E-DPDCH Data Source" on page 217

```
[:SOURce<hw>]:BB:W3GPp:MSTation<st>[:HSUPa]:CHANnel<ch>:DPDCh:E:
  DATA:DSElect <DSelect>
```

The command selects the data list for the DLISt data source.

The files are stored with the fixed file extensions *.dm_iqd in a directory of the user's choice. The directory applicable to the commands is defined with the command
MMEMory:CDIR. To access the files in this directory, you only have to give the file name, without the path and the file extension.

Parameters:

<DSelect> string

Example: SOUR:BB:W3GP:MST1:CHAN1:DPDC:E:DATA DLIS
selects data lists as the data source.
MMEM:CDIR '/var/user/temp/IQData'
selects the directory for the data lists.
BB:W3GP:MST1:CHAN1:DPDC:E:DATA:DSEL 'dp1'
selects the data list dp1.

Manual operation: See "DPDCH Data Source" on page 213

[[:SOURce<hw>]:BB:W3GPp:MSTation<st>[:HSUPa]:CHANnel<ch>:DPDCh:E:DATA:PATtern <Pattern>, <BitCount>

The command determines the bit pattern for the data component when the PATtern data source is selected. The first parameter determines the bit pattern (choice of hexadecimal, octal or binary notation), the second specifies the number of bits to use.

Parameters:

<Pattern> numeric
 *RST: #H0

<BitCount> integer
 Range: 1 to 64
 *RST: 1

Example: SOUR:BB:W3GP:MST1:HSUP:CHAN1:DPDC:E:PATT #H3F,8
 defines the bit pattern of the data for the DATA component.

Manual operation: See " [E-DPDCH Data Source](#) " on page 217

[[:SOURce<hw>]:BB:W3GPp:MSTation<st>[:HSUPa]:CHANnel<ch>:DPDCh:E:POWER <Power>

The command sets the power of the selected E-DPDCH channel.

Parameters:

<Power> float
 Range: -80 dB to 0 dB
 Increment: 0.01
 *RST: 0 dB

Example: BB:W3GP:MST1:HSUP:CHAN1:DPDC:E:POW -2.5dB
 sets the power of E-DPDCH channel 1 to 2.5 dB.

Manual operation: See " [Channel Power / dB](#) " on page 217

[[:SOURce<hw>]:BB:W3GPp:MSTation<st>[:HSUPa]:CHANnel<ch>:DPDCh:E:SRATe?

The command queries the symbol rate and the state of the E-DPDCH channel.

The symbol rate and the state of the channels are dependent on the overall symbol rate set and cannot be modified.

Return values:

<SRate> D15K | D30K | D60K | D120k | D240k | D480k | D960k |
 D1920k | D2X1920K | D2X960K2X1920K

Example: BB:W3GP:MST4:HSUP:CHAN1:DPDC:E:SRAT?
 queries the symbol rate of E-DPDCH 1 of user equipment 4.
 Response: 960
 the symbol rate is 960 ksps.

Usage: Query only

Manual operation: See "[Symbol Rate / State](#)" on page 217

**[[:SOURce<hw>]:BB:W3GPp:MSTation<st>[:HSUPa]:DPCCh:E:FRC:CHANnel
<Channel>**

The command sets the FRC according to TS 25.141 Annex A.10.

Selection of FRC#8 is enabled only for instruments equipped with option SMx/AMU-K59.

Parameters:

<Channel> USER | 1 | 2 | 3 | 4 | 5 | 6 | 7 | 8
*RST: 4

Example: SOUR:BB:W3GP:MST1:HSUP:DPCCh:E:FRC:CHAN 4
sets the FRC to channel 4.

Manual operation: See "[Fixed Reference Channel \(FRC\)](#)" on page 224

[[:SOURce<hw>]:BB:W3GPp:MSTation<st>[:HSUPa]:DPCCh:E:FRC:CRATe?

The command queries the relation between the information bits to binary channel bits.

Return values:

<CRate> float

Example: SOUR1:BB:W3GP:MST1:HSUP:DPCCh:E:FRC:CRAT?
queries the coding rate.
Response: 0.705
the coding rate is 0.705.

Usage: Query only

Manual operation: See "[Coding Rate \(Ninf/Nbin\)](#)" on page 227

[[:SOURce<hw>]:BB:W3GPp:MSTation<st>[:HSUPa]:DPCCh:E:FRC:DATA <Data>

Selects the data source for the E-DCH channels, i.e. this parameter affects the corresponding parameter of the E-DPDCH.

Parameters:

<Data> PN9 | PN11 | PN15 | PN16 | PN20 | PN21 | PN23 | DLISt |
ZERO | ONE | PATtern

PNxx

The pseudo-random sequence generator is used as the data source. Different random sequence lengths can be selected.

DLISt

A data list is used. The data list is selected with the command
[\[:SOURce<hw>\]:BB:W3GPp:MSTation<st>\[:HSUPa\]:
DPCCh:E:FRC:DATA:DSElect.](#)

ZERO | ONE

Internal 0 and 1 data is used.

PATtern

Internal data is used. The bit pattern for the data is defined by the command `[:SOURce<hw>] :BB:W3GPp:MSTation<st> [:HSUPa] :DPCCh:E:FRC:DATA:PATtern`. The maximum length is 64 bits.

*RST: PN9

Example:

`BB:W3GP:MST:HSUP:DPCC:E:FRC:DATA PATT`

Selects as the data source

`BB:W3GP:MST:HSUP:DPCC:E:FRC:DATA:PATT #H48D0,16`

Defines the bit pattern.

Manual operation: See "[Data Source \(E-DCH\)](#)" on page 225

[:SOURce<hw>] :BB:W3GPp:MSTation<st> [:HSUPa] :DPCCh:E:FRC:DATA: DSElect <DSelect>

The command selects the data list when the DLIS data source is selected for E-DCH channels.

The files are stored with the fixed file extensions `*.dm_iqd` in a directory of the user's choice. The directory applicable to the commands is defined with the command `MMEMemory:CDIR`. To access the files in this directory, you only have to give the file name, without the path and the file extension.

Parameters:

<DSelect> string

Example:

`BB:W3GP:MST:HSUP:DPCC:E:FRC:DATA DLIS`

selects the Data Lists data source.

`MMEMemory:CDIR '/var/user/temp/IQData'`

selects the directory for the data lists.

`BB:W3GP:MST:HSUP:DPCC:E:FRC:DATA:DSEL 'frc_1'`

selects the data list `frc_1`.

Manual operation: See "[Data Source \(E-DCH\)](#)" on page 225

[:SOURce<hw>] :BB:W3GPp:MSTation<st> [:HSUPa] :DPCCh:E:FRC:DATA: PATtern <Pattern>, <BitCount>

The command determines the bit pattern for the PATtern data source selection. The maximum length of the bit pattern is 64 bits.

Parameters:

<Pattern> numeric

*RST: #H0

<BitCount> integer

Range: 1 to 64

*RST: 1

Example: BB:W3GP:MST:HSUP:DPCC:E:FRC:DATA:PATT
#B11110000,8
defines the bit pattern of the data for the E-DCH channels.

Manual operation: See ["Data Source \(E-DCH\)"](#) on page 225

**[:SOURCE<hw>]:BB:W3GPp:MSTation<st>[:HSUPa]:DPCCh:E:FRC:DERRor:BIT:
LAYer <Layer>**

The command sets the layer in the coding process at which bit errors are inserted.

Parameters:

<Layer> TRANsport | PHYSical
*RST: PHYSical

Example: SOUR:BB:W3GP:MST1:HSUP:DPCC:E:FRC:DERR:BIT:LAY
TRAN
sets the bit error insertion to the transport layer.

Manual operation: See ["Insert Errors On"](#) on page 230

**[:SOURCE<hw>]:BB:W3GPp:MSTation<st>[:HSUPa]:DPCCh:E:FRC:DERRor:BIT:
RATE <Rate>**

Sets the bit error rate.

Parameters:

<Rate> float
Range: 1E-7 to 0.5
Increment: 1E-7
*RST: 0.001

Example: SOUR:BB:W3GP:MST1:HSUP:DPCC:E:FRC:DERR:BIT:RATE
1e-3
sets the bit error rate to 1E-3.

Manual operation: See ["Bit Error Rate"](#) on page 230

**[:SOURCE<hw>]:BB:W3GPp:MSTation<st>[:HSUPa]:DPCCh:E:FRC:DERRor:BIT:
STATE <State>**

The command activates or deactivates bit error generation.

Parameters:

<State> ON | OFF
*RST: 0

Example: SOUR:BB:W3GP:MST1:HSUP:DPCC:E:FRC:DERR:BIT:STAT
ON
activates the bit error state.

Manual operation: See ["Bit Error State"](#) on page 230

```
[:SOURce<hw>]:BB:W3GPp:MSTation<st>[:HSUPa]:DPCC:h:E:FRC:DERRor:
  BLOCK:RATE <Rate>
```

Sets the block error rate.

Parameters:

```
<Rate>          float
                Range:    1E-4 to 0.5
                Increment: 1E-4
                *RST:     0.1
```

Example: SOUR:BB:W3GP:MST1:HSUP:DPCC:E:FRC:DERR:BLOC:
 RATE 1E-3
 sets the block error rate.

Manual operation: See "[Block Error Rate](#)" on page 231

```
[:SOURce<hw>]:BB:W3GPp:MSTation<st>[:HSUPa]:DPCC:h:E:FRC:DERRor:
  BLOCK:STATe <State>
```

The command activates or deactivates block error generation.

Parameters:

```
<State>         ON | OFF
                *RST:    0
```

Example: SOUR:BB:W3GP:MST1:HSUP:DPCC:E:FRC:DERR:BLOC:
 STAT ON
 activates the block error generation.

Manual operation: See "[Block Error State](#)" on page 231

```
[:SOURce<hw>]:BB:W3GPp:MSTation<st>[:HSUPa]:DPCC:h:E:FRC:DTX:PATTern
  <Pattern>
```

The command sets the user-definable bit pattern for the DTX.

Parameters:

```
<Pattern>       string
                *RST:    "1"
```

Example: SOUR:BB:W3GP:MST1:HSUP:DPCC:E:FRC:DTX:PATT
 "11-1-"
 sets the bit pattern for the DTX.

Manual operation: See "[User Data \(DTX Pattern\)](#)" on page 228

```
[:SOURce<hw>]:BB:W3GPp:MSTation<st>[:HSUPa]:DPCC:h:E:FRC:DTX:STATe
  <State>
```

The command activates or deactivates the DTX (Discontinuous Transmission) mode.

Parameters:

<State> ON | OFF
 *RST: 0

Example:

SOUR:BB:W3GP:MST1:HSUP:DPCC:E:FRC:DTX:STAT ON
 activates the DTX.

Manual operation: See "[State \(DTX\)](#)" on page 228

**[:SOURCE<hw>]:BB:W3GPp:MSTation<st>[:HSUPa]:DPCC:h:E:FRC:HARQ:
 SIMulation:MODE <Mode>**

Selects the HARQ simulation mode.

Parameters:

<Mode> VHARq
VHARq
 Simulates basestation feedback.
 *RST: HFE

Example:

SOUR1:BB:W3GP:MST1:HSUP:DPCC:E:FRC:HARQ:SIM:
 MODE VHAR
 Sets simulation mode virtual HARQ.

Manual operation: See "[Mode \(HARQ\)](#)" on page 229

**[:SOURCE<hw>]:BB:W3GPp:MSTation<st>[:HSUPa]:DPCC:h:E:FRC:HARQ:
 SIMulation:RVZero <RvZero>**

If activated, the same redundancy version is sent, that is, the redundancy version is not adjusted for the next retransmission in case of a received NACK.

Parameters:

<RvZero> ON | OFF
 *RST: 1

Example:

SOUR1:BB:W3GP:MST1:HSUP:DPCC:E:FRC:HARQ:SIM:RVZ
 ON
 the same redundancy version is sent for the next retransmission.

Manual operation: See "[Always Use Redundancy Version 0 \(HARQ\)](#)" on page 229

**[:SOURCE<hw>]:BB:W3GPp:MSTation<st>[:HSUPa]:DPCC:h:E:FRC:HARQ:
 SIMulation[::STATE] <State>**

Activates or deactivates the HARQ simulation mode.

Parameters:

<State> ON | OFF
 *RST: 0

Example: SOUR1:BB:W3GP:MST1:HSUP:DPCC:E:FRC:HARQ:SIM:
STAT ON
activates the HARQ simulation mode.

Manual operation: See "[State \(HARQ\)](#)" on page 229

**[:SOURCE<hw>]:BB:W3GP:MSTation<st>[:HSUPa]:DPCCh:E:FRC:HARQ[:
SIMulation]:PATTern<ch> <Pattern>**

Sets the HARQ Pattern. The maximum length of the pattern is 32 bits.

Parameters:

<Pattern> string

Example: SOUR1:BB:W3GP:MST1:HSUP:DPCC:E:FRC:HARQ:SIM:
HARQ:PATT 1010
sets the HARQ simulation pattern.

Manual operation: See "[HARQ1..8: ACK/NACK](#)" on page 229

**[:SOURCE<hw>]:BB:W3GP:MSTation<st>[:HSUPa]:DPCCh:E:FRC:
HPROcesses?**

The command queries the number of HARQ (Hybrid-ARQ Acknowledgement) process.

Return values:

<HProcesses> integer
Range: 1 to 8

Example: SOUR:BB:W3GP:MST1:HSUP:DPCC:E:FRC:HPRO?
queries the number of HARQ processes.
Response: 5

Usage: Query only

Manual operation: See "[Number Of HARQ Processes](#)" on page 226

[:SOURCE<hw>]:BB:W3GP:MSTation<st>[:HSUPa]:DPCCh:E:FRC:MIBRate?

Queries the maximum information bit rate.

Return values:

<MiBRate> float
Increment: 0.1

Example: SOUR:BB:W3GP:MST1:HSUP:DPCC:E:FRC:HPRO?
Queries the maximum information bit rate.
Response: 1353.0

Usage: Query only

Manual operation: See "[Maximum Information Bitrate/kbps](#)" on page 224

[:SOURce<hw>]:BB:W3GPp:MSTation<st>[:HSUPa]:DPCC:h:E:FRC:MODulation
<Modulation>

Sets the modulation used for the selected FRC.

Two modulation schemes are defined: BPSK for FRC 1 - 7 and 4PAM (4 Pulse-Amplitude Modulation) for FRC 8.

Parameters:

<Modulation> BPSK | PAM4
*RST: BPSK

Example:

BB:W3GP:MST1:HSUP:DPCC:E:FRC:CHAN 8
sets the FRC to channel 8.
BB:W3GP:MST1:HSUP:DPCC:E:FRC:MOD 4PAM
sets the modulation.

Manual operation: See "[Modulation](#)" on page 226

[:SOURce<hw>]:BB:W3GPp:MSTation<st>[:HSUPa]:DPCC:h:E:FRC:ORATe
<ORate>

Sets the overall symbol rate for the E-DCH channels, i.e. this parameter affects the corresponding parameter of the E-DPDCH.

Parameters:

<ORate> D15K | D30K | D60K | D120k | D240k | D480k | D960k |
D1920k | D2X1920K | D2X960K2X1920K
*RST: D960k

Example:

BB:W3GP:MST1:HSUP:DPCC:E:FRC:ORAT D2X1920K

Manual operation: See "[Overall Symbol Rate](#)" on page 226

[:SOURce<hw>]:BB:W3GPp:MSTation<st>[:HSUPa]:DPCC:h:E:FRC:PAYBits?

The command queries the payload of the information bit. This value determines the number of transport layer bits sent in each HARQ process.

Return values:

<PayBits> integer

Example:

SOUR:BB:W3GP:MST1:HSUP:DPCC:E:FRC:PAYB?
Queries the payload of the information bit.
Response: 2706

Usage:

Query only

Manual operation: See "[Information Bit Payload \(Ninf\)](#)" on page 227

[:SOURce<hw>]:BB:W3GPp:MSTation<st>[:HSUPa]:DPCCh:E:FRC:STATE
 <State>

The command activates or deactivates the FRC state for the E-DPCCH channels.

Parameters:

<State> ON | OFF
 *RST: 0

Example: SOUR:BB:W3GP:MST1:HSUP:DPCC:E:FRC:STAT ON
 activates the FRC state for the E-DPCCH channels.

Manual operation: See "[State \(HSUPA FRC\)](#)" on page 223

[:SOURce<hw>]:BB:W3GPp:MSTation<st>[:HSUPa]:DPCCh:E:FRC:TBS:INDEX
 <Index>

Selects the Transport Block Size Index (E-TFCI) for the corresponding table, as described in 3GPP TS 25.321, Annex B.

The value range of this parameter depends on the selected Transport Block Size Table ([\[:SOURce<hw>\]:BB:W3GPp:MSTation<st>\[:HSUPa\]:DPCCh:E:FRC:TBS:TABLE](#)).

Parameters:

<Index> integer
 Range: 0 to max
 *RST: 41

Example: BB:W3GP:MST:HSUP:DPCC:E:FRC:TBS:TABLE TAB0TTI10
 sets the transport block size table
 BB:W3GP:MST:HSUP:DPCC:E:FRC:TBS:INX 127
 sets the transport block size index.

Manual operation: See "[Transport Block Size Index \(E-TFCI\)](#)" on page 227

[:SOURce<hw>]:BB:W3GPp:MSTation<st>[:HSUPa]:DPCCh:E:FRC:TBS:TABLE
 <Table>

Selects the Transport Block Size Table from 3GPP TS 25.321, Annex B according to that the transport block size is configured.

The transport block size is determined also by the Transport Block Size Index ([\[:SOURce<hw>\]:BB:W3GPp:MSTation<st>\[:HSUPa\]:DPCCh:E:FRC:TBS:INDEX](#)).

The allowed values for this command depend on the selected E-DCH TTI ([\[:SOURce<hw>\]:BB:W3GPp:MSTation<st>\[:HSUPa\]:DPCCh:E:FRC:TTIEdch](#)) and modulation scheme ([\[:SOURce<hw>\]:BB:W3GPp:MSTation<st>\[:HSUPa\]:DPCCh:E:FRC:MODulation](#)).

E-DCH TTI	Modulation	Transport Block Size Table	SCPI Parameter	Transport Block Size Index (E-TFCI)
2ms	BPSK	Table 0	TAB0TTI2	0 .. 127
		Table 1	TAB1TTI2	0 .. 125
	4PAM	Table 2	TAB2TTI2	0 .. 127
		Table 3	TAB3TTI2	0 .. 124
10ms	-	Table 0	TAB0TTI10	0 .. 127
		Table 1	TAB1TTI10	0 .. 120

Parameters:

<Table> TAB0TTI2 | TAB1TTI2 | TAB2TTI2 | TAB3TTI2 | TAB0TTI10 | TAB1TTI10
 *RST: TAB0TTI10

Example:

```
BB:W3GP:MST:HSUP:DPCC:E:FRC:ORAT D1920
sets the overall symbol rate
BB:W3GP:MST:HSUP:DPCC:E:FRC:MOD BPSK
sets the modulation
BB:W3GP:MST:HSUP:DPCC:E:FRC:TTIE 2
sets the E-DCH TTI
BB:W3GP:MST:HSUP:DPCC:E:FRC:TBS:TABL TAB0TTI2
sets the transport block size table
BB:W3GP:MST:HSUP:DPCC:E:FRC:TBS:IND 25
sets the transport block size index
```

Manual operation: See "[Transport Block Size Table](#)" on page 226

[[:SOURce<hw>]:BB:W3GPp:MSTation<st>[:HSUPa]:DPCC:h:E:FRC:TTIBits?

The command queries the number of physical bits sent in each HARQ process.

Return values:

<TtiBits> float

Example:

```
BB:W3GP:MST1:HSUP:DPCC:E:FRC:TTIB?
queries the number of physical bits sent in each HARQ process.
```

Usage:

Query only

**[[:SOURce<hw>]:BB:W3GPp:MSTation<st>[:HSUPa]:DPCC:h:E:FRC:TTIEdch
 <Ttiedch>**

Sets the TTI size (Transmission Time Interval).

Parameters:

<Ttiedch> 2ms | 10ms
 *RST: 2ms

Example: `BB:W3GP:MST1:HSUP:DPCC:E:FRC:TIE 2ms`
sets the TTI.

Manual operation: See "[E-DCH TTI](#)" on page 226

[:SOURCE<hw>]:BB:W3GPp:MSTation<st>[:HSUPa]:DPCC:h:E:FRC:UECategory?

Queries the UE category that is minimum required for the selected FRC.

Return values:
<UeCategory> integer

Example: `BB:W3GP:MST1:HSUP:DPCC:E:FRC:UEC?`
queries the UE category.

Usage: Query only

Manual operation: See "[UE Category](#)" on page 224

[:SOURCE<hw>]:BB:W3GPp:MSTation<st>[:HSUPa]:DPCC:h:E:CCODE?

Queries the channelization code.

Return values:
<CCode> integer
Range: 1 to max
*RST: 1

Usage: Query only

Manual operation: See "[Channelization Code](#)" on page 189

[:SOURCE<hw>]:BB:W3GPp:MSTation<st>[:HSUPa]:DPCC:h:E:HBIT <Hbit>

The command activates the happy bit.

Parameters:
<Hbit> ON | OFF
*RST: ON

Example: `BB:W3GP:MST1:HSUP:DPCC:E:HBIT ON`
sets the happy bit.

Manual operation: See "[Happy Bit](#)" on page 189

[:SOURCE<hw>]:BB:W3GPp:MSTation<st>[:HSUPa]:DPCC:h:E:POWER <Power>

The command sets the power of the E-DPCCH channel.

Parameters:

<Power> float
 Range: -80 dB to 0 dB
 Increment: 0.01
 *RST: 0 dB

Example:

BB:W3GP:MST1:HSUP:DPCC:E:POW -2.5dB
 sets the power of the E-DPCCH channel.

Manual operation: See " [Power](#) " on page 188

[:SOURCE<hw>]:BB:W3GPP:MSTation<st>[:HSUPa]:DPCC:h:E:RSNumber
 <RsNumber>

The command sets the retransmission sequence number.

Parameters:

<RsNumber> integer
 Range: 0 to 3
 *RST: 0

Example:

BB:W3GP:MST1:HSUP:DPCC:E:RSN 0
 sets the retransmission sequence number.

Manual operation: See " [Retransmission Sequence Number](#) " on page 188

[:SOURCE<hw>]:BB:W3GPP:MSTation<st>[:HSUPa]:DPCC:h:E:STATE <State>

The command activates/deactivates the E-DPCCH.

Parameters:

<State> ON | OFF
 *RST: OFF

Example:

BB:W3GP:MST1:HSUP:DPCC:E:STAT ON
 activates the E-DPCCH.

Manual operation: See " [State \(E-DPCCH\)](#) " on page 188

[:SOURCE<hw>]:BB:W3GPP:MSTation<st>[:HSUPa]:DPCC:h:E:TFCI <Tfci>

The command sets the value for the TFCI (Transport Format Combination Indicator) field.

Parameters:

<Tfci> integer
 Range: 0 to 127
 *RST: 0

Example:

BB:W3GP:MST1:HSUP:DPCC:E:TFCI 0
 sets the value for the TFCI.

Manual operation: See " [E-TFCI Information](#) " on page 189

[:SOURce<hw>]:BB:W3GPp:MSTation<st>[:HSUPa]:DPDCh:E:FCIO <Fcio>

The command sets the channelization code to I/O.

Parameters:

<Fcio> ON | OFF
*RST: OFF

Example: BB:W3GP:MST1:HSUP:DPDC:E:FCIO ON
sets the channelization code to I/O.

Manual operation: See " [Force Channelization Code To I/O](#) " on page 215

[:SOURce<hw>]:BB:W3GPp:MSTation<st>[:HSUPa]:DPDCh:E:MODulation <Modulation>

Sets the modulation of the E-DPDCH.

There are two possible modulation schemes specified for this channel, BPSK and 4PAM (4 Pulse-Amplitude Modulation). The latter one is available only for the following Overall Symbol Rates ([:SOURce<hw>]:BB:W3GPp:MSTation<st>[:HSUPa]:DPDCh:E:ORATe):

- 2x960 ksps
- 2x1920 ksps
- 2x960 + 2x1920 ksps
- 2x960 ksps, I or Q only
- 2x1920 ksps, I or Q only
- 2x960 + 2x1920 ksps, I or Q only

Parameters:

<Modulation> BPSK | PAM4
*RST: BPSK

Example: BB:W3GP:MST1:HSUP:DPDC:E:ORAT D2x960K2x1920K
sets the overall symbol rate
BB:W3GP:MST1:HSUP:DPDC:E:MOD 4PAM
sets the modulation to 4PAM

Options: Modulation scheme 4PAM requires the HSPA+ option R&S SMx/AMU-K59.

Manual operation: See " [Modulation](#) " on page 216

[:SOURce<hw>]:BB:W3GPp:MSTation<st>[:HSUPa]:DPDCh:E:ORATe <ORate>

Sets the overall symbol rate of all the E-DPDCH channels.

Parameters:

<ORate> D15K | D30K | D60K | D120k | D240k | D480k | D960k |
 D1920k | D2X1920K | D2X960K2X1920K | D2880k | D3840k |
 D4800k | D5760k | D2x960KI | D2x960KQ | D2X1920KI |
 D2X1920KQ | D2X960K2X1920KI | D2X960K2X1920KQ
 *RST: D60K

Example:

BB:W3GP:MST1:HSUP:DPDC:E:ORAT D60K

Manual operation: See " [Overall Symbol Rate](#) " on page 215

[:SOURCE<hw>] : BB : W3GPp : MSTation<st> [: HSUPa] : DPDC h : E : STATE <State>

The command activates or deactivates the E-DPDCHs. This always activates or deactivates all the channels.

Parameters:

<State> ON | OFF
 *RST: 0

Example:

BB:W3GP:MST1:HSUP:DPDC:E:STAT ON
 activates all the E-DPDCHs.

Manual operation: See " [State \(E-DPDCH\)](#) " on page 215

[:SOURCE<hw>] : BB : W3GPp : MSTation<st> [: HSUPa] : DPDC h : E : TTIEDch <Ttiedch>

The command sets the value for the TTI (Transmission Time Interval).

Parameters:

<Ttiedch> 2ms | 10ms
 *RST: 2ms

Example:

BB:W3GP:MST1:HSUP:DPDC:E:TTIE 2ms
 sets the value for the TTI to 2 ms.

Manual operation: See " [E-DCH TTI](#) " on page 220

[:SOURCE<hw>] : BB : W3GPp : MSTation<st> [: HSUPa] : EDCH : TTIEDch <Ttiedch>

Sets the value for the TTI size (Transmission Time Interval).

This command is a query only, if an UL-DTX is enabled ([: SOURCE<hw>] : BB : W3GPp : MSTation : UDTX : STATE ON) or an FRC is activated ([: SOURCE<hw>] : BB : W3GPp : MSTation<st> [: HSUPa] : DPCCh : E : FRC : STATE ON).

Parameters:

<Ttiedch> 2ms | 10ms
 *RST: 2ms

Example: BB:W3GP:MST[:HSUPa]:EDCH:TTIE 10ms
 BB:W3GP:MST:UDTX:TTIE 2ms
 BB:W3GP:MST:UDTX:STAT ON
 BB:W3GP:MST[:HSUPa]:EDCH:TTIE?
 Response: 2ms

Manual operation: See "E-DCH TTI" on page 220

[:SOURce<hw>]:BB:W3GPp:MSTation<st>[:HSUPa]:EDCH:REPeat <Repeat>

Determine the number of TTIs after that the E-DCH scheduling is repeated.

Parameters:

<Repeat> integer
 Range: 1 to dynamic
 *RST: 1

Example: [:SOURce<hw>]:BB:W3GPp:MSTation<st>[:HSUPa]:
 EDCH:ROWCount on page 416

Manual operation: See "E-DCH Schedule Repeats After" on page 221

**[:SOURce<hw>]:BB:W3GPp:MSTation<st>[:HSUPa]:EDCH:ROW<ch0>:FROM
 <TtiFrom>**

[:SOURce<hw>]:BB:W3GPp:MSTation<st>[:HSUPa]:EDCH:ROW<ch0>:TO <TtiTo>

Determines the start/end TTI of the corresponding E-DCH burst.

Parameters:

<TtiTo> integer
 Range: 0 to dynamic
 *RST: row index

Example: [:SOURce<hw>]:BB:W3GPp:MSTation<st>[:HSUPa]:
 EDCH:ROWCount on page 416

Manual operation: See "E-DCH TTI To" on page 221

**[:SOURce<hw>]:BB:W3GPp:MSTation<st>[:HSUPa]:EDCH:ROWCount
 <RowCount>**

Sets the number of the rows in the scheduling table.

Parameters:

<RowCount> integer
 Range: 1 to 32
 *RST: 1

Example: E-DCH scheduling example

```

BB:W3GP:MST[:HSUPa]:EDCH:TtIE 2ms
BB:W3GP:MST[:HSUPa]:EDCH:ROWC 2
BB:W3GP:MST[:HSUPa]:EDCH:REP 1000
BB:W3GP:MST[:HSUPa]:EDCH:ROW0:FROM 3
BB:W3GP:MST[:HSUPa]:EDCH:ROW0:TO 6
BB:W3GP:MST[:HSUPa]:EDCH:ROW1:FROM 128
BB:W3GP:MST[:HSUPa]:EDCH:ROW0:TO 156

```

Manual operation: See "Number of Table Rows" on page 220

7.9.9 UL-DTX and Uplink Scheduling Settings

The following are simple programming examples with the purpose to show **all** commands for this task. In real application, some of the commands can be omitted.

Example: Configuring the UL-DTX settings

```

*****
SOURCE:BB:W3GPp:LINK UP
SOURCE:BB:W3GPp:MSTation:UDTX:MODE UDTX
SOURCE:BB:W3GPp:MSTation:UDTX:TtIEdch 2
SOURCE:BB:W3GPp:MSTation:UDTX:OFFSet 2
SOURCE:BB:W3GPp:MSTation:UDTX:ITHReshold 8
SOURCE:BB:W3GPp:MSTation:UDTX:LPLength 4
SOURCE:BB:W3GPp:MSTation:UDTX:CYCLe1 4
SOURCE:BB:W3GPp:MSTation:UDTX:CYCLe2 8
SOURCE:BB:W3GPp:MSTation:UDTX:BURSt1 1
SOURCE:BB:W3GPp:MSTation:UDTX:BURSt2 1
// SOURCE:BB:W3GPp:MSTation:UDTX:PREamble2?
// SOURCE:BB:W3GPp:MSTation:UDTX:POSTamble1?
SOURCE:BB:W3GPp:MSTation:UDTX:STATe ON

```

[:SOURCE<hw>]:BB:W3GPp:MSTation:UDTX:MODE.....	417
[:SOURCE<hw>]:BB:W3GPp:MSTation:UDTX:STATe.....	418
[:SOURCE<hw>]:BB:W3GPp:MSTation:UDTX:TtIEdch.....	418
[:SOURCE<hw>]:BB:W3GPp:MSTation:UDTX:OFFSet.....	418
[:SOURCE<hw>]:BB:W3GPp:MSTation:UDTX:ITHReshold.....	419
[:SOURCE<hw>]:BB:W3GPp:MSTation:UDTX:LPLength.....	419
[:SOURCE<hw>]:BB:W3GPp:MSTation:UDTX:CYCLe<ch>.....	419
[:SOURCE<hw>]:BB:W3GPp:MSTation:UDTX:BURSt<ch>.....	420
[:SOURCE<hw>]:BB:W3GPp:MSTation:UDTX:PREamble<ch>?.....	420
[:SOURCE<hw>]:BB:W3GPp:MSTation:UDTX:POSTamble<ch>?.....	420

[:SOURCE<hw>]:BB:W3GPp:MSTation:UDTX:MODE <UldtxMode>

The mode is fixed to UL-DTX.

Parameters:

<UldtxMode> UDTX
 *RST: UDTX

Example: See ["Example: Configuring the UL-DTX settings"](#) on page 417.
Options: R&S SMx/AMU-K45/K59
Manual operation: See ["Mode"](#) on page 158

[:SOURCE<hw>]:BB:W3GPP:MSTation:UDTX:STATE <State>

Enables/disables UL-DTX.

Enabling the UL-DTX deactivates the DPDCH and the HSUPA FRC.

Parameters:

<State> 0 | 1 | OFF | ON
 *RST: 0

Example: See ["Example: Configuring the UL-DTX settings"](#) on page 417.
Options: R&S SMx/AMU-K45/K59
Manual operation: See ["UL-DTX... / User Scheduling State"](#) on page 158

[:SOURCE<hw>]:BB:W3GPP:MSTation:UDTX:TTIEdch <EdchTti>

Sets the duration of a E-DCH TTI.

Parameters:

<EdchTti> 2ms | 10ms
 Range: 2ms to 10ms
 *RST: 2ms

Example: see ["Example: Configuring the UL-DTX settings"](#) on page 417
Options: R&S SMx/AMU-K45/K59
Manual operation: See ["E-DCH TTI"](#) on page 158

[:SOURCE<hw>]:BB:W3GPP:MSTation:UDTX:OFFSet <Offset>

Sets the parameter UE_DTX_DRX_Offset and determines the start offset in subframes of the first uplink DPCCH burst (after the preamble). The offset is applied only for bursts belonging to the DPCCH burst pattern; HS-DPCCH or E-DCH transmissions are not affected.

Parameters:

<Offset> integer
 Range: 0 to 159
 Increment: depends on E-DCH TTI parameter
 *RST: 0

Example: See ["Example: Configuring the UL-DTX settings"](#) on page 417
Options: R&S SMx/AMU-K45/K59
Manual operation: See ["Offset"](#) on page 158

[:SOURCE<hw>]:BB:W3GPP:MSTation:UDTX:ITHReshold <Threshold>

Defines the number of consecutive E-DCH TTIs without an E-DCH transmission, after which the UE shall immediately move from UE-DTX cycle 1 to using UE-DTX cycle 2.

Parameters:

<Threshold> 1 | 4 | 8 | 16 | 32 | 64 | 128 | 256
*RST: 16

Example: see ["Example: Configuring the UL-DTX settings"](#) on page 417

Options: R&S SMx/AMU-K45/K59

Manual operation: See ["Inactivity Threshold for Cycle 2"](#) on page 159

[:SOURCE<hw>]:BB:W3GPP:MSTation:UDTX:LPLength <LongPreamble>

Determines the length in slots of the preamble associated with the UE-DTX cycle 2.

Parameters:

<LongPreamble> 2 | 4 | 15
*RST: 2

Example: see ["Example: Configuring the UL-DTX settings"](#) on page 417

Options: R&S SMx/AMU-K45/K59

Manual operation: See ["Long Preamble Length"](#) on page 159

[:SOURCE<hw>]:BB:W3GPP:MSTation:UDTX:CYCLE<ch> <DtxCycle>

Sets the offset in subframe between two consecutive DPCCH bursts within the corresponding UE-DTX cycle, i.e. determines how often the DPCCH bursts are transmitted.

The UE-DTX cycle 2 is an integer multiple of the UE-DTX cycle 1, i.e. has less frequent DPCCH transmission instants.

Note: The allowed values depend on the selected E-DCH TTI.

Suffix:

<ch> 1|2
UL-DTX cycle 1 or 2

Parameters:

<DtxCycle> 1 | 4 | 5 | 8 | 10 | 16 | 20 | 32 | 40 | 64 | 80 | 128 | 160
*RST: 5

Example: see ["Example: Configuring the UL-DTX settings"](#) on page 417

Options: R&S SMx/AMU-K45/K59

Manual operation: See ["DTX Cycle 1 / DTX Cycle 2"](#) on page 159

[:SOURCE<hw>]:BB:W3GPP:MSTation:UDTX:BURSt<ch> <BurstLength>

Determines the uplink DPCCH burst length in subframes without the preamble and postamble, when the corresponding UE-DTX cycle is applied.

Suffix:

<ch> 1|2
 UL-DTX cycle 1 or 2

Parameters:

<BurstLength> 1 | 2 | 5
 *RST: 1

Example: See ["Example: Configuring the UL-DTX settings"](#) on page 417

Options: R&S SMx/AMU-K45/K59

Manual operation: See ["DPCCH Burst Length 1 / DPCCH Burst Length 2"](#) on page 159

[:SOURCE<hw>]:BB:W3GPP:MSTation:UDTX:PREAmble<ch>?

Queries the preamble length in slots, when the corresponding UE-DTX cycle is applied.

The preamble length is fixed to 2 slots.

Suffix:

<ch> 1|2
 UL-DTX cycle 1 or 2

Return values:

<Preamble> integer
 Range: 2 to 2
 *RST: 2

Example: see ["Example: Configuring the UL-DTX settings"](#) on page 417

Usage: Query only

Options: R&S SMx/AMU-K45/K59

Manual operation: See ["Preamble Length 1 / Preamble Length 2"](#) on page 160

[:SOURCE<hw>]:BB:W3GPP:MSTation:UDTX:POSTamble<ch>?

Queries the postamble length in slots, when the corresponding UE-DTX cycle is applied.

The postamble length is fixed to 1 slot.

Suffix:

<ch> 1|2
 UL-DTX cycle 1 or 2

Return values:

<PostAmble> integer
Range: 1 to 1

Example: see "Example: Configuring the UL-DTX settings" on page 417

Usage: Query only

Options: R&S SMx/AMU-K45/K59

Manual operation: See "Postamble Length 1 / Postamble Length 2" on page 160

7.9.10 Dynamic Power Control Settings

Example: Configuring the Dynamic Power Control Settings

The following is a simple programming example with the purpose to show **all** commands for this task. In real application, some of the commands can be omitted.

```
SOURce:BB:W3GPP:MSTation:ENHanced:DPDCh:DPControl:DIRection UP
// selects direction up, a high level of the control signals
// leads to an increase of the channel power
SOURce:BB:W3GPP:MSTation:ENHanced:DPDCh:DPControl:STEP 1 dB
// selects a step width of 1 dB.
// A high level of the control signal leads to
// an increase of 1 dB of the channel power,
// a low level to a decrease of 1 dB.
SOURce:BB:W3GPP:MSTation:ENHanced:DPDCh:DPControl:RANGE:DOWN 10 dB
// selects a dynamic range of 10 dB for ranging up the channel power
SOURce:BB:W3GPP:MSTation:ENHanced:DPDCh:DPControl:RANGE:UP 50 dB
// selects a dynamic range of 50 dB for ranging up the channel power
// The overall increase and decrease of channel power,
// i.e. the dynamic range is limited to 60 dB
SOURce:BB:W3GPP:MSTation:ENHanced:DPDCh:DPControl:MODE TPC
// selects the source of the power control signal
SOURce:BB:W3GPP:MSTation:ENHanced:DPDCh:DPControl:STATE ON
// activates Dynamic Power Control for the enhanced channels of UE1
SOURce:BB:W3GPP:MSTation:ENHanced:DPDCh:DPControl:POWer?
// queries the deviation of the channel power (delta POW)
// from the set power start value of the DPDCH
SOURce:BB:W3GPP:MSTation:ENHanced:DPDCh:DPControl:AOUE ON
```

[SOURce<hw>]:BB:W3GPP:MSTation[:ENHanced:DPDCh]:DPControl:ASSignment..... 422
[SOURce<hw>]:BB:W3GPP:MSTation[:ENHanced:DPDCh]:DPControl:DIRection..... 422
[SOURce<hw>]:BB:W3GPP:MSTation[:ENHanced:DPDCh]:DPControl:MODE..... 422
[SOURce<hw>]:BB:W3GPP:MSTation[:ENHanced:DPDCh]:DPControl[:POWer]?..... 423
[SOURce<hw>]:BB:W3GPP:MSTation[:ENHanced:DPDCh]:DPControl:RANGE:DOWN..... 423
[SOURce<hw>]:BB:W3GPP:MSTation[:ENHanced:DPDCh]:DPControl:RANGE:UP..... 423
[SOURce<hw>]:BB:W3GPP:MSTation[:ENHanced:DPDCh]:DPControl:STATE..... 423
[SOURce<hw>]:BB:W3GPP:MSTation[:ENHanced:DPDCh]:DPControl:STEP:MANual..... 424
[SOURce<hw>]:BB:W3GPP:MSTation[:ENHanced:DPDCh]:DPControl:STEP[:EXternal]..... 424

[:SOURce<hw>]:BB:W3GPP:MSTation[:ENHanced:DPDCh]:DPCControl:ASSignment <ASSignment>

Enabled for UL-DTX mode only (`[:SOURce<hw>]:BB:W3GPP:MSTation:UDTX:STATE ON`).

The power control recognizes the UL-DPCCH gaps according to 3GPP TS 25.214. Some of the TPC commands sent to the instrument over the external line or by the TPC pattern are ignored, whereas others are summed up and applied later. The processing of the TPC commands depends only on whether the BS sends the TPC bits on the F-DPCH with slot format 0/ slot format 9 or not.

Parameters:

<ASSignment> NORMAl | FDPCh
*RST: NORMAl

Example:

BB:W3GP:MST1:UDTX:STAT ON
BB:W3GP:MST:DPC:ASS FDPCh

Manual operation: See ["Assignment Mode for UL-DTX"](#) on page 155

[:SOURce<hw>]:BB:W3GPP:MSTation[:ENHanced:DPDCh]:DPCControl:DIRection <Direction>

The command selects the Dynamic Power Control direction. The selected direction determines if the channel power is increased (`UP`) or decreased (`DOWN`) by control signal with high level.

Parameters:

<Direction> UP | DOWN
*RST: UP

Example:

see [Example "Configuring the Dynamic Power Control Settings"](#) on page 421

Manual operation: See ["Direction"](#) on page 153

[:SOURce<hw>]:BB:W3GPP:MSTation[:ENHanced:DPDCh]:DPCControl:MODE <Mode>

Determines the source of the control signal.

Parameters:

<Mode> TPC | MANual
*RST: EXTernal

Example:

See [Example "Configuring the Dynamic Power Control Settings"](#) on page 421.

Manual operation: See ["Mode"](#) on page 153

```
[ :SOURce<hw>]:BB:W3GPP:MSTation[:ENHanced:DPDCh]:DPControl[:POWER]?
```

The command queries the deviation of the channel power (delta POW) from the set power start value of the DPDCH.

Return values:

```
<Power>          float
                  Range:    -60 to 60
                  Increment: 0.01
                  *RST:     0
```

Example: see [Example "Configuring the Dynamic Power Control Settings"](#) on page 421

Usage: Query only

Manual operation: See ["Power Control Graph"](#) on page 154

```
[ :SOURce<hw>]:BB:W3GPP:MSTation[:ENHanced:DPDCh]:DPControl:RANGE:
DOWN <Down>
```

```
[ :SOURce<hw>]:BB:W3GPP:MSTation[:ENHanced:DPDCh]:DPControl:RANGE:
UP <Up>
```

The command selects the dynamic range for ranging up the channel power.

Parameters:

```
<Up>             float
                  Range:    0 to 60
                  Increment: 0.01
                  *RST:     10
                  Default unit: dB
```

Example: `BB:W3GPP:MST:ENH:DPDC:DPC:RANG:UP 20dB`
selects a dynamic range of 20 dB for ranging up the channel power.

Manual operation: See ["Up Range / Down Range"](#) on page 154

```
[ :SOURce<hw>]:BB:W3GPP:MSTation[:ENHanced:DPDCh]:DPControl:STATE
<State>
```

Activates/deactivates Dynamic Power Control.

Parameters:

```
<State>         0 | 1 | OFF | ON
                  *RST:     0
```

Example: See [Example "Configuring the Dynamic Power Control Settings"](#) on page 421.

Manual operation: See ["Dynamic Power Control State"](#) on page 153

[:SOURCE<hw>]:BB:W3GPP:MSTation[:ENHanced:DPDCh]:DPControl:STEP:MANual <Manual>

Sets the control signal for manual mode of Dynamic Power Control.

Parameters:

<Manual> MAN0 | MAN1
*RST: MAN0

Example:

```
BB:W3GP:MST:ENH:DPDC:DPC:STAT ON
BB:W3GP:MST:ENH:DPDC:DPC:MODE MAN
BB:W3GP:MST:ENH:DPDC:DPC:STEP:MAN MAN0
```

Manual operation: See ["Mode"](#) on page 153

[:SOURCE<hw>]:BB:W3GPP:MSTation[:ENHanced:DPDCh]:DPControl:STEP[:EXTernal] <External>

This command sets step width by which – with Dynamic Power Control being switched on - the channel power of the enhanced channels is increased or decreased.

Parameters:

<External> float
Range: 0.5 to 6
Increment: 0.01
*RST: 1
Default unit: dB

Example: see [Example "Configuring the Dynamic Power Control Settings"](#) on page 421

Manual operation: See ["Power Step"](#) on page 154

7.10 Enhanced Channels of the User Equipment

The `SOURCE:BB:W3GPP:MSTation:ENHanced` subsystem contains the commands for setting the enhanced channels of user equipment 1 (UE1).

The commands of this system only take effect when the 3GPP FDD standard is activated, the uplink transmission direction is selected and user equipment 1 is enabled:

- `SOURCE:BB:W3GPP:STATE ON`
- `SOURCE:BB:W3GPP:LINK UP`
- `SOURCE:BB:W3GPP:MSTation1:STATE ON`

TCHannel<di>

The transport channel designations for remote control are `TCHannel0` for DCCH, `TCHannel1` to `TCHannel6` for DTCH1 to DTCH6.

[SOURce<hw>]:BB:W3GPp:MSStation:ENHanced:DPDCh:BPFRame?.....	425
[SOURce<hw>]:BB:W3GPp:MSStation:ENHanced:DPDCh:CCODing:STATe.....	426
[SOURce<hw>]:BB:W3GPp:MSStation:ENHanced:DPDCh:CCODing:TYPE.....	426
[SOURce<hw>]:BB:W3GPp:MSStation:ENHanced:DPDCh:CCODing:USER:CATalog?.....	427
[SOURce<hw>]:BB:W3GPp:MSStation:ENHanced:DPDCh:CCODing:USER:DELete.....	427
[SOURce<hw>]:BB:W3GPp:MSStation:ENHanced:DPDCh:CCODing:USER:LOAD.....	428
[SOURce<hw>]:BB:W3GPp:MSStation:ENHanced:DPDCh:CCODing:USER:STORe.....	428
[SOURce<hw>]:BB:W3GPp:MSStation:ENHanced:DPDCh:DERRor:BIT:LAYer.....	428
[SOURce<hw>]:BB:W3GPp:MSStation:ENHanced:DPDCh:DERRor:BIT:RATE.....	429
[SOURce<hw>]:BB:W3GPp:MSStation:ENHanced:DPDCh:DERRor:BIT:STATe.....	429
[SOURce<hw>]:BB:W3GPp:MSStation:ENHanced:DPDCh:DERRor:BLOCK:RATE.....	430
[SOURce<hw>]:BB:W3GPp:MSStation:ENHanced:DPDCh:DERRor[.BLOCK]:STATe.....	430
[SOURce<hw>]:BB:W3GPp:MSStation:ENHanced:DPDCh:INTerleaver2.....	430
[SOURce<hw>]:BB:W3GPp:MSStation:ENHanced:DPDCh:ORATe.....	431
[SOURce<hw>]:BB:W3GPp:MSStation:ENHanced:DPDCh:STATe.....	431
[SOURce<hw>]:BB:W3GPp:MSStation:ENHanced:DPDCh:TCHannel<di0>:RMATribute.....	431
[SOURce<hw>]:BB:W3GPp:MSStation:ENHanced:DPDCh:TCHannel<di0>:STATe.....	432
[SOURce<hw>]:BB:W3GPp:MSStation:ENHanced:DPDCh:TCHannel<di0>:TBCount.....	432
[SOURce<hw>]:BB:W3GPp:MSStation:ENHanced:DPDCh:TCHannel<di0>:TBSize.....	432
[SOURce<hw>]:BB:W3GPp:MSStation:ENHanced:DPDCh:TCHannel<di0>:TTINterval.....	432
[SOURce<hw>]:BB:W3GPp:MSStation:ENHanced:DPDCh:TCHannel<di0>:CRCSize.....	433
[SOURce<hw>]:BB:W3GPp:MSStation:ENHanced:DPDCh:TCHannel<di0>:DATA.....	433
[SOURce<hw>]:BB:W3GPp:MSStation:ENHanced:DPDCh:TCHannel<di0>:DATA:DSELEct... 434	
[SOURce<hw>]:BB:W3GPp:MSStation:ENHanced:DPDCh:TCHannel<di0>:DATA:PATTern... 434	
[SOURce<hw>]:BB:W3GPp:MSStation:ENHanced:DPDCh:TCHannel<di0>:EPRotectio.n..... 434	
[SOURce<hw>]:BB:W3GPp:MSStation:ENHanced:DPDCh:TCHannel<di0>:INTerleaver..... 435	
[SOURce<hw>]:BB:W3GPp:MSStation:ENHanced:PCPCh:CCODing:STATe.....	435
[SOURce<hw>]:BB:W3GPp:MSStation:ENHanced:PCPCh:CCODing:TYPE.....	436
[SOURce<hw>]:BB:W3GPp:MSStation<st>:ENHanced:PRACH:CCODing:STATe.....	436
[SOURce<hw>]:BB:W3GPp:MSStation<st>:ENHanced:PRACH:CCODing:TYPE.....	436

[SOURce<hw>]:BB:W3GPp:MSStation:ENHanced:DPDCh:BPFRame?

The command queries the number of data bits in the DPDCH component of the frame at the physical layer. The number of data bits depends on the overall symbol rate.

Return values:

<BpFrame> integer
 Range: 150 to 9600

Example:

BB:W3GP:MS:ENH:DPDC:BPFR?
 queries the number of data bits.
 Response: 300
 the number of data bits is 300.

Usage: Query only

Manual operation: See " [Bits per Frame \(DPDCH\)](#) " on page 235

[:SOURce<hw>]:BB:W3GPP:MSTation:ENHanced:DPDCh:CCODing:STATe
 <State>

The command activates or deactivates channel coding for the enhanced channels.

When channel coding is activated, the overall symbol rate ([:SOURce<hw>]:BB:W3GPP:MSTation:ENHanced:DPDCh:ORATe) is set to the value predetermined by the selected channel coding type ([:SOURce<hw>]:BB:W3GPP:MSTation:ENHanced:DPDCh:CCODing:TYPE).

Parameters:

<State> 0 | 1 | OFF | ON
 *RST: 0

Example:

BB:W3GP:MST:ENH:DPDC:CCOD:TYPE M12K2
 selects channel coding type RMC 12.2 kbps.
 BB:W3GP:MST:ENH:DPDC:CCOD:STAT ON
 activates channel coding.

Manual operation: See " [Channel Coding State](#) " on page 233

[:SOURce<hw>]:BB:W3GPP:MSTation:ENHanced:DPDCh:CCODing:TYPE <Type>

The command selects the channel coding scheme in accordance with the 3GPP specification. The channel coding scheme selected predetermines the overall symbol rate.

When channel coding is activated ([:SOURce<hw>]:BB:W3GPP:MSTation:ENHanced:DPDCh:CCODing:STATe) the overall symbol rate ([:SOURce<hw>]:BB:W3GPP:MSTation:ENHanced:DPDCh:ORATe) is set to the value predetermined by the selected channel coding type.

Parameters:

<Type> M12K2 | M64K | M144k | M384k | AMR

M12K2

Measurement channel with an input data bit rate of 12.2 ksps.

M64K

Measurement channel with an input data bit rate of 64 ksps.

M144K

Measurement channel with an input data bit rate of 144 ksps.

M384K

Measurement channel with an input data bit rate of 384 ksps.

AMR

Channel coding for the AMR Coder (coding a voice channel).

USER

This parameter cannot be set. USER is returned whenever a user-defined channel coding is active, that is to say, after a channel coding parameter has been changed or a user coding file has been loaded. The file is loaded by the command [:SOURce<hw>]:BB:W3GPP:MSTation:ENHanced:DPDCh:CCODing:USER:LOAD.

*RST: M12K2

Example: BB:W3GP:MST:ENH:DPDC:CCOD:TYPE M144K
selects channel coding scheme RMC 144 kbps.

Manual operation: See " [Coding Type](#) " on page 233

**[:SOURCE<hw>]:BB:W3GPP:MSTation:ENHanced:DPDCh:CCODing:USER:
CATalog?**

The command queries existing files with stored user channel codings.

The files are stored with the fixed file extensions *.3g_ccod_ul in a directory of the user's choice. The directory applicable to the commands is defined with the command MMEMoRY:CDIR.

Return values:

<Catalog> string

Example: MMEM:CDIR '/var/user/temp/CcodDpchUser'
selects the directory for the user channel coding files.
BB:W3GP:MST:ENH:DPDC:CCOD:USER:CAT?
queries the existing files with user coding.
Response: 'user_cc1'
there is one file with user coding.

Usage: Query only

Manual operation: See " [User Coding ...](#) " on page 234

**[:SOURCE<hw>]:BB:W3GPP:MSTation:ENHanced:DPDCh:CCODing:USER:
DELete <Filename>**

The command deletes the specified files with stored user channel codings.

The files are stored with the fixed file extensions *.3g_ccod_ul in a directory of the user's choice. The directory applicable to the commands is defined with the command MMEMoRY:CDIR. To access the files in this directory, you only have to give the file name, without the path and the file extension.

The command triggers an event and therefore has no query form and no *RST value.

Setting parameters:

<Filename> string

Example: MMEM:CDIR '/var/user/temp/CcodDpchUser'
selects the directory for the user channel coding files.
BB:W3GP:MST:ENH:DPDC:CCOD:USER:DEL 'user_cc1'
deletes the specified file with user coding.

Usage: Setting only

Manual operation: See " [User Coding ...](#) " on page 234

```
[ :SOURce<hw>]:BB:W3GPp:MSTation:ENHanced:DPDCh:CCODing:USER:LOAD
<Filename>
```

The command loads the specified files with stored user channel codings.

The files are stored with the fixed file extensions *.3g_ccod_ul in a directory of the user's choice. The directory applicable to the commands is defined with the command `MMEMory:CDIR`. To access the files in this directory, you only have to give the file name, without the path and the file extension.

Setting parameters:

<Filename> string

Example: `MMEM:CDIR '/var/user/temp/CcodDpchUser'`
 selects the directory for the user channel coding files.
`BB:W3GP:MST:ENH:DPDC:CCOD:USER:LOAD 'user_cc1'`
 loads the specified file with user coding.

Usage: Setting only

Manual operation: See " [User Coding ...](#) " on page 234

```
[ :SOURce<hw>]:BB:W3GPp:MSTation:ENHanced:DPDCh:CCODing:USER:
STORE <Filename>
```

The command saves the current settings for channel coding as user channel coding in the specified file.

The files are stored with the fixed file extensions *.3g_ccod_ul in a directory of the user's choice. The directory in which the file is stored is defined with the command `MMEMory:CDIR`. To store the files in this directory, you only have to give the file name, without the path and the file extension.

Setting parameters:

<Filename> string

Example: `MMEM:CDIR '/var/user/temp/CcodDpchUser'`
 selects the directory for the user channel coding files.
`BB:W3GP:MST:ENH:DPDC:CCOD:USER:STOR 'user_cc1'`
 saves the current channel coding setting in file `user_cc1` in
 directory `/var/user/temp/CcodDpchUser`.

Usage: Setting only

Manual operation: See " [User Coding ...](#) " on page 234

```
[ :SOURce<hw>]:BB:W3GPp:MSTation:ENHanced:DPDCh:DERRor:BIT:LAYer
<Layer>
```

The command selects the layer at which bit errors are inserted.

Parameters:

<Layer> TRANsport | PHYSical

TRANsport

Transport Layer (Layer 2). This layer is only available when channel coding is active.

PHYSical

Physical layer (Layer 1)

*RST: PHYSical

Example:

BB:W3GP:MST:ENH:DPDC:DERR:BIT:LAY PHYS
selects layer 1 for entering bit errors.

Manual operation: See " [Insert Errors On](#) " on page 239

[:SOURCE<hw>]:BB:W3GPP:MSTation:ENHanced:DPDCh:DERRor:BIT:RATE
<Rate>

Sets the bit error rate.

Parameters:

<Rate> float
Range: 1E-7 to 0.5
Increment: 1E-7
*RST: 0.001

Example:

BB:W3GP:MST:ENH:DPDC:DERR:BIT:RATE 1E-2
sets a bit error rate of 0.01.

Manual operation: See " [Bit Error Rate TCH1](#) " on page 239

[:SOURCE<hw>]:BB:W3GPP:MSTation:ENHanced:DPDCh:DERRor:BIT:STATE
<State>

The command activates or deactivates bit error generation.

Bit errors are inserted into the data fields of the enhanced channels. When channel coding is active, it is possible to select the layer in which the errors are inserted (physical or transport layer). When the data source is read out, individual bits are deliberately inverted at random points in the data bit stream at the specified error rate in order to simulate an invalid signal.

Parameters:

<State> 0 | 1 | OFF | ON
*RST: 0

Example:

BB:W3GP:MST:ENH:DPDC:DERR:BIT:RATE 1E-2
sets a bit error rate of 0.01.

BB:W3GP:MST:ENH:DPDC:DERR:BIT:LAY PHYS
selects layer 1 for entering bit errors.

BB:W3GP:MST:ENH:DPDC:DERR:BIT:STAT ON
activates bit error generation.

Manual operation: See " [Bit Error State](#) " on page 238

[:SOURce<hw>]:BB:W3GPp:MSTation:ENHanced:DPDCh:DERRor:BLOCK:RATE
<Rate>

Sets the block error rate.

Parameters:

<Rate> float
 Range: 1E-4 to 0.5
 Increment: 1E-4
 *RST: 0.1

Example: BB:W3GP:MST:ENH:DPDC:DERR:BLOC:RATE 1E-2
 sets the block error rate to 0.01.

Manual operation: See " [Block Error Rate](#) " on page 239

[:SOURce<hw>]:BB:W3GPp:MSTation:ENHanced:DPDCh:DERRor[:BLOCk]:
STATE <State>

The command activates or deactivates block error generation. Block error generation is only possible when channel coding is activated.

During block error generation, the CRC checksum is determined and then the last bit is inverted at the specified error probability in order to simulate a defective signal.

Parameters:

<State> ON | OFF
 *RST: OFF

Example: BB:W3GP:MST:ENH:DPDC:CCOD:STAT ON
 activates channel coding.
 BB:W3GP:MST:ENH:DPDC:DERR:BLOC:RATE 10E-2
 sets the block error rate to 0.1.
 BB:W3GP:MST:ENH:DPDC:DERR:BLOC:STAT ON
 activates block error generation.

[:SOURce<hw>]:BB:W3GPp:MSTation:ENHanced:DPDCh:INTERleaver2
<Interleaver2>

The command activates or deactivates channel coding interleaver state 2 for all the transport channels.

Interleaver state 1 can be activated and deactivated for each channel individually ([:SOURce<hw>]:BB:W3GPp:MSTation:ENHanced:DPDCh:TCHannel<di0>:INTERleaver).

Note: The interleaver states do not cause the symbol rate to change

Parameters:

<Interleaver2> 0 | 1 | OFF | ON
 *RST: 1

Example: `BB:W3GP:MST:ENH:DPDC:INT2 OFF`
deactivates channel coding interleaver state 2 for all the transport channels.

Manual operation: See " [Interleaver 2 State](#) " on page 238

[:SOURce<hw>]:BB:W3GPp:MSTation:ENHanced:DPDCh:ORATe <ORate>

The command queries the overall symbol rate (Overall Symbol Rate) of the enhanced channels. The value is set with the command `[:SOURce<hw>] :BB:W3GPp:MSTation<st>:DPDCh:ORATe`. This setting also defines the number of active channels, their symbol rates and channelization codes.

Parameters:

<ORate> D15K | D30K | D60K | D120k | D240k | D480k | D960k |
D1920k | D2880k | D3840k | D4800k | D5760k
*RST: D60K

Example: `BB:W3GP:MST:ENH:DPDC:ORAT?`
queries the overall symbol rate of the DPDCH of user equipment 1.

Manual operation: See " [Overall Symbol Rate](#) " on page 235

[:SOURce<hw>]:BB:W3GPp:MSTation:ENHanced:DPDCh:STATe <State>

Queries the enhanced state of the station.

Parameters:

<State> 0 | 1 | OFF | ON
*RST: 1

Example: `BB:W3GP:MST1:ENH:DPDC:STAT?`

Manual operation: See " [Enhanced Channels State](#) " on page 231

[:SOURce<hw>]:BB:W3GPp:MSTation:ENHanced:DPDCh:TCHannel<di0>:RMATtribute <RmAttribute>

Sets data rate matching.

Parameters:

<RmAttribute> integer
Range: 1 to 1024
*RST: 1

Example: `BB:W3GP:MST:ENH:DPDC:TCH:RMAT 1024`
sets rate matching to 1024 for DTCH1.

Manual operation: See " [Rate Matching Attribute](#) " on page 237

```
[ :SOURce<hw>]:BB:W3GPp:MSTation:ENHanced:DPDCh:TCHannel<di0>:STATe
<State>
```

The command activates/deactivates the selected transport channel.

Parameters:

```
<State>          0 | 1 | OFF | ON
*RST:           0
```

Example: BB:W3GP:MST:ENH:DPDC:TCH1:STAT
activates DTCH1.

Manual operation: See "[Transport Channel State](#)" on page 236

```
[ :SOURce<hw>]:BB:W3GPp:MSTation:ENHanced:DPDCh:TCHannel<di0>:
TBCount <TbCount>
```

The command sets the transport block count.

Parameters:

```
<TbCount>       integer
Range:          1 to 16
*RST:           1
```

Example: BB:W3GP:MST:ENH:DPDC:TCH2:TBC 4
activates 4 transport blocks for DTCH1.

Manual operation: See "[Number of Transport Blocks](#)" on page 237

```
[ :SOURce<hw>]:BB:W3GPp:MSTation:ENHanced:DPDCh:TCHannel<di0>:TBSize
<TbSize>
```

Sets the size of the data blocks.

Parameters:

```
<TbSize>       integer
```

Example: BB:W3GP:MST:ENH:DPDC:TCH2:TBS 1024
sets the length of the transport blocks for DTCH2 to 1024.

Manual operation: See "[Transport Block Size](#)" on page 237

```
[ :SOURce<hw>]:BB:W3GPp:MSTation:ENHanced:DPDCh:TCHannel<di0>:
TTInterval <TtInterval>
```

Sets the number of frames into which a TCH is divided. This setting also defines the interleaver depth.

Parameters:

```
<TtInterval>   10MS | 20MS | 40MS
```

Example: BB:W3GP:MST:ENH:DPDC:TCH2:TTIN 20ms
sets that the transport channel is divided into 2 frames.

Manual operation: See "[Transport Time Interval](#)" on page 237

[:SOURce<hw>]:BB:W3GPp:MSTation:ENHanced:DPDCh:TCHannel<di0>:CRCSize <CrcSize>

The command defines the CRC length for the selected transport channel. It is also possible to deactivate checksum determination.

Parameters:

<CrcSize> NONE | 8 | 12 | 16 | 24
*RST: 12

Example: BB:W3GP:MST:ENH:DPDC:TCH:CRCS NONE
deactivates checksum determination for DTCH1.

Manual operation: See "[Size of CRC](#)" on page 237

[:SOURce<hw>]:BB:W3GPp:MSTation:ENHanced:DPDCh:TCHannel<di0>:DATA <Data>

Selects the data source for the transport channel.

Parameters:

<Data> ZERO | ONE | PATtern | PN9 | PN11 | PN15 | PN16 | PN20 | PN21 | PN23 | DLIST

PNxx

The pseudo-random sequence generator is used as the data source. Different random sequence lengths can be selected.

DLIST

A data list is used. The data list is selected with the command [\[:SOURce<hw>\]:BB:W3GPp:MSTation:ENHanced:DPDCh:TCHannel<di0>:DATA:DSElect](#).

ZERO | ONE

Internal 0 and 1 data is used.

PATtern

Internal data is used. The bit pattern for the data is defined by the command [\[:SOURce<hw>\]:BB:W3GPp:MSTation:ENHanced:DPDCh:TCHannel<di0>:DATA:PATtern](#).

*RST: PN9

Example: BB:W3GP:MST:ENH:DPDC:TCH2:DATA PATT
selects as the data source for the data fields of DTCH2 of user equipment 1, the bit pattern defined with the following command.
BB:W3GP:MST:ENH:DPDC:TCH2:DATA:PATT #H3F, 8
defines the bit pattern.

Manual operation: See "[Data List Management](#)" on page 49

**[:SOURce<hw>]:BB:W3GPp:MSTation:ENHanced:DPDCh:TCHannel<di0>:DATA:
DSElect <DSelect>**

The command selects the data list for the enhanced channels for the DLIS selection.

The files are stored with the fixed file extensions `*.dm_iqd` in a directory of the user's choice. The directory applicable to the commands is defined with the command `MMEMory:CDIR`. To access the files in this directory, you only have to give the file name, without the path and the file extension.

Parameters:

<DSelect> string

Example:

`BB:W3GP:MST:ENH:DPDC:TCH1:DATA DLIS`

selects the Data Lists data source.

`MMEM:CDIR '/var/user/temp/IQData'`

selects the directory for the data lists.

`BB:W3GP:MST:ENH:DPDC:TCH1:DATA:DSEL 'TCH1'`

selects the file `tch1` as the data source.

Manual operation: See "[Data List Management](#)" on page 49

**[:SOURce<hw>]:BB:W3GPp:MSTation:ENHanced:DPDCh:TCHannel<di0>:DATA:
PATtern <Pattern>, <BitCount>**

The command determines the bit pattern for the `PATtern` data source selection for transport channels.

Parameters:

<Pattern> numeric

*RST: #H0

<BitCount> integer

Range: 1 to 64

*RST: 1

Example:

`BB:W3GP:MST:ENH:DPDC:TCH0:DATA:PATT #H3F, 8`

defines the bit pattern for DCCH.

Manual operation: See "[Data Source](#)" on page 236

**[:SOURce<hw>]:BB:W3GPp:MSTation:ENHanced:DPDCh:TCHannel<di0>:
EPRotectio n <EProtection>**

The command determines the error protection.

Parameters:

<EProtection> NONE | CON2 | CON3 | TURBo3

NONE

No error protection.

TURBo3

Turbo Coder of rate 1/3 in accordance with the 3GPP specifications.

CON2 | CON3

Convolution Coder of rate 1/2 or 1/3 with generator polynomials defined by 3GPP.

*RST: CON1/3

Example:

BB:W3GP:MST:ENH:DPDC:TCH1:EPR NONE
error protection is deactivated.

Manual operation: See " [Error Protection](#) " on page 237

**[:SOURCE<hw>]:BB:W3GPp:MSTation:ENHanced:DPDCh:TCHannel<di0>:
INTerleaver <Interleaver>**

The command activates or deactivates channel coding interleaver state 1 for the selected channel. Interleaver state 1 can be activated and deactivated for each channel individually. The channel is selected via the suffix at TCHannel.

Interleaver state 2 can only be activated or deactivated for all the channels together ([:SOURCE<hw>]:BB:W3GPp:MSTation:ENHanced:DPDCh:INTerleaver2).

Parameters:

<Interleaver> 0 | 1 | OFF | ON

*RST: 1

Example:

BB:W3GP:MST:ENH:DPDC:TCH5:INT1 OFF
deactivates channel coding interleaver state 1 for TCH 5.

Manual operation: See " [Interleaver 1 State](#) " on page 238

**[:SOURCE<hw>]:BB:W3GPp:MSTation:ENHanced:PCPCh:CCODing:STATE
<State>**

The command activates or deactivates channel coding for the PCPCH.

When channel coding is active, the symbol rate is limited to the range between 15 and 120 ksps. Values above this limit are automatically set to 120 ksps.

Parameters:

<State> ON | OFF

*RST: 0

Example:

BB:W3GP:MST:ENH:PCPC:CCOD:TYPE TB168
selects channel coding type CPCH RMC (TB size 168 bits).
BB:W3GP:MST:ENH:PCPC:CCOD:STAT ON
activates channel coding.

Manual operation: See " [Channel Coding State](#) " on page 180

[:SOURce<hw>]:BB:W3GPp:MSTation:ENHanced:PCPCh:CCODing:TYPE <Type>

The command selects the channel coding scheme in accordance with the 3GPP specification.

Parameters:

<Type> TB168 | TB360

TB168

CPCH RMC (TB size 168 bits)

TB360

CPCH RMC (TB size 360 bits)

*RST: TB168

Example:

BB:W3GP:MST:ENH:PCPC:CCOD:TYPE TB168
selects channel coding scheme RMC 168 bits.

Manual operation: See " [Channel Coding Type](#) " on page 181

[:SOURce<hw>]:BB:W3GPp:MSTation<st>:ENHanced:PRACH:CCODing:STATE <State>

The command activates or deactivates channel coding for the PRACH.

Parameters:

<State> ON | OFF

*RST: 0

Example:

BB:W3GP:MST:ENH:PRAC:CCOD:TYPE TB168
selects channel coding type RACH RMC (TB size 168 bits).
BB:W3GP:MST:ENH:PRAC:CCOD:STAT ON
activates channel coding.

Manual operation: See " [Coding State](#) " on page 169

[:SOURce<hw>]:BB:W3GPp:MSTation<st>:ENHanced:PRACH:CCODing:TYPE <Type>

The command selects the channel coding scheme in accordance with the 3GPP specification.

Parameters:

<Type> TB168 | TB360 | TU168 | TU360

TB168

RACH RMC (TB size 168 bits)

TB360

RACH RMC (TB size 360 bits)

*RST: TB168

Example:

BB:W3GP:MST:ENH:PRAC:CCOD:TYPE TB168
selects channel coding scheme RMC 168 bits.

Manual operation: See " [Coding Type](#) " on page 169

Annex

A Reference

Supported channel types

Table A-1: List of supported channel types and their sequence in the 3GPP FDD channel table

Index	Short form	Name	Function	Optional enhanced in BS1
0	P-CPICH	Primary Common Pilot Channel	<ul style="list-style-type: none"> Specifies the scrambling code in the scrambling code group (2nd stage of scrambling code detection) Phase reference for additional downlink channels Reference for the signal strength 	no
1	S-CPICH	Secondary Common Pilot Channel		no
2	P-SCH	Primary Sync Channel	Slot synchronization	no
3	S-SCH	Secondary Sync Channel	<ul style="list-style-type: none"> Frame synchronization Specifies the scrambling code group 	no
4	P-CCPCH	Primary Common Control Phys. Channel	<ul style="list-style-type: none"> Transfers the system frame number (SFN) Timing reference for additional downlink channels Contains the BCH transport channel 	yes
5	S-CCPCH	Secondary Common Control Phys. Channel		no
6	PICH	Page Indication Channel	Transfers the paging indicator	no
7	AICH	Acquisition Indication Channel		no
8	AP-AICH	Access Preamble Acquisition Indication Channel		no
9 / 10	PDSCH	Phys. Downlink Shared Channel		no
	DL-DPCCH	Dedicated Physical Control Channel		
	HS-SCCH	High-Speed Shared Control Channel		
	E-AGCH	E-DCH Absolute Grant Channel		
	E-RGCH	E-DCH Relative Grant Channel		
	E-HICH	E-DCH Hybrid ARQ Indicator Channel		
11 - 13	DPCH	Dedicated Phys. Channel	Transfers the user data and the control information	yes

Index	Short form	Name	Function	Optional enhanced in BS1
	HS-SCCH	High-Speed Shared Control Channel		no
	HS-PDSCH (QPSK)	High Speed Physical Downlink Shared Channel (QPSK)		no
	HS-PDSCH (16 QAM)	High-Speed Physical Downlink Shared Channel (16 QAM)		no
	HS-PDSCH (64 QAM)	High-Speed Physical Downlink Shared Channel (64 QAM)		no
	HS-PDSCH (MIMO)	High Speed Physical Downlink Shared Channel (MIMO)		no
	E-AGCH	E-DCH Absolute Grant Channel		no
	E-RGCH	E-DCH Relative Grant Channel		no
	E-HICH	E-DCH Hybrid ARQ Indicator Channel		no
	F-DPCH	Fractional Dedicated Phys. Channel		no
14 - 138	DPCH	Dedicated Phys. Channel	Transfers the user data and the control information	no
	HS-SCCH	High-Speed Shared Control Channel		
	HS-PDSCH (QPSK)	High Speed Physical Downlink Shared Channel (QPSK)		
	HS-PDSCH (16 QAM)	High-Speed Physical Downlink Shared Channel (16 QAM)		
	HS-PDSCH (64 QAM)	High-Speed Physical Downlink Shared Channel (64 QAM)		
	HS-PDSCH (MIMO)	High Speed Physical Downlink Shared Channel (MIMO)		
	E-AGCH	E-DCH Absolute Grant Channel		
	E-RGCH	E-DCH Relative Grant Channel		
	E-HICH	E-DCH Hybrid ARQ Indicator Channel		
	F-DPCH	Fractional Dedicated Phys. Channel		

Channel tables of the DPDCH and E-DPDCH

Table A-2: Structure of the DPDCH channel table in conjunction with the overall symbol rate

Overall Symbol Rate	DPDCH 1	DPDCH 2	DPDCH 3	DPDCH 4	DPDCH 5	DPDCH 6
I or Q branch	I	Q	I	Q	I	Q
15 ksps	State: ON S-Rate: 15k Ch. Code: 64	State: OFF	State: OFF	State: OFF	State: OFF	State: OFF
30 ksps	State: ON S-Rate: 30k Ch. Code: 32	State: OFF	State: OFF	State: OFF	State: OFF	State: OFF
60 ksps	State: ON S-Rate: 60k Ch. Code: 16	State: OFF	State: OFF	State: OFF	State: OFF	State: OFF
120 ksps	State: ON S-Rate: 120k Ch. Code: 8	State: OFF	State: OFF	State: OFF	State: OFF	State: OFF
240 ksps	State: ON S-Rate: 240k Ch. Code: 4	State: OFF	State: OFF	State: OFF	State: OFF	State: OFF
480 ksps	State: ON S-Rate: 480k Ch. Code: 2	State: OFF	State: OFF	State: OFF	State: OFF	State: OFF
960 ksps	State: ON S-Rate: 960k Ch. Code: 1	State: OFF	State: OFF	State: OFF	State: OFF	State: OFF
2 x 960 ksps	State: ON S-Rate: 960k Ch. Code: 1	State: ON S-Rate: 960k Ch. Code: 1	State: OFF	State: OFF	State: OFF	State: OFF
3 x 960 ksps	State: ON S-Rate: 960k Ch. Code: 1	State: ON S-Rate: 960k Ch. Code: 1	State: ON S-Rate: 960k Ch. Code: 3	State: OFF	State: OFF	State: OFF

Overall Symbol Rate	DPDCH 1	DPDCH 2	DPDCH 3	DPDCH 4	DPDCH 5	DPDCH 6
4 x 960 kbps	State: ON S-Rate: 960k Ch. Code: 1	State: ON S-Rate: 960k Ch. Code: 1	State: ON S-Rate: 960k Ch. Code: 3	State: ON S-Rate: 960k Ch. Code: 3	State: OFF	State: OFF
5 x 960 kbps	State: ON S-Rate: 960k Ch. Code: 1	State: ON S-Rate: 960k Ch. Code: 1	State: ON S-Rate: 960k Ch. Code: 3	State: ON S-Rate: 960k Ch. Code: 3	State: ON S-Rate: 960k Ch. Code: 2	State: OFF
6 x 960 kbps	State: ON S-Rate: 960k Ch. Code: 1	State: ON S-Rate: 960k Ch. Code: 1	State: ON S-Rate: 960k Ch. Code: 3	State: ON S-Rate: 960k Ch. Code: 3	State: ON S-Rate: 960k Ch. Code: 2	State: ON S-Rate: 960k Ch. Code: 2

Table A-3: Structure of the E-DPDCH channel table in conjunction with the overall symbol rate and no DPDCH active

Overall Symbol Rate	E-DPDCH 1	E-DPDCH 2	E-DPDCH 3	E-DPDCH 4
I or Q branch	I	Q	I	Q
15 Kbps	State: ON S-Rate: 15 k Ch. Code: 64	State: OFF	State: OFF	State: OFF
30 kbps	State: ON S-Rate: 30 k Ch. Code: 32	State: OFF	State: OFF	State: OFF
60 kbps	State: ON S-Rate: 60 k Ch. Code: 16	State: OFF	State: OFF	State: OFF
120 kbps	State: ON S-Rate: 120 k Ch. Code: 8	State: OFF	State: OFF	State: OFF
240 kbps	State: ON S-Rate: 240 k Ch. Code: 4	State: OFF	State: OFF	State: OFF
480 kbps	State: ON S-Rate: 480 k Ch. Code: 2	State: OFF	State: OFF	State: OFF
960 kbps	State: ON S-Rate: 960 k Ch. Code: 1	State: OFF	State: OFF	State: OFF

Overall Symbol Rate	E-DPDCH 1	E-DPDCH 2	E-DPDCH 3	E-DPDCH 4
I or Q branch	I	Q	I	Q
2 x 960 ksps	State: ON S-Rate: 960 k Ch. Code: 1	State: ON S-Rate: 960 k Ch. Code: 1	State: OFF	State: OFF
2 x 1920 ksps	State: ON S-Rate: 1920 k Ch. Code: 1	State: ON S-Rate: 1920 k Ch. Code: 1	State: OFF	State: OFF
2 x 960 ksps + 2 x 1920 ksps	State: ON S-Rate: 1920 k Ch. Code: 1	State: ON S-Rate: 1920 k Ch. Code: 1	State: ON S-Rate: 960 k Ch. Code: 1	State: ON S-Rate: 960 k Ch. Code: 1
2 x 960 ksps, I only	State: ON S-Rate: 960 k Ch. Code: 1	State: OFF	State: OFF	State: OFF
2 x 960 ksps, Q only	State: OFF	State: ON S-Rate: 960 k Ch. Code: 1	State: OFF	State: OFF
2 x 1920 ksps, I only	State: ON S-Rate: 1920 k Ch. Code: 1	State: OFF	State: OFF	State: OFF
2 x 1920 ksps, Q only	State: OFF	State: ON S-Rate: 1920 k Ch. Code: 1	State: OFF	State: OFF
2 x 960 ksps + 2 x 1920 ksps, I only	State: ON S-Rate: 1920 k Ch. Code: 1	State: OFF	State: ON S-Rate: 960 k Ch. Code: 1	State: OFF
2 x 960 ksps + 2 x 1920 ksps, Q only	State: OFF	State: ON S-Rate: 1920 k Ch. Code: 1	State: OFF	State: ON S-Rate: 960 k Ch. Code: 1

Table A-4: Structure of the E-DPDCH channel table in conjunction with the overall symbol rate and one DPDCH active

Overall Symbol Rate	E-DPDCH 1	E-DPDCH 2	E-DPDCH 3	E-DPDCH 4
Active HS-DPCCH? I or Q branch	No Q	No I	Yes I	Yes Q
15 ksps	State: ON S-Rate: 15 k Ch. Code: 128	State: OFF	State: ON S-Rate: 15 k Ch. Code: 128	State: OFF
30 ksps	State: ON S-Rate: 30 k Ch. Code: 64	State: OFF	State: ON S-Rate: 30 k Ch. Code: 64	State: OFF
60 ksps	State: ON S-Rate: 60 k Ch. Code: 32	State: OFF	State: ON S-Rate: 60 k Ch. Code: 32	State: OFF
120 ksps	State: ON S-Rate: 120 k Ch. Code: 16	State: OFF	State: ON S-Rate: 120 k Ch. Code: 16	State: OFF
240 ksps	State: ON S-Rate: 240 k Ch. Code: 8	State: OFF	State: ON S-Rate: 240 k Ch. Code: 8	State: OFF
480 ksps	State: ON S-Rate: 480 k Ch. Code: 4	State: OFF	State: ON S-Rate: 480 k Ch. Code: 4	State: OFF
960 ksps	State: ON S-Rate: 960 k Ch. Code: 2	State: OFF	State: ON S-Rate: 960 k Ch. Code: 2	State: OFF
2 x 960 ksps	State: ON S-Rate: 960 k Ch. Code: 2	State: ON S-Rate: 960 k Ch. Code: 2	State: ON S-Rate: 960 k Ch. Code: 2	State: ON S-Rate: 960 k Ch. Code: 2
2 x 1920 ksps	State: ON S-Rate: 1920 k Ch. Code: 1	State: ON S-Rate: 1920 k Ch. Code: 1	State: ON S-Rate: 1920 k Ch. Code: 1	State: ON S-Rate: 1920 k Ch. Code: 1
2 x 960 ksps, I only	State: OFF	State: ON S-Rate: 960 k Ch. Code: 2	State: ON S-Rate: 960 k Ch. Code: 2	State: OFF
2 x 960 ksps, Q only	State: ON S-Rate: 960 k Ch. Code: 2	State: OFF	State: OFF	State: ON S-Rate: 960 k Ch. Code: 2

Overall Symbol Rate	E-DPDCH 1	E-DPDCH 2	E-DPDCH 3	E-DPDCH 4
Active HS-DPCCH? I or Q branch	No Q	No I	Yes I	Yes Q
2 x 1920 ksps, I only	State: OFF	State: ON S-Rate: 1920 k Ch. Code: 1	State: ON S-Rate: 1920 k Ch. Code: 1	State: OFF
2 x 1920 ksps, Q only	State: ON S-Rate: 1920 k Ch. Code: 1	State: OFF	State: OFF	State: ON S-Rate: 1920 k Ch. Code: 1

List of Commands

[SOURce]:BB:W3GPP:GPP3:VERSion?	255
[SOURce<hw>]:BB:W3GPP:BSTation:ENHanced:CHANnel:DPCH:CCODing:USER:CATalog?	328
[SOURce<hw>]:BB:W3GPP:BSTation:ENHanced:CHANnel:DPCH:CCODing:USER:DELeTe	325
[SOURce<hw>]:BB:W3GPP:BSTation:ENHanced:CHANnel<ch0>:DPCH:CCODing:BPFRame?	325
[SOURce<hw>]:BB:W3GPP:BSTation:ENHanced:CHANnel<ch0>:DPCH:CCODing:SFORmat	325
[SOURce<hw>]:BB:W3GPP:BSTation:ENHanced:CHANnel<ch0>:DPCH:CCODing:SRATE?	326
[SOURce<hw>]:BB:W3GPP:BSTation:ENHanced:CHANnel<ch0>:DPCH:CCODing:STATe	326
[SOURce<hw>]:BB:W3GPP:BSTation:ENHanced:CHANnel<ch0>:DPCH:CCODing:TYPE	327
[SOURce<hw>]:BB:W3GPP:BSTation:ENHanced:CHANnel<ch0>:DPCH:CCODing:USER:LOAD	328
[SOURce<hw>]:BB:W3GPP:BSTation:ENHanced:CHANnel<ch0>:DPCH:CCODing:USER:STORe	329
[SOURce<hw>]:BB:W3GPP:BSTation:ENHanced:CHANnel<ch0>:DPCH:DERRor:BIT:LAYer	339
[SOURce<hw>]:BB:W3GPP:BSTation:ENHanced:CHANnel<ch0>:DPCH:DERRor:BIT:RATE	339
[SOURce<hw>]:BB:W3GPP:BSTation:ENHanced:CHANnel<ch0>:DPCH:DERRor:BIT:STATe	339
[SOURce<hw>]:BB:W3GPP:BSTation:ENHanced:CHANnel<ch0>:DPCH:DERRor:BLOCK:RATE	340
[SOURce<hw>]:BB:W3GPP:BSTation:ENHanced:CHANnel<ch0>:DPCH:DERRor:BLOCK:STATe	340
[SOURce<hw>]:BB:W3GPP:BSTation:ENHanced:CHANnel<ch0>:DPCH:DPControl:DIRection	336
[SOURce<hw>]:BB:W3GPP:BSTation:ENHanced:CHANnel<ch0>:DPCH:DPControl:MODE	336
[SOURce<hw>]:BB:W3GPP:BSTation:ENHanced:CHANnel<ch0>:DPCH:DPControl:RANGe:DOWN	337
[SOURce<hw>]:BB:W3GPP:BSTation:ENHanced:CHANnel<ch0>:DPCH:DPControl:STATe	337
[SOURce<hw>]:BB:W3GPP:BSTation:ENHanced:CHANnel<ch0>:DPCH:DPControl:STEP:MANual	337
[SOURce<hw>]:BB:W3GPP:BSTation:ENHanced:CHANnel<ch0>:DPCH:DPControl:STEP[EXTErnal]	338
[SOURce<hw>]:BB:W3GPP:BSTation:ENHanced:CHANnel<ch0>:DPCH:DPControl[:POWER]?	338
[SOURce<hw>]:BB:W3GPP:BSTation:ENHanced:CHANnel<ch0>:DPCH:INTerleaver2	329
[SOURce<hw>]:BB:W3GPP:BSTation:ENHanced:CHANnel<ch0>:DPCH:STATe	323
[SOURce<hw>]:BB:W3GPP:BSTation:ENHanced:CHANnel<ch0>:DPCH:TCHannel<di0>:CRCSize	330
[SOURce<hw>]:BB:W3GPP:BSTation:ENHanced:CHANnel<ch0>:DPCH:TCHannel<di0>:DATA	330
[SOURce<hw>]:BB:W3GPP:BSTation:ENHanced:CHANnel<ch0>:DPCH:TCHannel<di0>:DATA: DSElect	331
[SOURce<hw>]:BB:W3GPP:BSTation:ENHanced:CHANnel<ch0>:DPCH:TCHannel<di0>:DATA:PATTErn	331
[SOURce<hw>]:BB:W3GPP:BSTation:ENHanced:CHANnel<ch0>:DPCH:TCHannel<di0>:DTX	332
[SOURce<hw>]:BB:W3GPP:BSTation:ENHanced:CHANnel<ch0>:DPCH:TCHannel<di0>:EPRotectioN	332
[SOURce<hw>]:BB:W3GPP:BSTation:ENHanced:CHANnel<ch0>:DPCH:TCHannel<di0>:INTerleaver	332
[SOURce<hw>]:BB:W3GPP:BSTation:ENHanced:CHANnel<ch0>:DPCH:TCHannel<di0>:RMATtribute	333
[SOURce<hw>]:BB:W3GPP:BSTation:ENHanced:CHANnel<ch0>:DPCH:TCHannel<di0>:STATe	333
[SOURce<hw>]:BB:W3GPP:BSTation:ENHanced:CHANnel<ch0>:DPCH:TCHannel<di0>:TBCount	333
[SOURce<hw>]:BB:W3GPP:BSTation:ENHanced:CHANnel<ch0>:DPCH:TCHannel<di0>:TBSize	334
[SOURce<hw>]:BB:W3GPP:BSTation:ENHanced:CHANnel<ch0>:DPCH:TCHannel<di0>:TTINterval	334
[SOURce<hw>]:BB:W3GPP:BSTation:ENHanced:PCCPch:CCODing:INTerleaver<di>	334
[SOURce<hw>]:BB:W3GPP:BSTation:ENHanced:PCCPch:CCODing:STATe	335
[SOURce<hw>]:BB:W3GPP:BSTation:ENHanced:PCCPch:CCODing:TYPE?	335
[SOURce<hw>]:BB:W3GPP:BSTation:ENHanced:PCCPch:STATe	323
[SOURce<hw>]:BB:W3GPP:BSTation:OCNS:MODE	275
[SOURce<hw>]:BB:W3GPP:BSTation:OCNS:SEED	276
[SOURce<hw>]:BB:W3GPP:BSTation:OCNS:STATe	275
[SOURce<hw>]:BB:W3GPP:BSTation:PRESet	255
[SOURce<hw>]:BB:W3GPP:BSTation[:ENHanced]:CHANnel<ch0>:HSDPa:DERRor:BIT:LAYer	341
[SOURce<hw>]:BB:W3GPP:BSTation[:ENHanced]:CHANnel<ch0>:HSDPa:DERRor:BIT:RATE	341

[:SOURCE<hw>]:BB:W3GPP:BSTation[:ENHanced]:CHANnel<ch0>:HSDPa:DERRor:BIT:STATE.....	341
[:SOURCE<hw>]:BB:W3GPP:BSTation[:ENHanced]:CHANnel<ch0>:HSDPa:DERRor:BLOCK:RATE.....	342
[:SOURCE<hw>]:BB:W3GPP:BSTation[:ENHanced]:CHANnel<ch0>:HSDPa:DERRor:BLOCK:STATE.....	342
[:SOURCE<hw>]:BB:W3GPP:BSTation<st>:CHANnel:HSDPa:HSET:PRESet.....	276
[:SOURCE<hw>]:BB:W3GPP:BSTation<st>:CHANnel:PRESet.....	277
[:SOURCE<hw>]:BB:W3GPP:BSTation<st>:CHANnel<ch0>:AICH:ASLOt.....	277
[:SOURCE<hw>]:BB:W3GPP:BSTation<st>:CHANnel<ch0>:AICH:SAPattern.....	277
[:SOURCE<hw>]:BB:W3GPP:BSTation<st>:CHANnel<ch0>:APAlch:ASLOt.....	277
[:SOURCE<hw>]:BB:W3GPP:BSTation<st>:CHANnel<ch0>:APAlch:SAPattern.....	278
[:SOURCE<hw>]:BB:W3GPP:BSTation<st>:CHANnel<ch0>:CCODE.....	278
[:SOURCE<hw>]:BB:W3GPP:BSTation<st>:CHANnel<ch0>:DATA.....	279
[:SOURCE<hw>]:BB:W3GPP:BSTation<st>:CHANnel<ch0>:DATA:DSElect.....	279
[:SOURCE<hw>]:BB:W3GPP:BSTation<st>:CHANnel<ch0>:DATA:PATtern.....	280
[:SOURCE<hw>]:BB:W3GPP:BSTation<st>:CHANnel<ch0>:DPCCh:MCODE.....	280
[:SOURCE<hw>]:BB:W3GPP:BSTation<st>:CHANnel<ch0>:DPCCh:PLENgtH.....	281
[:SOURCE<hw>]:BB:W3GPP:BSTation<st>:CHANnel<ch0>:DPCCh:POFFset:PILOt.....	281
[:SOURCE<hw>]:BB:W3GPP:BSTation<st>:CHANnel<ch0>:DPCCh:POFFset:TFCl.....	281
[:SOURCE<hw>]:BB:W3GPP:BSTation<st>:CHANnel<ch0>:DPCCh:POFFset:TPC.....	282
[:SOURCE<hw>]:BB:W3GPP:BSTation<st>:CHANnel<ch0>:DPCCh:TFCl.....	282
[:SOURCE<hw>]:BB:W3GPP:BSTation<st>:CHANnel<ch0>:DPCCh:TFCl:STATE.....	282
[:SOURCE<hw>]:BB:W3GPP:BSTation<st>:CHANnel<ch0>:DPCCh:TPC:DATA.....	283
[:SOURCE<hw>]:BB:W3GPP:BSTation<st>:CHANnel<ch0>:DPCCh:TPC:DATA:DSElect.....	284
[:SOURCE<hw>]:BB:W3GPP:BSTation<st>:CHANnel<ch0>:DPCCh:TPC:DATA:PATtern.....	284
[:SOURCE<hw>]:BB:W3GPP:BSTation<st>:CHANnel<ch0>:DPCCh:TPC:MISuse.....	284
[:SOURCE<hw>]:BB:W3GPP:BSTation<st>:CHANnel<ch0>:DPCCh:TPC:PSTep.....	285
[:SOURCE<hw>]:BB:W3GPP:BSTation<st>:CHANnel<ch0>:DPCCh:TPC:READ.....	285
[:SOURCE<hw>]:BB:W3GPP:BSTation<st>:CHANnel<ch0>:FDPCh:DPCCh:TPC:DATA.....	286
[:SOURCE<hw>]:BB:W3GPP:BSTation<st>:CHANnel<ch0>:FDPCh:DPCCh:TPC:DATA:DSElect.....	286
[:SOURCE<hw>]:BB:W3GPP:BSTation<st>:CHANnel<ch0>:FDPCh:DPCCh:TPC:DATA:PATtern.....	287
[:SOURCE<hw>]:BB:W3GPP:BSTation<st>:CHANnel<ch0>:FDPCh:DPCCh:TPC:MISuse.....	287
[:SOURCE<hw>]:BB:W3GPP:BSTation<st>:CHANnel<ch0>:FDPCh:DPCCh:TPC:PSTep.....	288
[:SOURCE<hw>]:BB:W3GPP:BSTation<st>:CHANnel<ch0>:FDPCh:DPCCh:TPC:READ.....	288
[:SOURCE<hw>]:BB:W3GPP:BSTation<st>:CHANnel<ch0>:HSDPa:BMODE[:STATE].....	289
[:SOURCE<hw>]:BB:W3GPP:BSTation<st>:CHANnel<ch0>:HSDPa:CVPB.....	289
[:SOURCE<hw>]:BB:W3GPP:BSTation<st>:CHANnel<ch0>:HSDPa:HSET:ACLength.....	290
[:SOURCE<hw>]:BB:W3GPP:BSTation<st>:CHANnel<ch0>:HSDPa:HSET:ALTModulation.....	290
[:SOURCE<hw>]:BB:W3GPP:BSTation<st>:CHANnel<ch0>:HSDPa:HSET:AMODE.....	289
[:SOURCE<hw>]:BB:W3GPP:BSTation<st>:CHANnel<ch0>:HSDPa:HSET:BCBTti<di>?.....	291
[:SOURCE<hw>]:BB:W3GPP:BSTation<st>:CHANnel<ch0>:HSDPa:HSET:BPAYload<di>?.....	291
[:SOURCE<hw>]:BB:W3GPP:BSTation<st>:CHANnel<ch0>:HSDPa:HSET:CLENgtH.....	292
[:SOURCE<hw>]:BB:W3GPP:BSTation<st>:CHANnel<ch0>:HSDPa:HSET:CRATE<di>?.....	292
[:SOURCE<hw>]:BB:W3GPP:BSTation<st>:CHANnel<ch0>:HSDPa:HSET:DATA.....	292
[:SOURCE<hw>]:BB:W3GPP:BSTation<st>:CHANnel<ch0>:HSDPa:HSET:DATA:DSElect.....	293
[:SOURCE<hw>]:BB:W3GPP:BSTation<st>:CHANnel<ch0>:HSDPa:HSET:DATA:PATtern.....	293
[:SOURCE<hw>]:BB:W3GPP:BSTation<st>:CHANnel<ch0>:HSDPa:HSET:HARQ:LENGth.....	294
[:SOURCE<hw>]:BB:W3GPP:BSTation<st>:CHANnel<ch0>:HSDPa:HSET:HARQ:MODE.....	294
[:SOURCE<hw>]:BB:W3GPP:BSTation<st>:CHANnel<ch0>:HSDPa:HSET:HSCCode.....	295
[:SOURCE<hw>]:BB:W3GPP:BSTation<st>:CHANnel<ch0>:HSDPa:HSET:MODulation<di>.....	295
[:SOURCE<hw>]:BB:W3GPP:BSTation<st>:CHANnel<ch0>:HSDPa:HSET:NAIBitrate?.....	295
[:SOURCE<hw>]:BB:W3GPP:BSTation<st>:CHANnel<ch0>:HSDPa:HSET:PREDEfined.....	296

[SOURce<hw>]:BB:W3GPp:BSTation<st>:CHANnel<ch0>:HSDPa:HSET:PWPatterm.....	296
[SOURce<hw>]:BB:W3GPp:BSTation<st>:CHANnel<ch0>:HSDPa:HSET:RVParameter<di>.....	297
[SOURce<hw>]:BB:W3GPp:BSTation<st>:CHANnel<ch0>:HSDPa:HSET:RVSequence<di>.....	297
[SOURce<hw>]:BB:W3GPp:BSTation<st>:CHANnel<ch0>:HSDPa:HSET:RVState.....	298
[SOURce<hw>]:BB:W3GPp:BSTation<st>:CHANnel<ch0>:HSDPa:HSET:S64Qam.....	299
[SOURce<hw>]:BB:W3GPp:BSTation<st>:CHANnel<ch0>:HSDPa:HSET:SCCode.....	299
[SOURce<hw>]:BB:W3GPp:BSTation<st>:CHANnel<ch0>:HSDPa:HSET:SEED.....	298
[SOURce<hw>]:BB:W3GPp:BSTation<st>:CHANnel<ch0>:HSDPa:HSET:SLENgth:ADJust.....	300
[SOURce<hw>]:BB:W3GPp:BSTation<st>:CHANnel<ch0>:HSDPa:HSET:SLENgth?.....	300
[SOURce<hw>]:BB:W3GPp:BSTation<st>:CHANnel<ch0>:HSDPa:HSET:SPATtern<di>?.....	300
[SOURce<hw>]:BB:W3GPp:BSTation<st>:CHANnel<ch0>:HSDPa:HSET:STAPattern.....	301
[SOURce<hw>]:BB:W3GPp:BSTation<st>:CHANnel<ch0>:HSDPa:HSET:TBS:INDEx<di>.....	302
[SOURce<hw>]:BB:W3GPp:BSTation<st>:CHANnel<ch0>:HSDPa:HSET:TBS:REFerence.....	302
[SOURce<hw>]:BB:W3GPp:BSTation<st>:CHANnel<ch0>:HSDPa:HSET:TBS:TABLE<di>.....	303
[SOURce<hw>]:BB:W3GPp:BSTation<st>:CHANnel<ch0>:HSDPa:HSET:TPOWer.....	301
[SOURce<hw>]:BB:W3GPp:BSTation<st>:CHANnel<ch0>:HSDPa:HSET:TYPE.....	303
[SOURce<hw>]:BB:W3GPp:BSTation<st>:CHANnel<ch0>:HSDPa:HSET:UECategory?.....	304
[SOURce<hw>]:BB:W3GPp:BSTation<st>:CHANnel<ch0>:HSDPa:HSET:UEID.....	304
[SOURce<hw>]:BB:W3GPp:BSTation<st>:CHANnel<ch0>:HSDPa:HSET:VIBSize<di>.....	305
[SOURce<hw>]:BB:W3GPp:BSTation<st>:CHANnel<ch0>:HSDPa:MIMO:CVPB<di>.....	305
[SOURce<hw>]:BB:W3GPp:BSTation<st>:CHANnel<ch0>:HSDPa:MIMO:MODulation<di>.....	306
[SOURce<hw>]:BB:W3GPp:BSTation<st>:CHANnel<ch0>:HSDPa:MIMO:PWPatterm.....	306
[SOURce<hw>]:BB:W3GPp:BSTation<st>:CHANnel<ch0>:HSDPa:MIMO:STAPattern.....	306
[SOURce<hw>]:BB:W3GPp:BSTation<st>:CHANnel<ch0>:HSDPa:MODE.....	307
[SOURce<hw>]:BB:W3GPp:BSTation<st>:CHANnel<ch0>:HSDPa:TTIDistance.....	307
[SOURce<hw>]:BB:W3GPp:BSTation<st>:CHANnel<ch0>:POWer.....	307
[SOURce<hw>]:BB:W3GPp:BSTation<st>:CHANnel<ch0>:SFORmat.....	308
[SOURce<hw>]:BB:W3GPp:BSTation<st>:CHANnel<ch0>:SRATE.....	308
[SOURce<hw>]:BB:W3GPp:BSTation<st>:CHANnel<ch0>:STATE.....	309
[SOURce<hw>]:BB:W3GPp:BSTation<st>:CHANnel<ch0>:TOFFset.....	309
[SOURce<hw>]:BB:W3GPp:BSTation<st>:CHANnel<ch0>:TYPE.....	309
[SOURce<hw>]:BB:W3GPp:BSTation<st>:CHANnel<ch0>[:HSUPa]:EAGCh:IFCoding.....	310
[SOURce<hw>]:BB:W3GPp:BSTation<st>:CHANnel<ch0>[:HSUPa]:EAGCh:TTI<di>:AGSCope.....	310
[SOURce<hw>]:BB:W3GPp:BSTation<st>:CHANnel<ch0>[:HSUPa]:EAGCh:TTI<di>:AGVIndex.....	311
[SOURce<hw>]:BB:W3GPp:BSTation<st>:CHANnel<ch0>[:HSUPa]:EAGCh:TTI<di>:UEID.....	311
[SOURce<hw>]:BB:W3GPp:BSTation<st>:CHANnel<ch0>[:HSUPa]:EAGCh:TTICount.....	311
[SOURce<hw>]:BB:W3GPp:BSTation<st>:CHANnel<ch0>[:HSUPa]:EAGCh:TTIEdch.....	311
[SOURce<hw>]:BB:W3GPp:BSTation<st>:CHANnel<ch0>[:HSUPa]:EHICH:CTYPE.....	312
[SOURce<hw>]:BB:W3GPp:BSTation<st>:CHANnel<ch0>[:HSUPa]:EHICH:DTAU.....	312
[SOURce<hw>]:BB:W3GPp:BSTation<st>:CHANnel<ch0>[:HSUPa]:EHICH:ETAU?.....	313
[SOURce<hw>]:BB:W3GPp:BSTation<st>:CHANnel<ch0>[:HSUPa]:EHICH:RGPATtern.....	313
[SOURce<hw>]:BB:W3GPp:BSTation<st>:CHANnel<ch0>[:HSUPa]:EHICH:SSINdex.....	313
[SOURce<hw>]:BB:W3GPp:BSTation<st>:CHANnel<ch0>[:HSUPa]:EHICH:TTIEdch.....	314
[SOURce<hw>]:BB:W3GPp:BSTation<st>:CHANnel<ch0>[:HSUPa]:ERGCh:CTYPE.....	314
[SOURce<hw>]:BB:W3GPp:BSTation<st>:CHANnel<ch0>[:HSUPa]:ERGCh:DTAU.....	314
[SOURce<hw>]:BB:W3GPp:BSTation<st>:CHANnel<ch0>[:HSUPa]:ERGCh:ETAU?.....	314
[SOURce<hw>]:BB:W3GPp:BSTation<st>:CHANnel<ch0>[:HSUPa]:ERGCh:RGPATtern.....	315
[SOURce<hw>]:BB:W3GPp:BSTation<st>:CHANnel<ch0>[:HSUPa]:ERGCh:SSINdex.....	315
[SOURce<hw>]:BB:W3GPp:BSTation<st>:CHANnel<ch0>[:HSUPa]:ERGCh:TTIEdch.....	315
[SOURce<hw>]:BB:W3GPp:BSTation<st>:CMODE:DLFStructure.....	315

[:SOURCE<hw>]:BB:W3GPp:BSTation<st>:CMODE:METHod.....	316
[:SOURCE<hw>]:BB:W3GPp:BSTation<st>:CMODE:PATtern<ch>:TGD.....	316
[:SOURCE<hw>]:BB:W3GPp:BSTation<st>:CMODE:PATtern<ch>:TGL<di>.....	316
[:SOURCE<hw>]:BB:W3GPp:BSTation<st>:CMODE:PATtern<ch>:TGPL.....	317
[:SOURCE<hw>]:BB:W3GPp:BSTation<st>:CMODE:PATtern<ch>:TGSN.....	317
[:SOURCE<hw>]:BB:W3GPp:BSTation<st>:CMODE:STATE.....	318
[:SOURCE<hw>]:BB:W3GPp:BSTation<st>:DCONflict:RESolve.....	318
[:SOURCE<hw>]:BB:W3GPp:BSTation<st>:DCONflict[:STATE]?.....	319
[:SOURCE<hw>]:BB:W3GPp:BSTation<st>:ENHanced:CHANnel<ch0>:DPCH:DPControl:RANGe:UP.....	337
[:SOURCE<hw>]:BB:W3GPp:BSTation<st>:ENHanced:PCPich:PATtern.....	323
[:SOURCE<hw>]:BB:W3GPp:BSTation<st>:OLTDiversity.....	319
[:SOURCE<hw>]:BB:W3GPp:BSTation<st>:PINDicator:COUNT.....	320
[:SOURCE<hw>]:BB:W3GPp:BSTation<st>:SCODE.....	320
[:SOURCE<hw>]:BB:W3GPp:BSTation<st>:SCODE:STATE.....	320
[:SOURCE<hw>]:BB:W3GPp:BSTation<st>:SCPich:PREFERENCE[:STATE].....	320
[:SOURCE<hw>]:BB:W3GPp:BSTation<st>:SSCG?.....	321
[:SOURCE<hw>]:BB:W3GPp:BSTation<st>:STATE.....	321
[:SOURCE<hw>]:BB:W3GPp:BSTation<st>:TDElay.....	321
[:SOURCE<hw>]:BB:W3GPp:BSTation<st>:TDIVersity.....	322
[:SOURCE<hw>]:BB:W3GPp:BSTation<st> MSTation<st>:CMODE:POFFset.....	317
[:SOURCE<hw>]:BB:W3GPp:BSTation<st> MSTation<st>:CMODE:POMode.....	318
[:SOURCE<hw>]:BB:W3GPp:CLIPping:LEVel.....	258
[:SOURCE<hw>]:BB:W3GPp:CLIPping:MODE.....	258
[:SOURCE<hw>]:BB:W3GPp:CLIPping:STATE.....	259
[:SOURCE<hw>]:BB:W3GPp:CLOCK:MODE.....	268
[:SOURCE<hw>]:BB:W3GPp:CLOCK:MULTIplier.....	268
[:SOURCE<hw>]:BB:W3GPp:CLOCK:SOURce.....	269
[:SOURCE<hw>]:BB:W3GPp:CLOCK:SYNChronization:EXECute.....	269
[:SOURCE<hw>]:BB:W3GPp:CLOCK:SYNChronization:MODE.....	269
[:SOURCE<hw>]:BB:W3GPp:COPIY:COFFset.....	255
[:SOURCE<hw>]:BB:W3GPp:COPIY:DESTination.....	255
[:SOURCE<hw>]:BB:W3GPp:COPIY:EXECute.....	256
[:SOURCE<hw>]:BB:W3GPp:COPIY:SOURce.....	256
[:SOURCE<hw>]:BB:W3GPp:CRATe:VARiation.....	259
[:SOURCE<hw>]:BB:W3GPp:CRATe?.....	259
[:SOURCE<hw>]:BB:W3GPp:FILTer:PARAmeter:APCO25.....	259
[:SOURCE<hw>]:BB:W3GPp:FILTer:PARAmeter:COSSine.....	260
[:SOURCE<hw>]:BB:W3GPp:FILTer:PARAmeter:GAUSS.....	260
[:SOURCE<hw>]:BB:W3GPp:FILTer:PARAmeter:LPASS.....	260
[:SOURCE<hw>]:BB:W3GPp:FILTer:PARAmeter:LPASSVM.....	261
[:SOURCE<hw>]:BB:W3GPp:FILTer:PARAmeter:RCOSSine.....	261
[:SOURCE<hw>]:BB:W3GPp:FILTer:PARAmeter:SPHase.....	261
[:SOURCE<hw>]:BB:W3GPp:FILTer:TYPE.....	262
[:SOURCE<hw>]:BB:W3GPp:LINK.....	257
[:SOURCE<hw>]:BB:W3GPp:LREFerence.....	347
[:SOURCE<hw>]:BB:W3GPp:MSTation:ADDITIONal:COUNT.....	343
[:SOURCE<hw>]:BB:W3GPp:MSTation:ADDITIONal:POWER:OFFSet.....	344
[:SOURCE<hw>]:BB:W3GPp:MSTation:ADDITIONal:SCODE:STEP.....	344
[:SOURCE<hw>]:BB:W3GPp:MSTation:ADDITIONal:STATE.....	344
[:SOURCE<hw>]:BB:W3GPp:MSTation:ADDITIONal:TDElay:STEP.....	344

[:SOURCE<hw>]:BB:W3GPP:MSTation:ENHanced:DPDCh:BPFRame?.....	425
[:SOURCE<hw>]:BB:W3GPP:MSTation:ENHanced:DPDCh:CCODing:STATE.....	426
[:SOURCE<hw>]:BB:W3GPP:MSTation:ENHanced:DPDCh:CCODing:TYPE.....	426
[:SOURCE<hw>]:BB:W3GPP:MSTation:ENHanced:DPDCh:CCODing:USER:CATalog?.....	427
[:SOURCE<hw>]:BB:W3GPP:MSTation:ENHanced:DPDCh:CCODing:USER:DELete.....	427
[:SOURCE<hw>]:BB:W3GPP:MSTation:ENHanced:DPDCh:CCODing:USER:LOAD.....	428
[:SOURCE<hw>]:BB:W3GPP:MSTation:ENHanced:DPDCh:CCODing:USER:STORe.....	428
[:SOURCE<hw>]:BB:W3GPP:MSTation:ENHanced:DPDCh:DERRor:BIT:LAYer.....	428
[:SOURCE<hw>]:BB:W3GPP:MSTation:ENHanced:DPDCh:DERRor:BIT:RATE.....	429
[:SOURCE<hw>]:BB:W3GPP:MSTation:ENHanced:DPDCh:DERRor:BIT:STATE.....	429
[:SOURCE<hw>]:BB:W3GPP:MSTation:ENHanced:DPDCh:DERRor:BLOCK:RATE.....	430
[:SOURCE<hw>]:BB:W3GPP:MSTation:ENHanced:DPDCh:DERRor[:BLOCK]:STATE.....	430
[:SOURCE<hw>]:BB:W3GPP:MSTation:ENHanced:DPDCh:INTerleaver2.....	430
[:SOURCE<hw>]:BB:W3GPP:MSTation:ENHanced:DPDCh:ORATe.....	431
[:SOURCE<hw>]:BB:W3GPP:MSTation:ENHanced:DPDCh:STATE.....	431
[:SOURCE<hw>]:BB:W3GPP:MSTation:ENHanced:DPDCh:TCHannel<di0>:CRCSIZE.....	433
[:SOURCE<hw>]:BB:W3GPP:MSTation:ENHanced:DPDCh:TCHannel<di0>:DATA.....	433
[:SOURCE<hw>]:BB:W3GPP:MSTation:ENHanced:DPDCh:TCHannel<di0>:DATA:DSElect.....	434
[:SOURCE<hw>]:BB:W3GPP:MSTation:ENHanced:DPDCh:TCHannel<di0>:DATA:PATtern.....	434
[:SOURCE<hw>]:BB:W3GPP:MSTation:ENHanced:DPDCh:TCHannel<di0>:EPRotectiOn.....	434
[:SOURCE<hw>]:BB:W3GPP:MSTation:ENHanced:DPDCh:TCHannel<di0>:INTerleaver.....	435
[:SOURCE<hw>]:BB:W3GPP:MSTation:ENHanced:DPDCh:TCHannel<di0>:RMATtribute.....	431
[:SOURCE<hw>]:BB:W3GPP:MSTation:ENHanced:DPDCh:TCHannel<di0>:STATE.....	432
[:SOURCE<hw>]:BB:W3GPP:MSTation:ENHanced:DPDCh:TCHannel<di0>:TBCount.....	432
[:SOURCE<hw>]:BB:W3GPP:MSTation:ENHanced:DPDCh:TCHannel<di0>:TBSIZE.....	432
[:SOURCE<hw>]:BB:W3GPP:MSTation:ENHanced:DPDCh:TCHannel<di0>:TTINterval.....	432
[:SOURCE<hw>]:BB:W3GPP:MSTation:ENHanced:PCPCh:CCODing:STATE.....	435
[:SOURCE<hw>]:BB:W3GPP:MSTation:ENHanced:PCPCh:CCODing:TYPE.....	436
[:SOURCE<hw>]:BB:W3GPP:MSTation:PRESet.....	345
[:SOURCE<hw>]:BB:W3GPP:MSTation:UDTX:BURSt<ch>.....	420
[:SOURCE<hw>]:BB:W3GPP:MSTation:UDTX:CYCLe<ch>.....	419
[:SOURCE<hw>]:BB:W3GPP:MSTation:UDTX:ITHReshold.....	419
[:SOURCE<hw>]:BB:W3GPP:MSTation:UDTX:LPLength.....	419
[:SOURCE<hw>]:BB:W3GPP:MSTation:UDTX:MODE.....	417
[:SOURCE<hw>]:BB:W3GPP:MSTation:UDTX:OFFSet.....	418
[:SOURCE<hw>]:BB:W3GPP:MSTation:UDTX:POSTamble<ch>?.....	420
[:SOURCE<hw>]:BB:W3GPP:MSTation:UDTX:PREamble<ch>?.....	420
[:SOURCE<hw>]:BB:W3GPP:MSTation:UDTX:STATE.....	418
[:SOURCE<hw>]:BB:W3GPP:MSTation:UDTX:TTIEdch.....	418
[:SOURCE<hw>]:BB:W3GPP:MSTation[:ENHanced:DPDCh]:DPCControl:ASSignment.....	422
[:SOURCE<hw>]:BB:W3GPP:MSTation[:ENHanced:DPDCh]:DPCControl:DIRectiOn.....	422
[:SOURCE<hw>]:BB:W3GPP:MSTation[:ENHanced:DPDCh]:DPCControl:MODE.....	422
[:SOURCE<hw>]:BB:W3GPP:MSTation[:ENHanced:DPDCh]:DPCControl:RANGE:DOWN.....	423
[:SOURCE<hw>]:BB:W3GPP:MSTation[:ENHanced:DPDCh]:DPCControl:RANGE:UP.....	423
[:SOURCE<hw>]:BB:W3GPP:MSTation[:ENHanced:DPDCh]:DPCControl:STATE.....	423
[:SOURCE<hw>]:BB:W3GPP:MSTation[:ENHanced:DPDCh]:DPCControl:STEP:MANual.....	424
[:SOURCE<hw>]:BB:W3GPP:MSTation[:ENHanced:DPDCh]:DPCControl:STEP[:EXTernal].....	424
[:SOURCE<hw>]:BB:W3GPP:MSTation[:ENHanced:DPDCh]:DPCControl[:POWER]?.....	423
[:SOURCE<hw>]:BB:W3GPP:MSTation<st>:CHANnel<ch>:DPDCh:CCODE?.....	375
[:SOURCE<hw>]:BB:W3GPP:MSTation<st>:CHANnel<ch>:DPDCh:DATA.....	375

[:SOURCE<hw>]:BB:W3GPP:MSTation<st>:CHANNEL<ch>:DPDCh:DATA:DSElect.....	376
[:SOURCE<hw>]:BB:W3GPP:MSTation<st>:CHANNEL<ch>:DPDCh:DATA:PATtern.....	376
[:SOURCE<hw>]:BB:W3GPP:MSTation<st>:CHANNEL<ch>:DPDCh:SRATE?.....	377
[:SOURCE<hw>]:BB:W3GPP:MSTation<st>:CMODE:METHod.....	348
[:SOURCE<hw>]:BB:W3GPP:MSTation<st>:CMODE:PATtern<ch>:TGD.....	348
[:SOURCE<hw>]:BB:W3GPP:MSTation<st>:CMODE:PATtern<ch>:TGL<di>.....	348
[:SOURCE<hw>]:BB:W3GPP:MSTation<st>:CMODE:PATtern<ch>:TGPL.....	349
[:SOURCE<hw>]:BB:W3GPP:MSTation<st>:CMODE:PATtern<ch>:TGSN.....	349
[:SOURCE<hw>]:BB:W3GPP:MSTation<st>:CMODE:STATE.....	349
[:SOURCE<hw>]:BB:W3GPP:MSTation<st>:DPCCh:CCODE?.....	350
[:SOURCE<hw>]:BB:W3GPP:MSTation<st>:DPCCh:FBI:MODE.....	350
[:SOURCE<hw>]:BB:W3GPP:MSTation<st>:DPCCh:FBI:PATtern.....	351
[:SOURCE<hw>]:BB:W3GPP:MSTation<st>:DPCCh:HS:CCODE?.....	358
[:SOURCE<hw>]:BB:W3GPP:MSTation<st>:DPCCh:HS:COMPAtibility.....	357
[:SOURCE<hw>]:BB:W3GPP:MSTation<st>:DPCCh:HS:CQI:PLENght.....	360
[:SOURCE<hw>]:BB:W3GPP:MSTation<st>:DPCCh:HS:CQI<ch>[:VALues].....	361
[:SOURCE<hw>]:BB:W3GPP:MSTation<st>:DPCCh:HS:HACK:REPeat.....	374
[:SOURCE<hw>]:BB:W3GPP:MSTation<st>:DPCCh:HS:HACK:ROWS.....	369
[:SOURCE<hw>]:BB:W3GPP:MSTation<st>:DPCCh:HS:HAPAttern.....	360
[:SOURCE<hw>]:BB:W3GPP:MSTation<st>:DPCCh:HS:MIMO:POAAck.....	361
[:SOURCE<hw>]:BB:W3GPP:MSTation<st>:DPCCh:HS:MIMO:PONAck.....	362
[:SOURCE<hw>]:BB:W3GPP:MSTation<st>:DPCCh:HS:MIMO:POCA.....	364
[:SOURCE<hw>]:BB:W3GPP:MSTation<st>:DPCCh:HS:MIMO:PONAck.....	362
[:SOURCE<hw>]:BB:W3GPP:MSTation<st>:DPCCh:HS:MIMO:PONNAck.....	363
[:SOURCE<hw>]:BB:W3GPP:MSTation<st>:DPCCh:HS:MIMO:TTI<ch0>:CQI<di>.....	366
[:SOURCE<hw>]:BB:W3GPP:MSTation<st>:DPCCh:HS:MIMO:TTI<ch0>:CQIType.....	365
[:SOURCE<hw>]:BB:W3GPP:MSTation<st>:DPCCh:HS:MIMO:TTI<ch0>:HACK.....	365
[:SOURCE<hw>]:BB:W3GPP:MSTation<st>:DPCCh:HS:MIMO:TTI<ch0>:PCI.....	365
[:SOURCE<hw>]:BB:W3GPP:MSTation<st>:DPCCh:HS:MIMO:TTICount.....	364
[:SOURCE<hw>]:BB:W3GPP:MSTation<st>:DPCCh:HS:MIMO[:MODE].....	361
[:SOURCE<hw>]:BB:W3GPP:MSTation<st>:DPCCh:HS:MMODE.....	368
[:SOURCE<hw>]:BB:W3GPP:MSTation<st>:DPCCh:HS:PCQI:REPeat.....	374
[:SOURCE<hw>]:BB:W3GPP:MSTation<st>:DPCCh:HS:PCQI:ROWS.....	369
[:SOURCE<hw>]:BB:W3GPP:MSTation<st>:DPCCh:HS:POACK.....	359
[:SOURCE<hw>]:BB:W3GPP:MSTation<st>:DPCCh:HS:PONAck.....	359
[:SOURCE<hw>]:BB:W3GPP:MSTation<st>:DPCCh:HS:POWER.....	357
[:SOURCE<hw>]:BB:W3GPP:MSTation<st>:DPCCh:HS:ROW<ch0>:HACK:FROM.....	370
[:SOURCE<hw>]:BB:W3GPP:MSTation<st>:DPCCh:HS:ROW<ch0>:HACK:TO.....	370
[:SOURCE<hw>]:BB:W3GPP:MSTation<st>:DPCCh:HS:ROW<ch0>:HACK<di>.....	370
[:SOURCE<hw>]:BB:W3GPP:MSTation<st>:DPCCh:HS:ROW<ch0>:PCQI:FROM.....	372
[:SOURCE<hw>]:BB:W3GPP:MSTation<st>:DPCCh:HS:ROW<ch0>:PCQI:TO.....	372
[:SOURCE<hw>]:BB:W3GPP:MSTation<st>:DPCCh:HS:ROW<ch0>:PCQI<di>:CQI<us>.....	373
[:SOURCE<hw>]:BB:W3GPP:MSTation<st>:DPCCh:HS:ROW<ch0>:PCQI<di>:PCI.....	373
[:SOURCE<hw>]:BB:W3GPP:MSTation<st>:DPCCh:HS:ROW<ch0>:PCQI<di>:TYPE.....	372
[:SOURCE<hw>]:BB:W3GPP:MSTation<st>:DPCCh:HS:ROW<ch0>:POHAck.....	371
[:SOURCE<hw>]:BB:W3GPP:MSTation<st>:DPCCh:HS:ROW<ch0>:POPCqi.....	373
[:SOURCE<hw>]:BB:W3GPP:MSTation<st>:DPCCh:HS:SC:ACTive.....	369
[:SOURCE<hw>]:BB:W3GPP:MSTation<st>:DPCCh:HS:SC:ENABled.....	369
[:SOURCE<hw>]:BB:W3GPP:MSTation<st>:DPCCh:HS:SDELay.....	358
[:SOURCE<hw>]:BB:W3GPP:MSTation<st>:DPCCh:HS:SFORMat?.....	368

[:SOURCE<hw>]:BB:W3GPp:MSTation<st>:DPCCh:HS:SLEngth:ADJust.....	374
[:SOURCE<hw>]:BB:W3GPp:MSTation<st>:DPCCh:HS:SLEngth?.....	374
[:SOURCE<hw>]:BB:W3GPp:MSTation<st>:DPCCh:HS:STATE.....	357
[:SOURCE<hw>]:BB:W3GPp:MSTation<st>:DPCCh:HS:TTIDistance.....	358
[:SOURCE<hw>]:BB:W3GPp:MSTation<st>:DPCCh:POWer.....	351
[:SOURCE<hw>]:BB:W3GPp:MSTation<st>:DPCCh:SFOrmat.....	351
[:SOURCE<hw>]:BB:W3GPp:MSTation<st>:DPCCh:TFCI.....	352
[:SOURCE<hw>]:BB:W3GPp:MSTation<st>:DPCCh:TFCI:STATE.....	352
[:SOURCE<hw>]:BB:W3GPp:MSTation<st>:DPCCh:TOFFset.....	353
[:SOURCE<hw>]:BB:W3GPp:MSTation<st>:DPCCh:TPC:DATA.....	353
[:SOURCE<hw>]:BB:W3GPp:MSTation<st>:DPCCh:TPC:DATA:DSElect.....	353
[:SOURCE<hw>]:BB:W3GPp:MSTation<st>:DPCCh:TPC:DATA:PATtern.....	354
[:SOURCE<hw>]:BB:W3GPp:MSTation<st>:DPCCh:TPC:MISe.....	354
[:SOURCE<hw>]:BB:W3GPp:MSTation<st>:DPCCh:TPC:MODE.....	355
[:SOURCE<hw>]:BB:W3GPp:MSTation<st>:DPCCh:TPC:PSTep.....	355
[:SOURCE<hw>]:BB:W3GPp:MSTation<st>:DPCCh:TPC:READ.....	356
[:SOURCE<hw>]:BB:W3GPp:MSTation<st>:DPDCh:FCIO.....	377
[:SOURCE<hw>]:BB:W3GPp:MSTation<st>:DPDCh:ORATe.....	378
[:SOURCE<hw>]:BB:W3GPp:MSTation<st>:DPDCh:POWer.....	378
[:SOURCE<hw>]:BB:W3GPp:MSTation<st>:DPDCh:STATE.....	378
[:SOURCE<hw>]:BB:W3GPp:MSTation<st>:ENHanced:PRACH:CCODing:STATE.....	436
[:SOURCE<hw>]:BB:W3GPp:MSTation<st>:ENHanced:PRACH:CCODing:TYPE.....	436
[:SOURCE<hw>]:BB:W3GPp:MSTation<st>:MODE.....	345
[:SOURCE<hw>]:BB:W3GPp:MSTation<st>:PCPCh:CPOWer.....	379
[:SOURCE<hw>]:BB:W3GPp:MSTation<st>:PCPCh:CPSFormat.....	380
[:SOURCE<hw>]:BB:W3GPp:MSTation<st>:PCPCh:DATA.....	380
[:SOURCE<hw>]:BB:W3GPp:MSTation<st>:PCPCh:DATA:DSElect.....	381
[:SOURCE<hw>]:BB:W3GPp:MSTation<st>:PCPCh:DATA:PATtern.....	381
[:SOURCE<hw>]:BB:W3GPp:MSTation<st>:PCPCh:DPOWer.....	381
[:SOURCE<hw>]:BB:W3GPp:MSTation<st>:PCPCh:FBI:MODE.....	382
[:SOURCE<hw>]:BB:W3GPp:MSTation<st>:PCPCh:FBI:PATtern.....	382
[:SOURCE<hw>]:BB:W3GPp:MSTation<st>:PCPCh:MLEngth.....	382
[:SOURCE<hw>]:BB:W3GPp:MSTation<st>:PCPCh:PLEngth.....	383
[:SOURCE<hw>]:BB:W3GPp:MSTation<st>:PCPCh:PPOWer.....	383
[:SOURCE<hw>]:BB:W3GPp:MSTation<st>:PCPCh:PPOWer:STEP.....	383
[:SOURCE<hw>]:BB:W3GPp:MSTation<st>:PCPCh:PREPetition.....	384
[:SOURCE<hw>]:BB:W3GPp:MSTation<st>:PCPCh:RAFTer.....	384
[:SOURCE<hw>]:BB:W3GPp:MSTation<st>:PCPCh:RARB.....	384
[:SOURCE<hw>]:BB:W3GPp:MSTation<st>:PCPCh:SIGNature.....	385
[:SOURCE<hw>]:BB:W3GPp:MSTation<st>:PCPCh:SRATe.....	385
[:SOURCE<hw>]:BB:W3GPp:MSTation<st>:PCPCh:TFCI.....	386
[:SOURCE<hw>]:BB:W3GPp:MSTation<st>:PCPCh:TIMing:DPOWer:MPART?.....	386
[:SOURCE<hw>]:BB:W3GPp:MSTation<st>:PCPCh:TIMing:DPOWer:PREAmble?.....	386
[:SOURCE<hw>]:BB:W3GPp:MSTation<st>:PCPCh:TIMing:SOFFset.....	387
[:SOURCE<hw>]:BB:W3GPp:MSTation<st>:PCPCh:TIMing:SPERiod?.....	387
[:SOURCE<hw>]:BB:W3GPp:MSTation<st>:PCPCh:TIMing:TIME:PREMp.....	387
[:SOURCE<hw>]:BB:W3GPp:MSTation<st>:PCPCh:TIMing:TIME:PREPre.....	388
[:SOURCE<hw>]:BB:W3GPp:MSTation<st>:PCPCh:TPC:DATA.....	388
[:SOURCE<hw>]:BB:W3GPp:MSTation<st>:PCPCh:TPC:DATA:DSElect.....	388
[:SOURCE<hw>]:BB:W3GPp:MSTation<st>:PCPCh:TPC:DATA:PATtern.....	389

[:SOURCE<hw>]:BB:W3GPP:MSTation<st>:PCPCh:TPC:READ.....	389
[:SOURCE<hw>]:BB:W3GPP:MSTation<st>:PRACH:ATTiming.....	390
[:SOURCE<hw>]:BB:W3GPP:MSTation<st>:PRACH:CPOWer.....	391
[:SOURCE<hw>]:BB:W3GPP:MSTation<st>:PRACH:DATA.....	391
[:SOURCE<hw>]:BB:W3GPP:MSTation<st>:PRACH:DATA:DSElect.....	392
[:SOURCE<hw>]:BB:W3GPP:MSTation<st>:PRACH:DATA:PATtern.....	392
[:SOURCE<hw>]:BB:W3GPP:MSTation<st>:PRACH:DPOWer.....	392
[:SOURCE<hw>]:BB:W3GPP:MSTation<st>:PRACH:MLENght.....	393
[:SOURCE<hw>]:BB:W3GPP:MSTation<st>:PRACH:PPOWer.....	393
[:SOURCE<hw>]:BB:W3GPP:MSTation<st>:PRACH:PPOWer:STEP.....	393
[:SOURCE<hw>]:BB:W3GPP:MSTation<st>:PRACH:PREPetition.....	394
[:SOURCE<hw>]:BB:W3GPP:MSTation<st>:PRACH:RAFter.....	394
[:SOURCE<hw>]:BB:W3GPP:MSTation<st>:PRACH:RARB.....	394
[:SOURCE<hw>]:BB:W3GPP:MSTation<st>:PRACH:SFOFormat.....	395
[:SOURCE<hw>]:BB:W3GPP:MSTation<st>:PRACH:SIGNature.....	395
[:SOURCE<hw>]:BB:W3GPP:MSTation<st>:PRACH:SRATe.....	395
[:SOURCE<hw>]:BB:W3GPP:MSTation<st>:PRACH:TFCI.....	396
[:SOURCE<hw>]:BB:W3GPP:MSTation<st>:PRACH:TIMing:DPOWer:MPART:CONTRol?.....	397
[:SOURCE<hw>]:BB:W3GPP:MSTation<st>:PRACH:TIMing:DPOWer:MPART:DATA?.....	397
[:SOURCE<hw>]:BB:W3GPP:MSTation<st>:PRACH:TIMing:DPOWer:MPART?.....	396
[:SOURCE<hw>]:BB:W3GPP:MSTation<st>:PRACH:TIMing:DPOWer:PREAmble?.....	397
[:SOURCE<hw>]:BB:W3GPP:MSTation<st>:PRACH:TIMing:SOFFset.....	398
[:SOURCE<hw>]:BB:W3GPP:MSTation<st>:PRACH:TIMing:SPERiod?.....	398
[:SOURCE<hw>]:BB:W3GPP:MSTation<st>:PRACH:TIMing:TIME:PREMp.....	398
[:SOURCE<hw>]:BB:W3GPP:MSTation<st>:PRACH:TIMing:TIME:PREPre.....	399
[:SOURCE<hw>]:BB:W3GPP:MSTation<st>:SCODE.....	346
[:SOURCE<hw>]:BB:W3GPP:MSTation<st>:SCODE:MODE.....	346
[:SOURCE<hw>]:BB:W3GPP:MSTation<st>:STATE.....	347
[:SOURCE<hw>]:BB:W3GPP:MSTation<st>:TDElay.....	347
[:SOURCE<hw>]:BB:W3GPP:MSTation<st>[:HSUPa]:CHANnel<ch>:DPDCh:E:CCODE?.....	400
[:SOURCE<hw>]:BB:W3GPP:MSTation<st>[:HSUPa]:CHANnel<ch>:DPDCh:E:DATA.....	401
[:SOURCE<hw>]:BB:W3GPP:MSTation<st>[:HSUPa]:CHANnel<ch>:DPDCh:E:DATA:DSElect.....	401
[:SOURCE<hw>]:BB:W3GPP:MSTation<st>[:HSUPa]:CHANnel<ch>:DPDCh:E:DATA:PATtern.....	402
[:SOURCE<hw>]:BB:W3GPP:MSTation<st>[:HSUPa]:CHANnel<ch>:DPDCh:E:POWer.....	402
[:SOURCE<hw>]:BB:W3GPP:MSTation<st>[:HSUPa]:CHANnel<ch>:DPDCh:E:SRATe?.....	402
[:SOURCE<hw>]:BB:W3GPP:MSTation<st>[:HSUPa]:DPCCh:E:CCODE?.....	412
[:SOURCE<hw>]:BB:W3GPP:MSTation<st>[:HSUPa]:DPCCh:E:FRC:CHANnel.....	403
[:SOURCE<hw>]:BB:W3GPP:MSTation<st>[:HSUPa]:DPCCh:E:FRC:CRATe?.....	403
[:SOURCE<hw>]:BB:W3GPP:MSTation<st>[:HSUPa]:DPCCh:E:FRC:DATA.....	403
[:SOURCE<hw>]:BB:W3GPP:MSTation<st>[:HSUPa]:DPCCh:E:FRC:DATA:DSElect.....	404
[:SOURCE<hw>]:BB:W3GPP:MSTation<st>[:HSUPa]:DPCCh:E:FRC:DATA:PATtern.....	404
[:SOURCE<hw>]:BB:W3GPP:MSTation<st>[:HSUPa]:DPCCh:E:FRC:DERRor:BIT:LAYer.....	405
[:SOURCE<hw>]:BB:W3GPP:MSTation<st>[:HSUPa]:DPCCh:E:FRC:DERRor:BIT:RATE.....	405
[:SOURCE<hw>]:BB:W3GPP:MSTation<st>[:HSUPa]:DPCCh:E:FRC:DERRor:BIT:STATE.....	405
[:SOURCE<hw>]:BB:W3GPP:MSTation<st>[:HSUPa]:DPCCh:E:FRC:DERRor:BLOCK:RATE.....	406
[:SOURCE<hw>]:BB:W3GPP:MSTation<st>[:HSUPa]:DPCCh:E:FRC:DERRor:BLOCK:STATE.....	406
[:SOURCE<hw>]:BB:W3GPP:MSTation<st>[:HSUPa]:DPCCh:E:FRC:DTX:PATtern.....	406
[:SOURCE<hw>]:BB:W3GPP:MSTation<st>[:HSUPa]:DPCCh:E:FRC:DTX:STATE.....	406
[:SOURCE<hw>]:BB:W3GPP:MSTation<st>[:HSUPa]:DPCCh:E:FRC:HARQ:SIMulation:MODE.....	407
[:SOURCE<hw>]:BB:W3GPP:MSTation<st>[:HSUPa]:DPCCh:E:FRC:HARQ:SIMulation:RVZero.....	407

[SOURce<hw>]:BB:W3GPp:MSTation<st>[:HSUPa]:DPCCh:E:FRC:HARQ:SIMulation[:STATe].....	407
[SOURce<hw>]:BB:W3GPp:MSTation<st>[:HSUPa]:DPCCh:E:FRC:HARQ[:SIMulation]:PATtern<ch>.....	408
[SOURce<hw>]:BB:W3GPp:MSTation<st>[:HSUPa]:DPCCh:E:FRC:HPRocesses?.....	408
[SOURce<hw>]:BB:W3GPp:MSTation<st>[:HSUPa]:DPCCh:E:FRC:MIBRate?.....	408
[SOURce<hw>]:BB:W3GPp:MSTation<st>[:HSUPa]:DPCCh:E:FRC:MODulation.....	409
[SOURce<hw>]:BB:W3GPp:MSTation<st>[:HSUPa]:DPCCh:E:FRC:ORATe.....	409
[SOURce<hw>]:BB:W3GPp:MSTation<st>[:HSUPa]:DPCCh:E:FRC:PAYBits?.....	409
[SOURce<hw>]:BB:W3GPp:MSTation<st>[:HSUPa]:DPCCh:E:FRC:STATe.....	410
[SOURce<hw>]:BB:W3GPp:MSTation<st>[:HSUPa]:DPCCh:E:FRC:TBS:INDex.....	410
[SOURce<hw>]:BB:W3GPp:MSTation<st>[:HSUPa]:DPCCh:E:FRC:TBS:TABLE.....	410
[SOURce<hw>]:BB:W3GPp:MSTation<st>[:HSUPa]:DPCCh:E:FRC:TTIBits?.....	411
[SOURce<hw>]:BB:W3GPp:MSTation<st>[:HSUPa]:DPCCh:E:FRC:TTIEdch.....	411
[SOURce<hw>]:BB:W3GPp:MSTation<st>[:HSUPa]:DPCCh:E:FRC:UECategory?.....	412
[SOURce<hw>]:BB:W3GPp:MSTation<st>[:HSUPa]:DPCCh:E:HBIT.....	412
[SOURce<hw>]:BB:W3GPp:MSTation<st>[:HSUPa]:DPCCh:E:POWer.....	412
[SOURce<hw>]:BB:W3GPp:MSTation<st>[:HSUPa]:DPCCh:E:RSNumber.....	413
[SOURce<hw>]:BB:W3GPp:MSTation<st>[:HSUPa]:DPCCh:E:STATe.....	413
[SOURce<hw>]:BB:W3GPp:MSTation<st>[:HSUPa]:DPCCh:E:TFCI.....	413
[SOURce<hw>]:BB:W3GPp:MSTation<st>[:HSUPa]:DPDCh:E:FCIO.....	414
[SOURce<hw>]:BB:W3GPp:MSTation<st>[:HSUPa]:DPDCh:E:MODulation.....	414
[SOURce<hw>]:BB:W3GPp:MSTation<st>[:HSUPa]:DPDCh:E:ORATe.....	414
[SOURce<hw>]:BB:W3GPp:MSTation<st>[:HSUPa]:DPDCh:E:STATe.....	415
[SOURce<hw>]:BB:W3GPp:MSTation<st>[:HSUPa]:DPDCh:E:TTIEdch.....	415
[SOURce<hw>]:BB:W3GPp:MSTation<st>[:HSUPa]:EDCH:REPeat.....	416
[SOURce<hw>]:BB:W3GPp:MSTation<st>[:HSUPa]:EDCH:ROW<ch0>:FROM.....	416
[SOURce<hw>]:BB:W3GPp:MSTation<st>[:HSUPa]:EDCH:ROW<ch0>:TO.....	416
[SOURce<hw>]:BB:W3GPp:MSTation<st>[:HSUPa]:EDCH:ROWCount.....	416
[SOURce<hw>]:BB:W3GPp:MSTation<st>[:HSUPa]:EDCH:TTIEdch.....	415
[SOURce<hw>]:BB:W3GPp:POWer:ADJust.....	257
[SOURce<hw>]:BB:W3GPp:POWer[:TOTal]?.....	257
[SOURce<hw>]:BB:W3GPp:PPARameter:CRESt.....	271
[SOURce<hw>]:BB:W3GPp:PPARameter:DPCH:COUNT.....	271
[SOURce<hw>]:BB:W3GPp:PPARameter:DPCH:SRATe.....	272
[SOURce<hw>]:BB:W3GPp:PPARameter:EXECute.....	272
[SOURce<hw>]:BB:W3GPp:PPARameter:SCCPch:SRATe.....	272
[SOURce<hw>]:BB:W3GPp:PPARameter:SCCPch:STATe.....	273
[SOURce<hw>]:BB:W3GPp:PPARameter:SCHannels.....	273
[SOURce<hw>]:BB:W3GPp:PRESet.....	252
[SOURce<hw>]:BB:W3GPp:SETTing:CATalog?.....	252
[SOURce<hw>]:BB:W3GPp:SETTing:DELeTe.....	252
[SOURce<hw>]:BB:W3GPp:SETTing:LOAD.....	253
[SOURce<hw>]:BB:W3GPp:SETTing:STORe.....	253
[SOURce<hw>]:BB:W3GPp:SETTing:STORe:FAST.....	253
[SOURce<hw>]:BB:W3GPp:SETTing:TMODeL:BSTation.....	273
[SOURce<hw>]:BB:W3GPp:SETTing:TMODeL:BSTation:CATalog?.....	273
[SOURce<hw>]:BB:W3GPp:SETTing:TMODeL:MSTation.....	274
[SOURce<hw>]:BB:W3GPp:SETTing:TMODeL:MSTation:CATalog?.....	274
[SOURce<hw>]:BB:W3GPp:SLENgth.....	254
[SOURce<hw>]:BB:W3GPp:STATe.....	254
[SOURce<hw>]:BB:W3GPp:TRIGger:ARM:EXECute.....	263

[:SOURCE<hw>]:BB:W3GPP:TRIGGER:EXECUTE.....	263
[:SOURCE<hw>]:BB:W3GPP:TRIGGER:EXTERNAL:SYNCHRONIZE:OUTPUT.....	264
[:SOURCE<hw>]:BB:W3GPP:TRIGGER:OUTPUT:DELAY:FIXED.....	267
[:SOURCE<hw>]:BB:W3GPP:TRIGGER:OUTPUT<ch>:DELAY.....	267
[:SOURCE<hw>]:BB:W3GPP:TRIGGER:OUTPUT<ch>:DELAY:MAXIMUM?.....	268
[:SOURCE<hw>]:BB:W3GPP:TRIGGER:OUTPUT<ch>:DELAY:MINIMUM?.....	268
[:SOURCE<hw>]:BB:W3GPP:TRIGGER:OUTPUT<ch>:MODE.....	266
[:SOURCE<hw>]:BB:W3GPP:TRIGGER:OUTPUT<ch>:OFFTIME.....	267
[:SOURCE<hw>]:BB:W3GPP:TRIGGER:OUTPUT<ch>:ONTIME.....	267
[:SOURCE<hw>]:BB:W3GPP:TRIGGER:OUTPUT<ch>:PERIOD.....	267
[:SOURCE<hw>]:BB:W3GPP:TRIGGER:RMODE?.....	264
[:SOURCE<hw>]:BB:W3GPP:TRIGGER:SLLENGTH.....	264
[:SOURCE<hw>]:BB:W3GPP:TRIGGER:SLUNIT.....	264
[:SOURCE<hw>]:BB:W3GPP:TRIGGER:SOURCE.....	263
[:SOURCE<hw>]:BB:W3GPP:TRIGGER[:EXTERNAL<ch>]:DELAY.....	265
[:SOURCE<hw>]:BB:W3GPP:TRIGGER[:EXTERNAL<ch>]:INHIBIT.....	265
[:SOURCE<hw>]:BB:W3GPP:WAVEFORM:CREATE.....	254
[:SOURCE<hw>]:BB:W3GPP[:TRIGGER]:SEQUENCE.....	263

Index

Symbols

(Mis-) use TPC for output power control

DPCCH	135, 187, 284, 354
F-DPCH	287
2nd search code group	77
2nd Search Code Group	321
3GPP Version	50, 255
3i OCNS mode	28
4C-HSDPA Mode	197
4C-HSPDA	
Reference Measurement Channel	244
8C-HSDPA Mode	197

A

Absolute Grant Scope	138
Absolute Grant Value Index	138
Accept	
Multi channel assistant	146
Predefined Settings	74
Accept copy	256
Access Slot	132
ACK Pattern	
AICH/AP-AICH	131
AP-AICH	278
HSUPA	140
Additional UE	75
Adjust	
HSDPA	102
Adjust ARB sequence length	
HS-DPCCH	202, 204
Adjust total power to 0 dB	56
Adjust Total Power to 0 dB	257
Advanced Mode	
HSDPA	101, 289
AICH Settings	131
AICH transmission timing	
PCPCH	174
AICH Transmission Timing	
PCPCH	387
PRACH	390, 398
Alternate HS-PDSCH Modulation	113
Alternate number of HS-PDSCH channelization codes ..	113
Always Use Redundancy Version 0 (HARQ)	
HSUPA FRC	229, 407
AP-AICH Settings	131
Application cards	13
Application notes	13
ARB sequence length	
PCPCH	175
Repeat structure after	165, 175
ARB sequence Length	
PRACH	165
ARB Settings	51
Arm	64
Assignment Mode for UL-DTX	155
At Slot	89

B

Base station default values	53, 255
Base station identification	77

Binary channel bits per TTI	107
Binary Channel Bits per TTI	291
Binary Channel Bits/TTI (Nbin)	
HSUPA FRC	411
Bit error rate	
HSDPA H-Set	111
Bit Error Rate	
Enhanced DPCHs	125
Enhanced DPDCH UE1	239
HSUPA FRC	230
Bit error state	230
Enhanced DPDCH UE1	238
HSDPA H-Set	111
Bit Error state	
Enhanced DPCHs	124
Bit Error State	
Enhanced DPCHs	339
Enhanced DPDCH	429
HSDPA H-Set	341
HSUPA FRC	405
Bits per Frame	
DPDCH	121, 235, 425
Block Error Rate	
Enhanced DPCHs	125
Enhanced DPDCH UE1	239
HSDPA H-Set	112, 342
HSUPA FRC	231
Block error state	
Enhanced DPCHs	125
Enhanced DPDCH UE1	239
HSDPA H-Set	111
HSUPA FRC	231
Block Error State	
Enhanced DPCHs	340
Enhanced DPDCH	430
HSDPA H-Set	342
HSUPA FRC	406
Brochures	13
Burst Mode	96, 100
HSDPA	289
BxT	59, 259

C

Channel Coding	
UE1	233
Channel Coding State	
Enhanced P-CCPCH	335
UE1	426
Channel Coding Type	
Enhanced P-CCPCH	116
P-CCPCH	335
Channel graph	93
Channel number	81
Channel Number	
DPDCH	212
E-DPDCH	216
Channel P-CCPCH	114
Channel power	
Multi channel assistant	145
Channel Power	83
DPDCH	211

Channel state	85	Compressed Mode	79
Multi channel assistant	146	BS	318
Channel State		UE	150
BS	309	Constellation version parameter b	96, 97
Channel table		Constellation Version Parameter b	305
DPCCH	181	Control Power	
DPDCH	210, 212, 439	PCPCH	177
E-DCH	218	PRACH	167, 391
E-DPDCH	214	Conventions	
Channel Table		SCPI commands	250
E-DPDCH	216, 440, 442	Convolution coder	
Channel type		BS1	124
Multi channel assistant	144	UE1	237
Channel Type	81	Convolution Coder	
DPDCH	213	UE1	434
E-DPDCH	217	Copy	
Channelization code	82	Base Station	54, 256
DPCCH	182	from Source	54
HS-DPCCH	194	User Equipment	54, 256
Multi channel assistant	144	Copy from Source	256
Channelization Code		Copying the data of a base or user equipment	256
DPDCH	213, 375	CQI	
E-DPCCH	189	HS-DPCCH	202, 209
E-DPDCH	217	CQI Length	
Channelization code HS-SCCH (SF128)	105	HS-DPCCH	205
Channelization Code Offset	54	CQI Type	
Channelization Code Offset	54	HS-DPCCH	201, 209
Channelization code step		CQI Values	
Multi channel assistant	145	HS-DPCCH	205
Chip clock	69	CQI1	
Chip Clock Multiplier	69	HS-DPCCH	202, 209
Chip Rate	51, 259	CQI2	
Chip Rate Variation	59	HS-DPCCH	202, 209
Clipping Level	61, 258	CQIs	
Clipping Mode	61, 258	HS-DPCCH	202, 209
Clipping Settings	51	Crest factor	74
Clock Mode	69	Clipping	258
Clock parameters	51	Crest factor - timing offset	84
Clock Source	68	Crest factor – Clipping	59
Code domain conflict	85, 91, 151	Current ARB sequence length	101
Code domain graph		HS-DPCCH	202
UE	151	Current range without recalculation	67
Code domain ideal display	91, 151	Cut Off Frequency Factor	59
Code tree of channelization codes	91		
Coding rate	108	D	
Coding Rate	292	Data	
Coding rate (N _{inf} /N _{bin})		BS	83, 279
HSUPA FRC	227	Data config	83
Coding Rate (N _{int} /N _{bin})		Data Power	
HSUPA FRC	403	PCPCH	177
Coding state		PRACH	167, 392
PCPCH	180	Data rate matching	
PRACH	169	BS1	123
Coding State		UE1	237
PCPCH	435	Data sheets	13
PRACH	436	Data source	23
Coding Type	119, 327	DPCCH	134, 186
Enhanced DPDCH UE1	233	DPDCH	213, 214
PCPCH	181, 436	E-DPDCH	217
PRACH	169, 436	F-DPCCH	141
Coding Type Enhanced		HSUPA FRC	225
DPDCH	426	Multi channel assistant	145
Compatibility Mode		PCPCH	178, 179
HS-DPCCH	193	PRACH	168
Composite CQI		Transport channel	122, 236
HS-DPCCH	202		

- Data Source
 - DPDCH 375
 - E-DCH 403
 - E-DPDCH 401
 - HS-PDSCH 104
 - PCPCH 380
 - PRACH 391
 - Transport Channel 330
 - DC-HSDPA Mode 197
 - DCCH Dedicated Control Channel 118
 - DCCH On
 - Enhanced DPCH 333
 - DCCH on enhanced DPCH 122
 - DCCH-Dedicated Control Channel 232
 - Default settings 48, 53, 255
 - All channels 79
 - BS 277
 - Channel table 79
 - HSDPA H-Set 79
 - Default Values User Equipment 54
 - Delay
 - Marker 67
 - Delete 3GPP FDD settings 48
 - Direction 336
 - Dynamic Power Control 128, 153
 - Distance 89
 - Diversity 77
 - BS 322
 - DL Frame Structure 88, 315
 - DL-UL timing offset
 - DPCCH 183
 - Documentation overview 11
 - Down range 154
 - Dynamic Power Control 129
 - Downlink 51
 - DPCCH + DPDCH 149, 345
 - DPCCH Burst Length 159
 - DPCCH Settings 132
 - DTCH Dedicated Traffic Channel 118
 - DTCH On
 - Enhanced DPCH 333
 - DTCH on enhanced DPCH 122
 - DTCH-Dedicated Traffic Channel 232
 - DTX cycle
 - UL-DTX 159
 - DTX indication bits
 - BS1 124
 - DTX Indication Bits 332
 - Dynamic Power Control 151, 153
 - Direction 128, 153
 - DL 128
 - Down Range 337, 423
 - Power Step 338
 - Step 424
 - Up Range 337, 423
 - Dynamic Power Control Direction 422
 - BS1 336
 - Dynamic Power Control Mode 128, 153
 - Dynamic range
 - Dynamic Power Control 129, 154, 423
- E**
- E-AGCH Information Filed Coding 138
 - E-AGCH Settings 137
 - E-DCH TTI 138, 139, 220
 - HSUPA FRC 226, 411
 - E-HICH Settings 139
 - E-RGCH Settings 139
 - Enhanced Channels Coding 326
 - Enhanced DPCHs 323
 - Enhanced P-CPICH Pattern 113, 323
 - Enhanced Settings
 - BS 81
 - P-CCPCH 114
 - P-CPICH 113
 - Error protection
 - UE1 237
 - Error Protection
 - BS1 124
 - UE1 434
 - External Power Control
 - BS1 128
 - External Trigger Inhibit 265
- F**
- F-DPCH Settings 140
 - FBI Mode
 - DPCCH 185, 350
 - PCPCH 178, 382
 - FBI pattern
 - PCPCH 178
 - FBI Pattern
 - DPCCH 185
 - Filter
 - Type 58
 - Filter Parameter 59, 259
 - Filtering Settings 51
 - Filtering, Clipping, ARB Settings 58
 - Fix marker delay to current range 67
 - Fixed reference Channel 224
 - Fixed Reference Channel 403
 - Fixed reference Channel (FRC)
 - HSUPA FRC 224
 - Fixed Reference Channel (FRC)
 - HSUPA 403
 - Force Channelization Code to I/O 377
 - E-DPDCH 414
 - Force Channelization Code to I/Q 212
 - E-DPDCH 215
 - FRC 224, 403
- G**
- Gap Distance
 - BS 89
 - Gap Length 89
 - Generate Waveform 50
 - Global trigger/clock settings 69
- H**
- H-Set 100
 - Happy Bit
 - E-DPCCH 189, 412
 - HARQ-ACK
 - HS-DPCCH 198, 209
 - HARQ-ACK pattern
 - HS-DPCCH 205
 - HSUPA FRC 229
 - HARQ-ACK Pattern
 - HS-DPCCH 360
 - Help 12

Higher layer scheduling	87, 316	MIMO Mode	
UE	348	HS-DPCCH	197, 206
HS-DPCCH Power	191	Mode	
HS-PDSCH Modulation	106	Dynamic Power Control	128, 153
HS-SCCH Type	102, 303	HARQ Simulation	294
HSDPA H-Set settings	97	UE	149, 345
HSDPA Mode	95, 99	Mode (HARQ simulation)	110
BS	307	Mode (HARQ)	
HSUPA Settings		HSUPA FRC	229
BS	94	Modulation	
HSUPA FRC	189	BS	97
HSUPA settings	137, 139	E-DPDCH	216, 414
		HSUPA FRC	226, 409
I		Modulation data	
Inactivity threshold	159	BS	83, 279
Information bit payload	108	Multi Channel Assistant	144
HSUPA FRC	227	Multicode state	
Information Bit Payload	291	DPCCH	133
Information Bit Payload (Ninf)		Multicode State	
HSUPA FRC	409	DPCCH	280
Insert errors	111	Multiplier	69
HSUPA FRC	230		
Insert Errors On		N	
Enhanced DPCHs	125, 339	Nominal average information bitrate	102
Enhanced DPDCH	428	Number of additional UE	75, 343
Enhanced DPDCH UE1	239	Number of configurable TTIs	138
HSDPA H-Set	341	Number of DPCH	
HSUPA FRC	405	Predefined Settings	73
Instrument help	12	Number of H-PDSCH channel codes	105
Instrument security procedures	12	Number of H-PDSCH Channel Codes	292
Inter TTI Distance	96, 108	Number of HARQ processes	
HSDPA	307	HSUPA FRC	226
Inter-TTI distance		Number of HARQ Processes	109
HS-DPCCH	194	Number Of HARQ Processes	
Interleaver		HSUPA FRC	408
P-CCPCH	334	Number of intervals	
Interleaver P-CCPCH	116	HARQ-ACK	197
		PCI / CQI	200
L		Number of PI per Frame	77, 320
Layer		Number of TTIs	
Bit error insertion	125, 239	HS-DPCCH	208
Level reference		O	
see Power reference	56	OCNS	52
Link Direction	51, 257	OCNS Mode	52
Long Preamble Length	159	Offset	
Long scrambling code	150	UL-DTX	158
Long Scrambling Code		Open loop transmit diversity	78
UE	346	Open Loop Transmit Diversity	319
		Open source acknowledgment	13
M		OSA	13
Marker	66	Overall Symbol Rate	
Marker Delay	67	DPDCH	212, 378
Maximum information bitrate		E-DPDCH	215
HSUPA FRC	224	UE1	235, 431
Measured external clock	69	Overall Symbol Rate RFC	
Message Length		HSUPA FRC	226
PCPCH	177, 382		
PRACH	167, 393	P	
Method for compressed mode	87	Pattern	
BS	87, 316	BS	83, 279
UE	348	Pattern Length	
MIMO	77	BS	90
BS	322		

- PCI
 - HS-DPCCH 202, 209
 - PCPCH only 149, 170, 345
 - PCPCH settings 170
 - Channel coding 180
 - Graphical display 172
 - Message part 177
 - Preamble settings 175
 - PCPCH structure 172
 - Pilot Length
 - DPCCH 131, 133
 - S-CCPCH 131, 133
 - Postamble Length
 - UL-DTX 160
 - Power
 - BS 83
 - DPCCH 351
 - E-DPCCH 188, 412
 - E-DPDCCH 217, 402
 - HS-DPCCH 193
 - Multi channel assistant 145
 - Power Control 153
 - BS1 128
 - Power Control Grap 423
 - Power Control graph
 - Ext. Power Control 154
 - Power Control Preamble Length
 - PCPCH 176, 383
 - Power DPCCH
 - DPCCH 183
 - Power Offset
 - Additional UE 75
 - BS 88
 - Pilot DPCCH 136
 - TFCI DPCCH 137
 - TPC DPCCH 137
 - UE 88
 - Power Offset ACK
 - HS-DPCCH 204
 - Power Offset ACK/ACK
 - HS-DPCCH 207
 - Power Offset ACK/NACK
 - HS-DPCCH 207
 - Power Offset CQI
 - HS-DPCCH 201
 - Power Offset CQI Type A
 - HS-DPCCH 208
 - Power Offset HARQ-ACK
 - HS-DPCCH 200
 - Power Offset Mode
 - BS 88, 317, 318
 - UE 88, 317, 318
 - Power Offset NACK
 - HS-DPCCH 205
 - Power Offset NACK/ACK
 - HS-DPCCH 208
 - Power Offset NACK/NACK
 - HS-DPCCH 208
 - Power Offset PCI
 - HS-DPCCH 201
 - Power reference 56
 - Power step 129, 154
 - DPCCH 188
 - Multi channel assistant 145
 - Power Step
 - TPC DPCCH 355
 - Power step TPC
 - F-DPCCH 143
 - Power Step TPC
 - DPCCH 285
 - F-DPCCH 288
 - Power step TPC - DPCCH
 - DPCCH 136
 - PowMp
 - PCPCH 173
 - PowMP 163
 - PowMpControl 163
 - PowMpData 163
 - PowPre 163
 - PCPCH 173
 - PRACH
 - PowMP 163
 - PowMpControl 163
 - PowMpData 163
 - PowPre 163
 - PRACH only 149, 345
 - PRACH settings 160
 - Channel coding 168
 - Graphical display 162
 - Message part 167
 - Preamble settings 166
 - Preamble Length
 - UL-DTX 160
 - Preamble Power
 - PCPCH 176
 - PRACH 166, 393
 - Preamble Power step
 - PCPCH 176
 - PRACH 166
 - Preamble Power Step
 - PCPCH 383
 - PRACH 393
 - Preamble repetition
 - PCPCH 176
 - PRACH 166
 - Preamble Repetition
 - PCPCH 384
 - PRACH 394
 - Precoding weight pattern (w2) 97, 103
 - Precoding Weight Pattern (w2) 296, 306
 - Predefined H-Set 296
 - Predefined Settings
 - Accept 272
 - Symbol Rate DPCH 272
 - Puncturing 87, 316
 - UE 348
- ## Q
- Quick start guide 12
- ## R
- Raised Cosine
 - see Cosine 58
 - Random seed 113
 - Randomly varying modulation 113
 - Randomly varying number of codes 113
 - Rate Matching Attribute
 - BS1 123
 - UE1 237

- Read out mode
 - DPCCH 135, 186
 - F-DPCCH 142
- Read out Mode
 - PCPCH 179
- Read Out Mode
 - DPCCH 285, 356
 - F-DPCCH 288
- Read Out Mode PCPCH
 - PCPCH 389
- Redundancy version parameter 110
- Redundancy Version Parameter 297
- Redundancy Version Parameter Sequence 297
- Reference measurement channel coding types 119, 327
- Relative Grant Pattern 140
- Release notes 13
- Repeat PCPCH structure 175
- Repeat PRACH structure 166
- Reset all base stations 53
- Reset All Base Stations 255
- Reset All User Equipment 54
- Retransmission Sequence Number
 - E-DPCCH 188, 413
- RMSpPower 56
- Roll Off 59, 259
- RRC filter
 - see Root Cosine 58
- Running 64
- S**
- S-CCPCH Settings 130
- Safety instructions 12
- Save 3GPP FDD settings 48
- Save-Recall 48
- Scrambling code
 - BS 77
 - UE 150
- Scrambling Code
 - UE 346
- Scrambling Code Step 75
- Scrambling mode
 - UE 150
- Scrambling Mode
 - UE 346
- Secondary cell
 - Active 197
 - Enabled 197
- Select Base Station 55
- Select User Equipment 55
- Sequence Length
 - ARB 61
 - PCPCH 174
- Service manual 12
- Set Synchronization Settings 269
- Set synchronizations settings 68
- Set to default 48
 - BS 277
 - Channel table 79
 - HSDPA H-Set 79
- SF2 87, 316
- SFN 115
- SFN restart 115
- Short scrambling code 150
- Short Scrambling Code
 - UE 346
- Show coding
 - PCPCH 181
 - PRACH 169
- Show details 120
 - UE1 234
- Signal duration 63
- Signal duration unit 63
- Signaling pattern 109
- Signalling Pattern
 - BS 300
- Signature
 - PCPCH 176, 385
 - PRACH 167, 395
- Signature Hopping Pattern Index 139
- Size of CRC 330
 - BS1 123
 - UE1 237, 433
- Slot format 82
 - 4C-HSDPA 195
 - DPCCH 184
 - Enhanced DPCH 121
 - F-DPCCH 141
 - Multi channel assistant 146
 - PCPCH 177
 - PRACH 167
- Slot Structure
 - DPCCH 133
 - F-DPCCH 141
 - S-CCPCH 130
- Spreading code generator (search code) 23
- Spreading code number 82
- Standard settings 48
 - All channels 79
 - BS 277
 - HSDPA H-Set 79
- Start channel No
 - Multi channel assistant 144
- Start channelization code HS-PDSCH (SF16) 105
- Start Delay m
 - HS-DPCCH 193
- Start Offset
 - PCPCH 387
 - PRACH 164, 398
- Start Offset PCPCH - UE 173
- State 48, 323
 - Bit Error 124
 - Block Error 125
 - BS 77
 - Channel Coding 326
 - Channel coding enhanced DPCHs 119
 - Channel Coding Enhanced P-CCPCH 116
 - Clipping 59
 - Compressed Mode 349
 - DPDCH 211, 378
 - Dynamic Power Control 128, 337
 - E-DPCCH 188, 413
 - E-DPDCH 215, 415
 - Enhanced DPCH Channels 117
 - Enhanced P-CCPCH 114
 - HARQ 407
 - HS-DPCCH 192, 357
 - HSUPA FRC 223, 410
 - Interleaver 1 124, 238, 332, 435
 - Interleaver 2 124, 238, 329, 430
 - Multicode 133
 - Transport Channel 333, 432

U

UE category	
BS	304
HSDPA	102
HSUPA FRC	224
UE supports 64QAM	107
UE Supports 64QAM	299
UE_DTX_DRX_Offset	158
UEID	
A-EGCH	138
BS	105, 304
UL DTX	151, 158
Up range	154
Dynamic Power Control	129
Uplink	51
Use Channels needed for Sync of Mobile (UE)	73, 273
Use Compressed Mode	
BS	318
UE	150, 349
Use E-TFCI	
E-DPCCH	189
Use S-CCPCH	73
Use S-CPICH as phase reference	78
Use S-CPICH as Phase Reference	320
Use scrambling code	
BS	77
Use Scrambling Code	
BS	320
Use TFCI	
DPCCH	130, 133, 185, 282, 352
S-CCPCH	130, 133
Use UL-DTX	151, 158
User coding	121
UE1	234
User Coding	427
User Data (DTX pattern)	
HSUPA FRC	228
User Data (DTX Pattern)	
HSUPA FRC	406
User Equipment default values	54
User manual	12

V

Version	50, 255
Virtual IR buffer size (per HARQ process)	108
Visualizing data bits of DPDCH with an oscilloscope	212

W

White papers	13
--------------	----