

R&S® SMBV100A

Vector Signal Generator

Operating Manual



1176801602

This document describes the R&S®SMBV100A, stock no. 1407.6004K02 and its options.

- R&S®SMBV-B1
- R&S®SMBV-B10/-B10F
- R&S®SMBV-B51
- R&S®SMBV-B90
- R&S®SMBV-B92
- R&S®SMBV-B103/-B106
- R&S®SMBV-K18
- R&S®SMBV-K22/-K23
- R&S®SMBV-K61
- R&S®SMBV-K62
- R&S®SMBV-K80
- R&S®SMBV-K200
- R&S®SMBV-K511/-K512
- R&S®SMBV-K521/-K522

This manual describes firmware version 4.70.108.xx and later of the R&S®SMBV100A.

© 2020 Rohde & Schwarz GmbH & Co. KG

Mühlhofstr. 15, 81671 München, Germany

Phone: +49 89 41 29 - 0

Email: info@rohde-schwarz.com

Internet: www.rohde-schwarz.com

Subject to change – Data without tolerance limits is not binding.

R&S® is a registered trademark of Rohde & Schwarz GmbH & Co. KG.

Trade names are trademarks of the owners.

1176.8016.02 | Version 18 | R&S®SMBV100A

The following abbreviations are used throughout this manual: R&S®SMBV100A is abbreviated as R&S SMBV, R&S®WinIQSIM2™ is abbreviated as R&S WinIQSIM2.

Basic Safety Instructions

Always read through and comply with the following safety instructions!

All plants and locations of the Rohde & Schwarz group of companies make every effort to keep the safety standards of our products up to date and to offer our customers the highest possible degree of safety. Our products and the auxiliary equipment they require are designed, built and tested in accordance with the safety standards that apply in each case. Compliance with these standards is continuously monitored by our quality assurance system. The product described here has been designed, built and tested in accordance with the EC Certificate of Conformity and has left the manufacturer's plant in a condition fully complying with safety standards. To maintain this condition and to ensure safe operation, you must observe all instructions and warnings provided in this manual. If you have any questions regarding these safety instructions, the Rohde & Schwarz group of companies will be happy to answer them.







Furthermore, it is your responsibility to use the product in an appropriate manner. This product is designed for use solely in industrial and laboratory environments or, if expressly permitted, also in the field and must not be used in any way that may cause personal injury or property damage. You are responsible if the product is used for any purpose other than its designated purpose or in disregard of the manufacturer's instructions. The manufacturer shall assume no responsibility for such use of the product.

The product is used for its designated purpose if it is used in accordance with its product documentation and within its performance limits (see data sheet, documentation, the following safety instructions). Using the product requires technical skills and, in some cases, a basic knowledge of English. It is therefore essential that only skilled and specialized staff or thoroughly trained personnel with the required skills be allowed to use the product. If personal safety gear is required for using Rohde & Schwarz products, this will be indicated at the appropriate place in the product documentation. Keep the basic safety instructions and the product documentation in a safe place and pass them on to the subsequent users.











Observing the safety instructions will help prevent personal injury or damage of any kind caused by dangerous situations. Therefore, carefully read through and adhere to the following safety instructions before and when using the product. It is also absolutely essential to observe the additional safety instructions on personal safety, for example, that appear in relevant parts of the product documentation. In these safety instructions, the word "product" refers to all merchandise sold and distributed by the Rohde & Schwarz group of companies, including instruments, systems and all accessories. For product-specific information, see the data sheet and the product documentation.

Safety labels on products

The following safety labels are used on products to warn against risks and dangers.

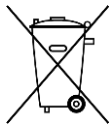
| Symbol | Meaning | Symbol | Meaning |
|---|--|---|---------------------|
|  | Notice, general danger location Observe product documentation |  | ON/OFF Power |
|  | Caution when handling heavy equipment |  | Standby indication |
|  | Danger of electric shock |  | Direct current (DC) |

Basic Safety Instructions

| Symbol | Meaning | Symbol | Meaning |
|---|---|--|--|
|  | Caution ! Hot surface |  | Alternating current (AC) |
|  | Protective conductor terminal To identify any terminal which is intended for connection to an external conductor for protection against electric shock in case of a fault, or the terminal of a protective earth |  | Direct/alternating current (DC/AC) |
|  | Earth (Ground) |  | Class II Equipment to identify equipment meeting the safety requirements specified for Class II equipment (device protected by double or reinforced insulation) |
|  | Frame or chassis Ground terminal |  | EU labeling for batteries and accumulators For additional information, see section "Waste disposal/Environmental protection", item 1. |
|  | Be careful when handling electrostatic sensitive devices |  | EU labeling for separate collection of electrical and electronic devices For additional information, see section "Waste disposal/Environmental protection", item 2. |
|  | Warning! Laser radiation For additional information, see section "Operation", item 7. | | |

Signal words and their meaning

The following signal words are used in the product documentation in order to warn the reader about risks and dangers.



Indicates a hazardous situation which, if not avoided, will result in death or serious injury.



Indicates a hazardous situation which, if not avoided, could result in death or serious injury.



Indicates a hazardous situation which, if not avoided, could result in minor or moderate injury.



Indicates information considered important, but not hazard-related, e.g. messages relating to property damage.

In the product documentation, the word ATTENTION is used synonymously.

These signal words are in accordance with the standard definition for civil applications in the European Economic Area. Definitions that deviate from the standard definition may also exist in other economic areas or military applications. It is therefore essential to make sure that the signal words described here are always used only in connection with the related product documentation and the related product. The use of signal words in connection with unrelated products or documentation can result in misinterpretation and in personal injury or material damage.

Basic Safety Instructions

Operating states and operating positions

The product may be operated only under the operating conditions and in the positions specified by the manufacturer, without the product's ventilation being obstructed. If the manufacturer's specifications are not observed, this can result in electric shock, fire and/or serious personal injury or death. Applicable local or national safety regulations and rules for the prevention of accidents must be observed in all work performed.

1. Unless otherwise specified, the following requirements apply to Rohde & Schwarz products: predefined operating position is always with the housing floor facing down, IP protection 2X, use only indoors, max. operating altitude 2000 m above sea level, max. transport altitude 4500 m above sea level. A tolerance of $\pm 10\%$ shall apply to the nominal voltage and $\pm 5\%$ to the nominal frequency, overvoltage category 2, pollution degree 2.
2. Do not place the product on surfaces, vehicles, cabinets or tables that for reasons of weight or stability are unsuitable for this purpose. Always follow the manufacturer's installation instructions when installing the product and fastening it to objects or structures (e.g. walls and shelves). An installation that is not carried out as described in the product documentation could result in personal injury or even death.
3. Do not place the product on heat-generating devices such as radiators or fan heaters. The ambient temperature must not exceed the maximum temperature specified in the product documentation or in the data sheet. Product overheating can cause electric shock, fire and/or serious personal injury or even death.

Electrical safety

If the information on electrical safety is not observed either at all or to the extent necessary, electric shock, fire and/or serious personal injury or death may occur.

1. Prior to switching on the product, always ensure that the nominal voltage setting on the product matches the nominal voltage of the mains-supply network. If a different voltage is to be set, the power fuse of the product may have to be changed accordingly.
2. In the case of products of safety class I with movable power cord and connector, operation is permitted only on sockets with a protective conductor contact and protective conductor.
3. Intentionally breaking the protective conductor either in the feed line or in the product itself is not permitted. Doing so can result in the danger of an electric shock from the product. If extension cords or connector strips are implemented, they must be checked on a regular basis to ensure that they are safe to use.
4. If there is no power switch for disconnecting the product from the mains, or if the power switch is not suitable for this purpose, use the plug of the connecting cable to disconnect the product from the mains. In such cases, always ensure that the power plug is easily reachable and accessible at all times. For example, if the power plug is the disconnecting device, the length of the connecting cable must not exceed 3 m. Functional or electronic switches are not suitable for providing disconnection from the AC supply network. If products without power switches are integrated into racks or systems, the disconnecting device must be provided at the system level.
5. Never use the product if the power cable is damaged. Check the power cables on a regular basis to ensure that they are in proper operating condition. By taking appropriate safety measures and carefully laying the power cable, ensure that the cable cannot be damaged and that no one can be hurt by, for example, tripping over the cable or suffering an electric shock.

Basic Safety Instructions

6. The product may be operated only from TN/TT supply networks fuse-protected with max. 16 A (higher fuse only after consulting with the Rohde & Schwarz group of companies).
7. Do not insert the plug into sockets that are dusty or dirty. Insert the plug firmly and all the way into the socket provided for this purpose. Otherwise, sparks that result in fire and/or injuries may occur.
8. Do not overload any sockets, extension cords or connector strips; doing so can cause fire or electric shocks.
9. For measurements in circuits with voltages $V_{rms} > 30$ V, suitable measures (e.g. appropriate measuring equipment, fuse protection, current limiting, electrical separation, insulation) should be taken to avoid any hazards.
10. Ensure that the connections with information technology equipment, e.g. PCs or other industrial computers, comply with the IEC 60950-1 / EN 60950-1 or IEC 61010-1 / EN 61010-1 standards that apply in each case.
11. Unless expressly permitted, never remove the cover or any part of the housing while the product is in operation. Doing so will expose circuits and components and can lead to injuries, fire or damage to the product.
12. If a product is to be permanently installed, the connection between the protective conductor terminal on site and the product's protective conductor must be made first before any other connection is made. The product may be installed and connected only by a licensed electrician.
13. For permanently installed equipment without built-in fuses, circuit breakers or similar protective devices, the supply circuit must be fuse-protected in such a way that anyone who has access to the product, as well as the product itself, is adequately protected from injury or damage.
14. Use suitable overvoltage protection to ensure that no overvoltage (such as that caused by a bolt of lightning) can reach the product. Otherwise, the person operating the product will be exposed to the danger of an electric shock.
15. Any object that is not designed to be placed in the openings of the housing must not be used for this purpose. Doing so can cause short circuits inside the product and/or electric shocks, fire or injuries.
16. Unless specified otherwise, products are not liquid-proof (see also section "Operating states and operating positions", item 1). Therefore, the equipment must be protected against penetration by liquids. If the necessary precautions are not taken, the user may suffer electric shock or the product itself may be damaged, which can also lead to personal injury.
17. Never use the product under conditions in which condensation has formed or can form in or on the product, e.g. if the product has been moved from a cold to a warm environment. Penetration by water increases the risk of electric shock.
18. Prior to cleaning the product, disconnect it completely from the power supply (e.g. AC supply network or battery). Use a soft, non-linting cloth to clean the product. Never use chemical cleaning agents such as alcohol, acetone or diluents for cellulose lacquers.

Operation

1. Operating the products requires special training and intense concentration. Make sure that persons who use the products are physically, mentally and emotionally fit enough to do so; otherwise, injuries or material damage may occur. It is the responsibility of the employer/operator to select suitable personnel for operating the products.

Basic Safety Instructions

2. Before you move or transport the product, read and observe the section titled "Transport".
3. As with all industrially manufactured goods, the use of substances that induce an allergic reaction (allergens) such as nickel cannot be generally excluded. If you develop an allergic reaction (such as a skin rash, frequent sneezing, red eyes or respiratory difficulties) when using a Rohde & Schwarz product, consult a physician immediately to determine the cause and to prevent health problems or stress.
4. Before you start processing the product mechanically and/or thermally, or before you take it apart, be sure to read and pay special attention to the section titled "Waste disposal/Environmental protection", item 1.
5. Depending on the function, certain products such as RF radio equipment can produce an elevated level of electromagnetic radiation. Considering that unborn babies require increased protection, pregnant women must be protected by appropriate measures. Persons with pacemakers may also be exposed to risks from electromagnetic radiation. The employer/operator must evaluate workplaces where there is a special risk of exposure to radiation and, if necessary, take measures to avert the potential danger.
6. Should a fire occur, the product may release hazardous substances (gases, fluids, etc.) that can cause health problems. Therefore, suitable measures must be taken, e.g. protective masks and protective clothing must be worn.
7. Laser products are given warning labels that are standardized according to their laser class. Lasers can cause biological harm due to the properties of their radiation and due to their extremely concentrated electromagnetic power. If a laser product (e.g. a CD/DVD drive) is integrated into a Rohde & Schwarz product, absolutely no other settings or functions may be used as described in the product documentation. The objective is to prevent personal injury (e.g. due to laser beams).
8. EMC classes (in line with EN 55011/CISPR 11, and analogously with EN 55022/CISPR 22, EN 55032/CISPR 32)
 - Class A equipment:
Equipment suitable for use in all environments except residential environments and environments that are directly connected to a low-voltage supply network that supplies residential buildings
Note: Class A equipment is intended for use in an industrial environment. This equipment may cause radio disturbances in residential environments, due to possible conducted as well as radiated disturbances. In this case, the operator may be required to take appropriate measures to eliminate these disturbances.
 - Class B equipment:
Equipment suitable for use in residential environments and environments that are directly connected to a low-voltage supply network that supplies residential buildings

Repair and service

1. The product may be opened only by authorized, specially trained personnel. Before any work is performed on the product or before the product is opened, it must be disconnected from the AC supply network. Otherwise, personnel will be exposed to the risk of an electric shock.

Basic Safety Instructions

- Adjustments, replacement of parts, maintenance and repair may be performed only by electrical experts authorized by Rohde & Schwarz. Only original parts may be used for replacing parts relevant to safety (e.g. power switches, power transformers, fuses). A safety test must always be performed after parts relevant to safety have been replaced (visual inspection, protective conductor test, insulation resistance measurement, leakage current measurement, functional test). This helps ensure the continued safety of the product.

Batteries and rechargeable batteries/cells

If the information regarding batteries and rechargeable batteries/cells is not observed either at all or to the extent necessary, product users may be exposed to the risk of explosions, fire and/or serious personal injury, and, in some cases, death. Batteries and rechargeable batteries with alkaline electrolytes (e.g. lithium cells) must be handled in accordance with the EN 62133 standard.

- Cells must not be taken apart or crushed.
- Cells or batteries must not be exposed to heat or fire. Storage in direct sunlight must be avoided. Keep cells and batteries clean and dry. Clean soiled connectors using a dry, clean cloth.
- Cells or batteries must not be short-circuited. Cells or batteries must not be stored in a box or in a drawer where they can short-circuit each other, or where they can be short-circuited by other conductive materials. Cells and batteries must not be removed from their original packaging until they are ready to be used.
- Cells and batteries must not be exposed to any mechanical shocks that are stronger than permitted.
- If a cell develops a leak, the fluid must not be allowed to come into contact with the skin or eyes. If contact occurs, wash the affected area with plenty of water and seek medical aid.
- Improperly replacing or charging cells or batteries that contain alkaline electrolytes (e.g. lithium cells) can cause explosions. Replace cells or batteries only with the matching Rohde & Schwarz type (see parts list) in order to ensure the safety of the product.
- Cells and batteries must be recycled and kept separate from residual waste. Rechargeable batteries and normal batteries that contain lead, mercury or cadmium are hazardous waste. Observe the national regulations regarding waste disposal and recycling.
- Follow the transport stipulations of the carrier (IATA-DGR, IMDG-Code, ADR, RID) when returning lithium batteries to Rohde & Schwarz subsidiaries.

Transport

- The product may be very heavy. Therefore, the product must be handled with care. In some cases, the user may require a suitable means of lifting or moving the product (e.g. with a lift-truck) to avoid back or other physical injuries.
- Handles on the products are designed exclusively to enable personnel to transport the product. It is therefore not permissible to use handles to fasten the product to or on transport equipment such as cranes, fork lifts, wagons, etc. The user is responsible for securely fastening the products to or on the means of transport or lifting. Observe the safety regulations of the manufacturer of the means of transport or lifting. Noncompliance can result in personal injury or material damage.

Instrucciones de seguridad elementales

3. If you use the product in a vehicle, it is the sole responsibility of the driver to drive the vehicle safely and properly. The manufacturer assumes no responsibility for accidents or collisions. Never use the product in a moving vehicle if doing so could distract the driver of the vehicle. Adequately secure the product in the vehicle to prevent injuries or other damage in the event of an accident.

Waste disposal/Environmental protection

1. Specially marked equipment has a battery or accumulator that must not be disposed of with unsorted municipal waste, but must be collected separately. It may only be disposed of at a suitable collection point or via a Rohde & Schwarz customer service center.
2. Waste electrical and electronic equipment must not be disposed of with unsorted municipal waste, but must be collected separately.
Rohde & Schwarz GmbH & Co. KG has developed a disposal concept and takes full responsibility for take-back obligations and disposal obligations for manufacturers within the EU. Contact your Rohde & Schwarz customer service center for environmentally responsible disposal of the product.
3. If products or their components are mechanically and/or thermally processed in a manner that goes beyond their intended use, hazardous substances (heavy-metal dust such as lead, beryllium, nickel) may be released. For this reason, the product may only be disassembled by specially trained personnel. Improper disassembly may be hazardous to your health. National waste disposal regulations must be observed.
4. If handling the product releases hazardous substances or fuels that must be disposed of in a special way, e.g. coolants or engine oils that must be replenished regularly, the safety instructions of the manufacturer of the hazardous substances or fuels and the applicable regional waste disposal regulations must be observed. Also observe the relevant safety instructions in the product documentation. The improper disposal of hazardous substances or fuels can cause health problems and lead to environmental damage.

For additional information about environmental protection, visit the Rohde & Schwarz website.

Instrucciones de seguridad elementales

¡Es imprescindible leer y cumplir las siguientes instrucciones e informaciones de seguridad!

El principio del grupo de empresas Rohde & Schwarz consiste en tener nuestros productos siempre al día con los estándares de seguridad y de ofrecer a nuestros clientes el máximo grado de seguridad. Nuestros productos y todos los equipos adicionales son siempre fabricados y examinados según las normas de seguridad vigentes. Nuestro sistema de garantía de calidad controla constantemente que sean cumplidas estas normas. El presente producto ha sido fabricado y examinado según el certificado de conformidad de la UE y ha salido de nuestra planta en estado impecable según los estándares técnicos de seguridad. Para poder preservar este estado y garantizar un funcionamiento libre de peligros, el usuario deberá atenerse a todas las indicaciones, informaciones de seguridad y notas de alerta. El grupo de empresas Rohde & Schwarz está siempre a su disposición en caso de que tengan preguntas referentes a estas informaciones de seguridad.

Instrucciones de seguridad elementales











Además queda en la responsabilidad del usuario utilizar el producto en la forma debida. Este producto está destinado exclusivamente al uso en la industria y el laboratorio o, si ha sido expresamente autorizado, para aplicaciones de campo y de ninguna manera deberá ser utilizado de modo que alguna persona/cosa pueda sufrir daño. El uso del producto fuera de sus fines definidos o sin tener en cuenta las instrucciones del fabricante queda en la responsabilidad del usuario. El fabricante no se hace en ninguna forma responsable de consecuencias a causa del mal uso del producto.

Se parte del uso correcto del producto para los fines definidos si el producto es utilizado conforme a las indicaciones de la correspondiente documentación del producto y dentro del margen de rendimiento definido (ver hoja de datos, documentación, informaciones de seguridad que siguen). El uso del producto hace necesarios conocimientos técnicos y ciertos conocimientos del idioma inglés. Por eso se debe tener en cuenta que el producto solo pueda ser operado por personal especializado o personas instruidas en profundidad con las capacidades correspondientes. Si fuera necesaria indumentaria de seguridad para el uso de productos de Rohde & Schwarz, encontraría la información debida en la documentación del producto en el capítulo correspondiente. Guarde bien las informaciones de seguridad elementales, así como la documentación del producto, y entréguelas a usuarios posteriores.







Tener en cuenta las informaciones de seguridad sirve para evitar en lo posible lesiones o daños por peligros de toda clase. Por eso es imprescindible leer detalladamente y comprender por completo las siguientes informaciones de seguridad antes de usar el producto, y respetarlas durante el uso del producto. Deberán tenerse en cuenta todas las demás informaciones de seguridad, como p. ej. las referentes a la protección de personas, que encontrarán en el capítulo correspondiente de la documentación del producto y que también son de obligado cumplimiento. En las presentes informaciones de seguridad se recogen todos los objetos que distribuye el grupo de empresas Rohde & Schwarz bajo la denominación de "producto", entre ellos también aparatos, instalaciones así como toda clase de accesorios. Los datos específicos del producto figuran en la hoja de datos y en la documentación del producto.

Señalización de seguridad de los productos

Las siguientes señales de seguridad se utilizan en los productos para advertir sobre riesgos y peligros.

| Símbolo | Significado | Símbolo | Significado |
|---|---|---|--|
|  | Aviso: punto de peligro general Observar la documentación del producto |  | Tensión de alimentación de PUESTA EN MARCHA / PARADA |
|  | Atención en el manejo de dispositivos de peso elevado |  | Indicación de estado de espera (standby) |
|  | Peligro de choque eléctrico |  | Corriente continua (DC) |
|  | Advertencia: superficie caliente |  | Corriente alterna (AC) |
|  | Conexión a conductor de protección |  | Corriente continua / Corriente alterna (DC/AC) |

Instrucciones de seguridad elementales

| Símbolo | Significado | Símbolo | Significado |
|---|---|---|---|
|  | Conexión a tierra |  | El aparato está protegido en su totalidad por un aislamiento doble (reforzado) |
|  | Conexión a masa |  | Distintivo de la UE para baterías y acumuladores Más información en la sección "Eliminación/protección del medio ambiente", punto 1. |
|  | Aviso: Cuidado en el manejo de dispositivos sensibles a la electrostática (ESD) |  | Distintivo de la UE para la eliminación por separado de dispositivos eléctricos y electrónicos Más información en la sección "Eliminación/protección del medio ambiente", punto 2. |
|  | Advertencia: rayo láser Más información en la sección "Funcionamiento", punto 7. | | |

Palabras de señal y su significado

En la documentación del producto se utilizan las siguientes palabras de señal con el fin de advertir contra riesgos y peligros.



Indica una situación de peligro que, si no se evita, causa lesiones graves o incluso la muerte.



Indica una situación de peligro que, si no se evita, puede causar lesiones graves o incluso la muerte.



Indica una situación de peligro que, si no se evita, puede causar lesiones leves o moderadas.



Indica información que se considera importante, pero no en relación con situaciones de peligro; p. ej., avisos sobre posibles daños materiales.

En la documentación del producto se emplea de forma sinónima el término CUIDADO.

Las palabras de señal corresponden a la definición habitual para aplicaciones civiles en el área económica europea. Pueden existir definiciones diferentes a esta definición en otras áreas económicas o en aplicaciones militares. Por eso se deberá tener en cuenta que las palabras de señal aquí descritas sean utilizadas siempre solamente en combinación con la correspondiente documentación del producto y solamente en combinación con el producto correspondiente. La utilización de las palabras de señal en combinación con productos o documentaciones que no les correspondan puede llevar a interpretaciones equivocadas y tener por consecuencia daños en personas u objetos.

Instrucciones de seguridad elementales

Estados operativos y posiciones de funcionamiento

El producto solamente debe ser utilizado según lo indicado por el fabricante respecto a los estados operativos y posiciones de funcionamiento sin que se obstruya la ventilación. Si no se siguen las indicaciones del fabricante, pueden producirse choques eléctricos, incendios y/o lesiones graves con posible consecuencia de muerte. En todos los trabajos deberán ser tenidas en cuenta las normas nacionales y locales de seguridad del trabajo y de prevención de accidentes.

1. Si no se convino de otra manera, es para los productos Rohde & Schwarz válido lo que sigue: como posición de funcionamiento se define por principio la posición con el suelo de la caja para abajo, modo de protección IP 2X, uso solamente en estancias interiores, utilización hasta 2000 m sobre el nivel del mar, transporte hasta 4500 m sobre el nivel del mar. Se aplicará una tolerancia de $\pm 10\%$ sobre el voltaje nominal y de $\pm 5\%$ sobre la frecuencia nominal. Categoría de sobrecarga eléctrica 2, índice de suciedad 2.
2. No sitúe el producto encima de superficies, vehículos, estantes o mesas, que por sus características de peso o de estabilidad no sean aptos para él. Siga siempre las instrucciones de instalación del fabricante cuando instale y asegure el producto en objetos o estructuras (p. ej. paredes y estantes). Si se realiza la instalación de modo distinto al indicado en la documentación del producto, se pueden causar lesiones o, en determinadas circunstancias, incluso la muerte.
3. No ponga el producto sobre aparatos que generen calor (p. ej. radiadores o calefactores). La temperatura ambiente no debe superar la temperatura máxima especificada en la documentación del producto o en la hoja de datos. En caso de sobrecalentamiento del producto, pueden producirse choques eléctricos, incendios y/o lesiones graves con posible consecuencia de muerte.

Seguridad eléctrica

Si no se siguen (o se siguen de modo insuficiente) las indicaciones del fabricante en cuanto a seguridad eléctrica, pueden producirse choques eléctricos, incendios y/o lesiones graves con posible consecuencia de muerte.

1. Antes de la puesta en marcha del producto se deberá comprobar siempre que la tensión preseleccionada en el producto coincida con la de la red de alimentación eléctrica. Si es necesario modificar el ajuste de tensión, también se deberán cambiar en caso dado los fusibles correspondientes del producto.
2. Los productos de la clase de protección I con alimentación móvil y enchufe individual solamente podrán enchufarse a tomas de corriente con contacto de seguridad y con conductor de protección conectado.
3. Queda prohibida la interrupción intencionada del conductor de protección, tanto en la toma de corriente como en el mismo producto. La interrupción puede tener como consecuencia el riesgo de que el producto sea fuente de choques eléctricos. Si se utilizan cables alargadores o regletas de enchufe, deberá garantizarse la realización de un examen regular de los mismos en cuanto a su estado técnico de seguridad.
4. Si el producto no está equipado con un interruptor para desconectarlo de la red, o bien si el interruptor existente no resulta apropiado para la desconexión de la red, el enchufe del cable de conexión se deberá considerar como un dispositivo de desconexión. El dispositivo de desconexión se debe poder alcanzar fácilmente y debe estar siempre bien accesible. Si, p. ej., el enchufe de conexión a la red es el dispositivo de desconexión, la longitud del cable de conexión no debe superar 3 m).
Los interruptores selectores o electrónicos no son aptos para el corte de la red eléctrica. Si se

Instrucciones de seguridad elementales

integran productos sin interruptor en bastidores o instalaciones, se deberá colocar el interruptor en el nivel de la instalación.

5. No utilice nunca el producto si está dañado el cable de conexión a red. Compruebe regularmente el correcto estado de los cables de conexión a red. Asegúrese, mediante las medidas de protección y de instalación adecuadas, de que el cable de conexión a red no pueda ser dañado o de que nadie pueda ser dañado por él, p. ej. al tropezar o por un choque eléctrico.
6. Solamente está permitido el funcionamiento en redes de alimentación TN/TT aseguradas con fusibles de 16 A como máximo (utilización de fusibles de mayor amperaje solo previa consulta con el grupo de empresas Rohde & Schwarz).
7. Nunca conecte el enchufe en tomas de corriente sucias o llenas de polvo. Introduzca el enchufe por completo y fuertemente en la toma de corriente. La no observación de estas medidas puede provocar chispas, fuego y/o lesiones.
8. No sobrecargue las tomas de corriente, los cables alargadores o las regletas de enchufe ya que esto podría causar fuego o choques eléctricos.
9. En las mediciones en circuitos de corriente con una tensión $U_{\text{eff}} > 30 \text{ V}$ se deberán tomar las medidas apropiadas para impedir cualquier peligro (p. ej. medios de medición adecuados, seguros, limitación de tensión, corte protector, aislamiento etc.).
10. Para la conexión con dispositivos informáticos como un PC o un ordenador industrial, debe comprobarse que éstos cumplan los estándares IEC60950-1/EN60950-1 o IEC61010-1/EN 61010-1 válidos en cada caso.
11. A menos que esté permitido expresamente, no retire nunca la tapa ni componentes de la carcasa mientras el producto esté en servicio. Esto pone a descubierto los cables y componentes eléctricos y puede causar lesiones, fuego o daños en el producto.
12. Si un producto se instala en un lugar fijo, se deberá primero conectar el conductor de protección fijo con el conductor de protección del producto antes de hacer cualquier otra conexión. La instalación y la conexión deberán ser efectuadas por un electricista especializado.
13. En el caso de dispositivos fijos que no estén provistos de fusibles, interruptor automático ni otros mecanismos de seguridad similares, el circuito de alimentación debe estar protegido de modo que todas las personas que puedan acceder al producto, así como el producto mismo, estén a salvo de posibles daños.
14. Todo producto debe estar protegido contra sobretensión (debida p. ej. a una caída del rayo) mediante los correspondientes sistemas de protección. Si no, el personal que lo utilice quedará expuesto al peligro de choque eléctrico.
15. No debe introducirse en los orificios de la caja del aparato ningún objeto que no esté destinado a ello. Esto puede producir cortocircuitos en el producto y/o puede causar choques eléctricos, fuego o lesiones.
16. Salvo indicación contraria, los productos no están impermeabilizados (ver también el capítulo "Estados operativos y posiciones de funcionamiento", punto 1). Por eso es necesario tomar las medidas necesarias para evitar la entrada de líquidos. En caso contrario, existe peligro de choque eléctrico para el usuario o de daños en el producto, que también pueden redundar en peligro para las personas.

Instrucciones de seguridad elementales

17. No utilice el producto en condiciones en las que pueda producirse o ya se hayan producido condensaciones sobre el producto o en el interior de éste, como p. ej. al desplazarlo de un lugar frío a otro caliente. La entrada de agua aumenta el riesgo de choque eléctrico.
18. Antes de la limpieza, desconecte por completo el producto de la alimentación de tensión (p. ej. red de alimentación o batería). Realice la limpieza de los aparatos con un paño suave, que no se deshilache. No utilice bajo ningún concepto productos de limpieza químicos como alcohol, acetona o diluyentes para lacas nitrocelulósicas.

Funcionamiento

1. El uso del producto requiere instrucciones especiales y una alta concentración durante el manejo. Debe asegurarse que las personas que manejen el producto estén a la altura de los requerimientos necesarios en cuanto a aptitudes físicas, psíquicas y emocionales, ya que de otra manera no se pueden excluir lesiones o daños de objetos. El empresario u operador es responsable de seleccionar el personal usuario apto para el manejo del producto.
2. Antes de desplazar o transportar el producto, lea y tenga en cuenta el capítulo "Transporte".
3. Como con todo producto de fabricación industrial no puede quedar excluida en general la posibilidad de que se produzcan alergias provocadas por algunos materiales empleados —los llamados alérgenos (p. ej. el níquel)—. Si durante el manejo de productos Rohde & Schwarz se producen reacciones alérgicas, como p. ej. irritaciones cutáneas, estornudos continuos, enrojecimiento de la conjuntiva o dificultades respiratorias, debe avisarse inmediatamente a un médico para investigar las causas y evitar cualquier molestia o daño a la salud.
4. Antes de la manipulación mecánica y/o térmica o el desmontaje del producto, debe tenerse en cuenta imprescindiblemente el capítulo "Eliminación/protección del medio ambiente", punto 1.
5. Ciertos productos, como p. ej. las instalaciones de radiocomunicación RF, pueden a causa de su función natural, emitir una radiación electromagnética aumentada. Deben tomarse todas las medidas necesarias para la protección de las mujeres embarazadas. También las personas con marcapasos pueden correr peligro a causa de la radiación electromagnética. El empresario/operador tiene la obligación de evaluar y señalar las áreas de trabajo en las que exista un riesgo elevado de exposición a radiaciones.
6. Tenga en cuenta que en caso de incendio pueden desprenderse del producto sustancias tóxicas (gases, líquidos etc.) que pueden generar daños a la salud. Por eso, en caso de incendio deben usarse medidas adecuadas, como p. ej. máscaras antigás e indumentaria de protección.
7. Los productos con láser están provistos de indicaciones de advertencia normalizadas en función de la clase de láser del que se trate. Los rayos láser pueden provocar daños de tipo biológico a causa de las propiedades de su radiación y debido a su concentración extrema de potencia electromagnética. En caso de que un producto Rohde & Schwarz contenga un producto láser (p. ej. un lector de CD/DVD), no debe usarse ninguna otra configuración o función aparte de las descritas en la documentación del producto, a fin de evitar lesiones (p. ej. debidas a irradiación láser).
8. Clases de compatibilidad electromagnética (conforme a EN 55011 / CISPR 11; y en analogía con EN 55022 / CISPR 22, EN 55032 / CISPR 32)
 - Aparato de clase A:
Aparato adecuado para su uso en todos los entornos excepto en los residenciales y en aquellos conectados directamente a una red de distribución de baja tensión que suministra corriente a edificios residenciales.
Nota: Los aparatos de clase A están destinados al uso en entornos industriales. Estos aparatos

Instrucciones de seguridad elementales

pueden causar perturbaciones radioeléctricas en entornos residenciales debido a posibles perturbaciones guiadas o radiadas. En este caso, se le podrá solicitar al operador que tome las medidas adecuadas para eliminar estas perturbaciones.

– Aparato de clase B:

Aparato adecuado para su uso en entornos residenciales, así como en aquellos conectados directamente a una red de distribución de baja tensión que suministra corriente a edificios residenciales.

Reparación y mantenimiento

1. El producto solamente debe ser abierto por personal especializado con autorización para ello. Antes de manipular el producto o abrirlo, es obligatorio desconectarlo de la tensión de alimentación, para evitar toda posibilidad de choque eléctrico.
2. El ajuste, el cambio de partes, el mantenimiento y la reparación deberán ser efectuadas solamente por electricistas autorizados por Rohde & Schwarz. Si se reponen partes con importancia para los aspectos de seguridad (p. ej. el enchufe, los transformadores o los fusibles), solamente podrán ser sustituidos por partes originales. Después de cada cambio de partes relevantes para la seguridad deberá realizarse un control de seguridad (control a primera vista, control del conductor de protección, medición de resistencia de aislamiento, medición de la corriente de fuga, control de funcionamiento). Con esto queda garantizada la seguridad del producto.

Baterías y acumuladores o celdas

Si no se siguen (o se siguen de modo insuficiente) las indicaciones en cuanto a las baterías y acumuladores o celdas, pueden producirse explosiones, incendios y/o lesiones graves con posible consecuencia de muerte. El manejo de baterías y acumuladores con electrolitos alcalinos (p. ej. celdas de litio) debe seguir el estándar EN 62133.

1. No deben desmontarse, abrirse ni triturarse las celdas.
2. Las celdas o baterías no deben someterse a calor ni fuego. Debe evitarse el almacenamiento a la luz directa del sol. Las celdas y baterías deben mantenerse limpias y secas. Limpiar las conexiones sucias con un paño seco y limpio.
3. Las celdas o baterías no deben cortocircuitarse. Es peligroso almacenar las celdas o baterías en estuches o cajones en cuyo interior puedan cortocircuitarse por contacto recíproco o por contacto con otros materiales conductores. No deben extraerse las celdas o baterías de sus embalajes originales hasta el momento en que vayan a utilizarse.
4. Las celdas o baterías no deben someterse a impactos mecánicos fuertes indebidos.
5. En caso de falta de estanqueidad de una celda, el líquido vertido no debe entrar en contacto con la piel ni los ojos. Si se produce contacto, lavar con agua abundante la zona afectada y avisar a un médico.
6. En caso de cambio o recarga inadecuados, las celdas o baterías que contienen electrolitos alcalinos (p. ej. las celdas de litio) pueden explotar. Para garantizar la seguridad del producto, las celdas o baterías solo deben ser sustituidas por el tipo Rohde & Schwarz correspondiente (ver lista de recambios).
7. Las baterías y celdas deben reciclarse y no deben tirarse a la basura doméstica. Las baterías o acumuladores que contienen plomo, mercurio o cadmio deben tratarse como residuos especiales. Respete en esta relación las normas nacionales de eliminación y reciclaje.

Instrucciones de seguridad elementales

8. En caso de devolver baterías de litio a las filiales de Rohde & Schwarz, debe cumplirse las normativas sobre los modos de transporte (IATA-DGR, código IMDG, ADR, RID).

Transporte

1. El producto puede tener un peso elevado. Por eso es necesario desplazarlo o transportarlo con precaución y, si es necesario, usando un sistema de elevación adecuado (p. ej. una carretilla elevadora), a fin de evitar lesiones en la espalda u otros daños personales.
2. Las asas instaladas en los productos sirven solamente de ayuda para el transporte del producto por personas. Por eso no está permitido utilizar las asas para la sujeción en o sobre medios de transporte como p. ej. grúas, carretillas elevadoras de horquilla, carros etc. Es responsabilidad suya fijar los productos de manera segura a los medios de transporte o elevación. Para evitar daños personales o daños en el producto, siga las instrucciones de seguridad del fabricante del medio de transporte o elevación utilizado.
3. Si se utiliza el producto dentro de un vehículo, recae de manera exclusiva en el conductor la responsabilidad de conducir el vehículo de manera segura y adecuada. El fabricante no asumirá ninguna responsabilidad por accidentes o colisiones. No utilice nunca el producto dentro de un vehículo en movimiento si esto pudiera distraer al conductor. Asegure el producto dentro del vehículo debidamente para evitar, en caso de un accidente, lesiones u otra clase de daños.

Eliminación/protección del medio ambiente

1. Los dispositivos marcados contienen una batería o un acumulador que no se debe desechar con los residuos domésticos sin clasificar, sino que debe ser recogido por separado. La eliminación se debe efectuar exclusivamente a través de un punto de recogida apropiado o del servicio de atención al cliente de Rohde & Schwarz.
2. Los dispositivos eléctricos usados no se deben desechar con los residuos domésticos sin clasificar, sino que deben ser recogidos por separado.
Rohde & Schwarz GmbH & Co.KG ha elaborado un concepto de eliminación de residuos y asume plenamente los deberes de recogida y eliminación para los fabricantes dentro de la UE. Para desechar el producto de manera respetuosa con el medio ambiente, diríjase a su servicio de atención al cliente de Rohde & Schwarz.
3. Si se trabaja de manera mecánica y/o térmica cualquier producto o componente más allá del funcionamiento previsto, pueden liberarse sustancias peligrosas (polvos con contenido de metales pesados como p. ej. plomo, berilio o níquel). Por eso el producto solo debe ser desmontado por personal especializado con formación adecuada. Un desmontaje inadecuado puede ocasionar daños para la salud. Se deben tener en cuenta las directivas nacionales referentes a la eliminación de residuos.
4. En caso de que durante el trato del producto se formen sustancias peligrosas o combustibles que deban tratarse como residuos especiales (p. ej. refrigerantes o aceites de motor con intervalos de cambio definidos), deben tenerse en cuenta las indicaciones de seguridad del fabricante de dichas sustancias y las normas regionales de eliminación de residuos. Tenga en cuenta también en caso necesario las indicaciones de seguridad especiales contenidas en la documentación del producto. La eliminación incorrecta de sustancias peligrosas o combustibles puede causar daños a la salud o daños al medio ambiente.

Se puede encontrar más información sobre la protección del medio ambiente en la página web de Rohde & Schwarz.

Grundlegende Sicherheitshinweise

Lesen und beachten Sie unbedingt die nachfolgenden Anweisungen und Sicherheitshinweise!

Alle Werke und Standorte der Rohde & Schwarz Firmengruppe sind ständig bemüht, den Sicherheitsstandard unserer Produkte auf dem aktuellsten Stand zu halten und unseren Kunden ein höchstmögliches Maß an Sicherheit zu bieten. Unsere Produkte und die dafür erforderlichen Zusatzgeräte werden entsprechend der jeweils gültigen Sicherheitsvorschriften gebaut und geprüft. Die Einhaltung dieser Bestimmungen wird durch unser Qualitätssicherungssystem laufend überwacht. Das vorliegende Produkt ist gemäß beiliegender EU-Konformitätsbescheinigung gebaut und geprüft und hat das Werk in sicherheitstechnisch einwandfreiem Zustand verlassen. Um diesen Zustand zu erhalten und einen gefahrlosen Betrieb sicherzustellen, muss der Benutzer alle Hinweise, Warnhinweise und Warnvermerke beachten. Bei allen Fragen bezüglich vorliegender Sicherheitshinweise steht Ihnen die Rohde & Schwarz Firmengruppe jederzeit gerne zur Verfügung.













Darüber hinaus liegt es in der Verantwortung des Benutzers, das Produkt in geeigneter Weise zu verwenden. Das Produkt ist ausschließlich für den Betrieb in Industrie und Labor bzw., wenn ausdrücklich zugelassen, auch für den Feldeinsatz bestimmt und darf in keiner Weise so verwendet werden, dass einer Person/Sache Schaden zugefügt werden kann. Die Benutzung des Produkts außerhalb des bestimmungsgemäßen Gebrauchs oder unter Missachtung der Anweisungen des Herstellers liegt in der Verantwortung des Benutzers. Der Hersteller übernimmt keine Verantwortung für die Zweckentfremdung des Produkts.

Die bestimmungsgemäße Verwendung des Produkts wird angenommen, wenn das Produkt nach den Vorgaben der zugehörigen Produktdokumentation innerhalb seiner Leistungsgrenzen verwendet wird (siehe Datenblatt, Dokumentation, nachfolgende Sicherheitshinweise). Die Benutzung des Produkts erfordert Fachkenntnisse und zum Teil englische Sprachkenntnisse. Es ist daher zu beachten, dass das Produkt ausschließlich von Fachkräften oder sorgfältig eingewiesenen Personen mit entsprechenden Fähigkeiten bedient werden darf. Sollte für die Verwendung von Rohde & Schwarz-Produkten persönliche Schutzausrüstung erforderlich sein, wird in der Produktdokumentation an entsprechender Stelle darauf hingewiesen. Bewahren Sie die grundlegenden Sicherheitshinweise und die Produktdokumentation gut auf und geben Sie diese an weitere Benutzer des Produkts weiter.

Die Einhaltung der Sicherheitshinweise dient dazu, Verletzungen oder Schäden durch Gefahren aller Art auszuschließen. Hierzu ist es erforderlich, dass die nachstehenden Sicherheitshinweise vor der Benutzung des Produkts sorgfältig gelesen und verstanden sowie bei der Benutzung des Produkts beachtet werden. Sämtliche weitere Sicherheitshinweise wie z.B. zum Personenschutz, die an entsprechender Stelle der Produktdokumentation stehen, sind ebenfalls unbedingt zu beachten. In den vorliegenden Sicherheitshinweisen sind sämtliche von der Rohde & Schwarz Firmengruppe vertriebenen Waren unter dem Begriff „Produkt“ zusammengefasst, hierzu zählen u. a. Geräte, Anlagen sowie sämtliches Zubehör.

Grundlegende Sicherheitshinweise

Symbole und Sicherheitskennzeichnungen

| Symbol | Bedeutung | Symbol | Bedeutung |
|---|---|---|---|
|  | Achtung, allgemeine Gefahrenstelle Produktdokumentation beachten | ○ | EIN-/AUS (Versorgung) |
|  | Vorsicht beim Umgang mit Geräten mit hohem Gewicht | ⏻ | Stand-by-Anzeige |
|  | Gefahr vor elektrischem Schlag | ≡ | Gleichstrom (DC) |
|  | Warnung vor heißer Oberfläche | ~ | Wechselstrom (AC) |
|  | Schutzleiteranschluss | ⎓ | Gleichstrom/Wechselstrom (DC/AC) |
|  | Erdungsanschluss |  | Gerät entspricht den Sicherheitsanforderungen an die Schutzklasse II (Gerät durchgehend durch doppelte / verstärkte Isolierung geschützt). |
|  | Masseanschluss des Gestells oder Gehäuses |  | EU - Kennzeichnung für Batterien und Akkumulatoren. Das Gerät enthält eine Batterie bzw. einen Akkumulator. Diese dürfen nicht über unsortierten Siedlungsabfall entsorgt werden, sondern sollten getrennt gesammelt werden. Weitere Informationen siehe Seite 7. |
|  | Achtung beim Umgang mit elektrostatisch gefährdeten Bauelementen |  | EU - Kennzeichnung für die getrennte Sammlung von Elektro- und Elektronikgeräten. Elektroaltgeräte dürfen nicht über unsortierten Siedlungsabfall entsorgt werden, sondern müssen getrennt gesammelt werden. Weitere Informationen siehe Seite 7. |
|  | Warnung vor Laserstrahl Produkte mit Laser sind je nach ihrer Laser-Klasse mit genormten Warnhinweisen versehen. Laser können aufgrund der Eigenschaften ihrer Strahlung und aufgrund ihrer extrem konzentrierten elektromagnetischen Leistung biologische Schäden verursachen. Für zusätzliche Informationen siehe Kapitel „Betrieb“ Punkt 7. | | |

Grundlegende Sicherheitshinweise

Signalworte und ihre Bedeutung

Die folgenden Signalworte werden in der Produktdokumentation verwendet, um vor Risiken und Gefahren zu warnen.



kennzeichnet eine unmittelbare Gefährdung mit hohem Risiko, die Tod oder schwere Körperverletzung zur Folge haben wird, wenn sie nicht vermieden wird.



kennzeichnet eine mögliche Gefährdung mit mittlerem Risiko, die Tod oder (schwere) Körperverletzung zur Folge haben kann, wenn sie nicht vermieden wird.



kennzeichnet eine Gefährdung mit geringem Risiko, die leichte oder mittlere Körperverletzungen zur Folge haben könnte, wenn sie nicht vermieden wird.



weist auf die Möglichkeit einer Fehlbedienung hin, bei der das Produkt Schaden nehmen kann.

Diese Signalworte entsprechen der im europäischen Wirtschaftsraum üblichen Definition für zivile Anwendungen. Neben dieser Definition können in anderen Wirtschaftsräumen oder bei militärischen Anwendungen abweichende Definitionen existieren. Es ist daher darauf zu achten, dass die hier beschriebenen Signalworte stets nur in Verbindung mit der zugehörigen Produktdokumentation und nur in Verbindung mit dem zugehörigen Produkt verwendet werden. Die Verwendung von Signalworten in Zusammenhang mit nicht zugehörigen Produkten oder nicht zugehörigen Dokumentationen kann zu Fehlinterpretationen führen und damit zu Personen- oder Sachschäden führen.

Betriebszustände und Betriebslagen

Das Produkt darf nur in den vom Hersteller angegebenen Betriebszuständen und Betriebslagen ohne Behinderung der Belüftung betrieben werden. Werden die Herstellerangaben nicht eingehalten, kann dies elektrischen Schlag, Brand und/oder schwere Verletzungen von Personen, unter Umständen mit Todesfolge, verursachen. Bei allen Arbeiten sind die örtlichen bzw. landesspezifischen Sicherheits- und Unfallverhütungsvorschriften zu beachten.

1. Sofern nicht anders vereinbart, gilt für R&S-Produkte folgendes:
als vorgeschriebene Betriebslage grundsätzlich Gehäuseboden unten, IP-Schutzart 2X, Verschmutzungsgrad 2, Überspannungskategorie 2, nur in Innenräumen verwenden, Betrieb bis 2000 m ü. NN, Transport bis 4500 m ü. NN, für die Nennspannung gilt eine Toleranz von $\pm 10\%$, für die Nennfrequenz eine Toleranz von $\pm 5\%$.
2. Stellen Sie das Produkt nicht auf Oberflächen, Fahrzeuge, Ablagen oder Tische, die aus Gewichts- oder Stabilitätsgründen nicht dafür geeignet sind. Folgen Sie bei Aufbau und Befestigung des Produkts an Gegenständen oder Strukturen (z.B. Wände und Regale) immer den Installationshinweisen des Herstellers. Bei Installation abweichend von der Produktdokumentation können Personen verletzt, unter Umständen sogar getötet werden.
3. Stellen Sie das Produkt nicht auf hitzeerzeugende Gerätschaften (z.B. Radiatoren und Heizlüfter). Die Umgebungstemperatur darf nicht die in der Produktdokumentation oder im Datenblatt spezifizierte Maximaltemperatur überschreiten. Eine Überhitzung des Produkts kann elektrischen Schlag, Brand und/oder schwere Verletzungen von Personen, unter Umständen mit Todesfolge, verursachen.

Grundlegende Sicherheitshinweise

Elektrische Sicherheit

Werden die Hinweise zur elektrischen Sicherheit nicht oder unzureichend beachtet, kann dies elektrischen Schlag, Brand und/oder schwere Verletzungen von Personen, unter Umständen mit Todesfolge, verursachen.

1. Vor jedem Einschalten des Produkts ist sicherzustellen, dass die am Produkt eingestellte Nennspannung und die Netzennspannung des Versorgungsnetzes übereinstimmen. Ist es erforderlich, die Spannungseinstellung zu ändern, so muss ggf. auch die dazu gehörige Netzsicherung des Produkts geändert werden.
2. Bei Produkten der Schutzklasse I mit beweglicher Netzzuleitung und Gerätesteckvorrichtung ist der Betrieb nur an Steckdosen mit Schutzkontakt und angeschlossenem Schutzleiter zulässig.
3. Jegliche absichtliche Unterbrechung des Schutzleiters, sowohl in der Zuleitung als auch am Produkt selbst, ist unzulässig. Es kann dazu führen, dass von dem Produkt die Gefahr eines elektrischen Schlags ausgeht. Bei Verwendung von Verlängerungsleitungen oder Steckdosenleisten ist sicherzustellen, dass diese regelmäßig auf ihren sicherheitstechnischen Zustand überprüft werden.
4. Sofern das Produkt nicht mit einem Netzschalter zur Netztrennung ausgerüstet ist, beziehungsweise der vorhandene Netzschalter zu Netztrennung nicht geeignet ist, so ist der Stecker des Anschlusskabels als Trennvorrichtung anzusehen.
Die Trennvorrichtung muss jederzeit leicht erreichbar und gut zugänglich sein. Ist z.B. der Netzstecker die Trennvorrichtung, darf die Länge des Anschlusskabels 3 m nicht überschreiten.
Funktionsschalter oder elektronische Schalter sind zur Netztrennung nicht geeignet. Werden Produkte ohne Netzschalter in Gestelle oder Anlagen integriert, so ist die Trennvorrichtung auf Anlagenebene zu verlagern.
5. Benutzen Sie das Produkt niemals, wenn das Netzkabel beschädigt ist. Überprüfen Sie regelmäßig den einwandfreien Zustand der Netzkabel. Stellen Sie durch geeignete Schutzmaßnahmen und Verlegearten sicher, dass das Netzkabel nicht beschädigt werden kann und niemand z.B. durch Stolperfallen oder elektrischen Schlag zu Schaden kommen kann.
6. Der Betrieb ist nur an TN/TT Versorgungsnetzen gestattet, die mit höchstens 16 A abgesichert sind (höhere Absicherung nur nach Rücksprache mit der Rohde & Schwarz Firmengruppe).
7. Stecken Sie den Stecker nicht in verstaubte oder verschmutzte Steckdosen/-buchsen. Stecken Sie die Steckverbindung/-vorrichtung fest und vollständig in die dafür vorgesehenen Steckdosen/-buchsen. Missachtung dieser Maßnahmen kann zu Funken, Feuer und/oder Verletzungen führen.
8. Überlasten Sie keine Steckdosen, Verlängerungskabel oder Steckdosenleisten, dies kann Feuer oder elektrische Schläge verursachen.
9. Bei Messungen in Stromkreisen mit Spannungen $U_{\text{eff}} > 30 \text{ V}$ ist mit geeigneten Maßnahmen Vorsorge zu treffen, dass jegliche Gefährdung ausgeschlossen wird (z.B. geeignete Messmittel, Absicherung, Strombegrenzung, Schutztrennung, Isolierung usw.).
10. Bei Verbindungen mit informationstechnischen Geräten, z.B. PC oder Industrierechner, ist darauf zu achten, dass diese der jeweils gültigen IEC 60950-1 / EN 60950-1 oder IEC 61010-1 / EN 61010-1 entsprechen.
11. Sofern nicht ausdrücklich erlaubt, darf der Deckel oder ein Teil des Gehäuses niemals entfernt werden, wenn das Produkt betrieben wird. Dies macht elektrische Leitungen und Komponenten zugänglich und kann zu Verletzungen, Feuer oder Schaden am Produkt führen.

Grundlegende Sicherheitshinweise

12. Wird ein Produkt ortsfest angeschlossen, ist die Verbindung zwischen dem Schutzleiteranschluss vor Ort und dem Geräteschutzleiter vor jeglicher anderer Verbindung herzustellen. Aufstellung und Anschluss darf nur durch eine Elektrofachkraft erfolgen.
13. Bei ortsfesten Geräten ohne eingebaute Sicherung, Selbstschalter oder ähnliche Schutzeinrichtung muss der Versorgungskreis so abgesichert sein, dass alle Personen, die Zugang zum Produkt haben, sowie das Produkt selbst ausreichend vor Schäden geschützt sind.
14. Jedes Produkt muss durch geeigneten Überspannungsschutz vor Überspannung (z.B. durch Blitzschlag) geschützt werden. Andernfalls ist das bedienende Personal durch elektrischen Schlag gefährdet.
15. Gegenstände, die nicht dafür vorgesehen sind, dürfen nicht in die Öffnungen des Gehäuses eingebracht werden. Dies kann Kurzschlüsse im Produkt und/oder elektrische Schläge, Feuer oder Verletzungen verursachen.
16. Sofern nicht anders spezifiziert, sind Produkte nicht gegen das Eindringen von Flüssigkeiten geschützt, siehe auch Abschnitt "Betriebszustände und Betriebslagen", Punkt 1. Daher müssen die Geräte vor Eindringen von Flüssigkeiten geschützt werden. Wird dies nicht beachtet, besteht Gefahr durch elektrischen Schlag für den Benutzer oder Beschädigung des Produkts, was ebenfalls zur Gefährdung von Personen führen kann.
17. Benutzen Sie das Produkt nicht unter Bedingungen, bei denen Kondensation in oder am Produkt stattfinden könnte oder ggf. bereits stattgefunden hat, z.B. wenn das Produkt von kalter in warme Umgebung bewegt wurde. Das Eindringen von Wasser erhöht das Risiko eines elektrischen Schlages.
18. Trennen Sie das Produkt vor der Reinigung komplett von der Energieversorgung (z.B. speisendes Netz oder Batterie). Nehmen Sie bei Geräten die Reinigung mit einem weichen, nicht fasernden Staublappen vor. Verwenden Sie keinesfalls chemische Reinigungsmittel wie z.B. Alkohol, Aceton, Nitroverdünnung.

Betrieb

1. Die Benutzung des Produkts erfordert spezielle Einweisung und hohe Konzentration während der Benutzung. Es muss sichergestellt sein, dass Personen, die das Produkt bedienen, bezüglich ihrer körperlichen, geistigen und seelischen Verfassung den Anforderungen gewachsen sind, da andernfalls Verletzungen oder Sachschäden nicht auszuschließen sind. Es liegt in der Verantwortung des Arbeitsgebers/Betreibers, geeignetes Personal für die Benutzung des Produkts auszuwählen.
2. Bevor Sie das Produkt bewegen oder transportieren, lesen und beachten Sie den Abschnitt "Transport".
3. Wie bei allen industriell gefertigten Gütern kann die Verwendung von Stoffen, die Allergien hervorrufen - so genannte Allergene (z.B. Nickel) - nicht generell ausgeschlossen werden. Sollten beim Umgang mit R&S-Produkten allergische Reaktionen, z.B. Hautausschlag, häufiges Niesen, Bindehautrötung oder Atembeschwerden auftreten, ist umgehend ein Arzt aufzusuchen, um die Ursachen zu klären und Gesundheitsschäden bzw. -belastungen zu vermeiden.
4. Vor der mechanischen und/oder thermischen Bearbeitung oder Zerlegung des Produkts beachten Sie unbedingt Abschnitt "Entsorgung", Punkt 1.

Grundlegende Sicherheitshinweise

- Bei bestimmten Produkten, z.B. HF-Funkanlagen, können funktionsbedingt erhöhte elektromagnetische Strahlungen auftreten. Unter Berücksichtigung der erhöhten Schutzwürdigkeit des ungeborenen Lebens müssen Schwangere durch geeignete Maßnahmen geschützt werden. Auch Träger von Herzschrittmachern können durch elektromagnetische Strahlungen gefährdet sein. Der Arbeitgeber/Betreiber ist verpflichtet, Arbeitsstätten, bei denen ein besonderes Risiko einer Strahlenexposition besteht, zu beurteilen und zu kennzeichnen und mögliche Gefahren abzuwenden.
- Im Falle eines Brandes entweichen ggf. giftige Stoffe (Gase, Flüssigkeiten etc.) aus dem Produkt, die Gesundheitsschäden verursachen können. Daher sind im Brandfall geeignete Maßnahmen wie z.B. Atemschutzmasken und Schutzkleidung zu verwenden.
- Falls ein Laser-Produkt in ein R&S-Produkt integriert ist (z.B. CD/DVD-Laufwerk), dürfen keine anderen Einstellungen oder Funktionen verwendet werden, als in der Produktdokumentation beschrieben, um Personenschäden zu vermeiden (z.B. durch Laserstrahl).
- EMV Klassen (nach EN 55011 / CISPR 11; sinngemäß EN 55022 / CISPR 22, EN 55032 / CISPR 32)

Gerät der Klasse A:

Ein Gerät, das sich für den Gebrauch in allen anderen Bereichen außer dem Wohnbereich und solchen Bereichen eignet, die direkt an ein Niederspannungs-Versorgungsnetz angeschlossen sind, das Wohngebäude versorgt.

Hinweis: Diese Einrichtung kann wegen möglicher auftretender leitungsgebundener als auch gestrahlter Störgrößen im Wohnbereich Funkstörungen verursachen. In diesem Fall kann vom Betreiber verlangt werden, angemessene Maßnahmen durchzuführen.

Gerät der Klasse B:

Ein Gerät, das sich für den Betrieb im Wohnbereich sowie in solchen Bereichen eignet, die direkt an ein Niederspannungs-Versorgungsnetz angeschlossen sind, das Wohngebäude versorgt.

Reparatur und Service

- Das Produkt darf nur von dafür autorisiertem Fachpersonal geöffnet werden. Vor Arbeiten am Produkt oder Öffnen des Produkts ist dieses von der Versorgungsspannung zu trennen, sonst besteht das Risiko eines elektrischen Schlages.
- Abgleich, Auswechseln von Teilen, Wartung und Reparatur darf nur von R&S-autorisierten Elektrofachkräften ausgeführt werden. Werden sicherheitsrelevante Teile (z.B. Netzschalter, Netztrafos oder Sicherungen) ausgewechselt, so dürfen diese nur durch Originalteile ersetzt werden. Nach jedem Austausch von sicherheitsrelevanten Teilen ist eine Sicherheitsprüfung durchzuführen (Sichtprüfung, Schutzleitertest, Isolationswiderstand-, Ableitstrommessung, Funktionstest). Damit wird sichergestellt, dass die Sicherheit des Produkts erhalten bleibt.

Batterien und Akkumulatoren/Zellen

Werden die Hinweise zu Batterien und Akkumulatoren/Zellen nicht oder unzureichend beachtet, kann dies Explosion, Brand und/oder schwere Verletzungen von Personen, unter Umständen mit Todesfolge, verursachen. Die Handhabung von Batterien und Akkumulatoren mit alkalischen Elektrolyten (z.B. Lithiumzellen) muss der EN 62133 entsprechen.

- Zellen dürfen nicht zerlegt, geöffnet oder zerkleinert werden.
- Zellen oder Batterien dürfen weder Hitze noch Feuer ausgesetzt werden. Die Lagerung im direkten Sonnenlicht ist zu vermeiden. Zellen und Batterien sauber und trocken halten. Verschmutzte Anschlüsse mit einem trockenen, sauberen Tuch reinigen.

Grundlegende Sicherheitshinweise

3. Zellen oder Batterien dürfen nicht kurzgeschlossen werden. Zellen oder Batterien dürfen nicht gefahrbringend in einer Schachtel oder in einem Schubfach gelagert werden, wo sie sich gegenseitig kurzschließen oder durch andere leitende Werkstoffe kurzgeschlossen werden können. Eine Zelle oder Batterie darf erst aus ihrer Originalverpackung entnommen werden, wenn sie verwendet werden soll.
4. Zellen oder Batterien dürfen keinen unzulässig starken, mechanischen Stößen ausgesetzt werden.
5. Bei Undichtheit einer Zelle darf die Flüssigkeit nicht mit der Haut in Berührung kommen oder in die Augen gelangen. Falls es zu einer Berührung gekommen ist, den betroffenen Bereich mit reichlich Wasser waschen und ärztliche Hilfe in Anspruch nehmen.
6. Werden Zellen oder Batterien, die alkalische Elektrolyte enthalten (z.B. Lithiumzellen), unsachgemäß ausgewechselt oder geladen, besteht Explosionsgefahr. Zellen oder Batterien nur durch den entsprechenden R&S-Typ ersetzen (siehe Ersatzteilliste), um die Sicherheit des Produkts zu erhalten.
7. Zellen oder Batterien müssen wiederverwertet werden und dürfen nicht in den Restmüll gelangen. Akkumulatoren oder Batterien, die Blei, Quecksilber oder Cadmium enthalten, sind Sonderabfall. Beachten Sie hierzu die landesspezifischen Entsorgungs- und Recycling-Bestimmungen.
8. Bei Rücksendungen von Lithiumbatterien zu Rohde & Schwarz - Niederlassungen müssen die Transportvorschriften der Verkehrsträger (IATA-DGR, IMDG-Code, ADR, RID) befolgt werden.

Transport

1. Das Produkt kann ein hohes Gewicht aufweisen. Daher muss es vorsichtig und ggf. unter Verwendung eines geeigneten Hebemittels (z.B. Hubwagen) bewegt bzw. transportiert werden, um Rückenschäden oder Verletzungen zu vermeiden.
2. Griffe an den Produkten sind eine Handhabungshilfe, die ausschließlich für den Transport des Produkts durch Personen vorgesehen ist. Es ist daher nicht zulässig, Griffe zur Befestigung an bzw. auf Transportmitteln, z.B. Kränen, Gabelstaplern, Karren etc. zu verwenden. Es liegt in Ihrer Verantwortung, die Produkte sicher an bzw. auf geeigneten Transport- oder Hebemitteln zu befestigen. Beachten Sie die Sicherheitsvorschriften des jeweiligen Herstellers eingesetzter Transport- oder Hebemittel, um Personenschäden und Schäden am Produkt zu vermeiden.
3. Falls Sie das Produkt in einem Fahrzeug benutzen, liegt es in der alleinigen Verantwortung des Fahrers, das Fahrzeug in sicherer und angemessener Weise zu führen. Der Hersteller übernimmt keine Verantwortung für Unfälle oder Kollisionen. Verwenden Sie das Produkt niemals in einem sich bewegenden Fahrzeug, sofern dies den Fahrzeugführer ablenken könnte. Sichern Sie das Produkt im Fahrzeug ausreichend ab, um im Falle eines Unfalls Verletzungen oder Schäden anderer Art zu verhindern.

Entsorgung

1. Batterien bzw. Akkumulatoren, die nicht mit dem Hausmüll entsorgt werden dürfen, darf nach Ende der Lebensdauer nur über eine geeignete Sammelstelle oder eine Rohde & Schwarz-Kundendienststelle entsorgt werden.
2. Am Ende der Lebensdauer des Produktes darf dieses Produkt nicht über den normalen Hausmüll entsorgt werden, sondern muss getrennt gesammelt werden. Rohde & Schwarz GmbH & Co.KG ein Entsorgungskonzept entwickelt und übernimmt die Pflichten der Rücknahme- und Entsorgung für Hersteller innerhalb der EU in vollem Umfang. Wenden Sie sich bitte an Ihre Rohde & Schwarz-Kundendienststelle, um das Produkt umweltgerecht zu entsorgen.

Grundlegende Sicherheitshinweise

3. Werden Produkte oder ihre Bestandteile über den bestimmungsgemäßen Betrieb hinaus mechanisch und/oder thermisch bearbeitet, können ggf. gefährliche Stoffe (schwermetallhaltiger Staub wie z.B. Blei, Beryllium, Nickel) freigesetzt werden. Die Zerlegung des Produkts darf daher nur von speziell geschultem Fachpersonal erfolgen. Unsachgemäßes Zerlegen kann Gesundheitsschäden hervorrufen. Die nationalen Vorschriften zur Entsorgung sind zu beachten.
4. Falls beim Umgang mit dem Produkt Gefahren- oder Betriebsstoffe entstehen, die speziell zu entsorgen sind, z.B. regelmäßig zu wechselnde Kühlmittel oder Motorenöle, sind die Sicherheitshinweise des Herstellers dieser Gefahren- oder Betriebsstoffe und die regional gültigen Entsorgungsvorschriften einzuhalten. Beachten Sie ggf. auch die zugehörigen speziellen Sicherheitshinweise in der Produktdokumentation. Die unsachgemäße Entsorgung von Gefahren- oder Betriebsstoffen kann zu Gesundheitsschäden von Personen und Umweltschäden führen.

Weitere Informationen zu Umweltschutz finden Sie auf der Rohde & Schwarz Home Page.

Consignes de sécurité fondamentales

Lisez et respectez impérativement les instructions et consignes de sécurité suivantes

Les usines et sites du groupe Rohde & Schwarz veillent à la conformité des produits du groupe avec les normes de sécurité en vigueur dans un souci constant de garantir aux clients le plus haut niveau de sécurité possible. Nos produits ainsi que les accessoires nécessaires sont fabriqués et testés conformément aux règles de sécurité en vigueur. Le respect de ces règles est vérifié régulièrement par notre système d'assurance qualité. Le présent produit a été fabriqué et contrôlé conformément au certificat de conformité CE ci-joint et a quitté l'usine dans un parfait état de sécurité. Pour le maintenir dans cet état et en garantir une utilisation sans danger, l'utilisateur doit respecter l'ensemble des consignes, remarques de sécurité et avertissements qui se trouvent dans ce manuel. Le groupe Rohde & Schwarz se tient à votre disposition pour toutes questions relatives aux présentes consignes de sécurité.













Il incombe à l'utilisateur d'employer ce produit de manière appropriée. Le produit est exclusivement destiné à l'utilisation en industrie et en laboratoire et/ou, si cela a été expressément autorisé, également aux travaux extérieurs ; il ne peut en aucun cas être utilisé à des fins pouvant causer des dommages corporels ou matériels. L'exploitation du produit en dehors de son utilisation prévue ou le non-respect des consignes du fabricant se font sous la responsabilité de l'utilisateur. Le fabricant décline toute responsabilité en cas d'utilisation non conforme du produit.

Le produit est présumé faire l'objet d'une utilisation conforme lorsqu'il est utilisé conformément aux consignes de la documentation produit correspondante et dans la limite de ses performances (voir fiche technique, documentation, consignes de sécurité ci-après). L'utilisation du produit exige des compétences en la matière et des connaissances de base de l'anglais. Par conséquent, le produit ne devra être utilisé que par un personnel qualifié ou des personnes formées de manière approfondie et possédant les compétences requises. Si, pour l'utilisation des produits Rohde & Schwarz, l'emploi d'un équipement personnel de protection s'avère nécessaire, il en est fait mention dans la documentation produit à l'emplacement correspondant. Conservez les consignes de sécurité fondamentales et la documentation produit dans un lieu sûr et transmettez ces documents aux autres utilisateurs du produit.

La stricte observation des consignes de sécurité a pour but d'exclure des blessures ou dommages causés par des dangers de toutes sortes. A cet effet, il est nécessaire de lire avec soin et de bien comprendre les consignes de sécurité ci-dessous avant l'utilisation du produit et de les respecter lors de l'utilisation du produit. Toutes les autres consignes de sécurité présentées à l'emplacement correspondant de la documentation produit, par exemple, celles concernant la protection des personnes, doivent également être impérativement respectées. Dans les présentes consignes de sécurité, toutes les marchandises commercialisées par le groupe Rohde & Schwarz, notamment les appareils, les systèmes ainsi que les accessoires, sont dénommés « produit ».

Consignes de sécurité fondamentales

Symboles et marquages de sécurité

| Symbole | Signification | Symbole | Signification |
|---|--|---|---|
|  | Avis, source générale de danger Se référer à la documentation produit | ○ | MARCHE / ARRET (tension d'alimentation) |
|  | Attention lors de la manipulation d'appareils ayant un poids élevé | ⏻ | Indicateur de veille |
|  | Risque de choc électrique | ≡ | Courant continu (CC) |
|  | Avertissement, surface chaude | ~ | Courant alternatif (CA) |
|  | Borne de conducteur de protection | ⎓ | Courant continu/alternatif (CC/CA) |
|  | Borne de mise à la terre |  | L'appareil est conforme aux exigences de sécurité du degré de protection II (appareil entièrement protégé par isolation double/renforcée). |
|  | Borne de mise à la masse du bâti ou du boîtier |  | Marquage UE pour batteries et accumulateurs. L'appareil contient une batterie ou un accumulateur. Ces pièces ne peuvent pas être éliminées avec les déchets urbains non triés, mais doivent faire l'objet d'une collecte séparée. Pour plus d'informations, voir la page 7. |
|  | Avis : prudence lors de la manipulation de composants sensibles aux décharges électrostatiques |  | Marquage UE pour la collecte séparée d'équipements électriques et électroniques. Les déchets d'équipements électriques et électroniques ne peuvent pas être éliminés avec les déchets urbains non triés, mais doivent faire l'objet d'une collecte séparée. Pour plus d'informations, voir la page 7. |
|  | Avertissement, rayon laser Les produits laser sont munis d'avertissements normalisés d'après leur catégorie laser. En raison des caractéristiques de leur rayonnement ainsi que de leur puissance électromagnétique extrêmement concentrée, les lasers peuvent causer des dommages biologiques. Pour plus d'informations, voir le chapitre « Fonctionnement », point 7. | | |

Consignes de sécurité fondamentales

Mots d'alerte et significations

Les mots d'alerte suivants sont utilisés dans la documentation produit pour avertir des risques et dangers.



Indique une situation dangereuse immédiate qui, si elle n'est pas évitée, comporte un risque élevé de blessures graves ou mortelles.



Indique une situation dangereuse possible qui, si elle n'est pas évitée, comporte un risque modéré de blessures (graves) ou mortelles.



Indique une situation dangereuse qui, si elle n'est pas évitée, comporte un risque faible de blessures mineures ou modérées.



Indique la possibilité d'une fausse manœuvre susceptible d'endommager le produit.

Ces mots d'alerte correspondent à la définition habituelle utilisée pour des applications civiles dans l'espace économique européen. Des définitions divergentes peuvent cependant exister dans d'autres espaces économiques ou dans le cadre d'applications militaires. Il faut donc veiller à ce que les mots d'alerte décrits ici ne soient utilisés qu'en relation avec la documentation produit correspondante et seulement avec le produit correspondant. L'utilisation des mots d'alerte en relation avec des produits ou des documentations non correspondants peut conduire à des erreurs d'interprétation et par conséquent à des dommages corporels ou matériels.

États et positions de fonctionnement

L'appareil ne doit être utilisé que dans les états et positions de fonctionnement indiqués par le fabricant. Tout obstacle à la ventilation doit être empêché. Le non-respect des indications du fabricant peut provoquer des chocs électriques, des incendies et/ou des blessures graves pouvant éventuellement entraîner la mort. Pour tous les travaux, les règles locales et/ou nationales de sécurité et de prévention des accidents doivent être respectées.

1. Sauf stipulations contraires, les produits Rohde & Schwarz répondent aux exigences ci-après : faire fonctionner le produit avec le fond du boîtier toujours en bas, degré de protection IP 2X, degré de pollution 2, catégorie de surtension 2, utilisation uniquement à l'intérieur, fonctionnement à une altitude max. de 2000 m au-dessus du niveau de la mer, transport à une altitude max. de 4500 m au-dessus du niveau de la mer, tolérance de $\pm 10\%$ pour la tension nominale et de $\pm 5\%$ pour la fréquence nominale.
2. Ne jamais placer le produit sur des surfaces, véhicules, dépôts ou tables non appropriés pour raisons de stabilité ou de poids. Suivre toujours strictement les indications d'installation du fabricant pour le montage et la fixation du produit sur des objets ou des structures (par exemple parois et étagères). En cas d'installation non conforme à la documentation produit, il y a risque de blessures, voire de mort.
3. Ne jamais placer le produit sur des dispositifs générant de la chaleur (par exemple radiateurs et appareils de chauffage soufflants). La température ambiante ne doit pas dépasser la température maximale spécifiée dans la documentation produit ou dans la fiche technique. Une surchauffe du produit peut provoquer des chocs électriques, des incendies et/ou des blessures graves pouvant éventuellement entraîner la mort.

Consignes de sécurité fondamentales

Sécurité électrique

Si les consignes relatives à la sécurité électrique ne sont pas ou sont insuffisamment respectées, il peut s'ensuivre des chocs électriques, des incendies et/ou des blessures graves pouvant éventuellement entraîner la mort.

1. Avant chaque mise sous tension du produit, il faut s'assurer que la tension nominale réglée sur le produit correspond à la tension nominale du réseau électrique. S'il est nécessaire de modifier le réglage de la tension, il faut remplacer le fusible du produit, le cas échéant.
2. L'utilisation des produits du degré de protection I pourvus d'un câble d'alimentation mobile et d'un connecteur n'est autorisée qu'avec des prises munies d'un contact de protection et d'un conducteur de protection raccordé.
3. Toute déconnexion intentionnelle du conducteur de protection, dans le câble ou dans le produit lui-même, est interdite. Elle entraîne un risque de choc électrique au niveau du produit. En cas d'utilisation de câbles prolongateurs ou de multiprises, ceux-ci doivent être examinés régulièrement quant à leur état de sécurité technique.
4. Si le produit n'est pas doté d'un interrupteur d'alimentation pour le couper du réseau électrique ou si l'interrupteur d'alimentation disponible n'est pas approprié pour couper le produit du réseau électrique, le connecteur mâle du câble de raccordement est à considérer comme dispositif de séparation. Le dispositif de séparation doit être à tout moment facilement accessible. Si, par exemple, le connecteur d'alimentation sert de dispositif de séparation, la longueur du câble de raccordement ne doit pas dépasser 3 m.
Les commutateurs fonctionnels ou électroniques ne sont pas appropriés pour couper l'appareil du réseau électrique. Si des produits sans interrupteur d'alimentation sont intégrés dans des bâtis ou systèmes, le dispositif de séparation doit être reporté au niveau du système.
5. Ne jamais utiliser le produit si le câble d'alimentation est endommagé. Vérifier régulièrement le parfait état du câble d'alimentation. Prendre les mesures préventives appropriées et opter pour des types de pose tels que le câble d'alimentation ne puisse pas être endommagé et que personne ne puisse subir de préjudice, par exemple en trébuchant sur le câble ou par des chocs électriques.
6. L'utilisation des produits est uniquement autorisée sur des réseaux d'alimentation de type TN/TT protégés par des fusibles d'une intensité max. de 16 A (pour toute intensité supérieure, consulter le groupe Rohde & Schwarz).
7. Ne pas brancher le connecteur dans des prises d'alimentation sales ou poussiéreuses. Enfoncer fermement le connecteur jusqu'au bout de la prise. Le non-respect de cette mesure peut provoquer des étincelles, incendies et/ou blessures.
8. Ne pas surcharger les prises, les câbles prolongateurs ou les multiprises, cela pouvant provoquer des incendies ou chocs électriques.
9. En cas de mesures sur les circuits électriques d'une tension efficace > 30 V, prendre les précautions nécessaires pour éviter tout risque (par exemple équipement de mesure approprié, fusibles, limitation de courant, coupe-circuit, isolation, etc.).
10. En cas d'interconnexion avec des équipements informatiques comme par exemple un PC ou un ordinateur industriel, veiller à ce que ces derniers soient conformes aux normes IEC 60950-1 / EN 60950-1 ou IEC 61010-1 / EN 61010-1 en vigueur.
11. Sauf autorisation expresse, il est interdit de retirer le couvercle ou toute autre pièce du boîtier lorsque le produit est en cours de service. Les câbles et composants électriques seraient ainsi accessibles, ce qui peut entraîner des blessures, des incendies ou des dégâts sur le produit.

Consignes de sécurité fondamentales

12. Si un produit est connecté de façon stationnaire, établir avant toute autre connexion le raccordement du conducteur de protection local et du conducteur de protection du produit. L'installation et le raccordement ne peuvent être effectués que par un électricien ou électronicien qualifié.
13. Sur les appareils stationnaires sans fusible ni disjoncteur automatique ou dispositif de protection similaire intégrés, le circuit d'alimentation doit être sécurisé de sorte que toutes les personnes ayant accès au produit et le produit lui-même soient suffisamment protégés contre tout dommage.
14. Chaque produit doit être protégé de manière appropriée contre les éventuelles surtensions (par exemple dues à un coup de foudre). Sinon, les utilisateurs sont exposés à des risques de choc électrique.
15. Ne jamais introduire d'objets non prévus à cet effet dans les ouvertures du boîtier, étant donné que cela peut entraîner des courts-circuits dans le produit et/ou des chocs électriques, incendies ou blessures.
16. Sauf spécification contraire, les produits ne sont pas protégés contre l'infiltration de liquides, voir aussi la section « États et positions de fonctionnement », point 1. Il faut donc protéger les produits contre l'infiltration de liquides. La non-observation de cette consigne entraîne le risque de choc électrique pour l'utilisateur ou d'endommagement du produit, ce qui peut également mettre les personnes en danger.
17. Ne pas utiliser le produit dans des conditions pouvant occasionner ou ayant déjà occasionné, le cas échéant, des condensations dans ou sur le produit, par exemple lorsque celui-ci est déplacé d'un environnement froid dans un environnement chaud. L'infiltration d'eau augmente le risque de choc électrique.
18. Avant le nettoyage, débrancher le produit de l'alimentation (par exemple réseau électrique ou batterie). Pour le nettoyage des appareils, utiliser un chiffon doux non pelucheux. N'utiliser en aucun cas de produit de nettoyage chimique, tel que de l'alcool, de l'acétone ou un diluant nitrocellulosique.

Fonctionnement

1. L'utilisation du produit exige une formation spécifique ainsi qu'une grande concentration. Il est impératif que les personnes qui utilisent le produit présentent les aptitudes physiques, mentales et psychiques requises, vu qu'autrement des dommages corporels ou matériels ne peuvent pas être exclus. Le choix du personnel qualifié pour l'utilisation du produit est sous la responsabilité de l'employeur/l'exploitant.
2. Avant de déplacer ou de transporter le produit, lire et respecter la section « Transport ».
3. Comme pour tous les biens produits de façon industrielle, l'utilisation de matériaux pouvant causer des allergies (allergènes, comme par exemple le nickel) ne peut être totalement exclue. Si, lors de l'utilisation de produits Rohde & Schwarz, des réactions allergiques surviennent, telles qu'éruption cutanée, éternuements fréquents, rougeur de la conjonctive ou difficultés respiratoires, il faut immédiatement consulter un médecin pour en clarifier la cause et éviter toute atteinte à la santé.
4. Avant le traitement mécanique et/ou thermique ou le démontage du produit, il faut impérativement observer la section « Élimination des déchets », point 1.

Consignes de sécurité fondamentales

5. Selon les fonctions, certains produits, tels que des systèmes de radiocommunication RF, peuvent produire des niveaux élevés de rayonnement électromagnétique. Étant donné la vulnérabilité de l'enfant à naître, les femmes enceintes doivent être protégées par des mesures appropriées. Les porteurs de stimulateurs cardiaques peuvent également être menacés par les rayonnements électromagnétiques. L'employeur/l'exploitant est tenu d'évaluer et de repérer les lieux de travail soumis à un risque particulier d'exposition aux rayonnements et de prévenir les dangers éventuels.
6. En cas d'incendie, il se peut que le produit dégage des matières toxiques (gaz, liquides, etc.) susceptibles de nuire à la santé. Il faut donc, en cas d'incendie, prendre des mesures adéquates comme par exemple le port de masques respiratoires et de vêtements de protection.
7. Si un produit laser est intégré dans un produit Rohde & Schwarz (par exemple lecteur CD/DVD), il ne faut pas utiliser de réglages ou fonctions autres que ceux décrits dans la documentation produit pour éviter tout dommage corporel (par exemple causé par rayon laser).
8. Classes CEM (selon EN 55011 / CISPR 11 ; selon EN 55022 / CISPR 22, EN 55032 / CISPR 32 par analogie)
 - Appareil de la classe A :
Appareil approprié à un usage dans tous les environnements autres que l'environnement résidentiel et les environnements raccordés directement à un réseau d'alimentation basse tension qui alimente des bâtiments résidentiels.
Remarque : ces appareils peuvent provoquer des perturbations radioélectriques dans l'environnement résidentiel en raison de perturbations conduites ou rayonnées. Dans ce cas, on peut exiger que l'exploitant mette en œuvre de mesures appropriées pour éliminer ces perturbations.
 - Appareil de la classe B :
Appareil approprié à un usage dans l'environnement résidentiel ainsi que dans les environnements raccordés directement à un réseau d'alimentation basse tension qui alimente des bâtiments résidentiels.

Réparation et service après-vente

1. Le produit ne doit être ouvert que par un personnel qualifié et autorisé. Avant de travailler sur le produit ou de l'ouvrir, il faut le couper de la tension d'alimentation ; sinon il y a risque de choc électrique.
2. Les travaux d'ajustement, le remplacement des pièces, la maintenance et la réparation ne doivent être effectués que par des électroniciens qualifiés et autorisés par Rohde & Schwarz. En cas de remplacement de pièces concernant la sécurité (notamment interrupteur d'alimentation, transformateur d'alimentation réseau ou fusibles), celles-ci ne doivent être remplacées que par des pièces d'origine. Après chaque remplacement de pièces concernant la sécurité, une vérification de sécurité doit être effectuée (contrôle visuel, vérification du conducteur de protection, mesure de la résistance d'isolement et du courant de fuite, essai de fonctionnement). Cela permet d'assurer le maintien de la sécurité du produit.

Consignes de sécurité fondamentales

Batteries et accumulateurs/cellules

Si les instructions concernant les batteries et accumulateurs/cellules ne sont pas ou sont insuffisamment respectées, cela peut provoquer des explosions, des incendies et/ou des blessures graves pouvant entraîner la mort. La manipulation de batteries et accumulateurs contenant des électrolytes alcalins (par exemple cellules de lithium) doit être conforme à la norme EN 62133.

1. Les cellules ne doivent être ni démontées, ni ouvertes, ni réduites en morceaux.
2. Ne jamais exposer les cellules ou batteries à la chaleur ou au feu. Ne pas les stocker dans un endroit où elles sont exposées au rayonnement direct du soleil. Tenir les cellules et batteries au sec. Nettoyer les raccords sales avec un chiffon sec et propre.
3. Ne jamais court-circuiter les cellules ou batteries. Les cellules ou batteries ne doivent pas être gardées dans une boîte ou un tiroir où elles peuvent se court-circuiter mutuellement ou être court-circuitées par d'autres matériaux conducteurs. Une cellule ou batterie ne doit être retirée de son emballage d'origine que lorsqu'on l'utilise.
4. Les cellules ou batteries ne doivent pas être exposées à des chocs mécaniques de force non admissible.
5. En cas de manque d'étanchéité d'une cellule, le liquide ne doit pas entrer en contact avec la peau ou les yeux. S'il y a contact, rincer abondamment à l'eau l'endroit concerné et consulter un médecin.
6. Il y a danger d'explosion en cas de remplacement ou chargement incorrect des cellules ou batteries qui contiennent des électrolytes alcalins (par exemple cellules de lithium). Remplacer les cellules ou batteries uniquement par le type Rohde & Schwarz correspondant (voir la liste des pièces de rechange) pour maintenir la sécurité du produit.
7. Il faut recycler les cellules ou batteries et il est interdit de les éliminer comme déchets normaux. Les accumulateurs ou batteries qui contiennent du plomb, du mercure ou du cadmium sont des déchets spéciaux. Observer les règles nationales d'élimination et de recyclage.
8. Lors des renvois de batteries au lithium à des filiales Rohde & Schwarz, il convient de respecter les prescriptions de transport (IATA-DGR, code IMDG, ADR, RID) fixées par les transporteurs.

Transport

1. Le produit peut avoir un poids élevé. Il faut donc le déplacer ou le transporter avec précaution et en utilisant le cas échéant un moyen de levage approprié (par exemple, chariot élévateur) pour éviter des dommages au dos ou des blessures.
2. Les poignées des produits sont une aide de manipulation exclusivement réservée au transport du produit par des personnes. Il est donc proscrit d'utiliser ces poignées pour attacher le produit à ou sur des moyens de transport, tels que grues, chariots et chariots élévateurs, etc. Vous êtes responsable de la fixation sûre des produits à ou sur des moyens de transport et de levage appropriés. Observer les consignes de sécurité du fabricant des moyens de transport ou de levage utilisés pour éviter des dommages corporels et des dégâts sur le produit.
3. L'utilisation du produit dans un véhicule se fait sous l'unique responsabilité du conducteur qui doit piloter le véhicule de manière sûre et appropriée. Le fabricant décline toute responsabilité en cas d'accidents ou de collisions. Ne jamais utiliser le produit dans un véhicule en mouvement si cela pouvait détourner l'attention du conducteur. Sécuriser suffisamment le produit dans le véhicule pour empêcher des blessures ou dommages de tout type en cas d'accident.

Consignes de sécurité fondamentales

Élimination des déchets

1. Au terme de leur durée de vie, les batteries ou accumulateurs qui ne peuvent pas être éliminés avec les déchets ménagers peuvent uniquement être éliminés par des points de collecte appropriés ou par un centre de service après-vente Rohde & Schwarz.
2. Au terme de sa durée de vie, un produit ne peut pas être éliminé avec les déchets ménagers normaux, mais doit être collecté séparément.
Rohde & Schwarz GmbH & Co. KG a développé un concept d'élimination des déchets et assume toutes les obligations en matière de reprise et d'élimination, valables pour les fabricants au sein de l'UE. Veuillez vous adresser à votre centre de service après-vente Rohde & Schwarz pour éliminer le produit de manière écologique.
3. Si les produits ou leurs composants sont travaillés mécaniquement et/ou thermiquement au-delà de l'utilisation prévue, ils peuvent, le cas échéant, libérer des substances dangereuses (poussières contenant des métaux lourds comme par exemple du plomb, du béryllium ou du nickel). Le démontage du produit ne doit donc être effectué que par un personnel qualifié et spécialement formé. Le démontage inadéquat peut nuire à la santé. Les règles nationales concernant l'élimination des déchets doivent être observées.
4. Si, lors de l'utilisation du produit, des substances dangereuses ou combustibles exigeant une élimination spéciale sont dégagées, comme par exemple liquides de refroidissement ou huiles moteurs qui sont à changer régulièrement, les consignes de sécurité du fabricant de ces substances dangereuses ou combustibles ainsi que les règles sur l'élimination en vigueur au niveau régional doivent être respectées. Les consignes de sécurité spéciales correspondantes dans la documentation produit doivent également être respectées, le cas échéant. L'élimination non conforme des substances dangereuses ou combustibles peut provoquer des atteintes à la santé et des dommages écologiques.

Pour plus d'informations concernant la protection de l'environnement, voir la page d'accueil de Rohde & Schwarz.

Customer Support

Technical support – where and when you need it

For quick, expert help with any Rohde & Schwarz product, contact our customer support center. A team of highly qualified engineers provides support and works with you to find a solution to your query on any aspect of the operation, programming or applications of Rohde & Schwarz products.

Contact information

Contact our customer support center at www.rohde-schwarz.com/support, or follow this QR code:



QR code to the Rohde & Schwarz support page

Contents

| | | |
|------------|--|-----------|
| 1 | Preface | 17 |
| 1.1 | For Your Safety | 17 |
| 1.2 | Documentation Overview | 17 |
| 1.2.1 | Quick Start Guide Manual..... | 17 |
| 1.2.2 | Operating Manual and Help..... | 17 |
| 1.2.3 | Service Manual..... | 18 |
| 1.2.4 | Instrument Security Procedures..... | 18 |
| 1.2.5 | Basic Safety Instructions..... | 18 |
| 1.2.6 | Data Sheets and Brochures..... | 18 |
| 1.2.7 | Release Notes and Open Source Acknowledgment (OSA)..... | 19 |
| 1.2.8 | Application Notes, Application Cards, White Papers, etc..... | 19 |
| 1.3 | Notes on Screenshots | 19 |
| 2 | Preparing for Use | 20 |
| 2.1 | Front Panel Tour | 20 |
| 2.1.1 | Utility Keys..... | 21 |
| 2.1.2 | Standby LEDs and Standby Key..... | 22 |
| 2.1.3 | Display..... | 22 |
| 2.1.4 | Setup Keys..... | 24 |
| 2.1.4.1 | Keys for Setting Parameters..... | 24 |
| 2.1.4.2 | Display Keys..... | 25 |
| 2.1.5 | Keypad for data entry..... | 26 |
| 2.1.6 | Rotary Knob and Navigation Keys..... | 27 |
| 2.1.7 | Front Panel Connectors..... | 27 |
| 2.2 | Rear Panel Tour | 28 |
| 2.2.1 | Description of the Connectors..... | 29 |
| 2.3 | Putting into Operation | 32 |
| 2.3.1 | EMI Suppression..... | 33 |
| 2.3.2 | Unpacking and Checking the Instrument..... | 34 |
| 2.3.3 | Placing or Mounting the Instrument..... | 34 |
| 2.3.4 | Connecting the Instrument to the AC Supply..... | 36 |
| 2.3.5 | Starting the Instrument..... | 36 |

| | | |
|------------|---|-----------|
| 2.3.5.1 | Standby and Ready state..... | 37 |
| 2.3.5.2 | Start Display and Booting..... | 37 |
| 2.3.5.3 | Function Check..... | 37 |
| 2.3.5.4 | Default Settings..... | 38 |
| 2.3.6 | Shutting Down the Instrument..... | 39 |
| 2.3.7 | Power Fuses..... | 40 |
| 2.4 | Connecting External Accessories..... | 40 |
| 2.4.1 | Connecting USB Devices..... | 40 |
| 2.5 | Linux Operating System..... | 41 |
| 2.6 | Setting Up a Network (LAN) Connection..... | 43 |
| 2.6.1 | Connecting the Instrument to the Network..... | 43 |
| 2.6.2 | Assigning the IP Address..... | 44 |
| 2.6.3 | Using Computer Names..... | 45 |
| 2.7 | Remote Access via an External Controller..... | 46 |
| 2.7.1 | Using a Web Browser for Remote Access..... | 47 |
| 2.7.2 | Remote Access via a VNC Client Software..... | 49 |
| 2.8 | LXI Configuration..... | 53 |
| 2.8.1 | LXI Browser Settings..... | 54 |
| 2.8.2 | LAN Configuration..... | 56 |
| 2.8.2.1 | IP Configuration..... | 56 |
| 2.8.2.2 | Advanced LAN Configuration..... | 57 |
| 2.8.2.3 | Ping Client..... | 58 |
| 2.8.2.4 | Web Control..... | 59 |
| 2.8.2.5 | SCPI Remote Trace..... | 60 |
| 3 | Getting Started..... | 63 |
| 3.1 | Brief Introduction to the Instrument's Concept..... | 63 |
| 3.2 | Baseband Section..... | 65 |
| 3.2.1 | Description of Individual Diagram Blocks of the Baseband Section..... | 67 |
| 3.3 | RF Section..... | 68 |
| 3.3.1 | Description of Individual Diagram Blocks of the RF Section..... | 68 |
| 3.4 | Example of Setup..... | 69 |
| 4 | Manual Operation..... | 76 |
| 4.1 | Key Features..... | 76 |

| | |
|--|------------|
| 4.2 Display..... | 81 |
| 4.2.1 Settings Displayed in the Header Section..... | 82 |
| 4.2.2 Status Information and Messages..... | 83 |
| 4.2.2.1 Status Information..... | 83 |
| 4.2.2.2 Messages..... | 83 |
| 4.2.2.3 Volatile messages..... | 83 |
| 4.2.2.4 Permanent Messages..... | 84 |
| 4.2.3 Info Window..... | 84 |
| 4.2.4 Block Diagram | 85 |
| 4.2.4.1 Function Blocks in the Block Diagram..... | 85 |
| 4.2.4.2 Signal Flow and Input/Output Symbols in the Block Diagram..... | 86 |
| 4.2.5 Winbar and Softkeys..... | 87 |
| 4.2.6 Structure of the Dialogs..... | 87 |
| 4.2.7 Graphical Display of Output Signal Characteristics..... | 88 |
| 4.3 Accessing Dialogs..... | 89 |
| 4.4 Setting Parameters..... | 90 |
| 4.4.1 Working with the Cursor..... | 91 |
| 4.4.2 Selecting a Control Element..... | 92 |
| 4.4.3 Switching Parameters On/Off..... | 92 |
| 4.4.4 Entering a Value..... | 92 |
| 4.4.5 Working with Units | 94 |
| 4.4.6 Selecting a Value from a List..... | 95 |
| 4.4.7 Terminating Entries with Confirmation..... | 95 |
| 4.4.8 Restoring the Previous Value..... | 96 |
| 4.5 Editors..... | 97 |
| 4.5.1 Working with List Editor..... | 97 |
| 4.5.2 Working with Data Editor..... | 99 |
| 4.5.3 Working with Control and Marker List Editor..... | 100 |
| 4.6 How to Use the Help System..... | 104 |
| 4.7 File Management..... | 105 |
| 4.7.1 File Select Dialog..... | 107 |
| 4.7.2 File Manager..... | 108 |
| 4.7.2.1 Extensions for User Files..... | 109 |

| | | |
|------------|--|------------|
| 4.8 | Legend of Front-Panel Controls..... | 112 |
| 4.8.1 | Front Panel Key Emulation..... | 113 |
| 5 | Instrument Function..... | 115 |
| 5.1 | Overview of Instrument Functions..... | 115 |
| 5.2 | General Instrument Settings..... | 118 |
| 5.2.1 | Overview of General Instrument Settings..... | 118 |
| 5.2.2 | Default Instrument Settings - Preset Key..... | 118 |
| 5.2.3 | General Configuration of Instrument - Setup Key..... | 119 |
| 5.2.3.1 | Internal Adjustments..... | 120 |
| 5.2.3.2 | Hardware Config..... | 122 |
| 5.2.3.3 | Software / Options..... | 123 |
| 5.2.3.4 | Manage License Keys..... | 124 |
| 5.2.3.5 | NRP Info/Update..... | 129 |
| 5.2.3.6 | Delete Temporary Files..... | 131 |
| 5.2.3.7 | Display Update..... | 132 |
| 5.2.3.8 | Selftest..... | 132 |
| 5.2.3.9 | Check Front Panel..... | 133 |
| 5.2.3.10 | Shutting Down and Rebooting the Instrument..... | 135 |
| 5.2.3.11 | Date and Time | 135 |
| 5.2.3.12 | Network Settings | 137 |
| 5.2.3.13 | Global Trigger/Clock/External Input Settings..... | 140 |
| 5.2.3.14 | Display/Keyboard Settings..... | 142 |
| 5.2.3.15 | Remote Channel Settings..... | 143 |
| 5.2.3.16 | Instrument Emulations..... | 145 |
| 5.2.3.17 | Protection..... | 146 |
| 5.2.3.18 | Security..... | 147 |
| 5.2.3.19 | Save/Recall..... | 155 |
| 5.2.3.20 | Factory Preset..... | 155 |
| 5.2.3.21 | Help..... | 156 |
| 5.2.4 | Switching to Manual Control - Local Key..... | 156 |
| 5.2.5 | Generating a Hard Copy of the Display..... | 157 |
| 5.2.5.1 | Hard Copy Settings..... | 157 |
| 5.2.5.2 | Hard Copy Options..... | 158 |

| | | |
|------------|--|------------|
| 5.2.6 | Messages - Info Key..... | 160 |
| 5.2.7 | Help System - Help Key..... | 160 |
| 5.2.8 | Storing and Loading Instrument Data - File Key..... | 161 |
| 5.2.8.1 | Save/Recall Menu..... | 162 |
| 5.2.8.2 | Saving Instrument Settings..... | 162 |
| 5.2.8.3 | Loading Instrument Settings..... | 164 |
| 5.2.8.4 | File Select Dialog..... | 166 |
| 5.2.8.5 | File Manager..... | 168 |
| 5.2.8.6 | Map Network Share Settings..... | 170 |
| 5.2.8.7 | Mapping a Network Folder..... | 171 |
| 5.2.8.8 | Accessing the File System of the Instrument and Transferring Files from and to the Instrument..... | 172 |
| 5.3 | Graphical Display - Graphics..... | 175 |
| 5.3.1 | Graphics Settings Menu..... | 176 |
| 5.3.2 | Bar of Graphics Window..... | 178 |
| 5.3.3 | Signal Displays..... | 180 |
| 5.3.3.1 | I/Q Diagram..... | 180 |
| 5.3.3.2 | Vector Diagram..... | 181 |
| 5.3.3.3 | Constellation Diagram..... | 182 |
| 5.3.3.4 | Eye Diagram..... | 182 |
| 5.3.3.5 | CCDF Display..... | 183 |
| 5.3.3.6 | Power Spectrum..... | 183 |
| 5.4 | Bit and Block Error Rate Measurements..... | 184 |
| 5.4.1 | Test Setup..... | 184 |
| 5.4.2 | PRBS Data..... | 185 |
| 5.4.3 | CRC Polynomial..... | 186 |
| 5.4.4 | Clock Signal..... | 186 |
| 5.4.5 | Ending the Measurement..... | 186 |
| 5.4.6 | Interrupt-free Measurement..... | 187 |
| 5.4.7 | Restart Function..... | 187 |
| 5.4.8 | Data Enable..... | 188 |
| 5.4.9 | Pattern Ignore..... | 188 |
| 5.4.10 | Bit Error Rate Settings..... | 189 |
| 5.4.10.1 | General Settings..... | 190 |

| | | |
|------------|---|------------|
| 5.4.10.2 | Configuration Settings..... | 192 |
| 5.4.11 | Block Error Rate Settings..... | 197 |
| 5.4.11.1 | General Settings..... | 197 |
| 5.4.11.2 | Configuration Settings..... | 200 |
| 5.4.12 | Connector Settings..... | 202 |
| 5.4.13 | Test Generator..... | 203 |
| 5.4.13.1 | Test Generator Setup..... | 204 |
| 5.4.13.2 | Test Generator Settings..... | 205 |
| 5.4.13.3 | BER/BLER Functionality Test..... | 207 |
| 5.5 | RF Block..... | 208 |
| 5.5.1 | Overview of RF Signal..... | 208 |
| 5.5.1.1 | RF Output..... | 208 |
| 5.5.1.2 | RF Signal Modes and Characteristics..... | 209 |
| 5.5.2 | RF Frequency..... | 210 |
| 5.5.2.1 | RF Frequency vs. RF Output Frequency..... | 210 |
| 5.5.2.2 | Setting the RF Frequency..... | 211 |
| 5.5.2.3 | RF Frequency Dialog..... | 211 |
| 5.5.2.4 | Frequency Settings..... | 211 |
| 5.5.2.5 | User Variation Settings..... | 213 |
| 5.5.3 | Phase..... | 213 |
| 5.5.3.1 | Phase Settings..... | 214 |
| 5.5.4 | Reference Oscillator..... | 214 |
| 5.5.4.1 | Reference Oscillator Settings..... | 216 |
| 5.5.5 | Local Oscillator - LO Coupling..... | 218 |
| 5.5.5.1 | Phase Coherence..... | 218 |
| 5.5.5.2 | Typical Applications..... | 219 |
| 5.5.5.3 | LO Coupling Settings..... | 219 |
| 5.5.6 | RF Level..... | 220 |
| 5.5.6.1 | Overview of RF Level..... | 220 |
| 5.5.6.2 | RF Level Dialog..... | 222 |
| 5.5.6.3 | Power-On/EMF Settings..... | 226 |
| 5.5.7 | Automatic Level Control - ALC..... | 227 |
| 5.5.7.1 | Automatic Level Control Settings..... | 228 |

| | | |
|------------|---|------------|
| 5.5.8 | NRP Level Control..... | 229 |
| 5.5.8.1 | NRP Level Control Settings..... | 231 |
| 5.5.9 | User Correction..... | 233 |
| 5.5.9.1 | User Correction Menu..... | 234 |
| 5.5.9.2 | Filling the Correction List automatically..... | 238 |
| 5.5.9.3 | Filling the Correction List with Power Sensor Measurement Data..... | 239 |
| 5.5.10 | Reverse Power Protection..... | 241 |
| 5.5.11 | RF Measurement..... | 241 |
| 5.5.11.1 | NRP Sensor Mapping..... | 241 |
| 5.5.11.2 | NRP Power Viewer..... | 243 |
| 5.5.12 | Modulation..... | 251 |
| 5.5.12.1 | Overview..... | 251 |
| 5.5.12.2 | Amplitude Modulation (AM)..... | 253 |
| 5.5.12.3 | Frequency Modulation (FM)..... | 256 |
| 5.5.12.4 | Phase Modulation (PhiM)..... | 259 |
| 5.5.12.5 | Pulse Modulation (PM)..... | 262 |
| 5.5.13 | Modulation Generator and LF Output..... | 264 |
| 5.5.13.1 | Overview of LF Generator..... | 264 |
| 5.5.13.2 | LF Output..... | 265 |
| 5.5.13.3 | LF Frequency Sweep..... | 266 |
| 5.5.13.4 | Pulse Generator..... | 272 |
| 5.5.14 | RF Sweep and List Mode..... | 278 |
| 5.5.14.1 | Overview..... | 278 |
| 5.5.14.2 | RF Frequency Sweep..... | 279 |
| 5.5.14.3 | RF Level Sweep..... | 286 |
| 5.5.14.4 | List Mode..... | 291 |
| 5.6 | I/Q Modulation - I/Q Mod Block..... | 299 |
| 5.6.1 | I/Q Modulator..... | 300 |
| 5.6.2 | I/Q Settings | 301 |
| 5.6.2.1 | General I/Q Mod Settings..... | 302 |
| 5.6.2.2 | Impairments..... | 303 |
| 5.6.2.3 | I/Q Swap and I/Q Wideband..... | 303 |
| 5.6.2.4 | Analog Wideband I/Q Input..... | 305 |

| | |
|---|------------|
| 5.7 Impairment of Digital I/Q Signal and Noise Generator - AWGN/IMP Block..... | 305 |
| 5.7.1 Impairments..... | 306 |
| 5.7.1.1 Gain and Gain Imbalance..... | 306 |
| 5.7.1.2 I and Q Offset..... | 307 |
| 5.7.1.3 Quadrature Offset..... | 308 |
| 5.7.1.4 Impairment Settings Menu..... | 308 |
| 5.7.2 AWGN - Noise Generator..... | 311 |
| 5.7.2.1 AWGN Settings Dialog..... | 312 |
| 5.7.3 Output of the Baseband Signal - I/Q Out..... | 319 |
| 5.7.3.1 I/Q Out Settings Menu..... | 319 |
| 5.7.3.2 Analog I/Q Output..... | 319 |
| 5.8 Digital I/Q Output Settings..... | 323 |
| 5.8.1 Digital I/Q Output General Settings..... | 323 |
| 5.8.2 Sample Rate..... | 323 |
| 5.8.3 Signal Output..... | 324 |
| 5.8.4 User Variation..... | 325 |
| 5.8.5 Signal Monitoring..... | 325 |
| 5.8.6 Power On Settings..... | 326 |
| 5.9 Baseband Signal - Baseband Block..... | 326 |
| 5.9.1 Working with the Baseband Signal..... | 327 |
| 5.9.2 Data and Signal Sources in Baseband..... | 329 |
| 5.9.2.1 Internal PRBS Data and Data Patterns..... | 330 |
| 5.9.2.2 Internal Modulation Data from Lists..... | 331 |
| 5.9.2.3 Clock Signals..... | 331 |
| 5.9.2.4 Synchronous Signal Generation..... | 332 |
| 5.9.2.5 Control Signals..... | 336 |
| 5.9.2.6 Trigger Signals..... | 338 |
| 5.9.2.7 Marker Output Signals..... | 339 |
| 5.9.3 Digital Modulation - Custom Digital Modulation..... | 341 |
| 5.9.3.1 Overview and Required Options..... | 341 |
| 5.9.3.2 Modulation Types - Custom Digital Mod..... | 341 |
| 5.9.3.3 Coding - Custom Digital Mod..... | 345 |
| 5.9.3.4 Baseband Filter - Custom Digital Mod..... | 348 |

| | | |
|-------------|---|------------|
| 5.9.3.5 | Conflicting Settings - Custom Digital Mod..... | 353 |
| 5.9.3.6 | Custom Digital Mod User Interface..... | 353 |
| 5.9.4 | Arbitrary Waveform Generator ARB..... | 382 |
| 5.9.4.1 | Introduction..... | 382 |
| 5.9.4.2 | ARB User Interface..... | 387 |
| 5.9.4.3 | Multi Segment Waveforms..... | 410 |
| 5.9.4.4 | Multi Carrier Waveforms..... | 426 |
| 5.9.4.5 | Waveform and List Format..... | 439 |
| 5.9.5 | Multi Carrier Continuous Wave..... | 464 |
| 5.9.5.1 | Multi Carrier CW User Interface..... | 464 |
| 5.10 | External Baseband Signal - Baseband Input..... | 478 |
| 5.10.1 | Important Signal Parameters..... | 479 |
| 5.10.2 | BB Input Block..... | 481 |
| 5.10.2.1 | Baseband Input Settings Menu..... | 481 |
| 5.10.2.2 | Frequency and Phase Offset..... | 485 |
| 6 | Remote Control Basics..... | 487 |
| 6.1 | Remote Control Interfaces and Protocols..... | 487 |
| 6.1.1 | VISA Libraries..... | 488 |
| 6.1.2 | Messages..... | 488 |
| 6.1.3 | LAN Interface..... | 489 |
| 6.1.3.1 | HiSLIP Protocol..... | 491 |
| 6.1.3.2 | VXI-11 Protocol..... | 491 |
| 6.1.3.3 | Socket Communication..... | 491 |
| 6.1.3.4 | LAN Interface Messages..... | 492 |
| 6.1.4 | USB Interface..... | 492 |
| 6.1.5 | Serial Interface..... | 493 |
| 6.1.6 | GPIB Interface (IEC/IEEE Bus Interface)..... | 493 |
| 6.1.6.1 | GPIB Interface Messages..... | 494 |
| 6.1.6.2 | GPIB Instrument Address..... | 495 |
| 6.1.7 | LXI Browser Interface..... | 495 |
| 6.2 | Starting a Remote Control Session..... | 496 |
| 6.2.1 | Switching to Remote Control..... | 496 |
| 6.2.2 | Returning to Manual Operation..... | 497 |

| | | |
|------------|---|------------|
| 6.2.3 | Examples..... | 498 |
| 6.2.3.1 | Remote Control over GPIB..... | 498 |
| 6.2.3.2 | Remote Control over LAN using VXI-11 Protocol..... | 499 |
| 6.2.3.3 | Remote Control over LAN using Socket Communication..... | 504 |
| 6.3 | SCPI Command Structure..... | 511 |
| 6.3.1 | Syntax for Common Commands..... | 512 |
| 6.3.2 | Syntax for Device-Specific Commands..... | 512 |
| 6.3.2.1 | Long and short form..... | 513 |
| 6.3.2.2 | Numeric Suffixes..... | 513 |
| 6.3.2.3 | Optional Mnemonics..... | 513 |
| 6.3.3 | SCPI Parameters..... | 514 |
| 6.3.3.1 | Numeric Values..... | 514 |
| 6.3.3.2 | Special Numeric Values..... | 515 |
| 6.3.3.3 | Boolean Parameters..... | 516 |
| 6.3.3.4 | Text Parameters..... | 516 |
| 6.3.3.5 | Character Strings..... | 516 |
| 6.3.3.6 | Block Data..... | 516 |
| 6.3.4 | Overview of Syntax Elements..... | 517 |
| 6.3.5 | Structure of a Command Line..... | 518 |
| 6.3.6 | Responses to Queries..... | 519 |
| 6.4 | Command Sequence and Synchronization..... | 520 |
| 6.4.1 | Preventing Overlapping Execution..... | 521 |
| 6.5 | Status Reporting System..... | 522 |
| 6.5.1 | Hierarchy of the Status Registers..... | 522 |
| 6.5.2 | Structure of a SCPI Status Register..... | 524 |
| 6.5.3 | Status Byte (STB) and Service Request Enable Register (SRE)..... | 526 |
| 6.5.4 | Event Status Register (ESR) and Event Status Enable Register (ESE)..... | 527 |
| 6.5.5 | Questionable Status Register (STATus:QUEStionable)..... | 528 |
| 6.5.6 | Operation Status Register (STATus:OPERation)..... | 528 |
| 6.5.7 | Application of the Status Reporting System..... | 528 |
| 6.5.7.1 | Service Request..... | 529 |
| 6.5.7.2 | Serial Poll..... | 529 |
| 6.5.7.3 | Query of an instrument status..... | 529 |

| | | |
|-------------|---|------------|
| 6.5.7.4 | Error Queue..... | 530 |
| 6.5.8 | Reset Values of the Status Reporting System..... | 530 |
| 6.6 | General Programming Recommendations..... | 531 |
| 7 | Remote Control Commands..... | 532 |
| 7.1 | Conventions used in SCPI Command Descriptions..... | 532 |
| 7.2 | Common Commands..... | 533 |
| 7.3 | Preset Commands..... | 537 |
| 7.4 | BERT and BLER Subsystems..... | 539 |
| 7.5 | CALibration Subsystem..... | 550 |
| 7.6 | CLOCK Subsystem..... | 554 |
| 7.7 | DIAGnostic Subsystem..... | 555 |
| 7.8 | DISPlay Subsystem..... | 557 |
| 7.9 | FORMat Subsystem..... | 560 |
| 7.10 | HCOPY Subsystem..... | 561 |
| 7.11 | KBOard Subsystem..... | 567 |
| 7.12 | MMEMory Subsystem..... | 567 |
| 7.12.1 | File Naming Conventions..... | 568 |
| 7.12.2 | Extensions for User Files..... | 569 |
| 7.12.3 | Examples..... | 571 |
| 7.12.4 | Remote Control Commands..... | 572 |
| 7.13 | OUTPut Subsystem..... | 580 |
| 7.14 | SENSe, READ and INITiate Subsystems..... | 583 |
| 7.15 | SOURce Subsystem..... | 595 |
| 7.15.1 | SOURce:AM Subsystem..... | 595 |
| 7.15.2 | SOURce:AWGN Subsystem..... | 597 |
| 7.15.3 | SOURce:BB Subsystem..... | 605 |
| 7.15.3.1 | SOURce:BB Subsystem General Commands..... | 606 |
| 7.15.3.2 | SOURce:BB:ARB Subsystem..... | 606 |
| 7.15.3.3 | SOURce:BB:DM Subsystem..... | 654 |
| 7.15.3.4 | SOURce:BB:GRAPhics Subsystem..... | 692 |
| 7.15.3.5 | SOURce:BB:IMPairment Subsystem..... | 694 |
| 7.15.3.6 | SOURce:BB:MCCW Subsystem..... | 698 |
| 7.15.3.7 | SOURce:BB:PROGress Subsystem General Commands..... | 720 |

| | | |
|-------------|--|------------|
| 7.15.4 | SOURce:BBIN Subsystem..... | 721 |
| 7.15.5 | SOURce:CORRection Subsystem..... | 727 |
| 7.15.6 | SOURce:FM Subsystem..... | 736 |
| 7.15.7 | SOURce:FREQuency Subsystem..... | 739 |
| 7.15.8 | SOURce:INPut Subsystem..... | 747 |
| 7.15.9 | SOURce:IQ Subsystem..... | 750 |
| 7.15.10 | SOURce:IQ:OUTput Subsystem..... | 754 |
| 7.15.10.1 | Analog I/Q Outputs..... | 754 |
| 7.15.10.2 | Digital I/Q Outputs..... | 757 |
| 7.15.11 | SOURce:LFOutput Subsystem..... | 762 |
| 7.15.12 | SOURce:LIST Subsystem..... | 772 |
| 7.15.13 | SOURce:MODulation Subsystem..... | 784 |
| 7.15.14 | SOURce:PGEN Subsystem..... | 785 |
| 7.15.15 | SOURce:PHASe Subsystem..... | 786 |
| 7.15.16 | SOURce:PM Subsystem..... | 786 |
| 7.15.17 | SOURce:POWer Subsystem..... | 790 |
| 7.15.18 | SOURce:PULM Subsystem..... | 800 |
| 7.15.19 | SOURce:ROSCillator Subsystem..... | 807 |
| 7.15.20 | SOURce:SWEep Subsystem..... | 810 |
| 7.16 | STATus Subsystem..... | 821 |
| 7.17 | SYSTem Subsystem..... | 825 |
| 7.18 | TEST Subsystem..... | 845 |
| 7.19 | TRIGger Subsystem..... | 848 |
| 7.20 | UNIT Subsystem..... | 854 |
| 8 | Maintenance..... | 855 |
| 8.1 | Cleaning..... | 855 |
| 8.2 | Storing and Packing..... | 856 |
| 9 | Status Information, Error Messages and Troubleshooting..... | 857 |
| 9.1 | Status Information..... | 857 |
| 9.1.1 | Status information displayed between the frequency and level fields..... | 857 |
| 9.1.2 | Status information displayed to the left of the Info line..... | 859 |
| 9.1.3 | Status information displayed in the Info line..... | 859 |
| 9.2 | Error Messages..... | 860 |

| | | |
|------------|---|------------|
| 9.2.1 | Volatile messages..... | 861 |
| 9.2.2 | Permanent messages..... | 861 |
| 9.3 | SCPI-Error Messages..... | 861 |
| 9.4 | Device-Specific Error Messages..... | 861 |
| 9.5 | Resolving Network Connection Failures..... | 863 |
| 9.6 | Obtaining Technical Support..... | 864 |
| | Annex..... | 866 |
| A | Hardware Interfaces..... | 866 |
| A.1 | GPIB Bus Interface..... | 866 |
| | List of Commands..... | 868 |
| | Index..... | 885 |

1 Preface

1.1 For Your Safety

The R&S SMBV is designated for the development, production and verification of electronic components and devices in industrial and laboratory environments. Use the R&S SMBV only for its designated purpose. Observe the operating conditions and performance limits stated in the data sheet.

The product documentation helps you to use the R&S SMBV safely and efficiently. Keep the product documentation in a safe place and pass it on to the subsequent users.

Safety information is part of the product documentation. It warns you about the potential dangers and gives instructions how to prevent personal injury or damage caused by dangerous situations. Safety information is provided as follows:

- In the "Basic Safety Instructions", safety issues are grouped according to subjects. For example, one subject is electrical safety. The "Basic Safety Instructions" are delivered with the R&S SMBV in different languages in print.
- Throughout the documentation, safety instructions are provided when you need to take care during setup or operation. Always read the safety instructions carefully. Make sure to comply fully with them. Do not take risks and do not underestimate the potential danger of small details such as a damaged power cable.

1.2 Documentation Overview

This section provides an overview of the R&S SMBV user documentation. Unless specified otherwise, you find the documents on the R&S SMBV product page at:

www.rohde-schwarz.com/manual/smbv100a

1.2.1 Quick Start Guide Manual

Introduces the R&S SMBV and describes how to set up and start working with the product. Includes basic operations, typical measurement examples, and general information, e.g. safety instructions, etc. A printed version is delivered with the instrument.

1.2.2 Operating Manual and Help

Separate manuals for the base unit and the software options are provided for download:

- Base unit manual

Contains the description of all instrument modes and functions. It also provides an introduction to remote control, a complete description of the remote control commands with programming examples, and information on maintenance, instrument interfaces and error messages. Includes the contents of the quick start guide manual.

- **Software option manual**
Contains the description of the specific functions of an option. Basic information on operating the R&S SMBV is not included.

The contents of the user manuals are available as help in the R&S SMBV. The help offers quick, context-sensitive access to the complete information for the base unit and the software options.

All user manuals are also available for download or for immediate display on the Internet.

1.2.3 Service Manual

Describes the performance test for checking the rated specifications, module replacement and repair, firmware update, troubleshooting and fault elimination, and contains mechanical drawings and spare part lists.

The service manual is available for registered users on the global Rohde & Schwarz information system (GLORIS, <https://gloris.rohde-schwarz.com>).

1.2.4 Instrument Security Procedures

Deals with security issues when working with the R&S SMBV in secure areas. It is available for download on the Internet.

1.2.5 Basic Safety Instructions

Contains safety instructions, operating conditions and further important information. The printed document is delivered with the instrument.

1.2.6 Data Sheets and Brochures

The data sheet contains the technical specifications of the R&S SMBV. It also lists the options and their order numbers and optional accessories.

The brochure provides an overview of the instrument and deals with the specific characteristics.

See www.rohde-schwarz.com/brochure-datasheet/smbv100a

1.2.7 Release Notes and Open Source Acknowledgment (OSA)

The release notes list new features, improvements and known issues of the current firmware version, and describe the firmware installation.

The open source acknowledgment document provides verbatim license texts of the used open source software.

See www.rohde-schwarz.com/firmware/smbv100a

1.2.8 Application Notes, Application Cards, White Papers, etc.

These documents deal with special applications or background information on particular topics.

See www.rohde-schwarz.com/application/smbv100a.

1.3 Notes on Screenshots

When describing the functions of the product, we use sample screenshots. These screenshots are meant to illustrate as many as possible of the provided functions and possible interdependencies between parameters. The shown values may not represent realistic usage scenarios.

The screenshots usually show a fully equipped product, that is: with all options installed. Thus, some functions shown in the screenshots may not be available in your particular product configuration.

2 Preparing for Use

The following topics help you to get familiar with the instrument and perform the first steps:

- [Front Panel Tour](#)
- [Rear Panel Tour](#)
- [Putting into Operation](#)

This section explains the control elements and connectors of the Signal Generator R&S SMBV with the aid of the front and rear views and describes how to put the instrument into operation. It also describes the connection of peripherals such as printer, keyboard or mouse. Specifications of interfaces can be found in the data sheet.

The [Chapter 3, "Getting Started"](#), on page 63 of this manual provides an overview of the generator functions and introduces the operating concept. Detailed operating instructions and an overview of menus follow in [Chapter 4, "Manual Operation"](#), on page 76.

For all reference information concerning manual and remote control of the instrument, refer to the online help system or its printed/printable version. A more detailed description of the hardware connectors and interfaces is also part of the help system.

2.1 Front Panel Tour

The front panel of the R&S SMBV consists of the VGA display, some utility keys (left side) and the hardkey area with connectors and control interfaces (right side). The subsequent sections provide brief explanations on the controls and connectors, the hardkey area and the front panel.



For more detailed information, refer to the corresponding description in the Operating Manual.

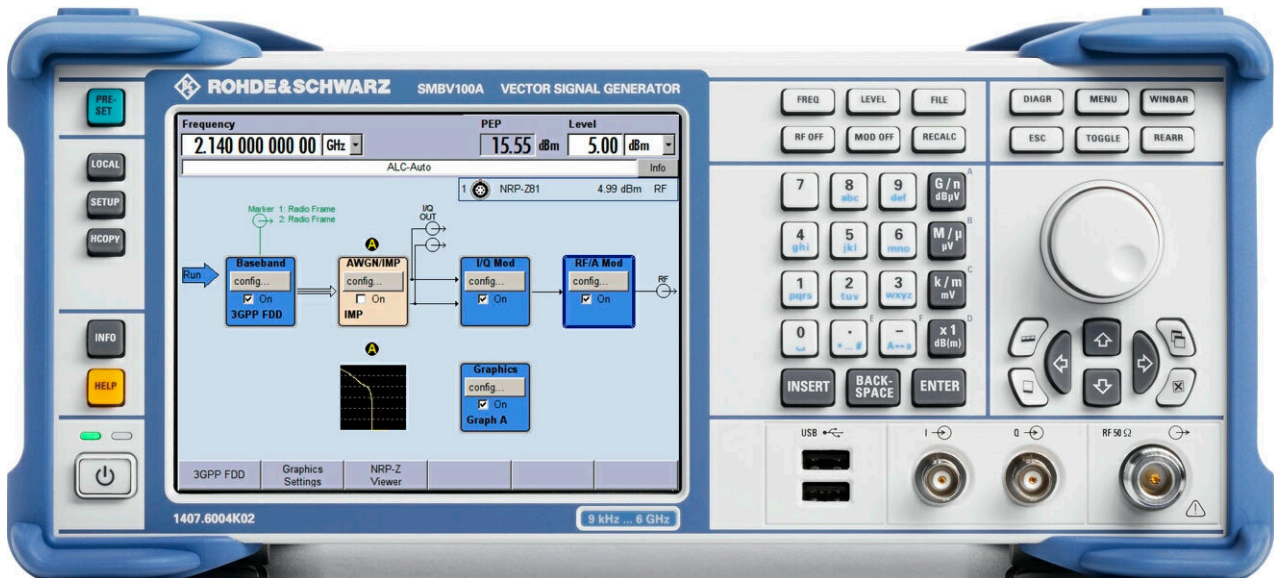

Figure 2-1: Front panel view

2.1.1 Utility Keys



The keys to the left of the display cause the R&S SMBV to return to a definite instrument state and provide information on the instrument and assistance.

For more information refer to chapter "Instrument Settings" in the Operating Manual.

[PRESET]

Sets the instrument to a defined state (see [Chapter 2.3.5.4, "Default Settings"](#), on page 38).

[LOCAL]

Switches from remote control to local (manual) control.

[SETUP]

Opens the "Setup" dialog for configuring presettings.

[HCOPIY]

Opens the "Hardcopy" menu for configuring and starting printing.

INFO

Displays status messages, error messages and warnings.

[HELP]

Displays context-sensitive help text.

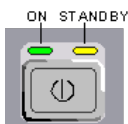
2.1.2 Standby LEDs and Standby Key

The standby LEDs and the [ON/STANDBY] key are located in the bottom left corner of the front panel.

The [ON/STANDBY] key toggles the instrument between standby and ready state (indicated by the standby LEDs).

The standby LEDs indicate the instrument states as follow:

- the green LED (left) is on when the instrument is ready for operation,
- the yellow LED (right) is on in the standby mode.

See also [Chapter 2.3.5.1, "Standby and Ready state"](#), on page 37.

2.1.3 Display

The display clearly shows all main settings and signal generator states.

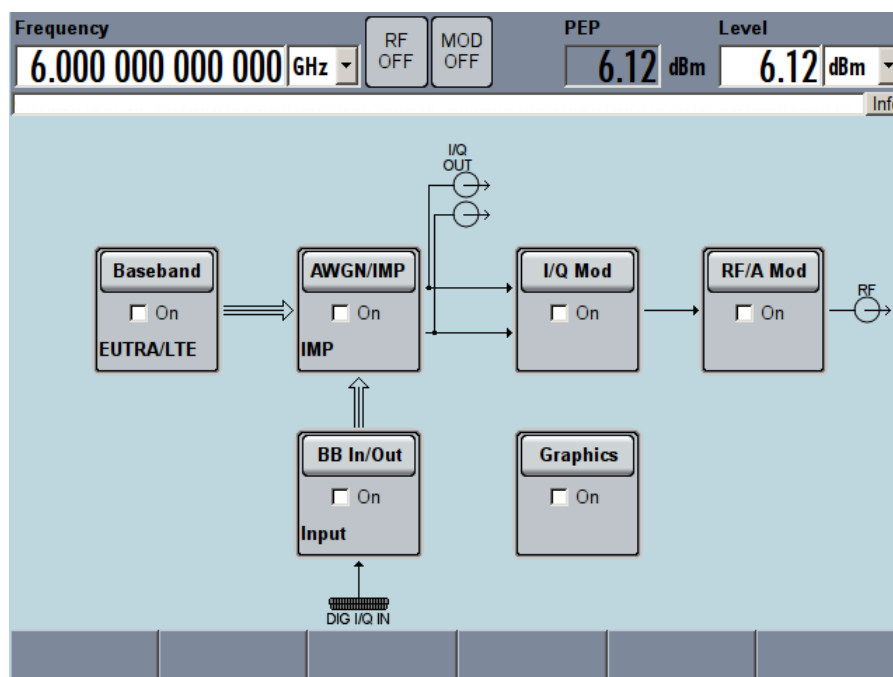



The display of the latest R&S SMBV Vector Signal Generators appears in slightly different colors, since these instruments are equipped with a new base board version. The functionality does not change. Therefore, images in this manual show the block diagram as before.

On the color of the display, you can see at a glance which version of the base board is installed in your instrument. Alternatively, see the "Instrument Function > General Configuration of Instrument - Setup Key > Hardware Config" in the operating manual for information on the baseboard version of your instrument.

Table 2-1: Display of instruments with current and previous baseboard versions

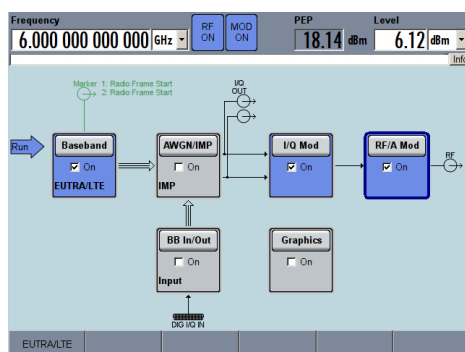

New base board (part number 1406.6900.02)

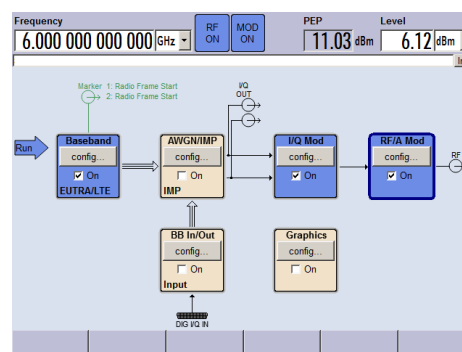

Former base board (part number 1406.6700.02)

The display is divided into the following sections:

- Frequency and level display with info line
 - Frequency and level settings containing offset and peak envelope power (PEP).
 - Status messages
 - Brief error messages.
To access an window with detailed information for a message, use the [INFO] key.
- Block diagram

The block diagram shows the current configuration and the signal flow in the generator with the aid of function blocks containing an on/off switch. Selecting a function block opens a list of associated setting menus. Active menus, info windows and graphs are displayed on top of the block diagram. The block diagram can be displayed in the foreground anytime with the [DIAGRAM] key.
- "Winbar" with labelled softkeys

Open menus are indicated by a labelled button in the "Winbar". The buttons determine the softkey functions for front-panel control. When a button or softkey is pressed, the associated menu is displayed either in the foreground or minimized in the "Winbar".

If required, the [Winbar] is covered by a row of buttons to which menu-specific functions of the active menu are assigned. By pressing the [WINBAR] key, the "Winbar" can be displayed in the foreground again. This allows the user to toggle between the button and softkey functions.

For detailed information, see [Chapter 4.2, "Display"](#), on page 81.

2.1.4 Setup Keys

The keys to the right of the display set parameters, select views and control the windows.

2.1.4.1 Keys for Setting Parameters

These keys provide direct access to the settings in the header of the instrument and can be used for fast changing the state of the modulation and the RF signal.



For more information refer to chapter "Instrument Functions" in the Operating Manual.

[FREQ]

Activates frequency entry.

[RF ON/OFF]

Switches the RF signal on and off.

"RF OFF" is displayed in the header next to the "Frequency" field.

[LEVEL]

Activates level entry.

[MOD ON/OFF]

Switches the modulations on and off.

"MOD OFF" is displayed in the info line of the header next to the "Level" field.

[File]

Activates the menu for storing or loading files (see [Chapter 4.7, "File Management"](#), on page 105).

[RECALCULATE]

Starts the recalculation of instrument settings.

If time-consuming calculations are required, the active modulation is automatically switched off and the calculation is interrupted to allow the user to make further settings. Calculation is restarted by a keystroke and the modulation is switched on again after the calculation is completed.

2.1.4.2 Display Keys

The keys on top of the rotary knob and the keys below the numeric key pad arrange different windows on the display.



[DIAGRAM]

Brings the block diagram to the foreground. Active menus are minimized.

Active menus are indicated by the buttons in the "Winbar".

[ESC]

The function of this key depends on the current cursor position.

- Calls the next higher selection level.
- Closes the open window without accepting new entries; the old value or parameter is retained.
- In dialog boxes that contain a "Cancel" button it activates that button.
- Closes all kinds of dialog boxes, if the edit mode is not active.
- Quits the edit mode, if the edit mode is active.
- Switches between different entry fields of a menu.
- Shifts the entry cursor from the header display to the previously active menu, or to the previously highlighted block in the block diagram if no menu is active.
- Shifts the cursor from a function block in the diagram to the first item in the "Winbar". If no menus are open, the current cursor position remains unchanged.

[TOGGLE]

- Switches highlighted elements or a function block on and off.
- Switches between two or more settings, e.g. items of selection lists. At the end of a list, the cursor is set on the first entry again.

[MENU]

Calls the menu tree.

[CLOSE]

Closes the active menu.

- If the entry mode is active, changes are cancelled.
- If settings in this menu require acknowledgment by means of an "Accept" button, a query is displayed asking whether the changes made should be cancelled.

[HIDE]

Minimizes the active open menu. The associated button in the "Winbar" remains visible.

[REARR]

Adjusts the size of the active menu to use the whole height of the display.

[WINBAR]

Toggles between the active menus.

2.1.5 Keypad for data entry

The keys in the data entry keypad are used to enter alphanumeric data and units.

Data entry keys are only enabled while the cursor is placed on a data input field in a dialog. Their function depends on the data type of the input field.



| Keys | Description |
|------------------|--|
| 0...9/abc | Enters the corresponding numbers (in numeric input fields) or characters (character input fields). |
| . | Inserts a decimal point (numeric input fields) or dot (character input fields) at the cursor position. Multiple decimal points are not allowed. |
| +/- | Changes the sign of a numeric parameter. In the case of an alphanumeric parameter, inserts a hyphen at the cursor position. |
| Unit keys | Selects a unit and thus determine the absolute value, or changes the unit, i.e. trigger a recalculation without changing the absolute value. The function depends on the time at which the [Unit] key is used during parameter entry (see Chapter 4.4.5, "Working with Units" , on page 94). For unit-free values, the [x1] key is equivalent to [ENTER]. It confirms the previous entry and deactivates the input field. |
| _ | Adds a blank in a character input field. |
| *... # | Enters special characters. Toggles through the available characters if the key is pressed several times in a row. |
| A <-> a | Toggles between uppercase and lowercase characters. |
| A, B, C, D, E, F | Enters hexadecimal values. The letters assigned to the keys are automatically active when an entry field with a hexadecimal value is active. |

[INSERT]

Toggles between insert and overwrite mode (see also [Chapter 4.4.4, "Entering a Value"](#), on page 92).

[BACKSPACE]

Deletes the last character before the cursor position or the selected character sequence.

[ENTER]

Pressing the rotary knob has the same effect.

- Concludes the entry of dimensionless entries. For other entries, this key can be used instead of the default unit key. The new value is accepted.
- Confirms ("OK") and closes open input windows.
- In a dialog box, selects the default or focused button.
- In a dialog box, activates the edit mode for the focused area, if available.
- In a dialog box, activates or deactivates the selected option of the focused area, if the edit mode is active.
- Calls the next menu level.

2.1.6 Rotary Knob and Navigation Keys

The rotary knob and the arrow keys are alternative control elements for data variation and navigation in the graphical user interface.

**[Rotary Knob]**

The rotary knob has several functions:

- Increases (clockwise direction) or decreases (counter-clockwise direction) numeric values at a defined step width in editing mode
- Moves the cursor, e.g. to a function block in the block diagram
- Scrolls within lists, tables or tree views
- Acts like the [ENTER] key, when it is pressed.
- Shifts the selection bar within focused areas (e.g. lists), if the edit mode is activated.

Note: Turning or pressing the rotary knob is equivalent to pressing the [Up] and [Down] keys or the [ENTER] key in the keypad.

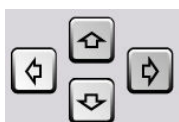
**[Navigation Keys]**

The navigation keys consist of 4 arrow keys which are used for navigation, alternatively to the rotary knob.

[UP/ DOWN
Keys]

The up and down arrow keys do the following:

- In a numeric edit dialog box, increase or decrease the instrument parameter.
- In a list, table, window or dialog box, scroll vertically.

[LEFT/ RIGHT
Keys]

The left and right arrow keys do the following:

- In an alphanumeric edit dialog box, move the cursor forward and back.
- In a list, table, window or dialog box, scroll horizontally.

2.1.7 Front Panel Connectors

The RF and I/O connectors and various additional interface connectors are located on the front panel.

[I , Q]

I and Q inputs for the external analog modulation signal in case of I/Q modulation.

For more information see:

- chapter "Data and Signal Sources in Baseband" in the Operating Manual

**[RF output]**

Outputs for the RF signal.

NOTICE! Maximum Input Levels. Do not overload the RF output.

The instrument is equipped with a reverse power protection that prevents the RF output against back feed, see section "Reverse Power Protection" in the operating manual. However, the maximum permissible reverse power is specified in the data sheet.

The RF signal is output via an N female connector.

NOTICE! Risk of RF connector and cable damage. If you tighten the connectors too strongly, you can damage the cables and connectors. If you do not tighten the connectors enough, the measurement results can be inaccurate.

Always use an appropriate torque wrench suitable for this type of connector and apply the torque specified in the application note [1MA99](#).

The application notes are available on the Internet and provide additional information on care and handling of RF connectors.

Rohde & Schwarz offers appropriate torque wrenches for various connectors. For ordering information, see the R&S SMBV data sheet or product brochure.

**[USB]**

USB (universal serial bus) interfaces of type A (host USB).

- Connection of peripherals such as mouse or keyboard
- Connection of memory stick for file transmission
- Firmware update

Note: Another USB interface type A (host USB) and a USB interface type B (device USB for data transmission) are available on the rear panel.

See also [Chapter 2.4.1, "Connecting USB Devices"](#), on page 40.

2.2 Rear Panel Tour

This section gives an overview of connectors on the rear panel of the instrument. Each connector is briefly described and a reference is given to the chapters containing detailed information. For technical data of the connectors refer to the data sheet.



For more detailed information, refer to the corresponding description in the Operating Manual.



Figure 2-2: Rear panel view

2.2.1 Description of the Connectors



[I OUT / Q OUT]

Direct output or Differential (non-inverting) output for analog I/Q signal.

[I OUT BAR / Q OUT BAR]



Differential (inverting) output for analog I/Q signal.



[MARKER 1, 2]

Outputs 1 and 2 for triggering and control of external devices with user-definable marker signals.

For more information see section "Global Trigger/Clock/Input Settings" in the Operating Manual.



[USB IN]

USB (universal serial bus) interface of type B (device USB).

This interface can be used for remote control of the instrument.



[USB Connectors type A]

USB (universal serial bus) interfaces of type A (host USB).

- Connection of peripherals such as mouse, keyboard, etc.
- Connection of memory stick for file transmission

- Firmware update

Further USB interface type A are available on the front panel.

See also [Chapter 2.4.1, "Connecting USB Devices"](#), on page 40.



[DIGITAL IQ IN/OUT]

Connector for the input/output of a digital I/Q signal from/to an R&S instrument, like a signal generator, analyzer or the R&S EX-IQ-BOX. The interface requires option R&S SMBV-K18, Digital Baseband Connectivity.

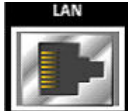

[LAN Connector]

Ethernet interface

- For integrating signal generators in a network
- Remote control of signal generator
- Remote access to the signal generator
- Firmware update

See also:

- [Chapter 2.6, "Setting Up a Network \(LAN\) Connection"](#), on page 43
- chapter "Remote Control Basics" in the Operating Manual

[Hard disc]

With respect to security concerns the hard disk can be removed from the instrument, but it is bound to the specific R&S SMBV. Therefore it cannot be changed between different instruments.

NOTICE! Risk of instrument damage and data loss!. During operation the instrument is accessing the hard disk. Removing the hard disk while operating will lead to data loss or even instrument damage.

Do not remove the hard disk during operation.



[CLOCK OUT]

Output for internal clock signal.

While working in synchronous master\slave mode, the system clock is output on this connector.



[CLOCK IN]

Input for the external (symbol) clock signal for synchronizing the external data signal and working in synchronous master-slave mode.

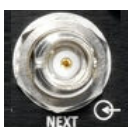

[NEXT]

This trigger input indicates the next (i.e. the 2nd, 3rd, 4th, ...) segment of a multi segment waveform, which can be a compound of e.g. a sine, a rectangular, or a sawtooth signal.



[TRIGGER]

Input for external triggering of digital modulations and standards and ARB and the external trigger in synchronous master\slave mode.

[SENSOR]

Connector for R&S NRP-Zxx sensors.

With the aid of the "User Correction" function, a table with correction values for external test assemblies can be automatically determined, e.g. for compensating the frequency response of cables.

The power sensors are connected by inserting the male connector. To disconnect hold the connector by its sleeve. Pulling on the sensor cable will not release the sensor connector.

**[LO IN, LO OUT]**

Local oscillator input and output:

- [LO IN]: Input for external LO signals
- [LO OUT]: Output for internal LO signals.

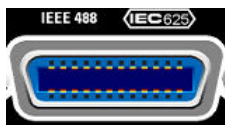
**[IEC 625/IEEE 488]**

IEC-bus (IEEE 488) interface for remote control of the instrument.

See also [Chapter A.1, "GPIB Bus Interface"](#), on page 866 and chapter "Remote Control Basics" in the Operating Manual.

Note: In order to avoid electromagnetic interference (EMI) caused by open lines, always terminate any connected IEC-bus cable with an instrument or a controller.

**[SIGNAL VALID]**

Output of valid signal. This signal marks the valid signal times (valid level and frequency indication). The signal is generated automatically.

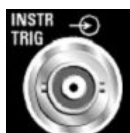
**[INSTR TRIG]**

Input for external trigger of sweeps and list mode.

**[PULSE VIDEO]**

Output of internal pulse generator signal or external pulse signal fed in via the [PULSE EXT] connector (video signal).

**[PULSE EXT]**

Input of external pulse signal or input of external trigger/gate signal for internal pulse generator.

**[REF OUT]**

Output of internal reference signal.

**[REF IN]**

Input for external reference signal.

[OCXO]

Oven-controlled reference oscillator (option R&S SMBV-B1)

The OCXO generates a very precise 10 MHz reference signal. It needs some minutes of warm-up time to reach its nominal frequency.

Refer also to the data sheet for detailed information.

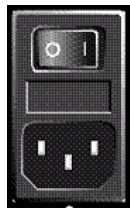
**[AC supply and power switch]**

When the R&S SMBV is connected to the AC supply, it automatically sets itself to the correct range for the applied voltage (range: see type label). There is no need to set the voltage manually or change fuses.

The instrument comes with or without a power switch, depending on the design of the otherwise technically equivalent power supply unit.

The power switch can be set to two positions:

- 0
The instrument is disconnected from the mains.
- I
The instrument is power-supplied. It is either ready for operation (STANDBY) or in operating mode, depending on the position of the [ON/STANDBY] switch on the instrument front.

See also data sheet and [Chapter 2.3.4, "Connecting the Instrument to the AC Supply"](#), on page 36.

**[EXT MOD]**

Input for external analog modulation signals.

**[LF]**

Output for internal LF modulation generator signal.

See also data sheet and Operating Manual, section "LF Generator and LF Output".

[Fuses]

The R&S SMBV is fully fused by two fuses IEC60127-T3.15H/250 V.

The fuses are accommodated in the fuse holders next to the power connector. Use only fuses of the mentioned type.

CAUTION! Danger of shock hazard!. Before replacing the fuses, disconnect the power cord from the R&S SMBV.

2.3 Putting into Operation

This section describes the basic steps to be taken when setting up the R&S SMBV for the first time.

⚠ WARNING**Risk of injury due to disregarding safety information**

Observe the information on appropriate operating conditions provided in the data sheet to prevent personal injury or damage to the instrument. Read and observe the basic safety instructions provided with the instrument, in addition to the safety instructions in the following sections. In particular:

- Do not open the instrument casing.

NOTICE**Risk of instrument damage due to inappropriate operating conditions**

Specific operating conditions are required to ensure accurate measurements and to avoid damage to the instrument. Observe the information on appropriate operating conditions provided in the basic safety instructions and the instrument's data sheet.

NOTICE**Instrument damage caused by electrostatic discharge**

Electrostatic discharge (ESD) can damage the electronic components of the instrument and the device under test (DUT). Electrostatic discharge is most likely to occur when you connect or disconnect a DUT or test fixture to the instrument's test ports. To prevent electrostatic discharge, use a wrist strap and cord and connect yourself to the ground, or use a conductive floor mat and heel strap combination.

NOTICE**Risk of instrument damage due to inappropriate operating conditions**

An unsuitable operating site or test setup can damage the instrument and connected devices. Before switching on the instrument, observe the information on appropriate operating conditions provided in the data sheet. In particular, ensure the following:

- All fan openings are unobstructed and the airflow perforations are unimpeded. A minimum distance of 10 cm to other objects is recommended.
- The instrument is dry and shows no sign of condensation.
- The instrument is positioned as described in the following sections.
- The ambient temperature does not exceed the range specified in the data sheet.
- Signal levels at the input connectors are all within the specified ranges.
- Signal outputs are connected correctly and are not overloaded.

2.3.1 EMI Suppression

Electromagnetic interference (EMI) may affect the measurement results.

To suppress generated Electromagnetic Interference (EMI),

- Use suitable shielded cables of high quality. For example use double-shielded RF, BNC and LAN cables (CAT6 STP).
Note: USB cables are of varying and often poor quality. Therefore, check the quality of each individual USB cable as described in the service manual.
- Always terminate open cable ends.
- Use the cable R&S SMU-Z6 for connection to the DIG I/Q interfaces of the instrument. The required cable is available under part number 1415.0201.02.

Note the EMC classification in the data sheet.

2.3.2 Unpacking and Checking the Instrument

To remove the instrument from its packaging and check the equipment for completeness, proceed as follows:

1. Pull off the polyethylene protection pads from the instrument's rear feet.
2. Carefully remove the pads from the instrument handles at the front.
3. Pull off the corrugated cardboard cover that protects the rear of the instrument.
4. Carefully unthread the corrugated cardboard cover at the front that protects the instrument handles and remove it.
5. Check the equipment for completeness using the delivery note and the accessory lists for the various items.
6. Check the instrument for any damage. If there is damage, immediately contact the carrier who delivered the instrument. Make sure not to discard the box and packing material.



Packing material

Retain the original packing material. If the instrument needs to be transported or shipped later, you can use the material to protect the control elements and connectors.

2.3.3 Placing or Mounting the Instrument

The R&S SMBV is designed for use under laboratory conditions, either on a bench top or in a rack using a rack adapter kit (order number see data sheet).

Bench Top Operation

If the R&S SMBV is operated on a bench top, the surface should be flat. The instrument can be used in horizontal position, standing on its feet, or with the support feet on the bottom extended.

⚠ WARNING**Risk of injury if feet are folded out**

The feet can fold in if they are not folded out completely or if the instrument is shifted. Collapsing feet can cause injury or damage the instrument.

- Fold the feet completely in or out to ensure stability of the instrument. Never shift the instrument when the feet are folded out.
- When the feet are folded out, do not work under the instrument or place anything underneath.
- The feet can break if they are overloaded. The overall load on the folded-out feet must not exceed 500 N.

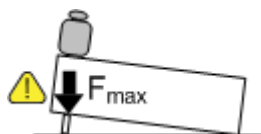
**⚠ WARNING****Risk of injury when stacking instruments**

A stack of instruments can tilt over and cause injury if not stacked correctly. Furthermore, the instruments at the bottom of the stack can be damaged due to the load imposed by the instruments on top.

Observe the following instructions when stacking instruments:

- Never stack more than three instruments. If you need to stack more than three instruments, install them in a rack.
- The overall load imposed on the lowest instrument must not exceed 500 N.
- It is best if all instruments have the same dimensions (width and length). If you need to stack smaller instruments on the top, the overall load imposed on the lowest instrument must not exceed 250 N.
- If the instruments have foldable feet, fold them in completely.

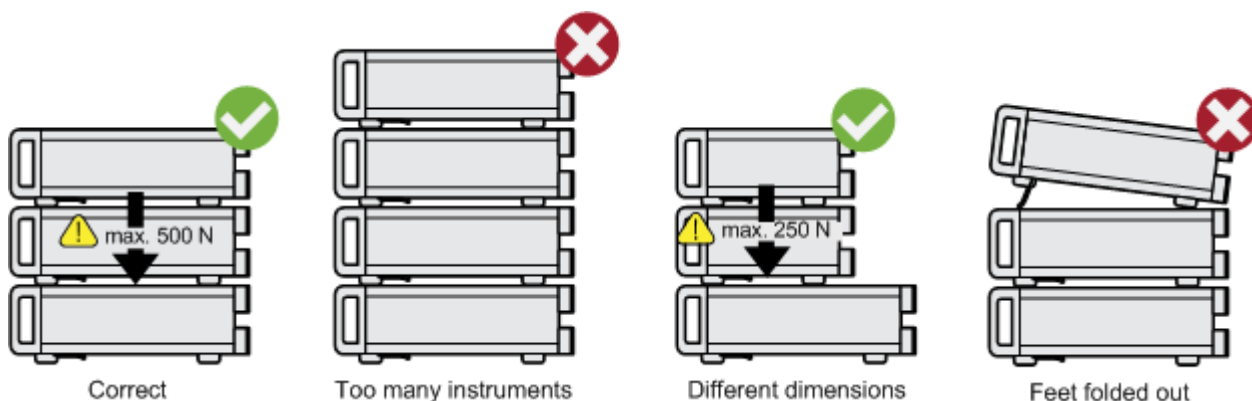

Rackmounting

The R&S SMBV can be installed in a rack using a rack adapter kit (Order No. see data sheet). The installation instructions are part of the adapter kit.

NOTICE

Risk of instrument damage due to insufficient airflow in a rack

If you mount several instruments in a rack, you need an efficient ventilation concept to ensure that the instruments do not overheat. Insufficient airflow for a longer period can disturb the operation and even cause damage.

2.3.4 Connecting the Instrument to the AC Supply

The R&S SMBV is automatically adapted to the AC voltage supplied. There is no need to set the voltage manually or change fuses. The [AC supply and power switch] is at the rear of the unit.

- ▶ Connect the instrument to the AC power source using the AC power cable delivered with the instrument.

Note: The instrument is in compliance with safety class EN61010-1. Connect the instrument only to a socket with earthing contact.

2.3.5 Starting the Instrument

The R&S SMBV comes with or without a power switch, depending on the design of the otherwise technically equivalent power supply unit.



Switching off the AC power

You can leave the AC power on permanently to preserve your last instrument settings. Switching off is required only if the instrument must be completely disconnected from all power supplies.

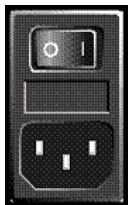

Starting up instruments with power switch

1. [Connect the instrument to the AC supply.](#)
2. To turn the power on, press the main power switch to position I (On).
After power-up, the instrument is in [standby or ready state](#), depending on the state of the [ON/STANDBY] key at the front panel of the instrument when the instrument was switched off for the last time.
3. In case the instrument is in standby mode, i.e. the yellow LED is on, press the [ON/STANDBY] key to switch the instrument to ready state.



Starting up instruments without power switch

1. [Connect the instrument to the AC supply.](#)

After connection to the AC supply, the instrument is in [standby or ready state](#), depending on the state of the [ON/STANDBY] key at the front panel of the instrument when the instrument was switched off for the last time.

2. In case the instrument is in standby mode, i.e. the yellow LED is on, press the [ON/STANDBY] key to switch the instrument to ready state.

2.3.5.1 Standby and Ready state

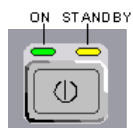

The [ON/STANDBY] key is located in the bottom left corner of the front panel.

Switching between standby and ready state

- ▶ Press the [ON/STANDBY] key briefly to switch the instrument from the standby to ready state or vice versa.

In ready state, the left, green LED is on. The instrument is ready for operation. All modules are power-supplied and the R&S SMBV initiates its [startup procedure](#).

In standby state, the right, yellow LED is on. The standby power only supplies the power switch circuits and the oven-controlled crystal oscillator to keep it at its operating temperature. In this state it is safe to switch off the AC power and disconnect the instrument from the power supply.

2.3.5.2 Start Display and Booting

The instrument boots the operating system, starts the instrument firmware and automatically performs a selftest. If the previous session was terminated regularly, the instrument uses the last setup with the relevant instrument settings.

Once the startup procedure has been terminated, the block diagram opened in the previous session is displayed and the instrument is ready for operation.



Use the [PRESET] key to return the instrument to its definite reset/preset state, if the current setup is not anymore relevant.

To customize the start settings, use the "File" dialog.



Rebooting the instrument

Press the [STANDBY] key for approx. 5 s. to reboot the instrument, if the software stops unexpectedly.

2.3.5.3 Function Check

The signal generator automatically monitors the main functions when the instrument is switched on and continuously during operation.

A detected fault is indicated by a "ERROR" message displayed in the info line together with a brief error description. For in-depth identification of the error, press the [INFO] key. In response, a description of the error(s) is displayed.

For more information, refer to section "Error Messages" in the Operating Manual.

Additionally to the automatic monitoring, the R&S SMBV offers the following capabilities to ensure correct functioning:

- **Internal Adjustments**
Press the [SETUP] key and select "System > Internal Adjustments" to access the dialog for performing and configuring of the adjustments settings. A maximum level accuracy can be obtained, for instance.
- **Selftest**
A selftest is provided for service purposes.

2.3.5.4 Default Settings

When the instrument is switched on, it is not the preset state that is active, but rather the instrument state that was set before the instrument was switched off. It is also recommended that you use the [PRESET] key to return the instrument to its defined preset state every time a new configuration is required or the current setup is not anymore relevant.

The R&S SMBV offers a three-stage preset concept:

- **Preset of the settings belonging to a digital standard or associated with one dialog.**
Most of the dialog boxes provide a special "Set to Default" button that resets directly the settings associated to the corresponding dialog, e.g. all digital modulation settings in the "Custom Digital Mod" dialog.
These settings are identical to those which are called up using the [PRESET] key.
- **Preset the instrument to a predefined state**
The [PRESET] key calls up a defined instrument setup. All parameters and switching states are preset (also those of inactive operating modes). The default instrument settings provide a reproducible initial basis for all other settings. However, functions that concern the integration of the instrument into a measurement setup are not changed, e.g. GPIB bus address or reference oscillator source settings.
- **Preset the instrument to its factory settings**
The instrument can also be forced to load its default factory settings. To access the corresponding dialog box, press the [SETUP] key and select the "Factory Preset".
For more information and an overview of the settings affected by the factory preset function, see section "Factory Preset" in the Operating Manual.

Overview of the Most Important Preset States

The following list gives an overview of the presets for the most important generator settings. The other presets can be found in the preset tables of the individual menus and the information accompanying the remote commands.

- "RF frequency" = 1 GHz
- "RF level" RF output switched off
- "Offsets" = 0

- "Modulations State" = Off
- Uninterrupted level settings are switched off
"Level Attenuator Mode" = AUTO
- Internal level control "Level ALC" = AUTO
- User correction "Level Ucor" = OFF
- "LF output State" = Off
- "Sweep State" = Off
- "List mode State" = Off

Settings that are not affected by the [PRESET] key

- Reference frequency settings ("Ref Oscillator" menu)
- Power on settings ("Level/EMF" menu)
- Network settings ("Setup" menu)
- GPIB address ("Setup" menu)
- *IDN? Identification and emulation ("Setup" menu)
- Password and settings protected by passwords ("Setup" menu)
- Start/Stop Display Update ("Setup" menu)
- Display and keyboard settings ("Setup" menu)



User-defined instrument states can be stored and called up in the "File" dialog.

2.3.6 Shutting Down the Instrument

To shut down the R&S SMBV, proceed as described below.

NOTICE

Risk of losing data

If you switch off the running instrument using the rear panel switch or by disconnecting the power cord, the instrument loses its current settings. Furthermore, program data can be lost.

Press the ON/STANDBY key first to shut down the application properly.

1. Press the [ON/STANDBY] key to save the current setup, shut down the operating system and set the instrument to standby state.
The yellow LED must be on.
2. To turn the power off:
 - a) For instruments with power switch, press the main power switch to position 0 (Off).

- b) For instruments without power switch, pull the power cable at the rear of the instrument.

Tip:

Switching off the AC power

You can leave the AC power on permanently to preserve your last instrument settings. Switching off is required only if the instrument must be completely disconnected from all power supplies.

None of the front-panel LEDs should be on.

2.3.7 Power Fuses

The R&S SMBV is fully fused by two fuses IEC60127-T3.15H/250 V.

The fuses are accommodated in the fuse holders next to the power connector. Use only fuses of the mentioned type.

⚠ WARNING**Risk of electric shock**

The fuse is part of the main power supply. Therefore, handling the fuse while power is on can lead to electric shock. Before opening the fuse holder, make sure that the instrument is switched off and disconnected from all power supplies.

Always use fuses supplied by Rohde & Schwarz as spare parts, or fuses of the same type and rating.

2.4 Connecting External Accessories

The equivalent USB ports on the front and/or rear panel of the R&S SMBV can be used to connect a variety of accessories.

In addition the instrument provides interfaces for network integration (see [Chapter 2.6, "Setting Up a Network \(LAN\) Connection"](#), on page 43).

2.4.1 Connecting USB Devices

Via the USB ports, you can connect external devices directly to the R&S SMBV. If you need more interfaces, you just use an USB hub.

The following list shows various USB devices that can be useful:

- Memory stick for easy transfer of data to/from a computer (for example firmware updates).
- CD-ROM drives for easy installation of firmware applications.
- Keyboard or mouse to simplify the entry of data, comments, file names, etc.
- Power sensors, for example of the NRPxS(N) Power Sensors family.

Installing USB devices is easy under Linux, because all USB devices are plug&play. After a device is connected to the USB interface, the operating system automatically searches for a suitable device driver.

If Linux does not find a suitable driver, it will prompt you to specify a directory that contains the driver software. If the driver software is on a CD, connect a USB CD-ROM drive to the instrument before proceeding.

When a USB device is subsequently disconnected from the R&S SMBV, the operating system immediately detects the change in hardware configuration and deactivates the corresponding driver.

All USB devices can be connected to or disconnected from the instrument during operation.

Connecting a memory stick or CD-ROM drive

If installation of a memory stick or CD-ROM drive is successful, the operating system informs you that the device is ready to use. The device is made available as a new drive (`/usb`). The name of the drive is manufacturer-dependent.

Connecting a keyboard

The keyboard is detected automatically when it is connected. The default keyboard layout is English - US.

Use the "Setup > Keyboard Settings" dialog to configure the keyboard properties.

Connecting a mouse

The mouse is detected automatically when it is connected.

2.5 Linux Operating System

The instrument uses an embedded Linux operating system. To make sure that the instrument software works properly, certain rules must be adhered to concerning the operating system.

NOTICE

Risk of causing instrument unusability

The instrument is equipped with the Linux operating system. Additional software can therefore be installed on the instrument. The use and installation of additional software may impair instrument function. Thus, run only programs that Rohde & Schwarz has tested for compatibility with the instrument software.

The drivers and programs used on the instrument under Linux have been adapted to the instrument. Existing instrument software must always be modified using only update software released by Rohde & Schwarz.

The configuration of the operating system is optimally adapted to signal generator functions in the factory. Changes in the system setup are only required when peripherals like keyboard are installed or if the network configuration does not comply with the default settings (see [Chapter 2.6.1, "Connecting the Instrument to the Network"](#), on page 43). After the R&S SMBV is started, the operating system boots and the instrument firmware is started automatically.



Accessing Operating System

No access to the operating system is required for normal operation. All necessary system settings can be made in the "Setup" dialog.

The R&S SMBV provides an internal flash memory and a hard disk (R&S SMBV-B92). Both, the internal flash memory and the hard disk can be used to store data but the firmware is always hold on the internal flash card. However, data transfer is only possible via a memory stick connected to a USB interface. The memory stick, the hard disk and the flash memory are accessed via the "File Manager".

Accessing the File System

The instrument also supports two standard methods to access the file system form a remote client:

- FTP (file transfer protocol)
- File sharing according to the SAMBA/SMB (server message block) protocol.

Both methods allow the access to the folder `/var/user/share`.



Default password

The FTP and SAMBA/SMB file access use the user "instrument" with the default password "instrument".

It is highly recommended that you change this password in the "Setup > Security > Change User Password" dialog before connecting the instrument to the network!

Refer also to Application Note 1GP72 "Connectivity of Signal Generators", provided on the Rohde & Schwarz website, at <http://www.rohde-schwarz.com/appnotes>.

Screen saver

A screen saver can be activated in the R&S SMBV. When active, the display is shut off when no entries via front panel, external mouse or external keyboard are made for a period of time. The screen saver prolongs the life time of the display.

Use the "Setup > Display Settings" dialog to switch on or off the screen saver and to adjust the screen saver settings.

2.6 Setting Up a Network (LAN) Connection

The R&S SMBV is equipped with a network interface and can be connected to an Ethernet LAN (local area network). Provided the appropriate rights have been assigned by the network administrator and the Linux firewall configuration is adapted accordingly, the interface can be used, for example:

- To transfer data between a controller and the instrument, e.g. in order to run a remote control program.
- To access or control the measurement from a remote computer using the R&S VISA or Ultr@VNC programs (or similar tools, like another VNC client or any Web browser supporting Java)
- To transfer data from a remote computer and back, e.g. using network folders

This section describes how to configure the LAN interface. It includes the following topics:

- [Chapter 2.6.1, "Connecting the Instrument to the Network"](#), on page 43
- [Chapter 2.6.2, "Assigning the IP Address"](#), on page 44



Accessing Operating System

No access to the operating system is required for normal operation. All necessary system settings can be made in the "Setup" dialog.

2.6.1 Connecting the Instrument to the Network

There are two methods to establish a LAN connection to the instrument:

- A non-dedicated network (Ethernet) connection from the instrument to an existing network
- A dedicated network connection (Point-to-point connection) between the instrument and a single computer

In both cases, an IP address has to be assigned to the instrument and the computer, which is usually accomplished automatically. See also [Chapter 2.6.2, "Assigning the IP Address"](#), on page 44.

To set up a network (LAN) connection

NOTICE

Risk of network failure

Consult your network administrator before performing the following tasks:

- Connecting the instrument to the network
- Configuring the network
- Changing IP addresses

Errors can affect the entire network.

- ▶ Connect the instrument to the network or to a single PC.

If the instrument is connected to the LAN, the operating system automatically detects the network connection and activates the required drivers.

By default, the instrument is configured to use dynamic TCP/IP configuration and obtain all address information automatically.

When connected, the R&S SMBV displays the address information on the screen.



IP: 10.124.0.206



Risk of network connection failure

Network cables and cable connectors of poor quality, or failures in the autonegotiation process, can cause network connection failures.

If the network connection to the instrument fails, check the network infrastructure and contact your network administrator.

For details, see section "Status Information, Error Messages and Troubleshooting".

2.6.2 Assigning the IP Address

Depending on the network capacities, the TCP/IP address information for the instrument can be obtained in different ways.

- If the network supports dynamic TCP/IP configuration using the Dynamic Host Configuration Protocol (DHCP), all address information can be assigned automatically.
- If the network does not support DHCP, the instrument tries to obtain the IP address via Zeroconf (APIPA) protocol. If this attempt does not succeed or if the instrument is set to use alternate TCP/IP configuration, the addresses must be set manually.

By default, the instrument is configured to use dynamic TCP/IP configuration and obtain all address information automatically. This means that it is safe to establish a physical connection to the LAN without any previous instrument configuration.

NOTICE**Risk of network errors!**

Connection errors can affect the entire network.

If your network does not support DHCP, or if you choose to disable dynamic TCP/IP configuration, you must assign valid address information before connecting the instrument to the LAN.

Contact your network administrator to obtain a valid IP address.

Assigning the IP address on the instrument

1. Press the [Setup] key and select the "Network Settings" dialog.
2. Set the "Address Mode" to Static.
3. Select the "IP Address" and enter the IP address, for example *192.168.0.1..*
The IP address consists of four number blocks separated by dots. Every block contains 3 numbers in maximum.
4. Select the "Subnet Mask" and enter the subnet mask, for example *255.255.255.0.*
The subnet mask consists of four number blocks separated by dots. Every block contains 3 numbers in maximum.

**Use computer names to identify the instrument**

In networks using a DHCP server, it is recommended that you address the instrument by its unambiguous computer name, see [Chapter 2.6.3, "Using Computer Names"](#), on page 45.

A computer name (*hostname*) is an unique dedicated identification of the instrument, that remains permanent as long as it is not explicitly changed. Hence, you can address an instrument by the same identification (computer name), irrespectively if a network or a point-to-point connection is used.

To assign the IP address manually on the remote computer

- ▶ Obtain the necessary information from your network administrator. If you use more than one LAN connector, you need separate address information for each connector.
For information on how to perform the configurations, refer to the documentation of the operating system the remote computer uses.

2.6.3 Using Computer Names

In a LAN that uses a DNS server (Domain Name System server), each PC or instrument connected in the LAN can be accessed via an unambiguous computer name instead of the IP address. The DNS server translates the host name to the IP address. This is especially useful when a DHCP server is used, as a new IP address may be assigned each time the instrument is restarted.

Each instrument is delivered with an assigned computer name, but this name can be changed.

The default instrument name is a non-case-sensitive string that follows the syntax `rs<instrument><serial number>`.

The serial number can be found on the rear panel of the instrument. It is the third part of the device ID printed on the bar code sticker:



Querying and changing a computer name

1. Press the "Setup" key and select "Network Settings".
The computer name is displayed under "Hostname".
2. Press the "Setup" key, select "Protection" and enable the "Protection Level 1".
The default password is *123456*.
The parameter "Hostname" in the "Network Settings" dialog is now enabled for configuration.
3. Change the "Hostname".

2.7 Remote Access via an External Controller

The R&S SMBV can be remote accessed from a remote computer (external controller) via a network link. This allows convenient operation of the instrument from the desktop although the instrument is integrated in a rack somewhere else.



For an overview of the instrument's operating concept and the different ways to control and operate the instrument, see [Chapter 3.1, "Brief Introduction to the Instrument's Concept"](#), on page 63.

There are different ways to establish a remote access connection to the signal generator but all of them require an established LAN connection between the instrument and the remote computer. The simplest way to remote access the instrument is to use a Web browser, such as Windows Internet Explorer or Mozilla Firefox for instance. Alternatively a remote access via a special application can be used.

For example, the free-of-charge program Ultr@VNC for PCs with Linux/Unix or Windows operating system is available for setting up the remote access connection. Using this application requires additional installation.

See the following table for an overview of the different ways to establish a remote access connection to the signal generator.

Table 2-2: Remote access via an external computer

| Remote access via | LAN connection | Installation of the additional application | |
|---|----------------|--|--|
| | | on the instrument | on the remote computer |
| Any web browser for example Windows Internet Explorer or Mozilla Firefox, see Chapter 2.7.1, "Using a Web Browser for Remote Access" , on page 47 | required | no | <i>Java Runtime</i> must be installed and activated in the browser settings. |
| VNC Client for example Ultr@VNC or other dedicated client software for PCs with Linux/Unix or Windows operating system see Chapter 2.7.2, "Remote Access via a VNC Client Software" , on page 49 | required | required | VNC Viewer required |

When the connection is set up with a VNC client software (Ultr@VNC), direct control on the instrument is possible while remote access is established.

For return to direct operation on the instrument, the connection must be cut. After cutting the connection, it is still enabled and can be established again any time. The connection is disabled only after deactivation of the program.

This section gives an information on how to use the Web browser for remote access, how to install the applications for remote access and how to establish the connection between the instrument and an external computer with Windows operating system. Remote access via an external computer with Linux/Unix operating system is performed accordingly.



Default password

Remote-access and file access require the user "instrument" with default password "instrument".

NOTICE

Changing the default user and security passwords

It is highly recommended to change the default user and security passwords in the menu "Setup > Security" before connecting the instrument to the network (see section "Security - Setup-Protection" in chapter "General Instrument Settings" of the Operating Manual).

2.7.1 Using a Web Browser for Remote Access

The instrument can be remote-accessed via any web browser, as for example the Windows Internet Explorer or Mozilla Firefox.

To remote access the instrument via a web browser:

1. Connect the instrument and the remote computer to a LAN, see [Chapter 2.6.1, "Connecting the Instrument to the Network"](#), on page 43.
2. Install the Java Runtime Environment JRE on the remote computer.
3. Type the instrument's IP address in the address field of the Web browser on your PC, e.g. `http://10.111.11.1`

The "VNC Authentication" screen appears.

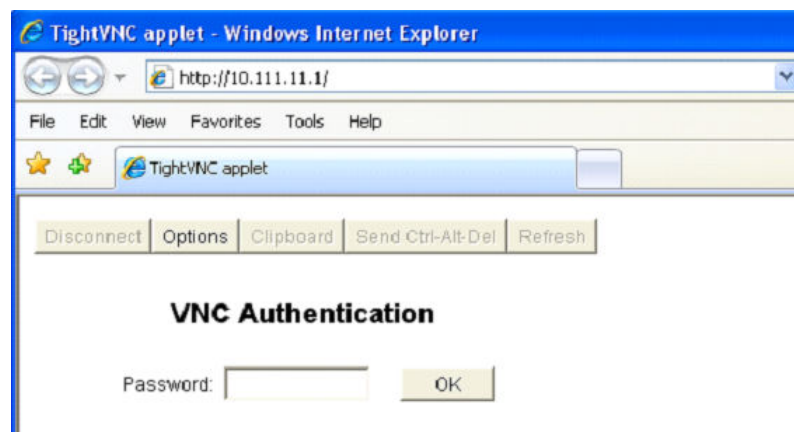

4. Enter the password and select "OK".
The default password is "instrument".

After the connection is established, the current signal generator screen with the block diagram is displayed and the instrument can be remote-accessed from the remote computer.

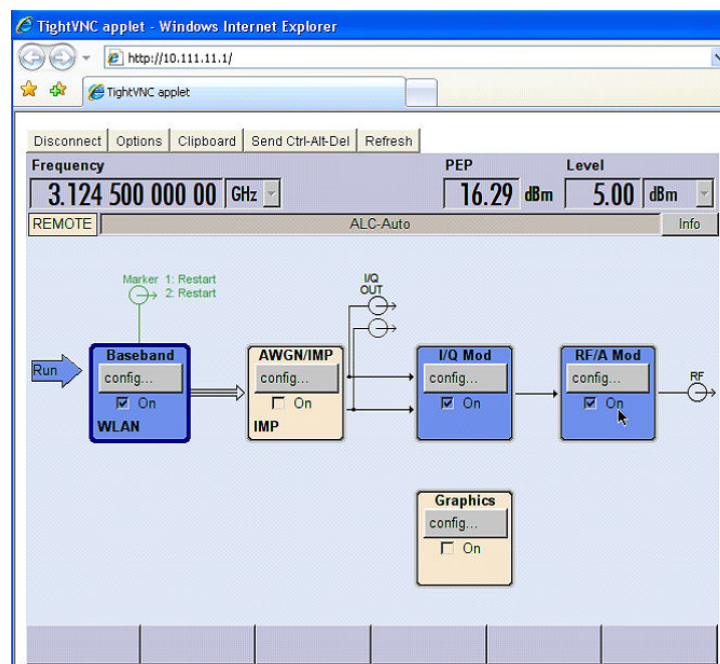

2.7.2 Remote Access via a VNC Client Software

A VNC client software is an application which can be used to access and control the instrument from a remote computer via LAN.

The following description explains how to establish the remote access, represented by means of the client software Ultr@VNC. The software is included in Linux/Unix operating system, but it is also available as a free-of-charge download on the Internet <http://www.uvnc.com/download/index.html>. Thus, it is also available for remote computers with Windows operating system.



The GUI appearance of Ultr@VNC may vary if you use a later release. Also, similar programs may deviate in some details, but the basic procedure is the same.

NOTICE

Risk of unauthorized access

If the VNC service is enabled on the instrument, any user in the network who knows the computer name and password can access it.

Disable the VNC service on the instrument to prevent unauthorized access.

Setting up a VNC connection

1. Connect the instrument and the remote computer to a LAN, see [Chapter 2.6.1, "Connecting the Instrument to the Network"](#), on page 43.
2. [Install the Ultr@VNC application](#) and enable it on the instrument.
3. In the ICF firewall, enable communication on the network via Ultr@VNC program.
4. Install the VNC Viewer on the remote computer with Windows operating system, see ["Installing the VNC Viewer on a Windows PC"](#) on page 51.
5. Set up the VNC connection between the instrument and:
 - a) the remote computer with Linux/Unix operating system, see ["Setting up the VNC connection on the Linux/Unix remote computer"](#) on page 51;
 - b) the remote computer with Windows operating system, see ["Setting up the VNC connection on the Windows remote computer"](#) on page 52.



Enabled Direct Control

The direct control of the instrument is not disabled and the instrument can be controlled from the front panel and via the remote computer alternately.

Installing the Ultr@VNC application

1. Download the program from the internet and copy it to a directory that can be accessed.
2. On the instrument, shut down firmware using the ALT+F4 key combination.

3. Double click on the setup file to start the installation.
The setup wizard leads through the installation. This description focus only on the relevant settings.
 - a) Select installation of all components.

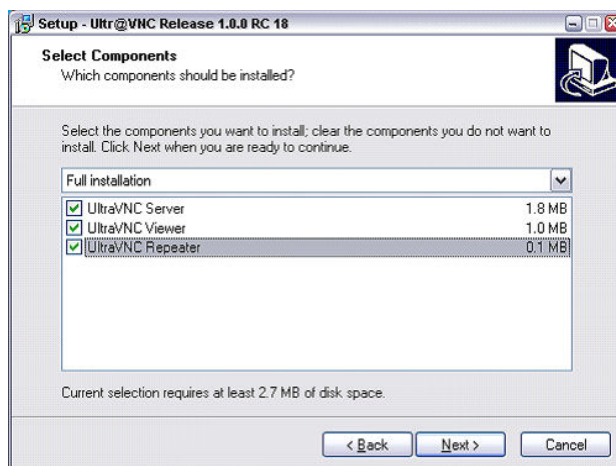

- b) In the "Additional Task Panel", enable all entries.

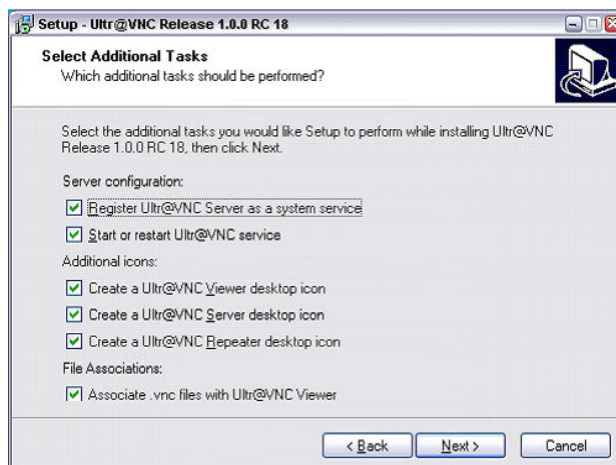

A successful installation is indicated by a message.

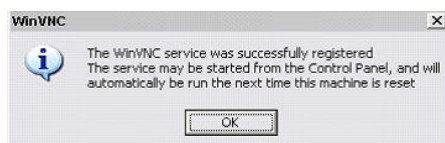

At the same time a warning is displayed stating that a password must be set.

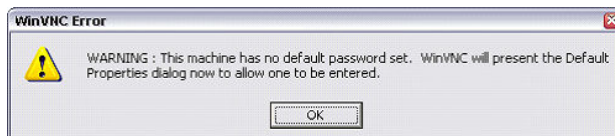

4. Select "OK".
The "Default Local System Properties" panel opens.

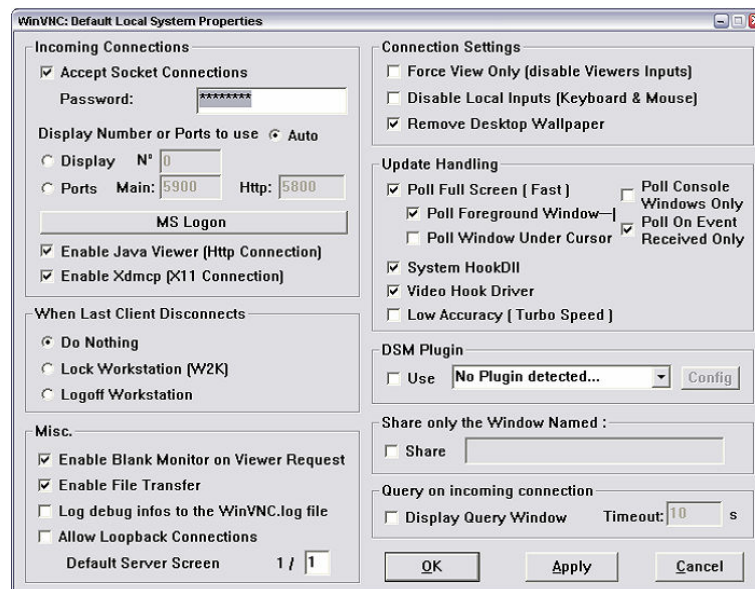

5. Enter a password with a length of at least five digits.

This password is used on the remote computer to access the instrument. Other settings may be changed according to the user-specific security requirements.

After the installation the Ultr@VNC program is automatically started together with the operating system. On mouse over, the IP address of the instrument is indicated.

This IP address and the user-defined password are the prerequisites to enable remote access on the remote computer. Terminated connection is indicated by changed icon color.

Installing the VNC Viewer on a Windows PC

1. Download the Ultr@VNC program from internet and follow the installation instructions.

Only the program component VNC Viewer is required.

Note: The VNC Viewer program is included in the download for the installation of the Ultr@VNC program on the signal generator if "Full installation" was selected in the "Select Component" panel. In this case, the program `ultr@vncviewer.exe` can be copied to the Windows PC.

2. Install VNC Viewer program component on the remote computer.

Setting up the VNC connection on the Linux/Unix remote computer

The VNC program is available per default for Linux/Unix operating systems.

1. Start a Web browser on the remote computer and enter the IP address of the instrument.
2. Enter the following address:

`vnc://<IP-address of the instrument>`, e.g. `vnc://192.168.1.1`.

A dialog is opened and the password for the remote VNC connection is requested.

3. Enter the password as defined in the "Default Local System Properties" panel of the Ultr@VNC program and select "Log On".

The connection is established, the instrument is remote accessed and the current signal generator screen with the block diagram is displayed. The individual functions are operated using the mouse and keyboard.

In contrast to remote access via Remote Desktop, the direct control of the instrument is not disabled and the instrument can be controlled from the front panel and via the remote computer alternately.

Setting up the VNC connection on the Windows remote computer

1. Start VNC Viewer program component on the PC, select "VNC Server" and enter IP address of the instrument.

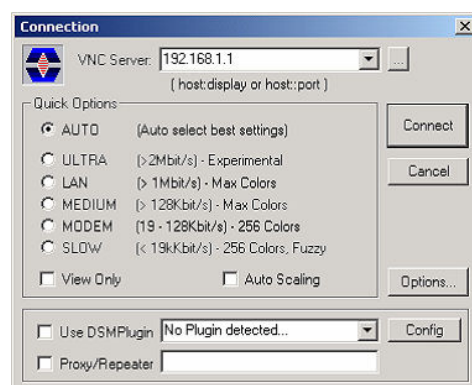

2. To initialize the connection, select "Connect".
A message requesting the password appears.

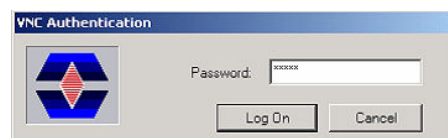

3. Enter the password as defined in the "Default Local System Properties" panel of the Ultr@VNC program and select "Log On".

The connection is established, the instrument is remote accessed and the current signal generator screen with the block diagram is displayed. The individual functions are operated using the mouse and keyboard.



Enabled Direct Control

The direct control of the instrument is not disabled and the instrument can be controlled from the front panel and via the remote computer alternately.

Terminating VNC Connection

The remote access via VNC connection can be terminated either on the R&S SMBV or on the external PC. Terminating the connection does not disable it. It can be established again any time. See the notice above concerning unauthorized access due to VNC connection!

1. Terminate the connection on the R&S SMBV
 - a) Press the "Windows" key to access the operating system.
 - b) Right-click on the VNC icon on the task bar and select "Kill all clients".
2. To terminate the connection on the external Linux/Unix PC, close the internet browser or close the signal generator window.
3. To terminate the connection on the external Windows PC, close the VNC Viewer program.

The connection is terminated. The color of the VNC icon in the status bar of the instrument changes.

A message on the external PC indicates the disconnection.

Disabling Remote Access via Ultr@VNC

The VNC connection can be disabled by removing the program on the instrument or by deactivating the VNC Server service.

1. Remove the VNC program
 - a) Press the "Windows" key to access the operating system and open the "Add or Remove Programs" by selecting "Start > Settings > Control Panel > Add or Remove Programs".
 - b) Remove the VNC program.
2. Deactivate the VNC Server service
 - a) Press the "Windows" key to access the operating system and open the "Services" by selecting "Start > Settings > Control Panel > Services".
 - b) Deactivate the VNC Server service.

The connection is disabled, the VNC icon disappears from the task bar of the instrument.

2.8 LXI Configuration

LXI ("LAN eXtensions for Instrumentation" is an instrumentation platform for measuring instruments and test systems that is based on standard Ethernet technology. LXI is intended to be the LAN-based successor to GPIB, combining the advantages of Ethernet with the simplicity and familiarity of GPIB.

Like GPIB, LXI determines and standardizes the way the instrument behaves in a LAN. The LXI implementation by the Rohde&Schwarz signal generators allows you to change certain LAN settings, to reset the LAN connection as well as to identify the instrument easily.



For information about the LXI standard, refer to the LXI website at <http://www.lxistandard.org>. See also "News from Rohde & Schwarz, article 2006/II - 190".

The R&S SMBV provides an integrated "LXI Status" dialog for LXI status indication and reset of the LAN configuration ("LAN Configuration Initialize", LCI). To access the LXI status dialog, press the [Setup] key and select "Remote > LXI Status".

For further information, see section "LXI Status" in the Operating Manual.



Firmware update

After a firmware update, shut down and restart the instrument in order to enable the full LXI functionality.

Default state of the network settings

According to the LXI standard, an LCI must set the following parameters to a default state.

| Parameter | Value |
|--------------------------------|------------------------|
| TCP/IP Mode | DHCP + Auto IP Address |
| Dynamic DNS | Enabled |
| ICMP Ping | Enabled |
| Password for LAN configuration | LxiWebIfc |

The LCI for the R&S SMBV also resets the following parameters:

| Parameter | Value |
|------------------|---------------------------------|
| Hostname | <Instrument-specific host name> |
| Description | Vector Signal Generator |
| Negotiation | Auto Detect |
| VXI-11 Discovery | Enabled |

The LAN settings are configured using the instrument's "LXI Browser Interface".

2.8.1 LXI Browser Settings

To access the instrument via the web browser:

- ▶ Type in the instrument's host name or IP address in the address field of the browser on your PC, for example "http://10.113.1.205".

Note: Do not add the missing zeros in the IP address, while opening the instrument home page.

The instrument home page (welcome page) opens.

The screenshot shows the LXI Instrument Properties page. The left navigation pane includes: LXI, Home, Lan Configuration, Status, Utilities, Instrument Control (Web Control), Diagnostics (SCPI Remote Trace), and Help (Glossary, www.rohde-schwarz.com). The main content area displays the following instrument properties:

| | |
|-----------------------|---|
| Instrument Model | R&S SMBV |
| Manufacturer | Rohde & Schwarz GmbH & Co. KG |
| Serial Number | 909911 |
| Description | SMBV (3.50.082.03) 909911 |
| LXI Version | 1.4 LXI Core 2011 |
| LXI Extended Features | |
| DNS Host Name(s) | instrument-10.local |
| MAC Address | 00:90:b8:1c:e9:63 |
| IP Address | 10.111.2.25 |
| Firmware Revision | 3.50.082.12 |
| Current Time | Tuesday, 2016/06/21, 18:10:58 |
| Current Time source | Operating System |
| VISA resource string | TCPIP::10.111.2.25::inst0::INSTR |
| Device Indicator | ACTIVE (press to toggle) ● |

The status bar at the bottom indicates "No error".

The navigation pane of the browser interface contains the following elements:

- "LXI"
 - "Home" opens the instrument home page. The home page displays the device information required by the LXI standard, including the VISA resource string in read-only format.
 - "Device Indicator" activates or deactivates the LXI status indication. When activated, the LXI LEDs flash, both in the browser dialog and in the LXI dialog of the connected instrument. A green LXI status symbol indicates that a LAN connection has been established; a red symbol indicates that no LAN cable is connected.
 - "Lan Configuration" allows you to configure LAN parameters and to initiate a ping, see [Chapter 2.8.2.3, "Ping Client"](#), on page 58.
 - "Status" displays information about the LXI status of the instrument.
 - "Utilities" provides access to the LXI event log functionality required by the LXI standard.
- "Instrument Control"
 - "Web Control" provides remote access to the instrument, see [Chapter 2.8.2.4, "Web Control"](#), on page 59.
- "Diagnostics"

- "SCPI Remote Trace" records messages exchanged via the remote control interface, see [Chapter 2.8.2.5, "SCPI Remote Trace"](#), on page 60.
- "Help"
 - "Glossary" explains terms related to the LXI standard.
 - www.rohde-schwarz.com opens the Rohde & Schwarz home page.
- ▶ Press the "INACTIVE (press to toggle)" button to activate the connection.

ACTIVE (press to toggle)



A green flashing status LED indicates the active connection. If the LAN connection fails, the LED turns red.

The status of the LAN connection is also indicated by the "LAN Status indicator" in the "LXI Status" dialog.

For further information, see section "LXI Status" in the Operating Manual.

2.8.2 LAN Configuration

The "LAN Configuration" web page provides access to the parameters required for identifying the R&S SMBV in the network, and allows modification.



Password protection

Changing the LAN configuration is password-protected. The default password is *Lxi-WebIfc* (notice upper and lower case characters). This password cannot be changed in the current firmware version.

It comprises the following navigation entries.

| | |
|--|----|
| • IP Configuration | 56 |
| • Advanced LAN Configuration | 57 |
| • Ping Client | 58 |
| • Web Control | 59 |
| • SCPI Remote Trace | 60 |

2.8.2.1 IP Configuration

The "IP Configuration" page displays all mandatory LAN parameters.

The screenshot shows the LXI configuration web interface. The left sidebar contains navigation options: Home, Lan Configuration (with sub-options IP Configuration, Advanced Config, Ping Client), Status, Utilities, Instrument Control (with sub-option Web Control), Diagnostics (with sub-option SCPI Remote Trace), and Help (with sub-option Glossary and website link www.rohde-schwarz.com). The main content area is titled 'LAN Parameters' and contains the following fields:

| | | |
|---|---|--|
| Hostname | <input type="text" value="rssmbv100a909911"/> | Attention! Changing the hostname reboots the device! |
| DNS Hostname(s) | <input type="text" value="rssmbv100a909911.rsint.net"/> | |
| Domain | <input type="text" value="rsint.net"/> | |
| Description | <input type="text" value="SMBV (3.50.082.12) 909911"/> | |
| IP Address Mode | <input type="text" value="DHCP + Auto IP Address"/> | |
| IP Address | <input type="text" value="10.111.2.25"/> | |
| Subnet Mask | <input type="text" value="255.255.252.0"/> | |
| Default Gateway | <input type="text" value="10.111.0.1"/> | |
| Obtain DNS Server Address automatically | <input checked="" type="checkbox"/> | |
| DNS Server(s) | <input type="text" value="10.0.2.166"/> | <input type="text" value="10.0.23.159"/> |
| Register Device at DNS Server dynamically | <input type="checkbox"/> | |
| | <input type="button" value="Submit"/> | <input type="text" value=""/> (Password required!) |

At the bottom of the configuration area, there is a 'Status' section showing 'No error'. A copyright notice '© 2016 ROHDE&SCHWARZ. All rights reserved.' is visible in the bottom right corner of the interface.

The "IP Address Mode" selects a configuration mode for the IP address of the R&S SMBV. With static configuration, the entered IP address, subnet mask, and default gateway are used. With dynamic configuration, DHCP or dynamic link local addressing (automatic IP) are used to obtain the instrument IP address.

See [Chapter 2.6.2, "Assigning the IP Address"](#), on page 44.

2.8.2.2 Advanced LAN Configuration

The "Advanced Config" page provides LAN settings that are not declared mandatory by the LXI standard.

The screenshot shows the LXI configuration web interface. The top navigation bar includes the Rohde & Schwarz logo and the LXI logo. The main content area is titled "LAN Parameters" and contains the following settings:

- mDNS and DNS-SD**: A dropdown menu set to "mDNS & DNS-SD".
- ICMP Ping enabled**: A checkbox that is checked.
- VXI-11 Discovery**: A checkbox that is checked.

Below these settings is a "Submit" button and a password input field with the text "(Password required!)".

The left sidebar contains the following menu items:

- LXI**
 - Home
 - Lan Configuration
 - IP Configuration
 - Advanced Config
 - Ping Client
 - Status
 - Utilities
- Instrument Control**
 - Web Control
- Diagnostics**
 - SCPI Remote Trace
- Help**
 - Glossary
 - www.rohde-schwarz.com

At the bottom of the page, there is a "Status" section indicating "No error" and a copyright notice: "© 2015 ROHDE&SCHWARZ. All rights reserved."

The following advanced parameters are available:

- "mDNS and DNS-SD": The additional protocols "multicast DNS" and "DNS service discovery" are used for device communication in zero configuration networks, working without DNS and DHCP.
- "ICMP Ping enabled": Must be enabled to use the ping utility. If you disable this setting, the instrument does not answer ping requests. The setting does not affect the LXI ping client. You can ping other hosts from the instrument, even if the setting is disabled.
- "VXI-11 Discovery": Must be enabled to detect the instrument in the LAN. If you disable this setting, the instrument cannot be detected by the VXI-11 discovery protocol mechanism. The setting does not affect other detection mechanisms. Setting up a VXI-11 connection via the IP address or the host name is independent of this setting.

2.8.2.3 Ping Client

The "Ping Client" page provides the ping utility to verify the connection between the LXI-compliant instrument and another device.

The ping is initiated from the instrument. Using the `ICMP` echo request and echo reply packets, the function checks whether the communication with a device via LAN works. Ping is useful for the diagnosis of IP network or router failures.

The ping utility is not password-protected.

To initiate a ping from the instrument to the device:

1. Enable "ICMP Ping" on the "Advanced LAN Configuration" page.
2. Select the "Ping Client" page.
3. In the "Destination Address" field, enter the IP address of the device you want to ping (without the ping command and without any further parameters), e.g. *10.113.1.203*.
4. Select "Submit".

The screenshot shows the LXI web interface. The left sidebar contains navigation options: Home, Lan Configuration, Status, Utilities, Instrument Control (Web Control), Diagnostics (SCPI Remote Trace), and Help (Glossary, www.rohde-schwarz.com). The main content area is titled 'Ping Parameter'. It features a 'Destination Address' input field with 'Clear' and 'Submit' buttons. Below this is a 'Result' section displaying the following ping output:

```
PING 10.111.2.25 (10.111.2.25): 56 data bytes
64 bytes from 10.111.2.25: seq=0 ttl=64 time=0.109 ms

--- 10.111.2.25 ping statistics ---
1 packets transmitted, 1 packets received, 0% packet loss
round-trip min/avg/max = 0.109/0.109/0.109 ms
```

At the bottom of the interface, a 'Status' bar shows 'No error' and a copyright notice: '© 2016 ROHDE&SCHWARZ. All rights reserved.'

2.8.2.4 Web Control

The web control functionality provides remote operation via VNC using a Web browser (with HTML5). This mode does not require additional installation or activation. The VNC protocol allows simultaneous operation from several remote devices. The instrument remains locally operable.

The GUI of the R&S SMBV is visible. To perform the settings, you can operate the instrument as with the manual control. The instrument controls are available via the front panel simulation. File upload and download between the instrument and the remote PC is also available.

Starting a Remote Control via the LXI web browser

This section assumes that the instrument and the controller PC are connected in the LAN.

1. Start a web browser that supports html5 (W3C compliant).
2. Enter the IP address of the R&S SMBV in the browser's address bar.
The R&S SMBV's welcome page is displayed.
3. In the navigation pane, select "Instrument Control" > "Web Control".
Remote access to the instrument requires the password. The default password is *instrument*.
4. Enter the password.
5. Confirm with the [Enter] key.

After the connection is established, the current screen of the R&S SMBV is displayed in the browser window.

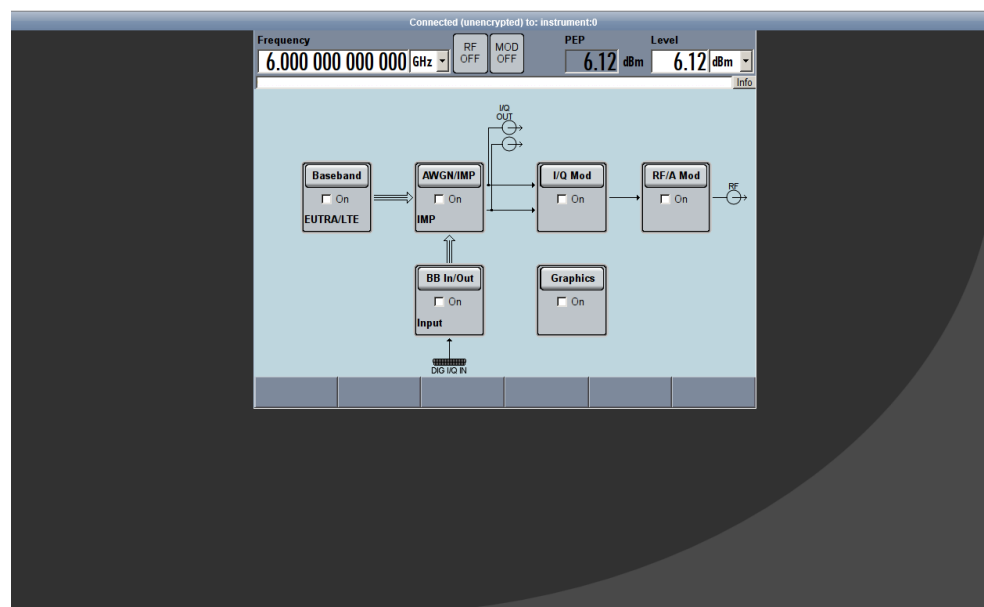

6. Use the mouse cursor and keyboard to access the functionality of the instrument as you would directly perform the settings on the instruments front panel.

2.8.2.5 SCPI Remote Trace

The remote trace functionality allows you to trace input and output strings at the remote control interface of the R&S SMBV.

A recorded trace (message log) can be evaluated directly in the dialog. Use the highlighting and navigation functions provided in the lower toolbar to locate error messages and messages containing arbitrary search strings. You can also export the message log to a *.csv file and evaluate the file using a suitable program.

To trace and display messages:

1. In the navigation pane, select "Diagnostics" > "SCPI Remote Trace".
2. In the toolbar bar of the "SCPI Remote Trace" page, select "live mode" > "on" and "logging" > "on".
 "live mode > on" displays all commands and responses, and "logging > on" also traces messages.
3. If you now control the R&S SMBV with SCPI commands, using an appropriate tool, the SCPI remote trace records the information sent and received.

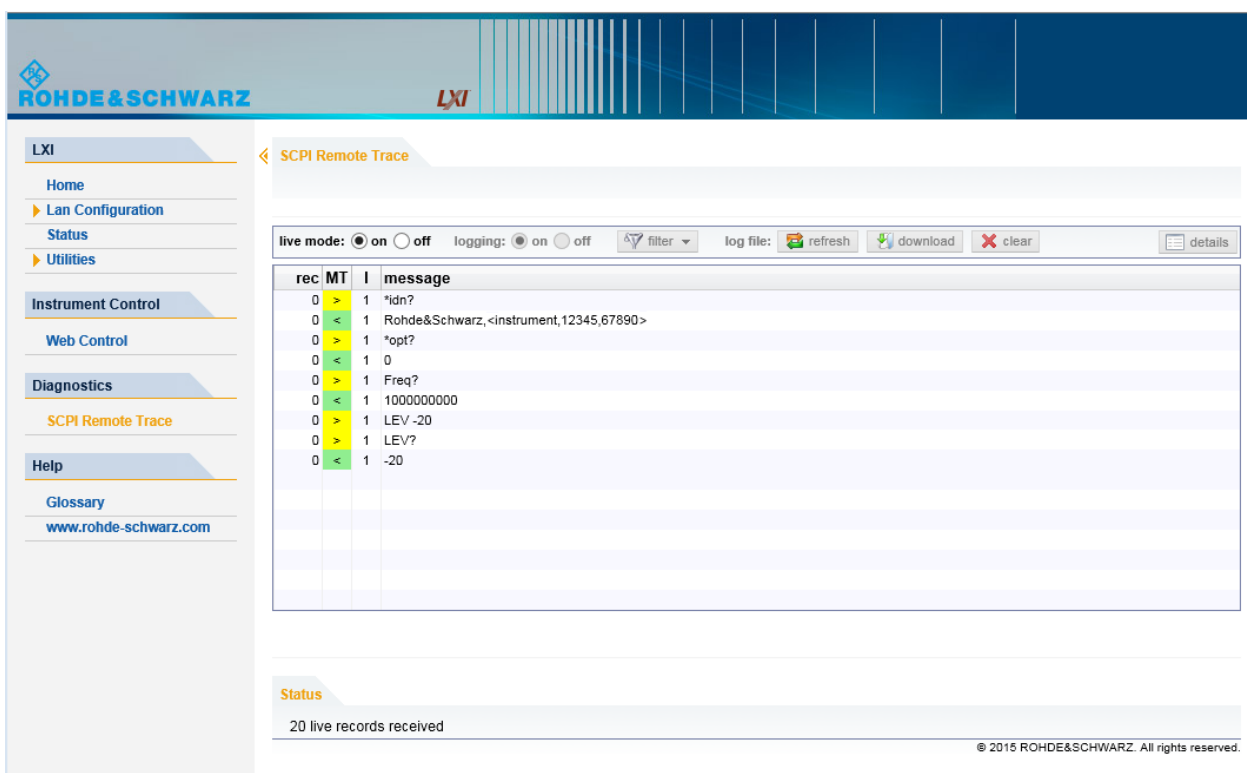

The function records all sent commands, received responses and messages, and stores them in an internal database. If "live mode" is disabled, you can display the recent traces upon request, using the "refresh" button. You can also store the log in a file.

Note: The diagnostics functionality is extended in later releases, e.g. to download or upload SCPI command files from / to the instrument.

Toolbars

The toolbar at the top of the dialog provides basic settings and functions.



- "Live mode" / "logging": If logging is switched on, messages are traced. They are stored in an internal database and can be displayed upon request, using the

refresh button (live mode off) or they can be displayed automatically (live mode on).

- "Filter": applies a filter to columns and/or rows when working (live mode off)
- "Refresh": reads the message log from the internal database and displays it
- "Download": stores the SCPI trace log to a *.CSV file
- "Clear": deletes all message log entries in the database and on the screen
- "Details": displays details of the selected message, for example an SCPI command in hex format (also possible by double-clicking a message)

Columns

The following columns are available if no column filter is applied:

- "Rec": record number of the message within the message log
- I: number of the subinstrument
- "MT": indicates the type of the message. Possible values and related message contents are:
 - > = incoming command
 - < = outgoing response to a query
 - E = error message, highlighted by red color
 - T = execution time, i.e. time required by the instrument to process the command internally
- "message": indicates the type of the message. Possible values and related message contents are:
 - > = incoming command
 - < = outgoing response to a query
 - E = error message, denoted in red
 - T = execution time, i.e. time required by the instrument to process the command internally

3 Getting Started

This section helps you to get familiar with the R&S SMBV. It provides an introduction to the general concept of the instrument with a sample of the possible application fields, and a description of the main blocks in the signal generation flow.

This section also explains the operating concept in general and includes a brief introduction to operation by a step-by-step description of the configuration. The example is intended to provide a quick overview of the settings provided. No additional equipment is required.

3.1 Brief Introduction to the Instrument's Concept

The R&S SMBV provides an entirely digital baseband section for generating I/Q signals and an RF section with I/Q modulator. The instrument uses I/Q (vector) modulation. Digital data streams are converted to an I/Q baseband signal. The baseband signal is then D/A-converted and modulated onto the target RF carrier frequency with the aid of an I/Q modulator.

For a detailed description of the blocks in the baseband and RF sections, refer to [Chapter 3.2, "Baseband Section"](#), on page 65 and [Chapter 3.3, "RF Section"](#), on page 68 respectively.

The **operating concept** of the R&S SMBV employs the following three ways of instrument control:

- Manual operation
- Remote control
- Remote access

Manual Operation

The R&S SMBV can be entirely operated from the front panel. Peripherals such as mouse or keyboard can be connected but are not essential.

The R&S SMBV is equipped with an intuitive user interface. The central element of the display is the block diagram that shows the signal flow and processing from the left on the display to most right, i.e. the generated signal can be seen at a glance.

Each block represents a functional unit of the instrument. Thus you always know the position at which a parameter affects the signal flow. The main settings of a block are indicated in the block. The interconnection of employed inputs and outputs is also shown. The user is thus always informed about the connection of inputs and outputs in the signal flow and where they can be configured. A window is opened for each menu where parameters can be set. When the window is opened, an entry is made in the "Winbar" below the display. All open menus are of equal priority (not modal) and can be accessed any time.

The block diagram in the figure below shows a fully equipped instrument.

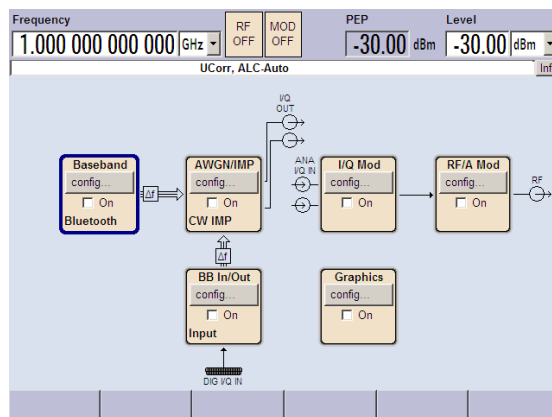

Figure 3-1: Block diagram of a fully equipped R&S SMBV

With the rotary knob, you can navigate in the block diagram and the dialogs, and operate the instrument with one hand. The cursor is moved line by line through the block diagram or dialog. Turning the button clockwise advances the cursor. The selected block can be activated or deactivated with the [TOGGLE] key. Active blocks are highlighted by a colored background.

The instrument comprises a comprehensive info and help system. You can access the context-sensitive help with the [HELP] ([F1]) key at any time. The help system indicates the currently selected parameter and offers additional services such as cross references, index and contents. The content of the help system corresponds to the operating manual of the instrument.

Warning and conflict messages caused by incorrect operation as well as further information are displayed in the "Info" line. A complete list of existing conflicts is displayed when the [INFO] ([CTRL+I]) key is pressed. Additional information on entries can be requested from the help system. The history function permits display of all messages.

Assistants simplify the completion of tables. After data entry in the assistant, the table is modified only after the "Accept" button has been pressed. Pressing the "Accept" button also stores the assistant data.

For an introduction into the manual operating of the instrument, detailed operating instructions and an overview of menus refer to [Chapter 4, "Manual Operation"](#), on page 76.

For an in-depth description of the dialog boxes and the instrument functions, refer to section "Instrument Functions" in the operating manual.

Remote Control

Remote control is an operation of the instrument by means of remote control commands or programs that automatize repeating settings. The instrument is connected to a computer running the program.

The R&S SMBV supports various remote control connections:

- Connecting the instrument to a (LAN) network
- Connecting a PC via the IEC-bus (IEEE 488) interface
- Remote control via the USB interface



Tip: For remote control over LAN or USB, you can use the R&S VISA (Virtual Instrument Software Architecture) library provided for download at the Rohde & Schwarz website <http://www.rohde-schwarz.com/rsvisa>.

This way of operation and the instructions how to set up a connection for remote control are described in the operating manual, chapter "Remote Control Basics". The description of the remote control commands is provided in the operating manual, chapter "Remote Control Commands".

Remote access

Remote access is the operating of the instrument from a remote computer. Both the R&S SMBV and the computer are connected in a LAN.

Remote access in contrast to **remote control** does not use remote-control commands but a separate software which is installed on the remote computer. After its start, the software simulates the user interface of the instrument. The instrument can thus be operated from the remote computer as on the unit itself. The individual functions are operated using the mouse and keyboard. Specific instrument functions can be executed using specific key combinations on the keyboard or a front panel key emulation that can be operated with the mouse.

This way of operation and the instructions how to set up a connection for remote access are described in [Chapter 2.7, "Remote Access via an External Controller"](#), on page 46.

3.2 Baseband Section

The baseband section of the R&S SMBV is fully digital and contains the hardware for generating and processing I/Q signals.

For detailed information on available options, refer to the R&S SMBV data sheet and the R&S SMBV configuration guide.

Up-to-date information is available at R&S SMBV homepage on the internet <http://www.rohde-schwarz.com/product/smbv100a.html>.

Baseband generator (option R&S SMBV-B10)

The generator produces baseband signals. It contains modules for real time signal generation and an arbitrary waveform generator (ARB).

The option Baseband Generator contains real time Custom Digital Modulation and ARB. Software options providing various digital standards are offered in addition. Option R&S SMBV-K40, for instance, generates signals to GSM/EDGE standard, option R&S SMBV-K42 signals to 3GPP FDD standard.

This module also offers digital I/Q impairment functions. The I/Q signal can be deliberately corrupted, e.g. for testing the receiver quality.

Digital Baseband Connectivity (option R&S SMBV-K18)

This option activates the [DIGITAL IQ IN/OUT] interface in order to apply an external signal to the baseband path, or to provide the internally generated baseband signal. Equipped with this option, the instrument indicates the "BB IN/Out" in the blockdiagram.

The interface enables you to directly transmit digital I/Q signals between R&S instruments. In addition, if you use the digital signal interface module (R&S EX-IQ-BOX), you get a versatile digital baseband interface for a variety of formats.



Special features...

- Option R&S SMBV-K18 is a combined interface, i.e. it operates one direction at a time.
- The R&S SMBV processes either the internally generated baseband signal, or the signal supplied externally. Therefore, the baseband signal generator is turned off with "BB In", and vice versa.
- If the baseband section and the RF section are decoupled, e.g. with output of the digital I/Q signal, or if an external analog signal is fed to the I/Q modulator, both sections can be processed independently.

Further processing of the I/Q signal

The R&S SMBV allows further processing of the I/Q signal, as summarized below:

- In the "AWGN/IMP" block, the R&S SMBV allows the digital I/Q signal to be impaired or added with noise before it is passed on. Additionally, a pure noise signal can be used and forwarded. In this case, the I/Q baseband signal is disabled, indicated by the interrupted signal flow in the diagram.
- If **digital I/Q output is on**, the R&S SMBV routes the signal, or the pure noise, directly to the digital interface.
- If **digital I/Q output is off**, the instrument converts the signal to an analog I/Q signal and routes it to the analog I/Q output and to the I/Q modulator of the RF path. Pure noise is also provided at the analog outputs or can be forwarded to the I/Q modulator.

Additional White Gaussian Noise (option R&S SMBV-K62)

Additive white noise, which may be required for instance for measurements on mobile radio base stations, can be produced with the AWGN software option (R&S SMBV-K62).

3.2.1 Description of Individual Diagram Blocks of the Baseband Section



Each function block can be activated or deactivated with the "ON" check box (on/off toggling).

The [ON/OFF TOGGLE] key at the front panel (see "[TOGGLE]" on page 25) switches the currently selected block on or off.

A detailed description of the blocks is provided below.



Baseband A block

In this block, the (first) baseband source is configured and activated. The block is displayed only if a baseband generator is available in the instrument.

Depending on the installed software options, various digital standards, user-configured digital real time modulation or the built-in waveform generator (ARB) can be selected. The selected modulation is displayed in the block.

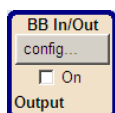

BB In/Out block

The block is displayed only if the Digital Baseband Connectivity (option R&S SMBV-K18) is installed.

As input, the "BB In/Out" block controls the baseband input module for external I/Q signals. Externally generated realtime baseband signals are fed into the digital signal path via the digital interface. The signal is transferred directly to the I/Q modulator (I/Q Mod function block).

Conversely, as output, the block is used to configure the digital I/Q output. The internally generated baseband signal is configured in the Baseband function block.

The digital settings are performed in the corresponding menus. I and Q components can also be swapped (I/Q Swap). The status line in a block displays the currently active control, e.g. "Output" denotes that the I/Q baseband signal is provided by the digital output.



AWGN/IMP A block

This block is displayed only if a baseband generator (R&S SMBV-B10) is installed.

In this block (digital) I/Q impairments for the baseband path can be set. With the aid of the software for AWGN generation (option R&S SMBV-K62), an (additive) noise signal can be produced.

AWGN and impairments can be activated independently of each other in the appropriate menus. The settings are displayed in the block. The entire block can be activated or deactivated. If the block is deactivated, the signal passes through the block unchanged.

In addition, the differential I/Q output is configured in this block.



Graphics block

With this block, the baseband signal can be graphically displayed in real time. The block is displayed only if a baseband generator is installed.

3.3 RF Section

An RF path is configured by installing a frequency option that comprises all required modules.



One of the following options must be installed.

- R&S SMBV-B103 (up to 3 GHz)
- R&S SMBV-B106 (up to 6 GHz)

For detailed information on available options, refer to the R&S SMBV data sheet and the R&S SMBV Configuration guide.

Up-to-date information is available at R&S SMBV homepage on the internet <http://www.rohde-schwarz.com/product/smbv100a.html>).

3.3.1 Description of Individual Diagram Blocks of the RF Section

This section gives an overview of the available blocks and a detailed description of their functions.



I/Q Mod A block

The (first) I/Q modulator is configured in this block. Also the Analog Wideband I/Q mode can be selected here, which allows external I/Q signals to be directly applied to the I/Q modulator, i.e. not via the baseband section. If no baseband modules are installed, I/Q modulation is possible only in the Analog Wideband I/Q mode.

I and Q components can also be swapped (I/Q Swap). (Analog) I/Q impairments can be set in addition. Unlike the impairments in the "AWGN/IMP" block, impairments in the "I/Q Mod" block also affect the externally applied signals in the Analog Wideband I/Q mode.

The status display in the block shows whether I/Q impairments and/or I/Q swap is active. I/Q modulation is switched on or off with the [TOGGLE ON/OFF] key.

Note: An I/Q modulator provided in the R&S SMBV is automatically activated when a connected baseband source is switched on. The I/Q modulator can also be separately switched on and off (select the "I/Q Mod" block and press the [TOGGLE ON/OFF] key). This permits the following configuration to be obtained with a single-path R&S SMBV. The baseband source generates an I/Q signal that is output via the analog I/Q output. At the same time, the RF section generates an unmodulated carrier.

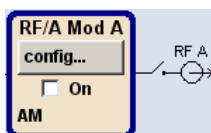

RF/A Mod A block

In this block, the RF parameters and the analog modulation modes are set.

The active analog modulation modes are displayed in the block. The [TOGGLE ON/OFF] key switches the RF signal on and off. When the RF signal is switched off, the switch before the RF output symbol is open.

RF settings include:

- Frequency and reference frequency
- Attenuator settings.
- Frequency and level sweep
- List Mode settings. In this mode, extremely fast frequency and level settings can be made.

Note: Numeric values for frequency and level are entered best and quickest with the aid of the [FREQ] and [LEVEL] keys.

Available analog modulation modes:

- Amplitude modulation
- Pulse modulation (option R&S SMBV-K22).

Note: For modulation modes that can be simultaneously used, refer to the R&S SMBV data sheet.

3.4 Example of Setup

This section provides an example on how to configure the instrument to generate and display a simple QPSK-modulated signal.

Configuring and displaying a QPSK-modulated signal

To generate and display a QPSK-modulated signal, proceed as follow:

1. Activate default (preset) state.
Press the [PRESET] key to set a defined instrument state.

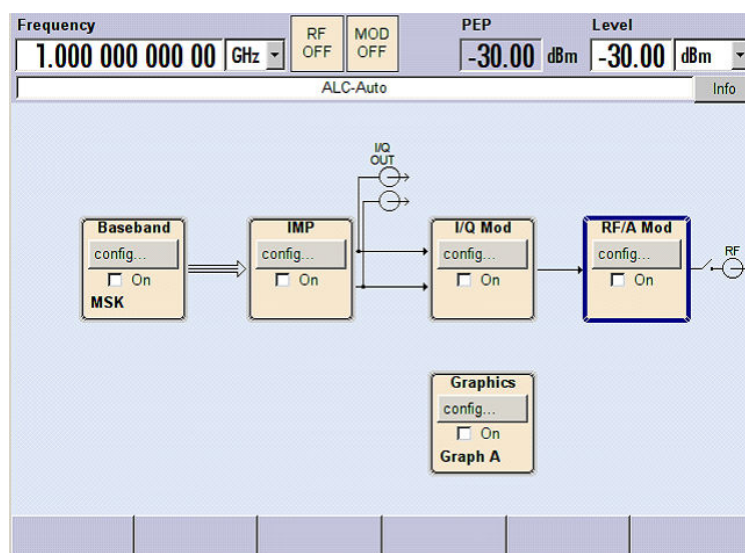

2. Select and activate digital modulation

- a) Turn the rotary knob and select the "Baseband A" block.

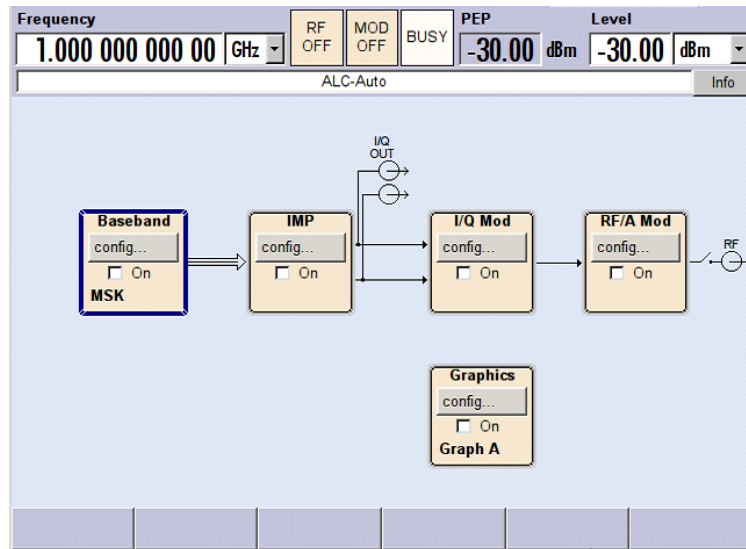

- b) Press the rotary knob to open the menu where the digital modulation can be selected (different modulation modes are available depending on the options installed).

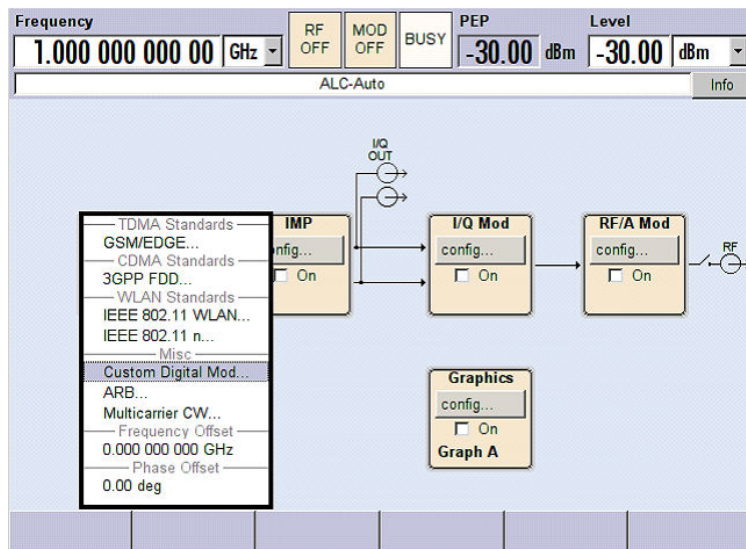

- c) Turn the rotary knob and highlight "Custom Digital Mod...".

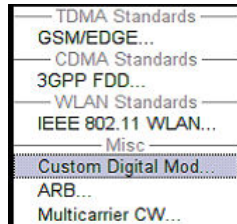

Press the rotary knob to open the "Custom Dig. Mod." dialog.

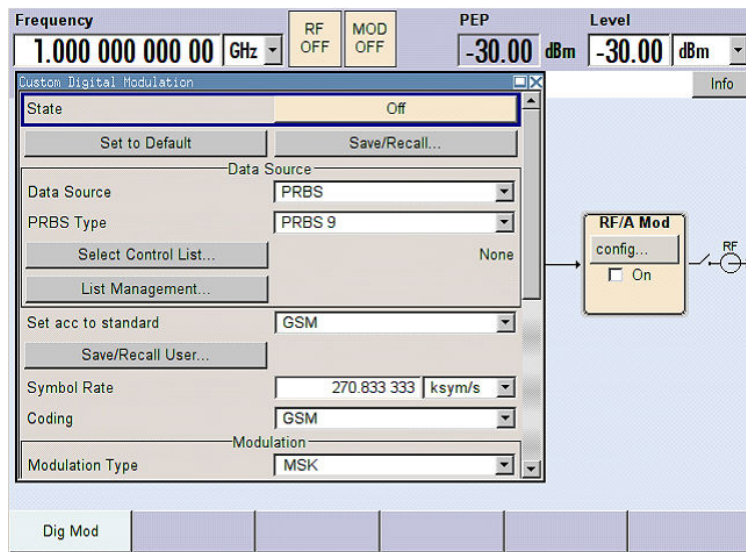

- d) Turn the rotary knob to select parameter "Symbol Rate", press the rotary knob to allow editing and enter the preferred symbol rate with the aid of the numeric keypad and the unit keys.

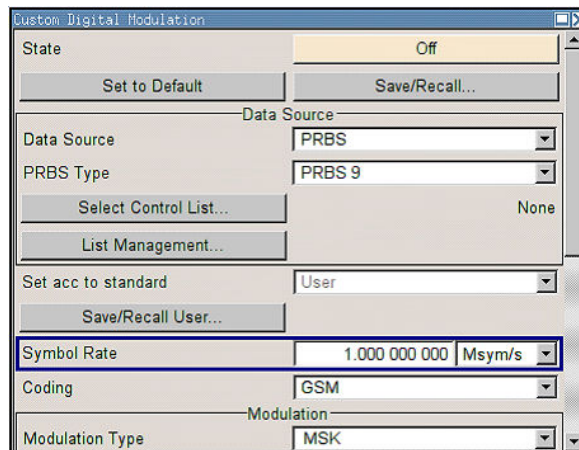

- e) Turn the rotary knob to select parameter "Coding".
Press the button to open the selection list.
Turn the rotary knob to select "Off" and press the knob to activate the selected item.

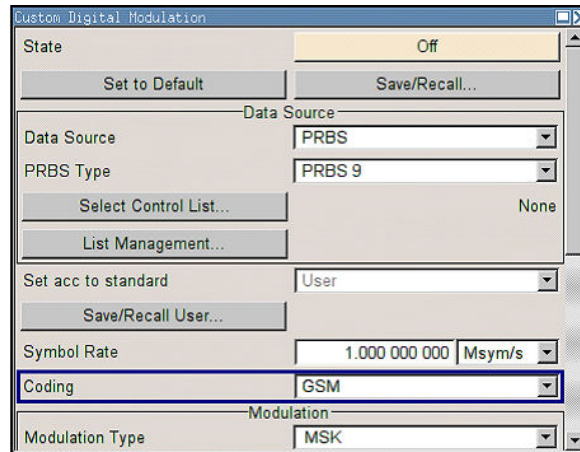

- f) Use the rotary knob in the same way to set "Modulation Type" QPSK and "Filter" Root Cosine with "Roll Off Factor" 0.3.

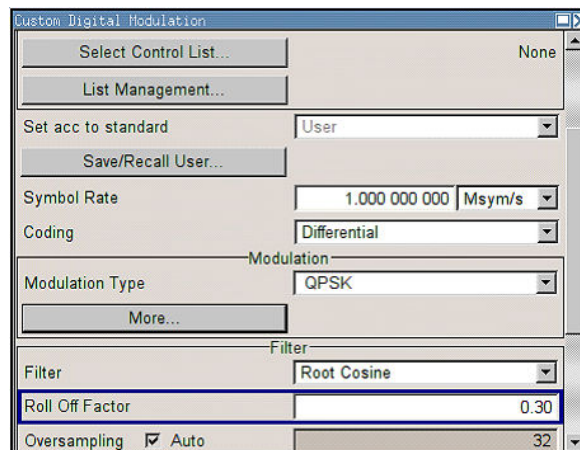

- g) Finally, select "State" and press the rotary knob to switch on the digital modulation.

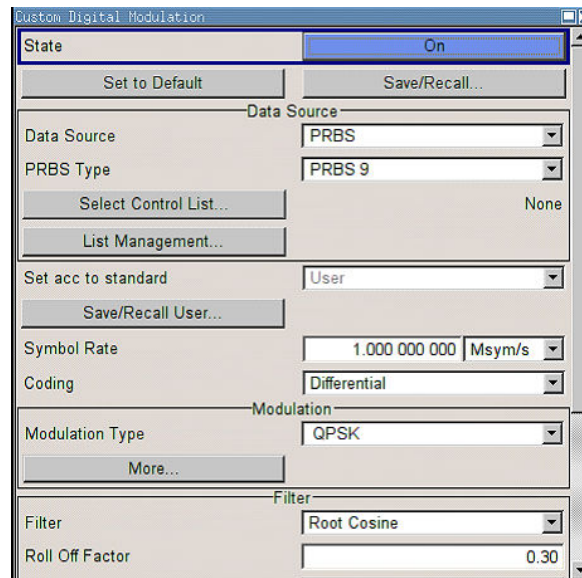

- h) Press the [DIAGRAM] key to display the complete block diagram.

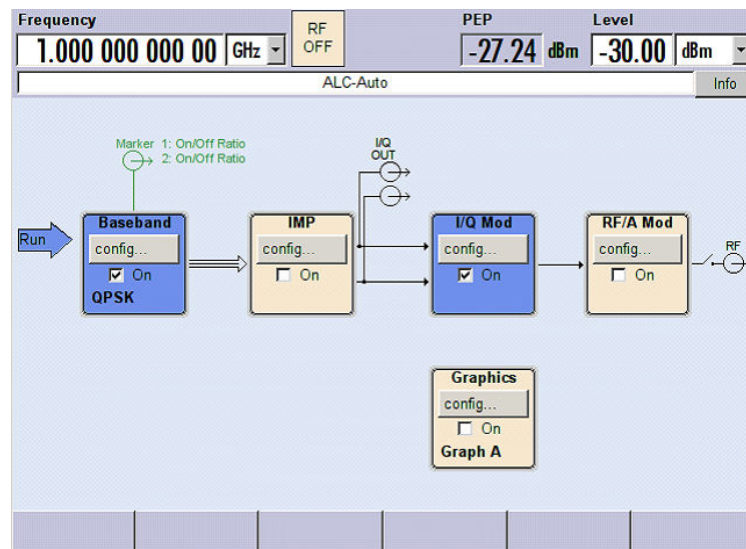

To indicate the active state, the "Baseband" block is displayed in blue.

- i) The entry in the Winbar indicates that the "Custom Dig. Mod." menu is still open in the background.
To display the menu in the foreground, press the softkey below the button in the "Windbar".

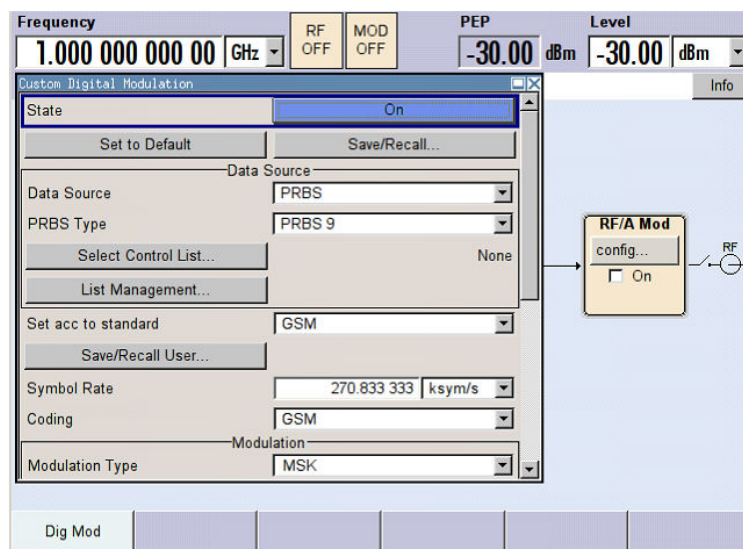

Press the [HIDE] key to minimize the menu again.

The "I/Q Mod" block is automatically activated.

The "RF/A Mod" is not yet active, which means that no RF signal is output.

3. Set frequency and level and activate RF signal
 - a) Press the [FREQ] key to activate the editing mode for frequency entry. The "Frequency" entry field in the header section of the display is highlighted.

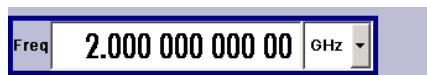

Enter the frequency using the numeric keypad and terminate the entry by pressing a unit key.

- b) Press the [LEVEL] key and enter the level settings in the same way.

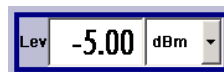

- c) Press the [DIAGRAM] key to display the complete block diagram.
 - d) Turn the rotary knob to select the "RF/A Mod" block.
Press the [TOGGLE ON/OFF] key to activate the "RF/A Mod" block.

The QPSK modulation signal is now present at the RF output.

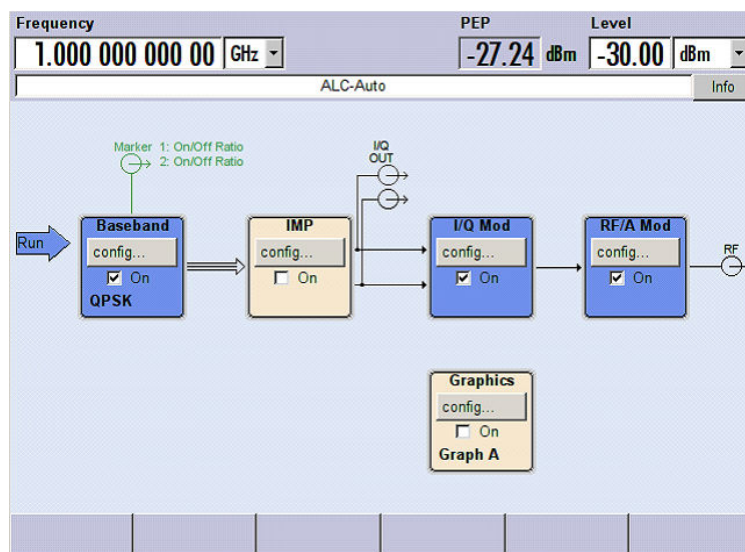

4. Select graphics display of I/Q signal
 - a) Turn the rotary knob to select the "Graphics" block and open the respective menu.

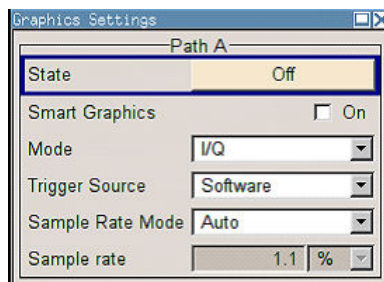

- b) Select "State On" with the rotary knob to activate display of the I/Q diagram.

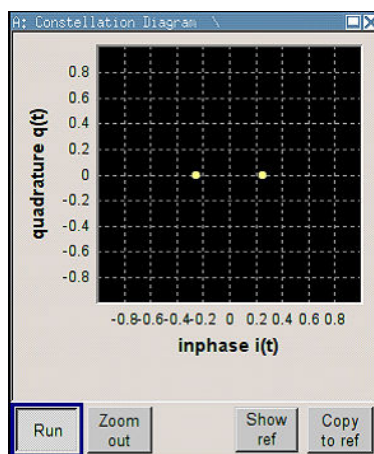

4 Manual Operation

The R&S SMBV can be operated intuitively either via the interactive block diagram or via a menu tree. All menus are in the form of windows that can be operated in the same way. Rotary knob, keys and softkeys, or alternatively a mouse, allow direct and therefore convenient access to entries and settings.

The clear-cut display shows the current signal generator state. Graphs, spectra, vector diagrams, etc. can be called for a visual check of the output signal. Numerous help functions support the user in signal configuration.

This section describes the concept of manual operation of the signal generator. This includes a description of the general structure of a dialog box, working with dialog boxes and the block diagram and the setting of parameters.

For an in-depth description of the dialog boxes and the instrument functions refer to section "Instrument Functions" in the Operating Manual.

4.1 Key Features

The manual operating concept of the R&S SMBV enables the user to make settings as intuitively as possible and at the same time gives a permanent overview of characteristics of the generated signal and of the current instrument state. Numerous online help functions support user settings.

Block diagram

The block diagram is the core of the operating concept.

A graphics display shows the current configuration and the signal flow in the form of a block diagram. All graphical elements can be accessed for operation. An element is selected by means of the arrow keys and the associated setting function is called by pressing Enter. Required menus and graphs are displayed on the block diagram which is displayed again in the foreground whenever the [DIAGRAM] ([CTRL+D]) key is pressed.

Permanent frequency and level display

The main characteristics of the RF signal, frequency and level, are permanently displayed in the header section of the screen and can be directly set in the display fields after the [FREQ] (CTRL+F) or [LEVEL] (CTRL+L) key is pressed. Status messages for the output signal are displayed in addition to frequency and level.

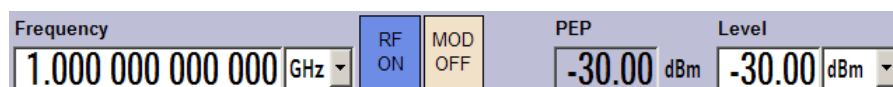

Operation via Graphical User Interface

- **Functional blocks**

Menus are assigned to the specific function blocks in the block diagram. The function blocks represent elements of signal generation. Function blocks displayed with a blue frame can be directly switched on and off by means of the [TOGGLE ON/OFF] (CTRL+T) key. The menus of the highlighted function blocks can be called by pressing the [ENTER] key.

– **Example:**

The "Baseband" block contains all menus required for baseband signal configuration.



In this block all digital standards and the digital modulation can be selected.

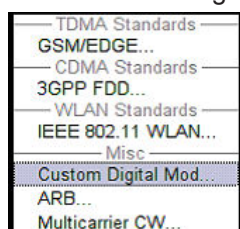

• **Signal flow**

The signal flow between the function blocks and the employed inputs and outputs are also shown.

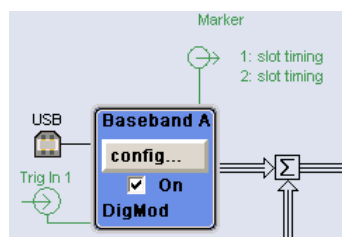

• **Menu tree**

The menu tree can be opened and closed with the [MENU] (CTRL+M) key. The menu tree is organized in the same way as the directories under Windows. The function blocks correspond to the first directory level, the menus to subdirectories.

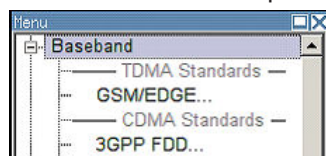

Operation corresponds to the Windows concept

To offer the user a familiar environment, operation is very similar to operation of Windows user interfaces. All menus and tables are made up of known elements, such as selection lists, check boxes and entry fields.

A blue frame indicates that the selected item is active. In the highlighted element, entries can be made.

Rotary knob



Operation is possible via front-panel keys, an external keyboard and the mouse. However, most of the settings can be easily made with the rotary knob:

- Turning the rotary knob shifts the entry focus to the target element.
- Pressing the rotary knob activates the selected entry field. Depending on the parameter, the submenu is called, the numeric value varied, the list entry selected or the check box activated or deactivated.
- If a value is entered, the entry is stored by another click on the rotary knob and the editing mode is exited.

Clear settings with the aid of independent subdialogs

A separate window is opened for each dialog and subdialog. The dialogs can be operated independently of each other, i.e. none of the dialogs requires that settings in other dialogs be completed before it can be closed. This ensures flexible operation at all times.

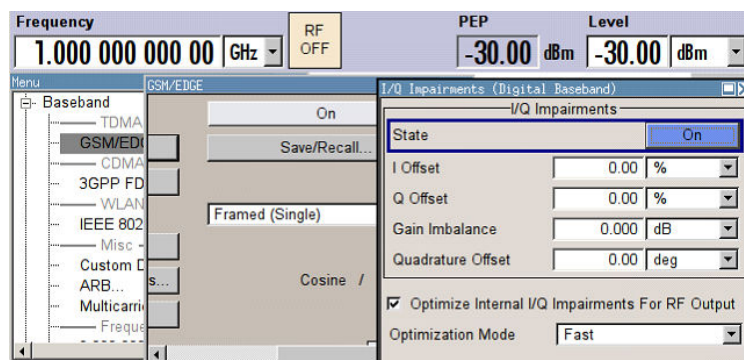

Winbar

The Winbar gives an overview of menus and simplifies their access.

The menus are displayed on top of the block diagram but they can be "hidden" with the aid of the [HIDE] (CTRL+H) key, i.e. displayed in the form of a button in the "Winbar" at the lower end of the screen.

They can be displayed again in full size by a keystroke ([REARR] (CTRL+A) key). This makes room on the screen for other displays that may be required but the setting menus can be still accessed any time.



Keys with assigned simple functions

Most keys on the front panel of the R&S SMBV directly perform a simple function.

Since a great number of settings can thus be made by a keystroke, operation is easy. For instance, the [CLOSE] (ESC) key closes the active menu; with the [RF ON/OFF] (CTRL+R) key the RF output signal can be switched on or off.

An exception are keys that call a menu such as the [MENU] (CTRL+M) key which opens the complete menu tree of the instrument, the [SETUP] (CTRL+E) key which opens the menus for general instrument settings or the [FILE] (CTRL+S) key which opens the menu for file management.

Help functions for user support

Numerous help functions support the user in signal configuration.

- **Value ranges**

The valid setting range is displayed for each numeric parameter. This requires a short wait after activation of the entry field. The range is then displayed automatically after a few seconds.

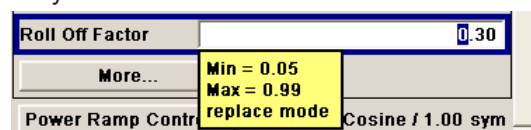

If the entered value is outside the permissible range, the next permissible value is automatically set and a message is output.

- **Context-sensitive help**

Context-sensitive help for each parameter can be called with the [HELP] or [F1] key.

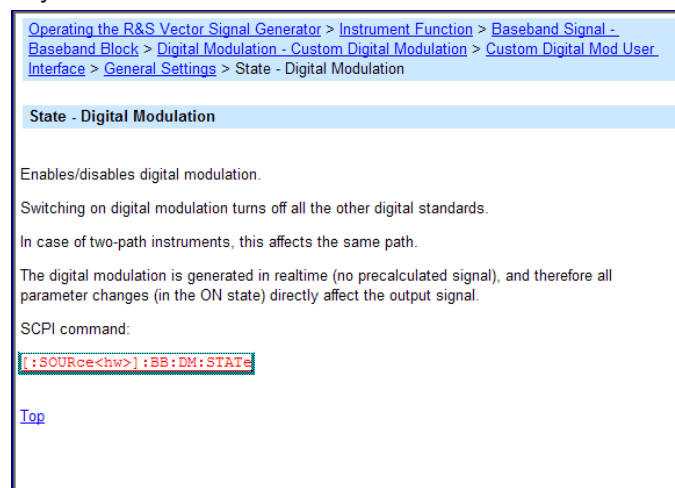

- **Comprehensive online help**

Each help page is part of a comprehensive online help function which can be called by means of an index, a content tree or the "Previous/Next" buttons.

Info line with messages for indication of the current instrument state

A great variety of different messages such as status messages, error messages, warnings or information are displayed in the header field of the screen. With the aid of the [INFO] (CTRL+I) key, help pages can be called for most of the messages. They provide background information on the message and indicate operating steps that may be required. All messages are explained in the online help which can be called with the [HELP] (F1) key.

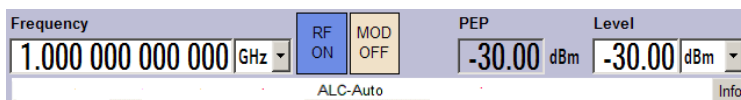

Graphical display of data structure

The structure of the baseband signal is graphically displayed in the respective menus; the individual signal elements can be graphically selected for processing.

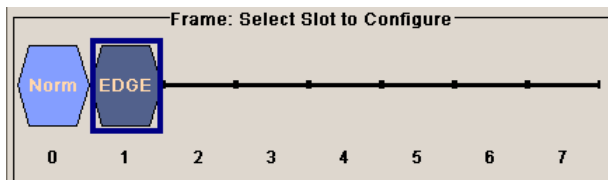

Graphics editor for definition of control signals

Control signals are also graphically configured.

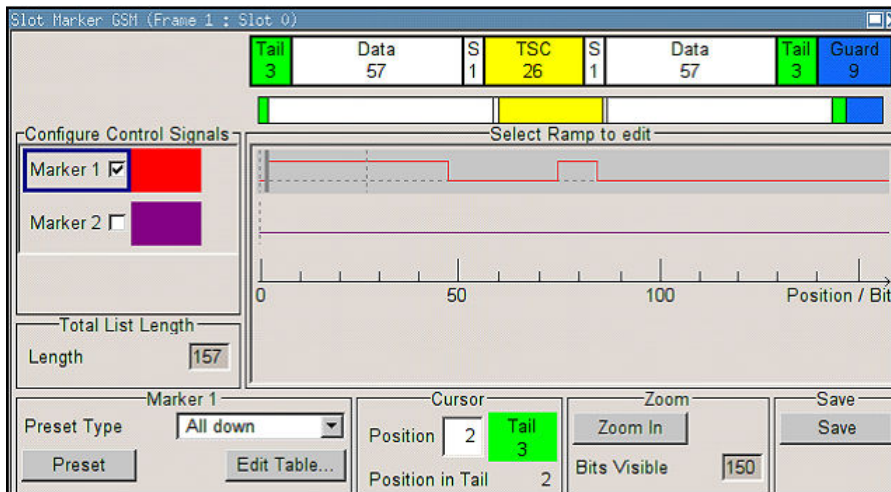

Graphical display of output signal in a diagram

The output signal can be graphically displayed in a number of diagrams. This allows a fast check of signal characteristics. Zoom functions and the insertion of a reference trace permit in-depth evaluation without an external analyzer being required.

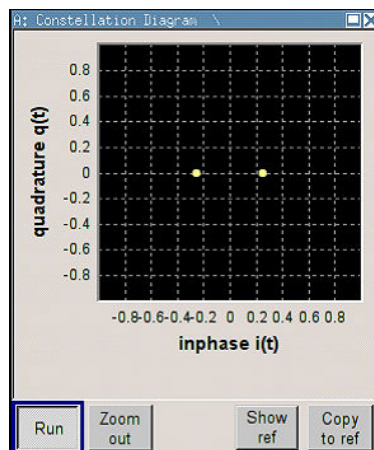

4.2 Display

The display shows the current signal generator state and offers graphical elements for direct operation. It is divided into three sections:

- The frequency and level display with info line indicates the main output signal parameters and reports the current state with status, error and warning messages.
- The block diagram shows the instrument configuration, the signal characteristic as well as the inputs and outputs used and permits interactive operation via graphics elements. Active menus and graphs are displayed on top of the block diagram.
- Winbar with labeled softkeys for menu display.

The block diagram in the figure below shows a fully equipped instrument.

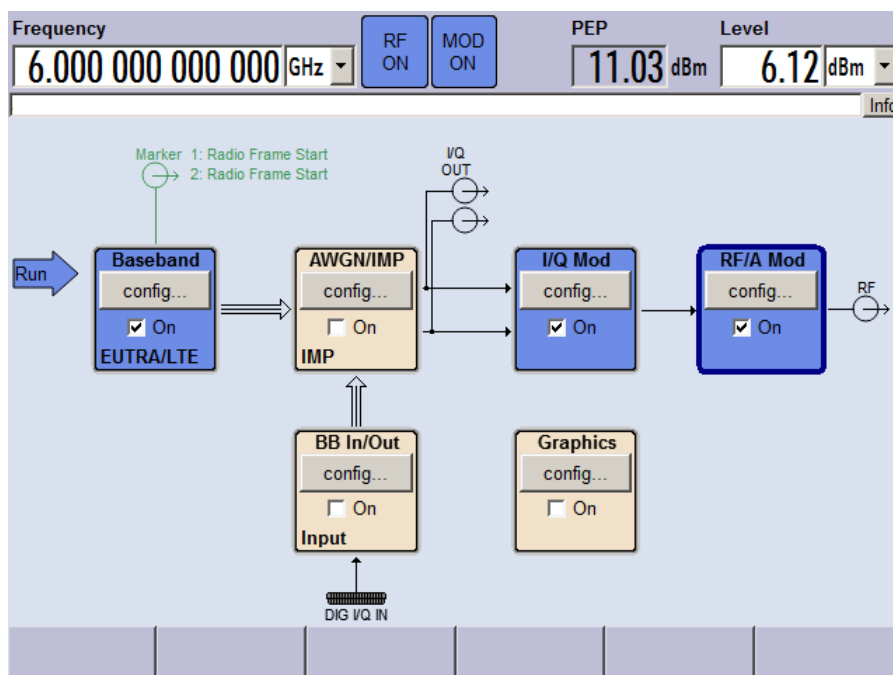

Figure 4-1: Block diagram of a fully equipped R&S SMBV



The latest R&S SMBV Vector Signal Generators are equipped with a new version of the base board, which shows the block diagram in slightly different shapes, see [Chapter 2.1.3, "Display"](#), on page 22. The functionality does not change.

4.2.1 Settings Displayed in the Header Section

Frequency/level settings and a few status messages (see [Chapter 4.2.2, "Status Information and Messages"](#), on page 83) are displayed in the header field of the screen. The display may vary depending on the instrument's operating mode:

- In the sweep mode, the current frequency or level of the output signal is displayed. The status message "SweepMode" is displayed in the info line.
- In the list mode, neither the current frequency nor level is displayed, the indication is dimmed.
- If user correction is active, the status message "UCorr" is displayed in the info line.
- In the case of digital modulation, "Freq" indicates the frequency, "PEP" the peak envelope power and "Level" the average level.



The values displayed in the "Freq" and "Level" fields include a set offset or multiplier factor.

See also "RF Frequency and Phase" and "RF Level" in the Operating Manual.

4.2.2 Status Information and Messages

The instrument indicates status information and messages in the header section of the screen. The messages differ with respect to their importance (errors, warnings, info) and the time of their appearance (brief and permanent messages), and require different treatment

For additional information refer to the info window (see [Chapter 4.2.3, "Info Window"](#), on page 84).

Refer to "Error messages" in the Operating Manual for an overview of all status information and messages and corrective actions.

4.2.2.1 Status Information

The status information gives the user an overview of the main operating states and settings of the instrument. The states are indicated for information only and do not necessitate any action by the user.

Status information is displayed between the frequency and level fields, at the left of the info line or in the info line itself.

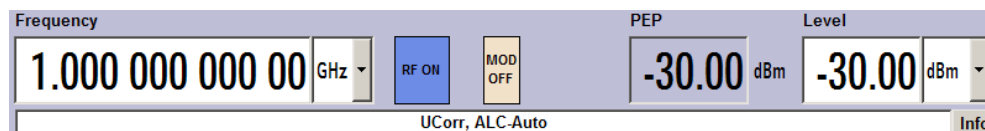

4.2.2.2 Messages

Messages indicate errors in the instrument. They are displayed in the info line in different colors depending on their importance and display duration. Errors (e.g. no calibration data) are displayed in red, information (e.g. file not found) and warnings in black. Warnings indicate less significant errors (e.g. the instrument operates outside specified data).

4.2.2.3 Volatile messages

Brief messages report automatic settings in the instrument (e.g. switching off of incompatible types of modulation) or on illegal entries that are not accepted by the instrument (e.g. range violations). They are displayed in the info line on a yellow background. They are displayed on top of status information or permanent messages.

Volatile messages do not normally demand user actions and disappear automatically after a brief period of time. They are stored in the history, however.

These messages can be read from remote using `SYST:ERR?` or `SYST:ERR:ALL?`.

4.2.2.4 Permanent Messages

Permanent messages are displayed if an error occurs that impairs further instrument operation, e.g. a hardware fault. The error signalled by a permanent message must be eliminated before correct instrument operation can be ensured.

The message is displayed until the error is eliminated. It covers the status display in the info line. After error elimination, the message automatically disappears and is also recorded in the history.

These messages can be read from remote using `SYST:ERRor:STAtic?`.

4.2.3 Info Window

A few operating states and the current message are displayed in the info line.

The [Info] window with a list of current permanent messages and a detailed description of each message can be opened with the [INFO] (CTRL+I) key.

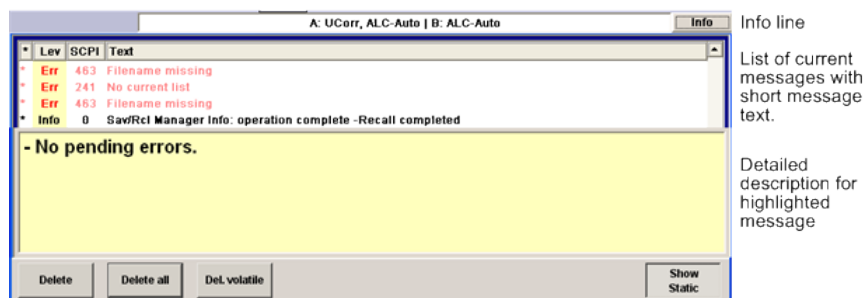

The upper section of the info window contains a list of all current permanent messages in the order of their occurrence, i.e. the most recent message is displayed first. In the lower section of the window, additional information on the highlighted message is displayed. A history of all messages that have occurred since instrument switch-on can be called with the "History" key. The most recent message is displayed first.

The messages are color-coded according to their level. Device-specific messages are red, info and remote control error are black. The level is also indicated in the "Lev" column (Err, Sys or Info). Column "SCPI" indicates the SCPI error code.

With the aid of the softkey buttons, error messages can be cleared and a history of all messages called.

Delete

Clears the highlighted message.

This button is available only if the history of the messages is displayed.

Delete All

Clears all messages.

This button is available only if the history of the messages is displayed.

Remote command:

`SYST:ERR:HIST:CLE`

Del. volatile

Clears all volatile messages.

This button is available only if the history of the messages is displayed.

Remote command:

`SYST:ERR:ALL?`

Each time a `SYST:ERR:ALL?` query is sent, the error queue is returned and at the same time cleared.

History

Calls the list of all messages that have occurred since instrument switch-on. The most recent messages are displayed at the top of the list. When the button is pressed again, the list of current messages is displayed.

Remote command:

`SYST:ERR?` or `STAT:QUE?`

Each time a `SYST:ERR?` or `STAT:QUE?` query is sent, the oldest entry in the error queue is returned and at the same time cleared in the list.

4.2.4 Block Diagram

The block diagram shows provided options, signal configuration and the currently selected signal flow of the generator with inputs and outputs used. Signal generation can be completely operated from the block diagram. The highlighted function block can be directly switched on and off with the [TOGGLE ON/OFF] (CTRL+T) key. Pressing the Enter opens the associated setting menu.

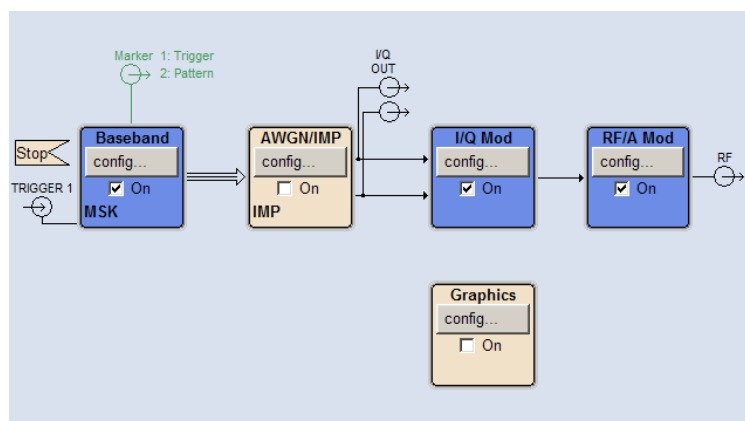

Figure 4-2: Block diagram of the R&S SMBV

4.2.4.1 Function Blocks in the Block Diagram

Each block represents a function of signal generation. The function is indicated in the headline of the block. In the check box, the respective function can be quickly activated/ deactivated with the [TOGGLE ON/OFF] (CTRL+T) key. After activation, the block is displayed in blue. Status information is displayed below the check box. It is different for the different blocks.

Pressing the rotary knob (front panel) or the "Config..." button (mouse) opens the associated setting menu.

In all function blocks where the signal flow can be influenced, the top menu level for setting signal routing parameters is offered.

Example: Baseband block

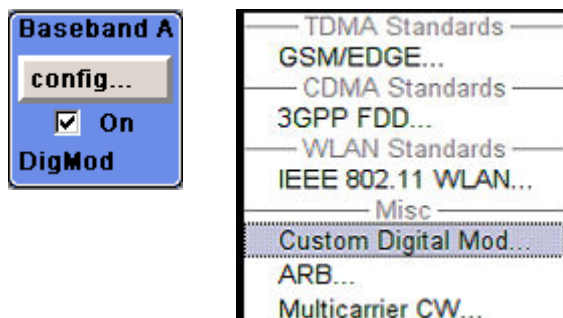

In this block, the digital modulation signal, the digital standards, arbitrary waveform generation and multicarrier CW are set. The status information of the "Baseband" block indicates the selected modulation and associated additional information, e.g. the number of channels.

4.2.4.2 Signal Flow and Input/Output Symbols in the Block Diagram

The input/output symbols in the block diagram show the currently used inputs and outputs of the signal generator. Unused inputs and outputs are not shown. The lines indicate the signal flow.

Symbols and labels refer to the corresponding inputs and outputs on the front and rear panel of the signal generator. The direction - input or output - is indicated by an arrow.

Example:

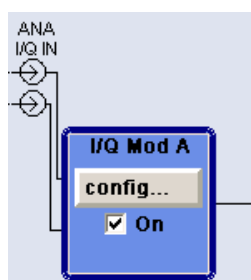

The symbols indicate the inputs for the analog I and Q signal.

If several markers are active, the marker characteristics are listed next to the marker symbol of the active markers.

Symbols and lines are displayed in different colors depending on their function.

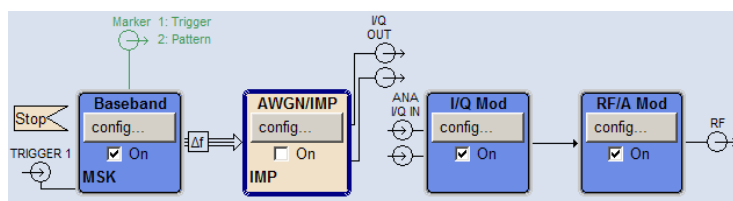

- The baseband signal is indicated by a three line arrow, the I- and Q-components of the signal by a single-line arrow.
- Connections are indicated by a "solder point".
- Black is used for the generated signal.
- Green is used for control signals.

The signal flow is configured in the individual menus. User interfaces are configured in:

- the "Setup > Global Trigger/Clock/External Inputs" dialog.

4.2.5 Winbar and Softkeys

The "Winbar" is displayed below the block diagram. Labelled buttons represent open menus, the label indicates the menu. If several menus are open, the button of the currently active menu is displayed in a lighter colour. The buttons also assign functions to the softkeys of the next lower level for front-panel operation. Up to eight menus may be open simultaneously. When the ninth menu is opened, the menu that was opened first is automatically closed.



Some menus, e.g. data and list editor menus, cover the "Winbar" and assign menu-specific functions to the front-panel softkeys by way of the menu buttons.

Any of the open menus can be activated either with the respective button in the "Winbar" or the front-panel softkey. In combination with the keys for menu operation ([CLOSE] (ESC), [HIDE] (CTRL+H) and [REARR] (CTRL+A)), convenient menu operation can be ensured.

Working with menus and dialog boxes is described in [Chapter 4.3, "Accessing Dialogs"](#), on page 89.

4.2.6 Structure of the Dialogs

The parameters are set in the menus. Menus are accessed either via the function blocks in the diagram or by means of the [MENU] (CTRL+M) key. The menus are displayed on top of the block diagram.

If the menu buttons assign menu-specific functions to the softkeys, the "Winbar" is hidden.

Working with menus and dialog boxes is described in [Chapter 4.3, "Accessing Dialogs"](#), on page 89; the setting of parameters in [Chapter 4.4, "Setting Parameters"](#), on page 90.

The menus are in Windows format. The menus differ in details depending on their function but they consist of the same main elements. Each menu consists of a menu header and one or more menu areas with various fields for setting parameters.

The header line contains the name of the menu and the buttons for minimizing and closing the menu. To operate the buttons, use the mouse or the front keys [HIDE] (CTRL+H) and [CLOSE] (ESC).

Several fields of associated but separately set parameters are organized in menu areas. A menu area is framed and labelled with the function common to all parameters.

Example: Impairments

| Impairments | | | |
|-------------------|-----------------------------------|-----|--------------------------|
| State | | | <input type="checkbox"/> |
| I Leakage | <input type="text" value="0.00"/> | % | ▼ |
| Q Leakage | <input type="text" value="0.00"/> | % | ▼ |
| Imbalance | <input type="text" value="0.00"/> | % | ▼ |
| Quadrature Offset | <input type="text" value="0.00"/> | deg | ▼ |

Each of the setting fields is assigned a parameter name. The kind of setting varies depending on the parameter to be set. Some settings can only be made in a specific configuration. If setting is not permitted with the specific configuration selected, the respective item is disabled and displayed in gray and the entry or selection field cannot be accessed.

4.2.7 Graphical Display of Output Signal Characteristics

The graphical display of the output signal enables the user to rapidly check signal characteristics without connecting an analyzer. Zoom functions and the display of a reference trace allow in-depth evaluation. The diagram is displayed on top of the block diagram. It can be minimized and called in the same way as a menu.

Example: Constellation Diagram

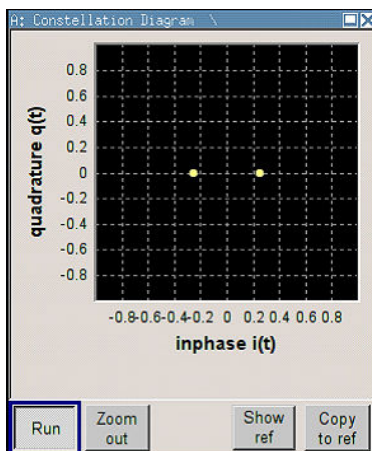

To access the "Graphics Settings" dialog for selecting the graphics display of the output signal, select the "Graphics" function block in the diagram or press the [MENU] (CTRL+M) key.

Operation of the graphics windows is analogous to menu operation.

The menu and the individual graphical displays are described in "Graphics Display" in the Operating Manual.

4.3 Accessing Dialogs

The [MENU] (CTRL+M) key opens the complete menu tree. Selecting a functional block and pressing the [Enter] key opens the menu associated with this block.

An alternatively way to access a dialog is to use the Winbar buttons or front-panel softkeys or to use the [HIDE] (CTRL+H), [CLOSE] (ESC), [DIAGRAM] (CTRL+D) and [REARR] (CTRL+A) keys on the front panel.

For a quick access to the dialogs, use one of the following alternative methods.

Displaying the block diagram or a dialog in the foreground

1. Press the [DIAGRAM] (CTRL+D) key to move the cursor to the block diagram. All active menus are minimized and displayed in the form of Winbar buttons.
2. Press the associated softkey (CTRL+F1 .. F8) to display the dialog in the foreground again.

Accessing the menu tree

- ▶ Press the [MENU] (CTRL+M) key to open the complete menu tree.

Calling the File, Setup or Hardcopy dialogs

- ▶ Use the [FILE] (CTRL+S), [SETUP] (CTRL+E) or [HCOPY] (CTRL+Y) keys to open the respective dialog.

Minimizing an active menu

- ▶ Use the [HIDE] (CTRL+H) key to minimize an active menu. It is displayed in the form of a Winbar button.

Automatically arranging displayed menus

- ▶ Press the [REARR] (CTRL+A) key to rearrange all open menus so that they overlap as little as possible.

Activating the Winbar

- ▶ Use the [WINBAR] (CTRL+W) key to toggle the cursor between a button of the "Winbar" and the block diagram.

The button that was active last in the Winbar is highlighted.

Closing an active menu

- ▶ Press the [CLOSE] key to close an active menu.

Tip: If the cursor is at the highest menu level, you can also use the [ESC] key to close the active menu.

Accessing the header area

- ▶ Press the [FREQ] (CTRL+F) and [LEVEL] (CTRL+L) keys to activate the "Frequency" or "Level" entry fields in the header area.

**Keyboard Shortcuts**

Keyboard shortcuts (e.g. "Ctrl + D" for the displaying the block diagram in the foreground) provide direct access to all utility dialogs of the instrument (see [Chapter 4.8, "Legend of Front-Panel Controls"](#), on page 112).

4.4 Setting Parameters

The R&S SMBV offers several and sometimes alternative possibilities for setting parameters. Operation is possible from the front panel, with the aid of a mouse and/or from a PC keyboard.



The examples within this description focus on the operation from the front panel.



For more information, refer to:

- [Chapter 4.8, "Legend of Front-Panel Controls"](#), on page 112 for an overview of key functions and a cross-reference between the front panel keys and the keyboard shortcuts
 - "Instrument Functions" in the Operating Manual for a detailed description of key functions.
-

Most of the parameters are set in the different menus. The R&S SMBV provides alternative ways for accessing the dialogs. Turn the rotary knob and navigate to the corresponding block in the block diagram and press the knob to open the dialog or perform a mouse click on the "Config..." button.

An exception are the "Setup", "File" and "Hcopy" dialogs. In the "Setup" dialog, general settings are made which are not directly concerned with signal generation, e.g. setting

of the GPIB-bus address. In the "File" dialog, files and lists are managed; in the "Hcopy" dialog, printout is configured and hardcopies can be made. These menus can only be called with the [SETUP] (CTRL+E), [FILE] (CTRL+S) and [HCOPY] (CTRL+Y) keys.

Frequency and level are directly set in the header area of the display using the [FREQ] and [LEVEL] keys.

Specific settings can also be made directly in the block diagram, e.g. activating a function block by means of the [TOGGLE ON/OFF] (CTRL+T) key or switching the RF output on and off with the aid of the [RF ON/OFF] (CTRL+R) key. Changes affecting the signal flow are immediately visible in the graphics display.

This section provides an information about the parameter handling that comprises of the following main steps:

- [Chapter 4.4.1, "Working with the Cursor"](#), on page 91
- [Chapter 4.4.2, "Selecting a Control Element"](#), on page 92
- [Chapter 4.4.3, "Switching Parameters On/Off"](#), on page 92
- [Chapter 4.4.4, "Entering a Value"](#), on page 92
- [Chapter 4.4.5, "Working with Units "](#), on page 94
- [Chapter 4.4.6, "Selecting a Value from a List"](#), on page 95
- [Chapter 4.4.7, "Terminating Entries with Confirmation"](#), on page 95
- [Chapter 4.4.8, "Restoring the Previous Value"](#), on page 96

4.4.1 Working with the Cursor

After the instrument is switched on, the cursor is always on the first function block of the diagram (default setting).

Moving the cursor on the display

- ▶ To move the cursor, use one of the following alternative methods:
 - a) Use the rotary knob or the arrow keys.
 - b) Use the appropriate softkeys (CTRL+F1..F8) to move the cursor to the "Winbar".
If the "Winbar" is covered by a menu, press the [WINBAR] (CTRL+W) key to display it in the foreground.
 - c) Use the [ESC] key.

Tip: Be aware that the function of the [ESC] key depends on the current cursor position.

The function of this key depends on the current cursor position.

- Calls the next higher selection level.
- Closes the open window without accepting new entries; the old value or parameter is retained.
- In dialog boxes that contain a "Cancel" button it activates that button.
- Closes all kinds of dialog boxes, if the edit mode is not active.
- Quits the edit mode, if the edit mode is active.
- Switches between different entry fields of a menu.

- Shifts the entry cursor from the header display to the previously active menu, or to the previously highlighted block in the block diagram if no menu is active.
- Shifts the cursor from a function block in the diagram to the first item in the "Winbar". If no menus are open, the current cursor position remains unchanged.

Moving the cursor to the heading area

- ▶ Press the [FREQ] (CTRL+F) or [LEVEL] (CTRL+L) key to move the cursor to the header area.

4.4.2 Selecting a Control Element

Control elements are always selected in the same way no matter whether a function block in the diagram, a menu in the menu tree, a parameter in the menu or an entry in a list or table is concerned.

- ▶ To activate an element, put the cursor on it.



An active element is highlighted by a blue frame.

4.4.3 Switching Parameters On/Off

A parameter can be activated and deactivated using a button or a check box.

1. Select the parameter.
2. To change the state of a parameter, use the "Enter" function of the different control media:
 - Press the rotary knob
 - Press [ENTER]
 - Press the [TOGGLE ON OFF] (CTRL+T) key.

Colour and label of a button change, the check box is ticked or the tick is removed.

4.4.4 Entering a Value

Numeric and alphanumeric values can be edited in the entry fields. In the editing mode, cursors of different colour are used. A blue cursor indicates the overwrite mode, a green cursor the insert mode.



Changing between the Insert and Overwrite mode

The insert mode is the default setting.

Use the [INSERT] key to toggle between the insert and overwrite mode.

Numeric and alphanumeric values can either be newly entered or the existing value can be changed. Incorrect entries are cleared with the [BACKSPACE] key.

Entering a new numerical value

1. Select the parameter.
2. Press a numeric key to activate the editing mode.
The previous value is cleared and the new value can be entered.

Editing a value in the insert mode (default setting)

1. Press the rotary knob (= Enter) to activate the editing mode.
If the cursor is placed at the right of the total value, the insert mode is always active.
2. Set the cursor to the left of the number to be changed using the [Left/Right] arrow keys.
The cursor is displayed in green.
3. Click on a numeric key to insert a new value.



Editing a value in the overwrite mode

1. Activate the editing mode.
2. Set the cursor on the numeric digit to be changed using the [Left/Right] arrow keys.
The cursor is displayed in blue and the number to be replaced is highlighted.
3. Click on a numeric key to overwrite the highlighted value.



Varying a value

1. Activate the editing mode.
2. Set the cursor to the left of the number to be changed using the [Left/Right] arrow keys.
The value at the cursor position is varied.
3. To vary the selected value, use the [Up/Down] arrow key or turn the rotary knob.
The value is increased or decreased.

Entering a new alphanumeric value

1. Select the parameter.

2. Press an alphanumeric key to start the editing mode.

The new value is entered.

Editing an alphanumeric value

An existing value, e.g. a file name, can be changed in the insert mode (see example) or in the overwrite mode.

1. Select the parameter and activate the editing mode.
2. Set the cursor to the left of the alphanumeric value using the [Left/Right] arrow keys.

Tip: If hexadecimal values are to be entered, the numeric front-panel keys are automatically changed to hexadecimal values.

3. Click on an alphanumeric key to insert a new alphanumeric value.



Terminating the entry of a numeric value

To terminate the entry of a numeric value:

1. Press the rotary knob (= Enter).
2. Press a [UNIT] key on the front panel.
3. Select a "Unit" in the selection field next to the parameter value.

4.4.5 Working with Units

The unit of a parameter is displayed next to the value. When the parameter is edited, the unit is selected either from the list or by means of the front-panel keys. When the entry is completed, the unit can be changed. In this case the value remains unchanged but is automatically adapted to the new unit.



While operating the instrument by means of a mouse, assign the unit to the selected parameter before entering its value.

Assigning a unit

To assign a unit to a value, use one of the following alternatives:

1. Press a [UNIT] key on the front panel.



2. Select a "Unit" in the selection field next to the parameter value.
Press the [ENTER] key.

The unit displayed in the entry field next to the value is assigned.

Changing a unit

To subsequently change a unit, i.e. after the entry has been terminated and when the editing mode is not active, use one of the following alternatives:

1. Press a [UNIT] key on the front panel.
2. Select "Unit" in the selection field next to the parameter value.

The value remains unchanged but the display is automatically adapted to the new unit, i.e. the value is recalculated to suit the new unit.

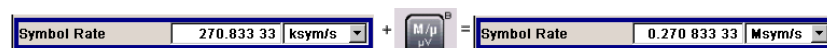

The new unit is indicated in the value field of the menu.

4.4.6 Selecting a Value from a List

Selection lists provide a list of predefined values for the selected parameter.

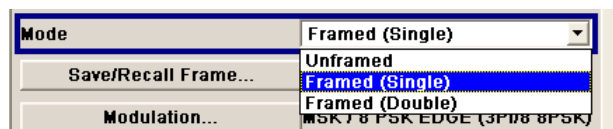

To select a item from a list, proceed as follow:

1. Press [ENTER] key to open the list.
2. Use one of the following alternatives to navigate through the list:
 - a) Turn the rotary knob or use the [Up/Down] arrow keys.
The selected item is highlighted.
 - b) Press [TOGGLE ON/OFF] key several times until the preferred entry is displayed in the selection field.
3. To confirm the selection, press the [ENTER] key.

4.4.7 Terminating Entries with Confirmation

The instrument behaves different by the termination of entries depending on the parameter type and the way this parameter is set.

Confirming settings

- ▶ To confirm the settings, press the rotary knob or one of the [Unit] keys (see also [Chapter 4.4.5, "Working with Units "](#), on page 94) .

Note: Variations by means of the rotary knob are immediately set.

Confirming multiple values

In some cases, like for instance when configuring the carriers for a multicarrier CW signal in a carrier table, it is useful first to enter few values and to confirm them together. Such settings require additional confirmation. Not yet confirmed settings are displayed on a yellow background as an indication that the currently displayed values do not represent the target signal.

- ▶ To confirm these settings, select the "Accept" button.

Confirming parameters with On/Off state

Most of the instrument functions with enabled and disabled states are calculated and effective only after this functions have been enabled. However, there are functions like the frequency variation of the reference oscillator for instance, that are immediately set after confirmation.

- ▶ To confirm a parameter with On/Off state, enable the parameter.

If time-consuming calculations are required, signal generation is automatically switched off and calculation is interrupted to allow the user to make further settings. Calculation is restarted with the [RECALCULATE] key and the modulation is switched on again when the calculation is completed.



Preventing recalculation

If an instrument function requires several parameter settings, switch the function off to prevent a recalculation.

Enable the function after the entire configuration of the settings have been completed. The signal is recalculated only once.

4.4.8 Restoring the Previous Value

Parameter variations with the rotary knob are immediately set and therefore not reversible.

Normally, values cannot be restored in the case of mouse control because no explicit confirmation is required in this case and entries are automatically confirmed when the entry or selection field is exited.

Restoring values

In the case of front-panel control or operation from the keyboard, previous values can be restored as long as the new value is not confirmed, i.e. the entry is not completed.

- ▶ To restore the values, press the [ESC] key.

Restoring values that require confirmation

All settings that are not confirmed with the "Accept" button but require this additional confirmation can be restored.

1. Press the [ESC] key.

A confirmation query is displayed.

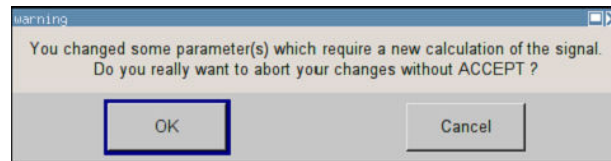

2. Confirm with "OK" to abort the changes.
Select "Cancel" to return to the dialog. The previous selected settings are displayed.

Restoring values after an extended calculation has been started

Calculation and setting might require different period of time. Many settings are made without noticeable calculation times; such operations are indicated by a "BUSY" message displayed in the status field of the header section.

A window with a progress indicates that the instrument performs an extended calculation that requires longer calculation time. The termination of such a calculation restores the previous values.

- ▶ Press the [Abort] button to terminate the calculation.
All previous values are restored.

4.5 Editors

The R&S SMBV provides user-friendly editors for defining data lists as well as control and marker signals. Lists containing frequency and level value pairs are used for the list mode and the user-defined level correction.

Internally generated data lists can be used for digital modulation and digital standards; the same applies to internally defined control and marker signals.

The lists are saved to files and may thus have any length. The file name of the lists and the directory to which the files are saved are user-selectable. The file prefix is different for each list type and is permanently assigned by the system.

For information about file handling and overview of the automatically assigned file prefixes, refer to [Chapter 4.7, "File Management"](#), on page 105.

4.5.1 Working with List Editor

The "User Correction" and "List Mode" dialogs provide a list editor for defining the frequency/level value pairs.

Editing list mode data lists

1. To access a list editor and open an existing data list for editing, use the cursor keys to select the associated button "Edit User Correction Data..." or "Edit List Mode Data..." (if available) in the individual menu.

The selected list is displayed and the cursor marks the first row of the "Frequency/Hz" column.

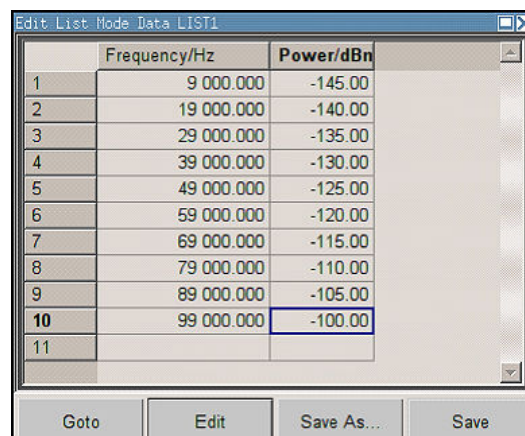

| | Frequency/Hz | Power/dBm |
|----|--------------|-----------|
| 1 | 9 000.000 | -145.00 |
| 2 | 19 000.000 | -140.00 |
| 3 | 29 000.000 | -135.00 |
| 4 | 39 000.000 | -130.00 |
| 5 | 49 000.000 | -125.00 |
| 6 | 59 000.000 | -120.00 |
| 7 | 69 000.000 | -115.00 |
| 8 | 79 000.000 | -110.00 |
| 9 | 89 000.000 | -105.00 |
| 10 | 99 000.000 | -100.00 |
| 11 | | |

Buttons: Goto, Edit, Save As..., Save

If no list has been selected, a blank list of only one row is displayed.

2. Press the [Left/Right] arrow keys to change between the columns.
Use the [Up/Down] arrow keys to mark a row.
3. Use the numeric keys to enter the value for the value pairs in the "Frequency/Hz" and "Power/dBm" table columns. A blank row is inserted at the end of the list.
An existing list can be edited in the insert or overwrite mode; use the [INSERT] key to toggle between this two modes.
Terminate the entry by pressing a [Unit] key.
4. To select a row, select the "GoTo" button and press the [ENTER] key.
Use the numeric keys to enter the row index in the entry field and press the [ENTER] key to confirm the entry.
The cursor moves to the selected row.
5. To insert a new row in the table, select the row above which the new row is to be inserted and select "Insert Row(s)".
A row is inserted above the currently marked row.
If no row has been selected, a row is inserted at the beginning of the list.
6. Use the "Save"/"Save As..." function to save the edited list under its current name or under a new name.
Enter the file name in the "File Select" dialog and select the directory (see [Chapter 4.7.1, "File Select Dialog"](#), on page 107).
Only complete value pairs are taken into consideration; rows containing an entry in only one column are ignored.

Creating a new list mode data list

A new list can be created under a new name either by generating a blank file in the "File Select" menu (see section [Chapter 4.7, "File Management"](#), on page 105) or by changing an existing list which will then be saved under a new name.

1. To create an empty data list, select "RF > List Mode > List Mode Data... > New List" or respectively "RF > User Correction > User Cor. Data... > New User Correction Data" and enter the file name of the new data list.
2. To open the data list for editing, select the associated button "Edit User Correction Data..." or "Edit List Mode Data..." in the individual menu. Edit the list and save it under a new name.

4.5.2 Working with Data Editor

The "Data Editor" is used to internally generate binary data lists for digital modulation and digital standards.

A list of binary values with a maximum length of 2^{31} bits can be entered in the "Data Editor". This value corresponds to a file size of approx. 268 Mbyte. While it is being processed, the file is continuously automatically buffered. When the dialog is exited, the file is automatically saved with the new values, i.e. there is no extra "Save" button. Depending on the size of the file, saving may take some time.

Editing an existing data list

1. To **access** a data editor and open an existing data list for editing, use the arrow keys to select the associated button "Edit Data List..." in the individual menu.

The selected data list is displayed.

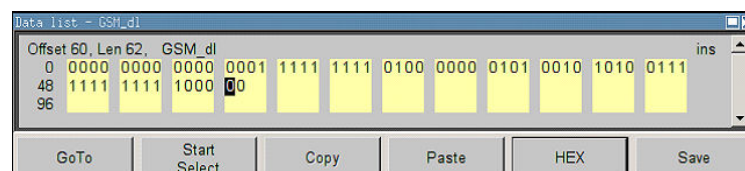

The cursor marks the start value of the list.

To increase readability, the bits are displayed in groups of four. The current cursor position, the length of the list and the list file name are displayed above the list. The offset starts with the value 0 which corresponds to the bit position on the left side of the first row, i.e. the beginning of the list. On the left edge of the editor, the last three offset positions are specified at the beginning of the row.

2. Use the numeric keys to enter the values 0 or 1.
An existing list can be edited in the insert or overwrite mode. Use the [INSERT] key to toggle between these two modes.
3. To **delete** a value, use the arrow keys to mark the bit that follows the value to be deleted.

Press the [INSERT] key to activate the insert mode. Values cannot be deleted in the overwrite mode.

Press the [BACKSPACE] key.

The value before the marked bit is deleted.

4. To **select a bit position**, select the "GoTo" button and press the [ENTER] key. Enter the bit position in the "GoTo Offset" entry field by means of the numeric keys and confirm the entry.

The cursor marks the bit at the selected position.

5. To **copy and paste** any range of bits at any position in the list:
 - a) Use the the arrow keys to mark the start bit of the selection.
 - b) Select the "Start Select" button and use the the arrow keys to mark the selection.
 - c) Click the "Copy" button.
 - d) Navigate to the insert position and select "Paste".

The selected and copied bits are pasted after the selected position.

6. To **display and edit** the values in hexadecimal form, select the "Hex" button.

Each four bits are displayed as a hexadecimal value: To increase readability, the hexadecimal values in turn are displayed in pairs of two. The hex functions are automatically assigned to the numeric keys at the front panel.

7. To **save** the data list, press the [ESC] key.

The list is saved automatically when the dialog is closed.

Creating a new data list

1. To create an empty data list, in the individual menu select "List Management > Select Data List to Edit... > Create Data List" and enter the file name of the new data list.
2. To open the data list for editing, select the associated button "Edit Data List..." in the individual menu.

4.5.3 Working with Control and Marker List Editor

The control and marker signals for digital modulation and digital standards can be very conveniently graphically defined in a "Control and Marker List Editor". The available marker signals – and, with custom digital modulation, the CW, Hop, Burst Gate and Lev Att control signals – can be defined in this editor.

While it is being processed, the file is continuously automatically buffered. Depending on the size of the file, saving may take some time.



The various functions of the editor are explained in the individual menus. This section focuses to the general use of the graphic editor.

Example:

The following figure shows the "Slot Marker Definition Editor" of the "GSM/EDGE" dialog as an example.

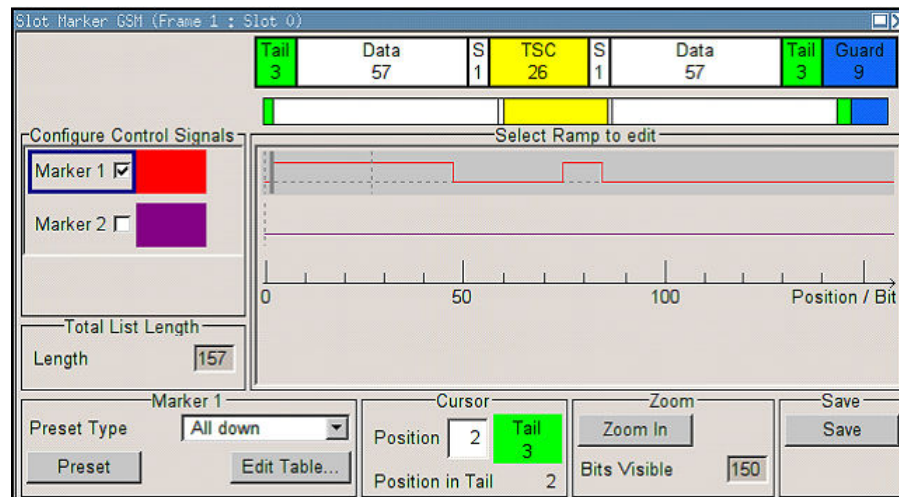

The upper area displays the signal for which the marker signals are to be defined. On the left side, the available signals (marker and control signals) are listed and colour-coded.

Auxiliary functions are offered in the lower editor area, e.g. presetting for the ramps in the marker signal, cursor positioning by entering the bit position and possible editing by means of value entries in a table.

The actual graphic definition of the control signals occurs in the center area of the editor. Each control signal is represented by means of a colored line along the bit axis. A cursor can be shifted alongside this line and marks the position where a ramp is to be set. The color of the cursor changes depending on the current function.

Use the [Enter] key to switch over between the colors (and therefore functions):

- black: marks the bit position on the marker line
- yellow: sets a ramp
- green: activates the marked ramp for shifting.

Accessing control and marker list

1. To access the control list editor (e.g. "CList Dig Mod") and open an existing list for editing, use the arrow keys to select "Custom Digital Mod > List Management > Edit Control List".
2. To access the slot marker list editor (e.g. "Slot Marker") and open an existing list for editing, use the arrow keys to select "GSM/EDGE > Burst Editor > Slot Marker Definition".

Editing an existing control or marker list

1. Activate control/marker signal line for editing.
Use the arrow keys to mark the editable graphic area and press the [ENTER] key.

Select the control/marker signal line to be edit and press the ENTER key.

The cursor is active for the selected line.

2. Define the cursor position.

Select the parameter "Cursor Position", specify the position by means of the numeric keys and confirm the entry.

The cursor is positioned according to the entry. If the entered value exceeds the selected length of the definition range, the length is adjusted automatically.

3. Configure the control and marker signals (see ["Handling of Ramps"](#) on page 102).

4. Define length of control list ("Custom Dig Mod" only).

Select the "Total List Length" entry field and press the [ENTER] key. Enter the length by means of the numeric keys and confirm the entry.

The control list length is defined.

5. Zoom displayed range ("Custom Dig Mod" only) in long control lists.

To zoom the displayed area around the current "Cursor Position", select the parameter "Visible/Bits Visible", enter the number of symbols/bits to be displayed by means of the numeric keys and confirm the entry.

Select the "Zoom In" button and press the [ENTER] key.

The selected number of symbols/bits around the current cursor position are displayed.

Ramps outside the displayed area are not lost by zooming.

6. Use the "Save"/"Save As..." function to save the edited control/marker list under its current name or under a new name.

Enter the file name in the "Create File" dialog and select the directory (see [Chapter 4.7.1, "File Select Dialog"](#), on page 107).

Handling of Ramps

1. Set a new ramp

Use the arrow keys or use the parameter "Cursor Position" to move the cursor to the position where the ramp is to be inserted. Press the [ENTER] key.

The ramp transition of the newly set ramp depends on the current status (high or low) of the control signal. If the signal is low, a ramp with low-high transition is generated; if the signal is high, a ramp with high-low transition is generated.



When ramps are set between existing ramps, the transition of the new ramp is also defined by the status of the signal before the new ramp. For this reason, a ramp that has already been set can be assigned low-low or high-high transition (as in the example), i.e. it will have no effect on the control signal in this configuration. However, the ramp remains saved, and its position is indicated by a dashed line.

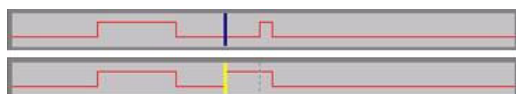

If another change produces effective transition, this ramp will be regenerated.

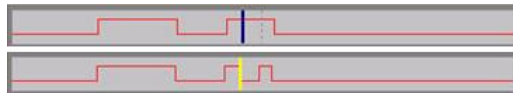

2. Shift a ramp

An existing ramp can be shifted to any positions. The transitions are adjusted accordingly.

Use the arrow keys to move the cursor to the ramp position; the cursor changes colour.

Press the [ENTER] key. The cursor again changes colour. The ramp will now be shifted by means of the cursor. Press the [ENTER] key. The ramp will be set at the current position.

The ramp transition depends on the status (high or low) of the control/marker signal before the ramp.



3. Delete a ramp

Use the arrow keys to move the cursor to the ramp position; the cursor changes colour.

Press the [BACKSPACE] key.

The ramp will be deleted. The ramp transitions of the other ramps are adapted to the changed signal status (high or low).

4. Set the ramps in a table

Select the "Edit Table..." button and define the positions and states of the ramps for the selected marker.

Confirm the entries with "Accept".

5. Preset a marker signal

Select the "Preset" button to preset the marker signal.

The ramps of the selected marker are adjusted according to the selected "Preset Type".

Creating a new control list

A new control list can be created under a new name either by generating a blank file or by changing an existing list which will then be saved under a new name.

1. To create an empty control list, select "BB > Cust Dig Mod > List Management... > Select Control List to Edit > Create Control List" and enter the file name of the new control list.
2. To open the control list for editing, select the associated button "BB > Cust Dig Mod > List Management... > Select Control List to Edit > Edit Control List..." and select an existing control list.

4.6 How to Use the Help System

The R&S SMBV is equipped with a context-sensitive help function. A help page is available for each parameter and can be called any time during instrument operation.

Calling context-sensitive and general help

- To display the general help dialog box, press the [HELP] (F1) key.

The help dialog is displayed. A topic containing information about the current menu or the currently opened dialog box and its function is displayed.

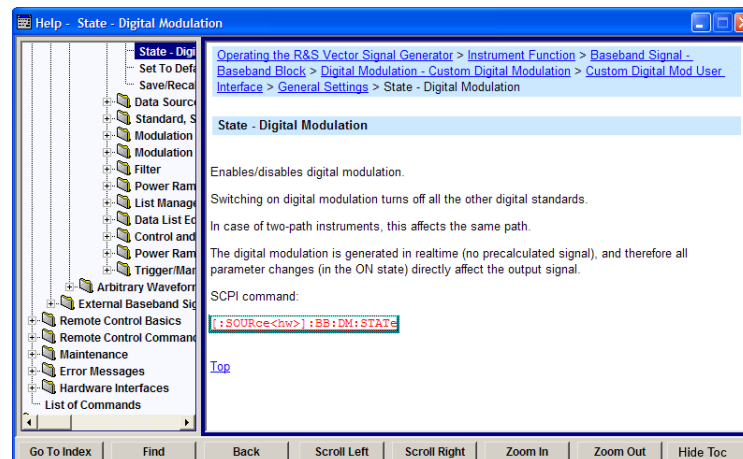

Contents of the help dialog box

The help dialog box contains two main areas:

- "Contents" - contains a table of help contents
- "Topic" - contains a specific help topic

The help system provides additionally an "Index" and a "Find" area, as well as "Zoom" functions that are accessed by means of the corresponding buttons.

Navigating in the table of contents

1. To navigate within the table of contents entries, use the [Up/Down] keys. Entries that contain further entries are marked with a plus sign.
2. To display a help topic, press the "ENTER" key.
The corresponding help topic is displayed.

Navigating in the help topics

1. To scroll through a page, use the [Up/Down] arrow keys.
2. To follow a cross-reference, select the link text.
3. To return to the previous page, select "Back".
This function scrolls back all steps that you have performed before.

4. Use the "Scroll Right" or "Scroll Left" buttons to shift the indicated area of the navigation window to the left or right.
5. To maximize the "Topics" window, you can hide the contents tree with the "Hide Contents" button, and vice versa.

Using the Index

1. Select the "Go to Index" button.
2. Enter the first characters of the topic you are interested in. The entries starting with these characters are displayed.
3. Press the [ENTER] key to change the focus.
4. Use the [Up/Down] keys to navigate and select the suitable keyword.
5. Press the [ENTER] key to display the help topic.
The corresponding help topic is displayed.

Closing the help window

- ▶ Press the [HELP] (F1) key.

4.7 File Management

The R&S SMBV uses files to save all instrument data, i.e. system and user data.

The user data includes saved instrument settings, data for the different digital standards, lists for the List mode and the user correction as well as the waveforms for the arbitrary waveform generator.

The files are stored on the internal flash card of the instrument, on a USB-stick or on the a hard disk (R&S SMBV-B92). Both, the `/var` directory on the internal flash card or the `/hdd` directory on the hard disk (R&S SMBV-B92), can be used to save user-defined data. Any directory structure can be created on `/var` and `/hdd`. Some default subdirectories are predefined, but can be changed at any time.

The `/opt` directory is a protected system drive and therefore unaccessible system directory. The files on this directory contain data that must not be changed. Therefore, this drive should not be accessed, since reconstruction of the system partition will lead to data loss. To prevent inadvertent deletion or overwriting of system files, this drive is not specified in the file menus.

Files can be exchanged either via a memory stick or a connected network. A memory stick is connected to the USB interface and is assigned the `var/usb/` drive. In the case of a connected network, all network drives that can be accessed are available. The files are accessed in a "Save/Recall" dialog in the individual menus.

The files are differentiated according to their extensions; each type of file is assigned a specific file content. The extension is usually of no consequence to the user since access to the files occurs in the individual menu where only the relevant type of file is

available. See [Chapter 4.7.2.1, "Extensions for User Files"](#), on page 109 for an overview of the supported file extensions.

The user data can be roughly divided into the following data types:

- **Settings**
Settings, e.g. the frame setting of the GSM/EDGE standard, can be loaded and current setting saved to the specified file.
- **Lists**
Lists, e.g. user correction lists, can be loaded. They can be generated either externally or internally. For internal generation, a new list must be created in the "File Select" dialog which will then be edited in the list editor of the individual menu.
- **Complex modulation and control data**
User data of this type can be loaded. It can be generated either externally or internally. For internal generation, a new list must be created which will then be edited in the data and control list editor. These functions are offered in the "Data List Management" dialog of the individual modulation menu.
- **Waveforms**
Waveforms are generated externally (e.g. by means of the R&S WinIQSIM2 program that is supplied together with the optional Baseband Generator R&S SMBV-B10) and can be loaded in the "Arbitrary Waveform Generation" dialog.



Softkeys are assigned to some of the functions and can be used for convenient operation.



For more information, refer to:

- [Chapter 4.8, "Legend of Front-Panel Controls"](#), on page 112 for an overview of key functions and a cross-reference between the front panel keys and the keyboard shortcuts
- to "Instrument Functions" in the Operating Manual for a detailed description of key functions.

Accessing files with user data

1. To access an editable user data file, select the "Save/Recall" or "File Manger" function in the individual dialog.



2. To access a loadable data file, select the "Select/New" or "File Manager" function in the individual dialog.

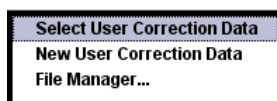

- To access the "File Manager" function, press the [SETUP] (CTRL+E) key and select "Save/Recall > File Manager".

A "File Select" window for loading, saving or creating a file or the "File Manager" dialog for managing all files is displayed.



Saving and loading of all instrument settings

All instrument settings are saved and loaded in the "File" menu.

To access the "File" menu, press the [FILE] (CTRL+S) key.

For more information, see chapter "Storing and Loading Instrument Data - File Key" in the Operating Manual.

4.7.1 File Select Dialog

The "Save/Recall" dialog displays the available drives and directories. In the upper part, "Recent Data Sets", the files last used are listed.

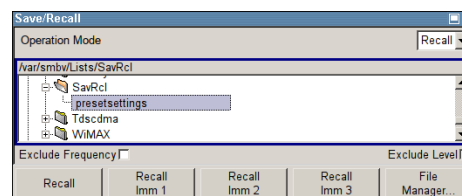
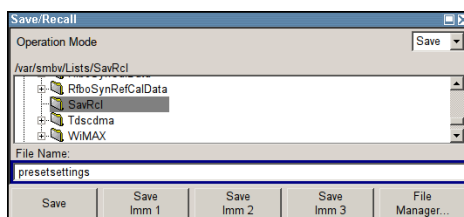

The available drives and directories and the files of the selected directory are displayed. The currently selected path is displayed above the window. Only the relevant files without file extensions are displayed. If the area is opened several times, the path last selected is displayed. When a file is saved or created, its name is user-selectable; the extension is assigned automatically and cannot be entered. The file is saved to the selected path.

In addition to the files saved by the user, some menus also offer files containing predefined contents. These files are saved to a specific directory on system drive; for this reason, this directory cannot be chosen from the "File Select" menu.

Example:

The following example shows the "File Select" menu of the GSM/EDGE digital standard when "Recall Predefined Frames" is selected.

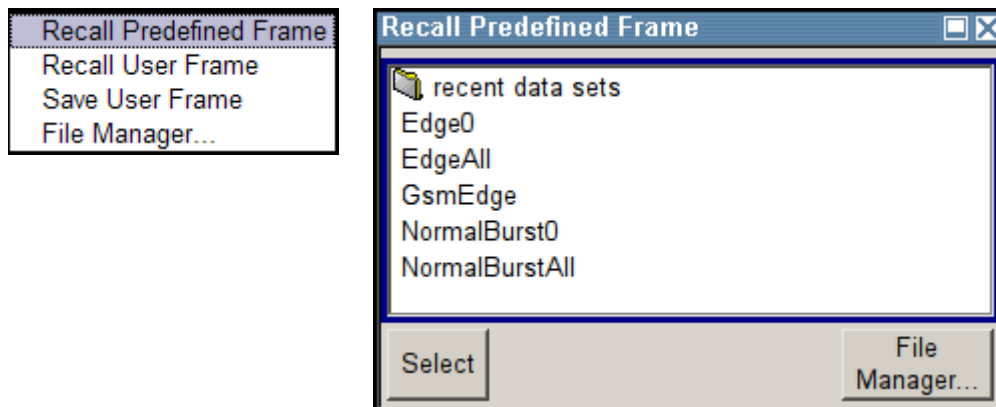
**Working with the File Select dialog**

1. Access the "File Select" dialog (see ["Accessing files with user data"](#) on page 106).
2. Navigate in the "File Select" dialog.
3. Load an existing file.
In the "Recall Settings" dialog, mark a file and press the "Select" button.
4. Save a file.
In the "Save Settings" dialog, enter file name in the "File Name:" field.
Select the directory to which the file is to be saved and then select the "Save" button.
5. Create a new file.
To create a new file, use the "Save Settings" functionality, i.e. specify file name and directory and save the file.

The created file is empty; it must be filled with the necessary values in the individual editor.

4.7.2 File Manager

The "File Manager" allows general file management such as copying, shifting, renaming and deleting files as well as generating new directories.

In addition it enables you to share the same storage area with another instrument over the network.

Thus, also externally created files, for example waveforms created by using the R&S®WinIQSIM2 program, can be saved to the R&S SMBV by copying them from a memory stick or a network to the internal hard disk.

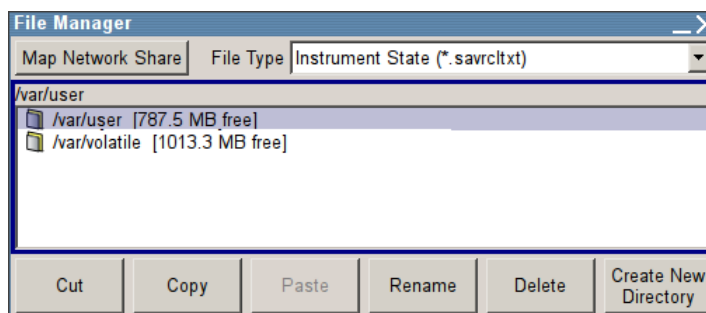

Use the "File Type" to select a file type from the list. This can be used to process either all files (all files (*) selection) or a specific selection of files. See [Chapter 4.7.2.1, "Extensions for User Files"](#), on page 109 for an overview of the supported file extensions. The available drives and directories and the files of the selected directory are displayed. The currently selected path is displayed above the windows. If the area is opened several times, the path last selected is displayed. Unlike the "File Select" window, the "File Manager" displays the full file names including extensions.

Working with the File Manager dialog

1. Accessing the "File Manager" dialog (see ["Accessing files with user data"](#) on page 106).
2. Navigating in the "File Manager" dialog.
Operation is very similar to the operation of a standard Windows explorer.
3. Moving, duplicating, deleting or renaming files
To move a file, select the file and press the "Cut" button. Mark the directory to which the file is to be moved and select the "Paste" button. If the target directory already contains a file with the same name, a confirmation query is displayed to confirm overwriting of this file.
Perform the similar steps and cut/copy/rename/delete the file.
Tip: The operation corresponds to the Windows concept.
4. Creating a new directory
Mark drive or directory level where the new directory is to be created, select the "Create New Directory" button and enter the name of the new directory in the entry window that opens. Confirm with [ENTER].
5. Mapping shared network folders
To configure a shared network folder, enter the path of the folder or computer, assign a folder name and confirm with the user name and password of the authorized user. See also chapter "File Manager > Map Network Share Settings" in the user manual of the instrument.

4.7.2.1 Extensions for User Files

The following table lists all available file extensions for user files. The currently available files on the instrument depend on the installed options.

Table 4-1: List of the automatically assigned file extensions in the instrument

| Function/Digital Standard | List type | Contents | File suffix |
|---------------------------------|--------------------|---|-------------------|
| Instrument State | Settings | Instrument settings | *.savrc1txt |
| "User Correction" | List | User-defined level correction values | *.uco |
| "List Mode" | List | User-defined frequency/level value pairs | *.lsw |
| "Frequency Response Correction" | Settings | User-defined frequency response correction file | *.frc |
| "Arbitrary Waveform Generator" | Waveform | ARB waveforms ARB multi segment waveforms | *.wv |
| | Waveform | ARB multi carrier settings | *.arb_multcarr |
| | Configuration data | Configuration file for creation of multisegment ARB waveforms | *.inf_mswv |
| | Play List | ARB Sequencing List | *.wvs |
| "DM" | Data List | Digital modulation data | *.dm_iqd *.tdm |
| | Control List | Data to control digital modulation | *.dm_iqc |
| | Settings | Digital modulation settings | *.dm |
| | User Standard | Digital modulation user standard | *.dm_stu |
| | User Mapping | Digital modulation user mapping | *.vam |
| | User Filter | Digital modulation user filter | *.vaf |
| "NRP Settings" | Settings | NRP Settings | *.nrp |
| "Fading" | Fading | Fading data | *.fad |
| "GSM/EDGE" | Settings | GSM/EDGE settings | *.gsm |
| | Slot | User-defined slot data | *.gsm_slu |
| | Frame | User-defined frame data | *.gsm_fu |
| | Slot | Higher symbol rate slot | *.gsm_hslu |
| | Frame | Higher symbol rate frame | *.gsm_hfu |
| "Bluetooth" | Bluetooth Settings | Complete setting of the Bluetooth menu | *.bto |
| "TETRA" | TETRA Settings | Complete setting of the TETRA menu | *.tetra |
| "3GPP FDD" | Settings | Complete setting of the 3GPP (FDD) menu | *.3g |
| | Settings | Channel coding enhanced DPCH channels (downlink) | *.3g_ccod_dl_s |
| | Settings | Channel coding enhanced DPDCH channels (uplink) | *.3g_ccod_ul |
| "CDMA2000" | Settings | Complete setting of the CDMA2000 menu | *.cdma2k |

| Function/Digital Standard | List type | Contents | File suffix |
|---------------------------|---------------|--|-------------------------|
| "TD-SCDMA2000" | Settings | Complete setting of the TD-SCDMA2000 menu | *.tdscdma |
| | Settings | Test Model for TD-SCDMA2000 | *.tdtmd |
| 1xEV-DO | Settings | Complete setting of the 1xEV-DO menu | *.evdo |
| "IEEE 802.11 WLAN" | Settings | Complete setting of the IEEE 802.11 WLAN menu | *.wlan |
| "IEEE 802.11 n WLAN" | Settings | Complete setting of the IEEE 802.11n WLAN menu | *.wlann |
| | Settings | Beamforming data | *.bmf |
| "IEEE 802.16 WiMAX" | Settings | Complete setting of the IEEE 802.16 WiMAX menu | *.wimax |
| "EUTRA/LTE" | Settings | Complete setting of the EUTRA/LTE menu | *.eutra |
| | Settings | TDD Settings | *.lte_tdd |
| | Settings | User-defined IQ-File | *.iqw |
| "GPS" | Settings | Complete setting of the GPS/A-GPS menu | *.gps |
| | Settings | GPS Almanac Settings | *.txt *.alm *.al3 |
| | Settings | GPS Waypoints File | *.txt |
| | Settings | GPS Generated Almanac File | *rs_al *.rs_yuma |
| | Settings | GPS Ionospheric File | *.rs_ion |
| | Settings | GPS Navigation Data | *.rs_nav |
| | Settings | GPS UTC File | *.rs_utc *.rs_acq |
| "FM-Stereo" | Settings | Complete setting of the FM-Stereo menu | *.fmstereo |
| | Settings | FM-Stereo Group Type Settings | *.fm_gt |
| | Settings | FM-Stereo Group Hex Type Settings | *.fm_ghex |
| | Waveform File | Waveform File | *.wav |
| "Sirius" | Settings | Complete setting of the Sirius menu | *.sirius |
| "XM-Radio" | Settings | Complete setting of the XM-Radio menu | *.xmradio |
| | Settings | XM-Radio TWTA Data | *.twta |
| "DVB" | Settings | Complete setting of the DVB menu | *.dvb |
| | Settings | DVB Transport Stream | *.gts *.ts *.trp |
| | Settings | Complete setting of the DAB/T-DMB menu | *.dab |

| Function/Digital Standard | List type | Contents | File suffix |
|---------------------------|-----------|----------------------------------|-----------------|
| | Settings | DAB ETI Files | *.eti *.xeti |
| NFC | Settings | Complete setting of the NFC menu | *.nfc |

4.8 Legend of Front-Panel Controls

The following table lists all key functions available on the front panel. Key combinations used on the PC keyboard to trigger key functions on the instrument front panel are also described. Keyboard labels are described in alphabetical order.

In addition, a front panel key emulation and an on-screen keyboard can be used for manual operation by mouse only.

Table 4-2: Cross-reference between the front panel keys and keyboard shortcuts

| Front-panel key | Key of PC keyboard | Function |
|--------------------------|---|--|
| Turning the rotary knob | Tab key (towards the right) Shift + Tab (towards the left) | Sets the cursor with the rotary knob. |
| Pressing the rotary knob | Enter | Pressing the rotary knob confirms an entry; it has the same function as the ENTER key. |
| Arrow keys | Arrow keys | Moves the cursor. |
| *1 / dB(m) | ALT + F12 | Confirms entries in the base unit and values without a unit. Selects dBm for the RF level and dB for level offset and level step width. |
| . / * ...# | . / * ...# | Enters a period/decimal point. Enters a special character. |
| +/- / A<->a | - / (shift+) a... z | Enters the sign. Switches between upper-case and lower-case letters. |
| 0-9 / a...z | CTRL+ 0-9 / a...z CTRL | Enters the number/letter. |
| [BACKSPACE] | Backspace | Clears the last entry (number, sign or decimal point) |
| [CLOSE] | CTRL + G | Closes an active menu. |
| [DIAGRAM] | CTRL+ D | Sets the cursor on the block diagram and hides all menus. |
| [ENTER] | Enter | Terminates an entry. |
| [ESC] | ESC | Selects the next higher menu/selection level. When the editing mode is exited with ESC, the previous value is restored. |
| [FILE] | CTRL + S | Activates the menu for storing instrument settings. |
| [FREQ] | CTRL+ F | Activates the frequency entry. |

| Front-panel key | Key of PC keyboard | Function |
|-----------------|--------------------|--|
| G/n / dBuV | ALT + F9 | Selects the unit Giga/Nano, dBuV for the RF level and dBu for the LF level. |
| [HCOPI] | CTRL + Y | Opens the menu for configuring and starting a hardcopy. |
| [HELP] | F1 | Opens/closes context-sensitive help. |
| [HIDE] | CTRL + H | Minimizes the active menu. Pressing the respective button in the Winbar opens the menu again. |
| [INFO] | CTRL + I | Opens/closes the info window |
| [INSERT] | Ins | Activates the insert mode. |
| k/m / uV | ALT + F11 | Selects the units Kilo/Milli and uV for RF levels. |
| [LEVEL] | CTRL + L | Activates the level entry. |
| [LOCAL] | CTRL + Q | Switches the instrument from remote control to manual control. |
| M/u / uV | ALT + F10 | Selects the units Mega/Micro and uV for levels. |
| [MENU] | CTRL + M | Calls the menu selection list. |
| [MOD ON/OFF] | CTRL + O | Switches modulation on/off. "MOD OFF" is indicated in the status line. |
| [TOGGLE] | CTRL + T | Switches a block or parameter on/off. Toggles between the different possibilities of setting a selection parameter. |
| [PRESET] | CTRL + P | Restores a defined basic instrument setup. |
| [REARR] | CTRL + A | Adjusts the size of the active menu to use the whole height of the display. |
| [RECALCULATE] | CTRL + C | Starts recalculation of the signal. |
| [RF ON/OFF] | CTRL + R | Switches the RF output signal on/off. "RF OFF" is indicated in the status line. |
| [SETUP] | CTRL + E | Opens the setup menu for general instrument settings. |
| Softkeys | CTRL + F1 – F6 | Triggers the function assigned to the softkey. |
| [WINBAR] | CTRL + W | Toggles between the active menus. |

4.8.1 Front Panel Key Emulation

The R&S SMBV provides a front panel key emulation to enable execution of the front panel key functions by mouse e.g. for remote access. The emulation is called by a right mouse click. The front panel key functions are executed by a mouse click on the associated button.



5 Instrument Function

5.1 Overview of Instrument Functions

This chapter explains the functions of the R&S SMBV and the options available in the setting menus. The associated SCPI command is specified for each parameter (where applicable).

The description begins with the general instrument settings which do not directly affect signal generation. The majority of these settings can be accessed by means of front-panel softkey menus and not by means of function block menus.

One exception is, for example, the signal graphics which are called up in the "Graphics" block.

The signal generation functions are then described, beginning with the RF section functions which affect the RF signal and the analog modulations and which are compiled in the "RF/A Mod" block of the block diagram.

This is followed by an explanation of all functions which are in the signal flow prior to being fed into the RF block and which do not affect the internal generation of a baseband signal - I/Q modulation, noise generation and impairment of the digital signal. These functions are accessed by means of the function blocks "I/Q Mod" and "AWGN/IMP".

The remaining (and largest) part of the chapter describes the functions used for the internal generation of the signals in the baseband (these functions are provided in the "Baseband" block).

The general instrument settings include various functions, such as:

- Setting a defined basic setup using the [PRESET] key
see [Chapter 5.2.2, "Default Instrument Settings - Preset Key"](#), on page 118
- Switching from remote control to manual control using the [LOCAL] key
see [Chapter 5.2.4, "Switching to Manual Control - Local Key"](#), on page 156
- Configuring the generator and its interfaces in the "Setup" menu - e.g. setting the GPIB address, starting an adjustment, querying instrument data
see [Chapter 5.2.3, "General Configuration of Instrument - Setup Key"](#), on page 119
- Generating a hardcopy of the display using the [HCOPY] key
see [Chapter 5.2.5, "Generating a Hard Copy of the Display"](#), on page 157
- Calling up the online help using the [HELP] key
see [Chapter 5.2.7, "Help System - Help Key"](#), on page 160
- Querying messages using the [INFO] key
see [Chapter 5.2.6, "Messages - Info Key"](#), on page 160
- Loading and storing complete instrument settings in the "File" menu
see [Chapter 5.2.8, "Storing and Loading Instrument Data - File Key"](#), on page 161
- Calling up the baseband signal graphics in the "Graphics" function block
see [Chapter 5.3, "Graphical Display - Graphics"](#), on page 175

The integrated bit error rate and block error tester is configured and activated in the "BERT" function block:

- Bit error rate and block error measurement
see [Chapter 5.4, "Bit and Block Error Rate Measurements"](#), on page 184

The RF signal is configured and the analog modulations activated in the "RF/A Mod" function block:

- CW mode
see [Chapter 5.5.1, "Overview of RF Signal"](#), on page 208
- List mode
see [Chapter 5.5.14.4, "List Mode"](#), on page 291
- Sweep mode
see [Chapter 5.5.14.1, "Overview"](#), on page 278
- Analog modulations
see [Chapter 5.5.12.1, "Overview"](#), on page 251

In the "I/Q-Mod" function block, I/Q modulation is possible with external analog signals and internally generated baseband signals.

- I/Q modulator
see [Chapter 5.6, "I/Q Modulation - I/Q Mod Block"](#), on page 299

Noise can be added to the baseband signal and the baseband signal can be impaired before input into the I/Q modulator. It is therefore possible to output a baseband signal with impairments via the I/Q-OUT outputs ("AWGN/IMP" function block). Impairment is also possible during I/Q modulation ("I/Q Mod" function block).

- Impairing the signal
see [Chapter 5.7.1, "Impairments"](#), on page 306
- Adding noise
see [Chapter 5.7.2, "AWGN - Noise Generator"](#), on page 311

The baseband signal is available at the I/O outputs.

- Output of the baseband signal
see [Chapter 5.7.3, "Output of the Baseband Signal - I/Q Out"](#), on page 319
- Digital I/Q Output
see [Chapter 5.8, "Digital I/Q Output Settings"](#), on page 323

The R&S SMBV offers various possibilities for generating digital modulation signals in compliance with the definitions of digital standards or with characteristics which can to a large extent be freely defined. The range of software options for this is being extended continuously.

- Baseband signals - Introduction
see [Chapter 5.9, "Baseband Signal - Baseband Block"](#), on page 326
- External Baseband signals
see [Chapter 5.10, "External Baseband Signal - Baseband Input"](#), on page 478
- Digital modulation
see [Chapter 5.9.3, "Digital Modulation - Custom Digital Modulation"](#), on page 341
- Arbitrary waveform generator ARB
see [Chapter 5.9.4, "Arbitrary Waveform Generator ARB"](#), on page 382
- Multi Carrier CW signals

see [Chapter 5.9.5, "Multi Carrier Continuous Wave"](#), on page 464

- Digital standard GSM/EDGE
see description "Digital Standard GSM/EDGE"
- Digital standard Bluetooth/EDR
see description "Digital Standard Bluetooth® Enhanced Data Rate"
- Digital standard TETRA2
see description "Digital Standard TETRA Release 2"
- Digital standard 3GPP FDD (WCDMA)
see description "Digital Standard 3GPP FDD (WCDMA)"
- Digital standard CDMA2000®
see description "Digital Standard CDMA2000®"
- Digital standard TD-SCDMA
see description "Digital Standard TD-SCDMA"
- Digital standard 1xEV-DO
see description "Digital Standard 1xEV-DO"
- Digital standard IEEE 802.11 (a/b/g) (WLAN)
see description "Digital Standard IEEE 802.11 (a/b/g) (WLAN)"
- Digital standard IEEE 802.11n (WLAN-N)
see description "Digital Standard IEEE 802.11n (WLAN-N)"
- Digital standard IEEE 802.16 (WiMAX)
see description "Digital Standard IEEE 802.16 (WiMAX)"
- Digital Standard EUTRA/LTE
see description "Digital Standard EUTRA/LTE"
- Satellite Navigation GNSS
see description "Satellite Navigation"
- Avionics Standards
see description "Avionics Standards"
- Sirius Radio
see description "Sirius Radio"
- Digital Standard XM Radio
see description "Digital Standard XM Radio"
- Digital Standard DVB-H
see description "Digital Standard DVB-H"
- Digital Standard DAB / T-DMB
see description "Digital Standard DVB / T-DMB"
- Digital Standard NFC/EMV
see description "Digital Standard NFC A/B/F and EMVCo"

5.2 General Instrument Settings

5.2.1 Overview of General Instrument Settings

This section describes the settings which do not directly affect signal generation. Most of these settings can only be accessed by means of menus which are opened using keys or key combinations on the external keyboard or keys on the front panel key emulation.

This does not apply to the graphical representation of output signals which is activated in the "Graphics" function block, or settings which can additionally be called up in the menus of the function blocks, e.g. input configuration which is possible in the "Setup" menu and in almost every menu of the "Baseband" function block.

See also [Chapter 4.8, "Legend of Front-Panel Controls"](#), on page 112.

The general instrument settings therefore affect various functions, such as storing instrument settings using the [FILE] key or setting the GPIB address in the menu of the [SETUP] key. The order in which the descriptions are given corresponds to the layout of the keys on the front panel of the R&S SMBV (from top left to bottom right).

5.2.2 Default Instrument Settings - Preset Key

The [PRESET] key performs a defined instrument setup. All parameters and switching states are preset (also those of inactive operating modes). The default instrument settings provide a reproducible initial basis for further settings.

However, functions concerning the integration of the instrument in a measurement setup are not changed, for example the GPIB address or reference oscillator settings.

In addition, only those settings associated with the menu can be reset directly in the individual dialogs, like the digital modulation settings in the "Custom Digital Mod" menu. These settings are identical with the values set with the [PRESET] key.

When the instrument is switched on, it is not the preset state that is active, but rather the instrument state that was set before the instrument was switched on.

User-defined instrument states can be accessed and stored in the "File" menu.



Resetting the instrument to the factory state is possible with the [Factory Preset](#) function.

Preset

Presets all parameters and switching states.

The following list gives an overview of the presets for the most important generator settings. The other presets can be found in the preset tables of the individual menus and the information accompanying the remote commands.

- "RF frequency" = 1 GHz

- "RF level" RF output switched off
- "Offsets" = 0
- "Modulations State" = Off
- Uninterrupted level settings are switched off
- "Level Attenuator Mode" = AUTO
- Internal level control "Level ALC" = AUTO
- User correction "Level Ucor" = OFF
- "LF output State" = Off
- "Sweep State" = Off
- "List mode State" = Off

Settings that are not affected by the [PRESET] key

- Reference frequency settings ("Ref Oscillator" menu)
- Power on settings ("Level/EMF" menu)
- Network settings ("Setup" menu)
- GPIB address ("Setup" menu)
- *IDN? Identification and emulation ("Setup" menu)
- Password and settings protected by passwords ("Setup" menu)
- Start/Stop Display Update ("Setup" menu)
- Display and keyboard settings ("Setup" menu)

Remote command:

*RST on page 535

5.2.3 General Configuration of Instrument - Setup Key

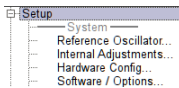

The "Setup" menu provides access to basic instrument settings, regardless of the currently set operating mode or measurement. It contains information on the instrument's equipment, and comprises all settings for the general configuration of the instrument and its interfaces.

To access the "Setup" menu, press the [SETUP] key.

The "Setup" menu is divided into functional sections as follows:

- "System": covers general instrument parameters.
- "Test": used to perform function tests.
- "Environment": used to configure the controller interfaces.
- "Remote": used to configure the remote control interfaces.
- "Protection": used to set the protection level for service functions and security settings.
- "Settings": used to save or recall instrument settings or to preset the instrument to factory settings.

Most submenus of this key can be accessed only via the [SETUP] key or the menu tree ([MENU] key), with the following exceptions:

- The "Reference Oscillator" dialog can also be accessed in the "RF" block and is therefore described in the section on this block (see [Chapter 5.5.4, "Reference Oscillator"](#), on page 214).

- The "Save/Recall" dialog can also be accessed with the [FILE] key and is therefore described in the section on this key (see [Chapter 5.2.8, "Storing and Loading Instrument Data - File Key"](#), on page 161).
- The "Global Trigger/Clock/ External Inputs" dialog is also available in all modulation dialogs of the "Baseband" function block where it can be accessed with the "Global Trigger/Clock Settings" button in the corresponding "Trigger/Marker/Clock" dialog. See also [Chapter 5.2.3.13, "Global Trigger/Clock/External Input Settings"](#), on page 140.

5.2.3.1 Internal Adjustments

The R&S SMBV is extremely accurate due to the integrated adjustment procedures, which you can execute directly on the instrument.



Self-calibration routines that do require additional (external) measurement equipment are either described in the Service Manual of the instrument, or they require to be performed by a Rohde & Schwarz service center.

NOTICE

Risk of invalid adjustment

Wait until the instrument has reached its operating temperature before you start the adjustment procedure. The warm-up time is 30 minutes.

When to perform adjustments?

It is recommended to perform internal adjustments prior to any application that requires a maximum of level and frequency accuracy, especially when a long period of time has passed or if the ambient temperature of the instrument significantly differs from the one of the last adjustment.

Additional Information to the Adjustments

During adjustments, a progress indicator shows the status of the process. If any error occurs, the process aborts and an error message appears in the info line.

The extent of the adjustments depends on the installed options.

- ▶ To access the settings for internal adjustments, press the [setup] key and select "System > Internal Adjustments".

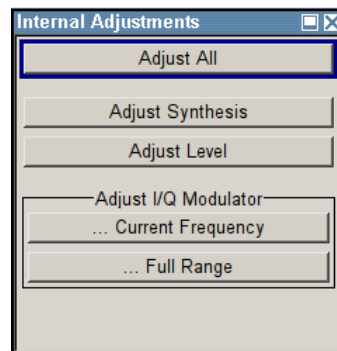

In this dialog you can perform internal calibration routines.

The remote commands required to define these settings are described in [Chapter 7.5, "CALibration Subsystem"](#), on page 550.

Adjust All

Performs all available internal calibration routines of the instrument.

Remote command:

`:CALibration:ALL[:MEASure]?` on page 551

Adjust Synthesis

Performs all adjustments which affect the frequency.

Remote command:

`:CALibration<hw>:FREquency[:MEASure]?` on page 552

Adjust Level

Performs all adjustments which affect the level. The acquired correction values improve the settling time and the signal quality.

Remote command:

`:CALibration<hw>:LEVel[:MEASure]?` on page 553

Adjust I/Q Modulator Current Frequency

Starts the adjustment for the I/Q modulator for the currently set frequency, I/Q swap, and baseband gain. The I/Q modulator is adjusted with respect to carrier leakage, I/Q imbalance and quadrature.

Adjustment for only the set frequency is considerably faster than adjustment across the entire frequency range. This is possible with "Full Range".

Remote command:

`:CALibration<hw>:IQModulator:LOCal?` on page 553

Adjust I/Q Modulator Full Range

Starts the adjustment for the I/Q modulator for the entire frequency range. The I/Q modulator is adjusted with respect to carrier leakage, I/Q imbalance and quadrature.

Remote command:

`:CALibration<hw>:IQModulator:FULL?` on page 552

5.2.3.2 Hardware Config

In the "Hardware Config" dialog, the installed assemblies together with their variants and revision states can be displayed for servicing purposes.

To open the "Hardware Config" dialog, select "System" and press the [SETUP] or [MENU] key.

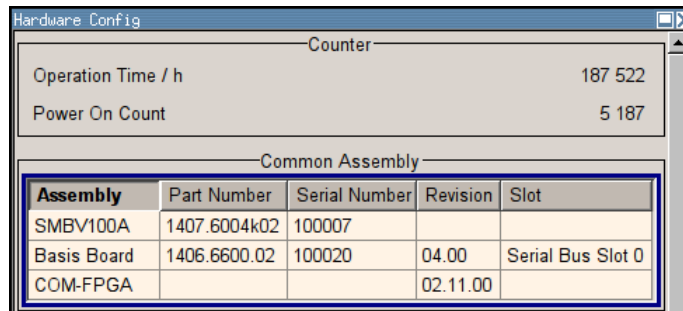

| Counter | | | | |
|--------------------|--------------|---------------|----------|-------------------|
| Operation Time / h | 187 522 | | | |
| Power On Count | 5 187 | | | |
| Common Assembly | | | | |
| Assembly | Part Number | Serial Number | Revision | Slot |
| SMBV100A | 1407.6004k02 | 100007 | | |
| Basis Board | 1406.6600.02 | 100020 | 04.00 | Serial Bus Slot 0 |
| COM-FPGA | | | 02.11.00 | |

Section "Counter" in the upper part of the menu shows the "Operation Time" (in hours) and the number of power-on ("Power On Counter").

The second part of the menu is a table that lists the installed assemblies. It is divided into the sections:

- "Common Assembly"
- "RF Assembly"
- "Baseband Assembly"

Operation Time / h

Displays the operation time in hours.

Remote command:

[:DIAGnostic:INFO:OTIME?](#) on page 556

Power On Count

Displays the number of power-on.

Remote command:

[:DIAGnostic:INFO:POCount?](#) on page 557

Assembly

The tables list the installed assemblies.

| | |
|-----------------|---|
| "Assembly" | Assembly name |
| "Part Number" | Part Number of assembly |
| "Serial Number" | Serial Number of assembly |
| "Revision" | Revision state of assembly |
| "Slot" | Indicates whether the assembly is connected to the serial bus or PCI bus. |

Remote command:

[:DIAGnostic<hw>:BGInfo?](#) on page 555

5.2.3.3 Software / Options

The "Software/Options" dialog shows the firmware version of the instrument software and all installed hardware and software options.



Software options purchased at a later stage can be activated with a keycode. The activation code is supplied with the software option.

How to install options is described in chapter 4 "Software Update / Installing Options" of the service manual.

The installation of hardware options purchased at a later stage is also described in the service manual. Most hardware options need to be installed at an authorized Rohde&Schwarz service shop.

To access the "Software/Options" dialog, select "System" and press the [SETUP] or [MENU] key.

The menu is divided into the following sections:

- "Firmware"
- "Hardware Options"
- "Software Options"
- "WinIQSIM"
- "Loaded Modules"

| Firmware | |
|-------------|---|
| Package | Version |
| SMBV100A FW | 02.05.142 beta (Release) (2008-06-18; 04:44:35) |
| R&S COMPASS | 2.2.2.3 (Release) |

| Hardware Options | |
|------------------|-------------------------------------|
| Option | Designation |
| SMBV-B10 | Baseband + ARB(32MS, 120 MHz RF BW) |
| SMBV-B55 | ARB memory up to 256MS |
| SMBV-B90 | Phase Coherence |
| SMBV-B92 | Removable hard disc |
| SMBV-B106 | 9 kHz to 6 GHz |

| Software Options (Internal) | | |
|-----------------------------|--------------------|-------------------|
| Option | Designation | Expiration Date |
| SMBV-K0 | Demo Option | 2009-03-11; 16:00 |
| SMBV-K22 | Pulse Modulator | 2009-03-11; 16:00 |
| SMBV-K23 | Pulse Generator | 2009-03-11; 16:00 |
| SMBV-K40 | Dig. Std. GSM/EDGE | 2009-03-11; 16:00 |

Firmware

The firmware section of the menu shows the firmware version and the version of the software platform.

Note: Your instrument is delivered with the latest firmware version available. Firmware updates and the "Release Notes" describing the improvements and modifications are provided on the Internet at the download site of the Rohde & Schwarz signal generator

home page. This home page always offers the latest information on your signal generator, e.g. also on changes of the firmware update procedure.

Remote command:

n.a.

Hardware Options / Software Options

The tables in the sections "Hardware", "Software" and "WinIQSIM2" list the installed hardware and software options.

"Option" Short name of option

"Designation" Name of option

"Licenses" (optional)
 Number of licenses.

Remote command:

*OPT? on page 534

*IDN? on page 534

Versions

The "Versions" tab shows the versions of the technical specification of the R&S SMBV and of the software components that comprise the firmware.

"Package" Name of the component.

"Version" Current issue of the component.

Remote command:

n.a.

Show Open Source Acknowledgments

Accesses the list of the used open source software packages and the corresponding verbatim license texts.

5.2.3.4 Manage License Keys

This dialog is the central dialog for managing licenses, like enabling newly purchased and/or newly registered options or performing the required instrument related steps during the process of unregistration and/or moving of licenses.

An option is ready to operate after it is enabled by means of a license key code supplied with the option. The license key is delivered as a file or on paper. Unregistered licenses must be registered for a particular instrument prior to the corresponding option can be enabled for operation.



License Registration

If your purchased license is delivered unregistered, you must register it before you can activate the option.

For detailed information about the license registration, refer to the installation instructions provided with the option (Supplement A) and the documentation of the online tool "Manage Licenses" (<https://extranet.rohde-schwarz.com/service>).



Only if the R&S SMBV is equipped with an older firmware version, a firmware update prior to enabling the software option may be required. The information on the valid firmware versions for the purchased software option is provided together with the option.

The firmware update is described in the service manual, chapter 4.

Example: Moving a portable license

This example is intended to explain how to perform the required steps at the instrument.

Use an USB stick to transfer the license key files between the instrument and the browser.



We assume knowledge about the handling of the R&S License Manager online tool and the description of the whole process.

1. Open your browser and go to <https://extranet.rohde-schwarz.com/service>. Select "Manage Licenses > Move Portable License".

The first step requires the Device IDs of the source and target instruments.

2. To find out the Device IDs, proceed as follows:
 - a) On the source instrument, select "Setup > Manage License Keys > Device ID".



- b) On the target instrument, select "Setup > Manage License Keys > Device ID".
 - c) In the browser, select "Manage Licenses > Move Portable License > Select Devices" and enter the Device IDs.
3. On the source instrument, select "Setup > Manage License Keys > Installed License Keys table", navigate to the portable license you want to move and click on the "Export License to File" column, e.g. R&S SMBV-K40.

A standard file manager dialog opens. Enter a user specific file name and save the exported license key, e.g. `k40_portable_key_to_move.xml`.

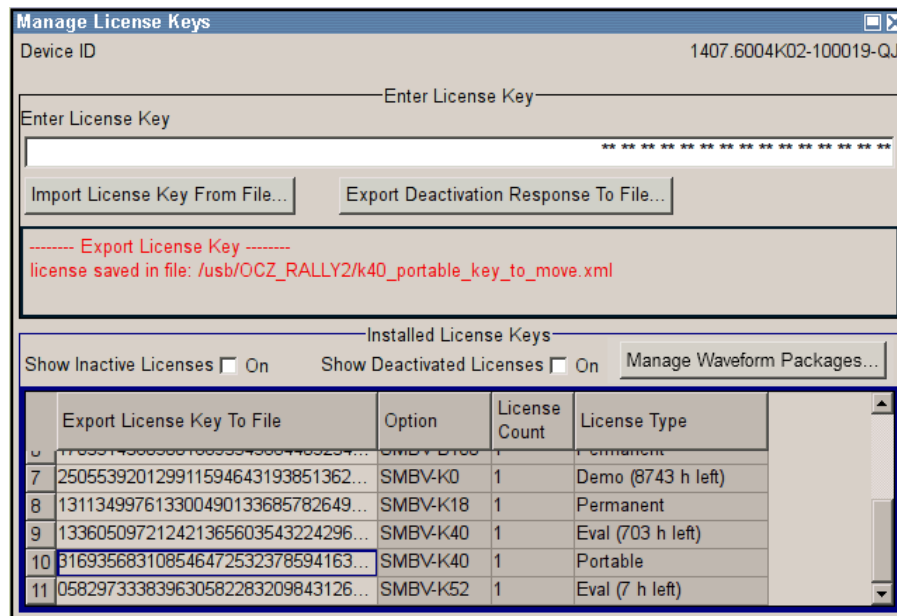

- In the browser, select "Manage Licenses > Move Portable License > Select License (from file)" and select the exported license key. Check the selection, create the deactivation key and save it to file.
- On the source instrument, select "Setup > Manage License Keys > Import License Keys from File" and select the transferred deactivation key.

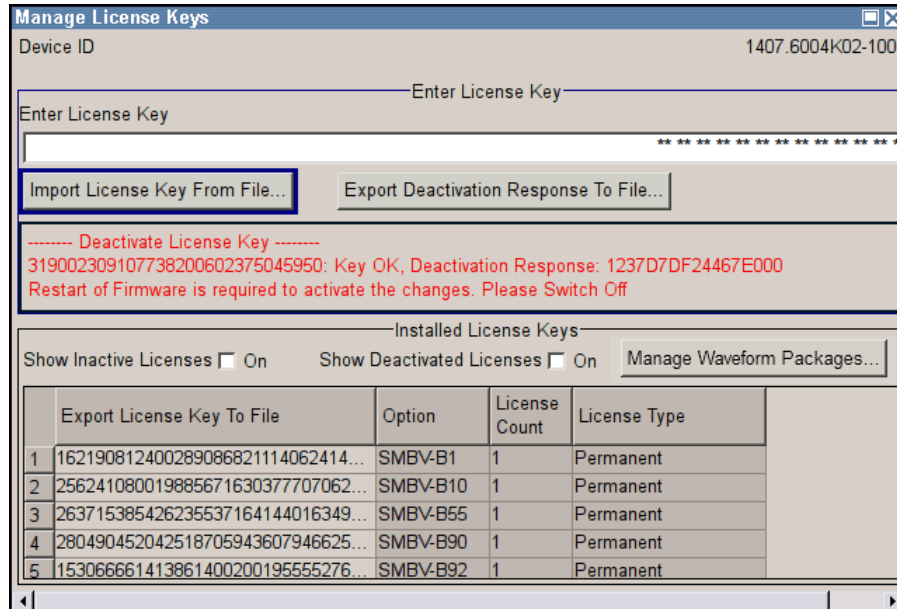

- On the source instrument, select "Manage License Keys > Export Deactivation Response to File".
 The instrument confirms the deactivation of the option. The deactivation key response is exported under the selected name, e.g. K40_portable_decat.txt.

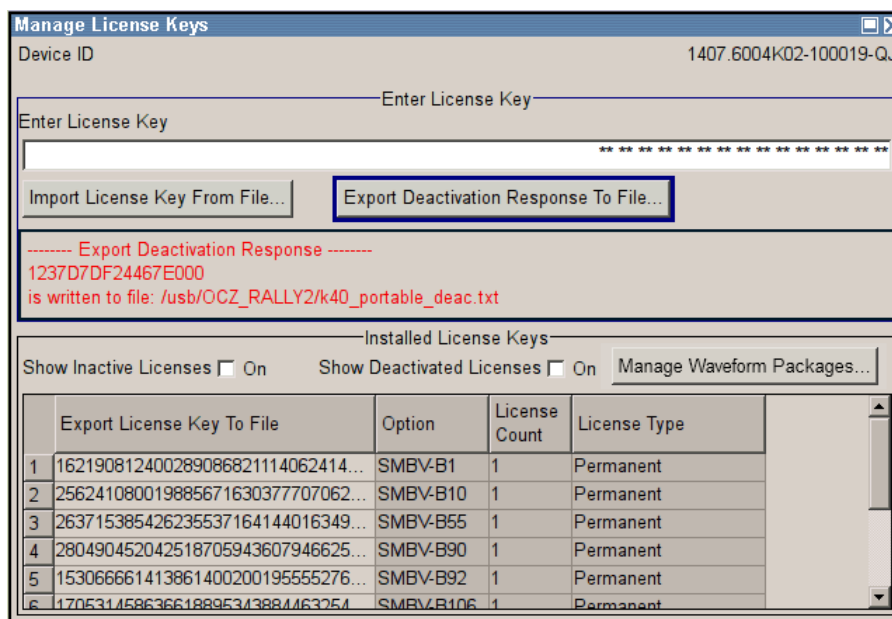

- In the browser, go the step "Manage Licenses > Move Portable License > Install Deactivation Key (from file)" and enter the deactivation response of the instrument. The license is deactivated for the source instrument.
- In the "Manage Licenses > Move Portable License" go to step "Create License" to generate a license key for this portable option and the selected target instrument. Download the license key as a file and transfer it to the target instrument.
- In the target instrument, select "Setup > Manage License Keys > Import License Keys from File" and select the created license key file.

The portable option is installed on the target instrument.

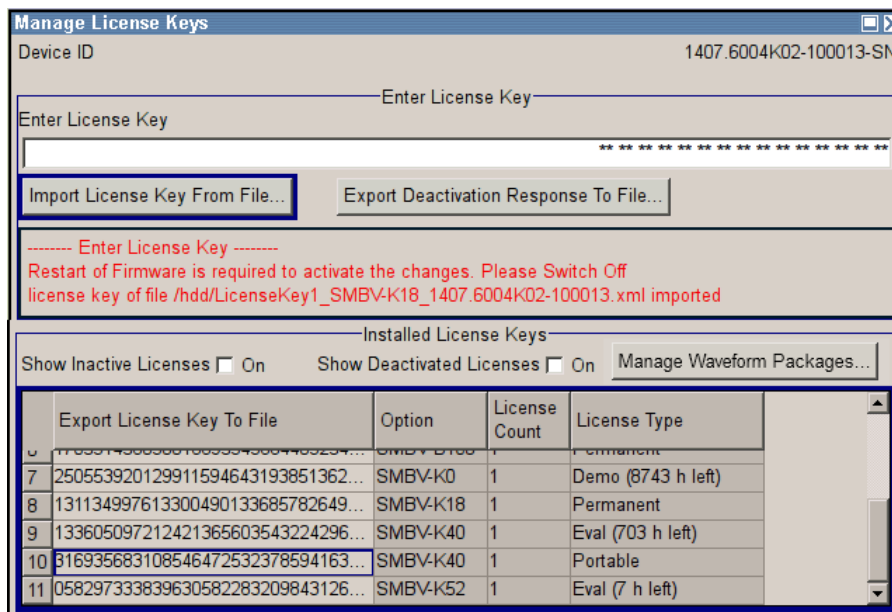

Device ID

Displays the instrument specific identification number. The device ID is an unique string with the following structure:

```
<stock number>-<serial number>-<checksum>
```

Enter License Key

Type here the license key provided with the option.

For license keys delivered as a file, use [Import License Key from File...](#)

Import License Key from File...

Opens a dialog for selecting the file with the license key.

Use this function also to import the deactivation key file generated by the R&S License Manager online tool (see [Example "Moving a portable license"](#) on page 125).

Export Deactivation Response to File...

Exports the generated deactivation response key to a file and opens a file management dialog to save the file. This key is required during the unregistration process.

In case the unregistered option is a portable one, it can be afterwards registered at another instrument (see [Example "Moving a portable license"](#) on page 125).

Status Information

Displays status information.

Show Inactive Licenses

Enables/disables the display of the inactive (expire) licenses in the [License Table](#).

Show Deactivated Licenses

Enables/disables the display of the deactivated licenses in the [License Table](#).

See [Example "Moving a portable license"](#) on page 125 for information on how to activate deactivated licenses.

Manage Waveform Packages

Opens the "Manages Waveform Packages" dialog.

| | Waveform | Registration Date | Used License(s) |
|---|--|---------------------|-----------------|
| 1 | drive:/path/simulatedMultiSegmentFilename_1762.wv | 2006-12-01 10:17:02 | 11 |
| 2 | drive:/path/simulatedMultiSegmentFilename_3545.wv | 2009-07-31 10:07:26 | 20 |
| 3 | drive:/path/simulatedWaveformFilename_16964.wv | 2007-09-24 10:01:42 | 1 |
| 4 | drive:/path/simulatedWaveformFilename_30007.wv | 2011-06-08 08:31:38 | 1 |
| 5 | drive:/path/simulatedMultiSegmentFilename_2888.wv | 2011-02-19 07:40:26 | 7 |
| 6 | drive:/path/simulatedMultiSegmentFilename_14577.wv | 2011-04-23 08:27:31 | 2 |

The waveform packages licenses are provided for the registration of waveforms. This kind of licences enables the instrument to play registered waveform file generated with the software R&S WinIQSIM2 even if the instrument is not equipped with the corresponding software option R&S SMBV-Kxy/-K2xy.

One waveform packages license per waveform is required. Once registered license cannot be moved to another instrument.

Note: One waveform package licence per segment is required for the registration of a multi segment waveform.

| | |
|--------------------------------|---|
| "Number of Licenses/Waveforms" | Displays the number of the available and used R&S SMBV-K200 licenses. |
| "Select Waveform" | Opens standard dialog to select the waveform to be registered. |
| "License Table" | Gives an overview of the registered waveforms, the registration date and the number of used licenses. |

License Table

Provides information about the currently installed options.

| | |
|------------------------------|---|
| "Export License Key to File" | Opens dialog to save the generated license key file. This file is required during the unregistration process. In case the unregistered option is a portable one, it can be afterwards registered at another instrument (see Example "Moving a portable license" on page 125). |
| "Option" | Displays the option short designation. Tip: Open the " Setup > Software/Options " dialog to retrieve more information about the installed options. |
| "License Count" | Displays the number of the licenses for the selected option key. |
| "License Type" | Display the type of license. A license type is a joint qualification for the duration of applicability and the portability of a license. The following license types are provided: evaluation, permanent, portable, quantified, timed with duration of 1, 3, 6 or 12 months. A license can also be in the states deactivated and expired. For time limited licenses, the left time of applicability is displayed too. |
| "Manage" | Opens the "Waveform Packages License" dialog (see Manage Waveform Packages). |

5.2.3.5 NRP Info/Update

The "NRP Info/Update..." dialog covers information on connected power sensors, like serial number, revision state and features of the particular sensor. You can directly update the sensor firmware.

Access:

- ▶ Select "Setup > System > NRP Info/Update...".

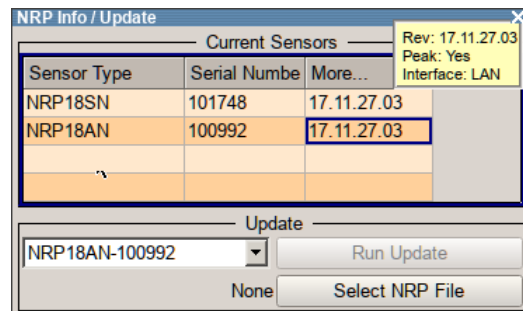

The "NRP Info / Update" dialog indicates the connected R&S NRP power sensors with specific information and contains the functions to update the firmware of a connected sensor.

The remote commands required to remotely configure the power sensor settings are described in [Chapter 7.14, "SENSe, READ and INITiate Subsystems"](#), on page 583.

How to update an R&S NRP sensor

To perform an R&S NRP sensor update proceed as follows:

1. Open the R&S website <http://www.rohde-schwarz.com> in section "Power Meters & Voltmeters > R&S NRP Sensors".
2. Select the respective sensor, e.g. R&S NRP18SN.
3. Select "Downloads > Firmware" and the offered firmware suitable for your sensor.
4. Transfer and save the firmware on the instruments, for example in the `/var/user/` directory.
5. Connect the sensor to the R&S SMBV and select "Setup > System > NRP Info Update" to open the dialog.
6. Select the sensor in the left sensor selection field.
7. Select the update file with "Select NRP File".
8. Start the update procedure with "Run Update".

The update starts and a bar indicates the progress.

How to restart an interrupted update of an R&S NRP sensor

An accidental removal of the sensor during the update process interrupts the update.

If no other sensor is connected to the instrument, proceed as follows to restart the update process:

1. Do not reconnect the sensor but keep it ready to be connected.

2. In the "Setup > System > NRP Info Update" dialog, select "Rescue" in the left sensor selection field
3. Activate "Run Update".
4. Confirm query in message box
5. Connect sensor within 4 seconds

The update starts, a bar informs about the progress.

Current Sensors

Shows the sensors that are connected to the generator with information on serial number, the revision state and some features.

Remote command:

[SENSe<ch>\[:POWer\]:TYPE?](#) on page 594

[SENSe<ch>\[:POWer\]:SVERsion?](#) on page 593

[SENSe<ch>\[:POWer\]:SNUMber?](#) on page 592

Update

Section "Update" provides access to the file system in order to select a file for an R&S NRP sensor update (Button "Select NRP File"), the selected file is indicated to the left of the button. On the left side, the sensor to be updated is selected.

Button "Run Update" starts the update.

Note: If the update is interrupted for example by accidental removal of the sensor during the process, the button "Rescue" appears. Thus, you can restart the update process.

Prerequisite is that no other sensor is connected to the instrument.

Refer to ["How to update an R&S NRP sensor"](#) on page 130 and ["How to restart an interrupted update of an R&S NRP sensor"](#) on page 130 for detailed instructions.

Remote command:

n.a.

5.2.3.6 Delete Temporary Files

During signal processing, the R&S SMBV creates and stores different temporary files, such as the waveform files (*.wv) of all ARB standards. The instrument stores these temporary files on a predefined directory on its internal memory and, if available, on the installed hard disk. This predefined directory is a protected system directory that is not accessible via the "File Manager" but you can delete all temporary files stored there.

To achieve more free disc space on the internal flash memory

To maintain sufficient amount of free disc space on the internal flash memory or on the hard disk, the R&S SMBV provides a convenient way to delete all temporary files stored on the predefined directory.

1. Select "SETUP > Delete Temporary Files"

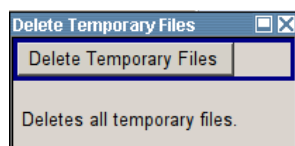

- Execute the "Delete Temporary Files" function.
The content of the predefined directory is deleted.



Another way to achieve more free disc space on the internal flash memory is to execute the **Factory Preset** function.

This function removes all temporary files, too, but also resets several parameters to their factory values.

SCPI command:

`:SYSTEM:FILES:TEMPorary:DElete` on page 838

5.2.3.7 Display Update

The "Start/Stop Display Update" dialog provides the possibility to switch off update of the displayed parameters to increase speed for certain settings.

The indicated values are not updated and may therefore differ from the intern, used values.

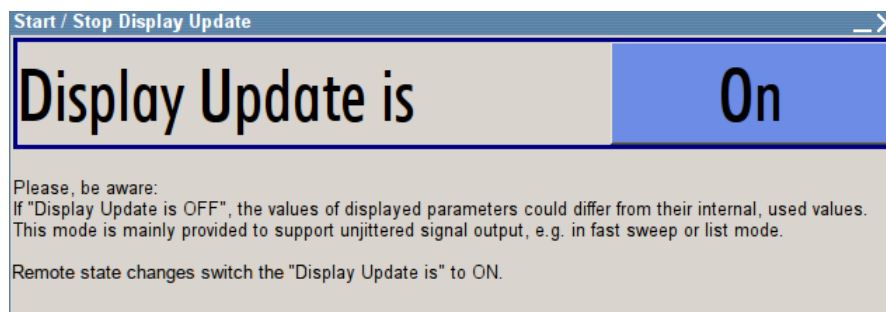

Display Update is On/Off

Switches on/off the update of the displayed parameters.

Switching off the update of the displayed parameters increases the speed for certain settings.

Note: For optimum sweep performance with short dwell times and for fast settling times, it is recommended to switch off the display update.

Remote command:

`:SYSTEM:DISPlay:UPDate` on page 842

5.2.3.8 Selftest

A selftest is provided for service purposes.

Access:

1. Select "Setup > Test > Selftest"
2. Select "Start Selftest".

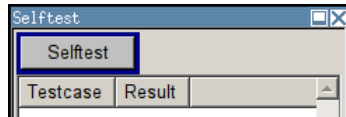

The following tests are only available via remote control:

- `:TEST<hw>:DIRect` on page 846

In addition, a direct test for the hardware assembly is provided only via remote control, see `:TEST<hw>:DIRect` on page 846.

Start Selftest

Performs a selftest on all installed hardware options.

When completed, the R&S SMBV displays a list of all performed test cases and the test results (passed or failed).

Note: While the self test is in progress, the actual signal level at the RF output is -50 dBm. This value is not indicated in the status bar.

Remote command:

`:TEST<hw>:ALL:START` on page 845

`:TEST<hw>:ALL:RESult?` on page 845

Active External IQ Device

Selects the external IQ device ("IQ IN / IQ Out").

Remote command:

n.a.

5.2.3.9 Check Front Panel

With the functions provided in this dialog you can verify the functionality of the control keys of the R&S SMBV.

In case of malfunctions, contact your Rohde & Schwarz Customer Support Center for technical support, see <http://www.customersupport@rohde-schwarz.com>.



Accessing the online help in the check front panel dialog or exiting via ESC

During the test, the actual functions of all keys are disabled, including the [help] and the [esc] keys.

Check Front Panel Settings

- ▶ To access this dialog, Press the "setup" key and select "Setup > Test > Check Front Panel".

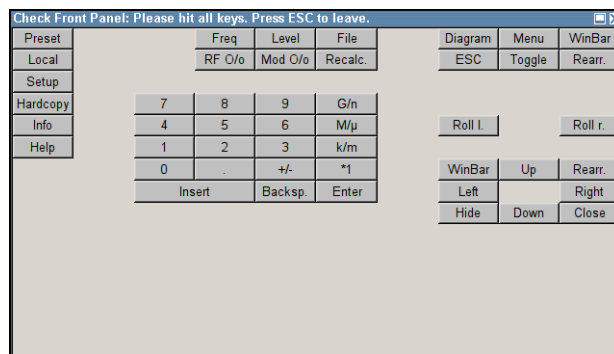

Reflecting the front panel, the "Check Front Panel" dialog contains all functions to test the operating elements of the instrument.

Performing the Front Panel Tests

To perform the front panel test, you operate the keys at the front panel, and check the response of the instrument in the "Check Front Panel" dialog. To perform this test properly, it is essential that you check each key of the front panel. The test is only completed, when you have verified all keys.

During the test, the actual functions of the keys are disabled.

Proceed as follows:

1. Press the [setup] key.
2. Select "Test > Check Front Panel"
The "Check Front Panel" dialog opens.
3. Press a key on the front panel.
Check if the corresponding key in the "Check Front Panel" dialog turns green.
4. Press the same key a second time.
Check that the key in the dialog turns red.
Note: Pressing the same key again has no further effect, with the exception of the [esc] key, see [Press the ESC key a third time.](#)
5. Continue with the next key on the front panel and repeat [step 3](#) to [step 5](#) until all keys are tested.

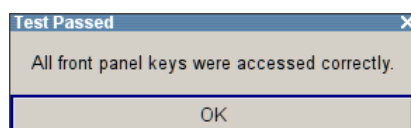

The test is completed, when each key is verified successfully, confirmed by a "Test passed" message.

Select "OK" to exit the test.

- ▶ Press the [esc] key a third time.
Exits the "Check Front Panel" dialog, even if you have not yet checked all the keys.

Expected responses:

- Pressing a key once (green), pressing twice (red)
- Pressing the [esc] key a third time exits the dialog.

If you detect a malfunction, for example, you press the front panel key the first time, and the color of the button in the dialog turns red (instead of green), the front panel key may be stuck. In this case, contact the Rohde & Schwarz Customer Support Center for technical support, see <http://www.customersupport@rohde-schwarz.com>.

5.2.3.10 Shutting Down and Rebooting the Instrument

The [Power On/Standby] front panel key switches the instrument from the standby to the ready state or vice versa. In remote operation from a remote computer or in manual control, the R&S SMBV provides you with another possibility to shut the instrument down or to reboot the system.

- ▶ To access the required settings, select "Setup > Environment > Shut Down".

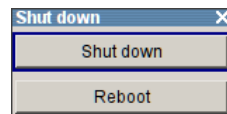

Remote control commands:

- `:SYSTEM:SHUTdown` on page 841
- `:SYSTEM:REBoot` on page 841
- see also `:SYSTEM:REStart` on page 841

5.2.3.11 Date and Time

The R&S SMBV uses an internal real time clock to determine the date and time. It adjusts the time and date to the timezone of your location automatically, by providing a selection list of continents and cities.

The instrument records the time whenever you create or modify files on your instrument or you use timed licences. By default, the instrument is set to the UTC timezone, but you can select the timezone according to your location.

Moreover, the instrument supports NTP protocol for synchronizing all connected instruments and computer systems to minimize time delays in the network.

Access:

- ▶ Select "Setup > Environment > Date/Time" via the [SETUP] or [MENU] key.

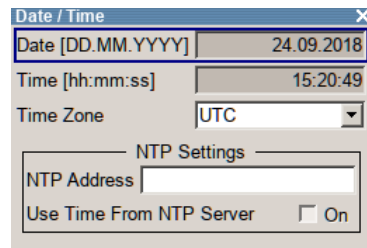

The "Date / Time" dialog contains the time and data settings of the operating system.



This function is password-protected. Unlock the protection level 1 to access it. To enable editing, unlock protection level 1, see [Chapter 5.2.3.17, "Protection"](#), on page 146.

Date

Displays the date set in the operating system in the format [dd.mm.yyyy].

Remote command:

:SYSTem:DATE on page 842

Time

Displays the time set in the operating system in the format [hh.mm.ss].

The time setting corresponds to the selected [Time Zone](#).

Remote command:

:SYSTem:TIME on page 843

Time Zone

Selects the time zone.

You can select the time zone according to the major cities on the respective continents.

Note: By typing the first letter, you can quickly navigate through the lists to find the desired destination.

Remote command:

:SYSTem:TIME:ZONE on page 843

:SYSTem:TIME:ZONE:CATalog? on page 843

NTP Address

Sets the IP address or host name of the NTP server.

NTP is a network time protocol used for synchronizing all participating devices in a data network.

You can select a high-precision time server to reduce the impact of varying network delays.

Remote command:

:SYSTem:NTP:HOSTname on page 840

Use Time from NTP Server

Activates clock synchronization of the network via the NTP protocol.

Remote command:

:SYSTem:NTP:STATe on page 840

5.2.3.12 Network Settings

The "Network Settings" dialog shows the parameters relevant for identifying the instrument in a network. The R&S SMBV is equipped with a network interface and can be connected to an Ethernet LAN (local area network).

How to connect the signal generator to the network is described in [Chapter 2.6.1, "Connecting the Instrument to the Network"](#), on page 43.

NOTICE

Risk of network errors!

Connection errors can affect the entire network.

If your network does not support DHCP, or if you choose to disable dynamic TCP/IP configuration, you must assign valid address information before connecting the instrument to the LAN.

Contact your network administrator to obtain a valid IP address.

- ▶ To access this dialog, press the [setup] or [menu] key and select "Environment > Network Settings".

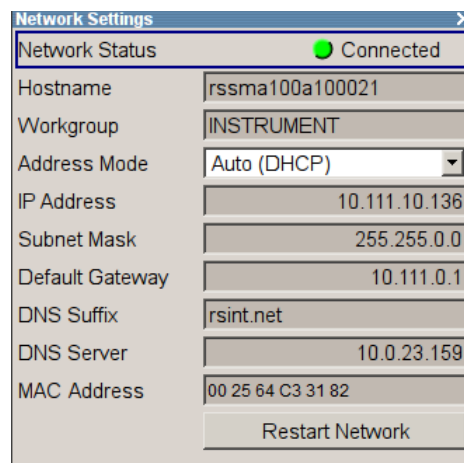

In the "Network Settings" dialog, you can configure the settings of the general network environment and specific identification parameters of the instrument in the network.

The remote commands required to remotely configure the network are described in [Chapter 7.17, "SYSTem Subsystem"](#), on page 825.

Network Status

Indicates that the instrument is connected to the network.

Remote command:

`:SYSTem:COMMunicate:NETWork:STATus?` on page 835

Hostname

Displays the host name.

Each instrument is delivered with an assigned host name, a logical name which can be used instead of the IP address. With the default network settings, the IP address is allocated by the DHCP server. This address may change each time the instrument is reconnected. Unlike the IP address, the host name does not change.

Note: Since the host name of the instrument is a protected parameter, you must first unlock protection level 1 to enable the entry (see [Chapter 5.2.3.17, "Protection"](#), on page 146).

It is recommended that you neither change the default network settings nor the host name in order to avoid problems with the network connection.

However, if you change the host name be sure to use a unique name.

Remote command:

`:SYSTem:COMMunicate:NETWork[:COMMON]:HOSTname` on page 832

Workgroup

Sets the individual windows workgroup name of the R&S SMBV. This parameter is required in case the instrument is integrated in a windows network.

Note: Since the workgroup name of the instrument is a protected parameter, you must first unlock protection level 1 to enable the entry (see [Chapter 5.2.3.17, "Protection"](#), on page 146).

Remote command:

`:SYSTem:COMMunicate:NETWork[:COMMON]:WORKgroup` on page 833

Address Mode

Selects the mode for assigning the IP address.

"Auto (DHCP)" Assigns the IP address automatically, provided the network supports DHCP (**D**ynamic **H**ost **C**onfiguration **P**rotocol)
The network used must support automatic assignment of the IP address via DHCP or APIPA (Zeroconf) in order to use this function.

"Static" Enables you to assign the IP address manually.

Remote command:

`:SYSTem:COMMunicate:NETWork:IPAddress:MODE` on page 833

IP Address

Displays the IP address.

By default, the R&S SMBV is configured to use dynamic TCP/IP configuration and to obtain the whole address information automatically.

If the network does not support DHCP or the attempt does not succeed, the instrument tries to obtain the IP address via Zeroconf (APIPA) protocol. IP addresses assigned via Zeroconf start with the number blocks 169.254.*.*.

Note: An IP address that is assigned via the Zeroconf protocol while the network requires an IP address assigned via the DHCP server may cause network connection failures.

See [Chapter 9.5, "Resolving Network Connection Failures"](#), on page 863.

To assign the IP address manually, select [Address Mode](#) "Static".

Remote command:

`:SYSTem:COMMunicate:NETWork:IPADdress` on page 834

Subnet Mask

Displays the bit group of the subnet in the host identifier.

To assign the subnet mask manually, select [Address Mode](#) "Static".

Remote command:

`:SYSTem:COMMunicate:NETWork[:IPADdress]:SUBNet:MASK` on page 834

Default Gateway

Displays the gateway address.

To assign the gateway address manually, select [Address Mode](#) "Static".

This address identifies the router on the same network as the instrument that is used to forward traffic to destinations beyond the local network.

Remote command:

`:SYSTem:COMMunicate:NETWork[:IPADdress]:GATeway` on page 834

DNS Suffix

Displays the primary DNS (**D**omain **N**ame **S**ystem) suffix, that means the DNS name without the host name part.

The DNS system uses the suffix for registration and name resolution to uniquely identify the instrument in the entire network.

To assign the DNS suffix manually, select [Address Mode](#) "Static".

Remote command:

`:SYSTem:COMMunicate:NETWork[:COMMON]:DOMain` on page 832

DNS Server

Determines the preferred server for name resolution. The DNS server contains the underlying numerical values that are required for name resolution of the host name as part of the IP address.

To select the DNS server manually, select [Address Mode](#) "Static".

Remote command:

`:SYSTem:COMMunicate:NETWork[:IPADdress]:DNS` on page 833

MAC Address

Indicates the MAC (**M**edia **A**ccess **C**ontrol) address, a unique identifier of the network adapter in the R&S SMBV.

Remote command:

:SYSTem:COMMunicate:NETWork:MACaddress on page 834

Restart Network

Terminates the network connection to the instrument and subsequently re-establishes it.

Used this function to resolve network problems.

Note: Only the connection of the instrument to the network restarts, the network itself is not affected.

Remote command:

:SYSTem:COMMunicate:NETWork:REStart on page 835

5.2.3.13 Global Trigger/Clock/External Input Settings

The "Global Trigger/Clock/External Inputs" menu can be opened using the [SETUP] or [MENU] key under the "Setup" menu as well as in all clock and trigger menus of the "Baseband" function block.

This menu is used to determine the physical characteristics of the input connectors for trigger, clock and control signals.

A common trigger threshold and input impedance is effective for all trigger and control signal inputs. The settings influence the digital modulations, the generation of waveforms or multicarrier signals, and all digital standards. These data sources are available for digital modulation ([Custom Digital Modulation](#)).

The instrument trigger setting influences all sweeps and is effective in the List mode.

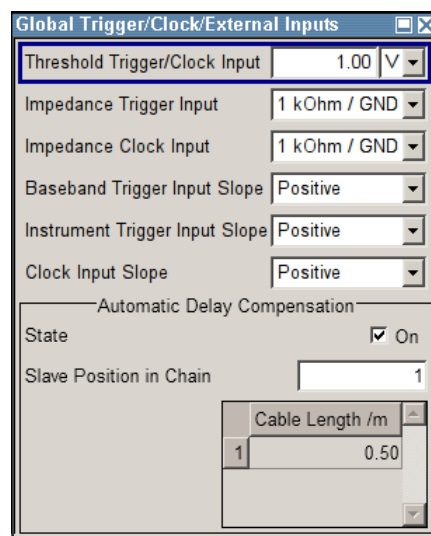

Threshold Trigger/Clock Input

Sets the high/low threshold in volts for the trigger and clock signal inputs of the baseband section.

The setting affects the [TRIGGER] input and the [CLOCK IN/OUT] connectors (BNC connectors at the rear of the instrument).

Remote command:

[\[:SOURCE\]:INPUT:TRIGGER:LEVEL](#) on page 749

Impedance Trigger Input

Selects the input impedance for the external trigger inputs. 1 kOhm/GND should be selected for high clock rates.

The setting affects the [TRIGGER] input connector (BNC connector at the rear of the instrument).

Remote command:

[\[:SOURCE\]:INPUT:TRIGGER:IMPEDANCE](#) on page 748

Impedance Clock Input

Selects the input impedance for the clock inputs. 1kOhm/GND should be selected for high clock rates.

The setting affects the [CLOCK IN] connector (BNC connector at the rear of the instrument).

Remote command:

[\[:SOURCE\]:INPUT:CLOCK:IMPEDANCE](#) on page 747

Baseband Trigger Input Slope

Selects the polarity of the active slope of an externally applied trigger signal.

This setting affects the [INST TRIG] input connector (BNC connector at the rear of the instrument).

Remote command:

[\[:SOURCE\]:INPUT:TRIGGER:BBAND:SLOPE](#) on page 748

Ext. Trigger Input Slope

Sets the polarity of the active slope of an externally applied instrument trigger.

This setting affects the TRIG input (BNC connector at the rear of the instrument).

"Positive" activates the rising edge of the trigger signal.

"Negative" activates the falling edge of the trigger signal.

Remote command:

[\[:SOURCE\]:INPUT:TRIGGER:SLOPE](#) on page 749

Clock Input Slope

Sets the polarity of the active slope of an externally applied symbol clock pulse.

This setting affects the [CLOCK] input (BNC connector).

Remote command:

[:CLOCK:INPUT:SLOPE](#) on page 555

Automatic Delay Compensation

While working in a master-slave mode, the instruments are connected as daisy chain (see also [Chapter 5.9.2.4, "Synchronous Signal Generation"](#), on page 332). The settings for automatic delay compensation enable each of the slaves to calculate and compensate the expected timing delay caused by the used cables. The calculation assumes an ordinary BNC cables that have a dielectrics with a permittivity of $\epsilon_r = 2.7$.

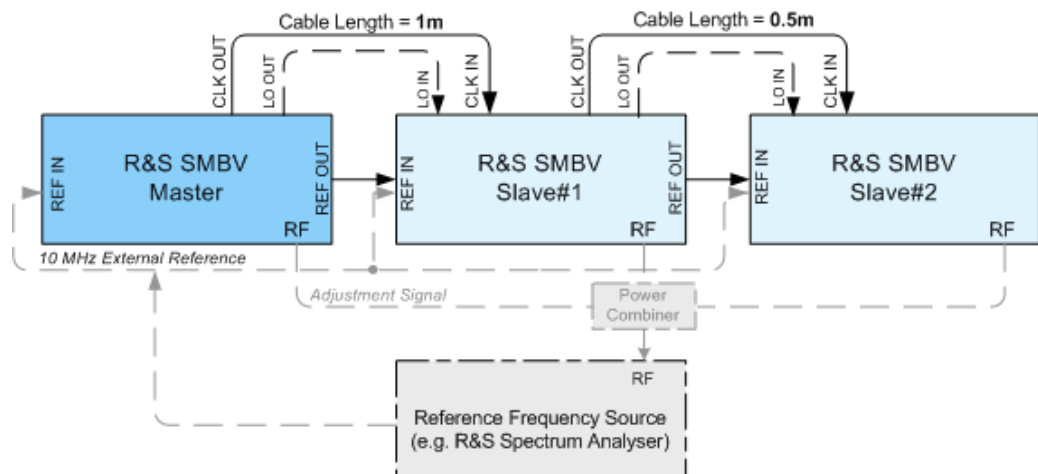

"State" Enables the automatic compensation.

Remote command:

[\[:SOURCE\]:INPUT:DElay:ADCState](#) on page 749

"Slave Position in Chain" Defines the position of the slave instrument in the daisy chain, where the slave directly connected to the master instrument is the one with number 1, etc.

Remote command:

[\[:SOURCE\]:INPUT:DElay:SPOSITION](#) on page 750

"Cable Length" Sets the total length of the cable used to connect the [CLK OUT] and [CLK IN] connectors. For the first slave in the chain, the value represents the cable length between the master and the first slave; for the second slave, the cable length to the first **and** to the second has to be defined, etc.

Remote command:

[\[:SOURCE\]:INPUT:DElay:CLEngth<ch>](#) on page 750

5.2.3.14 Display/Keyboard Settings

In the "Display/Keyboard Settings" dialog the power-save mode and external keyboard settings are made. It is opened using the [SETUP] or [MENU] key under "Environment".

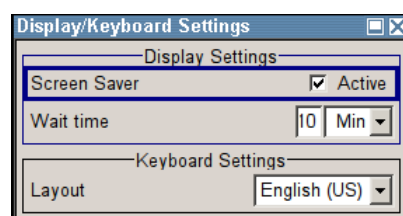

Screen Saver Active

Activates/deactivates the screen-save mode of the display.

If activated, the display including backlight is completely switched off after the elapse of the "Wait Time" when no entries via front panel, external mouse or external keyboard are made.

This mode is recommended for preserving the display especially if the instrument is exclusively operated via remote control.

Remote command:

:DISPlay:PSAVe[:STATe] on page 559

Wait Time

Enters the idle time that must elapse before the display lamp is shut off when no entries are made.

Remote command:

:DISPlay:PSAVe:HOLDoff on page 559

Layout (USB Keyboard Settings)

Selects the keyboard layout for the selected keyboard language.

The assignment of some keys depends on the selected layout and language.

Remote command:

:KBOard:LAYout on page 567

:KBOard:LANGuage on page 567

5.2.3.15 Remote Channel Settings

The "Remote Channel Settings" dialog provides access to the settings for remote control. The dialog is opened using the [SETUP] or [MENU] key under "Remote".

- ▶ To access this dialog, press the [setup] or [menu] key and select "Remote > GPIB,...".

The "Remote Channel Settings" dialog contains the GPIB address and displays the VISA resource strings provided for remote control via the various interfaces.

GPIB channel address

Sets the address of the GPIB channel the instrument is connected to.

Remote command:

`:SYSTem:COMMunicate:GPIB[:SELF]:ADDRes` on page 832

 RS232 using USB adapter

Remote control via a serial interface is possible via a USB. The controller and the instrument must be connected with the external USB/serial-adapter R&S TS1-USB (see recommended extras in the data sheet) and a serial crossover (null modem) cable. A USB connection requires the VISA library to be installed on the controller. VISA will detect and configure the R&S SMBV automatically when the USB connection is established.

In addition, you can also use a Bluetooth connection for remote control via the serial interface. The settings are effective for both interfaces (see also [Chapter 5.2.3.18, "Security"](#), on page 147).

 Baud Rate ← RS232 using USB adapter

Sets the baudrate for the serial remote control interface.

Remote command:

`:SYSTem:COMMunicate:SERial:BAUD` on page 837

 Parity ← RS232 using USB adapter

Sets the parity for the serial remote control interface.

Remote command:

`:SYSTem:COMMunicate:SERial:PARity` on page 837

 Stop Bits ← RS232 using USB adapter

Sets the number of stop bits for the serial remote control interface.

Remote command:

`:SYSTem:COMMunicate:SERial:SBITs` on page 837

 VISA Resource Strings

Displays the VISA resource strings, used for remote control of the instrument. Each interface requires an individual unique address, to identify the instrument for remote control.

Remote command:

`:SYSTem:COMMunicate:HISLip:RESource?` on page 836

`:SYSTem:COMMunicate:NETWork:RESource?` on page 836

`:SYSTem:COMMunicate:SOCKet:RESource?` on page 838

`:SYSTem:COMMunicate:GPIB:RESource?` on page 835

`:SYSTem:COMMunicate:USB:RESource?` on page 836

`:SYSTem:COMMunicate:SERial:RESource?` on page 836

 Goto Local

Switches the instrument to operate in local control mode.

Switching from remote to local control mode can be also done with one of the following actions:

- manually with the [LOCAL] key on the front panel
- with the interface command `>L` via the remote control interface
- with the key combination [CTRL + Q].

Remote command:

`>L`

5.2.3.16 Instrument Emulations

It is also possible to remotely control the R&S SMBV via the command set of another signal generator, as for example of an HP generator. With this function you can, for example, replace a signal generator with an R&S SMBV in an automated test setup, without adjusting the command scripts used. You find all the remote control command sets supported by the R&S SMBV in a selection list.

For more information on this topic, the application note [1GP91: Remote Emulations with the R&S SMBV100A Vector Signal Generator](#) describes in detail how to use this feature.

The selected instrument also defines the identification string that is retrieved with query `*IDN?`. In addition to the preset values, you can enter a user-defined identification string, for example to provide individual identification for each generator, like 'MY_R&S SMBV' (see [Mode](#) and [IDN String](#)).

As any other parameter, you can additionally change the remote control command set to be emulated via the [Language](#) command. However, once you have switched to an emulation, the R&S SMBV specific command set is disabled, that means this command is no longer effective. To return, you need to know the corresponding remote control command of the simulated instrument. If you emulate an HP generator for example, the HP command `EX` returns to the SCPI command set.

- To access this dialog, press the [setup] or [menu] key and select "Remote > Instrument Emulations".

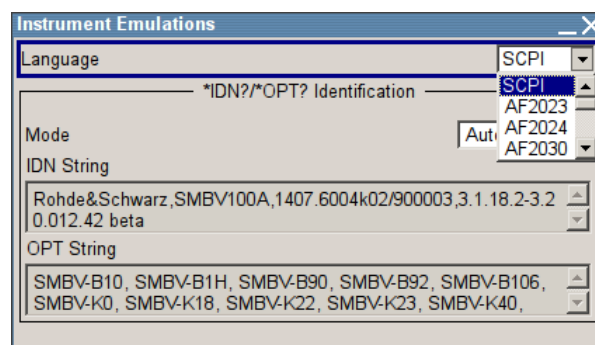

The "Instrument Emulations" dialog enables you to emulate a remote control command set of several other signal generators.

The remote commands required to remotely configure the emulation settings are described in [Chapter 7.17, "SYSTEM Subsystem"](#), on page 825.

Language

Selects the instrument whose remote command set is emulated by the R&S SMBV.

Remote command:

[:SYSTem:LANGuage](#) on page 840

Mode

Selects the way the instrument identification is performed.

"Automatic" Sets the "IDN String" and the "OPT String" automatically for the instrument selected with the parameter [Language](#).

"User Defined" Enables you to define the "IDN String" and the "OPT String" for the instrument selected with the parameter [Language](#).

Remote command:

[:SYSTem:IDENTification](#) on page 838

Set to default

Enables you to reset the *IDN and *OPT strings in user defined mode, see "[Mode](#)" on page 146 .

The default strings vary depending on the selected emulation mode ([Language](#))

Remote command:

[:SYSTem:IDENTification:PRESet](#) on page 839

IDN String

Indicates the identification string of the instrument when queried with the common command *IDN?.

To assign a user defined identification string, select [Mode](#) "User defined".

Remote command:

[*IDN?](#) on page 534

[:SYSTem:IRESpOnse](#) on page 839 (user defined mode)

OPT String

Indicates the option string of the instrument as queried with the common command *OPT?.

In "User defined" (see [Mode](#)) [IDN String](#), you can create a user defined option string in addition to the automatically created one.

Remote command:

[*OPT?](#) on page 534

[:SYSTem:ORESpOnse](#) on page 839

5.2.3.17 Protection

This "Protection" dialog provides access to the unlocking of different protection levels .

Access:

- ▶ Select "Setup > Protection"

After power on the instrument, all protection levels are locked. To unlock the protection, the correct password must be entered, see ["To unlock or lock a protection level..."](#) on page 147.

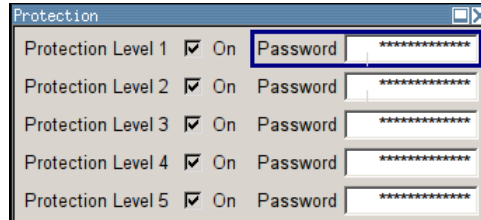

The following functions are protected in the respective levels:

- **Protection Level 1**
Protects against accidental changes to certain settings, e.g. clock and date, network settings or instrument names. You can access this protection level with the password *123456*.
- **Protection Level 2**
Provides access to the unlocking of protected service functions. It is accessible for authorized personnel of Rohde & Schwarz service departments.
- **Protection Level 3-5**
Are reserved for factory internal use.

To unlock or lock a protection level...

1. In the "Password" entry field, enter the password for the corresponding protection level.
2. Confirm with the [Enter] key.
The checkbox of the protection level is disabled, i.e. the protection is unlocked.
3. To lock a protection level again, select the checkbox.

Protection Level/Password

Locks or unlocks the corresponding protection level.

E.g. protection level 1 expands the functionality of the internal adjustment and to access the selftests.

The password is *123456*.

Remote command:

`:SYSTem:PROTect<ch>[:STATe]` on page 841

5.2.3.18 Security

The security concept of the R&S SMBV helps you to protect your instrument against uncontrolled access and changes. All provided security services require that you enter the security password.

Provided security services are:

- **Password** management secures controlled user access to the instrument

With the two-step password concept, you can assign a user-defined password for the operating system, as well as a security password for accessing the mass storage of the instrument.

For more information concerning the security password, see the description *Resolving Security Issues when Working with an R&S SMBV*. You can find this document on the R&S SMBV product page at "Downloads" > "Manuals".

- **LAN Services** secures controlled network access.
You can individually lock and unlock the supported LAN interface services, see "[LAN Services](#)" on page 150.
Remote control via LAN interface requires that the interface is activated, but you can enable the required services specifically.
- **General** security parameters as:
 - **USB Storage** secures controlled access to the mass memory of the instrument.
 - **Volatile mode** protects against modification or deletion of data in the file system.
 - **Annotation** frequency and amplitude prevents reading the display.
 - **User Interface** prevents front panel operation and/or reading the display
 - **Secure Update Policy** check that verifies the integrity and origin of the firmware package to be installed.
 - **Bluetooth** enables operation of the instrument via Bluetooth.



Changing the password for the operating system or the security password requires that you enter the old password, the new password and that you confirm the new password.

To assign the password, press the "Accept" button. This action can not be undone!

Keep also in mind, that security settings are never reset, even if you perform a factory preset.

- ▶ To access this dialog, press the [SETUP] or [MENU] key and select "Protection " > "Security".

The "Security" dialog comprises the parameters for configuring the passwords, as well as the security settings of the mass storage and the LAN services.



The settings in this dialog will not be assigned until you enter the [Security Password](#) and confirm with the [Accept](#) button.

User Name

Indicates the user name used for access to the Linux operating system.

The user name and password are required for remote access to the instrument via VNC, FTP or SAMBA.

Change User Password

Allows you to change and confirm the user password.

Old Password ← Change User Password

Enters the current user password. The default password is "instrument".

Note: It is highly recommended to change the default user password before connecting the instrument to the network.

New Password ← Change User Password

Enters the new user password.

Confirm Password ← Change User Password

Confirms the new user password by repeating.

Note: The new password will not be assigned until you select the [Change Password](#) button.

Change Password ← Change User Password

Changes the user password accordingly.

Note: Keep in mind, that a changed password is never reset, even if you perform a factory preset.

Change Security Password

Enables you to change and confirm the security password.

Old Password ← Change Security Password

Enters the currently used security password. The default password is '123456'.

Note: It is highly recommended to change the default security password before connecting the instrument to the network.

The security password is required when changing the status of the USB and LAN interface.

New Password ← Change Security Password

Enters the new security password.

The security password may contain decimal characters only.

Confirm Password ← Change Security Password

Confirms the new password by repeating.

Note: The new password will not be assigned until you select the [Change Password](#) button.

Change Password ← Change Security Password

Changes the password accordingly.

Note: Keep in mind, that a changed password is never reset, even if you perform a factory preset.

LAN Services

Opens the "LAN Services" dialog for individually enabling or disabling the available LAN interface services.

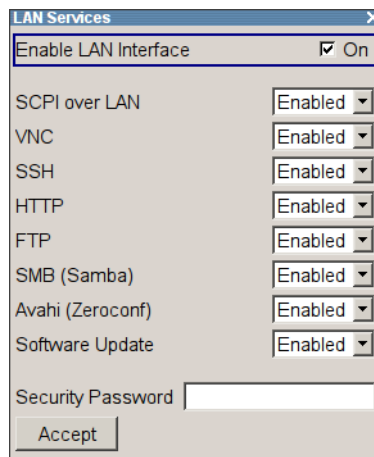

Enable LAN Interface ← LAN Services

Enables the LAN interface in general, and thus provides remote access via all unlocked services.

Note: The activated LAN services will not be assigned until you enter the [Security Password](#) and confirm with [Accept](#).

Enable LAN Services individually ← LAN Services

Enables or disables the following interface services individually.

"SCPI over LAN"

activates access over LAN to remotely control the instrument using SCPI (**S**tandard **C**ommands for **P**rogrammable **I**nstruments) commands.

"VNC"

activates access via VNC (**V**irtual **N**etwork **C**omputing) interface, a graphical desktop sharing system that uses RFB protocol to remotely control the instrument.

"SSH"

activates access via SSH (**S**ecure **S**hell), a network protocol for secure data communication.

"HTTP"

activates access via HTTP (**H**yper **T**ext **T**ransfer **P**rotocol), the application protocol for hypermedia information systems.

"FTP"

activates access via FTP (File Transfer Protocol), used to transfer files from a host to the instrument and vice versa.

"SMB (Samba)"

activates access to SMB (**S**erver **M**essage **B**lock), used for providing shared access to files, printers and serial ports of a network.

"Avahi (Zeroconf)"

activates Avahi, a service for automatic configuration of the instrument in a network environment.

"Software Update"

allows updating the instrument firmware via the LAN interface. For more information on this topic see the release notes of the instrument, provided on the Internet at the download site or the Rohde & Schwarz Signal Generator home page.

USB Storage

Activates the access to external USB storage media.

This setting has no effect on a mouse or a keyboard, connected via USB.

Note: The setting will not be assigned until you enter the [Security Password](#) and confirm with [Accept](#).

Volatile Mode

Activates write protection on the file system to prevent modification or erasure of valuable data.

Note: The setting will not be assigned until you enter the [Security Password](#), confirm with [Accept](#), and reboot the instrument.

Remote command:

[:SYSTEM:SECURITY:VOLMode\[:STATE\]](#) on page 831

Annotation Frequency

Enables/disables the display of the currently used frequency in the header of the instrument.

Note: The setting will not be assigned until you enter the [Security Password](#) and confirm with [Accept](#).

Remote command:

[:DISPLAY:ANNOTATION:FREQUENCY](#) on page 558

Annotation Amplitude

Enables/disables the display of the currently selected level in the header of the instrument.

Note: The setting will not be assigned until you enter the [Security Password](#) and confirm with [Accept](#).

Remote command:

[:DISPLAY:ANNOTATION:AMPLITUDE](#) on page 557

User Interface

Allows you to lock the manual of the controls of the instrument, and to hide even the entire display.

The setting requires the entry of the security password *123456* and is only accepted after the "Accept" button is pressed.

Tip: Section "[Enabling a locked user interface for manual operation](#)" on page 153 describes how you can unlock the control elements and the user interface.

| | |
|------------|---|
| "Enabled" | Enables the display and all controls for the manual operation of the instrument. |
| "VNC Only" | Locks the keys at the front panel and externally connected keyboard and mouse. The display on the screen remains and shows the current settings and changes. Unlocking is possible via VNC or turning off and on again. |

"Display only"

Locks the manual operation of the instrument. The display on the screen remains and shows the current settings and changes. This security feature protects the instrument against unauthorized access, but still shows the current settings and processes, for example when you operate the instrument via remote control.

The function disables:

- the keys at the front panel of the instrument
- the external mouse and keyboard

The instrument indicates the locked controls by a padlock  softkey in the taskbar.

"Disabled"

Locks the display and all controls for the manual operation of the instrument.

This security feature protects the instrument against unauthorized reading and access, for example when you operate the instrument via remote control.

The function disables:

- the display
- the keys at the front panel of the instrument
- the external mouse and keyboard

The screen shuts off and shows a padlock instead.



Remote command:

:SYSTem:ULOCK on page 830

:SYSTem:DLOCK on page 830

:SYSTem:KLOCK on page 830

Enabling a locked user interface for manual operation

To unlock the user interface for manual operation you have the following options:

- On the instrument's keypad or external keyboard, enter the security password 123456.

Even if you press any key, the instrument prompts you to enter the security password for unlocking.

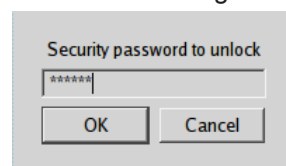

Note The character of the first key you pressed is immediately added in the input field. Prior to inserting the password delete this entry.

- In remote control mode, send the command `SYST:ULOC ENABLEd` to release all locks at once.

Alternatively, you can use the command `SYST:KLOC OFF` to unlock the keyboard, or `SYST:DLOC OFF` to release the display.

Via remote control, there is no password required.

Remote command:

:SYSTem:ULOCK on page 830

:SYSTem:DLOCK on page 830

:SYSTem:KLOCK on page 830

Secure Update Policy

Allows you to configure the automatic signature verification for firmware installation.

To apply the change: enter the security password and confirm with "Accept". Otherwise the change has no effect.

See also:

- [Chapter 5.2.3.18, "Security"](#), on page 147 for more information on the security concept.
- The release notes for details on signature verification when installing new or former firmware versions, available at www.rohde-schwarz.com/firmware/smbv100a.

"Confirm Unsigned"

Performs the signature verification.

If the check detects any discrepancies, the instrument issues a warning message. You can still update the firmware or reject updating.

This setting also enables you to downgrade the firmware version.

"All Packages" Accepts all packages without signature verification.

"R&S Signed Packages"

Performs the signature check.

If the check detects any discrepancies, the instrument issues a warning message and locks the update to this firmware.

Remote command:

:SYSTem:SECurity:SUPolicy on page 840

Security Password

Enters the password that is required to enable or to disable the settings protected by a security password. Default is '123456'.

Note: It is highly recommended that you to change the default security password before connecting the instrument to the network.

All settings are only accepted after the "Accept" button is pressed.

Accept

Applies the modified settings, provided the security password is entered correctly.

Note: This action can not be undone. Keep in mind, that a changed password is never reset, even if you perform a factory preset.

Bluetooth Pin

Sets the Bluetooth pin of an external Bluetooth device. The pin is required to enable remote control via an external Bluetooth device.

Requires a Bluetooth adapter (recommended extra, see data sheet) .

The interface parameters are identical to the RS232 interface parameters and can be set in the "Remote Channel Settings" dialog (see ["RS232 using USB adapter"](#) on page 144).

5.2.3.19 Save/Recall

The "Save/Recall" submenu can also be called up with the [FILE] key and is therefore described in the section of this key (see [Chapter 5.2.8, "Storing and Loading Instrument Data - File Key"](#), on page 161).

5.2.3.20 Factory Preset

The "Factory Preset" dialog provides a function to reset the instrument's settings to their factory state. This function is activated by pressing the "Execute Factory Preset" button.

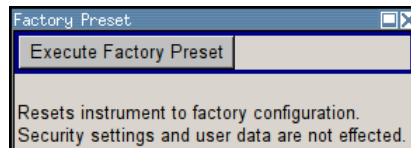

Factory Preset

Reset the instrument's settings to their factory state.

Note: "Factory Preset" resets the "Remote Channel" and network settings to the default values.

Executing "Factory Preset" via remote control terminates the connection to the instrument, if these settings had been configured to values different to the default ones.

The factory preset function resets nearly all instrument settings. In addition to the regular preset by means of the [PRESET] key, a "Factory Preset" resets also the following values:

- Reference frequency settings ("Ref Oscillator" menu)
- Power on settings ("Level/EMF" menu)
- Network settings including hostname ("Setup" menu)
- Remote channel settings including GPIB address ("Setup" menu)
- Start/Stop display update ("Setup" menu)
- Display and keyboard settings ("Setup" menu).

To maintain security, password settings and all settings protected by these passwords like disabled USB and LAN connections are not changed.

Not affected by the "Factory Preset" are also user data, lists or instrument settings files, created for example by means of the Save/Recall function.

Remote command:

:SYSTem:FPReset on page 538

5.2.3.21 Help

The "Help" dialog offers comprehensive online help for the R&S SMBV. A desired topic can be selected via the table of contents (select "Manual") or the index (select "Index").

For context-sensitive information about a marked parameter, press the [HELP] key. For a description of the "Help" menu, refer to the section covering to the [HELP] key (see [Chapter 5.2.7, "Help System - Help Key"](#), on page 160).

5.2.4 Switching to Manual Control - Local Key

The local key switches from remote control to manual control (local state).

In remote control mode the instrument indicates the remote state in the display header. The rest of the display remains unchanged and shows the current instrument status, that means the status which exists under the remote control settings. The instrument can be operated (for example dialogs can be opened). However, it is not possible to enter or change values.

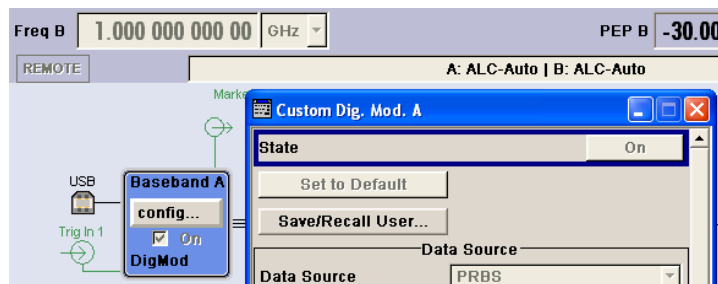

The status message additionally indicates whether the [LOCAL] key is disabled or enabled.

See also [Chapter 6.2.1, "Switching to Remote Control"](#), on page 496.

The following states are indicated:

- "REMOTE"
The [LOCAL] key switches the instrument from remote control to manual control. The current command must be fully processed before the mode is switched, otherwise the instrument switches immediately back to remote control.
- "REM-LLO"
The [LOCAL] key is locked, initiated by the &LLO (local lockout) command. The instrument can be switched from remote state to local state only via remote control, for example with >R or the Visual Basic command `CALL IBLOC (generator%)`. The [LOCAL] key has previously been locked by the remote command &LLO.

When switching from remote to manual control, the display update function is automatically deactivated ("SETUP" > "Start/Stop Display Update" > "Off").

5.2.5 Generating a Hard Copy of the Display

The save/recall function enables you to store the settings in a file. In addition, you can create a hard copy of the current display to save the most important settings of a performed signal generation in an image file.

5.2.5.1 Hard Copy Settings

- ▶ To access the dialog, press the [HCOPY] key.

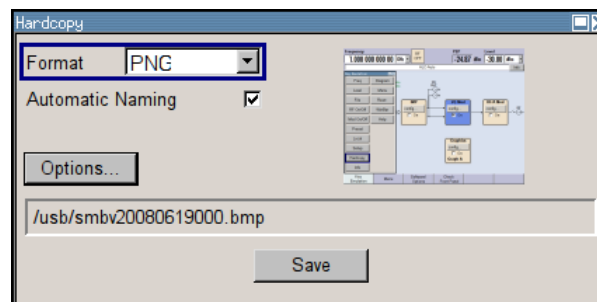

The dialog contains the parameters for configuring the output format and location of a hard copy.

The remote commands required to define the hard copy settings are described in [Chapter 7.10, "HCOPY Subsystem"](#), on page 561.

Options

Opens the "Hard Copy Options" dialog for configuring the corresponding parameters (see "[File Options](#)" on page 158).

Remote command:

n.a.

File

Some configuration parameters are already offered in the "Hard Copy" dialog. All configuration parameters are available in "[File Options](#)" on page 158.

Automatic Naming

Activates automatic generation of the file name. Automatic naming is configured in the "Options..." sub dialog, see "[File Options](#)" on page 158.

Remote command:

[:HCOPY:FILE\[:NAME\]:AUTO:STATE](#) on page 566

File Info

Indicates the file name. The file name can be entered either manually via the file manager (button "File...") or generated automatically (Automatic naming checkbox). Automatic naming is configured in the "Options..." submenu.

Remote command:

`:HCOPY:FILE[:NAME]` on page 564

`:HCOPY:FILE[:NAME]:AUTO:FILE?` on page 565

5.2.5.2 Hard Copy Options

This section describes the "Hard Copy Options" dialog.

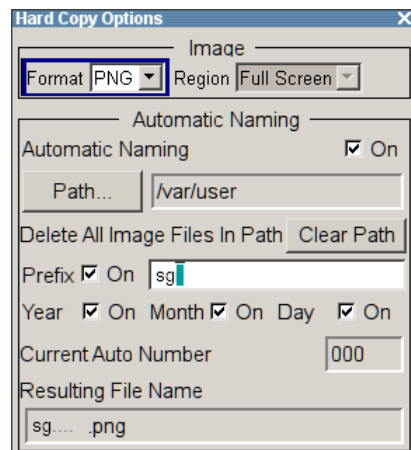

File Options

Dialog for setting the file parameters.

"Format" Selects the output file format, for example * .bmp, * .jpg* .xpm* .png.

Remote command:

`:HCOPY:IMAGE:FORMat` on page 563

`:HCOPY:DEVIce:LANGUage` on page 563

"Region" Selects the snapshot area, either the entire screen or the currently active dialog.

Remote command:

`:HCOPY:REGion` on page 566

"Automatic Naming" If enabled, creates the output filenames automatically according to rules following the activated components.

"Path..." Selects the directory.

Note: To select the destination path, you have to specify a file name as well. Otherwise an error message is displayed and the selection is canceled.

Directory, path and file name are displayed in the infoline right to the "Path" button.

Remote command:

`:HCOPY:FILE[:NAME]:AUTO:DIRectory` on page 564

`:HCOPY:FILE[:NAME]:AUTO?` on page 564

"Clear Path" Deletes all image files with extensions `bmp`, `img`, `png`, `xpm` and `csv` in the directory set for automatic naming. Before deleting the image files a warning message is displayed requiring the confirmation.

Remote command:

`:HCOPY:FILE[:NAME]:AUTO:DIRectory:CLEar` on page 564

"Prefix, Year, Month, Day" Determines the rules for "Automatic Naming". Per default, the automatically generated file name is composed of: `<Path>/<Prefix><YYYY><MM><DD><Number>.<Format>`, where `Y`, `M` and `D` mean Year, Month, Day; `Number` is the "Current Auto Number". You can deactivate/activate each component separately. The "Resulting File Name" indicates the current file name syntax.

Remote command:

`:HCOPY:FILE[:NAME]:AUTO[:FILE]:PREFIX:STATE` on page 566

`:HCOPY:FILE[:NAME]:AUTO[:FILE]:PREFIX` on page 566

`:HCOPY:FILE[:NAME]:AUTO[:FILE]:YEAR:STATE` on page 565

`:HCOPY:FILE[:NAME]:AUTO[:FILE]:MONTH:STATE` on page 565

`:HCOPY:FILE[:NAME]:AUTO[:FILE]:DAY:STATE` on page 565

"Current Auto Number" Indicates the number which is used in the automatically generated file name.

Note: When initially switching on the instrument the number is reset to the lowest possible value. Starting with number 0 the output directory is scanned for already existing files. As long as files with the same name are existing the number is increased by 1. The number is automatically set so that the resulting file name will be unique within the selected path. The current number is not in the save/recall file but will be temporarily stored within the database. At following save operations the number is increased.

Remote command:

`:HCOPY:FILE[:NAME]:AUTO[:FILE]:NUMBER?` on page 565

"Resulting File Name" Indicates the automatically generated file name.

Remote command:

`:HCOPY:FILE[:NAME]:AUTO:FILE?` on page 565

Save

Saves the hard copy.

Remote command:

`:HCOPY[:EXECute]` on page 563

5.2.6 Messages - Info Key

The [INFO] key opens a window containing a detailed description of every message displayed in the info bar, see [Chapter 4.2.3, "Info Window"](#), on page 84 and [Chapter 9, "Status Information, Error Messages and Troubleshooting"](#), on page 857.

5.2.7 Help System - Help Key

The [HELP] key opens a browser window containing a context-sensitive description of the highlighted parameter.

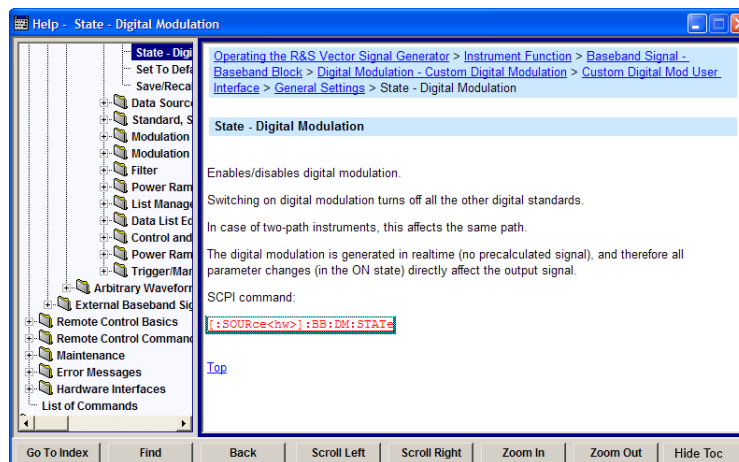

The context-sensitive page which is opened with the [HELP] key is part of a comprehensive help system. It is possible to move from this context-sensitive page to any page of the help system. The following navigation aids are available:

- Internal links in the text
They open pages which are directly linked to the described function. In this way it is possible, for example, to call up the description of the GPIB command for any particular function.
- Back
The "Back" button calls up the page last viewed.
- Contents in the navigation panel
The contents list is used to open the individual help pages. It has a hierarchical structure. The highlighted line indicates where the currently displayed page is within the contents list.
- Index in the navigation panel
The index is used to call up all pages which contain the selected entry. The index has an alphabetical structure and also contains all GPIB commands.
- Find
The find function allows you to look for freely selectable terms in all help pages. A list of the pages containing the entered term is displayed as the search result. The search can be limited to words in the page title to increase the number of hits.
- To maximize the "Topics" window, you can hide the contents tree with the "Hide Contents" button, and vice versa.

5.2.8 Storing and Loading Instrument Data - File Key

The R&S SMBV allows complete instrument settings to be saved in files on the internal flash memory, the USB stick or on the hard disk (requires option R&S SMBV-B92).

Defined and complex instrument settings can then be reproduced at any time by loading this data. If required, these settings can be loaded to various signal generators.

The corresponding menu is available under "Save/Recall" in the "Setup" menu or accessible by means of the [FILE] key. The instrument settings are saved in files which can be saved in data directories.

Additionally there are intermediate memories in which the current instrument setting can be saved and then called up again by just pressing a key. This provides fast switching between different instrument settings.

Only settings which differ from the preset values and configuration data for the operating elements (e.g. window positions) are saved. As a result the files remain relatively small. Furthermore, instrument settings can easily be transferred between different equipped signal generators since the files contain only relevant information. When loaded, the referenced settings are implemented and all non-referenced parameters are set to the associated preset values.

If list data is part of the instrument settings, e.g. a list of user correction data, a reference to this list is saved, not the list itself. The list is reactivated when the associated settings are loaded, but the list may have been modified or deleted in the meantime or may not be available on a different instrument. If the list has been modified, the new entries will be used. An error message appears if an attempt is made to access a non-existing list or to activate settings which are not supported by the instrument.



- Network settings and remote settings are not saved and restored.
 - Lists are saved and loaded in the appropriate menus. For example, the user correction data list is created and saved in the "User Correction" menu.
-

When loading an instrument setting, it is possible to select whether the current frequency and level setting is to be retained or whether the saved settings are to be activated. It is possible to delete saved instrument settings. A file can be copied by loading it with "Recall" and then storing it under a new name.

Settings can be transferred easily between instruments with different equipment options and/or firmware versions because only the settings which differ from the preset values are affected. When settings are loaded, only those which are possible on the instrument are implemented. Error messages indicate the settings which cannot be implemented.

The saved file is transferred from one instrument to another using the memory stick.

General file management functions such as copying and moving data are available in the "File Manager" dialog.

5.2.8.1 Save/Recall Menu

The settings available in the File menu "Save/Recall" depend on the selected "Operation Mode".

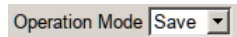

For more information, see [Chapter 4.7.1, "File Select Dialog"](#), on page 107.

Operation Mode

Selects the file function.

Accesses the settings for storing ("Save") and loading ("Recall") of the instrument settings.

"Save..." Calls the menu for storing the current instrument setting (see [Chapter 5.2.8.2, "Saving Instrument Settings"](#), on page 162).

"Recall..." Calls the menu for calling up a saved instrument setting (see [Chapter 5.2.8.3, "Loading Instrument Settings"](#), on page 164).

5.2.8.2 Saving Instrument Settings

In "Operation Mode > Save", you can save the current instrument setting in a file.

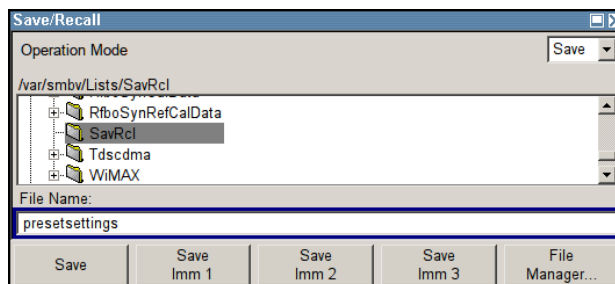

Recent files

Displays the files last used.

Directory, File List and File Name

Note:

You access this generic standard function each time you perform one of the following:

- store or load (settings) files
- define a folder these files are to be stored in or
- navigate through the file system.

The name of the dialog is context sensitive but the provided functions are self-explanatory and very similar.

With the provided settings, you can perform the following:

- to navigate through the file system, use the directory tree
- to create a new file, load and store files, use the dedicated functions "New", "Select", "Save" and [Recent files](#).

- to perform standard file management functions, like create new directories, move, copy, delete files and/or directories, use the standard "File Manager" function (see "[File Manager](#)" on page 164).

Remote command:

to list all files in a directory:

[:MMEMory:CDIRectory](#) on page 573

[:MMEMory:CATalog?](#) on page 573

refer to the description of firmware options for the syntax of the corresponding SCPI command:

[\[:SOURce<hw>\]:BB:<Digital Standard>:SETTing:CATalog](#)

[\[:SOURce\]:CORRection:CSET:CATalog?](#) on page 728

to list files with user data:

[\[:SOURce<hw>\]:BB:DM:DLISt:CATalog?](#) on page 681

[\[:SOURce<hw>\]:BB:DM:CLISt:CATalog?](#) on page 681

Save

Saves the current instrument settings in the specified file and path.

Remote command:

[:SYSTem:SAV](#) on page 831

[:MMEMory:STORe:STATe](#) on page 580

Refer to the descriptions of the firmware options for the correct syntax of the corresponding SCPI commands:

[\[:SOURce<hw>\]:BB:<Digital Standard>:SETTing:STORe](#)

[\[:SOURce<hw>\]:BB:<Digital Standard>:SETTing:DELeTe](#)

Fast Save

Determines whether the instrument performs an absolute or a differential storing of the settings.

Enable this function to accelerate the saving process by saving only the settings with values different to the default ones.

Note: This function is not affected by the "Preset" function.

Remote command:

[\[:SOURce<hw>\]:BB:DM:SETTing:STORe:FAST](#) on page 690

[\[:SOURce<hw>\]:BB:ARBitrary:MCARrier:SETTing:STORe:FAST](#) on page 638

refer to the description of firmware options for the syntax of the corresponding SCPI commands

Save Immediate x

Saves the current instrument setting in one of the three intermediate memories.

These instrument settings are retained until a different instrument setting is saved in the intermediate memory. When the instrument is switched off, the contents of the intermediate memories are retained.

Remote command:

*[SAV](#) on page 536

File Manager

Accesses the "File Manager" dialog, see [Chapter 5.2.8.5, "File Manager"](#), on page 168.

Remote command:

n.a.

5.2.8.3 Loading Instrument Settings

In "Operation Mode > Recall", you can load complete instrument settings, and select whether the current or saved frequency and level settings are to be used.

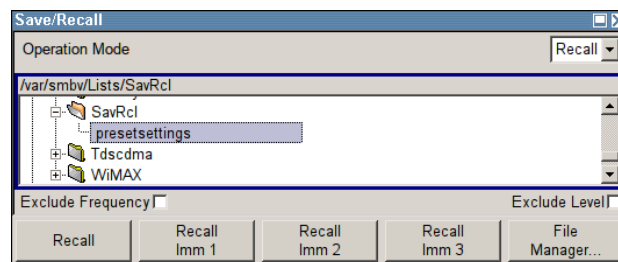

Recent files

Displays the files last used.

Directory, File List and File Name

Note:

You access this generic standard function each time you perform one of the following:

- store or load (settings) files
- define a folder these files are to be stored in or
- navigate through the file system.

The name of the dialog is context sensitive but the provided functions are self-explanatory and very similar.

With the provided settings, you can perform the following:

- to navigate through the file system, use the directory tree
- to create a new file, load and store files, use the dedicated functions "New", "Select", "Save" and [Recent files](#).
- to perform standard file management functions, like create new directories, move, copy, delete files and/or directories, use the standard "File Manager" function (see ["File Manager"](#) on page 164).

Remote command:

to list all files in a directory:

`:MMEMory:CDIRectory` on page 573

`:MMEMory:CATalog?` on page 573

refer to the description of firmware options for the syntax of the corresponding SCPI command:

`[:SOURce<hw>] :BB :<Digital Standard> :SETTing :CATalog`

`[:SOURce] :CORRection :CSET :CATalog?` on page 728

to list files with user data:

`[:SOURce<hw>] :BB :DM :DLISt :CATalog?` on page 681

`[:SOURce<hw>] :BB :DM :CLISt :CATalog?` on page 681

Exclude Frequency

The current frequency is retained when a saved instrument setting is loaded.

Remote command:

`[:SOURce<hw>] :FREQuency [:CW | FIXed] :RCL` on page 742

Exclude Level

The current level is retained when a saved instrument setting is loaded.

Remote command:

`[:SOURce<hw>] :POWer [:LEVel] [:IMMediate] :RCL` on page 794

Recall

Loads the selected configuration.

If an instrument setting in which a sweep was activated is saved, the sweep starts when the recall command is called.

If an instrument setting which accesses lists is saved, this list is also loaded.

If the list has been deleted in the meantime, an error message appears when the instrument setting is loaded. If the list has been overwritten in the meantime, the new entries will be used.

Remote command:

`:MMEMory:LOAD:STATe` on page 578

`:SYSTem:RCL` on page 831

Refer to the descriptions of the firmware options for the correct syntax of the corresponding SCPI command:

`[:SOURce<hw>] :BB:<Digital Standard>:SETTing:LOAD`

Recall Immediate x

Loads the selected configuration from one of the three intermediate memories.

If an instrument setting in which a sweep was activated is saved, the sweep is started when the recall command is called.

If an instrument setting which accesses lists is saved, this list is also loaded.

If the list has been deleted in the meantime, an error message appears when the instrument setting is loaded. If the list has been overwritten in the meantime, the new entries will be used.

A message appears if no instrument configuration is saved in this memory.

Remote command:

`*RCL` on page 535

File Manager

Accesses the "File Manager" dialog, see [Chapter 5.2.8.5, "File Manager"](#), on page 168.

Remote command:

n.a.

5.2.8.4 File Select Dialog

The "File Select" dialog opens automatically each time you select a data list file as data source or you select a control list.

To access a loadable data list file

1. Select the "Data List Name" in the individual dialog, e.g. for "Baseband > 3GPP FDD > Basestations > BS1 > Channel Table > P-CCPCH > Data = Data List" select "DList = None".

A "File Select" dialog for loading, creating and modifying a file is displayed.

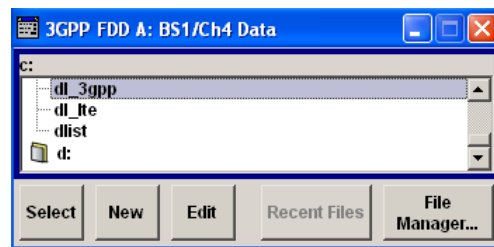

Tip: The name of the dialog is context sensitive and differs depending on the particular function this dialog is from. However, the provided functions are very similar.

2. To load an existing file, navigate through the file system, select the file and confirm with "Select".
3. To create a new file, for example if there is no data list file specified, navigate through the file system to the desired folder, select "New" and specify the file name.

A new empty file is created and saved in the selected folder.

4. To edit an existing or newly created file, navigate through the file system, select the file and select "Edit".

The standard "Data List Editor" dialog opens, see ["Data List Editor"](#) on page 367.

5. Edit the file content and confirm with "Save".

Directory, File List and File Name

Note:

You access this generic standard function each time you perform one of the following:

- store or load (settings) files
- define a folder these files are to be stored in or
- navigate through the file system.

The name of the dialog is context sensitive but the provided functions are self-explanatory and very similar.

With the provided settings, you can perform the following:

- to navigate through the file system, use the directory tree
- to create a new file, load and store files, use the dedicated functions "New", "Select", "Save" and [Recent files](#).

- to perform standard file management functions, like create new directories, move, copy, delete files and/or directories, use the standard "File Manager" function (see "[File Manager](#)" on page 164).

Remote command:

to list all files in a directory:

`:MMEMory:CDIRectory` on page 573

`:MMEMory:CATalog?` on page 573

refer to the description of firmware options for the syntax of the corresponding SCPI command:

`[:SOURce<hw>] :BB:<Digital Standard> :SETTing:CATalog`

`[:SOURce] :CORRection:CSET:CATalog?` on page 728

to list files with user data:

`[:SOURce<hw>] :BB:DM:DLISt:CATalog?` on page 681

`[:SOURce<hw>] :BB:DM:CLISt:CATalog?` on page 681

Functions for handling of data lists

Provided are the following standard functions for file handling:

"Select" Select and load the file.

Remote command:

`[:SOURce<hw>] :BB:DM:DLISt:SElect` on page 687

Refer to the descriptions of the firmware options for the correct syntax of the corresponding SCPI command:

`[:SOURce<hw>] :BB:<Digital Standard> :...:DATA DLISt`

`[:SOURce<hw>] :BB:<Digital Standard> :...:DSElect`

"New" Creates new file with the specified "File Name".
To confirm, select "OK"; use "Cancel" to undo the operation.
To edit the file content, select "File Select > Edit".

"Edit" Accesses the "Data List Editor" and loads the selected file for editing,
see "[Data List Editor](#)" on page 367.

Functions for handling of control lists

Provided are the following standard functions for file handling:

"Select" Select and load the file.

Remote command:

`[:SOURce<hw>] :BB:DM:CLISt:SElect` on page 684

"New" Creates new file with the specified name. To edit the file content,
select "File Select > Edit".

"Edit" Access the "Control List Editor" and loads the selected file for editing,
see "[Control and Marker List Editor](#)" on page 369.

Recent files

Displays the files last used.

File Manager

Accesses the "File Manager" dialog, see [Chapter 5.2.8.5, "File Manager"](#), on page 168.

Remote command:
n.a.

5.2.8.5 File Manager

The "File Manager" is a tool very similar to a standard Windows Explorer and helps you manage mass storage media and files saved on the R&S SMBV.

You can perform the following tasks:

- Copying multiple files from disk to other media and vice versa, see [Chapter 5.2.8.8, "Accessing the File System of the Instrument and Transferring Files from and to the Instrument"](#), on page 172
- Copying files into another directory, see [Copy](#) and [Paste](#)
- Renaming and deleting files, see [Rename](#) and [Delete](#)
- Creating new directories on the following drives:
 - hard disk
(requires option R&S SMBV-B92)
 - internal flash card
 - memory stick
 See [Create New Directory](#)
- Mapping shared network folders, see [Chapter 5.2.8.7, "Mapping a Network Folder"](#), on page 171

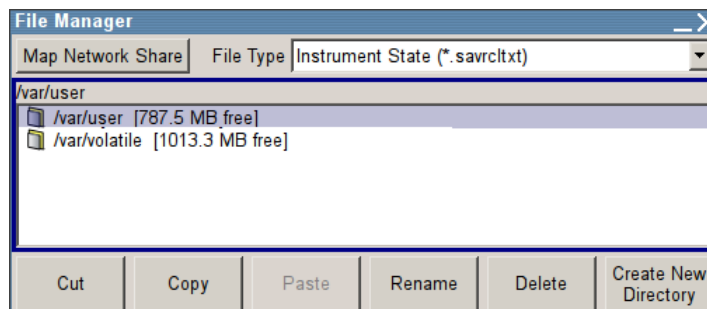

For more information, see [Chapter 4.7.2, "File Manager"](#), on page 108.

File Type

Selects the file type to be listed. If you select a file type with a specific file extension, only files with this extension are listed in the directory.

Remote command:
n.a.

Directory and File Name

Selects the directory in which the file to be deleted or copied is located. The dialog lists all files in this directory. Selected files are highlighted. The path is indicated above the directory window.

Unlike the "Save/Recall" and "File Select" dialogs, the "File Manager" displays the full file names including extensions.

Remote command:

[:MMEMory:CDIRectory](#) on page 573

Cut

Cuts the selected file. It can be pasted into a different directory using the "Paste" button.

Remote command:

[:MMEMory:DELeTe](#) on page 578

Copy

Copies the selected file. It can be pasted into a different or the same directory using the "Paste" button. When pasting the file into the same directory file name Copy of <file name> is given automatically. When pasting the file into a different directory, the original file name is kept.

Remote command:

[:MMEMory:COpy](#) on page 574

Paste

Pastes the file that has been copied or cut before.

Remote command:

n.a.

Rename

Renames the selected file or directory. The new name can be entered in the "New File-name" dialog.

Remote command:

[:MMEMory:MOVE](#) on page 579

Delete

Deletes the selected file. Before the file is deleted, a message appears prompting the user to confirm deletion of the file.

Remote command:

[:MMEMory:DELeTe](#) on page 578

Create New Directory

Creates a new directory. The name of the new directory can be entered in the "New Directory" dialog.

Note: When the subdirectory is entered, it is possible to enter an absolute path name (e.g. /var/user/MEAS) or the path relative to the current directory (e.g. ../MEAS).

The directory is created as a subdirectory in the selected level.

Remote command:

[:MMEMory:MDIRectory](#) on page 579

5.2.8.6 Map Network Share Settings

The "Map Network Share" dialog provides settings that are very similar to the standard Windows Explorer function "Map network drive". These settings help you to create up to 10 "shortcuts" to shared folders or computers in the network.

The dialog displays a list of current mapped network folders. The directory tree of the "File Manager", "Save/Recall" and "File Select" dialogs indicates a mapped network folder as /shares/<"Local Folder">.

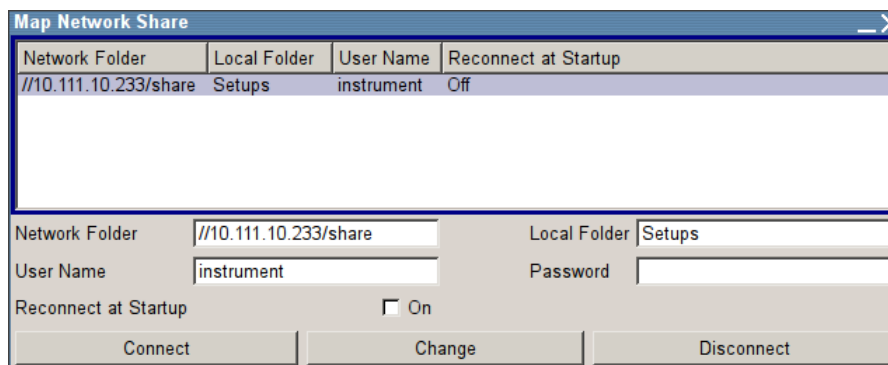

See also [Mapping a Network Folder](#).

Network Folder

Enter the path of the folder or computer, e.g. //<IP Address>/share or //<server name>/share.

Local Folder

Enter a letter or a alias name to describe the folder.

In the directory tree, a mapped network folder is indicated as /shares/<"Local Folder">.

User Name

Enter a user name of a user that has the permission to access the selected network folder.

Password

Enter the password of the selected user.

Reconnect at Startup

Enables reconnecting every time you start up the instrument.

Connect

Triggers the instrument to prove the credential and to map (i.e. connect) the selected network folder or computer to the instrument.

You can map up to 10 network folders.

Change

Applies the changes.

Disconnect

Disconnects the network drive.

5.2.8.7 Mapping a Network Folder

Possibly you would like to transfer instrument or user settings to another R&S SMBV, distribute waveform files to several instruments or you have to access frequently the same network drive. In these cases, on a R&S SMBV connected to a LAN you can create a shortcut to this network folder or this computer.

For information on how to set up a LAN connection, refer to [Chapter 2.6, "Setting Up a Network \(LAN\) Connection"](#), on page 43.

To map a network folder proceed as follows:

1. On the computer or the network folder you want to map, enable a remote access. You can specify a list of users allowed for remote access. The remote access settings depend on the operating system the remote computer is using. For step-by-step instructions, refer to the documentation of the particular operating system.
2. On the R&S SMBV, enable file transfer via SMB (samba), see "[LAN Services](#)" on page 150.
3. Select "Setup > Environmen > Network settings" and select:
 - a) "Address Mode > Auto (DHCP)"
 - b) Check that the "DNS Suffix" and "DNS Server" are correct.
4. Press the [SAVE/RCL] key.
5. In the "Save/Recall" dialog, select "File Manager > Map Network Share".
6. In the "Map Network Share" dialog, perform the following settings:
 - a) In the "Network Folder" field, enter `//<IP Address>/share` or `//<Server Name>/share`, e.g. `//10.111.10.233/share`.
 - b) In the "Local Folder" field, enter an alias name, for example *Setups*.
 - c) Enter the "User Name" and "Password" of the user who is enabled for remote access to the selected network folder.
 - d) If required, enable "Reconnect at Startup".
 - e) Select "Connect".

The selected network folder is mapped to your instrument. The list of mapped network folders is updated.

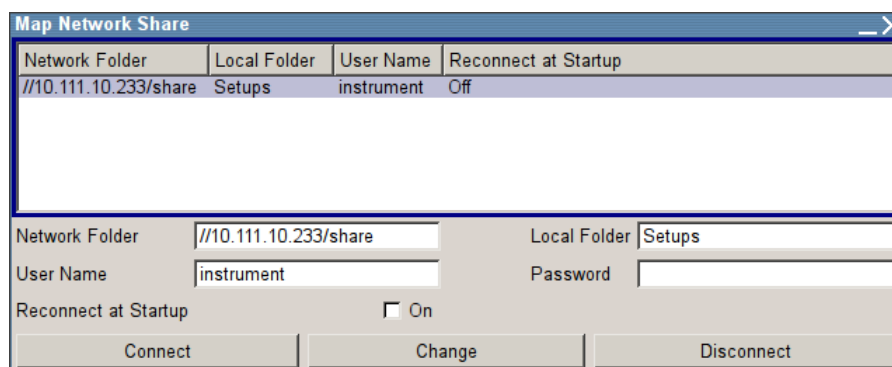

7. Close the "Map Network Share" dialog.

The navigation tree in the "File Manager" dialog displays the mapped network folder as `shares/Setups`.

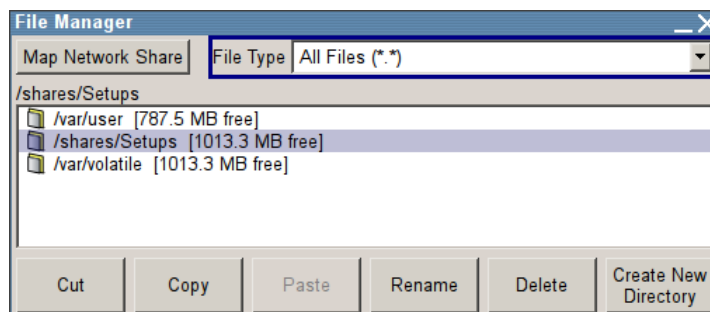

If the connection does not succeed, consider to check the following:

- Is the network folder, or computer you try to map turned on?
- Is the network folder or computer enabled for remote access?
- Does the selected user have the necessary permissions?

5.2.8.8 Accessing the File System of the Instrument and Transferring Files from and to the Instrument

To access files and the file system of the instrument or to use the general file management functions such as copying and moving data, use the standard "File Manager" dialog.

To transfer files from and to the instruments or to exchange files, use one of the following alternatives:

- Connect a memory stick to one of the USB interfaces.
The instrument recognizes automatically a connected memory stick.
- Connect the instrument to a LAN.
For information on how to set up a LAN connection, refer to [Chapter 2.6, "Setting Up a Network \(LAN\) Connection"](#), on page 43.

An instrument connected to a LAN supports the standard file transfer methods from a remote client:

- FTP (file transfer protocol)
see ["To access the file system of the R&S SMBV via ftp"](#) on page 173
- File sharing according to the SAMBA/SMB (server message block) protocol
see ["To access the file system of the R&S SMBV via SMB \(Samba\)"](#)
on page 174

Both file transfer methods access the folder `/var/user/share`.

- Map a network folder or a computer to an instrument connected to a LAN.
A mapped network folder is indicated as `/shares/<"Local Folder">`.
See [Chapter 5.2.8.7, "Mapping a Network Folder"](#), on page 171.

This section provides an introduction to this topic. For comprehensive information, refer to the Application Note 1GP72 "Connectivity of Rohde&Schwarz Signal Generators".

To access the file system of the R&S SMBV via ftp

If the R&S SMBV is connected to a LAN and the required configurations are completed, you can use File Transfer Protocol (ftp) to access the file system and to transfer files from and to the instrument.

1. Connect the instrument and the remote PC to a LAN.
2. Find out the "IP Address" of the instrument:
 - a) Select "Setup > Environment > Network Settings".
 - b) Write down the "IP Address" of the instrument, e.g. `10.113.10.105`.
3. On the remote PC, start the Windows Explorer.
4. In the address field, enter `ftp://<"IP Address" of the Instrument>`, e.g. `ftp://10.113.10.105`

A log on dialog opens and requests a password.

Tip: Default password. The FTP file access use the user *instrument* with default password *instrument*.

It is highly recommended that you change the user password in the "Security" dialog before connecting the instrument to the network!

See [Chapter 5.2.3.18, "Security"](#), on page 147.

5. Enter the password to access the `/var/user/share` directory.

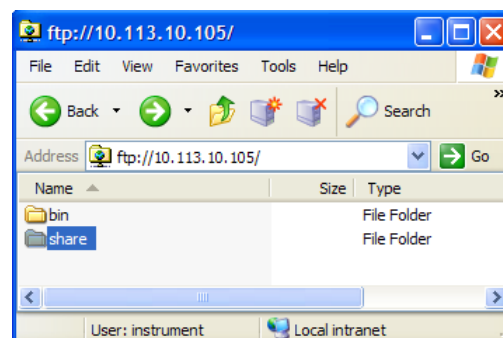

You can access the files in the `/var/user/` directory, perform standard function like creating directory, etc.

6. Open the `/var/user/share` directory and create a new directory, e.g. `testftp`.
7. On the instrument, press the [File] key and open the `/var/user/share` directory. The dialog displays the `testftp` directory.

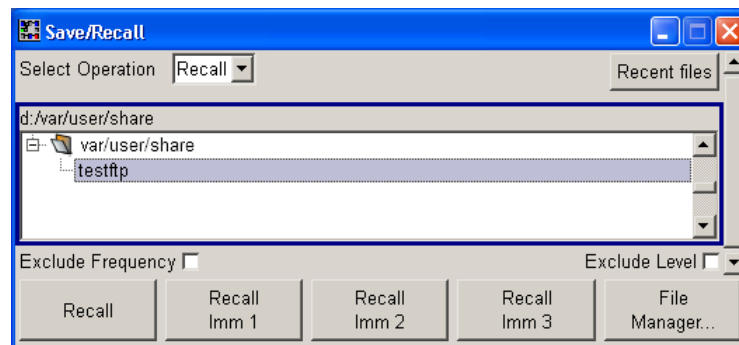

To access the file system of the R&S SMBV via SMB (Samba)

The SMB (Samba) protocol is an alternative way to access the file system of the instrument from a remote PC, if both the instrument and the PC are connected to a LAN.

1. Connect the instrument and the remote PC to a LAN.
2. Find out the "IP Address" of the instrument:
 - a) Select "Setup > Environment > Network Settings".
 - b) Write down the "IP Address" of the instrument, e.g. `10.113.10.105`.
3. On the remote PC, start the Windows Explorer and open the "Map Network Drive" dialog.
 - a) Select a valid "Drive", e.g. `W`.
 - b) In the "Folder" field, enter:

```
//<"IP Address" of the Instrument>/share or
          //<"Hostname" of the Instrument>/share, e.g. //10.113.10.105/share
```
 - c) Select "Finish".

A log on dialog opens and requests an user name and a password.

4. Enter the user name and the password of your instrument. The default user name and password is `instrument`.

Tip: Default password. The SAMBA/SMB file access use the user `instrument` with default password `instrument`.

It is highly recommended that you change the user password in the "Security" dialog before connecting the instrument to the network!

See [Chapter 5.2.3.18, "Security"](#), on page 147.

The `/var/user/share` directory of the instrument is mapped to and displayed as a network drive of the remote PC.

You can access the files in this directory, perform standard function like creating directory, storing files, etc.

5.3 Graphical Display - Graphics

The R&S SMBV can be used to graphically display the generated baseband signal. A selection of different signal displays assists the user in assessing and checking the increasingly complex modulation signals.



The Graphics function block is available for instruments with the option:

- R&S SMBV-B10/B51/B51x (Baseband + ARB)
- R&S SMBV-B62 (Noise Generator)

It is the baseband signal actually generated that is recorded and displayed, and not a signal calculated on the basis of the set parameters.

This graphical display allows the user to quickly view and check the current signal characteristics and also gives an overview of the changes in the signal over time. The signal quality can be permanently monitored. The results of parameter changes on the signal, such as a change in modulation mode, or the effects of certain configurations, e.g. the activation of several base stations in the case of (W)CDMA signals, can be analyzed directly in the display. Freezing the signal and then zooming permit a detailed evaluation of any signal segment. The definition and display of one or more reference curves makes it possible to compare various signals (i.e. by comparing the CCDF (Complementary Cumulative Distribution Function) with different channelization codes, or the spectra if different filter parameters are selected).

The displayed signal segment can be influenced by selecting the trigger that defines the time for recording to start. With automatic triggering, the signal is tapped at the point in the signal path that is best for the respective display. The displayed signal segment is selected internally depending on the signal such that the signal characteristics of interest (e.g. the useful signal) are displayed. This selection is appropriate for a representative display of the complete signal.

In addition, a user-definable trigger is available with which the displayed signal segment can be limited.

The time resolution can be set either automatically or manually, whereby for manual setting the bandwidth for which the trace is to be displayed is selected. The transient recorders used for signal recording have a variable recording depth which is specified under the respective display.

In addition to the large graphics window, the display can also be shown in a small window ("smart graphics"). This window is fitted into the block diagram as a block, and can be used for basic checking purposes (e.g. whether the signal is still being generated).

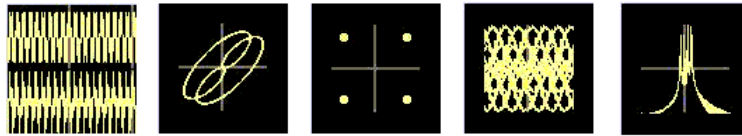

5.3.1 Graphics Settings Menu

The "Graphics Settings" menu for selecting the graphical display of the output signal is opened either in the "Graphics" function block or in the menu with the same name which is opened using the [MENU] key.

The signal display can be selected and activated in the menu.

With two-path instruments, the settings for the two paths can be entered separately. The signals can be displayed simultaneously in two separate windows.

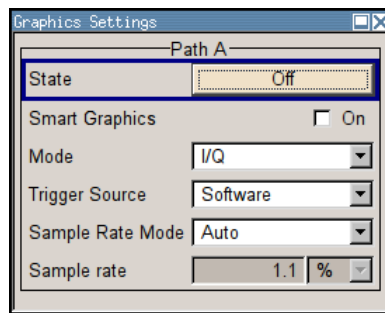

State

Activates the selected graphical display.

After activation, the diagram selected with "Mode" is displayed in the block diagram.

At the bottom of each graphics window there are several buttons for freezing and zooming the display and for activating a reference curve.

For more information, see [Chapter 5.3.2, "Bar of Graphics Window"](#), on page 178.

Remote command:

`[:SOURce<hw>] :BB:GRAPhics:STATe` on page 694

Smart Graphics

Activates the "smart graphics".

The graphic is displayed in a small window which is roughly the size of a block. These windows are displayed permanently in the block diagram until they are deactivated, and allow basic checking of the signal. They do not contain any buttons.

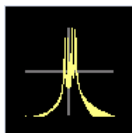

Remote command:

`[:SOURce<hw>] :BB:GRAPhics:SMARt:STATe` on page 692

Mode

Selects the graphical signal display. The display is not shown until it has been activated with "Status On".

The individual signal displays are described in the [Chapter 5.3.3, "Signal Displays"](#), on page 180.

Remote command:

[\[:SOURce<hw>\]:BB:GRAPhics:MODE](#) on page 692

Trigger Source

Defines the trigger for the starting time of the graphic recording.

| | |
|------------|---|
| "Software" | Recording of signals is started automatically in specified intervals. This asynchronous method is appropriate when a representative display of the complete signal is desired, as recording starts in a random time reference to the signal. |
| "Marker 1" | The starting point for recording signals is determined by marker 1 in the menu of the active standard. This synchronous method is appropriate when specific signal segments are to be shown in greater detail. With periodic signals, a static image is obtained by selecting a period length of marker 1 that is equal to the signal period. The displayed signal segment can be shifted as needed by entering a marker delay in the Trigger/Marker menu of the active standard. |

Remote command:

[\[:SOURce<hw>\]:BB:GRAPhics:TRIGger:SOURce](#) on page 694

Scrambling Code

(only if Code Domain (3GPP FDD DL) is selected)

Sets the scrambling code if the "Code Domain" display is selected. Since it is possible to select a different scrambling code in the menu for each of the 4 base stations and it is also possible to display an external signal, the scrambling code for which the display is to be generated must be explicitly specified here.

Remote command:

n.a.

Sample Rate Mode

Sets how the time resolution of the signal is determined. Maximum resolution corresponds to a display covering the entire signal bandwidth. The higher the resolution is, the shorter the length of the displayed signal segment will be for the specified recording depth.

| | |
|------------------|---|
| "Auto" | The resolution is set to an optimum value on the basis of the signal and display type. |
| "Full Bandwidth" | The resolution is set such that the display covers the entire signal bandwidth. |
| "User" | Under "Graphics Sample Rate", the user can determine the resolution by setting the signal bandwidth for which the display is to be generated. |

Remote command:

[\[:SOURce<hw>\]:BB:GRAPhics:SRATe:MODE](#) on page 693

Graphics Sample Rate

With "Auto" and "Full Bandwidth":

Displays the signal bandwidth for which the display is to be generated.

With "User":

Selects the signal bandwidth for which the display is to be generated. The setting range moves between the minimum and maximum bandwidth which is possible for the selected display. The selection is made graphically by moving the pointer.

Remote command:

[\[:SOURce<hw>\]:BB:GRAPhics:SRATe:USER](#) on page 693

5.3.2 Bar of Graphics Window

At the bottom of each graphics window there are buttons for freezing and zooming the display and for defining and activating a reference curve.

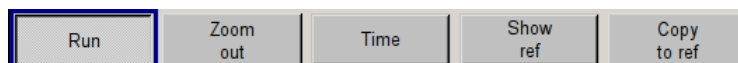

Run

Freezes the current display.

Clicking the button again reactivates the normal, permanently updated display.

Freezing the display allows it to be analyzed more easily. Zooming the display at the same time permits detailed evaluation of any signal segment.

Remote command:

n.a.

Zoom In (only possible with mouse)

The mouse can be used to freely select any section to be zoomed. This section is selected by pressing the left-hand mouse key and dragging a rectangular marquee. In this way a display can be zoomed in several steps. The zoom is cancelled by clicking the "Zoom Out" button.

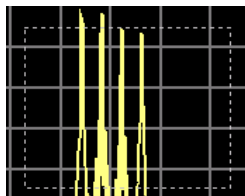

Remote command:

n.a.

Zoom out

Cancels the zoom.

Remote command:
n.a.

Time

(I/Q mode only)

Switches to seconds for time representation on the X axis of the I/Q diagram.

Remote command:
n.a.

Show ref

Displays the reference curve(s). All defined reference curves are displayed simultaneously (see the description of the "Copy to ref" button).

The reference curves are displayed together with the current signal. They allow visual comparison of two or more signals with different settings, e.g. with different filters.

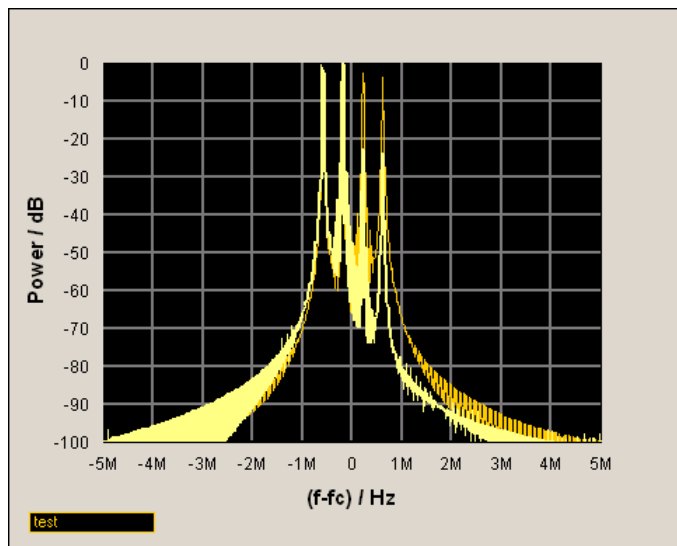

Clicking the button again hides the reference curves.

The reference curves must be defined beforehand using the "Copy to Ref" button.

Remote command:
n.a.

Copy to ref

Defines the current curve as the reference curve.

A window opens in which the curve can be given a comment and a color.

First of all the desired color is highlighted in the top window. If this color has already been assigned to a reference curve, this curve is overwritten. The command is entered in the bottom "Comment" section. This comment then appears next to the highlighted color.

Up to 5 reference curves can be defined and displayed simultaneously in different colors together with the current signal.

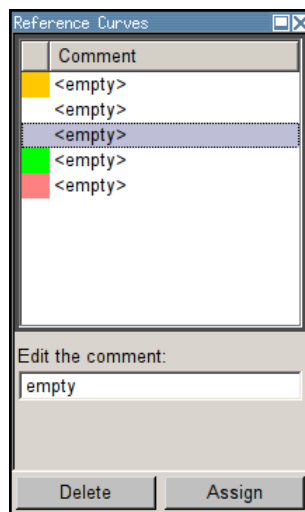

Each reference curve is available until it is deleted.

- "Display area" The comments entered for the defined reference curve are shown in the display area next the assigned color. A maximum of five colors (and reference curves) are available. If no reference curve is assigned to a particular color, the comment <empty> is displayed.
- "Comment" Enters a comment for the current curve which is to be defined as the reference curve. This comment then appears next to the highlighted color in the display area.
- "Delete" Deletes the curve highlighted in the display area. Curves which are no longer required can be deleted to reduce the number of reference curves displayed simultaneously.
- "Assign" Defines the current curve as the reference curve. The new reference curve is shown together with the entered comment next to the selected color in the display area.

Remote command:

n.a.

5.3.3 Signal Displays

All signal displays which are used for analyzing a baseband signal can be selected. A number of signal displays are only available if the corresponding signal is generated, e.g. Code Domain only available for (W)CDMA signals.

5.3.3.1 I/Q Diagram

The I/Q diagram displays the inphase component ($i[t]$) and quadrature component ($q[t]$) of the I/Q signal over time.

The diagram is displayed in a window with two separate coordinate systems. The coordinate systems have identical X and Y axes. The time (in number of symbols, chips or samples depending on the signal) is plotted on the X axes, and the amplitude scaled to

the peak envelope power (PEP) is plotted on the Y axes (minimum scaled amplitude = -1; maximum scaled amplitude = +1). The recording depth is 1 kSamples.

This signal is picked off at the output of the baseband main module ("Impairment" function block), i.e. contained in the displayed signal is:

- impairment of the signal as defined by the user and the addition of noise.

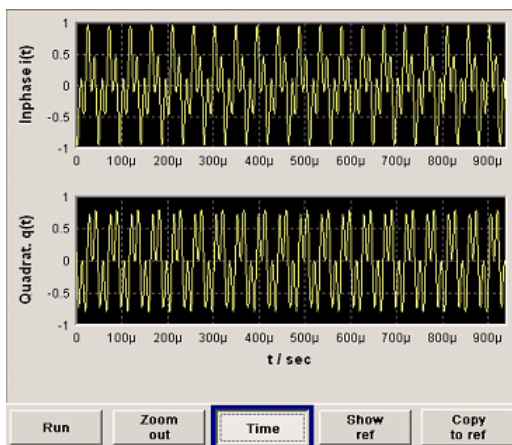

5.3.3.2 Vector Diagram

The Q component is displayed over the I component in the vector diagram. Each point is determined by a vector. The amplitudes of the signal components scaled to the peak envelope power (PEP) are plotted on the X and Y axis (minimum scaled amplitude = -1; maximum scaled amplitude = +1).

This display shows the curves between the various states of modulation mapping. The recording depth is 1 kSamples.

This signal is picked off at the output of the baseband main module ("Impairment" function block), i.e. contained in the displayed signal is:

- impairment of the signal as defined by the user and the addition of noise.

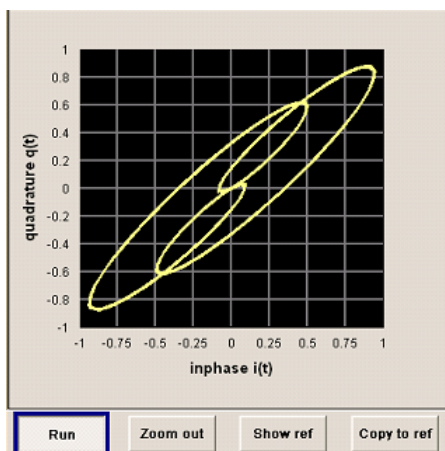

5.3.3.3 Constellation Diagram

In the constellation diagram, the Q component is also displayed over the I component. However, only the values at the constellation points (signal value at the ideal scanning instant of the symbol) are displayed, i.e. for each symbol only 1 value in the form of a circle is shown for the I and Q component.

The amplitudes of the signal components scaled to the peak envelope power (PEP) are plotted on the X and Y axis (minimum scaled amplitude = -1; maximum scaled amplitude = +1). The recording depth is 2kSamples.

This signal is picked off at the output of the baseband main module ("Impairment" function block), i.e. contained in the displayed signal is:

- impairment of the signal as defined by the user and the addition of noise.

This display shows the various states of modulation mapping which occur in the signal. The example shows the constellation diagram of a QPSK modulation signal.

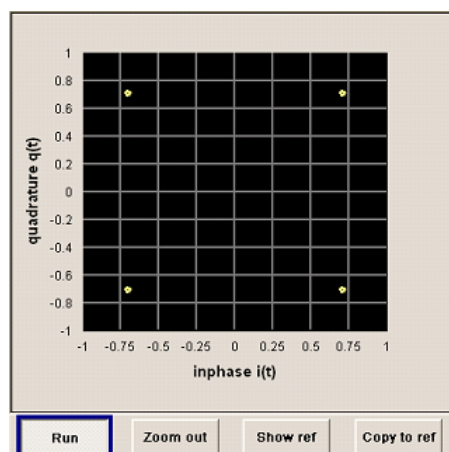

5.3.3.4 Eye Diagram

The eye diagram displays synchronized and superimposed sections of either the inphase or quadrature components of the signal.

The display width (eye length) is set at 2 symbols; several hundred curve segments are superimposed. The time (in the range ± 1 symbol) is plotted on the X axis, and the amplitude scaled to the peak envelope power (PEP) is plotted on the Y axis (minimum scaled amplitude = -1; maximum scaled amplitude = +1). The beginning of recording is synchronous to the symbol and chip clock pulse. The recording depth is 2kSamples.

This signal is picked off at the output of the baseband main module ("Impairment" function block), i.e. contained in the displayed signal is:

- impairment of the signal as defined by the user and the addition of noise.

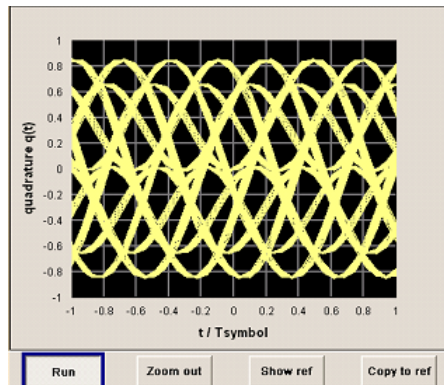

5.3.3.5 CCDF Display

The **Complementary Cumulative Distribution Function** shows the probability with which the output signal will exceed the average power.

The level over the average power is plotted from 0 to 20 dB on the X axis; the average power (RMS) corresponds to the origin. The probability of exceeding the average power is plotted between 0.0001% and 100% on the Y axis. The recording depth is 8kSamples.

This signal is picked off at the output of the baseband main module ("Impairment" function block), i.e. contained in the displayed signal is:

- impairment of the signal as defined by the user and the addition of noise.

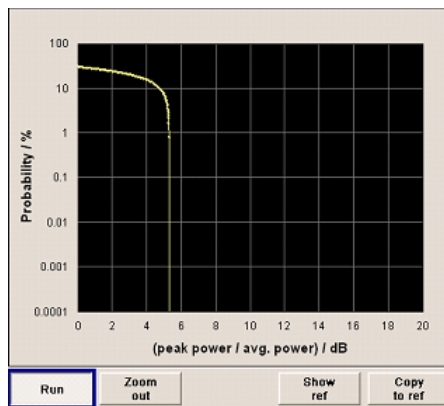

5.3.3.6 Power Spectrum

With the spectrum display, the signal spectrum is calculated from the I/Q signal by means of Fast Fourier Transform (FFT).

The power density over frequency is displayed. The power density is plotted on the Y axis, and the frequency is plotted symmetrically on the X axis (-sampling rate/2 to +sampling rate/2). FFT Points indicates the number of I/Q value pairs which are used for calculating a (part-)FFT. AVG indicates the number of subspectra used for averaging. The recording depth is 8kSamples.

This signal is picked off at the output of the baseband main module ("Impairment" function block), i.e. contained in the displayed signal is:

- impairment of the signal as defined by the user and the addition of noise.

The spectrum display of the output signal is particularly suitable for checking multi carrier signals.

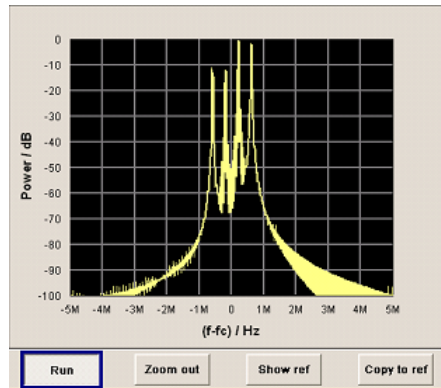

5.4 Bit and Block Error Rate Measurements

The option R&S SMBV-K80 provides a BER ("Bit Error Rate") tester to evaluate the bit error rate of a signal demodulated and decoded by a DUT. The instrument option also includes a BLER ("Block Error Rate") measurement, used to verify CRC checksums. The ratio of errored blocks to total blocks yields the block error rate.

In addition, a test generator allows you to check if the BER and BLER measurements work properly, see [Chapter 5.4.13.2, "Test Generator Settings"](#), on page 205.

5.4.1 Test Setup

The following figure shows the test setup for the bit/block error rate measurement. The data for the DUT can be generated by the R&S SMBV, or a user-defined external source. The R&S SMBV can also generate an externally computed modulation signal, e.g. created with the R&S WinIQSIM2 software (see [Chapter 5.9.4.2, "ARB User Interface"](#), on page 387).

For the bit error rate measurement, the R&S SMBV transmits a known PRBS (pseudo random binary sequence) to the DUT. The DUT demodulates the received data sequence, and returns the data and control signals as e.g. the clock signal, data enable, etc. to the R&S SMBV. The BER function synchronizes to the sent PRBS sequence and counts the bit errors. The resulting bit error rate is the quotient of the number of error bits to the total number of bits.

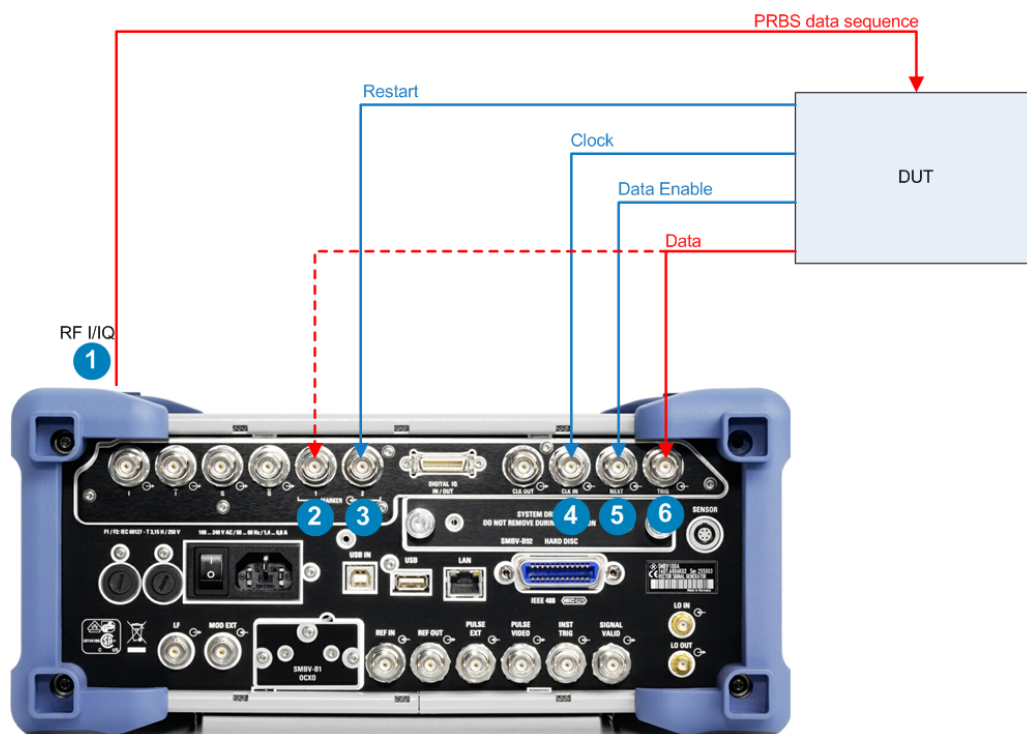

Figure 5-1: Test setup for bit or block error rate measurement

- 1 = PRBS data sequence (RF output connector (front)), see [PRBS Data185](#)
- 2 = Data (MARKER 1 connector (rear)), alternatively to the TRIG connector, see [PRBS Data185](#).
- 3 = Restart (MARKER 2 connector (rear)), BER measurement only, see [Restart Function187](#).
- 4 = Clock (CLOCK IN connector (rear)), see [Clock Signal186](#).
- 5 = Data enable (NEXT connector (rear)), [Data Enable188](#).
- 6 = Data (TRIG connector (rear)), see [PRBS Data185](#) and the following sections.

5.4.2 PRBS Data

To detect faulty bits using the BER measurement, you must know the data generation polynomial. The PRBS sequences are used as the method for computing the data (see [Chapter 5.9.2.1, "Internal PRBS Data and Data Patterns"](#), on page 330). These quasi-random bit sequences are repeated periodically, depending on the selected polynomial. A randomly selected initial status yields exactly one subsequent status. The initial status and therefore the subsequent status occur only once in the whole sequence.

Hence an advantage of the PRBS data is that the bit error detector must know only the polynomial but not the entire sequence. At measurement start, the feedback shift register is filled once with the applied data sequence (which corresponds to the synchronization time) and is subsequently switched from "fill" to "feedback". This function creates a defined initial status and generates the same data that the applied data stream has. Faulty bits can thus be identified and counted by comparing the received data with the results obtained from the shift register.

Creating a defined initial status makes it possible to start the analysis anywhere in the bit stream, i.e. the bit-stream source and the analyzer need not be synchronized.

Delays of the DUT and transmission over long air paths, where the transmitter and the receiver are located at separate sites, are therefore not a problem.

5.4.3 CRC Polynomial

In the block error rate measurement, the checksum (CRC) containing the data signal fed to the DUT is compared with the checksum the block error rate tester calculates from the feedback data. If the two checksums differ, a block error is counted. The quotient obtained by dividing the number of faulty blocks by the total number of blocks is the block error rate.

At the beginning of the data, the shift register is initialized with 0. All user data bits are then shifted through the shift register. The CRC component is then read into a second register and compared bit by bit with the result of the calculation.

CCITT CRC 16 : $G(x) = x^{16} + x^{12} + x^5 + 1$ is the CRC polynomial supported.

The user data is marked by a signal that comes from the DUT and is fed to the "Data Enable" input, see [Figure 5-1](#).

5.4.4 Clock Signal

Usually the DUT provides the clock signal. If not, the bit clock can be extracted from the CLOCK output connector (only with "Custom Dig Mod" signals in real time). If signals complying with digital standards are generated or if ARB waveforms are used, a marker signal can be used as a clock. As the DUT causes a delay, the ratio of clock-to-data transmission times must always be considered and checked with an oscilloscope if necessary. The R&S SMBV indicates the status of the clock and data lines and of the synchronization in the menus.

5.4.5 Ending the Measurement

The measurement results usually are in the range of 10^{-2} to 10^{-9} for the bit error rate, and in the range of 10^{-2} to 10^{-4} for the block error rate. Hence, a large number of bits or blocks must be tested before a faulty bit or block occurs. Because of the large number of bits/blocks, the measurement takes long time. Since 32-bit-wide counters are used for the total number of bits/blocks and the number of error bits, the maximum measurement time is 4.29×10^9 bits.

To keep the measurement times short for both small and large bit/block error rates, the R&S SMBV provides a number of ways to end the measurement.

In addition to manually interrupting the count, two termination criteria can be selected:

- Reaching a user-defined number of checked data bits/blocks.
- A maximum number of detected errors.

The measurement stops as soon as one of the two criteria has been met. The display shows which of the two criteria caused the measurement to stop.



The BER/BLER measurement measures statistical bit/block errors, i.e. errors which do not occur at regular intervals, but at random. Although a single measurement determines the exact number of errors in the measured interval, you can only obtain a statistically reliable BER/BLER when a sufficient number of errors occur in the measured interval. This way makes sure that the single BER/BLER measurement result approaches the true error rate with high probability.

Bit error rates of approximately 50 % indicate a faulty measurement.

5.4.6 Interrupt-free Measurement

In the case of continuously generated signals that contain whole-number multiples of the PRBS sequence, the measurement occurs without interruption. Only the data and clock lines of the BERT interface are used for the measurement. The length of the random sequence is 2 to the power of the degree of the polynomial minus 1. For example, PRBS9 length of 511 (2^9 equals 512 minus 1).

5.4.7 Restart Function

The "Restart" function allows BER measurements with short signals or with signals that are not continuously generated (and therefore do not contain any whole-number multiples of PRBS sequences). An external signal at the BERT input halts the measurement and restarts it when the data sequence begins, and the BER results of the relevant (sub)sequences are integrated.

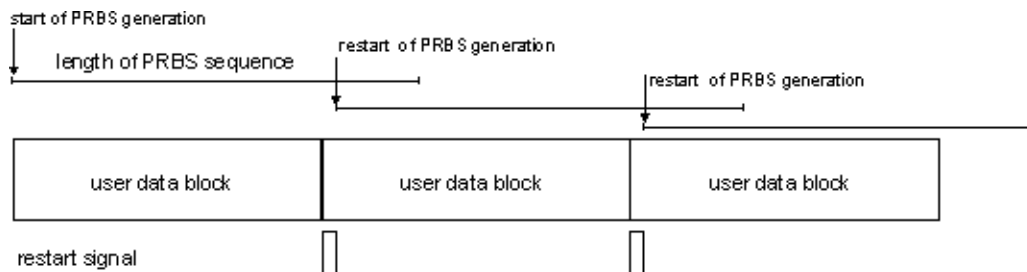

Figure 5-2: The length of the signal is too short for a complete PRBS sequence; PRBS generation is restarted by the Restart signal when the signal begins anew.

Frames generated by the R&S SMBV or the R&S WinIQSIM2 software contain continuous PRBS data, i.e. the PRBS sequence is continuously written to the user data fields. Consequently, if the R&S SMBV is used as a data source, a restart is necessary if (e.g. when using a waveform) the total length of the signal does not equal a whole-number multiple of a PRBS sequence.

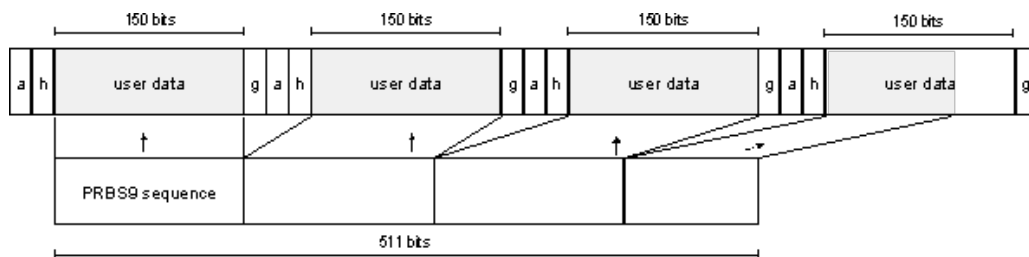

Figure 5-3: TDMA signal generated by the R&S SMBV with user data that contains the PRBS data sequence. The PRBS sequence is continuously written to the user data fields.

5.4.8 Data Enable

In the case of the bit error rate measurement, the data signals usually contain not only PRBS data but also other data (e.g. sync and preambles, see Figure 5-4) that would result in bit errors. The BER measurement for this data can then be interrupted using the "Data Enable" signal.

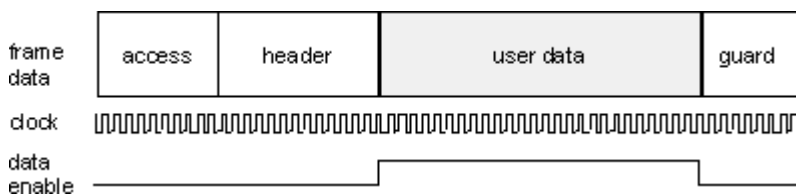

Figure 5-4: TDMA signal with user data that contains the PRBS data sequence and various check fields which can be ignored for the bit error rate measurement. Below that are the associated clock and data enable signals.

In the case of the block error rate measurement, the "Data Enable" signal masks the user data (see Figure 5-5).

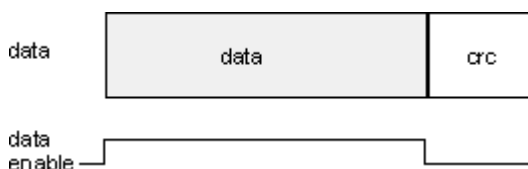

Figure 5-5: Data enable signal with block error rate measurement.

5.4.9 Pattern Ignore

Bit sequences of 32 bits or more with only "1" or "0", which some mobile radio standards provide instead of frame data when faulty frames are detected, can also be excluded from the measurement using the "Pattern Ignore" function (see Figure 5-6).

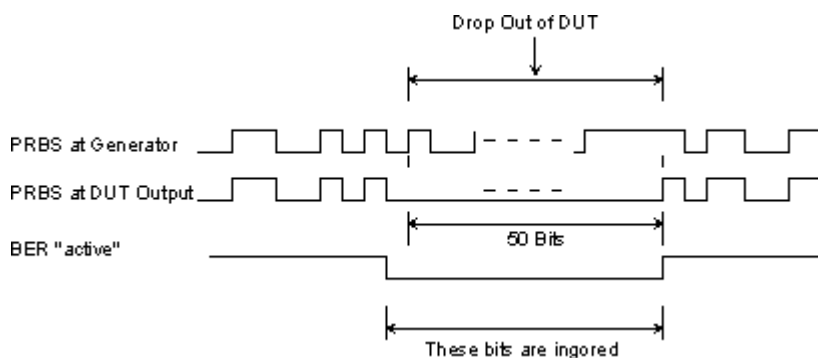
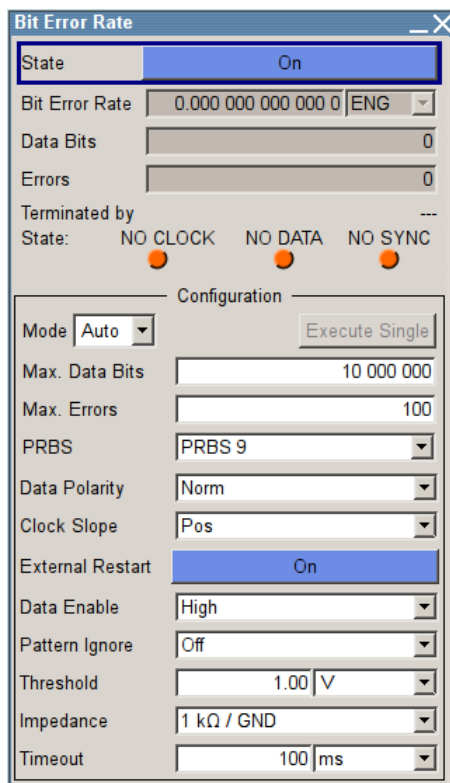

Figure 5-6: Example of functionality of pattern ignore: 50 bits were set to "0" by the DUT. These 50 bits plus the preceding "0" are ignored in the bit error rate measurement.

5.4.10 Bit Error Rate Settings

Access:

- ▶ Select "Baseband > MISC > Bit Error Rate".



The "Bit Error Rate" dialog contains all the parameters to configure, activate and evaluate the measurement.

The remote commands required to define these settings are described in [Chapter 7.4, "BERT and BLER Subsystems"](#), on page 539.

- [General Settings](#)..... 190
- [Configuration Settings](#)..... 192

5.4.10.1 General Settings

| | |
|--------------------------------------|-----|
| State | 190 |
| Bit Error Rate | 190 |
| Data Bits | 190 |
| Errors | 190 |
| Terminated By | 191 |
| State: | 191 |

State

Activates the bit error rate measurement. Depending on the selected [Mode](#), you can execute the measurement continuously ("Auto") or once ("Single"). To start a single measurement, select "Execute Single".

Remote command:

[:BERT:STATE](#) on page 548

Bit Error Rate

Displays the measured bit error rate.

The bit error rate is the ratio of occurred errors to transmitted data bits.

The display unit can be selected in the box to the right of the value.

| | |
|-------|---|
| "ENG" | The bit error rate is output in exponential notation with the exponent ⁻³ or ⁻⁶ . |
| "SCI" | The bit error rate is output in scientific notation, i.e. standardized to one place to the left of the decimal. |
| "%" | The bit error rate is output in percent. |
| "ppm" | The bit error rate is output in parts per million. |

Remote command:

[:BLER:RESult?](#) on page 540

[:BERT:UNIT](#) on page 549

Data Bits

Displays the current number of checked data bits.

Remote command:

[:BERT:RESult?](#) on page 542

Errors

Displays the current number of occurred errors.

Remote command:

[:BERT:RESult?](#) on page 542

Terminated By

Displays the termination criterion for the measurement.

These criteria can be entered to keep the duration of the measurement short for low as well as high bit error rates. The last measurement result is displayed after the measurement has been terminated.

"User" The measurement was manually stopped with **State > "Off"**.

"Number of Data Bits" The measurement stopped after the specified number of data bits was reached.

"Number of Errors" The measurement stopped after the specified number of errors was reached.

Remote command:

:BERT:STATE on page 548

:BERT:STOP on page 549

State:

Displays the status of the measurement.

A green LED indicates a correct status, red denotes a faulty status.

The function displays the status of the data and clock lines, and of the synchronization. It allows you to check if the measurement works properly. If the status is faulty, check the BER signals at the connectors with an oscilloscope.

"Clock" The applied clock signal is detected.

"No Clock" The applied clock signal is not detected. Possible causes are:

- The clock recovery is not available (e.g. with tests of RF components).
If the signal is generated by the R&S SMBV, the bit clock can be extracted from the CLOCK output connector (only with "Custom Dig Mod" signals in real time). If signals complying with other digital standards are generated, or if ARB waveforms are used, you can use a marker signal as a clock. As the DUT causes a delay, the ratio of clock-to-data transmission times must be considered and checked with an oscilloscope if necessary.
- The wrong **impedance** for the applied clock rate is selected.
- The wrong **threshold** for the applied clock signal is selected.

"Data" The applied data signal was detected.

"No Data" The applied data signal is not detected.
Only clocked-in signals are detected. If the clock signal is missing, data changes are also not detected.
If the data is not detected, although the clock signal is detected, it can be caused by:

- The signal from the DUT is missing.
- The wrong **impedance** for the applied clock rate was selected.
- The wrong **threshold** for the applied data signal was selected.

"Sync" The measurement is synchronized.

- "No Sync" The measurement is not synchronized.
- Generally, a measurement cannot be synchronized until a clock and a data signal have been detected. If synchronization still does not occur, it can be caused by:
- The selected PRBS is not correct. For the bit error rate measurement, the PRBS sequence on which the data is based must be set on the bit error rate tester. If the PRBS is not correct, the BER measurement cannot synchronize to the data (due to the incorrect polynomial).
 - A wrong **clock slope** is used, which violates setup or hold times.
 - The travel times of clock and data are unfavorable (e.g. clock slope at data change). Check the relationship of clock to data using an oscilloscope and optimize the travel times (e.g. clock slope when the data signal applied is stable).
 - Reflections on the clock line occur, clocking the data signal into the BER measurement twice, e.g. on lines without termination. The R&S SMBV input is not terminated.
 - Incorrect polarity of data signal (or "Data Enable" signal). In this case, the PRBS cannot synchronize. Note that an inversion of the output signal specified for some cases by the PRBS standard is performed automatically upon PRBS selection. Manual inversion of the data signal is therefore not required.
- No sync status and an error rate of approx. 50%:
- A bit error occurs during synchronization (e.g. nine data bits with PRBS9). The BER measurement is set up incorrectly. This fault is internally detected and automatically corrected.
 - If data that is not cyclically continued (i.e. when a break in the sequence occurs at the memory wrap-around), the measurement does not start at the right time. The signal on the "Restart" line enables the measurement to be started optimally at the beginning of the sequence.

Remote command:

:BERT:RESult? on page 542

5.4.10.2 Configuration Settings

The "Configuration" section is used to select the type of measurement, the data source and the termination criteria. If the data is not cyclically continued, the measurement can be selectively interrupted and restarted. Certain data areas and frames that have been marked as faulty can be excluded from the measurement.

| | |
|-----------------------|-----|
| Mode..... | 193 |
| Max Data Bits..... | 193 |
| Max Errors..... | 193 |
| PRBS..... | 194 |
| Data Polarity..... | 194 |
| Clock Slope..... | 194 |
| External Restart..... | 194 |
| Data Enable..... | 195 |

| | |
|---------------------|-----|
| Pattern Ignore..... | 196 |
| Threshold..... | 196 |
| Impedance..... | 196 |
| Timeout..... | 197 |
| Connectors..... | 197 |

Mode

Selects the type of measurement.

- "Auto" Continuous measurement of bit error rate.
 If either or both of the termination criteria are met, the measurement in progress is terminated and immediately a new one is started automatically. Depending on the settings, a measurement can take considerable time. During the first measurement, intermediate results are displayed. For the following measurements, only the final results are shown. The parameters "Data Bits" and "Errors" are continuously updated and indicate the relative values for the measurement in progress.
 To start a continuous measurement, use the command `:BERT:START` on page 548. To stop a measurement, use the command `:BERT:STOP` on page 549.
- "Single" Single measurement of bit error rate. The measurement is started by clicking the "Execute Single" button.
 If a measurement is in progress, the current values for "Bit Error Rate", "Errors" and "Data Bits" are cyclically displayed. The measurement is terminated when either or both of the termination criteria have been reached.
 To start a new measurement, the "Execute Single" button must be clicked again.

Remote command:

`:BERT:SEquence` on page 543

Max Data Bits

Sets the number of transmitted data bits to be checked before the measurement is terminated.

This criterion terminates the BER measurement after the specified number of data bits, even if few errors or none at all have been detected. With a low number of bit errors, the measurement result can be statistically unreliable.

If the measurement is terminated due to the set number of max data bits was checked, "Number of Data Bits" appears to the right of "Terminated By".

Data excluded from the measurement by "Data Enable" or "Pattern Ignore" is not counted.

Remote command:

`:BERT:SETup:MCOUNT` on page 546

Max Errors

Sets the number of bit errors to occur before the measurement is terminated.

This criterion terminates the measurement relatively quickly if the error rate is high. The measurement result is statistically reliable, since many errors were already counted.

If the measurement is terminated because the set number of bit errors was reached, "Number of Errors" appears to the right of "Terminated By".

Remote command:

`:BERT:SETup:MERRor` on page 547

PRBS

Selects the PRBS sequence. The data generated by the PRBS generator is used as a reference for the measurement.

Note: Standard-compliant data inversion for PRBS15 and PRBS23 is performed automatically when the PRBS is selected. "Data Polarity" remains unaffected.

Remote command:

`:BERT:SETup:TYPE` on page 547

Data Polarity

Sets the polarity of the feedback data bits.

Note: Standard-compliant data inversion for PRBS15 and PRBS23 is performed automatically when the PRBS is selected. "Data Polarity" remains unaffected.

"Norm" High level stands for logic 1, low level for logic 0.

"Inv" Low level stands for logic 1, high level for logic 0.

Remote command:

`:BERT:SETup:DATA[:POLarity]` on page 544

Clock Slope

Sets the polarity of the active slope of the feedback clock.

"Pos" The positive slope of the clock signal is active.

"Neg" The negative slope of the clock signal is active.

Remote command:

`:BERT:SETup:CLOCK[:POLarity]` on page 544

External Restart

Activates an external restart of the BER measurement, see [Chapter 5.4.7, "Restart Function"](#), on page 187.

| | |
|------------|---|
| "External" | <p>The reset signal for the BER measurement is fed via the "Restart" input of the BERT interface.</p> <p>If the PRBS cannot be continued uninterruptedly, the BER measurement must be stopped at the end of the data sequence and subsequently restarted at the beginning of the new data sequence. The measurement is stopped and started via a 0-1-0 slope of the restart signal. A transition from logic 0 to 1 causes a partial result to be generated and the measurement to be stopped. A transition from 1 to 0 starts the measurement for the next subinterval. This measurement is synchronized anew.</p> <p>If the R&S SMBV is used as a data source, a signal in which a single 1 was coded at the end of the data sequence can be used as a restart signal at the R&S SMBV marker output. This causes the BER measurement to stop briefly at the end of the data sequence and start again.</p> <p>Partial results (number of data and error bits) are added up until the predefined total number of data or error bits is reached or exceeded. The measurement is reset by "Pattern Ignore" or "Data Enable", regardless of its status.</p> |
| "Internal" | <p>The reset signal for the BER measurement is generated internally. This setting is suitable for PRBS sequences that run continuously and thus ensure uninterrupted repetition.</p> |

Remote command:

`:BERT:SETup:REStart [:STATe]` on page 547

Data Enable

Activates the use of the "Data Enable" signal and sets the polarity of this signal if it is used.

The "Data Enable" signal determines the data to be evaluated for the BER measurement. Any data in addition to the PRBS sequence is masked and thus not evaluated (e.g. sync, preambles, other channels, etc. that are present in the data bits supplied by the DUT).

The DUT usually provides the data enable signal, but you can also use a marker signal of R&S SMBV.

Note: If the data is not enabled, the BER measurement is stopped completely. The identification circuit for "Pattern Ignore" as well as the PRBS generator of the BER measurement wait as long as data is not enabled. If the data is enabled, the measurement is continued.

| | |
|------------|--|
| "Not Used" | Any signal at the "Data Enable" input is ignored; all data at the BER data input is used for the measurement. |
| "High" | The "Data Enable" signal is active. The BER tester measures all incoming data during the high level of the "Data Enable" signal. During the low level, the measurement is interrupted. |
| "Low" | The "Data Enable" signal is active. The BER tester measures all incoming data during the low level of the "Data Enable" signal. During the high level, the measurement is interrupted. |

Remote command:

[:BERT:SETup:DENable](#) on page 545

Pattern Ignore

Activates ignoring of pure "0" or "1" bit sequences at least 32 bits long. Activating "Pattern Ignore" excludes faulty frames from the measurement.

In the case of some mobile radio standards, pure "0" or "1" bit sequences are generated when errors (e.g. an incorrect checksum) are detected within a frame. These sequences, instead of the frame data, are provided for the BER measurement and signal that the frame in question should not be used for the measurement.

The R&S SMBV ignores sequences of 32 bits or longer, see [Chapter 5.4.9, "Pattern Ignore"](#), on page 188.

Note: While ignoring the bits, the PRBS generator for the BER measurement keeps running. Following the "0" or "1" sequence, the BER measurement is continued as if the ignored sequence had contained PRBS data.

If "Pattern Ignore" is switched on, synchronization time is 32 bits longer.

If "Pattern Ignore" and "External Restart" are active at the same time, the measurement terminates immediately when the restart signal is applied. None of the 32 bits within the "Pattern Ignore" detector is evaluated.

If "Data Enable" and "Pattern Ignore" are active at the same time, "Data Enable" is given priority, i.e. bits that are not enabled are not examined for "0" or "1" sequences.

"Off" Pattern ignore is not active.

"All 1" Bit sequences consisting of 32 or more consecutive "1" data are not used (i.e. ignored) for the BER measurement.

"All 0" Bit sequences consisting of 32 or more consecutive "0" data are not used (i.e. ignored) for the BER measurement.

Remote command:

[:BERT:SETup:IGNore](#) on page 546 [:BERT:SETup:DENable](#) on page 545

Threshold

Sets the threshold (high/low) in volts for the input signals "Clock", "Data", "Data Enable" and "Restart".

The threshold value enables you to variably adjust the level of different input signals, and thus suppress reflections and other interferences.

Note: This threshold setting is automatically passed to the global trigger threshold, see ["Threshold Trigger/Clock Input"](#) on page 140.

Remote command:

[\[:SOURce\]:INPut:BERT:THReshold](#) on page 550

Impedance

Sets the input impedance of the input signals "Clock", "Data", "Data Enable" and "Restart".

For high clock rates, select 50 Ohms.

Remote command:

[\[:SOURce\]:INPut:BERT:IMPedance](#) on page 549

Timeout

Sets a time limit for the BER process.

Remote command:

:BERT:SETup:TIMEout on page 548

Connectors

Accesses the dialog for mapping the signals to the corresponding connectors, see

5.4.11 Block Error Rate Settings

Access:

- ▶ Select "Baseband > MISC > Block Error Rate".

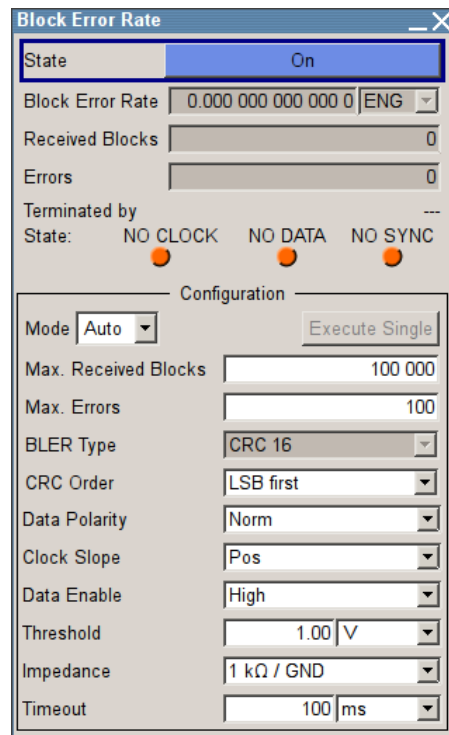

The "Block Error Rate" dialog contains all the parameters to configure, activate and evaluate the measurement.

The remote commands required to define these settings are described in [Chapter 7.4, "BERT and BLER Subsystems"](#), on page 539.

5.4.11.1 General Settings

State..... 198
 Block Error Rate..... 198
 Received Blocks..... 198

| | |
|--------------------|-----|
| Errors..... | 198 |
| Terminated By..... | 198 |
| State:..... | 199 |

State

Activates the block error rate measurement.

Depending on the selected **mode**, you can execute the measurement continuously ("Auto") or once ("Single"). To start a single measurement, select "Execute Single".

Remote command:

:BLER:STATE on page 548

Block Error Rate

Displays the measured block error rate.

The block error rate is the ratio of faulty blocks to total blocks.

You can select the unit on the right of the value.

| | |
|-------|---|
| "ENG" | The block error rate is indicated in exponential notation with the exponent ⁻³ or ⁻⁶ . |
| "SCI" | The block error rate is output in scientific notation, i.e. standardized to one place to the left of the decimal. |
| "%" | The block error rate is output in percent. |
| "ppm" | The block error rate is output in parts per million. |

Remote command:

:BLER:UNIT on page 549

Received Blocks

Displays the current number of checked data blocks.

Remote command:

:BLER:RESult? on page 540

Errors

Displays the current number of occurred errors.

Remote command:

:BLER:RESult? on page 540

Terminated By

Displays the termination criterion for the measurement.

These criteria can be set to keep the duration of the measurement short for low or high block error rates. The last measurement result is displayed after the measurement has been terminated.

| | |
|--------|---|
| "User" | The measurement was manually stopped with "State > Off" |
|--------|---|

Remote command:

:BLER:STATE on page 548

:BLER:STOP on page 549

"Number of Data Blocks"

The measurement stopped after the specified number of data blocks was reached.

"Number of Errors"

The measurement stopped after the specified number of errors was reached.

Remote command:

`:BLER:RESult?` on page 540

State:

Displays the status of the measurement.

A green LED indicates a correct status, red denotes a faulty status.

The function displays the status of the data and clock lines, and of the synchronization. It allows you to check if the measurement works properly. If the status is faulty, check the BLER signals at the connectors with an oscilloscope.

"Clock" The applied clock signal was detected.

"No Clock" The applied clock signal was not detected.

Possible causes are:

- Clock recovery is not available (e.g. with tests of RF components).

If the signal is generated using the instrument family, the bit clock can be extracted from the CLOCK output connector (only with "Custom Dig Mod" signals in real time). If signals complying with other digital standards are generated or if ARB waveforms are used, a marker signal can be used as a clock. As the DUT causes a delay, the ratio of clock-to-data travel times must always be considered and checked with an oscilloscope if necessary.

- The wrong **impedance** for the applied clock rate was selected.
- The wrong **threshold** for the applied clock signal was selected.

"Data" The applied data signal was detected.

"No Data" The applied data signal was not detected.

Possible causes are:

- The signal from the DUT is missing.
- The wrong **impedance** for the applied clock rate was selected (see "Impedance" parameter).
- The wrong **threshold** for the applied data signal was selected.

"Sync" The measurement is synchronized.

- "No Sync" The measurement is not synchronized. Generally, a measurement cannot be synchronized until a clock and a data signal have been detected. If synchronization still does not occur, can be caused by:
- A wrong **clock slope** is set, which violates setup or hold times.
 - Reflections on the clock line occur and clock the data signal into the BER measurement twice, e.g. on lines without termination. The R&S SMBV input is **not** terminated.
 - The travel times of clock and data are unfavorable (e.g. clock slope with data change).
Check the relationship of clock to data using an oscilloscope and optimize the travel times (e.g. clock slope when the data signal applied is stable).

Remote command:

`:BLER:RESult?` on page 540

5.4.11.2 Configuration Settings

The "Configuration" section is used to select the type of measurement and the termination criteria and to set the polarity of the input signals.

Mode

Selects the type of measurement.

- "Auto" Continuous measurement of block error rate. If either or both of the termination criteria are met, the current measurement is terminated and immediately a new one is started automatically. Depending on the settings made, a measurement can take considerable time. During the first measurement, intermediate results are displayed. For the measurements that follow, only the final results are shown. The parameters "Received Blocks" and "Errors" are continuously updated and indicate the relative values for the measurement in progress.
To start a continuous measurement, use the command `:BLER:START` on page 548. To stop a measurement, use the command `:BLER:STOP` on page 549.
- "Single" Single measurement of bit error rate. The measurement is started by clicking the "Execute Single" button. If a measurement is in progress, the current values for "Block Error Rate", "Errors" and "Received Blocks" are cyclically displayed. The measurement is terminated when either or both of the termination criteria have been reached. To start a new measurement, the "Execute Single" button must be clicked again.

Remote command:

`:BLER:SEQuence` on page 543

`:TRIGger:BLER[:IMMediate]` on page 550

Max Received Blocks

Enter the number of transmitted data blocks to be checked before the measurement is terminated.

This criterion will terminate the BLER measurement after the specified number of data blocks, even if only a few errors or none at all have been detected. With a low number of block errors, the measurement result can be statistically unreliable.

If the measurement is terminated because the number of data blocks entered here was checked, "Number of Data Blocks" appears to the right of "Terminated By".

Remote command:

`:BLER:SETup:MCOUNT` on page 546

Max Errors

Enter the number of block errors to occur before the measurement is terminated.

This criterion terminates the measurement relatively quickly if the error rate is high. The measurement result is statistically reliable, since many errors were already counted.

If the measurement is terminated because the number of block errors entered here was reached, "Number of Errors" appears to the right of "Terminated By".

Remote command:

`:BLER:SETup:MERRor` on page 547

BLER Type

Displays the CRC polynomial used. CCITT CRC 16 : $G(x) = x^{16} + x^{12} + x^5 + x^1$ is the CRC polynomial supported.

Remote command:

`:BLER:SETup:TYPE` on page 547

CRC Order

Selects the byte order of the checksum (CRC).

"LSB" The checksum starts with the least significant byte.

"MSB" The checksum starts with the most significant byte.

Remote command:

`:BLER:SETup:CORDer` on page 544

Data Polarity

Sets the polarity of the feedback data blocks.

Remote command:

`:BLER:SETup:DATA[:POLarity]` on page 544

Clock Slope

Sets the polarity of the active slope of the feedback clock.

Remote command:

`:BLER:SETup:CLOCK[:POLarity]` on page 544

Data Enable

Sets the polarity of the "Data Enable" signal. This signal determines the user data to be measured.

The DUT usually provides the data enable signal, but you can also use a marker signal of R&S SMBV.

"High" If the "Data Enable" signal is at a high level, the incoming data bits are interpreted as user data. During the low level, the data is interpreted as checksum bits.

"Low" If the "Data Enable" signal is at a low level, the incoming data bits are interpreted as user data. During the high level, the data is interpreted as checksum bits.

Remote command:

[:BLER:SETup:DENable](#) on page 545

Threshold

Sets the threshold (high/low) in volts for the input signals "Clock", "Data", "Data Enable" and "Restart".

The variable threshold enables you to align in puts with the level of different signals. In addition, reflections and other interference can be suppressed by selecting the appropriate threshold.

Remote command:

[\[:SOURce\]:INPut:BERT:THReshold](#) on page 550

Impedance

Sets the input impedance of the input signals "Clock", "Data", "Data Enable" and "Restart".

For high clock rates, select 50 Ohms.

Remote command:

[\[:SOURce\]:INPut:BERT:IMPedance](#) on page 549

Timeout

Sets a time limit for the BLER process.

Remote command:

[:BLER:SETup:TIMEout](#) on page 548

5.4.12 Connector Settings

For both, the BER and the BLER measurement, you can map the incoming data signal to one of the connectors TRIGGER, or MARKER 1. All other signals are firmly assigned to a connector, as shown in [Figure 5-1](#).

Access:

- ▶ Select "Baseband > MISC > Bit Error Rate, or Block Error Rate".

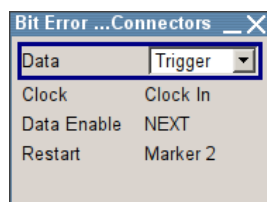

The dialog contains the connector selection list for the data signal, and shows the connectors of the other signals used for the BER/BLER test.

Settings:

| | |
|------------------|-----|
| Data..... | 203 |
| Clock..... | 203 |
| Data Enable..... | 203 |
| Restart..... | 203 |

Data

Assigns the data signal to the corresponding [TRIGGER] or [MARKER 1] connector.

Remote command:

[:BERT:SETup:DATA:CONNector](#) on page 545

[:BLER:SETup:DATA:CONNector](#) on page 545

Clock

Indicates that the [CLOCK IN] connector receives the clock signal.

Data Enable

Shows the mapping of the data enable control signal to the NEXT connector.

Restart

Shows the mapping of the restart signal to the [MARKER 2] for BER tests.

The BLER test does not use this control signal.

5.4.13 Test Generator

The BER/BLER test generator is a selftest that enables you to validate the BER and BLER measurements. The selftest is a protected function you can access when you unlock protection level 1.

To enable the BER/BLER test generator

- ▶ To unlock protection level 1, proceed as described in "[To unlock or lock a protection level...](#)" on page 147. The password is 123456.

When enabled, the BER/BLER dialogs provide the "Test Generator button" for access.

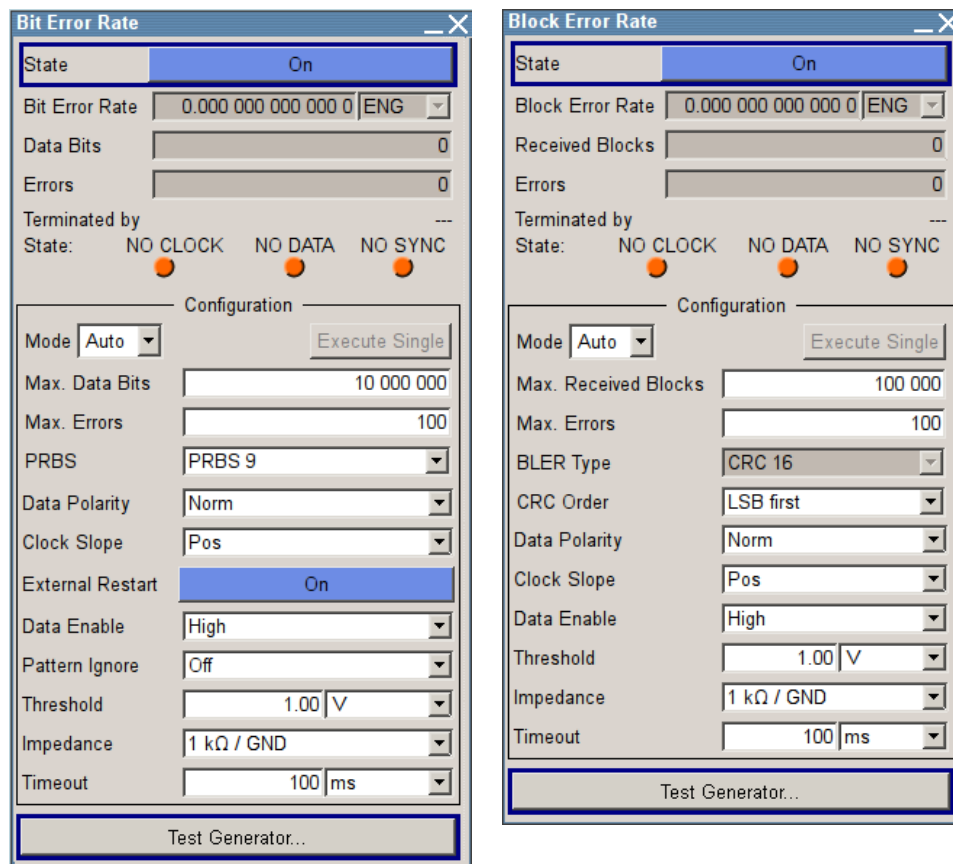

- [Test Generator Setup](#).....204
- [Test Generator Settings](#).....205
- [BER/BLER Functionality Test](#).....207

5.4.13.1 Test Generator Setup

The test setup requires that you loop back the signals as shown in [Figure 5-7](#).

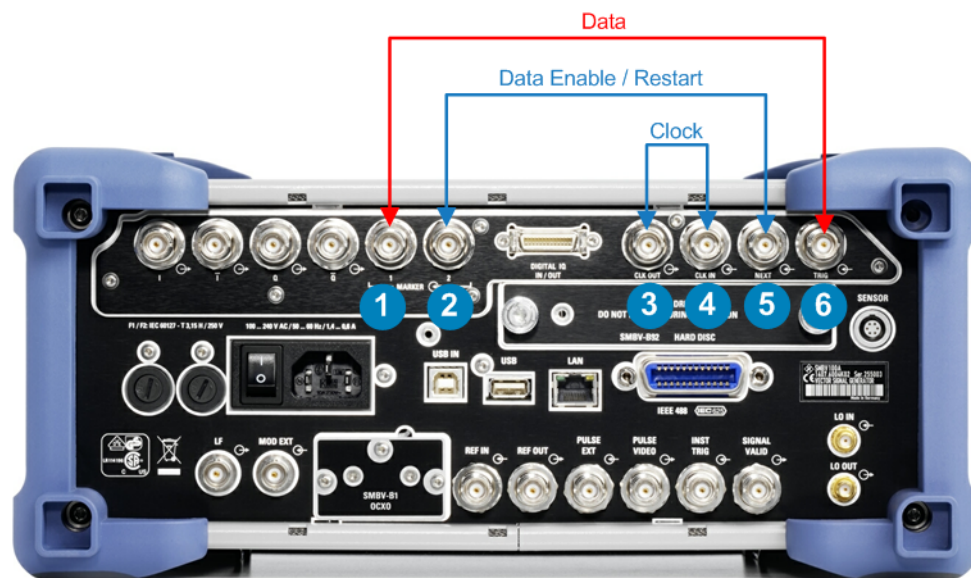

Figure 5-7: Test generator cabling

- 1 = MARKER 1 connector
- 2 = MARKER 2 connector
- 3 = CLOCK OUT connector
- 4 = CLOCK IN connector
- 5 = NEXT connector
- 6 = TRIG connector

To establish the connections

1. Connect MARKER 1 and TRIG (1 -> 6) for data signal loopback.
2. Connect MARKER 2 and NEXT (2 -> 5) to loop back the data enable, or the restart signal.
3. Connect CLOCK OUT and CLOCK IN (3 -> 4) to loop back the clock signal.

5.4.13.2 Test Generator Settings

Access:

- ▶ Select "Baseband > MISC > Bit Error Rate/Block Error Rate".

| | | |
|---|--|---|
| <p>BER/BLER Test Generator</p> <p>State: On</p> <p>Clock Frequency: 1.000 000 MHz</p> <p>Error Rate: 0.010 000</p> <p>Trigger: Not Used</p> | <p>BER/BLER Test Generator</p> <p>State: On</p> <p>Clock Frequency: 1.000 000 MHz</p> <p>Error Rate: 0.010 000</p> <p>Trigger: Restart</p> <p>Restart Delay: 1 000 Bit</p> | <p>BER/BLER Test Generator</p> <p>State: On</p> <p>Clock Frequency: 1.000 000 MHz</p> <p>Error Rate: 0.010 000</p> <p>Trigger: Data Enable</p> <p>Data Enable On Time: 1 000 Bit</p> <p>Data Enable Off Time: 1 000 Bit</p> |
|---|--|---|

The "BER/BLER Test Generator" dialog contains the parameters required to perform the selftest. Depending on the "Data Enable" and "Restart" settings in the "Bit Error Rate", or "Block Error Rate" dialogs, the available trigger parameters vary.

In the BLER test, the CRC is calculated on the basis of the test sequence "PRBS9". The value is set by default. In contrast to the BER test, it cannot be adjusted.

The remote commands required to define these settings are described in [Chapter 7.18, "TEST Subsystem"](#), on page 845.

State

Activates the BER/BLER selftest.

Remote command:

[:TEST:BB:DATA:STATE](#) on page 847

Clock Frequency

Selects the clock frequency for the BER/BLER test generator.

Remote command:

[:TEST:BB:DATA:FREQuency](#) on page 846

Error Rate

Sets the error bit pattern.

This parameter allows you to specify defined error bits to check whether the BER/BLER function detects the error properly.

Remote command:

[:TEST:BB:DATA:ERRor:RATE](#) on page 846

Trigger

Selects the trigger input mode.

"Not Used" Ignores the data enable and restart signals. The test generator acquires all input data.

"Data Enable" Acquires all input data within the measurement interval, determined with the [On Time](#), and [Off Time](#).

"Restart" Acquires the input data at each sequence start.

Remote command:

[:TEST:BB:DATA:TRIGger\[:MODE\]](#) on page 847

On Time, Off Time

Determines the time interval of the "Data Enable" signal for data acquisition. The time values are defined in bits. For BER measurements, it is prerequisite, that you have selected [Data Enable > "High"](#), or ["Low"](#). The setting [Data Enable > "Not Used"](#) suppresses these parameters. For basics, see [Chapter 5.4.8, "Data Enable"](#), on page 188

Remote command:

[:TEST:BB:DATA:ONTime](#) on page 847

[:TEST:BB:DATA:OFFTime](#) on page 847

Restart Delay

Determines the time delay to the start of the user data sequence for the BER measurement. The time value is defined in bits. This parameter requires that the [External Restart](#) is activated. For basics, see [Chapter 5.4.7, "Restart Function"](#), on page 187.

Remote command:

`:TEST:BB:DATA:RDELaY` on page 847

5.4.13.3 BER/BLER Functionality Test

The self test verifies the basic functionality of the bit and block error rate tester. The R&S SMBV continuously evaluates the incoming signal compared to the outgoing signal, and displays the results in the corresponding "Bit Error Rate", or "Block Error Rate" dialog. In addition, you can manually affect the selftest, e.g. to check the functionality of the LEDs, or the synchronization.

The following instructions explain how to perform the provided selftests by the example of the bit error rate tester. Proceed in the same way for the block error rate test.

It is assumed, that

- Protection level 1 is unlocked, for accessing the test generator, see ["To enable the BER/BLER test generator"](#) on page 203.
- The bit error rate dialog is accessed, see [Chapter 5.4.10, "Bit Error Rate Settings"](#), on page 189.
- The cabling for the selftest is established, see [Chapter 5.4.13.1, "Test Generator Setup"](#), on page 204.
- The test generator dialog is accessed, see [Chapter 5.4.13.2, "Test Generator Settings"](#), on page 205.

To check the bit error rate functionality continuously

1. In the "Bit error Rate" dialog, configure the outgoing signal.
2. Select "Test Generator".
3. In the "Test Generator" dialog, configure the corresponding settings.
4. Select "State > On".
5. In the "Bit error Rate" dialog, select "State > On".

The test runs continuously and displays the results in the "Bit error Rate" dialog.

The bit error rate tester works correctly, if no error occurs, and all LEDs are green.

To check the clock signal

- ▶ Remove the clock out connection ([Figure 5-7, \(3\)](#)).

In the "Bit error Rate" dialog, the "NO CLOCK" LED is expected to turn red.

To check the data transmission

- ▶ Remove the data connection (Figure 5-7, (6)).

In the "Bit error Rate" dialog, the "NO DATA" LED is expected to turn red.

To check the synchronization

- ▶ In the "BER/BLER Test Generator" dialog, arbitrarily increase the "Error Rate".

At a specific value, the synchronization is no longer given, and "NO SYNC" LED is expected to turn red.

5.5 RF Block

5.5.1 Overview of RF Signal

Settings for the RF output signal and analog modulation are made under "RF Signal" and "Analog Modulations". These settings can be accessed in the block diagram by way of the "RF/A MOD" function block, or by means of the menu with the same name which is opened using the [MENU] key.

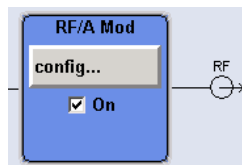

The function block is available for the basic unit (R&S SMBV + frequency option) without additional equipment options.

5.5.1.1 RF Output

Basically, the RF output signal is deactivated. The previous state is restored, when the signal is reactivated.

Activating RF Signal Output

If the settings for the RF signal are done, you can activate RF signal output via:

- the [RF ON/OFF] key (the current entry focus is irrelevant)
- the checkbox in the "RF/A Mod" block (see "RF On" on page 209)
- the "RF Frequency > RF ON" checkbox in the RF/A Mod block (see "RF Output State" on page 209).

To open the menu, select the "Configure" button in the RF/A Mod block.

The current state of the RF output (activated and deactivated) is indicated in the block diagram by means of the different block color and the status of the "On" checkbox.

The disconnected connection to the output is additionally shown when the output is deactivated.

Active analog modulation is also indicated in the block.



To query the impedance of the RF outputs, use the command `:OUTPut<hw>:IMPedance?` on page 582.

RF On

Activates RF signal output.

This function corresponds to the [RF ON /OFF] key.

See also [Chapter 5.5.1.1, "RF Output"](#), on page 208.

Remote command:

`:OUTPut<hw>[:STATe]` on page 583

RF Output State

Activates the RF output signal by selecting the RF checkbox in the "Configure" dialog of the "RF/A Mod" block.

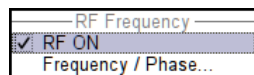

Remote command:

`:OUTPut<hw>[:STATe]` on page 583

5.5.1.2 RF Signal Modes and Characteristics

The CW, Sweep and List modes are available for generating the RF signal.

- **CW**
The RF signal is generated with the set frequency and level. This is the default mode.
- **Sweep**
The RF signal is generated as a sweep with the set parameters.
It is not possible to activate frequency, level and LF sweep simultaneously.
- **List Mode**
The RF signal is generated on the basis of a list of predefined frequency and level values. The duration of the individual steps can be predefined.

Instruments connected downstream can be taken into consideration when setting the frequency and level by entering a frequency and/or level offset.

Automatic level control ("ALC") ensures maximum level accuracy, even with I/Q modulation.

User-specific lists which contain level correction values for any frequency range ("User Correction") can be created to, for example, compensate the cable attenuation in a test assembly setup.

The R&S SMBV generates the RF signal in unmodulated or analog form. The signal generator is equipped therefore with the following sources for analog modulations:

- an internal LF generator
- an internal pulse generator
- the external modulation inputs [MOD EXT] and [PULSE EXT].

An external trigger signal for the sweeps and the LIST mode can be provided at the [INST TRIG] input.

The input [REF IN] is used to input an external instrument reference, and the output [REF OUT] serves as the output of the reference frequency (internal or external).

5.5.2 RF Frequency

The value of the RF frequency is displayed in the header of the display ("Freq"). This field provides the direct input of the RF frequency. Alternatively, you can enter the RF frequency in the "Frequency/Phase" dialog.

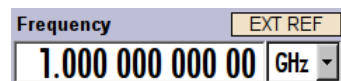

Note that the displayed RF frequency in the header, and the RF output frequency, entered in the "Frequency/Phase" dialog can be different, as explained in the following section.

5.5.2.1 RF Frequency vs. RF Output Frequency

If you are working with a downstream instrument, e.g. a mixer or a frequency multiplier, you can enter the related parameter value in the frequency settings dialog ("Offset", "Multiplier").

The generator includes these parameters and displays the result in the "Freq" field in the status bar, as if the downstream instrument and the generator were one unit. This displayed frequency corresponds to the value at the RF output of the downstream instrument. However, the frequency provided at the RF output of the signal generator corresponds to the frequency value set in the "Frequency/Phase" dialog.

The instrument activates the "Freq Offset" icon in the status bar, when a frequency offset or multiplication factor is set.

The correlation between the RF frequency, the RF output frequency and the frequency offset is as follows:

"Freq" (in header) = "RF output frequency" (Frequency in dialog) * "Multiplier" factor (Multiplier in dialog) + "Freq offset" (Offset in dialog)

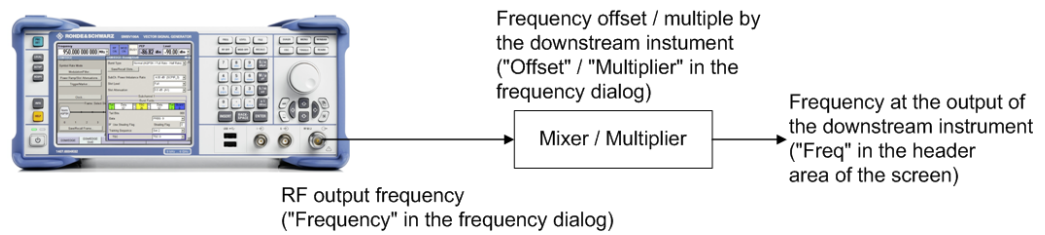

5.5.2.2 Setting the RF Frequency

To change the RF frequency, press the [FREQ] key and enter the desired frequency. Changes to the RF frequency have an immediate effect (without confirmation with the [Enter] key) on the output signal.

RF Freq

Enters the RF frequency, considering the frequency offset.

Note: The SCPI command sets the level of the "Freq" display, that means an entered frequency offset and multiplier factor are considered in the frequency value.

Remote command:

[:SOURce<hw>] :FREQuency [:CW|FIXed] on page 741

5.5.2.3 RF Frequency Dialog

The combined "RF Frequency / Phase..." dialog contains the parameters required for configuring the frequency and settings like a frequency offset, or a multiplier factor of an externally connected multiplier, see [Chapter 5.5.2.4, "Frequency Settings"](#), on page 211.

| Frequency Settings | |
|--------------------|-----------------------|
| Frequency | 1.000 000 000 000 GHz |
| Offset | 0.000 Hz |
| Multiplier | 1.000 |

Furthermore, the dialog provides additional settings parameters which are described in:

- [Chapter 5.5.2.5, "User Variation Settings"](#), on page 213
- [Chapter 5.5.3, "Phase"](#), on page 213
- [Chapter 5.5.5, "Local Oscillator - LO Coupling"](#), on page 218

5.5.2.4 Frequency Settings

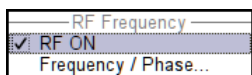

Access:

- ▶ Select "RF/A Mod > config... > RF Frequency > Frequency/Phase".

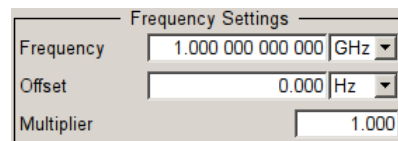

In the upper section of the combined "RF Frequency / Phase ..." settings dialog, you can configure the frequency of the RF signal.

The remote commands required to define the settings are described in [Chapter 7.15.7, "SOURCE:FREQUENCY Subsystem"](#), on page 739.

Frequency

Sets the RF frequency of the RF output connector. The frequency entered and displayed here corresponds to the frequency at the RF output, that means any offset entry is not considered.

Note: Suppressed values in the status bar

For security concerns or certain operating modes, you can hide the frequency and level display in the status bar.

- *********

The display has been disabled for security reasons.

See:

- [Annotation Frequency](#)
- [Annotation Amplitude](#)

-

The display is disabled when list mode is running, see "[State - List Mode](#)" on page 292.

Remote command:

`[:SOURCE<hw>] :FREQUENCY [:CW|FIXed]` on page 741

Note: This command sets the frequency of the "FREQ" display, that is the frequency containing offset.

Offset

Sets the frequency offset relative to the RF frequency. The frequency offset of a downstream instrument (for example a mixer) is entered.

The entry does not change the value of the RF frequency at the RF output. It only changes the RF frequency displayed in the display header. The value of the RF frequency in the header corresponds to the frequency at the output of the downstream instrument, see also [Chapter 5.5.2.1, "RF Frequency vs. RF Output Frequency"](#), on page 210.

Remote command:

`[:SOURCE<hw>] :FREQUENCY:OFFSet` on page 744

Multiplier

Sets the multiplication factor for the RF frequency.

In the frequency field of the status bar, the instrument adjusts its frequency display according to the set multiplication factor. This frequency value shows the frequency at the output of the downstream multiplier. The entry does not change the RF frequency at the RF output of the R&S SMBV, see also [Chapter 5.5.2.1, "RF Frequency vs. RF Output Frequency"](#), on page 210.

Remote command:

`[:SOURce<hw>] :FREQuency:MULTIplier` on page 744

5.5.2.5 User Variation Settings

Access:

- ▶ Select "RF/A Mod > config... > RF Frequency > Frequency/Phase".

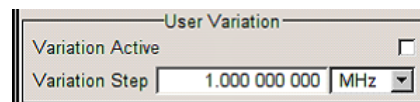

The combined "RF Frequency / Phase ..." settings dialog contains the parameters determine the step size for adjusting the frequency with the rotary knob.

Variation Active

Activates the user-defined step width used when varying the frequency value with the rotary knob.

"ON" The frequency value set with the rotary knob is varied using the user-defined step width which is entered under "Variation Step".

"OFF" The frequency value set with the rotary knob is varied in steps of one unit at the cursor position (standard operating mode).

Remote command:

`[:SOURce<hw>] :FREQuency:STEP:MODE` on page 746

Variation Step

Sets the user-defined step width. This step width is used when entering the RF frequency using the rotary knob. Frequency variation with this step width must also be activated with "Variation Active".

Remote command:

`[:SOURce<hw>] :FREQuency:STEP [:INCRement]` on page 746

5.5.3 Phase

The phase of the RF output signal can be changed in the "Phase Settings" section of the "RF Frequency/Phase" dialog.

5.5.3.1 Phase Settings

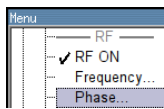

► To access the dialog for configuring the phase settings, perform one of the following:

- Select "RF/A Mod > config... > RF Frequency > Frequency/Phase".
- Press the [menu] key and select "RF/A Mod > RF Frequency > Frequency/Phase".

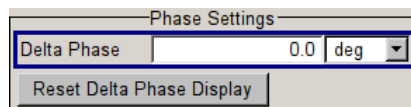

The combined "RF Frequency / Phase ..." settings dialog contains the parameters to configure the phase settings of the RF signal.

The remote commands required to define the settings are described in [Chapter 7.15.15, "SOURCE:PHASe Subsystem"](#), on page 786.

Delta Phase

Sets the phase of the RF signal. The current phase of the signal is used as the reference. This function allows, for example, the phase of the output signal to be synchronized with the phase of a signal from a second signal generator.

Remote command:

[:SOURCE<hw>] :PHASe on page 786

Reset Delta Phase Display

Resets delta phase value. The set phase is adopted as the new current phase, i.e. the delta phase value is reset to 0.

Remote command:

[:SOURCE<hw>] :PHASe:REFeRence on page 786

5.5.4 Reference Oscillator

The R&S SMBV is equipped with an internal reference oscillator that generates a reference frequency of 10 MHz. It is used as internal reference source for the synthesizer and the local oscillator. Alternatively, you can apply an external reference signal.

Regardless of the used reference source (internal or external), the R&S SMBV always provides the configured reference frequency at the output. You can use it, for example to synchronize several interconnected instruments.



The settings of the reference oscillator are not affected by an instrument preset ("PRE-SET" key).

The following examples briefly explain the possible test setups and the settings to be considered.

- Internal $f_{\text{ref}} = 10 \text{ MHz}$ (10 MHz [REF OUT])

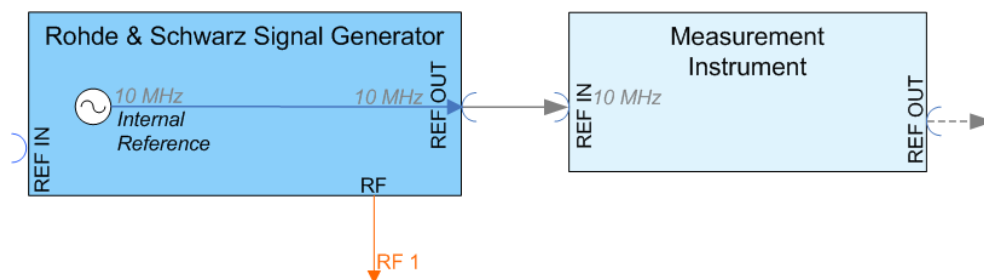

Figure 5-8: Synchronizing a subsequent instrument using the internal 10 MHz reference signal of the R&S SMBV

The internal reference oscillator supplies the reference frequency.

Settings:

- Source: "Internal"
- External $f_{\text{ref}} = 10 \text{ MHz}$ (10 MHz [REF OUT])

If you have a clean external reference signal with 10 MHz frequency, you can directly pass it to the output. The signal quality remains the same.

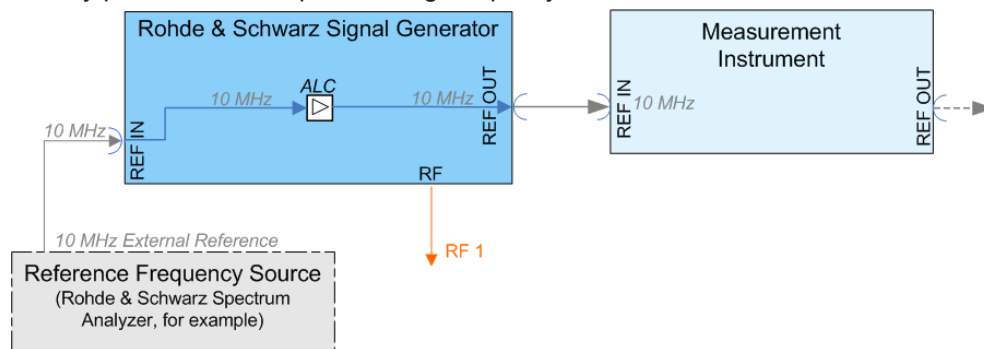

Figure 5-9: Synchronizing instruments by means of an externally applied reference signal having 10 MHz

Settings:

- Source: "External"
- External Reference Frequency: "10 MHz"

Set the additionally provided parameters, as for example the synchronization bandwidth according to the requirements of the application.

- External $f_{\text{ref}} = 5/10 \text{ MHz}$ (5/10 MHz [REF OUT])

If you have an external reference signal with 5 or 10 MHz, you can directly pass it to the output. The signal quality remains the same.

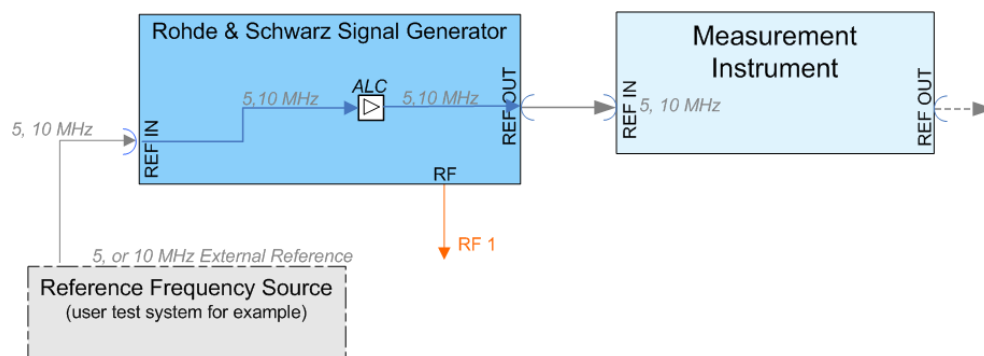

Figure 5-10: Synchronizing a subsequent instrument an externally applied reference frequency of 5 or 10 MHz

Settings:

- Source: "External"
- External Reference Frequency: "5 or 10 MHz"

Input and output connectors of the reference frequency

The appropriate connectors are located at the rear panel, see "[REF IN]" on page 32 and "[REF OUT]" on page 31.

5.5.4.1 Reference Oscillator Settings

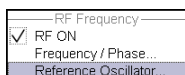

To access the settings dialog for configuring the reference signal, perform one of the following:

- In the block diagram, select "RF/A Mod > config... > RF Frequency > Reference Oscillator"
- Press the [menu] key and select "RF/A Mod > RF Frequency > Reference Oscillator"
- Press the [setup] key and select "Setup > System > Reference Oscillator"

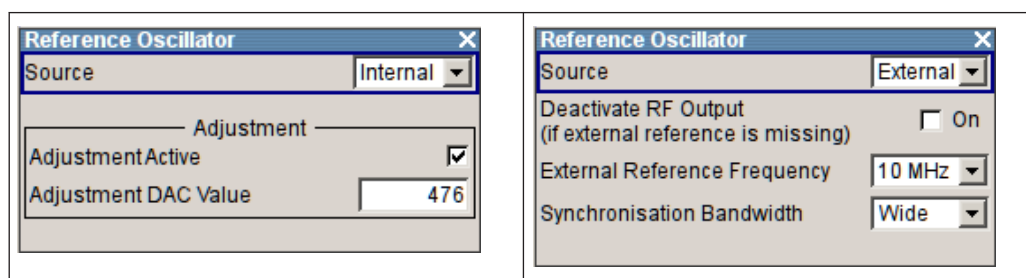

In the "Reference Oscillator Settings" dialog, you can select the signal source and frequency to be used as the reference frequency, and determine a user-defined adjustment value.

The remote commands required to define the reference oscillator settings are described in [Chapter 7.15.19, "SOURCE:ROSCillator Subsystem"](#), on page 807.

Source

Selects the source of the reference frequency.

See [Chapter 5.5.4, "Reference Oscillator"](#), on page 214, which provides an overview of the different test scenarios for configuring the reference frequency.

"Internal" Uses the internal 10 MHz reference signal, either with the calibrated or a user-defined adjustment value.

"External" Uses an external reference signal.
The frequency of the external reference signal must be selected under ["External Reference Frequency"](#) on page 217.
An external reference signal is required for each slave instrument configured to work in a synchronous mode (see [Chapter 5.9.2.4, "Synchronous Signal Generation"](#), on page 332).

Remote command:

`[:SOURce] :ROSCillator :SOURce` on page 810

Deactivate RF Output (if external reference is missing)

Turns the RF output off when the external reference signal is selected, but no signal is supplied.

This function prevents that no improper RF signal due to the missing external reference signal is used for measurements. A message indicates that the external signal is missing and the RF output is deactivated.

This setting is not affected by a reset.

Remote command:

`[:SOURce] :ROSCillator :EXTernal :RFOFF [:STATe]` on page 808

External Reference Frequency

Determines the frequency of the external reference signal.

You can select an external reference signal having a frequency of 5 MHz or 10 MHz.

Note: The installed hardware determines the available settings. Use the [Hardware Config](#) dialog to check the hardware the instrument is equipped with.

For information on the required hardware revision, refer to the release notes.

Remote command:

`[:SOURce] :ROSCillator :EXTernal :FREQuency` on page 808

Synchronization Bandwidth

Selects the synchronization bandwidth for an external reference signal.

"Narrow" Synchronization bandwidth is 50 Hz.

"Wide" The synchronization bandwidth is approximately 350 Hz.
This mode is useful for very precise reference sources of high spectral purity.

Remote command:

`[:SOURce] :ROSCillator :EXTernal :SBANdwidth` on page 809

Adjustment Active

Selects the adjustment mode.

| | |
|-------|---|
| "OFF" | Uses the calibrated internal reference frequency. |
| "ON" | Allows you to apply a deviation to the internal reference frequency, according to your requirements. To enter the value, use Adjustment DAC Value . |

Remote command:

`[:SOURce] :ROSCillator [:INTernal] :ADJust [:STATe]` on page 809

Adjustment DAC Value

Sets a user-defined deviation for the internal reference frequency. This value takes effect when it is activated with [Adjustment Active](#). "0" represents the calibrated state. The setting range depends on the reference oscillator type and its factory calibration value.

Note: A factory preset resets this setting to the calibration value of the instrument.

Remote command:

`[:SOURce] :ROSCillator [:INTernal] :ADJust :VALue` on page 809

5.5.5 Local Oscillator - LO Coupling

The LO Coupling function allows a distribution of the local oscillator signal in way that multiple RF signals can be driven by the same LO signal. This is mandatory for minimizing the phase drift between these RF signals.

The LO Coupling function is available only for instruments equipped with the option R&S SMBV-B90 (Phase Coherence).

The R&S SMBV outputs its local oscillator signal at the LO OUT connector (rear of instrument). In the external local oscillator mode, an external signal must be supplied at the LO IN connector.

5.5.5.1 Phase Coherence

Phase coherence of two RF signals means that there is a defined and stable phase relationship between two (or more) RF carriers, i.e. there is a fixed delta phase $\Delta\Phi$ between the carriers. Strictly speaking, phase coherence is only defined for CW carriers with the same frequency (or for CW carriers at frequencies that are multiples of each other).

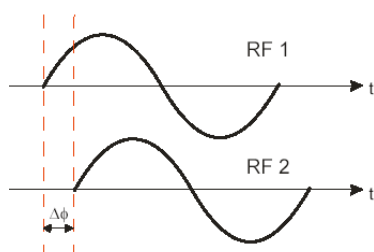

If two signal generators are coupled via their 10 MHz reference, they are generating exactly the same frequency but only from the long term perspective. Having a closer

look into the instantaneous differential phase (“delta phase”) of these two RF signals, this is quite instable due to:

- phase noise of the two synthesizers
- “weak” coupling at 10 MHz and a long synthesis chain up to the RF domain
- temperature differences which cause a change of the effective electrical length of some synthesizer components

Most critical for a stable delta phase is the thermal RF phase drift between multiple RF synthesizers. This drift can be minimized down to 0.1° by use of a common synthesizer, i.e. a common local oscillator (LO) signal, for all RF carriers. Only if this LO signal (which is internally used for upconverting the baseband signal to the RF) is the same for all carriers, a stable phase between the RF signals can be achieved.

5.5.5.2 Typical Applications

The LO Coupling function can be used to generate a beamformed signal.

- Generation of a beamformed signal with two instruments, working in External mode.

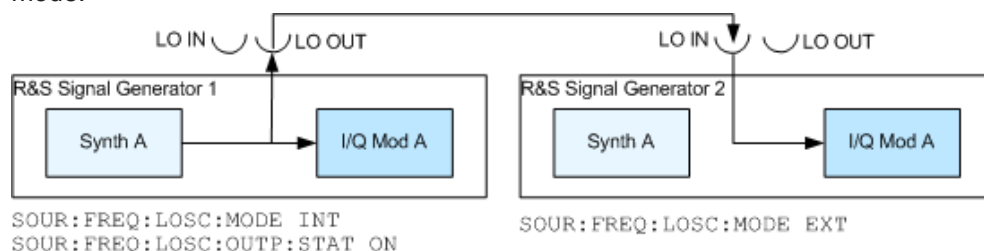

5.5.5.3 LO Coupling Settings

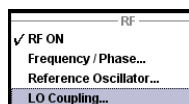

To open the "LO Coupling" dialog, select "RF/A Mod > Configure > LO Coupling" or use the [MENU] key under "RF/A Mod".

The menu is available only for instruments equipped with the option R&S SMBV-B90. This option enables phase coherent RF outputs of two or more RF paths.

The local oscillator coupling is set in the lower area of the group menu "Frequency/Phase". The menu is used to select the mode of the LO coupling and the state of the local oscillator output.

For more information about the upper areas, see:

- [Chapter 5.5.2.3, "RF Frequency Dialog"](#), on page 211
- [Chapter 5.5.3.1, "Phase Settings"](#), on page 214
- [Chapter 5.5.4.1, "Reference Oscillator Settings"](#), on page 216

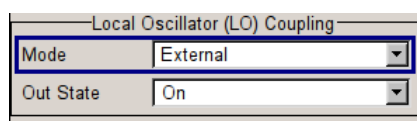

Mode - LO Coupling

Selects the mode of the local oscillator coupling.

- "Internal" This mode corresponds to a normal operation. The internal local oscillator is used.
- "External" An external signal is used.

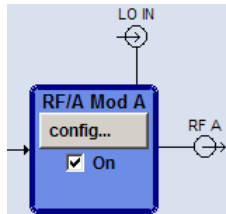

Note: Selection of LO Coupling "External" mode, disables all parameters in the "Frequency/Phase/Ref Osc" menu.

Remote command:

[\[:SOURce<hw>\]:FREQuency:LOSCillator:MODE](#) on page 740

Out State - LO Coupling

Switches on/off the LO output.

- "On" The internal local oscillator signal is also available on the LO OUT connector (in order to couple two instruments).
- "Off" The LO OUT signal is switched off.

Remote command:

[\[:SOURce<hw>\]:FREQuency:LOSCillator:OUTPut:STATe](#) on page 741

5.5.6 RF Level**5.5.6.1 Overview of RF Level****Message "Level overrange/underrange"**

If this message appears in the status line, the following parameter is in the overrange (see data sheet):

- The set level ("Level")
- The displayed peak envelope power ("PEP") for Digital Modulation or Digital Standard

In this case, the signal level at the output can deviate from the set value.

The value of the RF level is displayed in the level field in the header of the display ("Level"). This field provides the direct input of the RF level value. Alternatively, you can enter the level in the "Level/EMF/..." dialog.

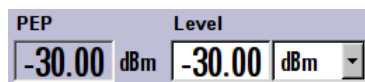

The center line ("Level") and the peak envelope power ("PEP") of the modulated RF output signal is displayed when digital modulation or digital standard signals are generated.

Note that the displayed RF level in the header, and the RF output level, set in the "Level/EMF" dialog can be different, as explained in the following section.

RF level vs. RF output level

If you are working with a downstream instrument, e.g. an attenuator or amplifier, you can enter the related parameter value in the level settings dialog ("Offset").

The generator includes these parameters and displays the result in the "Level" field in the status bar, as if the downstream instrument and the generator were one unit. This displayed level value corresponds to the value at the RF output of the downstream instrument. However, the level provided at the RF output of the signal generator corresponds to the level value set in the "Level/EMF/..." dialog.

The instrument activates the "Level Offset" icon in the status bar, when a level offset is set.

The correlation is as follows:

"Level" (in header) = "RF output level" (Level in menu) + "Level offset" (Offset in menu)

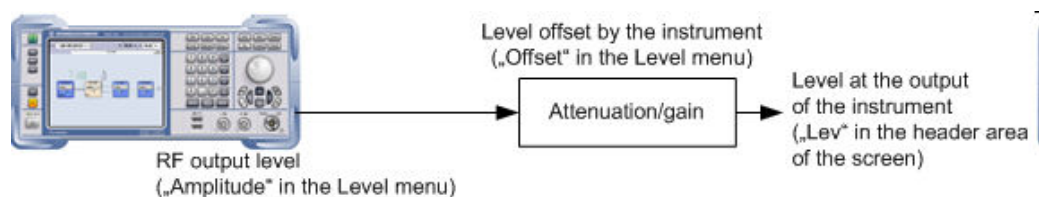

The RF output is protected against overloading by an external signal applied to the RF output (see [Chapter 5.5.10, "Reverse Power Protection"](#), on page 241).

Setting the RF level

To change the RF level, press the [LEVEL] key and enter the desired level. Changes to the RF level have an immediate effect (without confirmation with the Enter key) on the output signal.

RF Level

Enters the RF level, considering the level offset (see ["RF level vs. RF output level"](#) on page 221).

Note: Some SW options have specific requirements about the calculation of the level of the output signal. E.g. the displayed value corresponds to the level at the start simulation time, there are correction coefficients to be applied, etc. In this case, the displayed value in the header of the instrument does not always correspond to the level at the RF output.

When working with a software option, always refer to the corresponding documentation for related specific information.

In addition, when the self test is running, the displayed level in the header is 10 dBm, but the actual signal level at the RF output is -50 dBm.

dBm, dB μ V, mV and μ V can be used as the level units. The four unit keys are labeled with these units.

Note: The SCPI command sets the level of the "Level" display, i.e. an entered level offset is considered in the level value.

Remote command:

`[:SOURce<hw>] :POWER [:LEVel] [:IMMediate] [:AMPLitude]` on page 792

5.5.6.2 RF Level Dialog



Access:

- ▶ Select "RF/A Mod > config... > RF Level > Level/Attenuator".

The offset-free level, level offset and level limit are set in the top section of the dialog. The attenuator mode is set in the "Attenuator Settings" section.

The display is disabled when list mode is running, see " [State - List Mode](#) " on page 292.

Remote command:

`[:SOURce<hw>] :POWer:POWer` on page 796

Note: The SCPI command `[:SOURce<hw>] :POWer [:LEVel] [:IMMediate] [:AMPLitude]` sets the level of the "Level" display, that is the level containing offset.

Limit - RF Level

Sets an upper limit for the RF output power.

You can use it to protect your DUT from damage due to high input power. If you enter an RF level above this value, the instrument limits the output power to this specified value, and generates a warning message.

However, the level indication in the status bar is not affected.

Note: The value is not affected by an instrument preset ([PRESET] key), *RST and the "Save/Recall" function. It is influenced only by the [Factory Preset](#) and the factory value is equal to maximum level.

Remote command:

`[:SOURce<hw>] :POWer:LIMit [:AMPLitude]` on page 794

Offset (Level)

Sets the level offset relative to the RF level.

The level offset of a downstream instrument (for example an attenuator or amplifier) is entered.

The entry does not change the value of the RF level at the RF output. It only changes the RF level displayed in the display header. The value of the RF level in the header corresponds to the level at the output of the downstream instrument.

Remote command:

`[:SOURce<hw>] :POWer [:LEVel] [:IMMediate] :OFFSet` on page 793

Attenuator Settings

The attenuator mode is set in the Attenuator Settings section.

Attenuator Mode

Sets the attenuator mode at the RF output.

"Auto" Standard mode.
The electronically switching attenuator switches with a 5 dB step width at fixed switching points.

"Fixed" The level settings are made without switching the attenuator. When this operating mode is switched on, the attenuator and the relays are fixed in their current positions to provide level settings without interruption. The resulting variation range is defined and displayed under "Attenuator Fixed Range".

Note: The function is effective when automatic level control is activated ("ALC State = On").

If the normal variation range is overranged or underranged, level errors increase considerably and the warning "Level under/over-range" appears in the info line. The spectral purity of the output signal decreases with high attenuation.

Remote command:

`:OUTPut<hw>:AMODE` on page 581

Fixed Range (PEP) In

Displays the level range in which the level is set without interruption for the "Attenuator Mode fixed" setting.

Remote command:

`:OUTPut<hw>:AFIXed:RANGe:UPPer?` on page 581

`:OUTPut<hw>:AFIXed:RANGe:LOWer?` on page 580

RF OFF Mode

Selects the attenuator mode, when the RF signal is switched off.

The setting of the RF OFF mode is not affected by an instrument preset ([PRESET] key), *RST and the "Save/Recall" function. This parameter is influenced only by the [Factory Preset](#).

"Unchanged" Freezes the setting of the attenuator when RF is switched off. The attenuator is only activated when RF is switched on. This setting is recommended if a constant VSWR (**V**oltage **S**tanding **W**ave **R**atio) is required.

"Full Attenuation" Sets attenuation to maximum when the RF signal is switched off. This setting is recommended for applications that require a high level of noise suppression.

Remote command:

`[:SOURce<hw>] :POWer:ATTenuation:RFOff:MODE` on page 792

User Variation

If the level is set using the rotary knob, the step width is defined in the "User Variation" section.

Variation Active

Activates the user-defined step width used when varying the level value with the rotary knob.

"ON" The level value set with the rotary knob is varied using the user-defined step width which is entered under "Variation Step".

"OFF" The level value set with the rotary knob is varied in steps of one unit at the cursor position (standard operating mode).

Remote command:

`[:SOURce<hw>] :POWer:STEP:MODE` on page 800

Variation Step

Sets the user-defined step width for entering the RF level using the rotary knob. Level variation with this step width must also be activated with "Variation Active".

Remote command:

`[:SOURce<hw>] :POWer:STEP [:INCRement]` on page 799

External Level Adjustment

The external level adjustment provides information about the data that has been used for calibrating the RF level.

By default the instrument uses correction data obtained in the factory before delivery. In exceptional cases, you can determine the calibration values with an R&S NRP power sensor, and use these values for the external level correction. This feature is a protected function (see Service Manual, chapter 2, "Adjustment").

Adjustment Data

Indicates what data has been used for level calibration.

Remote command:

`:CALibration<hw>:LEVel:EXtern:DATA` on page 554

5.5.6.3 Power-On/EMF Settings



The power-on behavior of the R&S SMBV and the level display in the display header are set in the "Power-On / EMF Settings" section of the "RF Level/EMF/ALC/UCOR" dialog.

To open the "RF Level/EMF" dialog, select "RF/A Mod > Configure > Level/EMF" or use the [MENU] key under "RF/A Mod".

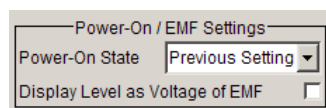

Power-On State - RF Signal

Selects the state which the RF output is to assume after the instrument is switched on.

"RF Off" The output is deactivated when the instrument is switched on.

"Previous Setting" When the instrument is switched on, the output assumes the same state as it had when the instrument was switched off.

Remote command:

`:OUTPut<hw> [:STATe] :PON` on page 583

Display Level as Voltage of EMF - RF Level

Activates display of the signal level as voltage of the EMF (no-load voltage). If this setting is deactivated, the level is displayed as a voltage over a 50 Ohm load.

Note: This setting is not affected by an instrument preset ([Preset] key), *RST) or the "Save/Recall" function. Only the [Chapter 5.2.3.20, "Factory Preset"](#), on page 155 resets the setting.

Remote command:

[:SOURce<hw>] :POWer:EMF:STATe on page 792

5.5.7 Automatic Level Control - ALC

Your signal generator is equipped with an automatic level control unit to obtain best RF level accuracy.

Automatic Level Control (ALC) is an adaptive control system to stabilize the RF output level. It continuously monitors the current level and adjusts it to keep a steady state over temperature and time.



ALC is active in almost all applications by default. However, some operating modes exclude ALC, as the control loop would detect incorrect values and result in level deviations. These are:

- Pulse modulation
- I/Q modulation

Also note that ALC may detect incorrect values in **multi-transmitter** test setups. If multiple generators are coupled, reverse power may affect the ALC readings. Based on incorrect values, ALC would have an impact on the signal to intermodulation ratio.

ALC States

The following description basically explains the ALC states and their principle of operation. In particular **ALC OFF (Sample & Hold)** gives an overview on the function in terms of the equipment of the generator.

The R&S SMBV offers the ALC states:

- AUTO
automatically adjusts the output level to the operating conditions.
- On
enables ALC permanently, regardless of the currently selected mode.
- Off
deactivates ALC.

To maintain a defined output level in Off mode, you can choose either **Sample & Hold (S&H)** status or **Table**.

- "S&H"
activates ALC briefly when frequency or level settings change.
- "Table"
uses predefined values from a table to adjust the level at changes.

The following section explains the functionality of "Sample & Hold", to provide an overview and to indicate what is to be considered. "On" and "Auto" require no additional explanation. Furthermore, find the ALC state settings described in detail in [State - ALC](#).

ALC OFF (Sample & Hold)

In "S&H" mode, the signal generator switches for a short period of time into CW mode and activates ALC. ALC adjusts the level to the set value and the generator holds the value (freeze). Then, the generator switches ALC off again and back to the operating mode.

RF output behavior during Sample & Hold depends on the configuration of your instrument. Instruments equipped with...:

- an **electronic step attenuator**
The level is decreased by 30 dB.
- a **mechanical step attenuator**

The level control status is permanently displayed as a status message in the info line.

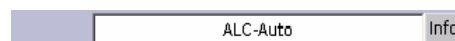

5.5.7.1 Automatic Level Control Settings

To open the "Automatic Level Control" dialog, select "RF/A Mod" > "Configure" > "Automatic Level Control" or use the [MENU] key under "RF/A Mod".

The combined dialog "ALC / UCOR" is divided into the several sections and provides access to the "Automatic Level Control" settings and to function "User Correction", see [Chapter 5.5.9, "User Correction"](#), on page 233).

The top sections of the dialog provide access to the level and attenuator settings (see [Chapter 5.5.6.3, "Power-On/EMF Settings"](#), on page 226 and [Chapter 5.5.6.2, "RF Level Dialog"](#), on page 222).

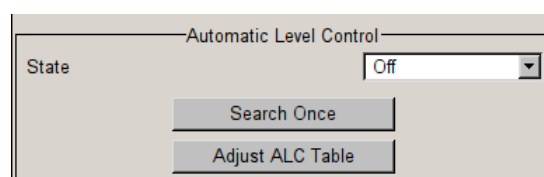

State - ALC

Activates/deactivates internal level control.

- "Auto" The instrument selects the most appropriate ALC mode automatically. ALC is on in most operating conditions. Default state.
- "On" Activates ALC, regardless of the operating conditions.
- "Off (Sample & Hold)"
Deactivates internal level control.
Sample & hold closes the level control loop at every frequency and level change for a short period of time. The level control voltage is sampled and then clamped.

| | |
|-------------------------------------|--|
| "Off (Sample & Hold High Accuracy)" | Deactivates internal level control. Works like Sample & Hold, but provides improved level accuracy, by increasing the frequency and level setting time up to 20 ms. |
| "Off (Table)" | Deactivates internal level control. For each change in the level or frequency, the instrument adjusts the level using an attenuation setting in a predefined table (ALC table). The table values are measured in advance and saved with function " Adjust ALC Table - ALC " on page 229. The table is stored in the memory of the instrument. Level attenuation between two table values is done by means of linear interpolation. This functionality enables faster level adjustments, since the output signal is not interrupted by the measurement, and also not disturbed. |

Remote command:

[\[:SOURce<hw>\]:POWER:ALC:OMODE](#) on page 790

Remote command:

[\[:SOURce<hw>\]:POWER:ALC\[:STATe\]](#) on page 791

Search Once - ALC

Forces the generator to execute level adjustment once, although the "Sample & Hold" mode is active.

Remote command:

[\[:SOURce<hw>\]:POWER:ALC:SONCe](#) on page 791

Adjust ALC Table - ALC

Saves ALC readings in an ALC table.

The R&S SMBV performs ALC adjustments according to these predefined values with the function [State - ALC](#) > "Off (Table)".

Remote command:

[:CALibration<hw>:LEVel:ALCTable\[:MEASure\]?](#) on page 553

5.5.8 NRP Level Control

With the NRP Level Control function, you can achieve a very stable and accurate RF power supplied to your DUT. With the aid of a downstream control circuit, a CLPC (Closed Loop Power Control), you can detect frequency response characteristics of the used components, such as losses due to cables, modules or components like power amplifiers, and compensate these effects accordingly.

Example: How to set up a closed loop power control

Figure 5-11: Example of a test setup with NRP Level Control

As shown in the example, the sensor measures a proportional power in defined time intervals, derived from a coupler. It considers optionally given S-parameters and returns the results to the generator. The signal generator compares the measured level with the set value and adjusts its output level accordingly.

This allows you to control the external signal level continuously and reliably reach a constant input level at the DUT in real time.

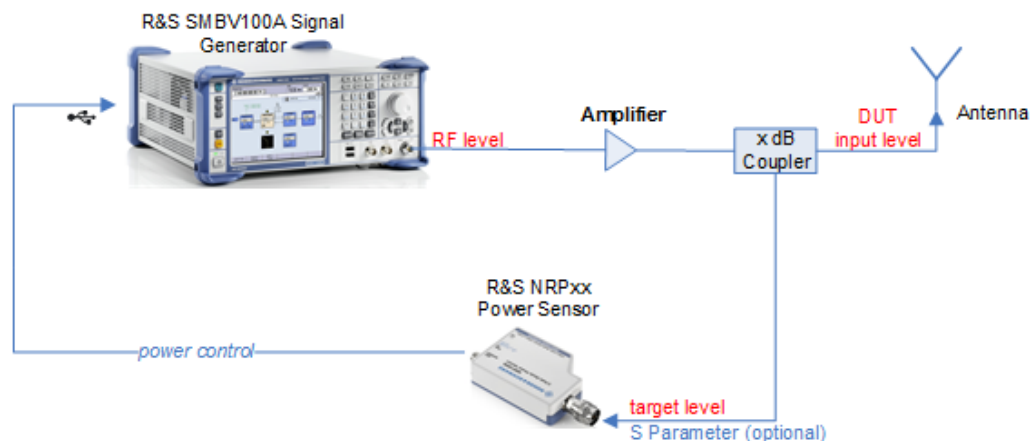

Impact of the NRP Level Control and the Operating Modes

Since the frequency and level of the RF output signal are continuously adjusted during "NRP Level Control", this operating mode interferes those with varying frequency and level values.

The reason is, that the generator regularly transmits the output frequency to the connected R&S NRPxx power sensor, which in turn requests the signal generator to adjust the output level according to its measurement. In contrast to this real time control loop, for example the list operating mode already generates the RF output signal on previously optimized frequency and level value pairs. In this case, the "NRP Level Control" as a second control loop would impact the already determined RF signal values and also considerably slow down the measurement. Similar impacts occur in sweep mode, and also the "NRP Power Viewer" and "NRP Level Control" affect each other's functionality.

Hence, the operating modes exclude each other as follows:

- "NRP Level Control" automatically disables [NRP Power Viewer](#), and vice versa.
- Activating the RF frequency sweep, RF level sweep or the list mode instantly deactivates a running "NRP Level Control".
- A running list or RF sweep mode blocks "NRP Level Control". It can not be activated.

Also keep in mind that modulated signals may differ from CW signals regarding mean power and peak power. This affects the operation of "NRP Level Control".

5.5.8.1 NRP Level Control Settings

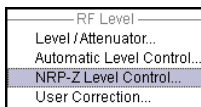

- To access the dialog for configuring the level control settings, perform one of the following:

- Select "RF/A Mod > config... > RF Level > NRP Level Control".
- Press the [menu] key and select "RF/A Mod > RF Level > NRP Level Control".

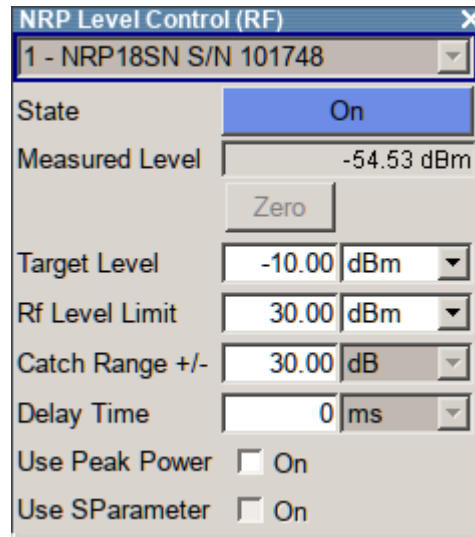

The dialog contains all parameters for configuring the settings for level control test setup.

The remote commands required to define these settings are described in [Chapter 7.15.17, "SOURce:POWer Subsystem"](#), on page 790

Sensor

Selects the R&S NRP power sensor for power control.

Note: In remote control, the sensors are set up using the `SENSE` commands. The remote measurement is triggered by the `READ` query which also provides the measurement results.

The software version of the connected power sensor can be retrieved by means of the remote control command `:SENS:POW:TYPE?`.

Use the "Setup >" [Chapter 5.2.3.5, "NRP Info/Update"](#), on page 129 dialog to update the sensor software.

Remote command:

`[:SOURce<hw>] :POWer:SPC:SElect` on page 798

State

Activates power control using the selected sensor.

The control loop periodically adjusts the generator output. After switching off, the running loop is completed.

Remote command:

`[:SOURce<hw>] :POWer:SPC:STATe` on page 798

Measured Level

Indicates the current reading of the sensor.

Zero - Power Sensors

Activates the auto zero function.

Zeroing calibrates the external power sensor by adjusting its reading at zero signal power. For this purpose, the RF power source must be switched off or disconnected from the sensor. If a Rohde & Schwarz power sensor receives an input power during the zeroing process, it aborts zeroing and generates an error message. Zeroing takes a few seconds, depending on the sensor model. Refer to the documentation of your power sensor for more information.

Tips for zeroing

When to perform zeroing:

- During warm up after switching on or connecting the instrument
- After a substantial change of the ambient temperature
- After fastening the power sensor module to an RF connector at high temperature
- After several hours of operation
- When low-power signals are to be measured, e.g. less than 10 dB above the lower measurement limit.
- Switch off the RF power source for zeroing, but do not disconnect it from the power sensor. This proceeding keeps the thermal equilibrium, and the zeroing process also compensates the noise that superimposes the measured signal (e.g. from a broadband amplifier).

Remote command:

`:SENSe<ch>[:POWER]:ZERO` on page 594

Target Level

Specifies the nominal level expected at the input of the sensor. The signal generator adjusts the output power accordingly, in order to meet the target value at the sensor input, and thus the power required at the DUT.

Remote command:

`[:SOURce<hw>]:POWER:SPC:TARGet` on page 798

Limit - RF Level

Sets an upper limit for the RF output power.

You can use it to protect your DUT from damage due to high input power. If you enter an RF level above this value, the instrument limits the output power to this specified value, and generates a warning message.

However, the level indication in the status bar is not affected.

Note: The value is not affected by an instrument preset ([PRESET] key), *RST and the "Save/Recall" function. It is influenced only by the [Factory Preset](#) and the factory value is equal to maximum level.

Remote command:

`[:SOURce<hw>]:POWER:LIMit[:AMPLitude]` on page 794

Catch Range +/-

Sets the capture range of the control system.

Within the range:

Target Level +/- Catch Range

the power control locks and tries to achieve the target level. Readings outside the range are not considered.

Remote command:

`[:SOURce<hw>] :POWer:SPC:CRANge` on page 797

Delay Time

Defines a waiting period between the level adjustment of the generator and the next measurement of the power sensor.

With this parameter, you compensate any dead times in the controlled system.

Remote command:

`[:SOURce<hw>] :POWer:SPC:DELay` on page 797

Use Peak Power

Activates control by means of the peak power values, provided the power sensor supports this function. Otherwise, the dialog does not show this parameter.

Remote command:

`[:SOURce<hw>] :POWer:SPC:PEAK` on page 798

Use SParameter - Power Sensors

Activates the use of the S-Parameter correction data of the connected power sensor. For sensors with attenuator this checkbox is automatically checked.

Refer to the manual of the connected R&S NRP power sensor for a description on how to use the SParameter table.

Remote command:

`:SENSe<ch> [:POWer] :CORRection:SPDevice:STATe` on page 587

5.5.9 User Correction

The "User Correction" function is used to create and activate lists in which level correction values predefined by the user are freely assigned to RF frequencies. Correction is performed by the user-defined table values being added to the output level for the respective RF frequency.

With frequencies which are not contained in the list, the level correction is determined by interpolation of the closest correction values.

The lists are created in the "List Editor". Each list is stored in its own file with the predefined file extension `*.uco`. The name of the User Correction file can be freely selected. The files are loaded from the "Lists..." file manager. Externally created tables with pairs of frequency and level values can be converted into User Correction files using the import function. The external files must have the file extension `*.txt` or `*.csv`. These file formats are provided e.g. by the Microsoft Excel program. The separators for table columns and for decimal floating-point numerals can be set. In addition, internally created User Correction data can be exported into ASCII files using the export function.

The amplitude can also be linearized automatically by means of an R&S NRP power sensor connected to one of the generator output signals. With the aid of the "Fill with Sensor" function, a table with correction values for external test assemblies can be automatically determined, e.g. for compensating the frequency response of cables. The User Correction list with the correction values acquired by the sensor is generated in the "Edit User Correction List" menu. The correction values can be acquired any time irrespective of the modulation settings of the generator.

If user correction is activated, the "UCOR" display (User Correction) is shown in the header together with the "Level" display. The RF output level is the sum of both values.

"Level" + "UCOR" = Output level

If activated, user correction is effective in all operating modes.

5.5.9.1 User Correction Menu

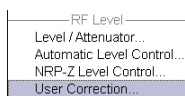

To open the "User Correction" menu, select "RF/A Mod > Configure User Correction" or use the [MENU] key under "RF/A Mod".

The combined menu "ALC/UCOR" is divided into the several sections.

The top sections provide access to the level and attenuator settings, see [Chapter 5.5.6.2, "RF Level Dialog"](#), on page 222, and to the automatic level control settings, see [Chapter 5.5.7, "Automatic Level Control - ALC"](#), on page 227.

User Correction Settings

The "User Correction" settings are set in the most lower section of the combined dialog; this section is used to activate/deactivate user correction, and to create, select and activate the lists.

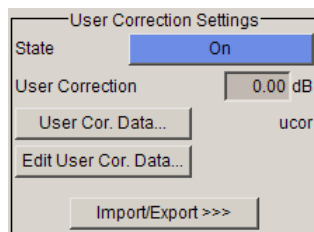

State - User Correction

Activates/deactivates user correction.

The "UCOR" status message appears in the frequency and level display.

Remote command:

[\[:SOURce<hw>\]:CORRection\[:STATe\]](#) on page 735

User Correction Value - User Correction

Indicates the current value for level correction.

Remote command:

[\[:SOURce<hw>\]:CORRection:VALue?](#) on page 735

User Cor. Data - User Correction

Calls the "File Select" menu for selecting and creating a list or the "File Manager".

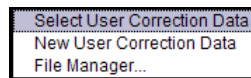

Remote command:

[:SOURce] :CORRection:CSET:CATalog? on page 728

[:SOURce<hw>] :CORRection:CSET [:SElect] on page 734

[:SOURce] :CORRection:CSET:DElete on page 730

Edit User Cor. Data - User Correction

Calls the editor for editing the selected user correction list.

A list consists of any number of frequency/level value pairs. The currently selected list is displayed.

Each list is saved as a separate file with extension *.ucO. The file name and the directory to which the file is saved are user-selectable.

Note: Save list only after filling both columns (frequency and level), otherwise the entries are lost.

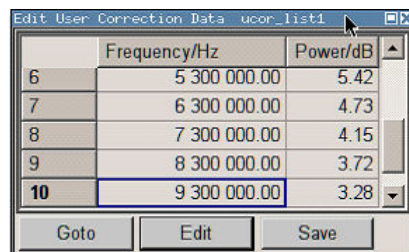

"Frequency /H z" Enters the frequency to which the level correction value applies.

Note: The "Fill..." function allows to automatically enter any number of frequencies with freely selectable range and increment. Using the "Fill With Sensor" function of the "Edit" sub menu requires only the entry of the frequency values. The level values are automatically acquired by the connected power sensor.

"Power/dB" Enters the level correction value to which the specified frequency applies. The values can be entered manually or automatically with the "Fill With Sensor" function (available in the "Edit" sub menu).

"Goto" Selects row for editing.

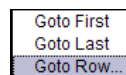

If Goto row is selected, a window opens for entering the requested row.

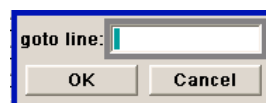

"Edit" Calls a selection of possible actions described below.

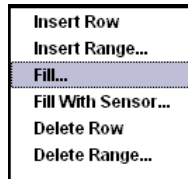

"Insert Row" Insert a new row before the marked row.

"Insert Range" Insert new rows before the marked row. The number of rows to be inserted can be defined in an entry window.

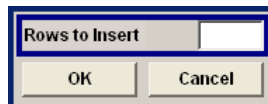

"Fill...." Opens a sub menu for defining a set of list values to be automatically entered in the ucor list (see [Chapter 5.5.9.2, "Filling the Correction List automatically"](#), on page 238).

"Fill With Sensor" Calls the menu to activate the filling of the user correction list with level values acquired by the selected power sensor (see [Chapter 5.5.9.3, "Filling the Correction List with Power Sensor Measurement Data"](#), on page 239).

"Delete Row" Deletes the marked row.

"Delete Range..." Allows to delete any number of rows starting with the marked row. The number of rows to be deleted can be defined in an entry window.

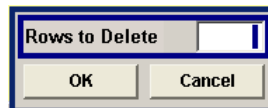

"Save as" Open the file menu to save the list under a new name.

Note: Save list only after filling both columns (frequency and level), otherwise the entries are lost.

Each list is saved to the R&S SMBV hard disk as a separate file with the file prefix *.ucor. The file name and the directory to which the file is saved are user-selectable.

"Save" The list is saved under its current name.

Remote command:

[\[:SOURce<hw>\]:CORRection:CSET\[:SElect\]](#) on page 734

[\[:SOURce<hw>\]:CORRection:CSET:DATA:FREQuency](#) on page 728

[\[:SOURce<hw>\]:CORRection:CSET:DATA:POWer](#) on page 729

Import/Export

User correction list can be imported from externally created files or exported into text or CSV-files. The import/export settings are available after clicking the "Import/Export" button.

Import/Export >>>

Expands the menu with the area for import and export of user correction files.

Externally edited Excel tables with any number of frequency/level value pairs can be imported as text or CSV-files and used for user correction.

Conversely, you can also export internally created user correction lists as text or CSV-files.

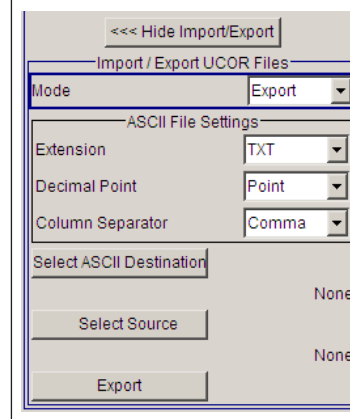
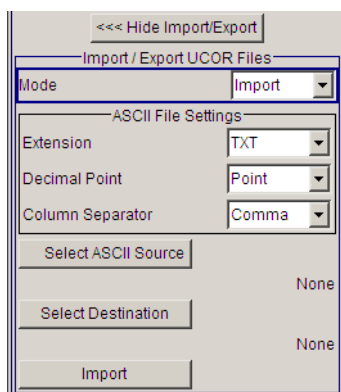
**Mode - User Correction**

Selects if user correction lists should be imported or exported. The settings offered depend on the selected mode.

Remote command:

[\[:SOURCE<hw>\]:CORREction:DEXChange:MODE](#) on page 733

Extension - User Correction

Selects the file extension of the ASCII file to be imported or exported. Selection "TXT" (text file) or "CSV" (Excel file) is available.

Remote command:

[\[:SOURCE<hw>\]:CORREction:DEXChange:AFILe:EXTension](#) on page 731

Decimal Point - User Correction

Selects the decimal separator used in the ASCII data between '.' (decimal point) and ',' (comma) with floating-point numerals.

Remote command:

[\[:SOURCE<hw>\]:CORREction:DEXChange:AFILe:SEPARATOR:DECimal](#) on page 732

Column Separator- User Correction

Selects the separator between the frequency and level column of the ASCII table the user correction list is exported to or imported from.

Remote command:

[\[:SOURCE<hw>\]:CORREction:DEXChange:AFILe:SEPARATOR:COLumn](#) on page 732

Select ASCII Source / Destination - User Correction

Calls the "File Manager" for selecting the ASCII file to be imported into a user correction list (source) or the ASCII file the user correction list is exported (destination) in.

Remote command:

`[:SOURce<hw>] :CORRection:DEXChange:AFILe:SELection` on page 731

Destination / Source - User Correction

Calls the "File Manager" for selecting the user correction list to be exported (source) into an ASCII file or the destination for the ASCII file to be imported (destination) in.

Remote command:

`[:SOURce<hw>] :CORRection:DEXChange:SELection` on page 734

Import / Export - User Correction

Starts the export or import of the selected file.

When import is selected, the ASCII file is imported as user correction list.

When export is selected, the user correction list is exported into the selected ASCII file.

Remote command:

`[:SOURce<hw>] :CORRection:DEXChange:EXECute` on page 733

5.5.9.2 Filling the Correction List automatically

The "Fill Table" menu enables you to automatically set the level correction values.

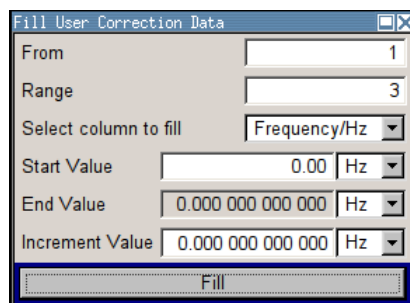

The start line and the number of rows to be filled are defined under "From" and "Range."

The column to be filled is selected under "Select column to fill". Depending on the selection here, the default for start, end, and increment value are set. As the settings are interdependent, a change of one parameter may result in the automatic change of one or more of the other parameters. The filling of the column with the selected value settings is started with button "Fill".



The correction list entries are only computed when the "Fill" button is pressed.

From

Sets the start value of the index range.

Remote command:
n.a.

Range

Sets the range for filling the table.

Remote command:
n.a.

Select column to fill

Selects either the frequency or the level column to be filled with the value defined below.

Remote command:
n.a.

Start value

Sets the start value for the frequency or the level entries.

Remote command:
n.a.

End value

Displays the end value for the frequency or the level entries.

Remote command:
n.a.

Increment value

Sets the increment for the frequency or the level entries.

Remote command:
n.a.

Fill

Fills the selected column in the set range with values, starting with the start value and using the set increment.

Remote command:
n.a.

5.5.9.3 Filling the Correction List with Power Sensor Measurement Data

The level correction values for the user correction list can be acquired by means of R&S NRP power sensors. The R&S NRP sensors are connected to either the [SENSOR] connector or to one of the [USB] interfaces. Configuration of the connection is performed in the "Power Sensor" menu (see [Chapter 5.5.11.2, "NRP Power Viewer"](#), on page 243). The filling of the user correction list with measurement data is performed in the ucor list editor (see ["Edit User Cor. Data - User Correction"](#) on page 235).

In the editor, the frequencies for which the correction values are to be acquired are entered in the frequency column (either manually or by means of the "Fill..." menu).



Do not save the list at this point, because the frequency entries are lost as long as there are no entries for the level column also. In the following these entries are automatically acquired by the connected power sensor.

All level correction values for the given frequency values are measured using the Power Sensor and automatically filled in the selected list after the "Execute" button is pressed. The list is automatically stored and recalled again after filling.

Fill User Correction Data with Sensor Settings

The "Fill with Sensor" button of the "Edit User Correction Data" menu opens the associated menu.

This dialog describes all parameters for filling a table automatically with sensor readings.



To select the sensor and determine its parameters, refer to [Chapter 5.5.11.2, "NRP Power Viewer"](#), on page 243.

To fill the table, press the "Execute" button.

Fill User Correction Data with Sensor

Enables you to fill the table with correction data acquired by a connected power sensor from Rohde & Schwarz.

- | | |
|-------------------|--|
| "Sensor" | Displays connected sensors for selection. |
| "List To Fill" | Indicates the used list file. |
| "Include Zeroing" | Performs a zeroing procedure before acquiring the user correction data to improve precision. Since during zeroing no signal may be applied to the sensor, RF is temporarily switched off at the generator. When unchecked, the zeroing procedure is skipped. The RF signal level might be blanked shortly. This setting is recommended if blanking of RF is undesirable or the absence of power at the sensor can not be guaranteed. |
| "Execute" | Performs automatic filling of the list, provided a sensor is detected and the user correction list contains at least one frequency value. |

Remote command:

`[:SOURce<hw>] :CORRection:ZERoing:STATe` on page 735

`[:SOURce<hw>] :CORRection:CSET:DATA [:SENSor<ch>] [:POWer] :SONCe`
on page 730

Used SMBV Settings for Measurement

Displays the settings relevant for the measurement.

"RF Source" Shows the path for which the correction menu settings are made.

"Modulation" Indicates the modulation state

"Amplitude" Shows the currently set level.

"Use SParameter"
Indicates whether SParameter correction is used.

"Attenuator Mode"
Displays the selected mode of the attenuator.

"Fixed Range (PEP) In:"
Shows the level range.

Remote command:

n.a.

5.5.10 Reverse Power Protection

The reverse power protection is tripped when the power of the external signal becomes too high. A relay opens and interrupts the internal connection to the RF output. This condition is indicated in the display header by the "OVERLOAD" status message.

Overload

If an "Overload" status message is indicated in the display header, reset the overload protection by pressing the [RF ON/OFF] key.

The RF input is activated when the overload protection is reset.

Remote command:

`:OUTPut<hw>:PROTection:TRIPped?` on page 582

`:OUTPut<hw>:PROTection:CLEAr` on page 582

`:OUTPut<hw> [:STATe]` on page 583

5.5.11 RF Measurement

5.5.11.1 NRP Sensor Mapping

The "NRP Sensor Mapping" lists all R&S NRP sensors detected by the instrument.

Any R&S NRP sensor that supports the USB legacy protocol and is connected to one of the USB interfaces, is detected automatically and added to the list. Vice versa, the R&S SMBV removes a sensor from the list, when it is disconnected.

R&S NRP sensors that are connected via LAN or use the USBTMC protocol are not automatically detected. They are detected by the scan search function.

Access:

- ▶ Select "RF/A Mod > config... > RF Measurement > NRP Sensor Mapping"

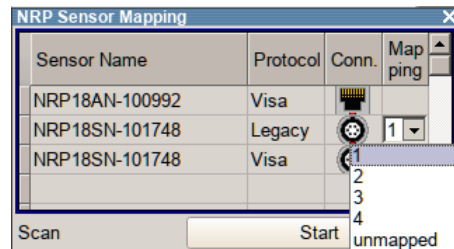

The dialog lists all detected R&S NRP sensors for selection and mapping. You can also browse the network for sensors.

The detected sensors are characterized by the used protocol and the corresponding connector icon. In the "Mapping" column, you can assign the sensor to one of the available sensor channels. The list can contain several entries but the R&S SMBV can only use up to four sensors simultaneously.

The remote commands required to define these settings are described in [Chapter 7.14, "SENSe, READ and INITiate Subsystems"](#), on page 583.

Settings

[Sensor Mapping List](#) 242
[Scan](#) 242

Sensor Mapping List

Displays a list of all sensor entries with information on the sensor name, the used protocol, the connector and the assigned mapping.

If a sensor is connected via LAN or uses the USBTMC protocol, its protocol is indicated as "Visa".

Remote command:

- :SLIST[:LIST]? on page 585
- :SLIST:ELEMENT<ch>:MAPPING on page 584
- :SLIST:SENSOR:MAP on page 585

Scan

Scans the network and the USB connections for sensors connected via the VISA communication protocol, i.e. sensors that are addressed via LAN or USBTMC.

Sensors communicating via the USB legacy protocol are detected automatically.

Remote command:

- :SLIST:SCAN[:STATe] on page 585

5.5.11.2 NRP Power Viewer

The R&S SMBV features the power viewer function for measuring or monitoring either the RF output power, or a freely selectable signal source with R&S NRP power sensors.

The instrument can perform up to 4 power measurements simultaneously.

To connect the sensors you have the following options:

- connect the sensor directly at the [SENSOR] connector.
The sensor at this connector is always assigned as "Sensor 1".
 - R&S NRP-ZK6 (six-pole interface cable) for R&S NRPxx power sensors
 - No additional cable for R&S NRP-Zxx power sensors (cable is fixed on the sensor)
- connect the sensor directly at a [USB] interface.
Requires the following cables, depending on the used sensor type:
 - R&S NRP-ZKU (USB interface cable) for R&S NRPxx power sensors
 - R&S NRP-Z3 or R&S NRP-Z4 (USB adapter cables) for sensors of the R&S NRP-Zxx family
- connect the sensor indirectly via [USB] using the R&S NRP-Z5 USB sensor hub.
The R&S NRP-Z5 USB sensor hub (high-speed USB 2.0) can host up to 4 R&S NRP sensors. It provides simultaneous internal and external triggering of all connected sensors.
Requires additional cables, depending on the used output connector of the hub.
Choose one of the following:
 - Short extension cable R&S NRP-Z2 for connection to the sensor connector.
This six-pole connection provides the external trigger capability.
 - Standard USB cable (USB type A to USB type B) to any USB type A connector of the R&S SMBV. This connection does not support external triggering.
- connection the sensor indirectly via USB hub with external power supply unit
Requires the following cables, depending on the used sensor type:
 - R&S NRP-ZKU (USB interface cable) for R&S NRPxx power sensors
 - R&S NRP-Z3
or R&S NRP-Z4 (USB adapter cables) for sensors of the R&S NRP-Zxx family
- connect an R&S NRPxxN power sensors via LAN
Using the Ethernet interface requires PoE (Power over Ethernet) to provide the electrical power.
To establish the connection, you can use:
 - A PoE Ethernet switch, e.g. R&S NRP-ZAP1 and an RJ-45 Ethernet cable.
 - A PoE injector and an RJ-45 Ethernet cable.

See also:

- [Chapter 2, "Preparing for Use"](#), on page 20 for the assignment to the available connectors
- Getting Started manual of the R&S NRPSeries Power Sensors

- The Rohde & Schwarz website <http://www.rohde-schwarz.com>, section "Power Meters & Voltmeters" for information on the sensor hub and the available accessories.

Detection and mapping

The R&S SMBV automatically detects a connected R&S NRP power sensor and indicates it in the dialogs "NRP Power Viewer" [NRP Power Viewer Settings](#) and [NRP Sensor Mapping](#) dialogs. By default, sensors 1 to 4 are assigned to the sensors at the USB connectors, according to their sequence of connection. In the "Sensor Mapping dialog", you can change the mapping.

For device specific information on the connected sensor, see [Chapter 5.2.3.5, "NRP Info/Update"](#), on page 129. For information on the scope of your power sensor refer to the manual of your R&S NRP power sensor.



On connection, the R&S SMBV immediately starts the measurement of a detected R&S NRP power sensor. If you perform an instrument preset ([PRESET] key or *RST), the R&S SMBV stops the measurements. The connection and the mapping of the power sensors remain, the measurements must be restarted.

A sensor continuously measures the average signal power of the selected source, such as an external signal, or the output signal of the signal generator with the RF level used as reference value. The R&S SMBV shows the result in the [NRP Power Viewer Settings](#) settings dialog, but you can also permanently display the readings in the block diagram.



Further functions of the R&S SMBV related to R&S NRP power sensors are:

- Acquisition of level correction data, see [Chapter 5.5.9, "User Correction"](#), on page 233.
The acquired level correction data is used to create and activate lists in which level correction values predefined by the user are freely assigned to RF frequencies. Correction is performed by the user-defined table values being added to the output level for the respective RF frequency.
- NRP Level Control, see [Chapter 5.5.8, "NRP Level Control"](#), on page 229.
Note that "NRP Power Viewer" automatically disables "NRP Level Control", and vice versa.
- The software version of the connected power sensor can be retrieved by means of the remote control command `SENSe<ch>[:POWER]:TYPE?` on page 594.
Use the [Chapter 5.2.3.5, "NRP Info/Update"](#), on page 129 dialog to update the sensor software.



"NRP Power Viewer" automatically disables [NRP Level Control](#), and vice versa.

NRP Power Viewer Settings

Access:

- ▶ Select one of the following:
 - Select "RF/A Mod > config... > RF Measurement > NRP Power Viewer".
 - Press the [menu] key and select "RF/A Mod > RF Measurement > NRP Power Viewer".

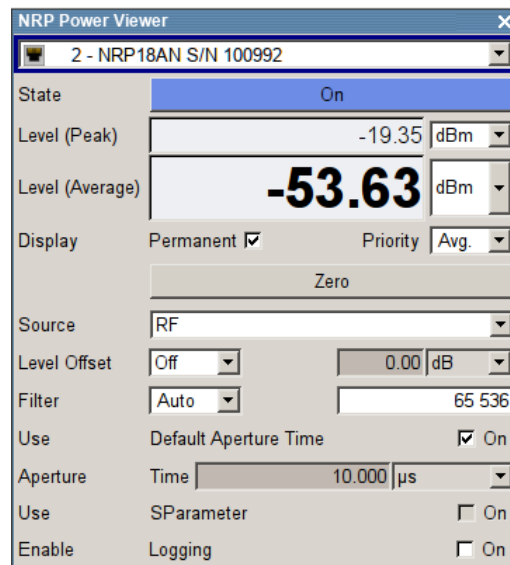

The dialog shows the settings and measurement values of the sensor selected in the field next to the connector symbol. For indicating the parameters of another sensor, switch to the respective sensor in the selection list.

The instrument detects connected sensors automatically and lists all in the selection field.

"Sensor 1" is firmly assigned to the sensor on the circled [SENSOR] socket. If no sensor is connected to this socket, channel 1 remains not assigned. Sensors 2...4 are assigned to the sensors at the USB connectors, according to their sequence of connection.



When you connect your power sensor(s) via the R&S NRP-Z5 USB sensor hub, each channel of the hub is firmly assigned to the associated sensor channel in the generator.

The remote commands required to define the settings are described in [Chapter 7.14, "SENSe, READ and INITiate Subsystems"](#), on page 583.

Sensor

Selects the R&S NRP power sensor for display.

In remote control, the sensors are set up using the `SENSe` commands. The remote measurement is triggered by the `READ` query which also provides the measurement results.

The sensor is selected by suffix 1, 2, 3 or 4 in key word `SENSe` or `READ` of the command header.

Suffix 1 denotes the sensor connected to [SENSOR], suffix 2 the one at the first [USB] interface, and suffix 3 and 4 are assigned to the sensors at the following USB interfaces. The suffix is identical to the index which is assigned automatically to each sensor upon connection.

Note: The software version of the connected power sensor can be retrieved by means of the remote control command `SENS:POW:TYPE?`.

Use the "Setup >" [Chapter 5.2.3.5, "NRP Info/Update"](#), on page 129 dialog to update the sensor software.

Remote command:

`SENSe<ch>[:POWER]:STATus[:DEVICE]?` on page 593

Type

Indicates the type and the serial number of the connected R&S NRP power sensor. The sensor type is automatically detected.

Remote command:

`SENSe<ch>[:POWER]:TYPE?` on page 594

`SENSe<ch>[:POWER]:SNUMber?` on page 592

State

Activates/deactivates level measurement by the power sensor.

The local state is set with the `INIT` command. Switching the local state off enhances the measurement performance.

In remote control, the sensors are set up using the `SENSe` commands. The remote measurement is triggered by the `READ` query which also provides the measurement results. The state is not influenced by these commands, measurements results can be retrieved with local State on or off.

The sensor is selected by suffix 1, 2, 3 or 4 in key word `SENSe` or `READ` of the command header.

Suffix 1 denotes the sensor connected to [SENSOR], suffix 2 the one at the first [USB] interface, and suffix 3 and 4 are assigned to the sensors at the following USB interfaces. The suffix is identical to the index which is assigned automatically to each sensor upon connection.

To query the availability of a sensor at a given connector, use the command

`SENSe<ch>[:POWER]:STATus[:DEVICE]?` on page 593.

Remote command:

`:INITiate<hw>[:POWER]:CONTInuous` on page 586

Level (Peak)

With certain power sensors only, for example R&S NRP-Z81.

Indicates the measured peak level value with the selected unit.

Remote command:

`:READ<ch>[:POWER]?` on page 587

Level (Avg.)

Indicates the measured level value with the selected unit.

Remote command:

`:READ<ch>[:POWER]?` on page 587

Unit

Selects the unit used for result display.

The power sensor provides the measured value in Watt.

In which unit the measured value is indicated is selected here and might be Watt, dBm or dBuV.

Remote command:

`:SENSe<ch>:UNIT[:POWER]` on page 594

Permanent Display State

Activates the permanent indication of the power measurement result in the upper right corner of the block diagram. The instrument shows the type of sensor, the corresponding connector, the measurement source and - if set - the offset.

| | | | |
|---|---|------------|-----|
| 1 |  NRP-Z81 | -20.67 dBm | Pk |
| 2 |  NRP-Z81 | -53.94 dBm | Avg |

It is possible to switch the permanent display active for several sensors. The instrument indicates the values of a maximum of two sensors simultaneously, in ascending order of connected channels. If you activate the display of a third sensor, the instrument fades out the values of the last highest channel number automatically.

Remote command:

`:SENSe<ch>[:POWER]:DISPlay:PERManent:STATe` on page 588

Display Priority

Determines whether the instrument displays the measured average or the peak power permanently on the screen.

To select the peak power display, it is required that the R&S NRP power sensor supports this feature. On power-on or connecting a sensor the average power value is set by default.

To enable the permanent display in the block diagram, select [Permanent Display State](#).

Remote command:

`:SENSe<ch>[:POWER]:DISPlay:PERManent:PRIority` on page 588

Zero - Power Sensors

Activates the auto zero function.

Zeroing calibrates the external power sensor by adjusting its reading at zero signal power. For this purpose, the RF power source must be switched off or disconnected from the sensor. If a Rohde & Schwarz power sensor receives an input power during the zeroing process, it aborts zeroing and generates an error message. Zeroing takes a few seconds, depending on the sensor model. Refer to the documentation of your power sensor for more information.

Tips for zeroing

When to perform zeroing:

- During warm up after switching on or connecting the instrument
- After a substantial change of the ambient temperature
- After fastening the power sensor module to an RF connector at high temperature
- After several hours of operation
- When low-power signals are to be measured, e.g. less than 10 dB above the lower measurement limit.
- Switch off the RF power source for zeroing, but do not disconnect it from the power sensor. This proceeding keeps the thermal equilibrium, and the zeroing process also compensates the noise that superimposes the measured signal (e.g. from a broadband amplifier).

Remote command:

`:SENSe<ch>[:POWer]:ZERO` on page 594

Source

Selects the source for measurement.

| | |
|--------|--|
| "RF" | Measurement source is the RF signal of the generator. The RF frequency is used as the measurement frequency of the sensor and the corresponding correction factor is used. In this mode the RF frequency of the generator is send to the sensor automatically if changed. |
| "User" | Measurements source is any freely selectable source. The frequency is entered manually under frequency (e.g. for measurement of amplifier gain with 2 sensors). |

Remote command:

`:SENSe<ch>[:POWer]:SOURce` on page 593

Frequency

Source User only

Enters the frequency for measurement source "User".

Remote command:

`:SENSe<ch>[:POWer]:FREQuency` on page 591

Level Offset

Activates and defines a level offset which is added to the measured value. This allows e.g. an attenuator in the signal path to be considered. The offset is always entered in dB, irrespective of the selected unit for result display.

Remote command:

`:SENSe<ch>[:POWer]:OFFSet:STATe` on page 592

`:SENSe<ch>[:POWer]:OFFSet` on page 592

Filter

Determines the length of the filter used for the measurement. The filter length affects the measurement time directly.

The averaging filter is used to reduce fluctuations in the measured result to the extent desired. Such fluctuations can be caused by inherent noise of the measuring instrument, modulation of the measurement signal or beats from the superposition of adjacent carriers. A more stable display has to be traded off against longer measurements. The measurement result is obtained from a two-stage averaging process.

Note: Longer measurements do not mean that it takes longer to display a new result, but rather that it takes longer for the result to settle when the power changes.

Measurements are continuously repeated in a predefined time window. The measurement result is obtained by averaging the measured values for the last $2N$ time windows. The number N is the filter length, the factor of 2 arises because the output signals from the microwave detector to suppress low-frequency noise are chopped at the same rate as the time windows, which means that an independent measured value can only be obtained from two consecutive values. As the filter length is the multiplier for the time window it directly influences the measurement time.

The filter length can be selected automatically or can be manually set to a fixed value. As a preliminary, you should always check if the auto mode is giving satisfactory results because you will always have to adjust an optimal, manual filter-length setting if the power is not constant.

Selection "Fixed Noise" is offered for achieving defined measurement accuracy.

"Auto" The filter length is automatically selected and adapted to the currently measured value. With very high signals the filter length and therefore the measurement time can be short. With very low signal levels the filter length and therefore the measurement time is increased in order to reduce noise. The used filter length is indicated in the field to the right, see [Filter Length](#).

"User" The filter length is set manually. The filter length is entered in the entry window to the right. As the filter length works as a multiplier for the time window, this results in a constant measurement time.

Note: The time window varies depending on the used sensor. For most sensors it is fixed to 20 ms. For the R&S NRP-Z81 sensor it is 10 us. Therefore, the user filter length for the R&S NRP-Z81 has to be about 1000 times larger than the filter length for other sensors in order to achieve the same filtering result.

The [Auto Once](#) button can be used to search for the optimum filter length for the current measurement conditions. The found filter length is indicated in the field to the right, see [Filter Length](#).

"Fixed Noise" The averaging factor is selected so that the sensors intrinsic noise (2 standard deviations) does not exceed the specified noise content. The desired noise content is entered in the entry field to the right, see [Noise Content](#).

To avoid very long settling times when the power is low, the averaging factor can be limited with the [Timeout](#) parameter.

Remote command:

`:SENSe<ch>[:POWER]:FILTer:TYPE` on page 591

Filter Length ← Filter

Indicates the used filter length for filter type "Auto" or "User".

Remote command:

`:SENSe<ch>[:POWer]:FILTer:LENGTh:AUTO?` on page 589

`:SENSe<ch>[:POWer]:FILTer:LENGTh[:USER]` on page 589

Noise Content ← Filter

Sets the noise content for filter type "Fixed Noise".

Remote command:

`:SENSe<ch>[:POWer]:FILTer:NSRatio` on page 589

Timeout ← Filter

Sets a time limit for the averaging process.

Remote command:

`:SENSe<ch>[:POWer]:FILTer:NSRatio:MTIME` on page 590

Auto Once ← Filter

Calculates the optimum filter length for the current measurement conditions and indicates the value in the [Filter Length](#).

Remote command:

`:SENSe<ch>[:POWer]:FILTer:SONCe` on page 590

Use Default Aperture Time

Enables you to specify a user-defined aperture time for the respective sensor.

The sensor default setting is usually sufficient. If however, the readings vary, it is recommended that you adjust the aperture time exactly to one modulation period, in order to obtain stable readings. To specify the aperture time, see [Aperture Time](#).

Remote command:

`:SENSe<ch>[:POWer]:APERTure:DEFAult:STATe` on page 586

Aperture Time

Defines the acquisition time for the respective sensor, provided the entry field is enabled, see [Use Default Aperture Time](#).

For example you can adjust the aperture time exactly to one signal period, in order to obtain a sufficient low average value.

Remote command:

`:SENSe<ch>[:POWer]:APERTure:TIME` on page 586

Use SParameter - Power Sensors

Activates the use of the S-Parameter correction data of the connected power sensor. For sensors with attenuator this checkbox is automatically checked.

Refer to the manual of the connected R&S NRP power sensor for a description on how to use the SParameter table.

Remote command:

`:SENSe<ch>[:POWer]:CORRection:SPDevice:STATe` on page 587

Enable Logging

Activates recording of R&S NRP power sensor readings.

If enabled, every value measured by a connected power sensor and indicated in the user interface, is written to a log file. Per measurement the function logs the measured value (2 readings when you work with peak sensors), the sensor type and the measurement time (time stamp).

The function automatically creates the file name `SensLog<n>.txt` and stores the file in `*txt` format under `/var/user/SensorLogging` on the hard disk. You can enable logging for each connected sensor separately. If enabled, one file per sensor is written.

Note: This specific function is intended for measurements with long time intervals, or if there is a risk that the connection to the sensor can be interrupted and you need the data for reconstruction.

The simplified recording function continuously writes the values in the file of the corresponding sensor number, like `Sens1Log.txt`. When you start a new measurement, the existing data will not be overwritten, but added to the file.

If you use this function, it is recommended that you regularly remove the files from the hard disk, since they require storage capacity.

Remote command:

`:SENSe<ch>[:POWER]:LOGGing:STATe` on page 591

5.5.12 Modulation

5.5.12.1 Overview

The R&S SMBV provides the analog modulations amplitude modulation (AM), frequency modulation (FM), phase modulation (PhiM) and pulse modulation (PM). In addition, the RF signal can be modulated with internal modulations waveforms, e.g. sine waves and rectangular signals.

Amplitude, frequency and phase modulation are available for the basic unit (R&S SMBV + frequency option R&S SMBV-B10x) without additional equipment options. A standard LF generator is provided for internal modulation.

Pulse modulation and a pulse generator are provided by options R&S SMBV-K22, Pulse Modulator and R&S SMBV-K23, Pulse Generator, respectively.

Settings for the modulation are made in separate modulation menus. These menus can be accessed in the block diagram by way of the "RF/A Mod" function block, or by means of the menu with the same name which is opened using the [MENU] key.

Enabling/Disabling Analog Modulations using the MOD On/Off Key

The [MOD ON/OFF] key switches the modulations on and off.

[MOD ON/OFF]

Press the [MOD ON/OFF] key to enable/disable analog modulations.

Pressing the key again restores the status that was active before the last switch-off. "MOD OFF" is displayed in the info line of the header next to the "Level" field.

Remote command:

[\[:SOURce<hw>\]:MODulation\[:ALL\] \[:STATe\]](#) on page 784

Modulation Sources

The following modulations use internal and external modulation sources:

- Amplitude modulation
- Pulse modulation
- Frequency modulation
- Phase modulation

Internal Modulation Sources

An LF generator and a pulse generator are available as internal modulation sources for a fully equipped instrument. The LF generator supplies sinusoidal or rectangular signals.

The optional pulse generator provides single and double pulse modulation with selectable pulse widths and periods.

The noise generator supplies white noise with selectable bandwidth and level distribution.

See also [Chapter 5.5.13.1, "Overview of LF Generator"](#), on page 264.

External Modulation Sources

The modulation input [EXT MOD] at the instrument front provides the external modulation sources for amplitude, frequency and phase modulation.

The external modulation signal for AM, FM and PM at the input must have a voltage of $U_S = 1 \text{ V}$ ($U_{EFF} = 0.707 \text{ V}$) in order to achieve the displayed modulation depth and range. The input voltage should not exceed 1 V, otherwise modulation distortions might occur.

The [PULSE EXT] connector at the rear of the instrument controls the external pulse modulation. The input shows some hysteresis with threshold levels of 0.5 V/1.5 V. The voltage must not exceed 5 V.

Simultaneous Operation of Several Modulations or Other Operating Modes

The table shows the modulations and operating modes which can be activated simultaneously (+) or which deactivate each other (-).

| | AM | FM | PhiM | Pulse | I/Q |
|---------------------------|----|----|------|-------|-----|
| Amplitude modulation (AM) | / | + | + | (+)* | - |
| Frequency modulation (FM) | + | / | - | + | + |
| Phase modulation (PhiM) | + | - | / | + | + |

| | AM | FM | PhiM | Pulse | I/Q |
|-------------------------|------|----|------|-------|-----|
| Pulse modulation | (+)* | + | + | / | + |
| Vector modulation (I/Q) | - | + | + | + | / |

* (+) = compatible with reduced AM modulation performance

5.5.12.2 Amplitude Modulation (AM)

An internal or external source can be selected for amplitude modulation. The LF GEN modulation generator is available as the internal source. The I/Q modulator is used for amplitude modulation. Two-tone AM is possible by simultaneously switching on the external and internal source.

The [MOD EXT] and [PULSE EXT] input connectors for external feed of analog modulation signals are at the rear of the instrument. The coupling mode of the input (AC or DC) can be selected.

It is not possible to use AM simultaneously with:

- I/Q modulation,
- arbitrary waveform generation,
- digital modulation and
- digital standards.

The AM modulation depth is limited by the maximum peak envelope power (PEP).

Amplitude Modulation Settings

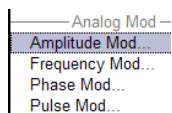

To open the "Amplitude Modulation" dialog, select "RF/A Mod > Configure > Amplitude Modulation" or use the [MENU] key under RF/A Mod.

In the upper section of the dialog, the modulation source is selected and the modulation switched on. The modulation source can be selected independently for the different modulation types and the LF output.

The configuration of the selected external and/or internal modulation source is performed in the lower section of the dialog or in the "LF Output" dialog (internal source only).

These settings affect all modulations which use the same modulation source.

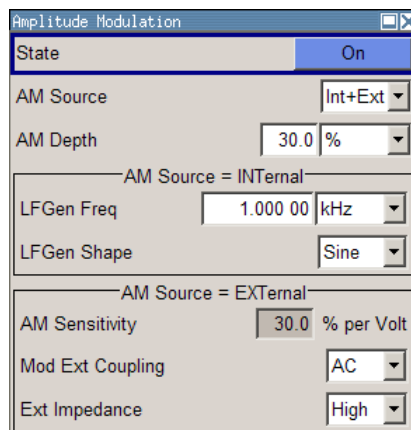

State

Activates amplitude modulation.

Activation of AM deactivates:

- I/Q modulation
- arbitrary waveform generation
- digital modulation
- digital standards

Remote command:

[\[:SOURce<hw>\]:AM:STATe](#) on page 597

AM Source

Selects the source for the AM modulation signal.

"Internal" Uses the internal LF generator as modulation signal source for AM.

"External" Uses an externally applied modulation signal.
The external signal is input via the [EXT MOD] connector.

"Intern + Extern"
Uses both, the internal and externally applied modulation signal, for example to perform two-tone AM.

Remote command:

[\[:SOURce<hw>\]:AM:SOURce](#) on page 597

AM Depth

Sets the modulation depth in percent.

Note: With two-tone modulation, observe that the set modulation depth applies to both signals and the sum modulation depth is determined by doubling the set modulation depth. This results in overmodulation if the maximal value for modulation depth is exceeded (see data sheet).

Remote command:

[\[:SOURce<hw>\]:AM\[:DEPTH\]](#) on page 595

LF Gen Freq

Sets the frequency of the LF generator.

This setting affects all analog modulations which use the LF generator as the internal modulation source.

Remote command:

[\[:SOURce\]:LFOutput:FREQuency](#) on page 763

LF Gen Shape

Selects the waveform shape of the LF signal.

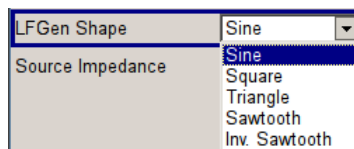

Note: The installed hardware determines the available settings. Use the [Hardware Config](#) dialog to check the hardware the instrument is equipped with.

For information on the required hardware revision, refer to the release notes.

Remote command:

[\[:SOURce\]:LFOutput:SHAPE](#) on page 771

AM Sensitivity

Displays the input sensitivity of the externally applied modulation signal at the [EXT MOD] input in %/V.

The modulation depth entered under [AM Depth](#) is achieved with 1 Volt modulation of the input.

Remote command:

[\[:SOURce<hw>\]:AM:SENSitivity?](#) on page 596

Mod Ext Coupling

Selects the coupling mode (AC or DC) for external feed.

Note: Coupling for external feed via input [EXT MOD] can be set independently for all modulations using the external modulation signal.

"AC" Disconnects the DC voltage component and uses only the AC component of the modulation signal.

"DC" Uses the modulation signal with both components, AC and DC.

Remote command:

[\[:SOURce<hw>\]:AM:EXTernal:COUpling](#) on page 596

Ext. Impedance

(Source "External" only)

Sets the impedance for the external modulation signal, applied at the [EXT MOD] connector.

You can select 600 Ohm or high (>100 kOhm).

This setting affects all analog modulations which use the external modulation signal.

Remote command:

[\[:SOURce<hw>\]:INPut:MODext:IMPedance](#) on page 748

5.5.12.3 Frequency Modulation (FM)

An internal and/or external source can be selected for frequency modulation. The LF GEN modulation generator is available as the internal source. Two-tone FM is possible by simultaneously switching on the external and internal source.

The [MOD EXT] and [PULSE EXT] input connectors for external feed of analog modulation signals are at the rear of the instrument. The coupling mode of the input (AC or DC) can be selected.

Selection between three modulation modes is possible:

- "Normal" mode with full setting range for modulation bandwidth and FM deviation.
- "Low Noise" mode with better signal/noise ratio, but reduced setting range for modulation bandwidth
- "High Deviation" mode with full setting range for FM deviation and a reduced setting range for modulation bandwidth (see data sheet).



It is not possible to use frequency modulation simultaneously with phase modulation. See ["Simultaneous Operation of Several Modulations or Other Operating Modes"](#) on page 252 for an overview in detail.

Frequency Modulation Settings

— Analog Mod —
Amplitude Mod...
Frequency Mod...
Phase Mod...
Pulse Mod...

To access the "Frequency Modulation" dialog, select "RF/A Mod > Configure > Frequency Modulation" or use the [MENU] key under "RF/A Mod".

In the upper section of the dialog, you can select the modulation source and activate modulation. The modulation source can be selected independently for the different modulation types and the LF output.

The configuration of the selected external and/or internal modulation source is performed in the lower section of the menu (internal source only).

These settings affect all modulations which use the same modulation sources.

State

Activates frequency modulation.

Activation of FM deactivates phase modulation.

Remote command:

[:SOURce<hw>] :FM:STATe on page 739

FM Source

Selects the source for the FM signal.

"Internal" Uses the internal LF generator as modulation signal source for FM.

"External" Uses an externally applied modulation signal.
The external signal is input via the [EXT MOD] connector.

"Internal + External"
Uses both, the internal and externally applied modulation signal, for example to perform two-tone FM.

Remote command:

[:SOURce<hw>] :FM:SOURce on page 738

FM Mode

Selects the mode for the frequency modulation.

"Normal" The maximum range for modulation bandwidth and FM deviation is available.

"Low Noise" Frequency modulation with phase noise and spurious characteristics close to CW mode. The ranges of modulation bandwidth and FM deviation are reduced (see data sheet).

"High Deviation"
Frequency modulation with full setting range for FM deviation. The range of modulation bandwidth is reduced (see data sheet).

Remote command:

[:SOURce<hw>] :FM:MODE on page 737

FM Deviation

Sets the modulation deviation in Hz.

The deviation is given as the absolute deviation in relation to the set center frequency. For example, a deviation of 5 MHz at a center frequency of 1 GHz leads to a frequency modulation between 995 MHz and 1005 MHz.

The maximum deviation depends on the RF frequency and the modulation mode (see data sheet).

Note that you can set a deviation that is too high for a specific RF frequency, or set an RF frequency outside of the adjustable range of the deviation. In both cases, the instrument sets the maximum deviation and displays an error message.

In "Int + Ext" modulation source mode, the instrument divides the deviation into half for each source.

Remote command:

[\[:SOURce<hw>\]:FM\[:DEVIation\]](#) on page 736

[\[:SOURce<hw>\]:FM:INTernal:DEVIation](#) on page 737

[\[:SOURce<hw>\]:FM:EXTernal:DEVIation](#) on page 737

LF Gen Freq

Sets the frequency of the LF generator.

This setting affects all analog modulations which use the LF generator as the internal modulation source.

Remote command:

[\[:SOURce\]:LFOutput:FREQuency](#) on page 763

LF Gen Shape

Selects the waveform shape of the LF signal.

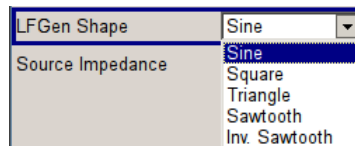

Note: The installed hardware determines the available settings. Use the [Hardware Config](#) dialog to check the hardware the instrument is equipped with.

For information on the required hardware revision, refer to the release notes.

Remote command:

[\[:SOURce\]:LFOutput:SHAPE](#) on page 771

FM Sensitivity

Displays the input sensitivity of the externally applied modulation signal at the [EXT MOD] input in Hz/V.

The modulation deviation entered with [FM Deviation](#) is achieved with 1 Volt (= U_{peak}) of the input signal.

Note: The input voltage must not exceed 1.1 V_p otherwise modulation distortions occur.

Remote command:

[\[:SOURce<hw>\]:FM:SENSitivity?](#) on page 738

Adjust FM Offset

Starts the adjustment for the FM/PhiM modulator. The option is adjusted concerning DC-offset.

Remote command:

[:CALibration<hw>:FMOffset\[:MEASure\]?](#) on page 552

Mod Ext Coupling

(Source "External" only)

Selects the coupling mode (AC or DC) for the externally applied frequency modulation signal.

Note: Coupling for external feed via input [EXT MOD] can be set independently for all modulations using the external modulation signal.

"AC" Disconnects the DC voltage component and uses only the AC component of the modulation signal.

"DC" Uses the modulation signal with both components, AC and DC.

Remote command:

`[:SOURce<hw>] :FM:EXTernal:COUpling` on page 736

Ext. Impedance

(Source "External" only)

Sets the impedance for the external modulation signal, applied at the [EXT MOD] connector.

You can select 600 Ohm or high (>100 kOhm).

This setting affects all analog modulations which use the external modulation signal.

Remote command:

`[:SOURce<hw>] :INPut:MODext:IMPedance` on page 748

5.5.12.4 Phase Modulation (PhiM)



It is not possible to use phase modulation simultaneously with frequency modulation. See "[Simultaneous Operation of Several Modulations or Other Operating Modes](#)" on page 252 for an overview in detail.

An internal and/or external source can be selected for phase modulation. The [LF GEN] modulation generator is available as the internal source.

The [EXT MOD] and [PULSE EXT] input connectors for external feed of analog modulation signals are at the rear of the instrument. The coupling mode of the input (AC or DC) and the impedance can be selected.

Selection between the following modulation modes is possible:

- "Normal" mode with full setting range for modulation bandwidth and PhiM deviation.
- "High Deviation" mode with full setting range for PhiM deviation and a reduced setting range for modulation bandwidth. Phase noise is reduced in the lower modulation frequency range compared to the default mode.
- "Low Noise" mode with better signal/noise ratio, but reduced setting range for modulation bandwidth and deviation (see data sheet)

Phase Modulation Dialog

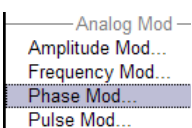

To open the "Phase Modulation" dialog, select "RF/A Mod > Configure > Phase Modulation" or use the [MENU] key under "RF/A Mod".

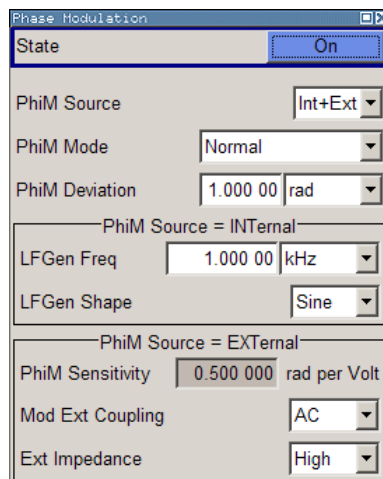

In the upper section of the dialog, the modulation source is selected and the modulation switched on. The modulation source can be selected independently for the different modulation types and the LF output.

The configuration of the selected external and/or internal modulation source is performed in the lower section of the dialog (internal source only).

These settings affect all modulations which use the same modulation sources.

State

Activates PhiM modulation.

Activation of PhiM deactivates frequency modulation.

Remote command:

[\[:SOURce<hw>\]:PM:STATe](#) on page 789

PhiM Source

Selects the source for the PhiM signal.

"Internal" Uses the internal LF generator as the modulation signal source for PhiM.

"External" Uses an externally applied modulation signal.
The external signal is input via the [EXT MOD] connector.

"Internal + External"
Uses both, the internal and externally applied modulation signal.

Remote command:

[\[:SOURce<hw>\]:PM:SOURce](#) on page 789

PhiM Mode

Selects the mode for the phase modulation.

"Normal"
The full range for modulation bandwidth and PM deviation is available.

"High Deviation"

The maximum range for ϕ M deviation is available. Phase noise is improved for low frequencies compared to the default mode. The range of modulation frequency is limited (see data sheet). This mode is recommended for low modulation frequencies and/or high PhiM deviation.

"Low Noise"

Phase modulation with phase noise and spurious characteristics close to CW mode. The range for modulation bandwidth and PM deviation is limited (see data sheet).

Remote command:

`[:SOURce<hw>] :PM:MODE` on page 788

PhiM Deviation

Sets the modulation deviation in RAD.

The maximum deviation depends on the set RF frequency and the selected modulation mode (see data sheet).

If the entered deviation is too high for the set RF frequency, the instrument provides the maximum value and displays an error message. The same applies, if the RF frequency is set to a value, at which the deviation cannot be determined.

The deviation of the internal source must not exceed the deviation of the external source in case of modulation source "Int+Ext".

Remote command:

`[:SOURce<hw>] :PM[:DEVIation]` on page 787

`[:SOURce<hw>] :PM:INTernal:DEVIation` on page 788

`[:SOURce<hw>] :PM:EXTernal:DEVIation` on page 787

LF Gen Freq

Sets the frequency of the LF generator.

This setting affects all analog modulations which use the LF generator as the internal modulation source.

Remote command:

`[:SOURce] :LFOutput:FREQuency` on page 763

LF Gen Shape

Selects the waveform shape of the LF signal.

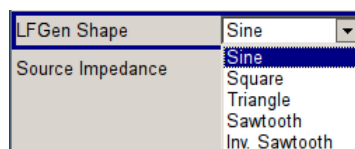

Note: The installed hardware determines the available settings. Use the [Hardware Config](#) dialog to check the hardware the instrument is equipped with.

For information on the required hardware revision, refer to the release notes.

Remote command:

`[:SOURce] :LFOutput:SHAPE` on page 771

PhiM Sensitivity

Displays the input sensitivity of the externally applied modulation signal at the [EXT MOD] input in RAD/V.

The modulation deviation entered with **PhiM Deviation**"PhiM Deviation" is achieved with 1 Volt ($=U_{\text{peak}}$) of the input signal.

Note: The input voltage must not exceed $1.1 V_p$ otherwise modulation distortions occur.

Remote command:

`[:SOURce<hw>] :PM:SENSitivity?` on page 788

Mod Ext Coupling

Selects the coupling mode ("AC" or "DC") for the external modulation signal.

Note: Coupling for external feed via input [EXT MOD] can be set independently for all modulations using the external modulation signal.

"AC" Disconnects the DC voltage component and uses only the AC component of the modulation signal.

"DC" Uses the modulation signal with both components, AC and DC.

Remote command:

`[:SOURce<hw>] :PM:EXTernal:COUpling` on page 787

Ext. Impedance

(Source "External" only)

Sets the impedance for the external modulation signal, applied at the [EXT MOD] connector.

You can select 600 Ohm or high (>100 kOhm).

This setting affects all analog modulations which use the external modulation signal.

Remote command:

`[:SOURce<hw>] :INPut:MODext:IMPedance` on page 748

5.5.12.5 Pulse Modulation (PM)

External and internal Pulse modulation requires options R&S SMBV-K22, Pulse Modulator and R&S SMBV-K23, Pulse Generator.

As modulation signal, you can either use the signal of the internal pulse generator or an externally supplied signal. In case of external source, the external signal is input via the [PULSE EXT] connector at the rear of the instrument. In case of internal source, this connector can be used as external trigger or gate signal input for internal pulse modulation. The polarity and input impedance of the connector can be selected.

The pulse signal is output at the [PULSE VIDEO] connector at the rear of the instrument.



Automatic Level Control is deactivated with pulse modulation!

When pulse modulation is activated, the R&S SMBV deactivates ALC automatically ("ALC OFF", i.e. switches to "Sample & Hold" state).

The "Sample & Hold" state opens the ALC loop, and disables the automatic control of the output level. The level modulator is set directly.

However, to correct the output level, the R&S SMBV executes a "Sample & Hold" measurement after each change of frequency or level settings.

The level is decreased by 30 dB during "Sample & Hold" measurement.

Pulse Modulation Settings

To open the "Pulse Modulation" menu, select "RF/A Mod > Configure > Pulse Modulation" or use the [MENU] key under "RF/A Mod".

In the upper section of the menu, the modulation source is selected and the modulation switched on. The configuration of the selected external and/or internal modulation source is performed in the lower section of the menu.

The menu varies according to the selected modulation source.

- Analog Modulation —
- Amplitude Modulation...
- Frequency Modulation...
- Phase Modulation...
- Pulse Modulation...

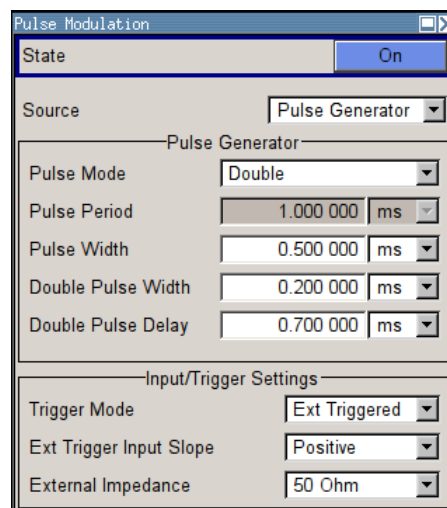

In case of modulation source pulse generator, the settings for the pulse characteristics and the trigger are provided in the "Pulse Generator" section of the "Pulse Modulation" dialog. Option R&S SMBV-K23 provides extended features, for example generation of double pulse or selection of trigger mode. For description of the pulse generator dialog, see [Chapter 5.5.13.4, "Pulse Generator"](#), on page 272.

The output of the video/sync signal at the [PULSE VIDEO] output is automatically switched on when activating pulse modulation. It can be switched off in the "Pulse Generator" dialog.

State

Activates pulse modulation.

Activation of pulse modulation deactivates ALC and power ramping.

When the internal modulation source (pulse generator) is selected, the pulse generator is switched on automatically and the video/sync signal is output at the [PULSE VIDEO] output at the rear of the instrument. Signal output can be switched off in the "Pulse Generator" dialog (see [Chapter 5.5.13.4, "Pulse Generator"](#), on page 272).

Remote command:

`[:SOURce<hw>] :PULM:STATe` on page 805

Source

Selects the modulation signal source for pulse modulation.

"Pulse Generator"

Uses the pulse generator as modulation signal source.

The settings for the pulse characteristics and the trigger are offered in the "Pulse Generator" section of the "Pulse Modulation" menu.

"External"

Uses an externally applied modulation signal.

The external modulation signal is input via the [EXT MOD] connector.

Remote command:

`[:SOURce<hw>] :PULM:SOURce` on page 805

Polarity

(External Source only)

Selects the polarity of the modulation signal.

"Normal"

The RF signal is **On** while the level is high at the modulation input.

"Inverted"

The RF level is ON while the level is LOW at the modulation input.

Remote command:

`[:SOURce<hw>] :PULM:POLarity` on page 805

5.5.13 Modulation Generator and LF Output

5.5.13.1 Overview of LF Generator

The internal modulation generator of the instrument provides a sinusoidal or rectangular LF modulation signal without additional equipment options. The corresponding key data, as for example the frequency range, is specified under "Modulation sources" in the data sheet.

You can use the internal LF signal as modulation signal source for the analog modulations, as for example the amplitude modulation. The signal applies to all modulations which are using the internal modulation signal. Therefore, any modification of the LF signal impacts all currently active modulations immediately.

To configure the LF generator signal, see "[LF Output Dialog](#)" on page 265. However, you can also configure the LF signal directly in the settings dialogs of the analog modulations.

Optionally, the instrument provides the following modulation sources:

- Pulse Generator (option R&S SMBV-K23) for generating single and double pulse signals, see [Chapter 5.5.13.4, "Pulse Generator"](#), on page 272.

The R&S SMBV also provides the configured LF signal at the corresponding output connector, for example as modulation signal source for interconnected instruments.

5.5.13.2 LF Output

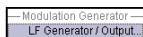

- ▶ To open the "LF Generator / Output" dialog, select "RF/A Mod > Configure > LF Generator / Output" or use the [MENU] key under RF/A Mod.

The dialog provides access to the configuration of the internal modulation generators, and you can activate the output of the LF signal

The available settings depend on the source selected and on the installed options. Alternatively, you can perform the settings also in the corresponding dialogs of the analog modulations, like "Amplitude Modulation". The configured LF signal applies to all modulations which use the internal modulation sources, and to the LF output.

The remote commands required to define these settings are described in [Chapter 7.15.11, "SOURCE:LFOutput Subsystem"](#), on page 762.

LF Output Dialog

LF Output State

Activates the LF output. This setting has no effect on the modulations.

The modulation signal is output at the [LF output] connector of the instrument.

Remote command:

`[:SOURCE] :LFOutput [:STATe]` on page 765

Display LF Gen Level as Voltage of EMF

Activates the display of the signal level as voltage of the EMF (no-load voltage). If this setting is deactivated, the level is displayed as a voltage over a 50 Ohm load (preset state).

Note: This setting is not affected by an instrument preset ([Preset] key), *RST) or the "Save/Recall" function. Only the [Chapter 5.2.3.20, "Factory Preset"](#), on page 155 resets the setting.

Remote command:
n.a.

LF Output Voltage

Sets the voltage (peak) of the LF output signal.

Remote command:
[\[:SOURce\]:LFOutput:VOLTage](#) on page 772

LF Gen Freq

Sets the frequency of the LF generator.

This setting affects all analog modulations which use the LF generator as the internal modulation source.

Remote command:
[\[:SOURce\]:LFOutput:FREQuency](#) on page 763

LF Gen Shape

Selects the waveform shape of the LF signal.

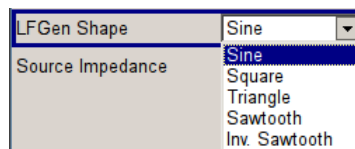

Note: The installed hardware determines the available settings. Use the [Hardware Config](#) dialog to check the hardware the instrument is equipped with.

For information on the required hardware revision, refer to the release notes.

Remote command:
[\[:SOURce\]:LFOutput:SHAPE](#) on page 771

LF Source Impedance

Selects the output impedance of the LF generator. Selection LOW and 600 Ohm are available.

For instruments with older version of the RF board, the LF output impedance is forced to LOW and cannot be changed.

Remote command:
[\[:SOURce\]:LFOutput:SIMPedance](#) on page 771

5.5.13.3 LF Frequency Sweep

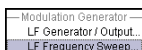

The "LF Frequency Sweep" dialog is used to configure and activate an LF frequency sweep signal.

To open the "LF Frequency Sweep" dialog, select "RF/A Mod > Configure > LF Frequency Sweep" or use the [MENU] key under "RF/A Mod".

The LF sweep mode is activated and the sweep mode is selected. The buttons are used to reset the LF sweep (all sweep modes) or to execute the LF sweep ("Single" mode).

The sweep range, sweep spacing and dwell time are set in the bottom of the section.

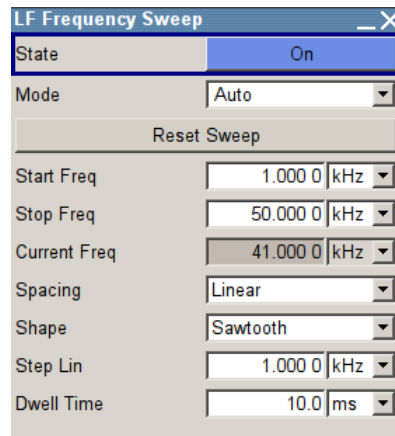

State

Activates the LF frequency sweep signal generation.

Note:

Activating a sweep mode automatically deactivates other sweeps and the list mode.

Remote command:

[\[:SOURce<hw>\]:LFOutput:FREQuency:MODE](#) on page 764

Mode

Selects the LF frequency sweep mode.

If you change the sweep mode during the execution, the signal generator stops the sweep and starts with the next trigger event at the initial value.

The "Reset Sweep" button sets the sweep to the start value.

"Auto" Generates a continuously repeating sweep signal immediately after activating the sweep mode.
The sweep steps are performed automatically, controlled by the dwell time, see "[Dwell Time - LF Sweep](#)" on page 271.

Example:

```
SOUR:LFO:SWE:FREQ:MODE AUTO
TRIG0:SWE:SOUR AUTO
SOUR:LFO:FREQ:MODE SWE
```

"Single" Generates a single sweep cycle after a trigger event. The sweep steps within the cycle are performed automatically, controlled by the dwell time. If one cycle is completed, the instrument waits for the next trigger event. To trigger the sweep, use "Execute Single Sweep" button, or the corresponding remote control commands, for example *TRG.

Example:

```
SOUR:LFO:SWE:FREQ:MODE AUTO
TRIG0:SWE:SOUR SING
SOUR:LFO:FREQ:MODE SWE
SOUR:LFO:SWE:FREQ:EXEC
```

"Step" Generates the sweep signal step-by-step, manually triggered. To perform the sweep steps, enter the frequency value under [Current Freq](#) .

Example:

```
SOUR:LFO:SWE:FREQ:MODE MAN
SOUR:LFO:FREQ:MODE SWE
SOUR:LFO:SWE:FREQ:SPAC LIN
SOUR:LFO:SWE:FREQ:STEP:LIN 1E34
SOUR:LFO:FREQ:MAN 12 kHz
```

The value entered with command

`SOUR:LFO:SWE:FREQ:STEP:LIN|LOG` sets the step width.

The value entered with command `SOUR:LFO:FREQ:MAN` has no effect, the command only sets the next sweep step. In remote control only a step-by-step sweep from start to stop frequency is possible.

"Extern Single"

Generates a single sweep cycle when an external trigger event occurs.

The sweep steps within the cycle are performed automatically, controlled by the dwell time. If one cycle is completed, the instrument waits for the next trigger event.

To trigger the sweep, apply an external trigger signal.

Refer to the description of the rear panel for information on the connectors for external trigger signal input (see [Chapter 2.2, "Rear Panel Tour"](#), on page 28).

Example:

```
SOUR:LFO:SWE:FREQ:MODE AUTO
TRIG0:SWE:SOUR EXT
SOUR:LFO:FREQ:MODE SWE (External trigger)
```

"Extern Step" Generates the sweep signal step-by-step, manually triggered. To trigger a sweep step, apply an external trigger signal. The step width corresponds to the step width set for the rotary knob.

Example:

```
SOUR:LFO:SWE:FREQ:MODE AUTO
TRIG0:SWE:SOUR EXT
SOUR:LFO:FREQ:MODE SWE (External trigger)
```

"Extern Start/Stop" Generates a continuously repeating sweep signal that is started, stopped and restarted by subsequent external trigger events. The sweep steps are performed automatically, controlled by the dwell time. Refer to the description of the rear panel for information on the connectors for the external trigger signal input (see [Chapter 2.2, "Rear Panel Tour"](#), on page 28).

Example:

```
SOUR:LFO:SWE:FREQ:MODE AUTO
TRIG0:SWE:SOUR EAUT
SOUR:LFO:FREQ:MODE SWE (External trigger)
```

Remote command:

```
[ :SOURce<hw> ] :LFOutput :SWEep [ :FREQuency ] :MODE on page 766
:TRIGger<hw> [ :SWEep ] :SOURce on page 852
[ :SOURce<hw> ] :LFOutput :FREQuency :MODE on page 764
```

Execute Single Sweep

Starts a sweep manually. This trigger button is displayed in "Single" mode.

Example:

```
SOUR:LFO:SWE:FREQ:MODE AUTO
TRIG:LFFS:SWE:SOUR SING
TRIG:LFFS
```

Remote command:

```
[ :SOURce<hw> ] :LFOutput :SWEep [ :FREQuency ] :EXECute on page 766
:TRIGger<hw> :LFFSweep :IMMediate on page 851
:TRIGger<hw> :LFFSweep on page 850
:TRIGger<hw> [ :IMMediate ] on page 853
```

Reset Sweep

Resets a sweep.

With the next trigger event, the sweep starts with at the initial value.

Remote command:

```
[ :SOURce<hw> ] :SWEep :RESet [ :ALL ] on page 821
```

Start Freq

Sets the start frequency.

Remote command:

[\[:SOURce<hw>\]:LFOutput:FREQuency:STARt](#) on page 765

Stop Freq

Sets the stop frequency.

Remote command:

[\[:SOURce<hw>\]:LFOutput:FREQuency:STOP](#) on page 765

Current Freq

Displays the current frequency.

In sweep "Step" mode, the parameter is editable and you can enter frequency for the next step.

Remote command:

[\[:SOURce<hw>\]:LFOutput:FREQuency:MANual](#) on page 763

Spacing

Selects the mode for the calculation of the frequency sweep intervals.

"Linear" Takes the frequency value entered as an absolute value in Hz

"Logarithmic" Takes the value entered as a logarithmic value, that means as a constant fraction of the current frequency in %.

Remote command:

[\[:SOURce<hw>\]:LFOutput:SWEep\[:FREQuency\]:SPACing](#) on page 769

Shape

Selects the waveform shape of the sweep signal.

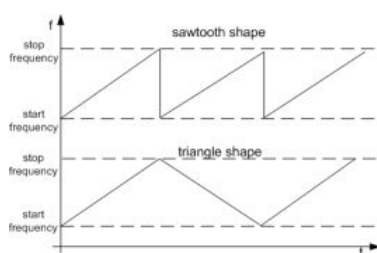

"Sawtooth" The sweep runs from the start to the stop frequency. Each subsequent sweep starts at the start frequency, that means the shape of the sweep sequence resembles a sawtooth.

"Triangle" The sweep runs from start to stop frequency and back, that means the shape of the sweep resembles a triangle. A subsequent sweep starts at the start frequency.

Remote command:

[\[:SOURce<hw>\]:LFOutput:SWEep\[:FREQuency\]:SHAPE](#) on page 769

Retrace - LF Frequency Sweep

Activates that the signal changes to the start frequency value while it is waiting for the next trigger event.

You can enable this feature, when you are working with sawtooth shapes in sweep mode "Single" or "External Single", see [Mode](#) .

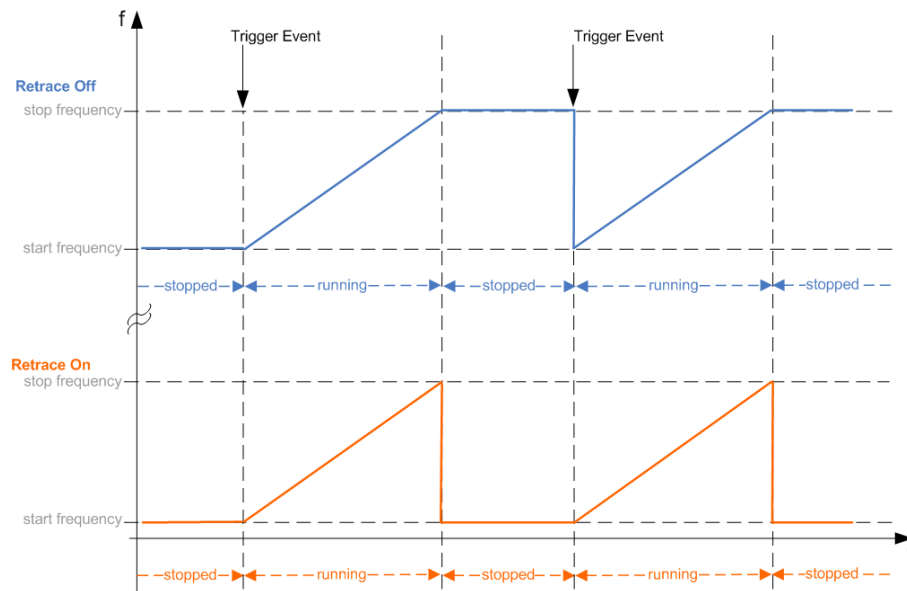

Remote command:

`[:SOURce<hw>] :LFOutput :SWEep [:FREQuency] :RETRace` on page 768

Step Lin/Log - LF Sweep

Sets the step width for the individual frequency sweep steps.

At each step this value is added to the current frequency.

Depending on the [Spacing](#) mode you have set, the corresponding parameter is displayed.

"Step Lin" The step width is a constant value in Hz.

Remote command:

`[:SOURce<hw>] :LFOutput :SWEep [:FREQuency] :STEP [:LINear]` on page 769

"Step Log" The step width is determined logarithmically in %, that means as a constant fraction of the current frequency.

Remote command:

`[:SOURce<hw>] :LFOutput :SWEep [:FREQuency] :STEP :LOGarithmic`
on page 770

Dwell Time - LF Sweep

Defines the duration of the individual sweep steps.

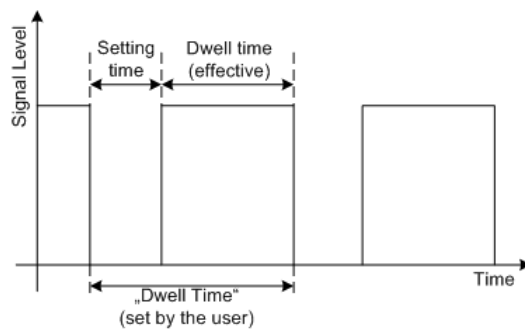

The "Dwell Time" set by the user is used as the step time of the sweep. The effective net dwell time is shorter, reduced by the setting time. This setting time may be greater than the time specified in the data sheet.

Note:

It is recommended to switch off the display update for optimum sweep performance especially with short dwell times (see [Chapter 5.2.3.7, "Display Update"](#), on page 132).

Remote command:

`[:SOURce<hw>] :LFOutput :SWEep [:FREQuency] :DWELl` on page 766

Ext. Trigger Input Slope

Sets the polarity of the active slope of an externally applied instrument trigger.

This setting affects the TRIG input (BNC connector at the rear of the instrument).

"Positive" activates the rising edge of the trigger signal.

"Negative" activates the falling edge of the trigger signal.

Remote command:

`[:SOURce] :INPut :TRIGger :SLOPe` on page 749

5.5.13.4 Pulse Generator

The "Pulse Generator" dialog is used to configure and activate a pulse modulation signal.

Pulse Generator Settings



To access the pulse generator settings ...

- ▶ Select "RF/A Mod > config... > Pulse Generator" or use the [MENU] key under "RF/A Mod". Alternatively, you can configure the pulse generator in the "Pulse Modulation" dialog of the "RF/A Mod" block.

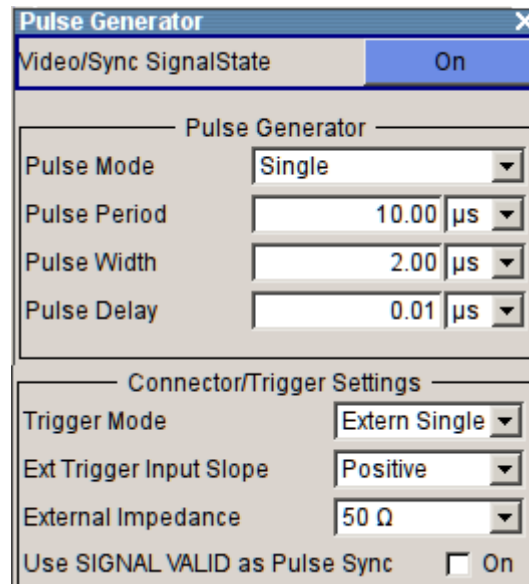

The dialog provides the settings for the pulse characteristics and trigger mode. Depending on the selected modulation source and pulse mode the provided parameters vary.

Video Sync Signal State - Pulse Generator

Switches on/off the output of the video/sync signal at the [PULSE VIDEO] connector. The signal output and the pulse generator are automatically switched on with activation of pulse modulation if pulse generator is selected as modulation source. The signal output can be switched off subsequently.

Remote command:

[\[:SOURCE<hw>\]:PGENERATOR:STATE](#) on page 785

Pulse Mode - Pulse Generator

Sets the mode of the pulse generator.

"Single" A single pulse is generated in one pulse period.

"Double" Two pulses are generated in one pulse period. Additional settings for the double pulse are available in the menu.

Remote command:

[\[:SOURCE<hw>\]:PULM:MODE](#) on page 803

Pulse Period - Pulse Generator

Sets the period of the generated pulse. The period determines the repetition frequency of the internal signal.

Remote command:

[\[:SOURCE<hw>\]:PULM:PERIOD](#) on page 804

Pulse Width - Pulse Generator

Sets the width of the generated pulse. The width determines the pulse length. The pulse width must be at least 20 ns less than the set pulse period.

Remote command:

`[:SOURce<hw>] :PULM:WIDTh` on page 807

Pulse Delay - Pulse Generator

(External trigger only)

Sets the pulse delay. The pulse delay determines the time that elapses after a trigger event before pulse modulation starts. The pulse delay is not effective for double pulse generation.

Remote command:

`[:SOURce<hw>] :PULM:DELay` on page 802

Double Pulse Width - Pulse Generator

(Double Pulse only)

Sets the width of the second pulse.

Remote command:

`[:SOURce<hw>] :PULM:DOUBle:WIDTh` on page 803

Double Pulse Delay - Pulse Generator

(Double Pulse only)

Sets the delay from the start of the first pulse to the start of the second pulse.

Remote command:

`[:SOURce<hw>] :PULM:DOUBle:DELay` on page 802

Trigger Mode - Pulse Generator

Selects the trigger mode for pulse modulation.

Note: An external trigger signal is supplied via the [PULSE EXT] connector.

"Auto"

The pulse generator signal is generated continuously.

"Ext Triggered"

The pulse generator signal is triggered by an external trigger event.

Example: Generation of pulse signals using trigger modes Ext Triggered (Single Pulse)

The measurement is performed using a 6-dB-attenuator.

| Parameter | Value |
|------------------------------|---------------|
| Trigger Mode | Ext Triggered |
| Double Pulse State | Off |
| External Trigger Input Slope | Positive |
| Pulse Delay | 100 ns |
| Pulse Width | 100 ns |
| Pulse Period | - |

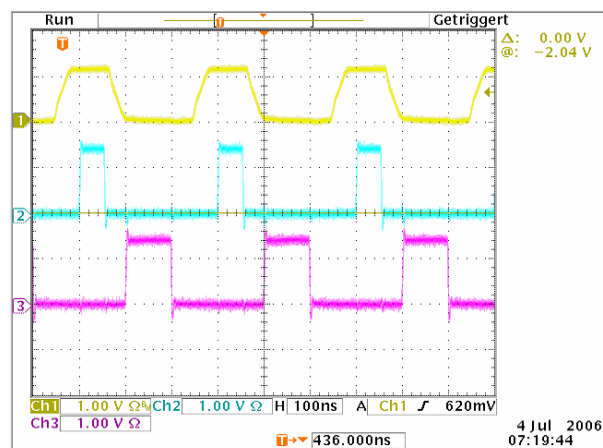

Channel 1 = Indicates the external trigger signal. The positive slope is active.

Channel 2 = Indicates the sync signal. The sync signal starts after a trigger delay of typically 50 ns (see specifications).

Channel 3 = Indicates the pulse signal. The pulse signal starts after the set pulse delay of 100 ns.

Note: The sync signal is output at the [PULSE SYNC] connector, and the pulse signal at the [PULSE VIDEO] connector.

Example: Generation of pulse signals using trigger modes Ext Triggered (Double Pulse)

The measurement were made using a 6-dB-attenuator.

| Parameter | Value |
|------------------------------|---------------|
| Trigger Mode | Ext Triggered |
| Double Pulse State | On |
| External Trigger Input Slope | Negative |
| Pulse Width | 100 ns |

| Parameter | Value |
|---------------------------|--------|
| Double Pulse Width | 100 ns |
| Double Pulse Delay | 200 ns |
| Pulse Period, Pulse Delay | - |

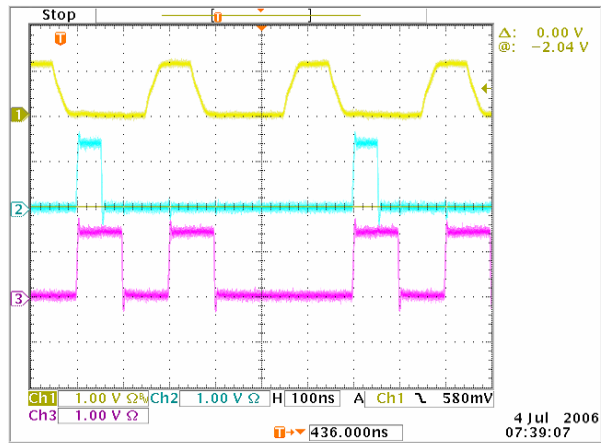

Channel 1 = Indicates the external trigger signal. The negative slope is active. A second trigger signal during double pulse generation is without effect.

Channel 2 = Indicates the sync signal. The sync signal starts after a trigger delay of typically 50 ns (see specifications).

Channel 3 = Indicates the double pulse signal. The first pulse starts without a delay. The second pulse starts after the set double pulse delay (time between start of first pulse to start of second pulse).

Note: The sync signal is output at the [PULSE SYNC] connector, and the double pulse signal at the [PULSE VIDEO] connector.

"Ext Gated"

The pulse generator signal is gated by an external gate signal.

Example: Generation of pulse signals using trigger mode External Gated (Single Pulse)

The measurement is performed using a 6-dB-attenuator.

| Parameter | Value |
|------------------------------|--------------|
| Trigger Mode | Extern Gated |
| Double Pulse State | Off |
| External Trigger Input Slope | Positive |
| Pulse Delay | 100 ns |
| Pulse Width | 100 ns |
| Pulse Period | 300 ns |

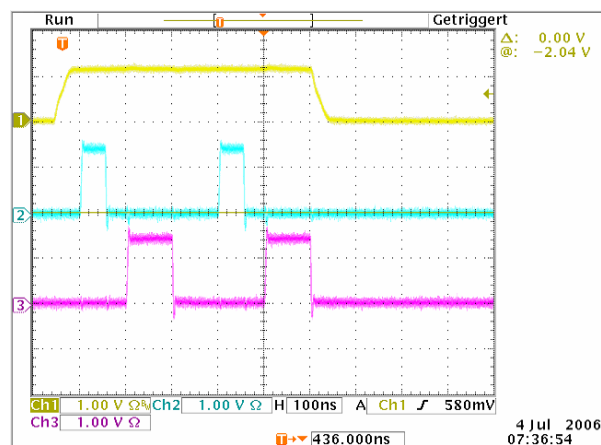

Channel 1 = Indicates the external gate signal. The signal is active when it is high (positive).

Channel 2 = Indicates the sync signal. The sync signal starts after a trigger delay of typically 50 ns (see specifications). It is repeated after the set pulse period of 300 ns as long as the gate signal is active.

Channel 3 = Indicates the pulse signal. The first pulse starts after the pulse delay of 100 ns. The second pulse starts after the set pulse period.

Remote command:

`[:SOURce<hw>] :PULM:TRIGger:MODE` on page 807

External Trigger Input Slope - Pulse Generator

(External Trigger only)

Sets the polarity of the active slope of an applied trigger signal.

"Positive" The pulse generator is triggered on the positive slope of the external trigger signal.

"Negative" The pulse generator is triggered on the negative slope of the external trigger signal.

Remote command:

`[:SOURce<hw>] :PULM:TRIGger:EXTernal:SLOPe` on page 806

Gate Input Polarity - Pulse Generator

(Trigger Mode External Gated only)

Selects the polarity of the Gate signal.

The signal is supplied via the [PULSE EXT] connector.

"Normal" The pulse signal is generated while the gate signal is high.

"Inverse" The pulse signal is generated while the gate signal is low.

Remote command:

`[:SOURce<hw>] :PULM:TRIGger:EXTernal:GATE:POLarity` on page 806

External Impedance

Selects the input impedance (10 kOhm or 50 Ohm) for the external trigger and gate signal input ([PULSE EXT]).

Remote command:

`[:SOURce<hw>] :PULM:TRIGger:EXTernal:IMPedance` on page 806

Use SIGNAL VALID as Pulse Sync

Configures the signal at the [SIGNAL VALID] connector (rear panel):

"selected" Indicates the validity of the RF signal at the output:

- **high:** while the signal settles.
- **low:** when it is stable (valid).

"cleared" Generates a single pulse at the beginning of a pulse sequence, e.g. to synchronize pulse modulation.

Remote command:

`[:SOURce<hw>] :PULM:OUTPut:SYNC [:STATe]` on page 804

5.5.14 RF Sweep and List Mode

5.5.14.1 Overview

The R&S SMBV offers three different sweep types (frequency sweep, level sweep and LF sweep) to be activated alternatively. Each type has 6 modes which differ with respect to the sweep cycle mode (continuous, individual and step-by-step) and triggering mode (automatic, internal and external).



- Sweeps and list mode can not be activated simultaneously, they deactivate each other.
- Activating a sweep mode immediately disables [NRP Level Control](#). Vice versa, a running sweep mode blocks "NRP Level Control". It can not be activated.
- If you want to remain at a specific frequency or level value during a sweep, enter the value directly in the status bar. The sweep stops immediately.

Setting a sweep

A sweep is set in five basic steps which are shown below taking a frequency sweep as an example.

1. Set the sweep range ("Start Freq" and "Stop Freq" or "Center Freq" and "Span").
2. Select linear or logarithmic sweep spacing ("Spacing").
3. Set the step width ("Step Lin/Log") and dwell time ("Dwell Time").
4. Activate the sweep ("Mode" to Auto, Single, Step or Extern Single, Extern Step).
5. Trigger the sweep, except for Auto mode ("Execute Single Sweep", Current Frequency or External Trigger Signal).



It is recommended to switch off the display update for optimum sweep performance especially with short dwell times (see [Chapter 5.2.3.7, "Display Update"](#), on page 132).

5.5.14.2 RF Frequency Sweep

The dialog enables you to activate and configure a sweep for the RF frequency.

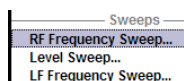

To open the "RF Frequency Sweep" dialog, select "RF/A Mod > Configure > RF Frequency Sweep" or use the [MENU] key under "RF/A Mod".

In the top section of the dialog, the RF sweep is activated and the sweep mode is selected.

The buttons are used to reset the RF sweep (all sweep modes) or to execute the RF sweep ("Single" mode).

The sweep range, sweep spacing and dwell time are set in the bottom section.

You can configure the sweep range of the RF sweep in two ways, either by entering the "Start" and "Stop" values or by entering the "Center" frequency and the "Span".

The two sets of parameters correlate as follows:

- "Start Freq" = "Center Freq" - "Span"/2
- "Stop Freq" = "Center Freq" + "Span"/2
- "Center Freq" = ("Start Freq" + [Stop Freq])/2
- "Span" = "Stop Freq" - "Start Freq"

| RF Frequency Sweep | |
|--------------------|-----------------------------|
| State | On |
| Mode | Extern Single |
| Reset Sweep | |
| Start Freq | 100.000 000 000 MHz |
| Stop Freq | 500.000 000 000 MHz |
| Center Freq | 300.000 000 000 MHz |
| Span | 400.000 000 000 MHz |
| Current Freq | 100.000 000 000 MHz |
| Spacing | Linear |
| Shape | Sawtooth |
| Retrace | <input type="checkbox"/> On |
| Step Lin | 1.000 000 000 MHz |
| Dwell Time | 10.0 ms |
| Ext Trig Inp Slope | Positive |

RF Frequency Sweep Settings

- ▶ To access the sweep dialog, select "RF/A Mod > configure > Sweep/List > RF Frequency Sweep".

In these dialogs you can configure the corresponding sweep signal.

State - Frequency Sweep

Activates RF sweep mode.

Note:

Activating a sweep mode automatically deactivates other sweeps and the list mode.

Remote command:

[:SOURce<hw>] :FREQuency:MODE on page 743

Mode - RF Frequency Sweep

Selects the RF frequency sweep mode.

If you change the sweep mode during the execution, the signal generator stops the sweep and starts with the next trigger event at the initial value.

The "Reset Sweep" button sets the sweep to the start value.

"Auto" Generates a continuously repeating sweep signal immediately after activating the sweep mode.
The sweep steps are performed automatically, controlled by the dwell time, see "Dwell Time - Frequency Sweep" on page 285.

Example:

```
SOUR:SWE:FREQ:MODE AUTO
TRIG:FSW:SOUR AUTO
SOUR:FREQ:MODE SWE
```

"Single"

Generates a single sweep cycle after a trigger event.

The sweep steps within the cycle are performed automatically, controlled by the dwell time. If one cycle is completed, the instrument waits for the next trigger event.

To trigger the sweep, use "Execute Single Sweep" button, or the corresponding remote control commands, for example *TRG.

Example:

```
SOUR:SWE:FREQ:MODE AUTO
TRIG:FSW:SOUR SING
SOUR:FREQ:MODE SWE
SOUR:SWE:FREQ:EXEC
```

"Step"

Generates the sweep signal step-by-step, manually triggered.

To perform the sweep steps, enter the frequency value under [Current Freq - Frequency Sweep](#). You can directly enter the value, but also use the [up] and [down] navigation keys or the [rotary knob].

You can determine the step width below in the entry field "Step Lin" or "Step Log", see [Step Lin/Log - Frequency Sweep](#).

If a step is out of the sweep range ("Start Freq" or "Stop Freq"), it is ignored.

Note: To step through the sweep frequencies in remote control mode, use the `FREQ:MAN` command with the `UP` or `DOWN` parameter.

Example:

```
SOUR:FREQ:CENT 300MHz
SOUR:FREQ:SPAN 400MHz
SOUR:SWE:FREQ:SPAC LIN
SOUR:SWE:FREQ:STEP:LIN 100MHz
SOUR:FREQ:MODE MAN
TRIG:FSW:SOUR SING
```

set sweep mode "Step".

```
SOUR:FREQ:MODE SWE
```

activate sweep mode, the frequency is set to "Start Freq".

```
SOUR:FREQ:MAN UP
```

set the frequency to the next higher sweep frequency.

```
SOUR:FREQ:MAN DOWN
```

set the frequency to the next lower sweep frequency.

"Extern Single" Generates a single sweep cycle when an external trigger event occurs.
The sweep steps within the cycle are performed automatically, controlled by the dwell time. If one cycle is completed, the instrument waits for the next trigger event.
To trigger the sweep, apply an external trigger signal.
Refer to the description of the rear panel for information on the connectors for external trigger signal input (see [Chapter 2.2, "Rear Panel Tour"](#), on page 28).

Example:

```
SOUR:SWE:FREQ:MODE AUTO
TRIG:FSW:SOUR EXT
SOUR:FREQ:MODE SWE (External trigger)
```

"Extern Step" Generates the sweep signal step-by-step, manually triggered.
To trigger a sweep step, apply an external trigger signal. The step width corresponds to the step width set for the rotary knob.

Example:

```
SOUR:SWE:FREQ:MODE STEP
SOUR:SWE:FREQ:SPAC LIN
SOUR:SWE:FREQ:STEP:LIN 1MHz
TRIG:FSW:SOUR EXT
SOUR:FREQ:MODE SWE (External trigger)
```

"Extern Start/Stop" Generates a continuously repeating sweep signal that is started, stopped and restarted by subsequent external trigger events. The sweep steps are performed automatically, controlled by the dwell time.
Refer to the description of the rear panel for information on the connectors for external trigger signal input (see [Chapter 2.2, "Rear Panel Tour"](#), on page 28).

Example:

```
SOUR:SWE:FREQ:MODE AUTO
TRIG:FSW:SOUR EAUT
SOUR:FREQ:MODE SWE (External trigger)
```

Remote command:

```
[ :SOURce<hw> ] :SWEep [ :FREQuency ] :MODE on page 812
:TRIGger<hw> :FSWEEP :SOURce on page 849
[ :SOURce<hw> ] :FREQuency :MODE on page 743
```

Execute Single Sweep - Frequency Sweep

Starts a sweep manually. This trigger button is displayed in "Single" mode.

Remote command:

[:SOURce<hw>] :SWEep [:FREQuency] :EXECute on page 812

:TRIGger<hw>:FSWep [:IMMediate] on page 849

:TRIGger<hw> [:SWEep] [:IMMediate] on page 853

Reset Sweep - Frequency Sweep

Resets the sweep.

With the next trigger event, the sweep starts with at the initial value.

Remote command:

[:SOURce<hw>] :SWEep:RESet [:ALL] on page 821

Start Freq - Frequency Sweep

Sets the start frequency.

Remote command:

[:SOURce<hw>] :FREQuency:START on page 745

Stop Freq - Frequency Sweep

Sets the stop frequency.

Remote command:

[:SOURce<hw>] :FREQuency:STOP on page 745

Center Freq - Frequency Sweep

Sets the center frequency.

Remote command:

[:SOURce<hw>] :FREQuency:CENTer on page 739

Span - Frequency Sweep

Sets the span.

Remote command:

[:SOURce<hw>] :FREQuency:SPAN on page 744

Current Freq - Frequency Sweep

Displays the current frequency.

In sweep "Step" mode, the parameter is editable and you can enter frequency for the next step.

Remote command:

[:SOURce<hw>] :FREQuency:MANual on page 742

Spacing - Frequency Sweep

Selects the mode for the calculation of the frequency sweep intervals.

"Linear" Takes the frequency value entered as an absolute value in Hz.

"Logarithmic" Takes the value entered as a logarithmic value, that means as a constant fraction of the current frequency in %.

Remote command:

[:SOURce<hw>] :SWEep [:FREQuency] :SPACing on page 815

Shape - RF Frequency Sweep

Selects the waveform shape of the sweep signal.

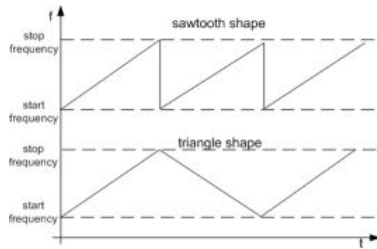

"Sawtooth" One sweep runs from start to stop frequency. Each subsequent sweep starts at the start frequency, that means the shape of the sweep sequence resembles a sawtooth.

"Triangle" The sweep runs from the start to the stop frequency and back, that means the shape of the sweep resembles a triangle. Each subsequent sweep starts at the start frequency.

Remote command:

```
[ :SOURce<hw> ] :SWEep [ :FREQuency ] :SHApe on page 814
```

Retrace - RF Frequency Sweep

Activates that the signal changes to the start frequency value while it is waiting for the next trigger event.

You can enable this feature, when you are working with sawtooth shapes in sweep mode "Single" or "External Single", see [Mode - RF Frequency Sweep](#) .

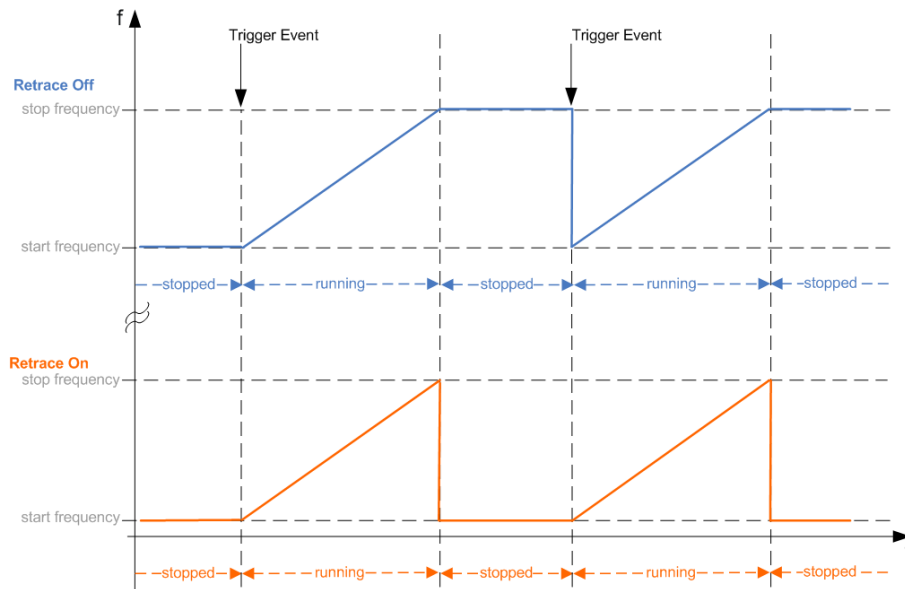

Remote command:

```
[ :SOURce<hw> ] :SWEep [ :FREQuency ] :RETRace on page 814
```

Step Lin/Log - Frequency Sweep

Sets the step width for the individual frequency sweep steps.

At each step this value is added to the current frequency.

Depending on the [Spacing - Frequency Sweep](#) mode you have set, the corresponding parameter is displayed.

"Step Lin" The step width is a constant value in Hz.

Remote command:

`[:SOURce<hw>] :SWEep [:FREQuency] :STEP [:LINear]` on page 815

"Step Log" The step width is determined logarithmically in %, that means as a constant fraction of the current frequency.

Successive frequencies are calculated as follows:

- **start_f < stop_f**
 $f_2 = f_1 * (1 + \text{step_log} / 100)$
 If $f_2 > \text{stop_f}$: f_2 is set to stop_f .
- **start_f > stop_f**
 $f_2 = f_1 / (1 + \text{step_log} / 100)$
 If $f_2 < \text{stop_f}$: f_2 is set to stop_f .

When the shape "Triangle" is set, the frequency values on the slope from **stop_f back to start_f** are the same as on the slope from **start_f to stop_f**.

Remote command:

`[:SOURce<hw>] :SWEep [:FREQuency] :STEP:LOGarithmic` on page 816

Dwell Time - Frequency Sweep

Sets the dwell time. The dwell time determines the duration of the individual sweep steps.

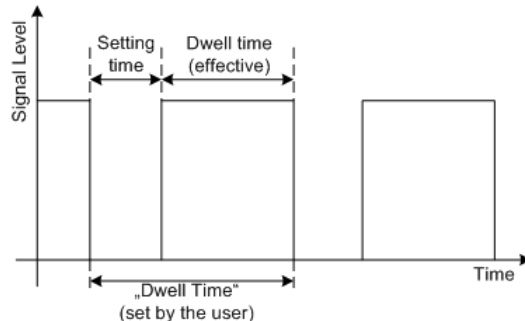

The "Dwell Time" set by the user is used as the step time of the sweep. The effective net dwell time is shorter, reduced by the setting time. This setting time may be greater than the time specified in the data sheet.

Note:

It is recommended to switch off the display update for optimum sweep performance especially with short dwell times (see [Chapter 5.2.3.7, "Display Update"](#), on page 132).

Remote command:

`[:SOURce<hw>] :SWEep [:FREQuency] :DWEL1` on page 812

Ext. Trigger Input Slope

Sets the polarity of the active slope of an externally applied instrument trigger.

This setting affects the TRIG input (BNC connector at the rear of the instrument).

"Positive" activates the rising edge of the trigger signal.

"Negative" activates the falling edge of the trigger signal.

Remote command:

[:SOURce] : INPut : TRIGger : SLOPe on page 749

5.5.14.3 RF Level Sweep

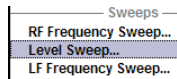

To open the "Level Sweep" menu, select "RF/A Mod > Configure > Level Sweep" or use the [MENU] key under "RF/A Mod".

RF Level Sweep Settings

The "RF Level Sweep" dialog is used to activate and configure a sweep for the RF level.

In the top section, the RF level sweep is activated and the sweep mode is selected. The buttons are used to reset the level sweep (all sweep modes) or to execute the level sweep ("Single" mode).

The sweep range, sweep spacing and dwell time are set in the bottom section.

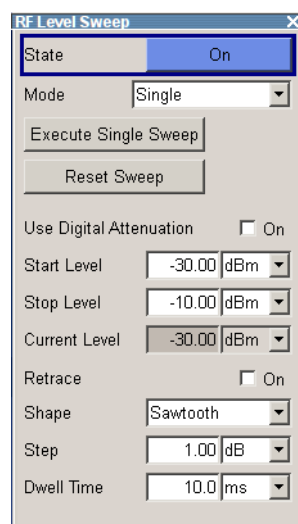

State - Level Sweep

Activates Level Sweep mode.

Note:

Activating a sweep mode automatically deactivates other sweeps and the list mode.

Remote command:

[:SOURce<hw>] : POWer : MODE on page 796

Mode - Level Sweep

Selects the level sweep instrument operating mode and the sweep mode.

If you change the sweep mode during the execution, the signal generator stops the sweep and starts with the next trigger event at the initial value.

The "Reset Sweep" button sets the sweep to the start value.

"Auto" Sets an automatically repeated sweep cycle.

Example:

```
SOUR:SWE:POW:MODE AUTO
TRIG:PSW:SOUR AUTO
SOUR:POW:MODE SWE
```

"Single" Sets a single sweep cycle. The sweep is triggered by the "Execute Single Sweep" button, or by means remote trigger commands, e.g. *TRG.

Example:

```
SOUR:SWE:POW:MODE AUTO
TRIG:PSW:SOUR SING
SOUR:POW:MODE SWE
SOUR:SWE:POW:EXEC
```

"Step" Sets a step-by-step sweep cycle.
 If this mode is activated, the cursor moves to the value displayed for "Current Level". Each sweep step is triggered by a variation of the value in the "Current Level" entry window. The step width is set below at entry field "Step".
 If this mode is activated, the cursor moves to the value displayed for "Current Level". If a different sweep mode was activated prior to the "Step" mode, the current sweep is stopped. The step sweep starts at the current level value.

Example:

```
SOUR:SWE:POW:MODE MAN
TRI:PSW:SOUR SING
SOUR:SWE:POW:STEP 0.5
SOUR:POW:MODE SWE
SOUR:POW:MAN -16
```

The value entered with command `SOUR:SWE:POW:STEP` sets the step width.

The value entered with command `SOUR:POW:MAN` has no effect, the command only triggers the next sweep step. However, the value has to be in the currently set sweep range (start to stop). In remote control only a step-by-step sweep from start to stop frequency is possible.

"Extern Single" Sets a single sweep cycle. The sweep is triggered by an external trigger signal.
Refer to the description of the rear panel for information about the connectors for external trigger signal input (see [Chapter 2.2, "Rear Panel Tour"](#), on page 28).

Example:

```
SOUR:SWE:POW:MODE AUTO
TRIG:PSW:SOUR EXT
SOUR:POW:MODE SWE (External trigger)
```

"Extern Step" Sets a step-by-step sweep cycle. Each sweep step is triggered by an external trigger signal (trigger source as described under "Extern Single"). The step width corresponds to the step width of the rotary knob.

Example:

```
SOUR:SWE:POW:MODE STEP
SOUR:SWE:POW:STEP 0.5
TRIG:PSW:SOUR EXT
SOUR:POW:MODE SWE (External trigger)
```

"Extern Start/Stop"

Sets an automatically repeated sweep cycle that is started, stopped and restarted by subsequent external trigger events.
The first external trigger signal starts the sweep (Start).
The next external trigger signal stops the sweep at the current frequency (Stop).
The third external trigger signal starts the sweep at the start frequency (Start).
Refer to the description of the rear panel for information about the connectors for external trigger signal input (see [Chapter 2.2, "Rear Panel Tour"](#), on page 28).

Example:

```
SOUR:SWE:POW:MODE AUTO
TRIG:PSW:SOUR EAUT
SOUR:POW:MODE SWE (External trigger)
```

Remote command:

```
[ :SOURce<hw> ] :SWEep:POWer:MODE on page 818
:TRIGger<hw>:PSWEEP:SOURce on page 851.
[ :SOURce<hw> ] :POWer:MODE on page 796
```

Reset Sweep - Level Sweep

Resets the sweep. The start level is set and the next sweep starts from there.

Remote command:

```
[ :SOURce<hw> ] :SWEep:RESet [ :ALL ] on page 821
```

Execute Single Sweep - Level Sweep

Triggers the sweep manually. A manual sweep can only be triggered if "Mode Single" is selected.

Example:

```
SOUR:SWE:POW:MODE AUTO
TRIG:PSW:SOUR SING
SOUR:POW:MODE SWE
SOUR:SWE:EXEC
```

Remote command:

```
[ :SOURce<hw> ] :SWEep:POWer:EXECute on page 817
:TRIGger<hw>:PSWEEP [ :IMMediate ] on page 852
:TRIGger<hw> [ :SWEep ] [ :IMMediate ] on page 853
```

Use Digital Attenuation

Activates the use of digital attenuation during RF power sweep.

Remote command:

```
[ :SOURce<hw> ] :SWEep:POWer:DATTenuator:STATe on page 817
```

Start Level - Level Sweep

Sets the start level.

Remote command:

```
[ :SOURce<hw> ] :POWer:START on page 799
```

Stop Level - Level Sweep

Sets the stop level.

Remote command:

```
[ :SOURce<hw> ] :POWer:STOP on page 800
```

Current Level - Level Sweep

Displays the current level.

If "Step" is set, the level for the next level step of the sweep is entered here.

Remote command:

```
[ :SOURce<hw> ] :POWer:MANual on page 795
```

Shape - RF Level Sweep

Selects the cycle mode for a sweep sequence (shape).

- | | |
|------------|---|
| "Sawtooth" | One sweep runs from the start level to the stop level. The subsequent sweep starts at the start level again, i.e. the shape of sweep sequence resembles a sawtooth. |
| "Triangle" | One sweep runs from start to stop level and back, i.e. the shape of the sweep resembles a triangle. Each subsequent sweep starts at the start level again. |

Remote command:

```
[ :SOURce<hw> ] :SWEep:POWer:SHAPE on page 819
```

Retrace - RF Level Sweep

Activates that the signal changes to the start level value while it is waiting for the next trigger event. It allows you to shift down the power during the waiting period.

You can enable this feature, when you are working with sawtooth shapes in sweep mode "Single" or "External Single", see [Mode - Level Sweep](#) .

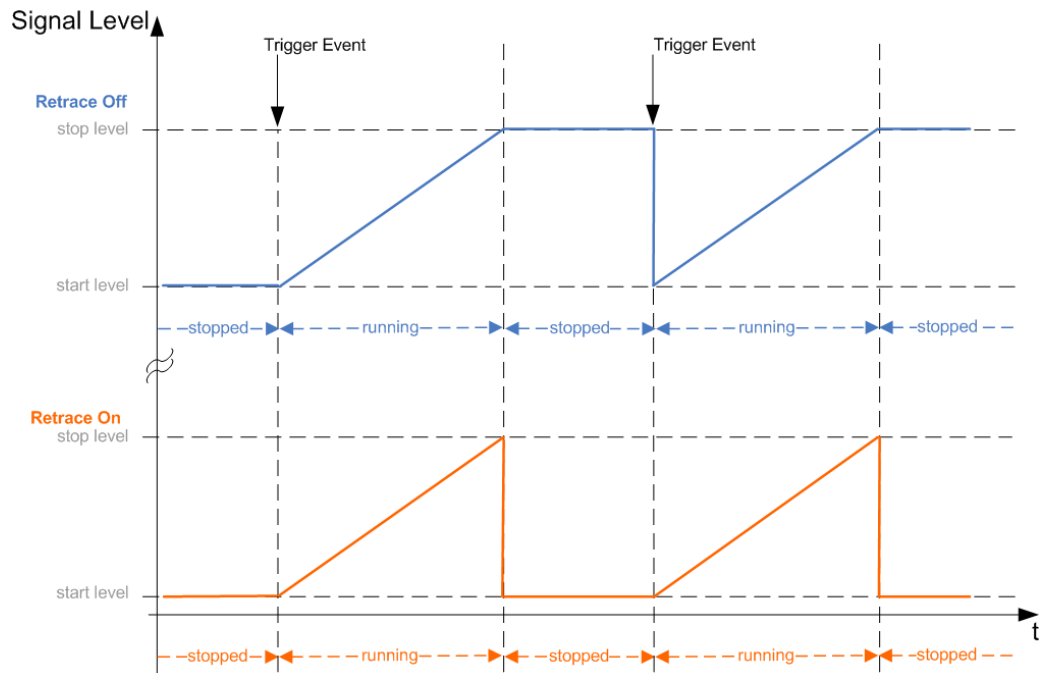

Remote command:

[\[:SOURce<hw>\]:SWEep:POWer:RETRace](#) on page 819

Step - Level Sweep

Sets the step width for the individual sweep steps. This entry is effective for all sweep modes.

With the level sweep, the logarithmic step width is a constant fraction of the current level. This fraction is added to the current level. The logarithmic step width is entered in dB.

Remote command:

[\[:SOURce<hw>\]:SWEep:POWer:STEP\[:LOGarithmic\]](#) on page 820

Dwell Time - Level Sweep

Enters the dwell time and determines the duration of the individual sweep steps.

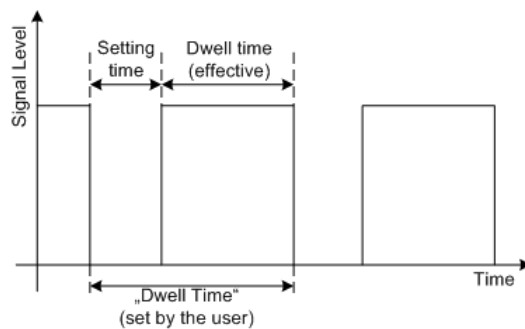

The "Dwell Time" set by the user is used as the step time of the sweep. The effective net dwell time is shorter, reduced by the setting time. This setting time may be greater than the time specified in the data sheet.

Note:

It is recommended to switch off the display update for optimum sweep performance especially with short dwell times (see [Chapter 5.2.3.7, "Display Update"](#), on page 132).

Remote command:

[\[:SOURce<hw>\]:SWEep:POWer:DWELL](#) on page 817

Ext. Trigger Input Slope

Sets the polarity of the active slope of an externally applied instrument trigger.

This setting affects the TRIG input (BNC connector at the rear of the instrument).

"Positive" activates the rising edge of the trigger signal.

"Negative" activates the falling edge of the trigger signal.

Remote command:

[\[:SOURce\]:INPut:TRIGger:SLOPe](#) on page 749

5.5.14.4 List Mode

Similar to a sweep, a series of previously defined frequency and level points is processed in List mode. In contrast to a sweep, however, a list with freely selectable value pairs (frequency and level) can be created. The value range for frequency and level covers the entire configurable value range of the instrument.



Interactions between List mode and other operating modes or settings

- List mode and sweeps can not be activated simultaneously, they deactivate each other.
- Activating the list mode instantly disables [NRP Level Control](#). A running list mode blocks "NRP Level Control". It can not be activated

The lists can be created in the "List Editor". Each list is stored in its own file with the predefined file extension *.lsw. The name of the list file can be freely selected. The files are loaded from the "Lists..." file manager. Externally created tables with pairs of frequency and level values can be converted into List files using the import function. The external files must have the file extension *.txt or *.csv. These file formats are

provided e.g. by the Microsoft®Excel program. The separators for table columns and for decimal floating-point numerals can be set. In addition, internally created List data can be exported into ASCII files using the export function.

The necessary hardware settings are calculated the first time a list is processed. With long dwell times, this calculation can be performed while the list is being processed; the entered dwell times are observed. With very short dwell times, calculation of the hardware settings increases the dwell time for the initial processing cycle; the entered value is only observed from the second processing cycle onwards. In this case a message appears to inform the user that there is a deviation between the current and set dwell times. No further calculations are required after the first run through a list. The current dwell times will definitely no longer deviate from the set dwell times.

The list is processed from the beginning to the end of the list (modes "Auto", ("External") "Single", ("External") "Step").

List Mode Dialog

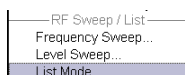

To open the "List Mode" menu, select "RF/A Mod > Configure > List Mode" or use the [MENU] key under "RF/A Mod".

The menu is used to activate/deactivate the operating mode List, to create, select and activate the lists, and to select the trigger mode and the dwell time.

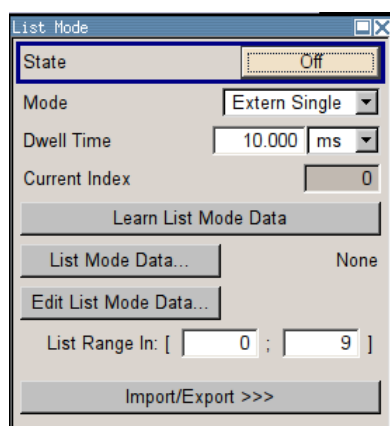

General Settings

State - List Mode

Activates/deactivates the List mode. The currently selected list is processed.

In case of a new or modified list, the necessary hardware settings are automatically determined on activation of the list mode. The data determined in this way is stored along with the list and is available whenever the list is used again.

This means that when activating the list mode, the system checks whether any hardware settings are present. If so, the list is started immediately, but if not they are automatically determined (the list is learnt).

A "Learn List Mode Data" button is available for deliberately activating list learning.

Note: Activating the list mode automatically deactivates all sweeps. During list mode the frequency and level indications do not display the currently set values.

Remote command:

[:SOURce<hw>] :FREQuency:MODE on page 743

Mode - List Mode

Selects the cycle mode of the List mode.

"Auto" Cycle from the beginning to the end of the list with automatic restart at the beginning. If a different mode was activated prior to the Auto mode, the cycle continues from the beginning of the list. The duration of a list step is determined by the set dwell time. Button "Reset" restarts the list at the starting point.

"Single" Single cycle from the beginning to the end of the list. If "Single" is selected, the cycle is not started immediately. The "Execute Single" button appears under the "Mode" line. The cycle is started with this button. The duration of a list step is determined by the set dwell time. Button "Reset" restarts the list at the starting point.

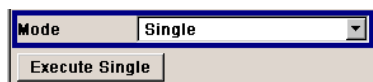

"Step" Manual, step-by-step processing of the list. Activating "Step" stops the current list and the cursor moves to the value displayed for "Current Index". It is now possible to scroll up and down in the list in discrete steps by varying the index. The duration of a list step is determined by the time between two index entries. Button "Reset" restarts the list at the starting point.



"Extern Single" Single cycle from the beginning to the end of the list as with "Single", but started by an external trigger. The external trigger signal is input at the BNC connector [INST TRIG]. Button "Reset" restarts the list at the starting point.

"Extern Step" Step-by-step cycle using the external trigger signal. Each trigger event starts a single step. The duration of a list step is determined by the time between two trigger events. The external trigger signal is input at the BNC connector [INST TRIG]. Button "Reset" restarts the list at the starting point.

Remote command:

[:SOURce<hw>] :LIST:MODE on page 782

[:SOURce<hw>] :LIST:TRIGger:SOURce on page 784

Execute Single - List Mode

Triggers the list manually. This button is available only if mode "Single" is selected.

Remote command:

[:SOURce<hw>] :LIST:TRIGger:EXECute on page 783

Reset - List Mode

Resets the list to the starting point.

Remote command:

`[:SOURce<hw>] :LIST:RESet` on page 783

Dwell Time - List Mode

Enters the dwell time. The dwell time determines the duration of a list step in list operating modes "Auto", "Single" and "Extern Single". In these modes a complete list is processed either once or continuously.

In list operating modes "Step" and "Extern Step", the set dwell time does not affect signal generation. In this case, the duration of a list step is determined by the time between two (internal or external) trigger events.

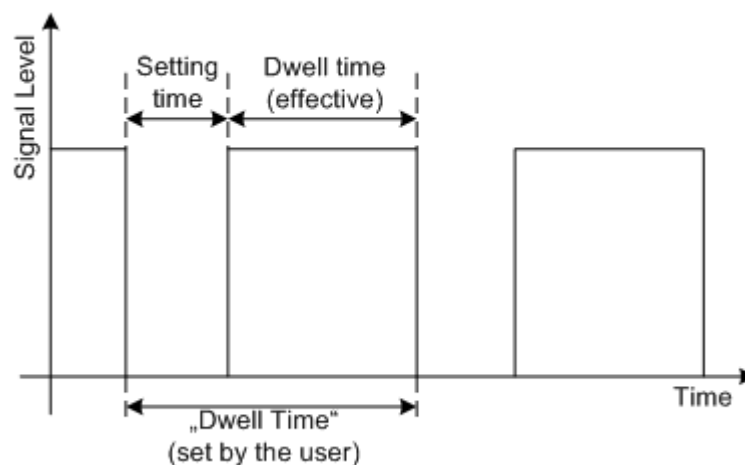

The "Dwell Time" set by the user is used as the step time of the list mode. The effective net dwell time is shorter, reduced by the setting time. This setting time may be greater than the time specified in the data sheet.

Remote command:

`[:SOURce<hw>] :LIST:DWELL` on page 778

Current Index - List Mode

Sets the list index in "Step" mode.

Remote command:

`[:SOURce<hw>] :LIST:INDEX` on page 780

Learn List Mode Data... - List Mode

Starts the determination of the hardware setting for the selected list. The data determined in this way is stored along with the list.

It may be necessary to deliberately activate list learning in the event of greatly altered environmental conditions that require new hardware settings.

If this is not done, a previously learned hardware setting will continue to be used when list mode is switched on ("State = On"). If no setting is available, e.g. when the list is used for the first time, learning is automatically activated.

Remote command:

`[:SOURce<hw>] :LIST:LEARN` on page 781

List Mode Data... - List Mode

Calls the "File Select" menu for selecting and creating a list or the "File Manager".



Remote command:

- [:SOURce<hw>] :LIST:SElect on page 783
- [:SOURce<hw>] :LIST:DElete on page 774
- [:SOURce<hw>] :LIST:DElete:ALL on page 774

Edit List Mode Data... - List Mode

Calls the editor for editing the selected list. A list consists of any number of frequency/level value pairs. The currently selected list is displayed.

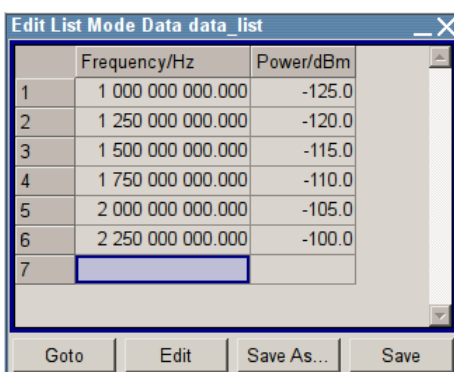

"Frequency /H z" Enter the frequency of the frequency/power value pair.

Remote command:

- [:SOURce<hw>] :LIST:FREQuency on page 779

"Power /dBm" Enter the level of the frequency/power value pair.

Remote command:

- [:SOURce<hw>] :LIST:POWer on page 782

"Goto" Selects row for editing.



If "Goto row" is selected, a window opens for entering the requested row.

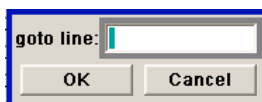

"Edit" Calls a selection of possible actions described below.



"Insert Row" Inserts a new row before the marked row.

"Insert Range" Inserts new rows before the marked row. The number of rows to be inserted can be defined in an entry window.

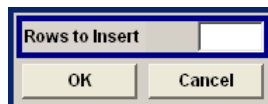

"Fill...." Opens a sub menu for defining a set of list values to be automatically entered in the List Mode table (see ["Filling the List Mode Data automatically"](#) on page 298).

"Delete Row" Deletes the marked row.

"Delete Range..." Allows to delete any number of rows starting with the marked row. The number of rows to be deleted can be defined in an entry window.

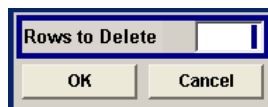

"Save as" Open the file menu to save the list under a new name. Each list is saved to the instrument's hard disk as a separate file with the file prefix *.lsw. The file name and the directory to which the file is saved are user-selectable.

"Save" The list is saved under its current name.

List Range In - List Mode

Defines an index range in the current list by setting the start and stop index. Only the values in the selected index range are processed in List mode, all other list entries are ignored.

Remote command:

[\[:SOURce<hw>\]:LIST:INDEX:START](#) on page 780

[\[:SOURce<hw>\]:LIST:INDEX:STOP](#) on page 781

Ext. Trigger Input Slope

Sets the polarity of the active slope of an externally applied instrument trigger.

This setting affects the TRIG input (BNC connector at the rear of the instrument).

"Positive" activates the rising edge of the trigger signal.

"Negative" activates the falling edge of the trigger signal.

Remote command:

[\[:SOURce\]:INPut:TRIGger:SLOPe](#) on page 749

Import/Export

Lists can be imported from externally created files or exported into text or CSV-files. The import/export settings are available after clicking the "Import/Export" button.

Import/Export - List Mode

Expands the menu with the area for import and export of list mode files.

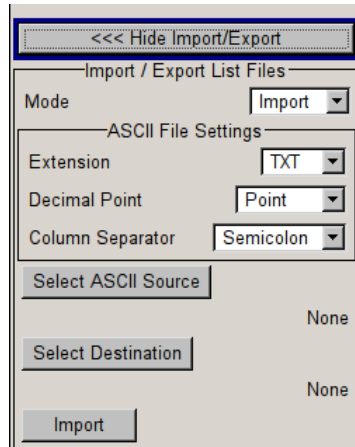

Externally edited Excel tables with frequency/level pairs can be imported as text or CSV-files and used for list mode.

On the other hand, internally created list mode lists can be exported as text or CSV-files.

Mode - List Mode

Selects if list mode lists should be imported or exported. The settings offered below depend on the selected mode.

Remote command:

[\[:SOURCE<hw>\]:LIST:DEXChange:MODE](#) on page 778

Extension - List Mode

Selects the file extension of the ASCII file to be imported or exported. Selection TXT (text file) or CSV (Excel file) is available.

Remote command:

[\[:SOURCE<hw>\]:LIST:DEXChange:AFILe:EXTension](#) on page 775

Decimal Point - List Mode

Selects the decimal separator used in the ASCII data between '.' (decimal point) and ',' (comma) with floating-point numerals.

Remote command:

[\[:SOURCE<hw>\]:LIST:DEXChange:AFILe:SEParator:DECimal](#) on page 777

Column Separator- List Mode

Selects the separator between the frequency and level column of the ASCII table.

Remote command:

[\[:SOURCE<hw>\]:LIST:DEXChange:AFILe:SEParator:COLumn](#) on page 776

Select ASCII Source / Destination - List Mode

Calls the "File Manager" for selecting the ASCII file to be imported into a list mode list (source) or the ASCII file the list mode list is exported (destination) in.

Remote command:

`[:SOURce<hw>] :LIST:DEXChange:AFILe:SElect` on page 776

Select Destination / Source - List Mode

Calls the "File Manager" for selecting the list mode list to be exported (source) into an ASCII file or the destination for the ASCII file to be imported (destination) in.

Remote command:

`[:SOURce<hw>] :LIST:DEXChange:SElect` on page 778

Import / Export - List Mode

Starts the export or import of the selected file.

When import is selected, the ASCII file is imported as list mode list.

When export is selected, the list mode list is exported into the selected ASCII file.

Remote command:

`[:SOURce<hw>] :LIST:DEXChange:EXECute` on page 777

Filling the List Mode Data automatically

The "Fill List Mode Data" menu enables you to automatically set the values in the List Mode table.

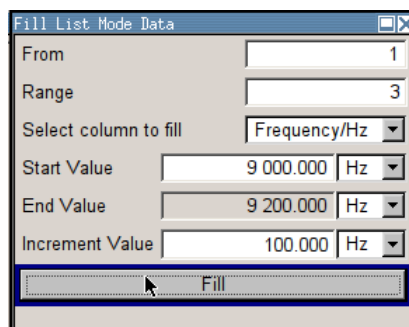

The start line and the number of rows to be filled are defined under "From" and "Range".

The column to be filled is selected under "Select column to fill". Depending on the selection here, the default for start, end, and increment value are set. As the settings are interdependent, a change of one parameter may result in the automatic change of one or more of the other parameters.

The filling of the column with the selected value settings is started with button "Fill".



The list entries are only computed when the "Fill" button is pressed.

From

Sets the start value of the index range.

Remote command:
n.a.

Range

Sets the range for filling the table.

Remote command:
n.a.

Select column to fill

Selects either the frequency or the level column to be filled with the value defined below.

Remote command:
n.a.

Start value

Sets the start value for the frequency or the level entries.

Remote command:
n.a.

End value

Sets the end value for the frequency or the level entries.

Remote command:
n.a.

Increment value

Sets the increment for the frequency or the level entries.

Remote command:
n.a.

Fill

Fills the selected column in the set range with values, starting with the start value and using the set increment.

Remote command:
n.a.

5.6 I/Q Modulation - I/Q Mod Block

The R&S SMBV offers I/Q modulation with:

- external analog I/Q signals,
- external digital signals,
- internal digital signals.

Either the external analog signal or the externally or internally generated baseband signal is fed into the I/Q modulator ("I/Q Mod" function block).

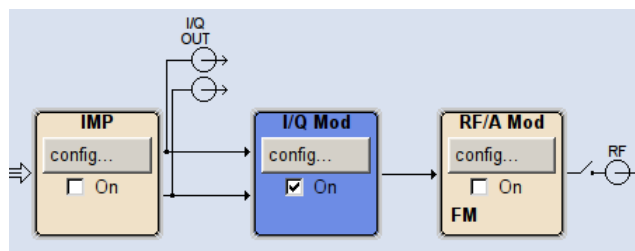

I/Q modulation with an external analog I/Q signal is possible for the basic unit (R&S SMBV with frequency option R&S SMBV-B10x) without additional equipment options.

The basic equipment configuration for generating an internal baseband signal includes the option R&S SMBV-B10 (Baseband Generator and ARB Module) and one of the ARB and memory extension options R&S SMBV-B51/K51x.

The external signal is input via the I and Q connector and transferred directly to the I/Q modulator ("I/Q Mod" function block). Externally generated realtime baseband signals can be fed into the digital signal path via the digital interface (digital signals) (Option R&S SMBV-K18, Baseband Input). The external digital signal is configured in the "BB In/Out" function block (see [Chapter 5.10, "External Baseband Signal - Baseband Input"](#), on page 478).

The internally generated baseband signal is configured in the Baseband function block (see [Chapter 5.9, "Baseband Signal - Baseband Block"](#), on page 326). Before the signal is fed into the I/Q modulator, noise can be added and/or the signal can be impaired. Impairment at this point along the signal flow is offered to allow a signal to be output at the I/Q-OUT outputs (a signal which, for example, compensates signal distortion in a connected test object (DUT)).

Impairment is integrated in the basic unit. The generation of noise requires the option R&S SMBV-K62 (AWGN).

Impairments can also be set in the I/Q Mod menu to allow an externally applied analog I/Q signal to be impaired. An internal baseband signal can thus be impaired both digital (in the Impairment block in the Impairment menu) and analog in the I/Q modulator. If impairments are set in both menus, they superimpose each other in the signal.

5.6.1 I/Q Modulator

To select the input signal of the I/Q modulator and to open the "I/Q Settings" menu, select "I/Q Mod > Configure".

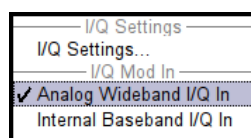

The "I/Q Settings" menu containing the modulation settings is opened in the top section (see [Chapter 5.6, "I/Q Modulation - I/Q Mod Block"](#), on page 299).

Use the "I/Q Mod In" section to select the input signal:

- select "Analog Wideband I/Q In", if the external analog signal is fed into the I/Q modulator.
The maximum available RF bandwidth is described in the instruments specifications (see data sheet).
- select "Internal Baseband I/Q In", if the internally generated baseband signal is used.
The RF bandwidth is reduced (see data sheet).

Alternatively, the input signal can be selected in the "I/Q Settings" menu (see [Chapter 5.6, "I/Q Modulation - I/Q Mod Block"](#), on page 299).

5.6.2 I/Q Settings

To open the menu for setting the I/Q modulation parameters, select "I/Q Mod > Configure > I/Q Settings" or use the [MENU] key.

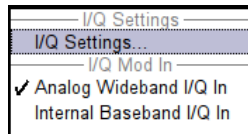

System error correction of the I/Q modulator permits precise and repeatable measurements. The correction routine should be called in the case of temperature fluctuations of several degrees. To call the routine, press the [SETUP] key and select "System > Internal Adjustment " and execute the desired adjustment procedure.

It is not possible to activate an I/Q modulation with an external analog signal ("Analog Wideband I/Q In") simultaneously with:

- AM,
- BB-AM,
- digital modulation,
- digital standards,
- noise,
- arbitrary waveform generation and
- multi carrier CW

I/Q modulation is activated and the source entered in the top section of the menu.

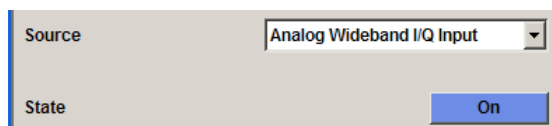

I/Q impairment for specific impairment of the I/Q modulation is set in the "Impairments" section.

| Impairments | |
|-------------------|-----------------------------|
| State | <input type="checkbox"/> On |
| I Offset | 0.00 % |
| Q Offset | 0.00 % |
| Gain Imbalance | 0.000 dB |
| Quadrature Offset | 0.00 deg |

I/Q control can be swapped in the lower section of the menu and the optimized settings for wideband modulation signals can be activated.

| | |
|--------------|-----------------------------|
| I/Q Swap | <input type="checkbox"/> On |
| I/Q Wideband | <input type="checkbox"/> On |

The bottom section of the menu differs depending on the selected input signal ("Analog Wideband I/Q Input" or "Internal Baseband").

The crest factor is input for the external signal.

| Analog Wideband I/Q Input | |
|---------------------------|---------|
| Crest Factor | 0.00 dB |

5.6.2.1 General I/Q Mod Settings

IQ Source - I/Q Mod

Selects the input signal for the I/Q modulator.

"Analog Wideband I/Q In" Selects an external analog signal as the input signal. The signal must be applied at the inputs I and Q.

"Internal Baseband I/Q In" Selects the internal baseband signal as the input signal. This setting requires the additional equipment options for generating the various baseband signals.

Remote command:

[\[:SOURce<hw>\]:IQ:SOURce](#) on page 752

State - I/Q Mod

Activates/deactivates I/Q modulation.

If "Analog Wideband I/Q In" is selected, the I/Q modulator is also deactivated and activated.

If "Internal Baseband I/Q In" is selected, the I/Q modulator is always activated automatically as soon as signal generation is activated in the "Baseband" block. It can, however, be deactivated later, e.g. if only the baseband signal which is output at the I/Q outputs is relevant.

Remote command:

[\[:SOURce<hw>\]:IQ:STATe](#) on page 753

5.6.2.2 Impairments

I/Q impairment for specific impairment of the I/Q modulation is set in the "Impairments" section.

State - Impairments I/Q Mod

Activates/deactivates I/Q impairment.

If activated, the settings for leakage, I/Q imbalance and quadrature offset become effective.

Whether or not I/Q impairment is activated is indicated in the function block.

Note: It is advisable to switch automatic level control to the Sample&Hold mode, as otherwise level errors may occur (see [Chapter 5.5.7, "Automatic Level Control - ALC"](#), on page 227).

Remote command:

`[:SOURce<hw>] :IQ:IMPairment [:STATe]` on page 752

Offset - I/Q Mod

Sets the carrier offset (in percent) of the amplitudes (scaled to the peak envelope power (PEP) for the I and/or Q signal component. An ideal I/Q modulator suppresses the carrier offset completely (offset = 0 percent).

For more information, see [Chapter 5.7.1.2, "I and Q Offset"](#), on page 307.

Remote command:

`[:SOURce<hw>] :IQ:IMPairment:LEAKage:I` on page 751

`[:SOURce<hw>] :IQ:IMPairment:LEAKage:Q` on page 752

Gain Imbalance - I/Q Mod

Sets the imbalance of the I and Q vector (see [Chapter 5.7.1.1, "Gain and Gain Imbalance"](#), on page 306).

The entry is made in dB (default) or %, where 1 dB offset is roughly 12 % according to the following:

$$\text{Imbalance [dB]} = 20 \log (| \text{GainQ} | / | \text{GainI} |)$$

Positive values mean that the Q vector is amplified more than the I vector by the corresponding percentage. Negative values have the opposite effect.

Remote command:

`[:SOURce<hw>] :IQ:IMPairment:IQRatio [:MAGNitude]` on page 751

Quadrature Offset - I/Q Mod

Sets the quadrature offset (see [Chapter 5.7.1.3, "Quadrature Offset"](#), on page 308).

Remote command:

`[:SOURce<hw>] :IQ:IMPairment:QUADrature [:ANGLE]` on page 752

5.6.2.3 I/Q Swap and I/Q Wideband

The I/Q control can be swapped and the optimized setting for wideband signals can be selected in the middle section of the menu.

I/Q-Swap - I/Q Mod

Selects normal or swapped I/Q control for an external analog signal. The modulation sidebands are inverted by swapping the I and Q signals.

This parameter enables I/Q modulation to be performed on signals according to IS2000 (cdma2000 standard) and the majority of all other standards. As a result, an I/Q demodulator defined according to IS2000 can also be used for demodulating the generated signals.

The I/Q modulator defined in the IS2000 standard differs from the definition in the R&S SMBV. The definition on which the R&S SMBV is based is used by virtually all digital communication standards (except IS95 and IS2000).

In the final step, the filtered I/Q signal is modulated to the desired RF in a different way in the I/Q modulator:

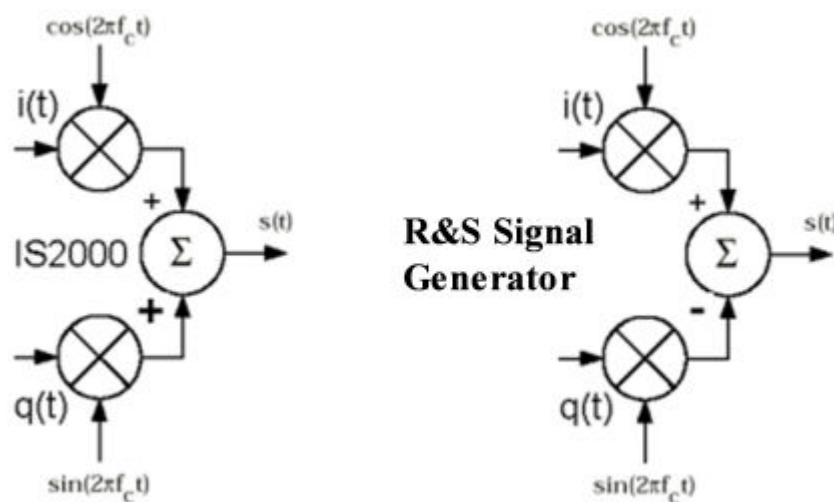

Figure 5-12: Definition of I/Q modulator in IS2000 and R&S SMBV f

According to IS2000, the RF signal $s(t)$ is derived from the baseband I/Q signal as follows:

$$s(t) = i(t)\cos(2\pi f_c t) + q(t)\sin(2\pi f_c t)$$

The instrument family is based on the following definition:

$$s(t) = i(t)\cos(2\pi f_c t) - q(t)\sin(2\pi f_c t)$$

"I/Q Swap" must now be set to "On" so that an I/Q modulator defined according to IS2000 can cope with the RF signal generated by the R&S SMBV.

"Off" I/Q control is normal.

"On" The I and Q signals are swapped.

Remote command:

`[:SOURce<hw>] :IQ:SWAP [:STATe]` on page 753

I/Q-Wideband - I/Q Mod

Optimized setting for wideband modulation signals (>5 MHz). Optimized setting for wideband modulation signals (>5 MHz).

The modulation frequency response is decreased at the expense of poorer harmonic suppression. This is achieved by shifting the switching frequencies of the lowpass filters in the output section.

Remote command:

[:SOURce<hw>] :IQ:WBState on page 753

5.6.2.4 Analog Wideband I/Q Input

In the bottom section of the menu the crest factor is input for the external signal ("Analog Wideband I/Q Input").

Crest Factor - I/Q Mod

(Analog Wideband I/Q Input only)

Sets the crest factor of the external analog signal.

The crest factor gives the difference in level between the peak envelope power (PEP) and average power value (RMS) in dB.

This value is necessary to allow the correct output power to be generated at the RF output. When the set output power is generated, the R&S SMBV uses this value to compensate the average power which is lower compared to the peak power.

The maximum input voltage at the I/Q input is equated to the peak power and is used as the "reference" for setting the level of the output signal. Since the signal does not usually supply the peak power at a constant level and instead supplies a lower average power, the crest factor specifies how many dB have to be added internally so that the correct output power is achieved.

Remote command:

[:SOURce<hw>] :IQ:CREStfactor on page 751

5.7 Impairment of Digital I/Q Signal and Noise Generator - AWGN/IMP Block

The R&S SMBV allows the digital I/Q signal to be impaired before it is passed on to the I/Q modulator, and also noise to be added to the signal. The noise generator can also be used to generate a pure noise signal.

These settings are available in the block diagram in the "AWGN/IMP" function block as well as in the menu with the same name which is opened using the [MENU] key.

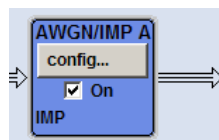

The equipment options for the basic unit (R&S SMBV with frequency option R&S SMBV-B10x) include the "Impairments" functionality and the option for noise generation R&S SMBV-K62 (Additive White Gaussian Noise) for "AWGN".

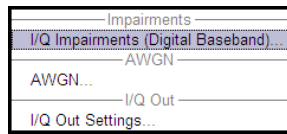

Selecting the menu item "I/Q Impairments (Digital Baseband)..." opens the I/Q impairment settings dialog. This dialog covers the settings for I/Q impairment, like carrier leakage, imbalance and quadrature offset.

To access the AWGN settings, select "AWGN...". This dialog contains the settings of the AWGN generator, noise level configuration and CW interfering parameters.

Selecting the menu item "I/Q Out Settings" opens a dialog with the parameters for the I/Q output signal.

The single ended or differential output is configured in the "I/Q Out Settings" dialog.

5.7.1 Impairments

Signal impairments (**I/Q Impairments**) are well-defined arithmetic modifications of the data. Every data sample is modified in the same way.

Impairment of the digital I/Q signal can be used to:

- compensate the distortion of a test object
- check the effect of a disturbed signal on a test object
- if the internal compensation of signal distortion is deactivated by the I/Q modulator, also to test its own baseband components.



In addition to impairment of the digital I/Q signal, the R&S SMBV also allows impairment of the analog signal to be set in the I/Q modulator. The relevant settings are made in the I/Q Mod function block (see [Chapter 5.6, "I/Q Modulation - I/Q Mod Block"](#), on page 299).

5.7.1.1 Gain and Gain Imbalance

An I/Q gain is a multiplication of all I/Q amplitudes by a common factor. The effect is equivalent to two identical I and Q gain factors. The effect of an increased gain factor in the I/Q constellation diagram is shown on [Figure 5-13](#).

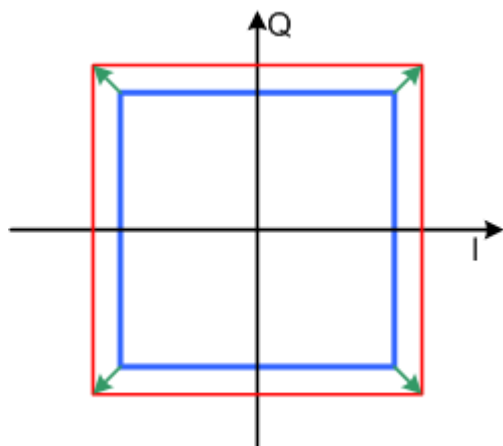

Figure 5-13: Effect of an increased amplitude in the I/Q constellation diagram

An I gain multiplies the I amplitudes by a factor, leaving the Q amplitudes unchanged. A Q gain has the opposite effect. Different I and Q gain factors result in an I/Q imbalance, which is due to different gains of the amplifiers in the I and Q channels of the I/Q modulator. The effect of a positive and negative gain imbalance is shown on [Figure 5-14](#).

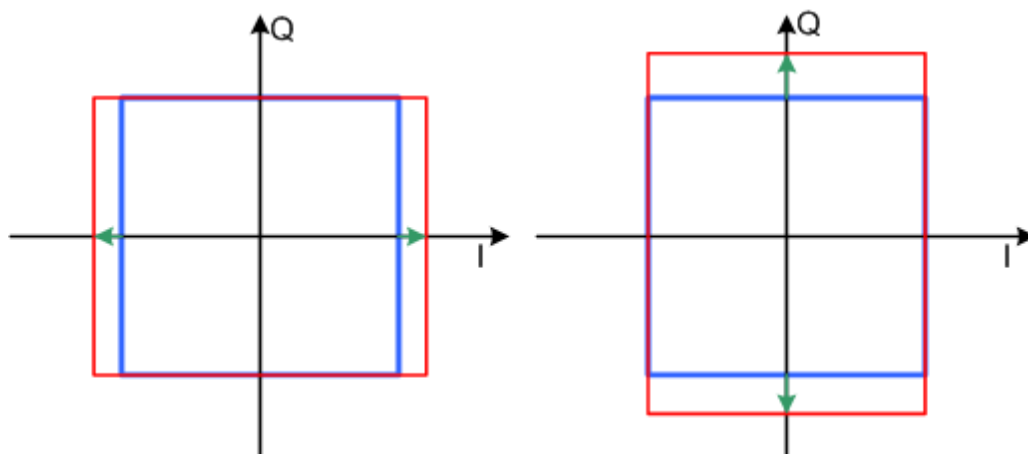

Figure 5-14: Negative gain imbalance (left) and positive gain imbalance (right) in the I/Q constellation diagram

5.7.1.2 I and Q Offset

An I offset adds a constant value to all I amplitudes, leaving the Q amplitudes unchanged. A Q offset has the opposite effect. A combination of I and Q values results in an I/Q offset, which is due to carrier feedthrough in the I/Q modulator. Possible reasons are interfering signals at the RF carrier frequency, e.g. an unsuppressed RF carrier subchannel. The effect of a positive I and Q offset in the I/Q constellation diagram is shown on [Figure 5-15](#).

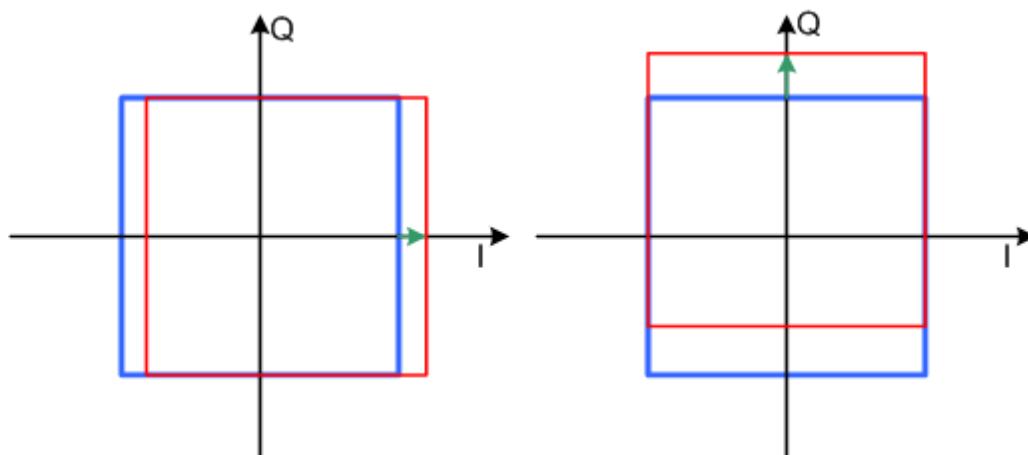

Figure 5-15: I offset (left) and Q offset (right) in the I/Q constellation diagram

5.7.1.3 Quadrature Offset

Changes the phase angle between the I and the Q vectors from the ideal 90 degrees, while the amplitudes are maintained. A positive quadrature offset results in a phase angle greater than 90 degrees. The effect of a positive quadrature offset in the I/Q constellation diagram is shown on Figure 5-16.

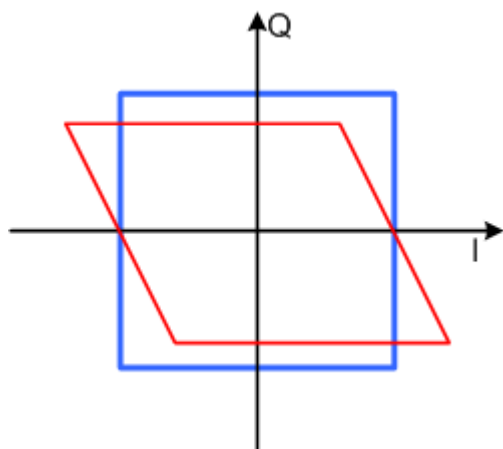
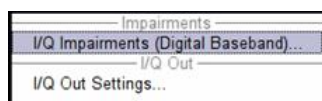

Figure 5-16: Positive quadrature offset in the I/Q constellation diagram

5.7.1.4 Impairment Settings Menu

To access the "Impairment Settings" menu for setting the digital I/Q impairments, select "AWGN/IMP > Configure > I/Q Impairments" or use the [MENU] key under "AWGN/IMP".



I/Q impairment is activated and set in the "I/Q Impairments" section.

| I/Q Impairments | |
|-------------------|----------|
| State | On |
| I Offset | 0.00 % |
| Q Offset | 0.00 % |
| Gain Imbalance | 0.000 dB |
| Quadrature Offset | 0.00 deg |
| Skew | 0.000 ns |
| IQ Delay | 0.000 ns |

"Internal compensation" of signal distortions of the RF output can be activated / deactivated.

| |
|---|
| <input checked="" type="checkbox"/> Optimize Internal I/Q Impairments For RF Output |
| Optimization Mode: Fast |

I/Q Impairments

In the "I/Q Impairments" section the parameters for carrier leakage, imbalance and quadrature offset can be set and I/Q impairment is activated.

State - Digital Impairments

Activates/deactivates digital I/Q impairment.

When activated, the settings for carrier leakage, I/Q imbalance and quadrature offset become effective.

Internal predistortion for compensating the I/Q modulator is not influenced by this setting.

Remote command:

`[:SOURce<hw>] :BB:IMPairment:STATe` on page 697

I/Q Offset - Digital Impairments

Sets the carrier leakage (in percent) of the amplitudes (scaled to the peak envelope power (PEP)) for the I and/or Q signal component. An ideal I/Q modulator suppresses the carrier leakage completely (offset = 0 percent).

For more information, see [Chapter 5.7.1.2, "I and Q Offset"](#), on page 307.

Remote command:

`[:SOURce<hw>] :BB:IMPairment:LEAKage:I` on page 696

`[:SOURce<hw>] :BB:IMPairment:LEAKage:Q` on page 696

Gain Imbalance - Digital Impairments

Sets the imbalance of the I and Q vector (see [Chapter 5.7.1.1, "Gain and Gain Imbalance"](#), on page 306).

The entry is made in dB (default) or %, where 1 dB offset is roughly 12 % according to the following:

$$\text{Imbalance [dB]} = 20 \log (| \text{GainQ} | / | \text{GainI} |)$$

Positive values mean that the Q vector is amplified more than the I vector by the corresponding percentage. Negative values have the opposite effect.

Remote command:

`[:SOURce<hw>] :BB:IMPairment:IQRatio[:MAGNitude]` on page 695

Quadrature Offset - Digital Impairments

Sets the quadrature offset (see [Chapter 5.7.1.3, "Quadrature Offset"](#), on page 308).

Remote command:

`[:SOURce<hw>] :BB:IMPairment:QUADrature[:ANGLE]` on page 696

I/Q Skew - Digital Impairments

Sets the time offset between the I and Q vectors.

In an I/Q modulator without I/Q skew, the I and Q vectors are aligned to the marker. With an I/Q skew, both vectors are shifted relative to the marker so that the offset of each of the vectors to the marker will be the half of the I/Q skew value.

A positive I/Q skew means that the Q vector delays relative to the I vector and vice versa.

Remote command:

`[:SOURce<hw>] :BB:IMPairment:SKEW` on page 697

IQ Delay

Sets the time delay of both I and Q vectors relative to the selected trigger and marker or relative to the other instrument(s) working in the master-slave synchronous mode (see [Chapter 5.9.2.4, "Synchronous Signal Generation"](#), on page 332).

A positive value means that the I and Q vectors delay relative to the marker/trigger or to the other instrument and vice versa.

Remote command:

`[:SOURce<hw>] :BB:IMPairment:DELAy` on page 695

Internal Compensation

Internal compensation of signal distortions of the RF output can be activated / deactivated.

Optimize internal IQ-Impairments for RF Output - Digital Impairments

Activates or deactivates internal compensation of signal distortions of the RF output. Signal distortions can be either optimized for the RF output (active) or for the differential I/Q output (not active).

Remote command:

`[:SOURce<hw>] :BB:IMPairment:OPTimization:STATe` on page 698

Optimization Mode - Digital Impairments

Selects the optimization mode of the internal equalization which flattens out the frequency response from the instrument automatically.

Use the parameter [Optimize internal IQ-Impairments for RF Output - Digital Impairments](#) to determine whether the optimization is performed for the RF signal or for the signal at the differential I/Q output.

| | |
|----------------|--|
| "Fast" | Optimization is reached by compensation for I/Q skew. This mode is based on the standard calibration values and is provided for time sensitive environments. |
| "High Quality" | Optimization is reached by compensation for I/Q skew and frequency response correction. In this optimization mode, the instrument measures internally the frequency response after every frequency and level change and automatically applies the data in the internal equalizer. This results in an extremely flat RF signal. The setting times, however, increases. For information on the I/Q modulation performance, see the data sheet. |

Remote command:

`[:SOURce<hw>] :BB:IMPAirment:OPTimization:MODE` on page 697

5.7.2 AWGN - Noise Generator

The noise generator generates an AWGN signal (Additive White Gaussian Noise) in the digital baseband, i.e. the noise power density has a Gaussian distribution and is distributed evenly across the frequency. This noise signal superimposes the (interference-free) useful signal ("Additive Noise" mode). Typical applications for the noise generator are bit-error or block-error measurements, depending on the set S/N or C/N ratio.

The Gaussian noise is generated by means of feedback shift registers with subsequent probability transformation. The switching configuration is such that virtually ideal statistical characteristics are achieved:

- I and Q paths are decorrelated from each other.
- The crest factor of 18 dB allows very small probabilities to be realized.
- The period of the noise signal depends on the selected system bandwidth. The relationship of period P to system bandwidth B_{sys} is approximated:

$$P \approx 1 \cdot 10^{13} / B_{\text{sys}}$$

This results in periods between 317 years with minimum bandwidth and approximately 2 days with maximum bandwidth.

This results in a period of approximately one month for 3GPP FDD with a bandwidth of 3.84 Mcps, and a period of 427 days for GSM with 270.833 ksps.

Scalable low-pass filters are used to produce a noise power with both a broad dynamic range and a broad bandwidth range (from 1 kHz to 60 MHz).

Apart from the "Additive Noise" mode, there are also the "Noise Only" and the "CW Interferer" mode. In the "Noise Only" mode a pure noise signal is generated and modulated to the carrier. In the "CW Interferer mode", a sinusoidal signal with an adjustable frequency offset to the baseband signal is generated and added to the baseband signal by means of a counter instead of a shift register.

5.7.2.1 AWGN Settings Dialog

To open the "AWGN Settings" menu for setting the noise generator, select "AWGN/IMP > Configure > AWGN" or use the [MENU] key under "AWGN/IMP".

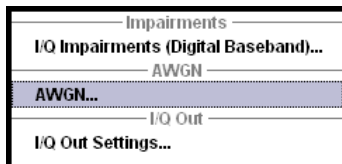

The "AWGN Settings" menu is divided into the following sections.

The RFI signal generator is activated, the mode selected and the interfering signal is configured in the top section of the menu.

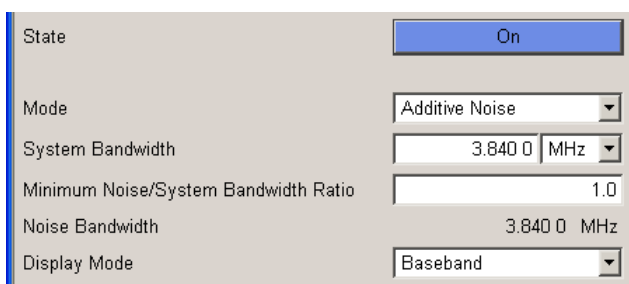

The power of the interfering signal is configured in the "Noise power Configuration And Output Results" section.

In "Additive Noise" and "CW interferer" mode, the interfering power can be defined and the resulting total power displayed here.

In "Noise Only" mode, only the noise power can be set here.

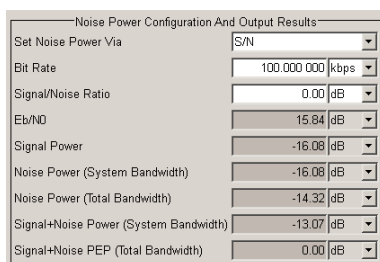

AWGN Settings

The RFI signal generator is activated, the mode selected and the interfering signal is configured in the top section of the menu.

State - AWGN

Activates/deactivates the RFI signal generator. The interferer (AWGN or CW interferer, depending on the selected mode) is generated as after the generator is activated.

Remote command:

[:SOURce<hw>] :AWGN:STATe on page 605

Mode - AWGN

Selects the mode for generating the interfering signal.

"Additive Noise"

The AWGN noise signal with selectable system bandwidth is added to the baseband signal.

"Noise Only"

The pure AWGN noise signal with selectable system bandwidth is modulated to the carrier. The connection to the baseband is interrupted.

"CW Interferer"

A sine with a defined frequency offset is added to the baseband signal. The calculation of E_b/N_0 ratio is omitted.

Remote command:

[:SOURce<hw>] :AWGN:MODE on page 601

System Bandwidth - AWGN

(Additive Noise and Noise Only)

Sets the RF bandwidth to which the set carrier/noise ratio relates.

Within this frequency range, the signal is superimposed with a noise signal whose power corresponds exactly to the set C/N or S/N ratio.

Note: The noise signal is not generated arbitrarily for a particular bandwidth, but instead it is generated in steps. Noise therefore also occurs outside the set system bandwidth.

Remote command:

[:SOURce<hw>] :AWGN:BWIDth on page 598

Minimum Noise/System Bandwidth Ratio - AWGN

(Additive Noise and Noise Only)

Sets the ratio of minimum noise bandwidth to system bandwidth.

Note: The noise signal is not generated arbitrarily for a particular bandwidth, but instead it is generated in steps. Noise therefore also occurs outside the set system bandwidth.

With this parameter the minimum real noise bandwidth can be set as required by some standards. It does not influence the calculation of power from the set C/N or S/N ratio in relation to system bandwidth.

The overall bandwidth is calculated as follow and may not exceed 120 MHz.

Overall Bandwidth = System BW x Minimum Noise/System BW Ratio

Remote command:

[:SOURce<hw>] :AWGN:BWIDth:RATio on page 599

Noise Bandwidth - AWGN

(Additive Noise and Noise Only)

Indicates the real noise bandwidth. The value is indicated when AWGN state is "On".

Note: The noise signal is not generated arbitrarily for a particular bandwidth, but instead it is generated in steps. Noise therefore also occurs outside the set system bandwidth.

Remote command:

[:SOURce<hw>] :AWGN:BWIDth:NOISe? on page 599

Display Mode - AWGN

Switches between Baseband and RF representation.

This setting influences the way the interfering parameters are displayed, as for example the SNR value defined as C/N, or as S/N.

Remote command:

[:SOURce<hw>] :AWGN:DISP:MODE on page 600

Target CW Frequency - AWGN

(CW Interferer mode only)

Sets the desired frequency of the sine in "CW Interferer" mode.

Remote command:

[:SOURce<hw>] :AWGN:FREQuency:TARGet on page 601

Resulting CW Frequency - AWGN

(CW Interferer mode only)

Indication of the actual CW frequency of the sinusoidal signal in "CW Interferer" mode.

The actual frequency may differ from the desired frequency, since the resolution is limited to 0.7 Hz.

Tip: The desired frequency constellation can be precisely set with an accuracy of up to 0.01 Hz by selecting a suitable frequency offset of the baseband source (e.g. Custom Dig Mod) and by correcting the RF frequency by the difference between Resulting and Target CW Frequency.

Remote command:

[:SOURce<hw>] :AWGN:FREQuency:RESult? on page 600

Noise Power Configuration And Output Results

The interfering signal is configured in the "Noise/Interferer Power Configuration and Output Results" section.

Set Power via - AWGN

(Additive Noise only)

Selects the mode for setting the noise power.

"C/N " "S/N" The noise power is set on the basis of the value entered for the carrier/noise or signal/noise ratio.
Whether a selection of C/N or S/N is enabled, depends on the selected "Display Mode".
With digital modulation, the associated E_b/N_0 value is determined and displayed.

Impairment of Digital I/Q Signal and Noise Generator - AWGN/IMP Block

" E_b/N_0 " The noise power is set on the basis of the value entered for the ratio of bit energy to noise power density. The associated C/N or S/N value is displayed. The correlation between the two values is as follows:
 C/N or $S/N = (E_b/N_0) \cdot (f_{bit}/B_{sys})$, where
 f_{bit} is the Bit rate (Symbol rate x Modulation value)
 B_{sys} is the System bandwidth
 With "Custom Dig Mod" signals, the bit rate used for calculation is defined by the selected standard in the "Custom Digital Mod" dialog. With "Digital Standard" signals, the bit rate to be used for calculating the E_b/N_0 can be entered at "Bit Rate".
 Some test cases with the 3GPP base station tests (TS 25.141) specify, for example, E/N settings that apply to channel-coded data or block segments.

Remote command:

[:SOURce<hw>] :AWGN:POWer:MODE on page 602

Reference Mode - AWGN

(Additive Noise and CW Interferer, Display Mode set to RF)

Select reference mode if the C/N or E_b/N_0 ratio is changed.

"Carrier" If the C/N value or E_b/N_0 value changes, the carrier power is kept constant and the noise power is adjusted. This is the standard procedure for measuring the bit error rate versus the noise power.

"Noise" If the C/N value or E_b/N_0 value changes, the noise power is kept constant and the carrier power is adjusted. Some test cases of 3GPP Base Station Tests (TS 25.141) specify, for example, that the noise power be permanently set as a function of the base station power class, whereas the carrier power is variable.

Remote command:

[:SOURce<hw>] :AWGN:POWer:RMODE on page 604

Bit Rate - AWGN

(Additive Noise)

Sets or indicates the bit rate used for converting C/N or S/N to E_b/N_0 .

With "Custom Digital Mod" signals, the bit rate used is indicated here. It is defined by the choice of the standard in the "Custom Digital Mod" menu.

With "Digital Standard" signals, the bit rate used for converting C/N or S/N to E_b/N_0 is set here.

When generating a "Digital Standard", it is thus possible to select which bit rate is to be used for calculating the ratio of bit energy to noise power density, e.g. the bit rate before or after channel coding.

Remote command:

[:SOURce<hw>] :AWGN:BRATe on page 598

Carrier/Noise Ratio / Signal/Noise Ratio

(Additive Noise and CW Interferer only)

Sets the carrier/noise, signal/noise or signal/interferer ratio.

Whether a configuration of C/N or S/N is enabled, depends on the selected "Display Mode".

- In "Carrier Reference Mode", this entry determines the RFI power and thus the power of the output signal. It does not affect the power of the useful signal, i.e. the carrier power remains constant.
- In "Noise Reference Mode", this entry determines the power of the useful signal, i.e. the carrier power. The RFI power remains constant.
- The power of the noise signal which is derived from the entered C/N or S/N value is displayed under "Noise Power". The value is displayed automatically in the units of the useful signal.
- The power of the useful signal is displayed in the menu under "Carrier Power" and can also be changed there. The displayed value corresponds to the value in the "Level" display field.
- The power of the output signal is displayed under "Carrier + Noise Power".

If "Set Noise Power via E_b/N_0 " is selected, the associated C/N or S/N value is displayed here.

Remote command:

[\[:SOURce<hw>\]:AWGN:CNRatio](#) on page 599

E_b/N_0 - AWGN

(Additive Noise)

Sets the ratio of bit energy to noise power density in "Additive Noise" mode.

- In "Carrier Reference Mode", this entry determines the noise power and hence the power of the output signal, that means the carrier + noise signal. It does not affect the power of the useful signal. The carrier power is kept constant.
- In "Noise Reference Mode", this entry determines the power of the useful signal, i.e. the carrier power. The noise power is kept constant.
- The power of the noise signal which is derived from the entered E_b/N_0 value is displayed under "Noise Power (System Bandwidth)". The value is displayed automatically in the units of the useful signal.
- The power of the useful signal is displayed in the menu under "Carrier Power". The displayed value corresponds to the value in the "Level" display field.
- The power of the output signal is displayed under "Carrier + Noise Power".

If "Set Noise Power via C/N or S/N" is selected, the associated E_b/N_0 value is displayed here.

Remote command:

[\[:SOURce<hw>\]:AWGN:ENRatio](#) on page 600

Carrier Power

(Additive Noise and CW Interferer)

The name of this parameter depends on the selected "Display Mode".

- In "Carrier Reference Mode", this parameter sets the carrier power. This entry corresponds to "Level" value in the header of the instrument.
The power of the noise signal which is derived from the entered C/N or S/N value is displayed under "Noise Power (System Bandwidth)". The value is displayed automatically in the units of the useful signal.

- In "Noise Reference Mode", this parameter indicates the carrier power which is derived from the entered C/N or S/N value. This value corresponds to the "Level" value indicated in the header.
The noise power is set under "Noise Power (System Bandwidth)".

Note: The peak envelope power (PEP) specified in the header corresponds to the PEP value of the carrier. The PEP value of the overall signal is displayed in the menu under "Carrier+Noise PEP".

Remote command:

[\[:SOURce<hw>\]:AWGN:POWer:CARRier](#) on page 602

Noise Power (System Bandwidth) / Interferer Power

(Additive Noise, Noise Only, CW Interferer)

- "Noise Only" mode
Sets the power of the noise signal. This value corresponds to the "Level" value in the header of the instrument.
- "Additive Noise" mode
 - "Noise Reference Mode"
Sets the power of the noise signal. The power of the carrier is derived from the entered C/N or S/N or Eb/N0 value.
 - "Carrier Reference Mode"
Displays the power of the noise signal in the system bandwidth. The power of the noise signal is derived from the entered C/N or S/N or Eb/N0 value. The carrier power is entered under "Carrier Power"; respectively the power is displayed under "Carrier Power".
- "CW Interferer" mode
 - "Noise Reference Mode"
Sets the power of the interfering signal. The power of the carrier is derived from the entered C/N or S/N value.
 - "Carrier Reference Mode"
Displays the power of the interfering signal. The power of the interfering signal is derived from the entered C/N or S/N value. The carrier power is entered under "Carrier Power".

Note: The noise signal is not generated arbitrarily for a particular bandwidth, but instead it is generated in steps. Noise therefore also occurs outside the set system bandwidth. This means that the total measurable noise power (see below) usually exceeds the value displayed here. Correct measurement of the noise power within the system bandwidth is possible by means of channel power measurement using a signal analyzer.

Impairment of Digital I/Q Signal and Noise Generator - AWGN/IMP Block

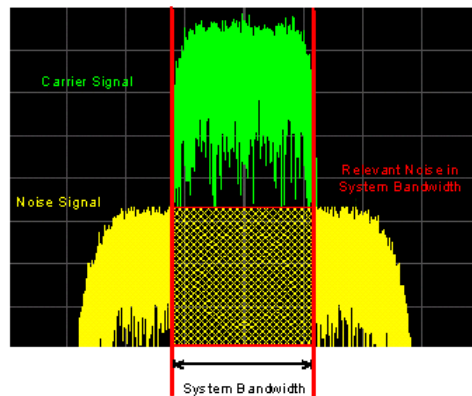

Remote command:

`[:SOURce<hw>] :AWGN:POWer:NOISe` on page 603

Noise Power (Total Bandwidth) - AWGN

Displays the power of the noise signal in the total bandwidth in "Noise Only" and "Additive Noise" mode.

Remote command:

`[:SOURce<hw>] :AWGN:POWer:NOISe:TOTal?` on page 603

Carrier + Noise Power / Signal + Noise Power (System Bandwidth) / Carrier + Interferer Power / Signal + Interferer Power

In "Additive Noise" and "CW Interferer" modes, displays the overall power of the noise/interferer signal plus useful signal.

Note: This parameter differs depending on the selected interfering and display mode, see [Mode - AWGN](#) and [Display Mode - AWGN](#). Consequently, the overall power of the measured signals is composed of different signals, and is also represented in different units, dBm or dB full scale.

Remote command:

`[:SOURce<hw>] :AWGN:POWer:SUM?` on page 604

Carrier + Noise PEP / Signal + Noise PEP (Total Bandwidth) / Carrier + Interferer PEP / Signal + Interferer PEP

(Additive Noise and CW Interferer)

Displays the peak envelope power of the overall signal composed of noise signal plus useful signal.

The name of this parameter depends on the selected "Display Mode".

Note: The peak envelope power (PEP) specified in the header corresponds to the PEP value of the carrier.

Remote command:

`[:SOURce<hw>] :AWGN:POWer:SUM:PEP?` on page 604

5.7.3 Output of the Baseband Signal - I/Q Out

The R&S SMBV provides various outputs of the baseband signal.

The digitally modulated signal can either be output directly or converted to an analog I/Q baseband output signal. The **analog baseband signal** can be output single-ended or differential (non-inverted).

The analog signal is output at the I/Q output connectors I OUT/I OUT BAR and Q OUT/Q OUT BAR on the rear panel of the instrument.

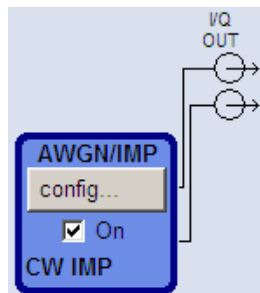

Equipped with option R&S SMBV-K18, Digital Baseband Connectivity, the instrument also provides the output of the digital I/Q signal, indicated in the "BB In/Out" function block. Refer to [Chapter 5.8, "Digital I/Q Output Settings"](#), on page 323 for description.

5.7.3.1 I/Q Out Settings Menu

The settings dialogs for the analog signal output are available in the block diagram in the "AWGN/IMP" function block as well as in the menu with the same name which is opened using the [MENU] key.

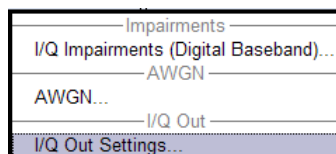

Selecting the menu item "I/Q Out Settings" opens a dialog with the parameters for the I/Q output signal.

The settings dialog for output of the digital signal is accessed in the "BB In/Out" function block, see [Chapter 5.8, "Digital I/Q Output Settings"](#), on page 323.

5.7.3.2 Analog I/Q Output

The differential output of the R&S SMBV provides symmetrical signals for differential inputs of DUTs without the need of additional external electric network.

Analog I/Q Output Settings

Optimize I/Q Signals For RF Output On

I/Q Output Type: Differential

Mode: Variable

I/Q Level Vp (EMF): 1.000 V

Couple I/Q Bias: On

I Settings

Bias (EMF): 3.050 V

Offset (EMF): 300.0 mV

Q Settings

Bias (EMF): 2.700 V

Offset (EMF): 300.0 mV

Optimize I/Q Signals for RF Output

Activates/deactivates optimization of level accuracy and imbalance for RF Output.

Level accuracy and imbalance can be either optimized for RF output (active) or for differential outputs (not active).

Remote command:

`[:SOURce<hw>] :IQ:OUTPut [:ANALog] :BIAS:OPTimization [:RF] :STATe`
on page 755

I/Q Output Type

Selects the type of output. The analog outputs can be operated in "Single Ended" mode or "Differential" (non-inverted) mode. The menu changes depending on the selected output mode

"Differential" Differential output at [I OUT] and [I OUT BAR] or [Q OUT] and [Q OUT BAR].

"Single Ended" Single-ended output at [I OUT] and [Q OUT].

Remote command:

`[:SOURce<hw>] :IQ:OUTPut [:ANALog] :TYPE` on page 757

Mode

Selects the mode for setting the outputs - independent or together. The menu changes depending on the selection here.

"Fixed" The settings for the I/Q signal components are fixed and cannot be changed.

- "Level Vp (EMF)" (Single ended) = 1.0 V
- "Level Vp (EMF)" (Differential) = 2.0 V

"Variable" The settings for the I/Q signal components are not fixed and can be modified.

"Var. Attenuated"

Enables a precise digital attenuation of the signal. The level of the baseband and the RF signal is attenuated by the value set with the parameter [Digital Attenuation](#).

Remote command:

`[:SOURce<hw>] :IQ:OUTPut [:ANALog] :MODE` on page 756

I/Q Level Vp (EMF)

Variable output mode

Sets the output voltage for both signal components. Small differences at the inputs can be taken into account via impairment settings (see [Chapter 5.7.1.4, "Impairment Settings Menu"](#), on page 308).

Single ended Output:

- Value range: 1 mV ... 1.5 V EMF.
- The maximum overall output voltage (" $\text{Level}_{\text{EMF}}$ " + " $|\text{Bias}_{\text{EMF}}|$ ") is 3.7 V.

Differential Output:

- Value range: 2 mV ... 3 V EMF.
- The maximum overall output voltage (" $0.5 * \text{Level}_{\text{EMF}}$ " + " $|\text{Bias}_{\text{EMF}}|$ " + " $0.5 * \text{Offset}$ ") is 3.7 V.

Remote command:

`[:SOURce<hw>] :IQ:OUTPut:LEVel` on page 755

Digital Attenuation

Var. Attenuated mode

Attenuates the level of the baseband and the RF signal.

Remote command:

`[:SOURce<hw>] :IQ:OUTPut [:ANALog] :POWer:DATTenuation` on page 757

Couple IQ Bias

(Variable output mode only)

Activates/deactivates coupling of bias setting of the I-signal and Q-signal component. For activated coupling, the setting can be made for the I-signal component, it automatically applies to the Q-signal component as well. The fields for setting the Q-signal component are shaded.

Remote command:

`[:SOURce<hw>] :IQ:OUTPut [:ANALog] :BIAS:COUPling[:STATe]` on page 754

Bias (EMF)

Sets the bias. A DC voltage is superimposed upon the I or Q signal. The maximum overall voltage (" $\text{Level}_{\text{EMF}}$ " + " Bias_{EMF} " + " $\text{Offset}_{\text{EMF}}$ ") is 3.7 volts.

This way, the operating point of a DUT can be set.

Remote command:

`[:SOURce<hw>] :IQ:OUTPut [:ANALog] :BIAS:I` on page 754

`[:SOURce<hw>] :IQ:OUTPut [:ANALog] :BIAS:Q` on page 754

Offset (EMF)

(available only for output type "Differential" only)

Sets an offset between the inverting and the non-inverting output.

The value range is dynamically adjusted in order to respect the following constrains:

The maximum overall voltage (" $Level_{EMF}$ " + " $Bias_{EMF}$ " + "Offset") is 3.7 V.

The set value is set half in the positive and half in the negative direction:

- A **positive offset** is set with half of the value in positive direction at the non-inverting outputs, in negative direction at the inverting outputs, respectively. For example, if a 100.0 mV offset value is set for the I signal component, the output signal at "I OUT" will have a 50.0 mV offset and the output signal at "I OUT Bar" will have a -50.0mV offset.

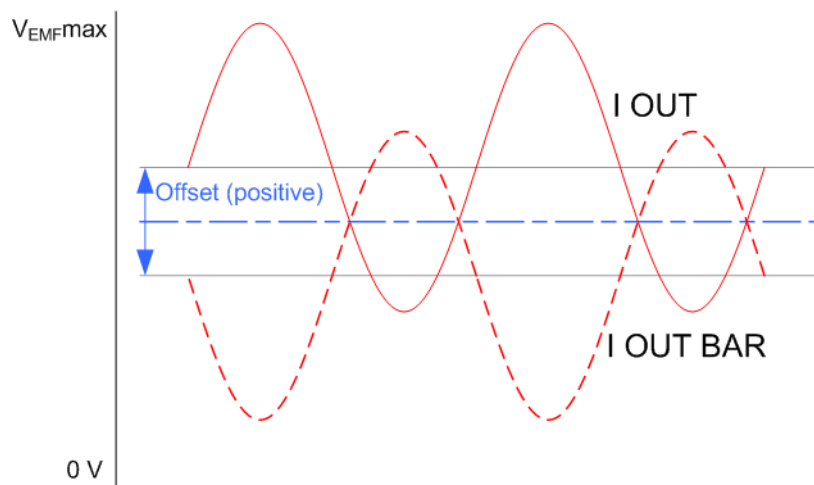

- A **negative offset** is set with half of the value in negative direction at the non-inverting outputs, in positive direction at the inverting outputs, respectively.

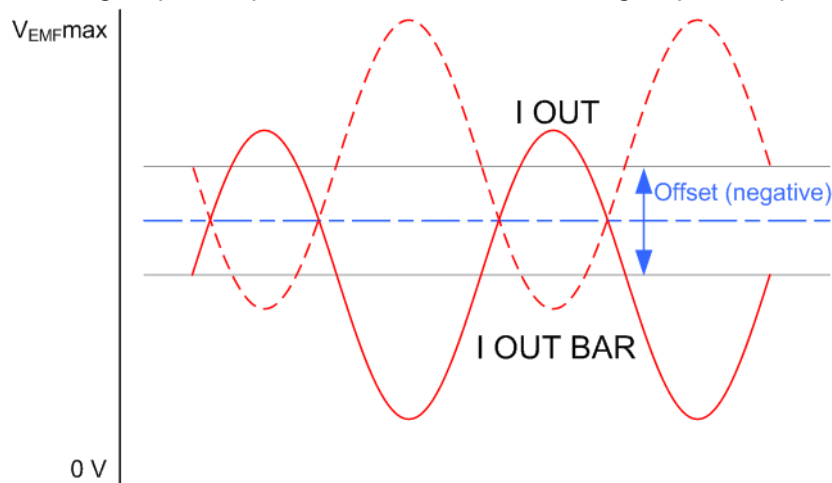

Remote command:

`[:SOURce<hw>] :IQ:OUTPut [:ANALog] :OFFSet:I` on page 755

`[:SOURce<hw>] :IQ:OUTPut [:ANALog] :OFFSet:Q` on page 755

5.8 Digital I/Q Output Settings

The output of the **digital baseband signal** requires the option R&S SMBV-K18, Digital Baseband Connectivity. If this option is connected, the instrument adds as separate function block to the block diagram, the "BB In/Out" block.

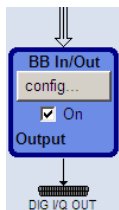

If digital Output is selected, the R&S SMBV displays "DIG I/Q OUT" and a corresponding symbol in the "BB In/Out" block.

The digital baseband signal is output at a standardized (LVDS) digital I/Q interface.

The settings dialogs for the digital signal output is available in the "BB In/Out" function block as well as in the menu with the same name which is opened using the [MENU] key.

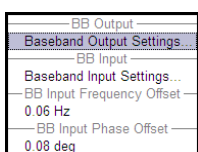

To access the settings for the digital I/Q output:

1. select "Block Diagram > BB In/Out > Config... > Baseband Output Settings"
2. press the [MENU] key and select "BB In/Out > Baseband Output Settings".

5.8.1 Digital I/Q Output General Settings

State - Digital I/Q Output

Switches On/Off the digital I/Q output signal.

Remote command:

[\[:SOURce<hw>\]:IQ:OUTPut:DIGital:STATe](#) on page 762

5.8.2 Sample Rate

In the "Sample Rate" section the sample rate for the digital I/Q output signal can be set and the state of signal transmission is indicated by the FIFO Status.

Sample Rate Source - Digital I/Q Output

Selects the source for the sample rate of the digital I/Q output signal.

- "User Defined" The internally generated clock reference signal is used. The sample rate is calculated and displayed in the field "Value".
- "Digital I/Q Out" An external clock reference signal is used. The clock signal is directly fed in via pin CLK2 of the digital output interface (option R&S SMBV-K18, Digital Baseband Connectivity). The sample rate is estimated and displayed in the field "Value".
Note: Estimation works best if the sample rate is close to the user defined value.

Remote command:

[\[:SOURce<hw>\]:IQ:OUTPut:DIGital:SRATe:SOURce](#) on page 761

Sample Rate Value - Digital I/Q Output

Sets or displays the sample rate of the digital I/Q output signal, depending on the selected sample rate "Source".

Remote command:

[\[:SOURce<hw>\]:IQ:OUTPut:DIGital:SRATe](#) on page 761

5.8.3 Signal Output

The level of the output signal is set in the "Signal Output" section. For entering the value, level type "Peak Level" or "Level" can be selected.

Set Level Via

Selects the level type (peak level/level) that is used to set the signal level. The entry field is activated in the status bar and the value can be edited directly. Either the "Peak Level" or the "Level" entry field can be edited in a path.

The level entry fields and the corresponding units are displayed in the status bar.

"Peak Level" The signal level is expressed in terms of a peak envelope power value (PEP).

"Level" The signal level is expressed in terms of a rms value.
 The level always refers to the RMS value of the output signal without noise, even if the AWGN generator is activated.

Remote command:

[\[:SOURce<hw>\]:IQ:OUTPut:POWer:VIA](#) on page 760

Peak Level - Digital I/Q Out

The signal level is expressed in terms of a peak envelope power value (peak level).

The level entry fields and the corresponding units are displayed in the status bar. The level display always refers to both signal components ($\text{SQR}(I^2+Q^2)$).

Remote command:

[\[:SOURce<hw>\]:IQ:OUTPut:DIGital:POWer:PEP](#) on page 759

Level - Digital I/Q Out

The signal level is expressed in terms of an rms level value.

The level entry fields and the corresponding unit are displayed in the status bar. The level display always refers to both signal components ($\text{SQR}(I^2+Q^2)$).

Remote command:

[\[:SOURce<hw>\]:IQ:OUTPut:DIGital:POWer:LEVel](#) on page 759

5.8.4 User Variation

If the level is set using the rotary knob, the step width is defined in the User Variation section.

Variation Active - Digital I/Q Out

Activates the user-defined step width that is used by varying the level value with the rotary knob.

"On" The level value set with the rotary knob is varied using the user-defined step width which is entered under "Variation Step".

"Off" The level value set with the rotary knob is varied in steps of one unit at the cursor position (standard operating mode).

Remote command:

[\[:SOURce<hw>\]:IQ:OUTPut:DIGital:POWer:STEP:MODE](#) on page 760

Variation Step - Digital I/Q Out

Sets the user defined step width for entering the level value using the rotary knob. Level variation with this step width must be activated with "Variation Active ON".

Remote command:

[\[:SOURce<hw>\]:IQ:OUTPut:DIGital:POWer:STEP\[:INCRement\]](#) on page 760

5.8.5 Signal Monitoring

The section "Signal Monitoring" indicates digital signal clipping.

Overflow - Digital I/Q Out

Indicates that the I/Q output signal is currently clipped. This indication also appears in the block diagram close to the digital I/Q Out connector.

Overload may occur, e.g. if the level of the output signal, or the noise level (AWGN) are too high.

Remote command:

[\[:SOURce\]:IQ:OUTPut:DIGital:OFLow:STATe?](#) on page 758

Overflow Hold - Digital I/Q Out

Indicates an overflow since last reset.

The overflow hold state can be reset via the "Reset" button next to the LED, or is reset automatically by starting a new signal generation or by setting new values to the output level.

Remote command:

[\[:SOURce\]:IQ:OUTPut:DIGital:OFLow:HOLD:STATe?](#) on page 758

Reset - Digital I/Q Out

Executes a reset of the overflow hold state and LED.

Remote command:

`[:SOURce] :IQ:OUTPut:DIGital:OFLow:HOLD:RESet` on page 758

5.8.6 Power On Settings

The power on behaviour of the R&S SMBV is set in the "Power On Settings" section.

Power-On State - Digital I/Q Out

Selects the state which the digital I/Q Output is to resume after the instrument is switched on.

"I/Q Out Off" The output is deactivated when the instrument is switched on.

"Previous Setting" When the instrument is switched on the digital I/Q output resumes to the status that was active before the last switch off.

Remote command:

`[:SOURce<hw>] :IQ:OUTPut:DIGital:PON` on page 759

Connected Device - Digital I/Q Out

if the connection is properly established and signal transmission is active, this parameter indicates the ID of an externally connected Rohde&Schwarz instrument.

Remote command:

`[:SOURce<hw>] :IQ:OUTPut:DIGital:CDEvice?` on page 758

5.9 Baseband Signal - Baseband Block

The R&S SMBV provides you with the ability to generate digital modulation signals in accordance with the definitions in the digital standards or with user-definable characteristics. Signals are generated in realtime or from a data store with the aid of external and internal data. You can also load externally computed modulation signals into the R&S SMBV in the form of waveform files.

Several digital standards are provided, plus digital modulation with user-definable signal characteristics, generation of waveforms with the aid of the Arbitrary Waveform Generator and generation of multi carrier CW signals with the aid of Multi Carrier CW.

The settings for digital modulation can be accessed in the block diagram via the "Baseband" function block or with the aid of the [MENU] key.

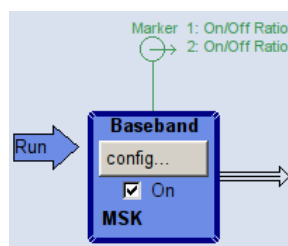

The equipment layout for generating the internal, digital modulation signals includes the options Baseband Generator (B10) and/or one of the ARB only options (B51/K51x). The ARB options feature different ARB memory sizes (see data sheet). Apart from the memory size, however, the options offer the same functionality, either one can be installed.

In addition, the appropriate option is required for the digital standards. These options are specified in the description of the respective standard.

In the subsequent signal route the baseband signals can be frequency-shifted, detuned or loaded with noise (see [Chapter 5.7, "Impairment of Digital I/Q Signal and Noise Generator - AWGN/IMP Block"](#), on page 305).

5.9.1 Working with the Baseband Signal

— Frequency Offset —
0.000 000 000 GHz
— Phase Offset —
0.00 deg

Frequency and phase offset are defined at the topmost menu level in the "Baseband" block or by using the [MENU] button under "Baseband".

The upper part of the "Baseband" dialog is used for selecting digital standards, digital modulation and waveform generation. These menus are described in the respective chapters relating to the modulation systems.

The lower part of the "Baseband" dialog can be used to define a frequency and phase offset.

Frequency Offset

Enters the frequency offset for the baseband signal.

The frequency offset shifts the baseband frequency interval and provides a quick way to shift the used frequency band in the RF frequency section without modifying the RF settings.



Wenn a frequency offset is defined, an icon is displayed in the signal flow right to the baseband block.

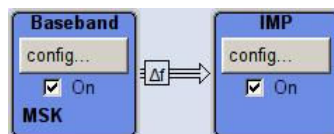

The complex I/Q bandwidth of the shifted useful signal must not exceed the total available baseband bandwidth (see data sheet). The setting range of the frequency offset is then calculated as follow:

$$-(TotalBasebandBandwidth/2) + f_{use}/2 \leq f_{offset} \leq (TotalBasebandBandwidth/2) - f_{use}/2 ,$$

where

f_{use} is the complex useful bandwidth of the I/Q signal before the offset

f_{offset} is the frequency offset

The [Figure 5-17](#) illustrates the setting range for the frequency offset.

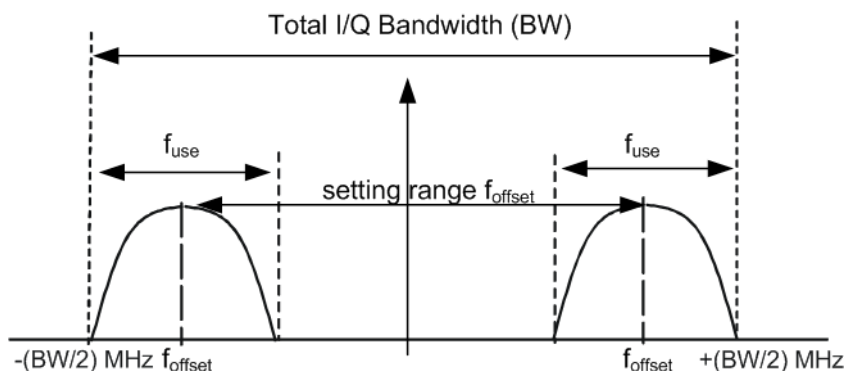

Figure 5-17: Setting range for frequency offset

Example: Calculating the maximum frequency offset

This example uses the following signal:

- "Standard = 3GPP FDD"
- "Chip Rate = 3.84 Mcps"
- "Filter Type = Root Cosine"
- "Roll Off Factor = 0.22"

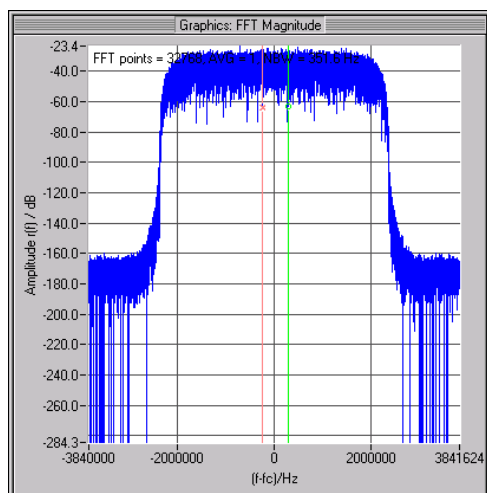

Figure 5-18: 3GPP FDD signal (chip rate 3.84 Mcps, root-cosine filter 0.22).

The complex useful bandwidth of filtered signal is calculated as follows:

$$f_{use} = (1 + \text{"Roll Off Factor"}) * \text{"Symbol Rate"}$$

$$f_{use} = (1 + 0.22) * 3.84 \text{ MHz} = 4.6848 \text{ MHz}$$

For instrument with a total available I/Q bandwidth of 120 MHz, the valid range of values for the frequency offset is then:

$$-120\text{MHz}/2 + 4.6848\text{MHz}/2 \leq f_{offset} \leq 120\text{MHz}/2 - 4.6848\text{MHz}/2 \text{ or}$$

$$-57.6576\text{MHz} \leq f_{offset} \leq 57.6576\text{MHz}$$

Remote command:

[:SOURce<hw>] :BB:Foffset on page 606

Phase Offset

Enter the relative phase offset for the baseband signal.



A phase offset rotates each point of an I/Q constellation diagram by the specified phase offset. The phase offset affects the signal on the "Baseband block" output.

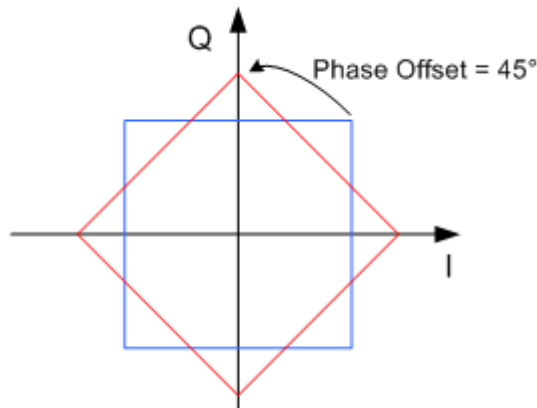

Figure 5-19: Effect of a Phase Offset of 45 degree angle on the I/Q constellation diagram

Observe that the points on the I/Q constellation diagram are turning counterclockwise.

Remote command:

`[:SOURce<hw>] :BB:POFFset` on page 606

5.9.2 Data and Signal Sources in Baseband

This section describes the common characteristics of the signals used for generating the baseband signal for all standards, including for example all listed data sources. The selection in the digital menus at any given time depends on the parameter and standard concerned and is clear from the selection list offered in the dialog. The external data sources may therefore not be available in certain cases.

Characteristics which are uniquely specific to particular standards are described in the corresponding manual.

The following input signals are used when digital modulation signals are being generated:

- Modulation data
- Clock signals
- Control signals

The input signals can be both internally generated and supplied from an external source. The internally generated clock signals are output on the [Clock] connectors.

Likewise control signals and also trigger signals for triggering signal generation in the R&S SMBV can be internally generated or supplied from an external source.

Two marker output signals for synchronizing external instruments can be user-defined.

Externally computed waveform files can be loaded in the instrument using computer interfaces or IEC bus.

Waveform files are processed with the aid of the Arbitrary Waveform Generator (ARB), see [Chapter 5.9.4, "Arbitrary Waveform Generator ARB"](#), on page 382.

Internally the "Multi Carrier CW" menu for defining multi carrier waveforms is available (see [Chapter 5.9.5, "Multi Carrier Continuous Wave"](#), on page 464).

5.9.2.1 Internal PRBS Data and Data Patterns

PRBS generators deliver pseudo-random binary sequences of differing length and duration. They are known as maximum length sequences, and are generated with the aid of ring shift registers with feedback points determined by the polynomial.

By way of example, the diagram below shows a 9-bit generator with feedback to registers 4 and 0 (output).

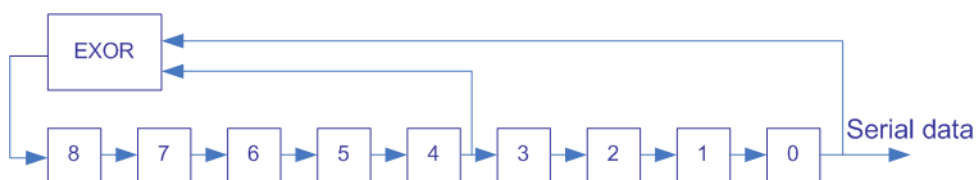
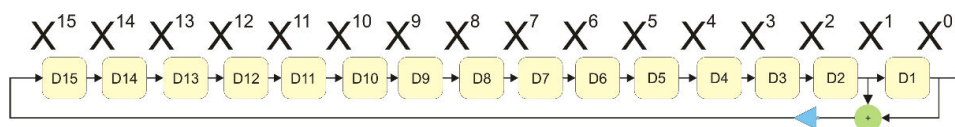

Figure 5-20: 9-bit PRBS generator



For PRBS15 and PRBS23, a CCITT V.52-compliant data inversion is performed in the feedback path automatically as shown below:



The pseudo-random sequence from a PRBS generator is uniquely defined by the register number and the feedback. The following table describes the available PRBS generators:

Table 5-1: PRBS generators

| PRBS generator | Length in bits | Feedback to | GUI selection |
|----------------|------------------------|----------------------|---------------|
| 9-bit | $2^9 - 1 = 511$ | Registers 4, 0 | PRBS 9 |
| 11-bit | $2^{11} - 1 = 2047$ | Registers 2, 0 | PRBS 11 |
| 16-bit | $2^{16} - 1 = 65535$ | Registers 5, 3, 2, 0 | PRBS 16 |
| 20-bit | $2^{20} - 1 = 1048575$ | Registers 3, 0 | PRBS 20 |
| 21-bit | $2^{21} - 1 = 2097151$ | Registers 2, 0 | PRBS 21 |

The "Data Source" selection for PRBS data from the dialog is "PN11, ...".

Simple data patterns such as binary 0 strings or 1 strings can also be used as internal modulation data. The "Data Source" selection from the menus is "ALL 0", "ALL 1". A variable bit string with a maximum length of 64 bits can be entered in an input field by selecting "Pattern."

5.9.2.2 Internal Modulation Data from Lists

Internal modulation data can be generated and stored in the form of binary lists. A separate file is created for each list and held on the instrument's internal flash card.

The file name can be defined by the user.

The "Data Source" selection from the menus is "Data List". When this menu item is chosen the "Select Data List" button appears; this opens the file-selection window for data lists. A list can be created and edited in the "Data List Editor", which is accessed from the menu via the "List Management" or "Data List Management" button.

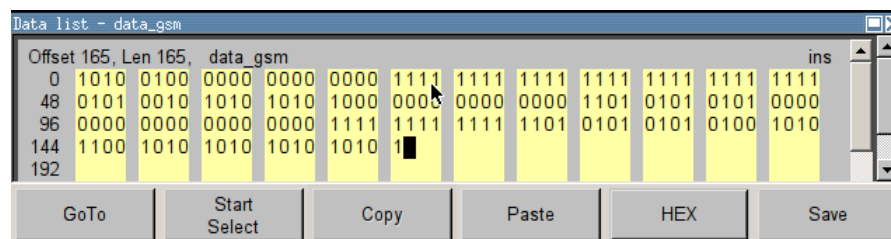

The maximum length of a data list is determined by the size of the data list memory (see data sheet). There is no restriction on the number of lists that can be stored.

5.9.2.3 Clock Signals

The clock reference used for generating the timing pulse can be either internal or external ("Clock Source" selection from the menu: "Internal / External").

To enable a very precise simultaneous signal generation of two or more R&S SMBVs, two additional clock signals, "Sync. Master" and "Sync. Slave", are available. These both clock signals are enabled only in the special synchronization mode. See [Chapter 5.9.2.4, "Synchronous Signal Generation"](#), on page 332 for information how to configure two or more instruments to work in a synchronization mode.

Internal clock reference

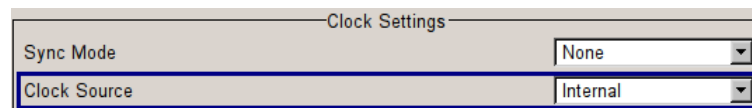

The table below gives an overview of the generated clock signals and the connectors they are output at for the case a internal clock reference is selected.

| Connector | Location | Clock Mode |
|-----------|------------|--------------|
| CLOCK OUT | rear panel | Symbol clock |

External clock reference

The screenshot shows a dialog box titled "Clock Settings". It contains two dropdown menus. The first is labeled "Sync Mode" and is set to "None". The second is labeled "Clock Source" and is set to "External". The "Clock Source" dropdown is highlighted with a blue border.

An external clock is always supplied via the CLOCK connector. When the external clock reference is selected, the internal clock is synchronized to it. The table below gives an overview of the connectors the internal clocks are output at.

| Connector | Location | Clock Mode |
|-----------|------------|--------------|
| CLOCK OUT | rear panel | Symbol clock |

The active edge of the external clock signal on the CLOCK input is selectable (menu "Setup > System > Global Trigger/Clock/External Inputs"). Internally the rising edge is always taken as the active edge. The active rising edge of the internal clocks is therefore synchronized with either the rising or the falling edge of the external clock reference. A symbol clock can be supplied externally or, if internally generated or externally asynchronous data is being fed in, a multiple of a symbol clock can be supplied.

In order for the clock synthesizer on the R&S SMBV to be synchronized correctly, the external clock reference must first be applied and the correct symbol rate must then be set. Until this has been done the external clock source must not be selected ("Clock Source External").



The symbol rate set must not deviate from the symbol rate of the external signal by more than 2% (see also data sheet).

5.9.2.4 Synchronous Signal Generation

Different simulation schemes such as MIMO for instance require the generation of two or more very precise synchronized signals in the baseband and the RF domain.

Two or more instruments are denoted as "perfectly synchronized" if the following criteria are fulfilled:

- The frequency and the phase of the RF carriers are equal.
- The RF levels are equal
- The modulation signals have equal timing, i.e. the symbol rate and the signal generation start determined by the triggering are equal. The contents of the signal, however, may be different, as it is for instance in a MIMO system.

In the R&S SMBV, the first two requirements are fulfilled by adjusting the parameters "Baseband Phase Offset" and "RF Level". A special synchronization mode is provided to meet the third requirement, i.e. to enable several R&S SMBV to generate a simultaneous and synchronous signal.

Synchronization mode is an instrument's configuration in which one of the instruments is used as a master and the other(s) are slave(s). The master instrument supplies the slave instrument(s) with its system and reference clock as well as with its trigger signal.

The instruments have to be configured and connected as described in the following sections.

This straightforward method ensure the simultaneous and synchronous signal generation in both the baseband and the RF part. However, to ensure even better phase coherence of the signal at the RF outputs, the LO Coupling feature of the R&S SMBV should be used. For more information about this feature, see [Chapter 5.5.5, "Local Oscillator - LO Coupling"](#), on page 218.

In the R&S SMBV, the parameters required to achieve a "perfectly synchronized" state have to be gathered only once; they are stable in the time are not influenced by turning the instrument on and off. Refer to Application Note 1GP67 for detailed information on how to adjust the required settings.

Connecting Several R&S SMBVs for Precise Synchronous Signal Generation

For working in master-slave synchronous mode, connect the instruments as follow:

1. Connect the instruments as a daisy chain, i.e. connect the inputs of each further instrument to the outputs of the previous one.
2. Connect the output CLK OUT of the master instrument to the signal input CLK IN of the slave one.
Note: From firmware version 2.05.269 on, the trigger information is modulated on the clock signal and no additional cabling is necessary. For older firmware versions however, a connection between the output MARKER 1 of the master instrument and the signal input TRIG of the slave one is required.
3. To ensure phase coherence of the RF signals, connect the output of the local oscillator LO OUT of the master instrument to the signal input LO IN of the first slave one.
The LO Coupling feature is available only for instruments equipped with the option R&S SMBV-B90.
4. Provide a reference signal for the instruments, i.e. connect the output REF OUT of the master instrument to the signal input REF IN of the first slave one or use a common external reference signal.
This connection is not necessary, if the local oscillators are connected.
5. Connect the power combiner and the spectrum analyzer. The connections are necessary only during the adjustment phase.
6. Avoid unnecessary cable lengths and branching points.

The figure below shows the cabling of two or more R&S SMBVs for working in master-slave synchronous mode.

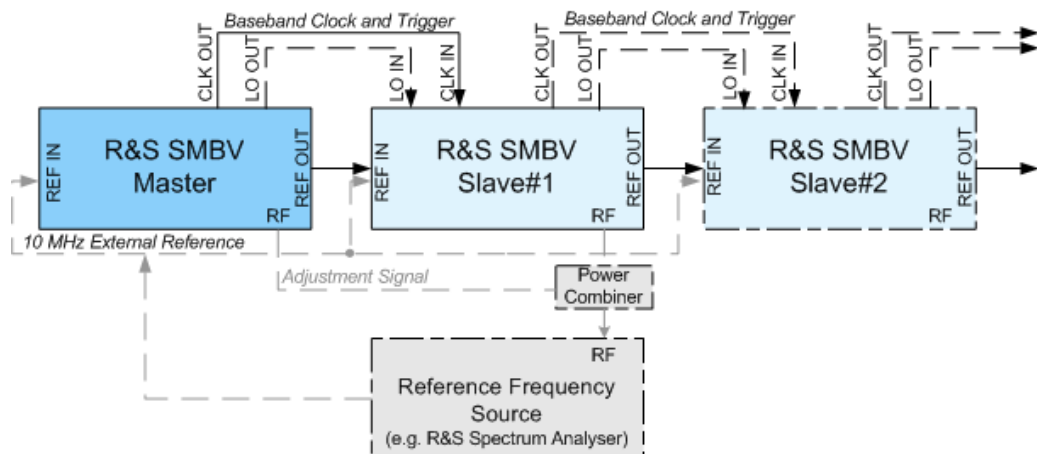

Figure 5-21: Connection of several R&S SMBVs for synchronous signal generation

Some applications require a common external trigger source for all instruments. The connections necessary for this case are not shown on figure above and not considered in this description. The following sections assume the default situation, i.e. that the master instrument provides the slaves with its internal trigger signal.

Configuring Several R&S SMBVs for Precise Synchronous Signal Generation

After the instruments had been connected as described in "[Connecting Several R&S SMBVs for Precise Synchronous Signal Generation](#)" on page 333 the instruments have to be configured.

The synchronization settings are available in the "Clock Settings" section of the "Custom Digital Modulation" menu, "ARB" menu and in each of the "Clock Settings" menus of the installed digital standards. The "Clock Settings" menu are described in the "[Trigger/Marker/Clock Settings](#)" on page 392 and in the respectively section "Trigger/Marker/Clock" of the installed digital standards.

To easy the configuration, an automatically adjustment of the required synchronization settings is provided.

Step 1: Adjust Phase and Level

- ▶ Refer to the Application Note 1GP67 for a detailed description on how to adjust the phase and level settings manually or by using the software tool PhaseTracker.

Step 2: Configure Master Instrument

For working in master-slave synchronous mode, configure the master instrument as follow:

1. Adjust the baseband settings (e.g. "Custom Digital Modulation" or "ARB") as required and activate signal generation.
2. Set the "Synch Mode" to Sync Master.

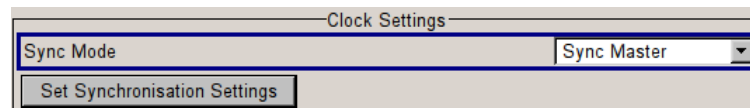

SCPI Command: `BB:DM:CLOC:SYNC:MODE MAST`

3. Perform "Set Synchronization Settings".

SCPI Command: `BB:DM:CLOC:SYNC:EXEC`

The synchronization settings are automatically set.

The synchronization clock (including the trigger signal) and the reference clock of the master instrument are output on the CLK OUT and the REF OUT connectors and supplied to the slave instrument.

Step 3: Configure Slave Instrument(s)

For working in master-slave synchronous mode, the slave instrument(s) has (have) to be configured as follow:

1. Configure the instrument to generate a baseband signal with the same settings as the master one and activate signal generation.
2. Adjust the state of the parameter "Trigger/Marker/Clock > Sync. Output to External Trigger" as follow:
 - a) Disable the parameter, if the master instrument provides the slaves with its internal trigger signal.
 - b) In case a common external trigger signal is provided for the master and the slave instrument(s), the state of this parameter in all instruments has to match.

SCPI Command: `BB:DM:TRIG:EXT:SYNC:OUTP OFF`

3. Set the "Sync Mode" to "Sync Slave".

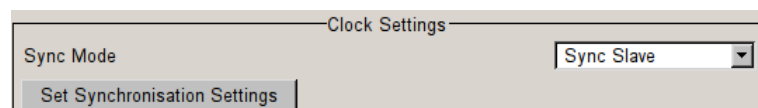

SCPI Command: `BB:DM:CLOC:SYNC:MODE SLAV`

4. Perform "Set Synchronization Settings".

SCPI Command: `BB:DM:CLOC:SYNC:EXEC`

5. Select "Trigger/Marker/Clock > Global Trigger/Clock/External Input Settings > Automatic Delay Compensation" and adjust the "Slave Position in Chain" and "Cable Length". Enable the automatic delay compensation.

Following parameters are set automatically:

- The "Reference Oscillator" source is set to external.
- The "Trigger Mode" is set to retrigger and the "Trigger Source" is set to external.
- The "Clock Source" is set to external.

The slave instrument receives the synchronization clock (including the trigger signal) and the reference clock of the master one.

The "Synchronization State" parameter of the slave instrument displays whether the synchronization is achieved or not.

Each of the slave instruments calculate and compensate the expected timing delay caused by the used cables.

5.9.2.5 Control Signals

The following control signals are processed in the R&S SMBV:

- "Burst Gate" for power ramping
- "Level Attenuation" for power ramping
- "CW" for controlling the CW (continuous wave) mode

A dedicated internal "Control Data Editor" is provided for defining the control signals. Refer to "[Control and Marker List Editor](#)" on page 369 for a description on the provided settings.

A separate file with the file extension *.dm_iqc is created for each defined control signal and held on the instrument's hard disk.

Continuous Wave Mode

The "CW" signal turns off digital modulation. The signal is output in unmodulated form.

In case of standards in which it is possible to switch between different modulation modes, the signal is output only and cannot be supplied from an external source. In such cases it indicates the modulation mode internally (standard GSM: signal high (1) = modulation mode GMSK and signal low (0) = modulation mode 8PSK EDGE).

The CW control signal and the signals for power ramping are generated internally.

Power Ramping and Level Attenuation

The R&S SMBV uses the two control signals "Burst Gate" and "Lev_Att" to trigger the power ramping and level attenuation functions.

The instrument internally generates control signals as configured in [Control and Marker List Editor](#).

- *Burst gate control signal*
The "Burst Gate" signal is a rectangular pulse signal with variable low and high periods. Signal generation is restricted to the gate high periods. If the power ramping function is enabled, each transition between two gate periods of the "Burst Gate" signal triggers the generation of a ramp. Further settings define the form and the steepness of this ramp, see "[Impact of the Power Ramping Settings on the Generated Signal](#)" on page 337.
- *Level attenuation control signal*
The "Lev_Att" signal is a rectangular pulse signal with variable low and high periods. Level attenuation is applied, if the "Lev_Att" signal is high. If level attenuation is enabled, the modulation signal level is attenuated by a defined value.

Related settings:

- "[Power Ramp Control](#)" on page 372



Possible applications

- Use the "Level Attenuation" function to simulate radio stations located at various distances.
- Use the "Power Ramp" function if it is necessary to control the RF output signal envelope synchronously, e.g. by the generation of TDMA signals.

Both the GSM/EDGE and the TD-SCDMA firmware options are equipped with embedded power ramping function. In the GSM/EDGE standard for example, a maximum of 7 different level attenuation values can be defined and allocated separately to the 8 slots independently of one another.

Impact of the Power Ramping Settings on the Generated Signal

The [Figure 5-22](#) explains the power ramping function in principle. The "Burst Gate" signal defines the start of the rising and falling edges of the envelope of the output signal, and the "Lev Att" signal defines the start and end of level attenuation. The signal level during the attenuation period is a configurable value.

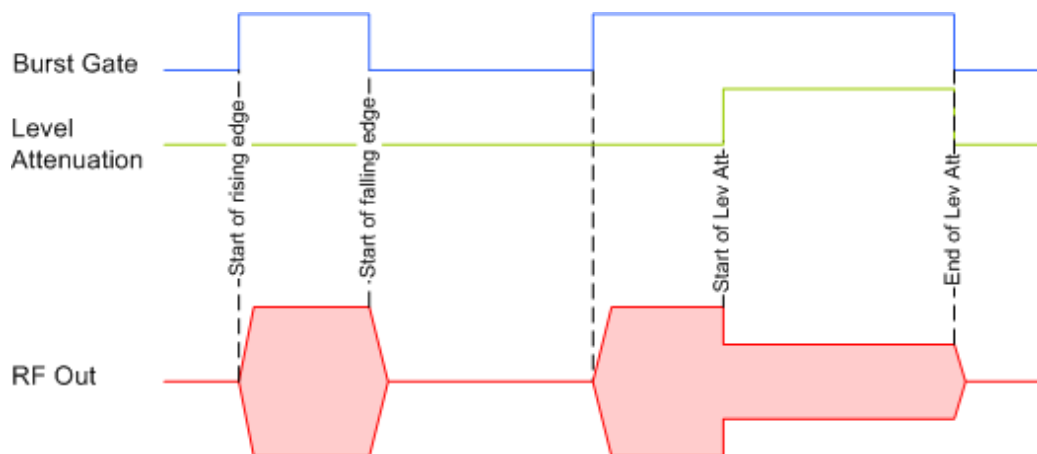

Figure 5-22: Signal behavior when power ramping and level attenuation are enabled

Several parameters are provided for precise definition of the form and the steepness of ramp. The [Figure 5-23](#) depicts the impact of the provided settings.

- Ramp function: defines the shape of the rising and falling edges
- Ramp time: defines the duration of the rising and the falling ramp
- Rise/fall delay: offsets the falling edge of the envelope at the beginning/end of a burst

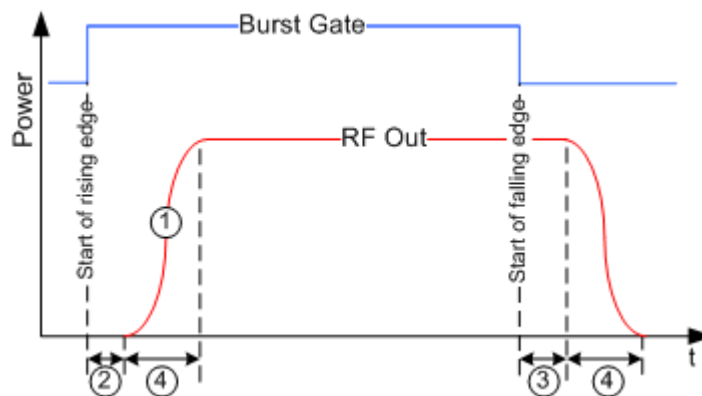

Figure 5-23: Impact of the ramp settings

- 1 = "Ramp Function"
- 2, 3 = "Rise Delay", "Fall Delay"
- 4 = "Ramp Time"

5.9.2.6 Trigger Signals

In the R&S SMBV, trigger signals are internally generated or externally supplied signals which start signal generation at a particular point in time.

Signal generation can also take place without triggering, in which case the signal is then generated in full after modulation is powered up. A trigger event either has no effect on signal generation (menu setting "Trigger Mode Auto") or triggers a signal restart (menu setting "Trigger Mode Retrigger").

If signal generation is triggered, the signal is continuously generated after the first trigger. In the "Armed_Auto" mode, a further trigger event has no effect. In the "Armed_Retrig" mode, every additional trigger event triggers a restart of the signal. In both cases, triggering can be reset to the initial state ("armed"), i.e. signal generation is stopped and the instrument waits for the next trigger to start signal generation anew.

The status of signal generation ("Running" or "Stopped") is displayed for all trigger modes in the corresponding trigger menu of the digital standard currently switched on. The signal generation status particularly with an external trigger can thus be checked.

Internal and external trigger sources are available for triggering.

- Internally, triggering is carried out manually by pressing the "Execute Trigger" button (menu selection "Internal").
- External trigger signals can be fed in via the TRIGGER connector (menu selection "External").

In the case of external triggering and internal triggering by the trigger signal on the second path, the start can be delayed by a definable number of symbols (menu setting "Trigger Delay External"). This makes it possible to purposely simulate the time delay between a base station signal and a user equipment signal, for example in the course of base station tests.

The effect of a restarted trigger signal in the "Retrigger" trigger mode can be suppressed for a definable number of symbols (menu setting "External Trigger Inhibit"). By this means the trigger can be suppressed for a definable number of

frames, for example in the course of base station tests, and yet the signal can still be generated synchronously. In each frame the base station generates a trigger which would cause a signal generation restart every time but for the suppression.

Example:

Entering 1000 samples means that after a trigger event, any subsequent trigger signal is ignored for the space of 1000 samples.

5.9.2.7 Marker Output Signals

The R&S SMBV generates user-definable marker output signals which can be used to synchronize external instruments. By this means a slot clock or frame clock can be set, for instance, or the start of a particular modulation symbol can be marked.

Two marker outputs are available.

| Marker | Connector | Location |
|-------------|-----------------------------|------------|
| Markers 1/2 | MARKER 1 / 2 BNC connectors | rear panel |

Marker Modes

Marker mode restart

The generated marker signal is a single "On" pulse. The rising edge of this pulse is generated at the signal generation start as well as at each subsequent signal restart time. This marker can be used to monitor the effects of the selected trigger, e.g. trigger causing restarts of the signal generation.

Marker mode pulse

Periodic marker with consecutive On and Off periods of equal length. The first On period starts at the beginning of the first generated sample/symbol. The marker frequency is defined by a "Divider". The frequency is derived as follows:

<Frequency> = "Symbol/Sample Rate" / "Divider", respectively

<Frequency> = "Sampling Frequency" / "Divider".

Example:

"Symbol Rate = 1 Msym/s", "Divider = 2"

The marker frequency is 500 kHz, corresponding to a marker period of 2 us. Each On and Off period has a length of 1 us, corresponding to one symbol period. With a divider of 4 (6, 8 ...), the length of each On and Off period is increased to 2 (3, 4, ...) symbol periods.

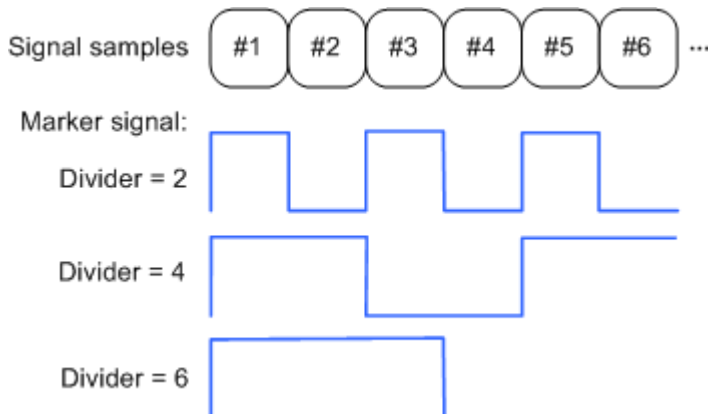

Marker mode pattern

Periodic marker where each period is defined by a bit pattern with a maximum length of 64 bits. A "1" ("0") in the pattern denotes an On (Off) signal segment with a duration of one sample/symbol period.

Example:

In the following example, the marker signal is defined by a pattern 100100...

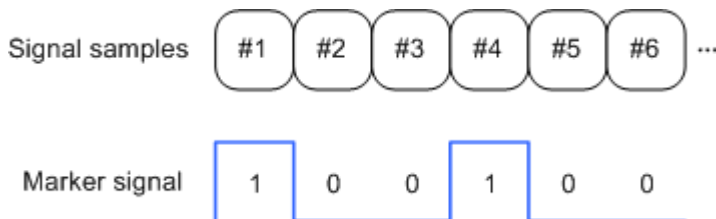

Marker mode ON/OFF ratio

Similar to "Pulse" but with independent lengths of the On and Off periods. The length of the periods is entered as a number of symbols/sample periods.

Example:

In the following example, the marker signal is defined by an "On Time" = 1 and "Off Time" = 2.

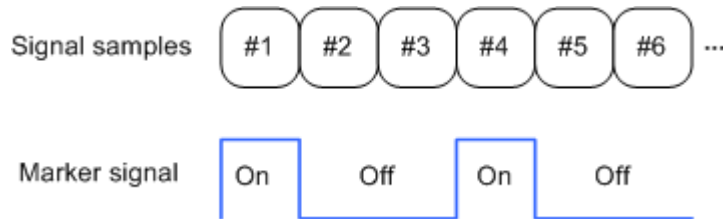

5.9.3 Digital Modulation - Custom Digital Modulation

The R&S SMBV can generate digital modulation signals with user-definable characteristics. Baseband filtering and the symbol rate can be set within wide limits.

5.9.3.1 Overview and Required Options

The equipment layout for generating the digital modulation signals includes the option Baseband Generator (R&S SMBV-B10).

When modulation is ON, a two-part level indication is shown in the header section of the display. This displays both the average power (LEVEL) and the peak envelope power (PEP) of the modulated output signal.



The difference between PEP and LEVEL depends on the modulation type and the filtering: Both values are pre-measured internally so that the displayed values match the true values in the signal. When external signals are used, they are replaced by PRBS data during pre-measurement.

5.9.3.2 Modulation Types - Custom Digital Mod

The available predefined modulation types are ASK (amplitude shift keying), FSK (frequency shift keying), PSK (phase shift keying) and QAM (quadrature amplitude modulation). Additionally, a user defined modulation mapping can be applied (see ["User Mapping"](#) on page 345).

The actual modulation procedure is described by mapping, which assigns I and Q values (PSK and QAM) or frequency shifts (FSK) to every modulation symbol that occurs. This is represented graphically in the constellation diagrams.

The mapping for the selected modulation type is displayed in the "More..." submenu in the "Modulation" menu section (see ["More - Modulation Type"](#) on page 361).

The QAM procedures 16QAM, 32QAM, 64QAM have been produced in accordance with ETSI standard ETS 300429 for digital video broadcasting (DVB). The QAM proce-

dures 256QAM and 1024QAM are not specified in this standard, but have been produced according to the same basic principles.

In the case of all FSK procedures, the user can set the symbol rate fSYMB up to a maximum value (see data sheet). If MSK is selected, the frequency deviation (FSK deviation) cannot be set since it is permanently set to ¼ of the symbol rate.

Table 5-2: Modulation type and associated mapping

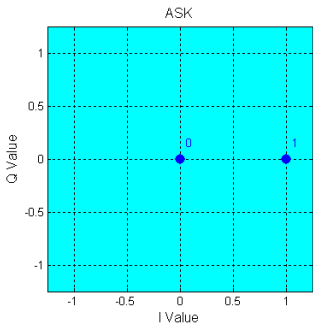
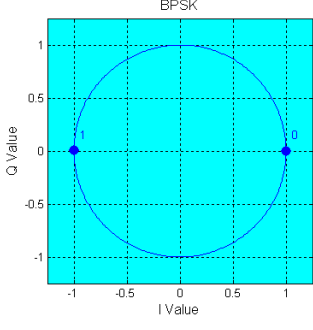
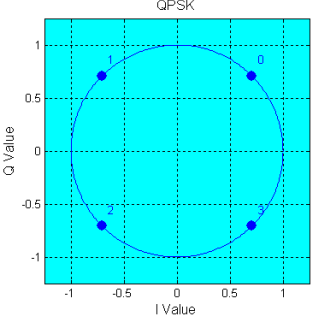
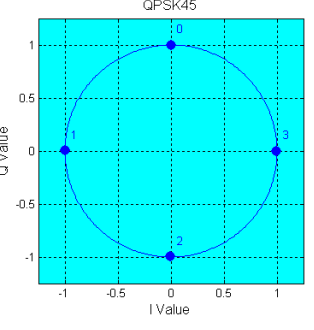
| | | |
|--|---|--|
| <p>ASK 1 bit per symbol SOUR:BB:DM:FORM ASK</p>  | | |
| <p>PSK</p> | | |
| <p>BPSK 1 bit per symbol SOUR:BB:DM:FORM BPSK</p>  | <p>QPSK 2 bits per symbol SOUR:BB:DM:FORM QPSK</p>  | <p>QPSK 45° Offset 2 bits per symbol, 45° rotation SOUR:BB:DM:FORM QPSK45</p>  |
| <p>QPSK EDGE 2 bits per symbol, 3pi/4 rotation SOUR:BB:DM:FORM QEDGE</p> | <p>AQPSK 2 bits per symbol, pi/2 rotation SOUR:BB:DM:FORM AQPSK</p> | <p>OQPSK 2 bits per symbol, Q offset SOUR:BB:DM:FORM OQPSK</p> |

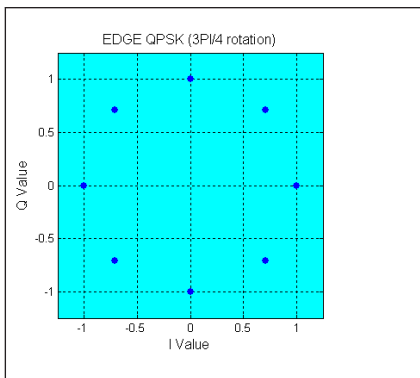
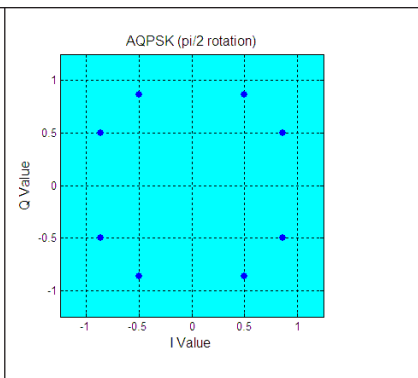
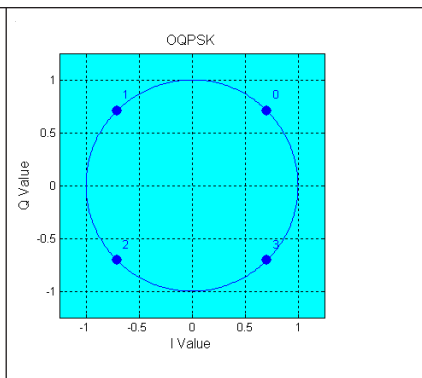
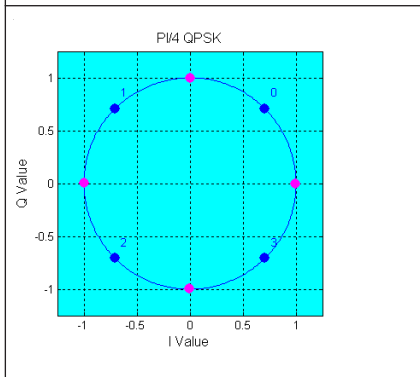
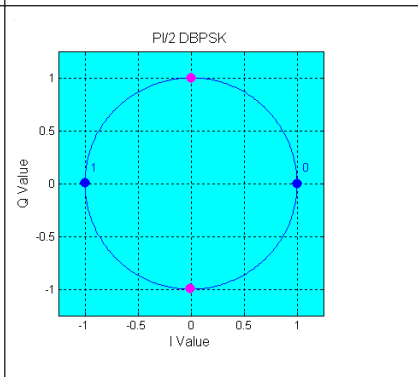
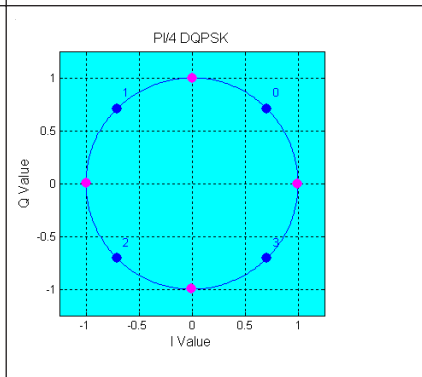
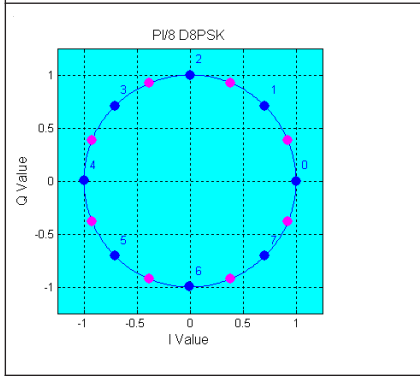
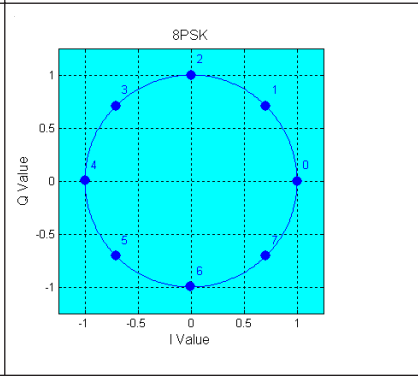
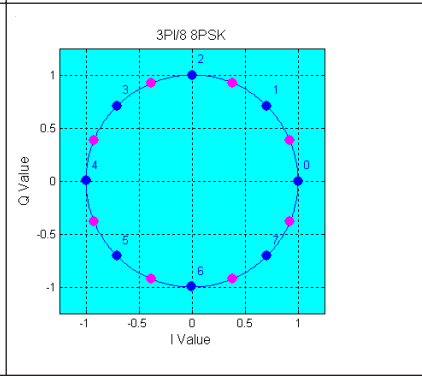
| | | |
|---|---|---|
|  <p>EDGE QPSK (3Pi/4 rotation)</p> |  <p>AQPSK (pi/2 rotation)</p> |  <p>OQPSK</p> |
| <p>pi/4-QPSK 2 bits per symbol pi/4rotation SOUR:BB:DM:FORM P4QP</p> | <p>pi/2-DBPSK 1 bit per symbol Differential coding, pi/2 rotation SOUR:BB:DM:FORM P2DB</p> | <p>pi/4-DQPSK 2 bits per symbol Differential coding, pi/4 rotation SOUR:BB:DM:FORM P4DQ</p> |
|  <p>PI/4 QPSK</p> |  <p>PI/2 DBPSK</p> |  <p>PI/4 DQPSK</p> |
| <p>pi/8-D8PSK 3 bits per symbol Differential coding, pi/8 rotation SOUR:BB:DM:FORM P8D8</p> | <p>8PSK 3 bits per symbol SOUR:BB:DM:FORM PSK8</p> | <p>8PSK EDGE (3pi/8 8PSK) 3 bits per symbol Edge coding, 3pi/8 rotation SOUR:BB:DM:FORM P8ED</p> |
|  <p>PI/8 D8PSK</p> |  <p>8PSK</p> |  <p>3PI/8 8PSK</p> |
| <p>QAM</p> | | |
| <p>16QAM 4 bits per symbol SOUR:BB:DM:FORM QAM16</p> | <p>16QAM EDGE 4 bits per symbol, pi/4 rotation SOUR:BB:DM:FORM QAM16EDge</p> | <p>32QAM 5 bits per symbol SOUR:BB:DM:FORM QAM32</p> |

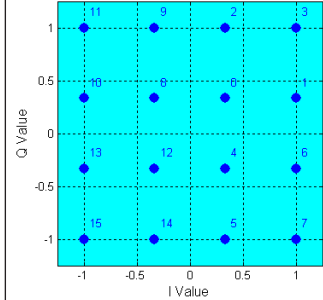
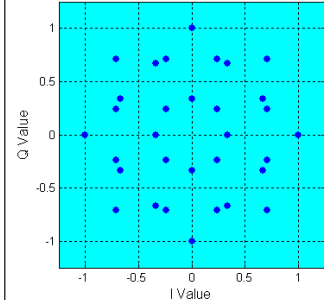
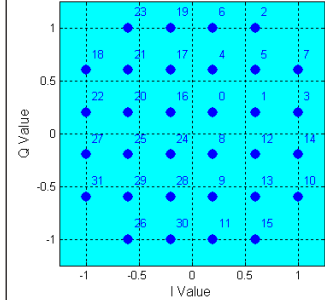
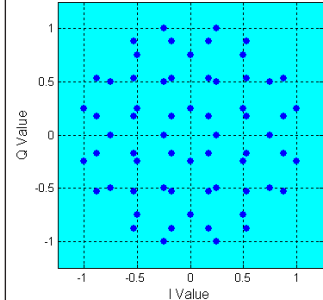
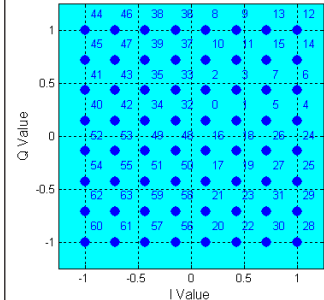
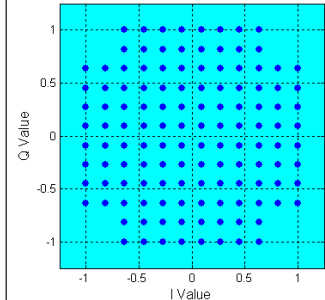
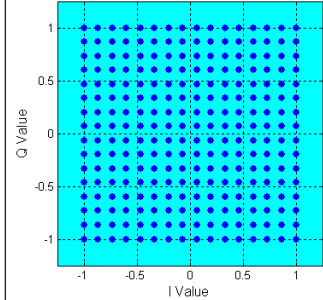
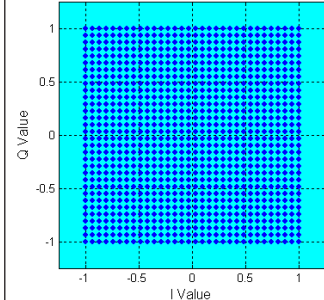
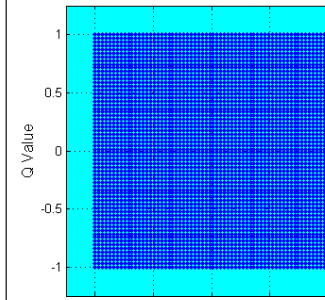
| | | |
|---|---|--|
| <p>16QAM</p>  | <p>EDGE 16QAM (Pi/4 rotation)</p>  | <p>32QAM</p>  |
| <p>32QAM EDGE 5 bits per symbol, -pi/4 rotation SOUR:BB:DM:FORM QAM32Edge</p> | <p>64QAM 6 bits per symbol SOUR:BB:DM:FORM QAM64</p> | <p>128QAM 7 bits per symbol SOUR:BB:DM:FORM QAM128</p> |
| <p>EDGE 32QAM (-Pi/4 rotation)</p>  | <p>64QAM</p>  | <p>128QAM</p>  |
| <p>256QAM 8 bits per symbol SOUR:BB:DM:FORM QAM256</p> | <p>1024QAM 10 bits per symbol SOUR:BB:DM:FORM QAM1024</p> | <p>4096QAM 12 bits per symbol SOUR:BB:DM:FORM QAM4096</p> |
| <p>256QAM</p>  | <p>1024QAM</p>  | <p>4096QAM</p>  |
| <p>FSK</p> | | |

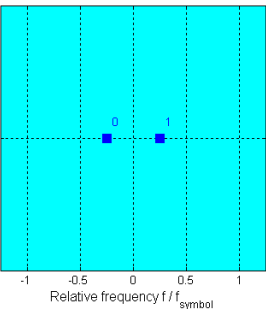
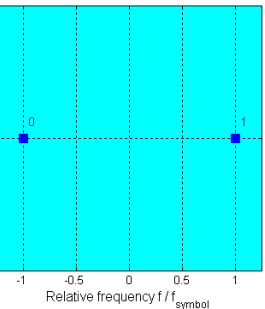
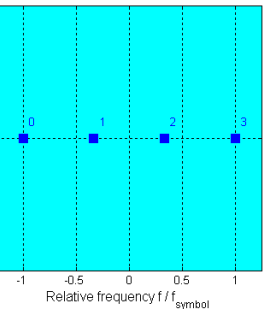
| | | |
|---|--|--|
| MSK 1 bit per symbol, FSK deviation SOUR:BB:DM:FORM MSK SOUR:BB:DM:FSK:DEV 0.1 MHz | 2FSK 1 bit per symbol SOUR:BB:DM:FORM FSK2 | 4FSK 2 bit per symbol SOUR:BB:DM:FORM FSK4 |
|  <p>MSK</p> <p>Relative frequency f/f_{symbol}</p> |  <p>2FSK</p> <p>Relative frequency f/f_{symbol}</p> |  <p>4FSK</p> <p>Relative frequency f/f_{symbol}</p> |

In addition to the FSK modulations, a variable FSK modulation with definable deviation per symbol is available.

[\[:SOURce<hw>\]:BB:DM:FORMat](#) on page 675

User Mapping

A user defined modulation mapping file can also be selected as modulation mapping source. The user modulation mapping file must have extension *.vam and can be created with the R&S mapping wizard. The mapping wizard (mapwiz) is a tool from Rohde & Schwarz designed for editing modulation schemes (e.g. QPSK, 32QAM). Its main purpose is the assignment of logical symbol numbers to constellation points and the selection of modulation specific parameters. Beyond this it supports the creation of nearly any arbitrarily chosen constellation diagram. The output of mapwiz is a mapping file (*.vam) that can be imported on a R&S SMBV. The program was developed on a 32-bit Microsoft Windows platform under MATLAB. For more information, refer to the description "Introduction to "mapwiz" Mapping Editor" on the Rohde&Schwarz Internet page.

5.9.3.3 Coding - Custom Digital Mod

Modulation symbols are coded directly before I and Q values or frequency shifts are assigned. Coding is thus directly related to modulation methods, which is the reason why codings are not freely combinable with modulation methods. The following table shows which of the coding combinations are available and defines the modulation types for which the various coding procedures can be used.

In the notation used below a_n denotes the n-th input symbol and b_n denotes the correspondingly coded output symbol. Individual bits in the symbols from the LSB (least significant bit) to the MSB (most significant bit) are denoted by a_{0n} , a_{1n} and so on. The same applies to the output symbols.

Table 5-3: Permissible coding combinations for modulation symbols and modulation type

| | OFF | Differ- ential | Phase Diff. | Diff. +Gray | Gray | GSM | NADC, PDC, PHS, TETRA, APCO25 (PSK), PWT | TFTS/ TETRA | INMARSAT, ICO, WCDMA, cdma2000 | VDL | APCO25 (FSK) | APCO25 (8PSK) |
|---------------------|-----|-------------------|----------------|----------------|------|-----|--|----------------|---|-----|-----------------|------------------|
| ASK | X | X | | X | X | | | | | | | |
| BPSK | X | X | | X | X | | | | | | | |
| pi/2 DBPSK | X | | | | X | | | | | | | |
| QPSK | X | X | | X | X | | | | X | | | |
| QPSK EDGE | X | | | | | | | | | | | |
| QPSK45° Off- set | X | X | | X | X | | | | | | | |
| Pi/4 QPSK | X | X | | | X | | | | | | | |
| Pi/4 DQPSK | X | | | | X | X | X | X | | | | |
| 8PSK | X | X | | X | X | | | | | X | | |
| AQPSK | X | X | | X | X | | | | | | | |
| OQPSK | X | X | | X | X | | | | | | | |
| 8PSK_EDGE | X | | | | | | | | | | | |
| Pi/8 D8PSK | X | | | | X | | | | | | | X |
| MSK | X | X | | X | X | X | | | | | | |
| 2FSK | X | X | | X | X | X | | | | | | |
| 4FSK | X | X | | X | X | | | | | | X | |
| 8FSK | X | X | | X | X | | | | | | | |
| 16FSK | X | X | | X | X | | | | | | | |
| 16QAM | X | X | X | X | X | | | | | | | |
| 16QAM EDGE | X | | | | | | | | | | | |
| 32QAM | X | X | X | X | X | | | | | | | |
| 32QAM EDGE | X | | | | | | | | | | | |
| 64QAM | X | X | X | X | X | | | | | | | |
| 128QAM | X | X | X | X | X | | | | | | | |
| 256QAM | X | X | X | X | X | | | | | | | |
| 1024QAM | X | X | X | X | X | | | | | | | |

Modulation type pi/4DQPSK

With differential coding switched on at the same time, a constellation diagram is obtained for pi/4DQPSK which is similar to that obtained for 8PSK. Phase shifts are

however assigned to the individual modulation symbols. The following tables show the assignment of modulation symbols to phase shifts of the I/Q vector in relation to the selected coding.

Table 5-4: Phase shifts for pi/4DQPSK

| | | | | |
|---|--------|--------|--------|--------|
| Modulation symbol a_n (binary indication: MSB, LSB) | 00 | 01 | 10 | 11 |
| Phase shifts without coding | + 45° | + 135° | - 135° | - 45° |
| Phase shifts with coding NADC, PDC, PHS, TETRA or APCO25 (PSK) | + 45° | + 135° | - 45° | - 135° |
| Phase shifts with coding TFPS | - 135° | + 135° | - 45° | + 45° |

Coding algorithms

Common coding types are listed in the following table.

Table 5-5: Coding algorithms

| Coding | Coding algorithm | Applicable for K bit/symbol |
|---------------------|---|-----------------------------|
| NONE | $b_n = a_n$ | $k = 1 \dots 8$ |
| Differential | $b_n = (a_n + b_{n-1}) \text{ modulo } 2^k$ | $k = 1 \dots 7$ |
| Differential + Gray | Gray coding with additional differential coding | $k = 1 \dots 7$ |
| GSM | $dc_n = \text{not}(d_n \text{ exor } d_{n-1})$ | $k = 1$ |

Example: Differential coding for QPSK modulation with K = 2 bit/symbol

Decimal display; value range for modulation symbols

$$a_n \in \{0; 1; 2; 3\}$$

Recursive coding is defined as follows: $b_n = (a_n + b_{n-1}) \text{ modulo } 4$

Depending on the state of a preceding modulation symbol b_{n-1} the coded modulation symbol b_n is obtained for example from modulation symbol $a_n = 2$ as follows:

| | | |
|-----------|-----------|-------|
| $a_n = 2$ | b_{n-1} | b_n |
| | 0 | 2 |
| | 1 | 3 |

| | | |
|--|---|---|
| | 2 | 0 |
| | 3 | 1 |

By means of differential coding, the assignment between modulation symbols and phase differences shown in the following table is generated:

| | | | | |
|--|----|-----|------|------|
| Modulation symbol a_n (binary, MSB, LSB) | 00 | 01 | 10 | 11 |
| Phase difference | 0° | 90° | 180° | 270° |

Example: Gray and differential coding for 8PSK modulation

First, a gray coding is performed according to the gray code. Afterwards, a differential coding is performed according to the recursive coding algorithm quoted above. The assignment between modulation symbols and phase differences shown in the following table is generated:

"Differential coding according to VDL" can be used for modulation types with 3 bits/symbol, e.g. 8PSK.

Table 5-6: Differential coding according to VDL

| | | | | | | | | |
|---|-----|-----|------|-----|------|------|------|------|
| Modulation symbol d_n | 000 | 001 | 010 | 011 | 100 | 101 | 110 | 111 |
| Phase difference | 0° | 45° | 135° | 90° | 270° | 315° | 225° | 180° |

"Phase differential coding" INMARSAT and PHASE DIFF correspond to system standards Inmarsat-M and DVB according to ETS 300 429. The INMARSAT coding can generally be used for modulation types with 2 bits/symbol, such as QPSK. It uses the following algorithm.

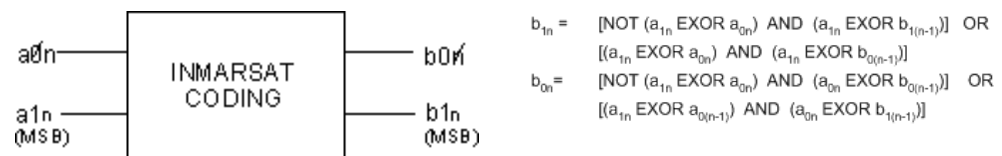

5.9.3.4 Baseband Filter - Custom Digital Mod

The R&S SMBV offers a wide selection of predefined baseband filters. The filter characteristic for the selected filter is displayed in the "More..." submenu in the "Filter" menu section (see "Filter" on page 363). Additionally, a user defined filter can be selected (see "User filter" on page 353).

The following table shows the filters that are available, together with the associated parameters and remote control commands. The filter characteristic is displayed in graphical form.

Table 5-7: Baseband filter

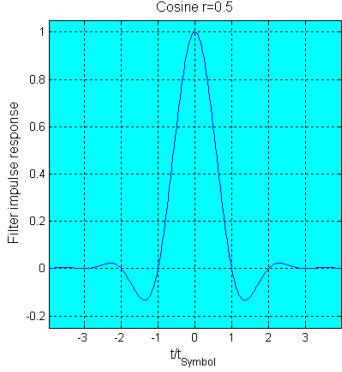
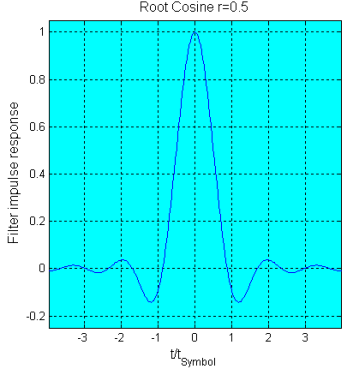
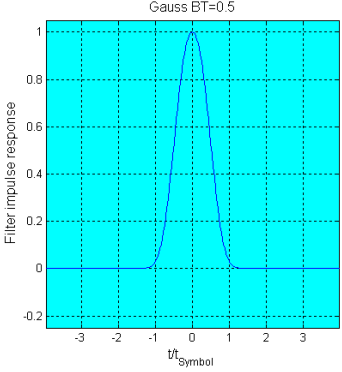
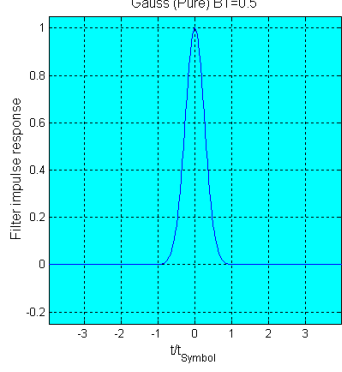
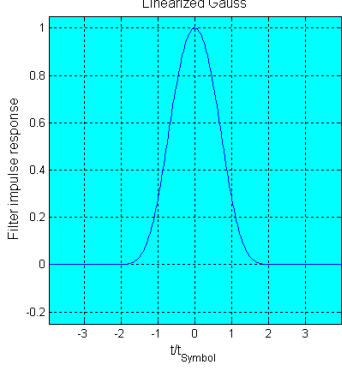
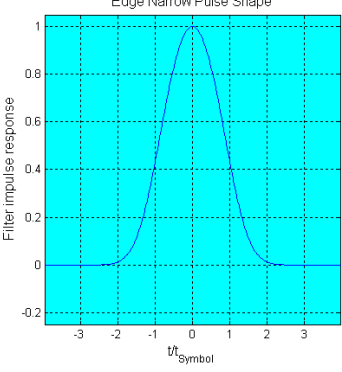
| | | |
|--|---|--|
| <p>Cosine</p> <p>Roll Off Factor</p> <p>SOUR:BB:DM:FILT:TYPE COS</p> <p>SOUR:BB:DM:FILT:PAR:COS 0.99</p> <p>Bandwidth</p> <p>SOUR:BB:DM:FILT:PAR:COS:BAND 7200</p> | <p>Root Cosine</p> <p>Roll Off Factor</p> <p>SOUR:BB:DM:FILT:TYPE RCOS</p> <p>SOUR:BB:DM:FILT:PAR:RCOS 0.99</p> | <p>Gauss (FSK)</p> <p>B x T</p> <p>SOUR:BB:DM:FILT:TYPE GAUS</p> <p>SOUR:BB:DM:FILT:PAR:GAUS 2.5</p> |
|  |  |  |
| <p>Pure Gauss</p> <p>B x T</p> <p>SOUR:BB:DM:FILT:TYPE PGA</p> <p>SOUR:BB:DM:FILT:PAR:PGA 2.5</p> | <p>Gauss Linearized</p> <p>SOUR:BB:DM:FILT:TYPE LGA</p> | <p>Edge Narrow Pulse Shape</p> <p>SOUR:BB:DM:FILT:TYPE ENPShape</p> |
|  |  |  |
| <p>Edge Wide Pulse Shape</p> <p>SOUR:BB:DM:FILT:TYPE EWPShape</p> | <p>cdmaOne</p> <p>SOUR:BB:DM:FILT:TYPE CONE</p> | <p>cdmaOne 705 kHz</p> <p>SOUR:BB:DM:FILT:TYPE COF705</p> |

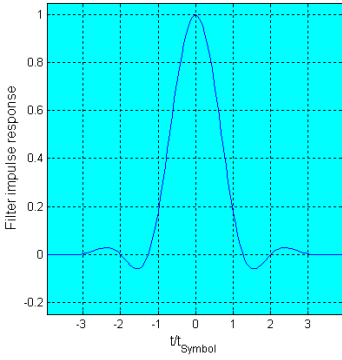
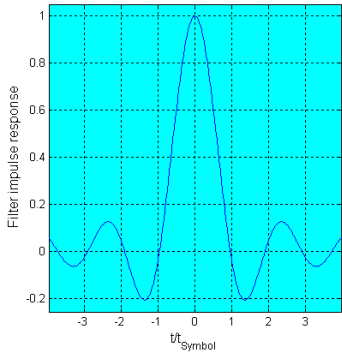
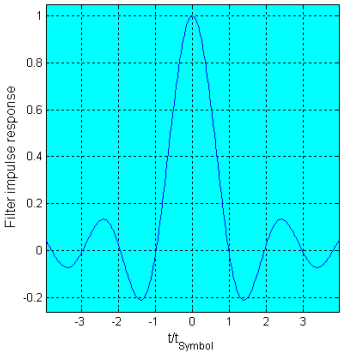
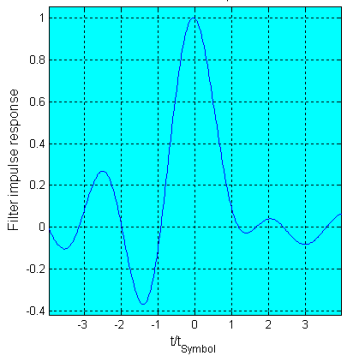
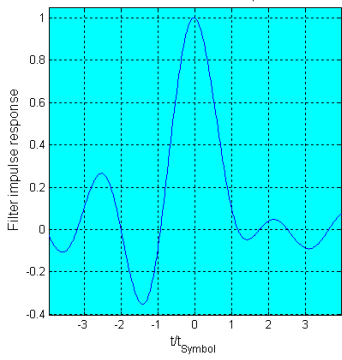
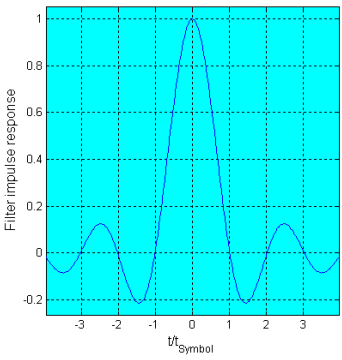
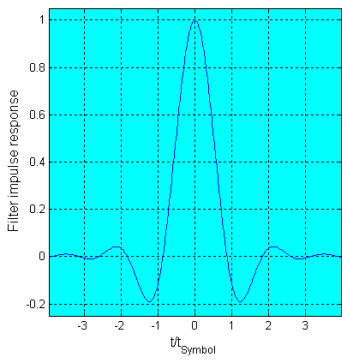
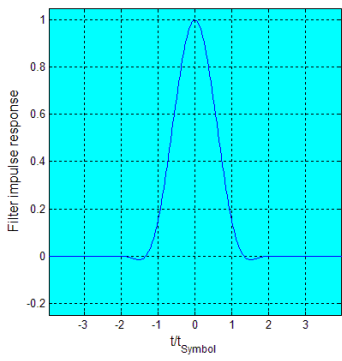
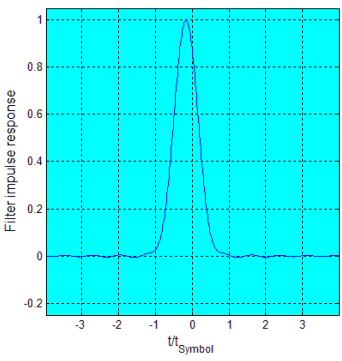
| | | |
|--|--|--|
| <p>Edge Wide Pulse Shape</p>  | <p>CdmaOne</p>  | <p>CdmaOne 705kHz</p>  |
| <p>cdmaOne + Equalizer SOUR:BB:DM:FILT:TYPE COE</p> | <p>cdmaOne 705 kHz + Equalizer SOUR:BB:DM:FILT:TYPE COFE228</p> | <p>cdma2000 3X SOUR:BB:DM:FILT:TYPE DM3x</p> |
| <p>CdmaOne with equalizer</p>  | <p>CdmaOne 705 kHz with equalizer</p>  | <p>Cdma2000 3X</p>  |
| <p>APCO25 Roll Off Factor SOUR:BB:DM:FILT:TYPE APCO25 SOUR:BB:DM:FILT:PAR:APC 0.5</p> | <p>APCO25 (H-CPM) SOUR:BB:DM:FILT:TYPE APCO25Hcpm</p> | <p>APCO25 (LSM) SOUR:BB:DM:FILT:TYPE APCO25Lsm Gauss Cut Off Frequency SOUR:BB:DM:FILT:PAR:APCO25L:GAUSS 25000 Gauss Cut Off Frequency SOUR:BB:DM:FILT:PAR:APCO25:LOWP 75000</p> |
| <p>APCO25 r=0.5</p>  | <p>APCO H-CPM</p>  | <p>APCO LSM</p>  |

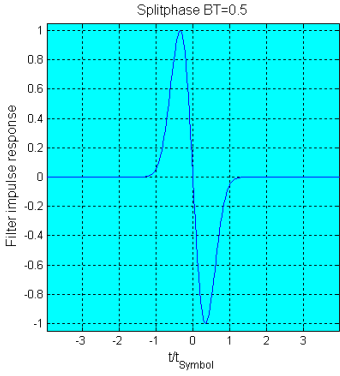
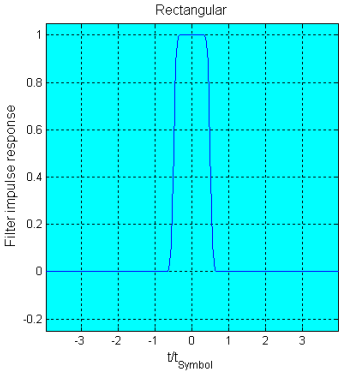
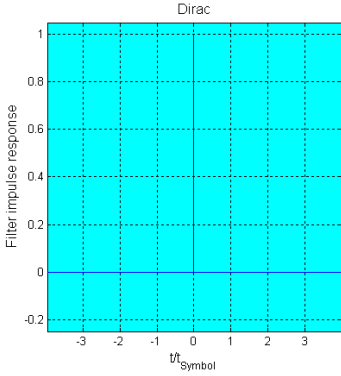
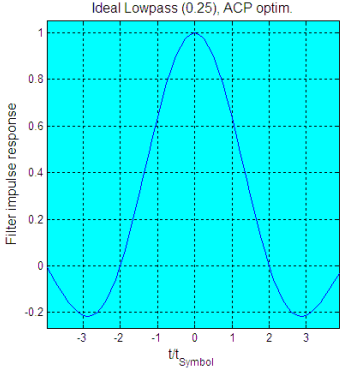
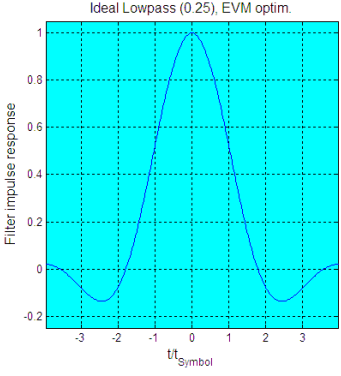
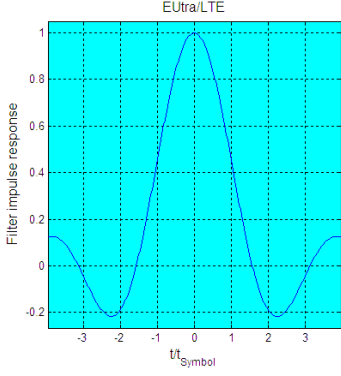
| | | |
|---|--|--|
| <p>Split Phase BxT SOUR:BB:DM:FILT:TYPE SPH SOUR:BB:DM:FILT:PAR:SPH 0.15</p> | <p>Rectangular SOUR:BB:DM:FILT:TYPE RECT</p> | <p>Dirac SOUR:BB:DM:FILT:TYPE DIRac</p> |
|  |  |  |
| <p>Lowpass ACP opt. SOUR:BB:DM:FILT:TYPE LPASs SOUR:BB:DM:FILT:PAR:LAPS 0.5</p> | <p>Lowpass EVM opt. BB:DM:FILT:TYPE LPASSEVM BB:DM:FILT:PAR:LAPSEVM 0.5</p> | <p>EUTRA/LTE SOUR:BB:DM:FILT:TYPE LTEFilter</p> |
|  |  |  |

These predefined filters are designed for the special spectrum characteristics of the different communication standards. However, depending on the selected filter form one or more filter parameters are additionally provided for even precise adjustment of the filter characteristic, like more steeper edges or customization the transition bandwidth. For more information on the provided settings, refer to ["Impact of the Filter Parameters"](#) on page 351.

Impact of the Filter Parameters

The following is a simple description of the filter parameters and the way they affect the main filter characteristics. Changing filter parameters is an effective way to ensure that the entire bandwidth of the desired signal is allowed to pass and adjust the filter form to reach the spectrum mask requirements.

Cut Off Frequency

The cut-off frequency or corner frequency is a filter characteristic that defines the frequency at the 3 dB down point. This frequency is bound to the transition band; here the filter characteristic changes from the passband to the stopband, where the signal is suppressed.

Rolloff Factor

The rolloff factor is a measure for the excess bandwidth compared to the ideal bandwidth of a "brick like" filter. The roll off factor affects the steepness of the filter flanks. A "Rolloff Factor" = 0 would result in the steepest theoretically possible flanks ; values near to 1 make the flanks more flat.

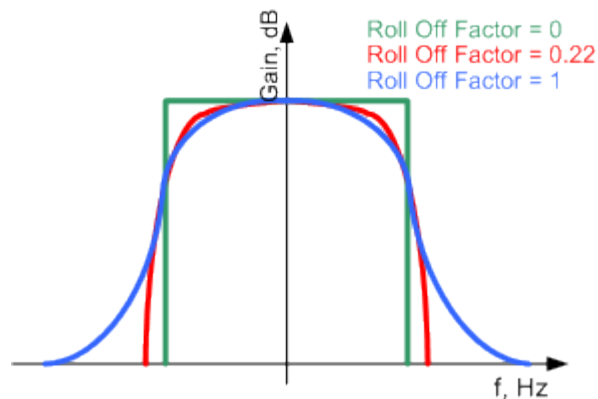

Passband

The passband describes the frequency span that the filter passes unchanged. The total passband of a filter is given as follows:

$$\text{Bandwidth} = (1 + \text{"Roll Off Factor"}) * \text{"Symbol Rate"}$$

Cut Off Frequency Shift

The "Cut Off Frequency Shift" affects the cut-off frequency in the way that the filter flanks are "moved" and the passband increases by "Cut Off Frequency Shift" * "Sample Rate":

$$\text{Cut Off Frequency} = (1 + \text{"Cut Off Frequency Shift"}) * \text{"Sample Rate"}$$

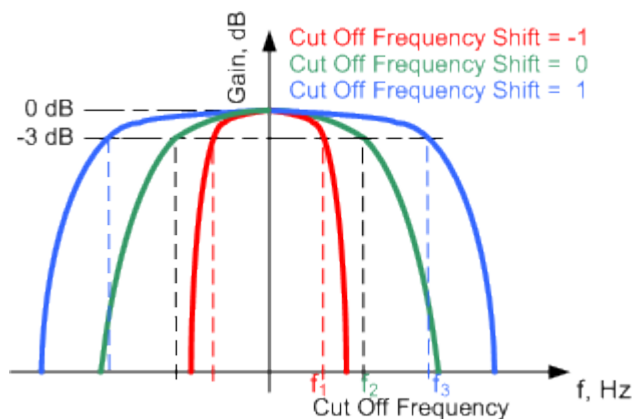

- A "Cut Off Frequency Shift" = -1 results in a very narrow-band filter
- Increasing the value up to 1 makes the filter more broad-band
- By "Cut Off Frequency Shift" = 0, the -3 dB point is at the frequency determined by the half of the selected "Sample Rate".

User filter

The user filter file must have extension `*.vaf` and can be created with the R&S filter wizard.

The filter wizard (filtwiz) is a tool from Rohde & Schwarz designed for creating filter files that can be imported on a R&S SMBV. Its main purpose is the conversion of user-defined finite impulse response (FIR) filters into the filter format (`*.vaf`). Beyond this filt wiz provides designs for standard filters, e.g. Root Raised Cosine, Gaussian.

The program was developed on a 32-bit Microsoft Windows platform under MATLAB.

For more information, refer to the description "Introduction to "filtwiz" Filter Editor" on the Rohde&Schwarz Internet page.

5.9.3.5 Conflicting Settings - Custom Digital Mod

Having selected a modulation procedure, not every combination is possible when selecting the settings for the modulation parameters "Symbol Rate" and "Coding". These restrictions inevitably give rise to conflicting settings if a parameter is changed and leads to a prohibited combination.

A conflicting setting is indicated by a message on the Info line in the display. The R&S SMBV displays the setting entered by the user, but the modulation signal actually generated does not correspond to this display. A conflict of settings can be triggered if the user changes a parameter inappropriately. The message disappears as soon as a conflict-free setting is entered.

A list of the possible settings conflicts and messages in digital modulation can be found in [Chapter 9, "Status Information, Error Messages and Troubleshooting"](#), on page 857.

5.9.3.6 Custom Digital Mod User Interface

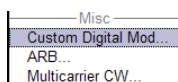

The menu for setting digital modulation can be opened either in the "Baseband" block or in the menu tree under "Baseband".

The "Custom Digital Modulation" menu enables direct selection of the data source, standard, symbol rate, coding, modulation type and filter. All other settings are entered in submenus which are called via "More" buttons.

The upper part of the menu is used for powering up digital modulation as well as for calling the default settings and user-defined standards.

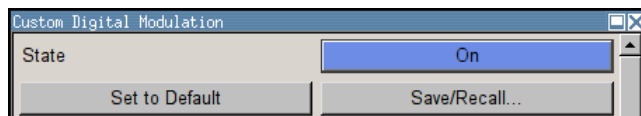

The data source is selected and set in the "Data Source" section.

The "List Management" button opens a submenu for calling the data editor and the file manager.

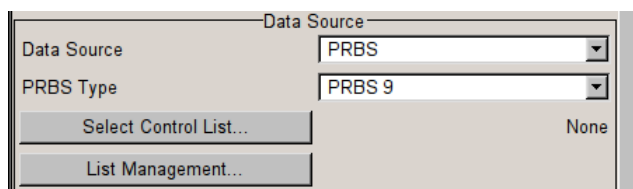

The middle part of the menu is used for selecting the standard, the symbol rate and the coding.

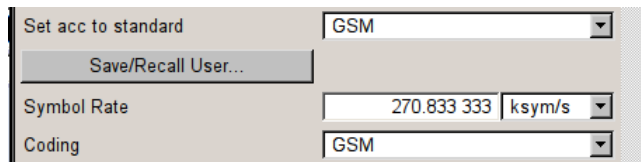

The modulation type is set in the "Modulation" section.

The "More" button opens a submenu that displays the mapping for the selected modulation.

This submenu can also be used to enable switching the signal between modulated and unmodulated.

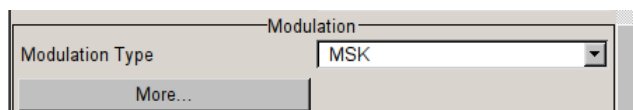

The filter is set in the "Filter" section. The "More" button opens a submenu where the filter characteristic of the selected filter is displayed.

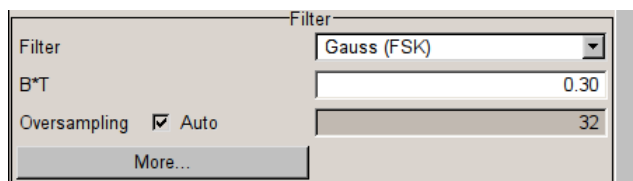

The buttons in the lower part of the menu open submenus for power ramping and for configuring triggers, markers and clocks.

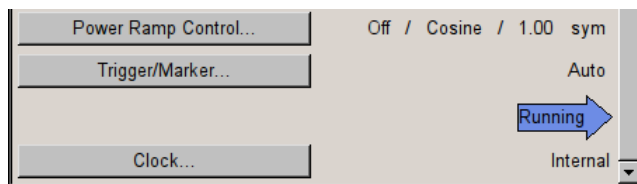

In each case the current setting is displayed next to the button.

General Settings

The upper part of the menu is used for powering up digital modulation as well as for calling the default settings and user-defined standards.

State

Enables/disables digital modulation.

Switching on digital modulation turns off all the other digital standards.

The digital modulation is generated in realtime (no precalculated signal), and therefore all parameter changes (in the ON state) directly affect the output signal.

Remote command:

[:SOURce<hw>] :BB:DM:STATe on page 657

Set To Default

Calls default settings. The values are shown in the following table.

| Parameter | Value |
|---------------------------|--------------------------------|
| State | Not affected by Set to Default |
| Data Source | PRBS 9 |
| Standard | GSM |
| Symbol Rate | 270.833 ksymb/s |
| Coding | GSM |
| Modulation Type | MSK |
| Filter | Gauss (FSK) |
| Filter Parameter BxT | 0.3 |
| Power Ramp Control | |
| Attenuation | 15 dB |
| Ramp Time | 1 sym |
| Ramp Function | Cosine |
| Fall Delay | 0 |
| Rise Delay | 0 |
| Source | Internal |

| Parameter | Value |
|--------------|----------------------------|
| State | Off |
| Trigger | Mode Auto, Source Internal |
| Clock | |
| Source | Internal |
| Mode | Symbol |

Remote command:

[\[:SOURce<hw>\]:BB:DM:PRESet](#) on page 655

Save/Recall

Calls the "Save/Recall" dialog.

From the "Save/Recall" dialog the "File Select" windows for saving and recalling the complete settings in the "Custom Digital Modulation" menu can be called.

The "Digital Modulation" settings are stored as files with the predefined file extension *.dm. The file name and the directory they are stored in are user-definable.

The complete settings in the "Custom Digital Modulation" dialog are saved and recalled.

Remote command:

[\[:SOURce<hw>\]:BB:DM:SETTing:CATalog?](#) on page 689

[\[:SOURce<hw>\]:BB:DM:SETTing:DELeTe](#) on page 689

[\[:SOURce<hw>\]:BB:DM:SETTing:LOAD](#) on page 690

[\[:SOURce<hw>\]:BB:DM:SETTing:STORe](#) on page 690

Fast Save

Determines whether the instrument performs an absolute or a differential storing of the settings.

Enable this function to accelerate the saving process by saving only the settings with values different to the default ones.

Note: This function is not affected by the "Preset" function.

Remote command:

[\[:SOURce<hw>\]:BB:DM:SETTing:STORe:FAST](#) on page 690

[\[:SOURce<hw>\]:BB:ARBitrary:MCARrier:SETTing:STORe:FAST](#) on page 638

refer to the description of firmware options for the syntax of the corresponding SCPI commands

Data Source

The data source is selected and set in the "Data Source" section. The parameters offered depend on the data source selected. The More button opens a submenu for calling the data editor and the file manager.

Data Source

Selects the data source (see [Chapter 5.9.2, "Data and Signal Sources in Baseband"](#), on page 329).

You may choose from the following data sources:

- "All 0, All 1" 0 data or 1 data is internally generated.
- "PRBS, PRBS Type" PRBS data in accordance with the IUT-T with period lengths between 2^9-1 and $2^{23}-1$ are internally generated. The length is selected in the "PRBS Type" input box.



Remote command:

`[:SOURce<hw>] :BB:DM:PRBS [:LENGth]` on page 655

- "Pattern" A user-definable bit pattern with a maximum length of 64 bits is internally generated. The bit pattern is defined in the "Pattern" input box.

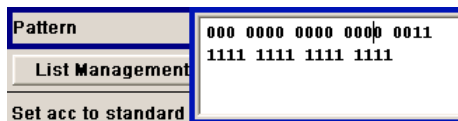

- "Data List ..., Select Data" Data lists will be used. Data lists can be generated internally in the data editor or externally. Data lists are selected in the "File Select" window, which is called by means of the "Select Data" button.



The "File" "Manager" is used to transmit external data lists to the R&S SMBV, and can be called within every "File" Select window by means of the "File" "Manager" button.

Remote command:

`[:SOURce<hw>] :BB:DM:DLIST:SElect` on page 687

Remote command:

`[:SOURce<hw>] :BB:DM:SOURce` on page 655

List Management

Calls the menu for managing data and control lists (see "List Management" on page 365).

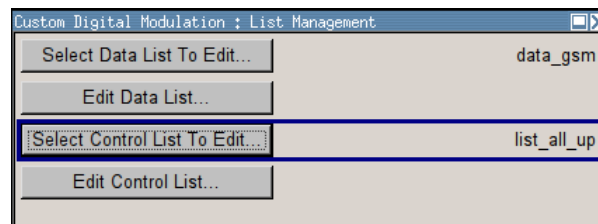

Remote command:

n.a.

Standard, Symbol Rate, Coding

The middle part of the menu is used for selecting the standard, the symbol rate and the coding.

Set acc. to Standard

Selects a standard.

After selection, modulation parameters "Modulation Type", "Symbol Rate", "Filter" and "Coding" are automatically set in accordance with the standard.

If one of these parameters is subsequently altered, the display changes to User. The User setting can be saved to a file so that it can be recalled at some later time ("Save/Recall User.." button).

The following table shows the standards that are available, together with the associated settings of the modulation parameters.

Table 5-8: Standards (Custom Digital Modulation)

| Standard | Modulation | Symbol Rate | Filter | Coding | Parameter for SCPI command |
|----------------------------|---------------------------|-------------------|--|--------------|----------------------------|
| APCO Phase1 C4FM | 4FSK, Deviation 1.8 KHz | 4.8 ksym/s | APCO25, roll off = 0.2 | APCO25(FSK) | APCOPH1C4fm |
| APCO Phase1 CQPSK | pi/4-DQPSK | 4.8 ksym/s | Cosine, roll off = 0.2, BW = 4.8 KHz | APCO25(PSK) | APCOPH1CQpsk |
| APCO Phase2 H-CPM | 4FSK, Deviation 3 KHz | 6 ksym/s | APCO25 (H-CPM) | APCO25(FSK) | APCOPH2HCpm |
| APCO Phase2 H-DQPSK | pi/4-DQPSK | 6 ksym/s | Cosine, roll off = 1, BW = 7.2 KHz | APCO25(PSK) | APCOPH2HDQpsk |
| APCO Phase2 H-D8PSK Wide | pi/8-D8PSK | 4 ksym/s | Cosine, roll off = 1, BW = 7.2 KHz | APCO25(8PSK) | APCOPH2HD8PSKW |
| APCO Phase2 H-D8PSK Narrow | pi/8-D8PSK | 4 ksym/s | Cosine, roll off = 1, BW = 5 KHz | APCO25(8PSK) | APCOPH2HD8PSKN |
| APCO Phase1 LSM | pi/4-DQPSK | 4.8 ksym/s | APCO25 (LSM), Gauss Cut Off = 2.04 KHz, Low-pass Cut Off = 6.2 KHz | APCO25(8FSK) | APCOPH1Lsm |
| APCO Phase1 WCQPSK | pi/4-DQPSK | 4.8 ksym/s | Cosine, roll off = 1, BW = 7.2 KHz | APCO25(8FSK) | APCOPH1Wcqpsk |
| Bluetooth | 2FSK, Deviation 160.0 kHz | 1.0 Msym/s | Gauss, B*T = 0.5 | OFF | BLUetooth |
| DECT | 2FSK, Deviation 288.0 kHz | 1.152 Msym/s | Gauss, B*T = 0.5 | OFF | DECT |
| ETC (ARIB STD T55) | ASK, ASK Depth 100% | 1.024 Msym/s | Split Phase, B*T = 2.0 | OFF | ETC |
| GSM | MSK | 270.833333 ksym/s | Gauss, B*T = 0.3 | GSM | GSM |
| GSM EDGE | 8PSK EDGE (3pi/8 8PSK) | 270.833333 ksym/s | Gauss linear | OFF | GSMEdge |
| NADC | pi/4 DQPSK | 24.3 ksym/s | Root Cosine, alpha = 0.35 | NADC | NADC |
| PDC | pi/4 DQPSK | 21.0 ksym/s | Root Cosine, alpha = 0.50 | PDC | PDC |
| PHS | pi/4 DQPSK | 192.0 ksym/s | Root Cosine, alpha = 0.50 | PHS | PHS |

| Standard | Modulation | Symbol Rate | Filter | Coding | Parameter for SCPI command |
|------------------|-----------------|---------------|---------------------------|-------------|----------------------------|
| TETRA | pi/4 DQPSK | 18.0 ksym/s | Root Cosine, alpha = 0.35 | TETRA | TETRa |
| WCDMA 3GPP | QPSK 45° Offset | 3.84 Msym/s | Root Cosine, alpha = 0.22 | WCDMA 3GPP | W3GPP |
| TD-SCDMA | QPSK 45° Offset | 1.28 Msym/s | Root Cosine, alpha = 0.22 | OFF | TCSCdma |
| cdma2000 Forward | QPSK | 1.2288 Msym/s | cdmaOne + Equalizer | cdma2000 | CFORward |
| cdma2000 Reverse | Offset QPSK | 1.2288 Msym/s | cdmaOne | cdma2000 | CREVerse |
| Worldspace | QPSK | 1.84 Msym/s | Root Cosine, alpha = 0.40 | OFF | WORLdspace |
| TFTS | pi/4 DQPSK | 22.1 ksym/s | Root Cosine, alpha = 0.40 | TFTS/ TETRA | TFTS |

Remote command:

[\[:SOURce<hw>\]:BB:DM:STANdard](#) on page 656

Save/Recall User

Calls the "Save/Recall User" menu.

From the "Save/Recall User Standard" menu the "File Select" windows for saving and recalling user-defined standards and the "File Manager" can be called.



User standards are stored as files with the predefined file extension *.dm_stu. The file name and the directory they are stored in are user-definable.

Remote command:

[\[:SOURce<hw>\]:BB:DM:STANdard:ULISt:CATalog?](#) on page 691

[\[:SOURce<hw>\]:BB:DM:STANdard:ULISt:DELeTe](#) on page 691

[\[:SOURce<hw>\]:BB:DM:STANdard:ULISt:LOAD](#) on page 691

[\[:SOURce<hw>\]:BB:DM:STANdard:ULISt:STORe](#) on page 692

Symbol Rate

Selects the symbol rate.

The value range is dependent on the selected modulation type.

When the modulation type changes, the range is automatically redefined. If the set symbol rate is outside this range, an error message is generated and the maximum value for the newly chosen modulation type is automatically set.

Remote command:

[\[:SOURce<hw>\]:BB:DM:SRATe](#) on page 656

Coding

Selects the coding (see [Chapter 5.9.3.3, "Coding - Custom Digital Mod"](#), on page 345).

The menu offers only the coding settings that are permissible for the chosen modulation type. The other coding methods are grayed out.

If the system is subsequently switched to a modulation type for which the selected coding is not available, coding is automatically set to OFF.

Remote command:

`[:SOURce<hw>] :BB:DM:CODing` on page 674

Modulation

The modulation type is set in the "Modulation section". The parameters offered depend on what is currently selected. The "More..." button opens a submenu for displaying the user-defined mapping.

Modulation Type

Selects a modulation type.

The associated symbol mapping is displayed in the "More..." submenu (see [Chapter 5.9.3.2, "Modulation Types - Custom Digital Mod"](#), on page 341).

If the "coding" that is set is not possible with the chosen modulation type, "coding" is set to "Off".

For selection "Variable FSK", the deviation of each symbol can be set in the "More..." submenu.

Remote command:

`[:SOURce<hw>] :BB:DM:FORMat` on page 675

Load User Mapping

Selects user defined mapping table. This opens the "Select List File User Mapping" window in which the mapping table can be selected (see ["User Mapping"](#) on page 345). The button is only available if modulation type "USER" is selected.

The button "File Manager" calls the "File Manager" menu. The "File" "Manager" menu is used to display and delete files.

Remote command:

`[:SOURce<hw>] :BB:DM:MLIST:SElect` on page 689

`[:SOURce<hw>] :BB:DM:MLIST:CATalog?` on page 681

`[:SOURce<hw>] :BB:DM:MLIST:DElete` on page 688

ASK Depth

Sets the modulation depth m for ASK modulation.

$$m = (\text{Amplitude}_{\text{max}} - \text{Amplitude}_{\text{min}}) / (\text{Amplitude}_{\text{max}} + \text{Amplitude}_{\text{min}})$$

Remote command:

`[:SOURce<hw>] :BB:DM:ASK:DEPTH` on page 674

FSK Deviation

Sets the frequency deviation for FSK modulation. The range of values depends on the chosen symbol rate (see data sheet).

Whenever "MSK" is selected, the deviation corresponds to 1/4 of the symbol rate and cannot be set.

Remote command:

[\[:SOURce<hw>\]:BB:DM:FSK:DEVIation](#) on page 675

Angle Alpha

For AQPSK modulation, sets the angle alpha between the point (0,0) and the I axis.

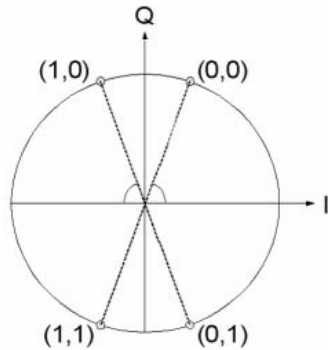

Remote command:

[\[:SOURce<hw>\]:BB:DM:AQPSk:ANGLE](#) on page 673

Gamma/Gamma 1

Selects the gamma function γ for the 16APSK and 32APSK modulations.

The values in brackets indicate the used code rate according to the DVB-S2 specification.

Remote command:

[\[:SOURce<hw>\]:BB:DM:APSK16:GAMMa](#) on page 658

[\[:SOURce<hw>\]:BB:DM:APSK32:GAMMa](#) on page 658

More - Modulation Type

Calls the submenu which displays the mapping of the currently selected modulation type and the digital modulation delay in the case of an external data source.

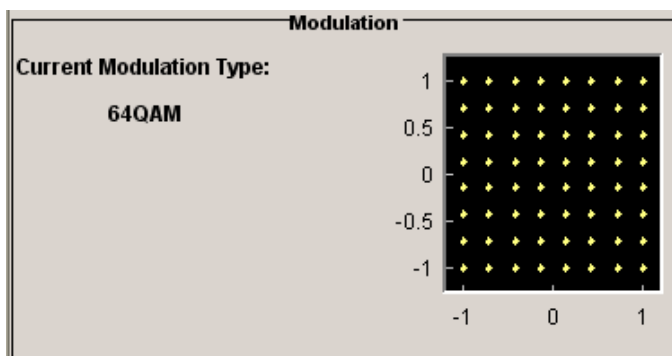

The "Modulation - CW Switching" section can be used to enable switching of the signal between modulated and unmodulated.

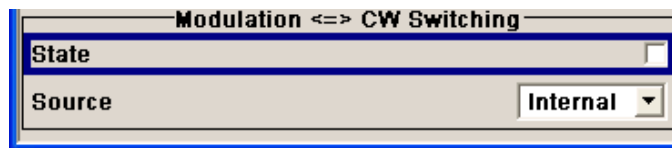

In case of selection "Variable FSK", the FSK type and the deviation for each symbols is set in the "Variable FSK" section.

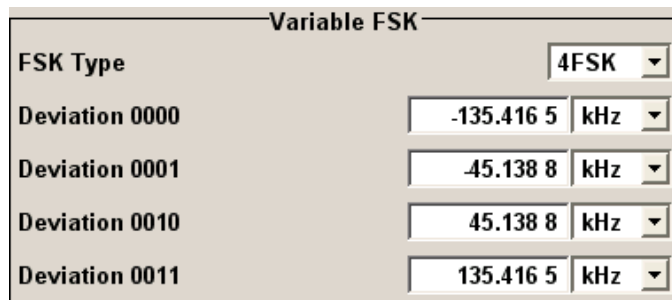

FSK Type

(Variable FSK only)

Selects the FSK modulation type for selection "Variable FSK".

You may choose from 4FSK, 8FSK and 16FSK.

Remote command:

[\[:SOURce<hw>\]:BB:DM:FSK:VARiable:TYPE](#) on page 676

Deviation xxxx

(Variable FSK only)

Set the deviation of the associated symbol. The number of symbols depends on the selected modulation type. The value of each symbol is indicated in binary format.

Remote command:

[\[:SOURce<hw>\]:BB:DM:FSK:VARiable:SYMBOL<ch0>:DEViation](#) on page 675

Modulation Delay

(Data Source ext serial only)

Displays the digital modulation delay from the data input to the I/Q output.

The value is displayed only if an external synchronous data source is selected. In this case the value represents the delay between the active clock edge for data and the corresponding peak I/Q value (associated with this data item) on the I/Q connectors.

Remote command:

[\[:SOURce<hw>\]:BB:DM:MDELay?](#) on page 676

Current Modulation Type

Displays the currently selected modulation type together with its associated mapping.

Remote command:

n.a.

Modulation - CW Switching

The "Modulation <=> CW Switching" section is used to enable switching the signal between modulated and unmodulated.

State Mod - CW

Enables switching between a modulated and an unmodulated signal.

Switching is carried out by a control signal (CW) that is defined internally in the control list or supplied from an external source via a user-defined input.

Remote command:

`[:SOURce<hw>] :BB:DM:SWITChing:STATe` on page 657

Source Mod - CW

Selects the CW control signal for switching between a modulated and an unmodulated signal.

"Internal" The CW signal in the control list is used for the control.

Remote command:

`[:SOURce<hw>] :BB:DM:SWITChing:SOURce` on page 657

Filter

The filter is set in the Filter section.

Filter

Selects the baseband filter (see [Chapter 5.9.3.4, "Baseband Filter - Custom Digital Mod"](#), on page 348).

Remote command:

`[:SOURce<hw>] :BB:DM:FILTer:TYPE` on page 672

Filter Parameter

Sets the filter parameter.

The filter parameter offered ("Roll Off Factor" or "B x T") depends on the currently selected filter type.

Remote command:

`[:SOURce<hw>] :BB:DM:FILTer:PARAmeter:APCO25` on page 671

`[:SOURce<hw>] :BB:DM:FILTer:PARAmeter:COsine[:ROLLoff]` on page 671

`[:SOURce<hw>] :BB:DM:FILTer:PARAmeter:GAUSSs` on page 671

`[:SOURce<hw>] :BB:DM:FILTer:PARAmeter:PGAuss` on page 671

`[:SOURce<hw>] :BB:DM:FILTer:PARAmeter:RCOSine` on page 671

`[:SOURce<hw>] :BB:DM:FILTer:PARAmeter:SPHase` on page 671

Cut Off Frequency Factor

(available for filter parameter Lowpass and APCO25 (LSM) only)

Sets the value for the cut off frequency factor. The cut off frequency of the filter can be adjusted to reach spectrum mask requirements.

Remote command:

[:SOURce<hw>] :BB:DM:FILTer:PARAmeter:LPASs on page 671

[:SOURce<hw>] :BB:DM:FILTer:PARAmeter:LPASSEVM on page 671

[:SOURce<hw>] :BB:DM:FILTer:PARAmeter:APCO25Lsm:GAUSS on page 672

[:SOURce<hw>] :BB:DM:FILTer:PARAmeter:APCO25Lsm:LOWPass on page 672

Bandwidth

Determines the bandwidth of the cosine filter, so that the function $H(f) = 0$ is fulfilled for $f \geq (1 + \text{RollOff}) * \text{Bandwidth} / 2$.

Remote command:

[:SOURce<hw>] :BB:DM:FILTer:PARAmeter:COSine:BANDwidth on page 672

Oversampling

Determines the upsampling factor. If the check box is activated, the most sensible parameter values are selected. The value depends on the coherence check. If the check box is deactivated, the values can be changed manually.

Remote command:

[:SOURce<hw>] :BB:DM:FILTer:OSAMpling:AUTO on page 670

[:SOURce<hw>] :BB:DM:FILTer:OSAMpling on page 670

More - Filter

Calls the menu for displaying the filter characteristic of the currently selected filter.

Load User Filter

Calls the menu "Select List File User Filter" for selecting a user-defined filter file with extension `*.vaf` (see "User filter" on page 353). The button is only available if filter type "USER" is selected.

The button "File" "Manager" calls the "File" "Manager" menu. The "File" "Manager" menu is used to display and delete files.

Remote command:

[:SOURce<hw>] :BB:DM:FLISt:SElect on page 688

[:SOURce<hw>] :BB:DM:FLISt:CATalog? on page 681

[:SOURce<hw>] :BB:DM:FLISt:DElete on page 687

Current Filter Response

Displays the filter characteristic of the currently selected filter.

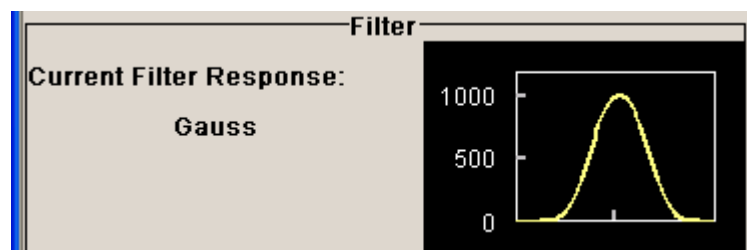

Remote command:

n.a.

Power Ramp

The lower part of the "Custom Digital Modulation" menu is used for setting triggers, marker and clocks, as well as for power ramp settings.

Power Ramp Control

Calls the power ramp control menu (see ["Power Ramp Control"](#) on page 372).

Remote command:

n.a.

Trigger/Marker

Calls the "Trigger/Marker/Clock" dialog, used to select the trigger source, set the time delay on an external trigger signal and configure the marker output signals.

See ["Trigger/Marker/Clock"](#) on page 375.

Remote command:

n.a.

Execute Trigger

Executes trigger manually. A manual trigger can be executed only when an internal trigger source and a trigger mode other than Auto have been selected.

Remote command:

[\[:SOURce<hw>\]:BB:DM:TRIGger:EXECute](#) on page 661

Clock

Calls the "Trigger/Marker/Clock" menu. The "Trigger/Marker/Clock" menu is used to select the clock source (see ["Clock Settings"](#) on page 380).

Remote command:

n.a.

List Management

The "List Management" menu is called from the "Custom Digital Modulation" main menu.

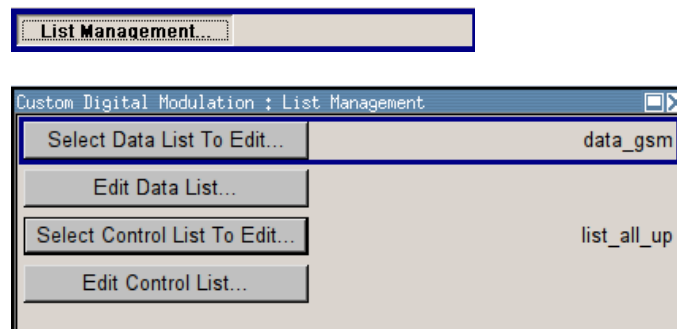

The data and control lists are selected and created in the "File Select" menu which is called up by means of the "Data List..." and "Control List..." buttons.



The "File Manager" is used to copy, rename and delete files and to create directories.

For more information, see [Chapter 4.7, "File Management"](#), on page 105.

To ensure that the selected data or control list is used for generating the digital signal, the list must be selected as the data source:

| Data | Parameter | Selection |
|--|---------------|-----------|
| Digital data | "Source" | DList |
| Marker | "Marker Mode" | CList |
| Control signals CW, Level Attenuation and Burst Gate | "Source" | Internal |

The data editor is called using the "Edit Data List..." and "Edit Control List ..." buttons. The contents of the selected list are displayed.

Operating the list editors is described in [Chapter 4.5.1, "Working with List Editor"](#), on page 97.

Select Data/Control List

Selects data/control list. This opens the "File Select" window in which the data/control list can be selected.

Remote command:

[\[:SOURce<hw>\]:BB:DM:DLIST:SElect](#) on page 687

[\[:SOURce<hw>\]:BB:DM:CLIST:SElect](#) on page 684

Create Data/Control List

Creates new data/control list. This opens the "File Select" window in which the data/control list can be created.

The file name has to be entered in field "File Name:". The new list contains no data, it can be edited in the list editor.

Remote command:

[\[:SOURce<hw>\]:BB:DM:DLIST:SElect](#) on page 687

[\[:SOURce<hw>\]:BB:DM:CLIST:SElect](#) on page 684

File Manager

Calls the "File Manager".

The "File Manager" is used to copy, delete and rename files and to create new directories.

For detailed description, see [Chapter 4.7.2, "File Manager"](#), on page 108.

Remote command:

[:SOURce<hw>] :BB:DM:DLIST:SElect on page 687

[:SOURce<hw>] :BB:DM:DLIST:COpy on page 682

[:SOURce<hw>] :BB:DM:DLIST:DElete on page 686

[:SOURce<hw>] :BB:DM:CLIST:SElect on page 684

[:SOURce<hw>] :BB:DM:CLIST:COpy on page 682

[:SOURce<hw>] :BB:DM:CLIST:DElete on page 683

Data List Editor

The "Data List Editor" for editing the selected data list is called up in the "List Management" submenu of the "Custom Digital Modulation" main menu by means of the "Edit Data List..." button.

See [Chapter 4.5, "Editors"](#), on page 97 for description on how to use the editor.

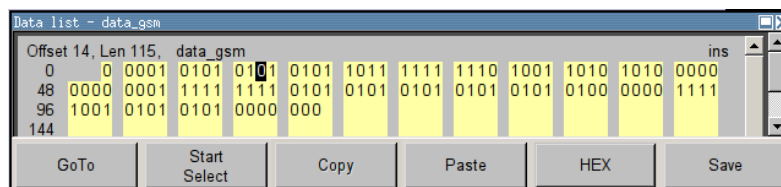

Data List Editor

A list of binary values with a maximum length of 2^{31} bits can be entered in the "Data List Editor". This value corresponds to a file size of approx. 268 Mbyte.

To increase readability, the bits are displayed in groups of four. The current cursor position, the length of the list and the list file name are displayed above the list. The offset starts with the value 0 which corresponds to the bit position on the left side of the first row, i.e. the beginning of the list. On the left edge of the editor, the last three offset positions are specified at the beginning of the row.

An existing list can be edited in the insert or overwrite mode.

Remote command:

[:SOURce<hw>] :BB:DM:DLIST:SElect on page 687

[:SOURce<hw>] :BB:DM:DLIST:DATA on page 684

[:SOURce<hw>] :BB:DM:DLIST:DATA:APPend on page 685

GoTo ← Data List Editor

Opens the entry window for the bit position. The cursor marks the bit at the selected position.

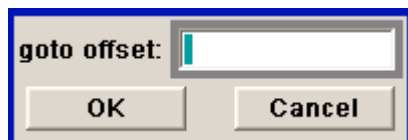

Remote command:

n.a.

Start Select ← Data List Editor

Defines the current cursor position as the start position for the range to be marked. The stop position is defined by entering an offset under "GoTo".

When a start position has been activated, the button will be re-labelled to "Undo Select". When the button is clicked now, the selected range will be deactivated.

Remote command:

n.a.

Copy ← Data List Editor

Copies the selected values.

Remote command:

n.a.

Cut ← Data List Editor

Cuts the selected values.

Remote command:

n.a.

Paste ← Data List Editor

Pastes the values that have been copied or cut before.

Remote command:

n.a.

Hex ← Data List Editor

Switchover to hexadecimal display.

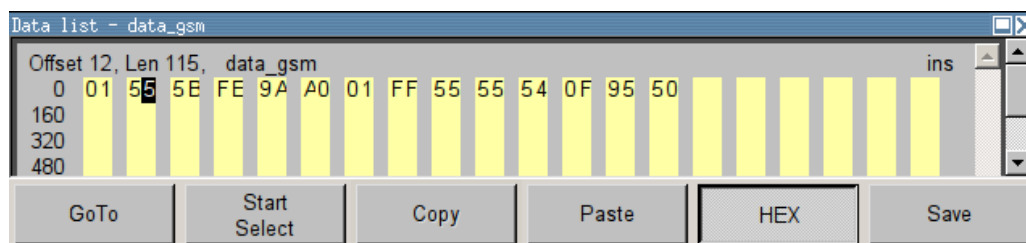

Each four bits are displayed as a hexadecimal value: To increase readability, the hexadecimal values in turn are displayed in pairs of two. The hex functions are automatically assigned to the numeric keys at the front panel.

Remote command:

n.a.

Save (Data List) ← Data List Editor

Saves the changes made to the Data List file selected for editing.

Remote command:

n.a.

Control and Marker List Editor

The "Control and Marker List Editor" for editing the selected control list is called up in the "List Management" submenu of the "Custom Digital Modulation" main menu by means of the "Edit Control List"... button.

Edit Control List...

The available marker signals and the CW, Hop, Burst Gate and Level Attenuation control signals can be defined in the "Control and Marker List Editor".



The marker signals defined in the Control and Marker List Editor are activated by selecting the Marker mode "CList" in the "Trigger/Marker/Clock" menu. The control signals have to be activated by selecting an "Internal Source" in the respective setting menu, e.g. the "Power Ramp Control" menu for the Burst Gate and Level Attenuation control signals.

The available marker/control signals are color-coded. In the left "Configure Control Signal" section, each individual signal is assigned a colour; a check in the check box shows the marker for which the "CList" marker type has been selected and the control signal for which the "Internal" source has been selected.

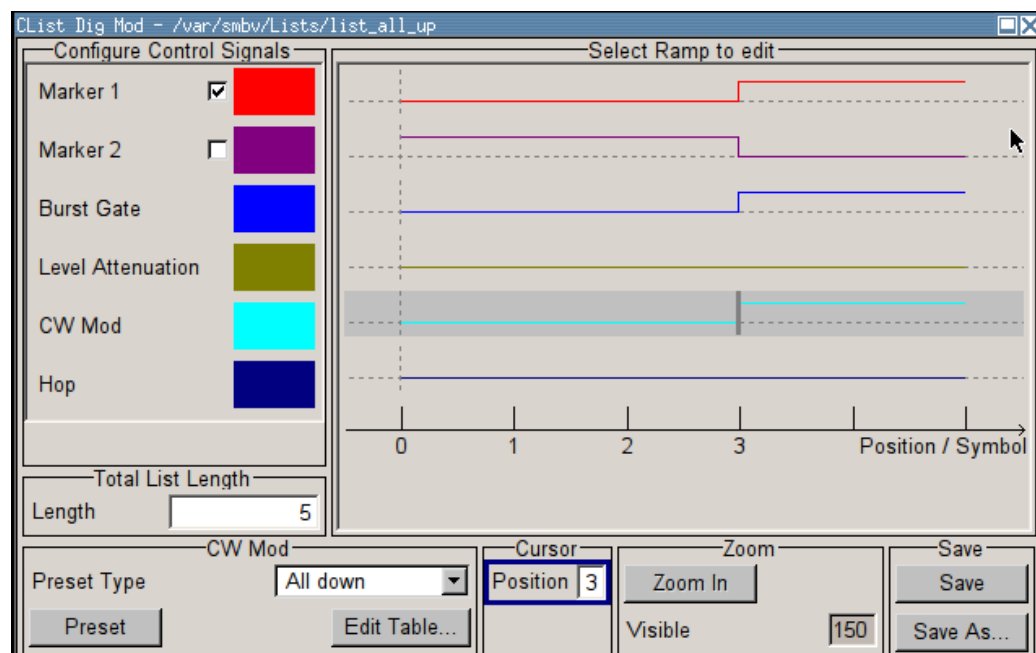

In the "Select Ramp to Edit" section the signal characteristics are graphically displayed. The scaling of the x-axis is always adapted to the overall length of the control list to provide constant overview of all defined ramps.

The ramps can be assigned the exact bit position in the signal by means of

- The bit scale below the marker/control signal characteristic.
- The display of the current cursor position in the "Cursor" menu section if the cursor marks the ramp.

The ramps can be set either graphically in the "Select Ramp to Edit" section or in the table of the "Positions <Signal>" section in the lower right corner. To make the setting easy, a selection of preset ramp characteristics is offered in the "Preset Ramp <Signal>" section.

Edit Control List

The configuration of the currently selected control list is displayed. This list is either selected in the "File Select" menu ("List Management" submenu by means of the "Control List..." button) or via the remote-control command.

Remote command:

[:SOURce<hw>] :BB:DM:CLISt:SElect on page 684

[:SOURce<hw>] :BB:DM:CLISt:DATA on page 682

Configure Control Signal

Displays the colour the marker/control signal has been assigned.

Displays whether the "CList" marker type has been selected in the Trigger/Marker/Clock menu for this marker.

Displays whether the "Internal" source has been selected for this control signal in the individual setting menu.

Burst Gate and Level Attenuation are set in the "Power Ramping" submenu, CW in the "Modulation" submenu.

The source "CList/Internal" for the individual marker/control signal can be selected here as well and will then be used in the associated menus.

Remote command:

n.a.

Select Ramp to Edit

Graphically edit marker/control signals.

For this purpose, the cursor is set to the position where a ramp is required. The ramp is generated by pressing Enter (e.g. clicking on the rotary knob). Any number of ramps can be defined per marker. Each of the generated ramp positions will be saved even if the definition of another ramp produces a low/low or high/high transition. These ramps are displayed as dashed lines.

Existing ramps can be shifted after the cursor has been placed on the ramp and Enter has been pressed - it then changes colour twice. The ramp is shifted by using the cursor keys or the rotary knob. The new position is determined by pressing Enter again.

Ramps can be deleted by means of the [BACKSPACE] key after the cursor has been placed on the ramp.

For detailed information on how to operate the control and marker list editor, see [Chapter 4.5.3, "Working with Control and Marker List Editor"](#), on page 100.

Remote command:

n.a.

Total List Length

Enters the length of the definition range of the control list in bits. The starting value is always bit 0. The entire definition range is displayed, i.e. the bit scale is adapted to the entry.

With very long control lists, the displayed area can be zoomed around the current cursor position ("Zoom in" button).

The preset functions set the ramp in the center of the currently selected area.

If the definition range is decreased, the ramps outside the range are lost.

When used, the control list is always repeated over the length of the definition range if the length of the data list exceeds the length of the control list.

Remote command:

n.a.

Preset Type

Activates presetting for the ramp characteristic of the selected control signal. The presetting is selected with "Preset Type" and activated by means of the "Preset" button.

You can select from:

| | |
|--------------------|--|
| "All Up " | The marker/control signal is continuously high. |
| "All Down" | The marker/control signal is continuously low. |
| "Ramp Up" | The marker/control signal contains a ramp from low to high. The ramp is shifted to the center of the displayed signal area and can subsequently be shifted as required. |
| "Ramp Down" | The marker/control signal contains a ramp from high to low. The ramp is shifted to the center of the displayed signal area and can subsequently be shifted as required. |
| "Ramp Up/ Down" | The marker/control signal contains a ramp from low to high and from high to low. The ramps are symmetrically shifted around the center of the displayed signal area and can subsequently be shifted as required. |
| "Ramp Down/Up" | The marker/control signal contains a ramp from high to low and from low to high. The ramps are symmetrically shifted around the center of the displayed signal area and can subsequently be shifted as required. |

Remote command:

n.a.

Cursor Position

Enters the cursor position.

In the graphic display, the cursor is positioned according to the entry.

Vice versa, graphically shifting the cursor will change the displayed value.

If the entered value exceeds the selected length of the definition range, the length is adjusted automatically.

Remote command:

n.a.

Positions Control Signal

Opens table by using the "Edit Table .." button.

The ramps of the selected signal can be edited in the table. When the table is opened, the current configuration of the selected marker/control signal is displayed.

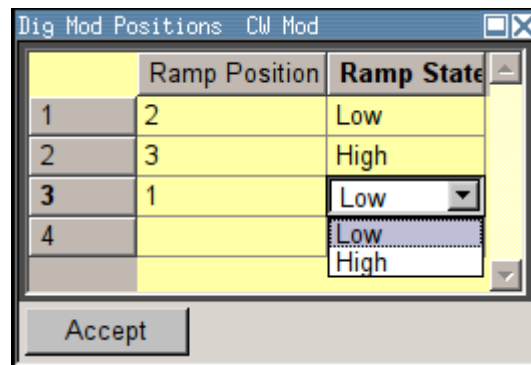

The bit position is specified in the "Ramp Position" column, the high or low signal status in the "Ramp State" column. At the end of the list, there is always a blank row for entering new values.

The changes are accepted in the graphic display after pressing the "Accept" button.

Remote command:

n.a.

Zoom/Visible

Zooms the displayed area of the control list. The designation of the button changes from "Zoom in" to "Zoom out".

With long control lists, the displayed area can be zoomed around the current "Cursor Position".

Parameter "Visible/Bits Visible" determines the number of symbols/bits to be displayed.

Ramps outside the displayed area are not lost by zooming.

Remote command:

n.a.

Save/Save As

Pressing the "Save" button saves the changes made to the CList file selected for editing.

Selecting the "Save As" button creates a new control list. This opens the "Create Lists Files Which Name?" window in which the control list can be created.

The file name has to be entered in field "File Name."

Remote command:

n.a.

Power Ramp Control

The Power Ramp Control menu is accessed via the "Custom Digital Modulation" main menu.

The dialog provides access to the settings used to configure the power ramping, like the source for the necessary control signals "Burst" and "Lev_Att", the form of the ramp function and the applied attenuation (see also "[Power Ramping and Level Attenuation](#)" on page 336).



Power ramping is possible up to a symbol rate of 5 MHz. If a higher symbol rate is set, power ramping is automatically switched off and an error message is output.

| | | |
|--|-----------------------------|-----|
| State | Off | |
| Source | Internal | |
| Ramp Function | Cosine | |
| Ramp Time | 1.00 | sym |
| Rise Delay | 0.00 | sym |
| Fall Delay | 0.00 | sym |
| Attenuation | 15.0 | dB |
| Power Ramping / Level Attenuation | | |
| In Baseband Only | <input type="checkbox"/> On | |

State

Enables/disables power ramping.

Remote command:

[\[:SOURce<hw>\]:BB:DM:PRAMP\[:STATe\]](#) on page 679

Source

Enters the source for the power ramp control signals.

"Internal" The control signals in the internal control list are used for control purposes.
See also "[Control and Marker List Editor](#)" on page 369.

"External Digital" R&S SMBV does not support external source for power ramp control.

Remote command:

n.a.

Ramp Function

Selects the ramp function that describes the shape of the rising and falling edges during power ramp control, see [Figure 5-23](#).

"Linear" The transmitted power rises and falls linear fashion.

"Cosine" The transmitted power rises and falls with a cosine-shaped edge.
This gives rise to a more favorable spectrum than the "Linear" setting.

Remote command:

[:SOURce<hw>] :BB:DM:PRAMp:SHAPE on page 678

Ramp Time

Enters the power ramping rise time and the fall time for a burst. The setting is expressed in symbols. See also [Figure 5-23](#).

Remote command:

[:SOURce<hw>] :BB:DM:PRAMp:TIME on page 679

Rise Delay

Sets the offset in the rising edge of the envelope at the start of a burst, see [Figure 5-23](#).

A positive value gives rise to a delay (the envelope length decreases) and a negative value causes an advance (the envelope length increases). The setting is expressed in symbols.

Remote command:

[:SOURce<hw>] :BB:DM:PRAMp:RDElay on page 678

Fall Delay

Sets the offset in the falling edge of the envelope at the end of a burst, see [Figure 5-23](#).

A positive value gives rise to a delay, the envelope length increases and a negative value causes an advance (the envelope length decreases). The setting is expressed in symbols.

Remote command:

[:SOURce<hw>] :BB:DM:PRAMp:FDElay on page 678

Attenuation

Determines the level by that the average signal level is attenuated during the signal attenuation period, during the time the "Lev_Att" signal is high. See also [Figure 5-22](#).

For information about the required control signal LEV_ATT, refer to ["Power Ramping and Level Attenuation"](#) on page 336.

The LEV_ATT control signal is defined in the "Control Data Editor".

Remote command:

[:SOURce<hw>] :BB:DM:PRAMp:ATTenuation on page 677

Baseband Only

Restricts power ramping to the baseband signal.

- | | |
|-------|---|
| "Off" | Level attenuation is effected via the attenuator stages in the RF section; only the remaining part is attenuated in the baseband. The signal is issued at the RF output with the defined level values. |
| "On" | Level attenuation is effected in the baseband only. This setting is mandatory in the following cases: When only the baseband signal is issued at the I/Q outputs. It is thus ensured that, with power ramping active, this signal is output with the defined level values. |

Remote command:

[:SOURce<hw>] :BB:DM:PRAMP:BBONly [:STATe] on page 677

Trigger/Marker/Clock

The "Trigger/Marker/Clock" dialog is accessed via the "Custom Digital Modulation" main menu.

The "Trigger In" section is where the trigger for the modulation signal is set. Various parameters will be provided for the settings, depending on which trigger source - internal or external - is selected. The current status of signal generation ("Running" or "Stopped") is indicated for all trigger modes.

The "Marker Mode" section is where the marker signals at the MARKER output connectors are configured.

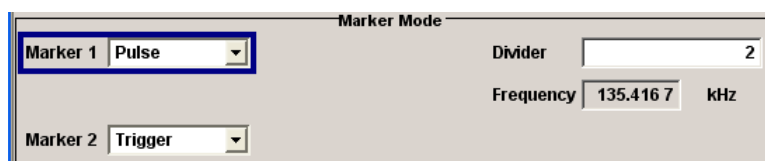

The "Marker Delay" section is where a marker signal delay can be defined, either without restriction or restricted to the dynamic section, i.e., the section in which it is possible to make settings without restarting signal and marker generation.

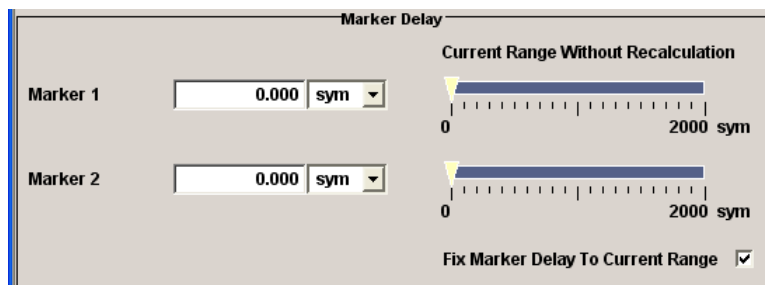

The "Clock Settings" section is where the clock source is selected and - in the case of an external source - the clock type.

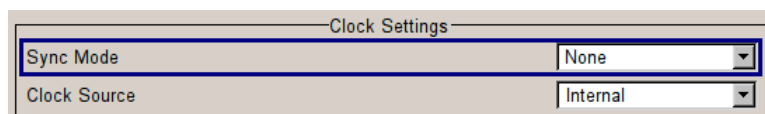

The "Global Trigger/Clock Settings" button leads to a submenu for general trigger, clock and external input settings.

Trigger In

The "Trigger In" section is used to configure the trigger signal for the digital modulation. The current status of signal generation is indicated for all trigger modes.

Trigger Mode

Selects trigger mode.

"Auto" The digital modulation signal is generated continuously.

| | |
|-------------------|--|
| "Retrigger" | The digital modulation signal is generated continuously. A trigger event (internal with "Execute Trigger" or external) causes a restart. |
| "Armed_Auto" | The digital modulation signal is generated only when a trigger event occurs. Then the digital modulation signal is generated continuously. Button "Arm" stops signal generation. A subsequent trigger event (internal with "Execute Trigger" or external) causes a restart. |
| "Armed_Retrigger" | The digital modulation signal is generated only when a trigger event occurs. Then the signal is generated continuously. Every subsequent trigger event (internal with "Execute Trigger" or external) causes a restart. The button "Arm" stops signal generation. A subsequent trigger event (internal with "Execute Trigger" or external) causes a restart. |
| "Single" | The digital modulation signal is generated only when a trigger event occurs. Then the signal is generated once to the length specified at "Signal Duration". Every subsequent trigger event (internal with "Execute Trigger" or external) causes a restart. |

Remote command:

[\[:SOURce<hw>\]:BB:DM\[:TRIGger\]:SEQuence](#) on page 666

Trigger Signal Duration

Enters the length of the signal sequence to be output in the "Single" trigger mode. The input is to be expressed in symbols.

Remote command:

[\[:SOURce<hw>\]:BB:DM:TRIGger:SEnGth](#) on page 664

Running - Stopped

Displays the status of signal generation for all trigger modes. This display appears only when Custom Dig Mod is enabled (State On).

| | |
|-----------|--|
| "Running" | The digital modulation signal is generated; a trigger was (internally or externally) initiated in triggered mode. If Armed_Auto and Armed_Retrigger have been selected, generation of signals can be stopped with the "Arm" button. A new trigger (internally with "Execute Trigger" or externally) causes a restart. |
| "Stopped" | The signal is not generated, and the instrument waits for a trigger event (internal or external). |

Remote command:

[\[:SOURce<hw>\]:BB:DM:TRIGger:RMODE?](#) on page 663

Arm

Stops signal generation. This button appears only with "Running" signal generation in the "Armed_Auto" and "Armed_Retrigger" trigger modes.

Signal generation can be restarted by a new trigger (internally with "Execute Trigger" or externally).

Remote command:

[\[:SOURce<hw>\]:BB:DM:TRIGger:ARM:EXECute](#) on page 661

Execute Trigger

Executes trigger manually. A manual trigger can be executed only when an internal trigger source and a trigger mode other than "Auto" have been selected.

Remote command:

[:SOURce<hw>] :BB:DM:TRIGger:EXECute on page 661

Trigger Source

Selects trigger source.

"Internal" The trigger event is executed by "Execute Trigger". As a precondition a trigger mode other than "Auto" must be selected.

"External" The trigger event is executed with the aid of the active edge of an external trigger signal.
The trigger signal is supplied via the [TRIG] connector.
The polarity, the trigger threshold and the input impedance of the trigger input can be set in the "Global Trigger Settings" menu.

Remote command:

[:SOURce<hw>] :BB:DM:TRIGger:SOURce on page 664

Sync. Output to External Trigger

(enabled for "Trigger Source" External)

Enables/disables output of the signal synchronous to the external trigger event.

For or two or more R&S SMBVs configured to work in a master-slave mode for synchronous signal generation, configure this parameter depending on the provided system trigger event and the properties of the output signal. See [Table 5-9](#) for an overview of the required settings.

Table 5-9: Typical Applications

| System Trigger | Application | Sync. Output to External Trigger |
|--|---|----------------------------------|
| Common External Trigger event | All instruments are synchronous to the external trigger event | ON |
| for the master and the slave instruments | All instruments are synchronous among themselves but starting the signal from first symbol is more important than synchronicity with external trigger event | OFF |
| Internal trigger signal of the master R&S SMBV for the slave instruments | All instruments are synchronous among themselves | OFF |

"On"

Corresponds to the default state of this parameter.

The signal calculation starts simultaneously with the external trigger event but because of the instrument's processing time the first samples are cut off and no signal is outputted. After elapsing of the internal processing time, the output signal is synchronous to the trigger event.

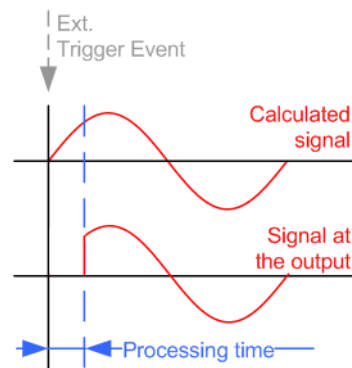

"Off"

The signal output begins after elapsing of the processing time and starts with sample 0, i.e. the complete signal is outputted.

This mode is recommended for triggering of short signal sequences with signal duration comparable with the processing time of the instrument.

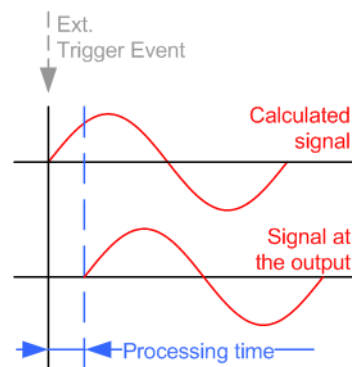

Remote command:

`[:SOURce<hw>] :BB:DM:TRIGger:EXTernal:SYNChronize:OUTPut`
on page 661

External Delay Unit

Determine whatever the trigger delay is expressed in samples or directly defined as a time period (seconds).

The parameter displays the delay converted in time.

Remote command:

`[:SOURce<hw>] :BB:DM:TRIGger:DELay:UNIT` on page 665

Trigger Delay

Sets trigger signal delay in symbols on external triggering.

This enables the R&S SMBV to be synchronized with the device under test or other external devices.

The parameter **Actual Trigger Delay** displays the delay converted in time.

Remote command:

`[:SOURce<hw>] :BB:DM:TRIGger [:EXTernal<ch>] :DELay` on page 665

`[:SOURce<hw>] :BB:DM:TRIGger [:EXTernal] :TDELay` on page 665

Actual Trigger Delay

Displays the time (in seconds) an external trigger event or a trigger event from the other path is delayed by.

Remote command:

`[:SOURce<hw>] :BB:DM:TRIGger [:EXTernal] :RDELay?` on page 666

Trigger Inhibit

(available on external triggering)

Sets the duration for inhibiting a new trigger event subsequent to triggering. The input is to be expressed in symbols.

In the "Retrigger" mode every trigger signal causes signal generation to restart. This restart is inhibited for the specified number of samples.

Remote command:

`[:SOURce<hw>] :BB:DM:TRIGger [:EXTernal<ch>] :INHibit` on page 666

Marker Mode

Provides the settings necessary to define the marker output signal for synchronizing external instruments.

Marker x

Marker configuration for up to 4 markers. The settings are used to select the marker mode defining the shape and periodicity of the markers. The contents of the dialog change with the selected marker mode; the settings are self-explanatory.

All regular marker signals are described in "**Marker Modes**" on page 339.

Remote command:

`[:SOURce<hw>] :BB:DM:TRIGger:OUTPut<ch>:MODE` on page 667

`[:SOURce<hw>] :BB:DM:TRIGger:OUTPut<ch>:PULSe:DIVider` on page 669

`[:SOURce<hw>] :BB:DM:TRIGger:OUTPut<ch>:PATtern` on page 669

`[:SOURce<hw>] :BB:DM:TRIGger:OUTPut<ch>:OFFTime` on page 668

`[:SOURce<hw>] :BB:DM:TRIGger:OUTPut<ch>:ONTime` on page 668

Marker x Delay

Defines the delay between the marker signal at the marker outputs relative to the signal generation start.

"Marker x" For the corresponding marker, sets the delay as a number of symbols.

Remote command:

`[:SOURce<hw>] :BB:DM:TRIGger:OUTPut<ch>:DELay` on page 663

"Current Range without Recalculation"

Displays the dynamic range within which the delay of the marker signals can be set without restarting the marker and the signal.
Move the setting mark to define the delay.

Remote command:

`[:SOURce<hw>] :BB:DM:TRIGger:OUTPut<ch>:DELay:MAXimum?` on page 663

`[:SOURce<hw>] :BB:DM:TRIGger:OUTPut<ch>:DELay:MINimum?` on page 663

"Fix marker delay to current range"

Restricts the marker delay setting range to the dynamic range.

Remote command:

`[:SOURce<hw>] :BB:DM:TRIGger:OUTPut:DELay:FIXed` on page 662

Clock Settings

The clock source is selected in the Clock Settings section.

Sync. Mode

Selects the synchronization mode.

This parameter is used to enable generation of very precise synchronous signal of several connected R&S SMBVs.

Note: If several instruments are connected, the connecting cables from the master instrument to the slave one and between each two consecutive slave instruments must have the same length and type. Avoid unnecessary cable length and branching points.

"None" The instrument is working in stand-alone mode.

"Sync. Master" The instrument provides all connected instrument with its synchronisation (including the trigger signal) and reference clock signal.

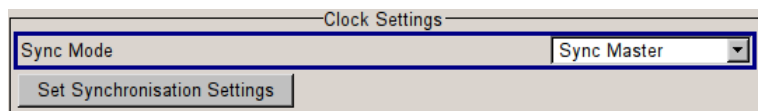

"Sync. Slave" The instrument receives the synchronisation and reference clock signal from another instrument working in a master mode.

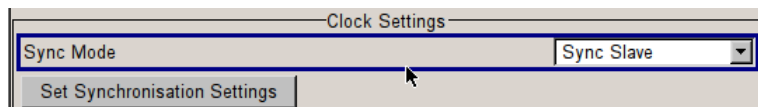

Remote command:

`[:SOURce<hw>] :BB:DM:CLOCK:SYNChronization:MODE` on page 659

Set Synchronization Settings

Performs automatically adjustment of the instrument's settings required for the synchronization mode, selected with the parameter "Synchronization Mode" (see [Chapter 5.9.2.4, "Synchronous Signal Generation"](#), on page 332).

The status of the external clock source is displayed with the parameter "Synchronisation State".

Remote command:

`[:SOURce<hw>] :BB:DM:CLOCK:SYNChronization:EXECute` on page 660

Clock Source

Selects the clock source (also see section "Clock Signals", page 2).

- "Internal" The internal clock reference is used.
- "External" The external clock reference is fed in as the symbol clock via the REF IN connector.
 While working in master-slave synchroniuos mode, an external clock source has to be selected for the slave-instrument(s) and the CLOCK IN connector has to be connector to the CLOCK OUT connector of the master instrument.
 This allows the slave instrument(s) to synchronise its clock to the system clock of the master instrument.
 The chip rate must be correctly set to an accuracy of ($\pm 2\%$ (see data sheet).
 The polarity of the clock input can be changed with the aid of "Global Trigger/Clock/External Input" Settings.

Remote command:

[\[:SOURce<hw>\]:BB:DM:CLOCK:SOURce](#) on page 659

Clock Mode

Enters the type of externally supplied clock.

- "Symbol" A symbol clock is supplied via the CLOCK connector.
- "Multiple Sym- A multiple of the symbol clock is supplied via the CLOCK connector, the symbol clock is derived internally from this.
 bol" The "Multiplier" window provided allows the multiplication factor to be entered.

Remote command:

[\[:SOURce<hw>\]:BB:DM:CLOCK:MODE](#) on page 658

Symbol Clock Multiplier

Enters the multiplication factor for clock type "Multiple".

Remote command:

[\[:SOURce<hw>\]:BB:DM:CLOCK:MULTiplier](#) on page 659

Measured External Clock

Displays the measured frequency of the external clock signal. This enables the user to permanently monitor the frequency of the externally introduced clock.

This information is displayed only if the external clock source has been selected.

Remote command:

[:CLOCK:INPut:FREQuency?](#) on page 555

Synchronisation State

For instruments working in slave synchronization mode, this parameter displays the status of the external clock source, i.e. whether the external clock source of the slave instrument is synchronized or not synchronized yet.

Remote command:

n.a.

Global Trigger/Clock/Input Settings

Calls the "Global Trigger/Clock/Input Settings" menu. This menu is used among other things for setting the trigger threshold, the input impedance and the polarity of the clock and trigger inputs.

The parameters in this menu affect all digital modulations and standards, and are described in the [Chapter 5.2.3.13, "Global Trigger/Clock/External Input Settings"](#), on page 140.

Remote command:
n.a.

5.9.4 Arbitrary Waveform Generator ARB

The Arbitrary Waveform Generator (ARB) is an I/Q modulation source forming an integral part of the R&S SMBV. It can be used to output any externally calculated modulation signals or internally generated multi carrier signals or waveform files.

The Arbitrary Waveform Generator is available for instruments equipped with option Baseband Generator (R&S SMBV-B10) or with any of the ARB only options (R&S SMBV-B51/K51x). The options feature different ARB memory sizes (see data sheet). Apart from the memory size, however, these options offer the same functionality, either one can be installed.

5.9.4.1 Introduction

This chapter provides background information on the ARB functionality and the impact of the provided settings.

For description on the multi carrier, multi segment and multi carrier continuous wave functions, refer to:

- [Chapter 5.9.4.4, "Multi Carrier Waveforms"](#), on page 426
- [Chapter 5.9.4.3, "Multi Segment Waveforms"](#), on page 410
- [Chapter 5.9.5, "Multi Carrier Continuous Wave"](#), on page 464

Waveform Files Sources

The R&S SMBV can replay any waveform file stored on a network drive but also generate and replay simple waveforms for test purposes.

A waveform is a file with specified file format containing raw IQ samples. The IQ values are calculated in advance and stored as waveform files with predefined extension * .wv. When created by the R&S SMBV, the instrument inserts a tagged waveform header at the beginning of each created ARB file. For more information, refer to [Chapter 5.9.4.5, "Waveform and List Format"](#), on page 439.

Depending on whether the R&S SMBV creates the waveform files itself or not, two waveform files sources can be distinguished:

- Internally generated waveforms

The ARB generator enables the calculation and the generation of multi segment and multi carrier waveform files as well as the build in function to create a test waveform (e.g. a sine or rectangle signal) and keep it as a file or in the RAM. Several digital standards provide the special function "Generate Waveform File" and enable the calculation and storage of the signal as a waveform file that can be afterwards processed by the ARB generator.

- Externally generated waveforms

The ARB can also process externally generated waveform files e.g. the waveform files generated on a PC by the Windows software package R&S WinIQSIM2, the software R&S ARB Toolbox, the R&S SMx-K6 Pulse Sequencer software or signals calculated using a mathematical program such as Matlab.

For more information also on the required options, refer to the Rohde&Schwarz web site at <http://www.rohde-schwarz.com>. See also the Application Note 1MA28, "IQWizard - I/Q Signal Measurement and Conversion".

The externally generated waveform files can be loaded into the instrument via one of the available interfaces (USB, LAN or GPIB). Usually, the waveform file is stored on one of the network drives which are accessible for the operating system.

Playing and Streaming Waveform Files

- Playback from the internal memory

In the most common case, the ARB generator plays back a waveform file with a selectable clock frequency. The R&S SMBV loads the entire file into the ARB memory from where the IQ samples are played repeatedly.

This is suitable for files of limited size, e.g. up to 128 MB for instruments equipped with option R&S SMBV-B10.

The maximum size for streaming and ARB files is also listed in the R&S SMBV data sheet.

ARB Test Signals

The following test signals are available:

- **Sine Test Signal:** Two sinewave signals with a selectable (but equal) number of samples per period and equal frequencies. When the generation is triggered, the number of samples per period, together with the frequency of the test signal, determines the ARB clock frequency: "Clock Frequency" = "Frequency" * "Samples per Period".

Note: Because the resulting clock rate must not exceed the maximum ARB clock rate (see data sheet), the number of sample values is automatically restricted depending on the selected frequency.

The first sine signal is mapped on the I samples, the second on the Q samples.

The two signals differ by a selectable phase offset. For a -90 deg offset, the result is a unit vector in the I/Q plane, rotating counter-clockwise and starting at I = 0, Q = -1. For a 0 deg offset, the I and Q samples are on the diagonal of a unit square (I(t) = Q(t)).

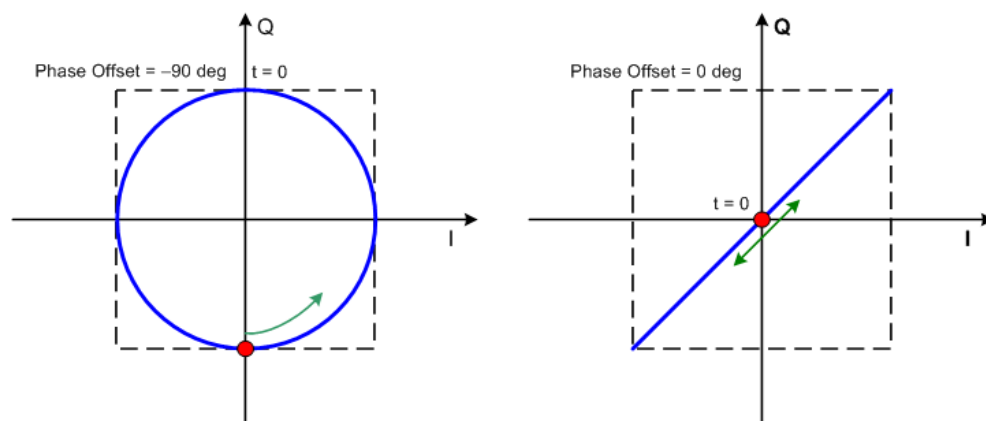

In general the I/Q samples are located on a deformed circle which is confined to the dashed square in the upper diagrams.

- Rect Test Signal:** Rectangle signal with selectable but equal On and Off periods and amplitude. The period is defined by the selected frequency: $\langle \text{Period} \rangle = 1 / \text{"Frequency"}$.
 The signal is mapped on both the I and Q samples. This results in two distinct points in the I/Q plane. The "Offset DC" shifts both points along the diagonal $I(t) = Q(t)$.

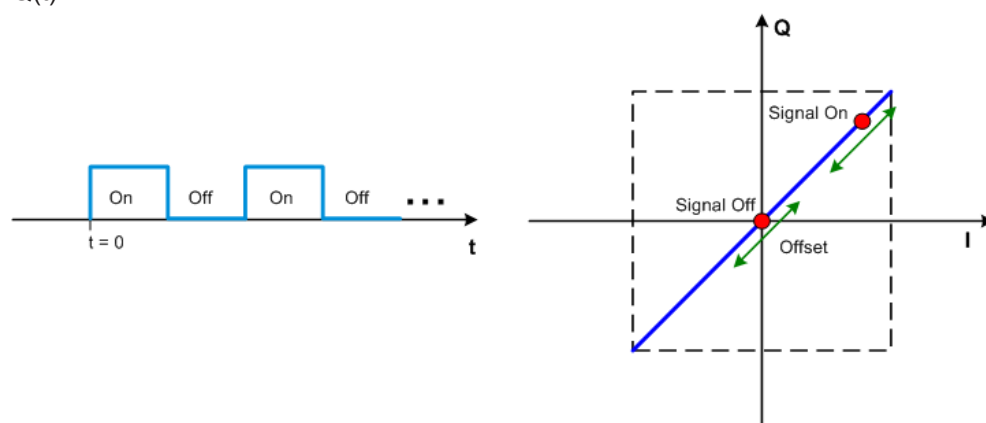

- Const I/Q Test Signal:** Continuous test signal with constant IQ and constant Clock Frequency of 10 KHz. The values for each I and Q components are selectable but constant. They are defined as a decimal number, which is decimal-to-binary converted internally. The signal is provided as a 16-bit wide digital signal for both I and Q channels.
 Converted to analog, the signal is output directly at the BNC connectors I and Q outputs of the instrument.

Waveform Sample Rate

The Arbitrary Waveform Generator includes a resampling unit that interpolates the input samples to reach a target digital output I/Q sample rate before digital-to-analog conversion (DAC). The input sample rate f_{input} is retrieved from the waveform (the default sample rate tag) or is defined by the corresponding parameter in the ARB user interface.

The [Figure 5-24](#) depicts the stages involved in the processing and resampling of a waveform in the ARB.

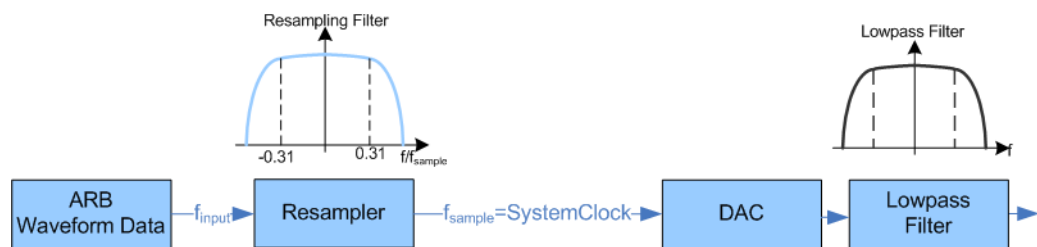

Figure 5-24: Processing of the waveform files in the ARB

The used system clock and sample rate depend on the installed options. In this description, we assume an instrument equipped with the combination of R&S SMBV-B10/K522. This R&S SMBV uses a 200 MHz system clock and a sample rate of max 200 MSamples/s. For more information, refer to the data sheet.

Impact of the Resampling Lowpass Filter

As illustrated on the [Figure 5-24](#), the lowpass filter in the resampling stage is a distortion-free for signals with the following maximum baseband bandwidth:

$$\text{BasebandBandwidth}_{\text{max}}, \text{ MHz} = 0.31 \times f_{\text{input}}$$

An externally created waveform file have to provide a sample rate f_{input} that is high enough for perfect signal reconstruction. For distortion-free resampling the lower bound of the required sample rate f_{input} is than calculated as follow:

$$f_{\text{input}} \geq \text{BasebandBandwidth} / 0.31$$

In instrument equipped with the combination R&S SMBV-B10/K522, a modulation signal with a sample rate $f_{\text{input}} = 200 \text{ MHz}$ is passed directly to the digital-to-analog converter (DAC), i.e. the resampling unit is bypassed. After the DAC, this signal features a $\text{RFBandwidth}_{\text{max}} = 160 \text{ MHz}$.

Impact of the Oversampling Factor

Waveforms generated by the R&S WinIQSIM2 software can be optimized by choosing a suitable integer oversampling factor.

In comparison with conventional ARB generators that often assume oversampling factors of 4, the ARB generator of the R&S SMBV requires low oversampling factors, but still providing excellent signal quality in terms of EVM and ACP.

A reduced sample rate saves significantly the amount of memory or allows an increased signal cycle time, vice versa.

Impact on the Enabled Number of Marker Signals on the Waveform Length

The R&S SMBV provides the possibility to define marker signals, that are sent to the marker outputs in synchronicity with the I/Q output signals. Marker signals can be either predefined or subsequently defined (see also [Chapter 5.9.2.7, "Marker Output Signals"](#), on page 339).

The I/Q data and marker data are located in separate memory areas of the SDRAM and can be independently configured whereas each marker signal requires one bit of the available memory size. In some cases, it might be useful to generate a modulation signal without additional marker signals in order to increase the maximum waveform length.

The example below explains the dependency between the number of enabled marker signals, the available memory size and the resulting waveform length.

Example: Calculating the maximum waveform length

The calculation in this example is based on an instrument equipped with option R&S SMBV-B10 (32 MSamples).

- Total Memory Size = 128 MB
- Required Memory Size (per complex sample) = 32 bits + 2 bits = 34 bits = 4.5 bytes, where:
 - the raw I/Q samples are stored as 16 bit values, i.e.
for I/Q data = 2 x 16 bits = 32 bits (16 bits per I/Q channel)
 - each software defined marker requires 1 bit, i.e.
for 4 enabled markers = 2 x 1 bit = 2 bits
- Maximum Waveform Length (with 2 markers) = 128 MB / 4.2 bytes = 30 MSamples
- Theoretical Maximum Waveform Length (no markers) = 128 MB / 4 bytes = 32 MSamples

Hence, a memory size of 128 MB yields a maximum waveform length of 30 MSamples if two markers are enabled. The maximum waveform length increases to 32 MSamples if the internal hardware markers are used, and the complete memory is available for I/Q data.

In instruments equipped with additional options, e.g. R&S SMBV-B10/B51+R&S SMBV-K511 and R&S SMBV-K512, the maximum available memory increases up to 1 GSamples.

The minimum length of a waveform is 512 samples. A waveform is shorter than this value is automatically repeated until it reaches the minimum length.

Specifying Delay and Inhibit Values in Time Units

In the R&S SMBV you can delay and suppress trigger events.

The delay and inhibit values are usually expressed in the units of the generated signal. To enable you to define the exact delay or inhibit period directly as a time value (e.g. in seconds), the instruments provide additional parameters. You can determine the units the values are defined in and the instrument calculates and displays the actual time delay/inhibit.

Example:

This example is based on a signal with 1 MHz clock frequency ("Baseband > ARB > Clock Frequency > 1 MHz").

Step 1: Enable the following settings:

- "Baseband > ARB > Trigger In > Mode > Armed Auto"
- "ARB > Trigger In > Source > External"
- "ARB > Trigger In > External Delay Unit > Samples"
- "ARB > Trigger In > External Delay > 100 Samples"

The parameter "Actual External Delay = 100 us" displays the time delay in seconds.

Step 2: Enable the following settings:

- "ARB > Trigger In > External Delay Unit > Time"
- "ARB > Trigger In > Specified External Delay > 10 us"
Logically, the "Actual External Delay" changes to 10 us.

Step 3:

- Switch to "ARB > Trigger In > External Delay Unit > Samples".

The value of "ARB > Trigger In > External Delay" is 10 Samples.

| Step 1 | Step 2 | Step 3 |
|--------|--------|--------|
| | | |



This principle applies for any external triggering and triggering via the other path(s).

5.9.4.2 ARB User Interface

To access the ARB dialog, select "Baseband > ARB" or use the [MENU] key under "Baseband".

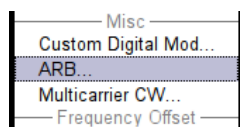

The "ARB" dialog is divided into an upper and a lower general part together with a "Marker" section.

The upper part of the menu is used for powering up, selecting and configuring ARB modulation.

The section "Multi Segment Waveform Options" is only indicated if a multi segment waveform is loaded. In this part, the segment to be output is selected.

The buttons in the lower part of the menu open submenus for setting triggers and clocks, for configuring the test signal and for calculating a multi segment waveform or a multi carrier waveform.

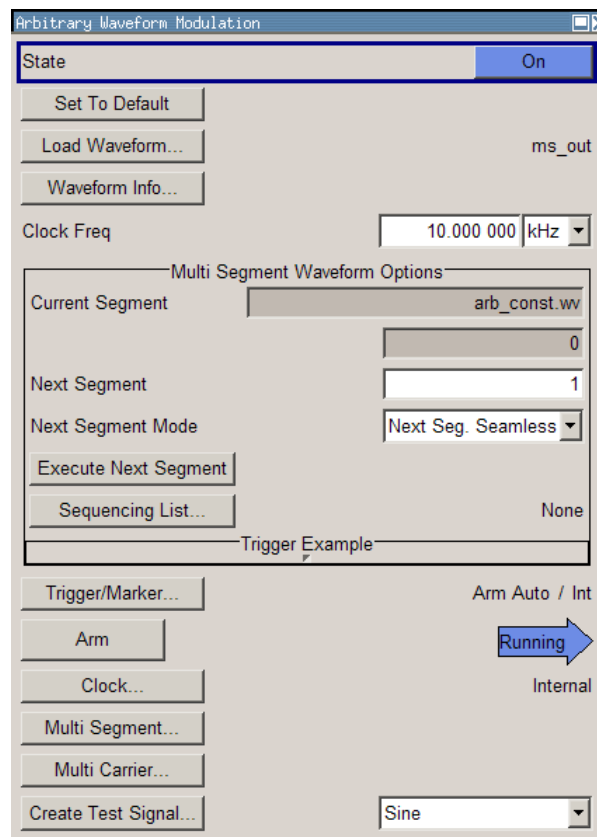

ARB MOD Main Menu

The upper part of the menu is used for powering up, selecting and configuring ARB modulation.

The lower part of the menu is used for setting triggers and clocks, as well as for file management. Test signals can be output for test purposes.

Multi Segment Waveform Options

The section "Multi Segment Waveform Options" of the menu is only displayed if a multi segment waveform is loaded.

The section comprises the settings necessary to adjust the trigger for the switch between the segments of a multi segment waveform. The parameters displayed depend on the selected trigger source.

The parameters in this sections are identical with the parameters in the section "Next Segment Trigger In" in the "Trigger/Marker" dialog; for detailed information see ["Next Segment Trigger In"](#) on page 397.

State (ARB)

Enables/disables ARB modulation.

Switching on this standard turns off all the other digital standards and digital modulation types.

The output is based on the waveform file that is loaded. The name of the waveform file is displayed next to "Load Waveform".

If a multi segment waveform is loaded the section "Multi Segment Waveform Options" is indicated. In this section, the segment to be output is selected.

If no waveform file is loaded, ARB modulation cannot be powered up. "None" will be displayed next to "Load Waveform". An error message asks the user to load a waveform file:

"No waveform file loaded. ARB MOD state remains off. Please select a waveform file to load, before switching ARB MOD state on."

Remote command:

`[:SOURce<hw>] :BB:ARBitrary:STATe` on page 607

Set To Default

Calls default settings. The values are shown in the [Table 5-10](#).

Table 5-10: Default Settings

| Parameter | Value |
|----------------|-----------|
| State | Off |
| Clock Freq. | 1 MHz |
| Trigger Mode | Auto |
| Trigger Source | Internal |
| Marker State | Off |
| Marker Mode | Unchanged |
| Clock Source | Internal |

Remote command:

`[:SOURce<hw>] :BB:ARBitrary:PRESet` on page 607

Load Waveform

Calls the "File Select" menu for loading the waveform file.

The files last used are listed in the "Recent Data Sets" section. The directory can be selected from the center left section. All waveform files (file extension *.wv) available from the selected directory are listed on the right side. The file info (tag contents and multi segment state) for the selected file is displayed below the file section.

The "Select..." button selects the marked file. This file is loaded when the ARB modulation is enabled ("State On").

The "File Manager..." button leads to the file manager.

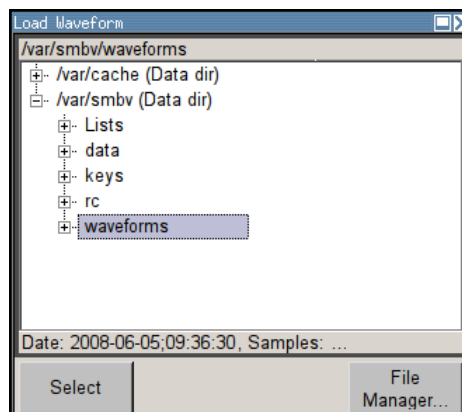

Remote command:

`[:SOURce<hw>] :BB:ARbitrary:WAVeform:SElect` on page 642

Waveform Info

Opens a dialog with detailed information about the currently selected waveform.

The waveform information displayed in this dialog depends on whether the selected waveform file is a multi segment one or not. All parameters are read-only.

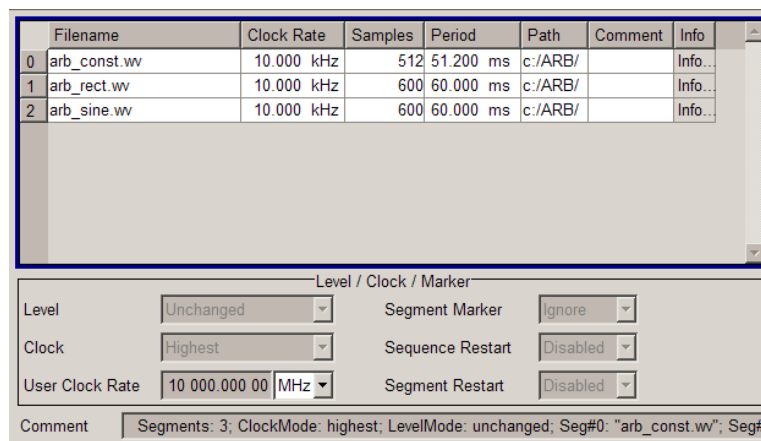

For non-multi segment waveform files, the values of the settings can be queried by means of the Tag commands (see [Chapter 5.9.4.5, "Waveform and List Format"](#), on page 439).

Remote command:

n.a.

Clock Frequency

Displays or enters the ARB output clock rate.

When the waveform file is loaded, this value is automatically set to the clock rate defined in the file (Clock tag). The user can subsequently alter the value if necessary.

When intending to work with an external clock source, the frequency to be applied must be entered here.

Remote command:

`[:SOURce<hw>] :BB:ARbitrary:CLOCK` on page 608

Trigger/Marker

Calls the Trigger and Marker menu.

This menu is used to select the trigger source, set the time delay on an external trigger signal and configure the marker output signals (see ["Trigger/Marker/Clock Settings"](#) on page 392).

Remote command:

n.a.

Execute Trigger

Executes trigger manually. A manual trigger can be executed only when an internal trigger source and a trigger mode other than Auto are selected.

Remote command:

`[:SOURce<hw>] :BB:ARbitrary:TRIGger:EXECute` on page 611

Clock

Calls the "Clock" menu. The "Clock" menu is used to select the clock source (see ["Clock Settings"](#) on page 405).

Remote command:

n.a.

Create Test Signal...

Selects the form of the test signal and calls the menu for generating it. A sinusoidal, rectangular or test signal with constant I/Q can be selected.

See the corresponding section for detailed description of the parameters for the selected test signal:

- ["Sine Test Signals"](#) on page 407
- ["Rect Test Signal"](#) on page 408
- ["Const IQ Test Signal"](#) on page 409

Remote command:

`[:SOURce<hw>] :BB:ARbitrary:SIGNal:TYPE` on page 621

RF Power Ramping with Burst Marker

Option: R&S SMBV-K22

If activated, the burst gate marker signal included in the ARB waveform file is used as marker signal for the pulse modulator.

If this parameter is activated, but the loaded ARB waveform does not contain control list or the burst gate marker is not defined, the ARB generator cannot be activated. An error message indicates this situation, too.

You can create the suitable waveform files including the required burst gate marker signals, for example, with the R&S Pulse Sequencer software.

Remote command:

`[:SOURce<hw>] :BB:ARbitrary:PRAMP [:STATe]` on page 607

Multi Segment

Calls the menu for calculating multi segment waveforms (see [Chapter 5.9.4.3, "Multi Segment Waveforms"](#), on page 410).

Remote command:
n.a.

Multi Carrier

Calls the menu for calculating multi carrier waveforms (see [Chapter 5.9.4.4, "Multi Carrier Waveforms"](#), on page 426).

Remote command:
n.a.

Trigger/Marker/Clock Settings

To access this dialog, select "Main Menu > Trigger/Marker".

The "Trigger In" section is where the trigger for the signal is set. Various parameters will be provided for the settings, depending on which trigger source - internal or external - is selected. The current status of signal generation ("Running" or "Stopped") is indicated for all trigger modes.

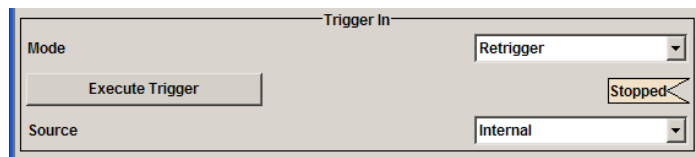

The "Next Segment Trigger In" is where the segment triggering is configured. This section is enabled only for multi segment waveforms.

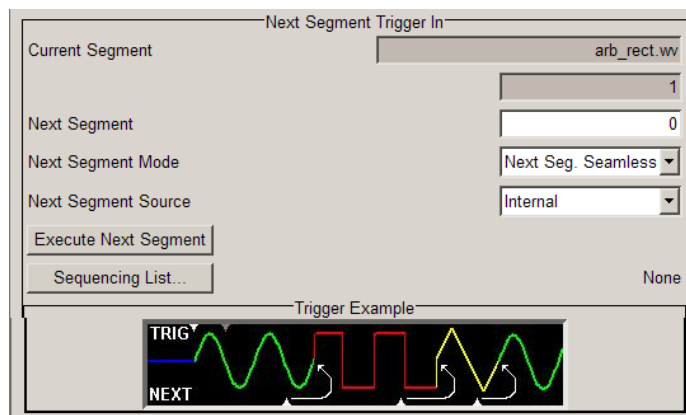

The "Marker Mode" section is where the marker signals at the [MARKER] output connectors are configured.

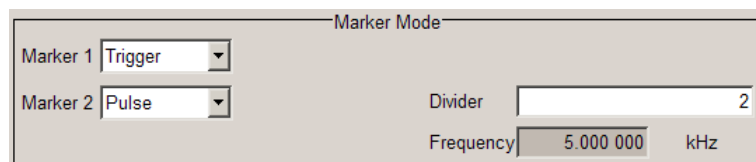

The "Marker Delay" section is where a marker signal delay can be defined, either without restriction or restricted to the dynamic section, i.e., the section in which it is possible to make settings without restarting signal and marker generation.

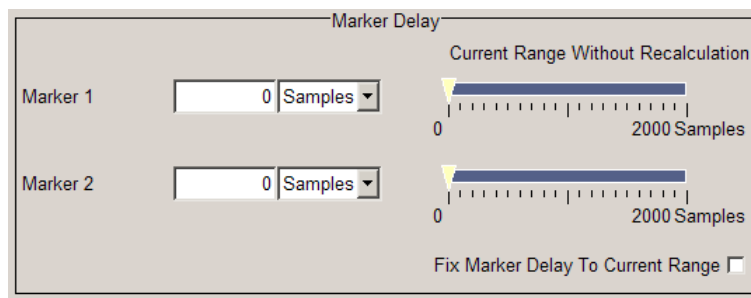

The "Clock Settings" section is where the clock source is selected and - in the case of an external source - the clock type.

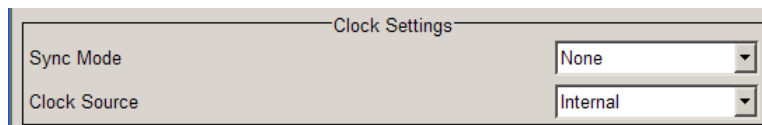

The buttons in the last section lead to submenu for general trigger, clock and mapping settings.



Trigger In

The "Trigger In" section is where the trigger for the signal is set. Various parameters will be provided for the settings, depending on which trigger source - internal or external - is selected. The current status of signal generation ("Running" or "Stopped") is indicated for all trigger modes.

Trigger Mode

Selects trigger mode.

The trigger mode determines the effect of a trigger on the signal generation.

| | |
|-------------------|---|
| "Auto" | The signal is generated continuously. |
| "Retrigger" | The signal is generated continuously. A trigger event (internal or external) causes a restart. |
| "Armed_Auto" | The signal is generated only when a trigger event occurs. Then the signal is generated continuously. Button "Arm" stops signal generation. A subsequent trigger event (internal with "Execute Trigger" or external) causes a restart. |
| "Armed_Retrigger" | The signal is generated only when a trigger event occurs. Then the signal is generated continuously. Every subsequent trigger event causes a restart. Button "Arm" stops signal generation. A subsequent trigger event (internal with "Execute Trigger" or external) causes a restart. |
| "Single" | The signal is generated only when a trigger event occurs. Then the signal is generated once to the length specified at "Signal Duration". Every subsequent trigger event (internal with "Execute Trigger" or external) causes a restart. |

Remote command:

`[:SOURce<hw>] :BB:ARbitrary[:TRIGger]:SEquence` on page 616

Signal Duration Unit

Defines the unit for the entry of the length of the signal sequence to be output in the "Single" trigger mode.

Remote command:

`[:SOURce<hw>] :BB:ARbitrary:TRIGger:SLUNit` on page 614

Signal Duration

Defines the length of the signal sequence to be output in the "Single" trigger mode. The unit of the entry is defined under "Signal Duration Unit". It is then possible to output deliberately just part of the signal, an exact sequence of the signal, or a defined number of repetitions of the signal.

Remote command:

`[:SOURce<hw>] :BB:ARbitrary:TRIGger:SLENgth` on page 613

Running/Stopped

Displays the status of signal generation for all trigger modes. This display appears only when signal generation is enabled ("State" On).

| | |
|-----------|--|
| "Running" | The waveform is output; a trigger was (internally or externally) initiated in triggered mode. If "Armed_Auto" and "Armed_Retrigger" have been selected, generation of signals can be stopped with the "Arm" button. A new trigger (internally with "Execute Trigger" or externally) causes a restart. |
| "Stopped" | The Waveform output is stopped. The instrument waits for an internal or external trigger event to restart. ARB modulation is disabled (State Off). |

Remote command:

`[:SOURce<hw>] :BB:ARbitrary:TRIGger:RMODE?` on page 613

Arm

Stops waveform output. This button appears only with "Running" signal generation in the "Armed_Auto" and "Armed_Retrigger" trigger modes.

Signal output can be restarted by a new trigger (internally with "Execute Trigger" or externally).

Remote command:

`[:SOURce<hw>] :BB:ARbitrary:TRIGger:ARM:EXECute` on page 611

Execute Trigger

Executes trigger manually. A manual trigger can be executed only when an internal trigger source and a trigger mode other than "Auto" have been selected.

Remote command:

`[:SOURce<hw>] :BB:ARbitrary:TRIGger:EXECute` on page 611

Trigger Source

Selects trigger source. This setting is effective only when a trigger mode other than "Auto" has been selected.

- "Internal" The trigger event is executed by "Execute Trigger".
- "External" The trigger event is executed with the aid of the active edge of an external trigger signal.
The trigger signal is supplied via the [TRIG] connector.
The polarity, the trigger threshold and the input impedance of the trigger input can be set in the "Global Trigger/Clock Settings" dialog.

Remote command:

`[:SOURce<hw>] :BB:ARbitrary:TRIGger:SOURce` on page 614

Sync. Output to External Trigger

(enabled for "Trigger Source > External")

Enables/disables output of the signal synchronous to the external trigger event.

For R&S SMBV instruments:

For one or two or more R&S SMBVs configured to work in a master-slave mode for synchronous signal generation, configure this parameter depending on the provided system trigger event and the properties of the output signal. See [Table 5-11](#) for an overview of the required settings.

Table 5-11: Typical Applications

| System Trigger | Application | "Sync. Output to External Trigger" |
|--|---|------------------------------------|
| Common External Trigger event for the master and the slave instruments | All instruments are synchronous to the external trigger event | ON |
| | All instruments are synchronous among themselves but starting the signal from first symbol is more important than synchronicity with external trigger event | OFF |
| Internal trigger signal of the master R&S SMBV for the slave instruments | All instruments are synchronous among themselves | OFF |

"On"

Corresponds to the default state of this parameter.

The signal calculation starts simultaneously with the external trigger event but because of the instrument's processing time the first samples are cut off and no signal is outputted. After elapsing of the internal processing time, the output signal is synchronous to the trigger event.

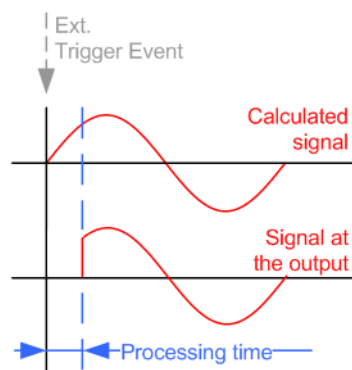

"Off"

The signal output begins after elapsing of the processing time and starts with sample 0, i.e. the complete signal is outputted.

This mode is recommended for triggering of short signal sequences with signal duration comparable with the processing time of the instrument.

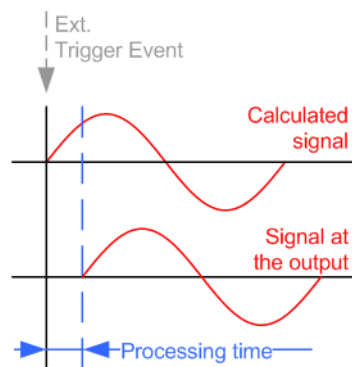

Remote command:

`[:SOURce<hw>] :BB:ARbitrary:TRIGger [:EXTernal] :SYNChronize:OUTPut`
on page 612

External Delay Unit

Determine whatever the trigger delay is expressed in samples or directly defined as a time period (seconds).

The parameter displays the delay converted in time.

Remote command:

`[:SOURce<hw>] :BB:ARbitrary:TRIGger:DELAy:UNIT` on page 615

Trigger Delay

Sets the trigger signal delay in samples on external triggering or on internal triggering via the second path. This enables the R&S SMBV to be synchronized with the device under test or other external devices.

The parameter **Actual Trigger Delay** displays the delay converted in time.

Remote command:

```
[ :SOURce<hw> ] :BB:ARbitrary:TRIGger [ :EXTernal<1|2> ] :DELay
```

on page 615

```
[ :SOURce<hw> ] :BB:ARbitrary:TRIGger [ :EXTernal<1|2> ] :TDELay
```

on page 615

Actual Trigger Delay

Displays the time (in seconds) an external trigger event or a trigger event from the other path is delayed by.

Remote command:

```
[ :SOURce<hw> ] :BB:ARbitrary:TRIGger [ :EXTernal<1|2> ] :RDELay?
```

on page 616

Trigger Inhibit

Sets the duration for inhibiting a new trigger event subsequent to triggering. The input is to be expressed in samples.

In the "Retrigger" mode, every trigger signal causes signal generation to restart. This restart is inhibited for the specified number of samples.

This parameter is only available on external triggering.

Remote command:

```
[ :SOURce<hw> ] :BB:ARbitrary:TRIGger [ :EXTernal<1|2> ] :INHibit
```

on page 616

Next Segment Trigger In

The section "Next Segment Trigger" In of the menu is only displayed if a multi segment waveform is loaded.

The section comprises the settings necessary to adjust the trigger for the switch between the segments of a multi segment waveform. The parameters displayed depend on the selected trigger source.

Current Segment

Indication of the waveform segment (segment file name and index) that is currently output.

Remote command:

```
[ :SOURce<hw> ] :BB:ARbitrary:WSEGment? on page 644
```

```
[ :SOURce<hw> ] :BB:ARbitrary:WSEGment:NAME? on page 651
```

Next Segment

Selects the waveform segment to be output next. It determines the start segment when switching on the ARB and enables switchover to any other segment.

The switchover is performed either after receiving an external next segment trigger event or, for the internal trigger case, by changing the segment index in the "Next Segment" field. The definition whether the new segment is generated immediately or only after the previous segment has been fully generated (wrap around) is determined by the parameter [Next Segment Mode](#).

The segment currently being output (segment index and file name) is displayed at "Current Segment". The subsequent trigger event after the last segment causes the first segment to be output again.

Remote command:

`[:SOURce<hw>] :BB:ARbitrary:WSEgment:NEXT` on page 651

Next Segment Mode

Sets the segmented trigger mode of a multi segment waveform, i.e. defines the way the **switch over between the segments** in a multi segment waveform will be executed:

- In "Same Segment" mode, the processing of the multi segment waveform file is similar to the processing of a non-multi segment waveform, i.e. there is no switching to consecutive segment the upon receiving of a trigger event. Switching between the segments is triggered by changing the segment index in the "Next Segment" field.
- When "Next Segment" is selected, the current segment ceases to be output as soon as a trigger event for a new segment occurs, and the new segment starts to be output after a system-imposed signal gap.

The following figure shows an example of the transition from a sinewave signal segment to a sawtooth segment (1 channel, above) in the case of next segment external triggering (below).

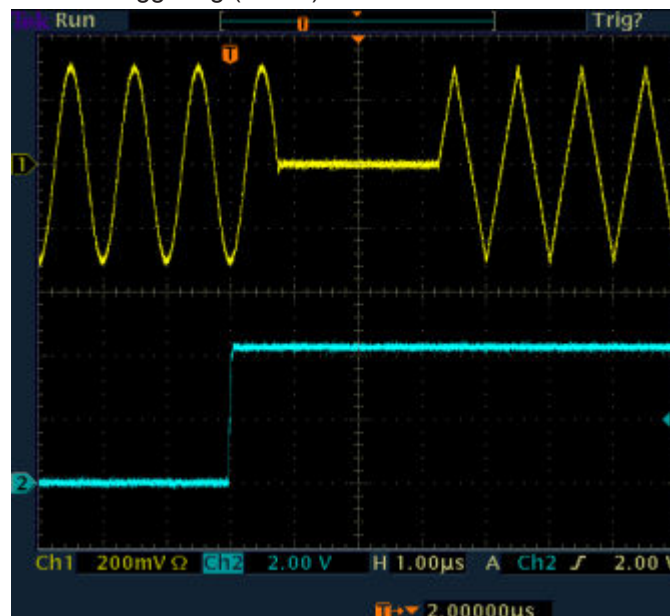

- When "Next Segment" Seamless is selected and a new segment trigger event occurs, the new segment is not output until the whole of the current segment has been output (wrap around). In this case the signal transition is seamless. As a prerequisite for a seamless switchover, all segments must have the same sample rate.

The following figure shows an example of the seamless transition from a sinewave signal segment to a sawtooth segment (1 channel, above) in the case of next segment external triggering (below).

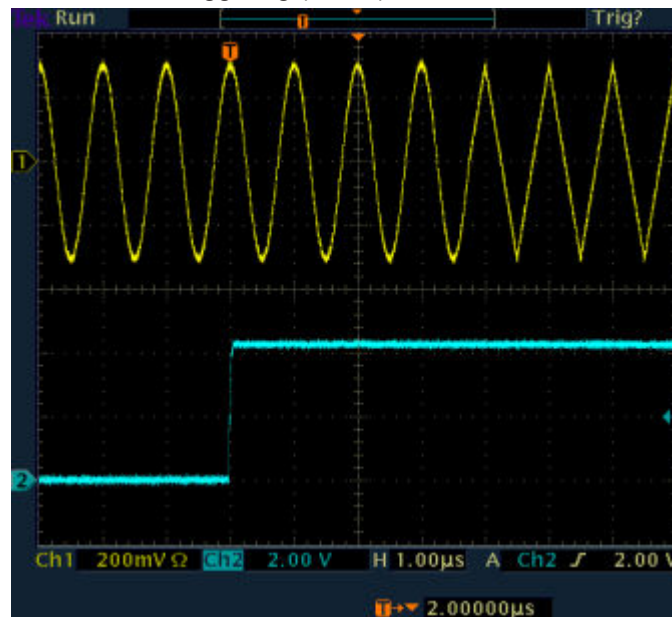

The regular trigger mode for starting the waveform generation and **triggering the whole multi segment sequence** is set with the parameters in the "Trigger In" section of the "Trigger/Marker/Clock" dialog.

The segment currently being output is displayed at "Current Segment".

The "Trigger Example" graph displays schematically the waveform output, depending on the activated trigger and the next segment settings.

| | |
|----------------|--|
| "Same Segment" | <p>Depending on the trigger setting, the currently selected segment is continuously output either immediately or after a trigger event.</p> <p>Signal generation takes place differently according to the trigger selected in the "Trigger In" section:</p> <ul style="list-style-type: none">• In the case of "Trigger = Auto", output starts at once and the segment is generated continuously. Trigger events are ignored. If the segment is changed in "Next Segment", output of the current segment is stopped and the new segment is output immediately, following a system-imposed signal gap (see above).• In the case of "Trigger = Armed_Auto", output starts after the first trigger event. The segment is then generated continuously. Further trigger events are ignored. If the segment is changed in "Next Segment", signal output is stopped and the new segment is not output until a trigger occurs.• In the case of "Trigger = Retrigger", output starts at once and the segment is generated continuously, a trigger event causes a restart. If the segment is changed in "Next Segment", output of the current segment is stopped and the new segment is output immediately, following a system-imposed signal gap (see above).• In the case of "Trigger = Armed_Retrigger", output starts after the first trigger event. The segment is then generated continuously. Further trigger events cause a restart. If the segment is changed in "Next Segment", signal output is stopped and the new segment is not output until a trigger occurs.• In the case of "Trigger = Single", output starts after the first trigger event. The segment is then generated once. Further trigger events cause a restart. If the segment is changed in "Next Segment", signal output is not stopped. The new segment is not output until a trigger occurs. |
|----------------|--|

"Next Segment"

Depending on the trigger setting, the segment selected under "Next Segment" is output either immediately or after a trigger event.

- In the case of "internal Trigger = Auto", output starts at once and the segment is generated continuously.
If the segment index is changed in "Next Segment", output of the current segment is stopped and the new segment is output immediately, following a system-imposed signal gap.
- In the case of "internal Trigger = Armed_Auto", output starts after the first trigger event. The segment is then generated continuously.
If the segment index is changed in "Next Segment", output of the current segment is stopped and the new segment is output immediately, following a system-imposed signal gap.
- In the case of "internal Trigger = Armed_Retrigger", output starts after the first trigger event. The segment is then generated continuously.
If the segment index is changed in "Next Segment", signal output is stopped and the new segment is not output until a trigger occurs.
- In the case of "internal Trigger = Single", output starts after the first trigger event. The segment is then generated once. Further trigger events cause a restart.
If the segment index is changed in "Next Segment", the new segment is not output until a trigger occurs.
- In the case of "External Trigger = Auto", output starts at once and the segment is generated continuously.
Further trigger events are ignored. Each next segment trigger event switches over to outputting the subsequent segment, following a system-imposed signal gap.
If the segment index is changed in "Next Segment", output of the current segment is stopped and the new segment is output immediately, following a system-imposed signal gap.
The subsequent trigger event after the last segment causes the first segment to be output again.
- In the case of "External Trigger = Armed_Auto", output starts after the first trigger event. The segment is then generated continuously.
Further trigger events are ignored. Each next segment trigger event switches over to outputting the subsequent segment, following a system-imposed signal gap.
If the segment is changed in Next Segment, signal output is stopped and the new segment is not output until a trigger occurs.
The subsequent trigger event after the last segment causes the first segment to be output again.
- In the case of "External Trigger = Single", output starts after the first trigger event. The segment is then generated once.
Each trigger event (re-)starts the segment; each next segment trigger event switches over to outputting the subsequent segment.
If the segment is changed in "Next Segment", signal output is not stopped. The new segment is not output until a trigger occurs.

The subsequent trigger event after the last segment causes the first segment to be output again.

| | |
|-------------------------|---|
| "Next Segment Seamless" | <p>The segment selected under "Next Segment" is output. This mode is only available if all segments have the same sample rate.</p> <ul style="list-style-type: none"> • In the case of "Internal Trigger = Auto", output starts at once and the segment is generated continuously. If the segment is changed in "Next Segment", the new segment is output seamlessly after the output of the current segment is complete. • In the case of "internal Trigger = Armed_Auto", output starts after the first trigger event. The segment is then generated continuously. If the segment is changed in "Next Segment", signal output is stopped and the new segment is not output until a trigger occurs. • In the case of "External Trigger = Auto", output starts at once and the segment is generated continuously. Each trigger event (re-)starts the segment; each next segment trigger event switches over to outputting the subsequent segment once the output of the current segment has been completed. If the segment is changed in "Next Segment", the new segment is output seamlessly after the output of the current segment is complete. • In the case of "External Trigger = Armed_Auto", output starts after the first trigger event. The segment is then generated continuously. Each trigger event (re-)starts the segment; each next segment trigger event switches over to outputting the subsequent segment once the output of the current segment has been completed. If the segment is changed in "Next Segment", signal output is stopped and the new segment is not output until a trigger occurs. <p>The remaining trigger modes ("Retrigger" and "Armed_Retrigger") are not available.</p> |
| "Sequencer" | <p>The waveform files are processed according to the order and repetition cycles defined in the special sequencing list file (*.wvs) assigned to the multi segment waveform file. This "play list" is defined in the Multi Segment Waveform Sequencing dialog.</p> <p>Note: This feature is disabled in case the segments in the multi segment waveform file have different clock rates.</p> |

Remote command:

`[:SOURce<hw>] :BB:ARbitrary:TRIGger:SMODE` on page 614

Next Segment Source

Selects the next segment source, i.e. determines whether the next segment is switched upon receiving of an external trigger signal or upon executing of software next segment trigger .

Any next segment trigger event (internal or external) causes a switchover to the subsequent available segment in the waveform. A sequence of external next segment trigger events can be used to cyclical output the segments in the multi segment file.

The currently output segment (segment file name and segment index) is indicated at "Current Segment". When the last segment of the multi segment waveform has been output, the sequence starts again with the output of the first segment after the subsequent trigger event.

Depending on the selected "Next Segment Mode", the new segment is output either at once or only after the complete output (wrap around) of the previous segment.

This parameter is disabled, if a sequencing play list is enabled.

"Internal" Switchover to any segment is triggered manually by means of the "Execute Next Segment" button.

"External (NEXT)" The trigger event for switching to the next segment is input on the NEXT connector.

Remote command:

`[:SOURce<hw>] :BB:ARbitrary:WSEgment:NEXT:SOURce` on page 652

Execute Next Segment

Triggers manually switchover to the subsequent segment in the mutli segment file. A manual trigger can be executed only when an internal "Next Segment Source" has been selected.

To perform a switchover to any segment within the multi segment file, adjust the parameter "Next Segment".

This parameter is disabled, if a sequencing play list is enabled.

Remote command:

`[:SOURce<hw>] :BB:ARbitrary:WSEgment:NEXT:EXECute` on page 652

Sequencing List

Open a dialog box for defining the "play lists" (see "[Multi Segment Waveform Sequencing](#)" on page 422).

Remote command:

`[:SOURce<hw>] :BB:ARbitrary:WSEgment:SEquence:SElect` on page 653

Trigger Example

Displays an example of a multi segment waveform. The currently enabled trigger and next segment mode are considered. After the instrument switch on, the graph of the last loaded waveform is displayed.

Note: The curves plotted in this dialog box are textbook examples, "not measured" waveforms. They are intended to visualize the trigger and next segment settings more clearly.

Remote command:

n.a.

Marker Mode

Provides the settings necessary to define the marker output signal for synchronizing external instruments.

Marker Mode

Marker configuration for up to 4 markers. The settings are used to select the marker mode defining the shape and periodicity of the markers. The contents of the dialog change with the selected marker mode; the settings are self-explanatory.

Note: The marker trace in the waveform file remains unchanged. It is not overwritten, even if something else than "Unchanged" has been selected.

All regular marker signals are described in "[Marker Modes](#)" on page 339.

"Unchanged" The marker signal remains unchanged as defined in the waveform file.

"Restart" A marker signal is generated at the start of each ARB sequence. This marker mode is not enabled for multi segment waveforms.

Remote command:

[\[:SOURce<hw>\]:BB:ARbitrary:TRIGger:OUTPut<ch>:MODE](#) on page 617

[\[:SOURce<hw>\]:BB:ARbitrary:TRIGger:OUTPut<ch>:PULSe:DIVider](#) on page 619

[\[:SOURce<hw>\]:BB:ARbitrary:TRIGger:OUTPut<ch>:PULSe:FREQuency?](#) on page 619

[\[:SOURce<hw>\]:BB:ARbitrary:TRIGger:OUTPut<ch>:PATtern](#) on page 618

[\[:SOURce<hw>\]:BB:ARbitrary:TRIGger:OUTPut<ch>:OFFTime](#) on page 618

[\[:SOURce<hw>\]:BB:ARbitrary:TRIGger:OUTPut<ch>:ONTime](#) on page 618

Marker Delay

The delay of the signals on the [MARKER] outputs is set in the "Marker Delay" section.

Marker x Delay

Enters the delay between the marker signal at the marker outputs and the start of the frame or slot.

The input is expressed as a number of symbols. If the setting "Fix marker delay to dynamic range" is enabled, the setting range is restricted to the dynamic range. In this range the delay of the marker signals can be set without restarting the marker and signal.

Remote command:

[\[:SOURce<hw>\]:BB:ARbitrary:TRIGger:OUTPut<ch>:DELay](#) on page 620

Current Range without Recalculation

Displays the dynamic range within which the delay of the marker signals can be set without restarting the marker and signal.

The delay can be defined by moving the setting mark.

Remote command:

`[:SOURce<hw>] :BB:ARBitrary:TRIGger:OUTPut<ch>:DELay:MINimum?`
on page 612

`[:SOURce<hw>] :BB:ARBitrary:TRIGger:OUTPut<ch>:DELay:MAXimum?`
on page 612

Fix marker delay to current range

Restricts the marker delay setting range to the dynamic range. In this range the delay can be set without restarting the marker and signal.

Remote command:

`[:SOURce<hw>] :BB:ARBitrary:TRIGger:OUTPut:DELay:FIXed` on page 620

Clock Settings

The "Clock Settings" is used to set the clock source and a delay if required.

Sync. Mode

Selects the synchronization mode.

This parameter is used to enable generation of very precise synchronous signal of several connected R&S SMBVs.

Note: If several instruments are connected, the connecting cables from the master instrument to the slave one and between each two consecutive slave instruments must have the same length and type.

Avoid unnecessary cable length and branching points.

"None" The instrument is working in stand-alone mode.

"Sync. Master" The instrument provides all connected instrument with its synchronisation (including the trigger signal) and reference clock signal.

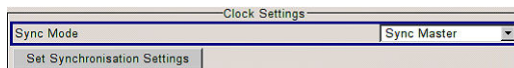

"Sync. Slave" The instrument receives the synchronisation and reference clock signal from another instrument working in a master mode.

Remote command:

`[:SOURce<hw>] :BB:ARBitrary:CLOCK:SYNChronization:MODE` on page 610

Set Synchronization Settings

Performs automatically adjustment of the instrument's settings required for the synchronization mode, selected with the parameter "Synchronization Mode".

Remote command:

`[:SOURce<hw>] :BB:ARBitrary:CLOCK:SYNChronization:EXECute`
on page 610

Clock Source

Selects the clock source.

"Internal" The internal clock reference is used to generate the symbol clock.

"External" The external clock reference is fed in as the symbol clock via the REF IN connector.
 While working in master-slave synchronous mode, an external clock source has to be selected for the slave-instrument(s) and the CLOCK IN connector has to be connected to the CLOCK OUT connector of the master instrument.
 This allows the slave instrument(s) to synchronise its clock to the system clock of the master instrument.
 The symbol rate must be correctly set to an accuracy of +/-2 % (see data sheet).
 The polarity of the clock input can be changed with the aid of "Global Trigger/Clock Settings".

Remote command:

[\[:SOURce<hw>\]:BB:ARbitrary:CLOCK:SOURce](#) on page 609

Clock Mode

Enters the type of externally supplied clock.

"Sample" A sample clock is supplied via the [CLOCK] connector.

"Multiple Sample" A multiple of the sample clock is supplied via the [CLOCK] connector; the sample clock is derived internally from this.
 The "Multiplier" window provided allows the multiplication factor to be entered.

Remote command:

[\[:SOURce<hw>\]:BB:ARbitrary:CLOCK:MODE](#) on page 608

Sample Clock Multiplier

Enters the multiplication factor for clock type "Multiple".

Remote command:

[\[:SOURce<hw>\]:BB:ARbitrary:CLOCK:MULTIPLIER](#) on page 609

Measured External Clock

Provided for permanent monitoring of the enabled and externally supplied clock signal.

Remote command:

`CLOCK:INPUT:FREQUENCY?`

Global Settings

The buttons in this section lead to submenu for general trigger, clock and mapping settings.

Global Trigger/Clock Settings

Calls the "Global Trigger/Clock/Input Settings" dialog.

This dialog is used among other things for setting the trigger threshold, the input impedance and the polarity of the clock and trigger inputs.

The parameters in this menu affect all digital modulations and standards, and are described in [Chapter 5.2.3.13, "Global Trigger/Clock/External Input Settings"](#), on page 140.

Sine Test Signals

To access the "Sine Test Signals" dialog, in the "ARB MOD" dialog set the parameter "Create Test Signal" to Sine and press "Create Test Signal".

The menu can be used to configure a sinusoidal test signal. A sine wave is generated on the I path, and a sine wave of the same frequency but phase-shifted is generated on the Q path.

The signal actually set is displayed in graphical form in the center of the menu.

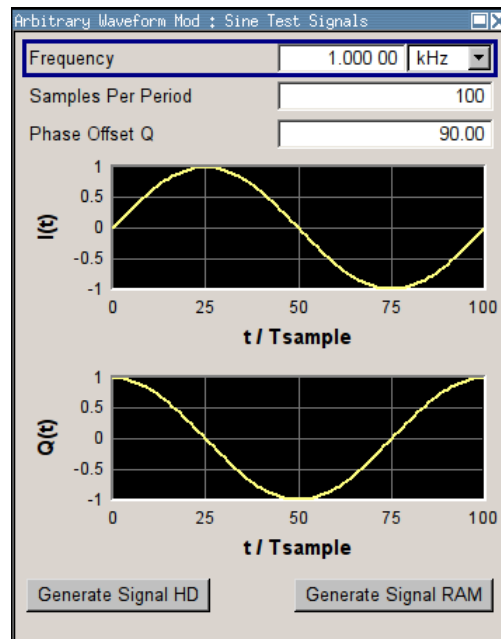

Frequency (Sine Test Signal)

Enters the frequency of the test signal.

Remote command:

[\[:SOURce<hw>\]:BB:ARbitrary:TSIGnal:SINE:FREQuency](#) on page 623

Samples per Period (Sine Test Signal)

Enters the number of sample values required from the sine wave per period.

The resulting clock rate must not exceed the maximum ARB clock rate (see data sheet). The number of sample values is automatically restricted by reference to the set frequency.

Remote command:

[\[:SOURce<hw>\]:BB:ARbitrary:TSIGnal:SINE:SAMPles](#) on page 624

Phase Offset Q (Sine Test Signal)

Enters the phase offset of the sinewave signal on the Q channel relative to the sinewave signal on the I channel.

Remote command:

[\[:SOURce<hw>\]:BB:ARbitrary:TSIGnal:SINE:PHASe](#) on page 623

Generate Signal HD (Sine Test Signal)

Generates a signal and saves it to a file.

The File Select window opens automatically and the signal can be stored as a waveform file.

Remote command:

[\[:SOURce<hw>\]:BB:ARbitrary:TSIGnal:SINE:CREate:NAMed](#) on page 621

Generate Signal RAM (Sine Test Signal)

Generates a signal and uses it as output straight away.

Remote command:

[\[:SOURce<hw>\]:BB:ARbitrary:TSIGnal:SINE:CREate](#) on page 621

Rect Test Signal

To access the "Sine Test Signals" dialog, in the "ARB MOD" dialog set the parameter "Create Test Signal" to Rect and press "Create Test Signal".

The dialog can be used to configure a rectangular test signal. A rectangular test signal with a duty factor of 0.5 is created. Amplitude and offset are adjustable. Both paths, I and Q, get the same signal.

| | |
|--|--------------|
| Frequency | 1.000 00 kHz |
| Samples Per Period | 200 |
| Amplitude | 0.800 FS |
| Offset DC | 0.000 FS |
| <input type="button" value="Generate Signal HD"/> <input type="button" value="Generate Signal RAM"/> | |

Frequency (Rect Test Signal)

Enters the frequency of the test signal.

Remote command:

[\[:SOURce<hw>\]:BB:ARbitrary:TSIGnal:RECTangle:FREQuency](#) on page 622

Samples per Period (Rect Test Signal)

Enters the number of sample values required for the rectangular signal per period.

The resulting clock rate must not exceed the maximum ARB clock rate (see data sheet). The number of sample values is automatically restricted by reference to the set frequency.

Remote command:

[\[:SOURce<hw>\]:BB:ARbitrary:TSIGnal:RECTangle:SAMPles](#) on page 623

Amplitude (Rect Test Signal)

Enters the digital amplitude of the rectangular wave.

The abbreviation FS means full scale.

Remote command:

[\[:SOURce<hw>\]:BB:ARbitrary:TSIGnal:RECTangle:AMPLitude](#) on page 622

Offset DC (Rect Test Signal)

Enters a DC component.

Remote command:

[\[:SOURce<hw>\]:BB:ARbitrary:TSIGnal:RECTangle:OFFSet](#) on page 622

Generate Signal HD (Rect Test Signal)

Generates a signal and saves it to a file.

The File Select window opens automatically and the signal can be stored as a waveform file.

Remote command:

[\[:SOURce<hw>\]:BB:ARbitrary:TSIGnal:RECTangle:CREate:NAMed](#) on page 621

Generate Signal RAM (Rect Test Signal)

Generates a signal and uses it as output straight away.

Remote command:

[\[:SOURce<hw>\]:BB:ARbitrary:TSIGnal:SINE:CREate](#) on page 621

Const IQ Test Signal

To access the "Sine Test Signals" dialog, in the "ARB MOD" dialog set the parameter "Create Test Signal" to Const I/Q and press "Create Test Signal".

The dialog can be used to configure a continuous test signal with constant IQ. The I and Q values for each path are adjustable but constant. The I and Q values are entered as a decimal number, which is decimal-to-binary converted internally. The signal is provided as a 16-bit wide digital signal for both I and Q channels.

Converted to analog the signal is output directly at the BNC connectors I and Q outputs of the instrument.

The image shows a software dialog box for configuring a Const IQ Test Signal. It contains two input fields: 'I Value' and 'Q Value'. Both fields have '0.000' entered and a dropdown menu set to 'FS'. Below these fields are two buttons: 'Generate Signal HD' and 'Generate Signal RAM'.

I Value (Const IQ Test Signal)

Enters the value for the I component of the test signal.

Remote command:

[\[:SOURce<hw>\]:BB:ARbitrary:TSIGnal:CIQ:I](#) on page 621

Q Value (Const IQ Test Signal)

Enters the value for the Q component of the test signal.

Remote command:

[\[:SOURce<hw>\]:BB:ARbitrary:TSIGnal:CIQ:Q](#) on page 621

Generate Signal HD

Generates a signal and saves it to a file.

The File Select window opens automatically and the signal can be stored as a waveform file.

Remote command:

`[:SOURce<hw>] :BB:ARbitrary:TSIGnal:CIQ:CREate:NAMed` on page 621

Generate Signal RAM

Generates a signal and uses it as output straight away.

Remote command:

`[:SOURce<hw>] :BB:ARbitrary:TSIGnal:CIQ:CREate` on page 621

5.9.4.3 Multi Segment Waveforms

Modern chip technologies implement several communication standards within one chip and rise spacial verification and test requirements. To fulfill the requirements of these test systems and to enable rapid alternation between different waveforms with differing test signals, the R&S SMBV provides the functionality to generate multi segment waveform files.

This section introduces the concept of the multi segment waveform files, together with description of the provided settings and some typical configuration examples.

Required options

Multi segment waveform files require the corresponding Digital Standard options (R&S SMBV-K2xx) of all included standards.

Introduction

A multi segment waveform is a composed signal containing several multiple independent waveforms called segments. Each segment represents a completely independent waveform that can be output with its own marker and clock settings.

The [Figure 5-25](#) shows the principle of building a multi segment waveform.

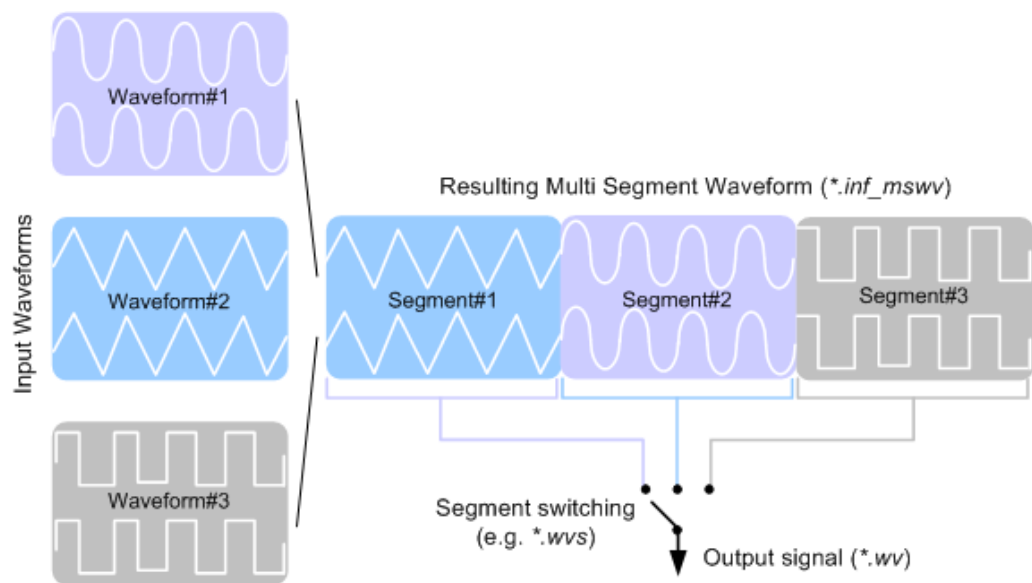

Figure 5-25: ARB Multi Segment Waveform Concept

It is also possible to create and output a blank segment, i.e. segments containing a zero signal.

Typical applications for the multi segment mode are described in section ["Typical Applications for Multi Segment Waveforms"](#) on page 425.

Multi Segment Waveforms Processing

Processing of the waveform is triggered by the "Create" or "Create and Load" function. To process the waveform, the instrument loads the entire multi segment waveform into the memory. It is therefore possible to alternate between the individual waveforms without delay due to loading. You can define the output order of the segments, as well as the segment intended to be output at any given moment.

When the created waveform is loaded, the graphical interface displays information on clock rate, number of samples and creation day. Additionally, you can acquire information about the waveform in the dedicated "Waveform Info" dialog.

The ARB Sequencer Mode

If very high switch over speeds are required, the test signals can be continuously scrolled through with the aid of an external trigger or by applying a predefined "Play List". The R&S SMBV provides the possibility not only to define a sequence of different segment but also to determine whether a segment is played once or repeated several times and to adjust the transition between the segments.

For the correct and fast processing as well as for seamless transition between the multiple waveforms, segments with a common sample rate are required. If the combined waveforms features different sample rates, they should be adapted to a common sample rate by resampling. Another advantage of this procedure is the scaling of the instantaneous amplitude of the various waveforms to a common RMS level.

File Concept

To provide flexible configuration, the building of a composed multi segment waveform file involves different stages; by completing of each of them, the R&S SMBV creates and stores a dedicated file. The following files are used:

- **Configuration list:** is a dedicated file with details on how a multi segment waveform is made up from different waveforms, the level and the clock rate settings, and the file name. The file extension is `*.inf_mswv`.
You can create any number of configurations as a basis for defining further multi segment waveforms.
- **Output file:** is the created output multi segment waveform file. The R&S SMBV stores it under a user definable name; as with the standard waveforms, the used file extension is `*.wv`. The instrument appends additional information to the header of the composed waveform file, e.g. user comments.
- **Sequencing list:** are files created in the "Multi Segment Waveform Sequencing" dialog, i.e. when the ARB sequencer mode is used (see ["The ARB Sequencer Mode"](#) on page 411).
The sequencing list file has an extension `*.wvs` and is automatically assigned to but independent from the multi segment file. By default, both files have the same name and are located in the same file directory. You can create more than one sequencing list file per multi segment waveform file.
The sequencing list file carries information only about the segment number, the corresponding waveform file names are retrieved from the assigned multi segment waveform file, i.e. the same sequencing list file can be reused for different multi segment waveform files with the same number of segments.
Changes and re-calculations of a multi segment waveform file cause a re-check whether the assigned sequencing list files are still valid. A message is displayed to inform about necessary corrections in the "play list".

Impact of the Marker Settings

The general purpose of the marker signal is the triggering of the DUT (device under test) and the synchronization with other measurement instruments.

For better flexibility, the instrument provides several possibilities to define marker signals:

- **Segment markers**
Because the multiple segments are stand alone waveforms, it might be that they already carry marker signals. Settings are provided to define how the instrument should process these available marker signal, to ignore them or to use them in the composed multi segment waveform.
- **Additional segment restart and sequence restart markers**
Additional marker signal can be defined to restart the multi segment sequence or to restart each of the multiple segments. A marker output configured and defined for one of these purposes overwrites markers that use the same output connector and that are defined in the individual waveforms.

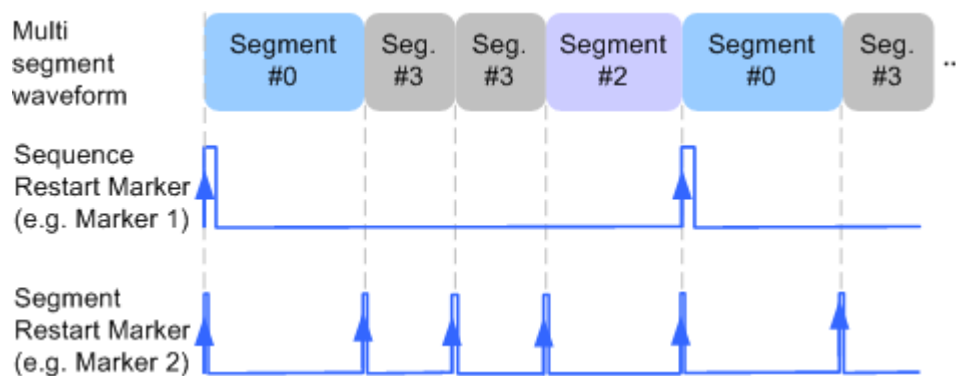

Figure 5-26: Example of marker signals

The segment begin is defined by the low-high slope of the marker. This applies for switching between two segments as well as in case of segment replay.

- General marker signals for the composed multi segment waveform
The "ARB" dialog provides also access to the standard marker settings. Settings other than "unchanged" overwrite existing marker in the waveforms or markers defined for the multi segment waveform.

The Figure 5-27 shows schematically how the instrument evaluates the priorities of the different marker signals, if multiple marker signals are mapped to the same connector.

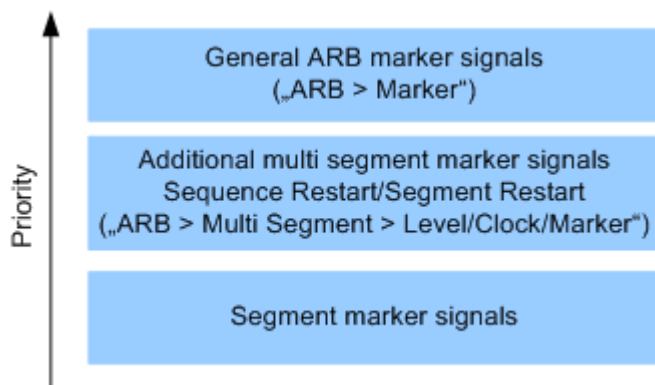

Figure 5-27: Marker priority used by assigning of marker signals to a hardware connector

Impact of the Trigger Settings and Next Segment Settings

The ARB dialog is equipped with the standard (regular) trigger settings. These settings are provided for triggering of the composed multi segment waveform as a **sequence**, i.e. as one file.

This section focuses on the additional settings provided for triggering of the individual segments building the composed multi segment waveform. These settings are enabled and visible only if a multi segment waveform is loaded for processing. The settings are grouped in the "Multi Segment Waveform Options/Next Segment Trigger In" section.

The Figure 5-28 is intended to explain how trigger events impact the processing of the multi segment waveforms.

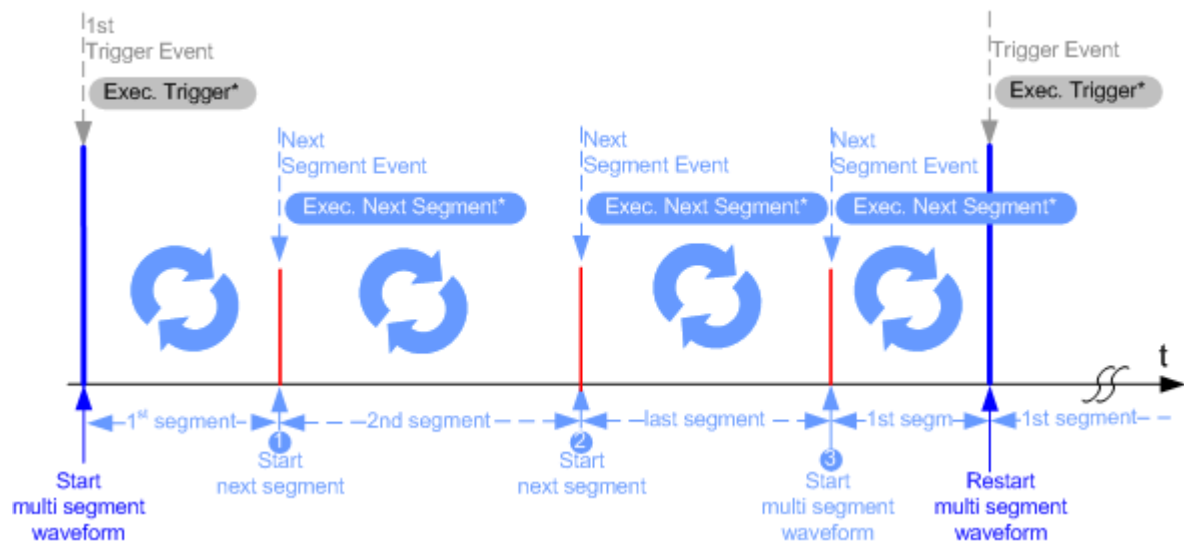

Figure 5-28: Principle of segment triggering

* = To simplify the description, an internal next segment trigger event ("Exec. Next Segment") and an internal trigger event ("Execute Trigger") are used; an external trigger event has the same effect on the signal generation.

1, 2 = Any next segment trigger event (internal or external) causes a switch over to the subsequent available segment in the waveform. The currently output segment (segment file name and segment index) is indicated at "Current Segment".

3 = When the last segment of the multi segment waveform has been output, the sequence starts again with the output of the first segment after the subsequent trigger event. Hence, a sequence of external next segment trigger events can be used to cyclically output the segments in the multi segment file.

Defining Next Segment Source

As with the standard trigger system, provided are the following two sources for the next segment signal:

- **Internal:** the switch over to the subsequent segment is triggered manually by means of the "Execute Next Segment" function.
To trigger a switch over to any segment within the multi segment waveform, change the value of the "Next Segment".
- **External:** the instrument expects an external trigger event (signal at the corresponding connector)

Defining the Subsequent Segment

By default, the instrument replays the segments in incremental order, e.g. Segment#1, Segment#2, etc. If other order is required, use one of the following possibilities to define the segment to be played next:

- **Next Segment:** defines the subsequent segment while triggering the segments manually, i.e. by "Next Segment Source > Internal"
- **Sequencing List:** the subsequent segment is defined in the selected play list.

Defining the Transition between the Segments

The R&S SMBV provides the parameter "Next Segment Mode" to define the transition to the subsequent segment (see the two graphics below).

- **Next Segment:** by receiving a Next Segment Event, the ARB aborts immediately the playing of the current waveform and starts playing the next segment waveform (see [Table 5-12](#)).
- **Next Segment Seamless:** by receiving a Next Segment Event, the ARB completes the processing of the current waveform before starting the next segment waveform (see [Table 5-12](#)).

Use this setting to avoid signal gaps and wrap-around problems. Seamless transition requires segments with equal clock rates.

Another way to generate a multi segment signal without signal gaps between the segments is to use the provided ARB sequencer mode (see "[Multi Segment Waveform Settings](#)" on page 416).

The [Table 5-12](#) shows two examples of the transition from a sinewave signal segment to a sawtooth segment (1 channel, upper curve) in the case of next segment external triggering. The left graphic displays an abrupt transition; the right graphic, the **seamless** transition case.

Table 5-12: Transition examples

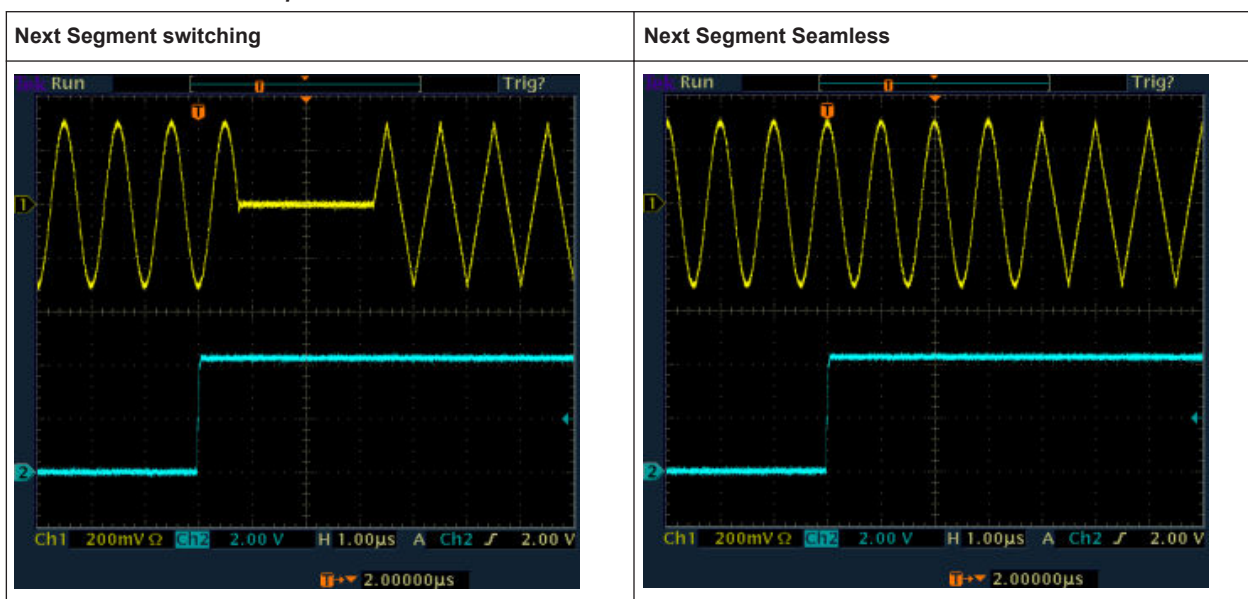

Understanding the Trigger Examples

A simplified diagram in the ARB dialog is intended to explain the effect of the triggering on the signal processing. The currently enabled settings for trigger and next segment mode are considered.



The curves plotted in the dialog are textbook examples, "not measured" waveforms. They are intended to visualize the trigger and the next segment settings more clearly.

- The triangle on the top line denotes a trigger event. A filled triangle on the bottom line denotes a next segment event.
- A green sinewave (or other shape) over a full period indicates one replay cycle of a segment ; A shorter example signal indicates a replay cycle which was interrupted, e.g. due to a next segment event (compare the two graphics in [Table 5-13](#)).

Table 5-13: Trigger examples in the "ARB" dialog

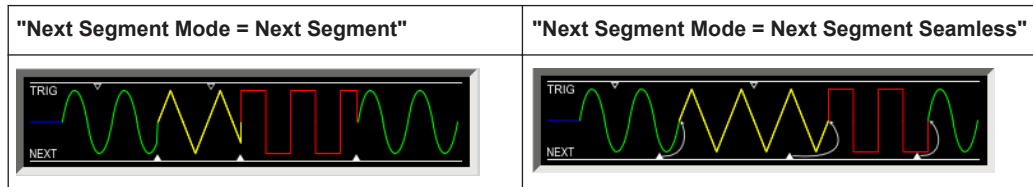

Multi Segment Waveform Settings

To access the "Multi Segment" dialog, select "Baseband > ARB > Multi Segment...".

Example

How to create multi segment waveform file

1. Select "New List" to create empty list.
2. Use the "Append" function to add two or more waveform files.
3. Adjust the "Level", "Clock" and "Segment Marker" settings.
4. Select the "Output File" and enter file name.
5. Select "Save List" to save the configuration.
6. Select "Create" or "Create and Load" to create and save the multi segment waveform.

| Filename | Clock Rate | Samples | Period | Path | Comment | Info |
|----------------|------------|----------|------------|---------|---------|---------|
| 0 arb_const.wv | 10.000 kHz | 1100.000 | µs | c:/ARB/ | | Info... |
| 1 arb_rect.wv | 10.000 kHz | 100 | 10.000 ms | c:/ARB/ | | Info... |
| 2 Blank | 10.000 kHz | 1000 | 100.000 ms | | | Info... |
| 3 arb_sine.wv | 10.000 kHz | 100 | 10.000 ms | c:/ARB/ | | Info... |

Append... Delete Shift Segm. Up Down

Blank Segment
 Clock 100.000 000 000 MHz Samples 1 000 Period 10.000 µs Append

Level / Clock / Marker
 Level Equal RMS Segment Marker Ignore
 Clock Unchanged Sequence Restart Disabled
 User Clock Rate 10 000.000 00 MHz Segment Restart Disabled

Comment comm
 Output File c:/_user/lists/ARB/ms_out.wv

New List Load List... Save List... Create Create and Load Sequencing List...

Multi Segment File Contents

The upper part of the dialog provides the functions, necessary to create and adjust the contents of the multi segment file.

Multi Segment Table

The table lists the individual waveforms (segments) of the selected multi segment waveform. The information about the segments is taken from the tags of the corresponding waveform files.

| | |
|--------------|---|
| "Segment#" | Indication of segment index. The segment index is used to select the segment to be output. The segment index also defines the sequence of the output during triggering in the "Next Segment" or "Next Segment Seamless". |
| "Waveform" | Indication of the waveform file name of the segment. |
| "Clock Rate" | Indication of the clock rate of the segment. |
| "Samples" | Indication of the number of samples in the segment. |
| "Period" | Indication of the segment duration. |
| "Path" | Indication of the location of the waveform file used for the corresponding segment. |
| "Comment" | Indication of the comment on the segment. |
| "Info" | Opens a dialog with detailed information about the currently selected waveform. |



Remote command:
n.a.

Append

Opens the file menu to enter the file name of the waveform file to be appended.

Remote command:

`[:SOURce<hw>] :BB:ARbitrary:WSEgment:CONFigure:SEGment:CATalog?`
on page 649

`[:SOURce<hw>] :BB:ARbitrary:WSEgment:CONFigure:SEGment:APPend`
on page 649

Delete

Deletes the selected segment.

Remote command:

`[:SOURce<hw>] :BB:ARBitrary:WSEgment:CONFigure:DELeTe` on page 647

Shift Seg.# Up/Down

Shifts the selected segment up and down.

Blank Segment

The Blank Segment section is where a blank segment can be configured.

Clock Rate

Selects the clock rate of the blank segment.

Remote command:

`[:SOURce<hw>] :BB:ARBitrary:WSEgment:CONFigure:BLANk:APPend`
on page 645

Samples

Selects the number of samples for the blank segment.

Remote command:

`[:SOURce<hw>] :BB:ARBitrary:WSEgment:CONFigure:BLANk:APPend`
on page 645

Period

Displays the resulting period for the blank segment.

Remote command:

n.a.

Append Blank

Adds the blank segment to the multi segment file.

Remote command:

`[:SOURce<hw>] :BB:ARBitrary:WSEgment:CONFigure:BLANk:APPend`
on page 645

Level / Clock /Marker

The Level/Marker/Clock section provides the parameters necessary to adjust the level, marker and clock settings for the selected multi segment waveform file.

Level

Defines the level mode for the multi segment waveform.

- | | |
|-------------|---|
| "Unchanged" | Concerning the level settings, the segments are output exactly as defined in the files. The "Level" display applies only to the segment with the highest rms value. In some circumstances the remaining segments are output at a lower level than that displayed. |
| "Equal RMS" | Segments are output so that all segments have the same rms value. The "Level" display applies to all segments. |

Remote command:

`[:SOURce<hw>] :BB:ARbitrary:WSEgment:CONFigure:LEVel [:MODE]`
on page 647

Clock

Selects the clock rate mode for the multi segment waveform.

- | | |
|-------------|--|
| "Unchanged" | A segment is output with the clock rate defined in the file. If segments have different clock rates, extended trigger mode "Next Segment" allows internal segment switchovers only ("Internal" trigger source). Extended trigger mode "Next Segment Seamless" can only be selected if all segments have the same clock rate. |
| "Highest" | All segments are output at the highest available clock rate. This mode provides very short switchover times between segments. The time for calculating the multi segment waveform is increased since the individual segments have to be resampled. |
| "User" | All segments are output at the clock rate defined in "User Clock". This mode provides very short switchover times between segments. The time for calculating the multi segment waveform is increased since the individual segments have to be resampled. |

Remote command:

`[:SOURce<hw>] :BB:ARbitrary:WSEgment:CONFigure:CLOCK:MODE`
on page 646

User Clock Rate

Defines the sample rate used for multi segment waveform output in case of Clock Mode "User".

Remote command:

`[:SOURce<hw>] :BB:ARbitrary:WSEgment:CONFigure:CLOCK` on page 646

Segment Marker

Defines the way the marker information within the separate segments is processed.

- | | |
|-------------|--|
| "Ignore" | The marker information carried in the individual segment waveform files is not considered. |
| "Take Over" | The output waveform file contains the marker information as configured in the individual waveform files. |

Remote command:

`[:SOURce<hw>] :BB:ARbitrary:WSEgment:CONFigure:MARKer:MODE`
on page 648

Sequence Restart

Enables/disables the generation of an additional marker restart signal in the output waveform file.

If additional marker generation is enabled, the existing marker signals in the individual segment waveform files are not considered.

- | | |
|-----------|------------------------------------|
| "Disable" | No additional marker is generated. |
|-----------|------------------------------------|

"Marker
1/2/3/4" Generates a restart marker signal at the beginning of the first segment for the corresponding marker.
Use this setting to generate a restart marker for the complete sequence.

Remote command:

`[:SOURCE<hw>] :BB:ARbitrary:WSEgment:CONFigure:MARKer:FSEgment`
on page 648

Segment Restart

Enables/disables the generation of an additional marker restart signal in the output waveform file.

If additional marker generation is enabled, the existing marker signals in the individual segment waveform files are not considered.

"Disable" No additional marker is generated.

"Marker
1/2/3/4" Generates a restart marker signal at the beginning of each segment for the corresponding marker.
The segment begin is defined by the low-high slope of the marker.
This applies for switching between two segments as well as in case of segment replay.

Remote command:

`[:SOURCE<hw>] :BB:ARbitrary:WSEgment:CONFigure:MARKer:ESEgment`
on page 647

Output File

In the Output File section, the output file name is specified and a comment can be added to the file.

Comment

Adds a comment to the multi segment file.

Remote command:

`[:SOURCE<hw>] :BB:ARbitrary:WSEgment:CONFigure:COMMeNt` on page 646

Output file

Opens the File menu, where the file name of the multi segment waveform which has to be calculated can be entered. The multi segment waveform is saved under this name by clicking the "Create" or "Create and Load" button.

A name must also be entered here before the list can be saved as a configuration file ("Save List"). In this case the name is needed for internal storage procedures. It is entered as the default name for the multi segment waveform file when loading the list.

Remote command:

`[:SOURCE<hw>] :BB:ARbitrary:WSEgment:CONFigure:OFILe` on page 649

Handling of Multi Segment Files

The buttons in this sections are provided for handling of the multi segment files.

Save List

Saves the current entries of the table in a configuration file, including the level mode, clock mode, segment marker mode and output file name settings.

The file name is entered in the "File" menu. Configuration files have the file extension *.inf_mswv. They can be used later as the basis for further multi segment waveforms.

Before a multi segment configuration file can be saved, a file name must be entered in "Output File", since this is saved with the configuration file for internal purposes.

Remote command:

The configuration file to be used for the creation of the multi segment waveform is defined with the command:

```
[ :SOURce<hw> ] :BB:ARbitrary:WSEgment:CREate
```

```
or [ :SOURce<hw> ] :BB:ARbitrary:WSEgment:CLOad
```

The file name of the waveform file is always determined with the command [:

```
SOURce<hw> ] :BB:ARbitrary:WSEgment:CONFigure:OFILe
```

Load List

Opens the file menu to select the configuration file to be edited.

Remote command:

```
[ :SOURce<hw> ] :BB:ARbitrary:WSEgment:CONFigure:CATalog? on page 645
```

```
[ :SOURce<hw> ] :BB:ARbitrary:WSEgment:CONFigure:SElect on page 650
```

New List

Calls the "Create Multi Segment Waveform List" dialog to enter the name of the new file.

A new new configuration table is created.

Remote command:

```
[ :SOURce<hw> ] :BB:ARbitrary:WSEgment:CONFigure:SElect on page 650
```

Define Sequencing List

Open a dialog box for configuring of the play lists (see "[Multi Segment Waveform Sequencing](#)" on page 422).

Remote command:

n.a.

Create

Creates a new multi segment waveform using the current table entries.

This multi segment waveform is saved with the file name specified in "Output File". As with normal waveforms, the file extension is "*.wv".

Depending on the configuration of the multi segment waveform, calculation may take some time. A panel with a progress bar and an "Abort" button appears during creating of the multi segment waveform.

In remote control the configuration file to be used for the creation of the multi segment waveform is defined with the command: [:SOURce<hw>] :BB:ARbitrary:

```
WSEgment:CREate or [ :SOURce<hw> ] :BB:ARbitrary:WSEgment:CLOad.
```

The file name of the waveform file is always determined with the command [:
SOURce<hw>]:BB:ARbitrary:WSEgment:CONFigure:OFILe

Remote command:

[:SOURce<hw>]:BB:ARbitrary:WSEgment:CREate on page 650

Create and Load

Creates a new multi segment waveform using the current table entries.

This multi segment waveform is saved with the file name specified in "Output File". As with normal waveforms, the file extension is *.wv.

Depending on the configuration of the multi segment waveform, calculation may take some time.

Following this the "Create Multi Segment Waveform File" submenu is closed and the new multi segment waveform is loaded.

In remote control the configuration file to be used for the creation of the multi segment waveform is defined with the command: [:SOURce<hw>]:BB:ARbitrary:WSEgment:CREate or [:SOURce<hw>]:BB:ARbitrary:WSEgment:CLoad.

The file name of the waveform file is always determined with the command [:
SOURce<hw>]:BB:ARbitrary:WSEgment:CONFigure:OFILe

Remote command:

[:SOURce<hw>]:BB:ARbitrary:WSEgment:CLoad on page 644

Multi Segment Waveform Sequencing

The settings provided in the "Multi Segment Waveform Sequencing" dialog can be adjusted to create a "play list", i.e. to define the sequence in which the waveform file segments are processed and how many times each of them is repeated. The configured play list is displayed in form of a "Sequencing Graphic".



All segments in a "play list" must have the same clock rate.

In the "ARB" main dialog or in the "ARB Trigger/Marker/Clock" dialog, set the "Next Segment Mode" to "Sequencer" to activate the configured "play list".

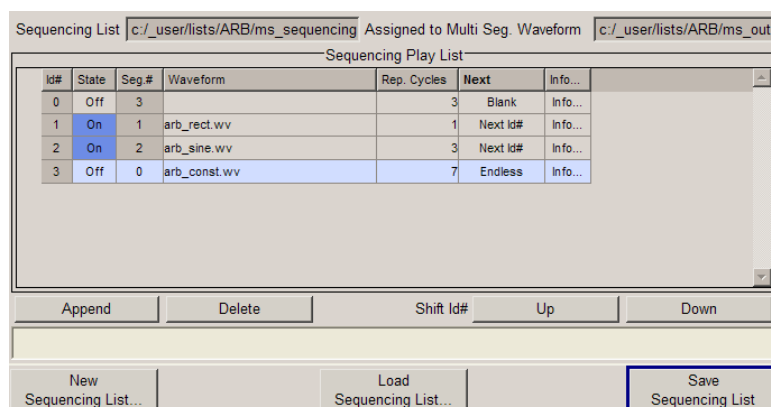

Sequencing List

Displays the name of the selected sequencing list file, i.e. the file with the “play list” settings.

The sequencing list file has an extension *.wvs and is automatically assigned to but independent from the multi segment file. By default, both files have the same name and are located in the same file directory. More than one sequencing list files can be created per multi segment waveform file.

The sequencing list file carries information only about the segment number, the corresponding wavefile names are retrieved from the assigned multi segment waveform file, i.e. the same sequencing list file can be reused for different multi segment waveform files with the same number of segments.

Changes and re-calculations of a multi segment waveform file cause a re-check whether the assigned sequencing list files are still valid. A message is displayed to inform about necessary corrections in the “play list”.

Remote command:

n.a.

Assigned to Multi Seg. Waveform

Displays the name of the multi segment waveform file the current sequencing list file is assigned to.

Remote command:

n.a.

Sequencing Play List

The "Sequencing Play List" table is used to define the sequence in which the waveform file segments are processed and how many times each of them is repeated.

Id# ← Sequencing Play List

Indication of the row number.

n.a.

State ← Sequencing Play List

Enables/disables the selected row. Only active segments are processed.

n.a.

Segment# ← Sequencing Play List

Indication of segment index.

The sequencing list file carries information only about the segment index, the corresponding wavefile names are retrieved from the assigned multi segment waveform file.

n.a.

Waveform ← Sequencing Play List

Indication of the waveform file name of the segment. The file name is retrieved from the assigned multi segment waveform file.

Available for selection are only waveform files from the pool of segments of the selected multi segment waveform file.

n.a.

Repetition Cycles ← Sequencing Play List

Sets the number of times the selected segment is cyclically repeated before the next segment in the sequence is processed.

n.a.

Next ← Sequencing Play List

Determines the action after completing the current one, like for instance which segment is processed after the processing of the current one is finished.

| | |
|------------|---|
| "Next Id#" | The next active segment in the play list is processed. |
| "Blank" | After the processing of the current segment is completed, the signal output is stopped until a signal restart like a retrigger signal is received. A restart signal causes a complete restart of the sequencing play list. |
| "Endless" | The current segment is re-played until a signal restart like a retrigger signal is received and the complete sequencing play list is restarted. Only active segments are considered. |
| "Goto Id#" | Determines the row number of the segment to be processed next. This feature is currently limited for the first 32 rows. |

Remote command:

n.a.

Info ← Sequencing Play List

Opens a dialog with detailed information about the currently selected waveform.

See also "[Waveform Info](#)" on page 390.

Remote command:

n.a.

Append

Inserts a new row at the end of the sequencing play list table.

Remote command:

[\[:SOURCE<hw>\]:BB:ARbitrary:WSEgment:SEquence:SElect](#) on page 653

[\[:SOURCE<hw>\]:BB:ARbitrary:WSEgment:SEquence:APPend](#) on page 653

Delete

Deletes the selected row.

Remote command:

n.a.

Shift Id# Up/Down

Shifts the selected row up and down.

Remote command:

n.a.

Sequencing Graphic

Displays the play list graph according to the current configuration.

The graph shows the segment sequence, the segment number and the number of times, the segment is repeated; considered are only the active segments.

Remote command:

n.a.

New Sequencing List

Opens the "Select Sequencing List" dialog to enter the name of the new file.

Remote command:

n.a.

Load Sequencing List

Opens the "Select Sequencing List" dialog to select an existing play list file.

Remote command:

n.a.

Save Sequencing List

Saves the current entries of the table in a play list file.

The default file name of the play list file is the same as the multi segment waveform file name, but it can be changed.

Play list files have the file extension `*.wvs`.

Remote command:

n.a.

Typical Applications for Multi Segment Waveforms

This section gives examples of the typical applications for multi segment waveforms.

High Speed Switchovers

To test DUTs/chips using different test signals at high throughput requires extremely fast switchovers (for instance when testing ATE devices during manufacture). The following settings enable switching times of approx. 5 us and the test signals are scrolled through with the aid of an external trigger signal:

1. "Trigger Mode" = "Auto"
2. "Trigger Source" = "External Trigger"
3. If the waveforms have different sample rates:
"Clock Mode" = "Highest" or "User" (when creating the waveform in the Multi Segment Editor)

Flexible Dynamic Switchovers

When testing DUTs using different test signals, it may be necessary to switch dynamically and flexibly between any of the test signals, for instance depending on the outcome of the previous test. When using remote control via an external computer, the fol-

lowing settings enable switching times of approx. 20 ms for segments with the same sample rate and approx. 200 ms for segments with different sample rates:

1. "Extended Trigger Mode" = "Next Segment"
2. "Trigger Mode" = "Auto"
3. "Trigger Source" = "Internal"

Flexible Dynamic Switchovers without Signal Interruptions

Testing receivers requires a continuous output of different test signals without interrupting the signal. The test signals then produce a complex total signal with no signal gaps on switchover. Control procedures can use a simulated back channel of the receiver (trigger line or remote control).

Switching times depend on the length of the segment currently being output, since switchover to the next segment does not take place until the current segment comes to an end.

1. "Extended Trigger Mode" = "Next Segment Seamless"
2. "Trigger Mode" = "Auto"
3. "Trigger Source" = "Internal or External"
If the waveforms have different sample rates:
4. "Clock Mode" = "Highest" or "User" (when creating the waveform in the Multi Segment Editor)

5.9.4.4 Multi Carrier Waveforms

Multi carrier waveforms consisting of up to 512 carriers modulated by user-selectable baseband signals can be created in order to simulate complex multi carrier scenarios with different baseband signals (e.g. CDMA2000 or 3GPP FDD).

The carriers are equally spaced and centered toward the RF frequency or baseband DC line, respectively. The carrier spacing is adjustable within the total available baseband bandwidth of 80 MHz. Each carrier can be separately defined in terms of power, phase and modulated input signal. Optionally, crest factor optimization can be applied.

Thus, multi carrier waveforms can be very easily configured as broadband test signals and used for such purposes as transmitter or receiver tests. Even complex multi carrier scenarios composed of signals from different digital standards can be created and used for these tests.

Example for the creation of a multi carrier waveform file

1. Configure general settings
2. Configure carrier table
3. Enter file name of multi carrier waveform ("Output File")
4. Save and load multi carrier waveform ("Create" or "Create and Load")

User Interface

To access the "Multi Carrier" dialog, select "Baseband > ARB > Multi Carrier...".

The menu can be used to create a multi carrier waveform and save it under its own name. As with normal waveforms, the file extension is *.wv. Information on clock rate, number of samples and creation day is displayed in the File menu when a waveform is loaded.

The "Multi Carrier" dialog is divided into the following sections.

The upper part of the menu is used for calling the default settings and saving and recalling the submenu settings.

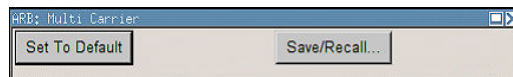

The General Settings section is used to configure the main multi carrier waveform.

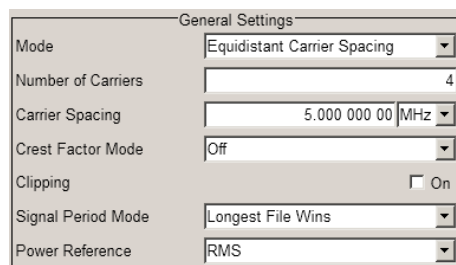

The buttons in the middle part of the menu open submenus for defining the carrier table. The carrier settings can be checked in the graphical "Carrier Graph" submenu.



The "Output Settings" section indicates the name, the size and the clock rate of the multi carrier waveform (after calculation).

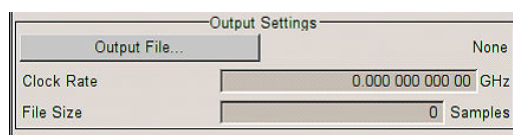

The buttons in the lower part of the menu activate creation and optionally loading of multi carrier waveform files into the main ARB menu.



Default Settings and State

The upper part of the dialog is used for calling the default settings and saving and recalling existing ARB multi carrier submenu settings.

Set to Default

Calls default settings. The values are shown in the following table.

| Parameter | Value |
|--------------------|-------------------|
| Number of Carriers | 1 |
| Carrier Spacing | 0 MHz |
| Crest Factor Mode | Off |
| Signal Period Mode | Longest file wins |

Remote command:

[\[:SOURce<hw>\]:BB:ARbitrary:MCARrier:PRESet](#) on page 636

Save/Recall Frame

Calls the "Save/Recall" menu.

From the "Save/Recall" menu the "File Select" windows for saving and recalling the configurations of the ARB "Multi Carrier" submenu and the "File Manager" can be called.

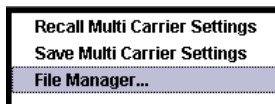

Multi Carrier configurations are stored as files with the predefined file extension *.arb_multcarr. The file name and the directory they are stored in are user-definable.

The complete settings in the Multi Carrier menu are saved and recalled.

"Recall Multi Carrier Settings"

Opens the "File Select" window for loading a saved Multi Carrier configuration.

The configuration of the selected (highlighted) file is loaded by pressing the "Select" button.

"Save Multi Carrier Settings"

Opens the "File Select" window for saving the current Multi Carrier signal configuration.

The name of the file is specified in the "File name" entry field, the directory selected in the "Save Into" field. The file is saved by pressing the "Save" button.

The "Fast Save" checkbox determines whether the instrument performs an absolute or a differential storing of the settings. Enable this function to accelerate the saving process by saving only the settings with values different to the default ones. "Fast Save" is not affected by the "Preset" function.

"File Manager"

Calls the "File Manager".
The "File Manager" is used to copy, delete, and rename files and to create new directories.

Remote command:

[\[:SOURce<hw>\]:BB:ARbitrary:MCARrier:SETTing:CATalog?](#) on page 637

[\[:SOURce<hw>\]:BB:ARbitrary:MCARrier:SETTing:LOAD](#) on page 637

[\[:SOURce<hw>\]:BB:ARbitrary:MCARrier:SETTing:STORe:FAST](#) on page 638

[\[:SOURce<hw>\]:BB:ARbitrary:MCARrier:SETTing:STORe](#) on page 637

General Settings

The "General Settings" section is used to configure the Multi Carrier signal.

Mode

Selects the carrier frequency mode.

"Equidistant Carrier Spacing"

Sets an equidistant carrier spacing. The carrier frequency in the carrier table is not configurable.

"Arbitrary Carrier Frequency"

Enables you to specify the carrier frequency in the carrier table. Carrier spacing is irrelevant.

Remote command:

[\[:SOURce<hw>\]:BB:ARbitrary:MCARrier:CARRier:MODE](#) on page 625

Number of Carriers

Sets the number of carriers for the multi carrier waveform.

By default the multi carrier table lists 1 carrier. When the number of carriers is increased, the multi carrier table is extended by adding further lines at the end of the table. If these carrier already have been defined before, the settings are preset according to the former settings. Otherwise the parameters are preset with the default values.

Remote command:

[\[:SOURce<hw>\]:BB:ARbitrary:MCARrier:CARRier:COUNT](#) on page 625

Carrier Spacing

Sets the frequency spacing between adjacent carriers of the multi carrier waveform.

The carriers are arranged symmetrically around the RF carrier and the maximum carrier spacing is limited to:

"Carrier Spacing" = Total Baseband Bandwidth / ("Number of Carriers" - 1).

The total baseband bandwidth depends on the installed option. For example, in R&S SMBV equipped with option R&S SMBV-B10, the total baseband bandwidth is 120 MHz.

Note: In order to avoid wrap-around problems, the effective "Carrier Spacing" might be slightly modified.

The "Carrier Spacing" is rounded in that way that the carrier closest to the center RF frequency shows no phase jump assuming that the carrier is unmodulated.

- For odd number of carriers:
RoundedCarrierSpacing=1/OutputSignalDuration* round(CarrierSpacing * OutputSignalDuration);
- For even number of carriers:
RoundedCarrierSpacing=2/OutputSignalDuration*round(0.5 *CarrierSpacing * OutputSignalDuration).

Remote command:

[\[:SOURce<hw>\]:BB:ARbitrary:MCARrier:CARRier:SPACing](#) on page 626

Crest Factor Mode

Selects the mode for optimizing the crest factor by calculating the carrier phases.

The crest factor represents the ratio of the peak voltage value to the rms voltage value. The higher the crest factor and resulting dynamics of a signal, the greater the requirement for a power amplifier fed by the signal to be linear.

The following modes are available:

- | | |
|------------|--|
| "Off" | There is no automatic setting for minimizing or maximizing the crest factor. The "Phase" setting as defined in the carrier table is in use. |
| "Minimize" | The crest factor is minimized by internally calculating optimized carrier phases. The Phase setting displayed in the carrier table is invalid. |
| "Maximize" | The crest factor is maximized by internally calculating optimized carrier phases. The Phase setting displayed in the carrier table is invalid. |

Remote command:

`[:SOURce<hw>] :BB:ARbitrary:MCARrier:CFACTOR:MODE` on page 629

Clipping

Switches baseband clipping on and off.

Clipping reduces the peak power of the resulting multi carrier signal according to the input parameter "Target Crest Factor".

The resulting clipped peak power is defined by sum of the the RMS level of the unclipped multi carrier signal and the input parameter "Target Crest Factor". Note that clipping reduces also the RMS level. Hence the resulting crest factor of the clipped signal is slightly above the "Target Crest Factor". In order to get the unclipped parts of the clipped multicarrier signal matched with the unclipped multicarrier signal, the RF output power should be reduced by the difference between resulting crest factor and "Target Crest Factor".

Remote command:

`[:SOURce<hw>] :BB:ARbitrary:MCARrier:CLIPPING[:STATe]` on page 630

Target Crest Factor

Sets the value of the desired crest factor, if baseband clipping is enabled.

A "Target Crest Factor" above the crest factor of the unclipped multicarrier signal has no effect.

Remote command:

`[:SOURce<hw>] :BB:ARbitrary:MCARrier:CLIPPING:CFACTOR` on page 629

Filter Cut Off Frequency

Sets the cut off frequency of the final lowpass filter, if baseband clipping is enabled.

When the cut off frequency is set as half of the output sample rate, a final lowpass filter improves the spectrum of the clipped multicarrier signal, but may also increase the resulting crest factor.

Remote command:

`[:SOURce<hw>] :BB:ARbitrary:MCARrier:CLIPPING:CUTOFF` on page 630

Signal Period Mode

Selects the mode for calculating the resulting signal period of the multi carrier waveform. The carrier table provides an information button to obtain sample rate and file length data of each carrier.

The resulting period is always calculated for all carriers in the carrier table irrespective of their state (On/Off).

Note: Wrap-around and timing problems may occur when I/Q signals of different length are used. Thus, demodulation of a carrier may be difficult or even impossible. It is therefore recommended to consider the timing already when creating the input I/Q files or to adjust the signal duration to the carrier which is subsequently demodulated (in this case, the other carriers are for interfering the signal only). These problems do not arise with signals of the same standard (e.g. 3GPP).

The following modes are available:

"Longest File Wins"

The resulting signal period is defined by the longest I/Q file in the carrier table. Shorter I/Q files are periodically repeated.

"Shortest File Wins"

The resulting signal period is defined by the shortest I/Q file in the carrier table. Only the first part of longer I/Q files is used.

"User"

The signal period can be set by the user in the "Signal Period" field. Shorter I/Q files are repeated periodically, and only the first part of longer I/Q files is used.

"Least Common Multiple"

The output file duration is the least common multiple of all input file durations.

Remote command:

`[:SOURce<hw>] :BB:ARbitrary:MCARrier:TIME:MODE` on page 638

Signal Period

Sets the signal period in Signal Duration Mode "User". Shorter I/Q files are repeated periodically, and only the first part of longer I/Q files is used.

Remote command:

`[:SOURce<hw>] :BB:ARbitrary:MCARrier:TIME` on page 638

Power Reference

Defines the way the individual carriers in a composed multi carrier signal are leveled. The difference between the provided modes is especially important if signals with different crest factors are composed together into a multi carrier signal.

"RMS" The individual carriers are leveled based on their RMS power and the configured "Carrier Gain".

Example:

A multi carrier signal is composed from two waveform files.

First carrier "Gain" = 0 dB

Second carrier "Gain" = -3 dB

In the resulting multi carrier signal, the *RMS power* of the second carrier signal is 3 dB lower than the RMS power of the first carrier signal.

"Peak" The individual carriers are leveled based on their peak power and the configured "Carrier Gain".

Example:

A multi carrier signal is composed from two waveform files.

First carrier "Gain" = 0 dB

Second carrier "Gain" = -3 dB

In the resulting multi carrier signal, the *peak power* of the second carrier signal is 3 dB lower than the peak power of the first carrier signal.

Example: Multi carrier signal composed of waveforms with different crest factor

A multi carrier signal is composed from two waveform files with the following characteristics:

3GPP FDD signals with the same "Sample Rate" but *different "Crest Factors"*.

"Peak" = 0 dBFS

"Carrier Gain" = 0 dB

| | State | Carrier Freq [MHz] | Gain [dB] | Phase [deg] | Delay [ns] | File | Info | !!! |
|---|-------|--------------------|-----------|-------------|------------|----------|---------|-----|
| 0 | On | -5.000 000 | 0.00 | 0.00 | 0 | e:/file1 | Info... | |
| 1 | On | 5.000 000 | 0.00 | 0.00 | 0 | e:/file2 | Info... | |

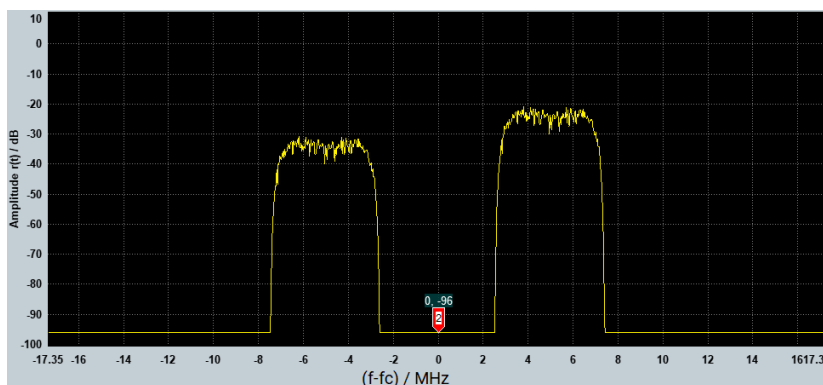

The Peak values of the carrier signals are equal, the RMS values are different.

Remote command:

`[:SOURce<hw>] :BB:ARbitrary:MCARrier:POWer:REFErence` on page 628

Carrier Table

Calls the table for configuring individual carriers. A selectable carrier range can be set with the aid of the optional "Carrier Table Assistant" (see "Muti Carrier Table" on page 434).

The multi carrier configuration can be checked with the aid of the "Carrier Graph".

Carrier Graph

Calls a graphical representation of the current multi carrier configuration in the frequency domain.

The height of the bars corresponds to the chosen gain of each individual carrier. The bandwidth of the carriers signals is indicated by the width of the bars.

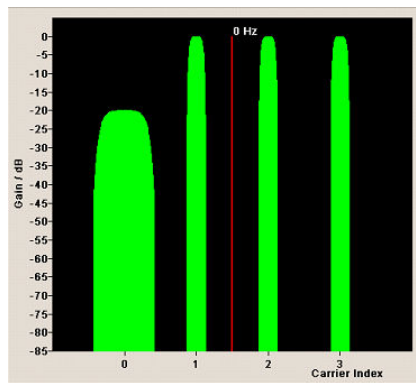

Output Settings

The "Output Settings" section in the multi carrier main menu indicates the name, the size and the clock rate of the currently calculated multi carrier output file.

File

Opens the "File" menu, where the output file name of the multi carrier waveform which has to be calculated can be entered.

The multi carrier waveform is calculated and saved under this name by clicking the "Create" or "Create and Load" button.

Remote command:

`[:SOURce<hw>] :BB:ARbitrary:MCARrier:OFILe` on page 636

Clock Rate

Displays the resulting sample rate at which the multi carrier waveform is output by the arbitrary waveform generator. The output clock rate depends on the number of carriers, carrier spacing and input sample rate of the leftmost or rightmost carriers.

Remote command:

`[:SOURce<hw>] :BB:ARbitrary:MCARrier:CLOCK?` on page 631

File Size

Displays the resulting number of samples of the multi carrier waveform.

Remote command:

`[:SOURce<hw>] :BB:ARbitrary:MCARrier:SAMPles?` on page 636

Create

Creates a new multi carrier waveform defined by the multi carrier table and General Setting entries.

This multi carrier waveform is saved with the file name specified in "Output File". If no file name is specified, the File Manager opens so that the file name can be entered. As with normal waveforms, the file extension is `*.wv`.

Depending on the configuration of the multi carrier waveform, calculation may take some time. A panel with a progress bar and an "Abort" button appears during the calculation process.

Remote command:

`[:SOURce<hw>] :BB:ARbitrary:MCARrier:CREate` on page 632

Create and Load

Creates a new multi carrier waveform defined by the multi carrier table and General Setting entries and loads it subsequently in the "ARB" main menu.

This multi carrier waveform is saved with the file name specified in "Output File". If no file name is specified, the File Manager opens so that the file name can be entered. As with normal waveforms, the file extension is `*.wv`.

Depending on the configuration of the multi carrier waveform, calculation may take some time. A panel with a progress bar and an "Abort" button appears during the calculation process.

Remote command:

`[:SOURce<hw>] :BB:ARbitrary:MCARrier:CLoad` on page 631

Muti Carrier Table

The "Multi Carrier Table" manu is oped by means of the "Carrier Table" button in the middle part of the Multi Carrier Waveforms menu. The carrier settings can be checked in the graphical "Carrier Graph" submenu.

The "Carrier Table Assistant" section can be used to set a selectable carrier range. This section serves as a optional mean to quickly set up a multi carrier scenario within a specified carrier range.

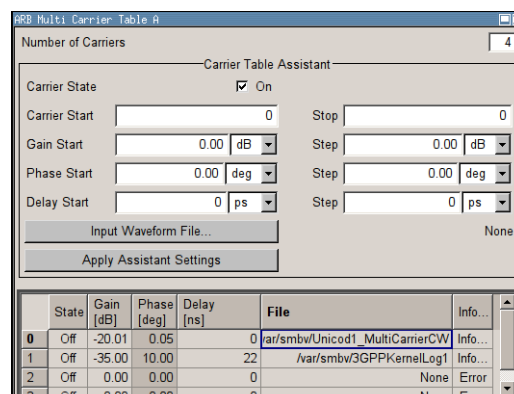

Carrier Table Assistant

Number of Carriers

Defines the number of carriers of the multi carrier waveform.

This parameter is identical to that in the "General Setting" section.

Remote command:

`[:SOURce<hw>] :BB:ARbitrary:MCARrier:CARRier:COUNT` on page 625

Carrier State

Switches the carriers in the range "Carrier Start" to "Carrier Stop" on/off.

Remote command:

`[:SOURce<hw>] :BB:ARbitrary:MCARrier:EDIT:CARRier:STATe` on page 636

Carrier Start

Defines the start index of the carrier range to which the assistant settings are intended to apply.

Remote command:

`[:SOURce<hw>] :BB:ARbitrary:MCARrier:EDIT:CARRier:START` on page 635

Carrier Stop

Defines the stop index of the carrier range to which the assistant settings are intended to apply.

Remote command:

`[:SOURce<hw>] :BB:ARbitrary:MCARrier:EDIT:CARRier:STOP` on page 635

Gain Start

Sets the gain of the carrier marked by "Carrier Start".

Remote command:

`[:SOURce<hw>] :BB:ARbitrary:MCARrier:EDIT:CARRier:POWer[:START]`
on page 635

Gain Step

Sets the step width that is used to increment the gain

The resulting carrier gain in the carrier table equals:

GainStart + n* Gain Step

where n ranges from 0 to (Carrier Stop - Carrier Start).

Remote command:

`[:SOURce<hw>] :BB:ARbitrary:MCARrier:EDIT:CARRier:POWer:STEP`
on page 634

Phase Start

Sets the phase of the carrier marked by "Carrier Start".

Remote command:

`[:SOURce<hw>] :BB:ARbitrary:MCARrier:EDIT:CARRier:PHASe[:START]`
on page 634

Phase Step

Sets the step width that is used to increment the phase.

The resulting phase in the carrier table equals:

PhaseStart + n* PhaseStep

where n ranges from 0 to (Carrier Stop – Carrier Start)

Remote command:

`[:SOURce<hw>] :BB:ARbitrary:MCARrier:EDIT:CARRier:POWer:STEP`
on page 634

Delay Start

Sets the delay of the carrier marked by "Carrier Start".

Remote command:

`[:SOURce<hw>] :BB:ARbitrary:MCARrier:EDIT:CARRier:DELay[:START]`
on page 633

Delay Step

Sets the step width that is used to increment the delay

The resulting delay in the carrier table equals:

DelayStart + n* DelayStep

where n ranges from 0 to (Carrier Stop – Carrier Start).

Remote command:

`[:SOURce<hw>] :BB:ARbitrary:MCARrier:EDIT:CARRier:DELay:STEP`
on page 632

Input Waveform File

Calls the "File" menu for selecting the inputfile with the I/Q signal to be modulated onto all carriers of the selected carrier range.

Remote command:

`[:SOURce<hw>] :BB:ARbitrary:MCARrier:EDIT:CARRier:FILE` on page 633

Apply Assistant Settings

Transfer the assistant settings to the carrier table.

Remote command:

`[:SOURce<hw>] :BB:ARbitrary:MCARrier:EDIT:CARRier:EXECute`
on page 633

Carrier Table

The table displays the settings of all available carriers. Previously applied assistant settings can be further refined. The number of lines corresponds to the number of carriers.

Note: The phase/deg settings are only valid if optimization of the crest factor is disabled ("Crest Factor Mode" = Off).

| | State | Gain [dB] | Phase [deg] | Delay [ns] | File | Info... |
|---|-------|-----------|-------------|------------|---------------------------------|------------|
| 0 | Off | -20.01 | 0.05 | | air/smbw/Unicod1_MultiCarrierCW | Info... |
| 1 | Off | -35.00 | 10.00 | 22 | /var/smbw/3GPPKernelLog1 | Info... |
| 2 | Off | 0.00 | 0.00 | 0 | | None Error |
| 3 | Off | 0.00 | 0.00 | 0 | | None Error |

No ← Carrier Table

Indicates the carrier index ranging from 0 to (number of carriers -1).

Individual carriers can be set using the remote control commands by specifying the index in the parameter CARR.

State ← Carrier Table

Switches On/Off a carrier.

Remote command:

`[:SOURce<hw>] :BB:ARbitrary:MCARrier:CARRier<ch>:STATe` on page 629

Carrier Freq [MHz] ← Carrier Table

Sets the carrier frequency.

Note: The carrier frequency can only be set in "Arbitrary Carrier frequency" mode. For "Equidistant Carrier Spacing", the carrier spacing is determined automatically.

Remote command:

`[:SOURce<hw>] :BB:ARbitrary:MCARrier:CARRier<ch>:FREQuency`
on page 627

Gain ← Carrier Table

Sets the gain of a carrier.

Remote command:

`[:SOURce<hw>] :BB:ARbitrary:MCARrier:CARRier<ch>:POWer` on page 628

Phase ← Carrier Table

Sets the starting phase of a carrier.

Remote command:

`[:SOURce<hw>] :BB:ARbitrary:MCARrier:CARRier<ch>:PHASe` on page 628

Delay ← Carrier Table

Sets the starting delay of a carrier.

Remote command:

`[:SOURce<hw>] :BB:ARbitrary:MCARrier:CARRier<ch>:DELay` on page 627

File ← Carrier Table

Calls the "File" menu for selecting the input file with the I/Q signal to be modulated onto the carrier.

Remote command:

`[:SOURce<hw>] :BB:ARbitrary:MCARrier:CARRier<ch>:FILE` on page 627

Info ← Carrier Table

Indicates the sample rate, number of I/Q value pairs (number of samples), and the resulting signal period of the selected I/Q input file.

Remote command:

n.a.

!!! ← Carrier Table

Indicates an occurred conflict by a means of a red LED. A conflict arises when the carriers overlap.

Example:

A conflict is indicated both in the table, as well as in the graph, as shown in the following figures:



Remote command:

```
[ :SOURce<hw> ] :BB:ARbitrary:MCARrier:CARRIER<ch>:CONFLICT?
```

on page 626

Typical Applications for Multi Carrier Waveforms

High Power Amplifiers of multi carrier base stations face increased requirements in terms of linearity and acceptable intermodulation performance.

A standard transmitter test might be quickly setup by the following instructions:

1. Load a standardized 3GPP downlink test model, e.g. "Test Model 1_16" and set State to "ON".
2. Create a 3GPP Testmodel ARB file by activating "Generate Waveform File".
3. Setup a multi carrier scenario with 4 carriers and a carrier spacing of 5 MHz.
4. Apply the input file containing the previously generated 3GPP testmodel to all 4 carriers.

5.9.4.5 Waveform and List Format

The R&S SMBV uses a tag-oriented format for externally or internally generated waveforms as well as for data and control lists. The data can be transmitted via the GPIB interface from an external computer to the instrument and vice versa.

For these purposes the file is transmitted as a binary data block, using SCPI command `[:SOURce<hw>] :BB:ARbitrary:WAVEform:DATA`.



A waveform version number is not necessary due to the flexible, tag-based form.

Tags are self-contained information units. Their general format is `{Name: Data}` or `{Name-Length: Data}`. The colon separates the name part and the data part. The colon can be followed by a space for the sake of legibility.

The **Name** identifies the tag. It is always expressed in capital letters.

The **Data** is tag-specific, and in most cases it is in ASCII plain text.

The **Length** specifies the number of bytes in a `WAVEFORM` tag, a `DATA LIST` tag or a `EMPTYTAG` (from `:` to `}`, ASCII integer).

Each waveform file must begin with the `TYPE` tag. The sequence of the remaining tags is arbitrary. For each tag an indication shows whether it must be included in the file concerned (mandatory) or may be included (optional).

Unknown tags are not analyzed by the R&S SMBV. On the other hand they are left unchanged, are saved without an error message and can be read back again.

R&S AMIQ waveforms can also be loaded on the instrument, where they are converted internally into an R&S SMBV waveform.

Tag Description

This section first describe the mandatory `TYPE` tag which identifies the file and is always located at the start of the file. The rest of the tags used in the R&S SMBV are then described in alphabetical order. Most tags are valid for all three file types. If a tag is valid only for a single file type, e.g. only for a waveform, this fact is indicated in the description.

| | |
|--|-----|
| Common Tags..... | 439 |
| Tags for Single and Multi-Segment Waveforms..... | 441 |
| Tags for Data Lists..... | 453 |
| Tags for Control Lists..... | 454 |

Common Tags

The following tags are common to all file types. For description of the dedicated tags, see

{TYPE: magic, xxxxxxxx}

(mandatory, must be the first tag in the file)

Identifies the file as a valid R&S SMBV file. It must be present and must be the first in the waveform. If a file of the same name exists on the target medium, it is overwritten.

Setting parameters:

magic Designates the file type and has the following values:

SMU-WV

A valid R&S SMBV waveform.

SMU-MWV

A valid R&S SMBV multi-segment waveform.

SMU-DL

A valid R&S SMBV data list.

SMU-CL

A valid R&S SMBV control list.

xxxxxxx

Is an ASCII-coded checksum of the data part of the `WAVEFORM` tag in the file. This value is always 0 for data lists and control lists.

The checksum for waveforms is used for detecting transmission errors. If the `TYPE` tag contains 0 or a non-numeric value for the checksum, it is ignored.

It is calculated in accordance with the algorithm given below, where:

`start` is a pointer to the first byte after the # character in the `WAVEFORM` tag

`length` is the number of bytes between `start` and the closing curly bracket (excluding the latter; `length` must be divisible by 4 without a remainder.

```
UINT32 checksum(void *start, UINT32 length)
{
    UINT32 i, result = 0xA50F74FF;
    for(i=0; i < length/4; i++)
        result = result ^ ((UINT32 *)start)[i];
    return(result);
}
```

The checksum is currently not verified when waveforms are loaded.

Example:

```
{TYPE: SMU-WV,106656}
```

```
BB:ARB:WAV:TAG? 'TYPE'
```

Queries the content of the `TYPE` tag.

```
Response: 'SMU-WV,106656'
```

This is a valid waveform.

{COMMENT: string}

The tag contains a plain text ASCII string of arbitrary length. The string is not analyzed in the R&S SMBV. It is used to describe the file. The string is allowed to contain all printable ASCII characters except the closing curly bracket.

Example: {COMMENT: File with data for 3GPP enhanced channels}
 BB:ARB:WAV:TAG? 'COMMENT'
 queries the content of the COMMENT tag of the selected waveform file.
 Response: 'File with data for 3GPP enhanced channels'
 the comment on the waveform reads "File with data for 3GPP enhanced channels".

Usage: Setting only

{COPYRIGHT: string}

The tag contains an ASCII string of arbitrary length. The string is not analyzed in the R&S SMBV. It is used to store copyright information about the file content.

Example: {COPYRIGHT: Rohde&Schwarz}
 BB:ARB:WAV:TAG? 'COPYRIGHT'
 queries the content of the COPYRIGHT tag of the selected waveform file.
 Response: 'Rohde&Schwarz'
 copyright resides with Rohde&Schwarz.

Usage: Setting only

{DATE: yyyy-mm-dd;hh:mm:ss}

(optional)

The tag contains the date and time at which the file was created. The year must be expressed as four digits. The instrument does not analyze this tag.

Example: {DATE: 2009-04-02;14:32:12}
 BB:ARB:WAV:TAG? 'DATE'
 queries the content of the DATE tag of the selected waveform file.
 Response: '2009-04-02;14:32:12'
 the waveform was created on April 2, 2009 at 14 hrs 32 min

Usage: Setting only

Tags for Single and Multi-Segment Waveforms

The following tags apply to waveforms and multi-segment waveforms, additionally to the tags listed in "[Common Tags](#)" on page 439.

| | |
|---|-----|
| {CLOCK: frequency}..... | 442 |
| {CONTROL LENGTH: ControlLength}..... | 442 |
| {MWV_SEGMENT_DURATION: SegDur0, SegDur1, ..., SegDurN-1}..... | 443 |
| {EMPTYTAG-Length: #EmptySequence}..... | 443 |
| {LEVEL OFFS: RMSOffset_dB, PeakOffset_dB}..... | 444 |
| {MARKER MODE [#]: GENERATOR}..... | 445 |
| {SAMPLES: Samples}..... | 446 |
| {BURST LIST [#]: Pos0:State0; Pos1:State1; ...PosN-1:StateN-1}..... | 446 |
| {CW MODE LIST [#]: Pos0:State0; Pos1:State1; ...PosN-1:StateN-1}..... | 446 |
| {HOP LIST [#]: Pos0:State0; Pos1:State1; ...PosN-1:StateN-1}..... | 446 |
| {LEVATT LIST [#]: Pos0:State0; Pos1:State1; ...PosN-1:StateN-1}..... | 446 |
| {MAP LIST [#]: Pos0:State0; Pos1:State1; ...PosN-1:StateN-1}..... | 446 |
| {MARKER LIST [#]: Pos0:State0; Pos1:State1; ...PosN-1:StateN-1}..... | 446 |
| {[TRACE] LIST [#]: Pos0:State0; Pos1:State1; ...PosN-1:StateN-1}..... | 446 |
| {WAVEFORM-Length: #I0Q0I1Q1...IxQx...IN-1QN-1...}..... | 447 |
| {MWV_SEGMENT_COUNT: NumOfSeg}..... | 449 |
| {MWV_SEGMENT_LENGTH: SamplesSeg0, SamplesSeg1, ..., SamplesSegN-1}..... | 449 |
| {MWV_SEGMENT_START: SampleStartOffsetSeg0, SampleStartOffsetSeg1, ..., SampleStartOffsetSegN-1}..... | 449 |
| {MWV_SEGMENT_CLOCK_MODE: Mode}..... | 449 |
| {MWV_SEGMENT_CLOCK: ClockSeg0, ClockSeg1, ..., ClockSegN-1}..... | 450 |
| {MWV_SEGMENT_LEVEL_MODE: Mode}..... | 451 |
| {MWV_SEGMENT_LEVEL_OFFS: RMSOffs_dBSg0, PeakOffs_dBSg0, ..., RMSOffs_dBSgN-1, PeakOffs_dBSgN-1}..... | 451 |
| {MWV_SEGMENT_SETTINGS_FILE: SegSettingFilePath}..... | 452 |
| {MWV_SEGMENT_FILES: "FileNameSeg0.wv", "FileNameSeg1.wv", ..., "FileNameSegN-1.wv"}..... | 452 |
| {MWV_SEGMENTx_COMMENT: text}..... | 452 |
| {CONTROL LIST WIDTH4-Length: #m0m1...mx...mM-1}..... | 452 |

{CLOCK: frequency}**(mandatory for waveforms)**

The tag specifies the clock frequency at which the waveform has to be output, in Hz (on multi-segment waveforms this tag contains the maximal clock of all segments).

A query of `ARB:CLOCK?` after loading the waveform returns the value set using the `CLOCK` tag. This value can later be altered with the command `ARB:CLOCK?`.

Example:

```
{CLOCK: 54000000}
BB:ARB:WAV:TAG? 'CLOCK'
```

Queries the content of the `CLOCK` tag.
Response: 54000000
The clock frequency is set to 54 MHz.

Usage: Setting only

{CONTROL LENGTH: ControlLength}**(optional / recommended for marker and control lists)**

The tag specifies the length of *all* control or marker list in ASCII format.

The control length influences the way the marker and control lists are processed, in particular the way traces are repeated; see [Figure 5-29](#).

MARKER LIST 1: 0:0; 10:1; 20:0

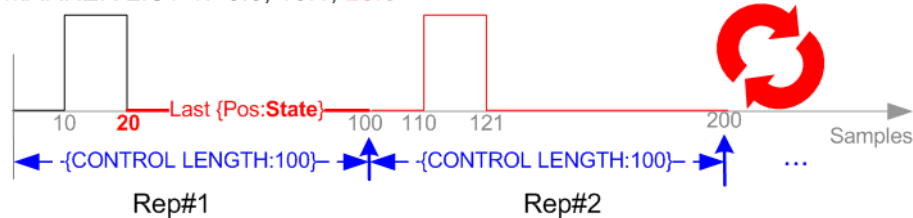

Figure 5-29: Example: Processing of MARKER TRACE if CONTROL LENGTH is specified

If the `CONTROL LENGTH` tag is not used, the marker and control list length are determined by the last position, that is the last `{Pos:State}` couple, defined in the particular `[TRACE] LIST` tag; see [Figure 5-30](#).

MARKER LIST 1: 0:0; 10:1; 20:0

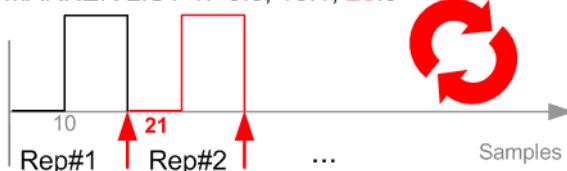

Figure 5-30: Example: Processing of MARKER TRACE if CONTROL LENGTH is not used

To maintain marker signals and waveform data synchronized, set the `CONTROL LENGTH` to be equal to the number of samples specified with the tag `SAMPLES`.

See also "[How to Define Periodically Repeating Traces](#)" on page 456.

Example:

```
{CONTROL LENGTH: 500}
SOURCE:BB:ARbitrary:CLIST:TAG? 'CONTROL LENGTH'
Queries the length of the control list.
Response: 500
```

{MWV_SEGMENT_DURATION: SegDur0, SegDur1, ..., SegDurN-1}

(optional for multi-segment waveforms)

The tag gives the time duration (in seconds) per segment.

Example:

```
{MWV_SEGMENT_DURATION: 1,0.5}
Multi-segment waveform with 2 segments, lasting 1 s and 0.5 s
each.
```

Usage: Setting only

{EMPTYTAG-Length: #EmptySequence}

(mandatory in automatically generated one and multi-segment waveforms)

This tag is empty, i.e. contains no data, and is used as placeholder.

Setting parameters:

Length An ASCII integer value that specifies the number of bytes in the EMPTYTAG, i.e. defines the number of bytes from the colon : to the end brace }

Note: If you change the content of a waveform file, change also the {EMPTYTAG-Length} value. For example, if you add a tag or add bytes to a tag, reduce the length by the number of newly introduced bytes.

EmptySequence An empty sequence containing blanks only. The number of used blanks is calculated as the difference between the hex addresses of the {WAVEFORM} tag and the hash sign # in the {EMPTYTAG}.

The {WAVEFORM} tag always starts at hex address #4000.

Example:

```
{TYPE:SMU-WV, 837236424}
{COPYRIGHT:2003 Rohde&Schwarz SMU}
{DATE:2012-07-11;14:38:01}
{SAMPLES:80000}
{CLOCK:86666666.666666666}
{VECTOR MAX:1.000000038569158}
{LEVEL OFFS:3.333553817875577e-07,0}
{MARKER LIST 1:0:1;1:0;1249:0}
{MARKER LIST 2:0:1;1:0;1249:0}
{MARKER LIST 3:0:1;1:0;1249:0}
{MARKER LIST 4:0:1;1:0;1249:0}
{EMPTYTAG-15947:# ...}
{WAVEFORM-320017:#IQIQIQ...}
```

The example waveform file contains 436 (0x1b4) bytes before the # sign in the EMPTYTAG; the hex address of the # sign is 0x1b5. The {WAVEFORM} starts at 0x4000. The EMPTYTAG contains 15946 blanks and has a length of (15946+1) bytes.

Usage: Setting only

{LEVEL OFFS: RMSOffset_dB,PeakOffset_dB}

(recommended for waveforms)

The tag determines the level of the ARB signal in the waveform file. The offset levels define the offset of RMS and peak value relative to the 16-bit full scale modulation (-32767 to + 32767) = 0 dB.

Setting parameters:

RMSOffset_dB Defines the RMS level offset of the signal relative to full scale ARB signal in the `WAVEFORM` tag. The offset is defined in ASCII float format. The value is always positive.
A 3 dB value indicates that the RMS level of the signal is 3 dBs below the full scale.
full scale = max. amplitude of vector of I/Q samples = $|S_{IQ}|_{\max} = \sqrt{I^2+Q^2}_{\max} = 0$ dB

PeakOffset_dB Defines the peak level offset of the signal relative to full scale for the ARB signal in the `WAVEFORM` tag. The offset is defined in ASCII float format.
The value usually equals 0 dB as usually the I/Q samples (signed 16-bit integer values) are modulated to full scale: Full scale = 0 dB = max. amplitude of vector of I/Q samples = $|S_{IQ}|_{\max} = \sqrt{I^2+Q^2}_{\max} = (2^{15})-1 = 32767$.
A positive `PeakOffset_dB` value indicates that a headroom to full scale is provided when generating the waveform. A negative `PeakOffset_dB` value indicates that overrange is likely for some samples, i.e. clipping might occur.
The crest factor can be calculated from the two values as follows:
Crest Factor = $|PeakOffset_dB - RMSOffset_dB|$

Example:

```
{LEVEL OFFS: 3.45,2}
BB:ARB:WAV:TAG? 'LEVEL OFFS'
```

Queries the content of the `LEVEL OFFS` tag of the selected waveform file.

```
Response: 3.45,2
```

The level of the waveform is below full scale, clipping does not occur.

Usage: Setting only

{MARKER MODE [#]: GENERATOR}**(Optional for waveforms)**

The tag defines how the marker signals are generated. The tag is included in the waveforms, created by the R&S WinIQSIM2 software.

- Tag not used
The marker signals defined with the tag `MARKER LIST` are converted into a separate binary control list. When the waveform is loaded into the ARB, this control list is also loaded automatically and processed synchronous with the waveform.
Note: This method reduces the maximum waveform length (given as number of samples). The number of available samples is limited, because each marker requires 4 bits per I/Q sample, additionally to the 32 bits required to describe an I/Q sample.
- Tag is used

The marker signals defined with the tag `MARKER LIST` are processed internally; additional control list is not created. If the tag is used for **all 4 markers**, the whole ARB memory is available for the I/Q samples.

Note: If this tag is used, the maximum number of marker states defined with the tag `MARKER LIST` is 64, i.e. `Pos63:State63`

Setting parameters:

[#] 1 to 4
Sets the marker number.

Example:
{MARKER MODE 1 : GENERATOR}
{MARKER MODE 2 : GENERATOR}
{MARKER MODE 3 : GENERATOR}

Usage: Setting only

{SAMPLES: Samples}

(recommended for waveforms)

The tag contains the number of I/Q samples in the waveform in ASCII format.

On multi-segment waveforms, this tag contains the total I/Q samples of all segments.

Example:
{SAMPLES: 1000}
BB:ARB:WAV:TAG? 'SAMPLES'
Queries the content of the `SAMPLES` tag of the selected waveform file.
Response: 1000
The waveform contains 1000 I/Q samples.

Usage: Setting only

See also ["How to Define Periodically Repeating Traces"](#) on page 456.

{BURST LIST [#]: Pos0:State0; Pos1:State1; ...PosN-1:StateN-1}
{CW MODE LIST [#]: Pos0:State0; Pos1:State1; ...PosN-1:StateN-1}
{HOP LIST [#]: Pos0:State0; Pos1:State1; ...PosN-1:StateN-1}
{LEVATT LIST [#]: Pos0:State0; Pos1:State1; ...PosN-1:StateN-1}
{MAP LIST [#]: Pos0:State0; Pos1:State1; ...PosN-1:StateN-1}
{MARKER LIST [#]: Pos0:State0; Pos1:State1; ...PosN-1:StateN-1}
{[TRACE] LIST [#]: Pos0:State0; Pos1:State1; ...PosN-1:StateN-1}

(mandatory for control lists / optional for waveforms)

The tag contains the data for the marker and control signals in the control list or the marker signals of ARB waveforms.

Traces are processed different, depending on the selected `CONTROL LENGTH`. See for example ["How to Define Periodically Repeating Traces"](#) on page 456.

The processing of the marker traces (`MARKER LIST`) depends additionally on the presence of the tag `MARKER MODE`.

Setting parameters:

| | |
|---------|--|
| [TRACE] | MARKER BURST LEVATT CW MODE HOP MAP Name of the marker or control signal. For ARB waveforms, it is only meaningful to define marker signals; in the ARB multi-segment waveforms these tags are ignored! |
| [#] | 1 to 4 Sets the marker or control trace number; supported is only LEVATT LIST 1. |
| Pos | Specifies in ASCII format the position (i.e. sample number or data value), with effect from which the binary State of the marker or of the control signal changes. If the tag MARKER MODE is used, the maximum number of marker states is 64, i.e. Pos ₆₃ :State ₆₃ . |
| State | 0 1 Specifies the binary state of the marker or of the control signal from Pos _N to Pos _{N+1} exclusive in ASCII format. |

Example:

```
{MARKER LIST 1: 0:0;10:1;20:0;30:1}
```

```
BB:DM:CLIS:TAG? 'MARKER LIST 1'
```

Queries the content of the MARKER LIST 1 tag of the selected control list file.

```
Response: '0:0;10:1;20:0;30:1'
```

The marker setting for samples 0 to 9 = 0 (low), for 10 to 19 = 1 (high) and for 20 to 29 = 0. From sample 30 onward the marker setting = 1.

Example:

```
{LEVATT LIST 1: 0:0;10:1;20:0;30:1}
```

```
BB:DM:CLIS:TAG? 'LEVATT LIST 1'
```

Queries the content of the LEVATT LIST 1 tag of the selected control list file.

```
Response: '0:0;10:1;20:0;30:1'
```

Level attenuation applies to data values 10 to 19 (high) and from data value 30 onward.

Usage:

Setting only

{WAVEFORM-Length: #I0Q0I1Q1...IxQx...IN-1QN-1...}

(mandatory for waveforms)

The tag contains the actual waveform data or multi-segment waveform data (I/Q stream).

Use the TYPE tag to define whether the waveform file contains a normal waveform or a multi-segment waveform.

The following figure shows the principle of multi-segment work mode.

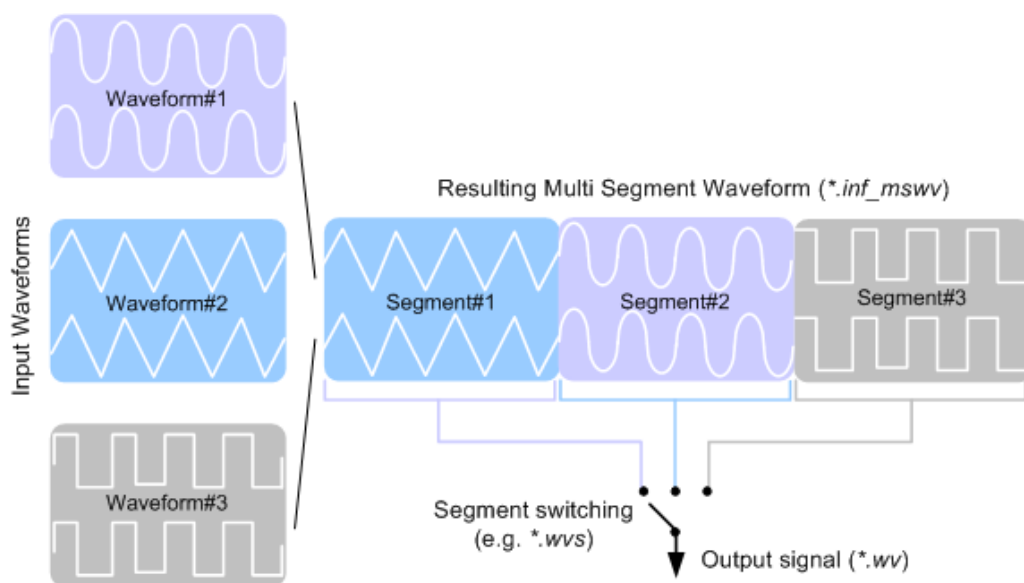
**Setting parameters:**

Length Specifies the number of bytes in a WAVEFORM tag and is calculated as follows:

$$\text{Length} = \text{Number of I/Q pairs} * 4 \text{ (2 bytes per I and 2 bytes per Q value)} + 1 \text{ byte (the length of the \#)}$$

IxQx

IxQx... represents binary data (16-bit signed integer in 2's complement notation) containing the I and Q component alternately and starting with the I component. Each component consists of 2 bytes in Little endian format representation, i.e. least significant byte (LSB) first.

The values of the 2 bytes in an I component and a Q component are in the range 0x0 to 0xFFFF (-32767 to +32767). This value is transferred to the D/A converter.

This tag is also used to store multi-segment waveforms. The I/Q streams of the individual waveforms are directly concatenated to one collectively waveform I/Q stream.

The number of segments and the start offset and length of the individual segments inside the total waveform I/Q stream is determined by the additional tags MWV_SEGMENT_COUNT, MWV_SEGMENT_START, and MWV_SEGMENT_LENGTH.

Further MWV_SEGMENT_... tags are also available, for example for level and clock information.

Example:**One segment waveform**

```
{WAVEFORM-401:#I0,Q0,I1,Q1,I2,Q2,...I99,Q99}
```

100 I/Q pairs with 4 bytes each are transmitted - none multi-segment

Example: **Multi-segment waveform**
 {WAVEFORM-1201:
 # $I_{0,Seg0}, Q_{0,Seg0}, I_{1,Seg0}, Q_{1,Seg0}, \dots, I_{99,Seg0}, Q_{99,Seg0}, I_{0,Seg1}, Q_{0,Seg1}, I_{1,Seg1},$
 $Q_{1,Seg1}, \dots, I_{199,Seg1}, Q_{199,Seg1}$ }
 2 segments: segment 0 with 100 I/Q pairs; segment 1 with 200
 I/Q pairs. Each I/Q pair consists of $2 \cdot 16$ bit = 4 bytes

Usage: Setting only

{MWV_SEGMENT_COUNT: NumOfSeg}

(mandatory for multi-segment waveforms)

The tag contains the number of segments in the multi-segment waveform in ASCII integer format.

Example: {MWV_SEGMENT_COUNT: 2}
 Multi-segment waveform with 2 segments

Usage: Setting only

{MWV_SEGMENT_LENGTH: SamplesSeg0, SamplesSeg1, ..., SamplesSegN-1}

(mandatory for multi-segment waveforms)

The tag contains a list of I/Q sample lengths for every segment in the multi-segment waveform in ASCII integer format.

Example: {MWV_SEGMENT_LENGTH: 100, 200}
 2 segments: 100 samples in segment 0 and 200 samples in segment 1.

Usage: Setting only

{MWV_SEGMENT_START:

SampleStartOffsetSeg0, SampleStartOffsetSeg1, ..., SampleStartOffsetSegN-1}

(mandatory for multi-segment waveforms)

The tag contains a list of I/Q sample start offsets for every segment in the multi-segment waveform in ASCII integer format.

Example: {MWV_SEGMENT_START: 0, 100}
 2 segments with 100 samples in segment 0 and 200 samples in segment 1.
 The start offset of first segment is 0 samples, start offset of next segment 1 is the sample length of segment 0 = 100 samples.

Usage: Setting only

{MWV_SEGMENT_CLOCK_MODE: Mode}

(mandatory for multi segment waveforms)

The tag contains a string in ASCII format which supplies the clock rate mode, that was used for calculation of the multi segment output waveform.

The tag `CLOCK` contains always the highest clock rate of all segments.

The tag `MWV_SEGMENT_CLOCK` contains the clock rates of the individual segments.

Setting parameters:

Mode

UNCHANGED

The segments may have different clock rates.

During the multi segment calculation, the clock rates of all individual original waveforms were taken over unchanged in the segments of the multi segment output waveform (no software resampling is done).

If the segments have different clock rates, there are some restrictions on signal output, i.e. switching per external trigger and seamless switching between segments is not possible.

If all segments have already an identical clock rate, this mode is usually set to `HIGHEST`.

HIGHEST

All segments have an identical clock rate, which is the highest clock rate of all original waveforms.

If an individual original waveform has a lower clock rate, an upsampling to the highest clock rate will be performed on calculation of the multi segment output waveform.

USER

All segments have an identical clock rate, which is given by the user.

Note: Only upsampling is allowed, no downsampling!

If an individual original waveform has a lower clock rate, an upsampling to the user clock rate will be performed on calculation of the multi segment output waveform.

Example:

```
{MWV_SEGMENT_CLOCK_MODE: UNCHANGED}
{MWV_SEGMENT_CLOCK_MODE: HIGHEST}
{MWV_SEGMENT_CLOCK_MODE: USER}
```

Usage:

Setting only

{MWV_SEGMENT_CLOCK: ClockSeg0, ClockSeg1, ..., ClockSegN-1}

(mandatory for multi segment waveforms)

The tag contains a list of clock frequencies for every segment in the multi segment waveform in ASCII floating point format.

Example: `{MWV_SEGMENT_CLOCK: 100e6,80e6}`
 2 segments: clock of segment 0 is 100 MHz, clock of segment 1 is 80 MHz.
 Note: If the segments have different clock frequencies, there are some restrictions on signal output, i.e. seamless switching between segments is only possible, if all segments have the same clock frequency. Software resampling (upsampling) can be used to bring all segments to the same clock.

Usage: Setting only

{MWV_SEGMENT_LEVEL_MODE: Mode}

(optional for multi-segment waveforms)

The tag contains a string in ASCII format which supplies the clock rate mode, that was used for calculation of the multi-segment output waveform.

Setting parameters:

Mode **UNCHANGED**
 Concerning the level settings, the segments are output exactly as defined in the individual files.
 The value displayed with the parameter "Task bar > Level" applies only to the segment with the highest RMS value. The remaining segments are output at a lower level than the displayed value.

EQUALRMS
 Segments are output so that all segments have the same RMS value. The value displayed with the parameter "Task bar > Level" applies to all segments.

Example: `{MWV_SEGMENT_LEVEL_MODE: UNCHANGED}`

Usage: Setting only

{MWV_SEGMENT_LEVEL_OFFS:

RMSOffs_dBSg0,PeakOffs_dBSg0, ..., RMSOffs_dBSgN-1, PeakOffs_dBSgN-1}

(mandatory for multi segment waveforms)

The tag contains a list of level pairs in ASCII floating point format, one pair for every segment in the multi segment waveform. The first value of a level pair defines the rms offset and the second value the peak offset relative to the 16-bit full scale modulation $(-32767; + 32767) = 0$ dB. The meaning of one level value pair is the same as in the [LEVEL OFFS](#) tag for normal waveforms.

Example: `{MWV_SEGMENT_LEVEL_OFFS: 3.0,0.0,6.0,0.0}`
 2 segments: RMS level of segment 0 is 3dB below full scale; RMS level of segment 1 is 6dB below full scale. Peak level of both segments is 0 dB full scale.

Usage: Setting only

{MWV_SEGMENT_SETTINGS_FILE: SegSettingFilePath}**(optional for multi-segment waveforms)**

The tag contains the file path and filename of the multi-segment file, used for the calculation of the multi-segment waveform.

Example: {MWV_SEGMENT_SETTINGS_FILE:
 "/var/user/Settings.inf_mswv"}
 Multi-segment file path and filename.

Usage: Setting only

{MWV_SEGMENT_FILES:

 "FileNameSeg0.wv", "FileNameSeg1.wv", ..., "FileNameSegN-1.wv"}
 }

(optional for multi segment waveforms)

The tag contains a list of file names for every segment in the multi segment waveform in ASCII format.

Example: {MWV_SEGMENT_FILES: "/var/user/sine.wv",
 "/var/user/rect.wv"}
 }

Usage: Setting only

{MWV_SEGMENTx_COMMENT: text}**(optional for multi segment waveforms)**

The tag contains a user comment for a specific segment $x = [0 \dots \text{NumOfSeg}-1]$ in the multi segment waveform in ASCII format.

Example: {MWV_SEGMENT1_FILES: segment 1 contains a QPSK
 signal.}
 }

Usage: Setting only

{CONTROL LIST WIDTH4–Length: #m0m1...mx...mM-1}**(optional for waveforms and multi segment waveforms)**

The tag contains a binary marker element stream, which will be given out synchronously to the I/Q sample sequence. One marker element m_x consists of 4 bit, which are assigned to the 4 possible marker lines of the instrument (one bit per marker line). One 4 bit marker elements is needed for every I/Q sample in the WAVEFORM tag - so the number of marker elements M should be equal to the number of I/Q samples. The CONTROL_LENGTH tag has to contain the number of all marker elements M .

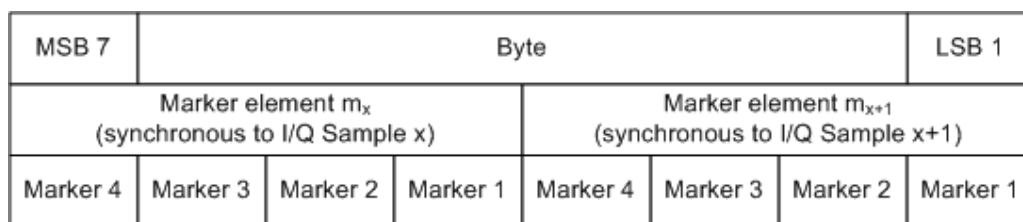

Figure 5-31: Marker element in 4-bit binary format bit order

For standard waveforms the `MARKER LIST x` tags are a more compact way to define markers, but in principle this `CONTROL LIST WIDTH4` format can also be used instead of the `MARKER LIST x` tags.

For multi segment waveforms this `CONTROL LIST WIDTH4` format is required for marker definition. The binary marker streams of the individual segments are directly concatenated (without any gap) to one collectively marker stream.

Setting parameters:

Length Defines the number of bytes in the `CONTROL LIST WIDTH4` tag in ASCII Format and is calculated as follow:

$$\text{Length} = \text{Size of "\#"} (1 \text{ byte}) + \text{Number of marker elements } m_x * (4 \text{ bit}) / (8 \text{ bits/byte})$$
The value is rounded up for byte alignment.

mx Marker element in 4-bit binary format.

Example: {CONTROL LIST WIDTH4-51: #m₀m₁...m_x...m₉₉}
100 marker elements, each marker element with 4 bits

Usage: Setting only

Tags for Data Lists

The following tags apply to data lists, additionally to the tags listed in "Common Tags" on page 439.

| | |
|---|-----|
| {DATA BITLENGTH: BitLength}..... | 453 |
| {DATA LIST-Length: #d0d1...dx...dN-1...}..... | 454 |

{DATA BITLENGTH: BitLength}

(mandatory for data lists)

The tag contains the length of the data held in the `DATA LIST` tag in bits in ASCII format.

Example: {DATA BITLENGTH: 444}
BB:DM:DLIS:TAG? 'DATA BITLENGTH'
queries the content of the `DATA BITLENGTH` tag of the selected data list file.
Response: '444'
the data list is 444 bits long.

Usage: Setting only

{DATA LIST-Length: #d0d1...dx...dN-1...}

(mandatory for data lists)

The tag contains the actual bit sequence of the data list in binary format.

Setting parameters:

Length Defines the number of bytes in the DATA LIST tag in ASCII Format (for format see WAVEFORM length).

dx Data bits in binary format (8-bit unsigned characters, MSB first).

Example: DATA LIST-17: #d0d1...dx...d127}
16 bytes containing 128 data bits, first bit is the MS bit of the first byte.

Usage: Setting only

Tags for Control Lists

The following tags apply to control lists, additionally to the tags listed in "Common Tags" on page 439.

| | |
|---|-----|
| {CONTROL LENGTH: ControlLength}..... | 454 |
| {BURST LIST [#]: Pos0:State0; Pos1:State1; ...PosN-1:StateN-1}..... | 455 |
| {CW MODE LIST [#]: Pos0:State0; Pos1:State1; ...PosN-1:StateN-1}..... | 455 |
| {HOP LIST [#]: Pos0:State0; Pos1:State1; ...PosN-1:StateN-1}..... | 455 |
| {LEVATT LIST [#]: Pos0:State0; Pos1:State1; ...PosN-1:StateN-1}..... | 455 |
| {MAP LIST [#]: Pos0:State0; Pos1:State1; ...PosN-1:StateN-1}..... | 455 |
| {MARKER LIST [#]: Pos0:State0; Pos1:State1; ...PosN-1:StateN-1}..... | 455 |
| {[TRACE] LIST [#]: Pos0:State0; Pos1:State1; ...PosN-1:StateN-1}..... | 455 |

{CONTROL LENGTH: ControlLength}

(optional / recommended for marker and control lists)

The tag specifies the length of *all* control or marker list in ASCII format.

The control length influences the way the marker and control lists are processed, in particular the way traces are repeated; see Figure 5-29.

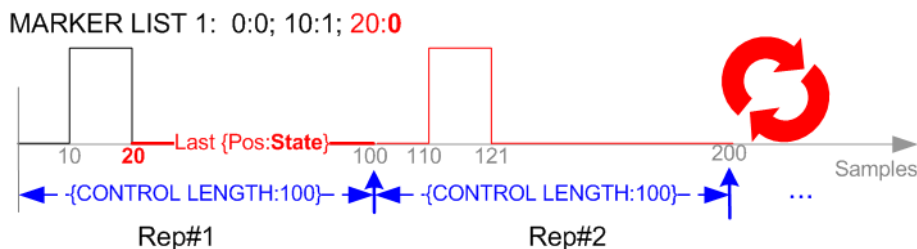

Figure 5-32: Example: Processing of MARKER TRACE if CONTROL LENGTH is specified

If the CONTROL LENGTH tag is not used, the marker and control list length are determined by the last position, that is the last {Pos:State} couple, defined in the particular [TRACE] LIST tag; see Figure 5-30.

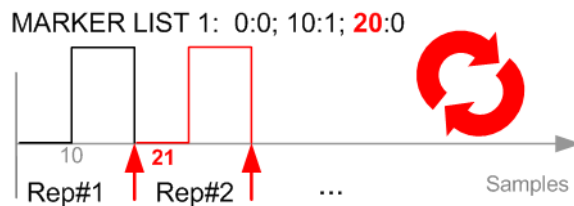

Figure 5-33: Example: Processing of MARKER TRACE if CONTROL LENGTH is not used

To maintain marker signals and waveform data synchronized, set the `CONTROL LENGTH` to be equal to the number of samples specified with the tag `SAMPLES`.

See also "[How to Define Periodically Repeating Traces](#)" on page 456.

Example:

```
{CONTROL LENGTH: 500}
SOURCE:BB:ARBITRARY:CLIST:TAG? 'CONTROL LENGTH'
Queries the length of the control list.
Response: 500
```

```
{BURST LIST [#]: Pos0:State0; Pos1:State1; ...PosN-1:StateN-1}
{CW MODE LIST [#]: Pos0:State0; Pos1:State1; ...PosN-1:StateN-1}
{HOP LIST [#]: Pos0:State0; Pos1:State1; ...PosN-1:StateN-1}
{LEVATT LIST [#]: Pos0:State0; Pos1:State1; ...PosN-1:StateN-1}
{MAP LIST [#]: Pos0:State0; Pos1:State1; ...PosN-1:StateN-1}
{MARKER LIST [#]: Pos0:State0; Pos1:State1; ...PosN-1:StateN-1}
{[TRACE] LIST [#]: Pos0:State0; Pos1:State1; ...PosN-1:StateN-1}
(mandatory for control lists / optional for waveforms)
```

The tag contains the data for the marker and control signals in the control list or the marker signals of ARB waveforms.

Traces are processed different, depending on the selected `CONTROL LENGTH`. See for example "[How to Define Periodically Repeating Traces](#)" on page 456.

The processing of the marker traces (`MARKER LIST`) depends additionally on the presence of the tag `MARKER MODE`.

Setting parameters:

| | |
|----------------------|--|
| <code>[TRACE]</code> | <code>MARKER BURST LEVATT CW MODE HOP MAP</code> Name of the marker or control signal. For ARB waveforms, it is only meaningful to define marker signals; in the ARB multi-segment waveforms these tags are ignored! |
| <code>[#]</code> | 1 to 4 Sets the marker or control trace number; supported is only <code>LEVATT LIST 1</code> . |

| | |
|-----------------|--|
| Pos | Specifies in ASCII format the position (i.e. sample number or data value), with effect from which the binary <code>State</code> of the marker or of the control signal changes. If the tag <code>MARKER MODE</code> is used, the maximum number of marker states is 64, i.e. <code>Pos₆₃:State₆₃</code> . |
| State | 0 1 Specifies the binary state of the marker or of the control signal from <code>Pos_N</code> to <code>Pos_{N+1}</code> exclusive in ASCII format. |
| Example: | <pre>{MARKER LIST 1: 0:0;10:1;20:0;30:1} BB:DM:CLIS:TAG? 'MARKER LIST 1'</pre> <p>Queries the content of the <code>MARKER LIST 1</code> tag of the selected control list file.</p> <p>Response: '0:0;10:1;20:0;30:1'</p> <p>The marker setting for samples 0 to 9 = 0 (low), for 10 to 19 = 1 (high) and for 20 to 29 = 0. From sample 30 onward the marker setting = 1.</p> |
| Example: | <pre>{LEVATT LIST 1: 0:0;10:1;20:0;30:1} BB:DM:CLIS:TAG? 'LEVATT LIST 1'</pre> <p>Queries the content of the <code>LEVATT LIST 1</code> tag of the selected control list file.</p> <p>Response: '0:0;10:1;20:0;30:1'</p> <p>Level attenuation applies to data values 10 to 19 (high) and from data value 30 onward.</p> |
| Usage: | Setting only |

How to Define Periodically Repeating Traces

If a marker trace is required that marks for example each frame start, it is sufficient to define the trace ones and repeat it over the length of a waveform. This is useful if you describe a long waveform and a periodical marker is required.

The following examples use marker traces; control lists are processed in the same way.

To define periodical marker trace

The waveform in the example on [Figure 5-34](#) consists of 3 frames, each frame is 100-samples long. The waveform is processed continuously ("Trigger Mode > Auto").

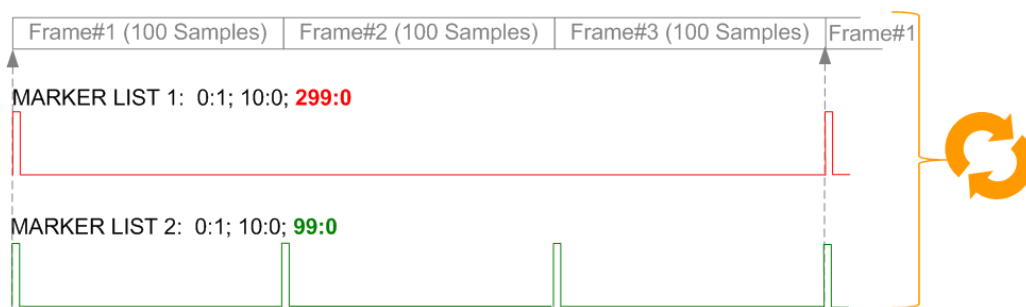

Figure 5-34: Example: Defining marker traces (*CONTROL LENGTH* tag is not used)

To define a restart marker and a frame start marker, use the following tags:

1. The waveform is 300 samples long, i.e. set `{SAMPLES: 300}`.
2. Set two `[TRACE] LIST` tags:
 - For Marker 1 that acts as a restart marker:
`{MARKER LIST 1: 0:1; 10:0; 299:0}`
 - For Marker 2 that marks each frame start:
`{MARKER LIST 2: 0:1; 10:0; 99:0}`
3. Do not use the `CONTROL LENGTH` tag.

The length of the repeated patterns is determined by the last sample number in the `[TRACE] LIST`, that is the last `{Pos:State}`.

Example: How the `CONTROL LENGTH` tag influences the processing of the traces

For the example on [Figure 5-34](#), use the same marker traces and set the `CONTROL LENGTH` tag, e.g. `{CONTROL LENGTH: 150}`.

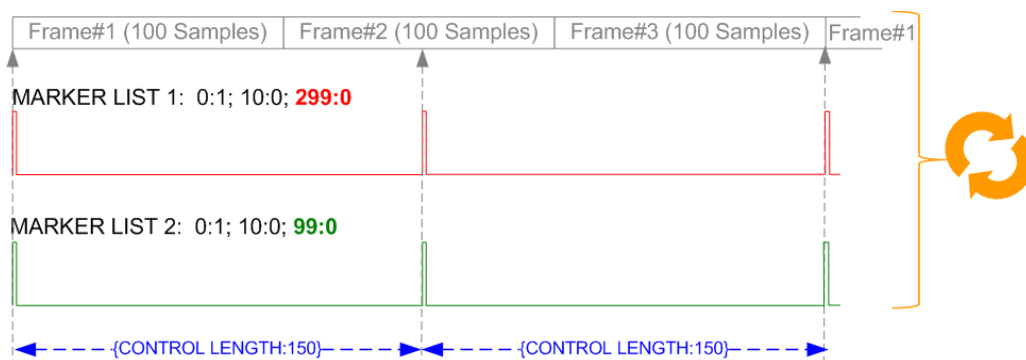

Figure 5-35: Example: Processing of control signals if the `CONTROL LENGTH` tag is used

The length of **all** control signals is determined by the `CONTROL LENGTH`. Observe how the marker traces are processed. In this example, both marker traces are repeated each 150 samples.

How to Manually Create a Waveform Using Tag File Format

The provided example uses a sine function in the I channel and a cosine function in the Q channel, each with 20 points. The example uses a short program written in the programming language C to calculate the sine and cosine values (see [Example "C-program for creating a waveform file"](#) on page 461). They are stored in the file `SICO.txt`. The decimal values in `SICO.txt` are normalized such that they are between -1.0 and $+1.0$. The data is converted into binary format. The appropriate mandatory tags are added and the data is packed into the `WAVEFORM` tag. As result, the waveform file `SICO.wv` is generated.

This example follows the general principle of creating of a waveform manually, using the tag file format. The [Figure 5-36](#) illustrates this general workflow.

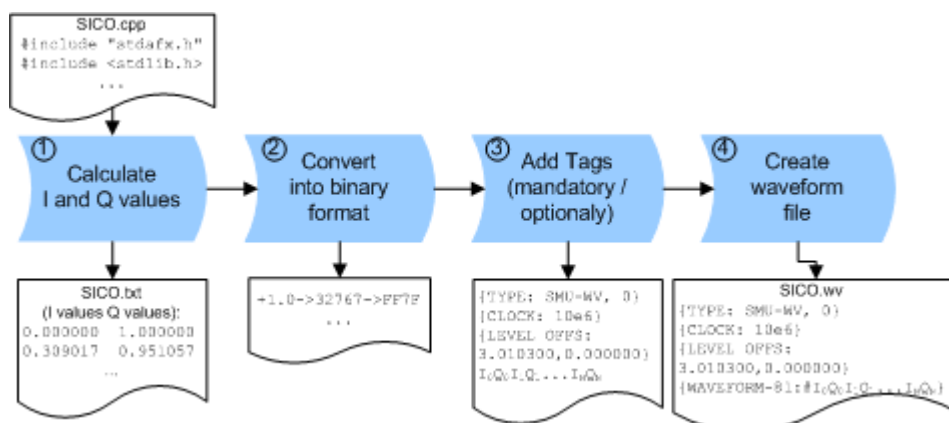

Figure 5-36: Principle of creating a waveform manually

The following steps outline how to create the waveform file `SICO.wv`:

1. Calculate the sine and cosine values, e.g. use the `SICO.cpp` program.

The result is stored in the file `SICO.txt`.

```

0.000000  1.000000
0.309017  0.951057
0.587785  0.809017
0.809017  0.587785
0.951057  0.309017
1.000000 -0.000000
0.951057 -0.309017
0.809017 -0.587785
0.587785 -0.809017
0.309017 -0.951057
-0.000000 -1.000000
-0.309017 -0.951056
-0.587785 -0.809017
-0.809017 -0.587785
-0.951056 -0.309017
-1.000000  0.000000
-0.951056  0.309017
-0.809017  0.587785
-0.587785  0.809017
-0.309017  0.951057

```

Figure 5-37: Contents of SICO.txt: first column Sine (I), second column Cosine (Q)

- Convert the values from the file `SICO.txt` into binary format consisting of 16-bit signed integer numbers. The numeric range between -1.0 and $+1.0$ corresponds to the modulation range of the waveform 16-bit D/A converter of -32767 to $+32767$.

```

+1.0 -> 32767 -> = 0x7FFF
0.0 -> 0 -> = 0x0000
-1.0 -> -32767 -> = 0x8001

```

The [Figure 5-38](#) shows the calculation and conversion steps. The highlighted columns contain the resulting I and Q values represented in Little endian format.

| Sample n | deg = 360°/20 * n | I = sin(deg) | I _{quant,dec} = I * FS = I * (2 ¹⁵ -1) | I _{quant,hex} | I _{quant,hex} (Little endian waveform file representation) | Q = cos(deg) | Q _{quant,dec} = I * FS = I * (2 ¹⁵ -1) | Q _{quant,hex} | Q _{quant,hex} (Little endian waveform file representation) |
|-------------|----------------------|--------------|--|------------------------|--|--------------|--|------------------------|--|
| 0 | 0 | 0.000000 | 0 | 0000 | 0000 I ₀ | 1.000000 | 32767 | 7FFF | FF7F Q ₀ |
| 1 | 18 | 0.309017 | 10126 | 278E | 8E27 | 0.951057 | 31163 | 79BB | BB79 |
| 2 | 36 | 0.587785 | 19260 | 4B3C | 3C4B | 0.809017 | 26509 | 678D | 8D67 |
| 3 | 54 | 0.809017 | 26509 | 678D | 8D67 | 0.587785 | 19260 | 4B3C | 3C4B |
| 4 | 72 | 0.951057 | 31163 | 79BB | BB79 | 0.309017 | 10126 | 278E | 8E27 |
| 5 | 90 | 1.000000 | 32767 | 7FFF | FF7F | 0.000000 | 0 | 0000 | 0000 |
| 6 | 108 | 0.951057 | 31163 | 79BB | BB79 | -0.309017 | -10126 | D872 | 72D8 |
| 7 | 126 | 0.809017 | 26509 | 678D | 8D67 | -0.587785 | -19260 | B4C4 | C4B4 |
| 8 | 144 | 0.587785 | 19260 | 4B3C | 3C4B | -0.809017 | -26509 | 9873 | 7398 |
| 9 | 162 | 0.309017 | 10126 | 278E | 8E27 | -0.951057 | -31163 | 8645 | 4586 |
| 10 | 180 | 0.000000 | 0 | 0000 | 0000 | -1.000000 | -32767 | 8001 | 0180 |
| 11 | 198 | -0.309017 | -10126 | D872 | 72D8 | -0.951057 | -31163 | 8645 | 4586 |
| 12 | 216 | -0.587785 | -19260 | B4C4 | C4B4 | -0.809017 | -26509 | 9873 | 7398 |
| 13 | 234 | -0.809017 | -26509 | 9873 | 7398 | -0.587785 | -19260 | B4C4 | C4B4 |
| 14 | 252 | -0.951057 | -31163 | 8645 | 4586 | -0.309017 | -10126 | D872 | 72D8 |
| 15 | 270 | -1.000000 | -32767 | 8001 | 0180 | 0.000000 | 0 | 0000 | 0000 |
| 16 | 288 | -0.951057 | -31163 | 8645 | 4586 | 0.309017 | 10126 | 278E | 8E27 |
| 17 | 306 | -0.809017 | -26509 | 9873 | 7398 | 0.587785 | 19260 | 4B3C | 3C4B |
| 18 | 324 | -0.587785 | -19260 | B4C4 | C4B4 | 0.809017 | 26509 | 678D | 8D67 |
| 19 | 342 | -0.309017 | -10126 | D872 | 72D8 | 0.951057 | 31163 | 79BB | BB79 |

Figure 5-38: I and Q values calculation and conversion

- Use an ASCII editor which is able to handle binary data. Create and add the following mandatory tags before this binary data set can be further processed:
 - TYPE
 - CLOCK
 - LEVEL OFFS

An example of the SICO.wv file contents could be:

```
{TYPE: SMU-WV, 0}{CLOCK: 10e6}{LEVEL OFFS: 3.010300,0.000000}
0000FF7F8E27BB79 ... 72D8BB79
```

To simplify the example, the checksum is set to 0, i.e. the instrument does not evaluate a checksum.

Tip: The tags TYPE, CLOCK, LEVEL OFFS and WAVEFORM are mandatory for each waveform. All other tags are optional and can be inserted after the TYPE tag in arbitrary order.

- Pack the binary data into a WAVEFORM tag with the described structure.

```
{WAVEFORM-Length: #I0Q0I1Q1I2Q2 ... InQn}
```

- Calculate the Length
Length = Number of I/Q pairs * 4 + 1 = 20*4 + 1 = 81 bytes
- Place the string {WAVEFORM-81: # at the beginning of the data set
- Place the symbol } at the end of the data set

The contents of the waveform file SICO.wv for 20 I/Q pairs is now ready for operation and reads:

```
{TYPE: SMU-WV, 0}
{CLOCK: 10e6}
{LEVEL OFFS: 3.010300,0.000000}
{WAVEFORM-81: #I0Q0I1Q1...InQn}
```

Note: There is no readable representation for binary values in this document. This is why we use the sequence I0Q0I1Q1...InQn to characterize the binary code in the present example.

The following figure shows this waveform in a data editor.

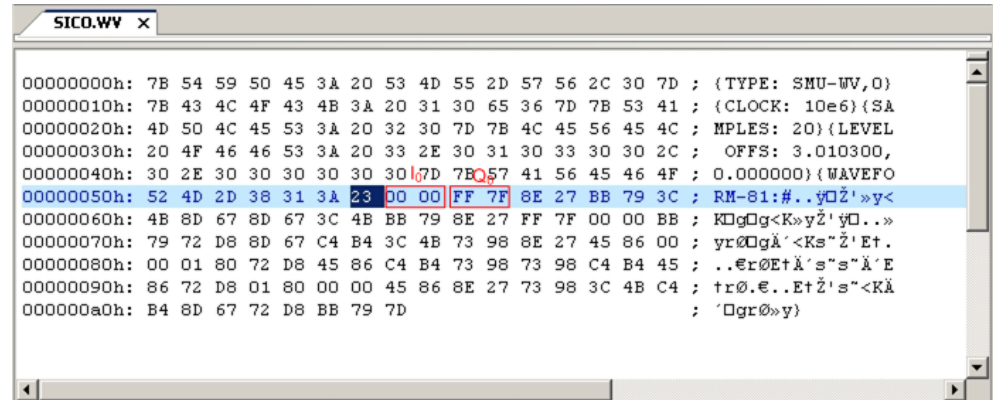

Example: C-program for creating a waveform file

C-program `SICO.cpp` for creating the file `SICO.txt` containing 20 sine and cosine pairs, converting them into binary data and creating the waveform file `SICO.wv`.

```
// SICO.cpp
// Defines the entry point for the console application

#include "stdafx.h"
#include <stdlib.h>
#include <stdio.h>
#include <math.h>

int _tmain(int argc, _TCHAR* argv[])
{
    const unsigned int samples = 20;
    const float pi = 3.141592654f;
    int i;

    // SICO.txt
    // Creating the file SICO.txt containing 20 sine and cosine pairs
    float grad, rad;
    FILE *fp;
    fp = fopen("SICO.txt", "w");
    if (fp == 0)
        return;
    for (i=0; i<samples; i++)
    {
        grad = (360.0f / (float)samples) * (float)i;
        rad = grad * (pi / 180.0f);
        fprintf(fp, "%f %f\n", sin(rad), cos(rad));
    }
    fclose(fp);
}
```



```

// SICO.wv
// Generating a binary data set from the I/Q pairs in the file SICO.txt
// and storing the result to file SICO.wv
FILE *fp_sour, *fp_dest;
float i_float, q_float;
unsigned short i_usint, q_usint;
fp_sour = fopen("SICO.TXT", "rt");
if (fp_sour == 0)
    return -1;
fp_dest = fopen("SICO.WV", "wb");
if (fp_dest == 0)
{
    fclose(fp_sour);
    return -1;
}
// Write required tags to waveform file
fprintf(fp_dest, "{TYPE: SMU-WV,0}");
fprintf(fp_dest, "{CLOCK: 10e6}");
fprintf(fp_dest, "{SAMPLES: %d}", samples);
// RMS, Peak
fprintf(fp_dest, "{LEVEL OFFS: %f,%f}", -1.0f * 20.0f * log10(1.0f/sqrt(2.0f)), 0.0f);
fprintf(fp_dest, "{WAVEFORM-%d:#", (samples * 4) + 1);
for (i=0; i<samples; i++)
{
    // Read I/Q pair from ASCII file
    if (fscanf(fp_sour, "%f %f", &i_float, &q_float) == EOF)
        break;
    // Convert I/Q pair to unsigned short
    i_usint = (unsigned short)floor((i_float * 32767.0) + 0.5);
    q_usint = (unsigned short)floor((q_float * 32767.0) + 0.5);
    // Write converted I/Q pair to waveform file
    fwrite(&i_usint, 2, 1, fp_dest);
    fwrite(&q_usint, 2, 1, fp_dest);
}
fprintf(fp_dest, "});
fclose(fp_dest);
fclose(fp_sour);
return 0;
}

```

Creating an ASCII C-List Manually

When you create the C-list in the editor, as shown in the figure, you get an ASCII file with the extension *.dm_iqc (see the example [C-List ASCII File](#)).

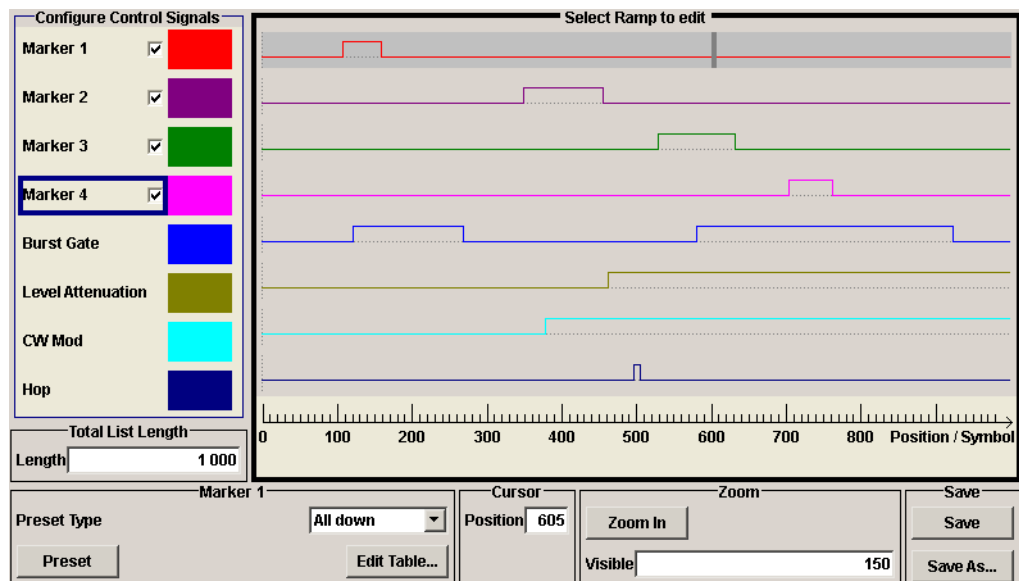

Figure 5-39: Representation in the C-List Editor

Example: C-List ASCII File

C-List in ASCII format, corresponding to C-List editor [Figure 5-39](#):

```
{TYPE:SMU-CL}{COPYRIGHT:2003 Rohde&Schwarz SMU}{DATE:2011-07-19;14:58:44}
{HOP LIST:0:0;498:1;506:0}{CW MODE LIST:0:0;380:1}{LEVATT LIST 1:0:0;464:1}
{BURST LIST:0:0;122:1;270:0;582:1;924:0}
{MARKER LIST 4:0:0;706:1;764:0}{MARKER LIST 3:0:0;530:1;633:0}
{MARKER LIST 2:0:0;350:1;457:0}{MARKER LIST 1:0:0;108:1;160:0}
{CONTROL LENGTH:1000}
```

The tags to the traces in the C-List editor are:

- HOP LIST
- CW MODE LIST
- LEVATT LIST 1
- BURST LIST
- MARKER LIST 4
- MARKER LIST 3
- MARKER LIST 2
- MARKER LIST 1
- CONTROL LENGTH

CONTROL LENGTH defines the periodicity of the total C-List. The remaining tags define the individual markers or control traces in a combined state/starting time way within the C-List period.

If you want to write an ASCII C-List directly without using the C-List editor, a special syntax has to be taken into account:

- The tag and the following [state: start time]-pairs are separated by a colon ":".

- The [state: start time] pairs in turn are separated by semicolons ";".
- The list state can be either 0 or 1.
- The time unit is the simple period.

Example:

"CW MODE LIST 0:0;380:1" for a CW trace:

The list status starts at time 0 with 0, and at time point 380 symbol periods after start, it changes to 1.



With the commands `BB:DM:CLIST:...` you can also generate control lists in binary format, if required. See "[DM Lists](#)" on page 679.

Editing Waveform Files, Data and Control Lists

You can edit the internally and externally created waveform files, data and control lists. The waveform, data and control lists files contain binary and ASCII data.

Consider the following rules while editing files with binary data.

Rules for editing binary data (waveforms, data and control lists)

- **Use hex data editor**
Always use a hex data editor to edit files containing binary data. Editing of binary data file with a text editor, even if you only change the ASCII part of the file, corrupts the file.
- **Adapt the length information in the {EMPTYTAG}**
If you change the content of a waveform file, change also the {EMPTYTAG-Length} value.
For example, if you add a tag or add bytes to an existing tag, reduce the length information by the number of newly introduced bytes.

5.9.5 Multi Carrier Continuous Wave

The R&S SMBV can generate a Multi Carrier CW signal with user-definable offset from carrier, based on a selection of up to 8192 unmodulated carriers. Each carrier can be separately set and switched on, or multiple carriers can be jointly configured. Automatic start phase setting is provided in order to minimize the crest factor.

Multi Carrier CW signals can be very easily configured as broadband test signals and used for such purposes as receiver tests.

To access the dialog for setting a Multi Carrier CW signal, select "Baseband > Multi Carrier CW" or use [MENU] key under "Baseband".

**5.9.5.1 Multi Carrier CW User Interface**

The "Multi Carrier CW" dialog is divided into the following sections.

The upper part of the menu is used for powering up the Multi Carrier CW and calling the default settings.

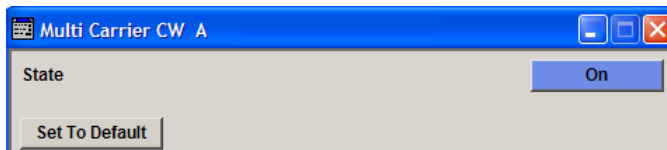

The "Carrier Setup" section is used to configure the Multi Carrier CW signal.

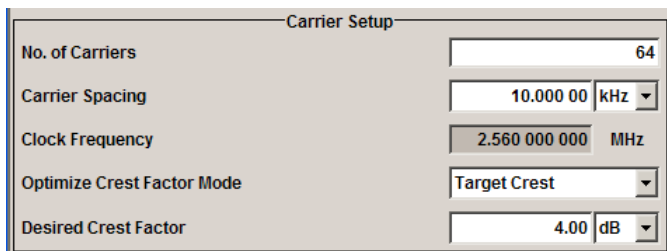

The "Table Setup Assistant" section can be used to set a selectable carrier range.

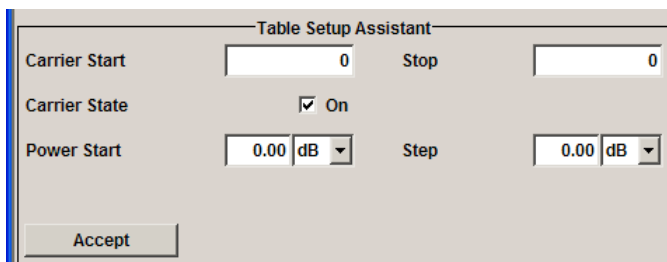

The buttons in the lower part of the menu open dialogs for defining carrier tables and for configuring markers, triggers and clocks.

The carrier settings can be visualized in the graphical "Carrier Graph" dialog.

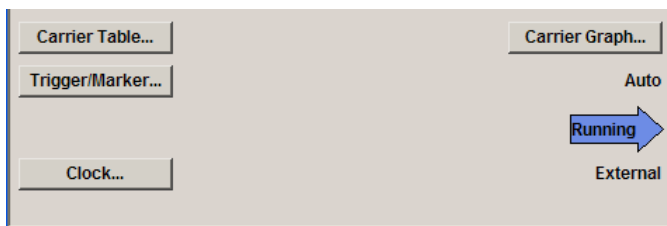

General Settings for Multi Carrier CW

The upper part of the menu is used for powering up the Multi Carrier CW signal and calling the default settings.

State

Enables/disables the Multi Carrier CW.

Switching on this standard turns off all the other digital standards and digital modulation modes.

Since Multi Carrier CW signals are computed in arbitrary waveform mode, changes to the settings of individual carriers are not adopted until the Accept button is pressed. This applies to the settings in the "Table Setup Assistant" section and the "Carrier Table" dialog.

Remote command:

[:SOURce<hw>] :BB:MCCW:STATe on page 699

Set to Default

Calls default settings. The values are shown in the following table.

| Parameter | Value |
|----------------------------|----------------------------------|
| State | Not affected by "Set to Default" |
| Carrier Setup | |
| Number of Carriers | 64 |
| Carrier Spacing | 10 kHz |
| Optimize Crest Factor | Chirp |
| Desired Crest Factor | 3 dB |
| Trigger | |
| Mode | Auto |
| Source | Internal |
| Ext. Delay | 0 |
| Ext. Inhibit | 0 |
| Marker | |
| Channel 1...4 | Restart |
| Clock | |
| Source | Internal |
| Multi Channel Setup | |
| Start Carrier | 0 |
| Stop Carrier | 0 |
| State | ON |
| Power | 0 dB |
| Power Step | 0 dB |
| Initial Phase | 0° |
| Phase Step | 0° |
| Channel Setup | |
| State | ON |

| Parameter | Value |
|-----------|-------|
| Phase | 0° |
| Power | 0 dB |

Remote command:

[\[:SOURce<hw>\]:BB:MCCW:PRESet](#) on page 699

Carrier Setup

The "Carrier Setup" section is used to configure the Multi Carrier CW.

Number of Carriers

Sets the number of carriers for the Multi Carrier CW signal.

By default the multi carrier table already lists 64 carriers that are preset to the settings State = ON, Power = 0 dB, Phase = 0°.

When entering fewer carriers than the table contains, the approach is generally to delete the superfluous entries from the table, and when entering more carriers than the table contains the missing entries are usually added at the end of the table.

Remote command:

[\[:SOURce<hw>\]:BB:MCCW:CARRier:COUNT](#) on page 699

Carrier Spacing

Sets the spacing between carriers for the Multi Carrier CW signal.

The carriers are arranged symmetrically around the HF carrier.

The total bandwidth is calculated as follow:

Total Bandwidth = ("Number of Carriers" - 1) * "Carrier Spacing"

The result must not exceed the system bandwidth of the instrument (see data sheet).

Remote command:

[\[:SOURce<hw>\]:BB:MCCW:CARRier:SPACing](#) on page 703

Clock Frequency

Displays the clock rate at which the multi carrier signal is output by the arbitrary waveform generator. The output clock rate depends on the number of carriers and the selected carrier offset.

The value indicates the resolution during the marker generation.

Remote command:

[\[:SOURce<hw>\]:BB:MCCW:CLOCK?](#) on page 705

Optimize Crest Factor Mode

Selects the mode for automatically minimizing the crest factor.

The carrier start phases are automatically set to this.

The crest factor represents the ratio of the peak voltage value to the rms voltage value. The higher the crest factor and resulting dynamics of a signal, the greater the requirement for a power amplifier fed by the signal to be linear.

A very high crest factor arises when the carriers have an identical start phase, since the carriers are periodically superposed and very high peak voltages occur in relation to the rms voltage values.

Methods of reducing the crest factor differ with regard to both the optimization achievable and the time required for computation.

| | |
|----------------|---|
| "Off" | There are no automatic settings for minimizing the crest factor. The "Phase" setting has an effect. |
| "Chirp" | Very rapid crest factor optimization regardless of the number of carriers. A minimal crest factor of < 3 dB is only obtained for multi carrier signals in which all carriers are switched on and the power of the carriers is identical. In a configuration which differs from this, the achievable crest factor is worse. |
| "Target Crest" | Optimization of the crest factor to a desired value for all carrier configurations. The optimization time depends on the number of carriers and the desired crest factor. Computation time increases only when the number of carriers exceeds 256 and the crest factor is below 4 dB. The desired value can be entered in "Desired Crest Factor". Note: Optimization can be cancelled at any time, and the current value being displayed at that moment is then used. |

Remote command:

[\[:SOURce<hw>\]:BB:MCCW:CFACTOR:MODE](#) on page 704

Desired Crest Factor

Enters the desired crest factor.

This is only possible when the optimization "Target Crest" has been selected.

Remote command:

[\[:SOURce<hw>\]:BB:MCCW:CFACTOR](#) on page 703

Table Setup Assistant

The "Table Setup Assistant" section can be used to set a selectable carrier range. The carrier table can be edited in the "Carrier Table" dialog.

Carrier Start

Defines the start index of the carrier range to which the following settings are intended to apply.

Remote command:

[\[:SOURce<hw>\]:BB:MCCW:EDIT:CARRIER:START](#) on page 707

Carrier Stop

Defines the stop index of the carrier range to which the following settings are intended to apply.

Remote command:

[\[:SOURce<hw>\]:BB:MCCW:EDIT:CARRIER:STOP](#) on page 708

Carrier State

Switches the carriers in the carrier range on/off.

Remote command:

`[:SOURce<hw>] :BB:MCCW:EDIT:CARRier:STATe` on page 708

Power Start

Sets the power of the starting carrier.

Remote command:

`[:SOURce<hw>] :BB:MCCW:EDIT:CARRier:POWer [:START]` on page 707

Power Step

Sets the width of the step with which the power will be changed from carrier to carrier.

The carrier power that is set with **Power + n* Power Step** must be within the valid value range -80 dB to 0 dB.

Remote command:

`[:SOURce<hw>] :BB:MCCW:EDIT:CARRier:POWer:STEP` on page 707

Phase Start

Sets the phase of the starting carrier. This setting is only available for "Optimize Crest Factor Mode" = Off.

Remote command:

`[:SOURce<hw>] :BB:MCCW:EDIT:CARRier:PHASe [:START]` on page 706

Phase Step

Sets the width of the step with which the phase will be changed from carrier to carrier.

The phase that is set with **Phase + n* Phase Step** must be within the valid value range 0° to 360°.

This setting is only available for "Optimize Crest Factor Mode" = Off.

Remote command:

`[:SOURce<hw>] :BB:MCCW:EDIT:CARRier:PHASe:STEP` on page 706

Accept

Adopts the carrier range setting into the table ("Carrier Table").

Remote command:

`[:SOURce<hw>] :BB:MCCW:EDIT:CARRier:EXECute` on page 705

Carrier Table and Carrier Graph

The lower part of the menu is used to open submenus for configuring carrier tables and for setting triggers, markers and clocks.

Carrier Table

Calls the table for configuring individual carriers. This configuration can be checked with the aid of the "Carrier Graph".

| | State | Power / dB | Phase / deg |
|---|-------|------------|-------------|
| 0 | On | 0.00 | 0.00 |
| 1 | On | 0.00 | 0.00 |
| 2 | On | 0.00 | 0.00 |
| 3 | Off | 0.00 | 0.00 |
| 4 | Off | 0.00 | 0.00 |
| 5 | Off | 0.00 | 0.00 |
| 6 | On | 0.00 | 0.00 |
| 7 | On | 0.00 | 0.00 |
| 8 | On | 0.00 | 0.00 |

The table displays the settings of all available carriers. Carriers in the On state are highlighted. All carrier parameters can be edited in the table.

The Multi Carrier CW signal is only computed when the "Accept" button is pressed. Whenever the table contains settings that have not yet been adopted with the "Accept" button, the background is yellow.

Note: The phase/deg settings are only valid if optimization of the crest factor is disabled ("Optimize Crest Factor" = Off).

| | |
|----------|---|
| "No." | This is the carrier index. |
| "State" | Switch a carrier on/off |
| "Power" | Sets the power of a carrier. |
| "Phase" | Sets the starting phase of a carrier. |
| "Accept" | Transfer the settings in the carrier table into the instrument. |

Remote command:

[\[:SOURce<hw>\]:BB:MCCW:CARRier:LIST:STATe](#) on page 701
[\[:SOURce<hw>\]:BB:MCCW:CARRier:STATe](#) on page 703
[\[:SOURce<hw>\]:BB:MCCW:CARRier:LIST:POWeR](#) on page 701
[\[:SOURce<hw>\]:BB:MCCW:CARRier:POWeR](#) on page 702
[\[:SOURce<hw>\]:BB:MCCW:CARRier:LIST:PHASe](#) on page 700
[\[:SOURce<hw>\]:BB:MCCW:CARRier:PHASe](#) on page 702

Carrier Graph

Calls a graphical representation of the chosen carrier configuration.

The carriers are on the X-axis and the colored bars represent those carriers which are in the On state. Power is on the Y-axis, and the height of the bars corresponds to the chosen power of each individual carrier.

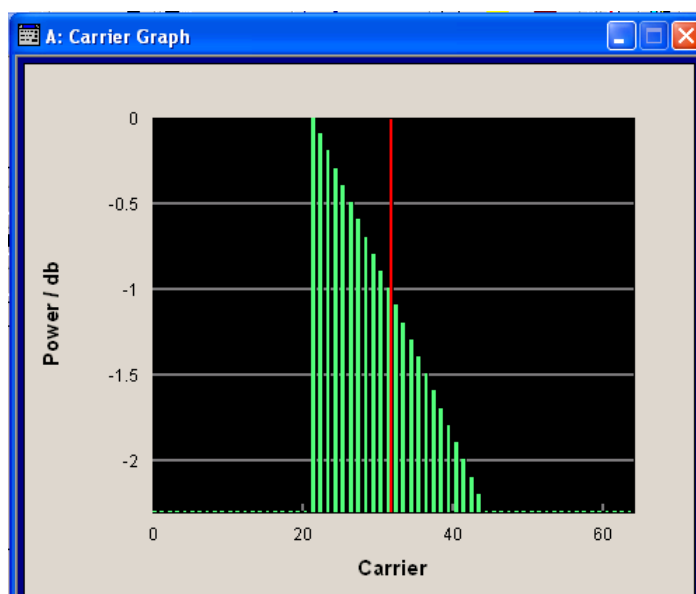

Remote command:

n.a.

Trigger/Marker

Calls the "Trigger/Marker" dialog (see ["Trigger/Marker/Clock Settings"](#) on page 471).

This dialog is used to select the trigger source, set the time delay on an external trigger signal and configure the marker output signals.

Remote command:

n.a.

Clock

Calls the "Clock" dialog for selecting the clock source (see ["Clock Settings"](#) on page 477).

Remote command:

n.a.

Trigger/Marker/Clock Settings

To access this dialog, select "Main Menu > Trigger/Marker".

The "Trigger In" section is where the trigger for the signal is set. Various parameters will be provided for the settings, depending on which trigger source - internal or external - is selected. The current status of signal generation ("Running" or "Stopped") is indicated for all trigger modes.

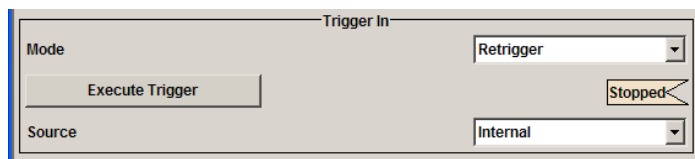

The "Marker Mode" section is where the marker signals at the [MARKER] output connectors are configured.

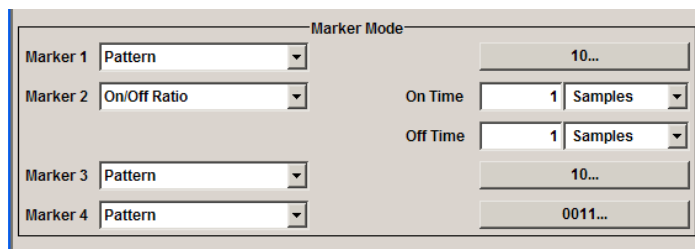

The "Marker Delay" section is where a marker signal delay can be defined, either without restriction or restricted to the dynamic section, i.e., the section in which it is possible to make settings without restarting signal and marker generation.

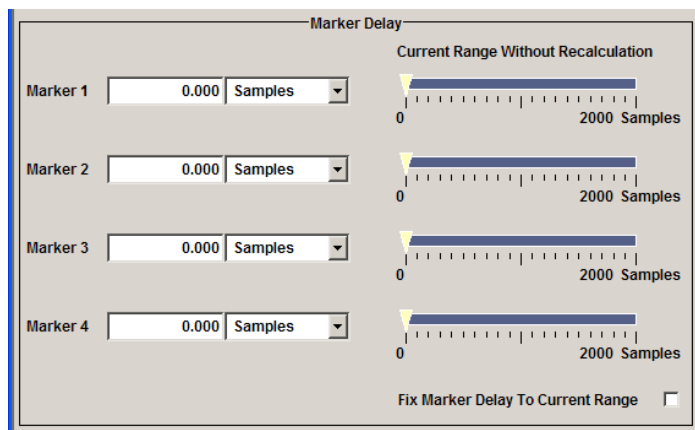

The "Clock Settings" section is where the clock source is selected and - in the case of an external source - the clock type.

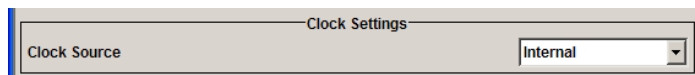

The buttons in the last section lead to submenu for general trigger, clock and mapping settings.



Trigger In

The "Trigger In" section is where the trigger for the signal is set. Various parameters will be provided for the settings, depending on which trigger source - internal or external - is selected. The current status of signal generation ("Running" or "Stopped") is indicated for all trigger modes.

Trigger Mode

Selects trigger mode.

The trigger mode determines the effect of a trigger on the signal generation.

"Auto" The signal is generated continuously.

| | |
|-------------------|---|
| "Retrigger" | The signal is generated continuously. A trigger event (internal or external) causes a restart. |
| "Armed_Auto" | The signal is generated only when a trigger event occurs. Then the signal is generated continuously. Button "Arm" stops signal generation. A subsequent trigger event (internal with "Execute Trigger" or external) causes a restart. |
| "Armed_Retrigger" | The signal is generated only when a trigger event occurs. Then the signal is generated continuously. Every subsequent trigger event causes a restart. Button "Arm" stops signal generation. A subsequent trigger event (internal with "Execute Trigger" or external) causes a restart. |
| "Single" | The signal is generated only when a trigger event occurs. Then the signal is generated once to the length specified at "Signal Duration". Every subsequent trigger event (internal with "Execute Trigger" or external) causes a restart. |

Remote command:

[\[:SOURce<hw>\]:BB:MCCW\[:TRIGger\]:SEQuence](#) on page 713

Signal Duration

Defines the length of the signal sequence to be output in the "Single" trigger mode. The unit of the entry is defined under "Signal Duration Unit". It is then possible to output deliberately just part of the signal, an exact sequence of the signal, or a defined number of repetitions of the signal.

Remote command:

[\[:SOURce<hw>\]:BB:MCCW:TRIGger:SLENgth](#) on page 711

Running/Stopped

Displays the status of signal generation for all trigger modes. This display appears only when signal generation is enabled ("State" On).

| | |
|-----------|--|
| "Running" | The modulation signal is generated; a trigger was (internally or externally) initiated in triggered mode. If "Armed_Auto" and "Armed_Retrigger" have been selected, generation of signals can be stopped with the "Arm" button. A new trigger (internally with "Execute Trigger" or externally) causes a restart. |
| "Stopped" | The signal is not generated, and the instrument waits for a trigger event (internal or external). |

Remote command:

[\[:SOURce<hw>\]:BB:MCCW:TRIGger:RMODe?](#) on page 711

Arm

Stops signal generation. This button appears only with "Running" signal generation in the "Armed_Auto" and "Armed_Retrigger" trigger modes.

Signal generation can be restarted by a new trigger (internally with "Execute Trigger" or externally).

Remote command:

[\[:SOURce<hw>\]:BB:MCCW:TRIGger:ARM:EXECute](#) on page 708

Execute Trigger

Executes trigger manually. A manual trigger can be executed only when an internal trigger source and a trigger mode other than "Auto" have been selected.

Remote command:

[\[:SOURce<hw>\]:BB:MCCW:TRIGger:EXECute](#) on page 709

Trigger Source

Selects trigger source. This setting is effective only when a trigger mode other than "Auto" has been selected.

"Internal" The trigger event is executed by "Execute Trigger".

"External" The trigger event is executed with the aid of the active edge of an external trigger signal.
The trigger signal is supplied via the [TRIG] connector.
The polarity, the trigger threshold and the input impedance of the trigger input can be set in the "Global Trigger/Clock Settings" dialog.

Remote command:

[\[:SOURce<hw>\]:BB:MCCW:TRIGger:SOURce](#) on page 712

Sync. Output to External Trigger

(enabled for Trigger Source External)

Enables/disables output of the signal synchronous to the external trigger event.

For R&S SMBV instruments:

For one or two or more R&S SMBVs configured to work in a master-slave mode for synchronous signal generation, configure this parameter depending on the provided system trigger event and the properties of the output signal. See the table below for an overview of the required settings.

Table 5-14: Typical Applications

| System Trigger | Application | "Sync. Output to External Trigger" |
|--|---|------------------------------------|
| Common External Trigger event for the master and the slave instruments | All instruments are synchronous to the external trigger event | ON |
| | All instruments are synchronous among themselves but starting the signal from first symbol is more important than synchronicity with external trigger event | OFF |
| Internal trigger signal of the master R&S SMBV for the slave instruments | All instruments are synchronous among themselves | OFF |

"On"

Corresponds to the default state of this parameter.

The signal calculation starts simultaneously with the external trigger event but because of the instrument's processing time the first samples are cut off and no signal is outputted. After elapsing of the internal processing time, the output signal is synchronous to the trigger event.

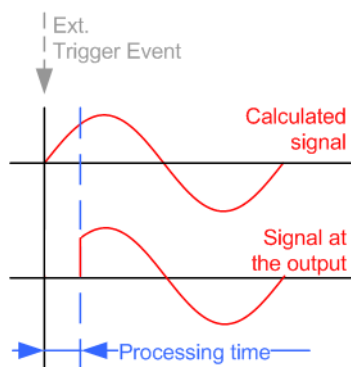

"Off"

The signal output begins after elapsing of the processing time and starts with sample 0, i.e. the complete signal is outputted.

This mode is recommended for triggering of short signal sequences with signal duration comparable with the processing time of the instrument.

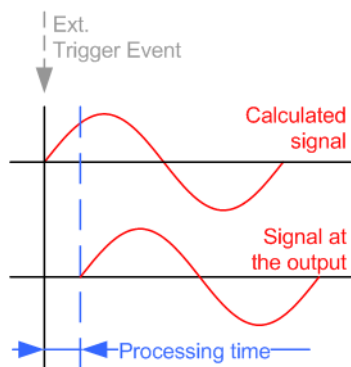

Remote command:

`[:SOURce<hw>] :BB:MCCW:TRIGger:EXTernal:SYNChronize:OUTPut`
on page 709

Trigger Delay

Delays the trigger event of the signal from:

- The external trigger source

Use this setting to:

- Synchronize the instrument with the device under test (DUT) or other external devices

Remote command:

`[:SOURce<hw>] :BB:MCCW:TRIGger [:EXTernal<ch>] :DELay` on page 712

Trigger Inhibit

Available on external triggering.

Sets the duration for inhibiting a new trigger event subsequent to triggering.

In the "Retrigger" mode, every trigger signal causes signal generation to restart. This restart is inhibited for the specified duration.

Remote command:

`[:SOURce<hw>] :BB:MCCW:TRIGger [:EXTernal<ch>] :INHibit` on page 712

Marker Mode

Provides the settings necessary to define the marker output signal for synchronizing external instruments.

Marker Mode

Marker configuration for up to 4 markers. The settings are used to select the marker mode defining the shape and periodicity of the markers. The contents of the dialog change with the selected marker mode; the settings are self-explanatory.

All regular marker signals are described in "[Marker Modes](#)" on page 339.

"Restart" A marker signal is generated at the start of the waveform.

Remote command:

`[:SOURce<hw>] :BB:MCCW:TRIGger:OUTPut<ch>:MODE` on page 715

`[:SOURce<hw>] :BB:MCCW:TRIGger:OUTPut<ch>:PULSe:DIVider` on page 717

`[:SOURce<hw>] :BB:MCCW:TRIGger:OUTPut<ch>:PULSe:FREQuency?`
on page 717

`[:SOURce<hw>] :BB:MCCW:TRIGger:OUTPut<ch>:PATtern` on page 716

`[:SOURce<hw>] :BB:MCCW:TRIGger:OUTPut<ch>:ONTime` on page 716

`[:SOURce<hw>] :BB:MCCW:TRIGger:OUTPut<ch>:OFFTime` on page 716

Marker Delay

The delay of the signals on the [MARKER] outputs is set in the "Marker Delay" section.

The R&S SMBV supports only two markers.

Marker x Delay

Enters the delay between the marker signal at the marker outputs and the start of the frame or slot.

The input is expressed as a number of symbols. If the setting "Fix marker delay to dynamic range" is enabled, the setting range is restricted to the dynamic range. In this range the delay of the marker signals can be set without restarting the marker and signal.

Remote command:

`[:SOURce<hw>] :BB:MCCW:TRIGger:OUTPut<ch>:DELay` on page 714

Current Range without Recalculation

Displays the dynamic range within which the delay of the marker signals can be set without restarting the marker and signal.

The delay can be defined by moving the setting mark.

Remote command:

`[:SOURce<hw>] :BB:MCCW:TRIGger:OUTPut<ch>:DELay:MINimum?`

on page 715

`[:SOURce<hw>] :BB:MCCW:TRIGger:OUTPut<ch>:DELay:MAXimum?`

on page 714

Fix marker delay to current range

Restricts the marker delay setting range to the dynamic range. In this range the delay can be set without restarting the marker and signal.

Remote command:

`[:SOURce<hw>] :BB:MCCW:TRIGger:OUTPut:DELay:FIXed` on page 714

Clock Settings

The Clock Settings is used to set the clock source and a delay if required.

Sync. Mode

Selects the synchronization mode.

This parameter is used to enable generation of very precise synchronous signal of several connected R&S SMBVs.

Note: If several instruments are connected, the connecting cables from the master instrument to the slave one and between each two consecutive slave instruments must have the same length and type.

Avoid unnecessary cable length and branching points.

"None" The instrument is working in stand-alone mode.

"Sync. Master" The instrument provides all connected instrument with its synchronisation (including the trigger signal) and reference clock signal.

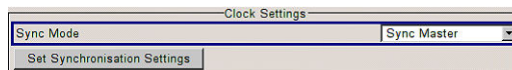

"Sync. Slave" The instrument receives the synchronisation and reference clock signal from another instrument working in a master mode.

Remote command:

`[:SOURce<hw>] :BB:MCCW:CLOCK:SYNChronization:MODE` on page 719

Set Synchronization Settings

Performs automatically adjustment of the instrument's settings required for the synchronization mode, selected with the parameter "Synchronization Mode".

Remote command:

`[:SOURce<hw>] :BB:MCCW:CLOCK:SYNChronization:EXECute` on page 720

Clock Source

Selects the clock source.

"Internal" The internal clock reference is used to generate the symbol clock.

"External" The external clock reference is fed in as the symbol clock or multiple thereof via the CLOCK connector.
The polarity of the clock input can be changed with the aid of "Global Trigger/Clock Settings".

Remote command:

[:SOURce<hw>] :BB:MCCW:CLOCK:SOURce on page 719

Clock Mode

Enters the type of externally supplied clock.

"Sample" A sample clock is supplied via the [CLOCK] connector.

"Multiple Sample" A multiple of the sample clock is supplied via the [CLOCK] connector; the sample clock is derived internally from this.

Remote command:

[:SOURce<hw>] :BB:MCCW:CLOCK:MODE on page 718

Clock Multiplier

Enters the multiplication factor for clock type "Multiple".

Remote command:

[:SOURce<hw>] :BB:MCCW:CLOCK:MULTiplier on page 718

Measured External Clock

Provided for permanent monitoring of the enabled and externally supplied clock signal.

Remote command:

CLOCK:INPut:FREQuency?

Global Settings

This section provides access general trigger, clock and mapping settings.

Global Trigger/Clock Settings

Accesses the "Global Trigger/Clock/Input Settings" dialog.

This dialog is to set the trigger threshold, the input impedance and the polarity of the clock and trigger inputs.

The parameters in this dialog affect all digital modulations and standards, and are described in chapter "Global Trigger/Clock/Input Settings" in the operating manual.

5.10 External Baseband Signal - Baseband Input

The R&S SMBV makes it possible to feed an external analog or digital baseband signal into the signal path.

User-specific wanted signals or interference signals can be frequency and offset shifted, detuned or loaded with noise (see description [Chapter 5.7, "Impairment of Digital I/Q Signal and Noise Generator - AWGN/IMP Block"](#), on page 305).

The equipment options for the basic unit (R&S SMBV with frequency option R&S SMBV-B10x) includes option R&S SMBV-K18 (Digital Baseband Connectivity) and options R&S SMBV-B10/B51 (Baseband Generator).

The R&S SMBV is equipped with the following input interfaces:

- the [I/Q] connectors as input for the external analog signal
The external analog signals are internally processed and A/D-converted.
- the [DIGITAL IQ IN] at the rear of the instrument as input connector for the external digital signal
This interface provides direct communication with other R&S instruments. Additionally, the external digital signal interface module (R&S EX-IQ-BOX) can be connected, providing parallel or serial signal transmission from external devices.
Note: The [DIGITAL IQ IN/OUT] interface is bi-directional and serves as signal input or output. If you for example enable it as a signal input, the signal output is automatically disabled, and vice versa.
The [Chapter 5.10.2, "BB Input Block"](#), on page 481 describes the settings for configuring an input signal. Refer to [Chapter 5.8, "Digital I/Q Output Settings"](#), on page 323 for information concerning signal output.



The signal source (typically a second R&S Instrument) and the receiving R&S Instrument have to be synchronized.



Analog Wideband I/Q In and Baseband Input are not possible simultaneously and therefore switch each other off. In addition to the I/Q impairments in the Impairments block, it is also possible to set analog I/Q impairments in the I/Q Modulator menu of the R&S SMBV.

5.10.1 Important Signal Parameters

The correct signal processing of the externally supplied input signals in the instrument require information of some signal parameters, like sampling rate, crest factor and signal level, expressed as peak or as RMS level value.

- **Sample rate**
The sample rate of the input signal can be defined manually or automatically retrieved from the input signal.
- **Crest factor**
Test setups may require feeding of external signal to the digital/analog input of the R&S SMBV. As a rule, whenever an I/Q signal is transferred between two instrument, the crest factor at the outputs of the "source" instrument has to match with the crest factor at the inputs of the receiving one.
The crest factor gives the difference in level between the peak level and RMS level value in dB (see [Figure 5-40](#)). The R&S SMBV uses the crest factor value by the calculation of power levels. The general principle is, that the R&S SMBV compensates the RMS levels of the externally supplied signal by the crest factor.

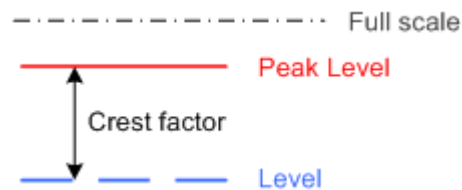

Figure 5-40: Relation between the level settings

In the instrument, level values are represented as relative to full scale.

Fulfilling the prerequisites for a correct signal processing of the externally supplied baseband signal

In the instrument, the **crest factor**, **peak level** and **RMS level** values can be adjusted in one of the following ways:

- Adjusted manually
If you have knowledge about these values, it is best to enter them directly (see [Crest Factor](#))
- Estimated automatically by the internal measurement function
Use the function [Auto Level Set](#) to trigger the R&S SMBV to measure the input signal, estimate the the peak level and RMS level and calculate the crest factor out of them.
Tip: To achieve correct signal leveling with external baseband signals, enable an appropriate measurement time and perform a measurement.
For accurate level measurements, set the measurement period to a time value that is long enough to capture several periods of the input signal.
- Determined automatically (digital baseband input only)
The R&S SMBV can receive the values from the connected transmitter.
If the external digital signal source is a second Rohde & Schwarz instrument, it signals the peak level and RMS level of the signal over the digital input interface. To enable the R&S SMBV to receive these values, trigger the [DIG IQ Auto Setting](#) function.

In the two automatic way, the R&S SMBV adjusts the corresponding input fields with the measured/received values. The internal gain control mechanism uses these received values to adjust the input signal gain to achieve an optimal dynamic range.

Sample rate

- External input signals with sample rates different than the system clock are resampled, as illustrated on [Figure 5-41](#).

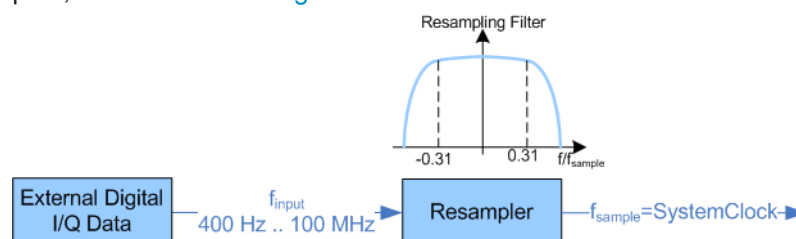

Figure 5-41: Resampling principle of external digital baseband signals

The R&S SMBV can process digital signals with sample rate from 400 Hz to 100 MHz, where as the internal signal processing is based on a sample rate with 200 MHz.

- **Estimating or defining the sample rate**

The sample rate of the signal at the digital interface can be determined with one of the following methods:

- User-defined sample rate
Provide both the external signal source and the receiving instrument with a common external reference signal and set the sample rate value.
- Estimated sample rate
Enable the instrument to evaluate the received I/Q data clock

Maximum modulation bandwidth

- A baseband signal with a sample rate that is smaller than the used system clock is interpolated (see [Figure 5-41](#)). With R&S SMBV-B10, the resulting modulation bandwidth is calculated as $Sample\ Rate * 0.62$, i.e. with a sample rate of exactly 100 MHz, the modulation bandwidth is 62 MHz.

5.10.2 BB Input Block

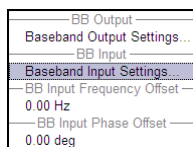

The settings for frequency and phase offset are available in the "BB In/Out" function block or in the "BB In/Out" menu which is opened using the [MENU] key.

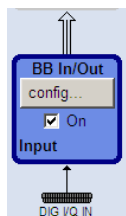

The external baseband signal is activated by switching on in the "Baseband Input" settings menu as well as by ticking the checkbox of the "BB In/Out" function block.

Select "Baseband Input Settings" in the menu to open the "Baseband Input Settings" dialog (see [Chapter 5.10.2.1, "Baseband Input Settings Menu"](#), on page 481). The menu additionally provides access to the "Baseband Output Settings" dialog (see [Chapter 5.8, "Digital I/Q Output Settings"](#), on page 323) and the entry of frequency and phase offset.

5.10.2.1 Baseband Input Settings Menu

The settings for the external baseband signal are available in the "BB In/Out" function block or in the "BB In/Out" menu which is opened using the [MENU] key.

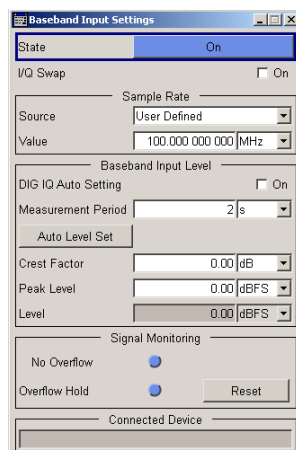

Baseband Input General Settings

State

Switches On/Off the feeding of an external digital signal into the signal path.

Note: Analog signals are directly applied to the I/Q modulator. The settings are made in the I/Q Mod menu (see section [Chapter 5.6, "I/Q Modulation - I/Q Mod Block"](#), on page 299).

"On" Switches On the external I/Q input signal of the "BB In/Out" block. The input symbol displays the active signal mode.

"Off" Switches Off the external I/Q input signal.

Remote command:

[\[:SOURce<hw>\]:BBIN:STATe](#) on page 727

I/Q-Swap

Activates swapping of the I and Q signal components, which mirrors the spectrum at the $f=0$ line and inverts the sign of the frequency.

The I/Q swap may be needed if an external CDMA signal is to be added to an internally generated baseband signal (see description "Digital Standard CDMA2000").

Remote command:

[\[:SOURce<hw>\]:BBIN:IQSWap\[:STATe\]](#) on page 723

Sample Rate

For digital input signals the section "Sample Rate" is available in the "Baseband Input Settings" dialog. The sample rate of the external digital baseband signal can be set and the state of signal transmission is indicated by the FIFO Status.

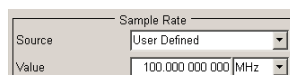

Sample Rate Source

Selects the source for estimating the sample rate or defining it by the user.

"User Defined" Enables the user to define the sample rate in the entry field value.

"Digital I/Q In" Estimates the sample rate on the digital I/Q input and displays the value in the value field.

Note: Estimation works best if the sample rate is close to the user defined value.

Remote command:

`[:SOURce<hw>] :BBIN:SRATe :SOURce` on page 726

Sample Rate Value

Sets the sample rate of the external digital baseband input signal.

Remote command:

`[:SOURce<hw>] :BBIN:SRATe [:ACTual]` on page 726

FIFO Status

Digital Input only

Indicates the state of the signal transmission.

Note: The FIFO status is a SCPI parameter that is not displayed in the GUI.

"OK" Resampling is working properly.

"OFL = Over-flow" The external sample rate frequency is too high which causes an overflow in signal transmission.

"URUN = Underrun" The external sample rate frequency is too low which causes an underrun in signal transmission.

Remote command:

`[:SOURce<hw>] :BBIN:SRATe:FIFO [:STATus] ?` on page 726

Baseband Input Level

The crest factor and the peak power of the external baseband signal are entered in the section "Baseband Input Level". These values are necessary for a correct internal signal processing in the R&S SMBV. They can also be automatically estimated by a measurement using the "Auto Level Set" button.

DIG IQ Auto Setting

Activates automatic adjustment of the baseband input signal.

The R&S SMBV receives Peak Level, level and crest factor values directly from the connected transmitter and recognizes changes automatically.

See also ["Fulfilling the prerequisites for a correct signal processing of the externally supplied baseband signal"](#) on page 480.

Remote command:

[\[:SOURce<hw>\]:BBIN:DIGital:ASETting:STATe](#) on page 723

Measurement Period

Sets the recording duration for measuring the baseband input signal by "Auto Level Set". For accurate level measurements, the measurement period should be set to a time value that is long enough to capture several periods of the input signal.

Remote command:

[\[:SOURce<hw>\]:BBIN:MPERiod](#) on page 724

Auto Level Set

Starts measuring the input signal. The measurement estimates the crest factor, the peak power and the rms power. The estimated values are automatically entered into the input fields "Crest Factor", "Peak Level" and "Level". Using these estimated values the internal gain control adjusts the input signal gain to achieve an optimal dynamic range.

See also ["Fulfilling the prerequisites for a correct signal processing of the externally supplied baseband signal"](#) on page 480.

Remote command:

[\[:SOURce<hw>\]:BBIN:ALEVel:EXECute](#) on page 722

Crest Factor

Sets the crest factor of the external analog or digital baseband signal. Indicates the crest factor acquired with "Auto Level Set".

See also ["Fulfilling the prerequisites for a correct signal processing of the externally supplied baseband signal"](#) on page 480.

Remote command:

[\[:SOURce<hw>\]:BBIN:CFACTOR](#) on page 722

Peak Level

Enters the peak level of the external analog or digital baseband signal relative to full scale of 0.5 V (in terms of dB full scale).

Indicates the peak level acquired with "Auto Level Set".

Remote command:

[\[:SOURce<hw>\]:BBIN:POWer:PEAK](#) on page 725

Level

Indicates the estimated rms level acquired with "Auto Level Set".

Remote command:

[\[:SOURce<hw>\]:BBIN:POWer:RMS?](#) on page 725

Signal Monitoring

The section "Signal Monitoring" indicates the overload of the A/D - Converter.

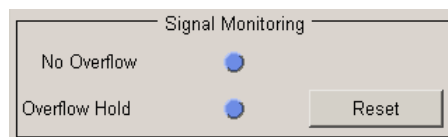

Overload

Indicates that the I/Q input is currently overloaded. This indication also appears in the block diagram close to the I/Q connector of the Baseband Input block.

If overload is indicated either the amplitude of the external signal is too high (full scale of 0.5 V) and must be reduced or the entered "Peak Level" (in dB full scale) value does not correspond with the real value and must be corrected. It also can be evaluated automatically with button "Auto Level Set".

Remote command:

`[:SOURce<hw>] :BBIN:OLOad:STATe?` on page 725

Overload Hold

Indicates an overload since last reset for evaluating the measurement.

The Overload Hold state can be reset via the "Reset" button next to the LED, or is reset automatically by starting a new measurement ("Auto Level Set") or by setting new values (Crest Factor, Peak Level, Level).

Remote command:

`[:SOURce<hw>] :BBIN:OLOad:HOLD:STATe?` on page 724

Reset

Executes a reset of the "Overload Hold" state and LED.

Remote command:

`[:SOURce<hw>] :BBIN:OLOad:HOLD:STATe?` on page 724

Connected Device

Indicates the ID of a connected R&S Instrument or R&S device.

If supported by the transmitter, also the transmitter sample rate is shown.

Note: The connected instrument is indicated only, if the connection is properly established and signal transmission is active.

Remote command:

`[:SOURce<hw>] :BBIN:CDEvice?` on page 722

5.10.2.2 Frequency and Phase Offset

A frequency and a phase offset can be added to the baseband signal. Define the parameters "BB Input Frequency Offset" and "BB Input Phase Offset" in the "Baseband In/Out" block menu.

Frequency Offset

Enters the frequency offset for the external baseband signal. It shifts the useful baseband signal in the center frequency.

The offset affects the signal on the output of the "Baseband In/Out" block.

The complex I/Q bandwidth of the shifted useful signal must not exceed the total available baseband bandwidth (see data sheet).

The setting range of the frequency offset is then calculated as described in "[Frequency Offset](#)" on page 327. With R&S SMBV-K522 for example, it is ± 80 MHz.

Remote command:

[:SOURce<hw>] :BBIN:FOFFset on page 723

Phase Offset

Enters the phase offset for the external baseband signal.

The offset affects the signal on the output of the "Baseband In/Out" block.

Remote command:

n.a.

6 Remote Control Basics

This chapter provides basic information on operating an instrument via remote control.

6.1 Remote Control Interfaces and Protocols

The instrument supports different interfaces for remote control. The following table gives an overview.

Table 6-1: Remote control interfaces and protocols

| Interface | Protocols, VISA ^{*)} address string | Remarks |
|-------------------------------|---|--|
| Local Area Network (LAN) | Protocols: <ul style="list-style-type: none"> HiSLIP High-Speed LAN Instrument Protocol (IVI-6.1) VISA^{*)} address string: TCPIP::host address:: hislip0[::INSTR] VXI-11 VISA^{*)} address string: TCPIP::host address[:: LAN device name][::INSTR] socket communication (Raw Ethernet, simple telnet) VISA^{*)} address string: TCPIP::host address[:: LAN device name]::<port>:: SOCKET | A LAN connector is located on the front or rear panel of the instrument, or both. The interface is based on TCP/IP and supports various protocols. For a description of the protocols refer to: <ul style="list-style-type: none"> Chapter 6.1.3.1, "HiSLIP Protocol", on page 491 Chapter 6.1.3.2, "VXI-11 Protocol", on page 491 Chapter 6.1.3.3, "Socket Communication", on page 491 |
| Serial Interface | VISA ^{*)} address string: ASRL[0-9][::INSTR] | For a description of the interface, refer to Chapter 6.1.5, "Serial Interface" , on page 493. |
| GPIB (IEC/IEEE Bus Interface) | VISA ^{*)} address string: GPIB::primary address[::INSTR] (no secondary address) | Optional GPIB bus interfaces according to standard IEC 625.1/IEEE 488.1 are located on the rear panel of the instrument. For a description of the interface, refer to Chapter 6.1.6, "GPIB Interface (IEC/IEEE Bus Interface)" , on page 493. Note: Within this interface description, the term GPIB is used as a synonym for the IEC/IEEE bus interface. |

^{*)} VISA is a standardized software interface library providing input and output functions to communicate with instruments. A VISA installation on the controller is a prerequisite for remote control over LAN (when using VXI-11 or HiSLIP protocol), USB and serial interface. For remote control via socket communication VISA installation is optional. For more information, see [Chapter 6.1.1, "VISA Libraries"](#), on page 488.



Rohde & Schwarz provides the standardized I/O software library R&S VISA for communication via TCP/IP (LAN: HiSlip, VXI-11 and raw socket) or USB (USBTMC) interfaces.

R&S VISA is available for download at the Rohde & Schwarz website <http://www.rohde-schwarz.com/rsvisa>.

How to configure the remote control interfaces, see [Chapter 6.2, "Starting a Remote Control Session"](#), on page 496.

SCPI (Standard Commands for Programmable Instruments)

SCPI commands - messages - are used for remote control. Commands that are not taken from the SCPI standard follow the SCPI syntax rules. The instrument supports the SCPI version 1999. The SCPI standard is based on standard IEEE 488.2 and aims at the standardization of device-specific commands, error handling and the status registers. The tutorial "Automatic Measurement Control - A tutorial on SCPI and IEEE 488.2" from John M. Pieper (R&S order number 0002.3536.00) offers detailed information on concepts and definitions of SCPI.

Tables provide a fast overview of the bit assignment in the status registers. The tables are supplemented by a comprehensive description of the status registers.

6.1.1 VISA Libraries

VISA is a standardized software interface library providing input and output functions to communicate with instruments. Thus, you can configure the interface and must not adjust the application program to the used interface. The I/O channel (LAN or TCP/IP, USB, GPIB,...) is selected at initialization time with the channel-specific address string ("VISA resource string"), or by a defined VISA alias (short name). See also [Chapter 6.1, "Remote Control Interfaces and Protocols"](#), on page 487 for an overview.

Instrument access via VXI-11 or HiSLIP protocols is achieved from high level programming platforms using VISA as an intermediate abstraction layer. VISA encapsulates the low-level VXI or GPIB function calls and thus makes the transport interface transparent for the user.

A VISA installation is a prerequisite for remote control using the following interfaces:

- LAN Interface using [Chapter 6.1.3, "LAN Interface"](#), on page 489
- LAN interface using [Chapter 6.1.3.2, "VXI-11 Protocol"](#), on page 491
- [Chapter 6.1.4, "USB Interface"](#), on page 492
- [Chapter 6.1.6, "GPIB Interface \(IEC/IEEE Bus Interface\)"](#), on page 493
- [Chapter 6.1.5, "Serial Interface"](#), on page 493

Instrument access via the LAN socket protocol or GPIB connections can be operated both, with or without the VISA library.

See also [Chapter 6.1.3.3, "Socket Communication"](#), on page 491 and [Chapter 6.1.6, "GPIB Interface \(IEC/IEEE Bus Interface\)"](#), on page 493.

For more information about VISA, refer to the user documentation.

6.1.2 Messages

The messages transferred on the data lines are divided into the following categories:

- Interface messages
Interface messages are transmitted to the instrument on the data lines, with the attention line being active (LOW). They are used to communicate between the controller and the instrument. Interface messages can only be sent by instruments that have GPIB bus functionality. For details see the sections for the required interface.

- **Instrument messages**
Instrument messages are employed in the same way for all interfaces, if not indicated otherwise in the description. Structure and syntax of the instrument messages are described in [Chapter 6.3, "SCPI Command Structure"](#), on page 511. A detailed description of all messages available for the instrument is provided in the chapter "Remote Control Commands".
There are different types of instrument messages, depending on the direction they are sent:
 - Commands
 - Instrument responses

Commands

Commands (program messages) are messages the controller sends to the instrument. They operate the instrument functions and request information. The commands are subdivided according to two criteria:

- According to the effect they have on the instrument:
 - **Setting commands** cause instrument settings such as a reset of the instrument or setting the frequency.
 - **Queries** cause data to be provided for remote control, e.g. for identification of the instrument or polling a parameter value. Queries are formed by directly appending a question mark to the command header.
- According to their definition in standards:
 - **Common commands:** their function and syntax are precisely defined in standard IEEE 488.2. They are employed identically on all instruments (if implemented). They refer to functions such as management of the standardized status registers, reset and self-test.
 - **Instrument control commands** refer to functions depending on the features of the instrument such as frequency settings. Many of these commands have also been standardized by the SCPI committee. These commands are marked as "SCPI confirmed" in the command reference chapters. Commands without this SCPI label are device-specific; however, their syntax follows SCPI rules as permitted by the standard.

Instrument responses

Instrument responses (response messages and service requests) are messages the instrument sends to the controller after a query. They can contain measurement results, instrument settings and information on the instrument status.

6.1.3 LAN Interface

To be integrated in a LAN, the instrument is equipped with a LAN interface, consisting of a connector, a network interface card and protocols. For remote control via a network, the PC and the instrument must be connected via the LAN interface to a common network with TCP/IP network protocol. They are connected using a commercial RJ45 cable. The TCP/IP network protocol and the associated network services are

preconfigured on the instrument. Software for instrument control and (for specified protocols only) the VISA program library must be installed on the controller.

VISA library

Instrument access via VXI-11 or HiSLIP protocols is achieved from high level programming platforms using VISA as an intermediate abstraction layer. VISA encapsulates the low level VXI or GPIB function calls and thus makes the transport interface transparent for the user. See [Chapter 6.1.1, "VISA Libraries"](#), on page 488 for details.

IP address

Only the IP address or the computer name (LAN device name) is required to set up the connection. The IP address/computer name is part of the "VISA resource string" used by the programs to identify and control the instrument.

Forms of the VISA resource string:

- TCPIP::host address[::LAN device name][::INSTR]
- TCPIP::host address::port::SOCKET

Where:

- TCPIP designates the network protocol used
- host address is the IP address or host name of the device
- LAN device name defines the protocol and the instance number of a subinstrument:
 - inst0 selects the VXI-11 protocol (optional, default)
 - hislip0 selects the newer HiSLIP protocol
- INSTR indicates the instrument resource class (optional)
- port determines the used port number
- SOCKET indicates the raw network socket resource class

Example:

- Instrument has the IP address *192.1.2.3*; the valid resource string using VXI-11 protocol is:
TCPIP::192.1.2.3::INSTR
- The DNS host name is *RSSM1*; the valid resource string is:
TCPIP::RSSM1::hislip0 (HiSLIP)
TCPIP::RSSM1::INSTR (VXI-11)
- A raw socket connection can be established using:
TCPIP::192.1.2.3::5025::SOCKET



Identifying instruments in a network

If several instruments are connected to the network, each instrument has its own IP address and associated resource string. The controller identifies these instruments by the resource string.

6.1.3.1 HiSLIP Protocol

The HiSLIP (**H**igh **S**peed **L**AN **I**nstrument **P**rotocol) is the successor protocol for VXI-11 for TCP-based instruments specified by the IVI foundation. The protocol uses two TCP sockets for a single connection - one for fast data transfer, the other for non-sequential control commands (e.g. `Device Clear` or `SRQ`).

HiSLIP has the following characteristics:

- High performance as with raw socket network connections
- Compatible IEEE 488.2 support for Message Exchange Protocol, Device Clear, Serial Poll, Remote/Local, Trigger, and Service Request
- Uses a single IANA registered port (4880), which simplifies the configuration of firewalls
- Supports simultaneous access of multiple users by providing versatile locking mechanisms
- Usable for IPv6 or IPv4 networks



Using VXI-11, each operation is blocked until a VXI-11 device handshake returns. However, using HiSLIP, data is sent to the device using the "fire and forget" method with immediate return. Thus, a successful return of a VISA operation such as `viWrite()` does not guarantee that the instrument has finished or started the requested command, but is delivered to the TCP/IP buffers.

For more information see also the application note:

[1MA208: Fast Remote Instrument Control with HiSLIP](#)

6.1.3.2 VXI-11 Protocol

The VXI-11 standard is based on the ONC RPC (Open Network Computing Remote Procedure Call) protocol which in turn relies on TCP/IP as the network/transport layer. The TCP/IP network protocol and the associated network services are preconfigured. TCP/IP ensures connection-oriented communication, where the order of the exchanged messages is adhered to and interrupted links are identified. With this protocol, messages cannot be lost.

6.1.3.3 Socket Communication

An alternative way for remote control of the software is to establish a simple network communication using sockets. The socket communication, also referred to as "Raw Ethernet communication", does not necessarily require a VISA installation on the remote controller side. It is available by default on all operating systems.

The simplest way to establish socket communication is to use the built-in telnet program. The telnet program is part of every operating system and supports a communication with the software on a command-by-command basis. For more convenience and to enable automation by means of programs, user-defined sockets can be programmed.

Socket connections are established on a specially defined port. The socket address is a combination of the IP address or the host name of the instrument and the number of the port configured for remote-control. All R&S SMBV use port number 5025 for this purpose. The port is configured for communication on a command-to-command basis and for remote control from a program.

6.1.3.4 LAN Interface Messages

In the LAN connection, the interface messages are called low-level control messages. These messages can be used to emulate interface messages of the GPIB bus.

| Command | Long term | Effect on the instrument |
|---------|-----------------------|--|
| &ABO | Abort | Aborts processing of the commands just received. |
| &DCL | Device Clear | Aborts processing of the commands just received and sets the command processing software to a defined initial state. Does not change the instrument setting. |
| >L | Go to Local | Transition to the "local" state (manual control). (The instrument automatically returns to remote state when a remote command is sent UNLESS &NREN was sent before.) |
| >R | Go to Remote | Enables automatic transition from local state to remote state by a subsequent remote command (after &NREN was sent). |
| &GET | Group Execute Trigger | Triggers a previously active instrument function (e.g. a sweep). The effect of the command is the same as with that of a pulse at the external trigger signal input. |
| &LLO | Local Lockout | Disables transition from remote control to manual control by means of the front panel keys. |
| &NREN | Not Remote Enable | Disables automatic transition from local state to remote state by a subsequent remote command. (To re-activate automatic transition use >R.) |
| &POL | Serial Poll | Starts a serial poll. |

6.1.4 USB Interface

For remote control via the USB connection, the PC and the instrument must be connected via the USB type B interface. A USB connection requires the VISA library to be installed. VISA detects and configures the R&S instrument automatically when the USB connection is established. You do not have to enter an address string or install a separate driver.

USB address

The used USB address string is:

```
USB::::<product ID>::::INSTR]
```

Where:

- <vendor ID> is the vendor ID for Rohde&Schwarz
- <product ID> is the product ID for the R&S instrument
- <serial number> is the individual serial number on the rear of the instrument

Example:

```
USB::0x0AAD::0x005F::100001::INSTR
```

0x0AAD is the vendor ID for Rohde&Schwarz

0x005F is the product ID for the R&S SMBV

100001 is the serial number of the particular instrument

6.1.5 Serial Interface

Remote control via the serial interface is possible either via RS232 interface or via a Bluetooth connection. The controller/Bluetooth device and the instrument must be connected via an external USB/serial-adapter (see recommended extras, data sheet) and a serial crossover (null modem) cable. A USB connection requires the VISA library to be installed on the controller. VISA detects and configures the R&S SMBV automatically when the USB connection is established.

Serial address

The used serial address string is:

```
ASRL[0-9] [ : : INSTR ]
```

Where `ASRL[0-9]` determines the number of the COM port on the controller side, that has to be used for the serial connection.

Access via a bluetooth device requires the entry of the bluetooth pin in addition (see [Chapter 5.2.3.18, "Security"](#), on page 147).

To enable an error-free and correct data transmission, the parameters of the generator and the controller must have the same setting. The serial interface is preset for a baud rate 115200, no parity and one stop bit. The parameters can be manually changed in "Remote Channel Settings" dialog (see [Chapter 5.2.3.15, "Remote Channel Settings"](#), on page 143).

6.1.6 GPIB Interface (IEC/IEEE Bus Interface)

To be able to control the instrument via the GPIB bus, the instrument and the controller must be linked by a GPIB bus cable. A GPIB bus card, the card drivers and the program libraries for the programming language used must be provided in the controller. The controller must address the instrument with the GPIB bus address (see [Chapter 6.1.6.2, "GPIB Instrument Address"](#), on page 495).

Characteristics

The GPIB interface is described by the following characteristics:

- Up to 15 instruments can be connected

- The total cable length is restricted to a maximum of 15 m; the cable length between two instruments should not exceed 2m.
- A wired "OR"-connection is used if several instruments are connected in parallel, since the slowest instrument determines the speed.



Any connected IEC bus cable must be terminated by an instrument or controller.

6.1.6.1 GPIB Interface Messages

Interface messages are transmitted to the instrument on the data lines, with the attention line (ATN) being active (LOW). They are used for communication between the controller and the instrument and can only be sent by a computer which has the function of a GPIB bus controller. GPIB interface messages can be further subdivided into:

- **Universal commands:** act on all instruments connected to the GPIB bus without previous addressing
- **Addressed commands:** only act on instruments previously addressed as listeners

Universal Commands

Universal commands are encoded in the range 10 through 1F hex. They affect all instruments connected to the bus and do not require addressing.

| Command | Effect on the instrument |
|---|---|
| DCL (Device Clear) | Aborts the processing of the commands just received and sets the command processing software to a defined initial state. Does not change the instrument settings. |
| IFC (Interface Clear) *) | Resets the interfaces to the default setting. |
| LLO (Local Lockout) | The "Local" softkey is disabled. Manual operation is no longer available until <code>GTL</code> is executed. |
| SPE (Serial Poll Enable) | Ready for serial poll. |
| SPD (Serial Poll Disable) | End of serial poll. |
| PPU (Parallel Poll Unconfigure) | End of the parallel-poll state. |
| *) IFC is not a real universal command, it is sent via a separate line; however, it also affects all instruments connected to the bus and does not require addressing | |

Addressed Commands

Addressed commands are encoded in the range 00 through 0F hex. They only affect instruments addressed as listeners.

| Command | Effect on the instrument |
|-------------------------------|--|
| GET (Group Execute Trigger) | Triggers a previously active instrument function (e.g. a sweep). The effect of the command is the same as with that of a pulse at the external trigger signal input. |
| GTL (Go to Local) | Transition to the "local" state (manual control). |
| GTR (Go to Remote) | Transition to the "remote" state (remote control). |
| PPC (Parallel Poll Configure) | Configures the instrument for parallel poll. |
| SDC (Selected Device Clear) | Aborts the processing of the commands just received and sets the command processing software to a defined initial state. Does not change the instrument setting. |

6.1.6.2 GPIB Instrument Address

In order to operate the instrument via remote control, it must be addressed using the GPIB address. The remote control address is factory preset, but it can be changed if it does not fit in the network environment. For remote control, addresses 0 through 30 are allowed. The GPIB address is maintained after a reset of the instrument settings.

Changing the GPIB address of the instrument

The GPIB address can be changed manually or using a remote control command.

1. Manually: press the [SETUP] key.
2. Select "Remote > GPIB".



3. Enter the GPIB address.
4. Remotely: use the remote control command:
`SYST:COMM:GPIB:ADDR 18`

6.1.7 LXI Browser Interface

LAN extension for instrumentation (LXI) is an instrumentation platform for measuring instruments and test systems that is based on standard Ethernet technology, see also [Chapter 2.8, "LXI Configuration"](#), on page 53.

The LXI browser interface allows easy configuration of the LAN and remote control of the R&S SMBV without additional installation requirements. The instrument's LXI browser interface works correctly with all W3C compliant browsers.

The LAN settings are configured using the LXI Browser Interface of the R&S SMBV described in [Chapter 2.8.2, "LAN Configuration"](#), on page 56. The LXI status settings in the R&S SMBV are described in "General Instrument Settings > Remote Channel Settings > LXI Status Settings".

6.2 Starting a Remote Control Session

The instrument and the controller have to be connected with the suitable cable and switched on.

A remote control program must open a connection to the instrument (using VISA functionality), before it can send commands to and receive device responses from the instrument.



Instrument Address

In order to operate the instrument via remote control it must be addressed using the defined interface address. See [Chapter 6.1.3, "LAN Interface"](#), on page 489, [Chapter 6.1.4, "USB Interface"](#), on page 492, [Chapter 6.1.5, "Serial Interface"](#), on page 493, [Chapter 6.1.6, "GPIB Interface \(IEC/IEEE Bus Interface\)"](#), on page 493 or [Chapter 6.1.7, "LXI Browser Interface"](#), on page 495 for details.

The VISA resource strings are indicated in the "Setup > Remote Channel Settings" menu.



Securing the display

To prevent unauthorized personnel from reading the display, you can disable the frequency and level display explicitly. This is useful when you remotely control the instrument from a different location.

For information on how to disable the frequency and level display, refer to "Security > Annotation Frequency" and "Security > Annotation Amplitude" in the operating manual.

Refer to [Chapter 6.2.3, "Examples"](#), on page 498 for practical examples on setting up of a remote control link and starting of a remote control session.

6.2.1 Switching to Remote Control

After switching on, the instrument is usually in the local state and can be operated via the front panel controls (for instruments equipped with a display), a mouse and an external keyboard.

Starting remote control

1. Send a command from a controller to the instrument.

The instrument changes to remote state as soon as it receives the command from the controller.

Note: If you have sent `&NREN` before, the automatic transition from local state to manual control by a subsequent remote command is disabled (use `>R` to enable it again).

In remote state, operation via the front panel or via mouse and keyboard is disabled. The status line indicates the "REMOTE" state.

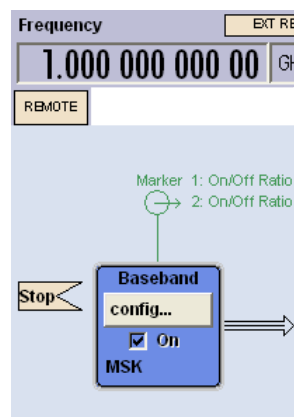

The instrument remains in the remote state until it is reset to the local state, see [Chapter 6.2.2, "Returning to Manual Operation"](#), on page 497).

Tip: Switching from manual operation to remote control and vice versa does not affect the other instrument settings.

- Although operation via front panel, mouse and keyboard is disabled, the dialog boxes can still be opened, for example to verify settings. The buttons and setting fields are grayed out and cannot be activated. Additionally, you can disable the access to the dialogs with the command `SYST:KLOC ON` to protect the instrument against unauthorized readings.
- To prevent unintentional return to manual operation, disable the [LOCAL] key of the instrument with the `&LLO` command (see [Chapter 6.1.3.4, "LAN Interface Messages"](#), on page 492).

The instrument switches to "REM-LLO" state.

The automatic transition from local state to remote state by a subsequent remote command, and the command `*GTL` are disabled.

To return to manual mode is only possible via remote control.

- Unlock the [LOCAL] key with `>R`.

6.2.2 Returning to Manual Operation



Before returning to manual control, command processing must be completed. Otherwise, the instrument switches back to remote control immediately.

To return to manual operation, perform one of the following:

- Press the [LOCAL] key on the front panel.
- Select "Setup > Remote Control Channels > Local".
- While using the socket communication, terminate the remote control session.
- Send the interface command `>L` via the remote control interface.



Use the >R to enable the [LOCAL] key if it is locked.

6.2.3 Examples

This section provides examples for setting up the remote control connection, and starting a remote control session.

This section assumes basic knowledge of programming and operation of the controller. A description of the interface commands can be obtained from the corresponding manuals.

6.2.3.1 Remote Control over GPIB

The program example in this section is written in VISUAL BASIC. A condition for programming in VISUAL BASIC is that the modules NIGLOBAL (`Niglobal.bas`) and VBIB32 (`Vbib_32.bas`) are added to the projects.



Drivers for instrument, e.g. IVI-COM and LabVIEW drivers, are available in the download area of the product website (http://www.rohde-schwarz.com/en/products/test_and_measurement/product_categories/signal_generation/).

Starting a remote control session over GPIB

As a prerequisite, the GPIB address of the instrument, which is factory-set to 28, must not have been changed.

1. Connect instrument and controller using GPIB cable and switch them on.
2. Execute following commands on the controller:
 - a) Open port to the instrument
`CALL IBFIND("DEV1", generator%)`
 - b) Inform controller about instrument address
`CALL IBPAD(generator%, 28)`
 - c) Reset instrument
`CALL IBWRT(generator%, "*RST;*CLS")`
 - d) Set instrument to new address
`CALL IBWRT(generator%, "SYST:COMM:GPIB:ADDR 18")`
 - e) Inform controller about new address
`CALL IBPAD(generator%, 18)`

The GPIB address of the instrument is changed.

3. To return to manual operation sent `CALL IBLOC (generator%)` or press the [LOCAL] key at the front panel.

6.2.3.2 Remote Control over LAN using VXI-11 Protocol

In this example, the I/O software library R&S VISA from Rohde & Schwarz is used to set up a LAN remote control link and remotely control the R&S SMBV. R&S VISA is running on a controller PC with Windows operating system. When the connection is set up you can send commands to the instrument, and receive the responses.

The remote control connection requires a VISA installation but no additional hardware on the controller PC. The LAN I/O channel is selected at initialization time using the VISA resource string (also referred to as "address string"). A VISA alias (short name) is used to replace the complete resource string. The host address is either the R&S SMBV's hostname or IP address. See also [Chapter 6.1.3, "LAN Interface"](#), on page 489.



In this example, it is assumed that:

- A LAN remote control link between the controller and the R&S SMBV is already set up.
- The R&S VISA program is installed on the remote PC, see "<http://www.rohde-schwarz.com/rsvisa> > RS VISA Release Notes".

Configuring the controller

To remote control the R&S SMBV, we use the R&S VISA Tester application.



The instrument is preconfigured for networks using DHCP (dynamic host configuration protocol). If this configuration is used, enter the computer name in the position of the IP address.

To enable the external controller to communicate with the R&S SMBV via TCP/IP protocol, set up a remote control link as follows:

1. Make sure that the controller and the instrument are connected in the network (network cable) and switched on.
2. On the controller, start "R&S VISA > Tester 32bit" or "R&S VISA > Tester 64bit", respectively.

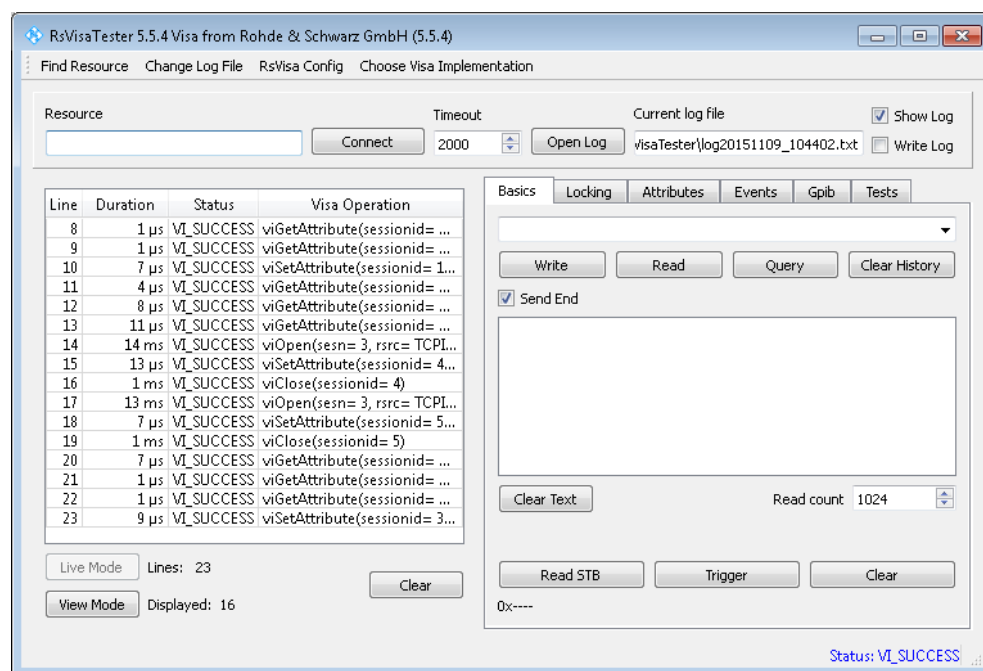

- In the menu bar, select "Choose VISA Implementation > Rohde & Schwarz Visa".

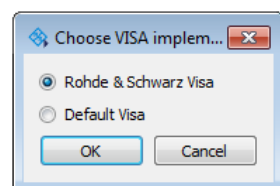

- Select "Rohde & Schwarz Visa" and confirm with "OK".
- In the menu bar, select "Find Resource" to search for the instrument in the LAN.

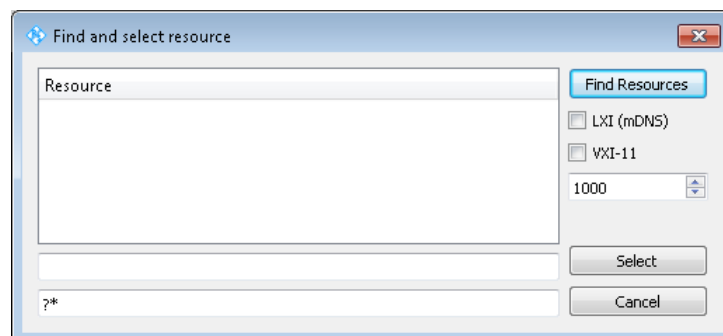

- Select "VXI-11" and "Find Resources".
R&S VISA scans the network for connected instruments and lists all detected instruments in the "Resource" list.
Note: The search may take some time, particularly in large networks.
- Select the required instrument and confirm with "Select".

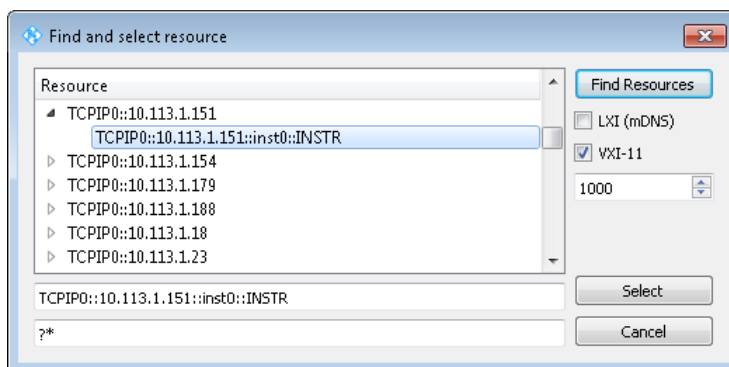

The "Find and select resource" dialog closes and R&S VISA indicates the instruments IP address in the "Resource" field of the main application window.

8. As an alternative to the IP address, you can assign an alias name to the R&S SMBV:
 - a) In the menu bar, select "RsVisaConfig".

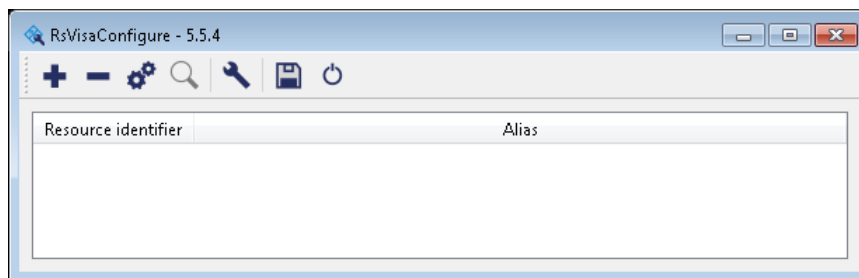

- b) In the toolbar, select "+" to access the "VISA Resource String Composer".

- c) Fill in the "Alias" name, the "VISA Resource String" and the "Device IP Address or host name" as shown in the figure, and confirm with "OK".

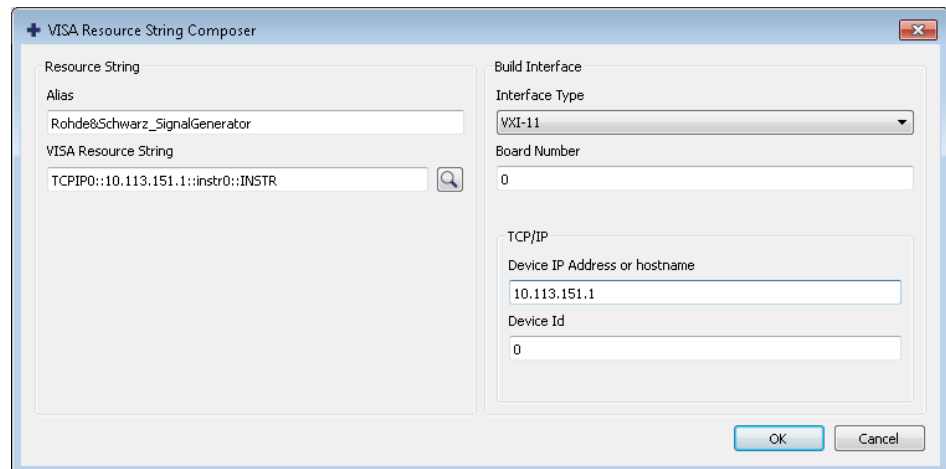

The "Alias" name is assigned to the instrument.

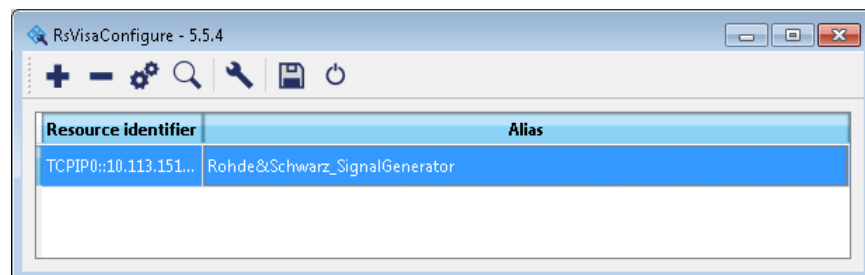

- d) Close the dialog.
The R&S SMBV is now registered in the program and can be addressed via the resource string or alias name.

9. In the main window, select "Connect".

R&S VISA establishes the connection to the R&S SMBV.

Now you can send settings to configure the instrument and receive its responses.

Note: If the connection cannot be set up, R&S VISA displays an error in the log view. For information on how to proceed when network failures occur, see "Status Information, Error Messages and Trouble Shooting > Resolving Network Connection Failures" in the operating manual.

For further information on the functions to read and write to an open session, as well as the utility applications the software provides, see the R&S VISA User Manual.

Starting a remote control over LAN (using VXI-11)

To set the instrument to remote control, you can use the addressed command `>R`, or send any command from the controller.

1. Start the R&S VISA Tester and establish the connection to the R&S SMBV, see ["Configuring the controller"](#) on page 499.

- In the R&S VISA "Basics" tab, enter a SCPI command, e.g. "*IDN?" and confirm with "Query".

The instrument is switched to remote control when it receives a command from the controller.

- Select "Read" to obtain the instrument response.

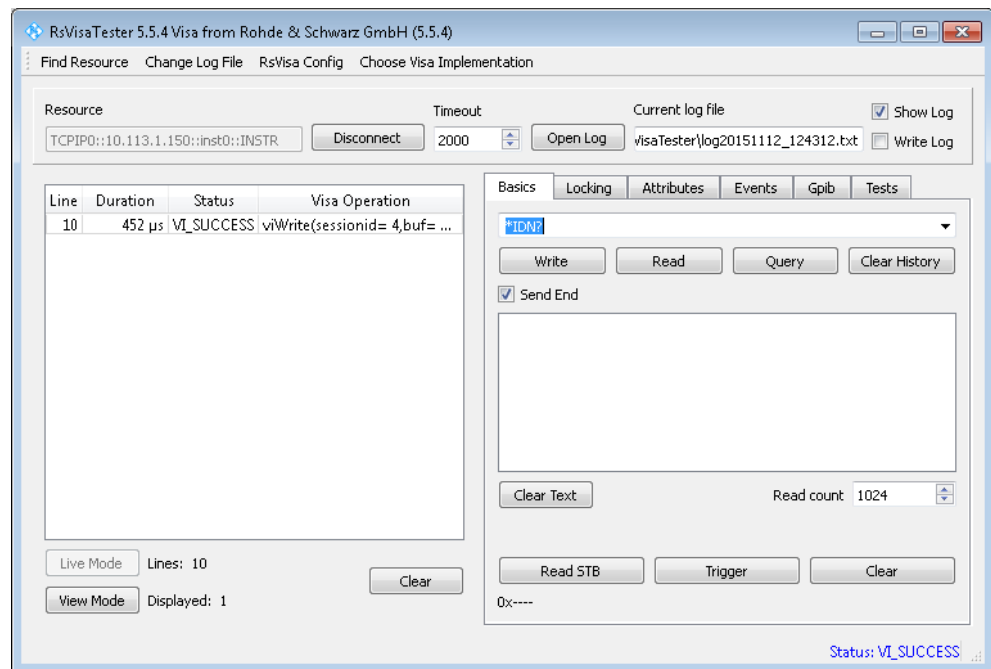

Tip: If the "Show Log" checkbox is checked R&S VISA displays each VISA function call in the log-view on the left. If you check the "Write Log" checkbox the log-view entry is written to the log file as well. You can operate the log-view in two modes: the "Live Mode" shows only the most recent messages whereas the "View Mode" allows you to scroll the history.

- To set, e.g. the frequency, enter `SOUR1:FREQ 4 GHz` and select "Write". To check the performed setting, `SOUR1:FREQ?` and select "Read". The instrument response is `4000000000`, i.e. the frequency is returned in Hz.

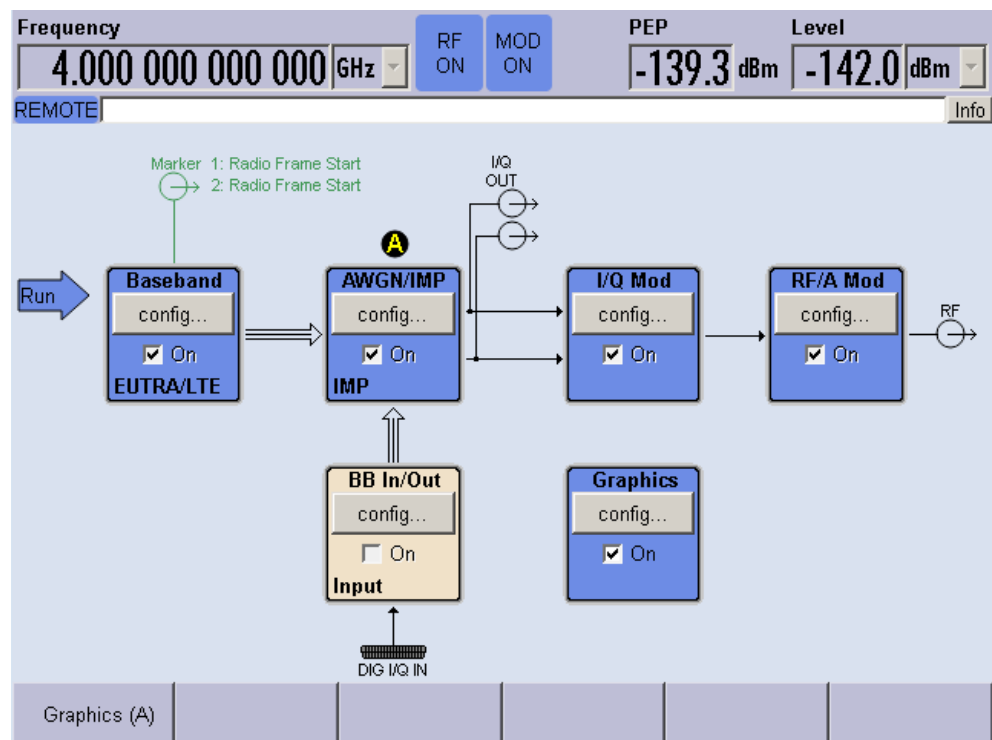

While remote control is active, the "Remote" icon in the status bar indicates that the instrument is in remote control mode. The operation via the front panel or via mouse and keyboard are locked, allowing a remote control program to be performed without interruption.

On the display, keys and entry fields are grayed out and cannot be activated or modified, but you can still open dialogs, for example to verify settings.

5. To disable the access to the dialogs, use the command `SYST:KLOC ON`.
6. To prevent unintentional return to manual operation, use the command `&LLO`. See also [Chapter 6.1.3.4, "LAN Interface Messages"](#), on page 492. The instrument switches to "Remote LLO" state. The [LOCAL] key is disabled.
7. To enable the [LOCAL] key, use the command `>R`.
8. To return to manual operation, see [Chapter 6.2.2, "Returning to Manual Operation"](#), on page 497.

Tip: Switching from manual operation to remote control and vice versa does not affect the other instrument settings.

6.2.3.3 Remote Control over LAN using Socket Communication

This chapter provides an example on how to establish a remote control connection over telnet protocol and a simple sockets-based program example that can be further developed.

Setting up a Telnet Connection

To control the software, only a telnet program is required. The telnet program is part of every operating system.

1. To establish a Telnet connection with the R&S SMBV, start the telnet program.
2. Enter the access string to connect to the instrument and confirm with [Enter].
The access string is composed of the open command short form) and the socket address. The socket address is a combination of the IP address or the host name of the R&S SMBV and the number of the port configured for remote-control via telnet. The R&S SMBV uses the port number 5025 for remote connection via Telnet.

Example: o 10.113.1.150 5025

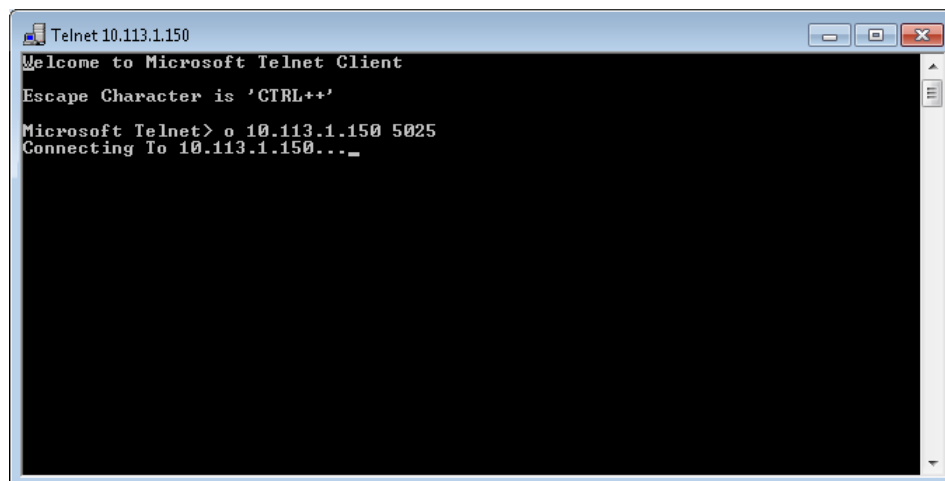

```
Telnet 10.113.1.150
Welcome to Microsoft Telnet Client
Escape Character is 'CTRL++'
Microsoft Telnet> o 10.113.1.150 5025
Connecting To 10.113.1.150..._
```

The connection to the instrument is set up and you can send remote-control commands.

3. Even if the cursor is not visible on the screen, enter blind a remote-control command and confirm with "Enter".

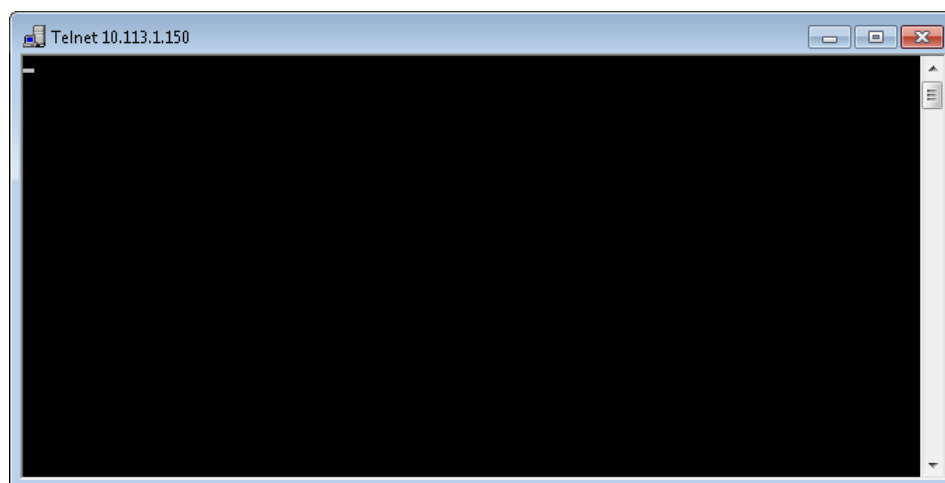

```
Telnet 10.113.1.150
```

```

Telnet 10.113.1.150
Freq?
1500000000
freq 1.5 GHz
Freq?
1500000000
pow?
0
pow -30
pow?
-30

```

After the first remote-control command has been sent, the instrument is in the "REMOTE" state, i.e. instrument control from the front panel or via mouse and keyboard is disabled and "REMOTE" is displayed in the status line.

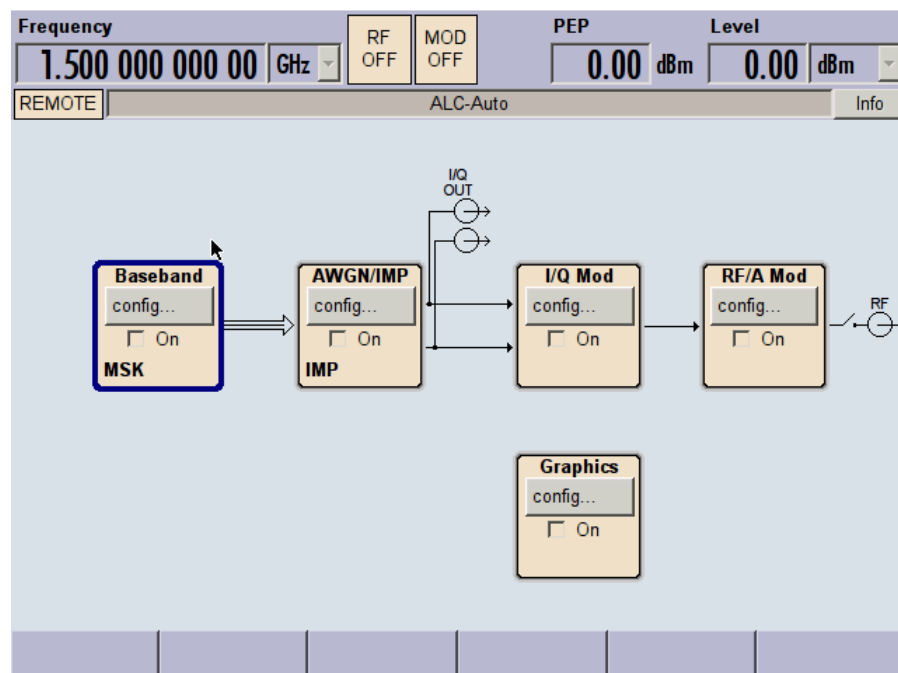

Telnet program examples

The following program example shows a simple TcpClient class that is intended to explain on how to get started with programming of sockets.

The example sets up a socket communication to R&S SMBV and opens a simple user interface, very similar to the telnet, which allows input of commands. To enable real automation, further development of the program is required.

TcpClient.h

```
#include <string>
//defines structs for socket handling
#include <netinet/in.h>
using namespace std;
typedef struct sockaddr_in SockAddrStruct;
typedef struct hostent      HostInfoStruct;
class TcpClient
{
public:
    TcpClient();
    ~TcpClient();
    void connectToServer( string &hostname, int port );
    void disconnect( );
    void transmit( string &txString );
    void receive( string &rxString );
    string getCurrentHostName( ) const;
    int    getCurrentPort( ) const;
private:
    string      currentHostName;
    int         currentPort;
    int         currentSocketDescr;
    SockAddrStruct  serverAddress;
    HostInfoStruct * currentHostInfo;
    bool        clientIsConnected;
    int         receiveBufferSize;
};
```

TcpClient.cpp

```
#include <string>
//defines structs for socket handling
#include <netinet/in.h>
using namespace std;
typedef struct sockaddr_in SockAddrStruct;
typedef struct hostent      HostInfoStruct;
class TcpClient
{
public:
    TcpClient();
    ~TcpClient();
    void connectToServer( string &hostname, int port );
    void disconnect( );
    void transmit( string &txString );
    void receive( string &rxString );
    string getCurrentHostName( ) const;
    int    getCurrentPort( ) const;
private:
    string      currentHostName;
    int         currentPort;
```

```

        int                currentSocketDescr;
        SockAddrStruct     serverAddress;
        HostInfoStruct *  currentHostInfo;
        bool               clientIsConnected;
        int                receiveBufferSize;
};

#include <netdb.h>
#include <netinet/in.h>
#include <unistd.h>
#include "TcpClient.h"
TcpClient::TcpClient()
: currentHostName( "" )
, currentPort( 0 )
, currentSocketDescr( 0 )
, serverAddress ( )
, currentHostInfo( NULL )
, clientIsConnected( false )
, receiveBufferSize( 1024 )
{
}
TcpClient::~~TcpClient()
{
    currentHostInfo = NULL;
}

void TcpClient::connectToServer( string &hostname, int port )
{
    currentHostInfo = gethostbyname( hostname.c_str( ) );
    if( currentHostInfo == NULL )
    {
        currentHostName = "";
        currentPort = 0;
        currentHostInfo = NULL;
        clientIsConnected = false;
        printf("error connecting host\n" );
    }
    currentHostName = hostname;
    currentPort = port;
    currentSocketDescr = socket(AF_INET, SOCK_STREAM, 0);
    if( currentSocketDescr == 0 )
    {
        currentHostName = "";
        currentPort = 0;
        currentHostInfo = NULL;
        clientIsConnected = false;
        printf("can't create socket\n" );
    }
    serverAddress.sin_family = currentHostInfo->h_addrtype;
    serverAddress.sin_port = htons( currentPort );
}

```

```

memcpy( (char *) &serverAddress.sin_addr.s_addr,
currentHostInfo->h_addr_list[0], currentHostInfo->h_length );
if( connect( currentSocketDescr, ( struct sockaddr *) &serverAddress,
sizeof( serverAddress ) ) < 0 )
{
    throw string("can't connect server\n" );
}
clientIsConnected = true;
}
void TcpClient::disconnect( )
{
    if( clientIsConnected )
    {
        close( currentSocketDescr );
    }
    currentSocketDescr = 0;
    currentHostName    = "";
    currentPort        = 0;
    currentHostInfo    = NULL;
    clientIsConnected  = false;
}
void TcpClient::transmit( string &txString )
{
    if( !clientIsConnected )
    {
        throw string("connection must be established before any data can be sent\n");
    }
    char * transmitBuffer = new char[txString.length() +1];
    memcpy( transmitBuffer, txString.c_str(), txString.length() );
    transmitBuffer[txString.length()] = '\n'; //newline is needed!
    if( send( currentSocketDescr, transmitBuffer, txString.length() + 1, 0 ) < 0 )
    {
        throw string("can't transmit data\n");
    }
    delete [] transmitBuffer;
}
void TcpClient::receive( string &rxString )
{
    if( !clientIsConnected )
    {
        throw string("connection must be established before any data can be received\n");
    }
    char * receiveBuffer = new char[receiveBufferSize];
    memset( receiveBuffer, 0, receiveBufferSize );
    bool receiving = true;
    while( receiving )
    {
        int receivedByteCount = recv( currentSocketDescr,
receiveBuffer, receiveBufferSize, 0 );
        if( receivedByteCount < 0 )

```



```

    {
        throw string("error while receiving data\n");
    }
    rxString += string( receiveBuffer );
    receiving = ( receivedByteCount == receiveBufferSize );
}
delete [] receiveBuffer;
}
string TcpClient::getCurrentHostName( ) const
{
    return currentHostName;
}
int TcpClient::getCurrentPort( ) const
{
    return currentPort;
}

```

TelnetClient.cpp

```

#include <iostream>
#include "TcpClient.h"
void printUsage()
{
    cout<<"usage: EthernetRawCommand <server-ip> [scpi-command]"<<endl;
}
int main( int argc, char *argv[] )
{
    int errorCode          = 0; //no error
    bool useSingleCommand = false;
    string singleCommand  = "";
    string hostname       = "";
    int    port           = 5025;
    string input          = "";
    TcpClient client;
    switch( argc )
    {
        case 3:
            useSingleCommand = true;
            singleCommand    = argv[2];
        case 2:
            hostname         = argv[1];
            break;
        default:
            printUsage();
            return(-1);
    }
    try
    {
        client.connectToServer( hostname, port );
        bool terminate = false;

```

```

while( !terminate )
{
    char buffer[1024];
    if( useSingleCommand )
    {
        input = singleCommand; //send string
    }
    else
    {
        cin.getline( buffer, 1024 );
        input = buffer;
        if( input == "end" )
        {
            terminate = true;
        }
    }
    if( !terminate)
    {
        client.transmit( input ); //send string
        int qPos = input.find( "?", 0 );
        //receive string only when needed
        if( qPos > 0 )
        {
            string rcStr = "";
            client.receive( rcStr );
            cout << rcStr << endl;
        }
    }
    if( useSingleCommand )
    {
        terminate = true;
    }
}
}catch( const string errorString )
{
    cout<<errorString<<endl;
}
client.disconnect( );
return errorCode;
}

```

6.3 SCPI Command Structure

SCPI commands consist of a header and, in most cases, one or more parameters. The header and the parameters are separated by a "white space" (ASCII code 0 to 9, 11 to 32 decimal, e.g. blank). The headers may consist of several mnemonics (keywords). Queries are formed by appending a question mark directly to the header.

The commands can be either device-specific or device-independent (common commands). Common and device-specific commands differ in their syntax.

6.3.1 Syntax for Common Commands

Common (= device-independent) commands consist of a header preceded by an asterisk (*), and possibly one or more parameters.

Table 6-2: Examples of common commands

| | | |
|-------|----------------------|---|
| *RST | RESET | Resets the instrument. |
| *ESE | EVENT STATUS ENABLE | Sets the bits of the event status enable registers. |
| *ESR? | EVENT STATUS QUERY | Queries the contents of the event status register. |
| *IDN? | IDENTIFICATION QUERY | Queries the instrument identification string. |

6.3.2 Syntax for Device-Specific Commands



Not all commands used in the following examples are necessarily implemented in the instrument. For demonstration purposes only, assume the existence of the following commands for this section:

- DISPLAY[:WINDow<1...4>]:MAXimize <Boolean>
- FORMat:READings:DATA <type>[,<length>]
- HCOpy:DEvice:COLor <Boolean>
- HCOpy:DEvice:CMAP:COLor:RGB <red>,<green>,<blue>
- HCOpy[:IMMediate]
- HCOpy:ITEM:ALL
- HCOpy:ITEM:LABel <string>
- HCOpy:PAGE:DIMensions:QUADrant [<N>]
- HCOpy:PAGE:ORientation LANDscape | PORTrait
- HCOpy:PAGE:SCALE <numeric value>
- MMEMory:COpy <file_source>,<file_destination>
- SENSE:BANDwidth|BWIDth[:RESolution] <numeric_value>
- SENSE:FREQuency:STOP <numeric value>
- SENSE:LIST:FREQuency <numeric_value>{,<numeric_value>}

- [Long and short form](#)..... 513
- [Numeric Suffixes](#)..... 513
- [Optional Mnemonics](#)..... 513

6.3.2.1 Long and short form

The mnemonics feature a long form and a short form. The short form is marked by upper case letters, the long form corresponds to the complete word. Either the short form or the long form can be entered; other abbreviations are not permitted.

Example:

`HCOPY:DEVIce:COLor ON` is equivalent to `HCOP:DEV:COL ON`.



Case-insensitivity

Upper case and lower case notation only serves to distinguish the two forms in the manual, the instrument itself is case-insensitive.

6.3.2.2 Numeric Suffixes

If a command can be applied to multiple instances of an object, e.g. specific channels or sources, the required instances can be specified by a suffix added to the command. Numeric suffixes are indicated by angular brackets (<1..4>, <n>, <i>) and are replaced by a single value in the command. Entries without a suffix are interpreted as having the suffix 1.

Example:

Definition: `HCOPY:PAGE:DIMensions:QUADrant [<N>]`

Command: `HCOP:PAGE:DIM:QUAD2`

This command refers to the quadrant 2.



Different numbering in remote control

For remote control, the suffix may differ from the number of the corresponding selection used in manual operation. SCPI prescribes that suffix counting starts with 1. Suffix 1 is the default state and used when no specific suffix is specified.

Some standards define a fixed numbering, starting with 0. If the numbering differs in manual operation and remote control, it is indicated for the corresponding command.

6.3.2.3 Optional Mnemonics

Some command systems permit certain mnemonics to be inserted into the header or omitted. These mnemonics are marked by square brackets in the description. The instrument must recognize the long command to comply with the SCPI standard. Some commands are considerably shortened by these optional mnemonics.

Example:

Definition: `HCOPY[:IMMEDIATE]`

Command: `HCOP:IMM` is equivalent to `HCOP`



Optional mnemonics with numeric suffixes

Do not omit an optional mnemonic if it includes a numeric suffix that is relevant for the effect of the command.

Example:

Definition: `DISPlay[:WINDow<1...4>]:MAXimize <Boolean>`

Command: `DISP:MAX ON` refers to window 1.

In order to refer to a window other than 1, you must include the optional `WINDow` parameter with the suffix for the required window.

`DISP:WIND2:MAX ON` refers to window 2.

6.3.3 SCPI Parameters

Many commands are supplemented by a parameter or a list of parameters. The parameters must be separated from the header by a "white space" (ASCII code 0 to 9, 11 to 32 decimal, e.g. blank).

The parameters required for each command and the allowed range of values are specified in the command description.

Allowed parameters are:

- [Numeric Values](#)..... 514
- [Special Numeric Values](#)..... 515
- [Boolean Parameters](#)..... 516
- [Text Parameters](#)..... 516
- [Character Strings](#)..... 516
- [Block Data](#)..... 516

6.3.3.1 Numeric Values

Numeric values can be entered in any form, i.e. with sign, decimal point and exponent. Values exceeding the resolution of the instrument are rounded up or down. The mantissa may comprise up to 255 characters, the exponent must lie inside the value range -32000 to 32000. The exponent is introduced by an "E" or "e". Entry of the exponent alone is not allowed.

Example:

`SENS:FREQ:STOP 1500000 = SENS:FREQ:STOP 1.5E6`

Units

For physical quantities, the unit can be entered. If the unit is missing, the basic unit is used. Allowed unit prefixes are:

- G (giga)
- MA (mega), MOHM, MHZ
- K (kilo)

- M (milli)
- U (micro)
- N (nano)

Example:

```
SENSe:FREQ:STOP 1.5GHz = SENSe:FREQ:STOP 1.5E9
```

Some settings allow relative values to be stated in percent. According to SCPI, this unit is represented by the `PCT` string.

Example:

```
HCOP:PAGE:SCAL 90PCT
```

6.3.3.2 Special Numeric Values

The following mnemonics are special numeric values. In the response to a query, the numeric value is provided.

- **MIN and MAX:** denote the minimum and maximum value.
- **DEF:** denotes a preset value which has been stored in the EPROM. This value conforms to the default setting, as it is called by the `*RST` command.
- **UP and DOWN:** increases or reduces the numeric value by one step. The step width can be specified via an allocated step command for each parameter which can be set via `UP` and `DOWN`.
- **INF and NINF:** INFinity and negative INFinity (NINF) represent the numeric values $9.9E37$ or $-9.9E37$, respectively. `INF` and `NINF` are only sent as instrument responses.
- **NAN:** Not A Number (NAN) represents the value $9.91E37$. `NAN` is only sent as a instrument response. This value is not defined. Possible causes are the division of zero by zero, the subtraction of infinite from infinite and the representation of missing values.

Example:

Setting command: `SENSe:LIST:FREQ MAXimum`

Query: `SENS:LIST:FREQ?`

Response: `3.5E9`



Queries for special numeric values

The numeric values associated to `MAXimum`/`MINimum`/`DEFault` can be queried by adding the corresponding mnemonic after the quotation mark.

Example: `SENSe:LIST:FREQ? MAXimum`

Returns the maximum numeric value as a result.

6.3.3.3 Boolean Parameters

Boolean parameters represent two states. The "ON" state (logically true) is represented by "ON" or a numeric value 1. The "OFF" state (logically untrue) is represented by "OFF" or the numeric value 0. The numeric values are provided as the response for a query.

Example:

Setting command: `HCOPY:DEV:COL ON`

Query: `HCOPY:DEV:COL?`

Response: 1

6.3.3.4 Text Parameters

Text parameters observe the syntactic rules for mnemonics, i.e. they can be entered using a short or long form. Like any parameter, they have to be separated from the header by a white space. In the response to a query, the short form of the text is provided.

Example:

Setting command: `HCOPY:PAGE:ORIENTATION LANDscape`

Query: `HCOPY:PAGE:ORI?`

Response: LAND

6.3.3.5 Character Strings

Strings must always be entered in quotation marks (' or ").

Example:

`HCOPY:ITEM:LABEL "Test1"`

`HCOPY:ITEM:LABEL 'Test1'`

6.3.3.6 Block Data

Block data is a format which is suitable for the transmission of large amounts of data. For example, a command using a block data parameter has the following structure:

```
FORMat:READings:DATA #45168xxxxxxxx
```

The ASCII character # introduces the data block. The next number indicates how many of the following digits describe the length of the data block. In the example the 4 following digits indicate the length to be 5168 bytes. The data bytes follow. During the transmission of these data bytes all end or other control signs are ignored until all bytes are transmitted.

#0 specifies a data block of indefinite length. The use of the indefinite format requires a `NL^END` message to terminate the data block. This format is useful when the length of

the transmission is not known or if speed or other considerations prevent segmentation of the data into blocks of definite length.

6.3.4 Overview of Syntax Elements

The following tables provide an overview of the syntax elements and special characters.

Table 6-3: Syntax elements

| | |
|-----|---|
| : | The colon separates the mnemonics of a command. |
| ; | The semicolon separates two commands of a command line. It does not alter the path. |
| , | The comma separates several parameters of a command. |
| ? | The question mark forms a query. |
| * | The asterisk marks a common command. |
| ' ' | Quotation marks introduce a string and terminate it (both single and double quotation marks are possible). |
| # | The hash symbol introduces binary, octal, hexadecimal and block data. <ul style="list-style-type: none"> • Binary: #B10110 • Octal: #O7612 • Hexa: #HF3A7 • Block: #21312 |
| | A "white space" (ASCII-Code 0 to 9, 11 to 32 decimal, e.g. blank) separates the header from the parameters. |

Table 6-4: Special characters

| | |
|-----|---|
| | <p>Parameters</p> <p>A vertical stroke in parameter definitions indicates alternative possibilities in the sense of "or". The effect of the command differs, depending on which parameter is used.</p> <p>Example:</p> <p>Definition: <code>HCOPY:PAGE:ORIENTATION LANDscape PORtrait</code></p> <p>Command <code>HCOP:PAGE:ORI LAND</code> specifies landscape orientation</p> <p>Command <code>HCOP:PAGE:ORI PORT</code> specifies portrait orientation</p> <p>Mnemonics</p> <p>A selection of mnemonics with an identical effect exists for several commands. These mnemonics are indicated in the same line; they are separated by a vertical stroke. Only one of these mnemonics needs to be included in the header of the command. The effect of the command is independent of which of the mnemonics is used.</p> <p>Example:</p> <p>Definition: <code>SENSE:BANDwidth BWIDTH[:RESolution] <numeric_value></code></p> <p>The two following commands with identical meaning can be created:</p> <p><code>SENS:BAND:RES 1</code></p> <p><code>SENS:BWID:RES 1</code></p> |
| [] | <p>Mnemonics in square brackets are optional and may be inserted into the header or omitted.</p> <p>Example: <code>HCOPY[:IMMEDIATE]</code></p> <p><code>HCOP:IMM</code> is equivalent to <code>HCOP</code></p> |
| { } | <p>Parameters in curly brackets are optional and can be inserted once or several times, or omitted.</p> <p>Example: <code>SENSE:LIST:FREQUENCY <numeric_value>{,<numeric_value>}</code></p> <p>The following are valid commands:</p> <p><code>SENS:LIST:FREQ 10</code></p> <p><code>SENS:LIST:FREQ 10,20</code></p> <p><code>SENS:LIST:FREQ 10,20,30,40</code></p> |

6.3.5 Structure of a Command Line

A command line may consist of one or several commands. It is terminated by one of the following:

- <New Line>
- <New Line> with EOI
- EOI together with the last data byte

Several commands in a command line must be separated by a semicolon ";".

Example:

```
MMEM:COPY "Test1","MeasurementXY";:HCOP:ITEM ALL
```

This command line contains two commands. The first command belongs to the MMEM system, the second command belongs to the HCOP system. If the next command belongs to a different command system, the semicolon is followed by a colon.

Example:

```
HCOP:ITEM ALL;:HCOP:IMM
```

This command line contains two commands. Both commands are part of the `HCOP` command system, i.e. they have one level in common.

If the successive commands belong to the same system, having one or several levels in common, the command line can be abbreviated. When abbreviating the command line, the second command begins with the level below `HCOP`. The colon after the semi-colon is omitted. The abbreviated form of the command line reads as follows:

```
HCOP:ITEM ALL;IMM
```

Example:

```
HCOP:ITEM ALL
```

```
HCOP:IMM
```

A new command line always begins with the complete path.

6.3.6 Responses to Queries

A query is defined for each setting command unless explicitly specified otherwise. It is formed by adding a question mark to the associated setting command. According to SCPI, the responses to queries are partly subject to stricter rules than in standard IEEE 488.2.

- The requested parameter is transmitted without a header.
Example: `HCOP:PAGE:ORI?`, **Response:** `LAND`
- Maximum values, minimum values and all other quantities that are requested via a special text parameter are returned as numeric values.
Example: `SENSe:FREQuency:STOP? MAX`, **Response:** `3.5E9`
- Numeric values are output without a unit. Physical quantities are referred to the basic units or to the units set using the `Unit` command. The response `3.5E9` in the previous example stands for 3.5 GHz.
- Truth values (Boolean values) are returned as 0 (for OFF) and 1 (for ON).
Example:
Setting command: `HCOPy:DEV:COL ON`
Query: `HCOPy:DEV:COL?`
Response: `1`
- Text (character data) is returned in a short form.
Example:
Setting command: `HCOPy:PAGE:ORIENTATION LANDscape`
Query: `HCOP:PAGE:ORI?`
Response: `LAND`
- Invalid numerical results
In some cases, particularly when a result consists of multiple numeric values, invalid values are returned as `9.91E37` (not a number).

6.4 Command Sequence and Synchronization

IEEE 488.2 defines a distinction between overlapped and sequential commands:

- A sequential command is one which finishes executing before the next command starts executing. Commands that are processed quickly are implemented as sequential commands. Sequential commands are not implemented in the instrument, however the execution time of most commands is so short that they act as sequential commands when sent in different command lines.
- An overlapping command is one which does not automatically finish executing before the next command starts executing. Usually, overlapping commands take longer to process and allow the program to do other tasks while being executed. If overlapping commands do have to be executed in a defined order, e.g. in order to avoid wrong measurement results, they must be serviced sequentially. Keeping the order is called synchronization between the controller and the instrument.

Setting commands within one command line, even though they can be implemented as sequential commands, are not necessarily serviced in the order in which they have been received. To make sure that commands are actually executed in a certain order, each command must be sent in a separate command line.

Example: Commands and queries in one message

The response to a query combined in a program message with commands that affect the queried value is not predictable.

The following commands always return the specified result:

```
:FREQ:STAR 1GHZ;SPAN 100 :FREQ:STAR?
```

Result:

```
1000000000 (1 GHz)
```

Whereas the result for the following commands is not specified by SCPI:

```
:FREQ:STAR 1GHz;STAR?;SPAN 1000000
```

The result could be the value of `START` before the command was sent since the instrument can defer executing the individual commands until a program message terminator is received. The result could also be 1 GHz if the instrument executes commands as they are received.



As a general rule, send commands and queries in different program messages.

Example: Overlapping command with *OPC

The instrument implements `INITiate[:IMMEDIATE]` as an overlapped command. Assuming that `INITiate[:IMMEDIATE]` takes longer to execute than `*OPC`, sending the following command sequence results in initiating a sweep and, after some time, setting the `OPC` bit in the `ESR`:

```
INIT; *OPC.
```

Sending the following commands still initiates a sweep:

```
INIT; *OPC; *CLS
```

However, since the operation is still pending when the instrument executes `*CLS`, forcing it into the "Operation Complete Command Idle" state (OCIS), `*OPC` is effectively skipped. The `OPC` bit is not set until the instrument executes another `*OPC` command.

Example: Overlapped command followed by non-conflicting commands

Suppose that the instrument is switched on to provide a real time test signal that requires some calculation time. At the same time, some settings for the configuration of a different signal are made which do not interact with the generated signal (e.g. the signal can be used later on). The signal generation and the signal configuration are independent from each other, so none of the following overlapped commands need to be synchronized:

```
SOUR:BB:3GPP:STAT ON
SOUR:BB:GSM:FORM FSK2
```

6.4.1 Preventing Overlapping Execution

To prevent an overlapping execution of commands, one of the commands `*OPC`, `*OPC?` or `*WAI` can be used. All three commands cause a certain action only to be carried out after the hardware has been set. The controller can be forced to wait for the corresponding action to occur.

Table 6-5: Synchronization using *OPC, *OPC? and *WAI

| Com-mand | Action | Programming the controller |
|----------|--|---|
| *OPC | Sets the Operation Complete bit in the ESR after all previous commands have been executed. | <ul style="list-style-type: none"> Setting bit 0 in the ESE Setting bit 5 in the SRE Waiting for service request (SRQ) |
| *OPC? | Stops command processing until 1 is returned. This occurs when all pending operations are completed. | Send *OPC? directly after the command whose processing must be terminated before other commands can be executed. |
| *WAI | Stops further command processing until all commands sent before *WAI have been executed. | Send *WAI directly after the command whose processing must be terminated before other commands are executed. |

Command synchronization using `*WAI` or `*OPC?` is a good choice if the overlapped command takes only little time to process. The two synchronization commands simply block overlapped execution of the command. Append the synchronization command to the overlapping command, for example:

SINGLE; *OPC?

For time consuming overlapped commands, you can allow the controller or the instrument to do other useful work while waiting for command execution. Use one of the following methods:

***OPC with a service request**

1. Set the OPC mask bit (bit no. 0) in the ESE: *ESE 1
2. Set bit no. 5 in the SRE: *SRE 32 to enable ESB service request.
3. Send the overlapped command with *OPC .
4. Wait for a service request.

The service request indicates that the overlapped command has finished.

***OPC? with a service request**

1. Set bit no. 4 in the SRE: *SRE 16 to enable MAV service request.
2. Send the overlapped command with *OPC?.
3. Wait for a service request.

The service request indicates that the overlapped command has finished.

Event status register (ESE)

1. Set the OPC mask bit (bit no. 0) in the ESE: *ESE 1
2. Send the overlapped command without *OPC, *OPC? or *WAI.
3. Poll the operation complete state periodically (with a timer) using the sequence: *OPC; *ESR?

A return value (LSB) of 1 indicates that the overlapped command has finished.

6.5 Status Reporting System

The status reporting system stores all information on the current operating state of the instrument, and on errors which have occurred. This information is stored in the status registers and in the error queue.

6.5.1 Hierarchy of the Status Registers

The [Figure 6-1](#) shows the hierarchical structure of information in the status registers (ascending from left to right).

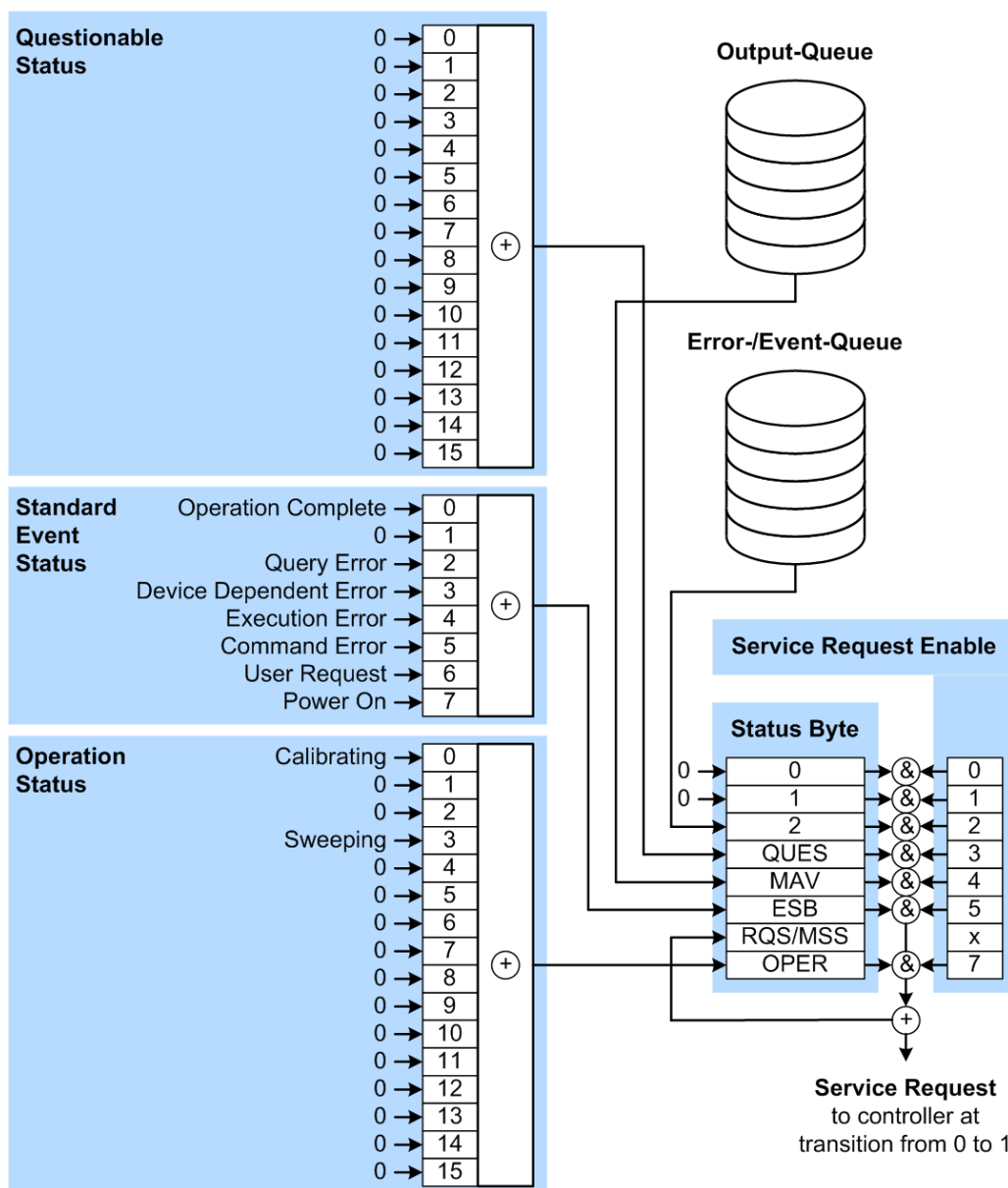

Figure 6-1: Graphical overview of the status registers hierarchy

- OPER = Operation Status Summary Bit
- RQS/MSS = Service Request Generation
- ESB = Standard Event Status Summary Bit
- MAV = Message Available in Output Queue
- QUES = Questionable Status Summary Bit
- 2 = Error- /Event-Queue
- 1, 0 = not used

Note: This legend explains the abbreviations to the Status Byte Register.

The R&S SMBV uses the following status registers:

- **Status Byte (STB)** and **Service Request Enable (SRE)**, see [Chapter 6.5.3, "Status Byte \(STB\) and Service Request Enable Register \(SRE\)"](#), on page 526.

- **Standard Event Status**, i.e. the Event status Register (ESR) and the Event Status Enable (ESE), see [Chapter 6.5.4, "Event Status Register \(ESR\) and Event Status Enable Register \(ESE\)"](#), on page 527.
- **Questionable Status and Operation Status**, the (SCPI status registers, see [Chapter 6.5.2, "Structure of a SCPI Status Register"](#), on page 524, [Chapter 6.5.5, "Questionable Status Register \(STATus:QUEStionable\)"](#), on page 528 and [Chapter 6.5.6, "Operation Status Register \(STATus:OPERation\)"](#), on page 528.
- **Output-Queue**
The output queue contains the messages the instrument returns to the controller. It is not part of the status reporting system but determines the value of the `MAV` bit in the `STB` and thus is represented in the overview.
- **Error- /Event-Queue**
The error-/event-queue contains all errors and events that have occurred in the past. When reading the queue, the instrument starts with the first occurred error/event.

All status registers have the same internal structure.



SRE, ESE

The service request enable register `SRE` can be used as `ENABLE` part of the `STB` if the `STB` is structured according to SCPI. By analogy, the `ESE` can be used as the `ENABLE` part of the `ESR`.

6.5.2 Structure of a SCPI Status Register

Each standard SCPI register consists of 5 parts. Each part has a width of 16 bits and has different functions. The individual bits are independent of each other, i.e. each hardware status is assigned a bit number which is valid for all five parts. Bit 15 (the most significant bit) is set to zero for all parts. Thus the contents of the register parts can be processed by the controller as positive integers.

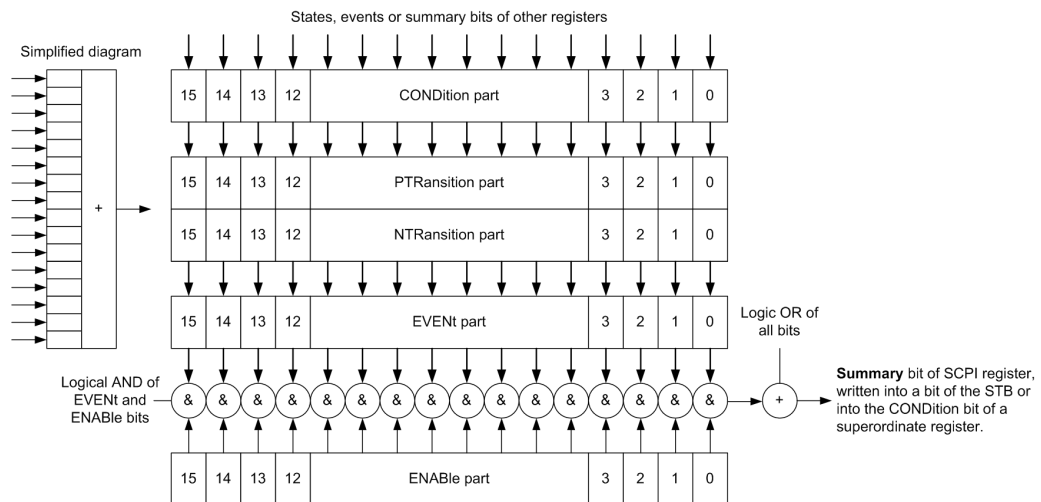

Figure 6-2: The status-register model

Description of the five status register parts

The five parts of a SCPI register have different properties and functions:

- **CONDition**

The **CONDition** part is written into directly by the hardware or the sum bit of the next lower register. Its contents reflect the current instrument status. This register part can only be read, but not written into or cleared. Its contents are not affected by reading.

- **PTRansition / NTRansition**

The two transition register parts define which state transition of the **CONDition** part (none, 0 to 1, 1 to 0 or both) is stored in the **EVENT** part.

The **Positive-TRansition** part acts as a transition filter. When a bit of the **CONDition** part is changed from 0 to 1, the associated **PTR** bit decides whether the **EVENT** bit is set to 1.

- **PTR** bit =1: the **EVENT** bit is set.
- **PTR** bit =0: the **EVENT** bit is not set.

This part can be written into and read as required. Its contents are not affected by reading.

The **Negative-TRansition** part also acts as a transition filter. When a bit of the **CONDition** part is changed from 1 to 0, the associated **NTR** bit decides whether the **EVENT** bit is set to 1.

- **NTR** bit =1: the **EVENT** bit is set.
- **NTR** bit =0: the **EVENT** bit is not set.

This part can be written into and read as required. Its contents are not affected by reading.

- **EVENT**

The **EVENT** part indicates whether an event has occurred since the last reading, it is the "memory" of the condition part. It only indicates events passed on by the transition filters. It is permanently updated by the instrument. This part can only be

read by the user. Reading the register clears it. This part is often equated with the entire register.

- **ENABLE**

The `ENABLE` part determines whether the associated `EVENT` bit contributes to the sum bit (see below). Each bit of the `EVENT` part is "ANDed" with the associated `ENABLE` bit (symbol '&'). The results of all logical operations of this part are passed on to the sum bit via an "OR" function (symbol '+').

`ENABLE` bit = 0: the associated `EVENT` bit does not contribute to the sum bit

`ENABLE` bit = 1: if the associated `EVENT` bit is "1", the sum bit is set to "1" as well.

This part can be written into and read by the user as required. Its contents are not affected by reading.

Sum bit

The sum bit is obtained from the `EVENT` and `ENABLE` part for each register. The result is then entered into a bit of the `CONDition` part of the higher-order register.

The instrument automatically generates the sum bit for each register. Thus an event can lead to a service request throughout all levels of the hierarchy.

6.5.3 Status Byte (STB) and Service Request Enable Register (SRE)

The `STatus Byte` (STB) is already defined in IEEE 488.2. It provides a rough overview of the instrument status by collecting the pieces of information of the lower registers. A special feature is that bit 6 acts as the sum bit of the remaining bits of the status byte.

The STB is read using the command `*STB?` or a serial poll.

The `STatus Byte` (STB) is linked to the `Service Request Enable` (SRE) register. Each bit of the STB is assigned a bit in the SRE. Bit 6 of the SRE is ignored. If a bit is set in the SRE and the associated bit in the STB changes from 0 to 1, a service request (SRQ) is generated. The SRE can be set using the command `*SRE` and read using the command `*SRE?`.

Table 6-6: Meaning of the bits used in the status byte

| Bit No. | Meaning |
|---------|--|
| 0...1 | Not used |
| 2 | Error Queue not empty The bit is set when an entry is made in the error queue. If this bit is enabled by the SRE, each entry of the error queue generates a service request. Thus an error can be recognized and specified in greater detail by polling the error queue. The poll provides an informative error message. This procedure is to be recommended since it considerably reduces the problems involved with remote control. |
| 3 | QUEStionable status register summary bit The bit is set if an <code>EVENT</code> bit is set in the <code>QUEStionable</code> status register and the associated <code>ENABLE</code> bit is set to 1. A set bit indicates a questionable instrument status, which can be specified in greater detail by querying the <code>STatus:QUEStionable</code> status register. |

| Bit No. | Meaning |
|---------|--|
| 4 | MAV bit (message available) The bit is set if a message is available in the output queue which can be read. This bit can be used to enable data to be automatically read from the instrument to the controller. |
| 5 | ESB bit Sum bit of the event status register. It is set if one of the bits in the event status register is set and enabled in the event status enable register. Setting of this bit indicates a serious error which can be specified in greater detail by polling the event status register. |
| 6 | MSS bit (master status summary bit) The bit is set if the instrument triggers a service request. This is the case if one of the other bits of this registers is set together with its mask bit in the service request enable register SRE. |
| 7 | STATUS:OPERation status register summary bit The bit is set if an EVENT bit is set in the OPERATION status register and the associated ENABLE bit is set to 1. A set bit indicates that the instrument is just performing an action. The type of action can be determined by querying the STATUS:OPERation status register. |

6.5.4 Event Status Register (ESR) and Event Status Enable Register (ESE)

The ESR is defined in IEEE 488.2. It can be compared with the EVENT part of a SCPI register. The event status register can be read out using command *ESR?.

The ESE corresponds to the ENABLE part of a SCPI register. If a bit is set in the ESE and the associated bit in the ESR changes from 0 to 1, the ESB bit in the STB is set. The ESE register can be set using the command *ESE and read using the command *ESE?.

Table 6-7: Meaning of the bits used in the event status register

| Bit No. | Meaning |
|---------|---|
| 0 | Operation Complete This bit is set on receipt of the command *OPC exactly when all previous commands have been executed. |
| 1 | Not used |
| 2 | Query Error This bit is set if either the controller wants to read data from the instrument without having sent a query, or if it does not fetch requested data and sends new instructions to the instrument instead. The cause is often a query which is faulty and hence cannot be executed. |
| 3 | Device-dependent Error This bit is set if a device-dependent error occurs. An error message with a number between -300 and -399 or a positive error number, which denotes the error in greater detail, is entered into the error queue. |
| 4 | Execution Error This bit is set if a received command is syntactically correct but cannot be performed for other reasons. An error message with a number between -200 and -300, which denotes the error in greater detail, is entered into the error queue. |

| Bit No. | Meaning |
|---------|---|
| 5 | Command Error This bit is set if a command is received, which is undefined or syntactically incorrect. An error message with a number between -100 and -200, which denotes the error in greater detail, is entered into the error queue. |
| 6 | User Request This bit is set when the instrument is switched over to manual control. |
| 7 | Power On (supply voltage on) This bit is set on switching on the instrument. |

6.5.5 Questionable Status Register (STATus:QUESTIONable)

This register contains information on questionable instrument states. Such states may occur when the instrument is not operated in compliance with its specifications.

Table 6-8: Meaning of the bits used in the questionable status register

| Bit No. | Meaning |
|---------|----------|
| 0–15 | Not used |

6.5.6 Operation Status Register (STATus:OPERation)

This condition part contains information on the actions currently being performed by the instrument, while the event part contains information on the actions performed by the instrument since the last readout of the register.

Table 6-9: Meaning of the bits used in the operation status register

| Bit No. | Meaning |
|---------|---|
| 0 | Calibrating The bit is set during the calibration phase. |
| 1–2 | Not used |
| 3 | |
| 4–15 | Not used |

6.5.7 Application of the Status Reporting System

The purpose of the status reporting system is to monitor the status of one or several devices in a measuring system. To do this and react appropriately, the controller must receive and evaluate the information of all devices. The following standard methods are used:

- **Service request** (SRQ) initiated by the instrument
- **Serial poll** of all devices in the bus system, initiated by the controller to find out who sent an SRQ and why

- Query of a **specific instrument status** by commands
- Query of the **error queue**

6.5.7.1 Service Request

Under certain circumstances, the instrument can send a service request (SRQ) to the controller. Usually this service request initiates an interrupt at the controller, to which the control program can react appropriately. An SRQ is always initiated if one or several of bits 2, 4 or 5 of the status byte are set and enabled in the SRE. Each of these bits combines the information of the error queue or the output buffer. To use the possibilities of the service request effectively, all bits should be set to "1" in the enable registers SRE and ESE.

Example:

Use command `*OPC` to generate an SRQ .

`*ESE 1` - set bit 0 of ESE (Operation Complete)

`*SRE 32` - set bit 5 of SRE (ESB).

After its settings have been completed, the instrument generates an SRQ.

The SRQ is the only possibility for the instrument to become active on its own. Each controller program should set the instrument such that a service request is initiated in the case of malfunction. The program should react appropriately to the service request.

6.5.7.2 Serial Poll

In a serial poll, just as with command `*STB`, the status byte of an instrument is queried. However, the query is realized via interface messages and is thus clearly faster.

The serial poll method is defined in IEEE 488.1 and used to be the only standard possibility for different instruments to poll the status byte. The method also works for instruments which do not adhere to SCPI or IEEE 488.2.

The serial poll is mainly used to obtain a fast overview of the state of several instruments connected to the controller.

6.5.7.3 Query of an instrument status

Each part of any status register can be read using queries. There are two types of commands:

- The common commands `*ESR?`, `*IDN?`, `*IST?`, `*STB?` query the higher-level registers.
- The commands of the `STATus` system query the SCPI registers (`STATus:QUEStionable...`)

The returned value is always a decimal number that represents the bit pattern of the queried register. This number is evaluated by the controller program.

Queries are usually used after an SRQ in order to obtain more detailed information on the cause of the SRQ.

6.5.7.4 Error Queue

Each error state in the instrument leads to an entry in the error queue. The entries of the error queue are detailed plain text error messages that can be looked up in the Error Log or queried via remote control using `SYSTem:ERRor[:NEXT]?`. Each call of `SYSTem:ERRor[:NEXT]?` provides one entry from the error queue. If no error messages are stored there any more, the instrument responds with 0, "No error".

The error queue should be queried after every SRQ in the controller program as the entries describe the cause of an error more precisely than the status registers. Especially in the test phase of a controller program the error queue should be queried regularly since faulty commands from the controller to the instrument are recorded there as well.

6.5.8 Reset Values of the Status Reporting System

The following table contains the different commands and events causing the status reporting system to be reset. None of the commands, except of `*RST` and `SYSTem:PRESet` affect the functional instrument settings. In particular, `DCL` does not change the instrument settings.

Table 6-10: Resetting the status reporting system

| Event | Switching on supply voltage Power-On-Status-Clear | | DCL, SDC (Device Clear, Selected Device Clear) | *RST or SYSTem: PRESet | STATus: PRESet | *CLS |
|---|--|-----|---|------------------------------|-------------------|------|
| | 0 | 1 | | | | |
| Clear STB, ESR | - | Yes | - | - | - | Yes |
| Clear SRE, ESE | - | Yes | - | - | - | - |
| Clear PPE | - | Yes | - | - | - | - |
| Clear error queue | Yes | Yes | - | - | - | Yes |
| Clear output buffer | Yes | Yes | Yes | 1) | 1) | 1) |
| Clear command processing and input buffer | Yes | Yes | Yes | - | - | - |

1) The first command in a command line that immediately follows a <PROGRAM MESSAGE TERMINATOR> clears the output buffer.

6.6 General Programming Recommendations

Initial instrument status before changing settings

Manual operation is designed for maximum possible operating convenience. In contrast, the priority of remote control is the "predictability" of the instrument status. Thus, when a command attempts to define incompatible settings, the command is ignored and the instrument status remains unchanged, i.e. other settings are not automatically adapted. Therefore, control programs should always define an initial instrument status (e.g. using the *RST command) and then implement the required settings.

Command sequence

As a general rule, send commands and queries in different program messages. Otherwise, the result of the query may vary depending on which operation is performed first (see also Preventing Overlapping Execution).

Reacting to malfunctions

The service request is the only possibility for the instrument to become active on its own. Each controller program should instruct the instrument to initiate a service request in case of malfunction. The program should react appropriately to the service request.

Error queues

The error queue should be queried after every service request in the controller program as the entries describe the cause of an error more precisely than the status registers. Especially in the test phase of a controller program the error queue should be queried regularly since faulty commands from the controller to the instrument are recorded there as well.

7 Remote Control Commands

In the following, all remote-control commands will be presented in detail with their parameters and the ranges of numerical values.

For an introduction to remote control and the status registers, refer to [Chapter 6, "Remote Control Basics"](#), on page 487.

7.1 Conventions used in SCPI Command Descriptions

Note the following conventions used in the remote command descriptions:

- **Command usage**
If not specified otherwise, commands can be used both for setting and for querying parameters.
If a command can be used for setting or querying only, or if it initiates an event, the usage is stated explicitly.
- **Parameter usage**
If not specified otherwise, a parameter can be used to set a value and it is the result of a query.
Parameters required only for setting are indicated as **Setting parameters**.
Parameters required only to refine a query are indicated as **Query parameters**.
Parameters that are only returned as the result of a query are indicated as **Return values**.
- **Conformity**
Commands that are taken from the SCPI standard are indicated as **SCPI confirmed**. All commands used by the R&S SMBV follow the SCPI syntax rules.
- **Asynchronous commands**
A command which does not automatically finish executing before the next command starts executing (overlapping command) is indicated as an **Asynchronous command**.
- **Reset values (*RST)**
Default parameter values that are used directly after resetting the instrument (*RST command) are indicated as ***RST** values, if available.
- **Factory preset values**
Default parameter values that are reset only by factory preset.
- **Default unit**
The default unit is used for numeric values if no other unit is provided with the parameter.
- **Manual operation**
If the result of a remote command can also be achieved in manual operation, a link to the description is inserted.

7.2 Common Commands

Common commands are described in the IEEE 488.2 (IEC 625-2) standard. These commands have the same effect and are employed in the same way on different devices. The headers of these commands consist of "*" followed by three letters. Many common commands are related to the Status Reporting System.

Available common commands:

| | |
|------------|-----|
| *CLS..... | 533 |
| *ESE..... | 533 |
| *ESR?..... | 533 |
| *IDN?..... | 534 |
| *IST?..... | 534 |
| *OPC..... | 534 |
| *OPT?..... | 534 |
| *PRE..... | 535 |
| *PSC..... | 535 |
| *RCL..... | 535 |
| *RST..... | 535 |
| *SAV..... | 536 |
| *SRE..... | 536 |
| *STB?..... | 536 |
| *TRG..... | 536 |
| *TST?..... | 537 |
| *WAI..... | 537 |

*CLS

Clear status

Sets the status byte (STB), the standard event register (ESR) and the `EVENT` part of the `QUESTIONABLE` and the `OPERATION` registers to zero. The command does not alter the mask and transition parts of the registers. It clears the output buffer.

Usage: Setting only

*ESE <Value>

Event status enable

Sets the event status enable register to the specified value. The query returns the contents of the event status enable register in decimal form.

Parameters:

<Value> Range: 0 to 255

*ESR?

Event status read

Returns the contents of the event status register in decimal form and then sets the register to zero.

Return values:

<Contents> Range: 0 to 255

Usage: Query only

***IDN?**

Identification

Returns the instrument identification.

Return values:

<ID> "Rohde&Schwarz,<device type>,<part number>/<serial number>,<firmware version>"

Example: Rohde&Schwarz, SMBV100A,
1407.6004K02/102030, 4.00.023

Usage: Query only

Manual operation: See "[Hardware Options / Software Options](#)" on page 124

***IST?**

Individual status query

Returns the contents of the IST flag in decimal form. The IST flag is the status bit which is sent during a parallel poll.

Return values:

<ISTflag> 0 | 1

Usage: Query only

***OPC**

Operation complete

Sets bit 0 in the event status register when all preceding commands have been executed. This bit can be used to initiate a service request. The query writes a "1" into the output buffer when all preceding commands have been executed, which is useful for command synchronization.

***OPT?**

Option identification query

Queries the options included in the instrument. For a list of all available options and their description, refer to the data sheet.

Return values:

<Options> The query returns a list of options. The options are returned at fixed positions in a comma-separated string. A zero is returned for options that are not installed.

Usage: Query only

Manual operation: See "[Hardware Options / Software Options](#)" on page 124

***PRE <Value>**

Parallel poll register enable

Sets parallel poll enable register to the indicated value. The query returns the contents of the parallel poll enable register in decimal form.

Parameters:

<Value> Range: 0 to 255

***PSC <Action>**

Power on status clear

Determines whether the contents of the `ENABLE` registers are preserved or reset when the instrument is switched on. Thus a service request can be triggered when the instrument is switched on, if the status registers ESE and SRE are suitably configured. The query reads out the contents of the "power-on-status-clear" flag.

Parameters:

<Action> 0 | 1
0
 The contents of the status registers are preserved.
1
 Resets the status registers.

***RCL <Number>**

Recall

Loads the instrument settings from an intermediate memory identified by the specified number. The instrument settings can be stored to this memory using the command `*SAV` with the associated number.

It also activates the instrument settings which are stored in a file and loaded using the `MMEMory:LOAD <number>, <file_name.extension>` command.

Manual operation: See "[Recall Immediate x](#)" on page 165

***RST**

Reset

Sets the instrument to a defined default status. The default settings are indicated in the description of commands.

The command is equivalent to `SYSTEM:PRESet`.

Usage: Setting only

Manual operation: See "Preset" on page 118

***SAV** <Number>

Save

Stores the current instrument settings under the specified number in an intermediate memory. The settings can be recalled using the command `*RCL` with the associated number.

To transfer the stored instrument settings in a file, use the command `:MMEM:STOR:STAT`.

Manual operation: See "Save Immediate x" on page 163

***SRE** <Contents>

Service request enable

Sets the service request enable register to the indicated value. This command determines under which conditions a service request is triggered.

Parameters:

<Contents> Contents of the service request enable register in decimal form.
Bit 6 (MSS mask bit) is always 0.
Range: 0 to 255

***STB?**

Status byte query

Reads the contents of the status byte in decimal form.

Usage: Query only

***TRG**

Trigger

Triggers all actions waiting for a trigger event. In particular, `*TRG` generates a manual trigger signal. This common command complements the commands of the `TRIGger` subsystem.

Usage: Event

***TST?**

Self-test query

Initiates self-tests of the instrument and returns an error code.

Return values:

<ErrorCode> **integer > 0 (in decimal format)**
 An error occurred.
 (For details, see the Service Manual supplied with the instrument).

0
 No errors occurred.

Usage: Query only

***WAI**

Wait to continue

Prevents servicing of the subsequent commands until all preceding commands have been executed and all signals have settled (see also command synchronization and [*OPC](#)).**Usage:** Event

7.3 Preset Commands

The preset commands are not bundled in one subsystem. Therefore, they are listed separately in this section. In addition, a specific preset command is provided for each digital standard and for the fader. These specific commands are described in the associated subsystems.

Four presetting actions are available:

- Activating the default state of all internal instrument functions ([*RST](#) on page 535). Functions that concern the integration of the instrument into a measurement setup are not changed, e.g. GPIB address or reference oscillator source settings.
- Activating the preset state of the parameters related to the selected signal path ([:SOURce<hw>:PRESet](#) on page 538)
- Activating the preset state of all parameters that are not related to the signal path ([:DEVIce:PRESet](#) on page 537)
- Activating the original state of delivery (factory reset, [:SYSTem:FPRreset](#) on page 538). Only functions that are protected by a password remain unchanged as well as the passwords themselves.

:DEVIce:PRESet

Presets all parameters which are not related to the signal path, including the LF generator.

Example: Presets all instruments settings that are not related to the signal path

Usage: Event

:SOURce<hw>:PRESet

Presets all parameters which are related to the selected signal path.

The following functions are only preset by command *RST: Fading, transient recorder.

Example: SOUR: PRES
Presets all settings that are related to signal path

Usage: Event

:SYSTem:PRESet

Triggers an instrument reset. It has the same effect as:

- The [PRESET] key.
However, the command does not close open GUI dialogs like the key does.
- The *RST command

For an overview of the settings affected by the preset function, see [Chapter 5.2.2, "Default Instrument Settings - Preset Key"](#), on page 118.

Example: SYST: PRES
All instrument settings (also the settings that are not currently active) are reset to their default values.

Usage: Setting only

:SYSTem:FPReset

Triggers an instrument reset to the original state of delivery.

Note: "Factory Preset" resets the "Remote Channel" and network settings to the default values.

Executing "Factory Preset" via remote control terminates the connection to the instrument, if these settings had been configured to values different to the default ones.

The factory preset function resets nearly all instrument settings. In addition to the regular preset by means of the [PRESET] key, a "Factory Preset" resets also the following values:

- Reference frequency settings ("Ref Oscillator" menu)
- Power on settings ("Level/EMF" menu)
- Network settings including hostname ("Setup" menu)
- Remote channel settings including GPIB address ("Setup" menu)
- Start/Stop display update ("Setup" menu)
- Display and keyboard settings ("Setup" menu).

To maintain security, password settings and all settings protected by these passwords like disabled USB and LAN connections are not changed.

Not affected by the "Factory Preset" are also user data, lists or instrument settings files, created for example by means of the Save/Recall function.

Example: SYST:FPR
All instrument settings (also the settings that are not currently active) are reset to the factory values.

Usage: Event

Manual operation: See "Factory Preset" on page 155

7.4 BERT and BLER Subsystems

These subsystems contain the commands for the bit and block error rate measurement. Since the commands of these two subsystems are essentially identical, they are summarized in the following section (when possible).

| | |
|-----------------------------------|-----|
| :BERT BLER:LOAD..... | 540 |
| :BERT BLER:PRESet..... | 540 |
| :BERT BLER:STORe..... | 540 |
| :BLER:RESult?..... | 540 |
| :BERT:RESult?..... | 542 |
| :BLER:SEQuence..... | 543 |
| :BERT:SEQuence..... | 543 |
| :BLER:SETup:CLOCK[:POLarity]..... | 544 |
| :BERT:SETup:CLOCK[:POLarity]..... | 544 |
| :BLER:SETup:CORDer..... | 544 |
| :BLER:SETup:DATA[:POLarity]..... | 544 |
| :BERT:SETup:DATA[:POLarity]..... | 544 |
| :BLER:SETup:DATA:CONNector..... | 545 |
| :BERT:SETup:DATA:CONNector..... | 545 |
| :BLER:SETup:DENable..... | 545 |
| :BERT:SETup:DENable..... | 545 |
| :BERT:SETup:IGNore..... | 546 |
| :BLER:SETup:MCOunt..... | 546 |
| :BERT:SETup:MCOunt..... | 546 |
| :BLER:SETup:MERRor..... | 547 |
| :BERT:SETup:MERRor..... | 547 |
| :BERT:SETup:RESStart[:STATe]..... | 547 |
| :BERT:SETup:TYPE..... | 547 |
| :BLER:SETup:TYPE..... | 547 |
| :BLER:SETup:TIMeout..... | 548 |
| :BERT:SETup:TIMeout..... | 548 |
| :BLER:START..... | 548 |
| :BERT:START..... | 548 |
| :BLER:STATe..... | 548 |
| :BERT:STATe..... | 548 |

| | |
|-------------------------------------|-----|
| :BLER:STOP..... | 549 |
| :BERT:STOP..... | 549 |
| :BLER:UNIT..... | 549 |
| :BERT:UNIT..... | 549 |
| [:SOURce]:INPut:BERT:IMPedance..... | 549 |
| [:SOURce]:INPut:BERT:THReshold..... | 550 |
| :TRIGger:BLER[:IMMediate]..... | 550 |
| :TRIGger:BERT[:IMMediate]..... | 550 |

:BERT|BLER:LOAD <Filename>

Loads the selected BERT/BLER settings file from the default or the specified directory.

Loaded are files with extension *.ber_bler.

Setting parameters:

| | |
|------------|--------------------------------|
| <Filename> | string |
| | Filename or complete file path |

Usage: Setting only

:BERT|BLER:PRESet

Sets the parameters of the BERT/BLER test generator to their default values.

Usage: Event

:BERT|BLER:STORe <Filename>

Stores the current BERT/BLER settings into the selected file; the file extension is assigned automatically.

Stored are files with extension *.ber_bler.

Setting parameters:

| | |
|------------|--------------------------------|
| <Filename> | string |
| | Filename or complete file path |

Usage: Setting only

:BLER:RESult?

Queries the result of the last BLER measurement. The response consists of seven results separated by commas. In the first measurement following the start, intermediate results for the number of data blocks, errors and error rate are also queried. In the following measurements (only for BLER:SEQ AUTO) only the final results of each single measurement are queried

Note: At the end of a measurement, the restart of a new one is delayed until the first measurement result has been queried with BLER:RES. The resulting brief measurement interruption is irrelevant because the subsequent measurement will be synchronized within 24 data bits.

Return values:**<NumBlock>** integer**<data blocks>**

Number of checked data blocks.

<NumErrors> integer

Number of errors.

<ErrorRate> float

If no termination criterion has been reached since the beginning of the measurement, the current quotient of "Number of errors" and "Number of data blocks" is entered. As soon as at least one final result has been reached in continuous measurement, the most recent final result is entered.

<MeasFinished> integer

Status of measurement.

1 = Measurement has been terminated, i.e. the number of data blocks or errors preset by the commands `BLER:SETup:MCOunt` and `BLER:SETup:MERRor` has been reached, or the measurement has been stopped by the command `BLER:STOP`.

0 = Measurement has not been terminated.

<ClockDetected> integer

Status of clock line.

1 = Clock line active.

0 = Clock line not active.

<DataDetected> integer

Status of data line.

1 = Data line active (only clocked data is detected; if the clock signal is missing, a data change is also not detected).

0 = Data line is not active.

<Synchronized> integer

1 = The measurement is synchronized, i.e. the clock and data lines are active and the "Number of errors" to "Number of data blocks" ratio is better than 0.1, so that the measurement ratio can be assumed to be realistic.

0 = The measurement is not synchronized.

Example:`BLER:RES?`

queries the results of the block error rate measurement.

Response: "1000,5,5E-4,1,1,1,1"

The measurement has been terminated, and synchronization has been performed. Out of 1000 data blocks, 5 error bits were measured, yielding an error rate of 0.005.

Usage:

Query only

Manual operation:See "[Bit Error Rate](#)" on page 190

:BERT:RESult?

Queries the result of the last BER measurement. The response consists of seven results separated by commas. In the first measurement following the start, intermediate results for the number of data bits, error bits and error rate are also queried. In the following measurements (only for `BERT:SEQ AUTO`) only the final results of each single measurement are queried

Note: At the end of a measurement, the restart of a new one is delayed until the first measurement result has been queried with `BERT:RES`. The resulting brief measurement interruption is irrelevant because the subsequent measurement will be synchronized within 24 data bits.

Return values:

| | |
|------------------------------------|---|
| <code><NumDataBits></code> | integer Number of checked data bits. |
| <code><NumErrors></code> | integer Number of error bits. |
| <code><ErrorRate></code> | float If no termination criterion has been reached since the beginning of the measurement, the current quotient of "Number of error bits" and "Number of data bits" is entered. As soon as at least one final result has been reached in continuous measurement, the most recent final result is entered. |
| <code><MeasFinished></code> | integer Status of measurement. 1 = Measurement has been terminated, i.e. the number of data bits or error bits preset by the commands <code>BERT:SETup:MCOunt</code> and <code>BERT:SETup:MERRor</code> has been reached, or the measurement has been stopped by the command <code>BERT:STOP</code> . 0 = Measurement has not been terminated. |
| <code><ClockDetected></code> | integer Status of clock line. 1 = Clock line active. 0 = Clock line not active. |
| <code><DataDetected></code> | integer Status of data line. 1 = Data line active (only clocked data is detected; if the clock signal is missing, a data change is also not detected). 0 = Data line is not active. |

| | |
|-----------------------------|--|
| <Synchronized> | integer 1 = The measurement is synchronized, i.e. the clock and data lines are active and the "Number of error bits" to "Number of data bits" ratio is better than 0.1, so that the measurement ratio can be assumed to be realistic. 0 = The measurement is not synchronized. |
| Example: | BERT:RES? queries the results of the bit error rate measurement. Response: "1000,5,5E-4,1,1,1,1" The measurement has been terminated, and synchronization has been performed. Out of 1000 data bits, 5 error bits were measured, yielding an error rate of 0.005. |
| Usage: | Query only |
| Manual operation: | See " Data Bits " on page 190 |

:BLER:SEQuence <Sequence>

:BERT:SEQuence <Sequence>

Selects the type of measurement: single or continuous measurement.

These commands are automatically set to AUTO by BERT:START or BLER:START.

Parameters:

<Sequence>

AUTO | SINGle

AUTO

Continuous measurement. If one or both termination criteria are met, the measurement in progress is terminated. At the end of a measurement, the restart of a new one is delayed until the first measurement result has been queried with BERT:RES. The resulting brief measurement interruption is irrelevant because the subsequent measurement will be synchronized within 24 data bits.

SIINGle

Single measurement. A single measurement must be started with :TRIG:BERT. A single measurement is terminated once the set number of data bits/blocks or number of errors is reached

*RST: AUTO

Example:

BERT:SEQ SING
selects single measurement.

Example:

TRIG: BERT
starts the single measurement.

Options:

Dependencies: These commands are automatically set to AUTO by BERT:START or BLER:START

Manual operation:

See "[Mode](#)" on page 193

```
:BLER:SETup:CLOCK[:POLarity] <Polarity>
```

```
:BERT:SETup:CLOCK[:POLarity] <Polarity>
```

Sets the polarity of the active slope of the feedback clock.

Parameters:

```
<Polarity>          RiSing | FaLLing
```

RiSing

The positive slope of the clock signal is active.

FaLLing

The negative slope of the clock signal is active.

```
*RST:          RiSing
```

Example:

```
BERT:SET:CLOC FALL
```

selects the falling slope of the clock signal as the active slope.

Manual operation: See "[Clock Slope](#)" on page 194

```
:BLER:SETup:CORDer <COrder>
```

Sets the byte order of the checksum (CRC).

Parameters:

```
<COrder>          LSB | MSB
```

LSB

The checksum starts with the least significant byte.

MSB

The checksum starts with the most significant byte.

```
*RST:          LSB
```

Example:

```
BLER:SET:CORD MSB
```

the checksum starts with the most significant byte.

Manual operation: See "[CRC Order](#)" on page 201

```
:BLER:SETup:DATA[:POLarity] <Polarity>
```

```
:BERT:SETup:DATA[:POLarity] <Polarity>
```

Sets the polarity of the feedback data bits.

Parameters:

```
<Polarity>        NORMal | INVerted
```

NORMal

High level stands for a logic 1, low level for a logic 0.

INVerted

Low level stands for a logic 1, high level for a logic 0.

```
*RST:          NORMal
```

Example:

```
BERT:SET:DATA INV
```

sets inversion of data signal.

Manual operation: See "[Data Polarity](#)" on page 194

:BLER:SETup:DATA:CONNector <Connector>

:BERT:SETup:DATA:CONNector <Connector>

Selects the connector for the data input signal.

You can map the signal either to the TRIGGER, or to the MARKER 1 connector.

Parameters:

<Connector> MRK1 | TRIGger
*RST: TRIGger

Manual operation: See "[Data](#)" on page 203

:BLER:SETup:DENable <DEnable>

:BERT:SETup:DENable <DEnable>

Activates/deactivates the use of the **Data Enable** signal and the polarity of the signal if it is used. The **Data Enable** signal marks the data that is actually to be evaluated for the BER measurement. Any data in addition to the PRBS sequence is masked and thus not evaluated (e.g. sync, preambles, other channels, etc that are present in the data bits supplied by the DUT).

Parameters:

<DEnable> OFF | LOW | HIGH

OFF

Any signal at the **Data Enable** input is ignored; all data at the BERT data input is used for the measurement.

HIGH

The **Data Enable** signal is used. The only data measured is the data at the BERT data input during a high level of the **Data Enable** signal. The measurement is interrupted during a low level of the **Data Enable** signal.

LOW

The **Data Enable** signal is used. The only data measured is the data at the BERT data input during a low level of the **Data Enable** signal. The measurement is interrupted during a high level of the **Data Enable** signal.

*RST: OFF

Example:

BERT:SET:DEN HIGH

The measurement is interrupted during the low level of the **Data Enable** input.

Manual operation: See "[Data Enable](#)" on page 195

:BERT:SETup:IGNore <Ignore>

Activates/deactivates ignoring of pure "0" or "1" bit sequences at least 32 bits long. Activating excludes faulty frames from the measurement. In the case of some mobile radio standards, pure "0" or "1" bit sequences are generated when errors (e.g. an incorrect checksum) are detected within a frame. These sequences, instead of the frame data, are provided for the BER measurement and signal that the frame in question should not be used for the measurement.

Parameters:

<Ignore> OFF | ZERO | ONE

OFF

Pattern Ignore is not active.

ONE

Bit sequences consisting of 32 or more consecutive "1" data are not used (i.e. ignored) for the BER measurement.

ZERO

Bit sequence consisting of 32 or more consecutive "0" data are not used (i.e. ignored) for the BER measurement.

*RST: OFF

Example:

BERT:SET:IGN ONE

specifies that bit sequences of "1" data at least 32 bits long are not used for the measurement.

Manual operation: See "[Pattern Ignore](#)" on page 196

:BLER:SETup:MCOunt <MCount>**:BERT:SETup:MCOunt** <MCount>

Enters the number of transmitted data bits/data blocks to be checked before the measurement is terminated. With a BER measurement, data that was suppressed by BERT:SETup:DENable is not counted. This termination criterion always terminates the measurement after the specified number of data bits/data blocks. Starting from this point, the fourth value is output with 1 (= terminate measurement) if the result is queried with :BERT|BLER:RES. If the continuous measurement mode (BERT|BLER:SEQ AUTO) has been selected, the measurement is restarted once the results have been queried.

Parameters:

<MCount> integer

Range: 0 to 4294967295

*RST: 1E7

Example:

BERT:SET:MCO 1E6

sets a measurement over 1000000 data bits.

Example:

BLER:SET:MCO 1E3

sets a measurement over 1000 data blocks.

Manual operation: See "[Max Data Bits](#)" on page 193

:BLER:SETup:MERRor <MError>

:BERT:SETup:MERRor <Merror>

Enters the number of errors to occur before the measurement is terminated. This termination criterion always terminates the measurement after the specified number of errors. Starting from this point, the fourth value is output with 1 (= terminate measurement) if the measurement result is queried with `:BERT|BLER:RES`.

Parameters:

<Merror> integer
 Range: 0 to 4294967295
 *RST: 100000

Example: `BERT:SET:MERR 1E4`
 sets a measurement over 1000 errors.

Manual operation: See ["Max Errors"](#) on page 193

:BERT:SETup:REStart[:STATe] <State>

Activates/deactivates an external restart of the BER measurement.

Parameters:

<State> 0 | OFF | 1 | ON
 *RST: 0

Example: `BERT:SET:REST:STAT 1`

Manual operation: See ["External Restart"](#) on page 194

:BERT:SETup:TYPE <Type>

Selects the PRBS sequence. The data generated by the PRBS generator is used as a reference for the measurement.

Parameters:

<Type> PRBS9 | PRBS11 | PRBS15 | PRBS16 | PRBS20 | PRBS21 |
 PRBS23
 *RST: PRBS9

Example: `BERT:SET:TYPE PN15`
 sets a pseudo random binary sequence consisting of 32767 bits.

Manual operation: See ["PRBS"](#) on page 194

:BLER:SETup:TYPE <Type>

Queries the CRC polynomial used. CCITT CRC 16 : $G(x) = x^{16} + x^{12} + x^5 + x^1$ is the CRC polynomial supported.

Parameters:

<Type> CRC16
 *RST: CRC16

Example: `BLER:SET:TYPE`
queries the type of measurement.

Example: Response: `CRC16`

Manual operation: See "[BLER Type](#)" on page 201

:BLER:SETup:TIMEout <Timeout>

:BERT:SETup:TIMEout <Timeout>

Sets the time out.

Parameters:

<Timeout> float
Range: 0.1 to 1
Increment: 0.001
*RST: 0.1

Manual operation: See "[Timeout](#)" on page 197

:BLER:START

:BERT:START

Starts a continuous measurement.

These commands automatically set `BERT:SEQuence` or `BLER:SEQuence` to `AUTO` and `BERT:STATe` or `BLER:STATe` to `ON`.

Example: `BERT:STAR`
starts a continuous measurement.

Usage: Event

Manual operation: See "[Mode](#)" on page 193

:BLER:STATe <State>

:BERT:STATe <State>

Switches the measurement on/off. Depending on the selected mode, either a continuous measurement (`BERT|BLER:SEQ AUTO`) or a single measurement (`BERT|BLER:SEQ SING`) is carried out. A single measurement must be triggered (`:TRIG:BERT|BLER`).

These commands are automatically set to `ON` by `BERT:START` or `BLER:START` and to `OFF` by `BERT:STOP` or `BLER:STOP`.

Parameters:

<State> 0 | 1 | OFF | ON
*RST: 0

Example: `BERT:SEQ SING`
selects a single measurement.
`BERT:STAT ON`
switches the BER measurement on.

Example: TRIG:BERT
starts a single measurement.

Manual operation: See "[State](#)" on page 190

:BLER:STOP

:BERT:STOP

Stops an ongoing measurement.

These commands automatically set BERT:STATe or BLER:STATe to OFF

.

Example: BERT:STOP
stops the measurement. To start a new measurement, the BER measurement must be switched on again by BERT:STATe ON.

Usage: Event

Manual operation: See "[Terminated By](#)" on page 191

:BLER:UNIT <Unit>

:BERT:UNIT <Unit>

Sets the unit for the error rate display on the screen. BERT|BLER:RES always specifies the error rate as the quotient of "Number of errors" and "Number of data items", unaffected by this command.

Parameters:

<Unit> ENgineering | SCientific | PCT | PPM

ENgineering

The error rate is output in exponential notation with the exponent -3 or -6.

SCientific

The error rate is output in scientific notation, i.e. standardized to one place to the left of the decimal.

PCT

The error rate is output in percent.

PPM

The error rate is output in parts per million.

*RST: ENgineering

Example: BERT:UNIT PPM
selects the unit "ppm" for the display of the error rate.

Manual operation: See "[Bit Error Rate](#)" on page 190

[:SOURce]:INPut:BERT:IMPedance <Impedance>

Sets the impedance of the BERT inputs [Clock], [Data], [Data Enable] and [Restart].

Parameters:

<Impedance> G1K | G50 | G10K
 *RST: G1K

Example:

INP:BERT:IMP G50

The impedance of the BERT inputs is set to 50 ohm to ground.

Manual operation: See "[Impedance](#)" on page 196

[:SOURce]:INPut:BERT:THReshold <Threshold>

Sets the high/low threshold of the BERT inputs **Clock, Data, Data Enable** and **Restart**. In the case of positive polarity, this threshold determines the point as of which a signal is high (active) or low (inactive).

Parameters:

<Threshold> float
 Range: 0.01 to 2
 Increment: 0.01
 *RST: 1
 Default unit: Volt

Example:

INP:BERT:THR 1 V

A high/low threshold of 1 volt is set at the BERT inputs. The signal is high (active) for a signal voltage of 1 volt and higher.

Manual operation: See "[Threshold](#)" on page 196

:TRIGger:BLER[:IMMEDIATE]

:TRIGger:BERT[:IMMEDIATE]

Triggers a single bit error rate or block error rate measurement if the single trigger mode (BERT|BLER:SEQ SING) is selected.

Example:

BERT:SEQ SING

selects the single trigger mode.

Example:

TRIG:BERT

starts a single bit error rate measurement.

Usage:

Event

7.5 CALibration Subsystem

The CALibration system contains the commands for performing internal adjustment. Adjustment is triggered by the query commands.

Understanding the query response

- 0: error-free execution of the adjustments
- 1: indicates that an error occurred, the process has been canceled.

Suffix <hw>

| Suffix | Value range | Description |
|-----------------|-------------|-----------------|
| CALibration<hw> | [1] | Optional suffix |

| | |
|--|-----|
| :CALibration:ALL[:MEASure]? | 551 |
| :CALibration<hw>:BBIN[:MEASure]? | 551 |
| :CALibration<hw>:FMOffset[:MEASure]? | 552 |
| :CALibration<hw>:FREQuency[:MEASure]? | 552 |
| :CALibration<hw>:IQModulator:FULL? | 552 |
| :CALibration<hw>:IQModulator:LOCal? | 553 |
| :CALibration<hw>:LEVel:ALCTable[:MEASure]? | 553 |
| :CALibration<hw>:LEVel[:MEASure]? | 553 |
| :CALibration<hw>:LEVel:EXtern:DATA | 554 |
| :CALibration<hw>:LEVel:STATe | 554 |
| :CALibration:ROSCillator[:DATA] | 554 |

:CALibration:ALL[:MEASure]? [<Force>]

Starts all internal adjustments that do not require external measurement equipment.

Query parameters:

<Force> string

Return values:

<Measure> 0 | 1 | OFF | ON

Example:

```
CAL:ALL:MEAS?
// Response "0"
// Adjustment has been performed successfully
```

Usage: Query only

Manual operation: See "[Adjust All](#)" on page 121

:CALibration<hw>:BBIN[:MEASure]?

Starts adjustment of the analog I/Q input. The I/Q input is adjusted with respect to DC offset and gain.

Return values:

<Measure> 0 | 1 | OFF | ON
*RST: 0

Example:

```
CAL:BBIN:MEAS?
starts the adjustment of the analog I/Q input.
Response: 0
adjustment has been performed successfully.
```

Usage: Query only

:CALibration<hw>:FMOffset[:MEASure]?

Starts all adjustment for the FM/PhiM modulator.

Return values:

<Measure> 0 | 1

Example:

CAL:FMOF?

starts the adjustments for the FM/PhiM modulator.

Response: "0"

the adjustments have been performed successfully

Usage:

Query only

Manual operation: See ["Adjust FM Offset"](#) on page 258

:CALibration<hw>:FREQUENCY[:MEASure]?

Starts all adjustments which affect the frequency.

Return values:

<Measure> 0 | 1

Example:

CAL:FREQ:MEAS?

starts the adjustments for maximum frequency accuracy.

Response: "0"

the adjustments have been performed successfully.

Usage:

Query only

Manual operation: See ["Adjust Synthesis"](#) on page 121

:CALibration<hw>:IQModulator:FULL?

Starts adjustment of the I/Q modulator for the entire frequency range. The I/Q modulator is adjusted with respect to carrier leakage, I/Q imbalance and quadrature.

Return values:

<Full> 0 | 1
*RST: 0

Example:

CAL:IQM:FULL?

starts adjustments for the I/Q modulator across the entire frequency range.

Response: "0"

adjustment has been performed successfully

Usage:

Query only

Manual operation: See ["Adjust I/Q Modulator Full Range"](#) on page 121

:CALibration<hw>:IQModulator:LOCal?

Starts adjustment of the I/Q modulator for the currently set frequency, I/Q swap and baseband gain. The I/Q modulator is adjusted with respect to carrier leakage, I/Q imbalance and quadrature.

Return values:

<Local> 0 | 1
 *RST: 0

Example:

CAL:IQM:LOC?
 starts adjustment for the I/Q modulator for the currently set frequency.
 Response: 0
 adjustment has been performed successfully

Usage: Query only

Manual operation: See "[Adjust I/Q Modulator Current Frequency](#)" on page 121

:CALibration<hw>:LEVel:ALCTable[:MEASure]?

Performs ALC adjustments according to the predefined values in the ALC table.

Return values:

<Measure> 0 | 1 | OFF | ON

Example:

CAL:LEV:ALCT:MEAS?
 starts adjustments according to the ALC table.
 Response: "0"
 adjustment has been performed successfully.

Usage: Query only

Manual operation: See "[Adjust ALC Table - ALC](#)" on page 229

:CALibration<hw>:LEVel[:MEASure]? [<Force>]

Starts all adjustments which affect the level.

Query parameters:

<Force> string
 *RST: force

Return values:

<Measure> 0 | 1

Example:

CAL:LEV:MEAS?
 starts adjustments for maximum level accuracy.
 Response: "0"
 adjustment has been performed successfully.

Usage: Query only

Manual operation: See "[Adjust Level](#)" on page 121

:CALibration<hw>:LEVel:EXTern:DATA <Data>

Queries what data has been used for the level calibration.

By default the instrument uses correction data obtained in the factory before delivery. In addition, customer data can be used for external level correction. The customer data is obtained using a R&S NRP power sensor. External level correction is a protected function (see service manual, chapter 2, "Adjustment").

Parameters:

<Data> FACTory | CUSTomer
*RST: FACTory

Example:

CAL:LEV:EXT:DATA FACT
selects the use of the data acquired at the factory for external level correction.

Manual operation: See "[Adjustment Data](#)" on page 226

:CALibration<hw>:LEVel:STATe <State>

Activates internal level correction.

Parameters:

<State> ON | OFF
*RST: ON

Example:

CAL:LEV:STAT
turns on level correction.

:CALibration:ROSCillator[:DATA] <Data>

Sets the calibration value for the custom defined external adjustment.

Parameters:

<Data> integer
Range: 0 to INT_MAX
*RST: 0

7.6 CLOCK Subsystem

The CLOCK system contains the commands for configuration of the signals at the clock output and input connectors.

[:CLOCK:INPut:FREQuency?](#)..... 555
[:CLOCK:INPut:SLOPe](#)..... 555

:CLOCK:INPut:FREQuency?

Queries the measured frequency of the external clock signal. An external clock reference must be supplied at the [CLOCK] input.

Return values:

<Frequency> float
 Range: 0 to max
 Increment: 0.001
 *RST: 0

Example: CLOC:INP:FREQ?
 queries the measured frequency of the external clock reference.

Usage: Query only

Manual operation: See "[Measured External Clock](#)" on page 381

:CLOCK:INPut:SLOPe <Slope>

Sets the active slope of an externally applied clock signal at the [CLOCK] connector.

Parameters:

<Slope> NEGative | POSitive
 *RST: POSitive

Example: CLOC:INP:SLOP NEG
 The active slope of the external clock signal is the falling slope.

Manual operation: See "[Clock Input Slope](#)" on page 141

7.7 DIAGnostic Subsystem

The DIAGnostic system contains the commands used for instrument diagnosis and servicing. SCPI does not define any DIAGnostic commands; the commands listed here are all device-specific. All DIAGnostic commands are query commands which are not influenced by *RST.

| | |
|---|-----|
| :DIAGnostic<hw>:BGINfo? | 555 |
| :DIAGnostic<hw>:BGINfo:CATalog? | 556 |
| :DIAGnostic:INFO:OTIMe? | 556 |
| :DIAGnostic:INFO:POCount? | 557 |

:DIAGnostic<hw>:BGINfo? [<Board>]

Checks the modules available in the instrument using the variant and revision state.

If the command is sent without parameters being specified, a complete list of all modules is returned (the various entries are separated by commas). The length of the list is variable and depends on the instrument equipment configuration.

If the command is sent with parameters, a list of the specified modules is returned (the various entries are separated by commas). A list of modules names can be called up using the command `:DIAGnostic<hw>:BGInfo:CATalog?` on page 556.

Query parameters:

<Board> string

Return values:

<BgInfo> < Module name> <Module stock number incl. variant> <Module revision> <Module serial number>

Each entry for one module consists of four parts which are separated by space characters.

Example:

DIAG:BGIN

Queries the instrument configuration.

Response: MBRD,SSYN,IQOP3,IQOP3_LCM,

Returns the data of all available modules.

DIAG:BGIN? 'MBRD'

Queries the configuration of the motherboard.

Response: MBRD 1141.3501.02 1.5.3 100023

Module motherboard with part number 1141.3501.01 has revision 1.5.3 and serial number 100023.

Usage: Query only

Manual operation: See "[Assembly](#)" on page 122

:DIAGnostic<hw>:BGInfo:CATalog?

Queries the names of the assemblies available in the instrument.

Return values:

<Catalog> string

A complete list of all assemblies is returned (the various entries are separated by commas). The length of the list is variable and depends on the instrument equipment configuration.

Example:

DIAG:BGIN:CAT

Queries the names of the assemblies.

Response: MBRD,SSYN,IQOP3,IQOP3_LCM,

Usage: Query only

:DIAGnostic:INFO:OTIME?

The command queries the number of operation hours.

Return values:

<OTIME> float

Example: DIAG:INFO:OTIM
 queries the operation hours.
 Response: 100023
 The instrument was operated for 100023 hours up to now.

Usage: Query only

Manual operation: See "[Operation Time / h](#)" on page 122

:DIAGnostic:INFO:POCount?

The command queries the number of power-on events.

Return values:

<Pocount> float

Example: DIAG:INFO:POC
 queries the number of power on events.
 Response: 123
 The instrument was switched on for 123 times up to now.

Usage: Query only

Manual operation: See "[Power On Count](#)" on page 122

7.8 DISPlay Subsystem

The DISPlay subsystem contains the commands to set the power-save mode of the instrument.

| | |
|---|-----|
| :DISPlay:ANNotation:AMPLitude | 557 |
| :DISPlay:ANNotation:FREQuency | 558 |
| :DISPlay:ANNotation[:ALL] | 558 |
| :DISPlay:DIALog:CLOSe | 558 |
| :DISPlay:DIALog:CLOSe:ALL | 558 |
| :DISPlay:DIALog:ID? | 558 |
| :DISPlay:DIALog:OPEN | 559 |
| :DISPlay:PSAVe:HOLDoff | 559 |
| :DISPlay:PSAVe[:STATe] | 559 |
| :DISPlay:UPDate | 560 |

:DISPlay:ANNotation:AMPLitude <State>

Indicates asterisks instead of the level values in the status bar.

Parameters:

<State> 0 | 1 | OFF | ON
 *RST: n.a. (factory preset: 1)

Example: DISP:ANN:AMPL ON
 Suppresses the level display.

Manual operation: See "[Annotation Amplitude](#)" on page 152

:DISPlay:ANNotation:FREQuency <State>

Indicates asterisks instead of the frequency values in the status bar.

Parameters:

<State> 0 | 1 | OFF | ON
 *RST: n.a. (factory preset: 1)

Example: DISP:ANN:FREQ ON
 Suppresses the frequency display.

Manual operation: See "[Annotation Frequency](#)" on page 152

:DISPlay:ANNotation[:ALL] <State>

Displays asterisks instead of the level and frequency values in the status bar of the instrument. This setting is useful when you remotely control the instrument.

Parameters:

<State> 0 | 1 | OFF | ON
 *RST: 1

Example: DISP:ANN:AMPL ON
 Shows asterisks instead of frequency and level values.

:DISPlay:DIALog:CLOSe <DialogId>

Closes the specified dialog. To determine the dialog identifier, use command : [DISPlay:DIALog:ID?](#).

Setting parameters:

<DialogId> string

Example: DISP:DIAL:CLOS "<dialog ID>"
 Closes the dialog, determined with the "<dialog ID>".

Usage: Setting only

:DISPlay:DIALog:CLOSe:ALL

Closes all open dialogs.

Example: DISP:DIAL:CLOS:ALL

Usage: Event

:DISPlay:DIALog:ID?

Returns the dialog identifiers of the open dialogs in a string separated by blanks.

Return values:

<DialogIdList> string

Example:

DISP:DIAL:ID?

Response: "<dialog ID(1)> <dialog ID(2)> ...
<dialog ID(n)>"

Returns the dialog identifiers of all opened dialogs.

Usage:

Query only

:DISPlay:DIALog:OPEN <DialogId>

Opens the specified dialog. To determine the dialog identifier, use command :
[DISPlay:DIALog:ID?](#).

Setting parameters:

<DialogId> string

Example:

DISP:DIAL:OPEN "<dialog ID>"

Opens the dialog, determined with the "<dialog ID>".

Usage:

Setting only

:DISPlay:PSAVe:HOLDoff <HoldoffTimeMin>

Sets the waiting time for the screen-save mode of the display.

Parameters:

<HoldoffTimeMin> integer

Range: 1 to 60

*RST: n.a. (factory preset: 10)

Default unit: minute

Example:

DISP:PSAV:HOLD 8

Sets the timeout of the screen saver to 8 minutes.

Manual operation: See "[Wait Time](#)" on page 143

:DISPlay:PSAVe[:STATe] <State>

Activates the screen-save mode of the display.

If activated, the display including backlight is switched off after the wait time elapses and if no entries via front panel, external mouse or external keyboard are made. To set the wait time, use command :[DISPlay:PSAVe:HOLDoff](#).

This mode is recommended for protecting the display, especially if you operate the instrument via remote control.

Parameters:

<State> 0 | 1 | OFF | ON

*RST: n.a. (factory preset: 0)

Example: DISP:PSAV ON
Activates screen saver mode.

Manual operation: See "[Screen Saver Active](#)" on page 142

:DISPlay:UPDate <Update>

Activates the refresh mode of the display.

Parameters:

<Update> 0 | 1 | OFF | ON
*RST: n.a. (factory preset: 1)

Example: DISP:UPD ON
Activates automatic update of the display at defined time intervals.

7.9 FORMat Subsystem

The FORMat subsystem contains the commands which determine the format of the data that the R&S SMBV returns to the controller. This affects all query commands which return a list of numerical data or block data. Reference is made to this in the descriptions of the commands.

| | |
|------------------------|-----|
| :FORMat:BORDER..... | 560 |
| :FORMat[DATA]..... | 561 |
| :FORMat:SREGister..... | 561 |

:FORMat:BORDER <Border>

Determines the sequence of bytes within a binary block. This only affects blocks which use the IEEE754 format internally.

Parameters:

<Border> NORMal | SWAPped

NORMal

The instrument expects (with setting commands) and sends (with queries) the least significant byte of each IEEE754 floating-point number first and the most significant byte last.

SWAPped

The instrument expects (with setting commands) and sends (with queries) the most significant byte of each IEEE754 floating-point number first and the least significant byte last.

*RST: NORMal

Example: FORM:BORD SWAP
The data is transferred with the most significant bit first.

:FORMat[:DATA] <Data>

Determines the data format which the R&S SMBV uses to return data. When data is transferred from the control computer to the instrument, the instrument detects the data format automatically. In this case, the value set here is irrelevant.

Parameters:

<Data> ASCII | PACKed

ASCII

Numerical data is transferred as plain text separated by commas.

PACKed

Numerical data is transferred as binary block data. The format within the binary data depends on the command. The various binary data formats are explained in the description of the parameter types.

*RST: ASCII

Example:

FORM ASC

The data is transferred as ASCII data.

:FORMat:SREGister <Format>

Determines the numerical format which is returned when the status registers are queried.

Parameters:

<Format> ASCII | BINary | HEXadecimal | OCTal

ASCII

The register content is returned as a decimal number.

BINary

The register content is returned as a binary number. #B is placed in front of the number.

HEXadecimal

The register content is returned as a hexadecimal number. #H is placed in front of the number.

OCTal

The register content is returned as an octal number. #Q is placed in front of the number.

*RST: ASCII

Example:

FORM:SREG HEX

The register content is returned as a hexadecimal number.

7.10 HCOPY Subsystem

The `HCOPY` subsystem contains the commands to generate a hardcopy of the display.

Example: Store a hard copy of the display

The following example lists commands to configure and execute a hard copy to an automatic named file.

```
// *****
// Hard copy settings
// *****
:HCOPY:DEVIce:LANGUage PNG
:HCOPY:FILE:NAME:AUTO:STATe 1
// defines the output format
// sets the instrument to automatically create output file names

// *****
// Configure hard copy options, set automatic naming rules
// An automatically generated file name consists of:
// <Prefix><YYYY><MM><DD><Number>.<Format>
// *****
:HCOPY:DEVIce:LANGUage BMP
// defines output format *.bmp
:HCOPY:REGion DIALog
// selects the region to be copied
:HCOPY:FILE:AUTO:DIR "usb/HCopy"
// sets destination directory of automatic named file to "/usb/HCopy"
:HCOPY:FILE:NAME:AUTO:FILE:PREFIx:STATe 1
:HCOPY:FILE:NAME:AUTO:FILE:PREFIx:"hardcopy"
:HCOPY:FILE:NAME:AUTO:FILE:YEAR:STATe 1
:HCOPY:FILE:NAME:AUTO:FILE:MONTH:STATe 1
// uses automatic naming prefix
// sets automatic naming prefix to "hardcopy"
// uses automatic naming date parameters year and month

// *****
// Execute and transfer the hard copy
// *****
:HCOPY:EXECute
:HCOPY:DATA
// generates a hard copy
// transfers the hard copy to the remote client
:HCOPY:FILE:AUTO:FILE?
// queries the automatic file name
// response: "hardcopy1607001.bmp"
:HCOPY:FILE:AUTO:NUMBer?
// queries the number in the automatic file name
// response: "001"
:HCOPY:FILE:AUTO?
// queries the path and file name of the automatically generated file
// response: "/usb/HCopy/hardcopy1607001.bmp"
```

| | |
|--|-----|
| :HCOPY:DATA?..... | 563 |
| :HCOPY:IMAGe:FORMat..... | 563 |
| :HCOPY:DEVice:LANGUage..... | 563 |
| :HCOPY[:EXECute]..... | 563 |
| :HCOPY:FILE[:NAME]..... | 564 |
| :HCOPY:FILE[:NAME]:AUTO?..... | 564 |
| :HCOPY:FILE[:NAME]:AUTO:DIRectory..... | 564 |
| :HCOPY:FILE[:NAME]:AUTO:DIRectory:CLEar..... | 564 |
| :HCOPY:FILE[:NAME]:AUTO:FILE?..... | 565 |
| :HCOPY:FILE[:NAME]:AUTO[:FILE]:DAY:STATe..... | 565 |
| :HCOPY:FILE[:NAME]:AUTO[:FILE]:MONTH:STATe..... | 565 |
| :HCOPY:FILE[:NAME]:AUTO[:FILE]:YEAR:STATe..... | 565 |
| :HCOPY:FILE[:NAME]:AUTO[:FILE]:NUMBer?..... | 565 |
| :HCOPY:FILE[:NAME]:AUTO[:FILE]:PREFix..... | 566 |
| :HCOPY:FILE[:NAME]:AUTO[:FILE]:PREFix:STATe..... | 566 |
| :HCOPY:FILE[:NAME]:AUTO:STATe..... | 566 |
| :HCOPY:REGion..... | 566 |

:HCOPY:DATA?

Transfers the hardcopy data directly as an NByte stream to the remote client.

Return values:

<Data> block data

Example: See [Example "Store a hard copy of the display"](#) on page 562.

Usage: Query only

:HCOPY:IMAGe:FORMat <Format>

:HCOPY:DEVice:LANGUage <Language>

Selects the graphic format for the hard copy. You can use both commands alternatively.

Parameters:

<Language> BMP | JPG | XPM | PNG
 *RST: PNG

Example: See [Example "Store a hard copy of the display"](#) on page 562.

Manual operation: See "[File Options](#)" on page 158

:HCOPY[:EXECute]

Generates a hard copy of the current display. The output destination is a file.

The data is written into the file selected/created with the `HCOPY:FILE` commands.

Example: See [Example "Store a hard copy of the display"](#) on page 562.

Usage: Event

Manual operation: See "[Save](#)" on page 159

:HCOPY:FILE[:NAME] <Name>

Determines the file name and path to save the hard copy, provided automatic naming is disabled.

Note: If you have enabled automatic naming, the instrument automatically generates the file name and directory.

Parameters:

<Name> string

Example: See [Example "Store a hard copy of the display"](#) on page 562.

Manual operation: See ["File Info"](#) on page 157

:HCOPY:FILE[:NAME]:AUTO?

Queries path and file name of the hard copy file, if you have enabled *Automatic Naming*.

Return values:

<Auto> string

Example: See [Example "Store a hard copy of the display"](#) on page 562.

Usage: Query only

Manual operation: See [" File Options "](#) on page 158

:HCOPY:FILE[:NAME]:AUTO:DIRectory <Directory>

Determines the path to save the hard copy, if you have enabled *Automatic Naming*.

If the directory does not exist, the instrument automatically generates a new directory, using the instrument name and /var/user/ by default.

Parameters:

<Directory> string
*RST: /var/user/

Example: See [Example "Store a hard copy of the display"](#) on page 562.

Manual operation: See [" File Options "](#) on page 158

:HCOPY:FILE[:NAME]:AUTO:DIRectory:CLEar

Deletes all files with extensions *.bmp, *.jpg, *.png and *.xpm in the directory set for automatic naming.

Example: See [Example "Store a hard copy of the display"](#) on page 562.

Usage: Event

Manual operation: See [" File Options "](#) on page 158

:HCOPY:FILE[:NAME]:AUTO:FILE?

Queries the name of the automatically named hard copy file.

An automatically generated name consists of:

<Prefix><YYYY><MM><DD><Number>.<Format>.

You can activate each component separately, to individually design the file name.

Return values:

<File> string

Example: See [Example "Store a hard copy of the display"](#) on page 562.

Usage: Query only

Manual operation: See ["File Info"](#) on page 157

:HCOPY:FILE[:NAME]:AUTO[:FILE]:DAY:STATe <State>**:HCOPY:FILE[:NAME]:AUTO[:FILE]:MONTH:STATe <State>****:HCOPY:FILE[:NAME]:AUTO[:FILE]:YEAR:STATe <State>**

Uses the date parameters (day, month or year) for the automatic naming. You can activate each parameter separately.

Parameters:

<State> 0 | 1 | OFF | ON

*RST: 1

Example: See [Example "Store a hard copy of the display"](#) on page 562.

Manual operation: See ["File Options"](#) on page 158

:HCOPY:FILE[:NAME]:AUTO[:FILE]:NUMBer?

Queries the number that is used as part of the file name for the next hard copy in automatic mode.

At the beginning, the count starts at 0. The R&S SMBV searches the specified output directory for the highest number in the stored files. It increases this number by one to achieve a unique name for the new file.

The resulting auto number is appended to the resulting file name with at least three digits.

Return values:

<Number> integer

Range: 0 to 999999

*RST: 0

Example: See [Example "Store a hard copy of the display"](#) on page 562.

Usage: Query only

Manual operation: See ["File Options"](#) on page 158

:HCOPY:FILE[:NAME]:AUTO[:FILE]:PREFIX <Prefix>

Defines the prefix part in the automatic file name. The usage of the prefix is activated with command `HCOP:FILE:AUTO:PREFIX:STAT 1`

Parameters:

<Prefix> string

Example: See [Example "Store a hard copy of the display"](#) on page 562.

Manual operation: See "[File Options](#)" on page 158

:HCOPY:FILE[:NAME]:AUTO[:FILE]:PREFIX:STATE <State>

Uses the prefix for the generation of the automatic filename, provided *Automatic Naming* is activated.

Parameters:

<State> 0 | 1 | OFF | ON

*RST: 1

Example: See [Example "Store a hard copy of the display"](#) on page 562.

Manual operation: See "[File Options](#)" on page 158

:HCOPY:FILE[:NAME]:AUTO:STATE <State>

Activates automatic naming of the hard copy files.

Parameters:

<State> 0 | 1 | OFF | ON

*RST: 1

Example: See [Example "Store a hard copy of the display"](#) on page 562.

Manual operation: See "[Automatic Naming](#)" on page 157

:HCOPY:REGion <Region>

Selects the area to be copied.

You can create a snapshot of the screen or an active dialog.

Parameters:

<Region> ALL | DIALog

*RST: ALL

Example: See [Example "Store a hard copy of the display"](#) on page 562.

Manual operation: See "[File Options](#)" on page 158

7.11 KBOard Subsystem

The KBOard system contains the commands to set the external keyboard.

| | |
|--|-----|
| :KBOard:LANGuage | 567 |
| :KBOard:LAYout | 567 |

:KBOard:LANGuage <Language>

This command selects the keyboard language. The assignment of some keys depends on the selected language.

Parameters:

<Language> US | DE
 *RST: US

Example: KBO:LANG US
 selects keyboard language American English.

Usage: SCPI confirmed

Manual operation: See "[Layout \(USB Keyboard Settings\)](#)" on page 143

:KBOard:LAYout <Layout>

Selects the keyboard language. The assignment of some keys depends on the selected language.

Parameters:

<Layout> CHINese | DANish | DUTCh | DUTBe | ENGLish | ENGUk |
 FINNish | FRENch | FREBe | FRECa | GERMan | ITALian |
 JAPANese | KORean | NORWegian | PORTuguese | RUSSian |
 SPANish | SWEDish | ENGUS
 *RST: n.a. (factory preset: ENGLISH)

Example: KBO:LAY US
 Activates American English keyboard layout.

Manual operation: See "[Layout \(USB Keyboard Settings\)](#)" on page 143

7.12 MMEMory Subsystem

The MMEMory subsystem (**Mass Memory**) contains the commands for managing files and directories as well as for loading and storing complete instrument settings in files.

The files are stored on the internal flash card of the instrument. The `/var/user/` directory can be used to save user-defined data; any subdirectory structure can be created on `/var/user/`. Some default subdirectories are predefined, but can be changed at any time.

The default directory is determined using the command `MMEMory:CDIR`.



Use the command `:SYSTem:MMEMory:PATH:USER?` to query the path of the directory for user-defined data.



The `/opt` directory is a protected and therefore a not accessible system directory. The files on this directory contain data that must not be changed. Therefore, this directory should not be accessed, since reconstruction of the system partition will lead to data loss.

7.12.1 File Naming Conventions

To enable files in different file systems to be used, the following file naming conventions should be observed.

The file name can be of any length and is case-sensitive, meaning it is distinguished between uppercase and lowercase letters.

The file and the optional file extension are separated by a dot. All letters and numbers are permitted (numbers are, however, not permitted at the beginning of the file name). If possible, special characters should not be used. The use of the slashes "\" and "/" should be avoided since they are used in file paths. A number of names are reserved for the operating system, e.g. `CLOCK$`, `CON`, `AUX`, `COM1 . . . COM4`, `LPT1 . . . LPT3`, `NUL` and `PRN`.

In the R&S SMBV all files in which lists and settings are stored are given a characteristic extension. The extension is separated from the actual file name by a dot (see [Chapter 4.7.2.1, "Extensions for User Files"](#), on page 109 for an overview of the file types).

The two characters "*" and "?" function as "wildcards", meaning they are used for selecting several files. The "?" character represents exactly one character, while the "*" character represents all characters up to the end of the file name. "*.*" therefore stands for all files in a directory.

When used in conjunction with the commands, the parameter `<file_name>` is specified as a string parameter with quotation marks. It can contain either the complete path including the drive, only the path and the file name, or only the file name. The file name must include the file extension. The same applies for the parameters `<directory_name>` and `<path>`.

Depending on how much information is provided, either the values specified in the parameter or the values specified with the command `MMEM:CDIR` (default directory) are used for the path and the drive settings in the commands.

Before the instrument settings can be stored in a file, they have to be stored in an intermediate memory using common command `*SAV <number>`. The specified number is subsequently used in the `:MMEMory:STORe:STATe` on page 580 command. Also, subsequently to loading a file with instrument settings with command `:MMEMory:LOAD:STATe` on page 578, these settings have to be activated with the common command `*RCL <number>`.

7.12.2 Extensions for User Files

The following table lists all available file extensions for user files. The currently available files on the instrument depend on the installed options.

Table 7-1: List of the automatically assigned file extensions in the instrument

| Function/Digital Standard | List type | Contents | File suffix |
|---------------------------------|--------------------|---|-------------------|
| Instrument State | Settings | Instrument settings | *.savrc1txt |
| "User Correction" | List | User-defined level correction values | *.uco |
| "List Mode" | List | User-defined frequency/level value pairs | *.lsw |
| "Frequency Response Correction" | Settings | User-defined frequency response correction file | *.frc |
| "Arbitrary Waveform Generator" | Waveform | ARB waveforms ARB multi segment waveforms | *.wv |
| | Waveform | ARB multi carrier settings | *.arb_multcarr |
| | Configuration data | Configuration file for creation of multisegment ARB waveforms | *.inf_mswv |
| | Play List | ARB Sequencing List | *.wvs |
| "DM" | Data List | Digital modulation data | *.dm_iqd *.tdm |
| | Control List | Data to control digital modulation | *.dm_iqc |
| | Settings | Digital modulation settings | *.dm |
| | User Standard | Digital modulation user standard | *.dm_stu |
| | User Mapping | Digital modulation user mapping | *.vam |
| | User Filter | Digital modulation user filter | *.vaf |
| "NRP Settings" | Settings | NRP Settings | *.nrp |
| "Fading" | Fading | Fading data | *.fad |
| "GSM/EDGE" | Settings | GSM/EDGE settings | *.gsm |
| | Slot | User-defined slot data | *.gsm_slu |
| | Frame | User-defined frame data | *.gsm_fu |
| | Slot | Higher symbol rate slot | *.gsm_hslu |
| | Frame | Higher symbol rate frame | *.gsm_hfu |
| "Bluetooth" | Bluetooth Settings | Complete setting of the Bluetooth menu | *.bto |
| "TETRA" | TETRA Settings | Complete setting of the TETRA menu | *.tetra |
| "3GPP FDD" | Settings | Complete setting of the 3GPP (FDD) menu | *.3g |

| Function/Digital Standard | List type | Contents | File suffix |
|---------------------------|---------------|--|-------------------------|
| | Settings | Channel coding enhanced DPCH channels (downlink) | *.3g_ccod_dl_s |
| | Settings | Channel coding enhanced DPDCH channels (uplink) | *.3g_ccod_ul |
| "CDMA2000" | Settings | Complete setting of the CDMA2000 menu | *.cdma2k |
| "TD-SCDMA2000" | Settings | Complete setting of the TD-SCDMA2000 menu | *.tdscdma |
| | Settings | Test Model for TD-SCDMA2000 | *.tdtmd |
| 1xEV-DO | Settings | Complete setting of the 1xEV-DO menu | *.evdo |
| "IEEE 802.11 WLAN" | Settings | Complete setting of the IEEE 802.11 WLAN menu | *.wlan |
| "IEEE 802.11 n WLAN" | Settings | Complete setting of the IEEE 802.11n WLAN menu | *.wlann |
| | Settings | Beamforming data | *.bmf |
| "IEEE 802.16 WiMAX" | Settings | Complete setting of the IEEE 802.16 WiMAX menu | *.wimax |
| "EUTRA/LTE" | Settings | Complete setting of the EUTRA/LTE menu | *.eutra |
| | Settings | TDD Settings | *.lte_tdd |
| | Settings | User-defined IQ-File | *.iqw |
| "GPS" | Settings | Complete setting of the GPS/A-GPS menu | *.gps |
| | Settings | GPS Almanac Settings | *.txt *.alm *.al3 |
| | Settings | GPS Waypoints File | *.txt |
| | Settings | GPS Generated Almanac File | *rs_al *.rs_yuma |
| | Settings | GPS Ionospheric File | *.rs_ion |
| | Settings | GPS Navigation Data | *.rs_nav |
| | Settings | GPS UTC File | *.rs_utc *.rs_acq |
| "FM-Stereo" | Settings | Complete setting of the FM-Stereo menu | *.fmstereo |
| | Settings | FM-Stereo Group Type Settings | *.fm_gt |
| | Settings | FM-Stereo Group Hex Type Settings | *.fm_ghex |
| | Waveform File | Waveform File | *.wav |
| "Sirius" | Settings | Complete setting of the Sirius menu | *.sirius |
| "XM-Radio" | Settings | Complete setting of the XM-Radio menu | *.xmradio |
| | Settings | XM-Radio TWTA Data | *.twta |

| Function/Digital Standard | List type | Contents | File suffix |
|---------------------------|-----------|--|------------------------|
| "DVB" | Settings | Complete setting of the DVB menu | *.dvb |
| | Settings | DVB Transport Stream | *.gts *.ts *.trp |
| "DAB/T-DMB" | Settings | Complete setting of the DAB/T-DMB menu | *.dab |
| | Settings | DAB ETI Files | *.eti *.xeti |
| NFC | Settings | Complete setting of the NFC menu | *.nfc |

7.12.3 Examples

In these examples, the current instrument setting is stored in the file `test.savrcltxt` in the directory `/var/user/..`

Storing and Loading Current Settings

1. Store the current setting in an intermediate memory with the number 4. This setting can be called using command `*RCL` and the associated number of the memory, for example `*RCL 4`.
`*SAV 4`
2. To store the settings in a file in a specific directory, specify the complete path.
`MMEM:STOR:STAT 4, "/var/user/test.savrcltxt"`
3. To store the settings in a file in the default drive, set the default drive and specify only the file name.
`MMEM:CDIR '/var/user/'*SAV 4`
`MMEM:STOR:STAT 4, "test.savrcltxt"`
4. Load the file `test.savrcltxt` in the user directory.
`MMEM:LOAD:STAT 4, '/var/user/test.savrcltxt'`
5. Activate the instrument setting of the file `test.savrcltxt`.
`*RCL 4`

Working with Files and Directories

1. Read out all files in the specified directory.
`MMEM:CAT? '/var/usb/user'`

Response: `127145265,175325184, "test,DIR,0", "temp,DIR,0", "readme.txt,ASC,1324", "state.savrcltxt,STAT,5327", "waveform.wv,BIN,2342"`

the directory `/var/usb/user` contains the subdirectories `test` and `temp` as well as the files `readme.txt`, `state.savrcltxt` and `waveform.wv` which have different file types.

Tip: To query only the subdirectories of the current or specified directory, perform:

```
MMEM:DCAT? '/var/usb/user'
```

```
Response: 'test', 'temp'
```

To query only the number of subdirectories in the current or specified directory, perform:

```
MMEM:DCAT:LENG? '/var/usb/user'
```

```
Response: 2
```

2. To query the number of files in the current or specified directory, perform:

```
MMEM:CAT:LENG? '/var/usb/user'
```

```
Response: 3
```

3. Create a new subdirectory for mass memory storage in the specified directory.

```
MMEM:MDIR '/var/usb/new'
```

4. Copy the file `state` to a new file.

```
MMEM:COPY '/var/user/state.savrcltxt','/var/usb/new'
```

5. Rename the file `state`.

```
MMEM:MOVE 'state.savrcltxt','state_new.savrcltxt'
```

6. Remove the `test` directory.

```
MMEM:RDIR '/var/usb/test'
```

7.12.4 Remote Control Commands

| | |
|---------------------------|-----|
| :MMEMory:CATalog? | 573 |
| :MMEMory:CATalog:LENGth? | 573 |
| :MMEMory:CDIRectory | 573 |
| :MMEMory:COPY | 574 |
| :MMEMory:DATA | 574 |
| :MMEMory:DATA:UNPRotected | 575 |
| :MMEMory:DCATalog? | 577 |
| :MMEMory:DCATalog:LENGth? | 577 |
| :MMEMory:DELeTe | 578 |
| :MEMory:HFRee? | 578 |
| :MMEMory:LOAD:STATe | 578 |
| :MMEMory:MDIRectory | 579 |
| :MMEMory:MOVE | 579 |
| :MMEMory:MSIS | 579 |
| :MMEMory:RDIRectory | 579 |
| :MMEMory:STORe:STATe | 580 |

:MMEMory:CATalog? <path>

Returns the content of a particular directory.

Query parameters:

| | |
|--------|--|
| <path> | string String parameter to specify the directory. If you leave out the path, the command returns the contents of the directory selected with <code>:MMEMory:CDIRectory</code> . The path may be relative or absolute. |
|--------|--|

Return values:

| | |
|-----------------|---|
| <UsedDiskSpace> | Byte size of all files in the directory. |
| <FreeDiskSpace> | Remaining disk space in bytes. |
| <FileInfo> | <NameFileN>,<SuffixFileN>,<SizeFileN> List of files, separated by commas <NameFileN> Name of the file. <SuffixFileN> Type of the file. Possible suffixes are: ASCii, BINary, DIRectory <SizeFileN> Size of the file in bytes. |

Example: See "[Working with Files and Directories](#)" on page 571.

Usage: Query only

Manual operation: See "[Directory, File List and File Name](#)" on page 162

:MMEMory:CATalog:LENGth? <Path>

Returns the number of files in the current or in the specified directory.

Query parameters:

| | |
|--------|--|
| <Path> | string String parameter to specify the directory. If the directory is omitted, the command queries the content of the current directory, queried with <code>:MMEMory:CDIRectory</code> command. |
|--------|--|

Return values:

| | |
|-------------|-----------------------------|
| <FileCount> | integer Number of files. |
|-------------|-----------------------------|

Example: See "[Working with Files and Directories](#)" on page 571.

Usage: Query only

:MMEMory:CDIRectory <Directory>

Changes the default directory for mass memory storage. The directory is used for all subsequent `MMEM` commands if no path is specified with them.

Parameters:

<Directory> <directory_name>
String containing the path to another directory. The path can be relative or absolute.
To change to a higher directory, use two dots '..'.

Example: See "[Working with Files and Directories](#)" on page 571.

Usage: SCPI confirmed

Manual operation: See "[Directory, File List and File Name](#)" on page 162

:MMEMory:COPY <SourceFile>[,<DestinationFile>]

Copies an existing file to a new file. Instead of just a file, this command can also be used to copy a complete directory together with all its files.

Setting parameters:

<SourceFile> string
String containing the path and file name of the source file

<DestinationFile> string
String containing the path and name of the target file. The path can be relative or absolute.
If <DestinationFile> is not specified, the <SourceFile> is copied to the current directory, queried with the [:MMEMory:CDIRectory](#) command.

Note: Existing files with the same name in the destination directory are overwritten without an error message.

Example: See "[Working with Files and Directories](#)" on page 571.

Usage: Setting only
SCPI confirmed

Manual operation: See "[Copy](#)" on page 169

:MMEMory:DATA <Filename>, <BinaryBlock>

:MMEMory:DATA? <Filename>

The setting command writes the block data <BinaryBlock> to the file identified by <Filename>.

Set the GPIB-bus terminator to `EOI` to ensure correct data transfer.

The query command transfers the specified file from the instrument to the GPIB-bus and then on to the controller. It is important to ensure that the intermediate memory on the controller is large enough to take the file. The setting for the GPIB-bus terminator is irrelevant.

Tip: Use this command to read/transfer stored instrument settings or waveforms directly from/to the instrument.

Parameters:

<BinaryBlock> #<number><length_entry><data>
 #: Hash sign; always comes first in the binary block
 <number>: the first digit indicates how many digits the subsequent length entry has
 <length_entry>: indicates the number of subsequent bytes
 <data>: binary block data for the specified length.
 For files with a size with more than nine digits (gigabytes), the instrument allows the syntax # (<Length>), where <Length> is the file size in decimal format.

Parameters for setting and query:

<Filename> string
 String parameter to specify the name of the file.

Example:

```
MMEMory:DATA '/var/user/test.txt',#15hallo
Writes the block data to the file test.txt.
The digit 1 indicates a length entry of one digit; the digit 5 indicate a length of the binary data (hallo) in bytes.
MMEMory:DATA? '/var/user/test.txt'
Sends the data of the file test.txt from the instrument to the controller in the form of a binary block.
Response: #15hallo
```

Usage: SCPI confirmed

:MMEMory:DATA:UNPRotected <Msus>, <Data>

The **setting** command sends the I/Q data and the marker data to the file defined with the <Msus> parameter. The required tags are created automatically so that the file content follows the waveform file format.

The **query** reads out the I/Q data part or the marker information of the specified file.

Waveform files can also be created with the command `[:SOURce<hw>] :BB: ARbitrary:WAVeform:DATA`. In this case, the *complete content* of the waveform file must be specified, i.e. not only the I/Q or marker data but all required tags.

Parameters:

<Msus> <Identifier>:<file name>
 Mass Storage Unit Specifier
 A string that specifies whether I/Q data (NVWFM) or marker data (NVMKR) is transferred and the file name the data is stored in.
 If the file with the specified name does not exist, a file is created.
 Any existing content in the file is *overwritten*.

Complete file path and file extension may also be specified. If omitted, files are stored in the default directory and the extension *.wv is assigned to the file name.

Setting parameters:

<Data>

block data

I/Q data or marker binary data, where the number of marker elements has to be equal to the number of I/Q samples

Binary block data follows the syntax:

#<Digits><Length><IQQ0..IxQx...IN-1QN-1> or

#<Digits><Length><MOM1...Mx...MN-1>

#

Indicates the start of the data block

<Digits>

Decimal value

Gives the number of decimal digits used for the <Length> value

<Length>

Decimal value

Number of bytes that follow in the <Binary data> part

IQQ0..IxQx...IN-1QN-1

Binary data in ASCII format

IxQx... represents binary data (16-bit signed integer in 2's complement notation) containing the I and Q component alternately and starting with the I component. Each I and Q component consists of 2 bytes in MSB format (most significant byte first).

The values of the 2 bytes in an I component and a Q component are in the range: -32767 to +32767.

MOM1...Mx...MN-1

Binary data in ASCII format

Mx represents one marker byte, where only the 4 least significant bits are used. These 4 bits are assigned to the 4 possible markers of the instrument, 1 bit per marker: Bit₀ = Marker 1, ... Bit₃ = Marker 4.

One 4-bit marker element is required for every I/Q sample.

Example:

```
:MMEM:DATA:UNPR "NVWFM:/var/user/wave.wv",#220<IQ00..IxQx>
// the binary data <IQ00..IxQx> is added to a file named wave.wv
// and saved in the selected directory
// <IQ00..IxQx> contains of 20 bytes, i.e. 5 I/Q samples,
// 2 bytes for each I and Q component
// <IQ00..IxQx> is a placeholder;
// the actual ASCII values are not printable

:MMEMory:DATA:UNPRotected? "NVWFM:/var/user/wave.wv"
:MMEMory:DATA:UNPRotected "NVMKR:/var/user/wave.wv",#15<M0M1...M5>
// the specified marker data is added to a file named wave.wv
// in the specified directory
// used are printable values;
// used are only the 4 least significant bits of a byte
:MMEMory:DATA:UNPRotected? "NVMKR:/var/user/wave.wv"
// note that, the query returns binary values
SOURce1:BB:ARbitrary:WAVeform:CLOCK "/var/user/wave.wv",1.1E6
SOURce1:BB:ARbitrary:WAVeform:CLOCK? "/var/user/wave.wv"
```

:MMEMory:DCATalog? <path>

Returns the subdirectories of a particular directory.

Query parameters:

<path> String parameter to specify the directory. If the directory is omitted, the command queries the content of the current directory, queried with [:MMEMory:CDIRectory](#) command.

Return values:

<Catalog> <file_entry>
Names of the subdirectories separated by colons. The first two strings are related to the parent directory.

Example: See ["Working with Files and Directories"](#) on page 571.

Usage: Query only

:MMEMory:DCATalog:LENGth? [<Path>]

Returns the number of subdirectories in the current or specified directory.

Query parameters:

<Path> String parameter to specify the directory. If the directory is omitted, the command queries the contents of the current directory, to be queried with [:MMEMory:CDIRectory](#) command.

Return values:

<DirectoryCount> integer
Number of parent and subdirectories.

Example: See ["Working with Files and Directories"](#) on page 571.

Usage: Query only

:MMEMory:DELeTe <Filename>

Removes a file from the specified directory.

Setting parameters:

<Filename> string
String parameter to specify the name and directory of the file to be removed.

Example: See "[Working with Files and Directories](#)" on page 571.

Usage: Event
SCPI confirmed

Manual operation: See "[Cut](#)" on page 169

:MEMory:HFRee?

Returns the used and available memory in Kb.

Return values:

<TotalPhysMemKb> integer
Total physical memory.

<ApplicMemKb> integer
Application memory.

<HeapUsedKb> integer
Used heap memory.

<HeapAvailableKb> integer
Available heap memory.

Usage: Query only

:MMEMory:LOAD:StAtE <SavRclStateNumb>, <file_name>

Loads the specified file stored under the specified name in an internal memory.

After the file has been loaded, the instrument setting must be activated using an *RCL command.

Setting parameters:

<SavRclStateNumb> Determines to the specific <number> to be used with the *RCL command, e.g. *RCL 4.

<file_name> String parameter to specify the file name with extension *.savrc1txt.

Example: See "[Storing and Loading Current Settings](#)" on page 571.

Usage: Setting only

Manual operation: See "[Recall](#)" on page 165

:MMEMory:MDIRectory <Directory>

Creates a subdirectory for mass memory storage in the specified directory. If no directory is specified, a subdirectory is created in the default directory. This command can also be used to create a directory tree.

Setting parameters:

<Directory> string
String parameter to specify the new directory.

Example: See "[Working with Files and Directories](#)" on page 571.

Usage: Event

Manual operation: See "[Create New Directory](#)" on page 169

:MMEMory:MOVE <SourceFile>, <DestinationFile>

Moves an existing file to a new location or, if no path is specified, renames an existing file.

Setting parameters:

<SourceFile> string
String parameter to specify the name of the file to be moved.

<DestinationFile> string
String parameters to specify the name of the new file.

Example: See "[Working with Files and Directories](#)" on page 571.

Usage: Event
SCPI confirmed

Manual operation: See "[Rename](#)" on page 169

:MMEMory:MSIS <Msis>

Defines the drive or network resource (in the case of networks) for instruments with windows operating system, using `msis` (MSIS = Mass Storage Identification String).

Note: Instruments with Linux operating system ignore this command, since Linux does not use drive letter assignment.

Usage: SCPI confirmed

:MMEMory:RDIRectory <Directory>

Removes an existing directory from the mass memory storage system. If no directory is specified, the subdirectory with the specified name is deleted in the default directory.

Setting parameters:

<Directory> string
String parameter to specify the directory to be deleted.

Example: See ["Working with Files and Directories"](#) on page 571.

Usage: Event

:MMEMory:STORE:STATe <savrcl_state_nr>, <file_name>

Stores the current instrument setting in the specified file.

The instrument setting must first be stored in an internal memory with the same number using the common command *SAV.

Setting parameters:

<savrcl_state_nr> Corresponds to the specific <number> defined with the *SAV command, e.g. *SAV 4.

<file_name> String parameter to specify the file name with extension *.savrcltxt.

Example: See ["Storing and Loading Current Settings"](#) on page 571.

Usage: Event

Manual operation: See [" Save"](#) on page 163

7.13 OUTPut Subsystem

The OUTPut system contains the commands which set the properties of the [RF output] connectors and [USER] connectors.

The properties of the LF output connector are set in the [SOURce:LFOutput Subsystem](#) system.

| | |
|---|-----|
| :OUTPut<hw>:AFIXed:RANGe:LOWer? | 580 |
| :OUTPut<hw>:AFIXed:RANGe:UPPer? | 581 |
| :OUTPut<hw>:AMODe | 581 |
| :OUTPut<hw>:IMPedance? | 582 |
| :OUTPut<hw>:PROTection:CLEar | 582 |
| :OUTPut<hw>:PROTection:TRIPped? | 582 |
| :OUTPut<hw>[:STATe] | 583 |
| :OUTPut<hw>[:STATe]:PON | 583 |

:OUTPut<hw>:AFIXed:RANGe:LOWer?

Queries the minimum level which can be set when the attenuator is fixed, see [:OUTPut<hw>:AMODe](#).

Return values:

<Lower> float
Increment: 0.01

Example:

OUTP:AFIX:RANG:LOW?
queries the minimum level for the FIXed setting.

Example:

Response: -50
The minimum level is -50 dBm.

Usage:

Query only

Manual operation: See " [Fixed Range \(PEP\) In](#) " on page 225

:OUTPut<hw>:AFIXed:RANGe:UPPer?

Queries the maximum level which can be set when the attenuator is fixed, see : [OUTPut<hw>:AMODE](#).

Return values:

<Upper> float
Increment: 0.01

Example:

OUTP:AFIX:RANG:UPP?
queries the maximum level for the FIXed setting for the RF output.

Example:

Response: -27
The maximum level is -27 dBm.

Usage:

Query only

Manual operation: See " [Fixed Range \(PEP\) In](#) " on page 225

:OUTPut<hw>:AMODE <AMode>

Selects the mode of the attenuator at the RF output (Attenuator MODE).

Parameters:

<AMode> AUTO | FIXed

AUTO

The electronically switching attenuator switches with a 5 dB step width at fixed switching points.

FIXed

The attenuator is fixed at the current position. The uninterrupted level settings are made if automatic level control is activated (SOURce:POWer:ALC ON).

*RST: AUTO

Example:

POW:ALC ON
activates automatic level control for RF output.
OUTP:AMOD FIX
sets the fixed mode with uninterrupted level for RF output.

Manual operation: See "[Attenuator Mode](#)" on page 224

:OUTPut<hw>:IMPedance?

Queries the impedance of the RF outputs. It enables you to convert the output level units between V and W. The impedances cannot be changed.

Return values:

<Impedance> G1K | G50 | G10K
 *RST: G50
 Default unit: Ohm

Example:

OUTP:IMP
 queries the impedance of RF output.
 Response: 50
 the impedance is 50 ohms

Usage: Query only

:OUTPut<hw>:PROTection:CLEAr

Resets the protective circuit after it has been tripped. The state of the output is again determined by `OUTPut:STATe`.

Example:

OUTP:PROT:CLE
 resets the protective circuit for RF output.

Usage: Event

Manual operation: See "[Overload](#)" on page 241

:OUTPut<hw>:PROTection:TRIPped?

Queries the state of the protective circuit.

Return values:

<Tripped> 0 | 1 | OFF | ON
 *RST: 0

Example:

OUTP:PROT:TRIP
 Queries the state of the protective circuit for RF output A.
 Response: 0
 The protective circuit has not tripped.
 Response: 1
 The protective circuit has tripped.

Usage: Query only

Manual operation: See "[Overload](#)" on page 241

:OUTPut<hw>[:STATe] <State>

Activates and deactivates the RF output signal (RF ON / RF OFF).

Parameters:

<State> 0 | 1 | OFF | ON
 *RST: 0

Example: `OUTP OFF`
 deactivates the RF output.

Manual operation: See "[RF On](#)" on page 209

:OUTPut<hw>[:STATe]:PON <Pon>

Selects the state of the RF output when the instrument is switched on.

Parameters:

<Pon> OFF | UNCHanged
OFF
 deactivates the output when the instrument is switched on (RF OFF).
UNCHanged
 restores the initial state of the RF output before the last turn off.
 sets the output status as it was when the instrument was switched off.
 *RST: n.a. (factory preset: UNCHanged)

Example: `OUTP:PON OFF`
 RF output A is deactivated when the instrument is switched on.

Manual operation: See "[Power-On State - RF Signal](#)" on page 226

7.14 SENSe, READ and INITiate Subsystems

The SENSe subsystem contains the commands for configuring the power measurements with R&S NRP-Zxx power sensor(s) connected to the generator. The measurement is started and the measurement result retrieved with the READ command. The description of this commands is included in the following.

Up to four sensors can be connected to the signal generator. They are distinguished by means of the suffix under SENSe:

- Power sensor connected to the SENSOR port = `SENSe[1]`
- Power sensor connected first to one of the USB interfaces = `SENSe 2`
- Further power sensors connected second and third via USB = `SENSe 3` and `SENSe 4`

The suffixes <ch>

Furthermore the following suffixes denote:

- Sensor assignment READ<ch> and INITiate<hw>; range: [1] to 4
- Sensor mapping list: ELEMEnt<ch>; range [1] to 25

| | |
|--|-----|
| :SLISt:ELEMEnt<ch>:MAPPING..... | 584 |
| :SLISt:SCAN[:STATe]..... | 585 |
| :SLISt:SENSor:MAP..... | 585 |
| :SLISt[:LIST]?..... | 585 |
| :SENSe<ch>[:POWEr]:APERture:DEFault:STATe..... | 586 |
| :SENSe<ch>[:POWEr]:APERture:TIME..... | 586 |
| :INITiate<hw>[:POWEr]:CONTInuous..... | 586 |
| :READ<ch>[:POWEr]?..... | 587 |
| :SENSe<ch>[:POWEr]:CORRection:SPDevice:SELEct..... | 587 |
| :SENSe<ch>[:POWEr]:CORRection:SPDevice:STATe..... | 587 |
| :SENSe<ch>[:POWEr]:CORRection:SPDevice:LIST?..... | 588 |
| :SENSe<ch>[:POWEr]:DISPlay:PERManent:STATe..... | 588 |
| :SENSe<ch>[:POWEr]:DISPlay:PERManent:PRiority..... | 588 |
| :SENSe<ch>[:POWEr]:FILTer:LENGth:AUTO?..... | 589 |
| :SENSe<ch>[:POWEr]:FILTer:LENGth[:USER]..... | 589 |
| :SENSe<ch>[:POWEr]:FILTer:NSRatio..... | 589 |
| :SENSe<ch>[:POWEr]:FILTer:NSRatio:MTIME..... | 590 |
| :SENSe<ch>[:POWEr]:FILTer:SONCe..... | 590 |
| :SENSe<ch>[:POWEr]:FILTer:TYPE..... | 591 |
| :SENSe<ch>[:POWEr]:LOGGing:STATe..... | 591 |
| :SENSe<ch>[:POWEr]:FREQUency..... | 591 |
| :SENSe<ch>[:POWEr]:OFFSet..... | 592 |
| :SENSe<ch>[:POWEr]:OFFSet:STATe..... | 592 |
| SENSe<ch>[:POWEr]:SNUMber?..... | 592 |
| :SENSe<ch>[:POWEr]:SOURce..... | 593 |
| SENSe<ch>[:POWEr]:STATus[:DEVice]?..... | 593 |
| SENSe<ch>[:POWEr]:SVERsion?..... | 593 |
| SENSe<ch>[:POWEr]:TYPE?..... | 594 |
| :SENSe<ch>[:POWEr]:ZERO..... | 594 |
| :SENSe<ch>:UNIT[:POWEr]..... | 594 |

:SLISt:ELEMEnt<ch>:MAPPING <Mapping>

Assigns an entry from the :SLISt[:LIST]? to one of the four sensor channels.

Parameters:

<Mapping> SENS1 | SENSor1 | SENS2 | SENSor2 | SENS3 | SENSor3 |
 SENS4 | SENSor4 | UNMapped
 *RST: UNMapped

Example:

SLISt:ELEMEnt3:MAPPING SENS1
 maps the third sensor from the list to the first sensor channel

Manual operation: See " [Sensor Mapping List](#) " on page 242

:SLIST:SCAN[:STATe] <State>

Starts the search for R&S NRP power sensors, connected in the LAN or via the USBTMC protocol.

Parameters:

<State> 0 | 1 | OFF | ON
*RST: 0

Example:

SLIST:SCAN:STATe 1
searches for sensors connected in the LAN or via the USBTMC protocol

Manual operation: See " [Scan](#) " on page 242

:SLIST:SENSor:MAP <SensorId>, <Mapping>

Assigns a sensor directly to one of the sensor channels, using the sensor name and serial number.

To find out the the sensor name and ID, you can get it from the label of the R&S NRP, or using the command `:SLIST:SCAN[:STATe]`. This command detects all R&S NRP power sensors connected in the LAN or via USBTMC protocol.

Setting parameters:

<SensorId> string
<Mapping> enum

Example:

SLIST:SENSor:MAP "NRPS18S-100654-USB Legacy",
SENS4
maps the sensor directly to channel 4

Usage: Setting only

Manual operation: See " [Sensor Mapping List](#) " on page 242

:SLIST[:LIST]?

Returns a list of all detected sensors in a comma-separated string.

Return values:

<SensorList> Each entry contains information on the sensor type, serial number and interface.
The order of the entries does not correspond to the order the sensors are displayed in the "NRP Sensor Mapping" dialog.

Example:

SLIST:LIST?
Response: "NRP33SN-V-900007-USB Legacy", "NRP-Z211-900001-USB Legacy", "NRP33SN-V-900005-USBTMC", "NRP33SN-V-900011-LAN"
list of automatically detected sensors; the list can contain more entries

Usage: Query only

Manual operation: See "[Sensor Mapping List](#)" on page 242

:SENSe<ch>[:POWer]:APERture:DEFault:STATe <UseDefAp>

Deactivates the default aperture time of the respective sensor.

To specify a user-defined value, use the command [:SENSe<ch>\[:POWer\]:APERture:TIME](#) on page 586.

Parameters:

<UseDefAp> 0 | 1 | OFF | ON
*RST: 1

Example: SENS:POW:APER:DEF:STAT 0
deactivates the default aperture time of the sensor.

Manual operation: See "[Use Default Aperture Time](#)" on page 250

:SENSe<ch>[:POWer]:APERture:TIME <ApTime>

Defines the aperture time (size of the acquisition interval) for the corresponding sensor.

Parameters:

<ApTime> float
Range: depends on connected power sensor
Increment: 1E-9
*RST: depends on connected power sensor

Example: SENS:POW:APER:TIM 23ms
sets 23 ms aperture time.

Manual operation: See "[Aperture Time](#)" on page 250

:INITiate<hw>[:POWer]:CONTInuous <Continuous>

The command switches the local state of the continuous power measurement by the R&S NRP-Zxx power sensors on and off. Switching off the local state enhances the measurement performance during remote control

The remote measurement is triggered by the READ query (command [:READ<ch>\[:POWer\]?](#) on page 587) which also provides the measurement results. The local state is not influenced by this command, measurements results can be retrieved with local state on or off.

Parameters:

<Continuous> 0 | 1 | OFF | ON
*RST: OFF

Example: INIT:CONT ON
switches local state of continuous power measurement on.

Manual operation: See " [State](#) " on page 246

:READ<ch>[:POWer]?

The command triggers the measurement with power sensors and provides the power measurement result of the selected power sensor. The value is provided with the unit set with command `SENSe:UNIT[:POWer]`.

For certain power sensors, e.g. R&S NRP-Z81, two values are returned, first the value for the average level and - separated by a comma - the peak level

Note: The local state is not influenced by this command, measurements results can be retrieved with local state on or off. For long measurement times it is recommended to use a SRQ (MAV bit) for command synchronization.

Suffix:

<ch> 1..3

Return values:

<Power> string

Example:

`SENS:UNIT DBM`

selects unit dBm for presentation of measurement result.

`READ1?`

queries the measurement result of the sensor connected to the SENSOR interface.

Response: `-45.6246576745440230`

-45.6 dBm were measured at the given frequency.

or e.g. for R&S NRP-Z81

Response:

`-55.62403263352178, -22.419472478812476`

-55,6 dbm is the measured average level, -22. 4 dBm is the measured peak level at the given frequency

Usage: Query only

Manual operation: See " [Level \(Peak\)](#) " on page 246

:SENSe<ch>[:POWer]:CORRection:SPDevice:SElect <Select>

Several S-parameter tables can be stored in a sensor. The command selects a loaded data set for S-parameter correction for the corresponding sensor.

Parameters:

<Select> float
*RST: 0

:SENSe<ch>[:POWer]:CORRection:SPDevice:STATe <State>

The command activates the use of the s-parameters correction data of the selected power sensor.

Note: For power sensor with attenuator this command is automatically set to ON.

Parameters:

<State> 0 | 1 | OFF | ON
 *RST: OFF

Example:

SENS:POW:CORR:SPD:STAT ON
 activates the use of the s-parameters correction data of power sensor 1.

Manual operation: See " [Use SParameter - Power Sensors](#) " on page 233

:SENSe<ch>[:POWer]:CORRection:SPDeVice:LIST?

Queries the list of the S-parameter data sets that have been loaded to the power sensor.

Return values:

<List> string list
 *RST: 0

Usage: Query only

:SENSe<ch>[:POWer]:DISPlay:PERMANent:STATe <State>

The command switches on and off the permanent indication of the power measurement result in the upper right corner of the block diagram. For each sensor, the type of sensor, the connector, the measurement source and - if set - the offset is indicated.

Parameters:

<State> 0 | 1 | OFF | ON
 *RST: ON

Example:

SENS1:POW:DISP:PERM:STAT ON
 the permanent viewer is switched on.

Manual operation: See " [Permanent Display State](#) " on page 247

:SENSe<ch>[:POWer]:DISPlay:PERMANent:PRiority <Priority>

The command selects which power measurement result (average or peak power) is indicated when permanent display is active.

Parameters:

<Priority> AVERAge | PEAK
 *RST: PEAK

Example:

SENS1:DISP:PERM:STAT ON
 the permanent viewer is switched on.
 SENS1:DISP:PERM:PRI AVER
 the measured average power is indicated.

Manual operation: See " [Display Priority](#) " on page 247

:SENSe<ch>[:POWer]:FILTer:LENGth:AUTO?

The command queries the current filter length for auto filter mode
(:SENSe<[1]...3>:POWer:FILTer:TYPE AUTO)

Return values:

<Auto> float
Range: 1 to 65536

Example:

```
SENS1:FILT:TYPE AUTO
selects auto filter mode for the power sensor connected to the
SENSOR connector.
SENS1:FILT:LENG:AUTO?
queries the automatically set filter length.
Response: 1024
```

Usage: Query only

Manual operation: See "[Filter Length](#)" on page 250

:SENSe<ch>[:POWer]:FILTer:LENGth[:USER] <User>

The command selects the filter length for user filter mode
(:SENSe:POWer:FILTer:TYPE USER). As the filter length works as a multiplier for the
time window, a constant filter length results in a constant measurement time. Values 1
and 2ⁿ are settable.

The time window is fixed to 20 ms.

Parameters:

<User> float
Range: 1 to 65536
*RST: 1

Example:

```
SENS:FILT:TYPE USER
selects user filter mode.
SENS:FILT:LENG 16
sets a filter length of 16. The resulting measurement time is 640
ms (2x16x20 ms).
```

Manual operation: See "[Filter Length](#)" on page 250

:SENSe<ch>[:POWer]:FILTer:NSRatio <NSRatio>

The command defines the noise content for fixed noise filter mode
(:SENSe<[1]...3>:POWer:FILTer:TYPE NSRatio). This value determines the
proportion of intrinsic noise in the measured result.

Parameters:

<NSRatio> float
Range: 0.001 to 1
Increment: 0.001
*RST: 0.01

Example: `SENS1:FILT:TYPE NSR`
 selects fixed noise filter mode for the power sensor connected to
 the SENSOR connector.
 `SENS1:FILT:NSR 0.2`
 sets a noise content of 0.2.

Manual operation: See "Noise Content" on page 250

:SENSe<ch>[:POWer]:FILTer:NSRatio:MTIME <MTime>

The command defines the timeout for fixed noise filter mode (`:SENSe<[1]...3>:POWer:FILTer:TYPE NSRatio`). This value ensures limited settling times.

Parameters:

<MTime> float
 Range: 1 to 999.99
 Increment: 0.01
 *RST: 4
 Default unit: s

Example: `SENS1:FILT:TYPE NSR`
 selects fixed noise filter mode for the power sensor connected to
 the SENSOR connector.
 `SENS1:FILT:NSR .2`
 sets a noise content of 0.2.
 `SENS1:FILT:NSR:MTIM 5`
 limits the settling time to 5 seconds

Manual operation: See "Timeout" on page 250

:SENSe<ch>[:POWer]:FILTer:SONCe

The command activates the search for the optimum filter length for the current measurement conditions. The found filter length can be retrieved with command `:SENSe:POWer:FILTer:LENGth:USER?`. This command is only available for user filter mode (`:SENSe:POWer:FILTer:TYPE USER`).

Example: `SENS:FILT:TYPE USER`
 selects user filter mode.
 `SENS:FILT:SONC`
 activates the search for the optimum filter length.
 `SENS:FILT:LENG?`
 returns the found optimum filter length.
 Response: 128

Usage: Event

Manual operation: See "Auto Once" on page 250

```
:SENSe<ch>[:POWer]:FILTer:TYPE <Type>
```

The command selects the filter mode. The filter length is the multiplier for the time window and thus directly influences the measurement time.

Parameters:

<Type>

AUTO | USER | NSRatio

AUTO

The filter length is automatically selected depending on the measured value. For high values, a short filter length is selected and for low values a long filter length is selected.

USER

The filter length is set manually. As the filter length works as a multiplier for the measurement time, this results in a constant measurement time.

NSRatio

The filter length (averaging factor) is selected so that the sensor's intrinsic noise (2 standard deviations) does not exceed the specified noise content. The desired noise content is entered with command `SENSe:FILTer:NSRatio`.

To avoid very long settling times when the power is low, the averaging factor can be limited with the Timeout parameter (command `SENSe:FILTer:NSRatio:MTIME`).

*RST: AUTO

Example:

```
SENS:FILT:TYPE AUTO
```

selects automatic filter selection.

Manual operation: See "[Filter](#)" on page 248

```
:SENSe<ch>[:POWer]:LOGGing:STATe <State>
```

Activates the recording of the power values, measured by a connected R&S NRP power sensor.

Parameters:

<State>

0 | 1 | OFF | ON

*RST: 0

Example:

```
SENS:LOGG:STAT ON
```

activates recording of the power measurement of the first sensor.

Manual operation: See "[Enable Logging](#)" on page 251

```
:SENSe<ch>[:POWer]:FREQuency <Frequency>
```

The command sets the RF frequency of the source if the user source is selected (`SENSe[:POWer]:SOURce USER`).

Parameters:

<Frequency> float
 *RST: 1 GHz

Example:

SENS:SOUR USER
 selects user-defined source.
 SENS:FREQ 2.44 GHz
 enters the RF frequency of the source which is 2.44 GHz.

Manual operation: See " [Frequency](#) " on page 248

:SENSe<ch>[:POWer]:OFFSet <Offset>

The command enters a level offset which is added to the measured level value after activation with command `SENSe[:POWer]:OFFSet:STATe ON`. This allows e.g. an attenuator in the signal path to be considered.

Parameters:

<Offset> float
 Range: -100.0 to 100.0
 *RST: 0
 Default unit: dB

Example:

SENS:POW:OFFS 10.0
 sets a level offset of 10 dB

Manual operation: See " [Level Offset](#) " on page 248

:SENSe<ch>[:POWer]:OFFSet:STATe <State>

The command activates the addition of the level offset to the measured value. The level offset value is set with command `SENSe[:POWer]:OFFSet`.

Parameters:

<State> 0 | 1 | OFF | ON
 *RST: OFF

Example:

SENS1:POW:OFFS 0.4dB
 sets a level offset of 0.4 dB
 SENS1:POW:OFFS:STAT ON
 a level offset of 0.4 dB is added to the measured value.

Manual operation: See " [Level Offset](#) " on page 248

SENSe<ch>[:POWer]:SNUMber?

The command queries the serial number of the sensor.

Return values:

<Snumber> string

Example:

SENS:SNUM?
 queries the serial number.

Usage: Query only
Manual operation: See "[Current Sensors](#)" on page 131

:SENSe<ch>[:POWer]:SOURce <Source>

The command selects the signal source for the measurement.

Parameters:

<Source> A | B | USER | RF
 *RST: A

Example: SENS:SOUR A
 selects the RF signal as measurement source. The RF frequency is used as the measurement frequency of the sensor and the corresponding correction factor is used. The level setting of the instrument serves as reference level of the measurement.

Manual operation: See "[Source](#)" on page 248

SENSe<ch>[:POWer]:STATus[:DEVIce]?

The command queries if a sensor is connected to the signal generator.

The sensor is selected by suffix in the keyword SENSe or READ of the command header. Suffix 1 denotes the sensor connected to the SENSOR connector, suffix 2 the sensor connected first to one of the USB interfaces and suffix 3 the sensor connected second to one of the USB interfaces.

Return values:

<DEVIce> 0 | 1 | OFF | ON

Example: SENS:STAT?
 queries if a sensor is connected to the instrument.
 Response: 1
 a sensor is connected to the POWER SENSOR interface.

Usage: Query only

Manual operation: See "[Sensor](#)" on page 245

SENSe<ch>[:POWer]:SVERsion?

The command queries the software version of the connected R&S NRP power sensor.

Return values:

<Sversion> string

Example: SENS:POW:SVER?
 queries the software version of the R&S NRP power sensor.

Usage: Query only

Manual operation: See "[Current Sensors](#)" on page 131

SENSe<ch>[:POWER]:TYPE?

The command queries the type of sensor. The type is automatically detected.

Return values:

<Type> string

Example:

SENS:TYPE?

queries the type of sensor connected to the POWER SENSOR connector.

Response: NRP-Z21

the R&S NRP-Z21 sensor is used.

Usage:

Query only

Manual operation: See "[Current Sensors](#)" on page 131

:SENSe<ch>[:POWER]:ZERO

The command activates the autozero function. Zeroing is required in regular interval (at least once a day) and if the temperature has varied more than about 5 °C, if the sensor has been replaced or if measurements of signals with very low power are to be performed. The RF power source must be switched off or disconnected from the sensor before starting the autozero function.

Example:

SENS:ZERO

activates autozero function.

Usage:

Event

Manual operation: See "[Zero - Power Sensors](#)" on page 232

:SENSe<ch>:UNIT[:POWER] <Power>

The command selects the unit used for result query with command READ. The power sensor provides the measured value in Watt. In which unit the measured value is returned is selected here and might be either Watt, dBm or dBuV.

Parameters:

<Power> DBM | DBUV | WATT

*RST: DBM

Example:

SENS2:UNIT DBM

selects unit dBm for the measured value returned by command READ.

READ2?

Response: 7.34

7.34 dBm are measured by sensor 2.

Manual operation: See "[Unit](#)" on page 247

7.15 SOURce Subsystem

The SOURce subsystem contains the commands for configuring the digital and analog signals.

SOURce<hw>

For one-path instruments, the keyword SOURce is optional and can be omitted.

| | |
|-------------------------------------|-----|
| • SOURce:AM Subsystem..... | 595 |
| • SOURce:AWGN Subsystem..... | 597 |
| • SOURce:BB Subsystem..... | 605 |
| • SOURce:BBIN Subsystem..... | 721 |
| • SOURce:CORRection Subsystem..... | 727 |
| • SOURce:FM Subsystem..... | 736 |
| • SOURce:FREQuency Subsystem..... | 739 |
| • SOURce:INPut Subsystem..... | 747 |
| • SOURce:IQ Subsystem..... | 750 |
| • SOURce:IQ:OUTput Subsystem..... | 754 |
| • SOURce:LFOutput Subsystem..... | 762 |
| • SOURce:LIST Subsystem..... | 772 |
| • SOURce:MODulation Subsystem..... | 784 |
| • SOURce:PGEN Subsystem..... | 785 |
| • SOURce:PHASe Subsystem..... | 786 |
| • SOURce:PM Subsystem..... | 786 |
| • SOURce:POWer Subsystem..... | 790 |
| • SOURce:PULM Subsystem..... | 800 |
| • SOURce:ROSCillator Subsystem..... | 807 |
| • SOURce:SWEep Subsystem..... | 810 |

7.15.1 SOURce:AM Subsystem

The AM subsystem contains the commands for setting the amplitude modulation.

An external modulation signal is input at the [EXT MOD] connector.

The settings for the internal modulation source (LF generator) are made in the SOURce:LFOutput subsystem.

| | |
|---|-----|
| [:SOURce<hw>]:AM[:DEPTh]..... | 595 |
| [:SOURce<hw>]:AM:EXTeRnal:COUPLing..... | 596 |
| [:SOURce<hw>]:AM:SENSitivity?..... | 596 |
| [:SOURce<hw>]:AM:SOURce..... | 597 |
| [:SOURce<hw>]:AM:STATE..... | 597 |

[:SOURce<hw>]:AM[:DEPTh] <Depth>

Sets the modulation depth of the amplitude modulation signal in percent.

Parameters:

<Depth> float
 Range: 0 to 100
 Increment: See data sheet
 *RST: 30

Example:

AM 15PCT
 sets the 15% AM modulation depth

Manual operation: See "AM Depth" on page 254

[:SOURce<hw>]:AM:EXTernal:COUPling <Coupling>

Selects the coupling mode for the external amplitude modulation signal.

Parameters:

<Coupling> AC | DC
AC
 Uses only the AC signal component of the modulation signal.
DC
 Uses the modulation signal as it is, with AC and DC.
 *RST: AC

Example:

AM:EXT:COUP AC
 selects the coupling mode AC for external amplitude modulation.

Manual operation: See "Mod Ext Coupling" on page 255

[:SOURce<hw>]:AM:SENSitivity?

Queries the input sensitivity of the externally applied signal for amplitude modulation.

The sensitivity depends on the set modulation [:SOURce<hw>]:AM[:DEPT]h].

The returned value reports the sensitivity in %/V. It is assigned to the voltage value for full modulation of the input.

Return values:

<Sensitivity> float
 Range: 0 to 100

Example:

AM:DEPT 50
 sets a modulation depth of 50 %.
 AM:SENS?
 queries the input sensitivity at the external modulation input.
 Response: 50
 since the voltage value for full modulation is 1V, the resulting sensitivity is precisely 50 %/V.

Usage: Query only

Manual operation: See "AM Sensitivity" on page 255

[:SOURce<hw>]:AM:SOURce <Source>

Selects the modulation signal source for amplitude modulation.

You can use both, the internal and an external modulation signal at a time.

Parameters:

<Source> INTernal | EXTernal | INT,EXT

INTernal

Uses the internally generated signal for modulation. To configure the frequency, use the commands of the [Chapter 7.15.11, "SOURce:LFOOutput Subsystem"](#), on page 762 subsystem.

EXTernal

Uses an externally applied modulation signal.

INT,EXT

Uses both, the internal and external modulation signals.

*RST: INT

Example:

AM:SOUR INT

selects the internal modulation source.

Manual operation: See ["AM Source"](#) on page 254

[:SOURce<hw>]:AM:STATe <State>

Activates amplitude modulation.

Parameters:

<State> 0 | 1 | OFF | ON

*RST: 0

Example:

AM:STAT ON

activates AM modulation.

Manual operation: See ["State"](#) on page 254

7.15.2 SOURce:AWGN Subsystem

The SOURce:AWGN subsystem contains the commands for setting the noise generator.

These commands are available in instrument equipped with the option R&S SMBV-K62 (Additive White Gaussian Noise).

| | |
|---|-----|
| [:SOURce<hw>]:AWGN:BRATe..... | 598 |
| [:SOURce<hw>]:AWGN:BWIDth..... | 598 |
| [:SOURce<hw>]:AWGN:BWIDth:NOISe?..... | 599 |
| [:SOURce<hw>]:AWGN:BWIDth:RATio..... | 599 |
| [:SOURce<hw>]:AWGN:CNRatio..... | 599 |
| [:SOURce<hw>]:AWGN:DISP:MODE..... | 600 |
| [:SOURce<hw>]:AWGN:ENRatio..... | 600 |
| [:SOURce<hw>]:AWGN:FREQuency:RESult?..... | 600 |
| [:SOURce<hw>]:AWGN:FREQuency:TARGet..... | 601 |

| | |
|--|-----|
| <code>[:SOURce<hw>]:AWGN:MODE</code> | 601 |
| <code>[:SOURce<hw>]:AWGN:POWer:CARRier</code> | 602 |
| <code>[:SOURce<hw>]:AWGN:POWer:MODE</code> | 602 |
| <code>[:SOURce<hw>]:AWGN:POWer:NOISe</code> | 603 |
| <code>[:SOURce<hw>]:AWGN:POWer:NOISe:TOTal?</code> | 603 |
| <code>[:SOURce<hw>]:AWGN:POWer:RMODE</code> | 604 |
| <code>[:SOURce<hw>]:AWGN:POWer:SUM?</code> | 604 |
| <code>[:SOURce<hw>]:AWGN:POWer:SUM:PEP?</code> | 604 |
| <code>[:SOURce<hw>]:AWGN:STATe</code> | 605 |

`[:SOURce<hw>]:AWGN:BRATe <BRate>`

Sets the bit rate which is used for calculation of bit energy to noise power ratio from carrier/noise ratio for Digital Standard signals.

For "Custom Digital Mod" signals, the bit rate which is used for calculation can be queried with this command.

Valid units are bps, kbps and mabps as well as b/s, kb/s and mab/s.

Parameters:

`<BRate>` float
 Range: 400 bps to 250E6 bps
 Increment: 0.001
 *RST: 100000

Example:

`SOURce1:AWGN:BRATe?`
 queries the bit rate which is used for calculation of the Eb/NO value from the C/N value.

Manual operation: See "[Bit Rate - AWGN](#)" on page 315

`[:SOURce<hw>]:AWGN:BWIDth <BWidth>`

Sets the system bandwidth. The noise signal at the level which corresponds to the specified carrier/noise ratio is generated in the bandwidth specified here.

This command is available for modes Additive Noise and Noise Only (`SOUR:AWGN:MODE ADD|ONLY`).

Parameters:

`<BWidth>` float
 Range: 1.0E3 to depends on the installed options:
 120MHz (R&S SMBV-B10/-B50) and 60MHz (R&S SMBV-B51)
 Increment: 0.1E3
 *RST: 3.84E6

Example:

`SOURce:AWGN:MODE ADD`
`SOURce:AWGN:BWIDth 10 MHz`
 Sets a system bandwidth of 10 MHz.

Manual operation: See "[System Bandwidth - AWGN](#)" on page 313

[[:SOURce<hw>]:AWGN:BWIDth:NOISe?

This command is available for modes In Additive Noise and Noise Only (SOUR:AWGN:MODE ADD|ONLY) modes, queries the real noise bandwidth.

Return values:

<Noise> float
 Range: 0 to 200E6
 Increment: 100
 *RST: 0

Example: AWGN:BWID:NOIS?
 queries the noise bandwidth.

Usage: Query only

Manual operation: See " [Noise Bandwidth - AWGN](#) " on page 313

[[:SOURce<hw>]:AWGN:BWIDth:RATio <Ratio>

In Additive Noise and Noise Only (SOUR:AWGN:MODE ADD|ONLY) modes, sets the ratio of minimum real noise bandwidth to system bandwidth.

The overall bandwidth is calculated as follows and may not exceed the total bandwidth specified in the data sheet:

Overall Bandwidth = System BW x Min Noise/System BW Ratio

Parameters:

<Ratio> float
 Range: 1 to Max
 Increment: 0.1
 *RST: 1

Example: AWGN:BWID:RAT 2
 sets a minimum noise/system bandwidth ratio of 2.

Manual operation: See " [Minimum Noise/System Bandwidth Ratio - AWGN](#) " on page 313

[[:SOURce<hw>]:AWGN:CNRatio <CnRatio>

In Additive Noise and CW Interferer (SOUR:AWGN:MODE ADD|CW) mode, sets the carrier/interferer ratio. The value range depends on the selected AWGN mode.

Parameters:

<CnRatio> float
 Range: -50 to 40
 Increment: 0.01
 *RST: 0
 Default unit: dB

Example: AWGN:CNR 10
 sets a carrier/noise ratio of 10 dB.

Manual operation: See " [Carrier/Noise Ratio / Signal/Noise Ratio](#) " on page 315

[[:SOURce<hw>]:AWGN:DISP:MODE <Mode>

Selects the display mode to Bseband or RF.

Parameters:

<Mode> RF | BB
*RST: RF

Example: AWGN:DISP:MODE RF
Sets the display mode to RF

Manual operation: See " [Display Mode - AWGN](#) " on page 314

[[:SOURce<hw>]:AWGN:ENRatio <EnRatio>

In Additive Noise mode, sets the ratio of bit energy to noise power density.

Depending on the selected reference mode either the noise power (AWGN:POW:RMOD NOISe) or the carrier power (AWGN:POW:RMOD CARRier) is adjusted to the set E_b/N_0 ratio.

- AWGN:POW:RMOD CARRier
the noise power is adjusted to the set E_b/N_0 ratio and the carrier power is kept constant.
- AWGN:POW:RMOD NOISe
the carrier power is adjusted to the set E_b/N_0 ratio and the noise power is kept constant.

For **Digital Standard** signals, the bit rate used for calculation of E_b/N_0 value from C/N value is defined with command SOUR:AWGN:BRAT .

For **Custom Digital Mod** signals the bit rate used for calculation of E_b/N_0 value from C/N value is determined by the selected standard (SOURce:BB:DM:STANDARD) and cannot be changed.

Parameters:

<EnRatio> float
Range: -50 to depends on hardware
Increment: 0.01
*RST: 15.84
Default unit: dB

Example: AWGN:ENR 10
sets a ratio of bit energy to noise power density of 10 dB

Manual operation: See " [\$E_b/N_0\$ - AWGN](#) " on page 316

[[:SOURce<hw>]:AWGN:FREQuency:RESult?

In CW inerferer mode, queries the actual frequency of the sine.

The actual frequency may differ from the desired frequency, since the resolution is limited to 0.7 Hz.

Return values:

<Result> float
 Range: -40E6 to 40E6
 Increment: 0.01
 *RST: 0

Example: AWGN:FREQ:RES?
 queries the actual frequency of the interfering sine

Usage: Query only

Manual operation: See " [Resulting CW Frequency - AWGN](#) " on page 314

[:SOURce<hw>]:AWGN:FREQuency:TARGet <Target>

Sets the desired frequency of the sine in AWGN:MODE CW mode.

The resulting frequency may differ from the desired frequency because of the limited frequency resolution of 0.7 Hz.

Parameters:

<Target> float
 Range: -40E6 to 40E6
 Increment: 0.01
 *RST: 0

Example: AWGN:FREQ:TARG 2kHz
 sets a frequency of 2 kHz for the interfering sine.

Manual operation: See " [Target CW Frequency - AWGN](#) " on page 314

[:SOURce<hw>]:AWGN:MODE <Mode>

Selects the mode for generating the interfering signal.

Parameters:

<Mode> ONLY | ADD | CW

ADD

The AWGN noise signal is added to the baseband signal.

ONLY

The pure AWGN noise signal is modulated to the carrier. The connection to the baseband is interrupted.

CW

The sine interfering signal is added to the baseband signal.

*RST: ADD

Example: SOURce:AWGN:MODE ONLY
 SOURce:AWGN:STATe ON
 selects the generation of a pure noise and activates it

Manual operation: See " [Mode - AWGN](#) " on page 313

[[:SOURce<hw>]:AWGN:POWer:CARRier <Carrier>

available for Additive Noise and CW Interferer (SOUR:AWGN:MODE ADD|CW) modes

Sets/queries the carrier or signal power depending on the selected reference mode.

- SOUR:AWGN:POW:RMOD CARR
Sets the carrier power. The power of the noise signal is derived from the entered C/N value.
- SOUR:AWGN:POW:RMOD NOIS
queries the carrier power which is derived from the entered C/N value. The noise power is set with command SOUR:AWGN:POW:NOISe.

Parameters:

<Carrier> float
Increment: 0.01
*RST: 0
Default unit: dBm

Example:

AWGN:DISP:MODE RF
sets the display mode to RF
AWGN:POW:CARR?
queries the carrier power

Manual operation: See " [Carrier Power](#) " on page 316

[[:SOURce<hw>]:AWGN:POWer:MODE <Mode>

In Additive Noise (SOUR:AWGN:MODE ADD) mode, selects the mode for setting the noise power.

Parameters:

<Mode> CN | SN | EN
CN|SN
The noise power is set on the basis of the value entered for the carrier/noise or signal/noise ratio (SOURce:AWGN:CNRatio|SNRatio).
Whether a selection of C/N or S/N is enabled, depends on the selected Display Mode (AWGN:DISP:MODE BB|RF)
EN
The noise power is set on the basis of the value entered for the ratio of bit energy to noise power density (AWGN:ENR).
*RST: CN

Example:

AWGN:DISP:MODE RF
sets the display mode to RF
SOUR:AWGN:POW:MODE CN
the noise power is set on the basis of the value entered for the carrier/noise ratio (AWGN:CNR).

Manual operation: See ["Set Power via - AWGN "](#) on page 314

[:SOURce<hw>]:AWGN:POWer:NOISe <Noise>

Sets or queries the noise power in the system bandwidth depending on the selected mode:

- `SOUR:AWGN:MODE ADD|CW`
 - `SOUR:AWGN:POW:RMOD CARR`
Queries the noise/interferer power which is derived from the entered C/N value. Use the command `SOURce:AWGN:POWer:CARRier` to set the carrier power.
 - `SOUR:AWGN:POW:RMOD NOIS`
Sets the noise/interferer power. The power of the carrier signal is derived from the selected C/N value.
- "Noise Only" mode
The command sets the noise power.

Parameters:

<Noise> float
Increment: 0.01
Default unit: dBm

Example:

`SOURce:AWGN:POWer:NOISe?`
queries the noise power in the system bandwidth.
Response: 10
the noise power in the system bandwidth is 10 dBm.

Manual operation: See [" Noise Power \(System Bandwidth\) / Interferer Power "](#) on page 317

[:SOURce<hw>]:AWGN:POWer:NOISe:TOTal?

In Additive Noise and CW Interferer (`SOUR:AWGN:MODE ADD|CW`) modes, queries the noise power in the total bandwidth.

Return values:

<Total> float
Range: -145 to 20
Increment: 0.01
*RST: -30

Example:

`SOURce:AWGN:POWer:NOISe:TOTal?`
queries the noise power in the total bandwidth.
Response: 15
the noise power in the total bandwidth is 15 dBm.

Usage: Query only

Manual operation: See [" Noise Power \(Total Bandwidth\) - AWGN "](#) on page 318

[:SOURce<hw>]:AWGN:POWer:RMODe <RMode>

In Additive Noise and CW Interferer (`SOUR:AWGN:MODE ADD|CW`) modes and Display Mode set to RF (`AWGN:DISP:MODE RF`), selects the mode for setting the interfering signal.

Parameters:

<RMode> CARRier | NOISe

CARRier

The carrier power is kept constant when the C/N value or Eb/N0 value is changed. The noise power is adjusted.

NOISe

The noise power is kept constant when the C/N value or Eb/N0 value is changed. The carrier power is adjusted.

*RST: CARRier

Example:

`SOURce:AWGN:MODE ADD`

selects Additive Noise mode.

`SOURce:AWGN:DISP:MODE RF`

sets the display mode to RF

`SOURce:AWGN:POWer:RMODe NOISe`

selects Reference Mode Noise. The noise power is kept constant when the C/N value or Eb/N0 value is changed. The carrier power is adjusted.

Manual operation: See " [Reference Mode - AWGN](#) " on page 315

[:SOURce<hw>]:AWGN:POWer:SUM?

In Additive Noise and CW Interferer (`SOUR:AWGN:MODE ADD|CW`) modes, queries the overall power of the noise signal plus useful signal.

Return values:

<Sum> float
 Range: -145 to 20
 Increment: 0.01
 *RST: 0

Example:

`SOURce:AWGN:POWer:SUM?`

queries the overall power of the noise signal plus useful signal.

Usage:

Query only

Manual operation:

See " [Carrier + Noise Power / Signal + Noise Power \(System Bandwidth\) / Carrier + Interferer Power / Signal + Interferer Power](#) " on page 318

[:SOURce<hw>]:AWGN:POWer:SUM:PEP?

In Additive Noise and CW Interferer (`SOUR:AWGN:MODE ADD|CW`) modes, queries the peak envelope power of the overall signal comprised of noise signal plus useful signal.

Return values:

<Pep> float
 Range: -145 to 20
 Increment: 0.01
 *RST: 0

Example:

SOURce:AWGN:POWer:SUM:PEP?
 queries the peak envelope power of the overall signal.

Usage:

Query only

Manual operation:

See " [Carrier + Noise PEP / Signal + Noise PEP \(Total Bandwidth\) / Carrier + Interferer PEP / Signal + Interferer PEP](#) " on page 318

[:SOURce<hw>]:AWGN:STATe <State>

Activates or deactivates the white noise (AWGN = Averaged White Gaussian Noise).

Use the command [:SOURce<hw>] :AWGN:MODE to define the mode the AWGN generator is working in.

Parameters:

<State> 0 | 1 | OFF | ON
 *RST: 0

Example:

SOURce:AWGN:STATe ON

Manual operation:

See " [State - AWGN](#) " on page 312

7.15.3 SOURce:BB Subsystem

This subsystem contains all commands for digital signal generation. It is divided into several subsystems which are described separately.

OUTPut<ch>

The numeric suffix to OUTPut distinguishes between the available markers.

Only two markers are available for the R&S SMBV, i.e. the allowed values for the suffix are 1 or 2.

EXTernal<ch>

The numeric suffix to EXTernal distinguishes between the available external trigger inputs.

- [SOURce:BB Subsystem General Commands](#)..... 606
- [SOURce:BB:ARB Subsystem](#)..... 606
- [SOURce:BB:DM Subsystem](#)..... 654
- [SOURce:BB:GRAPhics Subsystem](#)..... 692

- [SOURce:BB:IMPairment Subsystem](#)..... 694
- [SOURce:BB:MCCW Subsystem](#)..... 698
- [SOURce:BB:PROGress Subsystem General Commands](#)..... 720

7.15.3.1 SOURce:BB Subsystem General Commands

The following section describes the commands for setting the frequency shift and the phase offset for the signal at the "Baseband" block output.

| | |
|--|-----|
| [:SOURce<hw>]:BB:FOFFset | 606 |
| [:SOURce<hw>]:BB:POFFset | 606 |

[:SOURce<hw>]:BB:FOFFset <FOffset>

Sets the frequency offset for the baseband signal. The offset affects the signal on the baseband block output. It shifts the useful baseband signal in the center frequency.

Parameters:

| | |
|-----------|-----------------|
| <FOffset> | float |
| | Increment: 0.01 |
| | *RST: 0 |

Example: BB:FOFF 2MHZ
sets a frequency offset of 2 MHz.

Manual operation: See "[Frequency Offset](#)" on page 327

[:SOURce<hw>]:BB:POFFset <POffset>

The command sets the relative phase offset of the baseband signal.

The phase offset affects the signal on the "baseband block" output.

Parameters:

| | |
|-----------|-------------------|
| <POffset> | float |
| | Range: 0 to 359.9 |
| | Increment: 0.01 |
| | *RST: 0 |
| | Default unit: DEG |

Example: BB:POFF 0.5DEG
sets a relative phase offset of 0.5 DEG for the baseband signal

Manual operation: See "[Phase Offset](#)" on page 329

7.15.3.2 SOURce:BB:ARB Subsystem

The ARB subsystem contains the commands for setting the ARB Generator. Settings for clock and trigger interfaces and for external outputs are entered in the SOURce:INPut and SOURce:OUTPut subsystems.

Section [Chapter 5.9.4.5, "Waveform and List Format"](#), on page 439 describes the ARB waveform format and how it is used to transmit waveforms via the IEC bus.

| | |
|--|-----|
| • Common Settings | 607 |
| • Clock Settings | 608 |
| • Trigger Settings | 610 |
| • Marker Settings | 617 |
| • Test Signals Settings | 620 |
| • SOURce:BB:ARB:MCAR Subsystem | 624 |
| • SOURce:BB:ARB:WAV Subsystem | 639 |
| • SOURce:BB:ARB:WSEG Subsystem | 643 |

Common Settings

| | |
|--|-----|
| [:SOURce<hw>]:BB:ARbitrary:PRESet | 607 |
| [:SOURce<hw>]:BB:ARbitrary:STATe | 607 |
| [:SOURce<hw>]:BB:ARbitrary:PRAMP[:STATe] | 607 |

[\[:SOURce<hw>\]:BB:ARbitrary:PRESet](#)

Sets all ARB generator parameters to their default values.

Example: `SOURce1:BB:ARB:PRESet`

Usage: Event

Manual operation: See "[Set To Default](#)" on page 389

[\[:SOURce<hw>\]:BB:ARbitrary:STATe <State>](#)

Activates the standard and deactivates all the other digital standards and digital modulation modes in the same path.

You have to select a waveform first.

Parameters:

<State> 0 | 1 | OFF | ON
 *RST: 0

Example: `SOURce1:BB:ARbitrary:WAV:SElect 'wave1'`
 loads waveform file from the default directory.
`SOURce1:BB:ARbitrary:TRIGger:SEQ RETR`
 sets trigger mode Retrigger.
`SOURce1:BB:ARbitrary:STATe ON`
 switches on the ARB generator. The selected waveform is output straight away. A trigger event causes restart.

Manual operation: See "[State \(ARB\)](#)" on page 388

[\[:SOURce<hw>\]:BB:ARbitrary:PRAMP\[:STATe\] <ArbPramState>](#)

If activated, the burst gate marker signal included in the ARB waveform file is used as marker signal for the pulse modulator.

Parameters:

<ArbPramState> 0 | 1 | OFF | ON
 *RST: 0

Example:

```
SOURce1:BB:ARbitrary:WAVEform:SElect "/var/user/Pulse_PMod_Burst"
SOURce1:BB:ARbitrary:PRAMP:STATE 1
SOURce1:BB:ARbitrary:STATE 1
```

Options:

R&S SMBV-K22

Manual operation: See ["RF Power Ramping with Burst Marker"](#) on page 391

Clock Settings

The CLOCK subsystem contains the commands for setting the clock.

| | |
|--|-----|
| [:SOURce<hw>]:BB:ARbitrary:CLOCK | 608 |
| [:SOURce<hw>]:BB:ARbitrary:CLOCK:MODE | 608 |
| [:SOURce<hw>]:BB:ARbitrary:CLOCK:MULTIPLIER | 609 |
| [:SOURce<hw>]:BB:ARbitrary:CLOCK:SOURce | 609 |
| [:SOURce<hw>]:BB:ARbitrary:CLOCK:SYNChronization:MODE | 610 |
| [:SOURce<hw>]:BB:ARbitrary:CLOCK:SYNChronization:EXECute | 610 |

[\[:SOURce<hw>\]:BB:ARbitrary:CLOCK <Clock>](#)

The command sets the clock rate in samples. Loading a waveform waveform ([ARB:WAV:SEL <name>](#)) sets the clock rate that is defined in the waveform tag 'clock'. The command subsequently changes the clock rate; see data sheet for value range.

In the case of an external clock source (selection [ARB:CLOCK:SOURce EXTERNAL](#)) the clock for the external source must be entered with this command.

Parameters:

<Clock> float
 Increment: 0.001
 *RST: 1E6

Example:

```
BB:ARB:CLOCK:SOUR INT
selects the internal clock source for generating waveforms.
BB:ARB:CLOCK 0.5 MHz
sets the clock rate to 0.5 MHz.
```

Manual operation: See ["Clock Frequency"](#) on page 390

[\[:SOURce<hw>\]:BB:ARbitrary:CLOCK:MODE <Mode>](#)

The command enters the type of externally supplied clock ([:BB:ARB:CLOCK:SOURce EXTERNAL](#)). When MSAMPLE is used, a multiple of the sample clock is supplied via the CLOCK connector and the sample clock is derived internally from this. The multiplier is entered with the command [:BB:ARB:CLOCK:MULTIPLIER](#).

Parameters:

<Mode> SAMPLE | MSAMple
 *RST: SAMPlE

Example:

BB:ARB:CLOC:MODE SAMP
 selects clock type "Sample", i.e. the supplied clock is a sample clock.

Manual operation: See "[Clock Mode](#)" on page 406

[:SOURce<hw>]:BB:ARBitrary:CLOCK:MULTIplier <Multiplier>

The command specifies the multiplier for clock type "Multiple Samples" (:BB:ARB:CLOCK:MODE MSAM) in the case of an external clock source.

Parameters:

<Multiplier> integer
 Range: 1 to 64
 *RST: 4

Example:

BB:ARB:CLOC:SOUR EXT
 selects the external clock source. The clock is supplied via the CLOCK connector.
 BB:ARB:CLOC:MODE MSAM
 selects clock type Multiple Samples, i.e. the supplied clock has a rate which is a multiple of the sample rate.
 BB:ARB:CLOC:MULT 12
 The multiplier for the external clock rate is 12.

Manual operation: See "[Sample Clock Multiplier](#)" on page 406

[:SOURce<hw>]:BB:ARBitrary:CLOCK:SOURce <Source>

Sets the source for the digital modulation clock.

Parameters:

<Source> **INTernal**
 The internal clock reference is used.
 EXTernal
 The external clock reference is supplied to the connector.
 *RST: INTernal

Example:

BB:ARB:CLOC:SOUR EXT
 Selects an external clock reference. The clock is supplied via the connector.
 BB:ARB:CLOC:MODE SAMP
 Enters clock type sample.

Manual operation: See "[Clock Source](#)" on page 405

[:SOURce<hw>]:BB:ARbitrary:CLOCK:SYNChronization:MODE <Mode>

Selects the synchronization mode.

This parameter is used to enable generation of very precise synchronous signal of several connected instruments.

Note: If several instruments are connected, the connecting cables from the master instrument to the slave one and between each two consecutive slave instruments must have the same length and type. Avoid unnecessary cable length and branching points.

Parameters:

<Mode>

NONE | MASTer | SLAVe

NONE

The instrument is working in stand-alone mode.

MASTer

The instrument provides all connected instrument with its synchronisation (including the trigger signal) and reference clock signal.

SLAVe

The instrument receives the synchronisation and reference clock signal from another instrument working in a master mode.

*RST: NONE

Example:

BB:ARB:CLOC:SYNC:MODE MAST

The instrument is configured to work as a master one.

Manual operation: See "[Sync. Mode](#)" on page 405

[:SOURce<hw>]:BB:ARbitrary:CLOCK:SYNChronization:EXECute

Performs automatically adjustment of the instrument's settings required for the synchronization mode, set with the command `[:SOURce<hw>]:BB:ARbitrary:CLOCK:SYNChronization:MODE`.

Example:

BB:ARB:CLOC:SYNC:MODE MAST

the instrument is configured to work as a master one.

BB:ARB:CLOC:SYNC:EXEC

all synchronization's settings are adjusted accordingly.

Usage:

Event

Manual operation: See "[Set Synchronization Settings](#)" on page 405

Trigger Settings

The TRIGger subsystem contains the commands for setting the trigger.

| | |
|--|-----|
| <code>[:SOURce<hw>]:BB:ARbitrary:TRIGger:ARM:EXECute</code> | 611 |
| <code>[:SOURce<hw>]:BB:ARbitrary:TRIGger:EXECute</code> | 611 |
| <code>[:SOURce<hw>]:BB:ARbitrary:TRIGger[:EXternal]:SYNChronize:OUTPut</code> | 612 |
| <code>[:SOURce<hw>]:BB:ARbitrary:TRIGger:OUTPut<ch>:DELay:MAXimum?</code> | 612 |
| <code>[:SOURce<hw>]:BB:ARbitrary:TRIGger:OUTPut<ch>:DELay:MINimum?</code> | 612 |

| | |
|---|-----|
| <code>[:SOURce<hw>]:BB:ARbitrary:TRIGger:RMODe?</code> | 613 |
| <code>[:SOURce<hw>]:BB:ARbitrary:TRIGger:SLENgth</code> | 613 |
| <code>[:SOURce<hw>]:BB:ARbitrary:TRIGger:SLUNit</code> | 614 |
| <code>[:SOURce<hw>]:BB:ARbitrary:TRIGger:SMODE</code> | 614 |
| <code>[:SOURce<hw>]:BB:ARbitrary:TRIGger:SOURce</code> | 614 |
| <code>[:SOURce<hw>]:BB:ARbitrary:TRIGger:DELay:UNIT</code> | 615 |
| <code>[:SOURce<hw>]:BB:ARbitrary:TRIGger[:EXTernal<1 2>]:DELay</code> | 615 |
| <code>[:SOURce<hw>]:BB:ARbitrary:TRIGger[:EXTernal<1 2>]:TDELay</code> | 615 |
| <code>[:SOURce<hw>]:BB:ARbitrary:TRIGger[:EXTernal<1 2>]:RDELay?</code> | 616 |
| <code>[:SOURce<hw>]:BB:ARbitrary:TRIGger[:EXTernal<1 2>]:INHibit</code> | 616 |
| <code>[:SOURce<hw>]:BB:ARbitrary[:TRIGger]:SEQuence</code> | 616 |

`[:SOURce<hw>]:BB:ARbitrary:TRIGger:ARM:EXECute`

The command stops waveform output for trigger modes Armed_Auto and Armed_Retrigger. A subsequent internal or external trigger event restart waveform output.

Example:

```
BB:ARB:TRIG:SOUR INT
sets internal triggering.
BB:ARB:TRIG:SEQ ARET
sets Armed_Retrigger mode, i.e. every trigger event causes
waveform output to restart.
BB:ARB:TRIG:EXEC
executes a trigger, waveform output is started.
BB:ARB:TRIG:ARM:EXEC
waveform output is stopped.
BB:ARB:TRIG:EXEC
executes a trigger, waveform output is started again.
```

Usage: Event

Manual operation: See "[Arm](#)" on page 394

`[:SOURce<hw>]:BB:ARbitrary:TRIGger:EXECute`

The command executes a trigger. The internal trigger source must be selected using the command `ARB:TRIGger:SOURce INTernal` and a trigger mode other than AUTO must be selected using the command `:ARB:SEQuence`.

Example:

```
BB:ARB:TRIG:SOUR INT
sets internal triggering.
BB:ARB:SEQ RETR
sets Retrigger mode, i.e. every trigger event causes signal out-
put to restart.
BB:ARB:TRIG:EXEC
executes a trigger.
```

Usage: Event

Manual operation: See "[Execute Trigger](#)" on page 391

**[[:SOURce<hw>]:BB:ARbitrary:TRIGger[:EXternal]:SYNChronize:OUTPut
<Output>**

(enabled for "Trigger Source" External)

Enables/disables output of the signal synchronous to the external trigger event.

For two or more R&S SMBVs configured to work in a master-slave mode for synchronous signal generation:

- disable this parameter in the slave instruments, in case the master instrument provides the slaves with its internal trigger signal and
- use the default enabled state, if a common external trigger event is provided for the master and the slave instruments.

Parameters:

<Output> 0 | 1 | OFF | ON

ON

The signal calculation starts simultaneously with the external trigger event but because of the instrument's processing time the first samples are cut off and no signal is outputted. After elapsing of the internal processing time, the output signal is synchronous to the trigger event.

OFF

The signal output begins after elapsing of the processing time and starts with sample 0, i.e. the complete signal is outputted. This mode is recommended for triggering of short signal sequences with signal duration comparable with the processing time of the instrument.

*RST: ON

Example:

BB:ARB:TRIG:SOUR EXT

sets external triggering.

BB:ARB:TRIG:EXT:SYNC:OUTP ON

enables synchronous output to external trigger

Manual operation: See "[Sync. Output to External Trigger](#)" on page 395

**[[:SOURce<hw>]:BB:ARbitrary:TRIGger:OUTPut<ch>:DELay:MAXimum?
[:SOURce<hw>]:BB:ARbitrary:TRIGger:OUTPut<ch>:DELay:MINimum?**

The command queries the minimum marker delay for setting

:BB:ARB:TRIGger:OUTPut:DELay:FIXed ON.

Return values:

<Minimum> float
Range: 0 to 16777215
Increment: 1E-3
*RST: 0

- Example:** `BB:ARB:TRIG:OUTP:DEL:FIX ON`
restricts the marker signal delay setting range to the dynamic range.
- `BB:ARB:TRIG:OUTP:DEL:MIN`
queries the minimum of the dynamic range.
- Response: 0
the minimum for the marker delay setting is 0 samples.
- Usage:** Query only
- Manual operation:** See "[Current Range without Recalculation](#)" on page 404

`[:SOURce<hw>]:BB:ARbitrary:TRIGger:RMODe?`

The command queries the status of waveform output or all trigger modes with ARB on.

Return values:

<RMode>

STOP | RUN

RUN

The waveform is output. A trigger event occurred in the triggered mode.

STOP

The waveform is not output. A trigger event did not occur in the triggered modes, or waveform output was stopped by the command `BB:ARB:TRIG:ARM:EXECute` (armed trigger modes only).

- Example:** `BB:ARB:TRIG:SOUR EXT`
sets external triggering
- `BB:ARB:TRIG:MODE ARET`
selects the Armed_Retrigger mode.
- `BB:ARB:TRIG:RMOD?`
queries the current status of waveform output.
- Response: RUN
the waveform is output, an external trigger was executed.

- Usage:** Query only
- Manual operation:** See "[Running/Stopped](#)" on page 394

`[:SOURce<hw>]:BB:ARbitrary:TRIGger:SELength <SLength>`

The command defines the length of the signal sequence to be output in the Single trigger mode. The unit is defined with command `SOUR:BB:ARB:TRIG:SLUNit`. It is possible to output deliberately just part of the waveform, an exact sequence of the waveform, or a defined number of repetitions of the waveform.

Parameters:

<SLength>

integer

Range: 1 to dynamic

*RST: 1

Default unit: sample

Example: `BB:ARB:SEQ SING`
sets trigger mode Single.
`BB:ARB:TRIG:SLUN SAMP`
sets unit Samples for the entry of sequence length.
`BB:ARB:TRIG:SLEN 200`
sets a sequence length of 200 samples. The first 200 samples of the current waveform will be output after the next trigger event.

Manual operation: See "[Signal Duration](#)" on page 394

[[:SOURce<hw>]:BB:ARbitrary:TRIGger:SLUNit <SLUnit>

The command defines the unit for the entry of the length of the signal sequence (`SOUR:BB:ARB:TRIG:SLEN`) to be output in the "Single" trigger mode (`SOUR:BB:ARB:SEQ SING`).

Parameters:

<SLUnit> SEquence | SAMPlE
*RST: SEquence

Example: `BB:ARB:SEQ SING`
sets trigger mode Single.
`BB:ARB:TRIG:SLUN SEQ`
sets unit Sequence length for the entry of sequence length.
`BB:ARB:TRIG:SLEN 2`
sets a sequence length of 2 waveforms. The current waveforms will be output twice after the next trigger event.

Manual operation: See "[Signal Duration Unit](#)" on page 394

[[:SOURce<hw>]:BB:ARbitrary:TRIGger:SMODe <SMODE>

The command selects the extended trigger mode for multi segment waveforms.

Parameters:

<SMODE> SAME | NEXT | NSEAm | SEQuencer
NSEAm = Next Segment Seamless
*RST: NEXT

Example: `SOUR:BB:ARB:SEQ AUTO`
selects trigger mode AUTO.
`SOUR:BB:ARB:TRIG:SMOD SAME`
the same segment of the waveform is output repeatedly.

Manual operation: See "[Next Segment Mode](#)" on page 398

[[:SOURce<hw>]:BB:ARbitrary:TRIGger:SOURce <Source>

Selects the trigger source.

Parameters:

<Source> INTernal|EXTernal

INTernal

manual trigger or *TRG.

EXTernal

trigger signal on the TRIG connector.

*RST: INTernal

Example: SOURce1:BB:ARbitrary:TRIGger:SOURce EXTernal
sets external triggering via the TRIGGER connector.

Manual operation: See "[Trigger Source](#)" on page 395

[:SOURce<hw>]:BB:ARbitrary:TRIGger:DELay:UNIT <TrigDelUnit>

Determines the units the trigger delay is expressed in.

Parameters:

<TrigDelUnit> SAMPLE | TIME
*RST: SAMPlE

Manual operation: See "[External Delay Unit](#)" on page 396

[:SOURce<hw>]:BB:ARbitrary:TRIGger[:EXTernal<1|2>]:DELay <Delay>

The command specifies the trigger delay (expressed as a number of samples) for external triggering.

Parameters:

<Delay> float
Range: 0 to depends on other values
Increment: 0.01
*RST: 0
Default unit: sample

Example: BB:ARB:TRIG:SOUR EXT
selects an external trigger
BB:ARB:TRIG:DEL 200
sets a delay of 200 samples for the trigger.

Manual operation: See "[Trigger Delay](#)" on page 397

[:SOURce<hw>]:BB:ARbitrary:TRIGger[:EXTernal<1|2>]:TDELay <ExtTimeDelay>

Specifies the trigger delay for external triggering. The value affects all external trigger signals.

Parameters:

<ExtTimeDelay> float
Range: 0 to 688
Increment: 1E-9
*RST: 0
Default unit: s

Manual operation: See ["Trigger Delay"](#) on page 397

[:SOURce<hw>]:BB:ARbitrary:TRIGger[:EXternal<1|2>]:RDElay?

Queries the time (in seconds) an external trigger event is delayed for.

Return values:

<ResTimeDelaySec> float

| | |
|------------|----------|
| Range: | 0 to 688 |
| Increment: | 0.25E-9 |
| *RST: | 0 |

Usage: Query only

Manual operation: See ["Actual Trigger Delay"](#) on page 397

[:SOURce<hw>]:BB:ARbitrary:TRIGger[:EXternal<1|2>]:INHibit <Inhibit>

Specifies the number of samples by which a restart is to be inhibited following a trigger event. This command applies only in the case of external triggering.

Parameters:

<Inhibit> integer

| | |
|---------------|---------------|
| Range: | 0 to 67108863 |
| *RST: | 0 |
| Default unit: | sample |

Example:

```
BB:ARB:TRIG:SOUR EXT
selects an external trigger
BB:ARB:TRIG:INH 200
sets a restart inhibit for 200 samples following a trigger event.
```

Manual operation: See ["Trigger Inhibit"](#) on page 397

[:SOURce<hw>]:BB:ARbitrary[:TRIGger]:SEquence <Sequence>

The command selects the trigger mode.

Parameters:

<Sequence> AUTO | RETRigger | AAUTo | ARETrigger | SINGLE

AUTO

The waveform is output continuously.

RETRigger

The waveform is output continuously. A trigger event (internal or external) causes a restart.

AAUTo

The waveform is output only when a trigger event occurs. After the trigger event the waveform is output continuously. Waveform output is stopped with command

```
SOUR:BB:ARB:TRIG:ARM:EXEC
```

and started again when a trigger event occurs.

ARETrigger

The waveform is output only when a trigger event occurs. The device automatically toggles to RETRIG mode. Every subsequent trigger event causes a restart. Waveform output is stopped with command `SOUR:BB:ARB:TRIG:ARM:EXEC` and started again when a trigger event occurs.

SINGLE

The waveform is output only when a trigger event occurs. After the trigger event the waveform is output once to the set sequence length (`SOUR:BB:ARB:TRIG:SLen`). Every subsequent trigger event causes a restart.

*RST: AUTO

Example:

`BB:ARB:SEQ AAUT`

sets the "Armed_auto" trigger mode; the device waits for the first trigger (e.g. with *TRG) and then generates the signal continuously.

Manual operation: See "Trigger Mode" on page 393

Marker Settings

The `TRIGger:OUTPut` subsystem contains the commands for setting the marker.

| | |
|--|-----|
| <code>[[:SOURce<hw>]:BB:ARbitrary:TRIGger:OUTPut<ch>:MODE</code> | 617 |
| <code>[[:SOURce<hw>]:BB:ARbitrary:TRIGger:OUTPut<ch>:OFFTime</code> | 618 |
| <code>[[:SOURce<hw>]:BB:ARbitrary:TRIGger:OUTPut<ch>:ONTime</code> | 618 |
| <code>[[:SOURce<hw>]:BB:ARbitrary:TRIGger:OUTPut<ch>:PATtern</code> | 618 |
| <code>[[:SOURce<hw>]:BB:ARbitrary:TRIGger:OUTPut<ch>:PULSe:DIVider</code> | 619 |
| <code>[[:SOURce<hw>]:BB:ARbitrary:TRIGger:OUTPut<ch>:PULSe:FREquency?</code> | 619 |
| <code>[[:SOURce<hw>]:BB:ARbitrary:TRIGger:OUTPut:DELay:FIXed</code> | 620 |
| <code>[[:SOURce<hw>]:BB:ARbitrary:TRIGger:OUTPut<ch>:DELay</code> | 620 |

`[[:SOURce<hw>]:BB:ARbitrary:TRIGger:OUTPut<ch>:MODE <Mode>`

The command defines the signal for the selected marker output.

Parameters:

<Mode> UNCHanged | RESTart | PULSe | PATtern | RATio | TRIGger

UNCHanged

A marker signal as defined in the waveform file (tag 'marker mode x') is generated.

RESTart

A marker signal is generated at every waveform start.

PULSe

A pulsed marker signal is generated. The pulse frequency (= sample rate/divider) is defined with the

`SOUR:BB:ARB:TRIG:OUTP:PULS:DIV` command and can be queried with the `SOUR:BB:ARB:TRIG:OUTP:PULS:FREQ?` command.

PATtern

A marker signal is generated with the aid of a user-definable bit pattern. The bit pattern is entered with the aid of command `:BB:ARB:TRIGger:OUTPut:PATtern`. The bit pattern is a maximum of 32 bits long.

RATio

A regular marker signal corresponding to the Time Off / Time On specifications in the com-

mands `:ARB:TRIGger:OUTPut:OFFTime`

and `:ARB:TRIGger:OUTPut:ONTime` is generated.

TRIGger

A received internal or external trigger signal is output at the marker connector.

*RST: UNCHanged

Example:

`BB:ARB:TRIG:OUTP2:MODE PULS`

selects the pulsed marker signal on output MARKER 2.

`BB:ARB:TRIG:OUTP2:STAT ON`

activates the pulsed marker signal on output MARKER 2.

Manual operation: See "[Marker Mode](#)" on page 404

`[:SOURce<hw>]:BB:ARbitrary:TRIGger:OUTPut<ch>:OFFTime <OffTime>`

`[:SOURce<hw>]:BB:ARbitrary:TRIGger:OUTPut<ch>:ONTime <OnTime>`

The command sets the number of samples in a period (ON time + OFF time) during which the marker signal in setting `:ARB:TRIGger:OUTPut:MODE RATio` on the marker outputs is ON.

Parameters:

<OnTime> integer

Range: 1 to 14913079

*RST: 1

Example:

`BB:ARB:TRIG:OUTP2:ONT 20`

sets an ON time of 20 samples for marker 2

Manual operation: See "[Marker Mode](#)" on page 404

`[:SOURce<hw>]:BB:ARbitrary:TRIGger:OUTPut<ch>:PATtern <Pattern>, <BitCount>`

The command defines the bit pattern used to generate the marker signal.

Parameters:

<Pattern> numeric

0 is marker off, 1 is marker on.

*RST: #H2

<BitCount> integer
 Range: 1 to 64
 *RST: 2

Example: BB:ARB:TRIG:OUTP:MODE PATT
 BB:ARB:TRIG:OUTP:PATT #H39FE0000,32

Manual operation: See "Marker Mode" on page 404

[[:SOURce<hw>]:BB:ARbitrary:TRIGger:OUTPut<ch>:PULSe:DIVider <Divider>

The command sets the divider for the pulsed marker signal in the setting SOURce:BB:ARB:TRIGger:OUTPut:MODE PULSe. The pulse frequency is derived by dividing the symbol rate by the divider.

Parameters:

<Divider> integer
 Range: 2 to 1024
 *RST: 2

Example: BB:ARB:TRIG:OUTP2:PULS:DIV 2
 sets the divider for the marker signal on output MARKER 2 to the value 2.
 BB:ARB:TRIG:OUTP2:FREQ?
 queries the resulting pulse frequency of the marker signal
 Response: 66 000
 the resulting pulse frequency is 66 kHz.

Manual operation: See "Marker Mode" on page 404

[[:SOURce<hw>]:BB:ARbitrary:TRIGger:OUTPut<ch>:PULSe:FREQUency?

The command queries the pulse frequency of the pulsed marker signal in the setting SOURce:BB:ARB:TRIGger:OUTPut:MODE PULSe. The pulse frequency is derived by dividing the symbol rate by the divider. The divider is defined with command :BB:ARB:TRIG:OUTP:PULS:DIV.

Return values:

<Frequency> float
 Increment: 0.001

Example: BB:ARB:TRIG:OUTP2:PULS:DIV 4
 sets the divider for the marker signal on the output to the value 4.
 BB:ARB:TRIG:OUTP2:MODE PULS
 enables the pulsed marker signal.
 BB:ARB:TRIG:OUTP2:PULS:FREQ?
 queries the pulse frequency of the marker signal.
 Response: 33 000
 the resulting pulse frequency is 33 kHz.

Usage: Query only

Manual operation: See ["Marker Mode"](#) on page 404

[:SOURce<hw>]:BB:ARbitrary:TRIGger:OUTPut:DELay:FIXed <Fixed>

The command restricts the marker delay setting range to the dynamic range. In this range the delay can be set without restarting the marker and signal. If a delay is entered in setting ON but is outside this range, the maximum possible delay is set and an error message is output.

The setting always affects every marker.

Parameters:

<Fixed> 0 | 1 | OFF | ON
 *RST: 0

Example:

BB:ARB:TRIG:OUTP:DEL:FIX ON
 restricts the marker signal delay setting range to the dynamic range.

Manual operation: See ["Fix marker delay to current range "](#) on page 405

[:SOURce<hw>]:BB:ARbitrary:TRIGger:OUTPut<ch>:DELay <Delay>

Sets the delay between the signal on the marker outputs and the start of the signals.

Parameters:

<Delay> integer
 Range: 0 to depends on other values
 Increment: 1
 *RST: 0
 Default unit: Samples

Example:

BB:ARB:TRIG:OUTP2:DEL 16
 sets a delay for the signal on connector MARKER 2.

Manual operation: See ["Marker x Delay"](#) on page 404

Test Signals Settings

| | |
|--|-----|
| [:SOURce<hw>]:BB:ARbitrary:SIGnal:TYPE..... | 621 |
| [:SOURce<hw>]:BB:ARbitrary:TSIGnal:CIQ:CREate..... | 621 |
| [:SOURce<hw>]:BB:ARbitrary:TSIGnal:RECTangle:CREate..... | 621 |
| [:SOURce<hw>]:BB:ARbitrary:TSIGnal:SINE:CREate..... | 621 |
| [:SOURce<hw>]:BB:ARbitrary:TSIGnal:CIQ:CREate:NAMed..... | 621 |
| [:SOURce<hw>]:BB:ARbitrary:TSIGnal:RECTangle:CREate:NAMed..... | 621 |
| [:SOURce<hw>]:BB:ARbitrary:TSIGnal:SINE:CREate:NAMed..... | 621 |
| [:SOURce<hw>]:BB:ARbitrary:TSIGnal:CIQ:I..... | 621 |
| [:SOURce<hw>]:BB:ARbitrary:TSIGnal:CIQ:Q..... | 621 |
| [:SOURce<hw>]:BB:ARbitrary:TSIGnal:RECTangle:AMPLitude..... | 622 |
| [:SOURce<hw>]:BB:ARbitrary:TSIGnal:RECTangle:FREQuency..... | 622 |
| [:SOURce<hw>]:BB:ARbitrary:TSIGnal:RECTangle:OFFSet..... | 622 |
| [:SOURce<hw>]:BB:ARbitrary:TSIGnal:RECTangle:SAMPles..... | 623 |

| | |
|--|-----|
| [:SOURce<hw>]:BB:ARbitrary:TSIGnal:SINE:FREQuency..... | 623 |
| [:SOURce<hw>]:BB:ARbitrary:TSIGnal:SINE:PHASe..... | 623 |
| [:SOURce<hw>]:BB:ARbitrary:TSIGnal:SINE:SAMPles..... | 624 |

[:SOURce<hw>]:BB:ARbitrary:SIGNal:TYPE <ArbSignalType>

Selects the type of test signal.

Parameters:

<ArbSignalType> SINE | RECT | CIQ
*RST: SINE

Example: SOURce1:BB:ARbitrary:SIGNal:TYPE SINE

Manual operation: See ["Create Test Signal..."](#) on page 391

[:SOURce<hw>]:BB:ARbitrary:TSIGnal:CIQ:CREate
[:SOURce<hw>]:BB:ARbitrary:TSIGnal:RECTangle:CREate
[:SOURce<hw>]:BB:ARbitrary:TSIGnal:SINE:CREate

Generates a signal and uses it as output straight away.

Example: BB:ARB:TSIG:SINE:CRE
generates a test sine signal and uses it as output straight away.

Usage: Event

Manual operation: See ["Generate Signal RAM \(Sine Test Signal\)"](#) on page 408

[:SOURce<hw>]:BB:ARbitrary:TSIGnal:CIQ:CREate:NAMed <Filename>
[:SOURce<hw>]:BB:ARbitrary:TSIGnal:RECTangle:CREate:NAMed <Filename>
[:SOURce<hw>]:BB:ARbitrary:TSIGnal:SINE:CREate:NAMed <Filename>

Generates a signal and saves it to a waveform file.

Setting parameters:

<Filename> string

Example: BB:ARB:TSIG:SINE:CRE:NAM 'sine_test'
generates a test sine signal and saves it into the wavefile
sine_test.

Usage: Setting only

Manual operation: See ["Generate Signal HD \(Sine Test Signal\)"](#) on page 408

[:SOURce<hw>]:BB:ARbitrary:TSIGnal:CIQ:I <I>
[:SOURce<hw>]:BB:ARbitrary:TSIGnal:CIQ:Q <TSig>

Sets the value for the I/Q component of the test signal

Parameters:

<TSig> float
 Range: -1 to 1
 Increment: 0.001
 *RST: 0
 Default unit: FS

Example:

BB:ARB:TSIG:CIQ:Q 0.5
 sets the value for the Q component of the test signal.

Manual operation: See "[Q Value \(Const IQ Test Signal\)](#)" on page 409

[:SOURce<hw>]:BB:ARbitrary:TSIGnal:RECTangle:AMPLitude <Amplitude>

Sets the digital amplitude of the rectangular wave.

Parameters:

<Amplitude> float
 Range: 0 to 1
 Increment: 0.001
 *RST: 0.800
 Default unit: FS

Example:

BB:ARB:TSIG:RECT:AMPL 0.5
 sets the amplitude of the test signal

Manual operation: See "[Amplitude \(Rect Test Signal\)](#)" on page 408

[:SOURce<hw>]:BB:ARbitrary:TSIGnal:RECTangle:FREQuency <Frequency>

Sets the frequency of the test signal.

Parameters:

<Frequency> float
 Range: 100 to depends on hardware
 Increment: 0.01
 *RST: 1000

Example:

SOURce:BB:ARbitrary:TSIGnal:RECTangle:FREQuency
 100 kHz
 sets the frequency of the test signal of 100 kHz.

Manual operation: See "[Frequency \(Rect Test Signal\)](#)" on page 408

[:SOURce<hw>]:BB:ARbitrary:TSIGnal:RECTangle:OFFSet <Offset>

Sets the DC component.

Parameters:

<Offset> float
 Range: -1 to 1
 Increment: 0.001
 *RST: 0
 Default unit: FS

Example: BB:ARB:TSIG:RECT:OFFS 0.5
 sets the DC component

Manual operation: See "[Offset DC \(Rect Test Signal\)](#)" on page 409

[:SOURce<hw>]:BB:ARbitrary:TSIGnal:RECTangle:SAMPles <Samples>

Sets the number of sample values required for the rectangular signal per period.

Parameters:

<Samples> integer
 Range: 4 to 1000
 *RST: 100

Example: BB:ARB:TSIG:RECT:SAMP 400
 sets 400 samples per period

Manual operation: See "[Samples per Period \(Rect Test Signal\)](#)" on page 408

[:SOURce<hw>]:BB:ARbitrary:TSIGnal:SINE:FREQuency <Frequency>

Sets the frequency of the simple sinusoidal test signal. This signal is used as output via the I channel. A sine wave of the same frequency but optionally phase-shifted is generated on the Q path (ARB:TSIGnal:SINE:POFFset).

Parameters:

<Frequency> float
 Range: 100 to depends on hardware
 Increment: 0.01
 *RST: 1000
 Default unit: Hz

Example: BB:ARB:TSIG:SINE:FREQ 100 kHz
 sets a sine signal of 100 kHz.

Manual operation: See "[Frequency \(Sine Test Signal\)](#)" on page 407

[:SOURce<hw>]:BB:ARbitrary:TSIGnal:SINE:PHASe <Phase>

The command sets the phase offset of the sine wave on the Q channel relative to the sine wave on the I channel.

Parameters:

<Phase> float
 Range: -180 to 180
 Increment: 0.01
 *RST: 90
 Default unit: DEG

Example:

BB:ARB:TSIG:SINE:PHAS 90
 sets a phase offset of 90 degrees.

Manual operation: See "[Phase Offset Q \(Sine Test Signal\)](#)" on page 407

[:SOURce<hw>]:BB:ARbitrary:TSIGnal:SINE:SAMPles <Samples>

The command sets the sample rate for the sine signal in samples per period.

The resulting clock rate must not exceed the maximum ARB clock rate of 150 or 90 MHz depending on the installed options.

The maximum value is automatically restricted by reference to the set frequency and has to fulfill the rule $\text{Frequency} * \text{Samples} \leq \text{ARB clock rate}$.

Parameters:

<Samples> integer
 Range: 4 to 1000
 *RST: 100
 Default unit: 100 samples per period

Example:

BB:ARB:TSIG:SINE:SAMP 100
 sets a sample rate of 100 samples per period.

Manual operation: See "[Samples per Period \(Sine Test Signal\)](#)" on page 407

SOURce:BB:ARB:MCAR Subsystem

The `MCARrier` subsystem contains the commands for setting the Multi Carrier Waveform Generator.

Section [Chapter 5.9.4.5, "Waveform and List Format"](#), on page 439 describes the ARB waveform format and how it is used to transmit waveforms via the IEC bus.

CARRier<ch>

The numerical suffix under `CARRier` distinguish between the carriers. The value range is 0 .. 31.

| | |
|---|-----|
| [:SOURce<hw>]:BB:ARbitrary:MCARrier:CARRier:COUNT | 625 |
| [:SOURce<hw>]:BB:ARbitrary:MCARrier:CARRier:MODE | 625 |
| [:SOURce<hw>]:BB:ARbitrary:MCARrier:CARRier:SPACing | 626 |
| [:SOURce<hw>]:BB:ARbitrary:MCARrier:CARRier<ch>:CONFlct? | 626 |
| [:SOURce<hw>]:BB:ARbitrary:MCARrier:CARRier<ch>:DELay | 627 |
| [:SOURce<hw>]:BB:ARbitrary:MCARrier:CARRier<ch>:FILE | 627 |
| [:SOURce<hw>]:BB:ARbitrary:MCARrier:CARRier<ch>:FREQuency | 627 |
| [:SOURce<hw>]:BB:ARbitrary:MCARrier:CARRier<ch>:PHASe | 628 |

| | |
|---|-----|
| <code>[SOURce<hw>]:BB:ARBitrary:MCARrier:CARRier<ch>:POWER</code> | 628 |
| <code>[SOURce<hw>]:BB:ARBitrary:MCARrier:POWER:REfERENCE</code> | 628 |
| <code>[SOURce<hw>]:BB:ARBitrary:MCARrier:CARRier<ch>:STATe</code> | 629 |
| <code>[SOURce<hw>]:BB:ARBitrary:MCARrier:CFACTOR:MODE</code> | 629 |
| <code>[SOURce<hw>]:BB:ARBitrary:MCARrier:CLIPping:CFACTOR</code> | 629 |
| <code>[SOURce<hw>]:BB:ARBitrary:MCARrier:CLIPping:CUTOFF</code> | 630 |
| <code>[SOURce<hw>]:BB:ARBitrary:MCARrier:CLIPping[STATe]</code> | 630 |
| <code>[SOURce<hw>]:BB:ARBitrary:MCARrier:CLOAD</code> | 631 |
| <code>[SOURce<hw>]:BB:ARBitrary:MCARrier:CLOCK?</code> | 631 |
| <code>[SOURce<hw>]:BB:ARBitrary:MCARrier:CREATE</code> | 632 |
| <code>[SOURce<hw>]:BB:ARBitrary:MCARrier:EDIT:CARRier:DELAy:STEP</code> | 632 |
| <code>[SOURce<hw>]:BB:ARBitrary:MCARrier:EDIT:CARRier:DELAy[START]</code> | 633 |
| <code>[SOURce<hw>]:BB:ARBitrary:MCARrier:EDIT:CARRier:EXECute</code> | 633 |
| <code>[SOURce<hw>]:BB:ARBitrary:MCARrier:EDIT:CARRier:FILE</code> | 633 |
| <code>[SOURce<hw>]:BB:ARBitrary:MCARrier:EDIT:CARRier:PHASe:STEP</code> | 634 |
| <code>[SOURce<hw>]:BB:ARBitrary:MCARrier:EDIT:CARRier:PHASe[START]</code> | 634 |
| <code>[SOURce<hw>]:BB:ARBitrary:MCARrier:EDIT:CARRier:POWER:STEP</code> | 634 |
| <code>[SOURce<hw>]:BB:ARBitrary:MCARrier:EDIT:CARRier:POWER[START]</code> | 635 |
| <code>[SOURce<hw>]:BB:ARBitrary:MCARrier:EDIT:CARRier:START</code> | 635 |
| <code>[SOURce<hw>]:BB:ARBitrary:MCARrier:EDIT:CARRier:STOP</code> | 635 |
| <code>[SOURce<hw>]:BB:ARBitrary:MCARrier:EDIT:CARRier:STATe</code> | 636 |
| <code>[SOURce<hw>]:BB:ARBitrary:MCARrier:OFILe</code> | 636 |
| <code>[SOURce<hw>]:BB:ARBitrary:MCARrier:PRESet</code> | 636 |
| <code>[SOURce<hw>]:BB:ARBitrary:MCARrier:SAMPles?</code> | 636 |
| <code>[SOURce<hw>]:BB:ARBitrary:MCARrier:SETTING:CATALog?</code> | 637 |
| <code>[SOURce<hw>]:BB:ARBitrary:MCARrier:SETTING:LOAD</code> | 637 |
| <code>[SOURce<hw>]:BB:ARBitrary:MCARrier:SETTING:STORE</code> | 637 |
| <code>[SOURce<hw>]:BB:ARBitrary:MCARrier:SETTING:STORE:FAST</code> | 638 |
| <code>[SOURce<hw>]:BB:ARBitrary:MCARrier:TIME</code> | 638 |
| <code>[SOURce<hw>]:BB:ARBitrary:MCARrier:TIME:MODE</code> | 638 |

`[SOURce<hw>]:BB:ARBitrary:MCARrier:CARRier:COUNT <Count>`

Sets the number of carriers in the ARB multi carrier waveform.

Parameters:

| | |
|----------------------------|-----------------|
| <code><Count></code> | integer |
| | Range: 1 to 512 |
| | *RST: 1 |

Example: `BB:ARB:MCAR:CARR:COUN 10`
sets 10 carriers for the multi carrier waveform.

Manual operation: See "[Number of Carriers](#)" on page 429

`[SOURce<hw>]:BB:ARBitrary:MCARrier:CARRier:MODE <Mode>`

The command sets the carrier frequency mode.

Parameters:

| | |
|---------------------------|-------------------------|
| <code><Mode></code> | EQUidistant ARBitrary |
|---------------------------|-------------------------|

EQUidistant

Sets an equidistant carrier spacing. The carrier frequency in the carrier table is not configurable.

ARBitrary

Enables you to specify the carrier frequency in the carrier table. Carrier spacing is irrelevant.

*RST: EQUidistant

Example:

BB:ARB:MCAR:CARR:MODE EQU

sets an equidistant carrier spacing. The carrier frequency can not be set.

Manual operation: See "Mode" on page 429

[:SOURce<hw>]:BB:ARBitrary:MCARrier:CARRier:SPACing <Spacing>

The command sets the frequency spacing between adjacent carriers of the multi carrier waveform. The carriers are generated symmetrically around the RF carrier. The maximum carrier spacing is limited to **Carrier spacing = Total baseband bandwidth / (Number of carriers - 1)**.

The total baseband bandwidth is 120 or 60 MHz depending on the installed options.

Note: In order to avoid wrap-around problems, the effective "Carrier Spacing" might be slightly modified. The "Carrier Spacing" is rounded in that way that the carrier closest to the center RF frequency shows no phase jump assuming that the carrier is unmodulated.

- For odd number of carriers:
RoundedCarrierSpacing=1/OutputSignalDuration* round(CarrierSpacing * OutputSignalDuration);
- For even number of carriers:
RoundedCarrierSpacing=2/OutputSignalDuration*round(0.5 *CarrierSpacing * OutputSignalDuration);

Parameters:

<Spacing> float
 Range: 0.0 to 120E6
 Increment: 0.01
 *RST: 0
 Default unit: Hz

Example:

BB:ARB:MCAR:CARR:SPAC 10 MHz

sets a carrier spacing of 10 MHz.

Manual operation: See "Carrier Spacing" on page 429

[:SOURce<hw>]:BB:ARBitrary:MCARrier:CARRier<ch>:CONFLict?

Queries carrier conflicts. A conflict arises when the carriers overlap.

Return values:

<Conflict> 0 | 1 | OFF | ON
 *RST: 0

Example:

BB:ARB:MCAR:CARR2:CONF?
 queries the multi carrier conflict state.
 Response: 0 no conflict has occurred.

Usage:

Query only

Manual operation: See " !!! " on page 438

[:SOURce<hw>]:BB:ARbitrary:MCARrier:CARRier<ch>:DELay <Delay>

Sets the start delay of the selected carrier.

Parameters:

<Delay> float
 Range: 0 to 1
 Increment: 1E-9
 *RST: 0
 Default unit: s

Example:

BB:ARB:MCAR:CARR15:DEL 5us
 sets a start delay of 50 us for carrier 15.

Manual operation: See " Delay " on page 437

[:SOURce<hw>]:BB:ARbitrary:MCARrier:CARRier<ch>:FILE <File>

Selects the file with I/Q data to be modulated onto the selected carrier.

Parameters:

<File> <file name>

Example:

BB:ARB:MCAR:CARR15:FILE "/var/user/IQ_wcdma"
 selects file IQ_wcdma. The data of the file is modulated onto carrier 15.

Manual operation: See " File " on page 437

[:SOURce<hw>]:BB:ARbitrary:MCARrier:CARRier<ch>:FREQUency <Frequency>

Sets or indicates the carrier frequency, depending on the selected carrier frequency mode.

The carrier frequency can be set in "Arbitrary Carrier frequency" mode. For "Equidistant Carrier Spacing", the carrier spacing is determined automatically.

Parameters:

<Frequency> float
 Value range depends on the max bandwidth, see data sheet
 Range: -40E6 to 40E6
 *RST: 0

Example:

BB:ARB:MCAR:CARR:MODE ARB
 Activates ARB multi-carrier mode.
 BB:ARB:MCAR:CARR:FREQ 5.0
 Sets 5.0 MHz carrier frequency.

Manual operation: See " [Carrier Freq \[MHz\]](#) " on page 437

[:SOURce<hw>]:BB:ARbitrary:MCARrier:CARRier<ch>:PHASe <Phase>

The command sets the start phase of the selected carrier.

The phase settings are only valid if optimization of the crest factor is disabled
 (:SOURce:BB:ARB:MCARrier:CFACTOR:MODE OFF).

Parameters:

<Phase> float
 Range: 0 to 359.99
 Increment: 0.01
 *RST: 0
 Default unit: DEG

Example:

BB:ARB:MCAR:CARR15:PHAS 90 DEG
 sets a start phase of 90° for carrier 15.

Manual operation: See " [Phase](#) " on page 437

[:SOURce<hw>]:BB:ARbitrary:MCARrier:CARRier<ch>:POWER <Power>

The command sets the gain of the selected carrier.

Parameters:

<Power> float
 Range: -80 to 0
 Increment: 0.01
 *RST: 0
 Default unit: dB

Example:

BB:ARB:MCAR:CARR15:POW -50 dB
 sets the power of carrier 15 to -50 dB.

Manual operation: See " [Gain](#) " on page 437

[:SOURce<hw>]:BB:ARbitrary:MCARrier:POWER:REFERence <Reference>

Defines the way the individual carriers in a composed multi carrier signal are leveled.

Parameters:

<Reference> RMS | PEAK
 *RST: RMS

Manual operation: See "[Power Reference](#)" on page 431

[:SOURce<hw>]:BB:ARbitrary:MCARrier:CARRier<ch>:STATe <State>

Enables/disables the selected carrier.

Parameters:

<State> 0 | 1 | OFF | ON
 *RST: 0

Example: SOURce1:BB:ARbitrary:MCARrier:CARRier15:STATe
 ON

Manual operation: See "[State](#)" on page 437

[:SOURce<hw>]:BB:ARbitrary:MCARrier:CFACTOR:MODE <Mode>

The command sets the mode for optimizing the crest factor by calculating the carrier phases.

Parameters:

<Mode> OFF | MIN | MAX

OFF

There is no automatic setting for minimizing or maximizing the crest factor. The Phase setting (command BB:ARB:MCAR:CARR:PHAS) is in use.

MIN

The crest factor is minimized by internally calculating optimized carrier phases. The Phase setting (command BB:ARB:MCAR:CARR:PHAS) is invalid.

MAX

The crest factor is maximized by internally calculating optimized carrier phases. The Phase setting (command BB:ARB:MCAR:CARR:PHAS) is invalid.

*RST: OFF

Example: BB:ARB:MCAR:CFACTOR:MODE OFF
 switches off automatic crest factor optimization. The setting SOUR:BB:ARB:MCAR:CARR:PHAS has an effect.

Manual operation: See "[Crest Factor Mode](#)" on page 430

[:SOURce<hw>]:BB:ARbitrary:MCARrier:CLIPPING:CFACTOR <CFactor>

Sets the value of the desired crest factor, if baseband clipping is enabled (BB:ARB:MCAR:CLIP:STAT ON).

A Target Crest Factor above the crest factor of the unclipped multicarrier signal has no effect.

Parameters:

<CFactor> float
 Range: -50 to 50
 Increment: 0.01
 *RST: 50
 Default unit: dB

Example:

BB:ARB:MCAR:CLIP:STAT ON
 enables clipping.
 BB:ARB:MCAR:CLIP:CFAC 37 dB
 sets the target crest factor.

Manual operation: See "[Target Crest Factor](#)" on page 430

[[:SOURce<hw>]:BB:ARbitrary:MCARrier:CLIPping:CUToff <Cutoff>

Sets the cut off frequency of the final lowpass filter, if baseband clipping is enabled (BB:ARB:MCAR:CLIP:STAT ON).

When the cut off frequency is set as half of the output sample rate, a final lowpass filter improves the spectrum of the clipped multicarrier signal, but may also increase the resulting crest factor.

Parameters:

<Cutoff> float
 Range: 0 to 75E6
 Increment: 0.01
 *RST: 50E6
 Default unit: MHz

Example:

BB:ARB:MCAR:CLIP:STAT ON
 Enables clipping
 BB:ARB:MCAR:CLIP:CUT 50 MHz
 Sets the cut off frequency of the filter.

Manual operation: See "[Filter Cut Off Frequency](#)" on page 430

[[:SOURce<hw>]:BB:ARbitrary:MCARrier:CLIPping[:STATE] <State>

Switches baseband clipping on and off.

Clipping reduces the peak power of the resulting multi carrier signal according to the value set with the command BB:ARB:MCAR:CLIP:CFAC.

The resulting clipped peak power is defined by sum of the the RMS level of the unclipped multi carrier signal and the input parameter Target Crest Factor. Note that clipping reduces also the RMS level. Hence the resulting crest factor of the clipped signal is slightly above the Target Crest Factor. In order to get the unclipped parts of the clipped multicarrier signal matched with the unclipped multicarrier signal, the RF output power should be reduced by the difference between resulting crest factor and Target Crest Factor.

Parameters:

<State> 0 | 1 | OFF | ON
 *RST: 0

Example:

```
BB:ARB:MCAR:CLIP:STAT ON
enables clipping
BB:ARB:MCAR:CLIP:CFAC 37 dB
sets the target crest factor.
```

Manual operation: See "[Clipping](#)" on page 430

[:SOURce<hw>]:BB:ARbitrary:MCARrier:CLOad

Creates and loads a multi carrier waveform using the current entries of the carrier table.

This multi carrier waveform is saved with the file name specified with command `SOUR:BB:ARB:MCAR:OFIL`. The file extension is `*.wv`.

Digital standard "ARB" is activated, the new multi carrier waveform is loaded and is output in accordance to the trigger settings.

Example:

```
MMEM:CDIR '/var/user/waveform'
sets the default directory.
BB:ARB:MCAR:OFIL 'mcar1_2'
defines the file name mcar1_2.wv for the multi carrier wave-
form.
BB:ARB:MCAR:CLO
creates multi carrier waveform mcar1_2.wv.
The new multi carrier waveform is loaded and digital standard
"ARB" is activated.
```

Usage: Event

Manual operation: See "[Create and Load](#)" on page 434

[:SOURce<hw>]:BB:ARbitrary:MCARrier:CLOCK?

The command queries the resulting sample rate at which the multi carrier waveform is output by the arbitrary waveform generator. The output clock rate depends on the number of carriers, carrier spacing and input sample rate of the leftmost or rightmost carriers.

Return values:

<Clock> float
 Range: 400 to Max
 Increment: 1E-3

Example: BB:ARB:MCAR:CLOC?
 queries the ARB multi carrier output clock rate.

Usage: Query only

Manual operation: See "[Clock Rate](#)" on page 433

[[:SOURce<hw>]:BB:ARbitrary:MCARrier:CREate

Creates a multi carrier waveform using the current settings of the carrier table. The multi carrier waveform is saved into the file defined with command SOUR:BB:ARB:MCAR:OFIL. The file extension is *.wv.

Example: MMEM:CDIR '/var/user/waveform'
 sets the default directory.
 BB:ARB:MCAR:OFIL 'multi_wv1'
 defines the file name multi_wv1.wv for the multi carrier waveform.
 BB:ARB:MCAR:CRE
 creates multi carrier waveform multi_wv1.wv.

Usage: Event

Manual operation: See "[Create](#)" on page 434

[[:SOURce<hw>]:BB:ARbitrary:MCARrier:EDIT:CARRier:DELay:STEP <Step>

The command sets the step width by which the start delays of the carriers in the defined carrier range will be incremented.

Parameters:

<Step> float
 Range: -1 to 1
 Increment: 1E-9
 *RST: 0
 Default unit: s

Example: BB:ARB:MCAR:EDIT:CARR:DEL 5 us
 sets a start delay of 5 us for the carriers in the carrier range.
 BB:ARB:MCAR:EDIT:CARR:DEL:STEP 1 us
 the start delay is incremented by 1us for each carrier, i.e. the first carrier has a start delay of 5us, the second a start delay of 6 us, etc.

Manual operation: See "[Delay Step](#)" on page 436

[[:SOURce<hw>]:BB:ARbitrary:MCARrier:EDIT:CARRier:DELay]:START] <Start>

The command sets the start delay for the individual carriers in the defined carrier range. If the command `:BB:ARB:MCAR:EDIT:CARR:DEL:STEP` is used to define a step width, the delay entered here applies only to the starting carrier. The delays of the remaining carriers are stepped up or down by the delay value specified in the `:BB:ARB:MCAR:EDIT:CARR:DEL:STEP` command.

Parameters:

<Start> float
 Range: 0 to 1
 Increment: 1E-9
 *RST: 0
 Default unit: s

Example: `BB:ARB:MCAR:EDIT:CARR:DEL 5us`
 sets a start delay of 5 us for the carriers in the carrier range.

Manual operation: See "[Delay Start](#)" on page 436

[[:SOURce<hw>]:BB:ARbitrary:MCARrier:EDIT:CARRier:EXECute

The command adopts the settings for the carrier range which has been defined using the `:BB:ARB:MCAR:EDIT:CARR:...` commands.

Example: `BB:ARB:MCAR:EDIT:CARR:STAR 4`
 the carrier range starts at carrier 2.
`BB:ARB:MCAR:EDIT:CARR:STOP 20`
 the carrier range stops at carrier 20.
`BB:ARB:MCAR:EDIT:CARR:STAT ON`
 sets all the carriers in the carrier range (2 to 20) to ON.
`BB:ARB:MCAR:EDIT:CARR:EXEC`
 transfers the assistant settings for carrier 2 to 20 into the carrier table.

Usage: Event

Manual operation: See "[Apply Assistant Settings](#)" on page 436

[[:SOURce<hw>]:BB:ARbitrary:MCARrier:EDIT:CARRier:FILE <File>

Selects input file

Parameters:

<File> string

Example: `BB:ARB:MCAR:EDIT:CARR:FILE "/var/user/IQ_wcdma'`

Manual operation: See "[Input Waveform File](#)" on page 436

[[:SOURce<hw>]:BB:ARbitrary:MCARrier:EDIT:CARRier:PHASe:STEP <Step>

The command sets the step width by which the start phases of the carriers in the defined carrier range will be incremented.

The phase settings are only valid if optimization of the crest factor is disabled (`:SOURce:BB:ARB:MCARrier:CFACTOR:MODE OFF`).

Parameters:

<Step> float
 Range: -359.99 to 359.99
 Increment: 0.01
 *RST: 0
 Default unit: DEG

Example:

`BB:ARB:MCAR:EDIT:CARR:PHAS 90 DEG`
 sets a start phase of 90° for the carriers in the carrier range.
`BB:ARB:MCAR:EDIT:CARR:PHAS:STEP 1 DEG`
 the start phase is incremented by 1° for each carrier, i.e. the first carrier has a start phase of 90°, the second a start phase of 91°, etc.

[[:SOURce<hw>]:BB:ARbitrary:MCARrier:EDIT:CARRier:PHASe[:START] <Start>

The command sets the start phase for the individual carriers in the defined carrier range. If the command `:BB:ARB:MCAR:EDIT:CARR:PHAS:STEP` is used to define a step width, the phase entered here applies only to the starting carrier. The phases of the remaining carriers are stepped up or down by the phase value specified in the `:BB:ARB:MCAR:EDIT:CARR:PHAS:STEP` command.

The phase settings are only valid if optimization of the crest factor is disabled (`:SOURce:BB:ARB:MCARrier:CFACTOR:MODE OFF`).

Parameters:

<Start> float
 Range: 0 to 359.99
 Increment: 0.01
 *RST: 0
 Default unit: DEG

Example:

`BB:ARB:MCAR:EDIT:CARR:PHAS 90 DEG`
 sets a start phase of 90° for the carriers in the carrier range.

Manual operation: See "[Phase Start](#)" on page 435

[[:SOURce<hw>]:BB:ARbitrary:MCARrier:EDIT:CARRier:POWER:STEP <Step>

The command sets the step width by which the starting power of the carriers in the defined carrier range will be incremented.

Parameters:

<Step> float
 Range: -80 to 80
 Increment: 0.01
 *RST: 0
 Default unit: dB

Example:

BB:ARB:MCAR:EDIT:CARR:POW -80dB
 sets a power of -80 dB for the carriers in the carrier range.
 BB:ARB:MCAR:EDIT:CARR:POW:STEP 1 dB
 the power is incremented by 1dB for each carrier, i.e. the first carrier has -80dB, the second -79dB, etc.

Manual operation: See " [Gain Step](#) " on page 435

[[:SOURce<hw>]:BB:ARbitrary:MCARrier:EDIT:CARRier:POWER[:START] <Start>

The command sets the power for the individual carriers in the defined carrier range. If the command :BB:ARB:MCAR:EDIT:CARR:POW:STEP is used to define a step width, the power entered here applies only to the starting carrier. The power of the remaining carriers is stepped up or down by the power specified in the :BB:ARB:MCAR:EDIT:CARR:POW:STEP command.

Parameters:

<Start> float
 Range: -80 to 0
 Increment: 0.01
 *RST: 0
 Default unit: dB

Example:

BB:ARB:MCAR:EDIT:CARR:POW -50 dB
 sets the power of the carriers in the carrier range to -50 dB.

Manual operation: See " [Gain Start](#) " on page 435

[[:SOURce<hw>]:BB:ARbitrary:MCARrier:EDIT:CARRier:START <Start>

[[:SOURce<hw>]:BB:ARbitrary:MCARrier:EDIT:CARRier:STOP <Stop>

The command selects the last carrier in the carrier range to which the settings with the :BB:ARB:MCAR:EDIT:CARR:. . . commands shall apply.

Parameters:

<Stop> integer
 Range: 0 to 511
 *RST: 0

Example:

BB:ARB:MCAR:EDIT:CARR:STOP 4
 the carrier range stops at carrier 4.

Manual operation: See " [Carrier Stop](#) " on page 435

[:SOURce<hw>]:BB:ARbitrary:MCARrier:EDIT:CARRier:STATe <State>

The command switches all the carriers in the selected carrier range on or off.

Parameters:

<State> 0 | 1 | OFF | ON
*RST: 1

Example: BB:ARB:MCAR:EDIT:CARR:STAT ON
sets all the carriers in the carrier range to ON.

Manual operation: See "Carrier State" on page 435

[:SOURce<hw>]:BB:ARbitrary:MCARrier:OFILe <OFile>

This command defines the output file name for the multi carrier waveform. This file name is used when a waveform is calculated (command SOUR:BB:ARB:MCAR:CLOad or SOUR:BB:ARB:MCAR:CREate). The file extension is *.wv.

Parameters:

<OFile> string

Example: MMEM:CDIR "/var/user/waveform"
sets the default directory.
BB:ARB:MCAR:OFIL 'mcar1_2'
defines the file name mcar1_2.wv for the multi carrier waveform file

Manual operation: See "File" on page 433

[:SOURce<hw>]:BB:ARbitrary:MCARrier:PRESet

Sets all ARB multi carrier parameters to their default values.

Example: SOURce1:BB:ARB:MCARrier:PRESet

Usage: Event

Manual operation: See "Set to Default" on page 427

[:SOURce<hw>]:BB:ARbitrary:MCARrier:SAMPles?

The command queries the resulting file size. The file size is returned in samples.

Return values:

<Samples> integer
Range: 0 to INT_MAX
*RST: 0

Example: BB:ARB:MCAR:SAMP?
queries the file size of the currently calculated multi carrier waveform.

Usage: Query only

Manual operation: See ["File Size"](#) on page 433

[:SOURce<hw>]:BB:ARbitrary:MCARrier:SETTing:CATalog?

Queries the available settings files in the specified default directory. The settings files are used to set the ARB multi carrier submenu. Only files with the file extension *.arb_multcarr will be listed.

Return values:

<Catalog> string

Example:

```
MMEM:CDIR '/var/user/waveform'
sets the default directory
BB:ARB:MCAR:SETT:CAT?
reads out all the settings files in the default directory.
Response: mcar1, mcar2
the directory contains the configuration files
mcar1.arb_multcarr and mcar2.arb_multcarr.
```

Usage: Query only

Manual operation: See ["Save/Recall Frame"](#) on page 428

[:SOURce<hw>]:BB:ARbitrary:MCARrier:SETTing:LOAD <Filename>

Loads the settings file. If a settings file with the specified name does not yet exist, it is created. The file extension may be omitted. Only files with the file extension *.arb_multcarr will be loaded or created.

Setting parameters:

<Filename> string

Example:

```
BB:ARB:MCAR:SETT:LOAD '/var/user/new'
creates settings file new.arb_multcarr.
```

Usage: Setting only

Manual operation: See ["Save/Recall Frame"](#) on page 428

[:SOURce<hw>]:BB:ARbitrary:MCARrier:SETTing:STORe <Filename>

The command stores the current settings of submenu "Multi Carrier" in a file in the specified directory. The file extension may be omitted, the files are stored with the file extension *.arb_multcarr.

Setting parameters:

<Filename> string

Example:

```
BB:ARB:MCAR:SETT:STOR '/var/user/mcarr2'
stores settings file mcarr2.arb_multcarr in the default direc-
tory.
```

Usage: Setting only

Manual operation: See ["Save/Recall Frame"](#) on page 428

[:SOURce<hw>]:BB:ARbitrary:MCARrier:SETting:STORe:FAST <Fast>

Determines whether the instrument performs an absolute or a differential storing of the settings.

Enable this function to accelerate the saving process by saving only the settings with values different to the default ones.

Note: This function is not affected by the "Preset" function.

Parameters:

<Fast> 0 | 1 | OFF | ON
 *RST: 1

Manual operation: See ["Fast Save"](#) on page 163

[:SOURce<hw>]:BB:ARbitrary:MCARrier:TIME <Time>

Sets the user-defined signal period. This setting is only possible for Signal Period Mode User (BB:ARB:MCAR:TIME:MODE USER).

Parameters:

<Time> float
 Range: 0 to 1E9
 Increment: 1E-9
 *RST: 0
 Default unit: s

Example:

BB:ARB:MCAR:TIME:MODE USER
 selects Signal Period Mode User.
 BB:ARB:MCAR:TIME 10 s
 sets a signal period of 10 seconds

Manual operation: See ["Signal Period"](#) on page 431

[:SOURce<hw>]:BB:ARbitrary:MCARrier:TIME:MODE <Mode>

Selects the mode for calculating the resulting signal period of the multi carrier waveform. The resulting period is always calculated for all carriers in the carrier table irrespective of their state (ON/OFF).

Parameters:

<Mode> LONG | SHORT | LCM | USER

LONG

The resulting signal period is defined by the longest I/Q file in the carrier table. Shorter I/Q files are periodically repeated.

SHORT

The resulting signal period is defined by the shortest I/Q file in the carrier table. Only the first part of longer I/Q files is used.

USER

The signal period can be set with command `[:SOURce<hw>]:BB:ARBitrary:MCARrier:TIME`. Shorter I/Q files are repeated periodically, and only the first part of longer I/Q files is used.

LCM

The output file duration is the least common multiple of all input file durations.

*RST: LONG

Example: `SPOURce1:BB:ARBitrary:MCARrier:TIME:MODE LONG`
selects signal period mode long

Manual operation: See "Signal Period Mode" on page 431

SOURce:BB:ARB:WAV Subsystem

The WAVEform subsystem contains the commands for working with waveform files.

| | |
|--|-----|
| <code>[:SOURce<hw>]:BB:ARBitrary:WAVEform:CATalog?</code> | 639 |
| <code>[:SOURce<hw>]:BB:ARBitrary:WAVEform:CATalog:LENGth?</code> | 640 |
| <code>[:SOURce<hw>]:BB:ARBitrary:WAVEform:CLOCK</code> | 640 |
| <code>[:SOURce<hw>]:BB:ARBitrary:WAVEform:DATA</code> | 640 |
| <code>[:SOURce<hw>]:BB:ARBitrary:WAVEform:DELeTe</code> | 641 |
| <code>[:SOURce<hw>]:BB:ARBitrary:WAVEform:FREE?</code> | 642 |
| <code>[:SOURce<hw>]:BB:ARBitrary:WAVEform:POINts?</code> | 642 |
| <code>[:SOURce<hw>]:BB:ARBitrary:WAVEform:SELeCt</code> | 642 |
| <code>[:SOURce<hw>]:BB:ARBitrary:WAVEform:TAG?</code> | 643 |

[:SOURce<hw>]:BB:ARBitrary:WAVEform:CATalog?

Reads out the files in the default directory. The default directory is set using command `MMEM:CDIRectory`. When the names of the waveform files are returned they are separated by commas. Only files with the file extension `*.wv` will be listed.

Return values:

<Catalog> string

Example: `MMEM:CDIR '/var/user/waveform'`
sets the default directory.
`BB:ARB:WAV:CAT?`
reads out all the files in the default directory.
Response: `sin1, wave`
the directory contains the waveform files `sin1.wv` and `wave.wv`.

Usage: Query only

[[:SOURce<hw>]:BB:ARbitrary:WAVEform:CATalog:LENGth?

Reads out the files in the default directory and returns the number of waveform files in this directory. The default directory is set using command `MMEM:CDIRectory`. Only files with the file extension `*.wv` will be listed.

Return values:

<Length> integer
 Number of waveform files in default directory
 Range: 0 to INT_MAX
 *RST: 0

Example:

```
MMEM:CDIR '/var/user/waveform'
sets the default directory.
BB:ARB:WAV:CAT?
reads out all the files in the default directory.
Response: sin1, wave
the directory contains the waveform files sin1.wv and
wave.wv.
BB:ARB:WAV:CAT:LEN?
Response: 2
```

Usage: Query only

[[:SOURce<hw>]:BB:ARbitrary:WAVEform:CLOCK <Filename>, <Clock>

Appends information on the ARB clock rate to specified waveform file. The file must contain I/Q and/or marker data and have been created with the command `:MMEMory:DATA:UNPRotected` on page 575.

Parameters:

<Filename> string
 Complete file path and file name with file extension (`*.wv`).
 If the file is in the default directory, the file path can be omitted.

Setting parameters:

<Clock> float
 Range: 400 to 100E6
 Increment: 1E-3
 *RST: 1E6

Example: see `:MMEMory:DATA:UNPRotected` on page 575

**[[:SOURce<hw>]:BB:ARbitrary:WAVEform:DATA <Filename>, <Data>
[:SOURce<hw>]:BB:ARbitrary:WAVEform:DATA? <Tag>**

The **setting** command writes the binary block data `<data>` to the file identified by `<filename>`. The complete content of the waveform file is transmitted as a binary data block.

Tip: To ensure trouble-free data transmission, set the GPIB delimiter to EOI.

The **query** command retrieves the content of the specified tag of the currently selected waveform file or the waveform file specified with the <filename>.

See [Chapter 5.9.4.5, "Waveform and List Format"](#), on page 439.

By default, the waveform files are saved in the default directory of the instrument (/var/user/Lists).

To access waveform files located in another directory, the complete file path and file name are required.

Parameters:

<Filename> string
 Specifies the name of the waveform file the binary data will be copied to.
 The file extension (.wv) may be omitted.

Setting parameters:

<Data> block data
 Contents of the waveform file as a definite length binary block.

Query parameters:

<Tag> 'comment' | 'copyright' | 'date' | 'lacfilter' | 'marker name' |
 'poweroffset'
 Identifier of the tag which shall be retrieved from the waveform file.

Example:

Setting

```
BB:ARB:WAV:DATA "/var/user/temp/test1", <bin
data block>
writes the block data to file test1.wv in
the /var/user/temp/ directory.
```

Example:

Query

```
BB:ARB:WAV:SEL '/var/user/wave1.wv'
BB:ARB:WAV:DATA? 'comment'
queries the content of the 'comment' tag of the currently selected
file wave1.wv
Response: "Sine wave for test purposes"
BB:ARB:WAV:DATA? '/var/user/temp/test1',
'comment'
queries the content of the comment tag of a specific file
test1.wv
Response: "Test file"
```

[[:SOURce<hw>]:BB:ARbitrary:WAVEform:DElete <Filename>

Deletes the specified waveform file. If the file is not on the default path, the path must be specified at the same time. The file extension may be omitted. Only files with the file extension *.wv will be deleted.

Setting parameters:

<Filename> string

Example: `BB:ARB:WAV:DEL '/var/user/wave1.wv'`
deletes waveform file `wave1.wv`.

Usage: Setting only

[:SOURce<hw>]:BB:ARbitrary:WAVeform:FREE?

Queries the free disk space on the default path of the instrument's harddisk.

Return values:

<Free> integer
Range: 0 to INT_MAX
*RST: 1

Example: `M MEM:CDIR '/var/user/waveform'`
Sets the default directory.
`BB:ARB:WAV:FREE?`
Queries the free disk space in directory.

Usage: Query only

[:SOURce<hw>]:BB:ARbitrary:WAVeform:POINTs?

The command queries the number of samples in the waveform file selected using command `:ARB:WAV:SEL`. Only the file name has to be entered. Only files with the file extension `*.wv` will be read out.

Return values:

<Points> <waveform filename>
Range: 0 to 1000
*RST: 1

Example: `BB:ARB:WAV:POINT?`
queries the number of I/Q values pairs in the waveform file.
Response: 401
the waveform file contains 401 I/Q values pairs.

Usage: Query only

[:SOURce<hw>]:BB:ARbitrary:WAVeform:SELEct <Filename>

Selects the waveform file. If the file is not on the default path, the path must be specified.

The file extension may be omitted. Only files with the file extension `*.wv` will be created or loaded.

Parameters:

<Filename> string

Example: `BB:ARB:WAV:SEL '/var/user/wave1.wv'`
selects waveform file and loads it.

Manual operation: See "Load Waveform" on page 389

[:SOURce<hw>]:BB:ARbitrary:WAVeform:TAG?

Queries the content of the specified tag of the waveform file, selected with the command `[:SOURce<hw>] :BB:ARbitrary:WAVeform:SElect`.

See also [Chapter 5.9.4.5, "Waveform and List Format"](#), on page 439.

Return values:

<Tag> string

Example:

```
BB:ARB:WAV:SEL '/var/user/wave1.wv'
selects waveform file and loads it
BB:ARB:WAV:TAG? 'comment'
queries the content of the comment tag
Response: "Sine wave for test purposes"
```

Usage: Query only

SOURce:BB:ARB:WSEG Subsystem

The `WSEGment` subsystem contains the commands for setting the Multi Segment Waveform Generator.

Section [Chapter 5.9.4.5, "Waveform and List Format"](#), on page 439 describes the ARB waveform format and how it is used to transmit waveforms via the IEC bus.

| | |
|---|-----|
| <code>[:SOURce<hw>]:BB:ARbitrary:WSEGment?</code> | 644 |
| <code>[:SOURce<hw>]:BB:ARbitrary:WSEGment:CLOad</code> | 644 |
| <code>[:SOURce<hw>]:BB:ARbitrary:WSEGment:CONFigure:BLANK:APPend</code> | 645 |
| <code>[:SOURce<hw>]:BB:ARbitrary:WSEGment:CONFigure:CATalog?</code> | 645 |
| <code>[:SOURce<hw>]:BB:ARbitrary:WSEGment:CONFigure:CLOCK</code> | 646 |
| <code>[:SOURce<hw>]:BB:ARbitrary:WSEGment:CONFigure:CLOCK:MODE</code> | 646 |
| <code>[:SOURce<hw>]:BB:ARbitrary:WSEGment:CONFigure:COMMENT</code> | 646 |
| <code>[:SOURce<hw>]:BB:ARbitrary:WSEGment:CONFigure:DELeTe</code> | 647 |
| <code>[:SOURce<hw>]:BB:ARbitrary:WSEGment:CONFigure:LEVel[:MODE]</code> | 647 |
| <code>[:SOURce<hw>]:BB:ARbitrary:WSEGment:CONFigure:MARKer:ESEGment</code> | 647 |
| <code>[:SOURce<hw>]:BB:ARbitrary:WSEGment:CONFigure:MARKer:FSEGment</code> | 648 |
| <code>[:SOURce<hw>]:BB:ARbitrary:WSEGment:CONFigure:MARKer:MODE</code> | 648 |
| <code>[:SOURce<hw>]:BB:ARbitrary:WSEGment:CONFigure:OFILe</code> | 649 |
| <code>[:SOURce<hw>]:BB:ARbitrary:WSEGment:CONFigure:SEGment:APPend</code> | 649 |
| <code>[:SOURce<hw>]:BB:ARbitrary:WSEGment:CONFigure:SEGment:CATalog?</code> | 649 |
| <code>[:SOURce<hw>]:BB:ARbitrary:WSEGment:CONFigure:SElect</code> | 650 |
| <code>[:SOURce<hw>]:BB:ARbitrary:WSEGment:CREate</code> | 650 |
| <code>[:SOURce<hw>]:BB:ARbitrary:WSEGment:NAME?</code> | 651 |
| <code>[:SOURce<hw>]:BB:ARbitrary:WSEGment:NEXT</code> | 651 |
| <code>[:SOURce<hw>]:BB:ARbitrary:WSEGment:NEXT:EXECute</code> | 652 |
| <code>[:SOURce<hw>]:BB:ARbitrary:WSEGment:NEXT:SOURce</code> | 652 |
| <code>[:SOURce<hw>]:BB:ARbitrary:WSEGment:SEquence:APPend</code> | 653 |
| <code>[:SOURce<hw>]:BB:ARbitrary:WSEGment:SEquence:SElect</code> | 653 |

[:SOURce<hw>]:BB:ARbitrary:WSEgment?

This command queries the currently output segment of the multi segment waveform.

Return values:

<WSegment> integer
 Range: 0 to 1023
 *RST: 0

Example:

BB:ARB:WSEG?
 queries the currently output segment.
 Response 2
 segment 2 is currently output.

Usage: Query only

Manual operation: See "[Current Segment](#)" on page 397

[:SOURce<hw>]:BB:ARbitrary:WSEgment:CLOad <FilenameInput>

Creates a and loads a multi segment waveform using the current entries of the specified configuration file.

This multi segment waveform is saved with the file name specified in the configuration file. The file extension is *.wv.

ARB is activated, the new multi segment waveform is loaded and the first segment is output in accordance to the trigger settings.

Setting parameters:

<FilenameInput> string

Example:

MMEM:CDIR '/var/user/'
 sets the default directory.
 BB:ARB:WSEG:CONF:SEL 'multi_sin'
 creates the configuration file multi_sin.inf_mswv in the default directory.
 BB:ARB:WSEG:CONF:SEGM:APP 'sinus1'
 includes waveform sinus1.wv as segment 1 in the configuration file. The waveform must be available in the default directory.
 BB:ARB:WSEG:CONF:SEGM:APP 'sinus2'
 includes waveform sinus2.wv as segment 2 in the configuration file. The waveform must be available in the default directory.
 BB:ARB:WSEG:CONF:OFIL 'mseg1_2'
 defines the file name mseg1_2.wv for the multi segment waveform.
 BB:ARB:WSEG:CLO '/var/user/multi_sin.inf_mswv'
 creates multi segment waveform mseg1_2.wv using the settings of the configuration file multi_sin.inf_mswv.
 The new multi segment waveform is loaded and ARB is activated.

Usage: Setting only

Manual operation: See " [Save List](#) " on page 421

[[:SOURce<hw>]:BB:ARbitrary:WSEgment:CONFigure:BLANk:APPend
 <SampCount>, <Frequency>

Adds a blank segment to the multi segment file.

Setting parameters:

<SampCount> float
 Specifies the number of samples.
 Range: 512 to 1E7
 Increment: 1
 *RST: 1000

<Frequency> float
 Determines the clock rate.
 Range: 400 Hz to Max (depends on instrument type)
 Increment: 0.001
 *RST: 1E8

Example: SOUR:BB:ARB:WSEG:CONF:SEL "MSegFile"
 selects a multi segment file.
 SOUR:BB:ARB:WSEG:CONF:BLAN:APP 1000,100000000
 adds a blank segment with 1000 samples and 100 MHz clock
 rate to the selected multi segment file

Usage: Setting only

Manual operation: See " [Clock Rate](#) " on page 418

[[:SOURce<hw>]:BB:ARbitrary:WSEgment:CONFigure:CATalog?

Queries the available configuration files in the specified default directory. The configuration files are used to create multi segment waveform files.

Return values:

<Catalog> string

Example: MMEM:CDIR '/var/user/waveform'
 sets the default directory.
 BB:ARB:WSEG:CONF:CAT?
 reads out all the configuration files in the default directory.
 Response: mult1, multi2
 the directory contains the configuration files multi1.inf_mswv
 and multi2.inf_mswv.

Usage: Query only

Manual operation: See " [Load List](#) " on page 421

[:SOURce<hw>]:BB:ARbitrary:WSEgment:CONFigure:CLOCK <Clock>

This command defines the clock rate used for multi segment waveform output in case of Clock Mode "User" (:BB:ARB:WSEG:CONF:CLOCK:MODE USER).

Parameters:

<Clock> float
 Increment: 1E-3
 *RST: max SampleRate

Example:

BB:ARB:WSEG:CONF:CLOCK:MODE USER
 selects Clock Mode User.
 BB:ARB:WSEG:CONF:CLOCK 50MHZ
 defines a clock rate of 50 MHz.

Manual operation: See " [User Clock Rate](#) " on page 419

[:SOURce<hw>]:BB:ARbitrary:WSEgment:CONFigure:CLOCK:MODE <Mode>

Selects the clock rate mode for the multi segment waveform.

Parameters:

<Mode> UNCHanged | HIGHest | USER

UNCHanged

The segments are output with the clock rate defined in the waveform file.

HIGHest

The segments are output at the highest available clock rate.

USER

The segments are output with the clock rate defined with command `[:SOURce<hw>]:BB:ARbitrary:WSEgment:CONFigure:CLOCK`

*RST: UNCHanged

Example:

BB:ARB:WSEG:CONF:CLOCK:MODE UNCH
 selects clock mode unchanged. The segments are output with the clock rate defined in the waveform file.

Manual operation: See " [Clock](#) " on page 419

[:SOURce<hw>]:BB:ARbitrary:WSEgment:CONFigure:COMMENT <Comment>

This command enters a comment for the configuration file. The configuration file must be specified with command :BB:ARB:WSEG:CONF:SEL.

Parameters:

<Comment> string

Example:

BB:ARB:WSEG:CONF:COMM <3gpp_up>
 enters comment "3gpp_up".

Manual operation: See " [Comment](#) " on page 420

[[:SOURce<hw>]:BB:ARbitrary:WSEgment:CONFigure:DELeTe <Filename>

Deletes the configuration file. The configuration files are used to create multi segment waveform files.

Setting parameters:

<Filename> string

Example:

```
MMEM:CDIR '/var/user/waveform'
sets the default directory.
BB:ARB:WSEG:CONF:DEL 'multil'
deletes configuration file multil.inf_mswv.
```

Usage: Setting only

Manual operation: See " [Delete](#) " on page 417

[[:SOURce<hw>]:BB:ARbitrary:WSEgment:CONFigure:LEVel[:MODE] <Mode>

This command selects the level mode for the multi segment waveform.

Parameters:

<Mode> UNCHanged | ERMS

UNCHanged

The segments are output exactly as defined in the files.

ERMS

The segments are output so that all segments have the same rms value.

*RST: UNCHanged

Example:

```
BB:ARB:WSEG:CONF:LEV:MODE UNCH
selects level mode unchanged. The segments are output as
defined in the waveform file.
```

Manual operation: See " [Level](#) " on page 418

**[[:SOURce<hw>]:BB:ARbitrary:WSEgment:CONFigure:MARKer:ESEgment
<Mode>**

Enables/disables the generation of an additional marker restart signal in the output waveform file.

If additional marker generation is enabled, the existing marker signals in the individual segment waveform files are not considered.

Parameters:

<Mode> OFF | MRK1 | MRK2 | MRK3 | MRK4

OFF

No additional marker is generated.

MRK1|MRK2|MRK3|MRK4

Generates a restart marker signal at the beginning of each segment for the corresponding marker.

The segment begin is defined by the low-high slope of the marker. This applies for switching between two segments as well as in case of segment replay.

*RST: OFF

Example:

```
BB:ARB:WSEG:CONF:SEL 'ConfComm'
BB:ARB:WSEG:CONF:MARK:ESEG MRK3
```

Manual operation: See " [Segment Restart](#) " on page 420

[:SOURce<hw>]:BB:ARbitrary:WSEGment:CONFigure:MARKer:FSEGment
<Mode>

Enables/disables the generation of an additional marker restart signal in the output waveform file.

If additional marker generation is enabled, the existing marker signals in the individual segment waveform files are not considered.

Parameters:

<Mode> OFF | MRK1 | MRK2 | MRK3 | MRK4

OFF

No additional marker is generated.

MRK1|MRK2|MRK3|MRK4

Generates a restart marker signal at the beginning of the first segment for the corresponding marker.

Use this setting to generate a restart marker for the complete sequence.

*RST: OFF

Example:

```
BB:ARB:WSEG:CONF:SEL 'ConfComm'
BB:ARB:WSEG:CONF:MARK:FSEG MRK3
```

Manual operation: See " [Sequence Restart](#) " on page 419

[:SOURce<hw>]:BB:ARbitrary:WSEGment:CONFigure:MARKer:MODE <Mode>

Defines the way the marker information within the separate segments is processed.

Parameters:

<Mode> IGNore | TAKE

IGNore

The marker information carried in the individual segment waveform files is not considered.

TAKE

The output waveform file contains the marker information as configured in the individual waveform files.

*RST: TAKE

Example: BB:ARB:WSEG:CONF:SEL 'ConfComm'
BB:ARB:WSEG:CONF:MARK:MODE TAKE

Manual operation: See " [Segment Marker](#) " on page 419

[:SOURce<hw>]:BB:ARbitrary:WSEgment:CONFigure:OFILe <OFile>

Defines the file name for the multi segment waveform. The file extension is *.wv.

Parameters:

<OFile> string

Example: MMEM:CDIR '/var/user/waveform'
sets the default directory.
BB:ARB:WSEG:CONF:SEL 'multil'
creates the configuration file multil.inf_mswv in default directory.
BB:ARB:WSEG:CONF:OFIL 'mseg1_2'
defines the file name mseg1_2.wv for the multi segment waveform file created using configuration file multil.inf_mswv.

Manual operation: See " [Output file](#) " on page 420

**[:SOURce<hw>]:BB:ARbitrary:WSEgment:CONFigure:SEGMent:APPend
<Waveform>**

Appends the specified waveform to the configuration file.

Setting parameters:

<Waveform> string

Example: MMEM:CDIR '/var/user/waveform'
sets the default directory
BB:ARB:WSEG:CONF:SEL 'new'
creates the configuration file new.inf_mswv in the default directory.
BB:ARB:WSEG:CONF:SEGM:APP 'arb1'
appends waveform arb1.wv to configuration file new. Waveform arb1 will be the first segment of a multi segment waveform created with configuration file new.

Usage: Setting only

Manual operation: See " [Append](#) " on page 417

[:SOURce<hw>]:BB:ARbitrary:WSEgment:CONFigure:SEGMent:CATalog?

Queries the segments of the currently selected configuration file.

Return values:

<Catalog> string

Example: MMEM:CDIR '/var/user/waveform'
 sets the default directory.
 BB:ARB:WSEG:CONF:SEL 'multi_sin'
 selects the configuration file multi_sin.inf_mswv.
 BB:ARB:WSEG:CONF:SEGM:CAT?
 queries the segments of the selected configuration file.
 Response: arb4, arb2
 The configuration file includes the segments arb4.wv and
 arb2.wv.

Usage: Query only

Manual operation: See "[Append](#)" on page 417

[:SOURce<hw>]:BB:ARbitrary:WSEgment:CONFigure:SElect <Filename>

Selects the configuration file in the default directory.

A path can also be specified, in which case the files in the specified directory are selected. If a configuration file with the specified name does not yet exist, it is created. The file extension may be omitted. Only files with the file extension *.inf_mswv will be selected or created.

Parameters:

<Filename> string

Example: MMEM:CDIR '/var/user/waveform'
 sets the default directory.
 BB:ARB:WSEG:CONF:SEL 'new'
 create configuration file new.inf_mswv in the default directory.

Manual operation: See "[Load List](#)" on page 421

[:SOURce<hw>]:BB:ARbitrary:WSEgment:CREate <FilenameInput>

Creates a multi segment waveform using the current settings of the specified configuration file. The multi segment waveform is saved into the file defined in the configuration file. The file extension is *.wv.

Setting parameters:

<FilenameInput> string

Example:

```
MMEM:CDIR '/var/user/'
sets the default directory
BB:ARB:WSEG:CONF:SEL 'new'
creates the configuration file new.inf_mswv in the default
directory.
BB:ARB:WSEG:CONF:SEGM:APP 'arb1.wv'
'includes waveform arb1.wv as segment 1 in the configuration
file. The waveform must be available in the default directory.
BB:ARB:WSEG:CONF:OFIL 'multi_wv1'
defines the file name multi_wv1.wv for the multi segment
waveform.
BB:ARB:WSEG:CRE '/var/user/new.inf_mswv'
creates multi segment waveform multi_wv1.wv using the set-
tings of the configuration file new.inf_mswv.
```

Usage: Setting only

Manual operation: See "[Save List](#)" on page 421

[:SOURce<hw>]:BB:ARbitrary:WSEGment:NAME?

This command queries the name of the waveform of the currently output segment of the multi segment waveform.

Return values:

<Name> string

Example: BB:ARB:WSEG:NAME?
queries the currently output segment.

Usage: Query only

Manual operation: See "[Current Segment](#)" on page 397

[:SOURce<hw>]:BB:ARbitrary:WSEGment:NEXT <Next>

Selects the segment to be output.

Parameters:

<Next> float
Range: 0 to 1023
*RST: 0

Example: `M MEM:CDIR '/var/user/waveform'`
 sets the default directory.
`BB:ARB:WSEG:NEXT 2`
 selects segment 2 to be output.
`BB:ARB:TRIG:SMOD NEXT`
 selects extended trigger mode next, i.e. the segment specified with command `:BB:ARB:WSEG:NEXT` will be output.
`BB:ARB:SEQ AUTO`
 selects trigger mode Auto.
`BB:ARB:WAV:SEL 'multi_wv1'`
 loads multi segment waveform `multi_wv1.wv`. Generation of segment 2 starts.
`BB:ARB:WSEG:NEXT 3`
 switched at once to output of segment 3.

Manual operation: See ["Next Segment"](#) on page 397

[:SOURce<hw>]:BB:ARbitrary:WSEGment:NEXT:EXECute

Triggers manually switchover to the subsequent segment in the mutli segment file. A manual trigger can be executed only when an internal next segment source (`BB:ARB:WSEG:NEXT:SOUR INT`) has been selected.

To perform a switchover to any segment within the multi segment file, select the next segment with the command `BB:ARB:WSEG:NEXT`.

This command is disabled, if a sequencing play list is enabled.

Example: `BB:ARB:WSEG:NEXT:SOUR INT`
 selects internal next segment source.
`BB:ARB:WSEG:NEXT 2`
 selects segment 2 to be output.
`BB:ARB:WSEG:NEXT:EXEC`
 executes a switchover to the next segment.

Usage: Event

Manual operation: See ["Execute Next Segment"](#) on page 403

[:SOURce<hw>]:BB:ARbitrary:WSEGment:NEXT:SOURce <Source>

Selects the next segment source, i.e. determines whether the next segment is switched upon receiving of an external trigger signal or upon executing of software trigger .

Parameters:

<Source> INTernal | NEXT

INTernal

Switch over to any segment is triggered manually by means of the command `BB:ARB:WSEG:NEXT:EXEC`.

NEXT

The trigger event for switching to the next segment is input on the NEXT connector.

*RST: INTERNAL

Example: BB:ARB:WSEG:NEXT:SOUR INT
selects internal next segment source.

Manual operation: See "[Next Segment Source](#)" on page 402

[:SOURce<hw>]:BB:ARbitrary:WSEgment:SEquence:APPend <State>, <Segment>, <Count>, <Next>

Appends a new segment to the selected sequencing play list.

Setting parameters:

<State> ON | OFF
activates/deactivates the appended segment
*RST: ON

<Segment> integer
indicates the number of the segment as in the multi segment waveform file
Range: 0 to SegmentCount - 1

<Count> integer
defines how many times this segment is repeated
Range: 1 to 65535

<Next> NEXT | BLANK | ENDLess | SEG0 | SEG1 | ... | SEG31 | 0...maxSegment
determines the action after completing the current segment, like for instance which segment is processed after the processing of the current one is finished.

Example: BB:ARB:WSEG:SEQ:SEL '/var/user/play_list_1'
selects the sequencing list `play_list_1.wvs`.
BB:ARB:WSEG:SEQ:APP ON,3,15,BLANK
appends the segment number 3 as a new segment to the sequencing list; this segment is activated and will be repeated 15 times and followed by a blank segment.

Usage: Setting only

Manual operation: See "[Append](#)" on page 424

[:SOURce<hw>]:BB:ARbitrary:WSEgment:SEquence:SElect <Filename>

Selects the sequencing list (files with extension *.wvs)

Parameters:

<Filename> string

Example: `BB:ARB:WSEG:SEQ:SEL '/var/user/play_list_1'`
selects the sequencing list `play_list_1.wvs`.

Manual operation: See "[Sequencing List](#)" on page 403

7.15.3.3 SOURce:BB:DM Subsystem

The commands in the `SOURce:BB:DM` subsystem are described in two sections, separated into configuring digital modulation and lists for digital modulation.

DM General Remote-Control Commands

The following section contains the commands for generating the digital modulation signal.

| | |
|---|-----|
| • Common Settings | 654 |
| • Clock Settings | 658 |
| • Trigger Settings | 660 |
| • Marker Settings | 667 |
| • Filter Settings | 670 |
| • Modulation Settings | 673 |
| • Power Ramp | 677 |

Common Settings

| | |
|--|-----|
| <code>[[:SOURce<hw>]:BB:DM:PATtern</code> | 654 |
| <code>[[:SOURce<hw>]:BB:DM:PRBS[:LENGth]</code> | 655 |
| <code>[[:SOURce<hw>]:BB:DM:PRESet</code> | 655 |
| <code>[[:SOURce<hw>]:BB:DM:SOURce</code> | 655 |
| <code>[[:SOURce<hw>]:BB:DM:SRATe</code> | 656 |
| <code>[[:SOURce<hw>]:BB:DM:STANdard</code> | 656 |
| <code>[[:SOURce<hw>]:BB:DM:STATe</code> | 657 |
| <code>[[:SOURce<hw>]:BB:DM:SWITching:SOURce</code> | 657 |
| <code>[[:SOURce<hw>]:BB:DM:SWITching:STATE</code> | 657 |
| <code>[[:SOURce<hw>]:BB:DM:APSK16:GAMMa</code> | 658 |
| <code>[[:SOURce<hw>]:BB:DM:APSK32:GAMMa</code> | 658 |

`[[:SOURce<hw>]:BB:DM:PATtern <Pattern>, <BitCount>`

The command selects the data pattern for the internal data.

Parameters:

| | |
|-------------------------------|----------------|
| <code><Pattern></code> | numeric |
| | *RST: #H0 |
| <code><BitCount></code> | integer |
| | Range: 1 to 64 |
| | *RST: 1 |

Example: `BB:DM:SOUR PATT`
`BB:DM:PATT #B0111011101010101,17`

[[:SOURce<hw>]:BB:DM:PRBS[:LENGth] <Length>

The command defines the length of the pseudo-random sequence in accordance with the following equation:

$$\text{Length} = (2^{\text{Length}}) - 1$$

Parameters:

<Length> 9 | 11 | 15 | 16 | 20 | 21 | 23 | PN9 | PN11 | PN15 | PN16 | PN20 | PN21 | PN23

*RST: 9

Example:

BB:DM:SOUR PRBS

The internal pseudo-random generator is used as the data source.

BB:DM:PRBS 9

An internal pseudo-random sequence of 511 bits will be generated.

Manual operation: See ["Data Source"](#) on page 356

[[:SOURce<hw>]:BB:DM:PRESet

Sets the default settings for digital modulation (*RST values specified for the commands).

Not affected is the state set with the command `SOURce<hw>:BB:DM:STATe`

Example:

SOURce1:BB:DM:PRESet

Usage:

Event

Manual operation: See ["Set To Default"](#) on page 355

[[:SOURce<hw>]:BB:DM:SOURce <Source>

The command selects the data source.

Parameters:

<Source> ZERO | ONE | PRBS | PATtern | DLISt

ZERO|ONE

An internally generated 0 or 1 data sequence is used.

PRBS

The pseudo-random sequence generator is used as the data source. The length of the random sequence is defined with the command `SOURce:BB:DM:PRBS`.

PATtern

Internally generated data with a fixed pattern is used. The data pattern is defined using command `SOURce:BB:DM:PATtern`.

DLISt

Data from the selected data list is used.

*RST: PRBS

Example:

```
BB:DM:SOUR DLIS
BB:DM:DLIS:SEL 'test'
// the data list test.dm_iqd is used
```

Manual operation: See ["Data Source"](#) on page 356

[:SOURce<hw>]:BB:DM:SRATe <SRate>

Sets the symbol rate. The value range is dependent on the selected modulation type. On changing to an FSK modulation type, excessively high values are automatically limited to the maximum value that can be set for FSK (see data sheet). The symbol rate can be entered in Hz/kHz/MHz or Symb/s / kSymb/s and MSymb/s.

When a standard is selected (DM:STANdard), the symbol rate is automatically set to the appropriate default value.

The value range is dependent on the selected modulation type (:BB:DM:FORM). When a standard is selected (:BB:DM:STAN), the symbol rate is set to the default value.

Parameters:

| | |
|---------|-----------------------------------|
| <SRate> | float |
| | Range: 400 to depends on hardware |
| | Increment: 0.001 |
| | *RST: 270833.333 |
| | Default unit: Hz |

Example:

```
BB:DM:SRAT 10 MHz
sets a symbol rate of 10 MHz.
```

Manual operation: See ["Symbol Rate"](#) on page 359

[:SOURce<hw>]:BB:DM:STANdard <Standard>

Selects the standard.

After selection, modulation parameters "Modulation Type" (:BB:DM:FORMat), "Symbol Rate" (:BB:DM:SRATe), "Filter" (:BB:DM:FILTer:TYPE and :BB:DM:FILTer:PARAMeter:...) and "Coding" (:BB:DM:CODing) are automatically set in accordance with the standard.

The USER parameter cannot be set. A query returns this value if a user-defined Custom Dig Mod setting was loaded or if one of the associated settings was changed subsequent to the selection of a standard. The user defined settings are stored and loaded with commands :BB:DM:STAN:ULIS:... (see ["DM Lists"](#) on page 679).

Parameters:

<Standard> USER | BLUetooth | DECT | ETC | GSM | GSMEdge | NADC | PDC | PHS | TETRa | W3GPp | TDSCdma | CFORward | CREVerse | WORLdspace | TFTS | APCOPH1C4fm | APCOPH1CQpsk | APCOPH2HCpm | APCOPH2HDQpsk | APCOPH2HD8PSKW | APCOPH2HD8PSKN | APCOPH1Lsm | APCOPH1Wcqpsk
 *RST: GSM

Example:

BB:DM:STAN DECT
 Selects digital modulation according to the DECT standard.

Manual operation: See "Set acc. to Standard" on page 358

[:SOURce<hw>]:BB:DM:STATe <State>

Enables/disables digital modulation. Switching on digital modulation turns off all the other digital standards in the same signal path.

Parameters:

<State> 0 | 1 | OFF | ON
 *RST: 0

Example:

SOURce1:BB:DM:STATe ON

Manual operation: See "State" on page 355

[:SOURce<hw>]:BB:DM:SWITching:SOURce <Source>

Selects the source of the CW control signal for switching between a modulated and an unmodulated signal.

Parameters:

<Source> INTernal
INTernal
 The CW signal in the control list is used for the control.
 *RST: INTernal

Example:

BB:DM:SWIT INT
 the CW signal in the control list is used for the control.

Manual operation: See "Source Mod - CW" on page 363

[:SOURce<hw>]:BB:DM:SWITching:STATe <State>

Enables switching between a modulated and an unmodulated signal.

Parameters:

<State> 0 | 1 | OFF | ON
 *RST: 0

Example: BB:DM:SWIT:STAT INT
CW switching is active.

Manual operation: See "State Mod - CW" on page 363

[:SOURce<hw>]:BB:DM:APSK16:GAMMa <Gamma>

Sets the gamma function γ for the 16APSK modulation.

Parameters:

<Gamma> G2D3 | G3D4 | G4D5 | G5D6 | G8D9 | G9D10
GxDy: G = Gamma function, x γ = code rate
*RST: G2D3

Example: SOURce1:BB:DM:FORMat APSK16
SOURce1:BB:DM:APSK16:GAMMa G9D10

Manual operation: See "Gamma/Gamma 1" on page 361

[:SOURce<hw>]:BB:DM:APSK32:GAMMa <Gamma>

Sets the gamma function γ for the 32APSK modulation.

Parameters:

<Gamma> G3D4 | G4D5 | G5D6 | G8D9 | G9D10
GxDy: G = Gamma function, x γ = code rate
*RST: G3D4

Example: SOURce1:BB:DM:FORMat APSK32
SOURce1:BB:DM:APSK32:GAMMa G9D10

Manual operation: See "Gamma/Gamma 1" on page 361

Clock Settings

| | |
|--|-----|
| [:SOURce<hw>]:BB:DM:CLOCK:MODE..... | 658 |
| [:SOURce<hw>]:BB:DM:CLOCK:MULTIplier..... | 659 |
| [:SOURce<hw>]:BB:DM:CLOCK:SOURce..... | 659 |
| [:SOURce<hw>]:BB:DM:CLOCK:SYNChronization:MODE..... | 659 |
| [:SOURce<hw>]:BB:DM:CLOCK:SYNChronization:EXECute..... | 660 |

[:SOURce<hw>]:BB:DM:CLOCK:MODE <Mode>

The command enters the type of externally supplied clock (:BB:DM:CLOCK:SOURce EXTERNAL).

Parameters:

<Mode> SYMBol | MSYMBol
*RST: SYMBol

Example: `BB:DM:CLOCK:MODE SYMB`
selects clock type Symbols, i.e. the supplied clock is a symbol clock.

Manual operation: See "[Clock Mode](#)" on page 381

[:SOURce<hw>]:BB:DM:CLOCK:MULTIplier <Multiplier>

The command specifies the multiplier for clock type Multiple Symbols (`BB:DM:CLOCK:MODE MSYM`) in the case of an external clock source.

Parameters:

<Multiplier> integer
Range: 1 to 64
*RST: 4

Example: `BB:DM:CLOCK:SOUR EXT`
selects the external clock source. The clock is supplied via the CLOCK connector.
`BB:DM:CLOCK:MODE MSYM`
selects clock type Multiple Symbols, i.e. the supplied clock has a rate which is a multiple of the symbol rate.
`BB:DM:CLOCK:MULT 12`
the multiplier for the external clock rate is 12.

Manual operation: See "[Symbol Clock Multiplier](#)" on page 381

[:SOURce<hw>]:BB:DM:CLOCK:SOURce <Source>

Sets the source for the digital modulation clock.

Parameters:

<Source> INTERNAL | EXTERNAL
INTERNAL
The internal clock reference is used.
EXTERNAL
The external clock reference is supplied to the [CLOCK] connector.
*RST: INTERNAL

Example: `BB:DM:CLOCK:SOUR INT`
selects the internal clock reference.

Manual operation: See "[Clock Source](#)" on page 381

[:SOURce<hw>]:BB:DM:CLOCK:SYNChronization:MODE <Mode>

Selects the synchronization mode

This parameter is used to enable generation of very precise synchronous signal of several connected R&S SMBVs.

Note: If several instruments are connected, the connecting cables from the master instrument to the slave one and between each two consecutive slave instruments must have the same length and type. Avoid unnecessary cable length and branching points.

Parameters:

<Mode> NONE | MASTer | SLAVE

NONE

The instrument is working in stand-alone mode.

MASTer

The instrument provides all connected instrument with its synchronisation (including the trigger signal) and reference clock signal.

SLAVE

The instrument receives the synchronisation and reference clock signal from another instrument working in a master mode.

*RST: NONE

Example:

BB:DM:CLOC:SYNC:MODE MAST

the instrument is configured to work as a master one.

Manual operation: See "[Sync. Mode](#)" on page 380

[:SOURce<hw>]:BB:DM:CLOCK:SYNChronization:EXECute

Performs automatically adjustment of the instrument's settings required for the synchronization mode, set with the command BB:DM:CLOC:SYNC:MODE.

Example:

BB:DM:CLOC:SYNC:MODE MAST

the instrument is configured to work as a master one.

BB:DM:CLOC:SYNC:EXEC

all synchronization's settings are adjusted accordingly.

Usage: Event

Manual operation: See "[Set Synchronization Settings](#)" on page 380

Trigger Settings

The numeric suffix to OUTPut distinguishes between the available markers.

| | |
|--|-----|
| [:SOURce<hw>]:BB:DM:TRIGger:ARM:EXECute..... | 661 |
| [:SOURce<hw>]:BB:DM:TRIGger:EXECute..... | 661 |
| [:SOURce<hw>]:BB:DM:TRIGger:EXTErnal:SYNChronize:OUTPut..... | 661 |
| [:SOURce<hw>]:BB:DM:TRIGger:OUTPut:DELay:FIXed..... | 662 |
| [:SOURce<hw>]:BB:DM:TRIGger:OUTPut<ch>:DELay..... | 663 |
| [:SOURce<hw>]:BB:DM:TRIGger:OUTPut<ch>:DELay:MINimum?..... | 663 |
| [:SOURce<hw>]:BB:DM:TRIGger:OUTPut<ch>:DELay:MAXimum?..... | 663 |
| [:SOURce<hw>]:BB:DM:TRIGger:RMODE?..... | 663 |
| [:SOURce<hw>]:BB:DM:TRIGger:SLENgth..... | 664 |
| [:SOURce<hw>]:BB:DM:TRIGger:SOURce..... | 664 |
| [:SOURce<hw>]:BB:DM:TRIGger:DELay:UNIT..... | 665 |
| [:SOURce<hw>]:BB:DM:TRIGger[:EXTErnal<ch>]:DELay..... | 665 |

| | |
|---|-----|
| <code>[:SOURce<hw>]:BB:DM:TRIGger[:EXTeRnal]:TDElay</code> | 665 |
| <code>[:SOURce<hw>]:BB:DM:TRIGger[:EXTeRnal]:RDElay?</code> | 666 |
| <code>[:SOURce<hw>]:BB:DM:TRIGger[:EXTeRnal<ch>]:INHibit</code> | 666 |
| <code>[:SOURce<hw>]:BB:DM[:TRIGger]:SEQuence</code> | 666 |

`[:SOURce<hw>]:BB:DM:TRIGger:ARM:EXECute`

The command stops signal generation for trigger modes Armed_Auto and Armed_Retrigger. A subsequent internal or external trigger event restart signal generation.

Example:

```
BB:DM:TRIG:SOUR INT
sets internal triggering.
BB:DM:TRIG:SEQ ARET
sets Armed_Retrigger mode, i.e. every trigger event causes signal
generation to restart.
BB:DM:TRIG:EXEC
executes a trigger, signal generation is started.
BB:DM:TRIG:ARM:EXEC
signal generation is stopped.
BB:DM:TRIG:EXEC
executes a trigger, signal generation is started again.
```

Usage: Event

Manual operation: See "[Arm](#)" on page 376

`[:SOURce<hw>]:BB:DM:TRIGger:EXECute`

Executes a trigger. The internal trigger source must be selected using the command `BB:DM:TRIG:SOUR INT` and a trigger mode other than AUTO must be selected using the command `BB:DM:TRIG:SEQ`.

Example:

```
BB:DM:TRIG:SOUR INT
sets internal triggering.
BB:DM:TRIG:SEQ RETR
sets Retrigger mode, i.e. every trigger event causes signal gen-
eration to restart.
BB:DM:TRIG:EXEC
executes a trigger.
```

Usage: Event

Manual operation: See "[Execute Trigger](#)" on page 365

`[:SOURce<hw>]:BB:DM:TRIGger:EXTeRnal:SYNChronize:OUTPut <Output>`

(enabled for "Trigger Source" External)

Enables/disables output of the signal synchronous to the external trigger event.

For or two or more R&S SMBVs configured to work in a master-slave mode for synchronous signal generation:

- disable this parameter in the slave instruments, in case the master instrument provides the slaves with its internal trigger signal and
- use the default enabled state, if a common external trigger event is provided for the master and the slave instruments.

Parameters:

<Output> 0 | 1 | OFF | ON

ON

The signal calculation starts simultaneously with the external trigger event but because of the instrument's processing time the first samples are cut off and no signal is outputted. After elapsing of the internal processing time, the output signal is synchronous to the trigger event.

OFF

The signal output begins after elapsing of the processing time and starts with sample 0, i.e. the complete signal is outputted. This mode is recommended for triggering of short signal sequences with signal duration comparable with the processing time of the instrument.

*RST: 1

Example:

BB:DM:TRIG:SOUR EXT

sets external triggering.

BB:DM:TRIG:EXT:SYNC:OUTP ON

enables synchronous output to external trigger

Manual operation: See "[Sync. Output to External Trigger](#)" on page 377

[:SOURce<hw>]:BB:DM:TRIGger:OUTPut:DELay:FIXed <Fixed>

The command restricts the marker delay setting range to the dynamic range. In this range the delay can be set without restarting the marker and signal. If a delay is entered in setting ON but is outside this range, the maximum possible delay is set and an error message is generated.

The numeric suffix in `OUTPut` has no significance for this command, since the setting always affects every marker.

Parameters:

<Fixed> 0 | 1 | OFF | ON

*RST: 0

Example:

BB:DM:TRIG:OUTP:DEL:FIX ON

restricts the marker signal delay setting range to the dynamic range.

Manual operation: See "[Marker x Delay](#)" on page 379

[:SOURce<hw>]:BB:DM:TRIGger:OUTPut<ch>:DELay <Delay>

Defines the delay between the signal on the marker outputs and the start of the signal, expressed in terms of symbols. Command `[:SOURce<hw>] :BB:DM:TRIGger:OUTPut:DELay:FIXed` can be used to restrict the range of values to the dynamic range, i.e. the range within which a delay of the marker signals can be set without restarting the marker and signal.

Parameters:

<Delay> float
 Range: 0 to 16777215
 Increment: 1
 *RST: 0

Example: `BB:DM:TRIG:OUTP2:DEL 16`
 sets a delay of 16 symbols for the signal on connector MARKER 2.

Manual operation: See "[Marker x Delay](#)" on page 379

[:SOURce<hw>]:BB:DM:TRIGger:OUTPut<ch>:DELay:MINimum?
[:SOURce<hw>]:BB:DM:TRIGger:OUTPut<ch>:DELay:MAXimum?

Queries the maximum marker delay for setting `:BB:DM:TRIG:OUTP:DEL:FIX ON`.

Return values:

<Maximum> float
 Range: 0 to 16777215
 Increment: 1E-3
 *RST: 2000

Example: `BB:DM:TRIG:OUTP:DEL:FIX ON`
 restricts the marker signal delay setting range to the dynamic range.
`BB:DM:TRIG:OUTP:DEL:MAX`
 queries the maximum of the dynamic range.
 Response: 2000
 the maximum for the marker delay setting is 2000 symbols.

Usage: Query only

Manual operation: See "[Marker x Delay](#)" on page 379

[:SOURce<hw>]:BB:DM:TRIGger:RMODE?

Queries the status of signal generation for all trigger modes with digital modulation on.

Return values:

<RMode> STOP | RUN
RUN

The signal is generated. A trigger event occurred in the triggered mode.

STOP

The signal is not generated. A trigger event did not occur in the triggered modes, or signal generation was stopped by the command `:BB:DM:TRIG:ARM:EXECute` (armed trigger modes only).

Example:

```
BB:DM:TRIG:SOUR EXT
sets external triggering
BB:DM:TRIG:MODE ARET
selects the Armed_Retrigger mode
BB:DM:TRIG:RMOD?
queries the current status of signal generation.
Response: RUN
the signal is generated, an external trigger was executed.
```

Usage: Query only

Manual operation: See ["Running - Stopped"](#) on page 376

[:SOURce<hw>]:BB:DM:TRIGger:SLENgth <SLength>

Defines the length of the signal sequence to be output in the "Single" trigger mode.

Parameters:

<SLength> integer
 Range: 1 to 4294967295
 *RST: 1000
 Default unit: symbol

Example:

```
BB:DM:SEQ SING
sets trigger mode Single.
BB:DM:TRIG:SLEN 200
sets a sequence length of 200 symbols. 200 symbols will be output after the next trigger event.
```

Manual operation: See ["Trigger Signal Duration"](#) on page 376

[:SOURce<hw>]:BB:DM:TRIGger:SOURce <Source>

Selects the trigger source.

Parameters:

<Source> INTernal|EXTernal
INTernal
 manual trigger or *TRG.
EXTernal
 trigger signal on the TRIG connector.
 *RST: INTernal

Example:

```
SOURce1:BB:DM:TRIGger:SOURce EXTernal
sets external triggering via the TRIGGER connector.
```

Manual operation: See ["Trigger Source"](#) on page 377

[:SOURce<hw>]:BB:DM:TRIGger:DELay:UNIT <TrigDelUnit>

Determines the units in that the trigger delay is expressed.

Parameters:

<TrigDelUnit> SAMPLE | TIME
 *RST: SAMPLE

Example:

```
SOURce1:BB:DM:TRIGger:SEQuence RETR
SOURce1:BB:DM:TRIGger:SOURce EXT
SOURce1:BB:DM:TRIGger:DELay:UNIT TIME
SOURce1:BB:DM:TRIGger:EXTernal:TDELay 100
SOURce1:BB:DM:TRIGger:EXTernal:RDELay?
// Response: 100
SOURce1:BB:DM:TRIGger:DELay:UNIT SAMPLE
SOURce1:BB:DM:TRIGger:EXTernal:DELay?
// Response: 27.08
```

Manual operation: See "[External Delay Unit](#)" on page 378

[:SOURce<hw>]:BB:DM:TRIGger[:EXTernal<ch>]:DELay <Delay>

Sets the trigger delay on external triggering.

Parameters:

<Delay> float
 Range: 0 to 65535
 Increment: 0.01
 *RST: 0
 Default unit: symbol

Example:

```
BB:DM:TRIG:SOUR EXT
selects an external trigger
BB:DM:TRIG:DEL 50
sets a delay of 50 symbols for the trigger.
```

Manual operation: See "[Trigger Delay](#)" on page 378

[:SOURce<hw>]:BB:DM:TRIGger[:EXTernal]:TDELay <ExtTimeDelay>

Specifies the trigger delay for external triggering. The value affects all external trigger signals.

Parameters:

<ExtTimeDelay> float
 Range: 0 to 688
 Increment: 250E-12
 *RST: 0
 Default unit: s

Example:

See [\[:SOURce<hw>\]:BB:DM:TRIGger:DELay:UNIT](#) on page 665

Manual operation: See ["Trigger Delay"](#) on page 378

[:SOURce<hw>]:BB:DM:TRIGger[:EXternal]:RDElay?

Queries the time (in seconds) an external trigger event is delayed for.

Return values:

<ResTimeDelaySec> float

| | |
|------------|----------|
| Range: | 0 to 688 |
| Increment: | 0.25E-9 |
| *RST: | 0 |

Example: See [\[:SOURce<hw>\]:BB:DM:TRIGger:DElay:UNIT](#) on page 665

Usage: Query only

Manual operation: See ["Actual Trigger Delay"](#) on page 379

[:SOURce<hw>]:BB:DM:TRIGger[:EXternal<ch>]:INHibit <Inhibit>

Sets the number of symbols by which a restart is to be inhibited following a trigger event. This command applies only in the case of external triggering.

Parameters:

<Inhibit> integer

| | |
|---------------|---------------|
| Range: | 0 to 67108863 |
| *RST: | 0 |
| Default unit: | symbol |

Example:

```
BB:DM:TRIG:SOUR EXT
selects an external trigger
BB:DM:TRIG:INH 200
sets a restart inhibit for 200 symbols following a trigger event.
```

Manual operation: See ["Trigger Inhibit"](#) on page 379

[:SOURce<hw>]:BB:DM[:TRIGger]:SEQUence <Sequence>

The command selects the trigger mode.

Parameters:

<Sequence> AUTO | RETRigger | AAUTo | ARETRigger | SINGLE

AUTO

The modulation signal is generated continuously.

RETRigger

The modulation signal is generated continuously. A trigger event (internal or external) causes a restart.

AAUTO

The modulation signal is generated only when a trigger event occurs. After the trigger event the signal is generated continuously. Signal generation is stopped with command

`SOUR:BB:DM:TRIG:ARM:EXEC` and started again when a trigger event occurs.

ARETrigger

The modulation signal is generated only when a trigger event occurs. The device automatically toggles to RETRIG mode.

Every subsequent trigger event causes a restart. Signal generation is stopped with command `SOUR:BB:DM:TRIG:ARM:EXEC` and started again when a trigger event occurs.

SINGLE

The modulation signal is generated only when a trigger event occurs. After the trigger event the signal is generated once to the set sequence length (`SOUR:BB:DM:TRIG:SLen`). Every subsequent trigger event caused a restart.

*RST: AUTO

Example:

`BB:DM:SEQ AAUT`

sets the "Armed_auto" trigger mode; the device waits for the first trigger (e.g. with *TRG) and then generates the signal continuously.

Manual operation: See "Trigger Mode" on page 375

Marker Settings

| | |
|--|-----|
| <code>[:SOURce<hw>]:BB:DM:TRIGger:OUTPut<ch>:MODE</code> | 667 |
| <code>[:SOURce<hw>]:BB:DM:TRIGger:OUTPut<ch>:OFFTime</code> | 668 |
| <code>[:SOURce<hw>]:BB:DM:TRIGger:OUTPut<ch>:ONTime</code> | 668 |
| <code>[:SOURce<hw>]:BB:DM:TRIGger:OUTPut<ch>:PATtern</code> | 669 |
| <code>[:SOURce<hw>]:BB:DM:TRIGger:OUTPut<ch>:PULSe:DIVider</code> | 669 |
| <code>[:SOURce<hw>]:BB:DM:TRIGger:OUTPut<ch>:PULSe:FREQuency?</code> | 669 |

`[:SOURce<hw>]:BB:DM:TRIGger:OUTPut<ch>:MODE <Mode>`

Defines the signal for the selected marker output.

Parameters:

<Mode>

CLISt | PULSe | PATtern | RATio | TRIGger

CLISt

A marker signal that is defined in the selected control list is generated.

PULSe

A pulsed marker signal is generated. The pulse frequency (= symbol rate/divider) is defined with the

`SOUR:BB:DM:TRIG:OUTP:PULSe:DIVider` command and can be queried with the

`SOUR:BB:DM:TRIG:OUTP:PULSe:FREQuency?` command.

PATtern

A marker signal is generated with the aid of a user-definable bit pattern. The bit pattern is entered with the aid of command `SOURce:BB:DM:TRIGger:OUTPut:PATtern`. The bit pattern is a maximum of 32 bits long.

RATio

A regular marker signal corresponding to the Time Off / Time On specifications in the commands

`SOURce:BB:DM:TRIGger:OUTPut:OFFT` and `SOURce:BB:DM:TRIGger:OUTPut:ONT` is generated.

TRIGger

A received internal or external trigger signal is output at the marker connector.

*RST: RATio

Example: `BB:DM:TRIG:OUTP2:MODE PULS`
selects the pulsed marker signal on output MARKER 2.

Manual operation: See "[Marker x](#)" on page 379

[:SOURce<hw>]:BB:DM:TRIGger:OUTPut<ch>:OFFTime <OffTime>

Sets the number of symbols in a period (ON time + OFF time) during which the marker signal in setting `SOURce:BB:DM:TRIGger:OUTPut:MODE RATio` on the marker outputs is OFF.

Parameters:

<OffTime> integer
Range: 1 to 16777215
*RST: 1
Default unit: symbol

Example: `BB:DM:TRIG:OUTP2:OFFT 20`
sets an OFF time of 20 symbols for marker signal 2.

Manual operation: See "[Marker x](#)" on page 379

[:SOURce<hw>]:BB:DM:TRIGger:OUTPut<ch>:ONTime <OnTime>

Sets the number of symbols in a period (ON time + OFF time) during which the marker signal in setting `SOURce:BB:DM:TRIGger:OUTPut:MODE RATio` on the marker outputs is ON.

Parameters:

<OnTime> integer
Range: 1 to 16777215
*RST: 1
Default unit: symbol

Example: `BB:DM:TRIG:OUTP2:ONT 20`
sets an ON time of 20 symbols for marker 2

Manual operation: See "Marker x" on page 379

[:SOURce<hw>]:BB:DM:TRIGger:OUTPut<ch>:PATTern <Pattern>, <BitCount>

Sets the bit pattern used to generate the marker signal.

Parameters:

<Pattern> numeric
 0 is marker off, 1 is marker on.
 *RST: #H2

<BitCount> integer
 Range: 1 to 64
 *RST: 2

Example: BB:DM:TRIG:OUTP2:PATT #B000000011111111,15
 BB:DM:TRIG:OUTP2:MODE PATT

Manual operation: See "Marker x" on page 379

[:SOURce<hw>]:BB:DM:TRIGger:OUTPut<ch>:PULSe:DIVider <Divider>

Sets the divider for Pulse marker mode (SOUR:BB:DM:TRIGr:OUTP:MODE PULSe). The resulting pulse frequency is derived by dividing the symbol rate by the divider.

Parameters:

<Divider> integer
 Range: 2 to 1024
 *RST: 2

Example: BB:DM:TRIG:OUTP2:PULS:DIV 2
 sets the divider to 2 for the marker signal on output MARKER 2.
 BB:DM:TRIG:OUTP2:FREQ?
 queries the resulting pulse frequency of the marker signal.
 Response: 66 000
 the resulting pulse frequency is 66 kHz.

Manual operation: See "Marker x" on page 379

[:SOURce<hw>]:BB:DM:TRIGger:OUTPut<ch>:PULSe:FREQuency?

Queries the pulse frequency of the pulsed marker signal in the setting SOURce:BB:DM:TRIGger:OUTPut:MODE PULSe. The pulse frequency is derived by dividing the symbol rate by the divider.

Return values:

<Frequency> float

Example: BB:DM:TRIG:OUTP2:PULS:DIV 2
sets the divider marker signal on output MARKER 2 to the value 2.
BB:DM:TRIG:OUTP2:MODE PULS
enables the pulsed marker signal.
BB:DM:TRIG:OUTP2:PULS:FREQ?
queries the pulse frequency of the marker signal.
Response: 33 000
the resulting pulse frequency is

Usage: Query only

Filter Settings

| | |
|--|-----|
| [SOURce<hw>]:BB:DM:FILTer:OSAMpling..... | 670 |
| [SOURce<hw>]:BB:DM:FILTer:OSAMpling:AUTO..... | 670 |
| [SOURce<hw>]:BB:DM:FILTer:PARAmeter:COSSine[ROLLoff]..... | 671 |
| [SOURce<hw>]:BB:DM:FILTer:PARAmeter:GAUSSs..... | 671 |
| [SOURce<hw>]:BB:DM:FILTer:PARAmeter:LPASSs..... | 671 |
| [SOURce<hw>]:BB:DM:FILTer:PARAmeter:LPASSEVM..... | 671 |
| [SOURce<hw>]:BB:DM:FILTer:PARAmeter:PGAuss..... | 671 |
| [SOURce<hw>]:BB:DM:FILTer:PARAmeter:RCOSSine..... | 671 |
| [SOURce<hw>]:BB:DM:FILTer:PARAmeter:SPHase..... | 671 |
| [SOURce<hw>]:BB:DM:FILTer:PARAmeter:APCO25..... | 671 |
| [SOURce<hw>]:BB:DM:FILTer:PARAmeter:COSSine:BANDwidth..... | 672 |
| [SOURce<hw>]:BB:DM:FILTer:PARAmeter:APCO25Lsm:GAUSSs..... | 672 |
| [SOURce<hw>]:BB:DM:FILTer:PARAmeter:APCO25Lsm:LOWPass..... | 672 |
| [SOURce<hw>]:BB:DM:FILTer:TYPE..... | 672 |
| [SOURce<hw>]:DM:FILTer:PARAmeter..... | 673 |

[SOURce<hw>]:BB:DM:FILTer:OSAMpling <OSampling>

The command sets the upsampling factor.

Parameters:

<OSampling> integer
Range: 1 to 32
*RST: 32

Example: BB:DM:FILT:OSAM 32
sets the upsampling factor to 32.

Manual operation: See "[Oversampling](#)" on page 364

[SOURce<hw>]:BB:DM:FILTer:OSAMpling:AUTO <Auto>

The command activates/deactivates the upsampling factor state. If activated, the most sensible parameter values are selected. The value depends on the coherence check. If deactivated, the values can be changed manually.

Parameters:

<Auto> 0 | 1 | OFF | ON
 *RST: 1

Example:

BB:DM:FILT:OSAM:AUTO ON

The most sensible parameters are selected automatically.

Manual operation: See "[Oversampling](#)" on page 364

[[:SOURce<hw>]:BB:DM:FILT:PARAmeter:COSSine[:ROLLoff] <Cosine>

[[:SOURce<hw>]:BB:DM:FILT:PARAmeter:GAUSS <Gauss>

[[:SOURce<hw>]:BB:DM:FILT:PARAmeter:LPASS <LPass>

[[:SOURce<hw>]:BB:DM:FILT:PARAmeter:LPASSEVM <LPassEvm>

[[:SOURce<hw>]:BB:DM:FILT:PARAmeter:PGAUSS <PGauss>

[[:SOURce<hw>]:BB:DM:FILT:PARAmeter:RCOSSine <RCosine>

[[:SOURce<hw>]:BB:DM:FILT:PARAmeter:SPHase <SPhase>

[[:SOURce<hw>]:BB:DM:FILT:PARAmeter:APCO25 <Apco25>

Sets the roll-off factor.

Parameters:

| | |
|------------|-----------------------|
| <Apco25> | float |
| | Range: 0.05 to 0.99 |
| | Increment: 0.01 |
| | *RST: 0.2 |
| <Cosine> | float |
| | Range: 0.05 to 1 |
| | Increment: 0.01 |
| | *RST: 0.35 |
| <Gauss> | float |
| | Range: 0.15 to 100000 |
| | Increment: 0.01 |
| | *RST: 0.3 |
| <LPass> | float |
| | Range: 0.05 to 2 |
| | Increment: 0.01 |
| | *RST: 0.5 |
| <LPassEvm> | float |
| | Range: 0.05 to 2 |
| | Increment: 0.01 |
| | *RST: 0.5 |
| <PGauss> | float |
| | Range: 0.15 to 2.5 |
| | Increment: 0.01 |
| | *RST: 0.3 |

<RCosine> float
 Range: 0.05 to 1
 Increment: 0.001
 *RST: 0.35

<SPhase> float
 Range: 0.15 to 2.5
 Increment: 0.01
 *RST: 2

Example: BB:DM:FILT:PAR:APCO25 0.2
 Sets the roll-off factor to 0.2 for filter type APCO25.

Manual operation: See "[Filter Parameter](#)" on page 363

[:SOURce<hw>]:BB:DM:FILTER:PARAMeter:COsine:BAWdth <Bandwidth>

Sets the bandwidth of the cosine filter.

Parameters:

<Bandwidth> float
 Range: 400 to 25E6
 Increment: 1E-3
 *RST: 270833.333

Example: :BB:DM:FILT:TYPE COS
 :BB:DM:FILT:PAR:COS:BAW 7200

Manual operation: See "[Bandwidth](#)" on page 364

[:SOURce<hw>]:BB:DM:FILTER:PARAMeter:APCO25Lsm:GAUSS <Gauss>
[:SOURce<hw>]:BB:DM:FILTER:PARAMeter:APCO25Lsm:LOWPass <FiltParm>

Sets the cut off frequency for the lowpass/ gauss filter.

Parameters:

<FiltParm> float
 Range: 400 to 25E6
 Increment: 1E-3
 *RST: 270833.333

Example: :BB:DM:FILT:TYPE APCO25Lsm
 :BB:DM:FILT:PAR:APCO25L:LOWP 5166.667
 :BB:DM:FILT:PAR:APCO25L:GAUS 1700

Manual operation: See "[Cut Off Frequency Factor](#)" on page 363

[:SOURce<hw>]:BB:DM:FILTER:TYPE <Type>

The command selects the filter type.

When a standard is selected (:BB:DM:STAN), the filter type and filter parameter are set to the default value.

Parameters:

<Type> RCOSine | COSine | GAUSs | LGAuss | CONE | COF705 |
 COEqualizer | COFequalizer | C2K3x | APCO25 | SPHase |
 RECTangle | USER | PGAuss | LPASs | DIRac | ENPShape |
 EWPSshape | LTEFilter | LPASSEVM | APCO25Hcpm |
 APCO25Lsm
 *RST: GAUSs

Example:

BB:DM:FILT:TYPE COS
 selects the Cosine filter type.

Manual operation: See "Filter" on page 363

[:SOURce<hw>]:DM:FILT:PARAmeter <Parameter>

Sets the filter parameter of the currently selected filter type.

To set the filter type, use command [:SOURce<hw>]:BB:DM:FILT:TYPE on page 672.

Parameters:

<Parameter> float
 Range: 0.05 to 2.5
 Increment: 0.01
 *RST: 0.35

Example:

BB:DM:FILT:TYPE COS
 DM:FILT:PAR 0.5
 sets 0.5 roll-off factor for the cosine filter.

Modulation Settings

| | |
|--|-----|
| [:SOURce<hw>]:BB:DM:AQPSk:ANGLE..... | 673 |
| [:SOURce<hw>]:BB:DM:ASK:DEPT..... | 674 |
| [:SOURce<hw>]:BB:DM:CODing..... | 674 |
| [:SOURce<hw>]:BB:DM:FORMat..... | 675 |
| [:SOURce<hw>]:BB:DM:FSK:DEViation..... | 675 |
| [:SOURce<hw>]:BB:DM:FSK:VARiable:SYMBOL<ch0>:DEViation..... | 675 |
| [:SOURce<hw>]:BB:DM:FSK:VARiable:TYPE..... | 676 |
| [:SOURce<hw>]:BB:DM:MDELay?..... | 676 |

[:SOURce<hw>]:BB:DM:AQPSk:ANGLE <Angle>

For AQPSK modulation, sets the angle alpha between the point (0,0) and the I axis.

Parameters:

<Angle> float
 Range: 0 to 180
 Increment: 0.01
 *RST: 0
 Default unit: Deg

Example: `BB:DM:FORM AQPS`
 selects modulation type AQPSK.
`BB:DM:AQPS:ANGL 45`

Manual operation: See ["Angle Alpha"](#) on page 361

[:SOURce<hw>]:BB:DM:ASK:DEPTh <Depth>

The command sets the ASK modulation depth when modulation type ASK is selected.

Parameters:

<Depth> float
 Range: 0 to 100
 Increment: 0.1
 *RST: 100
 Default unit: PCT

Example: `BB:DM:FORM ASK`
 selects the ASK modulation type.
`BB:DM:ASK:DEPT 50 PCT`
 sets a modulation depth of 50 percent.

Manual operation: See ["ASK Depth"](#) on page 360

[:SOURce<hw>]:BB:DM:CODing <Coding>

The command selects the modulation coding.

If the modulation type selected (`:BB:DM:FORM`) is not possible with the coding that has been set, it is automatically set to OFF (`:BB:DM:COD OFF`).

When a standard is selected (`:BB:DM:STAN`), the coding is set to the default value.

Parameters:

<Coding> OFF | DIFF | DPHS | DGRay | GRAY | GSM | NADC | PDC |
 PHS | TETRa | APCO25 | PWT | TFTS | INMarsat | VDL |
 EDGE | APCO25FSK | ICO | CDMA2000 | WCDMA |
 APCO258PSK

DPHS

Phase Difference

DGRay

Difference + Gray

*RST: INTERNAL

Example: `BB:DM:COD GRAY`
 selects GRAY coding. This coding is valid for all modulation types.

Manual operation: See ["Coding"](#) on page 359

[:SOURce<hw>]:BB:DM:FORMat <Format>

Selects the modulation type.

If the coding that is set (:BB:DM:COD) is not possible with the modulation type selected, it is automatically set to OFF (:BB:DM:COD OFF).

When a standard is selected (:DM:STAN), the modulation type is set to the default value.

Parameters:

<Format> ASK | BPSK | P2DBpsk | QPSK | QPSK45 | OQPSk | P4QPsk | P4DQpsk | PSK8 | P8D8psk | P8EDge | QAM16 | QAM32 | QAM64 | QAM256 | QAM1024 | MSK | FSK2 | FSK4 | USER | FSKVar | QAM128 | QEDGe | QAM16EDge | QAM32EDge | AQPSk | QAM4096 | APSK16 | APSK32 | FSK32 | FSK64 | FSK8 | FSK16 | QAM512 | QAM2048

*RST: MSK

Example:

BB:DM:FORM QPSK
Selects modulation type QPSK.

Manual operation: See "[Modulation Type](#)" on page 360

[:SOURce<hw>]:BB:DM:FSK:DEViation <Deviation>

Sets the frequency deviation when FSK modulation is selected. The range of values depends on the symbol rate that is set (see data sheet) and the maximum deviation is 10 MHz.

If the symbol rate that is set exceeds the maximum possible value for the chosen frequency deviation, it is suitably adapted (:BB:DM:SRAT).

Parameters:

<Deviation> float
Range: 1 to 40E6
Increment: 0.5
*RST: 135416.5

Example:

BB:DM:FORM FSK
selects FSK modulation.
BB:DM:FSK:DEV 10 MHz
sets the frequency deviation to 10 MHz.

Manual operation: See "[FSK Deviation](#)" on page 360

[:SOURce<hw>]:BB:DM:FSK:VARiable:SYMBOL<ch0>:DEViation <Deviation>

The command sets the deviation of the selected symbol for variable FSK modulation mode.

Suffix:

<ch>

0 to 16

The number of symbols (and therefore the suffix range) depends on the selected FSK modulation type.

Parameters:

<Deviation>

float

The range of values depends on the symbol rate that is set (see data sheet) and the maximum deviation is 10 MHz.

Range: -40E6 to 40E6

Increment: 0.5

Default unit: Hz

Example:

BB:DM:FORM FSKV

selects Variable FSK modulation.

BB:DM:FSK:VAR:TYPE FSK16

selects 16FSK modulation.

BB:DM:FSK:VAR:SYMB0:DEV 135000

sets the frequency deviation of the least significant symbol to 135 kHz.

Manual operation: See "[Deviation xxxx](#)" on page 362

[:SOURce<hw>]:BB:DM:FSK:VAR:TYPE <Type>

The command selects the modulation type for Variable FSK.

Parameters:

<Type>

FSK4 | FSK8 | FSK16

*RST: FSK4

Example:

BB:DM:FORM FSKV

selects Variable FSK modulation.

BB:DM:FSK:VAR:TYPE FSK16

selects 16FSK modulation.

Manual operation: See "[FSK Type](#)" on page 362

[:SOURce<hw>]:BB:DM:MDELay?

The command queries the digital modulation delay from the data input to the I/Q output in the case of external modulation.

Return values:

<MDelay>

float

Range: 0 to 1

Increment: 1E-6

*RST: 0

Example: BB:DM:MDEL?
queries the delay in the case of external modulation.
Response: 0.4 ms
the delay is 0.4 ms.

Usage: Query only

Manual operation: See "Modulation Delay" on page 362

Power Ramp

| | |
|--|-----|
| [SOURce<hw>]:BB:DM:PRAMP:ATTenuation..... | 677 |
| [SOURce<hw>]:BB:DM:PRAMP:BBONLY[:STATe]..... | 677 |
| [SOURce<hw>]:BB:DM:PRAMP:FDELay..... | 678 |
| [SOURce<hw>]:BB:DM:PRAMP:RDELay..... | 678 |
| [SOURce<hw>]:BB:DM:PRAMP:SHAPE..... | 678 |
| [SOURce<hw>]:BB:DM:PRAMP:SOURce..... | 679 |
| [SOURce<hw>]:BB:DM:PRAMP:TIME..... | 679 |
| [SOURce<hw>]:BB:DM:PRAMP[:STATe]..... | 679 |

[SOURce<hw>]:BB:DM:PRAMP:ATTenuation <Attenuation>

Sets the level attenuation for signal ranges that are flagged with level attribute attenuated by the LEV_ATT control signal.

Parameters:

<Attenuation> float
Range: 0 to 50
Increment: 0.1
*RST: 15
Default unit: dB

Example: BB:DM:PRAMP:ATT 15 dB
sets a level attenuation of 15 dB.

Manual operation: See "Attenuation" on page 374

[SOURce<hw>]:BB:DM:PRAMP:BBONLY[:STATe] <State>

This command selects power ramping in the baseband only or mixed power ramping in the baseband and the RF section.

The **ON** setting is mandatory if, with power ramping active, only the baseband signal is output (I/Q outputs)

Only then can a signal with a defined, predictable level be output.

Parameters:

<State> 0 | 1 | OFF | ON
*RST: 0

Example: BB:DM:PRAMP:BBON ON
selects power ramping in the baseband only.

Manual operation: See ["Baseband Only"](#) on page 374

[:SOURce<hw>]:BB:DM:PRAMP:FDElay <FDelay>

Sets the delay in the falling edge. A positive value gives rise to a delay and a negative value causes an advance.

Parameters:

<FDelay> float
 Range: -4 to 4
 Increment: 0.01
 *RST: 0
 Default unit: symbol

Example: BB:DM:PRAMP:FDEL 1
 The falling edge starts 1 symbol later.

Manual operation: See ["Fall Delay"](#) on page 374

[:SOURce<hw>]:BB:DM:PRAMP:RDElay <RDelay>

Sets the delay in the rising edge. A positive value gives rise to a delay and a negative value causes an advance.

Parameters:

<RDelay> float
 Range: 0 to 4
 Increment: 0.01
 *RST: 0
 Default unit: symbol

Example: BB:DM:PRAMP:RDEL 1
 The rising edge starts 1 symbol later.

Manual operation: See ["Rise Delay"](#) on page 374

[:SOURce<hw>]:BB:DM:PRAMP:SHAPE <Shape>

The command sets the edge shape of the ramp envelope.

Parameters:

<Shape> LINear | COSine
 *RST: COSine

Example: BB:DM:PRAMP:SHAP COS
 selects a cosine-shaped rise and fall for the transmitted power edge.

Manual operation: See ["Ramp Function"](#) on page 373

[:SOURce<hw>]:BB:DM:PRAMP:SOURce <Source>

Sets the source for the power ramp control signals.

Parameters:

<Source> INTernal

INTernal

The internal control signals LEV_ATT and BURST are used. Control signals are stored in dedicated lists. When remote control is in use, the list to be used is defined, selected and enabled with the aid of `SOURce:BB:DM:CLISt:...` commands.

*RST: INTernal

Example:

`BB:DM:PRAMP:SOUR INT`

enables the use of internal control signals for power ramp control.

[:SOURce<hw>]:BB:DM:PRAMP:TIME <Time>

Sets the power ramping rise time and fall time for a burst.

Parameters:

<Time> float

Range: 0.25 to 16

Increment: 0.01

*RST: 1

Default unit: symbol

Example:

`BB:DM:PRAMP:TIME 2`

sets a time of 2 symbols for the edges to rise and fall.

Manual operation: See "[Ramp Time](#)" on page 374

[:SOURce<hw>]:BB:DM:PRAMP[:STATe] <State>

The command enables or disables power ramping.

Parameters:

<State> 0 | 1 | OFF | ON

*RST: 0

Example:

`BB:DM:PRAMP:STAT ON`

switches power ramping on.

Manual operation: See "[State](#)" on page 373

DM Lists

The following section brings together the commands for defining and managing the data lists and control lists for digital modulation.

Lists are stored as files with specific file extensions in a user-definable directory (see [Table 7-2](#)). To specify the default directory, use the command `:MMEMory:CDIRectory`. To access files in this directory, enter their file name; the path and extension are optional.

Table 7-2: Overview of the used list types

| List type | Content | File extension |
|----------------|-------------------------------------|----------------|
| Data List | Digital modulation data | *.dm_iqd |
| Control List | Digital modulation control data | *.dm_iqc |
| User Standards | User settings of digital modulation | *.dm_stu |
| Usr Filter | Usr filter settings | *.vaf |
| User Mapping | User mapping settings | *.vam |

It is not possible to use other file extensions with the commands. Attempting to do so will cause an error message. If the file extension is changed in any other way (e.g. by directly accessing the file system) the lists are no longer recognized and therefore invalid.



The `CLIST` commands always create a binary control list, even if ASCII format is specified.

Therefore, to create a *.vw file with R&S WinIQSIM2 using a control list, use the input control list in ASCII format. Refer to the example in "[Creating an ASCII C-List Manually](#)" on page 462 for more information.

List of Commands

| | |
|--|-----|
| <code>[:SOURce<hw>]:BB:DM:CLISt:CATalog?</code> | 681 |
| <code>[:SOURce<hw>]:BB:DM:DLISt:CATalog?</code> | 681 |
| <code>[:SOURce<hw>]:BB:DM:FLISt:CATalog?</code> | 681 |
| <code>[:SOURce<hw>]:BB:DM:MLISt:CATalog?</code> | 681 |
| <code>[:SOURce<hw>]:BB:DM:CLISt:FREE?</code> | 681 |
| <code>[:SOURce<hw>]:BB:DM:DLISt:FREE?</code> | 681 |
| <code>[:SOURce<hw>]:BB:DM:FLISt:FREE?</code> | 681 |
| <code>[:SOURce<hw>]:BB:DM:MLISt:FREE?</code> | 681 |
| <code>[:SOURce<hw>]:BB:DM:CLISt:COpy</code> | 682 |
| <code>[:SOURce<hw>]:BB:DM:DLISt:COpy</code> | 682 |
| <code>[:SOURce<hw>]:BB:DM:CLISt:TAG?</code> | 682 |
| <code>[:SOURce<hw>]:BB:DM:DLISt:TAG?</code> | 682 |
| <code>[:SOURce<hw>]:BB:DM:CLISt:DATA</code> | 682 |
| <code>[:SOURce<hw>]:BB:DM:CLISt:DELeTe</code> | 683 |
| <code>[:SOURce<hw>]:BB:DM:CLISt:POINts?</code> | 684 |
| <code>[:SOURce<hw>]:BB:DM:CLISt:SELeCt</code> | 684 |
| <code>[:SOURce<hw>]:BB:DM:DLISt:DATA</code> | 684 |
| <code>[:SOURce<hw>]:BB:DM:DLISt:DATA:APPend</code> | 685 |
| <code>[:SOURce<hw>]:BB:DM:DLISt:DELeTe</code> | 686 |
| <code>[:SOURce<hw>]:BB:DM:DLISt:POINts</code> | 686 |
| <code>[:SOURce<hw>]:BB:DM:DLISt:SELeCt</code> | 687 |

| | |
|---|-----|
| <code>[SOURce<hw>]:BB:DM:FLISt:DELeTe</code> | 687 |
| <code>[SOURce<hw>]:BB:DM:FLISt:POINts?</code> | 687 |
| <code>[SOURce<hw>]:BB:DM:FLISt:SELeCt</code> | 688 |
| <code>[SOURce<hw>]:BB:DM:MLISt:DELeTe</code> | 688 |
| <code>[SOURce<hw>]:BB:DM:MLISt:POINts?</code> | 688 |
| <code>[SOURce<hw>]:BB:DM:MLISt:SELeCt</code> | 689 |
| <code>[SOURce<hw>]:BB:DM:SETTing:CATalog?</code> | 689 |
| <code>[SOURce<hw>]:BB:DM:SETTing:DELeTe</code> | 689 |
| <code>[SOURce<hw>]:BB:DM:SETTing:LOAD</code> | 690 |
| <code>[SOURce<hw>]:BB:DM:SETTing:STORe</code> | 690 |
| <code>[SOURce<hw>]:BB:DM:SETTing:STORe:FAST</code> | 690 |
| <code>[SOURce<hw>]:BB:DM:STANdard:ULISt:CATalog?</code> | 691 |
| <code>[SOURce<hw>]:BB:DM:STANdard:ULISt:DELeTe</code> | 691 |
| <code>[SOURce<hw>]:BB:DM:STANdard:ULISt:LOAD</code> | 691 |
| <code>[SOURce<hw>]:BB:DM:STANdard:ULISt:STORe</code> | 692 |

`[SOURce<hw>]:BB:DM:CLISt:CATalog?`
`[SOURce<hw>]:BB:DM:DLISt:CATalog?`
`[SOURce<hw>]:BB:DM:FLISt:CATalog?`
`[SOURce<hw>]:BB:DM:MLISt:CATalog?`

Queries the user mapping lists present in the default directory. The default directory is set using command `M MEM:CDIRectory`. When the names of the files are returned they are separated by commas.

The command only reads out files with the `*.vam` extension (see also [Table 7-2](#)).

Return values:

<Catalog> string

Example:

```
BB:DM:FORM USER
selects the User modulation type.
M MEM:CDIR '/var/user/mapping_List'
sets the default directory for the user mapping lists.
BB:DM:MLIS:CAT?
queries the user mapping lists in the directory.
```

Usage: Query only

Manual operation: See "[Load User Mapping](#)" on page 360

`[SOURce<hw>]:BB:DM:CLISt:FREE?`
`[SOURce<hw>]:BB:DM:DLISt:FREE?`
`[SOURce<hw>]:BB:DM:FLISt:FREE?`
`[SOURce<hw>]:BB:DM:MLISt:FREE?`

Queries the user modulation mapping list free memory.

Return values:

<Free> integer
 Range: 0 to INT_MAX
 *RST: 0

Example: BB:DM:FORM USER
selects the User modulation type.
BB:DM:FLIS:FREE?
queries the free memory.

Usage: Query only

[:SOURce<hw>]:BB:DM:CLIS:COPY <Filename>

[:SOURce<hw>]:BB:DM:DLIS:COPY <Filename>

The command copies the selected data list into the data list specified by <list name>. If a data list with the specified name already exists, it is overwritten. If it does not yet exist, it is created.

The source file has to be available in the default directory. The default directory is set using command `MMEM:CDIRectory`. A path can be specified, in which case the source file is copied into the file <list name> in the specified directory. The file extension may be omitted.

Only files with the file extension `*.dm_iqc` will be copied (see also [Table 7-2](#)).

Setting parameters:

<Filename> string

Example: BB:DM:DLIS 'd_list1'
selects data list d_list1.
BB:DM:DLIS:COPY 'd_list2'
copies the content of data list d_list1 into data list d_list2.
Any existing content in data list d_list2 is overwritten.

Usage: Setting only

Manual operation: See "[File Manager](#)" on page 366

[:SOURce<hw>]:BB:DM:CLIS:TAG?

[:SOURce<hw>]:BB:DM:DLIS:TAG?

The command queries the content of the specified tag in the selected file.

Return values:

<Tag> <control list>,<tag name>

Example: BB:DM:DLIS:TAG 'D_list1','date'
queries the Date tag in control list D_list1.
Response:10.10.2008
the data list was created on 10.10.2008.

Usage: Query only

[:SOURce<hw>]:BB:DM:CLIS:DATA <Data>

Sends the data to the currently selected control list. If the list already contains data, it is overwritten. This command only writes data into the data section of the file.

The values for the control signals are sent, arranged in an 8-bit value as follows:

| Signal | Order | Decimal value of bits |
|----------|-------|-----------------------|
| Marker 1 | LSBit | 1 |
| Marker 2 | | 2 |
| Burst = | LSBit | 16 |
| LevAtt1 | LSBit | 32 |
| CWMod | LSBit | 64 |
| Hop | MSBit | 128 |

You can also send the data as a binary block. Each binary block is a 2-byte value in which the 16 bits represent the binary values (16-bit unsigned integer, 2 bytes, LSB first).

When binary data transmission is in use, you can use the command `:SYSTEM:COMMunicate:GPIB:LTERminator EOI` to set the termination character mode to 'EOI control data message only'. Then, a random LF in the data sequence is not interpreted as end, i.e. prematurely terminating the data transmission. The command `...LTER STANdard` resets the mode.

For query purposes, the command `:FORMat ASCii | PACKed` can be used to switch between the formats. The byte sequence is defined in the IEC bus standard as 'most significant byte first'

Note: C-Lists are created in binary format. However, if you need the C-List in ASCII format, e.g. for creating a waveform file with R&S WinIQSIM2, see the example in "[Creating an ASCII C-List Manually](#)" on page 462.

*RST has no effect on data lists. This command is without query.

Setting parameters:

<Data> string

Example:

```
BB:DM:CLIS:SEL 'c_list1'
```

Selects the control list.

```
BB:DM:CLIS:DATA 0,0,0,0,8,8,8,0,0,0,0...
```

Enters the control values in list c_list1. In the example, only ramps for marker 4 are set.

Usage:

Setting only

Manual operation: See "[Edit Control List](#)" on page 370

[:SOURce<hw>]:BB:DM:CLIS:DELeTe <Filename>

The command deletes the specified control list from the default directory. The default directory is set using command `MMEM:CDIRectory`. A path can also be specified, in which case the files in the specified directory are deleted. The file extension may be omitted. Only files with the file extension `*.dm_iqc` will be deleted.

Setting parameters:

<Filename> <list name>

Example: BB:DM:CLIS:DEL 'c_list3'
deletes control list c_list3.

Usage: Setting only

Manual operation: See ["File Manager"](#) on page 366

[:SOURce<hw>]:BB:DM:CLIS:POINTs?

The command queries the number of lines (2 bytes) in the currently selected list.

Return values:

<Points> integer
Range: 0 to INT_MAX
*RST: 0

Example: BB:DM:CLIS:SEL "c_list1"
selects control list c_list1.
BB:DM:CLIS:POIN?
queries the number of lines in the control list.
Response: 20
the control list consists of 20 lines.

Usage: Query only

[:SOURce<hw>]:BB:DM:CLIS:SElect <Filename>

The command selects the control list in the default directory. The default directory is set using command `MMEM:CDIRECTory`. A path can also be specified, in which case the files in the specified directory are selected. If a control list with the specified name does not yet exist, it is created. The file extension may be omitted. Only files with the file extension `*.dm_iqc` will be selected or created.

Parameters:

<Filename> <list name>

Example: BB:DM:CLIS:SEL 'c_list1'
selects control list c_list1.

Manual operation: See ["Functions for handling of control lists"](#) on page 167

[:SOURce<hw>]:BB:DM:DLIS:DATA <Data>

[:SOURce<hw>]:BB:DM:DLIS:DATA? [<Start>[, <Count>]]

The **Setting** command sends the bit data to the data list selected with the command `:BB:DM:DLIS:SElect`. Any existing content in the data list is overwritten. This command only writes data into the data section of the file.

This command sends the bit data to the selected data list, which is overwritten.

The data can also be sent as block data in binary or PACKed format, each byte being interpreted as 8 data bits. Use the command `:SYSTEM:COMMunicate:GPIB:LTERminator EOI` to set the termination character mode to 'EOI control data message only'. The command causes that a random LF in the data sequence is not interpreted as end, i.e. prematurely terminating the data transmission. The command `...LTER STAN` resets the mode.

The **query** reads out the data part of the data list. If the query is expanded by using the two parameters <start> and <length>, the list is read out in smaller sections. Start and Length are expressed in bits. Without the parameters, the total length is always read out starting from address 1. The command `:FORMat ASCii | PACKed` can be used to select the data format. The byte sequence is defined in the IEC bus standard (read/write most significant byte first). *RST has no effect on data lists.

Parameters:

<Data> integer

Query parameters:

<Start> integer

Range: 1 to 2147483647

<Count> integer

Range: 1 to 2147483647

Example:

```
BB:DM:DLIS:SEL 'dlist1'
```

Selects data list dlist1. If the file does not yet exist, it is created.

```
BB:DM:DLIS:DATA 1,1,1,0,0,0,1,1,0,1...
```

Sends the specified data to file dlist1. Any data already present is overwritten.

Example:

```
BB:DM:DLIS:SEL 'dlist1'
```

Selects data list dlist1.

```
FORM ASCI
```

Selects ASCII data transmission format.

```
BB:DM:DLIS:DATA? 2048,1024
```

Queries the data starting at bit 2048 for 1024 bits.

Manual operation: See "[Data List Editor](#)" on page 367

[:SOURce<hw>]:BB:DM:DLIS:DATA:APPend <Bits>

The command appends the bit data onto the end of the existing data in the selected data list. This means that existing content in the data list is not overwritten. By this means very long data lists can be built up piecemeal. The data format is as specified in command `SOURce:BB:DM:DLIS:DATA`.

The command cannot be used with an empty data list, such as one that has just been created, for example. In this case the command `SOURce:BB:DM:DLIS:DATA` must first be used to enter modulation data in the list.

*RST has no effect on data lists.

Setting parameters:

<Bits> 0 | 1 {,0 | 1 } | block data

Example: BB:DM:DLIS:SEL ' d_list2'
 selects data list d_list2.
 FORM ASC
 selects ASCII data transmission format.
 BB:DM:DLIS:DATA:APP 1,1,1,0,0,0,1,1,0,1...
 adds the specified numeric data to the existing data in data list d_list2.

Usage: Setting only

Manual operation: See "[Data List Editor](#)" on page 367

[:SOURce<hw>]:BB:DM:DLIS:DELeT e <Filename>

The command deletes the specified data list. from the default directory. The default directory is set using command `M MEM:CDIRectory`. A path can also be specified, in which case the files in the specified directory are deleted. The file extension may be omitted. Only files with the file extension `*.dm_iqd` will be deleted.

Setting parameters:

<Filename> string

Example: BB:DM:DLIS:DEL ' d_list2'
 deletes data list d_list2.

Usage: Setting only

Manual operation: See "[File Manager](#)" on page 366

[:SOURce<hw>]:BB:DM:DLIS:POINt s <Points>

The command defines the number of bits in the selected data list to be utilized. When a list is being filled with block data, this data is only ever sent in multiples of 8 bits. However the exact number of bits to be exploited can be set to a different figure. The superfluous bits in the list are then ignored.

Parameters:

<Points> integer
 Range: 0 to INT_MAX
 *RST: 0

Example: BB:DM:DLIS:POIN 234
 defines the number of bits in the data list to be utilized as 234 bits. If the list was filled with block data, at least the last 6 bits will be ignored.

[[:SOURce<hw>]:BB:DM:DLIS:SElect <Select>

The command selects the data list in the default directory. The default directory is set using command `MMEM:CDIRectory`. A path can also be specified, in which case the files in the specified directory are selected. If a data list with the specified name does not yet exist, it is created. The file extension may be omitted. Only files with the file extension `*.dm_iqd` will be selected or created.

The modulation data in this data list is used when the data source is selected using the command `SOURce:BB:DM:SOURce DLIS`.

Parameters:

<Select> <list name>

Example: `BB:DM:DLIS:SEL 'd_list2'`
selects data list `d_list2`.

Manual operation: See "[Functions for handling of data lists](#)" on page 167

[[:SOURce<hw>]:BB:DM:FLIS:DElete <Filename>

Deletes the specified user filter file. The default directory is set using command `MMEM:CDIRectory`. A path can also be specified, in which case the files in the specified directory are read. The file extension may be omitted. Only files with the file extension `*.vaf*.vaf` will be deleted.

Setting parameters:

<Filename> string

Example: `BB:DM:FILT:TYPE USER`
selects the User filter type.
`MMEM:CDIR '/var/user/Filter_List'`
sets the default directory for the user-defined filters.
`BB:DM:FLIS:DEL user_filter3`
deletes the user-defined filter.

Usage: Setting only

Manual operation: See "[Load User Filter](#)" on page 364

[[:SOURce<hw>]:BB:DM:FLIS:POINts?

Queries the user filter list length.

Return values:

<Points> integer
Range: 0 to INT_MAX
*RST: 0

Example: `BB:DM:FILT:TYPE USER`
selects the User filter type.
`BB:DM:FLIS:POIN?`
queries the list length.

Usage: Query only

[:SOURce<hw>]:BB:DM:FLIS:SElect <Filename>

Selects the user-defined filter (*.vaf).

The directory applicable to the following command is defined with the command `MMEM:CDIRectory`. To access the files in this directory, only the file name is required, without the path and the file extension.

Parameters:

<Filename> string

Example:

```
BB:DM:FILT:TYPE USER
selects the User filter type.
MMEM:CDIR '/var/user/Filter_List'
sets the default directory for the user-defined filters.
BB:DM:FLIS:SEL user_filter3
selects the user-defined filter.
```

Manual operation: See ["Load User Filter"](#) on page 364

[:SOURce<hw>]:BB:DM:MLIS:DElete <Filename>

Deletes the specified user mapping file. The default directory is set using command `MMEM:CDIRectory`. A path can also be specified, in which case the files in the specified directory are read. The file extension may be omitted. Only files with the file extension *.vam will be deleted.

Setting parameters:

<Filename> string

Example:

```
BB:DM:FORM USER
selects the User modulation type.
MMEM:CDIR '/var/user/mapping_List'
sets the default directory for the user mapping lists.
BB:DM:MLIS:DEL user_mapping3
deletes the user mapping list.
```

Usage: Setting only

Manual operation: See ["Load User Mapping"](#) on page 360

[:SOURce<hw>]:BB:DM:MLIS:POINTs?

Queries the user modulation mapping list length.

Return values:

<Points> integer

Range: 0 to INT_MAX

*RST: 0

Example: BB:DM:FORM USER
selects the User modulation type.
BB:DM:MLIS:POIN?
queries the list length.

Usage: Query only

[:SOURce<hw>]:BB:DM:MLIS:SElect <Filename>

Selects the user mapping list in the default directory. The default directory is set using command `MMEM:CDIRECTory`. A path can also be specified, in which case the files in the specified directory are selected. If a user mapping list with the specified name does not yet exist, it is created. The file extension may be omitted. Only files with the file extension `*.vam` will be selected or created.

Parameters:
<Filename> string

Example: BB:DM:MLIS:SEL 'c_list1'
selects the user mapping list `c_list1`.

Manual operation: See "[Load User Mapping](#)" on page 360

[:SOURce<hw>]:BB:DM:SETTING:CATalog?

Reads out the files with Custom Digital Modulation settings in the default directory. The default directory is set using command `MMEM:CDIRECTory`. Only files with the file extension `*.dm` will be listed.

Return values:
<Catalog> string

Example: `MMEM:CDIR '/var/user/dig_mod'`
sets the default directory.
`BB:DM:SETT:CAT?`
reads out all the files with Custom Digital Modulation settings in the default directory.
Response: 'DM_1'
the file `DM_1` with Custom Digital Modulation settings is available.

Usage: Query only

Manual operation: See "[Save/Recall](#)" on page 356

[:SOURce<hw>]:BB:DM:SETTING:DELeTe <Filename>

This command deletes the selected file with Custom Digital Modulation settings. The directory is set using command `MMEM:CDIRECTory`. A path can also be specified, in which case the files in the specified directory are read. The file extension may be omitted. Only files with the file extension `*.dm` will be deleted.

Setting parameters:

<Filename> string

Example:

```
BB:DM:STAN:ULIS:DEL 'DM_1'
```

deletes file DM_1.

Usage:

Setting only

Manual operation: See ["Save/Recall"](#) on page 356**[:SOURce<hw>]:BB:DM:SETTING:LOAD <Filename>**

This command loads the selected file with Custom Digital Modulation settings. The directory is set using command `MMEM:CDIRECTORY`. A path can also be specified, in which case the files in the specified directory are read. The file extension may be omitted. Only files with the file extension `*.dm` will be loaded.

Setting parameters:

<Filename> string

Example:

```
BB:DM:STAN:ULIS:LOAD 'DM_1'
```

loads file DM_1.

Usage:

Setting only

Manual operation: See ["Save/Recall"](#) on page 356**[:SOURce<hw>]:BB:DM:SETTING:STORE <Filename>**

This command stores the current Custom Digital Modulation settings into the selected file. The directory is set using command `MMEM:CDIRECTORY`. A path can also be specified, in which case the files in the specified directory are read. Only the file name has to be entered. User Standards are stored as files with the specific file extensions `*.dm`.

Setting parameters:

<Filename> string

Example:

```
BB:DM:STAN:ULIS:STOR 'DM_QAM'
```

stores the current Custom Digital Modulation settings into file DM_QAM.

Usage:

Setting only

Manual operation: See ["Save/Recall"](#) on page 356**[:SOURce<hw>]:BB:DM:SETTING:STORE:FAST <Fast>**

Determines whether the instrument performs an absolute or a differential storing of the settings.

Enable this function to accelerate the saving process by saving only the settings with values different to the default ones.

Note: This function is not affected by the "Preset" function.

Parameters:

<Fast> 0 | 1 | OFF | ON
 *RST: 1

Manual operation: See "Fast Save" on page 163

[:SOURce<hw>]:BB:DM:STANdard:ULISt:CATalog?

Reads out the files with Digital Standard settings in the default directory. The default directory is set using command `M MEM:CDIRectory`. Only files with the file extension `*.dm_stu` will be listed.

Return values:

<Catalog> string

Example:

`M MEM:CDIR '/var/user/dig_mod'`

sets the default directory.

`BB:DM:STAN:ULIS:CAT?`

reads out all the files with Digital Standard settings in the default directory.

Response: 'DM_QAM'

the file `DM_QAM` with Digital Standard settings is available.

Usage: Query only

Manual operation: See "Save/Recall User" on page 359

[:SOURce<hw>]:BB:DM:STANdard:ULISt:DELeTe <Filename>

Deletes the selected file with Digital Standard settings. The directory is set using command `M MEM:CDIRectory`. A path can also be specified, in which case the files in the specified directory are read. The file extension may be omitted. Only files with the file extension `*.dm_stu` will be deleted.

Setting parameters:

<Filename> string

Example:

`BB:DM:STAN:ULIS:DEL 'DM_QAM'`

deletes file 'DM_QAM'.

Usage: Setting only

Manual operation: See "Save/Recall User" on page 359

[:SOURce<hw>]:BB:DM:STANdard:ULISt:LOAD <Filename>

Loads the selected file with Digital Standard settings. The directory is set using command `M MEM:CDIRectory`. A path can also be specified, in which case the files in the specified directory are read. The file extension may be omitted. Only files with the file extension `*.dm_stu` will be loaded.

Setting parameters:

<Filename> string

Example: `BB:DM:STAN:ULIS:LOAD 'DM_QAM'`
loads file 'DM_QAM'.

Usage: Setting only

Manual operation: See "[Save/Recall User](#)" on page 359

[:SOURce<hw>]:BB:DM:STANdard:ULIS:STORe <Filename>

Stores the current Digital Standard settings into the selected file. The directory is set using command `MMEM:CDIRectory`. A path can also be specified, in which case the files in the specified directory are read. Only the file name has to be entered. User Standards are stored as files with the specific file extensions `*.dm_stu`.

Setting parameters:

<Filename> string

Example: `BB:DM:STAN:ULIS:STOR 'DM_QAM'`
stores the current Digital Standard settings into file 'DM_QAM'.

Usage: Setting only

Manual operation: See "[Save/Recall User](#)" on page 359

7.15.3.4 SOURce:BB:GRAPhics Subsystem

This subsystem contains the commands used to setup the graphical display.

| | |
|---|-----|
| <code>[:SOURce<hw>]:BB:GRAPhics:MODE</code> | 692 |
| <code>[:SOURce<hw>]:BB:GRAPhics:SMARt:STATe</code> | 692 |
| <code>[:SOURce<hw>]:BB:GRAPhics:SRATe:MODE</code> | 693 |
| <code>[:SOURce<hw>]:BB:GRAPhics:SRATe:USER</code> | 693 |
| <code>[:SOURce<hw>]:BB:GRAPhics:STATe</code> | 694 |
| <code>[:SOURce<hw>]:BB:GRAPhics:TRIGger:SOURce</code> | 694 |

[:SOURce<hw>]:BB:GRAPhics:MODE <Mode>

Selects the graphical signal display.

Parameters:

<Mode> IQ | VECTor | CCDF | PSPectrum | CONSTellation | EYEI | EYEQ
*RST: IQ

Example: `BB:GRAP:MODE VECT`
selects vector diagram.

Manual operation: See "[Mode](#)" on page 177

[:SOURce<hw>]:BB:GRAPhics:SMARt:STATe <State>

Activates/deactivates the "smart graphics".

Parameters:

<State> 0 | 1 | OFF | ON
 *RST: 0

Example:

BB:GRAP:SMAR:STAT ON
 Activates smart graphics.

Manual operation: See "[Smart Graphics](#)" on page 176

[[:SOURce<hw>]:BB:GRAPhics:SRATe:MODE <Mode>

Sets how the time resolution of the signal is determined. Maximum resolution corresponds to a display covering the entire signal bandwidth. The higher the resolution is, the shorter the length of the displayed signal segment will be for the specified recording depth.

Parameters:

<Mode> AUTO | FULL | USER

AUTO

The resolution is set to an optimum value on the basis of the signal and display type.

FULL

The resolution is set such that the display covers the entire signal bandwidth.

USER

with the command `SOUR:BB:GRAP:SRAT:USER`, the user can determine the resolution by setting the signal bandwidth for which the display is to be generated

*RST: AUTO

Example:

BB:GRAP:SRAT:MODE FULL
 sets the sample rate mode.

Manual operation: See "[Sample Rate Mode](#)" on page 177

[[:SOURce<hw>]:BB:GRAPhics:SRATe:USER <User>

(Enabled for `BB:GRAP:SRAT:MODE USER`)

Selects the signal bandwidth for which the display is to be generated. The setting range moves between the minimum and maximum bandwidth which is possible for the selected display. The selection is made graphically by moving the pointer.

Parameters:

<User> float
 Range: 0.01 to 100
 Increment: 0.01
 *RST: 10
 Default unit: PCT

Example: BB:GRAP:SRAT:MODE USER
sets the sample rate mode.
BB:GRAP:SRAT:USER 20
sets the sample rate factor.

Manual operation: See ["Graphics Sample Rate"](#) on page 178

[:SOURce<hw>]:BB:GRAPhics:STATe <State>

Activates/deactivates the selected graphical display.

Parameters:

<State> 0 | 1 | OFF | ON
*RST: 0

Example: BB:GRAP:STAT ON
activates the graphical graphics.

Manual operation: See ["State"](#) on page 176

[:SOURce<hw>]:BB:GRAPhics:TRIGger:SOURce <Source>

Defines the trigger for the starting time of the graphic recording.

Parameters:

<Source> SOFTware | MARKer

SOFTware

Recording of signals is started automatically in specified intervals. This asynchronous method is appropriate when a representative display of the complete signal is desired, as recording starts in a random time reference to the signal.

MARKer

The starting point for recording signals is determined by "Marker 1" in the menu of the active standard.

This synchronous method is appropriate when specific signal segments are to be shown in greater detail. With periodic signals, a static image is obtained by selecting a period length of "Marker 1" that is equal to the signal period.

The displayed signal segment can be shifted as needed by entering a "Marker Delay" in the "Trigger/Marker" menu of the active standard.

*RST: SOFTware

Example: BB:GRAP:TRIG:SOUR MARK
sets the trigger source.

Manual operation: See ["Trigger Source"](#) on page 177

7.15.3.5 SOURce:BB:IMPairment Subsystem

This subsystem contains the commands for the digital I/Q impairments.

Included in this section is also the description of command

`SOURce:BB:IQOutput:SOURce` that determined the source for the I/Q output connectors.

| | |
|--|-----|
| <code>[:SOURce<hw>]:BB:IMPairment:DELay</code> | 695 |
| <code>[:SOURce<hw>]:BB:IMPairment:IQRatio[:MAGNitude]</code> | 695 |
| <code>[:SOURce<hw>]:BB:IMPairment:LEAKage:I</code> | 696 |
| <code>[:SOURce<hw>]:BB:IMPairment:LEAKage:Q</code> | 696 |
| <code>[:SOURce<hw>]:BB:IMPairment:QUADrature[:ANGLE]</code> | 696 |
| <code>[:SOURce<hw>]:BB:IMPairment:SKEW</code> | 697 |
| <code>[:SOURce<hw>]:BB:IMPairment:STATe</code> | 697 |
| <code>[:SOURce<hw>]:BB:IMPairment:OPTimization:MODE</code> | 697 |
| <code>[:SOURce<hw>]:BB:IMPairment:OPTimization:STATe</code> | 698 |

`[:SOURce<hw>]:BB:IMPairment:DELay <Delay>`

Sets the time delay of both I and Q vectors relative to the selected trigger and marker or relative to the other instrument(s) working in the master-slave synchronous mode (see section [Chapter 5.9.2.4, "Synchronous Signal Generation"](#), on page 332).

A positive value means that the I and Q vectors delay relative to the marker/trigger or to the other instrument and vice versa.

Parameters:

`<Delay>` float
 Range: -500E-9 to 500E-9
 Increment: 1E-12
 *RST: 0

Example: `BB:IMP:DEL 32.0E-9`
 Sets the I/Q delay

Manual operation: See ["IQ Delay"](#) on page 310

`[:SOURce<hw>]:BB:IMPairment:IQRatio[:MAGNitude] <IqRatio>`

This command sets the ratio of I modulation to Q modulation (amplification "imbalance"). The input may be either in dB or %. The resolution is 0.001 dB, an input in percent is rounded to the closest valid value in dB. A query returns the value in dB.

Parameters:

`<IqRatio>` float
 Range: -1 to 1
 Increment: 1E-4
 *RST: 0

Example: `BB:IMP:IQR 3 PCT`
 sets the imbalance to 3 percent.
`BB:IMP:IQR?`
 queries the imbalance.
 Response: 0.259000
 the value is returned in dB

Manual operation: See ["Gain Imbalance - Digital Impairments"](#) on page 309

[:SOURce<hw>]:BB:IMPairment:LEAKage:I <I>

This command sets the carrier leakage amplitude for the I-signal component.

Parameters:

<I> float
 Range: -10 to 10
 Increment: 0.01
 *RST: 0
 Default unit: PCT

Example: BB:IMP:LEAK:I 3 PCT
 sets the leakage for the I-component to 3 percent.

Manual operation: See ["I/Q Offset - Digital Impairments"](#) on page 309

[:SOURce<hw>]:BB:IMPairment:LEAKage:Q <Q>

This command sets the carrier leakage amplitude for the Q-signal component.

Parameters:

<Q> float
 Range: -10 to 10
 Increment: 0.01
 *RST: 0
 Default unit: PCT

Example: BB:IMP:LEAK:Q 3 PCT
 sets the leakage for the Q-component to 3 percent.

Manual operation: See ["I/Q Offset - Digital Impairments"](#) on page 309

[:SOURce<hw>]:BB:IMPairment:QUADrature[:ANGLe] <Angle>

This command sets the quadrature offset for the digital I/Q signal.

Parameters:

<Angle> float
 Range: -10 to 10
 Increment: 0.01
 *RST: 0
 Default unit: DEG

Example: BB:IMP:QUAD:ANGL -5DEG
 sets the quadrature offset to -5 degrees.

Manual operation: See ["Quadrature Offset - Digital Impairments"](#) on page 310

[[:SOURce<hw>]:BB:IMPAirment:SKEW <Skew>

Sets the time offset between the I and Q vectors.

In an I/Q modulator without I/Q skew, the I and Q vectors are aligned to the marker. With an I/Q skew, both vectors are shifted relative to the marker so that the offset of each of the vectors to the marker will be the half of the I/Q skew value.

A positive I/Q skew means that the Q vector delays relative to the I vector and vice versa.

Parameters:

<Skew> float
 Range: -500E-9 to 500E-9
 Increment: 1E-12
 *RST: 0

Example: BB:IMP:SKEW 410.0E-9
 sets the I/Q skew.

Manual operation: See "[I/Q Skew - Digital Impairments](#)" on page 310

[[:SOURce<hw>]:BB:IMPAirment:STATE <State>

The command activates (ON) and deactivates (OFF) the three impairment or correction values LEAKage, QUADrature and IQRatio for the digital baseband signal prior to input into the I/Q modulator.

Parameters:

<State> 0 | 1 | OFF | ON
 *RST: 0

Example: BB:IMP:STAT OFF
 deactivates digital impairment.

Manual operation: See "[State - Digital Impairments](#)" on page 309

[[:SOURce<hw>]:BB:IMPAirment:OPTimization:MODE <Mode>

This command sets the optimization mode.

Parameters:

<Mode> FAST | QHIGH
FAST
 Optimization is reached by compensation for I/Q skew.
QHIGH
 Optimization is reached by compensation for I/Q skew and frequency response correction.
 *RST: FAST

Example: BB:IMP:OPT:MODE FAST
 sets the optimization mode Fast.

Manual operation: See "Optimization Mode - Digital Impairments" on page 310

[:SOURce<hw>]:BB:IMPairment:OPTimization:STATe <State>

Activates and deactivates internal compensation of signal distortions by the I/Q modulator.

Parameters:

<State> 0 | 1 | OFF | ON

*RST: 1

Example:

BB:IMP:OPT:STAT ON

activates internal compensation of signal distortions.

Manual operation: See "Optimize internal IQ-Impairments for RF Output - Digital Impairments" on page 310

7.15.3.6 SOURce:BB:MCCW Subsystem

This subsystem contains the commands for setting the Multi Carrier CW signals.

Suffixes

SOURce<hw>

For one-path instruments, the keyword SOURce is optional and can be omitted.

The numeric suffix to SOURce distinguishes between signal generation for path A and path B in the case of two-path instruments:

- SOURce [1] = path A
The keyword SOURce is optional and can be omitted
- SOURce2 = path B
The keyword SOURce is mandatory, i.e. the command must contain the keyword with suffix 2.

OUTPut<ch>

The numeric suffix to OUTPut distinguishes between the available markers.

Only two markers are available for the R&S SMBV, i.e. the allowed values for the suffix are 1 or 2.

General Settings and Carrier Setup Settings

| | |
|---|-----|
| [:SOURce<hw>]:BB:MCCW:STATe | 699 |
| [:SOURce<hw>]:BB:MCCW:PRESet | 699 |
| [:SOURce<hw>]:BB:MCCW:CARRier:COUNT | 699 |
| [:SOURce<hw>]:BB:MCCW:CARRier:LIST:PHASe | 700 |
| [:SOURce<hw>]:BB:MCCW:CARRier:LIST:POWER | 701 |
| [:SOURce<hw>]:BB:MCCW:CARRier:LIST:STATe | 701 |
| [:SOURce<hw>]:BB:MCCW:CARRier:PHASe | 702 |
| [:SOURce<hw>]:BB:MCCW:CARRier:POWER | 702 |
| [:SOURce<hw>]:BB:MCCW:CARRier:SPACing | 703 |

| | |
|---|-----|
| <code>[:SOURce<hw>]:BB:MCCW:CARRier:STATe</code> | 703 |
| <code>[:SOURce<hw>]:BB:MCCW:CFACtor</code> | 703 |
| <code>[:SOURce<hw>]:BB:MCCW:CFACtor:ACTual?</code> | 704 |
| <code>[:SOURce<hw>]:BB:MCCW:CFACtor:MODE</code> | 704 |
| <code>[:SOURce<hw>]:BB:MCCW:CLOCK?</code> | 705 |
| <code>[:SOURce<hw>]:BB:MCCW:EDIT:CARRier:EXECute</code> | 705 |
| <code>[:SOURce<hw>]:BB:MCCW:EDIT:CARRier:PHASe:STEP</code> | 706 |
| <code>[:SOURce<hw>]:BB:MCCW:EDIT:CARRier:PHASe[:START]</code> | 706 |
| <code>[:SOURce<hw>]:BB:MCCW:EDIT:CARRier:POWer:STEP</code> | 707 |
| <code>[:SOURce<hw>]:BB:MCCW:EDIT:CARRier:POWer[:START]</code> | 707 |
| <code>[:SOURce<hw>]:BB:MCCW:EDIT:CARRier:START</code> | 707 |
| <code>[:SOURce<hw>]:BB:MCCW:EDIT:CARRier:STATe</code> | 708 |
| <code>[:SOURce<hw>]:BB:MCCW:EDIT:CARRier:STOP</code> | 708 |

`[:SOURce<hw>]:BB:MCCW:STATe <State>`

Activates the multi carrier CW signal generation and deactivates all the other digital standards and digital modulation modes in the same path.

Parameters:

<State> 0 | 1 | OFF | ON
 *RST: 0

Example: `SOURce1:BB:MCCW:STATe ON`

Manual operation: See "[State](#)" on page 465

`[:SOURce<hw>]:BB:MCCW:PRESet`

Sets the multi carrier signal parameters to their default values (*RST values specified for the commands).

Not affected is the state set with the command `SOURce<hw>:BB:MCCW:STATe`

Example: `SOURce1:BB:MCCW:PRESet`

Usage: Event

Manual operation: See "[Set to Default](#)" on page 466

`[:SOURce<hw>]:BB:MCCW:CARRier:COUNT <Count>`

Sets the number of carriers in the Multi Carrier CW signal. The total bandwidth is calculated as (Number of carriers - 1) * Carrier spacing and must not exceed the system bandwidth of the instrument (see data sheet).

The carrier spacing (`:BB:MCCW:CARRier:SPACing`) is reduced if the total bandwidth is not respected when entering the number of carriers.

The number of carriers entered therefore defines the maximum carrier spacing (`:BB:MCCW:CARRier:SPACing`).

Parameters:

<Count> integer
 Range: 1 to 160001
 *RST: 64

Example:

BB:MCCW:CARR:COUN 10
 sets 10 CW carriers for the multi carrier signal.

Manual operation: See "[Number of Carriers](#)" on page 467

**[[:SOURce<hw>]:BB:MCCW:CARRier:LIST:PHASe <Phas0[,Phas1..]>
 [:SOURce<hw>]:BB:MCCW:CARRier:LIST:PHASe? [<Start>[, <Count>]]**

Sets the start phase of the carrier with the aid of a value list. The first value in the list is assigned to the carrier with index 0, the second value to the carrier with index 1, etc. The maximum length corresponds to the maximum number of multi carriers. There is no need to enter all the values every time. Values not set by the value list are set with the default values provided they have already been explicitly set by a previous command. If this is the case, the values continue to apply until overwritten.

Setting parameters:

<Phas0[,Phas1..]> float
 Range: 0 to 360
 Increment: 0.01
 *RST: 0
 Default unit: DEG

Query parameters:

<Start> integer
 Range: 0 to lastCarrier
 <Count> integer
 Range: 1 to lastCarrier

Return values:

<Phas[,Phas..]> float

Example:

BB:MCCW:CARR:LIST:PHAS 1,20,30,40,50,60
 sets a start phase for carriers 0, 1, 2, 3 and 4.
 BB:MCCW:CARR:LIST:PHAS? 2,3
 queries the phase of carrier 1, 2 and 3.
 Response: 20,30,40

Manual operation: See "[Carrier Table](#)" on page 469

```
[:SOURce<hw>]:BB:MCCW:CARRier:LIST:POWer <Pow0[,Pow1..]>
[:SOURce<hw>]:BB:MCCW:CARRier:LIST:POWer? <Start>, <Count>
```

Sets the power of the carrier with the aid of a value list. The first value in the list is assigned to the carrier with index 0, the second value to the carrier with index 1, etc. The maximum length corresponds to the maximum number of multi carriers. There is no need to enter all the values every time. Values not set by the value list are set with the default values provided they have already been explicitly set by a previous command. If this is the case, the values continue to apply until overwritten.

Setting parameters:

```
<Pow0[,Pow1..]> float
Increment: 0.01
```

Query parameters:

```
<Start> integer
Range: 0 to lastCarrier

<Count> integer
Range: 1 to lastCarrier
```

Return values:

```
<Pow[,Pow..]> float
```

Example:

```
BB:MCCW:CARR:LIST:POW -65 dB, -30 dB, -50
dB, . . .
sets the power of carrier 0 to -65 dB, carrier 1 to -30 dB and so
on.
BB:MCCW:CARR:LIST:POW? 2, 3
queries the power of carrier 1 and 2.
Response: -30, -50
```

Manual operation: See "[Carrier Table](#)" on page 469

```
[:SOURce<hw>]:BB:MCCW:CARRier:LIST:STATe <Stat0[,Stat1..]>
[:SOURce<hw>]:BB:MCCW:CARRier:LIST:STATe? <Start>, <Count>
```

Switches the carrier on or off with the aid of a value list. The first value in the list is assigned to the carrier with index 0, the second value to the carrier with index 1, etc. The maximum length corresponds to the maximum number of multi carriers. There is no need to enter all the values every time. Values not set by the value list are set with the default values provided they have already been explicitly set by a previous command. If this is the case, the values continue to apply until overwritten.

Setting parameters:

```
<Stat0[,Stat1..]> ON | OFF[,ON | OFF,...]
```

Query parameters:

```
<Start> integer
Range: 0 to lastCarrier

<Count> integer
Range: 1 to lastCarrier
```

Return values:`<State[,State..]> select`**Example:**

```
BB:MCCW:CARR:LIST:STAT 1,0,1,1,0,0...
switches carrier 0 on, carrier 1 off, etc.
BB:MCCW:CARR:LIST:STAT? 2,4
queries the states of carrier 2, 3, 4 and 5.
Response: 0,1,1,0
```

Manual operation: See "[Carrier Table](#)" on page 469**[[:SOURce<hw>]:BB:MCCW:CARRier:PHASe <CarrierIndex>, <Phase>**

Sets the start phase of the selected carrier.

The phase settings are only valid if optimization of the crest factor is disabled
([:SOURce:BB:MCCW:CFACTor:MODE OFF).

Parameters:`<CarrierIndex> integer`

Range: 0 to lastCarrier

`<Phase> float`

Sets the start phase of the selected carrier.

Range: 0 to 359.99

Increment: 0.01

*RST: 0

Default unit: DEG

Example:

```
BB:MCCW:CARR:PHAS 15,90
sets a start phase of 90 DEG for carrier 15.
```

Manual operation: See "[Carrier Table](#)" on page 469**[[:SOURce<hw>]:BB:MCCW:CARRier:POWER <CarrierIndex>, <Power>**

Sets the power of the selected carrier.

Parameters:`<CarrierIndex> integer`

Range: 0 to lastCarrier

`<Power> float`

Sets the power of the selected carrier.

Range: -80 to 0

Increment: 0.01

*RST: 0

Example:

```
BB:MCCW:CARR:POW 15, -50 dB
sets the power of carrier 15 to -50 dB.
```

Manual operation: See "[Carrier Table](#)" on page 469

[:SOURce<hw>]:BB:MCCW:CARRier:SPACing <Spacing>

The command sets the carrier spacing.

The carriers are generated symmetrically around the center carrier. The total bandwidth is calculated as ("Number of carriers" - 1) * "Carrier spacing" and must not exceed the system bandwidth of the instrument (see data sheet).

The maximum carrier spacing that can be set is dependent on the chosen number of carriers

The maximum carrier spacing is automatically reduced so that the maximum total bandwidth is not exceeded on entering the number of carriers
(:BB:MCCW:CARRier:COUNT).

Parameters:

<Spacing> float
Range: 0 to 120E6
Increment: 0.01
*RST: 10E3

Example: BB:MCCW:CARR:SPAC 10 MHz
sets a carrier spacing of 10 MHz.

Manual operation: See "[Carrier Spacing](#)" on page 467

[:SOURce<hw>]:BB:MCCW:CARRier:STATe <CarrierIndex>, <State>

Switches the selected carrier on or off.

The counting in remote control differs from the numbers in the carrier table. Index 0 corresponds to number 1 (first line) in the table. Therefore, switching the state of the channel via remote control always switches the state of <channel index> + 1 in the table.

Parameters:

<CarrierIndex> integer
Range: 0 to lastCarrier
<State> 0 | 1 | OFF | ON
*RST: 0

Example: BB:MCCW:CARR:STAT 15, ON
switches carrier 16 on.

Manual operation: See "[Carrier Table](#)" on page 469

[:SOURce<hw>]:BB:MCCW:CFACtor <CFactor>

Sets the desired crest factor for the multi carrier signal on selection of the command
SOUR:BB:MCCW:CFAC:MODE SLOW.

Parameters:

<CFactor> float
 Range: 0 to 30
 Increment: 0.01
 *RST: 3

Example:

BB:MCCW:CFAC:MODE SLOW
 sets the Target Crest optimization mode.
 BB:MCCW:CFAC 10 dB
 sets the desired crest factor to 10 dB.

Manual operation: See "[Desired Crest Factor](#)" on page 468

[[:SOURce<hw>]:BB:MCCW:CFACtor:ACTual?

Queries the actual Crest Factor for BB:MCCW:CFAC:MODE SLOW.

Return values:

<Actual> float
 Range: 0 to 100
 Increment: 0.01
 *RST: 3

Example:

SOUR:BB:MCCW:CFAC:MODE SLOW
 BB:MCCW:CFAC:ACT?
 Response: 3

Usage:

Query only

[[:SOURce<hw>]:BB:MCCW:CFACtor:MODE <Mode>

Sets the mode by which automatic settings will minimize the crest factor or hold it at a chosen value.

Parameters:

<Mode> OFF | CHIRp | SLOW

OFF

Crest factor optimization is switched off. The carrier PHASE setting has an effect.

CHIRp

The crest factor is very rapidly optimized to < 3 dB for multi carrier signals so that all carriers are switched on and have the same amplitude. The computation time is independent of the number of carriers. In other carrier configurations the achievable crest factor is worse.

SLOW

The crest factor entered using `SOURceBB:MCCW:CFACtor` is maintained for all carrier configurations by means of automatic settings. The computation time depends on the number of carriers and on the crest factor that has been set. Computation time increases only when the number of carriers exceeds 256 and the crest factor is above 4 dB.

*RST: CHIRp

Example:

`BB:MCCW:CFAC:MODE OFF`
switches off automatic crest factor optimization.
The setting `SOURBB:MCCW:CARR:PHAS` has an effect.

Manual operation: See "[Optimize Crest Factor Mode](#)" on page 467

[[:SOURce<hw>]:BB:MCCW:CLOCK?

Queries the output clock rate. The output clock rate depends on the number of carriers and the selected carrier spacing.

Return values:

<Clock> float
Range: 0 to Max
Increment: 1E-3
*RST: 0

Example:

`BB:MCCW:CLOC?`
queries the output clock rate.
Response: 256 000 000
the output clock rate is 256 MHz.

Usage: Query only

Manual operation: See "[Clock Frequency](#)" on page 467

[[:SOURce<hw>]:BB:MCCW:EDIT:CARRier:EXECute

Adopts the settings for the carrier range which has been defined using the `:BB:MCCW:EDIT:CARR:...` commands.

Example:

`BB:MCCW:EDIT:CARR:STAR 4`
the carrier range starts at carrier 4.
`BB:MCCW:EDIT:CARR:STOP 400`
the carrier range stops at carrier 400.
`BB:MCCW:EDIT:CARR:STAT ON`
sets all the carriers in the carrier range to ON.
`BB:MCCW:EDIT:CARR:EXEC`
adopts the settings for all the carriers in the carrier range.
`BB:MCCW:STAT`
starts generation of the multi carrier signal. Carriers 4 to 400 are in the ON state.

Usage: Event

Manual operation: See ["Accept"](#) on page 469

[:SOURce<hw>]:BB:MCCW:EDIT:CARRIER:PHASe:STEP <Step>

Sets the step width by which the start phases of the carriers in the defined carrier range will be incremented.

The phase settings are only valid if optimization of the crest factor is disabled (`:SOURce:BB:MCCW:CFACTOR:MODE OFF`).

Parameters:

| | |
|------------|-------------------|
| <Step> | float |
| Range: | -359.99 to 359.99 |
| Increment: | 0.01 |
| *RST: | 0 |

Example: `BB:MCCW:EDIT:CARR:PHAS 90 DEG`
 sets a start phase of 90° for the carriers in the carrier range.
`BB:MCCW:EDIT:CARR:PHAS:STEP 1 DEG`
 the start phase is incremented by 1° for each carrier, i.e. the first carrier has a start phase of 90°, the second a start phase of 91°, etc.

Manual operation: See ["Phase Step"](#) on page 469

[:SOURce<hw>]:BB:MCCW:EDIT:CARRIER:PHASe[:START] <Start>

Sets the start phase for the individual carriers in the defined carrier range. If the command `:BB:MCCW:EDIT:CARR:PHAS:STEP` is used to define a step width, the phase entered here applies only to the starting carrier. The phases of the remaining carriers are stepped up or down by the phase value specified in the `:BB:MCCW:EDIT:CARR:PHAS:STEP` command.

The phase settings are only valid if optimization of the crest factor is disabled (`:SOURce:BB:MCCW:CFACTOR:MODE OFF`).

Parameters:

| | |
|------------|-------------|
| <Start> | float |
| Range: | 0 to 359.99 |
| Increment: | 0.01 |
| *RST: | 0 |

Example: `BB:MCCW:EDIT:CARR:PHAS 90 DEG`
 sets a start phase of 90° for the carriers in the carrier range.

Manual operation: See ["Phase Start"](#) on page 469

[:SOURce<hw>]:BB:MCCW:EDIT:CARRIER:POWER:STEP <Step>

Sets the step width by which the starting power of the carriers in the defined carrier range will be incremented.

Parameters:

<Step> float
 Range: -80 to 80
 Increment: 0.01
 *RST: 0

Example:

BB:MCCW:EDIT:CARR:POW -80dB
 sets a power of -80 dB for the carriers in the carrier range.
 BB:MCCW:EDIT:CARR:POW:STEP 1 dB
 the power phase is incremented by dB for each carrier, i.e. the first carrier has -80 dB, the second -79 dB, etc.

Manual operation: See ["Power Step"](#) on page 469

[:SOURce<hw>]:BB:MCCW:EDIT:CARRIER:POWER[:START] <Start>

Sets the power for the individual carriers in the defined carrier range. If the command :BB:MCCW:EDIT:CARR:POW:STEP is used to define a step width, the power entered here applies only to the starting carrier. The power of the remaining carriers is stepped up or down by the power specified in the :BB:MCCW:EDIT:CARR:POW:STEP command.

Parameters:

<Start> float
 Range: -80 to 0
 Increment: 0.01
 *RST: 0

Example:

BB:MCCW:EDIT:CARR:POW -50 dB
 sets the power of the carrier to -50 dB.

Manual operation: See ["Power Start"](#) on page 469

[:SOURce<hw>]:BB:MCCW:EDIT:CARRIER:START <Start>

Selects the first carrier in the carrier range to which the settings with the :BB:MCCW:EDIT:CARR:... commands shall apply.

Parameters:

<Start> integer
 Range: 0 to 8191
 *RST: 0

Example:

BB:MCCW:EDIT:CARR:STAR 4
 the carrier range starts at carrier 4.

Manual operation: See ["Carrier Start"](#) on page 468

[:SOURce<hw>]:BB:MCCW:EDIT:CARRier:STATe <State>

Switches all the carriers in the selected carrier range on or off.

Parameters:

<State> 0 | 1 | OFF | ON
 *RST: 1

Example: BB:MCCW:EDIT:CARR:STAT ON
 sets all the carriers in the carrier range to ON.

Manual operation: See "[Carrier State](#)" on page 468

[:SOURce<hw>]:BB:MCCW:EDIT:CARRier:STOP <Stop>

Selects the last carrier in the carrier range to which the settings with the :BB:MCCW:EDIT:CARR:... commands shall apply.

Parameters:

<Stop> integer
 Range: 0 to 8191
 *RST: 0

Example: BB:MCCW:EDIT:CARR:STOP 40
 the carrier range stops at carrier 40.

Manual operation: See "[Carrier Stop](#)" on page 468

Trigger Settings

| | |
|--|-----|
| [:SOURce<hw>]:BB:MCCW:TRIGger:ARM:EXECute | 708 |
| [:SOURce<hw>]:BB:MCCW:TRIGger:EXECute | 709 |
| [:SOURce<hw>]:BB:MCCW:TRIGger:EXTerنال:SYNChronize:OUTPut | 709 |
| [:SOURce<hw>]:BB:MCCW:TRIGger:OBASeband:DELay | 710 |
| [:SOURce<hw>]:BB:MCCW:TRIGger:OBASeband:INHibit | 710 |
| [:SOURce<hw>]:BB:MCCW:TRIGger:RMODE? | 711 |
| [:SOURce<hw>]:BB:MCCW:TRIGger:SLENgth | 711 |
| [:SOURce<hw>]:BB:MCCW:TRIGger:SOURce | 712 |
| [:SOURce<hw>]:BB:MCCW:TRIGger[:EXTerنال<ch>]:DELay | 712 |
| [:SOURce<hw>]:BB:MCCW:TRIGger[:EXTerنال<ch>]:INHibit | 712 |
| [:SOURce<hw>]:BB:MCCW[:TRIGger]:SEQUence | 713 |

[:SOURce<hw>]:BB:MCCW:TRIGger:ARM:EXECute

Stops signal generation for trigger modes Armed_Auto and Armed_Retrigger. A subsequent internal or external trigger event restart signal generation.

Example:

```
BB:MCCW:TRIG:SOUR INT
sets internal triggering.
BB:MCCW:TRIG:SEQ ARET
sets Armed_Retrigger mode, i.e. every trigger event causes signal
generation to restart.
BB:MCCW:TRIG:EXEC
executes a trigger, signal generation is started.
BB:MCCW:TRIG:ARM:EXEC
signal generation is stopped.
BB:MCCW:TRIG:EXEC
executes a trigger, signal generation is started again.
```

Usage: Event

Manual operation: See ["Arm"](#) on page 473

[:SOURce<hw>]:BB:MCCW:TRIGger:EXECute

Executes a trigger. The internal trigger source must be selected using the command `MCCW:TRIGger:SOURce INTernal` and a trigger mode other than `AUTO` must be selected using the command `:BB:MCCW:TRIGger:MODE`.

Example:

```
BB:MCCW:TRIG:SOUR INT
sets internal triggering.
BB:MCCW:TRIG:SEQ RETR
sets Retrigger mode, i.e. every trigger event causes signal gen-
eration to restart.
BB:MCCW:TRIG:EXEC
executes a trigger.
```

Usage: Event

Manual operation: See ["Execute Trigger"](#) on page 474

[:SOURce<hw>]:BB:MCCW:TRIGger:EXTernal:SYNChronize:OUTPut <Output>

(enabled for Trigger Source External)

Enables/disables output of the signal synchronous to the external trigger event.

See also section ["Sync. Output to External Trigger"](#) on page 474 for a detailed description of the applications of this setting.

Parameters:

<Output> 0 | 1 | OFF | ON

ON

The signal calculation starts simultaneously with the external trigger event but because of the instrument's processing time the first samples are cut off and no signal is outputted. After elapsing of the internal processing time, the output signal is synchronous to the trigger event.

OFF

The signal output begins after elapsing of the processing time and starts with sample 0, i.e. the complete signal is outputted. This mode is recommended for triggering of short signal sequences with signal duration comparable with the processing time of the instrument.

*RST: 1

Example:

```
BB:MCCW:TRIG:SOUR EXT
```

sets external triggering.

```
BB:MCCW:TRIG:EXT:SYNC:OUTP ON
```

enables synchronous output to external trigger.

Manual operation: See "[Sync. Output to External Trigger](#)" on page 474

[[:SOURce<hw>]:BB:MCCW:TRIGger:OBASeband:DELay <Delay>

Sets the trigger delay for external triggering.

Parameters:

<Delay>

float

Range: 0 to 65535

Increment: 0.01

*RST: 0

Example:

```
BB:MCCW:TRIG:SOUR EXT
```

selects an external trigger

```
BB:MCCW:TRIG:DEL 200
```

sets a delay of 200 samples for the trigger.

[[:SOURce<hw>]:BB:MCCW:TRIGger:OBASeband:INHibit <Inhibit>

Sets the number of samples by which a restart is to be inhibited following a trigger event. This command applies only in the case of external triggering.

Parameters:

<Inhibit>

integer

Range: 0 to 67108863

*RST: 0

Example:

```
BB:MCCW:TRIG:SOUR EXT
```

selects an external trigger

```
BB:MCCW:TRIG:INH 200
```

sets a restart inhibit for 200 samples following a trigger event.

[:SOURce<hw>]:BB:MCCW:TRIGger:RMODe?

Queries the current status of signal generation for all trigger modes with Multi Carrier CW on.

Return values:

<RMode> STOP | RUN

RUN

The signal is generated. A trigger event occurred in the triggered mode.

STOP

The signal is not generated. A trigger event did not occur in the triggered modes, or signal generation was stopped by the command `BB:MCCW:TRIG:ARM:EXECute` (armed trigger modes only).

Example:

`SOURBB:MCCW:TRIG:SOUR EXT`

sets external triggering

`SOURBB:MCCW:TRIG:MODE ARET`

selects the Armed_Retrigger mode

`SOURBB:MCCW:TRIG:RMODe?`

queries the current status of signal generation.

Response: RUN

the signal is generated, an external trigger was executed.

Usage: Query only

Manual operation: See "[Running/Stopped](#)" on page 473

[:SOURce<hw>]:BB:MCCW:TRIGger:SENGth <SLength>

Sets the length of the signal sequence to be output in the "Single" trigger mode. The input is to be expressed in samples. It is then possible to output deliberately just part of the waveform, an exact sequence of the waveform, or a defined number of repetitions of the waveform.

Parameters:

<SLength> integer

Range: 1 to 1000

*RST: 1

Example:

`SOURBB:MCCW:SEQ SING`

sets trigger mode Single.

`SOURBB:MCCW:TRIG:SENG 200`

sets a sequence length of 200 samples. The first 200 samples of the current waveform will be output after the next trigger event.

Manual operation: See "[Signal Duration](#)" on page 473

[:SOURce<hw>]:BB:MCCW:TRIGger:SOURce <Source>

Selects the trigger source.

Parameters:

<Source> INTernal|EXTernal
INTernal
 manual trigger or *TRG.
EXTernal
 trigger signal on the TRIG connector.
 *RST: INTernal

Example: SOURce1:BB:MCCW:TRIGger:SOURce EXTernal
 sets external triggering via the TRIGGER connector.

Manual operation: See ["Trigger Source"](#) on page 474

[:SOURce<hw>]:BB:MCCW:TRIGger[:EXTernal<ch>]:DELay <Delay>

Specifies the trigger delay (expressed as a number of samples) for external triggering.

Parameters:

<Delay> float
 Range: 0 to 65535
 Increment: 0.01
 *RST: 0

Example: BB:MCCW:TRIG:SOUR EXT
 selects an external trigger
 BB:MCCW:TRIG:DEL 200
 sets a delay of 200 samples for the trigger.

Manual operation: See ["Trigger Delay"](#) on page 475

[:SOURce<hw>]:BB:MCCW:TRIGger[:EXTernal<ch>]:INHibit <Inhibit>

Specifies the number of samples by which a restart is to be inhibited following a trigger event. This command applies only in the case of external triggering.

Parameters:

<Inhibit> integer
 Range: 0 to 67108863
 *RST: 0

Example: BB:MCCW:TRIG:SOUR EXT
 selects an external trigger
 BB:MCCW:TRIG:INH 200
 sets a restart inhibit for 200 samples following a trigger event.

Manual operation: See ["Trigger Inhibit"](#) on page 476

[[:SOURce<hw>]:BB:MCCW[:TRIGger]:SEQuence <Sequence>

Selects the trigger mode.

Parameters:

<Sequence>

AUTO | RETRigger | AAUTo | ARETrigger | SINGle

AUTO

The multi carrier signal is generated continuously.

RETRigger

The multi carrier signal is generated continuously. A trigger event (internal or external) causes a restart.

AAUTo

The multi carrier signal is generated only when a trigger event occurs. After the trigger event the signal is generated continuously. Signal generation is stopped with command `SOURBB:MCCW:TRIG:ARM:EXEC` and started again when a trigger event occurs.

ARETrigger

The multi carrier signal is generated only when a trigger event occurs. The device automatically toggles to RETRIG mode. Every subsequent trigger event causes a restart. Signal generation is stopped with command `SOURBB:MCCW:TRIG:ARM:EXEC` and started again when a trigger event occurs.

SINGle

The multi carrier signal is output only when a trigger event occurs. After the trigger event the signal is output once to the set sequence length (`SOURBB:MCCW:TRIG:SLEN`). Every subsequent trigger event causes a restart.

*RST: AUTO

Example:

`BB:MCCW:SEQ AAUT`

sets the "Armed_auto" trigger mode; the device waits for the first trigger (e.g. with *TRG) and then generates the signal continuously.

Manual operation: See "[Trigger Mode](#)" on page 472

Marker Settings

This section lists the remote control commands, necessary to configure the markers.



The marker delay settings are available for R&S SMx and R&S AMU instruments only.

| | |
|---|-----|
| <code>[[:SOURce<hw>]:BB:MCCW:TRIGger:OUTPut:DELay:FIXed</code> | 714 |
| <code>[[:SOURce<hw>]:BB:MCCW:TRIGger:OUTPut<ch>:DELay</code> | 714 |
| <code>[[:SOURce<hw>]:BB:MCCW:TRIGger:OUTPut<ch>:DELay:MAXimum?</code> | 714 |
| <code>[[:SOURce<hw>]:BB:MCCW:TRIGger:OUTPut<ch>:DELay:MINimum?</code> | 715 |
| <code>[[:SOURce<hw>]:BB:MCCW:TRIGger:OUTPut<ch>:MODE</code> | 715 |

| | |
|--|-----|
| <code>[:SOURce<hw>]:BB:MCCW:TRIGger:OUTPut<ch>:OFFTime</code> | 716 |
| <code>[:SOURce<hw>]:BB:MCCW:TRIGger:OUTPut<ch>:ONTime</code> | 716 |
| <code>[:SOURce<hw>]:BB:MCCW:TRIGger:OUTPut<ch>:PATtern</code> | 716 |
| <code>[:SOURce<hw>]:BB:MCCW:TRIGger:OUTPut<ch>:PULSe:DIVider</code> | 717 |
| <code>[:SOURce<hw>]:BB:MCCW:TRIGger:OUTPut<ch>:PULSe:FREQUency?</code> | 717 |

`[:SOURce<hw>]:BB:MCCW:TRIGger:OUTPut:DELay:FIXed <Fixed>`

Restricts the marker delay setting range to the dynamic range. In this range the delay can be set without restarting the marker and signal. If a delay is entered in setting ON but is outside this range, the maximum possible delay is set and an error message is generated.

The numeric suffix in OUTPut has no significance for this command, since the setting always affects every marker.

Parameters:

<Fixed> 0 | 1 | OFF | ON
 *RST: 0

Example:

`BB:MCCW:TRIG:OUTP:DEL:FIX ON`
 restricts the marker signal delay setting range to the dynamic range.

Manual operation: See "[Fix marker delay to current range](#)" on page 477

`[:SOURce<hw>]:BB:MCCW:TRIGger:OUTPut<ch>:DELay <Delay>`

Sets the delay between the signal on the marker outputs and the start of the signals, expressed in terms of samples. Command `:BB:MCCW:TRIGger:OUTPut:DELay:FIXed ON` can be used to restrict the range of values to the dynamic range, i.e. the range within which a delay of the marker signals can be set without restarting the marker and signal.

Parameters:

<Delay> float
 Range: 0 to 16777215
 Increment: 1
 *RST: 0

Example:

`BB:MCCW:TRIG:OUTP2:DEL 16`
 sets a delay of 16 samples for the signal on connector MARKER 2.

Manual operation: See "[Marker x Delay](#)" on page 476

`[:SOURce<hw>]:BB:MCCW:TRIGger:OUTPut<ch>:DELay:MAXimum?`

Queries the maximum marker delay for setting `:BB:MCCW:TRIGger:OUTPut:DELay:FIXed ON`.

Return values:

<Maximum> float
 Range: 0 to 16777215
 Increment: 1E-3

Example:

BB:MCCW:TRIG:OUTP:DEL:FIX ON
 restricts the marker signal delay setting range to the dynamic range.
 BB:MCCW:TRIG:OUTP:DEL:MAX
 queries the maximum of the dynamic range.
 Response: 2000
 the maximum for the marker delay setting is 2000 samples.

Usage: Query only

Manual operation: See "[Current Range without Recalculation](#)" on page 476

[[:SOURce<hw>]:BB:MCCW:TRIGger:OUTPut<ch>:DELay:MINimum?

Queries the minimum marker delay for setting :BB:MCCW:TRIGger:OUTPut:DELay:FIXed ON.

Return values:

<Minimum> float
 Range: 0 to 16777215
 Increment: 1E-3
 *RST: 0

Example:

BB:MCCW:TRIG:OUTP:DEL:FIX ON
 restricts the marker signal delay setting range to the dynamic range.
 BB:MCCW:TRIG:OUTP:DEL:MIN
 queries the minimum of the dynamic range.
 Response: 0
 the minimum for the marker delay setting is 0 samples.

Usage: Query only

Manual operation: See "[Current Range without Recalculation](#)" on page 476

[[:SOURce<hw>]:BB:MCCW:TRIGger:OUTPut<ch>:MODE <Mode>

Defines the signal for the selected marker output.

Parameters:

<Mode> REStart | PULSe | PATtern | RATio | TRIGger

REStart

A brief marker signal is generated at the start of the waveform.

PULSe

A pulsed marker signal is generated. The pulse frequency (= sample rate/divider) is defined with the

`SOUR:BB:MCCW:TRIG:OUTP:PULSe:DIVider` command and can be queried with the

`SOUR:BB:MCCW:TRIG:OUTP:PULSe:FREQuency?` command.

PATtern

A marker signal is generated with the aid of a user-definable bit pattern. The bit pattern is entered with the aid of command

`SOURce:BB:MCCW:TRIGger:OUTPut:PATtern`. The bit pattern is a maximum of 32 bits long.

RATio

A regular marker signal corresponding to the Time Off / Time On specifications in the commands

`SOURce:BB:MCCW:TRIGger:OUTPut:OFFT` and

`SOURce:BB:MCCW:TRIGger:OUTPut:ONT` is generated.

TRIGger

A received internal or external trigger signal is output at the marker connector.

*RST: REStart

Example:

`BB:MCCW:TRIG:OUTP2:MODE PULS`

selects the pulsed marker signal on output MARKER 2.

Manual operation: See "[Marker Mode](#)" on page 476

[:SOURce<hw>]:BB:MCCW:TRIGger:OUTPut<ch>:OFFTime <OffTime>

[:SOURce<hw>]:BB:MCCW:TRIGger:OUTPut<ch>:ONTime <OnTime>

Sets the number of samples in a period (ON time + OFF time) during which the marker signal in setting `SOURce:BB:MCCW:TRIGger:OUTPut:MODE RATio` on the marker outputs is ON.

Parameters:

<OnTime> integer

Range: 1 to 16777215

*RST: 1

Example:

`BB:MCCW:TRIG:OUTP2:ONT 20`

sets an ON time of 20 samples for marker 2.

Manual operation: See "[Marker Mode](#)" on page 476

[:SOURce<hw>]:BB:MCCW:TRIGger:OUTPut<ch>:PATtern <Pattern>, <BitCount>

Sets the bit pattern used to generate the marker signal.

Parameters:

<Pattern> numeric
 0 is marker off, 1 is marker on.
 *RST: #H2

<BitCount> integer
 Range: 1 to 64
 *RST: 2

Example:

```
BB:MCCW:TRIG:OUTP2:MODE PATT
BB:MCCW:TRIG:OUTP2:PATT #HE0F52,20
```

Manual operation: See "[Marker Mode](#)" on page 476

[[:SOURce<hw>]:BB:MCCW:TRIGger:OUTPut<ch>:PULSe:DIVider <Divider>

Sets the divider for Pulse marker mode (SOUR:BB:MCCW:TRIG:OUTP:MODE PULSe). The resulting pulse frequency is derived by dividing the symbol rate by the divider.

Parameters:

<Divider> integer
 Range: 2 to 1024
 *RST: 2

Example:

```
BB:MCCW:TRIG:OUTP2:PULS:DIV 2
sets the divider for the marker signal on output MARKER 2 to
the value 2.
BB:MCCW:TRIG:OUTP2:FREQ?
queries the resulting pulse frequency of the marker signal
Response: 66 000
the resulting pulse frequency is 66 kHz.
```

Manual operation: See "[Marker Mode](#)" on page 476

[[:SOURce<hw>]:BB:MCCW:TRIGger:OUTPut<ch>:PULSe:FREQuency?

Queries the pulse frequency of the pulsed marker signal in the setting SOUR:BB:MCCW:TRIG:OUTP:MODE PULS. The pulse frequency is derived by dividing the symbol rate by the divider. The divider is defined with command SOUR:BB:MCCW:TRIG:OUTP:PULS:DIV.

Return values:

<Frequency> float
 Increment: 1E-3

Example: `BB:MCCW:TRIG:OUTP2:PULS:DIV 4`
 sets the divider for the marker signal on output MARKER 2 to the value 4.
`BB:MCCW:TRIG:OUTP2:MODE PULS`
 enables the pulsed marker signal
`BB:MCCW:TRIG:OUTP2:PULS:FREQ?`
 queries the pulse frequency for the marker signal.
 Response: "33 000"
 the resulting pulse frequency is 33 kHz.

Usage: Query only

Manual operation: See "[Marker Mode](#)" on page 476

Clock Settings

| | |
|--|-----|
| [:SOURce<hw>]:BB:MCCW:CLOCK:MODE..... | 718 |
| [:SOURce<hw>]:BB:MCCW:CLOCK:MULTIplier..... | 718 |
| [:SOURce<hw>]:BB:MCCW:CLOCK:SOURce..... | 719 |
| [:SOURce<hw>]:BB:MCCW:CLOCK:SYNChronization:MODE..... | 719 |
| [:SOURce<hw>]:BB:MCCW:CLOCK:SYNChronization:EXECute..... | 720 |

[:SOURce<hw>]:BB:MCCW:CLOCK:MODE <Mode>

Sets the type of externally supplied clock (`:BB:MCCW:CLOCK:SOURce EXTERNAL`). When `MSAMPLE` is used, a multiple of the sample clock is supplied via the `CLOCK` connector and the sample clock is derived internally from this. The multiplier is entered with the command `BB:MCCW:CLOCK:MULTIplier`.

Parameters:

<Mode> SAMPLE | MSAMPLE
 *RST: SAMPLE

Example: `BB:MCCW:CLOCK:MODE SAMP`
 selects clock type "Sample", i.e. the supplied clock is a sample clock.

Manual operation: See "[Clock Mode](#)" on page 478

[:SOURce<hw>]:BB:MCCW:CLOCK:MULTIplier <Multiplier>

Specifies the multiplier for clock type Multiple Samples (`:BB:MCCW:CLOCK:MODE MSAM`) in the case of an external clock source.

Parameters:

<Multiplier> integer
 Range: 1 to 64
 *RST: 4

Example: `BB:MCCW:CLOC:SOUR EXT`
 selects the external clock source. The clock is supplied via the CLOCK connector.
`BB:MCCW:CLOC:MODE MSAM`
 selects clock type "Multiple Samples", i.e. the supplied clock has a rate which is a multiple of the sample rate.
`BB:MCCW:CLOC:MULT 12`
 the multiplier for the external clock rate is 12.

Manual operation: See "[Clock Multiplier](#)" on page 478

[[:SOURce<hw>]:BB:MCCW:CLOCK:SOURce <Source>

Selects the source for the digital modulation clock.

Parameters:

<Source> INTERNAL | EXTERNAL | AINTERNAL

INTERNAL

The internal clock reference is used.

EXTERNAL

The external clock reference is supplied to the CLOCK connector.

*RST: INTERNAL

Example: `BB:MCCW:CLOC:SOUR EXT`
 selects an external clock reference. The clock is supplied via the CLOCK connector.

Manual operation: See "[Clock Source](#)" on page 477

[[:SOURce<hw>]:BB:MCCW:CLOCK:SYNChronization:MODE <Mode>

Selects the synchronization mode.

This parameter is used to enable generation of very precise synchronous signal of several connected R&S SMBVs.

Note

If several instruments are connected, the connecting cables from the master instrument to the slave one and between each two consecutive slave instruments must have the same length and type.

Avoid unnecessary cable length and branching points.

Parameters:

<Mode> NONE | MASTER | SLAVE

NONE

The instrument is working in stand-alone mode.

MASTer

The instrument provides all connected instrument with its synchronization (including the trigger signal) and reference clock signal.

SLAVe

The instrument receives the synchronization and reference clock signal from another instrument working in a master mode.

*RST: NONE

Example: BB:MCCW:CLOC:SYNC:MODE MAST
the instrument is configured to work as a master one.

Manual operation: See "[Sync. Mode](#)" on page 477

[:SOURce<hw>]:BB:MCCW:CLOCK:SYNChronization:EXECute

Performs automatically adjustment of the instrument's settings required for the synchronization mode, set with the command [:SOURce<hw>] :BB:MCCW:CLOCK:SYNChronization:MODE.

Example: BB:MCCW:CLOC:SYNC:MODE MAST
the instrument is configured to work as a master one.
BB:MCCW:CLOC:SYNC:EXEC
all synchronization's settings are adjusted accordingly.

Usage: Event

Manual operation: See "[Set Synchronization Settings](#)" on page 477

7.15.3.7 SOURce:BB:PROGress Subsystem General Commands

In the R&S SMBV, some calculation processes may take longer time. While operating the instrument manually, you can observe the status of an initiated process by the busy indicator. The following commands fulfill the same task in the remote control operation.

Example: Querying the status of the Create Waveform file process

The following is an example on how to use these commands to retrieve information about how many percent of the initiated process are completed.

```
:SOURce1:BB:EUTRa:SETTing:TMOD:DL "E-TM1_1__15MHz"
:SOURce1:BB:EUTRa:SLENgth 100
:SOURce1:BB:PROGress:MCODer?
// 100 (task compleated)
:SOURce1:BB:EUTRa:STATe ON
:BB:PROGress:MCODer?
// 67 (task in progress)
:SOURce1:BB:EUTRa:WAVEform:CREate
:SOURce1:BB:PROGress:MCODer?
// 25 (task in progress)
```

```
// :SOURce1:BB:PROGress:MCODer:DM:FILTer?
// 100
```

```
[:SOURce<hw>]:BB:PROGress:MCODer?.....721
[:SOURce<hw>]:BB:PROGress:MCODer:ARBitrary:MCARrier?.....721
[:SOURce<hw>]:BB:PROGress:MCODer:ARBitrary:WSEGment?.....721
[:SOURce<hw>]:BB:PROGress:MCODer:DM:FILTer?.....721
```

[:SOURce<hw>]:BB:PROGress:MCODer?
[:SOURce<hw>]:BB:PROGress:MCODer:ARBitrary:MCARrier?
[:SOURce<hw>]:BB:PROGress:MCODer:ARBitrary:WSEGment?

Queries the status of an initiated process, like for example the calculation of a signal in accordance to a digital standard, or the calculation of a multi carrier or multi segment waveform file.

Return values:

<WSegment> integer
 Indicates the task progress in percent
 Range: 0 to 100
 *RST: 100

Example: see [Example "Querying the status of the Create Waveform file process"](#) on page 720

Usage: Query only

[:SOURce<hw>]:BB:PROGress:MCODer:DM:FILTer?

Queries the status of an applied offline filtering, like for example during the calculation of a waveform and a multi carrier waveform file.

Return values:

<Filter> integer
 Indicates the task progress in percent
 Range: 0 to 100
 *RST: 100

Example: see [Example "Querying the status of the Create Waveform file process"](#) on page 720

Usage: Query only

7.15.4 SOURce:BBIN Subsystem

The SOURce:BBIN subsystem contains the commands for setting the external digital and analog baseband signals.

The external baseband signal A can be routed to path A, path B, or both paths. The external baseband signal B can be routed to path B only.

| | |
|---|-----|
| <code>[SOURce<hw>]:BBIN:ALEVel:EXECute</code> | 722 |
| <code>[SOURce<hw>]:BBIN:CDEvice?</code> | 722 |
| <code>[SOURce<hw>]:BBIN:POWer:CFACtor</code> | 722 |
| <code>[SOURce<hw>]:BBIN:CFACtor</code> | 722 |
| <code>[SOURce<hw>]:BBIN:DIGital:ASETting:STATe</code> | 723 |
| <code>[SOURce<hw>]:BBIN:FOFFset</code> | 723 |
| <code>[SOURce<hw>]:BBIN:IQSWap[:STATe]</code> | 723 |
| <code>[SOURce<hw>]:BBIN:MPERiod</code> | 724 |
| <code>[SOURce<hw>]:BBIN:OLOad:HOLD:RESet</code> | 724 |
| <code>[SOURce<hw>]:BBIN:OLOad:HOLD:STATe?</code> | 724 |
| <code>[SOURce<hw>]:BBIN:OLOad:STATe?</code> | 725 |
| <code>[SOURce<hw>]:BBIN:POWer:PEAK</code> | 725 |
| <code>[SOURce<hw>]:BBIN:POWer:RMS?</code> | 725 |
| <code>[SOURce<hw>]:BBIN:SRATe[:ACTual]</code> | 726 |
| <code>[SOURce<hw>]:BBIN:SRATe:FIFO[:STATus]?</code> | 726 |
| <code>[SOURce<hw>]:BBIN:SRATe:SOURce</code> | 726 |
| <code>[SOURce<hw>]:BBIN:STATe</code> | 727 |

`[SOURce<hw>]:BBIN:ALEVel:EXECute`

This command starts measuring the input signal. The measurement estimates the crest factor and the peak power.

Example: `BBIN:ALEV:EXEC`
starts measuring the input signal.

Usage: Event

Manual operation: See "[Auto Level Set](#)" on page 484

`[SOURce<hw>]:BBIN:CDEvice?`

Digital Input only.

Indicates the ID of an externally connected R&S Instrument or R&S Device.

Return values:

<CDevice> string

Example: `BBIN:CDEV`
queries the connected device ID.

Usage: Query only

Manual operation: See "[Connected Device](#)" on page 485

`[SOURce<hw>]:BBIN:POWer:CFACtor <CFactor>`

`[SOURce<hw>]:BBIN:CFACtor <CFactor>`

This command enters the crest factor of the external baseband signal.

Parameters:

<CFactor> float
 Range: 0 to 30
 Increment: 0.01
 *RST: 0
 Default unit: dB

Example:

BBIN:CFAC 10
 enters a crest factor of 10 dB for the external baseband signal.

Manual operation: See "[Crest Factor](#)" on page 484

[[:SOURce<hw>]:BBIN:DIGital:ASETting:STATe <State>

Activates automatic adjustment of the baseband input signal.

The R&S SMBV receives peak level, level and crest factor values directly from the connected transmitter and recognizes changes automatically.

Parameters:

<State> 0 | 1 | OFF | ON
 *RST: 0

Example:

BBIN:DIG:ASET:STAT ON
 switches on automatic adjustment of the baseband input signal.

Manual operation: See "[DIG IQ Auto Setting](#)" on page 483

[[:SOURce<hw>]:BBIN:FOFFset <FOffset>

Enters the frequency offset for the external baseband signal.

The complex I/Q bandwidth of the shifted useful signal must not exceed the total available baseband bandwidth (see data sheet).

Parameters:

<FOffset> float
 Range: -40E6 to 40E6
 Increment: 0.01
 *RST: 0
 Default unit: Hz

Example:

BBIN:FOFF 2 MHz
 sets a frequency offset of 2 MHz.

Manual operation: See "[Frequency Offset](#)" on page 485

[[:SOURce<hw>]:BBIN:IQSWap[:STATe] <State>

This command swaps the I and Q channel if set to ON.

Parameters:

<State> 0 | 1 | OFF | ON
 *RST: 0

Example:

BBIN:IQSW ON
 swaps the I and Q channel of the external baseband signal.

Manual operation: See "[I/Q-Swap](#)" on page 482

[:SOURce<hw>]:BBIN:MPERiod <MPeriod>

Sets the recording duration for measuring the baseband input signal by Auto Level Set.

Parameters:

<MPeriod> integer
 Range: 1 to 32
 *RST: 2
 Default unit: s

Example:

BBIN:MPER 4s
 sets the recording duration for Auto Level Set to 4 seconds.

Manual operation: See "[Measurement Period](#)" on page 484

[:SOURce<hw>]:BBIN:OLOad:HOLD:RESet

This command executes a reset of the Overload Hold State and LED.

Example:

BBIN:MODE DIG
 selects the digital baseband input mode.
 BBIN:OLO:HOLD:RES
 resets the overload hold state.

Usage:

Event

[:SOURce<hw>]:BBIN:OLOad:HOLD:STATe?

This command queries an overload since the last reset for evaluating the measurement. The Overload Hold state can be reset via the "Reset" command, or is reset automatically by starting a new measurement ("Auto Level Set") or by setting new values (Crest Factor, Peak Level, Level).

Return values:

<State> 0 | 1 | OFF | ON
 *RST: 0

Example:

BBIN:MODE DIG
 selects the digital baseband input mode.
 BBIN:OLO:HOLD:STAT?
 queries the overload state.
 Response: 0
 the AC/DC converter has not been overloaded.

Usage: Query only
Manual operation: See "[Overload Hold](#)" on page 485

[[:SOURce<hw>]:BBIN:OLOad:STATE?

This command queries the current overload state of the A/D converter.

Return values:

<State> 0 | 1 | OFF | ON
 *RST: 0

Example: BBIN:MODE DIG
 selects the digital baseband input mode.
 BBIN:OLO:STAT?
 queries the overload state.
 Response: 0
 The AC/DC converter is not overloaded.

Usage: Query only
Manual operation: See "[Overload](#)" on page 485

[[:SOURce<hw>]:BBIN:POWER:PEAK <Peak>

This command enters the peak level of the external baseband signal relative to full scale of 0.5 V (in terms of dB full scale).

Parameters:

<Peak> float
 Range: -60 to 3.02
 Increment: 0.01
 *RST: 0
 Default unit: dBfs

Example: BBIN:POW:PEAK -2
 enters the peak level of -2 dBfs.

Manual operation: See "[Peak Level](#)" on page 484

[[:SOURce<hw>]:BBIN:POWER:RMS?

This command queries the rms level of the external digital baseband signal.

Return values:

<Rms> float
 Range: -100 to 10
 Increment: 0.01
 *RST: 0

Example: BBIN:POW:RMS
 queries the estimated rms level.

Usage: Query only
Manual operation: See "[Level](#)" on page 484

[[:SOURce<hw>]:BBIN:SRATe[:ACTual] <Actual>

Sets the sample rate of the external digital baseband signal.

Parameters:

<Actual> float
 Range: 25E6 to 200E6
 Increment: 5E6
 *RST: 100E6

Example: :SOURce:BBIN:SRATe:ACTual 50E6

Manual operation: See "[Sample Rate Value](#)" on page 483

[[:SOURce<hw>]:BBIN:SRATe:FIFO[:STATus]?

This command indicates the state of the signal transmission.

Return values:

<Status> OK | OFLow | URUN
OK
 Resampling is working properly.
OFL = Overflow
 The external sample rate frequency is too high which causes an overflow in signal transmission.
URUN = Underrun
 The external sample rate frequency is too low which causes an underrun in signal transmission.
 *RST: OK

Example: BBIN:SRAT:FIFO:STAT
 queries the FIFO Status of the sample rate.

Usage: Query only

Manual operation: See "[FIFO Status](#)" on page 483

[[:SOURce<hw>]:BBIN:SRATe:SOURce <Source>

Queries the source for estimating the sample rate of the digital input signal or defining it by the user.

Parameters:

<Source> USER | DIN
 *RST: USER

Example: BBIN:SRAT:SOUR?

Manual operation: See "Sample Rate Source" on page 482

[:SOURce<hw>]:BBIN:STATe <State>

This command switches the feeding of an external analog signal into the signal path on/off.

Parameters:

<State> 0 | 1 | OFF | ON

*RST: 0

Example:

BBIN:SOUR ANAL

selects an external analog signal as the input signal. The signal must be applied at the inputs I and Q.

BBIN:STAT ON

switches on the Baseband In block. The external analog signal is A/D-converted and fed into the digital signal.

Manual operation: See "State" on page 482

7.15.5 SOURce:CORRection Subsystem

The output level is corrected in the CORRection subsystem. Correction is performed by user-defined table values being added to the output level for the respective RF frequency. In the R&S SMBV, this subsystem is used to select, transfer and activate user correction tables.

Each list is stored as a file. The name of the user correction file can be freely selected. The file extension *.uco is assigned automatically and cannot be changed.

The files can be stored in a freely selectable directory and opened from there. The default directory is set using command :MMEMory:CDIRectory on page 573. In the case of files which are stored in the default directory, only the file name has to be specified in commands. Otherwise, the complete absolute path has to be specified with every command. The extension can be omitted in any case.



In the following command examples, the files are stored in the default directory.

The amplitude can also be linearized automatically by means of a R&S NRP power sensor connected to the generator output signal. With the aid of the command [:SOURce<hw>]:CORRection:CSET:DATA[:SENSor<ch>][:POWER]:SONCe, a list with correction values for external test assemblies can be automatically determined, e.g. for compensating the frequency response of cables. The correction values can be acquired any time irrespective of the modulation settings of the generator.

| | |
|--|-----|
| [:SOURce]:CORRection:CSET:CATalog?..... | 728 |
| [:SOURce<hw>]:CORRection:CSET:DATA:FREQUency..... | 728 |
| [:SOURce<hw>]:CORRection:CSET:DATA:FREQUency:POINts?..... | 729 |
| [:SOURce<hw>]:CORRection:CSET:DATA:POWER..... | 729 |

| | |
|--|-----|
| <code>[:SOURce<hw>]:CORRection:CSET:DATA:POWer:POINts?</code> | 729 |
| <code>[:SOURce<hw>]:CORRection:CSET:DATA[:SENSor<ch>][:POWer]:SONCe</code> | 730 |
| <code>[:SOURce]:CORRection:CSET:DELete</code> | 730 |
| <code>[:SOURce<hw>]:CORRection:DEXChange:AFILe:CATalog?</code> | 730 |
| <code>[:SOURce<hw>]:CORRection:DEXChange:AFILe:EXTension</code> | 731 |
| <code>[:SOURce<hw>]:CORRection:DEXChange:AFILe:SELect</code> | 731 |
| <code>[:SOURce<hw>]:CORRection:DEXChange:AFILe:SEParator:COLumn</code> | 732 |
| <code>[:SOURce<hw>]:CORRection:DEXChange:AFILe:SEParator:DECimal</code> | 732 |
| <code>[:SOURce<hw>]:CORRection:DEXChange:EXECute</code> | 733 |
| <code>[:SOURce<hw>]:CORRection:DEXChange:MODE</code> | 733 |
| <code>[:SOURce<hw>]:CORRection:DEXChange:SELect</code> | 734 |
| <code>[:SOURce<hw>]:CORRection:CSET[:SELect]</code> | 734 |
| <code>[:SOURce<hw>]:CORRection[:STATe]</code> | 735 |
| <code>[:SOURce<hw>]:CORRection:VALue?</code> | 735 |
| <code>[:SOURce<hw>]:CORRection:ZERoing:STATe</code> | 735 |

`[:SOURce]:CORRection:CSET:CATalog?`

Requests a list of user correction tables. The individual lists are separated by commas.

The lists are stored with the fixed file extensions `*.uco` in a directory of the user's choice. The directory applicable to the commands is defined with the command `MMEMoRY:CDIR`.

Return values:

<Catalog> string

Example:

```
MMEM:CDIR '/var/user/ucor'
```

selects the directory for the user correction files.

```
CORR:CSET:CAT?
```

queries which correction tables are available.

```
Response:UCOR1,UCOR2,UCOR3
```

the correction tables `UCOR1`, `UCOR2` and `UCOR3` are available.

Usage: Query only

Manual operation: See "[Directory, File List and File Name](#)" on page 162

`[:SOURce<hw>]:CORRection:CSET:DATA:FREQuency <Frequency>`

Transfers the frequency data to the table selected with `:CORRection:CSET:SELect`.

The numerical suffix at `SOURce` must not be used for this command.

Parameters:

<Frequency> Frequency#1[, Frequency#2, ...]
 Range: 300 kHz to RFmax (depending on model)

Example:

```
CORR:CSET '/var/user/ucor1'
```

selects the table `ucor1`.

```
CORR:CSET:DATA:FREQ 100MHz,102MHz,103MHz,...
```

enters the frequency value in the table `ucor1`.

Manual operation: See " [Edit User Cor. Data - User Correction](#) " on page 235

[[:SOURce<hw>]:CORRection:CSET:DATA:FREQUency:POINts?

Queries the number of frequency values in the selected table.

The numerical suffix at SOURce must not be used for this command.

Return values:

<Points> integer
 Range: 0 to 10000
 *RST: 0

Example:

```
CORR:CSET '/var/user/'
selects the table ucor1.
CORR:CSET:DATA:FREQ:POIN?
queries the number of frequency values in the table ucor1.
Response: 440
the table ucor1 contains 440 frequency values.
```

Usage: Query only

[[:SOURce<hw>]:CORRection:CSET:DATA:POWer <Power>

Transfers the level data to the table selected with [\[:SOURce<hw>\]:CORRection:CSET\[:SELEct\]](#).

*RST does not affect data lists. The numerical suffix at SOURce must not be used for this command.

Parameters:

<Power> Power#1[, Power#2, ...]

Example:

```
CORR:CSET '/var/user/ucor1'
selects the table ucor1.
CORR:CSET:DATA:POW 1dB, 0.8dB, 0.75dB, ...
enters the level values in the table ucor1.
```

Manual operation: See " [Edit User Cor. Data - User Correction](#) " on page 235

[[:SOURce<hw>]:CORRection:CSET:DATA:POWer:POINts?

Queries the number of level values in the selected table.

The numerical suffix at SOURce must not be used for this command.

Return values:

<Points> integer
 Range: 0 to 10000
 *RST: 0

Example: `CORR:CSET '/var/user/ucor1'`
 selects the table ucor1.
 `CORR:CSET:DATA:POW:POIN?`
 queries the number of level values in the table ucor1.
 Response: 440
 the table ucor1 contains 440 level values.

Usage: Query only

[[:SOURce<hw>]:CORRection:CSET:DATA[:SENSor<ch>]][:POWER]:SONCe

The command fills the selected user correction list with the level values measured by the power sensor for the given frequencies.

To select the used power sensor set the suffix in key word `SENSe`.

Example: `CORR:CSET:DATA:SENS:POW:SONC`
 fills the user correction list with level values acquired by the
 power sensor connector to the [SENSOR] connector.

Usage: Event

Manual operation: See "[Fill User Correction Data with Sensor](#)" on page 240

[[:SOURce]:CORRection:CSET:DELeTe <Filename>

Deletes the specified table.

The lists are stored with the fixed file extensions `*.uco` in a directory of the user's choice. The directory applicable to the commands is defined with the command `MMEMoRY:CDIR`. A path can also be specified in command `SOUR:CORR:CSET:CAT?`, in which case the file in the specified directory is deleted.

Setting parameters:

<Filename> <table name>

Example: `MMEM:CDIR '/var/user/ucor'`
 selects the directory for the user correction files.
 `CORR:CSET:DEL 'UCOR1'`
 deletes the table ucor1.

Usage: Setting only

Manual operation: See "[User Cor. Data - User Correction](#)" on page 235

[[:SOURce<hw>]:CORRection:DEXChange:AFILe:CATalog?

Requests a list of available ASCII files for export/import of user correction data. The individual files are separated by commas.

The ASCII files are stored with the fixed file extensions `*.txt` or `*.csv` in a directory of the user's choice. The directory applicable to the commands is defined with the command `MMEMoRY:CDIR`.

Return values:

<Catalog> string

Example:

```
MMEM:CDIR '/var/user/import'
```

selects the directory for the ASCII files with frequency and level value pairs.

```
CORR:DEXC:AFIL:EXT TXT
```

selects that ASCII files with extension *.txt are listed.

```
CORR:DEXC:AFIL:CAT?
```

queries the available files with extension *.txt.

Response: 'ucor1,ucor2'

the ASCII files ucor1.txt and ucor2.txt are available.

Usage: Query only

[[:SOURce<hw>]:CORRection:DEXChange:AFIL:EXTension <Extension>

Selects the file extension of the ASCII file to be imported or exported. Selection TXT (text file) or CSV (Excel file) is available.

Parameters:

<Extension> TXT | CSV

*RST: TXT

Example:

```
MMEM:CDIR '/var/user/import'
```

selects the directory for the ASCII files with frequency and level value pairs.

```
CORR:DEXC:AFIL:EXT TXT
```

selects that ASCII files with extension *.txt are listed.

```
CORR:DEXC:AFIL:CAT?
```

queries the available files with extension *.txt.

Response: 'list1,list2'

the ASCII files ucor1.txt and ucor2.txt are available.

Manual operation: See "[Extension - User Correction](#)" on page 237

[[:SOURce<hw>]:CORRection:DEXChange:AFIL:SElect <Filename>

Selects the ASCII file to be imported or exported.

The ASCII files are stored with the fixed file extensions *.txt or *.csv in a directory of the user's choice. The directory applicable to the commands is defined with the command `MMEMoRY:CDIR`. A path can also be specified in command `SOUR:CORR:DEXC:AFIL:SEL`, in which case the files are stored or loaded in the specified directory.

Parameters:

<Filename> <ascii file name>

Example: `CORR:DEXC:MODE IMP`
 selects that ASCII files with frequency and level value pairs are imported and transferred into user correction lists.
`CORR:DEXC:AFIL:SEL '/var/user/import_ucor.csv'`
 selects that ASCII file `ucor.csv` is imported.
`CORR:DEXC:SEL '/var/user/import_ucor_imp'`
 selects that the ASCII file `ucor.csv` is imported into user correction list `ucor_imp`.

Manual operation: See "[Select ASCII Source / Destination - User Correction](#)" on page 238

[:SOURce<hw>]:CORRection:DEXChange:AFILe:SEParator:COLumn <Column>

Selects the separator between the frequency and level column of the ASCII table.

Parameters:

<Column> TABulator | SEMicolon | COMMa | SPACe
 *RST: COMMa

Example: `CORR:DEXC:MODE EXP`
 selects that the user correction list is exported into an ASCII file.
`CORR:DEXC:AFIL:SEL '/var/user/import_ucor.csv'`
 selects ASCII file `ucor.csv` as destination for the user correction list data.
`CORR:DEXC:AFIL:SEP:COL TAB`
 the pairs of frequency and level values are separated by a tabulator.
`CORR:DEXC:AFIL:SEP:DEC DOT`
 selects the decimal separator dot.
`CORR:DEXC:SEL '/var/user/import_ucor_imp'`
 selects that the user correction list `ucor_imp` is imported into ASCII file `ucor.csv`.

Manual operation: See "[Column Separator- User Correction](#)" on page 237

[:SOURce<hw>]:CORRection:DEXChange:AFILe:SEParator:DECimal <Decimal>

Selects the decimal separator used in the ASCII data between '.' (decimal point) and ',' (comma) with floating-point numerals.

Parameters:

<Decimal> DOT | COMMa
 *RST: DOT

Example:

```
CORR:DEXC:MODE EXP
```

selects that the user correction list is exported into an ASCII file.

```
CORR:DEXC:AFIL:SEL '/var/user/import_ucor.csv'
```

selects ASCII file ucor.csv as destination for the user correction list data.

```
CORR:DEXC:AFIL:SEP:COL TAB
```

the pairs of frequency and level values are separated by a tabulator.

```
CORR:DEXC:AFIL:SEP:DEC DOT
```

selects the decimal separator dot.

```
CORR:DEXC:SEL '/var/user/import_ucor_imp'
```

selects that the user correction list ucor_imp is imported into ASCII file ucor.csv.

Manual operation: See "[Decimal Point - User Correction](#)" on page 237

[:SOURce<hw>]:CORRection:DEXChange:EXECute

Starts the export or import of the selected file. When import is selected, the ASCII file is imported as user correction list. When export is selected, the user correction list is exported into the selected ASCII file.

Example:

```
CORR:DEXC:MODE IMP
```

selects that ASCII files with frequency and level value pairs are imported and transferred into user correction lists.

```
CORR:DEXC:AFIL:SEL '/var/user/import_ucor.csv'
```

selects that ASCII file ucor.csv is imported.

```
CORR:DEXC:SEL '/var/user/import_ucor_imp'
```

selects that the ASCII file ucor.csv is imported into user correction list ucor_imp.

```
CORR:DEXC:EXEC
```

starts the import of the ASCII file data into the user correction file.

Usage: Event

Manual operation: See "[Import / Export - User Correction](#)" on page 238

[:SOURce<hw>]:CORRection:DEXChange:MODE <Mode>

Selects if user correction lists should be imported or exported. Depending on the selection here, the file select command defines either the source or the destination for user correction lists and ASCII files.

Parameters:

```
<Mode>          IMPort | EXPort
*RST:          IMPort
```

Example:

```
CORR:DEXC:MODE IMP
selects that ASCII files with frequency and level value pairs are
imported and transferred into user correction lists.
CORR:DEXC:AFIL:SEL '/var/user/ucor.csv'
selects that ASCII file ucor.csv is imported.
CORR:DEXC:SEL '/var/user/ucor_imp'
selects that the ASCII file ucor.csv is imported into user cor-
rection list ucor_imp.
```

Manual operation: See "[Mode - User Correction](#)" on page 237

[[:SOURce<hw>]:CORRection:DEXChange:SELEct <Filename>

Selects the user correction list to be imported or exported.

The user correction files are stored with the fixed file extensions *.uco in a directory of the user's choice. The directory applicable to the commands is defined with the command `MMEMoRY:CDIR`. A path can also be specified in command `SOUR:CORR:DEXC:SEL`, in which case the files are stored or loaded in the specified directory.

Parameters:

<Filename> string

Example:

```
CORR:DEXC:MODE IMP
selects that ASCII files with frequency and level value pairs are
imported and transferred into user correction lists.
CORR:DEXC:AFIL:SEL '/var/user/import_ucor.csv'
selects that ASCII file ucor.csv is imported.
CORR:DEXC:SEL '/var/user/import_ucor_imp'
selects that the ASCII file ucor.csv is imported into user cor-
rection list ucor_imp.
```

Manual operation: See "[Destination / Source - User Correction](#)" on page 238

[[:SOURce<hw>]:CORRection:CSET[:SELEct] <Filename>

Selects or creates a file for the user correction data.

If the file does not exist, the instrument automatically creates a new file with the name you assigned. Note the predefined file extensions under [Chapter 4.7.2.1, "Extensions for User Files"](#), on page 109.

To determine the file location (directory/path) you can either enter it with the command directly, or use the command `MMEMoRY:CDIR`.

To activate level correction use the command `[[:SOURce<hw>]:CORRection[:STATe]`.

Parameters:

<Filename> <table name>

Example: CORR:CSET '/var/user/ucor1'
selects the table ucor1.
CORR ON
activates level correction. Correction is performed using the
table ucor1.

Manual operation: See " [User Cor. Data - User Correction](#) " on page 235

[[:SOURce<hw>]:CORRection[:STATe] <State>

Activates/deactivates level correction. Level correction is performed using the table which has been selected with the command `[[:SOURce<hw>]:CORRection:CSET[:SELEct]`.

Parameters:

<State> 0 | 1 | OFF | ON
*RST: 0

Example: SOUR:CORR:CSET '/var/user/ucor1'
selects the table ucor1.
SOUR:CORR ON
activates user correction.

Manual operation: See " [State - User Correction](#) " on page 234

[[:SOURce<hw>]:CORRection:VALue?

Queries the current value for user correction.

Return values:

<Value> float
Range: -100 to 100
Increment: 0.01
*RST: 0

Example: CORR:VAL?
queries the value currently used for level correction.
Response: -3
the correction value is - 3 dB.

Usage: Query only

Manual operation: See " [User Correction Value - User Correction](#) " on page 234

[[:SOURce<hw>]:CORRection:ZERoing:STATe <State>

Activates the zeroing procedure before filling the user correction data acquired by a sensor.

Parameters:

<State> 0 | 1 | OFF | ON
*RST: 1

Manual operation: See "[Fill User Correction Data with Sensor](#)" on page 240

7.15.6 SOURce:FM Subsystem

The FM subsystem contains the commands for checking the frequency modulation.

The settings for the internal modulation source (LF generator) are made in the [SOURce:LFOuTput](#) subsystem).

For information about the required options, see [Chapter 5.5.12.3, "Frequency Modulation \(FM\)"](#), on page 256.

| | |
|---|-----|
| [:SOURce<hw>]:FM[:DEViation] | 736 |
| [:SOURce<hw>]:FM:EXtErnal:COUPling | 736 |
| [:SOURce<hw>]:FM:EXtErnal:DEViation | 737 |
| [:SOURce<hw>]:FM:INtErnal:DEViation | 737 |
| [:SOURce<hw>]:FM:MODE | 737 |
| [:SOURce<hw>]:FM:SENSitivity? | 738 |
| [:SOURce<hw>]:FM:SOURce | 738 |
| [:SOURce<hw>]:FM:STATe | 739 |

[:SOURce<hw>]:FM[:DEViation] <Deviation>

Sets the deviation of the frequency modulation signals in Hz. The maximum deviation depends on the set RF frequency and the selected modulation mode (see data sheet).

Parameters:

<Deviation> float
 Range: 0 to dynamic
 Increment: 0.01
 *RST: 1000

Example: FM 2E3
 sets a 2 kHz deviation to the modulation signal.

Manual operation: See "[FM Deviation](#)" on page 257

[:SOURce<hw>]:FM:EXtErnal:COUPling <Coupling>

Selects the coupling mode for the external frequency modulation signal.

Parameters:

<Coupling> AC | DC
 AC
 Uses only the AC signal component of the modulation signal.
 DC
 Uses the modulation signal as it is, with AC and DC.
 *RST: AC

Example: `FM:EXT:COUP AC`
selects the coupling mode AC for the external frequency modulation signal.

Manual operation: See ["Mod Ext Coupling"](#) on page 258

[:SOURce<hw>]:FM:EXTernal:DEViation <Deviation>

Sets the deviation of the external frequency modulation signal in Hz. The maximum deviation depends on the set RF frequency and the selected modulation mode (see data sheet).

The sum of the deviations of all active frequency modulation signals may not exceed the total value set with command `[:SOURce<hw>]:FM[:DEViation]`.

Parameters:

<Deviation> float
Range: see data sheet
Increment: 0.01
*RST: 1000

Example: `FM:EXT:DEV 3kHz`
sets 3 kHz deviation to the frequency modulation signal.

Manual operation: See ["FM Deviation"](#) on page 257

[:SOURce<hw>]:FM:INTernal:DEViation <Deviation>

Sets the deviation of the internal frequency modulation signal in Hz.

The sum of the deviations of all active frequency modulation signals may not exceed the total value set with command `[:SOURce<hw>]:FM[:DEViation]`.

Parameters:

<Deviation> float
Range: 0 to dynamic
Increment: 0.01
*RST: 1E3

Example: `FM:INT1:DEV 2E3`
sets 2 kHz deviation for the frequency modulation signal.

Manual operation: See ["FM Deviation"](#) on page 257

[:SOURce<hw>]:FM:MODE <Mode>

Selects the mode for the frequency modulation.

Parameters:

<Mode> NORMAL | LNOise | HDEViation
NORMAL
Provides full setting range of modulation bandwidth and FM deviation.

LNOise

Provides phase noise and spurious characteristics close to CW. The range for modulation bandwidth and FM deviation is reduced (see data sheet).

HDEVIation

Provides full setting range for FM deviation. The range of modulation bandwidth is reduced (see data sheet).

*RST: NORM

Example: FM:MODE NORM
selects normal mode for external frequency modulation.

Manual operation: See "FM Mode" on page 257

[:SOURce<hw>]:FM:SENSitivity?

Queries the input sensitivity of the externally applied signal for frequency modulation. The returned value reports the sensitivity in Hz/V. It is assigned to the voltage value for full modulation of the input signal.

The sensitivity depends on the set [:SOURce<hw>]:FM[:DEVIation].

Return values:

<Sensitivity> float
Range: 0 to max
Increment: 0.01

Example: FM:DEV 5E3
sets a modulation deviation of 5 kHz.
FM:SENS
queries the input sensitivity at the external modulation input.
Response: 5E3
since the voltage value for full modulation is 1V, the resulting sensitivity is precisely 5000 Hz/V.

Usage: Query only

Manual operation: See "FM Sensitivity" on page 258

[:SOURce<hw>]:FM:SOURce <Source>

Selects the modulation signal source for frequency modulation.

You can use both, the internal and an external modulation signal at a time.

Parameters:

<Source> INTernal | EXTernal | INT,EXT

INT

Uses the internally generated signal for modulation. To configure the frequency, use the commands of the [Chapter 7.15.11](#), "SOURce:LFOutput Subsystem", on page 762 subsystem.

EXT

Uses an externally applied modulation signal.
The external signal is input at the [EXT MOD] connector.

INT,EXT

Uses both, the internal and external modulation signals.

*RST: INT

Example:

```
FM:SOUR INT
selects the internal modulation source.
```

Manual operation: See "FM Source" on page 257

[:SOURce<hw>]:FM:STATe <State>

Activates frequency modulation.

Note: Activation of FM deactivates phase modulation (PM).

Parameters:

<State> 0 | 1 | OFF | ON
*RST: 0

Example:

```
FM:STAT ON
Activates FM modulation.
```

Manual operation: See "State" on page 257

7.15.7 SOURce:FREQuency Subsystem

This subsystem contains the commands used to define the frequency settings for the RF sources and sweeps.

| | |
|--|-----|
| [:SOURce<hw>]:FREQuency:CENTer | 739 |
| [:SOURce<hw>]:FREQuency:LOSCillator:MODE | 740 |
| [:SOURce<hw>]:FREQuency:LOSCillator:OUTPut:STATe | 741 |
| [:SOURce<hw>]:FREQuency[:CW FIXed] | 741 |
| [:SOURce<hw>]:FREQuency[:CW FIXed]:RCL | 742 |
| [:SOURce<hw>]:FREQuency:MANual | 742 |
| [:SOURce<hw>]:FREQuency:MODE | 743 |
| [:SOURce<hw>]:FREQuency:MULTiplier | 744 |
| [:SOURce<hw>]:FREQuency:OFFSet | 744 |
| [:SOURce<hw>]:FREQuency:SPAN | 744 |
| [:SOURce<hw>]:FREQuency:STARt | 745 |
| [:SOURce<hw>]:FREQuency:STOP | 745 |
| [:SOURce<hw>]:FREQuency:STEP[:INCRement] | 746 |
| [:SOURce<hw>]:FREQuency:STEP:MODE | 746 |

[:SOURce<hw>]:FREQuency:CENTer <Center>

Sets the center frequency of the RF sweep range.

The range is defined by this center frequency and the specified `[:SOURce<hw>] :FREQuency:SPAN`, according to the formula:

$$f_{\text{CENTer}} - (f_{\text{SPAN}}/2) \dots f_{\text{CENTer}} + (f_{\text{SPAN}}/2)$$

with:

$$f_{\text{SPAN}} = f_{\text{STOP}} - f_{\text{START}}$$

The center frequency directly relates to the span, and the start and stop frequencies. If you change one of these parameters, the center frequency changes accordingly.

$$f_{\text{CENTer}} = (f_{\text{STOP}} + f_{\text{START}})/2$$

Note: You can select any frequency within the setting range. The range is defined with the parameters `[:SOURce<hw>] :FREQuency:START` and `[:SOURce<hw>] :FREQuency:STOP`.

A defined offset and the multiplier factor affect the sweep frequency range and therefore all correlated parameters. The set frequencies are only absolute values, if the offset = 0 and the multiplication factor = 1. The multiplier multiplies the frequencies accordingly, and the offset ≠ 0 shifts the frequencies corresponding to the set value.

$$300 \text{ kHz} * f_{\text{MULTiplier}} + f_{\text{OFFSet}} \dots f_{\text{max}} * f_{\text{MULTiplier}} + f_{\text{OFFSet}}$$

Parameters:

<Center> float
 Range: full frequency range
 Increment: see the data sheet: RF characteristics > Resolution of setting
 *RST: depends on model

Example:

```
FREQ:CENT 400 MHz
sets the center frequency for the frequency sweep to 400 MHz.
FREQ:SPAN 200 MHz
sets a span of 200 MHz. This sets the sweep range to 300 MHz
to 500 MHz.
```

Manual operation: See "[Center Freq - Frequency Sweep](#)" on page 283

`[:SOURce<hw>] :FREQuency:LOSCillator:MODE <Mode>`

Parameters:

<Mode> INTERNAL | EXTERNAL | COUPled | ECOupled

INTERNAL
 The signal of the internal local oscillator is used. This mode corresponds to a normal operation.

EXTERNAL
 An external signal is used for path A.
Note: Selection of LO Coupling "External" mode, disables all parameters in the "Frequency/Phase/Ref Osc" dialog of the selected path.

*RST: INTERNAL

Example: `FREQ:LOSC:MODE EXT`
sets the LO coupling mode to External.

Manual operation: See " [Mode - LO Coupling](#) " on page 220

[:SOURce<hw>]:FREQuency:LOSCillator:OUTPut:STATe <State>

Switches on/off the LO output.

Parameters:
<State> 0 | 1 | OFF | ON
*RST: 0

Example: `FREQ:LOSC:OUTP:STAT ON`
switches on the LO output state.

Manual operation: See " [Out State - LO Coupling](#) " on page 220

[:SOURce<hw>]:FREQuency[:CW|FIXed] <Fixed>

Sets the frequency of the RF output signal.

In CW mode, see `FREQ:MODE CW|FIXed`, the instrument operates at a fixed frequency.

In sweep mode `FREQ:MODE SWE`, the value applies to the sweep frequency and the instrument processes the frequency settings in defined sweep steps.

You can enter either a numerical frequency value, or decrease or increase the current frequency step by step with `FREQ UP` and `FREQ DOWN`. The frequency is then increased or decreased by the value `[:SOURce<hw>]:FREQuency:STEP[: INCRement]` in `FREQ:STEP:MODE USER`.

Note:

A defined offset and the multiplier factor affect the sweep range and therefore all correlated parameters. The set frequencies are only absolute values, if the offset = 0 and the multiplication factor = 1. The multiplier multiplies the frequencies accordingly, and the offset ≠ 0 shifts the frequencies corresponding to the set value.

The actual frequency at the RF output does not change, but rather the value queried with `[:SOUR]:FREQ?`, according to the formula:

$$f_{\text{FREQ}} = f_{\text{RFout}} * f_{\text{MULTIplier}} + f_{\text{OFFSet}}$$

Correlation: `FREQ` for `FREQ:MODE SWE` is linked to the sweep frequency.

Parameters:
<Fixed> float
Range: full frequency range
Increment: see the data sheet: RF characteristics > Resolution of setting
*RST: 100 MHz

Example: `FREQ 500kHz`
sets the frequency of RF output signal A to 500 kHz.

Manual operation: See "RF Freq" on page 211

[:SOURce<hw>]:FREQuency[:CW|FIXed]:RCL <Rcl>

Determines whether the RF frequency value is retained or taken from a loaded instrument configuration, when you recall instrument settings with the command `*RCL`.

Parameters:

<Rcl> INCLude | EXCLude

INCLude

Takes the frequency value of the loaded settings.

EXCLude

Retains the current frequency when an instrument configuration is loaded.

*RST: INCLude

Example: `FREQ:RCL INCL`
takes the frequency from the loaded instrument configuration.

Manual operation: See " Exclude Frequency " on page 165

[:SOURce<hw>]:FREQuency:MANual <Manual>

Determines the frequency and triggers a sweep step manually in `SWE:MODE MAN`.

Note: You can select any frequency within the setting range. The range is defined with the parameters `[:SOURce<hw>]:FREQuency:START` and `[:SOURce<hw>]:FREQuency:STOP`. A defined offset and the multiplier factor affect the sweep range and therefore all correlated parameters. The set frequencies are only absolute values, if the offset = 0 and the multiplication factor = 1. The multiplier multiplies the frequencies accordingly, and the offset ≠ 0 shifts the frequencies corresponding to the set value.

$$f_{\text{START}} * f_{\text{MULTIplier}} + f_{\text{OFFset}} \dots f_{\text{STOP}} * f_{\text{MULTIplier}} + f_{\text{OFFset}}$$

Parameters:

<Manual> float

Range: full frequency range

Increment: see the data sheet: RF characteristics > Resolution of setting

Example: `SWE:MODE MAN`
sets the Step sweep mode.

Example: `FREQ:MODE SWE`
sets the frequency sweep mode. The sweep start frequency is output.

`FREQ:MAN UP`
triggers the next higher sweep step.

`FREQ:MAN 500MHz`
outputs 500 MHz RF frequency (must e within the sweep frequency range).

`FREQ:MAN DOWN`
triggers the next lower sweep step relative to 500 MHz.

Manual operation: See " [Current Freq - Frequency Sweep](#) " on page 283

[:SOURce<hw>] : FREQuency : MODE <Mode>

Selects the frequency mode for the generating the RF output signal. The selected mode determines the parameters to be used for further frequency settings.

Parameters:

<Mode>

CW | FIXed | SWEep | LIST

CW|FIXed

Sets the fixed frequency mode.

CW and FIXed are synonyms. The instrument operates at a defined frequency, set with command [:SOURce<hw>] :

[FREQuency \[:CW | FIXed \]](#).

SWEep

Sets the sweep mode. The instrument processes the frequency settings in defined sweep steps. To determine the corresponding frequency values, use the commands [:SOURce<hw>] :

[FREQuency : START](#) and [:SOURce<hw>] : [FREQuency : STOP](#),

or [:SOURce<hw>] : [FREQuency : CENTER](#) and [:

[SOURce<hw> \] : FREQuency : SPAN](#) and [:SOURce<hw>] :

[FREQuency : MANual](#).

LIST

Sets the list mode. The instrument processes the frequency and level settings by means of values loaded from a list.

To configure the list mode settings use the commands of the

[SOURce:LIST Subsystem](#)

*RST: CW

Example: `FREQ:MODE SWE`
sets the SWEep mode.

Example: `FREQ:MODE CW`
turns off the SWEep or LIST mode.

Manual operation: See " [State - Frequency Sweep](#) " on page 280

[[:SOURce<hw>]:FREQUENCY:MULTIPLIER <Multiplier>

Sets the value for the multiplication factor of a subsequent downstream instrument.

Parameters:

<Multiplier> float
 Range: 1 to dynamic
 Increment: 0.001
 *RST: 1

Example:

FREQ:MULT 1
 sets the multiplication factor to 1.

Manual operation: See "Multiplier" on page 213

[[:SOURce<hw>]:FREQUENCY:OFFSET <Offset>

Sets the frequency offset of a downstream instrument, for example a mixer.

If you have specified an OFFSet and / or a MULTiplier factor, the actual frequency at the RF output does not change, but rather the value queried with [[:SOUR]:FREQ?], according to the following formula:

$$f_{\text{FREQ}} = f_{\text{RFout}} * f_{\text{MULTiplier}} + f_{\text{OFFSet}}$$

Parameters:

<Offset> float
 Increment: 0.01
 *RST: 0

Example:

FREQ:OFFS 500kHz
 sets the frequency offset to 500 kHz.

Manual operation: See "Offset" on page 212

**[[:SOURce<hw>]:FREQUENCY:SPAN **

Determines the extent of the frequency sweep range. This setting in combination with the center frequency setting ([[:SOURce<hw>]:FREQUENCY:CENTer]) defines the sweep range.

This parameter is related to the start and stop frequencies. If you change the frequency, the span changes accordingly.

$$f_{\text{SPAN}} = f_{\text{STOP}} - f_{\text{START}}$$

$f_{\text{START}} > f_{\text{STOP}}$ is permitted.

Parameters:

 float
 Range: full frequency range
 Increment: see the data sheet: RF characteristics > Resolution of setting
 *RST: 400E6

Example: FREQ:CENT 400 MHz
sets the center frequency of the frequency sweep to 400 MHz.
FREQ:SPAN 200 MHz
sets a span of 200 MHz. This sets the sweep range to 300 MHz
to 500 MHz.

Manual operation: See "[Span - Frequency Sweep](#)" on page 283

[SOURce<hw>]:FREQuency:STARt <Start>

Sets the start frequency for the RF sweep.

This parameter relates to the center frequency and span. If you change the frequency, these parameters change accordingly.

$f_{\text{START}} > f_{\text{STOP}}$ is permitted.

$$f_{\text{START}} = (f_{\text{CENTer}} - f_{\text{SPAN}/2}).$$

Note: A defined offset and the multiplier factor affect the sweep range and therefore all correlated parameters. The set frequencies are only absolute values, if the offset = 0 and the multiplication factor = 1. The multiplier multiplies the frequencies accordingly, and the offset $\neq 0$ shifts the frequencies corresponding to the set value.

$$f_{\text{START}} * f_{\text{MULTIplier}} + f_{\text{OFFset}} \dots f_{\text{STOP}} * f_{\text{MULTIplier}} + f_{\text{OFFset}}$$

Parameters:

| | |
|------------|--|
| <Start> | float |
| Range: | full frequency range |
| Increment: | see the data sheet: RF characteristics > Resolution of setting |
| *RST: | 100 MHz |

Example: FREQ:STARt 1 MHz
sets the start frequency for the frequency sweep to 1 MHz.
FREQ:STOP 2 GHz
sets the stop frequency for the frequency sweep to 2 GHz.

Manual operation: See "[Start Freq - Frequency Sweep](#)" on page 283

[SOURce<hw>]:FREQuency:STOP <Stop>

Sets the stop frequency for the RF sweep.

This parameter is related to the center frequency and span. If you change the frequency, these parameters change accordingly.

$f_{\text{START}} > f_{\text{STOP}}$ is permitted.

$$f_{\text{STOP}} = (f_{\text{CENTer}} + f_{\text{SPAN}/2}).$$

Note: A defined offset affects the sweep range and consequently all correlating parameters. The set frequencies are only absolute values, if the Offset = 0. Offset $\neq 0$ shifts the frequencies according to the offset value.

$$f_{\text{START}} * f_{\text{MULTIplier}} + f_{\text{OFFSet}} \dots f_{\text{STOP}} * f_{\text{MULTIplier}} + f_{\text{OFFSet}}$$

Parameters:

<Stop> float
 Range: full frequency range
 Increment: see the data sheet: RF characteristics > Resolution of setting
 *RST: 500 MHz

Example:

FREQ:STOP 2 GHz
 sets the stop frequency for the frequency sweep to 2 GHz.
 FREQ:STAR 1 MHz
 sets the start frequency for the frequency sweep to 1 MHz.

Manual operation: See "[Stop Freq - Frequency Sweep](#)" on page 283

[:SOURce<hw>]:FREQUENCY:STEP[:INCREMENT] <Increment>

Sets the step width for [FREQ:STEP:MODE USER](#).

To adjust the frequency step by step with this step size, use the [FREQ:UP](#) and [FREQ:DOWN](#) commands.

Note: This value also applies to the step width of the rotary knob of the instrument and increases or decreases the frequency accordingly, when you work in user-defined step mode.

Parameters:

<Increment> float
 Range: full frequency range
 Increment: see the data sheet: RF characteristics > Resolution of setting
 *RST: 1E6

Example:

FREQ:STEP 50 kHz
 sets the step width for the frequency setting to 50 kHz.

Manual operation: See "[Variation Step](#)" on page 213

[:SOURce<hw>]:FREQUENCY:STEP:MODE <Mode>

Activates ([USER](#)) or deactivates ([DECimal](#)) the user-defined step width used when varying the frequency value with the frequency values [UP/DOWN](#). The command is linked to the command "Variation Active" for manual control, i.e. the command also activates/deactivates the user-defined step width used when varying the frequency value with the rotary knob.

Parameters:

<Mode> DECimal | USER
 *RST: DECimal

Example: FREQ:STEP 50 kHz
sets the step width for the frequency setting to 50 kHz.
FREQ:STEP:MODE USER
activates this step width for frequency variation with the rotary knob (manual control) and with frequency values UP/DOWN (remote control).

Manual operation: See "[Variation Active](#)" on page 213

7.15.8 SOURce:INPut Subsystem

The SOURce:INPut subsystem contains the commands for configuring the inputs for trigger, data and control signals. A common trigger threshold and input impedance is effective for all trigger and control signal inputs.

The settings influence the digital modulations, the generation of waveforms or multicarrier signals, and all digital standards. Irrespective of this, a common threshold and input impedance is effective for the serial and parallel data input (Path A only). These data sources are available for digital modulation ("Custom Digital Modulation").

| | |
|--|-----|
| [:SOURce]:INPut:CLOCK:IMPedance | 747 |
| [:SOURce<hw>]:INPut:MODext:IMPedance | 748 |
| [:SOURce]:INPut:TRIGger:BBANd:SLOPe | 748 |
| [:SOURce]:INPut:TRIGger:IMPedance | 748 |
| [:SOURce]:INPut:TRIGger:LEVel | 749 |
| [:SOURce]:INPut:TRIGger:SLOPe | 749 |
| [:SOURce]:INPut:DELay:ADCState | 749 |
| [:SOURce]:INPut:DELay:SPOSition | 750 |
| [:SOURce]:INPut:DELay:CLENgth<ch> | 750 |

[\[:SOURce\]:INPut:CLOCK:IMPedance](#) <Impedance>

Selects the input impedance for the clock inputs. 1kOhm/GND should be selected for high clock rates.

The setting affects the [CLOCK IN BNC] connector at the rear of the instrument.

Parameters:

<Impedance> G50 | G1K
G1K
1 kOhm to ground
G50
50 Ohm to ground
*RST: G1K

Example: INP:CLOC:IMP G1K
sets the clock inputs to 1 kOhm to ground.

Manual operation: See "[Impedance Clock Input](#)" on page 141

[[:SOURce<hw>]:INPut:MODext:IMPedance <Impedance>

Sets the impedance for an externally applied modulation signal.

Parameters:

<Impedance> HIGH | G600
HIGH
 > 100 kOhm to ground
G600
 600 Ohm to ground
 *RST: HIGH

Example: INP:MOD:IMP HIGH
 sets > 100 kOhm to ground.

Manual operation: See "[Ext. Impedance](#)" on page 255

[[:SOURce]:INPut:TRIGger:BBANd:SLOPe <Slope>

Sets the active slope of an externally applied trigger signal at the [TRIGGER] connectors. The setting is effective for both connectors at the same time.

Parameters:

<Slope> NEGative | POSitive
 *RST: POSitive

Example: INP:TRIG:BBAN:SLOP NEG
 activates the falling slope of the external trigger signal at the TRIGGER connectors.

Manual operation: See "[Baseband Trigger Input Slope](#)" on page 141

[[:SOURce]:INPut:TRIGger:IMPedance <Impedance>

The command sets the impedance of the trigger and control signal inputs and affects:

- [TRIGGER] inputs
- [CLOCK] inputs

Parameters:

<Impedance> G50 | G1K
G1K
 1 kOhm to ground
G50
 50 Ohm to ground
 *RST: G1K

Example: INP:TRIG:IMP G50
 all trigger and control signal inputs are set to 50 ohm to ground. This setting is recommended in the case of high clock rates.

Manual operation: See "[Impedance Trigger Input](#)" on page 141

[[:SOURce]:INPut:TRIGger:LEVel <Level>

Sets the high/low threshold of the trigger and control signal inputs in the baseband section. In the case of positive polarity, this threshold determines the point as of which a signal is high (active) or low (inactive).

The command affects:

- [TRIGGER] inputs
- [CLOCK] inputs

Parameters:

<Level> float
 Range: 0.01 to 2
 Increment: 0.01
 *RST: 1
 Default unit: V

Example:

```
INP:TRIG:LEV 1 V
```

a high/low threshold of 1 volt is set at all trigger and control signal inputs of the baseband section. In the case of positive polarity, the signal is high (active) for a signal voltage of 1 volt and higher.

Manual operation: See "[Threshold Trigger/Clock Input](#)" on page 140

[[:SOURce]:INPut:TRIGger:SLOPe <Slope>

Sets the polarity of the active slope of an externally applied trigger signal at the trigger input (BNC connector at the rear of the instrument).

Parameters:

<Slope> NEGative | POSitive
 *RST: POSitive

Example:

```
INP:TRIG:SLOP NEG
```

Activates the falling slope of the external trigger signal at the trigger input.

Manual operation: See "[Ext. Trigger Input Slope](#)" on page 141

[[:SOURce]:INPut:DELay:ADCState <State>

Enables/disables the automatic delay compensation.

Parameters:

<State> 0 | 1 | OFF | ON
 *RST: 1

Example:

see example for `[[:SOURce]:INPut:DELay:CLENgth<ch>` on page 750

Manual operation: See "[Automatic Delay Compensation](#)" on page 141

[[:SOURce]:INPut:DElay:SPOsition <Position>

Defines the position of the slave instrument in the daisy chain. The slave directly connected to the master instrument is the one with number 1.

Parameters:

<Position> integer
 Range: 1 to 10
 *RST: 1

Example: see example for `[[:SOURce]:INPut:DElay:CLEngth<ch>` on page 750

Manual operation: See ["Automatic Delay Compensation"](#) on page 141

[[:SOURce]:INPut:DElay:CLEngth<ch> <CableLength>

Sets the total length of the cable used to connect the [CLK OUT] and [CLK IN] connectors. For the first slave in the chain, the value represents the cable length between the master and the first slave; for the second slave, the cable length to the first **and** to the second has to be defined, etc.

Parameters:

<CableLength> float
 Range: 0 to 10
 Increment: 0.01
 *RST: 0.5

Example: Setting in the first slave instrument Slave#1:
`:SOURce:INPut:DElay:SPOsition 1`
`:SOURce:INPut:DElay:CLEngth1 1`
`:SOURce:INPut:DElay:ADCState ON`

Example: Setting in the second slave instrument Slave#2:
`:SOURce:INPut:DElay:SPOsition 2`
`:SOURce:INPut:DElay:CLEngth1 1`
`:SOURce:INPut:DElay:CLEngth2 0.5`
`:SOURce:INPut:DElay:ADCState ON`

Manual operation: See ["Automatic Delay Compensation"](#) on page 141

7.15.9 SOURce:IQ Subsystem

This subsystem contains the commands for checking the I/Q modulation.

| | |
|---|-----|
| <code>[[:SOURce<hw>]:IQ:CREStfactor</code> | 751 |
| <code>[[:SOURce<hw>]:IQ:IMPairment:IQRatio[:MAGNitude]</code> | 751 |
| <code>[[:SOURce<hw>]:IQ:IMPairment:LEAKage:I</code> | 751 |
| <code>[[:SOURce<hw>]:IQ:IMPairment:LEAKage:Q</code> | 752 |
| <code>[[:SOURce<hw>]:IQ:IMPairment:QUADrature[:ANGLE]</code> | 752 |
| <code>[[:SOURce<hw>]:IQ:IMPairment[:STATE]</code> | 752 |
| <code>[[:SOURce<hw>]:IQ:SOURce</code> | 752 |

| | |
|--|-----|
| [:SOURce<hw>]:IQ:STATe..... | 753 |
| [:SOURce<hw>]:IQ:SWAP[:STATe]..... | 753 |
| [:SOURce<hw>]:IQ:WBSTate..... | 753 |

[:SOURce<hw>]:IQ:CREStfactor <CrestFactor>

Sets the crest factor of the external analog signal.

Parameters:

<CrestFactor> float
 Range: 0 to 35
 Increment: 0.01
 *RST: 0
 Default unit: dB

Example: IQ:CRESt 10
 specifies a crest factor of 10 dB for the external analog signal.

Manual operation: See "[Crest Factor - I/Q Mod](#)" on page 305

[:SOURce<hw>]:IQ:IMPairment:IQRatio[:MAGNitude] <Magnitude>

This command sets the ratio of I modulation to Q modulation (amplification "imbalance").

Parameters:

<Magnitude> float
 Range: -1.0dB to +1.0dB
 Increment: 0.005dB
 *RST: 0
 Default unit: 0dB

Example: IQ:IMP:IQR 0.5 dB
 sets the imbalance.

Manual operation: See "[Gain Imbalance - I/Q Mod](#)" on page 303

[:SOURce<hw>]:IQ:IMPairment:LEAKage:I <I>

Sets the carrier offset for the I-channel of the I/Q modulation.

Parameters:

<I> float
 Range: -10 to 10
 Increment: 0.01
 *RST: 0
 Default unit: PCT

Example: IQ:IMP:LEAK:I 3 PCT
 sets the leakage for the I-channel to 3 percent.

Manual operation: See "[Offset - I/Q Mod](#)" on page 303

[[:SOURce<hw>]:IQ:IMPAirment:LEAKage:Q <Q>

Sets the carrier leakage amplitude for the Q-channel of the I/Q modulation.

Parameters:

| | |
|-----|-------------------|
| <Q> | float |
| | Range: -10 to 10 |
| | Increment: 0.01 |
| | *RST: 0 |
| | Default unit: PCT |

Example: IQ:IMP:LEAK:Q 3 PCT
sets the leakage for the Q-channel to 3 percent.

Manual operation: See ["Offset - I/Q Mod"](#) on page 303

[[:SOURce<hw>]:IQ:IMPAirment:QUADrature[:ANGLE] <Angle>

Sets the quadrature offset for the I/Q modulation.

Parameters:

| | |
|---------|-------------------|
| <Angle> | float |
| | Range: -10 to 10 |
| | Increment: 0.01 |
| | *RST: 0 |
| | Default unit: DEG |

Example: IQ:IMP:QUAD:ANGL -5DEG
sets the quadrature offset to -5 degrees.

Manual operation: See ["Quadrature Offset - I/Q Mod"](#) on page 303

[[:SOURce<hw>]:IQ:IMPAirment[:STATe] <State>

Activates/deactivates the three impairment or correction values LEAKage, QUADrature and IQRatio for the analog signal in the I/Q modulator.

Parameters:

| | |
|---------|------------------|
| <State> | 0 1 OFF ON |
| | *RST: 0 |

Example: IQ:IMP OFF
deactivates I/Q impairment.

Manual operation: See ["State - Impairments I/Q Mod"](#) on page 303

[[:SOURce<hw>]:IQ:SOURce <Source>

Selects the input signal for the I/Q modulator.

Selecting ANALog (Wideband I/Q In) switches off:

- SOURce:AM:STATe OFF

- SOURce:BBAM:STATe OFF
- SOURce:BB:DM:STATe OFF
- SOURce:BB:<Dig. Standard>:STATe OFF

Parameters:

<Source> BASeband | ANALog | DIFFerential

Example:

IQ:SOUR ANAL

selects an external analog signal as the input signal. The signal must be applied at the inputs I and Q.

Manual operation: See "[IQ Source - I/Q Mod](#)" on page 302

[:SOURce<hw>]:IQ:STATe <State>

Activates I/Q modulation.

Parameters:

<State> 0 | 1 | OFF | ON

*RST: 0

Example:

IQ:STAT ON

activates I/Q modulation.

Manual operation: See "[State - I/Q Mod](#)" on page 302

[:SOURce<hw>]:IQ:SWAP[:STATe] <State>

When set to ON, this command swaps the I and Q channel.

Parameters:

<State> 0 | 1 | OFF | ON

*RST: 0

Example:

IQ:SWAP ON

swaps the I and Q channel.

Manual operation: See "[I/Q-Swap - I/Q Mod](#)" on page 304

[:SOURce<hw>]:IQ:WBSTate <WbState>

Selects optimized setting for wideband modulation signals (>5 MHz) (State ON).

Parameters:

<WbState> 0 | 1 | OFF | ON

*RST: 0

Example:

IQ:WBST ON

activates optimized setting for wideband signals.

Manual operation: See "[I/Q-Wideband - I/Q Mod](#)" on page 304

7.15.10 SOURce:IQ:OUTPut Subsystem

7.15.10.1 Analog I/Q Outputs

This subsystem contains the commands for configuring the differential output.

For information about the required options, see [Chapter 5.7.3.2, "Analog I/Q Output"](#), on page 319.

| | |
|---|-----|
| <code>[:SOURce<hw>]:IQ:OUTPut[:ANALog]:BIAS:COUPling[:STATe]</code> | 754 |
| <code>[:SOURce<hw>]:IQ:OUTPut[:ANALog]:BIAS:I</code> | 754 |
| <code>[:SOURce<hw>]:IQ:OUTPut[:ANALog]:BIAS:Q</code> | 754 |
| <code>[:SOURce<hw>]:IQ:OUTPut[:ANALog]:OFFSet:I</code> | 755 |
| <code>[:SOURce<hw>]:IQ:OUTPut[:ANALog]:OFFSet:Q</code> | 755 |
| <code>[:SOURce<hw>]:IQ:OUTPut[:ANALog]:BIAS:OPTimization[:RF]:STATe</code> | 755 |
| <code>[:SOURce<hw>]:IQ:OUTPut:LEVel</code> | 755 |
| <code>[:SOURce<hw>]:IQ:OUTPut[:ANALog]:POWer:PEP:RESult?</code> | 756 |
| <code>[:SOURce<hw>]:IQ:OUTPut[:ANALog]:MODE</code> | 756 |
| <code>[:SOURce<hw>]:IQ:OUTPut[:ANALog]:POWer:DATTenuation</code> | 757 |
| <code>[:SOURce<hw>]:IQ:OUTPut[:ANALog]:TYPE</code> | 757 |

`[:SOURce<hw>]:IQ:OUTPut[:ANALog]:BIAS:COUPling[:STATe] <State>`

Couples the bias setting of the I and Q signal components.

If coupling is activated, settings made for the I-signal component (`[:SOURce<hw>]:IQ:OUTPut[:ANALog]:BIAS:I`) automatically applies to the Q-signal (`[:SOURce<hw>]:IQ:OUTPut[:ANALog]:BIAS:Q`)

Parameters:

`<State>` 0 | 1 | OFF | ON
 *RST: 0

Example:

`IQ:OUTP:BIAS:ANAL:COUP ON`
 activates I/Q bias coupling.

Manual operation: See "[Couple IQ Bias](#)" on page 321

`[:SOURce<hw>]:IQ:OUTPut[:ANALog]:BIAS:I <I>` `[:SOURce<hw>]:IQ:OUTPut[:ANALog]:BIAS:Q <Q>`

Specifies the amplifier bias of the respective I/Q- component.

Parameters:

`<Q>` float
 Range: -4 to 4
 Increment: 1E-4
 *RST: 0

Example:

`IQ:OUTP:ANAL:BIAS:Q 0.1 V`
 sets a bias of 100 mV for the Q-signal.

Manual operation: See ["Bias \(EMF\)"](#) on page 321

```
[:SOURce<hw>]:IQ:OUTPut[:ANALog]:OFFSet:I <I>
[:SOURce<hw>]:IQ:OUTPut[:ANALog]:OFFSet:Q <Q>
```

Valid only for output type Differential (IQ:OUTP:ANAL:TYPE DIFF).

Sets an offset between the inverting and non-inverting output.

Parameters:

```
<Q> float
Range: -4 to 4
Increment: 1E-4
*RST: 0
```

Example: IQ:OUTP:ANAL:TYPE DIFF
the I/Q-signal components are output differential
:IQ:OUTP:ANAL:OFFS:Q 0.05 V
sets an offset of 50 mV for the I-signal.

Manual operation: See ["Offset \(EMF\)"](#) on page 322

```
[:SOURce<hw>]:IQ:OUTPut[:ANALog]:BIAS:OPTimization[:RF]:STATe <State>
```

Activates/deactivates optimization of level accuracy and imbalance for RF Output. Level accuracy and imbalance can be either optimized for RF output (active) or for differential outputs (not active).

Parameters:

```
<State> 0 | 1 | OFF | ON
*RST: 1
```

Example: IQ:OUTP:ANAL:BIAS:OPT:STAT ON
activates optimization for RF output.

Manual operation: See ["Optimize I/Q Signals for RF Output"](#) on page 320

```
[:SOURce<hw>]:IQ:OUTPut:LEVel <Level>
```

Sets the off-load voltage.

Single ended Output:

- Value range: 1 mV ... 1.5 V EMF.

Differential Output:

- Value range: 2 mV ... 3 V EMF.

Parameters:

<Level> float
 Range: 0.02 to 4
 Increment: 1E-4
 *RST: 1
 Default unit: V

Example:

SOURce1:IQ:OUTPut:LEVel 2
 sets a off-load level of 2 V

Manual operation: See "[I/Q Level Vp \(EMF\)](#)" on page 321

[:SOURce<hw>] : IQ : OUTPut [: ANALog] : POWer : PEP : RESult ?

Displays the resulting output off-load voltage of both signal components at the rear panel.

Return values:

<Result> float
 Range: 0.02 to 4
 Increment: 0.001
 *RST: 1

Usage: Query only

[:SOURce<hw>] : IQ : OUTPut [: ANALog] : MODE <Mode>

Selects the mode for setting the outputs.

Selection **FIXed** locks all IQ:OUTPut-commands except for IQ:OUTPut:TYPE and sets them to predefined values (*RST).

Parameters:

<Mode> **FIXed** | **VARi**able | **VATTenuated**

FIXed

The settings are fixed and cannot be changed.

VARiable

The settings can be changed (command `[:SOURce<hw>] : IQ : OUTPut : LEVel` on page 755).

VATTenuated

Enables a precise digital attenuation of the signal. The level of the baseband and the RF signal is attenuated by the value set with the command `[:SOURce<hw>] : IQ : OUTPut [: ANALog] : POWer : DATTenuation`.

*RST: **FIXed**

Manual operation: See "[Mode](#)" on page 320

[[:SOURce<hw>]:IQ:OUTPut[:ANALog]:POWer:DATTenuation <DAttenuation>

The level of the baseband and the RF signal is attenuated by this value.

Parameters:

<DAttenuation> float
 Range: -3.522 to 80
 Increment: 1E-3
 *RST: 0

Example:

```
SOUR:IQ:OUTP:ANAL:MODE VATT
SOUR:IQ:OUTP:ANAL:POW:DATT 10dB
```

The level of the baseband and RF signal is attenuated with 10dB.

Manual operation: See ["Digital Attenuation"](#) on page 321

[[:SOURce<hw>]:IQ:OUTPut[:ANALog]:TYPE <Type>

Selects an input type.

Parameters:

<Type> SINGLE | DIFFerential
SINGLE
 The I/Q-signal components are output single-ended.
DIFFerential
 The I/Q-signal components are output differential.
 *RST: SINGLE

Example:

```
IQ:OUTP:ANAL:TYPE DIFF
```

the I/Q-signal components are output differential.

Manual operation: See ["I/Q Output Type"](#) on page 320

7.15.10.2 Digital I/Q Outputs

This subsystem contains the commands for configuring the digital I/Q output. The digital signal can be output with the aid of a standardized (LVDS) digital user interface.

For information about the required options, see [Chapter 5.8, "Digital I/Q Output Settings"](#), on page 323.

| | |
|--|-----|
| [[:SOURce<hw>]:IQ:OUTPut:DIGital:CDEvice?..... | 758 |
| [[:SOURce]:IQ:OUTPut:DIGital:OFLow:HOLD:RESet..... | 758 |
| [[:SOURce]:IQ:OUTPut:DIGital:OFLow:HOLD:STATe?..... | 758 |
| [[:SOURce]:IQ:OUTPut:DIGital:OFLow:STATe?..... | 758 |
| [[:SOURce<hw>]:IQ:OUTPut:DIGital:PON..... | 759 |
| [[:SOURce<hw>]:IQ:OUTPut:DIGital:POWer:LEVel..... | 759 |
| [[:SOURce<hw>]:IQ:OUTPut:DIGital:POWer:PEP..... | 759 |
| [[:SOURce<hw>]:IQ:OUTPut:DIGital:POWer:STEP[:INCRement]..... | 760 |
| [[:SOURce<hw>]:IQ:OUTPut:DIGital:POWer:STEP:MODE..... | 760 |
| [[:SOURce<hw>]:IQ:OUTPut:POWer:VIA..... | 760 |

| | |
|---|-----|
| <code>[:SOURce<hw>]:IQ:OUTPut:DIGital:SRATe.....</code> | 761 |
| <code>[:SOURce<hw>]:IQ:OUTPut:DIGital:SRATe:SOURce.....</code> | 761 |
| <code>[:SOURce<hw>]:IQ:OUTPut:DIGital:STATe.....</code> | 762 |

`[:SOURce<hw>]:IQ:OUTPut:DIGital:CDEVIce?`

Queries the ID of a connected Rohde&Schwarz instrument.

Return values:

<CDevice> string

Example: `IQ:OUTP:DIG:CDEV?`
queries the connected device ID.

Usage: Query only

Manual operation: See "[Connected Device - Digital I/Q Out](#)" on page 326

`[:SOURce]:IQ:OUTPut:DIGital:OFLow:HOLD:RESet`

Resets the overflow hold state and LED.

Example: `SOUR:IQ:OUTP:DIG:OFL:HOLD:RESet`
resets the overflow hold state.

Usage: Event

Manual operation: See "[Reset - Digital I/Q Out](#)" on page 326

`[:SOURce]:IQ:OUTPut:DIGital:OFLow:HOLD:STATe?`

Queries an overflow since the last reset.

To reset the overflow hold state, use one of the following:

- send the command `[:SOURce]:IQ:OUTPut:DIGital:OFLow:HOLD:RESet`
- start a new signal generation
- set a new output level

Return values:

<State> 0 | 1 | OFF | ON
*RST: 0

Example: `SOUR:IQ:OUTP:DIG:OFL:HOLD:STAT?`
Response: "0" (no overflow)

Usage: Query only

Manual operation: See "[Overflow Hold - Digital I/Q Out](#)" on page 325

`[:SOURce]:IQ:OUTPut:DIGital:OFLow:STATe?`

Queries the current overflow state of the output signal and indicates that the I/Q output signal is currently clipped.

Return values:

<State> 0 | 1 | OFF | ON
 *RST: 0

Example:

`IQ:OUTP:DIG:OFL:STAT?`
 queries the overflow state.
 Response: "0" (no overflow).

Usage:

Query only

Manual operation: See "[Overflow - Digital I/Q Out](#)" on page 325

[[:SOURce<hw>]:IQ:OUTPut:DIGital:PON <Pon>

Selects the state which the digital I/Q Output is to assume after the instrument is switched on.

Parameters:

<Pon> OFF | UNCHanged
 *RST: OFF

Example:

`SOURce:IQ:OUTPut:DIGital:PON OFF`
 deactivates the output when the instrument is switched on.

Manual operation: See "[Power-On State - Digital I/Q Out](#)" on page 326

[[:SOURce<hw>]:IQ:OUTPut:DIGital:POWER:LEVel <Level>

Sets the rms level of the digital output signal.

Parameters:

<Level> float
 Range: -80 to 0
 Increment: 0.01
 *RST: 0
 Default unit: dBFS

Example:

`IQ:OUTP:DIG:POW:LEV -10`
 sets the output signal level to -10 dBFS.

Manual operation: See "[Level - Digital I/Q Out](#)" on page 324

[[:SOURce<hw>]:IQ:OUTPut:DIGital:POWER:PEP <Pep>

Sets the peak envelope power of the digital output signal (PEP).

Parameters:

<Pep> float
 Range: -80 to 0
 Increment: 0.01
 *RST: 0
 Default unit: dBFS

Example: `IQ:OUTP:DIG:POW:PEP -10`
Sets the signal output level to -10 dBFS.

Manual operation: See "[Peak Level - Digital I/Q Out](#)" on page 324

[[:SOURce<hw>]:IQ:OUTPut:DIGital:POWER:STEP[:INCRement] <Increment>

Sets the step width for the frequency setting if the frequency values UP/DOWN are used and variation mode `SOUR:IQ:OUTP:DIG:POW:STEP:MODE USER` is selected. The command is linked to "Variation Step" for manual operation, i.e. the command also sets the step width of the rotary knob for "Variation Active ON".

Parameters:

<Increment> float
Range: 0 to 100
Increment: 0.01
*RST: 1
Default unit: dB

Example: `SOUR:IQ:OUTP:ANAL:POW:STEP:INCR 50 mV`
sets the step width for the level setting to 50 mV.

Manual operation: See "[Variation Step - Digital I/Q Out](#)" on page 325

[[:SOURce<hw>]:IQ:OUTPut:DIGital:POWER:STEP:MODE <Mode>

Activates (USER) or deactivates (DECimal) the user-defined step width used when varying the level value with the level values UP/DOWN. The command is linked to setting "Variation Active" for manual operation, i.e. the command also activates/deactivates the user-defined step width used when varying the level value with the rotary knob.

Parameters:

<Mode> DECimal | USER
*RST: DECimal

Example: `IQ:OUTP:DIG:POW:STEP:MODE USER`
activates the step width for level variation with the rotary knob (manual operation) and with level values UP/DOWN (remote control).

Manual operation: See "[Variation Active - Digital I/Q Out](#)" on page 325

[[:SOURce<hw>]:IQ:OUTPut:POWER:VIA <Via>

Activates the selected I/Q output level entry fields of the currently selected signal path in the status bar.

Parameters:

<Via> PEP | LEVei

PEP

The signal level is expressed in terms of a peak envelope power value (PEP). The level entry fields and the corresponding units are displayed in the status bar.

LEVel

The signal level is expressed in terms of a rms value. The level entry field and the corresponding units are displayed in the status bar.

*RST: PEP

Example:

`IQ:OUTP:POW:VIA PEP`

the I/Q-signal level is set via PEP for the signal of path A.

Manual operation: See "[Set Level Via](#)" on page 324

[:SOURce<hw>]:IQ:OUTPut:DIGital:SRATe <SRate>

Using the sample rate source User, the command sets the sample rate value of the output signal. This command is not active for external clock sources

Parameters:

<SRate> float
 Range: 400 to max
 Increment: 0.001
 *RST: 1E8

Example:

`IQ:OUTP:DIG:SRAT:MODE USER`

with sample rate source User the internally generated clock reference signal is selected.

`IQ:OUTP:DIG:SRAT 100 MHz`

the sample rate for the output signal is set to 100 MHz.

Manual operation: See "[Sample Rate Value - Digital I/Q Output](#)" on page 324

[:SOURce<hw>]:IQ:OUTPut:DIGital:SRATe:SOURce <Source>

Selects the source for setting the sample rate of the digital I/Q output signal.

Note: With a connected R&S EX-IQ-Box either the internal clock source (User defined) or an external clock (Digital I/Q In) can be selected in the settings dialog of the R&S EX-IQ-Box. Therefore, the sample rate source is only indicated in this field.

Parameters:

<Source> USER | DIN | DOUT | USER | DOUT

USER

The internally generated clock reference signal is used. The sample rate is calculated and displayed in the field "Value".

DOUT

An external clock reference signal is used. The clock signal is directly fed in via pin CLK2 of the digital output interface (option R&S SMBV-B18, Digital I/Q Out). The sample rate is displayed in the field "Value".

```
*RST:      USER
```

Example: `IQ:OUTP:DIG:SRAT:SOUR USER`
the internally generated clock reference signal is selected.

Manual operation: See ["Sample Rate Source - Digital I/Q Output"](#) on page 323

```
[:SOURce<hw>]:IQ:OUTPut:DIGital:STATe <State>
```

Switches on and off the digital I/Q output signals.

Parameters:

```
<State>      0 | 1 | OFF | ON
*RST:        0
```

Example: `IQ:OUTP:DIG:STAT ON`
the digital I/Q output signals of path A are activated.

Manual operation: See ["State - Digital I/Q Output"](#) on page 323

7.15.11 SOURce:LFOutput Subsystem

The `SOURce:LFOutput` subsystem contains the commands for setting the LF signal source in CW and Sweep mode and for analog modulation.

Example

The following example shows how to set an LF sweep.

1. Set the sweep range.
`LFOutput:FREQuency:START 4 kHz`
`LFOutput:FREQuency:STOP 10 kHz`
2. Select linear or logarithmic sweep spacing.
`LFOutput:SWEep[:FREQuency]:SPACing LIN`
3. Set the step width and dwell time.
`LFOutput:SWEep[:FREQuency]:STEP[:LINear] 100 Hz`
`LFOutput:SWEep[:FREQuency]:DWELL 20 ms`
4. Determine the sweep mode.
`LFOutput:SWEep:MODE AUTO`
5. Determine the trigger.
`TRIGger0:SOURce SINGLE`
6. Activate the sweep.

LFOutput:FREQUENCY:MODE SWEep

7. Trigger the sweep (depending on the mode).

LFOutput:SWEep:EXECute

| | |
|---|-----|
| [SOURce]:LFOutput:FREQUENCY..... | 763 |
| [SOURce<hw>]:LFOutput:FREQUENCY:MANual..... | 763 |
| [SOURce<hw>]:LFOutput:FREQUENCY:MODE..... | 764 |
| [SOURce<hw>]:LFOutput:FREQUENCY:START..... | 765 |
| [SOURce<hw>]:LFOutput:FREQUENCY:STOP..... | 765 |
| [SOURce]:LFOutput[:STATe]..... | 765 |
| [SOURce<hw>]:LFOutput:SWEep[:FREQUENCY]:DWEll..... | 766 |
| [SOURce<hw>]:LFOutput:SWEep[:FREQUENCY]:EXECute..... | 766 |
| [SOURce<hw>]:LFOutput:SWEep[:FREQUENCY]:MODE..... | 766 |
| [SOURce<hw>]:LFOutput:SWEep[:FREQUENCY]:POINts..... | 767 |
| [SOURce<hw>]:LFOutput:SWEep[:FREQUENCY]:RETRace..... | 768 |
| [SOURce<hw>]:LFOutput:SWEep[:FREQUENCY]:RUNNING?..... | 768 |
| [SOURce<hw>]:LFOutput:SWEep[:FREQUENCY]:SHAPE..... | 769 |
| [SOURce<hw>]:LFOutput:SWEep[:FREQUENCY]:SPACing..... | 769 |
| [SOURce<hw>]:LFOutput:SWEep[:FREQUENCY]:STEP[:LINear]..... | 769 |
| [SOURce<hw>]:LFOutput:SWEep[:FREQUENCY]:STEP:LOGarithmic..... | 770 |
| [SOURce]:LFOutput:SHAPE..... | 771 |
| [SOURce]:LFOutput:SIMPedance..... | 771 |
| [SOURce]:LFOutput:VOLTage..... | 772 |

[SOURce]:LFOutput:FREQUENCY <Frequency>

Sets the frequency of the LF signal in `LFO:FREQ:MODE CW|FIXed` mode.

Note:

- If signal Source "Internal" is set, the instrument performs the analog modulations (AM/FM/φM/PM) with this frequency.
- In sweep mode (`LFO:FREQ:MODE SWEep`), the frequency is coupled with the sweep frequency.

Parameters:

| | |
|-------------|--|
| <Frequency> | float |
| Range: | full frequency range |
| Increment: | see the data sheet: Modulation sources > Resolution of frequency setting |
| *RST: | 1E3 |

Example:

`LFO:FREQ 5kHz`
sets the frequency of the LF signal to 5 kHz

Manual operation: See "LF Gen Freq" on page 254

[SOURce<hw>]:LFOutput:FREQUENCY:MANual <Manual>

Determines the frequency and triggers the next sweep step manually in `LFO:SWE[:FREQ]:MODE MAN`, and `LFO:SWE[:FREQ]:MODE STEP`.

Note: You can select any frequency within the setting range. The range is defined with `LFO:FREQ:START` and `LFO:FREQ:STOP`.

Parameters:

<Manual> float
 Range: full frequency range
 Increment: see the data sheet: Modulation sources > Internal modulation generator > Resolution of frequency setting
 *RST: 1000

Example:

```
LFO:SWE:MODE MAN
sets the "Step" sweep mode.
LFO:FREQ:MAN 5 kHz
sets an LF frequency of 5 kHz for the next step in the "Step"
sweep mode.
LFO:FREQ:MODE SWE
sets the LF Sweep mode. An LF frequency of 5 kHz is output.
LFO:FREQ:MAN 5.1 kHz
triggers the next sweep step with a frequency of 5.1 kHz.
```

Manual operation: See " [Current Freq](#) " on page 270

[[:SOURce<hw>]:LFOOutput:FREQuency:MODE <Mode>

Sets the instrument operating mode, and determines the commands to be used for frequency settings.

Parameters:

<Mode> CW | FIXed | SWEep
CW|FIXed
 Sets the CW frequency mode. `CW` and `FIXed` are synonyms. The instrument operates at a fixed frequency. To set the LF output frequency use the command `[[:SOURce]:LFOOutput:FREQuency`.
SWEep
 Sets the sweep mode. The instrument processes the frequency settings in defined sweep steps. To determine the corresponding frequency values, use the commands `[[:SOURce<hw>]:LFOOutput:FREQuency:START`, `[[:SOURce<hw>]:LFOOutput:FREQuency:STOP` or `[[:SOURce<hw>]:LFOOutput:FREQuency:MANual`.
 *RST: CW

Example:

```
LFO:FREQ:MODE SWE
sets the sweep mode.
```

Manual operation: See " [State](#) " on page 267

[:SOURce<hw>]:LFOOutput:FREQUENCY:START <Start>

Sets the start frequency for the LF sweep.

Parameters:

<Start> float
 Range: full frequency range
 Increment: see the data sheet: Resolution of frequency setting
 *RST: 1 KHz

Example:

RST*

activates all presettings.

LFO:SWE:MODE AUTO

TRIG0:SOUR SING

LFO:FREQ:STAR 1 kHz

LFO:FREQ:STOP 10 kHz

LFO:FREQ:MODE SWE

LFO:SWE:EXEC

the instrument generates a single sweep cycle from 1 kHz to 10 kHz automatically after a manual trigger event occurs

(:LFOOutput:SWEep:EXECute or *TRG). The step width is 1 kHz linear, with 15 ms dwell time until the signal switches to the subsequent step.

Manual operation: See " [Start Freq](#) " on page 270

[:SOURce<hw>]:LFOOutput:FREQUENCY:STOP <Stop>

Sets the stop frequency for the LF sweep.

Parameters:

<Stop> float
 Range: full frequency range
 Increment: see the data sheet: resolution of frequency setting
 *RST: 100 KHz

Example:

LFO:FREQ:STOP 10 kHz

sets the stop frequency for the LF sweep to 10 kHz.

Manual operation: See " [Stop Freq](#) " on page 270

[:SOURce]:LFOOutput[:STATe] <State>

Activates/deactivates the LF output.

Parameters:

<State> 0 | 1 | OFF | ON
 *RST: 0

Example:

LFO ON

activates the LF output. The settings under LFO:FREQ and

LFO:SWE become effective.

Manual operation: See "[LF Output State](#)" on page 265

[:SOURce<hw>]:LFOOutput:SWEep[:FREQUENCY]:DWELI <Dwell>

Sets the dwell time for each frequency step of the sweep.

Tip: It is recommended to switch off the "Display Update" for optimum sweep performance especially with short dwell times (`SYSTem:DISPlay:UPDate OFF`).

Parameters:

| | |
|------------|--|
| <Dwell> | float |
| Range: | see data sheet: Dwell time setting range |
| Increment: | 100E-6 |
| *RST: | 15E-3 |

Example: `LFO:SWE:DWEL 20 ms`
sets a dwell time of 20 ms.

Manual operation: See "[Dwell Time - LF Sweep](#)" on page 271

[:SOURce<hw>]:LFOOutput:SWEep[:FREQUENCY]:EXECute

Immediately starts an LF frequency sweep in `LFO:SWE:MODE SINGLE`.

Example: `LFO:SWE:MODE SING`
sets the single cycle mode of the LF sweep.
`LFO:SWE:EXEC`
starts one cycle of the LF sweep.

Usage: Event

Manual operation: See "[Execute Single Sweep](#)" on page 269

[:SOURce<hw>]:LFOOutput:SWEep[:FREQUENCY]:MODE <Mode>

Sets the cycle mode of the LF sweep.

The assignment of the GPIB commands to the sweep modes is given in the description of the sweep dialogs.

Parameters:

| | |
|--------|----------------------|
| <Mode> | AUTO MANual STEP |
|--------|----------------------|

AUTO
Performs a complete sweep cycle from the start to the end value when a trigger event occurs.
The dwell time determines the time period for the signal to switch to the next step.

MANual

Performs a single sweep step when a manual trigger event occurs.

The trigger system is not active. You can trigger each frequency step of the sweep individually with the command [:SOURce<hw>] :LFOutput:FREQuency:MANual. In manual mode, use the rotary knob for switching to the next step.

With each step, the frequency increases by the value specified with the command [:SOURce<hw>] :LFOutput:SWEep[:FREQuency]:STEP[:LINear] or [:SOURce<hw>] :LFOutput:SWEep[:FREQuency]:STEP:LOGarithmic, respectively. A frequency value, entered with [:SOURce<hw>] :LFOutput:FREQuency:MANual takes no effect.

With manual control, the frequency increases or decreases (depending on the direction of the rotary encoder) by the value specified under SOUR:LFO:SWE:FREQ:STEP:LIN (linear spacing) or . . . :STEP:LOG (logarithmic spacing).

With manual control, the frequency increases or decreases (depending on the direction of the rotary encoder) by the value specified under SOUR:LFO:SWE:FREQ:STEP:LIN (linear spacing) or . . . :STEP:LOG (logarithmic spacing).

With manual control, the frequency increases or decreases (depending on the direction of the rotary encoder) by the value specified under SOUR:LFO:SWE:FREQ:STEP:LIN (linear spacing) or . . . :STEP:LOG (logarithmic spacing).

With manual control, the frequency increases or decreases (depending on the direction of the rotary encoder) by the value specified under SOUR:LFO:SWE:FREQ:STEP:LIN (linear spacing) or . . . :STEP:LOG (logarithmic spacing).

With manual control, the frequency increases or decreases (depending on the direction of the rotary encoder) by the value specified under SOUR:LFO:SWE:FREQ:STEP:LIN (linear spacing) or . . . :STEP:LOG (logarithmic spacing).

With manual control, the frequency increases or decreases (depending on the direction of the rotary encoder) by the value specified under SOUR:LFO:SWE:FREQ:STEP:LIN (linear spacing) or . . . :STEP:LOG (logarithmic spacing).

STEP

Each trigger triggers one sweep step only. The frequency increases by the value entered with [:SOURce<hw>] :LFOutput:SWEep[:FREQuency]:STEP[:LINear] or [:SOURce<hw>] :LFOutput:SWEep[:FREQuency]:STEP:LOGarithmic.

Each trigger triggers one sweep step only. The frequency increases by the value entered with [:SOURce<hw>] :LFOutput:SWEep[:FREQuency]:STEP[:LINear] or [:SOURce<hw>] :LFOutput:SWEep[:FREQuency]:STEP:LOGarithmic.

Each trigger triggers one sweep step only. The frequency increases by the value entered with [:SOURce<hw>] :LFOutput:SWEep[:FREQuency]:STEP[:LINear] or [:SOURce<hw>] :LFOutput:SWEep[:FREQuency]:STEP:LOGarithmic.

*RST: AUTO

Example:

```
LFO:SWE:MODE AUTO
selects Auto mode.
```

Manual operation: See " Mode " on page 267

[:SOURce<hw>] :LFOutput:SWEep[:FREQuency]:POINTs <Points>

Determines the number of steps for the LF frequency sweep within the sweep range.

This parameter always applies to the currently set sweep spacing and correlates with the step size as follows:

- for linear sweeps and $f_{\text{START}} < f_{\text{STOP}}$
 $\text{freq_points} = (f_{\text{SPAN}} / \text{step_lin}) + 1$
with $f_{\text{SPAN}} = f_{\text{STOP}} - f_{\text{START}}$
To determine the step size, use the command `SWE:STEP[:LIN]`.
- logarithmic sweeps and $f_{\text{START}} < f_{\text{STOP}}$
 $\text{freq_points} = ((\log f_{\text{STOP}} - \log f_{\text{START}}) / \log \text{step_log}) + 1$
To determine the logarithmic step size, use the command `SWE:STEP:LOG`.

If you change the number of sweep points, the step size changes accordingly. The sweep range remains the same.

Each sweep spacing mode has assigned the POINTs setting separately. Thus, the command refers always to the particular set mode, see [:SOURce<hw>] :LFOutput:SWEep[:FREQuency]:SPACing.

Parameters:

<Points> integer
 Range: 2...max

Example:

```
LFO:FREQ:STAR
sets the start frequency to 2 kHz.
LFO:FREQ:STOP
sets the stop frequency to 20 kHz
LFO:SWE:SPAC LIN
sets linear sweep spacing.
LFO:SWE:POIN 11
sets 11 sweep steps for linear sweep spacing. The sweep step
width (STEP) is automatically set to 2 kHz.
```

[[:SOURce<hw>]:LFOOutput:SWEep[:FREQUENCY]:RETRace <State>

Activates that the signal changes to the start frequency value while it is waiting for the next trigger event.

You can enable this feature, when you are working with sawtooth shapes in sweep mode "Single" or "External Single".

Parameters:

<State> 0 | 1 | OFF | ON
 *RST: 0

Example:

```
TRIG0:SWE:SOUR SING
LFO:SWE:MODE SWE
LFO:SWE:SHAP SAWT
LFO:SWE:RETR ON
activates retrace function, that means the frequency changes to
the value at start frequency while waiting for the next trigger
event.
```

Manual operation: See "[Retrace - LF Frequency Sweep](#)" on page 271

[[:SOURce<hw>]:LFOOutput:SWEep[:FREQUENCY]:RUNNING?

Queries the current status of the LF frequency sweep mode.

Return values:

<State> 0 | 1 | OFF | ON

Example:

```
LFO:SWE:RUNN?
Response "1": the frequency sweep is running.
```

Usage:

Query only

[:SOURce<hw>]:LFOOutput:SWEep[:FREQUENCY]:SHAPE <Shape>

Sets the cycle mode for a sweep sequence (shape).

Parameters:

<Shape> SAWTooth | TRIangle

SAWTooth

A sweep runs from the start to the stop frequency. A subsequent sweep starts at the start frequency, that means the shape of the sweep sequence resembles a sawtooth.

TRIangle

A sweep runs from the start to the stop frequency and back, that means the shape of the sweep resembles a triangle. A subsequent sweep starts at the start frequency.

*RST: SAWTooth

Example:

SOUR:LFO:SWE:SHAP TRI

selects the sweep cycle with alternating ascending and descending sweep directions.

Manual operation: See "Shape" on page 270

[:SOURce<hw>]:LFOOutput:SWEep[:FREQUENCY]:SPACING <Spacing>

Selects the mode for the calculation of the frequency sweep intervals. The frequency increases or decreases by this value at each step.

Parameters:

<Spacing> LINear | LOGarithmic

LINear

With the linear sweep, the step width is a fixed frequency value which is added to the current frequency. The step width for linear sweep is entered in Hz (see [:SOURce<hw>]:LFOOutput:SWEep[:FREQUENCY]:STEP[:LINear] on page 769).

LOGarithmic

With the logarithmic sweep, the step width is a constant fraction of the current frequency. This fraction is added to the current frequency. The logarithmic step width is entered in % (see [:SOURce<hw>]:LFOOutput:SWEep[:FREQUENCY]:STEP:LOGarithmic on page 770).

*RST: LINear

Example:

LFO:SWE:SPAC LIN

selects linear sweep spacing.

Manual operation: See "Spacing" on page 270

[:SOURce<hw>]:LFOOutput:SWEep[:FREQUENCY]:STEP[:LINear] <Linear>

Sets the step size for linear LF frequency sweep steps.

This parameter correlates with the number of steps `[:SOURce<hw>] :LFOOutput :SWEep [:FREQuency] :POINts` within the sweep range as follows:

$$f_{\text{START}} < f_{\text{STOP}}$$

$$\text{freq_points} = ((f_{\text{START}} - f_{\text{STOP}}) / \text{step_lin}) + 1$$

If you change the step size, the number of steps changes accordingly. The sweep range remains the same.

Parameters:

<Linear> float
 Range: full frequency range
 Increment: see the data sheet: Modulation sources > Resolution of frequency setting
 *RST: 1000

Example:

`LFO:FREQ:STAR`
 sets the start frequency to 2 kHz.
`LFO:FREQ:STOP`
 sets the stop frequency to 20 kHz.
`LFO:SWE:SPAC LIN`
 sets linear sweep spacing.
`LFO:SWE:STEP 2 kHz`
 sets the sweep step width to 2 kHz. The number of sweep steps for linear sweep spacing (`POINts`) is automatically set to 11.

Manual operation: See " [Step Lin/Log - LF Sweep](#) " on page 271

**[:SOURce<hw>] :LFOOutput :SWEep [:FREQuency] :STEP :LOGarithmic
 <Logarithmic>**

Sets the logarithmically determined sweep step size for the LF frequency sweep. It is expressed in percent and you must enter the *value* and the unit *PCT* with the command.

The frequency is increased by a logarithmically calculated fraction of the current frequency according to:

$$\text{step_log}_{\text{step}+1} = f_{\text{step}} + \text{step_log}_{\text{step}} \times f_{\text{step}}$$

$$f_{\text{step}+1} = f_{\text{step}} + \text{step_log}_{\text{step}+1}$$

with $f_{\text{START}} < f_{\text{STOP}}$ and *step* = the current number of the sweep steps

This parameter correlates with the number of steps `LFO:SWE [:FREQuency] :POIN` within the sweep range as follows:

$$\text{freq_points} = ((\log f_{\text{STOP}} - \log f_{\text{START}}) / \log \text{step_log}) + 1$$

If you change the step size, the number of steps changes accordingly. The sweep range remains the same.

Parameters:

<Logarithmic> float
 Range: 0.01 to 100
 Increment: 0.01
 *RST: 1

Example:

LFO:FREQ:STAR
 sets the start frequency to 1 kHz.
 LFO:FREQ:STOP
 sets the stop frequency to 100 kHz.
 LFO:SWE:SPAC LOG
 sets logarithmic sweep spacing.
 LFO:SWE:STEP:LOG 10PCT
 sets the step width for logarithmic sweep spacing to 10% of the previous frequency in each instance.

Manual operation: See "[Step Lin/Log - LF Sweep](#)" on page 271

[[:SOURce]:LFOutput:SHAPE <Shape>

Selects the shape of the LF signal.

Note: The installed hardware determines the available settings. Use the [Hardware Config](#) dialog to check the hardware the instrument is equipped with.

For information on the required hardware revision, refer to the release notes.

Parameters:

<Shape> SINE | SQUARE | SAWTOOTH
 *RST: SINE

Example:

LFO:SHAP SQU
 selects a rectangular shape for the signal of the LF generator.

Manual operation: See "[LF Gen Shape](#)" on page 255

[[:SOURce]:LFOutput:SIMPedance <SImpedance>

Selects the output impedance of the LF generator. Selection "LOW" and "600 Ohm" are available.

Note: The installed hardware determines the available settings. Use the [Hardware Config](#) dialog to check the hardware the instrument is equipped with.

For information on the required hardware revision, refer to the release notes.

Parameters:

<SImpedance> LOW | G600
 *RST: LOW

Example:

SOUR:LFO:SIMP G600
 'sets the output impedance of the LF generator to 600 Ohms

Manual operation: See "[LF Source Impedance](#)" on page 266

[[:SOURce]:LFOutput:VOLTage <Voltage>

Sets the voltage of the LF output signal.

Parameters:

| | |
|------------|--|
| <Voltage> | float |
| Range: | see the data sheet: Internal modulation generator > Output voltage range |
| Increment: | see the data sheet: resolution of output voltage setting |
| *RST: | 1 |

Example:

```
LFO:VOLT 2 V
sets the voltage of the LF output to 2 V.
```

Manual operation: See " LF Output Voltage " on page 266

7.15.12 SOURce:LIST Subsystem

This subsystem contains the commands for the List mode of the instrument.

The following settings are required to operate the instrument in List mode:

1. Create a list.
If a list which does not exist is selected with the :LIST:SEL command, an empty list with the name of the selected list is created.

```
SOUR1:LIST:SEL "New_list"
```
2. Fill the list with values.
All list components must be of the same length. This does not apply to components of length 1. This is interpreted as if the component has the same length as the other components and as if all values are the same as the first value.

```
SOUR1:LIST:FREQ 100 MHz, 110 MHz, 120 MHz...
SOUR1:LIST:POW 2dBm, -1dBm, 0dBm...
```
3. Select a list.
If a new empty file has been created with the :LIST:SEL command, this file is selected, otherwise an existing list must be selected before the List mode is activated.

```
SOUR1:LIST:SEL "Old_list"
```
4. Set the dwell time.
The dwell time determines the duration of the individual list steps.

```
SOUR1:LIST:DWEL 3ms
```
5. Set the List mode.
The List mode determines the way in which the list is processed. In the example the list is processed once only or repeatedly depending on the trigger setting.

```
SOUR1:LIST:MODE AUTO
```
6. Determine the trigger.

In the example each trigger causes the list to be processed once from beginning to end.

```
SOUR:LIST:TRIG:SOUR SING
```

7. Activate the List mode.

```
SOUR1:FREQ:MODE LIST
```

8. Trigger the list (depending on the mode).

```
SOUR1:LIST:TRIG:EXEC
```

9. Deactivate the List mode.

```
SOUR1:FREQ:MODE CW
```



SCPI refers to the individual lists as segments.

| | |
|---|-----|
| <code>[:SOURce<hw>]:LIST:CATalog?</code> | 773 |
| <code>[:SOURce<hw>]:LIST:DELeTe</code> | 774 |
| <code>[:SOURce<hw>]:LIST:DELeTe:ALL</code> | 774 |
| <code>[:SOURce<hw>]:LIST:DEXChange:AFILe:CATalog?</code> | 775 |
| <code>[:SOURce<hw>]:LIST:DEXChange:AFILe:EXTension</code> | 775 |
| <code>[:SOURce<hw>]:LIST:DEXChange:AFILe:SELeCt</code> | 776 |
| <code>[:SOURce<hw>]:LIST:DEXChange:AFILe:SEPARator:COLumn</code> | 776 |
| <code>[:SOURce<hw>]:LIST:DEXChange:AFILe:SEPARator:DECimal</code> | 777 |
| <code>[:SOURce<hw>]:LIST:DEXChange:EXECute</code> | 777 |
| <code>[:SOURce<hw>]:LIST:DEXChange:MODE</code> | 778 |
| <code>[:SOURce<hw>]:LIST:DEXChange:SELeCt</code> | 778 |
| <code>[:SOURce<hw>]:LIST:DWELl</code> | 778 |
| <code>[:SOURce<hw>]:LIST:FREE?</code> | 779 |
| <code>[:SOURce<hw>]:LIST:FREQUency</code> | 779 |
| <code>[:SOURce<hw>]:LIST:FREQUency:POINts?</code> | 780 |
| <code>[:SOURce<hw>]:LIST:INDex</code> | 780 |
| <code>[:SOURce<hw>]:LIST:INDex:START</code> | 780 |
| <code>[:SOURce<hw>]:LIST:INDex:STOP</code> | 781 |
| <code>[:SOURce<hw>]:LIST:LEARn</code> | 781 |
| <code>[:SOURce<hw>]:LIST:MODE</code> | 782 |
| <code>[:SOURce<hw>]:LIST:POWEr</code> | 782 |
| <code>[:SOURce<hw>]:LIST:POWEr:POINts?</code> | 782 |
| <code>[:SOURce<hw>]:LIST:RESEt</code> | 783 |
| <code>[:SOURce<hw>]:LIST:SELeCt</code> | 783 |
| <code>[:SOURce<hw>]:LIST:TRIGger:EXECute</code> | 783 |
| <code>[:SOURce<hw>]:LIST:TRIGger:SOURce</code> | 784 |

`[:SOURce<hw>]:LIST:CATalog?`

Requests a list of available lists. The individual lists are separated by commas.

The lists are stored with the fixed file extensions `*.lsw` in a directory of the user's choice. The directory applicable to the commands is defined with the command `MMEMoRY:CDIR`.

Return values:

<Catalog> string

Example:

```
MMEM:CDIR '/var/user/Listmode'
selects the directory for the list mode files.
LIST:CAT?
queries the available lists.
Response: 'list1,list2'
the lists list1 and list2 are available.
```

Usage:

Query only

[:SOURce<hw>]:LIST:DELeTe <Filename>

Deletes the specified list.

The files are stored with the fixed file extensions *.lsw in a directory of the user's choice. The directory applicable to the command is defined with the command `MMEMory:CDIR`. To access the files in this directory, only the file name has to be given, without the path and the file extension. A path can also be specified in command `:SOUR:LIST:CAT?`, in which case the file in the specified directory is deleted.

*RST does not affect data lists.

Setting parameters:

<Filename> string

Example:

```
MMEM:CDIR '/var/user/Listmode'
selects the directory for the list mode files.
LIST:DEL 'LIST1'
deletes the list list1.
```

Usage:

Setting only

Manual operation: See "[List Mode Data... - List Mode](#)" on page 295

[:SOURce<hw>]:LIST:DELeTe:ALL

Deletes all lists in the selected directory.

Note: The list mode must be previously disabled to make sure that no records are selected when you set the frequency mode (`[:SOURce<hw>] :FREQuency:MODE`).

The files are stored with the fixed file extensions *.lsw in a directory of the user's choice. You can select the directory with the commands `:MMEMory:CDIRectory` or `[:SOURce<hw>] :LIST:CATalog?`.

*RST does not affect data lists.

Example: `MMEM:CDIR '/var/user/Listmode'`
selects the directory for the list mode files.
`FREQ:MODE SWE`
deactivates the list mode for RF output and activates the sweep mode.
`LIST:DEL:ALL`
deletes all list mode files in the selected directory.

Usage: Event

Manual operation: See "[List Mode Data... - List Mode](#)" on page 295

[[:SOURce<hw>]:LIST:DEXChange:AFILe:CATalog?

Queries the available ASCII files for export or import of list mode data in the current or specified directory.

As response, you get a string containing the existing ASCII files `*.txt` or `*.csv`, separated by commas.

Return values:

<Catalog> string

Example: `MMEM:CDIR '/var/user/import'`
selects the directory for the ASCII files with frequency and level value pairs.
`LIST:DEXC:AFIL:EXT TXT`
determines the extension `*.txt` for the query.
`LIST:DEXC:AFIL:CAT?`
queries the available files with extension `*.txt`.
Response: `'list1,list2'`
the ASCII files `list1.txt` and `list2.txt` are available.

Usage: Query only

[[:SOURce<hw>]:LIST:DEXChange:AFILe:EXTension <Extension>

Determines the extension of the ASCII file for import or export, or to query existing files.

Parameters:

<Extension> TXT | CSV
*RST: TXT

Example: MMEM:CDIR '/var/user/import'
 selects the directory for the ASCII files with frequency and level value pairs.
 LIST:DEXC:AFIL:EXT TXT
 selects ASCII files with the extension *.txt for the query.
 LIST:DEXC:AFIL:CAT?
 queries the available files with extension *.txt.
 Response: 'list1,list2'
 the ASCII files list1.txt and list2.txt exist.

Manual operation: See "[Extension - List Mode](#)" on page 297

[:SOURce<hw>]:LIST:DEXChange:AFIL:SElect <Filename>

Selects the ASCII file to be imported or exported.

Parameters:

<Filename> <ascii_file_name>

Example: LIST:DEXC:MODE IMP
 determines that ASCII files with frequency and level value pairs are imported into list mode lists.
 LIST:DEXC:AFIL:EXT TXT
 determines the extension *.txt for the query.
 LIST:DEXC:AFIL:CAT?
 queries the available files with extension *.txt.
 Response: 'list1,list2'
 the ASCII files list1.txt and list2.txt exist.
 LIST:DEXC:AFIL:SEL '/var/user/list.csv'
 selects list.csv for import.
 LIST:DEXC:SEL '/var/user/list_imp'
 determines the destination file list_imp.
 LIST:DEXC:EXEC
 imports the ASCII file data into the list file.

Manual operation: See "[Select ASCII Source / Destination - List Mode](#)" on page 298

[:SOURce<hw>]:LIST:DEXChange:AFIL:SEPARATOR:COLumn <Column>

Selects the separator between the frequency and level column of the ASCII table.

Parameters:

<Column> TABulator | SEMicolon | COMMa | SPACe
 *RST: COMMa

Example:

```
LIST:DEXC:MODE EXP
selects that the list is exported into an ASCII file.
LIST:DEXC:AFIL:SEL '/var/user/list.csv'
determines ASCII file list.csv as destination for the list mode list
data.
LIST:DEXC:AFIL:SEP:COL TAB
defines a tabulator to separate the frequency and level values
pairs.
LIST:DEXC:AFIL:SEP:DEC DOT
selects the decimal separator dot.
LIST:DEXC:SEL '/var/user/list_imp'
determines the source file list_imp for export into the ASCII file
list.csv.
LIST:DEXC:EXEC
exports the list file data into the ASCII file.
```

Manual operation: See "[Column Separator- List Mode](#)" on page 297

[:SOURce<hw>]:LIST:DEXChange:AFILe:SEParator:DECimal <Decimal>

Sets the decimal separator used in the ASCII data between '.' (decimal point) and ',' (comma) with floating-point numerals.

Parameters:

<Decimal> DOT | COMMa
*RST: DOT

Example: see [\[:SOURce<hw>\]:LIST:DEXChange:AFILe:SEParator:COLumn](#) on page 776

Manual operation: See "[Decimal Point - List Mode](#)" on page 297

[:SOURce<hw>]:LIST:DEXChange:EXECute

Executes the import or export of the selected list file, according to the previously set transfer direction with command [\[:SOURce<hw>\]:LIST:DEXChange:MODE](#).

Example:

```
LIST:DEXC:MODE IMP
determines that ASCII files with frequency and level value pairs
are imported into list mode lists.
LIST:DEXC:AFIL:SEL '/var/user/list.csv'
selects the ASCII file list.csv for import.
LIST:DEXC:SEL '/var/user/list_imp'
determines the destination file list_imp.
LIST:DEXC:EXEC
imports the ASCII file data into the list mode file.
```

Usage: Event

Manual operation: See "[Import / Export - List Mode](#)" on page 298

[[:SOURce<hw>]:LIST:DEXChange:MODE <Mode>

Selects if list mode lists should be imported or exported. Depending on the selection here, the file select command defines either the source or the destination for list mode lists and ASCII files.

Parameters:

<Mode> IMPort | EXPort
*RST: IMPort

Example:

```
LIST:DEXC:MODE IMP
selects that ASCII files with frequency and level value pairs are
imported and transferred into list mode lists.
LIST:DEXC:AFIL:SEL '/var/user/list.csv'
selects that ASCII file list.csv is imported.
LIST:DEXC:SEL '/var/user/list_imp'
selects that the ASCII file list.csv is imported into list mode
list list_imp.
```

Manual operation: See "[Mode - List Mode](#)" on page 297

[[:SOURce<hw>]:LIST:DEXChange:SElect <Filename>

Selects the list mode list to be imported or exported.

The list mode files are stored with the fixed file extensions *.lsw in a directory of the user's choice. The directory applicable to the commands is defined with the command `MMEMory:CDIR`. A path can also be specified in command `SOUR:LIST:DEXC:SEL`, in which case the files are stored or loaded in the specified directory.

Parameters:

<Filename> <list_name>

Example:

```
LIST:DEXC:MODE IMP
selects that ASCII files with frequency and level value pairs are
imported and transferred into list mode lists.
LIST:DEXC:AFIL:SEL '/var/user/list.csv'
selects that ASCII file list.csv is imported.
LIST:DEXC:SEL '/var/user/list_imp'
selects that the ASCII file list.csv is imported into list mode
list list_imp.
```

Manual operation: See "[Select Destination / Source - List Mode](#)" on page 298

[[:SOURce<hw>]:LIST:DWELI <Dwell>

Sets the dwell time. The R&S SMBV generates the signal with the frequency / power value pairs of each list entry for that particular period.

Parameters:

<Dwell> float
 Range: 7E-4 to 100
 Increment: 1E-4
 *RST: 15E-3

Example:

LIST:DWELL 15
 retains each setting in the list for 15 ms.

Manual operation: See "[Dwell Time - List Mode](#)" on page 294

[[:SOURce<hw>]:LIST:FREE?

Queries on the free storage space for list mode lists.

Return values:

<Free> integer
 Range: 0 to INT_MAX
 *RST: 0

Example:

LIST:FREE?

Usage: Query only

Response: 2147483647;1

[[:SOURce<hw>]:LIST:FREQuency <Frequency>

Fills the FREQuency column of the selected list with data.

*RST does not affect data lists.

Parameters:

<Frequency> <Frequency#1>{, <Frequency#2>, ...} | block data
 The data can be given either as a list of numbers (list can be of any length and list entries must be separated by commas) or as binary block data. When block data is transferred, 8 bytes are always interpreted as a floating-point number with double accuracy (see :FORMat [:DATA] on page 561).
 Range: 300 kHz to RFmax

Example:

LIST:SEL '/var/user/list3'
 selects list3 for editing. The R&S SMBV generates a new file automatically, if it does not exist yet.
 SOUR:LIST:FREQ 1.4GHz, 1.3GHz, 1.2GHz, ...
 specifies the frequency values in list3. If the list already contains data, it is overwritten.

Manual operation: See "[Edit List Mode Data... - List Mode](#)" on page 295

[[:SOURce<hw>]:LIST:FREQuency:POINts?

The command queries the length (in points) of the FREQuency component of the selected list.

Return values:

<Points> integer
 Range: 0 to INT_MAX
 *RST: 0

Example:

```
LIST:SEL '/var/user/list3'
selects list3 for editing. The R&S SMBV creates a new file
automatically, if it does not exist yet.
LIST:FREQ:POIN?
queries the number of frequency values in the list
Response: 327
```

Usage: Query only

[[:SOURce<hw>]:LIST:INDex <Index>

Sets the list index in step mode (LIST:MODE STEP).

After the trigger signal the frequency and level settings of the selected index are processed in List mode.

Parameters:

<Index> integer
 *RST: 0

Example:

```
LIST:SEL '/var/user/list3'
selects list3 for use in List mode.
FREQ:MODE LIST
activates List mode. List3 is processed.
LIST:MODE STEP
selects manual, step-by-step processing of the list.
LIST:IND 5
the frequency/level value pair with index 5 is executed.
TRIG:LIST:SOUR SING
selects triggering by means of the single trigger. The list is exe-
cuted once.
SOUR:LIST:TRIG:EXEC
triggers the processing of the selected list.
```

Manual operation: See "[Current Index - List Mode](#)" on page 294

[[:SOURce<hw>]:LIST:INDex:STARt <Start>

Sets the start index of the index range which defines a subgroup of frequency/level value pairs in the current list. Only the values in the set index range (:LIST:INDex:STARt ... :LIST:INDex:STOP) are processed in List mode.

Parameters:

<Start> integer
 Range: 0 to list length
 *RST: 0

Example:

```
LIST:SEL '/var/user/list3'
selects list3 for use in List mode.
LIST:IND:STAR 25
sets 25 as start index of the index range.
LIST:IND:STOP 49
sets 49 as stop index of the index range.
FREQ:MODE LIST
activates List mode. The frequency/level value pairs from index
25 to index 49 in list3 are processed. All other entries of the list
are ignored.
```

Manual operation: See "[List Range In - List Mode](#)" on page 296

[:SOURce<hw>]:LIST:INDEX:STOP <Stop>

Sets the stop index of the index range which defines a subgroup of frequency/level value pairs in the current list. Only the values in the set index range (:LIST:INDEX:START ... :LIST:INDEX:STOP) are processed in list mode.

Parameters:

<Stop> integer
 Range: 0 to list length
 *RST: 0

Example: see [:SOURce<hw>]:LIST:INDEX:START on page 780

Manual operation: See "[List Range In - List Mode](#)" on page 296

[:SOURce<hw>]:LIST:LEARn

Learns the selected list to determine the hardware setting for all list entries. The results are saved with the list. When the list is activated the first time, these settings are calculated automatically.

Example:

```
LIST:SEL '/var/user/list3'
selects list file. The file is created if it does not yet exist.
LIST:LEAR
starts learning of the hardware setting for list3 and stores the
setting.
```

Usage: Event

Manual operation: See "[Learn List Mode Data... - List Mode](#)" on page 294

[:SOURce<hw>]:LIST:MODE <Mode>

Selects how the list is to be processed (similar to `SOURce:SWEep:MODE`).

Parameters:

<Mode> AUTO | STEP

AUTO

Each trigger event triggers a complete list cycle. Possible trigger settings for `:LIST:TRIGger:SOURce` are `AUTO`, `SINGLE` and `EXT`.

STEP

Each trigger event triggers only one step in the list processing cycle. The list is processed in ascending order.

Possible trigger settings for `:LIST:TRIGger:SOURce` are `SINGLE` and `EXT`

*RST: AUTO

Example:

```
LIST:MODE STEP
```

selects step-by-step processing of the list.

Manual operation: See "[Mode - List Mode](#)" on page 293

[:SOURce<hw>]:LIST:POWer <Power>

Fills the `Level` part of the selected list with data.

*RST does not affect data lists.

Parameters:

<Power> <Power#1>{, <Power#2>, ...} | block data

The data can be given either as a list of numbers (list can be of any length and list entries must be separated by commas) or as binary block data. When block data is transferred, 8 bytes are always interpreted as a floating-point number with double accuracy (see `:FORMat[:DATA]` on page 561).

Range: Minimum level to Maximum level

Default unit: dBm

Example:

```
LIST:SEL '/var/user/list3'
```

selects `list3` for editing. The R&S SMBV generates a new file automatically, if it does not exist yet.

```
LIST:POW 0dBm, 2dBm, 2dBm, 3dBm, ..
```

specifies the level values in `list3`. The number of level values must correspond to the number of frequency values. The previous data is overwritten.

Manual operation: See "[Edit List Mode Data... - List Mode](#)" on page 295

[:SOURce<hw>]:LIST:POWer:POINts?

Queries the length (in points) of the `LEVEL` part of the selected list.

Return values:

<Points> integer
 Range: 0 to INT_MAX
 *RST: 0

Example:

```
LIST:SEL '/var/user/list3'
```

selects `list3` for editing. The R&S SMBV generates a new file automatically, if it does not exist yet.

```
LIST:POW:POIN?
```

queries the number of levels in the list file
 Response: 327

Usage: Query only

[:SOURce<hw>]:LIST:RESet

Resets the list to the starting point.

Example: `LIST:RES`
 resets the list to the starting point.

Usage: Event

Manual operation: See "[Reset - List Mode](#)" on page 294

[:SOURce<hw>]:LIST:SElect <Filename>

Selects the specified list. If a new list is to be created, the name can be entered here. The list is created if it does not yet exist. The list selected here is available for the further processing steps (editing) and is used in the instrument when the list mode is activated.

The files are stored with the fixed file extensions `*.lsw` in a directory of the user's choice. The directory applicable to the command is defined with the command `MMEMory:CDIR`. A path can also be specified in which case the list mode file in the specified directory is selected.

*RST does not affect data lists.

Parameters:

<Filename> '<list name>'

Example: `LIST:SEL '/var/user/list3'`
 selects `list3` for editing.

Manual operation: See "[List Mode Data... - List Mode](#)" on page 295

[:SOURce<hw>]:LIST:TRIGger:EXECute

Starts the processing of a list in list mode. It corresponds to the manual-control command "Execute Single."

Example: SOUR:LIST:TRIG:EXEC
triggers the processing of the selected list.

Usage: Event

Manual operation: See "Execute Single - List Mode" on page 293

[:SOURce<hw>]:LIST:TRIGger:SOURce <Source>

Selects the trigger source processing lists.

The names of the parameters correspond to those under sweep mode. SCPI uses other names for the parameters; these names are also accepted by the instrument. The SCPI names should be used if compatibility is an important consideration. An overview of the various names is given in the following table:

| R&S name | SCPI name | Command under manual control |
|----------|-----------|--|
| AUTO | IMMediate | MODE AUTO |
| SINGle | BUS | MODE SINGLE or STEP |
| EXTernal | EXTernal | MODE EXT TRIG SINGLE or EXT TRIG STEP |

Parameters:

<Source>

AUTO | IMMediate | SINGle | BUS | EXTernal

AUTO|IMMediate

The trigger is free-running, i.e. the trigger condition is fulfilled continuously. The selected list in List mode is restarted as soon as it is finished.

SINGle|BUS

The list is triggered by the GPIB commands [:SOURce<hw>] : LIST:TRIGger:EXECute. The list is executed once.

EXTernal

The list is triggered externally via the [INST TRIG] connector. The list is executed once.

*RST: AUTO

Example: LIST:TRIG:SOUR EXT
selects triggering by means of the external trigger.

Manual operation: See "Mode - List Mode" on page 293

7.15.13 SOURce:MODulation Subsystem

This subsystem contains the command for switching on/off all modulations.

[:SOURce<hw>]:MODulation[:ALL][:STATE] <State>

Activates/deactivates the modulations.

The command `SOUR:MOD:ALL:STAT OFF` switches all modulations off. A subsequent command `SOUR:MOD:ALL:STAT ON` restores the status that was active before the last switch-off. "MOD OFF" is displayed in the info line of the header next to the "Level" field.

Parameters:

<State> 0 | 1 | OFF | ON
*RST: 0

Example:

`MOD:STAT OFF`
switches off all modulations.

Manual operation: See "[MOD ON/OFF]" on page 251

7.15.14 SOURce:PGEN Subsystem

This subsystem contains the commands for setting the pulse generator.

[\[:SOURce<hw>\]:PGENerator:STATe.....](#) 785

[[:SOURce<hw>]:PGENerator:STATe <State>

Activates/deactivates the output of the video/sync signal at the [PULSE VIDEO] connector at the rear of the instrument.

The signal output and the pulse generator are automatically switched on with activation of pulse modulation if pulse generator is selected as modulation source. The signal output can be switched off subsequently.

Parameters:

<State> 0 | 1 | OFF | ON
*RST: 0

Example:

`PULM:SOUR INT`
selects the internal pulse generator as source for pulse modulation
`PULM:STAT ON`
activates pulse modulation. The pulse generator and the output of the signals at the [PULSE VIDEO] connector are automatically activated in addition.
`PGEN:STAT OFF`
deactivates the output of the pulse signal by the pulse generator at the [PULSE VIDEO] connector. The pulse modulation of the RF carrier must be activated with command
`SOURce:PULM:STATe.`

Options:

R&S SMBV-K23

Manual operation: See "Video Sync Signal State - Pulse Generator" on page 273

7.15.15 SOURce:PHASe Subsystem

This subsystem contains the commands for adjusting the phase of the RF output signal relative to a reference signal of the same frequency.

| | |
|---|-----|
| [:SOURce<hw>]:PHASe | 786 |
| [:SOURce<hw>]:PHASe:REFerence | 786 |

[:SOURce<hw>]:PHASe <Phase>

Sets the phase variation relative to the current phase. The variation is specified in RADians.

Parameters:

| | |
|---------|--------------------|
| <Phase> | float |
| | Range: -720 to 720 |
| | Increment: 0.1 |
| | *RST: 0 |

Example: PHAS 0.1 RAD
changes the phase by 0.1 RAD relative to the current phase.
PHAS:REF
adopts the set phase as the current phase.

Manual operation: See "[Delta Phase](#)" on page 214

[:SOURce<hw>]:PHASe:REFerence

Adopts the phase set with `SOURce:PHASe:ADJust` as the current phase.

Example: PHAS 0.1RAD
changes the phase by 0.1 RAD relative to the current phase.
PHAS:REF
adopts the set phase as the current phase.

Usage: Event

Manual operation: See "[Reset Delta Phase Display](#)" on page 214

7.15.16 SOURce:PM Subsystem

The PM subsystem contains the commands for checking the phase modulation. The settings for the internal modulation source (LF generator) are made in the [SOURce:LFOuTput](#) subsystem.

For information on the required options, see [Chapter 5.5.12.4, "Phase Modulation \(PhiM\)"](#), on page 259.

| | |
|---|-----|
| [:SOURce<hw>]:PM[:DEViation] | 787 |
| [:SOURce<hw>]:PM:EXTernal:COUPling | 787 |
| [:SOURce<hw>]:PM:EXTernal:DEViation | 787 |
| [:SOURce<hw>]:PM:INTernal:DEViation | 788 |
| [:SOURce<hw>]:PM:MODE | 788 |

| | |
|---|-----|
| [:SOURce<hw>]:PM:SENSitivity? | 788 |
| [:SOURce<hw>]:PM:SOURce | 789 |
| [:SOURce<hw>]:PM:STATe | 789 |

[:SOURce<hw>]:PM[:DEViation] <Deviation>

Sets the deviation of the phase modulation signals in RAD. The maximum deviation depends on the set RF frequency and the selected modulation mode (see data sheet).

Parameters:

<Deviation> float
 Range: see data sheet
 Increment: 1E-6

Example: PM 2
 sets 2 RAD deviation to the phase modulation signal.

Manual operation: See "[PhiM Deviation](#)" on page 261

[:SOURce<hw>]:PM:EXTernal:COUpling <Coupling>

Selects the coupling mode for the external phase modulation signal.

Parameters:

<Coupling> AC | DC
 AC
 Uses only the AC signal component of the modulation signal.
 DC
 Uses the modulation signal as it is, with AC and DC.
 *RST: AC

Example: PM:EXT:COUP AC
 selects the coupling mode AC for the external phase modulation signal.

Manual operation: See "[Mod Ext Coupling](#)" on page 262

[:SOURce<hw>]:PM:EXTernal:DEViation <Deviation>

Sets the modulation deviation of the external phase modulation signal in RAD. The maximum value depends on the set RF frequency and the selected modulation mode (see data sheet).

The sum of the deviations of all active frequency modulation signals may not exceed the total value set with command [\[:SOURce<hw>\]:PM:EXTernal:DEViation](#).

Parameters:

<Deviation> float
 Range: 0 to 20
 *RST: 1

Example: `PM 5`
sets 5 RAD deviation for the external phase modulation signal.

Manual operation: See "[PhiM Deviation](#)" on page 261

[:SOURce<hw>]:PM:INTernal:DEViation <Deviation>

Sets the deviation of the internal phase modulation signal in RAD.

The sum of the deviations of all active frequency modulation signals may not exceed the total value set with command `[:SOURce<hw>]:PM[:DEViation]`.

Parameters:

<Deviation> float
Range: see data sheet
Increment: 1E-6
*RST: 1

Example: `PM:INT1:DEV 3RAD`
sets 3 RAD deviation for the internal phase modulation signal.

Manual operation: See "[PhiM Deviation](#)" on page 261

[:SOURce<hw>]:PM:MODE <Mode>

Selects the mode for the phase modulation.

Parameters:

<Mode> HDEViation | NORMal | LNOise

HDEViation

Provides full setting range of PhiM deviation. The range of modulation frequency is limited (see data sheet). Recommended for low modulation frequencies and/or high PhiM deviation.

NORMal

Provides full setting range of modulation bandwidth and PhiM deviation. Recommended for high modulation frequencies.

*RST: HBANdwidth

Example: `PM:MODE LNO`
selects Low Noise mode for external phase modulation.

Manual operation: See "[PhiM Mode](#)" on page 260

[:SOURce<hw>]:PM:SENSitivity?

Queries the input sensitivity of the externally applied signal for phase modulation. The returned value reports the sensitivity in RAD/V. It is assigned to the voltage value for full modulation of the input.

Return values:

<Sensitivity> float

Example: PM:DEV 1
 sets a modulation deviation of 1RAD.
 PM:SENS?
 queries the input sensitivity at the external modulation input.
 Response: 1
 since the voltage value for full modulation is 1V, the resulting
 sensitivity is precisely 1RAD/V.

Usage: Query only

Manual operation: See "[PhiM Sensitivity](#)" on page 262

[:SOURce<hw>]:PM:SOURce <Source>

Selects the modulation signal source for phase modulation.

You can use both, the internal and an external modulation signal at a time.

Parameters:

<Source> INTernal | EXTernal | INT,EXT

INTernal

Uses the internally generated signal for modulation. To configure the LF signal, use the commands of the [SOURce:LFOutput Subsystem](#) subsystem.

EXTernal

Uses an externally applied modulation signal.

INT,EXT

Uses both, the internal and external modulation signals.

*RST: INT

Example: PM:SOUR INT
 selects the internal modulation source.

Manual operation: See "[PhiM Source](#)" on page 260

[:SOURce<hw>]:PM:STATe <State>

Activates phase modulation.

Note: Activation of PM deactivates frequency modulation (FM).

Parameters:

<State> 0 | 1 | OFF | ON

*RST: 0

Example: PM:STAT ON
 activates PM.

Manual operation: See "[State](#)" on page 260

7.15.17 SOURce:POWer Subsystem

This subsystem contains the commands for setting the output level, level control and level correction of the RF signal.

Other units can also be used instead of dBm:

- by entering the unit directly after the numerical value (example :POW 0.5V)
- by changing the DEFault unit in the UNIT system (see the command :UNIT:POWer).

| | |
|--|-----|
| [:SOURce<hw>]:POWer:ALC:OMODE..... | 790 |
| [:SOURce<hw>]:POWer:ALC:SONCe..... | 791 |
| [:SOURce<hw>]:POWer:ALC[:STATe]..... | 791 |
| [:SOURce<hw>]:POWer:ATTenuation:RFOff:MODE..... | 792 |
| [:SOURce<hw>]:POWer:EMF:STATe..... | 792 |
| [:SOURce<hw>]:POWer[:LEVel][:IMMEDIATE][:AMPLitude]..... | 792 |
| [:SOURce<hw>]:POWer[:LEVel][:IMMEDIATE]:OFFSet..... | 793 |
| [:SOURce<hw>]:POWer[:LEVel][:IMMEDIATE]:RCL..... | 794 |
| [:SOURce<hw>]:POWer:LIMit[:AMPLitude]..... | 794 |
| [:SOURce<hw>]:POWer:LMODE..... | 794 |
| [:SOURce<hw>]:POWer:MANual..... | 795 |
| [:SOURce<hw>]:POWer:MODE..... | 796 |
| [:SOURce<hw>]:POWer:PEP?..... | 796 |
| [:SOURce<hw>]:POWer:POWer..... | 796 |
| [:SOURce<hw>]:POWer:SPC:CRANge..... | 797 |
| [:SOURce<hw>]:POWer:SPC:DELay..... | 797 |
| [:SOURce<hw>]:POWer:SPC:PEAK..... | 798 |
| [:SOURce<hw>]:POWer:SPC:SElect..... | 798 |
| [:SOURce<hw>]:POWer:SPC:STATe..... | 798 |
| [:SOURce<hw>]:POWer:SPC:TARGet..... | 798 |
| [:SOURce<hw>]:POWer:STARt..... | 799 |
| [:SOURce<hw>]:POWer:STEP[:INCRement]..... | 799 |
| [:SOURce<hw>]:POWer:STEP:MODE..... | 800 |
| [:SOURce<hw>]:POWer:STOP..... | 800 |

[:SOURce<hw>]:POWer:ALC:OMODE <OffMode>

The command sets the level control mode which becomes active when automatic level control is deactivated (ALC Off).

Parameters:

<OffMode>

SHOLd | TABLe | HIGHAccuracy

SHOLd

Level control is activated briefly if the level or frequency changes ("ALC Off Sample & Hold").

HIGHAccuracy

The ALC mode High Accuracy ensures improved level accuracy.

Note: This mode increases the frequency and level setting time up to 20 ms!

TABLE

Internal level control is performed according to the ALC table.

*RST: SHOLd

Example:

POW:ALC OFF

deactivates automatic level control for RF output A.

POW:ALC:OMOD SHOL

level control is briefly activated if the frequency or level changes.

Manual operation: See " [State - ALC](#) " on page 228

[:SOURce<hw>]:POWER:ALC:SONCe

Temporarily activates level control for correction purposes.

Example:

POW:ALC OFF

deactivates automatic level control for RF output A.

POW:ALC:SONC

level control is performed once only.

Usage:

Event

Manual operation: See "[Search Once - ALC](#)" on page 229

[:SOURce<hw>]:POWER:ALC[:STATe] <State>

Activates/deactivates automatic level control.

Parameters:

<State>

0 | OFF | AUTO | 1 | ON | OFFTable | OFFHighAccuracy

ON

Internal level control is permanently activated.

OFF|ONSample

Internal level control is deactivated.

AUTO

Internal level control is activated/deactivated automatically depending on the operating state.

ONTable

Internal level control is performed according to the ALC table.

OFFHighAccuracy

The ALC mode High Accuracy ensures improved level accuracy.

Note: This mode increases the frequency and level setting time up to 20 ms!

*RST: AUTO

Manual operation: See " [State - ALC](#) " on page 228

[[:SOURce<hw>]:POWER:ATTenuation:RFOff:MODE <Mode>

Selects the attenuator mode, when the RF signal is switched off.

Parameters:

<Mode>

UNCHanged | FATTenuation

UNCHanged

Freezes the setting of the attenuator when RF is switched off.

The attenuator is only activated when RF is switched on.

This setting recommended if a constant VSWR (**V**oltage **S**tanding **W**ave **R**atio) is required.

FATTenuation

Sets attenuation to maximum when the RF signal is switched off.

This setting is recommended for applications that require a high level of noise suppression.

*RST: n.a. (factory preset: FATTenuation)

Example:

SOUR:POW:ATT:RFOFF:MODE FATT

sets the RF OFF attenuator to maximum.

Manual operation: See " [RF OFF Mode](#) " on page 225

[[:SOURce<hw>]:POWER:EMF:STATe <State>

Displays the signal level as voltage of the EMF. The displayed value represents the voltage over a 50 Ohm load.

Parameters:

<State>

0 | 1 | OFF | ON

*RST: n.a. (factory preset: 0)

Example:

POW:EMF:STAT 1

activates voltage level display.

Manual operation: See " [Display Level as Voltage of EMF - RF Level](#) " on page 227

[[:SOURce<hw>]:POWER[:LEVel][:IMMediate][:AMPLitude] <Amplitude>

Sets the RF level applied to the DUT.

Notes:

If specified, a level offset `[[:SOURce<hw>]:POWER[:LEVel][:IMMediate]:OFFSet` is included according to the formula:

Minimum level + OFFSet ... Maximum level + OFFSet

In addition to numerical values, you can increase or decrease the values step by step with the UP and DOWN according to the step width defined with `[[:SOURce<hw>]:POWER:STEP[:INCRement]`.

The RF output is activated with `:OUTPut<hw>[:STATe]` on page 583 (RF ON / RF OFF).

Parameters:

<Amplitude> Minimum level ... Maximum level
 Determines the RF output level.
 Range: Minimum level to Maximum level
 *RST: -30

Example:

The keywords of this command are largely optional. Therefore, both the long and short form of the command are shown.

```
SOUR:POW:LEV:IMM:AMPL 15
```

or

```
:POW 15
```

sets the RF level at output A to 15 dBm.

Manual operation: See "[RF Level](#)" on page 221

[:SOURce<hw>]:POWer[:LEVel][:IMMediate]:OFFSet <Offset>

Note: The level offset is also effective for level sweeps!

Specifies the constant level offset of a downstream attenuator/amplifier. If a level offset is entered, the level entered with `:POWer` no longer corresponds to the RF output level.

The following correlation applies:

$$POWer = \text{RF output level} + POWer:OFFSet.$$

Entering a level offset does not change the RF output level, but rather the query value of `:POWer`.

For more information, see "[RF level vs. RF output level](#)" on page 221.

Only dB is permitted as the unit here. The linear units (V, W, etc.) are not permitted.

The keywords of this command are largely optional. Therefore, both the long and short form of the command are shown in the example.

Parameters:

<Offset> float
 Range: -100 to 100
 Increment: 0.01
 *RST: 0

Example:

```
SOURce:POWer:LEVel:IMMediate:OFFSet -10
```

or

```
POW:OFFS 10
```

sets the RF level offset to 10 dB

Manual operation: See "[Offset \(Level\)](#)" on page 224

[[:SOURce<hw>]:POWER[:LEVel][:IMMediate]:RCL <Rcl>

Determines whether the RF level is retained or taken from a loaded instrument configuration, when you recall instrument settings with the command *RCL.

Parameters:

<Rcl> INCLude | EXCLude

INCLude

Takes the level value of the loaded settings.

EXCLude

Retains the current level when an instrument configuration is loaded.

*RST: INCLude

Example:

POW:RCL INCL

takes the level value from an instrument configuration loaded with command *RCL.

Manual operation: See "[Exclude Level](#)" on page 165

[[:SOURce<hw>]:POWER:LIMit[:AMPLitude] <Amplitude>

Limits the maximum RF output level in CW and SWEEP mode. It does not influence the "Level" display or the response to the POW? query command.

Parameters:

<Amplitude> float

Minimum level ... Maximum level

The value range for the level setting varies according to the instrument model.

The values are given in the data sheet.

Increment: 0.01

*RST: n.a. (factory preset: 30)

Example:

SOURce:POWER:LIMit:AMPLitude 10

or

:POW:LIM 10

limits the RF level to maximum +10 dBm.

Manual operation: See "[Limit - RF Level](#)" on page 224

[[:SOURce<hw>]:POWER:LMODe <LevMode>

Sets the RF level mode.

Parameters:

<LevMode> NORMal | LOWNoise | LOWDistortion

NORMal

The RF signal is output in the standard values of the instrument.

LOWNoise

A very low noise sinewave signal is output.

LOWDistortion

A very pure sinewave signal is output.

*RST: NORMal

Example:

POW:LMODE LOWD

sets the LOWDistortion mode. The instrument reduces distortions of the RF signal to a minimum.

Manual operation: See "[RF Mode](#)" on page 223

[:SOURce<hw>]:POWER:MANual <Manual>

In Sweep mode (:SOUR:POW:MODE SWE) the command sets the level for the next sweep step in the Step sweep mode (:SOUR:SWE:POW:MODE MAN). Here only level values between the settings [:SOUR]:POW:STAR and [:SOUR]:POW:STOP are permitted. Each sweep step is triggered by a separate :SOUR:POW:MAN command.

As with the "Level" value entered in the "RF Level" menu, the OFFSet value is also taken into consideration with this command.

The specified value range is therefore only effective if :SOURce:POWer:OFFSet is set to 0. The value range for other OFFset values can be calculated using the following formula:

Minimum level + OFFSet ... Maximum level + OFFSet

Parameters:

<Manual> float

Minimum level ... Maximum level

The value range for the level setting varies according to the instrument model

The values are given in the data sheet.

Increment: 0.01

*RST: -30

Example:

POW:SWE:MODE MAN

sets the Step sweep mode for RF output A.

POW:MAN -5 dBm

sets an RF level of -5 dBm for the next setting in the Step sweep mode for RF output A.

POW:MODE SWE

sets the Level Sweep mode for RF output A.

POW:MAN -5.5 dBm

triggers the next sweep step with a level of -5.5 dBm.

Manual operation: See "[Current Level - Level Sweep](#)" on page 289

[:SOURce<hw>]:POWER:MODE <Mode>

Sets the instrument operating mode and therefore also the commands used to set the output level.

Parameters:

<Mode> CW | FIXed | SWEep

CW|FIXed

Operates at a constant level.

CW and FIXed are synonyms. To set the output level value, use the command [:SOURce<hw>]:POWER[:LEVel][:IMMediate][:AMPLitude].

SWEep

Operates in power sweep mode.

Set the range and current level with the commands [:SOURce<hw>]:POWER:STARt, [:SOURce<hw>]:POWER:STOP and [:SOURce<hw>]:POWER:MANual.

*RST: CW

Example:

POW:MODE SWEep
selects the SWEep mode using the
POW:STAR; POW:STOP; POW:MAN settings.

Manual operation: See " [State - Level Sweep](#) " on page 286

[:SOURce<hw>]:POWER:PEP?

Queries the peak envelope power (PEP) in dBm for digital modulation and all digital standards. This value corresponds to the value shown under the **Level** specification in the PEP lines in the display header.

Return values:

<Pep> float

Example:

POW:PEP?
queries the PEP value for RF output A in the case of digital modulation.
Response: 4
the PEP value for RF output A is 4 dBm.

Usage: Query only

[:SOURce<hw>]:POWER:POWER <Power>

Sets the RF level of the RF output connector.

The level entered with this command corresponds to the level at the RF output, i.e. any offset entry is not taken into consideration.

Note: The SCPI command [:SOURce<hw>]:POWER[:LEVel][:IMMediate][:AMPLitude] sets the level of the "Level" display, i.e. the level containing offset.

Parameters:

<Power> Minimum level ... Maximum level
 The value range for the level setting varies according to the instrument model.
 The values are given in the data sheet.
 Increment: 0.01
 *RST: -30

Example:

SOUR:POW:POW 15
 sets the RF level at output to 15 dBm.

Manual operation: See "[Amplitude](#)" on page 223

[[:SOURce<hw>]:POWER:SPC:CRANge <PowCntrlCRange>

Defines the capture range of the power control system.

Within the range:

Target Level +/- Catch Range

the power control locks and tries to achieve the target level. Readings outside the range are not considered.

Parameters:

<PowCntrlCRange> float
 Range: 0 to 50
 Increment: 0.01
 *RST: 30
 Default unit: dB

Example:

POW:SPC:CRAN 15
 sets the capture range to +/- 15 dB.

Manual operation: See "[Catch Range +/-](#)" on page 232

[[:SOURce<hw>]:POWER:SPC:DELay <PowCntrlDelay>

Defines a waiting period between the level adjustment of the generator and the next measurement of the power sensor.

Parameters:

<PowCntrlDelay> integer
 Range: 0 to 1000
 *RST: 0

Example:

POW:SPC:DEL 2 ms
 the sensor starts the next reading 2 ms after the level adjustment.

Manual operation: See "[Delay Time](#)" on page 233

[[:SOURce<hw>]:POWER:SPC:PEAK <PowCntrlPeak>

Activates power control by means of the peak power values, provided the power sensor supports this function.

Parameters:

<PowCntrlPeak> 0 | 1 | OFF | ON
*RST: 0

Example:

POW:SPC:PEAK ON
uses the measured peak power for power control.

Manual operation: See "[Use Peak Power](#)" on page 233

[[:SOURce<hw>]:POWER:SPC:SElect <PowCntrlSelect>

Defines the currently selected sensor to be used for power control.

Parameters:

<PowCntrlSelect> SENS1 | SENS2 | SENS3 | SENS4
*RST: SENS1

Example:

POW:SPC:SEL SENS2
selects the sensor connected to a second USB interface for power control.

Manual operation: See "[Sensor](#)" on page 231

[[:SOURce<hw>]:POWER:SPC:STATe <PowCntrlState>

Activates power control using the selected sensor. The control loop periodically adjusts the generator output. After switching off, the running loop is completed.

Parameters:

<PowCntrlState> 0 | 1 | OFF | ON
*RST: 0

Example:

POW:SPC:STAT ON
activates power control.

Manual operation: See "[State](#)" on page 231

[[:SOURce<hw>]:POWER:SPC:TARGet <PowCntrlTarget>

Sets the nominal level expected at the input of the sensor. To define the unit of the power value, use command `:SENSe<ch>:UNIT[:POWER]` on page 594.

Parameters:

<PowCntrlTarget> float
Range: -50 to 30
Increment: 0.01
*RST: -10

Example: SENS:UNIT dBm
selects unit dBm for setting the target level value.
POW:SPC:TARG -10
sets -10 dBm target level.

Manual operation: See "[Target Level](#)" on page 232

[:SOURce<hw>]:POWER:START <Start>

Sets the start level for the RF sweep.

Note: You can select any level within the setting range. The range is defined by this start value and the [:SOURce<hw>]:POWER:STOP value.

A defined offset ([:SOURce<hw>]:POWER[:LEVel] [:IMMediate]:OFFSet) affects the level values according to the formula:

Minimum level + OFFSet ... Maximum level + OFFSet

Parameters:

<Start> float
Determines the first level value of the sweep setting range.
Range: full specified level range
Increment: see the data sheet: Level sweep > Step size setting resolution
*RST: -30

Example: POW:STAR -20 dBm
sets the start level for the level sweep to -15 dBm for RF output A.

Manual operation: See "[Start Level - Level Sweep](#)" on page 289

[:SOURce<hw>]:POWER:STEP[:INCRement] <Increment>

Sets the step width for POW:STEP:MODE USER.

To adjust the level step by step with this step size, use the POW:UP and POW:UP commands.

Note: This value also applies to the step width of the rotary knob of the instrument and increases or decreases the level accordingly, when you work in user-defined step mode.

Parameters:

<Increment> float
Range: full specified level range
Increment: see the data sheet: Level sweep > Step size setting resolution
*RST: 1

Example: POW:STEP 2
sets the step width for entering the RF level to 2 dB.

Manual operation: See " [Variation Step](#) " on page 226

[:SOURce<hw>]:POWer:STEP:MODE <Mode>

Activates (USER) or deactivates (DECimal) the user-defined step width used when varying the level value with the level values UP/DOWN. The command is linked to setting "Variation Active" for manual control, i.e. the command also activates/deactivates the user-defined step width used when varying the level value with the rotary knob.

Parameters:

<Mode> DECimal | USER
 *RST: DECimal

Example:

POW:STEP 2
 sets the step width for the level setting to 2 dB.
 POW:STEP:MODE USER
 activates this step width for level variation with the rotary knob (manual control) and with level values UP/DOWN (remote control).

Manual operation: See " [Variation Active](#) " on page 225

[:SOURce<hw>]:POWer:STOP <Stop>

Sets the stop level for the RF sweep.

Note: You can select any level within the setting range. The range is defined by the [:SOURce<hw>]:POWer:START value and this stop value.

A defined offset ([:SOURce<hw>]:POWer[:LEVel] [:IMMediate]:OFFSet) affects the level values according to the formula:

Minimum level + OFFSet ... Maximum level + OFFSet

Parameters:

<Stop> float
 Determines the last level value of the sweep setting range.
 Range: full specified level range
 Increment: see the data sheet: Level sweep > Step size setting resolution
 *RST: -10

Example:

POW:STOP 3
 sets the stop level for the level sweep to 3 dBm for RF output A.

Manual operation: See " [Stop Level - Level Sweep](#) " on page 289

7.15.18 SOURce:PULM Subsystem

This subsystem contains the commands for setting the pulse modulation.

The LF generator is used as the internal modulation source. The pulse frequency of the internal rectangular signal is therefore set in the `SOURce:LFOutput` subsystem.

The external signal is input at the [PULSE EXT] connector. The connector can be used as trigger input for internal pulse modulation. The polarity and input impedance of the connector can be selected. The pulse modulation signal is output at the [PULSE VIDEO] connector.

Programming Examples

Example: Performing pulse modulation

This example shows a command sequence to perform pulse modulation.

```
// *****
// Reset the instrument to start from an initial state
// *****
*RST; *CLS

// *****
// Set the RF signal frequency and level
// *****
SOURce:FREQuency:CW 400000000
SOURce:POWer:LEVel:IMMediate:AMPLitude -25

// *****
// Configure the pulse modulation settings
// *****
// Select the internal modulation generator
SOURce:PULM:SOURce INT
// Set trigger mode
SOURce:PULM:TRIGger:MODE AUTO
// Select pulse mode
SOURce:PULM:MODE DOUB

// *****
// Alternatively configure the pulse modulation settings for
// external modulation source
// *****
// Select the external modulation source
SOURce:PULM:SOURce EXT
// Set the polarity of the externally applied modulation signal.
SOURce:PULM:POLarity NORMal
// Select the impedance for the external pulse modulation trigger input
SOURce:PULM:TRIGger:EXTernal:IMPedance G10K

// *****
// Configure the pulse generator settings
// *****
// Set pulse period
```

```

SOURce:PULM:PERiod 10 us
// Set pulse width
SOURce:PULM:WIDth 8 us
// Set double pulse width
SOURce:PULM:DOUBle:WIDth 0.0000012
// Set double pulse delay
SOURce:PULM:DOUBle:DELay 0.0000045

// *****
// Activate the signal output
// *****

SOURce:PGENERator:OUTPut:STATe 1
SOURce:PULM:STATe 1
OUTPut1:STATe 1

[:SOURce<hw>]:PULM:DELay..... 802
[:SOURce<hw>]:PULM:DOUBle:DELay.....802
[:SOURce<hw>]:PULM:DOUBle:STATe..... 803
[:SOURce<hw>]:PULM:DOUBle:WIDth..... 803
[:SOURce<hw>]:PULM:MODE..... 803
[:SOURce<hw>]:PULM:OUTPut:SYNc[:STATe].....804
[:SOURce<hw>]:PULM:PERiod..... 804
[:SOURce<hw>]:PULM:POLarity..... 805
[:SOURce<hw>]:PULM:SOURce..... 805
[:SOURce<hw>]:PULM:STATe.....805
[:SOURce<hw>]:PULM:TRIGger:EXTernal:GATE:POLarity.....806
[:SOURce<hw>]:PULM:TRIGger:EXTernal:IMPedance..... 806
[:SOURce<hw>]:PULM:TRIGger:EXTernal:SLOPe..... 806
[:SOURce<hw>]:PULM:TRIGger:MODE.....807
[:SOURce<hw>]:PULM:WIDth.....807

```

[:SOURce<hw>]:PULM:DELay <Delay>

Sets the pulse delay.

Parameters:

| | |
|---------|-------------------|
| <Delay> | float |
| | Range: 0 to 100 s |
| | Increment: 10 ns |
| | *RST: 10 ns |

Example:

```
PULM:DEL 13 us
13 us elapse after a trigger before the first pulse is generated.
```

Options:

R&S R&S SMBV-K23 (Pulse Generator)

Manual operation: See " [Pulse Delay - Pulse Generator](#) " on page 274

[:SOURce<hw>]:PULM:DOUBle:DELay <Delay>

Sets the delay from the start of the first pulse to the start of the second pulse.

Parameters:

<Delay> float
 Range: 10 ns to 100 s
 Increment: 5 ns
 *RST: 3 us

Example:

PULM:DOUB:DEL 22 us
 22 us elapse between the beginning of the first pulse and the beginning of the second pulse in double-pulse mode.

Options:

R&S SMBV-K23 (Pulse Generator)

Manual operation: See " [Double Pulse Delay - Pulse Generator](#) " on page 274

[[:SOURce<hw>]:PULM:DOUBle:STATe <State>

Activates double pulse generation. The two pulses are generated in one pulse period.

Parameters:

<State> 0 | 1 | OFF | ON
 *RST: 0

Example:

PULM:DOUB:STAT ON
 double-pulse mode is enabled.

Options:

R&S SMBV-K23 (Pulse Generator)

[[:SOURce<hw>]:PULM:DOUBle:WIDTh <Width>

Sets the width of the second pulse in case of double pulse generation.

Parameters:

<Width> float
 Range: 10 ns to 100 s
 Increment: 10 ns
 *RST: 3 us

Example:

PULM:DOUB:WIDT 33 us
 sets a width of 33 us for the second pulse.

Options:

R&S SMBV-K23 (Pulse Generator)

Manual operation: See " [Double Pulse Width - Pulse Generator](#) " on page 274

[[:SOURce<hw>]:PULM:MODE <Mode>

Sets the mode of the pulse generator.

Parameters:

<Mode> SINGle | DOUBle
SINGle
 Enables single pulse generation.

DOUBle

Enables double pulse generation. The two pulses are generated in one pulse period.

*RST: SINGLE

Example:

PULM:MODE DOUB
enables double pulse generation.

Options:

R&S SMBV-K23 (Pulse Generator)

Manual operation: See " [Pulse Mode - Pulse Generator](#) " on page 273

[:SOURce<hw>]:PULM:OUTPut:SYNC[:STATe] <Sync>

Configures the signal at the [SIGNAL VALID] connector.

Parameters:

<Sync> 0 | 1 | OFF | ON

ON

Generates a single pulse at the beginning of a pulse sequence, e.g. to synchronize pulse modulation.

OFF

Returns the validity of the RF signal at the output:

1 (high), while the signal settles.

0 (low), when it is stable (valid).

*RST: OFF

Example:

PULM:OUTP:SYNC ON
uses the signal for synchronizing the pulse modulation.

Options:

R&S SMBV-K23 (Pulse Generator)

Manual operation: See "[Use SIGNAL VALID as Pulse Sync](#)" on page 278

[:SOURce<hw>]:PULM:PERiod <Period>

Sets the period of the generated pulse. The period determines the repetition frequency of the internal signal.

Parameters:

<Period> float

Range: 5 us | 20 ns to 100 s

Increment: 1us | 5 ns

*RST: 10 us

Example:

PULM:PER 220 us
the pulse period is 220 us.

Options:

R&S SMBV-K23 (Pulse Generator)

Manual operation: See " [Pulse Period - Pulse Generator](#) " on page 273

[[:SOURce<hw>]:PULM:POLarity <Polarity>

Sets the polarity between modulating and modulated signal. This command is effective only for an external modulation signal.

Parameters:

<Polarity> NORMal | INVerted

NORMal

The RF signal is suppressed during the pulse pause.

INVerted

The RF signal is suppressed during the pulse.

*RST: NORMal

Example:

PULM:SOUR EXT

selects the external modulation source.

Example:

PULM:POL INV

selects inverted polarity.

Manual operation: See "[Polarity](#)" on page 264

[[:SOURce<hw>]:PULM:SOURce <Source>

Selects the source for the pulse modulation signal.

Parameters:

<Source> INTernal | EXTernal

INTernal

The internally generated rectangular signal is used for the pulse modulation. The frequency of the internal signal can be set in the `SOURce:LFOutput` subsystem.

EXTernal

The signal applied externally via the EXT MOD connector is used for the pulse modulation.

*RST: INTernal

Example:

PULM:SOUR INT

selects the internal modulation source.

PULM:STAT ON

activates the pulse modulation.

Usage:

SCPI confirmed

Options:

R&S SMBV-K22 (Pulse Modulator)

Manual operation: See "[Source](#)" on page 264

[[:SOURce<hw>]:PULM:STATe <State>

Activates the pulse modulation.

Parameters:

<State> 0 | 1 | OFF | ON
 *RST: 0

Example:

PULM:STAT ON
 activates pulse modulation.

Manual operation: See "[State](#)" on page 263

[[:SOURce<hw>]:PULM:TRIGger:EXTernal:GATE:POLarity <Polarity>

Selects the polarity of the Gate signal.

The signal is supplied via the [PULSE EXT] connector.

Parameters:

<Polarity> NORMal | INVerted
 *RST: NORMal

Example:

PULM:TRIG:EXT:GATE:POL NORM
 The pulse signal is generated while the gate signal is high.

Options: R&S SMBV-K23 (Pulse Generator)

Manual operation: See "[Gate Input Polarity - Pulse Generator](#)" on page 278

[[:SOURce<hw>]:PULM:TRIGger:EXTernal:IMPedance <Impedance>

Selects the impedance for external pulse trigger.

Parameters:

<Impedance> G50 | G10K
 *RST: G50

Example:

SOUR:PULM:TRIG:EXT:IMP G50
 selects 50 Ohm as the trigger impedance for the external pulse trigger.

Options: R&S SMBV-K22 (Pulse Modulator)

Manual operation: See "[External Impedance](#)" on page 278

[[:SOURce<hw>]:PULM:TRIGger:EXTernal:SLOPe <Slope>

Sets the polarity of the active slope of an applied trigger at the [PULSE EXT] connector.

Parameters:

<Slope> NEGative | POSitive
 *RST: POSitive

Example:

PULM:TRIG:EXT:SLOP NEG
 The pulse generator is triggered on the negative slope of the external trigger signal.

Options: R&S SMBV-K23 (Pulse Generator)
Manual operation: See " [External Trigger Input Slope - Pulse Generator](#) " on page 277

[:SOURce<hw>]:PULM:TRIGger:MODE <Mode>

Selects the trigger mode for pulse modulation.

Parameters:

<Mode> AUTO | EXTeRnal | EGATe

AUTO

The pulse modulation is generated continuously.

EXTeRnal

The pulse modulation is triggered by an external trigger event. The trigger signal is supplied via the [PULSE EXT] connector.

EGATe

The pulse modulation is gated by an external gate signal. The signal is supplied via the [PULSE EXT] connector.

*RST: AUTO

Example: PULM:TRIG:MODE EXT
 selects triggering by an external trigger event.

Options: R&S SMBV-K23 (Pulse Generator)

Manual operation: See " [Trigger Mode - Pulse Generator](#) " on page 274

[:SOURce<hw>]:PULM:WIDTh <Width>

Sets the width of the generated pulse. The width determines the pulse length. The pulse width must be at least 20ns less than the set pulse period.

Parameters:

<Width> float
 Range: 10 ns to 100 s
 Increment: 10 ns
 *RST: 2 us

Example: PULM:WIDT 33 us
 sets a width of 33 us for the pulse.

Options: R&S SMBV-K23 (Pulse Generator)

Manual operation: See " [Pulse Width - Pulse Generator](#) " on page 274

7.15.19 SOURce:ROSCillator Subsystem

This subsystem contains the commands for setting the external and internal reference frequency.



The settings of the reference oscillator are not affected by an instrument reset (***RST** on page 535). They are only reset to factory state by the factory-preset (**:SYSTem:FPReset** on page 538).

| | |
|--|-----|
| [:SOURce]:ROSCillator:EXTernal:FREQUENCY | 808 |
| [:SOURce]:ROSCillator:EXTernal:RFOFF[:STATe] | 808 |
| [:SOURce]:ROSCillator:EXTernal:SBANdwidth | 809 |
| [:SOURce]:ROSCillator[:INTernal]:ADJust:VALue | 809 |
| [:SOURce]:ROSCillator[:INTernal]:ADJust[:STATe] | 809 |
| [:SOURce]:ROSCillator:SOURce | 810 |

[:SOURce]:ROSCillator:EXTernal:FREQUENCY <Frequency>

Selects the external reference frequency.

Note: The installed hardware determines the available settings. Use the [Hardware Config](#) dialog to check the hardware the instrument is equipped with.

For information on the required hardware revision, refer to the release notes.

Parameters:

<Frequency> 5MHZ | 10MHZ
 *RST: n.a. (factory preset: 10MHZ)

Example:

```
ROSC:SOUR EXT
Selects the external source. The reference must be input at the
REF IN input.
ROSC:EXT:FREQ 10MHz
Selects 10 MHz external reference frequency.
```

Manual operation: See "[External Reference Frequency](#)" on page 217

[:SOURce]:ROSCillator:EXTernal:RFOFF[:STATe] <State>

Activates that RF output is automatically switched off, when in external source mode no reference signal is supplied.

This setting ensures that no improper RF signal due to the missing external reference signal is output and used for measurements.

In addition to the error message "Ext Ref missing", the instrument generates the message "RF output deactivated".

Parameters:

<State> 0 | 1 | OFF | ON
 *RST: n.a. (factory preset: 0)

Example:

```
ROSC:SOUR EXT
Selects the external source. The reference must be input at the
REF IN input.
```

Example:

```
ROSC:EXT:RFOF:STAT ON
If the external signal is missing, no RF signal is output.
```

Manual operation: See "[Deactivate RF Output \(if external reference is missing\)](#)" on page 217

[:SOURce]:ROSCillator:EXTernal:SBANdwidth <SBandwidth>

Sets the synchronization bandwidth for an external reference signal.

Parameters:

<SBandwidth>

WIDE | NARRow

NARRow

The synchronization bandwidth is approx. 50 Hz.

WIDE

The synchronization bandwidth is approx. 350 Hz.

*RST: n.a. (factory preset)

Example:

ROSC:SOUR EXT

Selects the external source.

ROSC:EXT:FREQ 10 MHz

Informs the instrument that the external reference has a frequency of 10 MHz.

ROSC:EXT:SBAN WID

Selects wideband setting for synchronization bandwidth.

Manual operation: See "[Synchronization Bandwidth](#)" on page 217

[:SOURce]:ROSCillator[:INTernal]:ADJust:VALue <Value>

Specifies the frequency correction value (adjustment value).

Parameters:

<Value>

integer

Range: 0 to maximum value (see data sheet)

Increment: see data sheet

*RST: ---

Example:

ROSC:ADJ:VAL 456

Sets the adjustment value to 456.

Manual operation: See "[Adjustment DAC Value](#)" on page 218

[:SOURce]:ROSCillator[:INTernal]:ADJust[:STATe] <State>

Determines whether the calibrated (OFF) or a user-defined (ON) adjustment value is used for fine adjustment of the frequency.

If user-defined values are used, the instrument is no longer in the calibrated state. However, the calibration value is not changed and the instrument resumes the calibrated state after sending the com-

mand `:SOURce:ROSCillator:INTernal:ADJust:STATe OFF`.

Parameters:

<State> 0 | 1 | OFF | ON
 *RST: n.a. (factory preset: 0)

Example:

ROSC:SOUR INT
 Selects the internal source.
 ROSC:ADJ ON
 Activates use of a user-defined adjustment value.
 ROSC:ADJ:VAL 1400
 Sets the adjustment value to 1400.

Manual operation: See "[Adjustment Active](#)" on page 217

[:SOURce]:ROSCillator:SOURce <Source>

Selects the reference frequency source.

Parameters:

<Source> INTernal | EXTernal

INTernal

The internal reference oscillator is used.

EXTernal

An external reference signal is used. It must be input at the [REF IN] connector at the rear of the instrument.

The instrument is informed of the frequency of the external reference signal with the command `[:SOURce] :ROSCillator :EXTernal :FREQuency`.

*RST: n.a. (factory preset: INTernal)

Example:

ROSC:SOUR EXT
 Selects the external source.
 ROSC:EXT:FREQ 5 MHz
 Informs the instrument that the external reference has a frequency of 5 MHz.

Manual operation: See "[Source](#)" on page 217

7.15.20 SOURce:SWEep Subsystem

The SOURce : subsystem contains the commands for configuring RF sweep signals.



- The keyword [:FREQUENCY] can be omitted, then the commands are SCPI-compliant.
- To activate a RF sweep mode, use the following commands:
 - RF frequency sweep: SOURce:FREQUENCY:MODE SWEep (SOURce:FREQUENCY:MODE CW (off))
 - RF level sweep: SOURce:POWer:MODE SWEep (SOURce:POWer:MODE CW (off))
- All sweeps, including the LF sweep, can be set independently from each other.

This example shows how to set up a frequency sweep.

1. Set the sweep range.
 SOUR:FREQ:CENT 200 MHz
 SOUR:FREQ:SPAN 300 MHz
2. Select linear or logarithmic spacing.
 SOUR:SWE:FREQ:SPAC LIN
3. Set the step width and dwell time.
 SOUR:SWE:FREQ:STEP:LIN 20 MHz
 SOUR:SWE:FREQ:DWEL 12 ms
4. Select the trigger mode.
 TRIG:FSW:SOUR SING
5. Select the sweep mode and activate the sweep.
 SOUR:SWE:FREQ:MODE AUTO
 SOUR:FREQ:MODE SWE
6. Trigger the sweep.
 SOURce:SWE:FREQ:EXEC



It is recommended that you switch off the "Start/Stop Display Update" for optimum sweep performance, especially with short dwell times (SYST:DISP:UPD OFF).

| | |
|---|-----|
| [:SOURce<hw>]:SWEep[:FREQUENCY]:DWELI..... | 812 |
| [:SOURce<hw>]:SWEep[:FREQUENCY]:EXECute..... | 812 |
| [:SOURce<hw>]:SWEep[:FREQUENCY]:MODE..... | 812 |
| [:SOURce<hw>]:SWEep[:FREQUENCY]:POINTs..... | 813 |
| [:SOURce<hw>]:SWEep[:FREQUENCY]:RETRace..... | 814 |
| [:SOURce<hw>]:SWEep[:FREQUENCY]:RUNNing?..... | 814 |
| [:SOURce<hw>]:SWEep[:FREQUENCY]:SHApe..... | 814 |
| [:SOURce<hw>]:SWEep[:FREQUENCY]:SPACing..... | 815 |
| [:SOURce<hw>]:SWEep[:FREQUENCY]:STEP[:LINear]..... | 815 |
| [:SOURce<hw>]:SWEep[:FREQUENCY]:STEP:LOGarithmic..... | 816 |
| [:SOURce<hw>]:SWEep:POWer:DATTenuator:STATe..... | 817 |
| [:SOURce<hw>]:SWEep:POWer:DWELI..... | 817 |
| [:SOURce<hw>]:SWEep:POWer:EXECute..... | 817 |

| | |
|---|-----|
| <code>[:SOURce<hw>]:SWEep:POWer:MODE</code> | 818 |
| <code>[:SOURce<hw>]:SWEep:POWer:POINts</code> | 818 |
| <code>[:SOURce<hw>]:SWEep:POWer:RETRace</code> | 819 |
| <code>[:SOURce<hw>]:SWEep:POWer:RUNNing?</code> | 819 |
| <code>[:SOURce<hw>]:SWEep:POWer:SHAPE</code> | 819 |
| <code>[:SOURce<hw>]:SWEep:POWer:SPACing:MODE?</code> | 820 |
| <code>[:SOURce<hw>]:SWEep:POWer:STEP[:LOGarithmic]</code> | 820 |
| <code>[:SOURce<hw>]:SWEep:RESet[:ALL]</code> | 821 |

`[:SOURce<hw>]:SWEep[:FREQuency]:DWELl <Dwell>`

Sets the time taken for each frequency step of the sweep.

The keyword `[:FREQuency]` can be omitted (see example). The command is then SCPI-compliant.

Tip: It is recommended to switch off the "Display Update" for optimum sweep performance especially with short dwell times (`SYSTem:DISPlay:UPDate OFF`).

Parameters:

| | |
|----------------------------|--------------------|
| <code><Dwell></code> | float |
| | Range: 2E-3 to 100 |
| | Increment: 100E-6 |
| | *RST: 15E-3 |

Example: `SWE:DWEL 12 ms`
sets a dwell time of 12 ms for a frequency sweep at the RF output.

Manual operation: See " [Dwell Time - Frequency Sweep](#) " on page 285

`[:SOURce<hw>]:SWEep[:FREQuency]:EXECute`

Starts an RF frequency sweep cycle manually.

The command is only effective in single mode.

Example: `TRIG:FSW:SOUR SING`
`SOUR:SWE:FREQ:MODE AUT`
`SWE:FREQ:EXEC`
triggers a frequency sweep at the RF output.

Usage: Event

Manual operation: See " [Execute Single Sweep - Frequency Sweep](#) " on page 282

`[:SOURce<hw>]:SWEep[:FREQuency]:MODE <Mode>`

Sets the sweep mode.

The keyword [:FREQuency] can be omitted (see example). The command is then SCPI-compliant.

Parameters:

<Mode> AUTO | MANual | STEP

AUTO

Each trigger triggers exactly one complete sweep.

MANual

The trigger system is not active. Each frequency step of the sweep is triggered individually, either by varying the "Current Frequency" value using the rotary knob under manual control or by means of a `FREQ:MAN` command under remote control. With manual control, the frequency increases or decreases (depending on the direction of the rotary encoder) by the value specified under `FREQ:STEP:INCRement`. With remote control, the frequency is set directly with the command `:FREQ:MAN`.

STEP

Each trigger triggers one sweep step only (Mode Single Step). The frequency increases by the value entered under `SOUR:SWE:FREQ:STEP:LIN` (linear spacing) or `...:STEP:LOG` (logarithmic spacing).

*RST: AUTO

Example:

`SWE:MODE AUTO`

selects **Mode Auto** for a frequency sweep at the RF output.

Manual operation: See " [Mode - RF Frequency Sweep](#) " on page 280

[:SOURce<hw>]:SWEep[:FREQuency]:POINTs <Points>

Determines the number of steps for the RF frequency sweep within the sweep range.

This parameter always applies to the currently set sweep spacing and correlates with the step size as follows:

- for linear sweeps

$$\text{freq_points} = (f_{\text{SPAN}} / \text{step_lin}) + 1$$
 To determine the step size, use the command `SWE:STEP[:LIN]`.
- logarithmic sweeps and $f_{\text{START}} < f_{\text{STOP}}$

$$\text{freq_points} = ((\log f_{\text{STOP}} - \log f_{\text{START}}) / \log \text{step_log}) + 1$$
 To determine the logarithmic step size, use the command `SWE:STEP:LOG`.

If you change the number of sweep points, the step size changes accordingly. The sweep range remains the same.

Parameters:

<Points> integer
 Range: 2..max

Example:

```
FREQ:STAR
sets the start frequency to 100 MHz.
FREQ:STOP
sets the stop frequency to 500 MHz.
SWE:SPAC LIN
sets linear sweep spacing.
SWE:POIN 401
sets 401 sweep steps for linear sweep spacing. The sweep step
width (STEP) is automatically set to 1 MHz.
```

[[:SOURce<hw>]:SWEep[:FREQuency]:RETRace <State>

Activates that the signal changes to the start frequency value while it is waiting for the next trigger event.

You can enable this feature, when you are working with sawtooth shapes in sweep mode "Single" or "External Single".

Parameters:

<State> 0 | 1 | OFF | ON
*RST: 0

Example:

```
TRIG0:SWE:SOUR SING
FREQ:MODE SWE
SWE:SHAP SAWT
SWE:RETR ON
```

activates retrace function, i.e. the frequency changes to the value at start frequency while waiting for the next trigger event.

Manual operation: See "[Retrace - RF Frequency Sweep](#)" on page 284

[[:SOURce<hw>]:SWEep[:FREQuency]:RUNNING?

Queries the current state of the frequency sweep mode.

Return values:

<State> 0 | 1 | OFF | ON

Example:

```
SWE:RUNN?
```

Response "1": signal generation in level sweep active.

Usage:

Query only

[[:SOURce<hw>]:SWEep[:FREQuency]:SHAPE <Shape>

Sets the cycle mode for a sweep sequence (shape).

Parameters:

<Shape> SAWTooth | TRIangle

SAWTooth

One sweep runs from start to stop frequency. Each subsequent sweep starts at the start frequency, i.e. the shape of the sweep sequence resembles a sawtooth.

TRiangle

One sweep runs from start to stop frequency and back, i.e. the shape of the sweep resembles a triangle. Each subsequent sweep starts at the start frequency.

*RST: SAWTooth

Example:

SOUR:SWE:SHAP TRI

selects the sweep cycle with alternating ascending and descending sweep directions.

Manual operation: See " [Shape - RF Frequency Sweep](#) " on page 284

[:SOURce<hw>]:SWEep[:FREQuency]:SPACing <Spacing>

Selects the mode for the calculation of the frequency sweep intervals. The frequency increases or decreases by this value at each step.

The keyword [:FREQuency] can be omitted. Then the command is SCPI-compliant.

Parameters:

<Spacing>

LINear | LOGarithmic

LINear

With the linear sweep, the step width is a fixed frequency value which is added to the current frequency. The step width for linear sweep is entered in Hz (see [:SOURce<hw>]:SWEep[:FREQuency]:STEP[:LINear] on page 815).

LOGarithmic

With the logarithmic sweep, the step width is a constant fraction of the current frequency. This fraction is added to the current frequency. The logarithmic step width is entered in % (see [:SOURce<hw>]:SWEep[:FREQuency]:STEP:LOGarithmic on page 816).

*RST: LINear

Example:

SWE:SPAC LIN

selects linear sweep spacing for a frequency sweep at the RF output.

Manual operation: See " [Spacing - Frequency Sweep](#) " on page 283

[:SOURce<hw>]:SWEep[:FREQuency]:STEP[:LINear] <Linear>

Sets the step size for linear RF frequency sweep steps.

This parameter is related to the number of steps ([:SOURce<hw>]:SWEep[:FREQuency]:POINTs) within the sweep range as follows:

$$f_{\text{START}} < f_{\text{STOP}}$$

$$\text{freq_points} = (f_{\text{SPAN}} / \text{step_lin}) + 1$$

If you change the step size, the number of steps changes accordingly. The sweep range remains the same.

The keywords `[:FREQuency]` and `[:LINear]` can be omitted. The command is then SCPI-compliant.

Parameters:

<Linear> float
 Range: full frequency range
 Increment: see the data sheet: RF characteristics > Resolution of setting

Example:

```
FREQ:STAR 1GHz
sets the start frequency to 1 GHz.
FREQ:STOP 5GHz
sets the stop frequency to 5 GHz.
SWE:SPAC LIN
sets linear sweep spacing.
SWE:STEP 2 MHz
sets the step width for linear sweep spacing to 2 MHz (RF sweep) at the RF output. The number of sweep steps for linear sweep spacing (POINTS) is automatically set to 2001.
```

Manual operation: See "[Step Lin/Log - Frequency Sweep](#)" on page 284

`[:SOURce<hw>]:SWEep[:FREQuency]:STEP:LOGarithmic <Logarithmic>`

Sets a logarithmically determined sweep step size for the RF frequency sweep. It is expressed in percent and you must enter the *value* and the unit *PCT* with the command.

The frequency is increased by a logarithmically calculated fraction of the current frequency according to:

$$\text{step_log}_{n+1} = f_n + \text{step_log}_n \times f_n$$

$$f_{n+1} = f_n + \text{step_log}_{n+1}$$

with $f_{\text{START}} < f_{\text{STOP}}$ and n = number of sweep steps

This parameter correlates with the number of steps `SWE:FREQ:POIN` within the sweep range as follows:

$$\text{freq_points} = ((\log f_{\text{STOP}} - \log f_{\text{START}}) / \log \text{step_log}) + 1$$

If you change the step size, the number of steps changes accordingly. The sweep range remains the same.

Parameters:

<Logarithmic> float
 Range: 0.01 to 100
 Increment: 1E-3
 *RST: 1

Example:

FREQ:STAR 1GHz
 sets the start frequency to 1 GHz.
 FREQ:STOP 5GHz
 sets the stop frequency to 5 GHz.
 SWE:SPAC LOG
 sets logarithmic sweep spacing.
 SWE:STEP:LOG 10PCT
 sets the step width for logarithmic sweep spacing to 10% of the previous frequency in each instance (for a frequency sweep).

Manual operation: See "[Step Lin/Log - Frequency Sweep](#)" on page 284

[:SOURce<hw>]:SWEep:POWer:DATTenuator:STATe <Dattstate>

Activates digital attenuation during RF power sweep.

Parameters:

<Dattstate> 0 | 1 | OFF | ON
 *RST: 0

Example:

SWE:POW:DATT:STAT ON
 switches on digital attenuation.

Manual operation: See "[Use Digital Attenuation](#)" on page 289

[:SOURce<hw>]:SWEep:POWer:DWELI <Dwell>

Sets the time taken for each level step of the sweep.

Tip: It is recommended to switch off the "Display Update" for optimum sweep performance especially with short dwell times (`SYSTem:DISPlay:UPDate OFF`).

Parameters:

<Dwell> float
 Range: 1E-3 to 100
 Increment: 100E-6
 *RST: 15E-3

Example:

SWE:POW:DWEL 12 ms
 sets a dwell time of 12 ms for a level sweep at the RF output.

Manual operation: See "[Dwell Time - Level Sweep](#)" on page 290

[:SOURce<hw>]:SWEep:POWer:EXECute

Triggers a sweep.

- Example:** `SWE:POW:EXEC`
triggers a level sweep at the RF output.
- Usage:** Event
- Manual operation:** See " [Execute Single Sweep - Level Sweep](#) " on page 289

[:SOURce<hw>]:SWEep:POWer:MODE <Mode>

Sets the cycle mode of the level sweep.

Parameters:

<Mode>

AUTO | MANual | STEP

AUTO

Each trigger triggers exactly one complete sweep.

MANual

The trigger system is not active. Each level step of the sweep is triggered individually, either by varying the "Current Level" value using the rotary knob under manual control or by means of a `POW:MAN` command under remote control.

With manual control, the level increases or decreases (depending on the direction of the rotary encoder) by the value specified under `SOUR:SWE:POW:STEP`. With remote control, the level increases by the value specified under `SWEep:POW:STEP` which each sent `:POW:MAN` command, irrespective the value entered there.

STEP

Each trigger triggers one sweep step only. The level increases by the value entered under `:SWEep:POWer:STEP`.

*RST: AUTO

- Example:** `SWE:POW:MODE AUTO`
selects Mode Auto for a level sweep at RF output.

Manual operation: See " [Mode - Level Sweep](#) " on page 286

[:SOURce<hw>]:SWEep:POWer:POINts <Points>

Determines the number of steps for the RF level sweep within the sweep range.

This parameter always applies to the currently set sweep spacing and correlates with the step size as follows:

$$\text{pow_points} = (f_{\text{STOP}} - f_{\text{START}} / \text{step_log}) + 1$$

To determine the step size use the command `SWE:POW:STEP[:LOG]`.

If you change the number of sweep points, the step size changes accordingly. The sweep range remains the same.

Parameters:

<Points> integer
 Range: 2...max

Example:

```
POW:STAR - 30 dBm
sets the start frequency to -30 dBm.
POW:STOP - 10 dBm
sets the stop frequency to -10 dBm.
SWE:POW:POIN 20
sets 20 sweep steps. The sweep step width (STEP) is automati-
cally set to 1 dB.
```

[[:SOURce<hw>]:SWEep:POWer:RETRace <State>

Activates that the signal changes to the start level value while it is waiting for the next trigger event.

You can enable this feature, when you are working with sawtooth shapes in sweep mode "Single" or "External Single".

Parameters:

<State> 0 | 1 | OFF | ON
 *RST: 0

Example:

```
TRIG0:SWE:SOUR SING
POW:MODE SWE
SWE:POW:SHAP SAWT
SWE:POW:RETR ON
activates retrace function, i.e. the level changes to the value at
start level while waiting for the next trigger event.
```

Manual operation: See "[Retrace - RF Level Sweep](#)" on page 290

[[:SOURce<hw>]:SWEep:POWer:RUNNing?

Queries the current state of the level sweep mode.

Return values:

<State> 0 | 1 | OFF | ON

Example:

```
SWE:POW:RUNN?
Response "1": signal generation in level sweep active.
```

Usage: Query only

[[:SOURce<hw>]:SWEep:POWer:SHAPe <Shape>

Sets the cycle mode for a sweep sequence (shape).

Parameters:

<Shape> SAWTooth | TRIangle

SAWTooth

One sweep runs from the start level to the stop level. The subsequent sweep starts at the start level again, i.e. the shape of sweep sequence resembles a sawtooth.

TRiangle

One sweep runs from start to stop level and back, i.e. the shape of the sweep resembles a triangle. Each subsequent sweep starts at the start level again.

*RST: SAWTooth

Example:

SOUR:SWE:POW:SHAP TRI
selects the sweep cycle with alternating ascending and descending sweep directions.

Manual operation: See "[Shape - RF Level Sweep](#)" on page 289

[[:SOURce<hw>]:SWEep:POWer:SPACing:MODE?

Queries the sweep spacing mode. The sweep spacing for level sweeps is always linear.

Return values:

<Mode> LINear
*RST: LINear

Example:

SWE:POW:SPAC:MODE?
queries the sweep spacing for a level sweep at RF output.
Result: LIN
linear spacing

Usage: Query only

[[:SOURce<hw>]:SWEep:POWer:STEP[:LOGarithmic] <Logarithmic>

Sets a logarithmically determined sweep step size for the RF level sweep. It is expressed in decibels and you must enter the *value* and the unit *dB* with the command.

The level is increased by a logarithmically calculated fraction of the current level according to:

$$\text{step_size}_{n+1} = \text{Level}_n + \text{step_size}_n \times \text{Level}_n$$

$$\text{Level}_{n+1} = \text{Level}_n + \text{step_size}_{n+1}$$

with $\text{Level}_{\text{START}} < \text{level}_{\text{STOP}}$, $\text{step_size} = \text{SWE:POW:STEP[:LOG]}$ and $n =$ number of sweep steps

This parameter correlates with the number of steps `SWE:POW:POIN` within the sweep range as follows:

$$\text{level_points} = ((\text{Level}_{\text{STOP}} - \text{Level}_{\text{START}}) / \text{step_size}) + 1$$

If you change the step size, the number of steps changes accordingly. The sweep range remains the same.

Parameters:

<Logarithmic> float
 Increment: 0.01
 *RST: 1

Example:

SWE:POW:STEP 10dB
 sets the step width for logarithmic sweep spacing to 10 dB of the previous level in each instance (for a level sweep).

Manual operation: See " [Step - Level Sweep](#) " on page 290

[:SOURce<hw>]:SWEep:RESet[:ALL]

Resets all active sweeps to the starting point.

Example:

SWE:RES
 resets all active sweeps to the starting point.

Usage:

Event

Manual operation: See " [Reset Sweep](#) " on page 269

7.16 STATus Subsystem

This system contains the commands for the status reporting system. See also [Chapter 6.5, "Status Reporting System"](#), on page 522 for detailed information.

*RST on page 535 has no effect on the status registers.

Value ranges

- Queries return the current value of the respective register, which permits a check of the device status.
Return values: A decimal value in the range 0 to 32767 ($=2^{15}-1$)
- The configuration commands set the respective register thus determining which status changes of the R&S SMBV cause the status registers to be changed.
Setting values: A decimal value in the range 0 to 32767 ($=2^{15}-1$)

| | |
|----------------------------------|-----|
| :STATus:OPERation:CONDition? | 822 |
| :STATus:OPERation:ENABLE | 822 |
| :STATus:OPERation[:EVENT] | 822 |
| :STATus:OPERation:NTRansition | 822 |
| :STATus:OPERation:PTRansition | 823 |
| :STATus:PRESet | 823 |
| :STATus:QUESTionable:CONDition | 823 |
| :STATus:QUESTionable:ENABLE | 823 |
| :STATus:QUESTionable[:EVENT] | 824 |
| :STATus:QUESTionable:NTRansition | 824 |
| :STATus:QUESTionable:PTRansition | 824 |
| :STATus:QUEue[:NEXT]? | 824 |

:STATus:OPERation:CONDition?

Queries the content of the CONDition part of the STATus:OPERation register.

This part contains information on the action currently being performed in the instrument. The content is not deleted after being read out because it indicates the current hardware status.

Return values:

<Condition> string

Example: :STATus:OPERation:CONDition?

Usage: Query only

:STATus:OPERation:ENABle <Enable>

Sets the bits of the ENABle part of the STATus:OPERation register. This setting determines which events of the Status-Event part are forwarded to the sum bit in the status byte. These events can be used for a service request.

Parameters:

<Enable> string

Example: :STAT:OPER:ENAB 32767
all events are forwarded to the sum bit of the status byte.

:STATus:OPERation[:EVENT] <Event>

Queries the content of the EVENT part of the STATus:OPERation register. This part contains information on the actions performed in the instrument since the last readout. The content of the EVENT part is deleted after being read out.

Parameters:

<Event> string

Example: :STAT:OPER:EVENT?
queries the STATus:OPERation:EVENT register.

:STATus:OPERation:NTRansition <Ntransition>

Sets the bits of the NTRansition part of the STATus:OPERation register. If a bit is set, a transition from 1 to 0 in the condition part causes an entry to be made in the EVENT part of the register. The disappearance of an event in the hardware is thus registered, for example the end of an adjustment.

Parameters:

<Ntransition> string

Example: :STAT:OPER:NTR 0
a transition from 1 to 0 in the condition part of the Status:Operation register does not cause an entry to be made in the EVENT part.

:STATus:OPERation:PTRansition <Ptransition>

Sets the bits of the PTRansition part of the STATus:OPERation register. If a bit is set, a transition from 0 to 1 in the condition part causes an entry to be made in the EVENT part of the register. A new event in the hardware is thus registered, for example the start of an adjustment.

Parameters:

<Ptransition> string

Example:

`:STAT:OPER:PTR 32767`

all transitions from 0 to 1 in the condition part of the Status:Operation register cause an entry to be made in the EVENT part.

:STATus:PRESet <Preset>

Resets the status registers. All PTRansition parts are set to FFFFh (32767), i.e. all transitions from 0 to 1 are detected. All NTRansition parts are set to 0, i.e. a transition from 1 to 0 in a CONDition bit is not detected. The ENABle parts of STATus:OPERation and STATus:QUEStionable are set to 0, i.e. all events in these registers are not passed on.

Parameters:

<Preset> string

Example:

`STAT:PRES`

resets the status registers.

:STATus:QUEStionable:CONDition <Condition>

Queries the content of the CONDition part of the STATus:QUEStionable register. This part contains information on the action currently being performed in the instrument. The content is not deleted after being read out since it indicates the current hardware status.

Parameters:

<Condition> string

Example:

`:STATus:QUEStionable:CONDition?`

queries the Status:Questionable:Condition register.

:STATus:QUEStionable:ENABle <Enable>

Sets the bits of the ENABle part of the STATus:QUEStionable register. The enable part determines which events of the STATus:EVENT part are enabled for the summary bit in the status byte. These events can be used for a service request.

If a bit in the ENABle part is 1, and the corresponding EVENT bit is true, a positive transition occurs in the summary bit. This transition is reported to the next higher level.

Parameters:

<Enable> string

Example: `STAT:QUES:ENAB 1`
 Problems when performing an adjustment cause an entry to be made in the sum bit.

:STATus:QUESTionable[:EVENT] <Event>

Queries the content of the EVENT part of the STATus:QUESTionable register. This part contains information on the actions performed in the instrument since the last readout. The content of the EVENT part is deleted after being read out.

Parameters:

<Event> string

Example: `STAT:QUES:EVENT?`
 queries the Status:Questionable:Event register.

:STATus:QUESTionable:NTRansition <Ntransition>

Sets the bits of the NTRansition part of the STATus:QUESTionable register. If a bit is set, a transition from 1 to 0 in the condition part causes an entry to be made in the EVENT part of the register.

Parameters:

<Ntransition> string

Example: `STAT:QUES:NTR 0`
 a transition from 1 to 0 in the condition part of the STATus:QUESTionable register does not cause an entry to be made in the EVENT part

:STATus:QUESTionable:PTRansition <PTransition>

Sets the bits of the PTRansition part of the STATus:QUESTionable register. If a bit is set, a transition from 1 to 0 in the condition part causes an entry to be made in the EVENT part of the register.

Parameters:

<PTransition> string

Example: `STAT:QUES:PTR 32767`
 all transitions from 0 to 1 in the condition part of the STATus:QUESTionable register cause an entry to be made in the EVENT part

:STATus:QUEue[:NEXT]?

Queries the oldest entry in the error queue and then deletes it. Positive error numbers denote device-specific errors, and negative error numbers denote error messages defined by SCPI. If the error queue is empty, 0 ("No error") is returned.

The command is identical to `:SYSTem:ERRor[:NEXT]?` on page 828.

Return values:

<Next> string

Example:

:STATus:QUEue?

queries the oldest entry in the error queue.

Response: 0, 'no error'

no errors have occurred since the error queue was last read out

Usage:

Query only

7.17 SYSTem Subsystem

The SYSTem subsystem contains a series of commands for general functions which do not directly affect signal generation.

| | |
|---|-----|
| :SYSTem:ERRor:ALL? | 826 |
| :SYSTem:ERRor:CODE:ALL? | 827 |
| :SYSTem:ERRor:CODE[:NEXT]? | 827 |
| :SYSTem:ERRor:COUNt? | 828 |
| :SYSTem:ERRor[:NEXT]? | 828 |
| :SYSTem:ERRor:HISTory? | 828 |
| :SYSTem:ERRor:HISTory:CLEar | 829 |
| :SYSTem:ERRor:STATic? | 829 |
| :SYSTem:HELP:EXPort | 829 |
| :SYSTem:DLOCK | 830 |
| :SYSTem:KLOCK | 830 |
| :SYSTem:ULOCK | 830 |
| :SYSTem:RCL | 831 |
| :SYSTem:SAV | 831 |
| :SYSTem:SECurity:VOLMode[:STATe] | 831 |
| :SYSTem:COMMunicate:GPIB:LTERminator | 832 |
| :SYSTem:COMMunicate:GPIB[:SELF]:ADDRes | 832 |
| :SYSTem:COMMunicate:NETWork[:COMMOn]:DOMain | 832 |
| :SYSTem:COMMunicate:NETWork[:COMMOn]:HOSName | 832 |
| :SYSTem:COMMunicate:NETWork[:COMMOn]:WORKgroup | 833 |
| :SYSTem:COMMunicate:NETWork[:IPADdress]:DNS | 833 |
| :SYSTem:COMMunicate:NETWork:IPADdress:MODE | 833 |
| :SYSTem:COMMunicate:NETWork:IPADdress | 834 |
| :SYSTem:COMMunicate:NETWork[:IPADdress]:GATeway | 834 |
| :SYSTem:COMMunicate:NETWork[:IPADdress]:SUBNet:MASK | 834 |
| :SYSTem:COMMunicate:NETWork:MACAddress | 834 |
| :SYSTem:COMMunicate:NETWork:STATus? | 835 |
| :SYSTem:COMMunicate:NETWork:RESart | 835 |
| :SYSTem:NINformation? | 835 |
| :SYSTem:COMMunicate:GPIB:RESource? | 835 |
| :SYSTem:COMMunicate:NETWork:RESource? | 836 |
| :SYSTem:COMMunicate:HISLip:RESource? | 836 |
| :SYSTem:COMMunicate:USB:RESource? | 836 |
| :SYSTem:COMMunicate:SERial:RESource? | 836 |

| | |
|---|-----|
| :SYSTem:COMMunicate:SERial:BAUD..... | 837 |
| :SYSTem:COMMunicate:SERial:PARity..... | 837 |
| :SYSTem:COMMunicate:SERial:SBITs..... | 837 |
| :SYSTem:COMMunicate:SOCKet:RESource?..... | 838 |
| :SYSTem:FILEs:TEMPorary:DELete..... | 838 |
| :SYSTem:MMEMory:HDD?..... | 838 |
| :SYSTem:IDENtification..... | 838 |
| :SYSTem:IDENtification:PRESet..... | 839 |
| :SYSTem:IRESpone..... | 839 |
| :SYSTem:ORESpone..... | 839 |
| :SYSTem:NTP:HOSTname..... | 840 |
| :SYSTem:NTP:STATe..... | 840 |
| :SYSTem:LANGuage..... | 840 |
| :SYSTem:SECurity:SUPolicy..... | 840 |
| :SYSTem:PROTect<ch>[:STATe]..... | 841 |
| :SYSTem:REBoot..... | 841 |
| :SYSTem:REStart..... | 841 |
| :SYSTem:SHUTdown..... | 841 |
| :SYSTem:STARtup:COMPLete?..... | 842 |
| :SYSTem:DISPlay:UPDate..... | 842 |
| :SYSTem:DATE..... | 842 |
| :SYSTem:TIME..... | 843 |
| :SYSTem:TIME:ZONE..... | 843 |
| :SYSTem:TIME:ZONE:CATalog?..... | 843 |
| :SYSTem:VERSIon?..... | 843 |
| :SYSTem:OSYStem?..... | 844 |
| :SYSTem:MMEMory:PATH:USER?..... | 844 |
| :SYSTem:WAIT..... | 844 |

:SYSTem:ERRor:ALL?

Queries the error/event queue for all unread items and removes them from the queue.

Return values:

<All> string
 Error/event_number,"Error/event_description">[:Device-depend-ent info]"
 A comma separated list of error number and a short description of the error in FIFO order.
 If the queue is empty, the response is 0, "No error"
 Positive error numbers are instrument-dependent. Negative error numbers are reserved by the SCPI standard.
 Volatile errors are reported once, at the time they appear. Identical errors are reported repeatedly only if the original error has already been retrieved from (and hence not any more present in) the error queue.

Example:

```
SYST:ERR:ALL?
Queries all entries in the error queue.
Response: 0, 'no error'
No errors have occurred since the error queue was last read out.
```

Usage: Query only

:SYSTem:ERRor:CODE:ALL?

Queries the error numbers of all entries in the error queue and then deletes them.

Return values:

<All> string
Returns the error numbers. To retrieve the entire error text, send the command `:SYSTem:ERRor:ALL?`.

0
"No error", i.e. the error queue is empty

Positive value
Positive error numbers denote device-specific errors

Negative value
Negative error numbers denote error messages defined by SCPI.

Example:

`SYST:ERR:CODE:ALL`
Queries all entries in the error queue.
Response: 0
No errors have occurred since the error queue was last read out.

Usage: Query only

:SYSTem:ERRor:CODE[:NEXT]?

Queries the error number of the oldest entry in the error queue and then deletes it.

Return values:

<Next> string
Returns the error number. To retrieve the entire error text, send the command `:SYSTem:ERRor:ALL?`.

0
"No error", i.e. the error queue is empty

Positive value
Positive error numbers denote device-specific errors

Negative value
Negative error numbers denote error messages defined by SCPI.

Example:

`SYST:ERR:CODE`
Queries the oldest entry in the error queue.
Response: 0
No errors have occurred since the error queue was last read out.

Usage: Query only

:SYSTem:ERRor:COUNT?

Queries the number of entries in the error queue.

Return values:

<Count> integer

0

The error queue is empty.

Example:

SYST:ERR:COUN

Queries the number of entries in the error queue.

Response: 1

One error has occurred since the error queue was last read out.

Usage:

Query only

:SYSTem:ERRor[:NEXT]?

Queries the error/event queue for the oldest item and removes it from the queue.

Return values:

<Next> string

Error/event_number,"Error/event_description>[:Device-dependent info]"

Error number and a short description of the error.

If the queue is empty, the response is 0, "No error"

Positive error numbers are instrument-dependent. Negative error numbers are reserved by the SCPI standard.

Volatile errors are reported once, at the time they appear. Identical errors are reported repeatedly only if the original error has already been retrieved from (and hence not any more present in) the error queue.

Example:

SYST:ERR?

Queries the oldest entry in the error queue.

Response: 0, 'no error'

No errors have occurred since the error queue was last read out.

Usage:

Query only

:SYSTem:ERRor:HISTory?

Queries the error history.

Note that the result can amount several kilobytes.

Return values:

<ErrorHistory> string

Example:

```

SYSTEM:ERRor:HISTory?
// 90,"Info;(*)Instrument startup... (Mar-13-2017/ 10:25:16-601 ms)",
90,"Info;(*)Information generated while processing license keys.,
Repaired Error!
COND: ( hr == false )
FILE: /home/sa_okbuildserver/jenkins/workspace/OK-Legacy-Distribution-30/
ok_services_oklib/Src/CServiceExtension.cpp
LINE: 3554
ADDITIONAL INFO: Init ServiceExtension failed, 2877, -2147218613
HRESULT = 80001007
", 90,"[RF A] No frequency calibration data found.
Please run Adjust All!", ...
// returns all entries of the error queue

```

Usage: Query only

:SYSTEM:ERRor:HISTory:CLEar

Clears the error history.

Example:

```

SYSTEM:ERRor:HISTory:CLEar
// Deletes the history entries

```

Usage: Event

:SYSTEM:ERRor:STATIC?

Returns a list of all errors existing at the time when the query is started. This list corresponds to the display on the info page under manual control.

Return values:

<StaticErrors> string

Example:

```

SYSTEM:ERRor:STATIC?
// -221,"Settings conflict", 153,"Input voltage out of range", ...
// returns all static errors that are collected in the error queue

```

Usage: Query only

:SYSTEM:HELP:EXPort

Saves the online help as zip archive in the user directory.

Example:

```

:SYSTEM:HELP:EXPort
MMEM:CDIR?
// "/var/user"
MMEM:CAT?
// ..,"Log,DIR,4096","help.tgz,BIN,69836600"
// confirms that help zip archive is saved.

```

Usage: Event

:SYSTem:DLOCK <DispLockStat>

Disables the display, or enables it again (OFF).

The command disables also the front panel keyboard of the instrument including the [LOCAL] key.

Parameters:

<DispLockStat> 0 | 1 | OFF | ON
*RST: n.a. (factory preset: 0)

Example:

SYST:DLOC ON
Locks the display. To unlock the display SYST:DLOC OFF.

Manual operation: See "User Interface" on page 152

:SYSTem:KLOCK <State>

Keyboard lock disables the front panel keyboard of the instrument including the [LOCAL] key, or enables it again (OFF).

The command disables also the front panel keyboard of the instrument including the [LOCAL] key.

Parameters:

<State> 0 | 1 | OFF | ON
*RST: n.a. (factory preset: 0)

Example:

SYST:KLOC ON
Locks the front panel and external controls. To enable the controls, set SYST:KLOC OFF.

Manual operation: See "User Interface" on page 152

:SYSTem:ULOCK <Mode>

Locks or unlocks the user interface of the instrument.

Parameters:

<Mode> ENABLEd | DONLy | DISabled | VNConly

ENABLEd

Unlocks the display and all controls for the manual operation.

DONLy

Locks the controls for the manual operation of the instrument. The display shows the current settings.

DISabled

Locks the controls for the manual operation, and enables remote operation over VNC. The display shows the current settings.

VNConly

Locks the display and all controls for the manual operation.

*RST: n.a. (factory preset: ENABLEd)

Example: `:SYST:ULOC DIS`
 Activates the user interface lock, including display and controls.

Manual operation: See "[User Interface](#)" on page 152

:SYSTEM:RCL <Pathname>

Loads a file with previously saved instrument settings.

Setting parameters:

<Pathname> string

Example: `SYSTEM:RCL
"/var/user/Instrument_settings.savrcltxt"`

Usage: Setting only

Manual operation: See "[Recall](#)" on page 165

:SYSTEM:SAV <Pathname>

Saves the current instrument settings to a file with defined filename.

Setting parameters:

<Pathname> string

Example: `SYSTEM:SAV
"/var/user/Instrument_settings.savrcltxt"`

Usage: Setting only

Manual operation: See "[Save](#)" on page 163

:SYSTEM:SECURITY:VOLMode[:STATE] <SecPassWord>, <MmemProtState>

Activates volatile mode, so that no user data can be written to the internal memory permanently.

To enable volatile mode, reboot the instrument. Otherwise the change has no effect.

Parameters:

<MmemProtState> 0 | 1 | OFF | ON
 *RST: 0

Setting parameters:

<SecPassWord> string
 Current security password
 The default password is 123456.

Example: `SYSTEM:SECURITY:VOLMode:STATE "123456", 1
SYSTEM:REBoot`

Manual operation: See "[Volatile Mode](#)" on page 152

:SYSTem:COMMunicate:GPIB:LTERminator <LTerminator>

Sets the terminator recognition for remote control via GPIB bus.

Parameters:

<LTerminator> STANdard | EOI

EOI

The terminator must be sent together with the line message EOI (End of Line). This setting is recommended for binary block transmissions where a character could coincidentally have the value LF (Line Feed) but is not intended as the terminator. This setting must be selected for block data with undefined length.

STANdard

An LF (Line Feed) is recognized as the terminator regardless of whether it is sent with or without EOI.

*RST: n.a. (factory preset: STANdard)

Example:

SYSTem:COMMunicate:GPIB:LTERminator EOI

Only a character which is sent simultaneously with the line message EOI is accepted as the terminator.

:SYSTem:COMMunicate:GPIB[:SELF]:ADDRess <Address>

Sets the GPIB address.

Parameters:

<Address> integer

Range: 0 to 30

*RST: n.a. (factory preset: 28)

Example:

SYSTem:COMMunicate:GPIB:SELF:ADDRess 28

Sets GPIB address.

Manual operation: See "[GPIB channel address](#)" on page 144

:SYSTem:COMMunicate:NETWork[:COMMON]:DOMain <Domain>

Sets the primary suffix, that is the DNS name without the host name part.

Parameters:

<Domain> string

Example:

SYSTem:COMMunicate:NETWork:COMMON:DOMain

'ABC.DE'

sets the domain of the network.

Manual operation: See "[DNS Suffix](#)" on page 139

:SYSTem:COMMunicate:NETWork[:COMMON]:HOSTname <Hostname>

Sets the individual host name of the R&S SMBV.

Note: it is recommended that you do not change the host name in order to avoid problems with the network connection. However, if you change the host name be sure to use an unique name.

The host name is a protected parameter, To change it, first disable protection level 1 with command `:SYSTEM:PROTECT<ch>[:STATE]` on page 841.

Parameters:

<Hostname> string

Example:

```
SYSTEM:PROTECT1:STATE OFF,123456
SYSTEM:COMMUNICATE:NETWORK:HOSTNAME 'SIGGEN'
```

sets the individual computer name of the R&S SMBV.

Manual operation: See "[Hostname](#)" on page 138

:SYSTEM:COMMUNICATE:NETWORK[:COMMON]:WORKGROUP <Workgroup>

Sets the individual workgroup name of the instrument.

Parameters:

<Workgroup> string

Example:

```
SYSTEM:COMMUNICATE:NETWORK:COMMON:WORKGROUP
'TEST_09'
```

sets the workgroup name

Manual operation: See "[Workgroup](#)" on page 138

:SYSTEM:COMMUNICATE:NETWORK[:IPADDRESS]:DNS <DNS>

Determines the net DNS server to resolve the name.

Parameters:

<DNS> string

Example:

```
SYST:COMM:NETW:IPAD:DNS 123.456.0.1
```

Manual operation: See "[DNS Server](#)" on page 139

:SYSTEM:COMMUNICATE:NETWORK:IPADDRESS:MODE <Mode>

Selects manual or automatic setting of the IP address.

Parameters:

<Mode> AUTO | STATIC
*RST: n.a. (factory preset: AUTO)

Example:

```
SYSTEM:COMMUNICATE:NETWORK:IPADDRESS:MODE AUTO
```

The IP address is assigned automatically (DHCP)

Manual operation: See "[Address Mode](#)" on page 138

:SYSTEM:COMMunicate:NETWork:IPADdress <IpAddress>

Sets the IP address.

Parameters:

<IpAddress> string
Range: 0.0.0.0. to ff.ff.ff.ff

Example: SYSTEM:COMMunicate:NETWork:IPADdress "7.8.9.10"
sets the IP address of the instrument.

Manual operation: See "[IP Address](#)" on page 138

:SYSTEM:COMMunicate:NETWork[:IPADdress]:GATeway <Gateway>

Sets the IP address of the default gateway.

Parameters:

<Gateway> string
Range: 0.0.0.0 to ff.ff.ff.ff

Example: SYSTEM:COMMunicate:NETWork:IPADdress:GATeway
'1.2.3.4'
sets the IP address of the default gateway.

Manual operation: See "[Default Gateway](#)" on page 139

:SYSTEM:COMMunicate:NETWork[:IPADdress]:SUBNet:MASK <Mask>

Sets the subnet mask.

Parameters:

<Mask> string

Example: SYSTEM:COMMunicate:NETWork:IPADdress:SUBNet:
MASK '255.255.0.0'
determines the subnet mask.

Manual operation: See "[Subnet Mask](#)" on page 139

:SYSTEM:COMMunicate:NETWork:MACaddress <MacAddress>

Queries the MAC address of the network adapter.

Parameters:

<MacAddress> string

Example: SYST:COMM:NETW:MAC
queries the MAC address.

Manual operation: See "[MAC Address](#)" on page 139

:SYSTem:COMMunicate:NETWork:STATus?

Queries the network configuration state.

Return values:

<State> 0 | 1 | OFF | ON

Usage: Query only

Manual operation: See "[Network Status](#)" on page 138

:SYSTem:COMMunicate:NETWork:REStart

Restarts the network connection to the instrument, terminates the connection and sets it up again.

Example: SYSTem:COMMunicate:NETWork:REStart

Usage: Event

Manual operation: See "[Restart Network](#)" on page 140

:SYSTem:NINFormation?

Queries the oldest information message ("Error History > Level > Info") in the error/event queue.

Return values:

<NextInfo> string

Example: :SYSTem:NINFormation?

Queries the oldest entry in the info message queue.

Response: 90,"Info;=== Instrument startup...
==="

Information message containing error number 90, that states, that the instrument startup is complete.

Usage: Query only

:SYSTem:COMMunicate:GPIB:RESource?

Queries the VISA resource string for remote control via the GPIB interface.

To change the GPIB address, use the command `:SYSTem:COMMunicate:GPIB[:SELF]:ADDRESS`.

Return values:

<Resource> string

Example: SYSTem:COMMunicate:GPIB:RESource?

queries the VISA resource string.

Response: "GPIB::28::INSTR"

Usage: Query only

Manual operation: See "[VISA Resource Strings](#)" on page 144

:SYSTEM:COMMunicate:NETWork:RESource?

Queries the VISA resource string, used for remote control of the instrument with VXI-11 protocol.

Return values:

<Resource> string

Example:

SYSTEM:COMMunicate:NETWork:RESource?

Response: "TCPIP::192.1.2.3::INSTR"

Usage:

Query only

Manual operation: See "[VISA Resource Strings](#)" on page 144

:SYSTEM:COMMunicate:HISLip:RESource?

Queries the VISA resource string, used for remote control of the instrument with HiSLIP protocol.

Return values:

<Resource> string

Example:

SYSTEM:COMMunicate:HISLip:RESource?

Response: "TCPIP::192.1.2.3::hislip0::INSTR"

Usage:

Query only

Manual operation: See "[VISA Resource Strings](#)" on page 144

:SYSTEM:COMMunicate:USB:RESource?

Queries the VISA resource string for remote control via the USB interface.

Return values:

<Resource> string

Example:

SYSTEM:COMMunicate:USB:RESource?

queries the VISA resource string for remote control via the USB interface.

Response: "USB::72::000000::INSTR"

Usage:

Query only

Manual operation: See "[VISA Resource Strings](#)" on page 144

:SYSTEM:COMMunicate:SERial:RESource?

Queries the VISA resource string for the serial remote control interface. This string is used for remote control of the instrument.

Return values:

<Resource> string

Example:

SYSTem:COMMunicate:SERial:RESource?
queries the VISA resource string.
Response: "ASRL1::INSTR"

Usage:

Query only

Manual operation: See "[VISA Resource Strings](#)" on page 144

:SYSTem:COMMunicate:SERial:BAUD <Baud>

Sets the baudrate for the serial remote control interface.

Parameters:

<Baud> 2400 | 4800 | 9600 | 19200 | 38400 | 57600 | 115200
*RST: n.a. (factory preset: 115200)

Example:

SYSTem:COMMunicate:SERial:BAUD 115200
Sets 115200 baudrate.

Manual operation: See "[Baud Rate](#)" on page 144

:SYSTem:COMMunicate:SERial:PARity <Parity>

Sets the parity for the serial remote control interface.

Parameters:

<Parity> NONE | ODD | EVEN
*RST: n.a. (factory preset: NONE)

Example:

SYST:COMM:SER:PAR NONE
Selects parity NONE.

Manual operation: See "[Parity](#)" on page 144

:SYSTem:COMMunicate:SERial:SBITs <SBits>

Sets the number of stop bits for the serial remote control interface.

Parameters:

<SBits> 1 | 2
*RST: n.a. (factory preset: 1)

Example:

SYST:COMM:SER:SBIT 2
Selects 2 stop bits.

Manual operation: See "[Stop Bits](#)" on page 144

:SYSTEM:COMMunicate:SOCKET:RESOURCE?

Queries the VISA resource string for remote control via LAN interface, using TCP/IP socket protocol.

Return values:

<Resource> string

Example:

SYSTEM:COMMunicate:SOCKET:RESOURCE?

Response: "TCPIP::10.113.1.150::5025::SOCKET"

Usage:

Query only

Manual operation: See "[VISA Resource Strings](#)" on page 144

:SYSTEM:FILES:TEMPorary:DELETE

Deletes the temporary files from the internal memory or, if installed, from the hard disk.

Example:

:SYSTEM:FILES:TEMPorary:DELETE

All temporary files are removed.

Usage:

Event

:SYSTEM:MMEMory:HDD?

Queries the status of the mass memory hard disk drive.

Return values:

<State> 0 | 1 | OFF | ON

*RST: ON

Example:

SYST:MMEM:HDD?

Response: 1

the hard disk drive is ready for use.

Usage:

Query only

:SYSTEM:IDENTification <Identification>

Selects the mode the instrument identification is performed.

Parameters:

<Identification> AUTO | USER

AUTO

The *IDN string and the *OPT string are set automatically.

USER

Enables the selection of user definable *IDN and *OPT strings.

*RST: n.a. (factory preset: AUTO)

Example:

SYST:IDEN USER

Selects the user-defined identification string.

Manual operation: See ["Mode"](#) on page 146

:SYSTEM:IDENTification:PRESet

Sets the *IDN and *OPT strings in user defined mode to default values.

Example:

```
SYSTEM:IDENTification USER
SYSTEM:IDENTification:PRESet
```

Usage: Event

Manual operation: See ["Set to default"](#) on page 146

:SYSTEM:IRESpOse <IdnResponse>

Defines the user defined identification string for *IDN.

Note: While working in an emulation mode, the instrument's specific command set is disabled, i.e. the SCPI command `SYST:IRES` is discarded.

Parameters:

<IdnResponse> string

Example:

```
SYST:IDEN USER
// Selects a user-defined identification
SYST:IRES "Test Device"
// Defines identification string 'test device'
*IDN?
// Response: 'test device'
```

Manual operation: See ["IDN String"](#) on page 146

:SYSTEM:ORESpOse <OResponse>

Defines the user defined response string for *OPT.

Note: While working in an emulation mode, the instrument's specific command set is disabled, i.e. the SCPI command `SYST:ORES` is discarded.

Parameters:

<OResponse> string

Example:

```
SYST:IDEN USER
// Selects a user-defined identification
SYST:ORES "Test Option"
// Defines the OPT string 'test option'
*OPT?
// Response: 'test option'
```

Manual operation: See ["OPT String"](#) on page 146

:SYSTem:NTP:HOSTname <NTPName>

Sets the address of the NTP server. You can enter the IP address, or the hostname.

Parameters:

<NTPName> string

Example: `SYSTem:NTP:HOSTname "pool.ntp.org"`

Manual operation: See "[NTP Address](#)" on page 136

:SYSTem:NTP:STATe <UseNtpState>

Activates clock synchronization via NTP.

Parameters:

<UseNtpState> 0 | 1 | OFF | ON

*RST: 0

Example: `SYSTem:NTP:STATe 1`

Manual operation: See "[Use Time from NTP Server](#)" on page 137

:SYSTem:LANGuage <Language>

Sets the remote control command set.

The instrument can also be remote controlled via the command set of several other generators, for example HP generator. See the Application Note [1GP71](#) at the download area of the product site on the Internet.

Note: While working in a emulation mode, the instrument's specific command set is disabled, i.e. the SCPI command `SYSTem:LANGuage` will be discarded.

The return to the SCPI command set of the R&S SMBV can only be performed by using the appropriate command of the selected command set. For example, the HP command `EX` returns to the instrument-specific GPIB command set (selection `SYST:LANG 'HPxxxx'`).

Parameters:

<Language> string

Example: `SYSTem:LANGuage "SCPI"`
sets the SCPI command set.

Manual operation: See "[Language](#)" on page 146

:SYSTem:SECurity:SUPolicy <SecPassWord>, <UpdatePolicy>

Configures the automatic signature verification for firmware installation.

Parameters:

<UpdatePolicy> STRict | CONFirm | IGNore

*RST: n.a. (factory preset: CONFirm)

Setting parameters:

<SecPassWord> string

Manual operation: See ["Secure Update Policy"](#) on page 154

:SYSTEM:PROTECT<ch>[:STATE] <State>[, <Key>]

Activates and deactivates the specified protection level.

Suffix:

<ch> Indicates the protection level.
See also [Chapter 5.2.3.17, "Protection"](#), on page 146.

Parameters:

<State> select
*RST: n.a. (factory preset: 1)

Setting parameters:

<Key> integer
The respective functions are disabled when the protection level is activated. No password is required for activation of a level. A password must be entered to deactivate the protection level. The password for the first level is 123456.

Example:

```
// to activate protection level
SYSTEM:PROTECT1:STATE 1
// internal adjustments or hostname cannot be changed
// to unlock protection level 1
SYSTEM:PROTECT1:STATE 0,123456
// internal adjustments are accessible
```

Manual operation: See ["Protection Level/Password"](#) on page 147

:SYSTEM:REBOOT

Restarts the firmware and the operating system.

Usage: Event

:SYSTEM:RESTART

Restarts the firmware. The operating system remains active.

Usage: Event

:SYSTEM:SHUTDOWN

Shuts down the instrument.

Usage: Event

:SYSTem:STARtup:COMPLete?

Queries if the startup of the instrument is completed.

Return values:

<Complete> 0 | 1 | OFF | ON
 *RST: 0

Example:

```
SYST:STAR:COMP?
// 1
// the startup of the instrument is completed
```

Usage: Query only

:SYSTem:DISPlay:UPDate <Update>

Switches the update of the display on/off. A switchover from remote control to manual control always sets the status of the update of the display to ON.

Parameters:

<Update> 0 | 1 | OFF | ON
 *RST: ON

Example:

```
SYST:DISP:UPD OFF
switches update of displayed parameter values off.
```

Manual operation: See ["Display Update is On/Off"](#) on page 132

:SYSTem:DATE <Year>, <Month>, <Day>

Queries or sets the date for the instrument-internal calendar.

This parameter is protected, in order to prevent accidental changes.

It can be accessed with protection level 1, see [:SYSTem:PROTect<ch>\[:STATe\]](#) on page 841.

Parameters:

<Year> <year>,<month>,<day>
 <Month> integer
 Range: 1 to 12
 <Day> integer
 Range: 1 to 31

Example:

```
SYST:DATE?
Response: "2011,05,01"
it is the 1st of May, 2011.
```

Manual operation: See ["Date"](#) on page 136

:SYSTEM:TIME <Hour>, <Minute>, <Second>

Queries or sets the time for the instrument-internal clock.

The parameter is protected, in order to prevent accidental changes.

It can be accessed with protection level 1, see `:SYSTEM:PROTECT<ch>[:STATE]` on page 841.

Parameters:

| | |
|----------|----------------------|
| <Hour> | 0...23,0...59,0...59 |
| | Range: 0 to 23 |
| <Minute> | integer |
| | Range: 0 to 59 |
| <Second> | integer |
| | Range: 0 to 59 |

Example:

SYSTEM:TIME?

Response: "12, 0, 0" it is precisely 12 pm.

Manual operation: See "Time" on page 136

:SYSTEM:TIME:ZONE <TimeZone>

Sets the time zone. You can query the list of the available time zones with `:SYSTEM:TIME:ZONE:CATALOG?`.

Parameters:

<TimeZone> string

Manual operation: See "Time Zone" on page 136

:SYSTEM:TIME:ZONE:CATALOG?

Queries the list of available time zones.

Return values:

<Catalog>

Usage: Query only

Manual operation: See "Time Zone" on page 136

:SYSTEM:VERSION?

Queries the SCPI version the instrument's command set complies with.

Return values:

<Version> string

Example: `SYST:VERS`
 queries the SCPI version.
Response: "1996"
 The instrument complies with the SCPI version from 1996.

Usage: Query only

:SYSTem:OSYSstem?

Queries the operating system of the instrument.

Return values:

<OperSystem> string

Example: `SYSTem:OSYSstem?`
Response: "Linux"

Usage: Query only

:SYSTem:MMEMory:PATH:USER?

Queries the user directory, that means the directory the instrument stores user files on.

Return values:

<PathUser> string

Example: `SYSTem:MMEMory:PATH:USER?`
Response: "/var/user/"

Usage: Query only

:SYSTem:WAIT <TimeMs>

Delays the execution of the subsequent remote command by the specified time.

This function is useful, for example to execute an SCPI sequence automatically but with a defined time delay between some commands.

Setting parameters:

<TimeMs> integer

Wait time in ms

Range: 0 to 10000

*RST: 0

Example: `:SYSTem:WAIT 10000`
 `// waits 10s before resetting the instrument`
 `*RST`

Usage: Setting only

7.18 TEST Subsystem

The TEST system contains the commands for performing selftest routines, and for direct adjustment of the hardware assemblies (:TEST:DIReCt).

The self tests return a "0" if the test is performed successfully, otherwise a value other than "0" is returned. None of the commands of this system have an *RST value.

NOTICE

Improper use can destroy the assembly

The respective hardware assembly responds directly to the :TEST:DIReCt command; any safety mechanisms are bypassed. The command is intended for servicing purposes and should be used only by the Rohde & Schwarz service personnel.

| | |
|-----------------------------------|-----|
| :TEST<hw>:ALL:START..... | 845 |
| :TEST<hw>:ALL:RESult?..... | 845 |
| :TEST:EIQMode..... | 846 |
| :TEST<hw>:DIReCt..... | 846 |
| :TEST:BB:DATA:ERRor:RATE..... | 846 |
| :TEST:BB:DATA:FREQuency..... | 846 |
| :TEST:BB:DATA:OFFTime..... | 847 |
| :TEST:BB:DATA:ONTime..... | 847 |
| :TEST:BB:DATA:RDElay..... | 847 |
| :TEST:BB:DATA:STATe..... | 847 |
| :TEST:BB:DATA:TRIGger[:MODE]..... | 847 |
| :TEST:BB:DATA:TYPE..... | 847 |

:TEST<hw>:ALL:START

Starts a self-test on all installed hardware options.

To query the result, use the command :TEST<hw>:ALL:RESult? on page 845.

Example: See :TEST<hw>:ALL:RESult? on page 845

Usage: Event

Manual operation: See "Start Selftest" on page 133

:TEST<hw>:ALL:RESult?

Queries the result of the performed self-test (command :TEST<hw>:ALL:START on page 845).

Return values:

<Result> 0 | 1 | RUNning | STOPped
0
 Success

1

Fail

*RST: STOPped

Example:

```
TEST:ALL:STAR
Starts the self-test
TEST:ALL:RES?
```

Usage:

Query only

Manual operation: See "[Start Selftest](#)" on page 133**:TEST:EIQMode** <EiqMode>

Triggers a connection test for testing the active external IQ devices.

Parameters:

```
<EiqMode>          IQIN | IQOut
*RST:              IQOut
```

:TEST<hw>:DIRect <HW_assembly>,<subadress>,<hex data string>**:TEST<hw>:DIRect?** <HW_assembly>,<subadress>

The respective hardware assembly responds directly to the command; any safety mechanisms are bypassed. This function is only available via remote control.

Example:

```
TEST:DIR 'SSYN',0,#H12345678
TEST:DIR? 'SSYN',0
Response: #H12345678
```

:TEST:BB:DATA:ERRor:RATE <ErrorRate>

Sets the error bit pattern of the BER/BLER test generator.

Parameters:

```
<ErrorRate>        float
                    Range:    1E-6 to 1
                    Increment: 1E-6
*RST:              0.01
```

Manual operation: See "[Error Rate](#)" on page 206**:TEST:BB:DATA:FREQuency** <Clock>

Sets the clock frequency for the BER/BLER test generator.

Parameters:

```
<Clock>            integer
                    Range:    100 to 1E8
*RST:              1E6
```

Manual operation: See ["Clock Frequency"](#) on page 206

:TEST:BB:DATA:OFFTime <OffTime>

:TEST:BB:DATA:ONTime <OnTime>

Sets the data enable time interval of the BER/BLER test generator.

Parameters:

<OnTime> integer
 Range: 0 to 4294967295
 *RST: 1000

Manual operation: See ["On Time, Off Time"](#) on page 206

:TEST:BB:DATA:RDElay <RestartDelay>

Sets the delay time for the restart signal of the BER/BLER test generator.

Parameters:

<RestartDelay> integer
 Range: 0 to 4294967295
 *RST: 1000

Manual operation: See ["Restart Delay"](#) on page 207

:TEST:BB:DATA:STATe <State>

Activates the test generator for the bit error rate measurement, or the block error rate measurement respectively.

Parameters:

<State> 0 | 1 | OFF | ON
 *RST: 0

Manual operation: See ["State"](#) on page 206

:TEST:BB:DATA:TRIGger[:MODE] <TriggerMode>

Selects the trigger input mode for the BER/BLER test generator.

Parameters:

<TriggerMode> DENable | REStart
 *RST: DENable

Manual operation: See ["Trigger"](#) on page 206

:TEST:BB:DATA:TYPE <Type>

Selects the measurement mode of the BER/BLER test generator.

Parameters:

<Type> BER | BLER
 *RST: BER

7.19 TRIGger Subsystem

The TRIGger system contains the commands for selecting the trigger source for the RF and LF sweep. The trigger input connectors are configured in the SOURCE:INPUT subsystem.

The trigger system of the R&S SMBV is a simplified implementation of the SCPI trigger system. The TRIGger system differs from the SCPI system as follows:

- No INITiate command; the instrument behaves as if INITiate:CONTinuous ON were set.
- Under TRIGger several sweep subsystems exist.

Other commands associated with the trigger system of the R&S SMBV can be found in the modulation and RF signal subsystems.

TRIGger<hw>

- Suffix TRIGger<1|2> is not permitted
- TRIGger0 activates the LF output.

Table 7-3: Cross-reference between the manual and remote control

| R&S name | SCPI name | Command under manual control |
|----------|-----------|--|
| AUTO | IMMediate | "Auto" mode |
| SINGLE | BUS | "Single" mode. |
| EXTernal | EXTernal | "Ext Single" and "Ext Step" mode. Use command LFO:SWEep:MODE to select between the two sweep modes. |
| EAUTO | - | "Ext Start/Stop" mode. |

| | |
|---------------------------------------|-----|
| :TRIGger<hw>:FSWEEP:SOURce..... | 849 |
| :TRIGger<hw>:FSWEEP[:IMMediate]..... | 849 |
| :TRIGger<hw>:LFFSWEEP..... | 850 |
| :TRIGger<hw>:LFFSWEEP:SOURce..... | 850 |
| :TRIGger<hw>:LFFSWEEP:IMMediate..... | 851 |
| :TRIGger<hw>:PSWEEP:SOURce..... | 851 |
| :TRIGger<hw>:PSWEEP[:IMMediate]..... | 852 |
| :TRIGger<hw>[:SWEep]:SOURce..... | 852 |
| :TRIGger<hw>[:SWEep][:IMMediate]..... | 853 |
| :TRIGger<hw>[:IMMediate]..... | 853 |

:TRIGger<hw>:FSWeep:SOURce <Source>

Sets the trigger source for the RF frequency sweep.

The names of the parameters correspond directly to the various settings under manual control. SCPI uses other names for the parameters; these names are also accepted by the instrument. The SCPI names should be used if compatibility is an important consideration.

An overview of the various names is given in [Table 7-3](#).

Parameters:

<Source>

AUTO | IMMEDIATE | SINGLE | BUS | EXTERNAL | EAUTO

AUTO|IMMEDIATE

The trigger is free-running, i.e. the trigger condition is fulfilled continuously. As soon as one sweep is finished, the next sweep is started.

SINGLE|BUS

One complete sweep cycle is triggered by the GPIB commands `[:SOURce<hw>] :SWEep [:FREQuency] :EXECute, : TRIGger<hw>:FSWeep [:IMMEDIATE]` or `*TRG`. The mode has to be set to `AUTO (:SOURce :SWEep :FREQuency :MODE AUTO)`.

EXTERNAL

The sweep is triggered externally via the [INST TRIG] connector.

EAUTO

The sweep is triggered externally via the [INST TRIG] connector. As soon as one sweep is finished, the next sweep is started. A second trigger event stops the sweep at the current frequency, a third trigger event starts the trigger at the start frequency, and so on.

*RST: AUTO

Example:

`TRIG:FSW:SOUR EXT`

selects triggering with an external trigger.

Manual operation: See "[Mode - RF Frequency Sweep](#)" on page 280

:TRIGger<hw>:FSWeep[:IMMEDIATE]

Immediately starts an RF frequency sweep cycle.

The command is only effective for sweep mode "Single" (`SOUR:SWE:FREQ:MODE AUTO` in combination with `TRIG:FSW:SOUR SING`).

The command corresponds to the manual control "Execute Single Sweep".

- Example:** `SWE:FREQ:MODE AUTO`
sets the triggered sweep mode, i.e. a trigger is required to start the sweep.
- `TRIG:FSW:SOUR SING`
sets the "Single" trigger mode, i.e. a trigger starts a single sweep.
- `TRIG:FSW`
starts a single RF frequency sweep.
- Usage:** Event
- Manual operation:** See "[Execute Single Sweep - Frequency Sweep](#)" on page 282

:TRIGger<hw>:LFFSweep

- Usage:** Event
- Manual operation:** See "[Execute Single Sweep](#)" on page 269

Immediately starts an LF frequency sweep.

The command is effective in sweep mode "Single" (`LFO:SWE:MODE AUTO` in combination with `TRIG:LFFS:SOUR SING`).

:TRIGger<hw>:LFFSweep:SOURce <Source>

Sets the trigger source for the LF sweep. The trigger is triggered by the command `:SOURce:LFOOutput:SWEep[:FREQuency] EXECute`.

The names of the parameters correspond directly to the various settings under manual control. SCPI uses other names for the parameters; these names are also accepted by the instrument. The SCPI names should be used if compatibility is an important consideration.

An overview of the various names is given in the [Table 7-3](#).

Parameters:

<Source> AUTO | IMMEDIATE | SINGLE | BUS | EXTERNAL | EAUTO

AUTO|IMMEDIATE

The trigger is free-running, i.e. the trigger condition is fulfilled continuously. As soon as one sweep is finished, the next sweep is started.

SINGLE|BUS

One complete sweep cycle is triggered by the GPIB commands `[:SOURce<hw>]:LFOOutput:SWEep[:FREQuency]: EXECute` or `*TRG`.

The mode has to be set to `AUTO` (`[:SOURce<hw>]:LFOOutput:SWEep[:FREQuency]:MODE`).

EXTERNAL

The sweep is triggered externally via the [INST TRIG] connector.

EAUTO

The sweep is triggered externally via the [INST TRIG] connector. As soon as one sweep is finished, the next sweep is started. A second trigger event stops the sweep at the current frequency, a third trigger event starts the trigger at the start frequency, and so on.

*RST: AUTO

Example:

```
TRIG:LFFS:SOUR EXT
selects triggering with an external trigger.
```

:TRIGger<hw>:LFFSweep:IMMEDIATE

Immediately starts an LF frequency sweep.

The command is effective in sweep mode "Single" (LFO:SWE:MODE AUTO in combination with TRIG:LFFS:SOUR SING).

Usage: Event

Manual operation: See "Execute Single Sweep" on page 269

:TRIGger<hw>:PSweep:SOURce <Source>

Sets the trigger source for the RF level sweep.

The names of the parameters correspond directly to the various settings under manual control. SCPI uses other names for the parameters; these names are also accepted by the instrument. The SCPI names should be used if compatibility is an important consideration.

An overview of the various names is given in [Table 7-3](#).

Parameters:

<Source> AUTO | IMMEDIATE | SINGLE | BUS | EXTERNAL | EAUTO

AUTO|IMMEDIATE

The trigger is free-running, i.e. the trigger condition is fulfilled continuously. As soon as one sweep is finished, the next sweep is started.

SINGLE|BUS

One complete sweep cycle is triggered by the GPIB commands [:SOURce<hw>]:SWEep:POWer:EXECute, :TRIGger<hw>:PSweep[:IMMEDIATE] or *TRG. The mode has to be set to AUTO (:SOURce:SWEep:LEVel:MODE AUTO).

EXTERNAL

The sweep is triggered externally via the [INST TRIG] connector.

EAUTO

The sweep is triggered externally via the [INST TRIG] connector. As soon as one sweep is finished, the next sweep is started. A second trigger event stops the sweep at the current frequency, a third trigger event starts the trigger at the start frequency, and so on.

*RST: AUTO

Example:

TRIG:PSW:SOUR EXT

selects triggering with an external trigger.

Manual operation: See " [Mode - Level Sweep](#) " on page 286

:TRIGger<hw>:PSWEEP[:IMMEDIATE]

Immediately starts an RF level sweep.

The command is only effective for sweep mode "Single"

(SOURCE:SWEep:POWer:MODE AUTO in combination with TRIG:PSW:SOUR SING).

The command corresponds to the manual control "Execute Single Sweep".

Example:

SWE:POW:MODE AUTO

selects the triggered sweep mode, i.e. a trigger is required to start the sweep.

TRIG:PSW:SOUR SING

sets the single trigger mode, i.e. a trigger starts a single sweep.

TRIG:PSW

starts a single RF level sweep.

Usage:

Event

Manual operation: See " [Execute Single Sweep - Level Sweep](#) " on page 289

:TRIGger<hw>[:SWEep]:SOURce <Source>

Sets the trigger source for all sweeps.

The names of the parameters correspond directly to the various settings under manual control. SCPI uses other names for the parameters; these names are also accepted by the instrument. The SCPI names should be used if compatibility is an important consideration.

An overview of the various names is given in the [Table 7-3](#).

Setting parameters:

<Source> AUTO | IMMEDIATE | SINGLE | BUS | EXTERNAL | EAUTO

AUTO|IMMEDIATE

The trigger is free-running, i.e. the trigger condition is fulfilled continuously. As soon as one sweep is finished, the next sweep is started.

SINGLE|BUS

One complete sweep cycle is triggered by the GPIB commands `:SOURce:SWEep:POWer|FREQuency:EXEC, TRIGger:PSWep|FSWep:IMMediate` or `*TRG`.

If `:SOURce:SWEep:POWer:MODE` is set to `STEP`, one step is executed.

The mode has to be set to `AUTO`.

EXTErnal

The sweep is triggered externally via the [INST TRIG] connector.

EAUTO

The sweep is triggered externally via the [INST TRIG] connector. As soon as one sweep is finished, the next sweep is started. A second trigger event stops the sweep at the current frequency, a third trigger event starts the trigger at the start frequency, and so on.

`*RST: AUTO`

- Example:** `TRIG0:SOUR EXT`
selects triggering with an external trigger. The trigger is input via the [INST TRIG] connector.
- Usage:** Setting only
- Manual operation:** See " [Mode](#) " on page 267

:TRIGger<hw>[:SWEep][:IMMediate]

Starts all sweeps which are activated for the respective path. The command starts all sweeps which are activated.

The sweep to be executed depends on the respective `MODE` setting (`:SOUR:SWEep:POW|FREQ:MODE` and `:SOUR:LFO:SWEep[:FREQ]:MODE`).

The command corresponds to the manual-control command "Execute Trigger".

- Example:** `TRIG`
starts all active sweeps.

Usage: Event

Manual operation: See " [Execute Single Sweep - Frequency Sweep](#) " on page 282

:TRIGger<hw>[:IMMediate]

The command immediately starts the activated sweep.

The command performs a single sweep and therefore applies to sweep mode `AUTO` with sweep source `SINGLE`. Use the commands

`TRIG:FSW|LFFS|PSW[:SWE]:SOUR SING`, and `SOUR:SWE:FREQ|POW:MODE`, or `SOUR:LFO:SWE:[FREQ]:MODE` to set the respective single sweep. You can alternatively use an `IMMediate` command instead of the respective `SWEep:[FREQ:]|POW:EXECute` command.

- Example:** TRIG
starts all active sweeps.
- Usage:** Event
- Manual operation:** See " [Execute Single Sweep](#) " on page 269

7.20 UNIT Subsystem

The `UNIT` subsystem contains the commands specifying which units are valid if no unit is indicated in a command. These settings are valid for the entire instrument.

`:UNIT:ANGLE` <Angle>

Defines the default unit for the phase modulation angle. It is not valid for commands which determine angle values, e.g. RF phase. It does not influence the manual control parameter unit and the display.

Parameters:

<Angle> DEGREE | RADIAN
*RST: RADIAN

Example: UNIT:ANGL DEG
sets DEG as a default unit for all commands which determine angle values.

`:UNIT:POWER` <Power>

Defines the default unit for power parameters. This setting affects the GUI, as well as all remote control commands that determine power values.

Parameters:

<Power> V | DBUV | DBM
*RST: DBM

Example: UNIT:POW V
sets V as a default unit for all commands which determine power values.

8 Maintenance

The instrument does not need periodic maintenance. Only the cleaning of the instrument is essential.

Follow the instructions in the service manual and the safety instructions when exchanging modules or ordering spares. The order no. for spare parts is included in the service manual. The service manual includes further information particularly on troubleshooting, repair, exchange of modules and alignment.

The address of our support center and a list of all Rohde & Schwarz service centers can be found at the beginning of this manual.

NOTICE

Risk of damage during shipment

Insufficient protection against mechanical and electrostatic effects during shipment can damage the instrument.

- When shipping an instrument, use the original packaging. If you do not have the original packaging, use sufficient padding to prevent the instrument from moving around inside the box.
- Pack the instrument in antistatic wrap to protect it from electrostatic charging.
- Secure the instrument to prevent any movement and other mechanical effects during transportation.

8.1 Cleaning

WARNING

Risk of electric shock

If moisture enters the casing, for example if you clean the instrument using a moist cloth, contact with the instrument can lead to electric shock. Before cleaning the instrument other than with a dry cloth, make sure that the instrument is switched off and disconnected from all power supplies.

NOTICE**Instrument damage caused by cleaning agents**

Cleaning agents contain substances such as solvents (thinners, acetone, etc.), acids, bases, or other substances. Solvents can damage the front panel labeling, plastic parts, or screens, for example.

Never use cleaning agents to clean the outside of the instrument. Use a soft, dry, lint-free dust cloth instead.

NOTICE**Risk of instrument damage due to obstructed fans**

If the instrument is operated in dusty areas, the fans become obstructed by dust or other particles over time. Check and clean the fans regularly to ensure that they always operate properly. If the instrument is run with obstructed fans for a longer period, the instrument overheats, which can disturb the operation and even cause damage.

1. Clean the outside of the instrument using a soft, dry, lint-free dust cloth.
2. Check and clean the fans regularly to ensure that they always operate properly.

8.2 Storing and Packing

The storage temperature range of the instrument is given in the data sheet. If the instrument is to be stored for a longer period of time, it must be protected against dust.

Repack the instrument as it was originally packed when transporting or shipping. The two protective foam plastic parts prevent the control elements and connectors from being damaged. The antistatic packing foil avoids any undesired electrostatic charging to occur.

If you do not use the original packaging, use a sturdy cardboard box of suitable size and provide for sufficient padding to prevent the instrument from slipping inside the package. Wrap antistatic packing foil around the instrument to protect it from electrostatic charging.

9 Status Information, Error Messages and Troubleshooting

The R&S SMBV distinguishes between a variety of different messages such as status messages, error messages, warnings, or information that are displayed in the "Info" line on the screen, and also entered in the error/event queue of the status reporting system.

This section describes the information and status messages concerning the operating status of the instrument and the types of error messages and warnings. Some error messages require that the error must be eliminated before correct instrument operation can be ensured. The info window with a list of current messages and a detailed description of each message can be opened with the [INFO] key.

In the remote control mode, error messages are entered in the error/event queue of the status reporting system and can be queried with the command `SYSTEM:ERROR?`. If the error queue is empty, 0 ("No error") is returned. The status reporting system is described in detail in [Chapter 6.5, "Status Reporting System"](#), on page 522.

Section [Chapter 9.5, "Resolving Network Connection Failures"](#), on page 863 provides recommended solutions for network connection errors, and helps you to collect the information required for quick and efficient support.

9.1 Status Information

The status messages are displayed in the header section of the screen. The status information gives the user an overview of the main operating states and settings of the instrument. The states are indicated for information only and do not necessitate any action by the user. Status information is displayed between the frequency and level fields, at the left of the info line or in the info line itself.

9.1.1 Status information displayed between the frequency and level fields

This section gives an overview of the status messages displayed between the frequency and level fields.

RF OFF

The RF output is switched off

MOD OFF

All modulations are switched off

FREQ OFFSET

A frequency offset is set.

The frequency entered and displayed in the "Frequency" field takes any set frequency offset into consideration, e.g. an offset set for a downstream instrument. This means that with a frequency offset the frequency displayed in the header does not correspond to the frequency at the RF output, but rather to the frequency at the output of the downstream instrument.

This allows the target frequency at the output of a downstream instrument to be entered in the frequency field. The signal generator changes the RF output frequency according to the entered offset.

However, the frequency entered and displayed in the "Frequency/Phase" dialog of the "RF" function block always corresponds to the RF output frequency. Any frequency offset is not taken into consideration.

The correlation is as follows:

Freq in header = RF output frequency (= Freq in dialog) + Freq offset (= Offset in dialog)

OVERLOAD

The power of the external signal applied to the RF output is too high. The overload protection is tripped and the connection between the RF output and attenuator is interrupted. The overload protection is reset by pressing the [RF ON/OFF] key. The RF input is activated when the overload protection is reset.

LEVEL OFFSET

A level offset is set.

The level entered and displayed in the "Level" field takes the offset of any downstream attenuators/amplifiers into consideration by way of calculation. This means that with a level offset the level displayed in the header does not correspond to the level at the RF output, but rather to the level at the output of the downstream instrument.

This allows the target level at the output of downstream instruments to be entered. The signal generator changes the RF output level according to the set offset.

However, the level entered and displayed in the "Level" dialog of the "RF" function block always corresponds to the RF output level. Any level offset is not taken into consideration.

The correlation is as follows:

Level in header = RF output level (= Level in dialog) + Level offset

EXT REF

An external reference is used.

The external signal with selectable frequency and defined level must be input at the [REF IN] connector. It is output at the [REF OUT] connector.

BUSY

A setting or calculation is executed.

9.1.2 Status information displayed to the left of the Info line

This section gives an overview of the status messages displayed to the left of the Info line.

REMOTE

Indicates that the instrument is in remote control mode.

The keys on the front panel are usable, but all parameters are in read only mode.

To return to manual control, use the [local] key or the command `>L`. The current command must be fully processed before the mode is switched, otherwise the instrument switches immediately back to remote control.

REM-LLO

Indicates that the instrument is in remote control mode with local lockout enabled.

The [local] key is locked. To set the local lockout, use the command `&LLO` (local lockout).

The keys on the front panel are usable, but all parameters are in read only mode.

To return to manual operation or to "REMOTE" state, use one of the following commands:

- `&LOCS`
switches directly from "REM-LLO" to manual operation.
- `&REMS`
changes the remote control state from "REM-LLO" to "REMOTE".
- `CALL IBLOC (generator%)` (Visual Basic command)
switches from remote control state to manual operation.

LOC-LLO

For the direct operation the state has been changed from remote control to manual operation (local state). The [LOCAL] key was disabled with the command `LLO` (local lockout).

With the next activating of the remote control mode, the instrument cannot be switched to manual operation by the operator. The status information changes to "REM-LLO".

The instrument can be switched to manual operation by means of remote control only (e.g. with the Visual Basic command `CALL IBLOC (generator%)`).

SYS CTRL

Indicates that the instrument controls another instrument.

9.1.3 Status information displayed in the Info line

This section gives an overview of the status messages displayed in the Info line.

RFSweep / LevelSweep / LFSweep

The indicated sweep is enabled.

ALC On / Auto / S&H

The status of the automatic level control is indicated:

- ON
automatic level control permanently on
- Auto
automatic level control is automatically adapted to the operating states
- S&H
automatic level control off, recalibration of the level whenever the level or frequency is set (sample and hold mode)
- Table
automatic level control off, recalibration of the level according to the internal ALC table

ListMode

List mode is active.

The values of the frequency/level pairs in the selected list are set for the chosen dwell time.

AttFixed

Attenuator fixed mode is active.

The uninterrupted level settings are made in a fixed range without attenuator switching. The variation range is set automatically when this mode is activated. The range is displayed under "Attenuator Fixed Range" in the "Level" dialog.

UCorr

User Correction is active.

The level is corrected by the given values in the selected user correction list. Correction is performed by the user-defined list values being added to the output level for the respective RF frequency. With frequencies which are not contained in the list, the level correction is determined by interpolation of the closest correction values.

OvenCold

The reference oscillator has not yet reached its nominal frequency.

When switching on from the STANDBY mode, the specified frequency accuracy is reached immediately. If the power switch was switched off, the reference oscillator needs some warm-up time to reach its nominal frequency. During this period of time, the output frequency does not yet reach its final value either.

9.2 Error Messages

Messages indicate errors in the instrument. They are displayed in the info line in different colors depending on their importance and display duration. Errors (e.g. no calibration data) are displayed in red, information (e.g. file not found) and warnings in black. Warnings indicate less significant errors (e.g. the instrument operates outside specified data).

9.2.1 Volatile messages

Volatile messages report automatic settings in the instrument (e.g. switching off of incompatible types of modulation) or on illegal entries that are not accepted by the instrument (e.g. range violations). They are displayed in the info line on a yellow background. They are displayed on top of status information or permanent messages.

Volatile messages do not normally demand user actions and disappear automatically after a brief period of time. They are stored in the history, however.

SCPI command: `:SYSTem:ERRor:ALL?` or `:SYSTem:ERRor[:NEXT]?`

9.2.2 Permanent messages

Permanent messages are displayed if an error occurs that impairs further instrument operation, e.g. a hardware fault. The error signaled by a permanent message must be eliminated before correct instrument operation can be ensured.

The message is displayed until the error is eliminated. It covers the status display in the info line. After error elimination, the message automatically disappears and is also recorded in the history.

SCPI command: `:SYSTem:ERRor:STATic?`

9.3 SCPI-Error Messages

The SCPI error messages are the same in all SCPI instruments. Detailed information and an overview of all error messages as defined in SCPI standard can be found in the corresponding documentation.

The errors are assigned negative numbers. The error text being entered into the error/event queue or being displayed is printed in bold face on the left together with the error code. Below the error text, there is an explanation as to the respective error.

9.4 Device-Specific Error Messages

The following table contains all error messages specific for the instrument in alphabetical order, as well as an explanation of the error situation. The positive error codes mark the errors specific of the instrument.

The device-specific error messages set bit 3 in the ESR register.



The index provides a list of the error messages sorted according to their error codes.

| Error Code | Error | Description | Remedy |
|------------|---|--|--|
| 50 | Extern reference out of range or disconnected | External reference is selected but no external signal is applied or the signal is out of range. | <ul style="list-style-type: none"> Check the selected reference signal source (internal or external) in the "Setup > Reference Oscillator" dialog. Change setting to 'internal' if no appropriate external source is available. |
| 140 | This modulation forces other modulations off | A modulation has been switched on which cannot be used at the same time as an already active modulation. The previous modulation has been switched off. Example: Enabling modulation GSM/EDGE switches any active digital modulation off. | |
| 180 | Adjustment failed | Adjustment could not be executed | The adjustment data have to be generated first by an internal or external adjustment or to be loaded into the device (see Chapter 5.2.3.1, "Internal Adjustments" , on page 120). |
| 182 | Adjustment data missing | Adjustment data are missing. | The adjustment data have to be generated first by an internal or external adjustment or to be loaded into the instrument. |
| 183 | Adjustment data invalid | Adjustment data are invalid and must be restored. | The adjustment data have to be generated again by an internal or external adjustment or to be loaded into the instrument. |
| 200 | Cannot access hardware | The data transmission to a module was unsuccessful. | The module is not installed, not properly installed or missing. |
| 201 | Hardware revision out of date | A later version of certain parts of the instrument is necessary to execute the function selected. | The driver does not support the installed version of a module. |
| 202 | Cannot access the EEPROM | A error occurs when writing or reading a EEPROM. | The EEPROM might be defect and has to be replaced. |
| 203 | Invalid EEPROM data | Reading a EEPROM is possible, however the data are inconsistent. | |
| 204 | Driver initialization failed | Initialization of a driver fails when booting the instrument firmware. | The driver is not compatible with the hardware or software configuration of the instrument. |
| 241 | No current list | There is no list selected. To execute the required operation, a list has to be selected in the related menu. If no list is available, a new list must be created. | |

| Error Code | Error | Description | Remedy |
|------------|-----------------------------|---|--|
| 242 | Unknown list type specified | The list type selected is not valid for the required operation. For instance, the file extension for waveform list files is *.wv. It is not possible to enter another file extension when selecting a list. | Check the selected list type. |
| 261 | Waveform Protected | The selected waveform file cannot be transferred to a controller. The waveform is produced with simulation software R&S WinIQSIM2 and is protected. | |
| 460 | Cannot open file | The selected file can not be opened. | Check the path and file name. |
| 461 | Cannot write file | The file can not be written. | Check if the file is read-only. |
| 462 | Cannot read file | The file can not be read. | Check if the file contents are compatible with the file type. |
| 463 | Filename missing | The required operation cannot be executed because the file name is not specified. | A file name has to be entered when creating a new list. |
| 464 | Invalid filename extension | The file extension is not valid for the required operation. | Check the file extension. For instance, the file extension for waveform list files is *.wv. It is not possible to enter another file extension when storing a list. |
| 465 | File contains invalid data | The selected file contains data that is not valid for the file type. The file extension determines the data that is valid for this file type. If the file extension is changed the lists are no longer recognized and the data are therefore invalid. Example: the extension of a waveform file (= *.wv) was changed to *.txt | Check the file extension. |

9.5 Resolving Network Connection Failures

Several issues may cause failures in the network connection to the instrument. This section lists the most likely reasons and the recommended solutions.

Common reasons for network connection failures

- Network connecting cables and cable connectors of poor quality
- Incompatibility between the network interface of the R&S SMBV and certain switches or routers available on the market
- An invalid IP address assigned to the instrument

Possible solutions to network connection failures

1. **NOTICE!** Connecting to the network can cause network failure. Errors can affect the entire network.

Consult your network administrator before performing the following tasks:

- Connecting the instrument to the network
- Configuring the network
- Changing IP addresses

2. Try out the following to resolve network connection failures:

- Check the network infrastructure. Exchange connecting cables, if obvious damage is visible.
- Observe the link status LED on the R&S SMBV or the connected network device. The link status LED is located next to the LAN connector. If a link failure is detected, connect the instrument to a different device port or to a different network device.
- Check whether the LAN interface and the required LAN services are enabled. See "[LAN Services](#)" on page 150.
- If the IP address is set manually (no DHCP) or obtained via the Zeroconf (APIPA) protocol:
 - Check whether the IP address of the instrument is within the network's address range.
 - Check whether the IP address is valid.

See "[IP Address](#)" on page 138.

9.6 Obtaining Technical Support

If you encounter problems that you cannot solve yourself, contact your Rohde & Schwarz support center as listed at <http://www.customersupport.rohde-schwarz.com>. Our support center staff is optimally trained to assist you in solving problems.

The support center finds solutions more quickly and efficiently if you provide them with information on the instrument and an error description.

- The following dialog boxes in the "Setup > System" menu provide useful information:
 - **Hardware Configuration:** hardware assemblies
 - **Software/Options:** the status of all software and hardware options installed on your instrument
- **System Messages:** displayed in the "Info" line and provide information on any errors that may have occurred. See also the description of error messages [Chapter 9, "Status Information, Error Messages and Troubleshooting"](#), on page 857.

To collect error information

- ▶ Collect the error information and attach it to an email in which you describe the problem.
Send the email to the customer support address for your region as listed on the Internet (<http://www.customersupport.rohde-schwarz.com>).

To remove sensitive data

- ▶ For information on how to handle or remove the sensitive data from your instrument, refer to the description "Resolving Security Issues when working with R&S SMBV".

Packing and transporting the instrument

- ▶ If the instrument has to be transported or shipped, observe the notes described in [Chapter 2.3.2, "Unpacking and Checking the Instrument"](#), on page 34.

Annex

A Hardware Interfaces

This section covers hardware related topics, like pin assignment of the GPIB bus interface, monitor and [AUX I/O] connectors.

The remote control interfaces are described in details in the Operating Manual, section "Remote Control Basics".

For specifications refer to the data sheet.

A.1 GPIB Bus Interface

Pin assignment

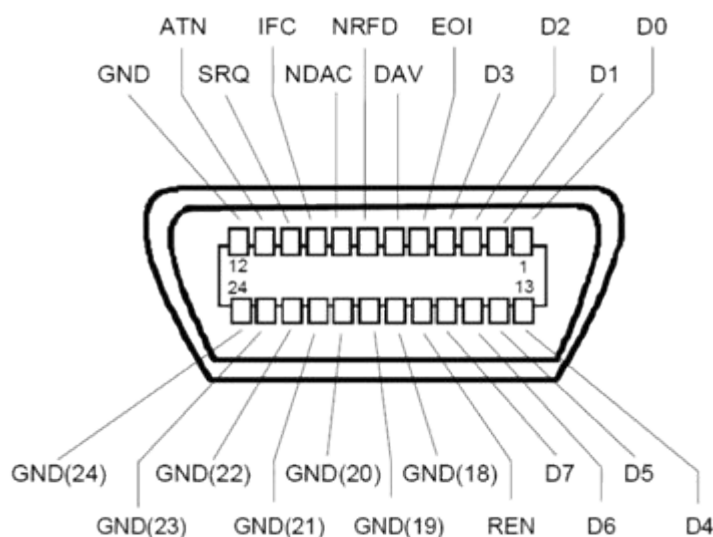

Figure A-1: Pin assignment of GPIB bus interface

Bus lines

- Data bus with 8 lines D0 to D7:
The transmission is bit-parallel and byte-serial in the ASCII/ISO code. D0 is the least significant bit, D7 the most significant bit.
- Control bus with five lines:
IFC (Interface Clear): active LOW resets the interfaces of the instruments connected to the default setting.
ATN (Attention): active LOW signals the transmission of interface messages, inactive HIGH signals the transmission of device messages.

SRQ (Service Request): active LOW enables the connected device to send a service request to the controller.

REN (Remote Enable): active LOW permits switchover to remote control.

EOI (End or Identify): has two functions in connection with ATN:

- ATN=HIGH active LOW marks the end of data transmission.
- ATN=LOW active LOW triggers a parallel poll.

- Handshake bus with three lines:

DAV (Data Valid): active LOW signals a valid data byte on the data bus.

NRFD (Not Ready For Data): active LOW signals that one of the connected devices is not ready for data transfer.

NDAC (Not Data Accepted): active LOW signals that the instrument connected is accepting the data on the data bus.

Interface Functions

Instruments which can be controlled via GPIB bus can be equipped with different interface functions. The interface function for the R&S SMBV are listed in the following table.

Table A-1: GPIB bus interface functions

| Control character | Interface function |
|-------------------|---|
| SH1 | Handshake source function (source handshake), full capability |
| AH1 | Handshake sink function (acceptor handshake), full capability |
| L4 | Listener function, full capability, de-addressed by MTA. |
| T6 | Talker function, full capability, ability to respond to serial poll, deaddressed by MLA |
| SR1 | Service request function (Service Request), full capability |
| PP1 | Parallel poll function, full capability |
| RL1 | Remote/Local switch over function, full capability |
| DC1 | Reset function (Device Clear), full capability |
| DT1 | Trigger function (Device Trigger), full capability |

List of Commands

| | |
|--|-----|
| :BERT:RESult? | 542 |
| :BERT:SEquence | 543 |
| :BERT:SETup:CLOCK[:POLarity] | 544 |
| :BERT:SETup:DATA:CONNector | 545 |
| :BERT:SETup:DATA[:POLarity] | 544 |
| :BERT:SETup:DENable | 545 |
| :BERT:SETup:IGNore | 546 |
| :BERT:SETup:MCOunt | 546 |
| :BERT:SETup:MERRor | 547 |
| :BERT:SETup:REStart[:STATe] | 547 |
| :BERT:SETup:TIMeout | 548 |
| :BERT:SETup:TYPE | 547 |
| :BERT:START | 548 |
| :BERT:STATe | 548 |
| :BERT:STOP | 549 |
| :BERT:UNIT | 549 |
| :BERT BLER:LOAD | 540 |
| :BERT BLER:PRESet | 540 |
| :BERT BLER:STORe | 540 |
| :BLER:RESult? | 540 |
| :BLER:SEquence | 543 |
| :BLER:SETup:CLOCK[:POLarity] | 544 |
| :BLER:SETup:CORDer | 544 |
| :BLER:SETup:DATA:CONNector | 545 |
| :BLER:SETup:DATA[:POLarity] | 544 |
| :BLER:SETup:DENable | 545 |
| :BLER:SETup:MCOunt | 546 |
| :BLER:SETup:MERRor | 547 |
| :BLER:SETup:TIMeout | 548 |
| :BLER:SETup:TYPE | 547 |
| :BLER:START | 548 |
| :BLER:STATe | 548 |
| :BLER:STOP | 549 |
| :BLER:UNIT | 549 |
| :CALibration:ALL[:MEASure]? | 551 |
| :CALibration:ROSCillator[:DATA] | 554 |
| :CALibration<hw>:BBIN[:MEASure]? | 551 |
| :CALibration<hw>:FMOFset[:MEASure]? | 552 |
| :CALibration<hw>:FREQuency[:MEASure]? | 552 |
| :CALibration<hw>:IQModulator:FULL? | 552 |
| :CALibration<hw>:IQModulator:LOCAL? | 553 |
| :CALibration<hw>:LEVel:ALCTable[:MEASure]? | 553 |
| :CALibration<hw>:LEVel:EXTern:DATA | 554 |
| :CALibration<hw>:LEVel:STATe | 554 |
| :CALibration<hw>:LEVel[:MEASure]? | 553 |
| :CLOCK:INPut:FREQuency? | 555 |
| :CLOCK:INPut:SLOPe | 555 |

| | |
|--|-----|
| :DEvice:PRESet..... | 537 |
| :DIAGnostic:INFO:OTIME?..... | 556 |
| :DIAGnostic:INFO:POCount?..... | 557 |
| :DIAGnostic<hw>:BGInfo:CATalog?..... | 556 |
| :DIAGnostic<hw>:BGInfo?..... | 555 |
| :DISPlay:ANNotation:AMPLitude..... | 557 |
| :DISPlay:ANNotation:FREQuency..... | 558 |
| :DISPlay:ANNotation[:ALL]..... | 558 |
| :DISPlay:DIALog:CLOSe..... | 558 |
| :DISPlay:DIALog:CLOSe:ALL..... | 558 |
| :DISPlay:DIALog:ID?..... | 558 |
| :DISPlay:DIALog:OPEN..... | 559 |
| :DISPlay:PSAVe:HOLDoff..... | 559 |
| :DISPlay:PSAVe[:STATe]..... | 559 |
| :DISPlay:UPDate..... | 560 |
| :FORMat:BORDer..... | 560 |
| :FORMat:SREGister..... | 561 |
| :FORMat[:DATA]..... | 561 |
| :HCOPy:DATA?..... | 563 |
| :HCOPy:DEVice:LANGUage..... | 563 |
| :HCOPy:FILE[:NAME]..... | 564 |
| :HCOPy:FILE[:NAME]:AUTO:DIRectory..... | 564 |
| :HCOPy:FILE[:NAME]:AUTO:DIRectory:CLEar..... | 564 |
| :HCOPy:FILE[:NAME]:AUTO:FILE?..... | 565 |
| :HCOPy:FILE[:NAME]:AUTO:STATe..... | 566 |
| :HCOPy:FILE[:NAME]:AUTO?..... | 564 |
| :HCOPy:FILE[:NAME]:AUTO[:FILE]:DAY:STATe..... | 565 |
| :HCOPy:FILE[:NAME]:AUTO[:FILE]:MONTH:STATe..... | 565 |
| :HCOPy:FILE[:NAME]:AUTO[:FILE]:NUMBer?..... | 565 |
| :HCOPy:FILE[:NAME]:AUTO[:FILE]:PREFix..... | 566 |
| :HCOPy:FILE[:NAME]:AUTO[:FILE]:PREFix:STATe..... | 566 |
| :HCOPy:FILE[:NAME]:AUTO[:FILE]:YEAR:STATe..... | 565 |
| :HCOPy:IMAGe:FORMat..... | 563 |
| :HCOPy:REGion..... | 566 |
| :HCOPy[:EXECute]..... | 563 |
| :INITiate<hw>[:POWER]:CONTInuous..... | 586 |
| :KBOard:LANGUage..... | 567 |
| :KBOard:LAYout..... | 567 |
| :MEMory:HFRee?..... | 578 |
| :MMEMory:CATalog:LENGth?..... | 573 |
| :MMEMory:CATalog?..... | 573 |
| :MMEMory:CDIRectory..... | 573 |
| :MMEMory:COpy..... | 574 |
| :MMEMory:DATA..... | 574 |
| :MMEMory:DATA:UNPRotected..... | 575 |
| :MMEMory:DCATalog:LENGth?..... | 577 |
| :MMEMory:DCATalog?..... | 577 |
| :MMEMory:DELeTe..... | 578 |
| :MMEMory:LOAD:STATe..... | 578 |
| :MMEMory:MDIRectory..... | 579 |

| | |
|--|-----|
| :MMEMory:MOVE..... | 579 |
| :MMEMory:MSIS..... | 579 |
| :MMEMory:RDIRECTory..... | 579 |
| :MMEMory:STORE:STATe..... | 580 |
| :OUTPut<hw>:AFIXed:RANGe:LOWer?..... | 580 |
| :OUTPut<hw>:AFIXed:RANGe:UPPer?..... | 581 |
| :OUTPut<hw>:AMODE..... | 581 |
| :OUTPut<hw>:IMPedance?..... | 582 |
| :OUTPut<hw>:PROTection:CLEar..... | 582 |
| :OUTPut<hw>:PROTection:TRIPped?..... | 582 |
| :OUTPut<hw>[:STATe]..... | 583 |
| :OUTPut<hw>[:STATe]:PON..... | 583 |
| :READ<ch>[:POWer]?..... | 587 |
| :SENSe<ch>:UNIT[:POWer]..... | 594 |
| :SENSe<ch>[:POWer]:APERture:DEFault:STATe..... | 586 |
| :SENSe<ch>[:POWer]:APERture:TIME..... | 586 |
| :SENSe<ch>[:POWer]:CORRection:SPDevice:LIST?..... | 588 |
| :SENSe<ch>[:POWer]:CORRection:SPDevice:SElect..... | 587 |
| :SENSe<ch>[:POWer]:CORRection:SPDevice:STATe..... | 587 |
| :SENSe<ch>[:POWer]:DISPlay:PERManent:PRiority..... | 588 |
| :SENSe<ch>[:POWer]:DISPlay:PERManent:STATe..... | 588 |
| :SENSe<ch>[:POWer]:FILTer:LENGth:AUTO?..... | 589 |
| :SENSe<ch>[:POWer]:FILTer:LENGth[:USER]..... | 589 |
| :SENSe<ch>[:POWer]:FILTer:NSRatio..... | 589 |
| :SENSe<ch>[:POWer]:FILTer:NSRatio:MTIME..... | 590 |
| :SENSe<ch>[:POWer]:FILTer:SONCe..... | 590 |
| :SENSe<ch>[:POWer]:FILTer:TYPE..... | 591 |
| :SENSe<ch>[:POWer]:FREQUency..... | 591 |
| :SENSe<ch>[:POWer]:LOGGing:STATe..... | 591 |
| :SENSe<ch>[:POWer]:OFFSet..... | 592 |
| :SENSe<ch>[:POWer]:OFFSet:STATe..... | 592 |
| :SENSe<ch>[:POWer]:SOURce..... | 593 |
| :SENSe<ch>[:POWer]:ZERO..... | 594 |
| :SLISt:ELEMent<ch>:MAPPING..... | 584 |
| :SLISt:SCAN[:STATe]..... | 585 |
| :SLISt:SENSor:MAP..... | 585 |
| :SLISt[:LIST]?..... | 585 |
| :SOURce<hw>:PRESet..... | 538 |
| :STATus:OPERation:CONDition?..... | 822 |
| :STATus:OPERation:ENABLE..... | 822 |
| :STATus:OPERation:NTRansition..... | 822 |
| :STATus:OPERation:PTRansition..... | 823 |
| :STATus:OPERation[:EVENT]..... | 822 |
| :STATus:PRESet..... | 823 |
| :STATus:QUEStionable:CONDition..... | 823 |
| :STATus:QUEStionable:ENABLE..... | 823 |
| :STATus:QUEStionable:NTRansition..... | 824 |
| :STATus:QUEStionable:PTRansition..... | 824 |
| :STATus:QUEStionable[:EVENT]..... | 824 |
| :STATus:QUEue[:NEXT]?..... | 824 |

| | |
|--|-----|
| :SYSTem:COMMunicate:GPIB:LTERminator..... | 832 |
| :SYSTem:COMMunicate:GPIB:RESource?..... | 835 |
| :SYSTem:COMMunicate:GPIB[:SELF]:ADDResS..... | 832 |
| :SYSTem:COMMunicate:HISLip:RESource?..... | 836 |
| :SYSTem:COMMunicate:NETWork:IPADdress..... | 834 |
| :SYSTem:COMMunicate:NETWork:IPADdress:MODE..... | 833 |
| :SYSTem:COMMunicate:NETWork:MACaddress..... | 834 |
| :SYSTem:COMMunicate:NETWork:RESource?..... | 836 |
| :SYSTem:COMMunicate:NETWork:REStart..... | 835 |
| :SYSTem:COMMunicate:NETWork:STATus?..... | 835 |
| :SYSTem:COMMunicate:NETWork[:COMMON]:DOMain..... | 832 |
| :SYSTem:COMMunicate:NETWork[:COMMON]:HOSTname..... | 832 |
| :SYSTem:COMMunicate:NETWork[:COMMON]:WORKgroup..... | 833 |
| :SYSTem:COMMunicate:NETWork[:IPADdress]:DNS..... | 833 |
| :SYSTem:COMMunicate:NETWork[:IPADdress]:GATeway..... | 834 |
| :SYSTem:COMMunicate:NETWork[:IPADdress]:SUBNet:MASK..... | 834 |
| :SYSTem:COMMunicate:SERial:BAUD..... | 837 |
| :SYSTem:COMMunicate:SERial:PARity..... | 837 |
| :SYSTem:COMMunicate:SERial:RESource?..... | 836 |
| :SYSTem:COMMunicate:SERial:SBITs..... | 837 |
| :SYSTem:COMMunicate:SOCKet:RESource?..... | 838 |
| :SYSTem:COMMunicate:USB:RESource?..... | 836 |
| :SYSTem:DATE..... | 842 |
| :SYSTem:DISPlay:UPDate..... | 842 |
| :SYSTem:DLOCK..... | 830 |
| :SYSTem:ERRor:ALL?..... | 826 |
| :SYSTem:ERRor:CODE:ALL?..... | 827 |
| :SYSTem:ERRor:CODE[:NEXT]?..... | 827 |
| :SYSTem:ERRor:COUNT?..... | 828 |
| :SYSTem:ERRor:HISTory:CLEar..... | 829 |
| :SYSTem:ERRor:HISTory?..... | 828 |
| :SYSTem:ERRor:STATic?..... | 829 |
| :SYSTem:ERRor[:NEXT]?..... | 828 |
| :SYSTem:FILEs:TEMPorary:DELeTe..... | 838 |
| :SYSTem:FPReset..... | 538 |
| :SYSTem:HELP:EXPort..... | 829 |
| :SYSTem:IDENtification..... | 838 |
| :SYSTem:IDENtification:PRESet..... | 839 |
| :SYSTem:IRESpone..... | 839 |
| :SYSTem:KLOCK..... | 830 |
| :SYSTem:LANGUage..... | 840 |
| :SYSTem:MMEMory:HDD?..... | 838 |
| :SYSTem:MMEMory:PATH:USER?..... | 844 |
| :SYSTem:NINFormation?..... | 835 |
| :SYSTem:NTP:HOSTname..... | 840 |
| :SYSTem:NTP:STATe..... | 840 |
| :SYSTem:ORESpone..... | 839 |
| :SYSTem:OSYStem?..... | 844 |
| :SYSTem:PRESet..... | 538 |
| :SYSTem:PROTect<ch>[:STATe]..... | 841 |

| | |
|--|-----|
| :SYSTem:RCL..... | 831 |
| :SYSTem:REBoot..... | 841 |
| :SYSTem:REStArt..... | 841 |
| :SYSTem:SAV..... | 831 |
| :SYSTem:SECurity:SUPolicy..... | 840 |
| :SYSTem:SECurity:VOLMode[:STATe]..... | 831 |
| :SYSTem:SHUTdown..... | 841 |
| :SYSTem:STARtup:COMPLete?..... | 842 |
| :SYSTem:TIME..... | 843 |
| :SYSTem:TIME:ZONE..... | 843 |
| :SYSTem:TIME:ZONE:CATalog?..... | 843 |
| :SYSTem:ULOCK..... | 830 |
| :SYSTem:VERSIon?..... | 843 |
| :SYSTem:WAIT..... | 844 |
| :TEST:BB:DATA:ERRor:RATE..... | 846 |
| :TEST:BB:DATA:FREQuency..... | 846 |
| :TEST:BB:DATA:OFFTime..... | 847 |
| :TEST:BB:DATA:ONTime..... | 847 |
| :TEST:BB:DATA:RDELay..... | 847 |
| :TEST:BB:DATA:STATe..... | 847 |
| :TEST:BB:DATA:TRIGger[:MODE]..... | 847 |
| :TEST:BB:DATA:TYPE..... | 847 |
| :TEST:EIQMode..... | 846 |
| :TEST<hw>:ALL:RESult?..... | 845 |
| :TEST<hw>:ALL:STARt..... | 845 |
| :TEST<hw>:DIRect..... | 846 |
| :TRIGger:BERT[:IMMediate]..... | 550 |
| :TRIGger:BLER[:IMMediate]..... | 550 |
| :TRIGger<hw>:FSWeep:SOURce..... | 849 |
| :TRIGger<hw>:FSWeep[:IMMediate]..... | 849 |
| :TRIGger<hw>:LFFSweep..... | 850 |
| :TRIGger<hw>:LFFSweep:IMMediate..... | 851 |
| :TRIGger<hw>:LFFSweep:SOURce..... | 850 |
| :TRIGger<hw>:PSWeep:SOURce..... | 851 |
| :TRIGger<hw>:PSWeep[:IMMediate]..... | 852 |
| :TRIGger<hw>[:IMMediate]..... | 853 |
| :TRIGger<hw>[:SWEep]:SOURce..... | 852 |
| :TRIGger<hw>[:SWEep][:IMMediate]..... | 853 |
| :UNIT:ANGLE..... | 854 |
| :UNIT:POWer..... | 854 |
| [:SOURce]:CORRection:CSET:CATalog?..... | 728 |
| [:SOURce]:CORRection:CSET:DELeTe..... | 730 |
| [:SOURce]:INPut:BERT:IMPedance..... | 549 |
| [:SOURce]:INPut:BERT:THReshold..... | 550 |
| [:SOURce]:INPut:CLOCK:IMPedance..... | 747 |
| [:SOURce]:INPut:DELay:ADCState..... | 749 |
| [:SOURce]:INPut:DELay:CLENgth<ch>..... | 750 |
| [:SOURce]:INPut:DELay:SPOSItion..... | 750 |
| [:SOURce]:INPut:TRIGger:BBANd:SLOPe..... | 748 |
| [:SOURce]:INPut:TRIGger:IMPedance..... | 748 |

| | |
|--|-----|
| [:SOURce]:INPut:TRIGger:LEVel..... | 749 |
| [:SOURce]:INPut:TRIGger:SLOPe..... | 749 |
| [:SOURce]:IQ:OUTPut:DIGital:OFLow:HOLD:RESet..... | 758 |
| [:SOURce]:IQ:OUTPut:DIGital:OFLow:HOLD:STATe?..... | 758 |
| [:SOURce]:IQ:OUTPut:DIGital:OFLow:STATe?..... | 758 |
| [:SOURce]:LFOutput:FREQuency..... | 763 |
| [:SOURce]:LFOutput:SHApe..... | 771 |
| [:SOURce]:LFOutput:SIMPedance..... | 771 |
| [:SOURce]:LFOutput:VOLTage..... | 772 |
| [:SOURce]:LFOutput[:STATe]..... | 765 |
| [:SOURce]:ROSCillator:EXTernal:FREQuency..... | 808 |
| [:SOURce]:ROSCillator:EXTernal:RFOFf[:STATe]..... | 808 |
| [:SOURce]:ROSCillator:EXTernal:SBANdwidth..... | 809 |
| [:SOURce]:ROSCillator:SOURce..... | 810 |
| [:SOURce]:ROSCillator[:INTernal]:ADJust:VALue..... | 809 |
| [:SOURce]:ROSCillator[:INTernal]:ADJust[:STATe]..... | 809 |
| [:SOURce<hw>]:AM:EXTernal:COUPling..... | 596 |
| [:SOURce<hw>]:AM:SENSitivity?..... | 596 |
| [:SOURce<hw>]:AM:SOURce..... | 597 |
| [:SOURce<hw>]:AM:STATe..... | 597 |
| [:SOURce<hw>]:AM[:DEPTH]..... | 595 |
| [:SOURce<hw>]:AWGN:BRATe..... | 598 |
| [:SOURce<hw>]:AWGN:BWIDth..... | 598 |
| [:SOURce<hw>]:AWGN:BWIDth:NOISe?..... | 599 |
| [:SOURce<hw>]:AWGN:BWIDth:RATio..... | 599 |
| [:SOURce<hw>]:AWGN:CNRatio..... | 599 |
| [:SOURce<hw>]:AWGN:DISP:MODE..... | 600 |
| [:SOURce<hw>]:AWGN:ENRatio..... | 600 |
| [:SOURce<hw>]:AWGN:FREQuency:RESult?..... | 600 |
| [:SOURce<hw>]:AWGN:FREQuency:TARGet..... | 601 |
| [:SOURce<hw>]:AWGN:MODE..... | 601 |
| [:SOURce<hw>]:AWGN:POWer:CARRier..... | 602 |
| [:SOURce<hw>]:AWGN:POWer:MODE..... | 602 |
| [:SOURce<hw>]:AWGN:POWer:NOISe..... | 603 |
| [:SOURce<hw>]:AWGN:POWer:NOISe:TOTal?..... | 603 |
| [:SOURce<hw>]:AWGN:POWer:RMODE..... | 604 |
| [:SOURce<hw>]:AWGN:POWer:SUM:PEP?..... | 604 |
| [:SOURce<hw>]:AWGN:POWer:SUM?..... | 604 |
| [:SOURce<hw>]:AWGN:STATe..... | 605 |
| [:SOURce<hw>]:BB:ARBITrary:CLOCK..... | 608 |
| [:SOURce<hw>]:BB:ARBITrary:CLOCK:MODE..... | 608 |
| [:SOURce<hw>]:BB:ARBITrary:CLOCK:MULTIplier..... | 609 |
| [:SOURce<hw>]:BB:ARBITrary:CLOCK:SOURce..... | 609 |
| [:SOURce<hw>]:BB:ARBITrary:CLOCK:SYNChronization:EXECute..... | 610 |
| [:SOURce<hw>]:BB:ARBITrary:CLOCK:SYNChronization:MODE..... | 610 |
| [:SOURce<hw>]:BB:ARBITrary:MCARRier:CARRier:COUNT..... | 625 |
| [:SOURce<hw>]:BB:ARBITrary:MCARRier:CARRier:MODE..... | 625 |
| [:SOURce<hw>]:BB:ARBITrary:MCARRier:CARRier:SPACing..... | 626 |
| [:SOURce<hw>]:BB:ARBITrary:MCARRier:CARRier<ch>:CONFLICT?..... | 626 |
| [:SOURce<hw>]:BB:ARBITrary:MCARRier:CARRier<ch>:DELay..... | 627 |

| | |
|---|-----|
| [:SOURce<hw>]:BB:ARBitrary:MCARrier:CARRier<ch>:FILE..... | 627 |
| [:SOURce<hw>]:BB:ARBitrary:MCARrier:CARRier<ch>:FREQuency..... | 627 |
| [:SOURce<hw>]:BB:ARBitrary:MCARrier:CARRier<ch>:PHASe..... | 628 |
| [:SOURce<hw>]:BB:ARBitrary:MCARrier:CARRier<ch>:POWer..... | 628 |
| [:SOURce<hw>]:BB:ARBitrary:MCARrier:CARRier<ch>:STATe..... | 629 |
| [:SOURce<hw>]:BB:ARBitrary:MCARrier:CFACTOR:MODE..... | 629 |
| [:SOURce<hw>]:BB:ARBitrary:MCARrier:CLIPping:CFACTOR..... | 629 |
| [:SOURce<hw>]:BB:ARBitrary:MCARrier:CLIPping:CUToff..... | 630 |
| [:SOURce<hw>]:BB:ARBitrary:MCARrier:CLIPping[STATe]..... | 630 |
| [:SOURce<hw>]:BB:ARBitrary:MCARrier:CLoad..... | 631 |
| [:SOURce<hw>]:BB:ARBitrary:MCARrier:CLOCK?..... | 631 |
| [:SOURce<hw>]:BB:ARBitrary:MCARrier:CREate..... | 632 |
| [:SOURce<hw>]:BB:ARBitrary:MCARrier:EDIT:CARRier:DELay:STEP..... | 632 |
| [:SOURce<hw>]:BB:ARBitrary:MCARrier:EDIT:CARRier:DELay[START]..... | 633 |
| [:SOURce<hw>]:BB:ARBitrary:MCARrier:EDIT:CARRier:EXECute..... | 633 |
| [:SOURce<hw>]:BB:ARBitrary:MCARrier:EDIT:CARRier:FILE..... | 633 |
| [:SOURce<hw>]:BB:ARBitrary:MCARrier:EDIT:CARRier:PHASe:STEP..... | 634 |
| [:SOURce<hw>]:BB:ARBitrary:MCARrier:EDIT:CARRier:PHASe[START]..... | 634 |
| [:SOURce<hw>]:BB:ARBitrary:MCARrier:EDIT:CARRier:POWer:STEP..... | 634 |
| [:SOURce<hw>]:BB:ARBitrary:MCARrier:EDIT:CARRier:POWer[START]..... | 635 |
| [:SOURce<hw>]:BB:ARBitrary:MCARrier:EDIT:CARRier:START..... | 635 |
| [:SOURce<hw>]:BB:ARBitrary:MCARrier:EDIT:CARRier:STATe..... | 636 |
| [:SOURce<hw>]:BB:ARBitrary:MCARrier:EDIT:CARRier:STOP..... | 635 |
| [:SOURce<hw>]:BB:ARBitrary:MCARrier:OFILe..... | 636 |
| [:SOURce<hw>]:BB:ARBitrary:MCARrier:POWer:REFerence..... | 628 |
| [:SOURce<hw>]:BB:ARBitrary:MCARrier:PRESet..... | 636 |
| [:SOURce<hw>]:BB:ARBitrary:MCARrier:SAMPles?..... | 636 |
| [:SOURce<hw>]:BB:ARBitrary:MCARrier:SETTing:CATalog?..... | 637 |
| [:SOURce<hw>]:BB:ARBitrary:MCARrier:SETTing:LOAD..... | 637 |
| [:SOURce<hw>]:BB:ARBitrary:MCARrier:SETTing:STORE..... | 637 |
| [:SOURce<hw>]:BB:ARBitrary:MCARrier:SETTing:STORE:FAST..... | 638 |
| [:SOURce<hw>]:BB:ARBitrary:MCARrier:TIME..... | 638 |
| [:SOURce<hw>]:BB:ARBitrary:MCARrier:TIME:MODE..... | 638 |
| [:SOURce<hw>]:BB:ARBitrary:PRAMP[STATe]..... | 607 |
| [:SOURce<hw>]:BB:ARBitrary:PRESet..... | 607 |
| [:SOURce<hw>]:BB:ARBitrary:SIGNAL:TYPE..... | 621 |
| [:SOURce<hw>]:BB:ARBitrary:STATe..... | 607 |
| [:SOURce<hw>]:BB:ARBitrary:TRIGger:ARM:EXECute..... | 611 |
| [:SOURce<hw>]:BB:ARBitrary:TRIGger:DELay:UNIT..... | 615 |
| [:SOURce<hw>]:BB:ARBitrary:TRIGger:EXECute..... | 611 |
| [:SOURce<hw>]:BB:ARBitrary:TRIGger:OUTPut:DELay:FIXed..... | 620 |
| [:SOURce<hw>]:BB:ARBitrary:TRIGger:OUTPut<ch>:DELay..... | 620 |
| [:SOURce<hw>]:BB:ARBitrary:TRIGger:OUTPut<ch>:DELay:MAXimum?..... | 612 |
| [:SOURce<hw>]:BB:ARBitrary:TRIGger:OUTPut<ch>:DELay:MINimum?..... | 612 |
| [:SOURce<hw>]:BB:ARBitrary:TRIGger:OUTPut<ch>:MODE..... | 617 |
| [:SOURce<hw>]:BB:ARBitrary:TRIGger:OUTPut<ch>:OFFTime..... | 618 |
| [:SOURce<hw>]:BB:ARBitrary:TRIGger:OUTPut<ch>:ONTTime..... | 618 |
| [:SOURce<hw>]:BB:ARBitrary:TRIGger:OUTPut<ch>:PATTern..... | 618 |
| [:SOURce<hw>]:BB:ARBitrary:TRIGger:OUTPut<ch>:PULSe:DIVider..... | 619 |
| [:SOURce<hw>]:BB:ARBitrary:TRIGger:OUTPut<ch>:PULSe:FREQuency?..... | 619 |

| | |
|--|-----|
| [:SOURce<hw>]:BB:ARBitrary:TRIGger:RMODE? | 613 |
| [:SOURce<hw>]:BB:ARBitrary:TRIGger:SLENgth | 613 |
| [:SOURce<hw>]:BB:ARBitrary:TRIGger:SLUNit | 614 |
| [:SOURce<hw>]:BB:ARBitrary:TRIGger:SMODE | 614 |
| [:SOURce<hw>]:BB:ARBitrary:TRIGger:SOURce | 614 |
| [:SOURce<hw>]:BB:ARBitrary:TRIGger[:EXTErnal]:SYNChronize:OUTPut | 612 |
| [:SOURce<hw>]:BB:ARBitrary:TRIGger[:EXTErnal<1 2>]:DELay | 615 |
| [:SOURce<hw>]:BB:ARBitrary:TRIGger[:EXTErnal<1 2>]:INHibit | 616 |
| [:SOURce<hw>]:BB:ARBitrary:TRIGger[:EXTErnal<1 2>]:RDELay? | 616 |
| [:SOURce<hw>]:BB:ARBitrary:TRIGger[:EXTErnal<1 2>]:TDELay | 615 |
| [:SOURce<hw>]:BB:ARBitrary:TSIGnal:CIQ:CREate | 621 |
| [:SOURce<hw>]:BB:ARBitrary:TSIGnal:CIQ:CREate:NAMed | 621 |
| [:SOURce<hw>]:BB:ARBitrary:TSIGnal:CIQ:I | 621 |
| [:SOURce<hw>]:BB:ARBitrary:TSIGnal:CIQ:Q | 621 |
| [:SOURce<hw>]:BB:ARBitrary:TSIGnal:RECTangle:AMPLitude | 622 |
| [:SOURce<hw>]:BB:ARBitrary:TSIGnal:RECTangle:CREate | 621 |
| [:SOURce<hw>]:BB:ARBitrary:TSIGnal:RECTangle:CREate:NAMed | 621 |
| [:SOURce<hw>]:BB:ARBitrary:TSIGnal:RECTangle:FREQUency | 622 |
| [:SOURce<hw>]:BB:ARBitrary:TSIGnal:RECTangle:OFFSet | 622 |
| [:SOURce<hw>]:BB:ARBitrary:TSIGnal:RECTangle:SAMPles | 623 |
| [:SOURce<hw>]:BB:ARBitrary:TSIGnal:SINE:CREate | 621 |
| [:SOURce<hw>]:BB:ARBitrary:TSIGnal:SINE:CREate:NAMed | 621 |
| [:SOURce<hw>]:BB:ARBitrary:TSIGnal:SINE:FREQUency | 623 |
| [:SOURce<hw>]:BB:ARBitrary:TSIGnal:SINE:PHASe | 623 |
| [:SOURce<hw>]:BB:ARBitrary:TSIGnal:SINE:SAMPles | 624 |
| [:SOURce<hw>]:BB:ARBitrary:WAVEform:CATalog:LENGth? | 640 |
| [:SOURce<hw>]:BB:ARBitrary:WAVEform:CATalog? | 639 |
| [:SOURce<hw>]:BB:ARBitrary:WAVEform:CLOCK | 640 |
| [:SOURce<hw>]:BB:ARBitrary:WAVEform:DATA | 640 |
| [:SOURce<hw>]:BB:ARBitrary:WAVEform:DELeTe | 641 |
| [:SOURce<hw>]:BB:ARBitrary:WAVEform:FREE? | 642 |
| [:SOURce<hw>]:BB:ARBitrary:WAVEform:POINts? | 642 |
| [:SOURce<hw>]:BB:ARBitrary:WAVEform:SELEct | 642 |
| [:SOURce<hw>]:BB:ARBitrary:WAVEform:TAG? | 643 |
| [:SOURce<hw>]:BB:ARBitrary:WSEGment:CLOad | 644 |
| [:SOURce<hw>]:BB:ARBitrary:WSEGment:CONFigure:BLANK:APPend | 645 |
| [:SOURce<hw>]:BB:ARBitrary:WSEGment:CONFigure:CATalog? | 645 |
| [:SOURce<hw>]:BB:ARBitrary:WSEGment:CONFigure:CLOCK | 646 |
| [:SOURce<hw>]:BB:ARBitrary:WSEGment:CONFigure:CLOCK:MODE | 646 |
| [:SOURce<hw>]:BB:ARBitrary:WSEGment:CONFigure:COMMENT | 646 |
| [:SOURce<hw>]:BB:ARBitrary:WSEGment:CONFigure:DELeTe | 647 |
| [:SOURce<hw>]:BB:ARBitrary:WSEGment:CONFigure:LEVel[:MODE] | 647 |
| [:SOURce<hw>]:BB:ARBitrary:WSEGment:CONFigure:MARKer:ESEGment | 647 |
| [:SOURce<hw>]:BB:ARBitrary:WSEGment:CONFigure:MARKer:FSEGment | 648 |
| [:SOURce<hw>]:BB:ARBitrary:WSEGment:CONFigure:MARKer:MODE | 648 |
| [:SOURce<hw>]:BB:ARBitrary:WSEGment:CONFigure:OFILe | 649 |
| [:SOURce<hw>]:BB:ARBitrary:WSEGment:CONFigure:SEGMENT:APPend | 649 |
| [:SOURce<hw>]:BB:ARBitrary:WSEGment:CONFigure:SEGMENT:CATalog? | 649 |
| [:SOURce<hw>]:BB:ARBitrary:WSEGment:CONFigure:SELEct | 650 |
| [:SOURce<hw>]:BB:ARBitrary:WSEGment:CREate | 650 |

| | |
|---|-----|
| [:SOURce<hw>]:BB:ARBitrary:WSEgment:NAME?..... | 651 |
| [:SOURce<hw>]:BB:ARBitrary:WSEgment:NEXT..... | 651 |
| [:SOURce<hw>]:BB:ARBitrary:WSEgment:NEXT:EXECute..... | 652 |
| [:SOURce<hw>]:BB:ARBitrary:WSEgment:NEXT:SOURce..... | 652 |
| [:SOURce<hw>]:BB:ARBitrary:WSEgment:SEquence:APPend..... | 653 |
| [:SOURce<hw>]:BB:ARBitrary:WSEgment:SEquence:SElect..... | 653 |
| [:SOURce<hw>]:BB:ARBitrary:WSEgment?..... | 644 |
| [:SOURce<hw>]:BB:ARBitrary[:TRIGger]:SEquence..... | 616 |
| [:SOURce<hw>]:BB:DM:APSK16:GAMMa..... | 658 |
| [:SOURce<hw>]:BB:DM:APSK32:GAMMa..... | 658 |
| [:SOURce<hw>]:BB:DM:AQPSk:ANGLE..... | 673 |
| [:SOURce<hw>]:BB:DM:ASK:DEPTTh..... | 674 |
| [:SOURce<hw>]:BB:DM:CLISt:CATalog?..... | 681 |
| [:SOURce<hw>]:BB:DM:CLISt:COPIY..... | 682 |
| [:SOURce<hw>]:BB:DM:CLISt:DATA..... | 682 |
| [:SOURce<hw>]:BB:DM:CLISt:DELeTe..... | 683 |
| [:SOURce<hw>]:BB:DM:CLISt:FREE?..... | 681 |
| [:SOURce<hw>]:BB:DM:CLISt:POINts?..... | 684 |
| [:SOURce<hw>]:BB:DM:CLISt:SElect..... | 684 |
| [:SOURce<hw>]:BB:DM:CLISt:TAG?..... | 682 |
| [:SOURce<hw>]:BB:DM:CLOCK:MODE..... | 658 |
| [:SOURce<hw>]:BB:DM:CLOCK:MULTIplier..... | 659 |
| [:SOURce<hw>]:BB:DM:CLOCK:SOURce..... | 659 |
| [:SOURce<hw>]:BB:DM:CLOCK:SYNChronization:EXECute..... | 660 |
| [:SOURce<hw>]:BB:DM:CLOCK:SYNChronization:MODE..... | 659 |
| [:SOURce<hw>]:BB:DM:CODing..... | 674 |
| [:SOURce<hw>]:BB:DM:DLISt:CATalog?..... | 681 |
| [:SOURce<hw>]:BB:DM:DLISt:COPIY..... | 682 |
| [:SOURce<hw>]:BB:DM:DLISt:DATA..... | 684 |
| [:SOURce<hw>]:BB:DM:DLISt:DATA:APPend..... | 685 |
| [:SOURce<hw>]:BB:DM:DLISt:DELeTe..... | 686 |
| [:SOURce<hw>]:BB:DM:DLISt:FREE?..... | 681 |
| [:SOURce<hw>]:BB:DM:DLISt:POINts..... | 686 |
| [:SOURce<hw>]:BB:DM:DLISt:SElect..... | 687 |
| [:SOURce<hw>]:BB:DM:DLISt:TAG?..... | 682 |
| [:SOURce<hw>]:BB:DM:FILTer:OSAMpling..... | 670 |
| [:SOURce<hw>]:BB:DM:FILTer:OSAMpling:AUTO..... | 670 |
| [:SOURce<hw>]:BB:DM:FILTer:PARAmeter:APCO25..... | 671 |
| [:SOURce<hw>]:BB:DM:FILTer:PARAmeter:APCO25Lsm:GAUSSs..... | 672 |
| [:SOURce<hw>]:BB:DM:FILTer:PARAmeter:APCO25Lsm:LOWPass..... | 672 |
| [:SOURce<hw>]:BB:DM:FILTer:PARAmeter:COSSine:BANDwidth..... | 672 |
| [:SOURce<hw>]:BB:DM:FILTer:PARAmeter:COSSine[:ROLLoff]..... | 671 |
| [:SOURce<hw>]:BB:DM:FILTer:PARAmeter:GAUSSs..... | 671 |
| [:SOURce<hw>]:BB:DM:FILTer:PARAmeter:LPASSs..... | 671 |
| [:SOURce<hw>]:BB:DM:FILTer:PARAmeter:LPASSEVM..... | 671 |
| [:SOURce<hw>]:BB:DM:FILTer:PARAmeter:PGAuss..... | 671 |
| [:SOURce<hw>]:BB:DM:FILTer:PARAmeter:RCOSSine..... | 671 |
| [:SOURce<hw>]:BB:DM:FILTer:PARAmeter:SPHase..... | 671 |
| [:SOURce<hw>]:BB:DM:FILTer:TYPE..... | 672 |
| [:SOURce<hw>]:BB:DM:FLISt:CATalog?..... | 681 |

| | |
|--|-----|
| [:SOURce<hw>]:BB:DM:FLISt:DELeTe..... | 687 |
| [:SOURce<hw>]:BB:DM:FLISt:FREE?..... | 681 |
| [:SOURce<hw>]:BB:DM:FLISt:POINts?..... | 687 |
| [:SOURce<hw>]:BB:DM:FLISt:SELeCt..... | 688 |
| [:SOURce<hw>]:BB:DM:FORMat..... | 675 |
| [:SOURce<hw>]:BB:DM:FSK:DEViatiOn..... | 675 |
| [:SOURce<hw>]:BB:DM:FSK:VARiAbLe:SYMBol<ch0>:DEViatiOn..... | 675 |
| [:SOURce<hw>]:BB:DM:FSK:VARiAbLe:TYPE..... | 676 |
| [:SOURce<hw>]:BB:DM:MDELay?..... | 676 |
| [:SOURce<hw>]:BB:DM:MLISt:CATalog?..... | 681 |
| [:SOURce<hw>]:BB:DM:MLISt:DELeTe..... | 688 |
| [:SOURce<hw>]:BB:DM:MLISt:FREE?..... | 681 |
| [:SOURce<hw>]:BB:DM:MLISt:POINts?..... | 688 |
| [:SOURce<hw>]:BB:DM:MLISt:SELeCt..... | 689 |
| [:SOURce<hw>]:BB:DM:PATTern..... | 654 |
| [:SOURce<hw>]:BB:DM:PRAMp:ATTenuatiOn..... | 677 |
| [:SOURce<hw>]:BB:DM:PRAMp:BBONly[:STATe]..... | 677 |
| [:SOURce<hw>]:BB:DM:PRAMp:FDELay..... | 678 |
| [:SOURce<hw>]:BB:DM:PRAMp:RDELay..... | 678 |
| [:SOURce<hw>]:BB:DM:PRAMp:SHAPE..... | 678 |
| [:SOURce<hw>]:BB:DM:PRAMp:SOURce..... | 679 |
| [:SOURce<hw>]:BB:DM:PRAMp:TIME..... | 679 |
| [:SOURce<hw>]:BB:DM:PRAMp[:STATe]..... | 679 |
| [:SOURce<hw>]:BB:DM:PRBS[:LENGth]..... | 655 |
| [:SOURce<hw>]:BB:DM:PRESet..... | 655 |
| [:SOURce<hw>]:BB:DM:SETTing:CATalog?..... | 689 |
| [:SOURce<hw>]:BB:DM:SETTing:DELeTe..... | 689 |
| [:SOURce<hw>]:BB:DM:SETTing:LOAD..... | 690 |
| [:SOURce<hw>]:BB:DM:SETTing:STORE..... | 690 |
| [:SOURce<hw>]:BB:DM:SETTing:STORE:FAST..... | 690 |
| [:SOURce<hw>]:BB:DM:SOURce..... | 655 |
| [:SOURce<hw>]:BB:DM:SRATe..... | 656 |
| [:SOURce<hw>]:BB:DM:STANdard..... | 656 |
| [:SOURce<hw>]:BB:DM:STANdard:ULISt:CATalog?..... | 691 |
| [:SOURce<hw>]:BB:DM:STANdard:ULISt:DELeTe..... | 691 |
| [:SOURce<hw>]:BB:DM:STANdard:ULISt:LOAD..... | 691 |
| [:SOURce<hw>]:BB:DM:STANdard:ULISt:STORE..... | 692 |
| [:SOURce<hw>]:BB:DM:STATe..... | 657 |
| [:SOURce<hw>]:BB:DM:SWITChing:SOURce..... | 657 |
| [:SOURce<hw>]:BB:DM:SWITChing:STATe..... | 657 |
| [:SOURce<hw>]:BB:DM:TRIGger:ARM:EXECute..... | 661 |
| [:SOURce<hw>]:BB:DM:TRIGger:DELay:UNIT..... | 665 |
| [:SOURce<hw>]:BB:DM:TRIGger:EXECute..... | 661 |
| [:SOURce<hw>]:BB:DM:TRIGger:EXTernal:SYNChronize:OUTPut..... | 661 |
| [:SOURce<hw>]:BB:DM:TRIGger:OUTPut:DELay:FIXed..... | 662 |
| [:SOURce<hw>]:BB:DM:TRIGger:OUTPut<ch>:DELay..... | 663 |
| [:SOURce<hw>]:BB:DM:TRIGger:OUTPut<ch>:DELay:MAXimum?..... | 663 |
| [:SOURce<hw>]:BB:DM:TRIGger:OUTPut<ch>:DELay:MINimum?..... | 663 |
| [:SOURce<hw>]:BB:DM:TRIGger:OUTPut<ch>:MODE..... | 667 |
| [:SOURce<hw>]:BB:DM:TRIGger:OUTPut<ch>:OFFTime..... | 668 |

| | |
|---|-----|
| [[:SOURce<hw>]:BB:DM:TRIGger:OUTPut<ch>:ONTime..... | 668 |
| [[:SOURce<hw>]:BB:DM:TRIGger:OUTPut<ch>:PATtern..... | 669 |
| [[:SOURce<hw>]:BB:DM:TRIGger:OUTPut<ch>:PULSe:DIVider..... | 669 |
| [[:SOURce<hw>]:BB:DM:TRIGger:OUTPut<ch>:PULSe:FREQUency?..... | 669 |
| [[:SOURce<hw>]:BB:DM:TRIGger:RMODE?..... | 663 |
| [[:SOURce<hw>]:BB:DM:TRIGger:SLENgth..... | 664 |
| [[:SOURce<hw>]:BB:DM:TRIGger:SOURce..... | 664 |
| [[:SOURce<hw>]:BB:DM:TRIGger[:EXternal]:RDElay?..... | 666 |
| [[:SOURce<hw>]:BB:DM:TRIGger[:EXternal]:TDElay..... | 665 |
| [[:SOURce<hw>]:BB:DM:TRIGger[:EXternal<ch>]:DElay..... | 665 |
| [[:SOURce<hw>]:BB:DM:TRIGger[:EXternal<ch>]:INHibit..... | 666 |
| [[:SOURce<hw>]:BB:DM[:TRIGger]:SEQUence..... | 666 |
| [[:SOURce<hw>]:BB:FOFFset..... | 606 |
| [[:SOURce<hw>]:BB:GRAPhics:MODE..... | 692 |
| [[:SOURce<hw>]:BB:GRAPhics:SMARt:STATe..... | 692 |
| [[:SOURce<hw>]:BB:GRAPhics:SRATe:MODE..... | 693 |
| [[:SOURce<hw>]:BB:GRAPhics:SRATe:USER..... | 693 |
| [[:SOURce<hw>]:BB:GRAPhics:STATe..... | 694 |
| [[:SOURce<hw>]:BB:GRAPhics:TRIGger:SOURce..... | 694 |
| [[:SOURce<hw>]:BB:IMPairment:DElay..... | 695 |
| [[:SOURce<hw>]:BB:IMPairment:IQRatio[:MAGNitude]..... | 695 |
| [[:SOURce<hw>]:BB:IMPairment:LEAKage:I..... | 696 |
| [[:SOURce<hw>]:BB:IMPairment:LEAKage:Q..... | 696 |
| [[:SOURce<hw>]:BB:IMPairment:OPTimization:MODE..... | 697 |
| [[:SOURce<hw>]:BB:IMPairment:OPTimization:STATe..... | 698 |
| [[:SOURce<hw>]:BB:IMPairment:QUADrature[:ANGLE]..... | 696 |
| [[:SOURce<hw>]:BB:IMPairment:SKEW..... | 697 |
| [[:SOURce<hw>]:BB:IMPairment:STATe..... | 697 |
| [[:SOURce<hw>]:BB:MCCW:CARRier:COUNT..... | 699 |
| [[:SOURce<hw>]:BB:MCCW:CARRier:LIST:PHASe..... | 700 |
| [[:SOURce<hw>]:BB:MCCW:CARRier:LIST:POWer..... | 701 |
| [[:SOURce<hw>]:BB:MCCW:CARRier:LIST:STATe..... | 701 |
| [[:SOURce<hw>]:BB:MCCW:CARRier:PHASe..... | 702 |
| [[:SOURce<hw>]:BB:MCCW:CARRier:POWer..... | 702 |
| [[:SOURce<hw>]:BB:MCCW:CARRier:SPACing..... | 703 |
| [[:SOURce<hw>]:BB:MCCW:CARRier:STATe..... | 703 |
| [[:SOURce<hw>]:BB:MCCW:CFACTor..... | 703 |
| [[:SOURce<hw>]:BB:MCCW:CFACTor:ACTual?..... | 704 |
| [[:SOURce<hw>]:BB:MCCW:CFACTor:MODE..... | 704 |
| [[:SOURce<hw>]:BB:MCCW:CLOCK:MODE..... | 718 |
| [[:SOURce<hw>]:BB:MCCW:CLOCK:MULTIplier..... | 718 |
| [[:SOURce<hw>]:BB:MCCW:CLOCK:SOURce..... | 719 |
| [[:SOURce<hw>]:BB:MCCW:CLOCK:SYNChronization:EXECute..... | 720 |
| [[:SOURce<hw>]:BB:MCCW:CLOCK:SYNChronization:MODE..... | 719 |
| [[:SOURce<hw>]:BB:MCCW:CLOCK?..... | 705 |
| [[:SOURce<hw>]:BB:MCCW:EDIT:CARRier:EXECute..... | 705 |
| [[:SOURce<hw>]:BB:MCCW:EDIT:CARRier:PHASe:STEP..... | 706 |
| [[:SOURce<hw>]:BB:MCCW:EDIT:CARRier:PHASe[:START]..... | 706 |
| [[:SOURce<hw>]:BB:MCCW:EDIT:CARRier:POWer:STEP..... | 707 |
| [[:SOURce<hw>]:BB:MCCW:EDIT:CARRier:POWer[:START]..... | 707 |

| | |
|--|-----|
| [:SOURce<hw>]:BB:MCCW:EDIT:CARRier:START..... | 707 |
| [:SOURce<hw>]:BB:MCCW:EDIT:CARRier:STATE..... | 708 |
| [:SOURce<hw>]:BB:MCCW:EDIT:CARRier:STOP..... | 708 |
| [:SOURce<hw>]:BB:MCCW:PRESet..... | 699 |
| [:SOURce<hw>]:BB:MCCW:STATE..... | 699 |
| [:SOURce<hw>]:BB:MCCW:TRIGger:ARM:EXECute..... | 708 |
| [:SOURce<hw>]:BB:MCCW:TRIGger:EXECute..... | 709 |
| [:SOURce<hw>]:BB:MCCW:TRIGger:EXTErnal:SYNChronize:OUTPut..... | 709 |
| [:SOURce<hw>]:BB:MCCW:TRIGger:OBASeband:DELAy..... | 710 |
| [:SOURce<hw>]:BB:MCCW:TRIGger:OBASeband:INHibit..... | 710 |
| [:SOURce<hw>]:BB:MCCW:TRIGger:OUTPut:DELAy:FIXed..... | 714 |
| [:SOURce<hw>]:BB:MCCW:TRIGger:OUTPut<ch>:DELAy..... | 714 |
| [:SOURce<hw>]:BB:MCCW:TRIGger:OUTPut<ch>:DELAy:MAXimum?..... | 714 |
| [:SOURce<hw>]:BB:MCCW:TRIGger:OUTPut<ch>:DELAy:MINimum?..... | 715 |
| [:SOURce<hw>]:BB:MCCW:TRIGger:OUTPut<ch>:MODE..... | 715 |
| [:SOURce<hw>]:BB:MCCW:TRIGger:OUTPut<ch>:OFFTime..... | 716 |
| [:SOURce<hw>]:BB:MCCW:TRIGger:OUTPut<ch>:ONTime..... | 716 |
| [:SOURce<hw>]:BB:MCCW:TRIGger:OUTPut<ch>:PATTErn..... | 716 |
| [:SOURce<hw>]:BB:MCCW:TRIGger:OUTPut<ch>:PULSe:DIVider..... | 717 |
| [:SOURce<hw>]:BB:MCCW:TRIGger:OUTPut<ch>:PULSe:FREQUency?..... | 717 |
| [:SOURce<hw>]:BB:MCCW:TRIGger:RMODE?..... | 711 |
| [:SOURce<hw>]:BB:MCCW:TRIGger:SLENgth..... | 711 |
| [:SOURce<hw>]:BB:MCCW:TRIGger:SOURce..... | 712 |
| [:SOURce<hw>]:BB:MCCW:TRIGger[EXTErnal<ch>]:DELAy..... | 712 |
| [:SOURce<hw>]:BB:MCCW:TRIGger[EXTErnal<ch>]:INHibit..... | 712 |
| [:SOURce<hw>]:BB:MCCW[TRIGger]:SEQUence..... | 713 |
| [:SOURce<hw>]:BB:POFFset..... | 606 |
| [:SOURce<hw>]:BB:PROGress:MCODer:ARBITrary:MCARrier?..... | 721 |
| [:SOURce<hw>]:BB:PROGress:MCODer:ARBITrary:WSEGment?..... | 721 |
| [:SOURce<hw>]:BB:PROGress:MCODer:DM:FILTER?..... | 721 |
| [:SOURce<hw>]:BB:PROGress:MCODer?..... | 721 |
| [:SOURce<hw>]:BBIN:ALEVel:EXECute..... | 722 |
| [:SOURce<hw>]:BBIN:CDEVice?..... | 722 |
| [:SOURce<hw>]:BBIN:CFACTOR..... | 722 |
| [:SOURce<hw>]:BBIN:DIGital:ASETting:STATE..... | 723 |
| [:SOURce<hw>]:BBIN:FOFFset..... | 723 |
| [:SOURce<hw>]:BBIN:IQSWap[STATE]..... | 723 |
| [:SOURce<hw>]:BBIN:MPERiod..... | 724 |
| [:SOURce<hw>]:BBIN:OLOad:HOLD:RESet..... | 724 |
| [:SOURce<hw>]:BBIN:OLOad:HOLD:STATE?..... | 724 |
| [:SOURce<hw>]:BBIN:OLOad:STATE?..... | 725 |
| [:SOURce<hw>]:BBIN:POWer:CFACTOR..... | 722 |
| [:SOURce<hw>]:BBIN:POWer:PEAK..... | 725 |
| [:SOURce<hw>]:BBIN:POWer:RMS?..... | 725 |
| [:SOURce<hw>]:BBIN:SRATE:FIFO[STATus]?..... | 726 |
| [:SOURce<hw>]:BBIN:SRATE:SOURce..... | 726 |
| [:SOURce<hw>]:BBIN:SRATE[ACTual]..... | 726 |
| [:SOURce<hw>]:BBIN:STATE..... | 727 |
| [:SOURce<hw>]:CORRection:CSET:DATA:FREQUency..... | 728 |
| [:SOURce<hw>]:CORRection:CSET:DATA:FREQUency:POINts?..... | 729 |

| | |
|--|-----|
| [[:SOURce<hw>]:CORRection:CSET:DATA:POWer..... | 729 |
| [[:SOURce<hw>]:CORRection:CSET:DATA:POWer:POINts?..... | 729 |
| [[:SOURce<hw>]:CORRection:CSET:DATA[:SENSor<ch>]][:POWer]:SONCe..... | 730 |
| [[:SOURce<hw>]:CORRection:CSET[:SELEct]..... | 734 |
| [[:SOURce<hw>]:CORRection:DEXChange:AFILe:CATALog?..... | 730 |
| [[:SOURce<hw>]:CORRection:DEXChange:AFILe:EXTension..... | 731 |
| [[:SOURce<hw>]:CORRection:DEXChange:AFILe:SELEct..... | 731 |
| [[:SOURce<hw>]:CORRection:DEXChange:AFILe:SEParator:COLumn..... | 732 |
| [[:SOURce<hw>]:CORRection:DEXChange:AFILe:SEParator:DECimal..... | 732 |
| [[:SOURce<hw>]:CORRection:DEXChange:EXECute..... | 733 |
| [[:SOURce<hw>]:CORRection:DEXChange:MODE..... | 733 |
| [[:SOURce<hw>]:CORRection:DEXChange:SELEct..... | 734 |
| [[:SOURce<hw>]:CORRection:VALue?..... | 735 |
| [[:SOURce<hw>]:CORRection:ZERoing:STATe..... | 735 |
| [[:SOURce<hw>]:CORRection[:STATe]..... | 735 |
| [[:SOURce<hw>]:DM:FILTer:PARAmeter..... | 673 |
| [[:SOURce<hw>]:FM:EXTernal:COUPling..... | 736 |
| [[:SOURce<hw>]:FM:EXTernal:DEViation..... | 737 |
| [[:SOURce<hw>]:FM:INTernal:DEViation..... | 737 |
| [[:SOURce<hw>]:FM:MODE..... | 737 |
| [[:SOURce<hw>]:FM:SENSitivity?..... | 738 |
| [[:SOURce<hw>]:FM:SOURce..... | 738 |
| [[:SOURce<hw>]:FM:STATe..... | 739 |
| [[:SOURce<hw>]:FM[:DEViation]..... | 736 |
| [[:SOURce<hw>]:FREQuency:CENTer..... | 739 |
| [[:SOURce<hw>]:FREQuency:LOSCillator:MODE..... | 740 |
| [[:SOURce<hw>]:FREQuency:LOSCillator:OUTPut:STATe..... | 741 |
| [[:SOURce<hw>]:FREQuency:MANual..... | 742 |
| [[:SOURce<hw>]:FREQuency:MODE..... | 743 |
| [[:SOURce<hw>]:FREQuency:MULTiplier..... | 744 |
| [[:SOURce<hw>]:FREQuency:OFFSet..... | 744 |
| [[:SOURce<hw>]:FREQuency:SPAN..... | 744 |
| [[:SOURce<hw>]:FREQuency:STARt..... | 745 |
| [[:SOURce<hw>]:FREQuency:STEP:MODE..... | 746 |
| [[:SOURce<hw>]:FREQuency:STEP[:INCRement]..... | 746 |
| [[:SOURce<hw>]:FREQuency:STOP..... | 745 |
| [[:SOURce<hw>]:FREQuency[:CW FIXed]..... | 741 |
| [[:SOURce<hw>]:FREQuency[:CW FIXed]:RCL..... | 742 |
| [[:SOURce<hw>]:INPut:MODext:IMPedance..... | 748 |
| [[:SOURce<hw>]:IQ:CREStfactor..... | 751 |
| [[:SOURce<hw>]:IQ:IMPairment:IQRatio[:MAGNitude]..... | 751 |
| [[:SOURce<hw>]:IQ:IMPairment:LEAKage:I..... | 751 |
| [[:SOURce<hw>]:IQ:IMPairment:LEAKage:Q..... | 752 |
| [[:SOURce<hw>]:IQ:IMPairment:QUADrature[:ANGLe]..... | 752 |
| [[:SOURce<hw>]:IQ:IMPairment[:STATe]..... | 752 |
| [[:SOURce<hw>]:IQ:OUTPut:DIGital:CDEVice?..... | 758 |
| [[:SOURce<hw>]:IQ:OUTPut:DIGital:PON..... | 759 |
| [[:SOURce<hw>]:IQ:OUTPut:DIGital:POWer:LEVel..... | 759 |
| [[:SOURce<hw>]:IQ:OUTPut:DIGital:POWer:PEP..... | 759 |
| [[:SOURce<hw>]:IQ:OUTPut:DIGital:POWer:STEP:MODE..... | 760 |

| | |
|---|-----|
| [[:SOURce<hw>]:IQ:OUTPut:DIGital:POWer:STEP[:INCRement]]..... | 760 |
| [[:SOURce<hw>]:IQ:OUTPut:DIGital:SRATe..... | 761 |
| [[:SOURce<hw>]:IQ:OUTPut:DIGital:SRATe:SOURce..... | 761 |
| [[:SOURce<hw>]:IQ:OUTPut:DIGital:STATe..... | 762 |
| [[:SOURce<hw>]:IQ:OUTPut:LEVel..... | 755 |
| [[:SOURce<hw>]:IQ:OUTPut:POWer:VIA..... | 760 |
| [[:SOURce<hw>]:IQ:OUTPut[:ANALog]:BIAS:COUPling[:STATe]..... | 754 |
| [[:SOURce<hw>]:IQ:OUTPut[:ANALog]:BIAS:I..... | 754 |
| [[:SOURce<hw>]:IQ:OUTPut[:ANALog]:BIAS:OPTimization[:RF]:STATe..... | 755 |
| [[:SOURce<hw>]:IQ:OUTPut[:ANALog]:BIAS:Q..... | 754 |
| [[:SOURce<hw>]:IQ:OUTPut[:ANALog]:MODE..... | 756 |
| [[:SOURce<hw>]:IQ:OUTPut[:ANALog]:OFFSet:I..... | 755 |
| [[:SOURce<hw>]:IQ:OUTPut[:ANALog]:OFFSet:Q..... | 755 |
| [[:SOURce<hw>]:IQ:OUTPut[:ANALog]:POWer:DATenuation..... | 757 |
| [[:SOURce<hw>]:IQ:OUTPut[:ANALog]:POWer:PEP:RESult?..... | 756 |
| [[:SOURce<hw>]:IQ:OUTPut[:ANALog]:TYPE..... | 757 |
| [[:SOURce<hw>]:IQ:SOURce..... | 752 |
| [[:SOURce<hw>]:IQ:STATe..... | 753 |
| [[:SOURce<hw>]:IQ:SWAP[:STATe]..... | 753 |
| [[:SOURce<hw>]:IQ:WBState..... | 753 |
| [[:SOURce<hw>]:LFOutput:FREQuency:MANual..... | 763 |
| [[:SOURce<hw>]:LFOutput:FREQuency:MODE..... | 764 |
| [[:SOURce<hw>]:LFOutput:FREQuency:START..... | 765 |
| [[:SOURce<hw>]:LFOutput:FREQuency:STOP..... | 765 |
| [[:SOURce<hw>]:LFOutput:SWEep[:FREQuency]:DWELl..... | 766 |
| [[:SOURce<hw>]:LFOutput:SWEep[:FREQuency]:EXECute..... | 766 |
| [[:SOURce<hw>]:LFOutput:SWEep[:FREQuency]:MODE..... | 766 |
| [[:SOURce<hw>]:LFOutput:SWEep[:FREQuency]:POINts..... | 767 |
| [[:SOURce<hw>]:LFOutput:SWEep[:FREQuency]:RETRace..... | 768 |
| [[:SOURce<hw>]:LFOutput:SWEep[:FREQuency]:RUNNING?..... | 768 |
| [[:SOURce<hw>]:LFOutput:SWEep[:FREQuency]:SHAPE..... | 769 |
| [[:SOURce<hw>]:LFOutput:SWEep[:FREQuency]:SPACing..... | 769 |
| [[:SOURce<hw>]:LFOutput:SWEep[:FREQuency]:STEP:LOGarithmic..... | 770 |
| [[:SOURce<hw>]:LFOutput:SWEep[:FREQuency]:STEP[:LINear]..... | 769 |
| [[:SOURce<hw>]:LIST:CATAlog?..... | 773 |
| [[:SOURce<hw>]:LIST:DELete..... | 774 |
| [[:SOURce<hw>]:LIST:DELete:ALL..... | 774 |
| [[:SOURce<hw>]:LIST:DEXChange:AFILe:CATAlog?..... | 775 |
| [[:SOURce<hw>]:LIST:DEXChange:AFILe:EXTension..... | 775 |
| [[:SOURce<hw>]:LIST:DEXChange:AFILe:SElect..... | 776 |
| [[:SOURce<hw>]:LIST:DEXChange:AFILe:SEParator:COLumn..... | 776 |
| [[:SOURce<hw>]:LIST:DEXChange:AFILe:SEParator:DECimal..... | 777 |
| [[:SOURce<hw>]:LIST:DEXChange:EXECute..... | 777 |
| [[:SOURce<hw>]:LIST:DEXChange:MODE..... | 778 |
| [[:SOURce<hw>]:LIST:DEXChange:SElect..... | 778 |
| [[:SOURce<hw>]:LIST:DWELl..... | 778 |
| [[:SOURce<hw>]:LIST:FREE?..... | 779 |
| [[:SOURce<hw>]:LIST:FREQuency..... | 779 |
| [[:SOURce<hw>]:LIST:FREQuency:POINts?..... | 780 |
| [[:SOURce<hw>]:LIST:INDex..... | 780 |

| | |
|---|-----|
| [[:SOURce<hw>]:LIST:INDEX:START..... | 780 |
| [[:SOURce<hw>]:LIST:INDEX:STOP..... | 781 |
| [[:SOURce<hw>]:LIST:LEARN..... | 781 |
| [[:SOURce<hw>]:LIST:MODE..... | 782 |
| [[:SOURce<hw>]:LIST:POWER..... | 782 |
| [[:SOURce<hw>]:LIST:POWER:POINTS?..... | 782 |
| [[:SOURce<hw>]:LIST:RESET..... | 783 |
| [[:SOURce<hw>]:LIST:SELECT..... | 783 |
| [[:SOURce<hw>]:LIST:TRIGGER:EXECUTE..... | 783 |
| [[:SOURce<hw>]:LIST:TRIGGER:SOURCE..... | 784 |
| [[:SOURce<hw>]:MODULATION[:ALL][:STATE]..... | 784 |
| [[:SOURce<hw>]:PGENERATOR:STATE..... | 785 |
| [[:SOURce<hw>]:PHASE..... | 786 |
| [[:SOURce<hw>]:PHASE:REFERENCE..... | 786 |
| [[:SOURce<hw>]:PM:EXTERNAL:COUPLING..... | 787 |
| [[:SOURce<hw>]:PM:EXTERNAL:DEVIATION..... | 787 |
| [[:SOURce<hw>]:PM:INTERNAL:DEVIATION..... | 788 |
| [[:SOURce<hw>]:PM:MODE..... | 788 |
| [[:SOURce<hw>]:PM:SENSITIVITY?..... | 788 |
| [[:SOURce<hw>]:PM:SOURCE..... | 789 |
| [[:SOURce<hw>]:PM:STATE..... | 789 |
| [[:SOURce<hw>]:PM[:DEVIATION]..... | 787 |
| [[:SOURce<hw>]:POWER:ALC:OMODE..... | 790 |
| [[:SOURce<hw>]:POWER:ALC:SONCE..... | 791 |
| [[:SOURce<hw>]:POWER:ALC[:STATE]..... | 791 |
| [[:SOURce<hw>]:POWER:ATTENUATION:RFOFF:MODE..... | 792 |
| [[:SOURce<hw>]:POWER:EMF:STATE..... | 792 |
| [[:SOURce<hw>]:POWER:LIMIT[:AMPLITUDE]..... | 794 |
| [[:SOURce<hw>]:POWER:LMODE..... | 794 |
| [[:SOURce<hw>]:POWER:MANUAL..... | 795 |
| [[:SOURce<hw>]:POWER:MODE..... | 796 |
| [[:SOURce<hw>]:POWER:PEP?..... | 796 |
| [[:SOURce<hw>]:POWER:POWER..... | 796 |
| [[:SOURce<hw>]:POWER:SPC:CRANGE..... | 797 |
| [[:SOURce<hw>]:POWER:SPC:DELAY..... | 797 |
| [[:SOURce<hw>]:POWER:SPC:PEAK..... | 798 |
| [[:SOURce<hw>]:POWER:SPC:SELECT..... | 798 |
| [[:SOURce<hw>]:POWER:SPC:STATE..... | 798 |
| [[:SOURce<hw>]:POWER:SPC:TARGET..... | 798 |
| [[:SOURce<hw>]:POWER:START..... | 799 |
| [[:SOURce<hw>]:POWER:STEP:MODE..... | 800 |
| [[:SOURce<hw>]:POWER:STEP[:INCREMENT]..... | 799 |
| [[:SOURce<hw>]:POWER:STOP..... | 800 |
| [[:SOURce<hw>]:POWER[:LEVEL][:IMMEDIATE]:OFFSET..... | 793 |
| [[:SOURce<hw>]:POWER[:LEVEL][:IMMEDIATE]:RCL..... | 794 |
| [[:SOURce<hw>]:POWER[:LEVEL][:IMMEDIATE][:AMPLITUDE]..... | 792 |
| [[:SOURce<hw>]:PULM:DELAY..... | 802 |
| [[:SOURce<hw>]:PULM:DOUBLE:DELAY..... | 802 |
| [[:SOURce<hw>]:PULM:DOUBLE:STATE..... | 803 |
| [[:SOURce<hw>]:PULM:DOUBLE:WIDTH..... | 803 |

| | |
|---|-----|
| [[:SOURce<hw>]:PULM:MODE..... | 803 |
| [[:SOURce<hw>]:PULM:OUTPut:SYNC[:STATe]..... | 804 |
| [[:SOURce<hw>]:PULM:PERiod..... | 804 |
| [[:SOURce<hw>]:PULM:POLarity..... | 805 |
| [[:SOURce<hw>]:PULM:SOURce..... | 805 |
| [[:SOURce<hw>]:PULM:STATe..... | 805 |
| [[:SOURce<hw>]:PULM:TRIGger:EXTernal:GATE:POLarity..... | 806 |
| [[:SOURce<hw>]:PULM:TRIGger:EXTernal:IMPedance..... | 806 |
| [[:SOURce<hw>]:PULM:TRIGger:EXTernal:SLOPe..... | 806 |
| [[:SOURce<hw>]:PULM:TRIGger:MODE..... | 807 |
| [[:SOURce<hw>]:PULM:WIDTh..... | 807 |
| [[:SOURce<hw>]:SWEep:POWer:DATTenuator:STATe..... | 817 |
| [[:SOURce<hw>]:SWEep:POWer:DWELI..... | 817 |
| [[:SOURce<hw>]:SWEep:POWer:EXECute..... | 817 |
| [[:SOURce<hw>]:SWEep:POWer:MODE..... | 818 |
| [[:SOURce<hw>]:SWEep:POWer:POINts..... | 818 |
| [[:SOURce<hw>]:SWEep:POWer:RETRace..... | 819 |
| [[:SOURce<hw>]:SWEep:POWer:RUNNing?..... | 819 |
| [[:SOURce<hw>]:SWEep:POWer:SHAPE..... | 819 |
| [[:SOURce<hw>]:SWEep:POWer:SPACing:MODE?..... | 820 |
| [[:SOURce<hw>]:SWEep:POWer:STEP[:LOGarithmic]..... | 820 |
| [[:SOURce<hw>]:SWEep:RESEt[:ALL]..... | 821 |
| [[:SOURce<hw>]:SWEep[:FREQUency]:DWELI..... | 812 |
| [[:SOURce<hw>]:SWEep[:FREQUency]:EXECute..... | 812 |
| [[:SOURce<hw>]:SWEep[:FREQUency]:MODE..... | 812 |
| [[:SOURce<hw>]:SWEep[:FREQUency]:POINts..... | 813 |
| [[:SOURce<hw>]:SWEep[:FREQUency]:RETRace..... | 814 |
| [[:SOURce<hw>]:SWEep[:FREQUency]:RUNNing?..... | 814 |
| [[:SOURce<hw>]:SWEep[:FREQUency]:SHAPE..... | 814 |
| [[:SOURce<hw>]:SWEep[:FREQUency]:SPACing..... | 815 |
| [[:SOURce<hw>]:SWEep[:FREQUency]:STEP:LOGarithmic..... | 816 |
| [[:SOURce<hw>]:SWEep[:FREQUency]:STEP[:LINear]..... | 815 |
| {[TRACE] LIST [#]: Pos0:State0; Pos1:State1; ...PosN-1:StateN-1}..... | 446 |
| {[TRACE] LIST [#]: Pos0:State0; Pos1:State1; ...PosN-1:StateN-1}..... | 455 |
| {BURST LIST [#]: Pos0:State0; Pos1:State1; ...PosN-1:StateN-1}..... | 446 |
| {BURST LIST [#]: Pos0:State0; Pos1:State1; ...PosN-1:StateN-1}..... | 455 |
| {CLOCK: frequency}..... | 442 |
| {COMMENT: string}..... | 441 |
| {CONTROL LENGTH: ControlLength}..... | 442 |
| {CONTROL LENGTH: ControlLength}..... | 454 |
| {CONTROL LIST WIDTH4-Length: #m0m1...mx...mM-1}..... | 452 |
| {COPYRIGHT: string}..... | 441 |
| {CW MODE LIST [#]: Pos0:State0; Pos1:State1; ...PosN-1:StateN-1}..... | 446 |
| {CW MODE LIST [#]: Pos0:State0; Pos1:State1; ...PosN-1:StateN-1}..... | 455 |
| {DATA BITLENGTH: BitLength}..... | 453 |
| {DATA LIST-Length: #d0d1...dx...dN-1...}..... | 454 |
| {DATE: yyyy-mm-dd;hh:mm:ss}..... | 441 |
| {EMPTYTAG-Length: #EmptySequence}..... | 443 |
| {HOP LIST [#]: Pos0:State0; Pos1:State1; ...PosN-1:StateN-1}..... | 446 |
| {HOP LIST [#]: Pos0:State0; Pos1:State1; ...PosN-1:StateN-1}..... | 455 |

| | |
|---|-----|
| {LEVATT LIST [#]: Pos0:State0; Pos1:State1; ...PosN-1:StateN-1}..... | 446 |
| {LEVATT LIST [#]: Pos0:State0; Pos1:State1; ...PosN-1:StateN-1}..... | 455 |
| {LEVEL OFFS: RMSOffset_dB,PeakOffset_dB}..... | 444 |
| {MAP LIST [#]: Pos0:State0; Pos1:State1; ...PosN-1:StateN-1}..... | 446 |
| {MAP LIST [#]: Pos0:State0; Pos1:State1; ...PosN-1:StateN-1}..... | 455 |
| {MARKER LIST [#]: Pos0:State0; Pos1:State1; ...PosN-1:StateN-1}..... | 446 |
| {MARKER LIST [#]: Pos0:State0; Pos1:State1; ...PosN-1:StateN-1}..... | 455 |
| {MARKER MODE [#]: GENERATOR}..... | 445 |
| {MWV_SEGMENT_CLOCK_MODE: Mode}..... | 449 |
| {MWV_SEGMENT_CLOCK: ClockSeg0, ClockSeg1, ..., ClockSegN-1}..... | 450 |
| {MWV_SEGMENT_COUNT: NumOfSeg}..... | 449 |
| {MWV_SEGMENT_DURATION: SegDur0, SegDur1, ..., SegDurN-1}..... | 443 |
| {MWV_SEGMENT_FILES: "FileNameSeg0.wv", "FileNameSeg1.wv", ..., "FileNameSegN-1.wv"}..... | 452 |
| {MWV_SEGMENT_LENGTH: SamplesSeg0, SamplesSeg1, ..., SamplesSegN-1}..... | 449 |
| {MWV_SEGMENT_LEVEL_MODE: Mode}..... | 451 |
| {MWV_SEGMENT_LEVEL_OFFS: RMSOffs_dBSg0,PeakOffs_dBSg0, ..., RMSOffs_dBSgN-1, PeakOffs_dBSgN-1}..... | 451 |
| {MWV_SEGMENT_SETTINGS_FILE: SegSettingFilePath}..... | 452 |
| {MWV_SEGMENT_START: SampleStartOffsetSeg0, SampleStartOffsetSeg1, ..., SampleStartOffsetSegN-1}..... | 449 |
| {MWV_SEGMENTx_COMMENT: text}..... | 452 |
| {SAMPLES: Samples}..... | 446 |
| {TYPE: magic, xxxxxxxx}..... | 440 |
| {WAVEFORM-Length: #I0Q0I1Q1...IxQx...IN-1QN-1...}..... | 447 |
| *CLS..... | 533 |
| *ESE..... | 533 |
| *ESR?..... | 533 |
| *IDN?..... | 534 |
| *IST?..... | 534 |
| *OPC..... | 534 |
| *OPT?..... | 534 |
| *PRE..... | 535 |
| *PSC..... | 535 |
| *RCL..... | 535 |
| *RST..... | 535 |
| *SAV..... | 536 |
| *SRE..... | 536 |
| *STB?..... | 536 |
| *TRG..... | 536 |
| *TST?..... | 537 |
| *WAI..... | 537 |
| SENSe<ch>[:POWer]:SNUMber?..... | 592 |
| SENSe<ch>[:POWer]:STATus[:DEvIce]?..... | 593 |
| SENSe<ch>[:POWer]:SVERsion?..... | 593 |
| SENSe<ch>[:POWer]:TYPE?..... | 594 |

Index

Symbols

| | |
|--|-----|
| *OPC | 521 |
| *OPC? | 521 |
| *RST | 531 |
| *WAI | 521 |
| /var directory | 567 |
| >L | 497 |
| >R | 497 |
| &LLO | 497 |
| 9.91E37 | |
| Remote control | 519 |
| 50 - Extern reference out of range or disconnected | 862 |
| 140 - This modulation forces other modulations off | 862 |
| 180 - Adjustment failed | 862 |
| 182 - Adjustment data missing | 862 |
| 183 - Adjustment data invalid | 862 |
| 200 - Cannot access hardware | 862 |
| 201 - Hardware revision out of date | 862 |
| 202 - Cannot access the EEPROM | 862 |
| 203 - Invalid EEPROM data | 862 |
| 204 - river initialization failed | 862 |
| 241 - No current list | 862 |
| 242 - Unknown list type specified | 863 |
| 261 - Waveform Protected | 863 |
| 460 - Cannot open file | 863 |
| 461 - Cannot write file | 863 |
| 462 - Cannot read file | 863 |
| 463 - Filename missing | 863 |
| 464 - Invalid filename extension | 863 |
| 465 - File contains invalid data | 863 |

A

| | |
|---|-----|
| Abort button | 97 |
| Abort calculation | 97 |
| AC supply | 32 |
| Accept | |
| Security Settings | 154 |
| Accept - MCCW | 469 |
| Accept Carrier Table - MCCW | 469 |
| Access denied | 88 |
| Accurate level measurement | |
| Measurement period | 480 |
| Active IQ ext. device | |
| Selftest | 133 |
| Additional White Gaussian Noise (option R&S SMBV-K62) | 66 |
| Additive Noise | 313 |
| Address mode | |
| Network settings | 138 |
| Adjust ALC Table | 229 |
| Adjust All | 121 |
| Adjust I/Q modulator | 121 |
| Adjust Level | 121 |
| Adjust Synthesis | 121 |
| Adjust Synthesis Extension | 121 |
| Adjustment active | |
| Reference oscillator | 217 |
| Adjustment Data | 226 |
| Adjustment frequency | |
| Reference oscillator | 218 |

Adjustments

| | |
|--------------------------------------|----------|
| All | 121 |
| ALC (automatic level control) | 227, 790 |
| ALC Auto | 860 |
| ALC On | 227, 860 |
| ALC S&H | 860 |
| ALC Table | 860 |
| All packages | |
| Secure update policy | 154 |
| AM Depth | 254 |
| AM Sensitivity | 255 |
| AM Source | 254 |
| AM State | 254 |
| Amplitude | |
| Annotation (setup security) | 152 |
| Amplitude of test signal | 408 |
| Analog Impairments | 303 |
| Analog Wideband I/Q In | 302 |
| Angle alpha | 361 |
| Annotation | |
| Amplitude (security) | 152 |
| Frequency (security) | 152 |
| Aperture time | |
| Power sensors | 250 |
| Append | 417, 424 |
| Append Blank | 418 |
| Application cards | 19 |
| Application notes | 19 |
| Apply Assistant Settings | 436, 633 |
| APSK | |
| Code rate | 361 |
| Gamma | 361 |
| ARB | |
| Required options | 382 |
| ARB Multi Carrier | |
| carrier frequency | 437 |
| conflict | 438, 626 |
| mode | 429, 625 |
| ARB sequencer mode | 411 |
| ARbitrary Waveform Generator | 382 |
| Architecture of the instrument | 63 |
| Arm | 394, 473 |
| Arm Trigger | 611 |
| DM | 376 |
| Armed_Auto | 393 |
| DM | 375 |
| Armed_Retrigger | 393 |
| DM | 375 |
| Arrow keys | 27 |
| ASCII file import/export | |
| List Mode | 291 |
| ASK Depth | 360 |
| Assemblies display | 122 |
| ATN | 866 |
| Attention | 866 |
| Attenuation | |
| DM | 374 |
| Attenuator Mode | 224 |
| Attenuator Settings | |
| Fixed Range (PEP) in | 225 |
| mode | 224 |
| RF OFF Mode | 225 |
| AttFixed | 860 |

- Auto 393
 - DM 375
- Auto Level Set 484
- Auto Level Set - Baseband Input 722
- Auto once
 - Power Sensors 250
- Auto Once - Power Sensors 590
- Auto-negotiation
 - see Autonegotiation 44
- Autonegotiation
 - Failed 863
 - Failure 44
- Avahi
 - LAN Services 151
- Avoiding signal gaps 415
- Avoiding wrap-around 415
- B**
- B x T
 - DM 363
- Bandwidth
 - DM 364
- Baseband block menu 327
- Baseband generator (option R&S SMBV-B10/B51) 65
- Baseband In - Crest-Faktor 722
- Baseband Input 481
- Baseband Only 374
- Baseband section 65
- Baseband Trigger Input Slope 141
- Baudrate
 - RS232 interface 144
- Beamformed signal
 - Generation 219
- BER measurement
 - General settings 190
 - Settings 189
- BER/BLER
 - Clock signal 186
 - Clock signal connector 203
 - Connector mapping 202
 - Data enable 188
 - Data enable signal connector 203
 - Data signal connector 203
 - End of measurement 186
 - Interrupt free measurement 187
 - Pattern ignore 188
 - PRBS data 185
 - Restart function 187
 - Restart signal connector 203
 - Test generator 203
 - Test setup 184
- BER/BLER test generator
 - Clock frequency 206
 - Error rate 206
 - Off time 206
 - On time (date enable) 206
 - Restart delay 207
 - Settings 205
 - Setup 204
 - State 206
 - Trigger 206
- Bias - I/Q out 321
- Binary data
 - Edit, rules 464
- Bit energy to noise power density 316
- Bit error rate
 - Clock slope 194
 - Configuration settings 192
 - Data bits 190
 - Data enable 195
 - Data polarity 194
 - Errors 190
 - External restart 194
 - General Settings 190
 - Impedance 196
 - Max data bits 193
 - Max errors 193
 - Mode 193
 - No clock 191
 - No sync 191
 - Pattern ignore 196
 - PRBS 194
 - Result 190
 - Settings 189
 - State 190
 - State: 191
 - Terminated by 191
 - Threshold 196
 - Timeout 197
 - Trigger 193
 - Unit 190
- Bit Error Rate Measurement 184, 539
- Bit Rate - AWGN 315
- BLER
 - CRC polynomial 186
- BLER type
 - Block error rate 201
- Block data 516
- Block error rate
 - BLER type 201
 - Clock slope 201
 - Configuration settings 200
 - CRC order 201
 - Data enable 202
 - Data polarity 201
 - Errors 198
 - General settings 197
 - Impedance 202
 - Max errors 201
 - Max received blocks 201
 - Mode 200
 - No clock 199
 - No sync 199
 - received blocks 198
 - Result 198
 - Settings 197
 - State 198
 - State: 199
 - Terminated by 198
 - Threshold 202
 - Timeout 202
 - Trigger 200
 - Unit 198
- Block Error Rate Measurement 184, 539
- Bluetooth
 - RS232 Interface 144
- Bluetooth Pin 154
- Boolean parameters 516
- Brackets 517
- Brochures 18
- Browser settings
 - LXI 54

- Burst gate 336
- BUSY 858
- C**
- Carrier + Interferer PEP 318
- Carrier + Interferer Power 318
- Carrier + Noise PEP 318
- Carrier + Noise Power 318
- Carrier Delay 437
- Carrier frequency 437
- Carrier Gain 437
- Carrier Graph 433
- Carrier Graph - MCCW 470
- Carrier Index 437
- Carrier leakage 307
- Carrier power - AWGN 316
- Carrier spacing
 - Depends on 429
- Carrier Spacing 626
- Carrier Spacing - MCCW 467
- Carrier Start 435, 635
- Carrier Start - MCCW 468
- Carrier State 435, 437, 636
- Carrier State - MCCW 468
- Carrier Stop 435, 635
- Carrier Stop - MCCW 468
- Carrier table 433
- Carrier Table - MCCW 469
- Carrier Table Assistant 435, 635
- Carrier Table Assistant - MCCW 468
- Carrier/Noise Ratio 315
- Case-sensitivity
 - SCPI 513
- Catch range
 - NRP level control 232
- CCDF display 183
- Center Freq 283
- Change
 - Map network share 170
- Change password
 - Setup (security) 150
- Channel x 404
- Check front panel 133
 - Performing 134
 - Settings 134
- Cleaning 855
- Clear status
 - Remote 533
- Clipping 430
- Clock frequency
 - BER/BLER test generator 206
- Clock Frequency 390
- Clock Input Slope 141
- Clock Mode 406, 478, 608
 - DM 381
- Clock Multiplier 406, 478, 609
 - DM 381
- Clock Parameter 405
- Clock rate 390, 418
- Clock rate mode 419
- Clock Reference 331
- Clock signal
 - BER/BLER measurement 186
- Clock signal connector
 - BER/BLER 203
- Clock slope
 - Bit error rate 194
 - Block error rate 201
- Clock Source 405, 477
 - DM 381
- Closed loop power control
 - see NRP level control 229
- CLPC
 - see NRP level control 229
- Coding
 - DM 359
- Colon 517
- Column Separator Import/Export - User Correction data 237
- Comma 517
- Command sequence
 - recommendation 531
 - Remote 537
- Commands 489
 - Brackets 517
 - Colon 517
 - Comma 517
 - Command line structure 518
 - Common 489
 - Double dagger 517
 - GBIP, addressed 495
 - GBIP, universal 494
 - Instrument control 489
 - Overlapping 520
 - Question mark 517
 - Quotation mark 517
 - SCPI confirmed 489
 - Sequential 520
 - Syntax elements 517
 - Vertical stroke 517
 - White space 517
- Comment 420
- Common commands
 - Syntax 512
- Computer name
 - Changing 45
 - see hostname 138
 - use instead of IP address 45
- CONDition 525
- Configuration list
 - Multi segment waveform 412
- Configuration settings
 - Bit error rate 192
 - Block error rate 200
- Configure Control Signal 370
- Confirm unsigned
 - Secure update policy 154
- Confirm user password
 - Setup (security) 150
- Conflict 438, 626
- Connect
 - Map network share 170
- Connected device 485
- Connected device - Baseband Input 722
- Connected device - Digital I/Q Output Settings 326
- Connection fault
 - 169.254.*.* 863
- Connection to an external controller 46
- Connector
 - CLOCK IN 30
 - CLOCK OUT 30
 - Digital IQ 30
 - EXT MOD 32

- GPIB 31
- I 28
- I OUT 29
- I OUT BAR 29
- IEC/IEEE 31
- INSTR TRIG 31
- LAN 30
- LF 32
- LO IN 31
- LO OUT 31
- MARKER 1, 2 29
- NEXT 30
- PULSE EXT 31
- PULSE VIDEO 31
- Q 28
- Q OUT 29
- Q OUT BAR 29
- REF IN 31
- REF OUT 31
- RF 28
- SENSOR 31
- SIGNAL VALID 31
- TRIGGER 30
- USB 28
- USB type A 29
- USB type B 29
- Connector mapping
 - BER/BLER 202
- Const I/Q test signal 383
- Const IQ Test Signal 409
- Constellation diagram 182
- Control bus 866
- Control list
 - Edit, rules 464
 - Select, edit, new 167
- Control Lists
 - DM 365
- Control signals 336
- Controller, external 46
- Copy
 - Several files 172
- Copy instrument settings 169
- Copy, data editor 368
- Counter 122, 556, 557
- Couple I/Q Bias 321
- Coupling mode 258
- Coupling mode - EXT MOD (AM) 255
- CRC order
 - Block error rate 201
- CRC polynomial
 - BLER measurement 186
- Create 421, 434
 - Multi carrier waveforms 426
- Create and Load 422, 434
- Create multi segment waveforms 410
- Create New Directory 169
- Crest factor
 - Match 479
- Crest Factor 484
- Crest Factor - Basisband In 722
- Crest Factor - MCCW 467
- Crest factor (I/Q) 305
- Crest Factor Mode 430, 629
- Current Freq (LF Sweep) 270
- Current Freq (RF Sweep) 283
- Current Frequency 121
- Current Index
 - List Mode 294
- Current Level 289
- Current range without recalculation 379
- Current Range without Recalculation 404, 476, 612
- Current Segment 397
- Current Sensors 129
- Cursor keys 27
- Cursor Length 371
- Cursor Position 371
- Cut 169
- Cut Off Frequency Factor 363
- Cut, data editor 368
- CW (continuous wave) 336
- CW Interferer 313
- CW Switching 363
- CW/Mod 336
- D**
- Data bits
 - Bit error rate 190
- Data enable
 - BER/BLER measurement 188
 - Bit error rate 195
 - Block error rate 202
- Data enable signal connector 203
- Data list
 - Edit, rules 464
 - Select, edit, new 167
- Data List 331
- Data Lists
 - DM 365
- Data pattern
 - DM 356
- Data polarity
 - Bit error rate 194
 - Block error rate 201
- Data sheets 18
- Data signal connector 203
- Data Source
 - DM 356
- Data Valid 866
- Date
 - Setup 136
- DAV 866
- DCL 494
- Deactivate RF output 217
- Deactivated Licenses 128
- Decimal Point Import/Export - List Mode data 297
- Decimal Point Import/Export - User Correction data 237
- DEF 515
- Default gateway
 - Network settings 139
- Default instrument settings 38, 118
- Default settings 389, 427
 - DM 355
- Default settings - MCCW 466
- Default values
 - Remote 535
- Delay
 - Double pulse 274
 - Marker 379
 - Pulse generator 274
- Delay - Falling Edge of Ramp Envelope 374
- Delay - Rising Edge of Ramp Envelope 374

- Delay - Trigger
 - DM 378
 - Delay Start 436, 627, 633
 - Delay Step 436, 632
 - Delay time
 - NRP level control 233
 - Delete 417, 424
 - Delete instrument settings 169, 578
 - Delete temporary files 131
 - Delta Phase 214
 - Desired Crest Factor - MCCW 468
 - Destination Import/Export
 - User Correction data 238
 - Destination Import/Export - List Mode data 298
 - Deviation
 - FSK Modulation 360
 - Variable FSK Modulation 362
 - Device ID 128
 - Device-specific commands 489
 - Device-specific error messages 861
 - DHCP 44
 - Differential coding
 - DM 359
 - Differential output 319
 - Differential settings storing 163, 356
 - DIG IQ Auto Setting 483
 - Digital Attenuation 321
 - Digital Baseband Connectivity (option R&S SMBV-K18) .. 66
 - Digital I/Q Output peak level - I/Q OUT 324
 - Digital I/Q Output Peak Level - I/Q OUT 324
 - Digital I/Q Output Power-On State - I/Q OUT 326
 - Digital I/Q Output State - I/Q OUT 323
 - Digital I/Q Output Step width - I/Q OUT 325
 - Digital I/Q Output Variation Active - I/Q OUT 325
 - Digital I/Q Output Variation Step - I/Q OUT 325
 - Disconnect
 - Map network share 171
 - Display 81
 - Lock (security) 152
 - Display I/Q Output Level Via 324
 - Display Mode - AWGN 314
 - Display priority
 - Power sensors 247
 - DISPlay subsystem 557
 - DNS server
 - Network settings 139
 - DNS suffix
 - Network settings 139
 - Documentation overview 17
 - Double dagger 517
 - Double Pulse 273
 - Double pulse delay
 - Pulse generator 274
 - Double pulse width
 - Pulse generator 274
 - DOWN 515
 - Duration
 - Measurement period external digital signal 480
 - Dwell time
 - RF sweep 285
 - Dwell Time 271, 290, 294
 - List Mode 294
- E**
- Edge form of ramp envelope
 - DM 373
 - Edge slope of ramp envelope 374
 - Edit
 - Binary data 464
 - Edit User Correction Data 235
 - Electrostatic discharge 33
 - EMF
 - LF Level display 265
 - EMF - Level display 227
 - EMI suppression 33
 - Emulation
 - IDN string 146
 - Language 146
 - Mode 146
 - Set IDN and OPT to default 146
 - Enable
 - LAN interface 151
 - ENABle 525
 - Enable registers
 - Remote 535
 - End of measurement
 - BER/BLER measurement 186
 - Enter License Key 128
 - EOI 866
 - Error log 864
 - Error messages 84, 857
 - Adjustment data invalid (183) 862
 - Adjustment data missing (182) 862
 - Adjustment failed (180) 862
 - Cannot access hardware (200) 862
 - Cannot access the EEPROM (202) 862
 - Cannot open file (460) 863
 - Cannot read file (462) 863
 - Cannot write file (461) 863
 - Driver initialization failed (204) 862
 - Extern reference out of range or disconnected (50) . 862
 - File contains invalid data (465) 863
 - Filename missing (463) 863
 - Hardware revision out of date (201) 862
 - Invalid EEPROM data (203) 862
 - Invalid filename extension (464) 863
 - No current list (241) 862
 - This modulation forces other modulations off (140) .. 862
 - Unknown list type specified (242) 863
 - Waveform Protected (261) 863
 - Error Messages 860
 - device-specific 861
 - SCPI 861
 - Error queue 526
 - Error queue query 827, 828
 - Error queues
 - recommendations 531
 - Error rate
 - BER/BLER test generator 206
 - Errors
 - Bit error rate 190
 - Block error rate 198
 - ESD 33
 - ESE (event status enable register) 527
 - ESR 523
 - ESR (event status register) 527
 - EVENT 525
 - Event status enable register (ESE) 527
 - Remote 533
 - Event status register (ESR) 527
 - Remote 533
 - Exclude Frequency 165
 - Exclude Level 165

- Execute Next Segment 403, 652
- Execute Single
List Mode 293
- Execute single sweep
Frequency sweep 282
- Execute Single Sweep
Level Sweep 289
- Execute Single Sweep - LF Sweep 269
- Execute Trigger 365, 391, 394, 474, 611
- Expiration date of option 124
- Export Deactivation Response 128
- Export License Key 129
- EXT REF 858
- Extension Import/Export - List Mode data 297
- Extension Import/Export - User Correction data 237
- External frequency
Reference oscillator 217
- External impedance
Pulse generator 278
- External input impedance 278
- External mode - Local Oscillator 218
- External modulation signal 253
- FM
PhiM 256
- PhiM 259
- External restart
Bit error rate 194
- External Trigger Delay
DM 378
- Eye diagram 182
- F**
- Factory preset 155
- Failure
Network connection 44
- Fall Delay 374
- Fast Save 163, 356
- FIFO Status 483
- FIFO Status - Baseband Input 726
- File 437
- Hard copy 157
- File info
Hard copy 157
- File list 573
- File Management 389
- File menu
Save/Recall 162
- File name
Hard copy 157
- File setup
Hard copy 158
- File size 636
- File type selection 168
- Fill Table
List Mode 295
- Fill Table - List mode 298
- Fill Table From 298
- Fill Table Range 238, 299
- Filter
DM 363
- Power Sensors 248
- Filter Cut Off Frequency 430
- Filter Length
Power Sensors 248
- Filter Length - Power Sensors 589, 590, 591
- Filter parameter
Impact 351
- Filter Parameter
DM 363
- Firmware version 123
- Fix marker delay to current range 379, 405, 477, 620
- Flat RF signal
Optimisation mode high quality 310
- Floating licenses 124
- FM deviation 257
- FM mode 257
- FM sensitivity 258
- FM source 257
- FM state 257
- FM-DC mode 214
- Free space
Internal flash/hard disk 131
- FREQ OFFSET 857
- Frequency 221
- Annotation (setup security) 152
- LF generator 254, 258, 261, 266
- List Mode 295
- Multiplier 213
- PM 273
- Power sensors 248
- RF signal 210
- Set Frequency 211
- Frequency - RF sweep 283
- Frequency - Test Signal ARB 407
- Frequency (status bar)
RF signal 211
- Frequency dialog
RF signal 211
- Frequency display 82
- Frequency of test signal 408
- Frequency Offset 327, 485
- Front panel key emulation 113
- Front panel test
Performing 134
- FSK Deviation 360
- FSK Type (Variable FSK) 362
- FTP
How to 172
- LAN Services 151
- Full Range 121
- Fuses 36
- G**
- Gain 628
- Impairment 306
- Gain Imbalance 306
- Gain Start 435
- Gain Step 435
- Gate input polarity 278
- Gated
Pulse trigger input 278
- Gated signal
Pulse modulation 274
- Gateway 139
- General settings
Bit error rate 190
- Block error rate 197
- Generate Signal HD 408, 409, 621
- Generate Signal HD - Test Signal 621
- Generate Signal HD - Test Signal ARB 621
- Generate Signal RAM 408, 409, 410, 621
- Generate Signal RAM - Test Signal ARB 621
- GET 495

- Getting started 63
 - Global trigger/clock settings 478
 - Global Trigger/Clock Settings 406
 - Global Trigger/Clock/External Input Settings 140
 - Goto local
 - Remote channel settings 144
 - GPIB 144
 - bus address 144
 - Characteristics 493
 - interface messages 494
 - Remote control interface 487
 - GPIB address 495
 - Graphical display of output signal 175
 - Graphics block 175
 - GTL 495
- H**
- Hard copy
 - File 157
 - File info 157
 - File name 157
 - File setup 158
 - Hard disk
 - Deleting temp files 131
 - Hardware Config 122
 - Hardware options 123
 - Help 17
 - High quality optimization 310
 - HiSLIP
 - Protocol 491
 - Resource string 490
 - Host name
 - see Computer name 45
 - Hostname
 - Network settings 138
 - see Computer name 45
 - HTTP
 - LAN Services 151
- I**
- I Offset 307
 - I Value - Test Signal ARB 409
 - I/Q Delay-Impairments 310
 - I/Q diagram 180
 - I/Q modulation 299, 302
 - I/Q modulation - Crest factor 305
 - I/Q Skew-Impairments 310
 - I/Q Swap - I/Q 304
 - I/Q Wideband - I/Q 304
 - I/Q-Swap 482
 - I/Q-Swap - Baseband Input 723
 - I/QOutput Type - I/Q out 320
 - Identification
 - Emulation mode 146
 - Remote 534
 - Identification mode 146
 - IDN string
 - Emulation 146
 - Emulation mode 146
 - IFC 494, 866
 - Imbalance
 - I/Q digital 309
 - Imbalance - I/Q analog 303, 751
 - Impairments analog 303
 - Impairments digital 309, 697
 - Impedance
 - Bit error rate 196
 - Block error rate 202
 - External input 255, 259, 262
 - Impedance Clock Input 141
 - Impedance trigger input 141
 - Import License Key 128
 - Import/Export
 - List Mode data 298
 - User Correction data 237, 238
 - Import/Export - List Mode data 297
 - Inactive Licenses 128
 - INF 515
 - INFO key 84
 - Input connector 28, 30, 31, 32
 - Input Waveform File 436
 - Installed Assembly 122
 - Instrument Config 122
 - Instrument Emulations 145
 - Instrument help 17
 - Instrument messages 488
 - Instrument security procedures 18
 - Instrument settings
 - Recall 164, 535, 578
 - Save 162, 536, 580
 - Instrument Trigger 141, 272, 285, 291, 296
 - Interface
 - functions (GPIB bus) 867
 - Interface Clear 866
 - Interface messages 488, 492
 - Interfaces
 - GPIB 493
 - USB 492
 - Internal adjustments
 - Setup 120
 - Internal Baseband I/Q In 302
 - Internal flash
 - Deleting temp files 131
 - Interrupt 529
 - Interrupt free measurement
 - BER/BLER measurement 187
 - Invalid results
 - Remote control 519
 - IP address 490
 - Changing 44
 - Network settings 138
 - Not recognized 863
 - IP address mode 138
 - IST 523
 - IST flag
 - Remote 534
- K**
- Key
 - Arrow key 27
 - BACKSPACE 26
 - CLOSE 25
 - Cursor key 27
 - DIAGRAM 25
 - ENTER 27
 - ESC 25
 - FILE 24, 161
 - FREQ 24
 - HCOPY 21
 - HELP 22
 - HIDE 25

- INFO 22
- INSERT 26
- LEVEL 24
- LOCAL 21
- MENU 25
- MOD ON/OFF 24, 251
- ON/OFF 25
- PRESET 21, 38, 118
- REARR 25
- RECALCULATE 24
- RF ON/OFF 24
- SETUP 21, 119
- TOGGLE 25
- WINBAR 26
- Key - HELP 160
- Key - LOCAL 156
- Key combinations 112
- Keyboard
 - Layout 143
- Keyboard Language 567
- Keypad 26
- Keywords
 - see Mnemonics 511
- L**
- LAN
 - Configuration 43
 - Interface 489
 - IP address 490
 - Remote control interface 487
 - VISA 490
 - VXI protocol 491
- LAN connection
 - Not working 44
- LAN interface
 - Avahi 151
 - enable 151
 - FTP 151
 - HTTP 151
 - LAN over SCPI 151
 - SMB (Samba) 151
 - SSH 151
 - VNC 151
- LAN Interface
 - Services 150
 - Setup 150
- Language
 - Emulation 146
- Language Keyboard 567
- Layout
 - Keyboard 143
- Leakage
 - I/Q digital 309
- Leakage - I/Q digital 696
- Learn List Mode Data 294
- Lev Att
 - see Level attenuation 336
- Level 221
 - limit 224, 232
 - Power sensors 246
 - RF output 223
 - uninterrupted setting 224
- Level - Step width 226
- Level (Avg.)
 - Power sensors 247
- Level attenuation 336
- Level Attenuation
 - DM 374
- Level control 227, 790
- Level display 82
- Level display EMF 227
- Level display EMF (LF) 265
- Level EMF - I/Q out 321
- Level limit
 - RF level 224, 232
- Level mode 418
- Level mode - ARB 647
- Level offset 224
 - Power Sensors 248
 - State (power sensors) 248
- LEVEL OFFSET 858
- Level Sweep 286
- Level user correction 233
- LevelSweep 859
- LF frequency sweep
 - Retrace 271
- LF gen frequency 254, 258, 261, 266
- LF gen shape 255, 258, 261, 266
- LF Gen Voltage 266
- LF generator 264
 - Frequency 254, 258, 261, 266
 - Shape 255, 258, 261, 266
- LF Level display
 - EMF 265
- LF output 265
- LF Output
 - State 265
- LF output - Source Impedance 266
- LF Source Impedance 266
- LF sweep
 - Step lin 271
 - Step log 271
 - Step width 271
- LF Sweep 270
- LFSweep 859
- License for software option 124
- License Key 124
- Limit
 - Level 224, 232
- Linux 41
- Linux controller 49
- List Management
 - DM 357
- List mode 291
 - manual processing of lists 293
- List Mode Data 295
- List Range In 296
- ListMode 860
- LLO 494
- LO IN connector 218
- LO OUT output 218
- Load instrument settings 164, 535, 578
- Load list 421
- Load Sequencing List 425
- Load Waveform 389
- LOC-LLO 859
- Local folder
 - Map network share 170
- Local oscillator 218
- Local to remote switchover 496, 497
- Lock
 - Display (setup security) 152

- LXI
- Browser interface 54
 - Browser settings 54
 - Configuration 53
 - LAN configuration 56
 - Ping 58
 - Remote trace (SCPI) 60
 - Web Control 59
- M**
- Mac address 139
 - Maintenance 120
 - Malfuncions
 - reacting 531
 - Manual Remote Control 46
 - Manual trigger 365
 - Manual Trigger 391, 611
 - Map network share
 - Change 170
 - Connect 170
 - Disconnect 171
 - Local folder 170
 - Network folder 170
 - Password 170
 - Reconnect at setup 170
 - Settings 170
 - User name 170
 - Marker 339
 - Marker CH x 617
 - Marker Channel x
 - DM 379
 - Marker Delay 379
 - MARKER LIST 446, 455
 - Marker Mode 404, 476
 - Marker output signals 339
 - Marker Positions 372
 - Marker trace
 - Periodical 442, 454
 - Marker x Delay 404, 476
 - Matching
 - Crest factor 479
 - MAX 515
 - Max data bits
 - Bit error rate 193
 - Max errors
 - Bit error rate 193
 - Block error rate 201
 - Max received blocks
 - Block error rate 201
 - Maximum deviation 261
 - FM 257
 - Measured external clock 406, 478
 - Measured External Clock 381
 - Measured level
 - NRP level control 232
 - Measurement period
 - How long 480
 - Measurement Period 484
 - Measurement Period - Baseband Input 724
 - Menu structure
 - Access denied 88
 - Header 88
 - Menu area 88
 - Messages
 - Commands 489
 - Instrument 488
 - Instrument responses 489
 - Interface 488
 - MIN 515
 - Minimum Noise/System Bandwidth Ratio - AWGN 313
 - Mnemonics 511
 - Optional 513
 - Mod external coupling
 - AM 255
 - FM 258
 - Mod External Coupling
 - PhiM 262
 - MOD OFF 857
 - MOD ON/OFF Key 251
 - Mode 429, 625
 - Bit error rate 193
 - Block error rate 200
 - Emulation 146
 - FM 257
 - Level Sweep 286
 - LF Gen 267
 - LF sweep 267
 - List Mode 293
 - PhiM 260
 - Pulse generator 273
 - RF frequency sweep 280
 - RF level 223
 - Mode - LO Coupling 220
 - Mode Import/Export - List Mode data 297
 - Mode Import/Export - User Correction data 237
 - Modular design 63
 - Modulation
 - AM 253
 - DM 361
 - FM 256
 - PhiM 259
 - PM 262
 - Pulse modulation 262
 - Modulation Delay for ext. Data 362
 - Modulation depth - AM 254
 - Modulation deviation
 - FM 257
 - PhiM 261
 - Modulation I/Q 302
 - Modulation input 32
 - Modulation Type
 - DM 360
 - More free disc space
 - Deleting temp files 131
 - Multi Carrier CW 464, 698
 - Multi carrier waveforms 426
 - Multi Segment table 417
 - Multi segment waveform sequencing 411
 - Multi Segment Waveforms 410
 - Multi transmitter measurements 227
 - Multiple files
 - Copy 172
 - Multiplier 609
 - DM 381
 - Frequency 213
- N**
- NAN 515
 - NAN (not a number)
 - Remote control 519
 - Navigation keys 27
 - NDAC 866

| | |
|---|--------------------|
| Network | |
| Connection fails | 863 |
| Network connection | |
| Error | 44 |
| Network folder | |
| Map network share | 170 |
| Network settings | 137 |
| Address mode | 138 |
| Default gateway | 139 |
| DNS server | 139 |
| DNS suffix | 139 |
| Hostname | 138 |
| IP address | 138 |
| Status | 138 |
| Subnet mask | 139 |
| Workgroup | 138 |
| Network status | 138 |
| New list | 421 |
| New password | |
| Setup (security) | 150 |
| New Sequencing List | 425 |
| New user password | |
| Setup (security) | 149 |
| Next Segment | 397 |
| Next Segment Mode | 398 |
| Next Segment Source | 402 |
| NINF | 515 |
| No clock | |
| Bit error rate | 191 |
| Block error rate | 199 |
| No sync | |
| Bit error rate | 191 |
| Block error rate | 199 |
| No-load voltage (EMF LF) | 265 |
| No-load voltage (EMF) | 227 |
| Noise Bandwidth - AWGN | 313 |
| Noise generator, switching on | 312 |
| Noise Only | 313 |
| Noise power - AWGN | 317 |
| Noise power Total Bandwidth - AWGN | 318 |
| NRF D | 866 |
| NRP Info | 129 |
| NRP level control | 229 |
| catch range | 232 |
| delay time | 233 |
| measured level | 232 |
| sensor | 231 |
| state | 231 |
| target level | 232 |
| use peak power | 233 |
| NRP power viewer | |
| use SParameter | 233, 250 |
| NRP sensor mapping | |
| Connector | 242 |
| Protocol | 242 |
| Scan | 242 |
| Sensor name | 242 |
| Settings | 242 |
| NTP | |
| Address | 136 |
| NTRansition | 525 |
| Number of Carriers | 429 |
| Number of Carriers - MCCW | 467 |
| Number of licenses | 124 |
| Numeric parameters | 514 |
| Numeric values | |
| Special | 515 |
| O | |
| OCXO | 32 |
| Offset | 303 |
| RF signal | 212 |
| Offset - I/Q out | 322 |
| Offset - Level | 224 |
| Offset DC | 409 |
| Old password | |
| Setup (security) | 150 |
| Old user password | |
| Setup (security) | 149 |
| On time | |
| BER/BLER test generator | 206 |
| ON/OFF ratio marker | 340 |
| ON/OFF Ratio Marker | 404, 618 |
| DM | 379 |
| Online help | |
| Working with | 104 |
| Open source acknowledgment | 19 |
| Open source acknowledgments | 124 |
| Operating concept | 63 |
| Operating system | 41 |
| Operation complete | |
| Remote | 534 |
| Operation hours | 122, 556, 557 |
| Operation mode | |
| File menu | 162 |
| OPT String | 146 |
| Optimization | |
| Fast | 310 |
| High quality | 310 |
| Optimize Crest Factor | 430, 629 |
| Optimize Crest Factor - MCCW | 467 |
| Optimize I/Q Signals for RF Output | 320 |
| Optimize internal I/Q-Impairments for RF Output | 310 |
| Option | |
| ARB Baseband Generator | 382 |
| Baseband Generator (B10/B51) | 326 |
| Hardware | 123 |
| R&S SMBV-B10/B51 (Baseband Generator) | 478 |
| R&S SMBV-K18 (Digital Baseband Connectivity) | 323, 478 |
| Software | 123 |
| Option - R&S SMx-B16 (Differential Output) | 319 |
| Option: expiration date | 124 |
| Options | |
| Hard copy | 157 |
| Identification (remote) | 534 |
| OSA | 19 |
| Oscillator | |
| Reference | 214 |
| Source (reference) | 217 |
| Out State - LO Coupling | 220 |
| Output | |
| LF | 265 |
| Output connector | 28, 29, 30, 31, 32 |
| Output file | |
| Multi segment waveform | 412 |
| Output File | 420, 433 |
| Output Mode - IQ Out | 320 |
| Output queue | 523 |
| Output Voltage - LF output | 266 |
| OvenCold | 860 |
| Overflow - Digital I/Q Output Settings | 325 |
| Overflow Hold - Digital I/Q Output Settings | 325 |

- Overlapping commands 520
 - Preventing 521
- Overload 241, 485
- OVERLOAD 858
- Overload - Basisband In 725
- Overload Hold 485
- Overload Hold - Basisband In 724
- Oversampling 670
 - DM 364
- Oversampling Auto State 670
- Oversampling factor 385
- P**
- Packing 856
- Parallel poll register enable
 - Remote 535
- Parameters
 - Block data 516
 - Boolean 516
 - Numeric values 514
 - SCPI 514
 - Special numeric values 515
 - String 516
 - Text 516
- Parity
 - RS232 interface 144
- Part numbers 122
- Password
 - Change (security password) 150
 - Confirm (security password) 150
 - Confirm (user password (security)) 150
 - Map network share 170
 - New (security password) 150
 - New (user password (security)) 149
 - Old (security password) 150
- Paste 169
- Paste, data editor 368
- Pattern
 - DM 356
- Pattern ignore
 - BER/BLER measurement 188
 - Bit error rate 196
- PCI bus 122
- Peak Level 484
- Peak Level - Baseband Input 725
- Period 418
 - Pulse generator 273
- Periodical
 - Marker trace 442, 454
- Periodical markers 456
- Permanent display
 - Power sensors 247
- Phase
 - RF signal 213, 214
- Phase coherence
 - Several instruments 219
- Phase Offset 329, 486
- Phase Offset Q - Test Signal 623
- Phase Offset Q - Test Signal ARB 407
- Phase Start 435, 628
- Phase Start - MCCW 469
- Phase Step 436, 634
- Phase Step - MCCW 469
- PhiM
 - Mode 260
 - Modulation deviation 261
 - Source 260
- PhiM Sensitivity 262
- PhiM State 260
- Ping
 - LXI 58
- Play list 403, 412, 421, 423
- Play list file
 - Sequencing list file 412
- Playlist
 - See play list 412
- Point-to-point connection 43
- Polarity
 - Pulse Modulation 264
- Power
 - List Mode 295
 - Power - AWGN 316
 - Power of starting carrier 435, 628
 - Power of starting carrier - MCCW 469
 - Power ramping 336
 - DM 373
 - Power reference 431
 - Power sensors
 - Aperture time 250
 - Auto once 250
 - Display priority 247
 - Filter 248
 - Frequency 248
 - Level 246
 - Level (Avg.) 247
 - Level offset 248
 - NRP level control 229
 - Permanent display 247
 - Power viewer 245
 - Source 248
 - State 246
 - State (level offset) 248
 - Type 246
 - Unit 247
 - Use default aperture time 250
 - zero 232, 247
 - Power spectrum 183
 - Power Start 628
 - Power Start - MCCW 469
 - Power Step 634
 - Power Step - MCCW 469
 - Power-On Count 122
 - Power-On Counter 557
 - Power-On State 226
 - PPC 495
 - PPE 523
 - PPU 494
 - PRBS
 - Bit error rate 194
 - PRBS data
 - BER/BLER measurement 185
 - PRBS generator 330
 - PRBS Type
 - DM 356
 - Preset 38
 - Preset - instrument settings 118
 - Preset instrument settings 38
 - Protection 146
 - Protocol
 - VXI 491

- PTRansition 525
 Pulse delay
 Pulse generator 274
 Pulse divider marker 339
 Pulse Divider Marker 404, 619
 DM 379
 Pulse external impedance 278
 Pulse frequency marker 339
 Pulse Frequency Marker 404, 619
 DM 379
 Pulse generator 272
 Delay 274
 Double pulse delay 274
 Double pulse width 274
 External impedance 278
 Mode 273
 Period 273
 Settings 272
 Signal valid as pulse sync 278
 Trigger mode 274
 Video-Sync signal state 273
 Width 274
 Pulse generator state 273
 Pulse mode
 Pulse generator 273
 Pulse Mode 273
 Pulse modulation 262
 repetition frequency 273
 Signal valid as pulse sync 278
 Source 264
 State 263
 Trigger mode 274
 Pulse period
 Pulse generator 273
 Pulse trigger input slope 277
 Pulse width
 Pulse generator 274
- Q**
- Q Offset 307
 Q Value - Test Signal ARB 409
 Quadrature Offset 308
 Quadrature Offset - I/Q analog 303
 Quadrature Offset - I/Q digital 310, 696
 Quantified Licenses 128
 Queries 489, 519
 Status 529
 Question mark 517, 519
 Questionable status register 528
 Quick start guide 17
 Quotation mark 517
- R**
- R&S signed packages
 Secure update policy 154
 R&S SMBV-K200 128
 Rackmounting 36
 Ramp Function 373
 Ramp Time 374
 Ratio Noise/System Bandwidth - AWGN 313
 Recall instrument settings 164, 165, 535, 578
 Recall intermediate 535
 Recall Intermediate 165
 Received blocks
 Block error rate 198
- Recommendations
 remote control programming 531
 Reconnect at setup
 Map network share 170
 Rect test signal 383
 Rect Test Signal 408
 Reference
 Source (oscillator) 217
 Reference frequency
 External 217
 Reference Mode - AWGN 315
 Reference oscillator 214
 Adjustment active 217
 Adjustment frequency 218
 External frequency 217
 RF off state 217
 Settings 216
 Source 217
 synchronization bandwidth 217
 Registers 523
 Release notes 19
 REM-LLO 859
 Remote
 Bluetooth 144
 RS232 144
 REMOTE 859
 Remote access 46
 Remote channel
 GPIO address 144
 Remote channel settings 143
 Goto local 144
 GPIO resource (VISA resource string) 144
 HISLIP resource (VISA resource string) 144
 Network resource (Ethernet resource string) 144
 Serial 144
 Socket resource (VISA resource string) 144
 USB VISA resource string 144
 Remote connection
 Not working 44
 Remote control
 Basics 487
 GPIO address 495
 Interfaces 487
 Protocols 487
 Remote Control
 GPIO 498
 Remote control switchover 496
 Remote trace
 LXI 60
 Removable hard disc 30
 Removing sensitive data 864
 REN 866
 Rename 169
 File 579
 Required options
 ARB 382
 Resampling
 External baseband signal 480
 Resart Marker 419, 420
 Reset 283, 485
 List Mode 294
 Reset - Baseband In 724
 Reset - Digital I/Q Output Settings 326
 Reset - RF sweep 283
 Reset Delta Phase Display 214
 Reset instrument settings 38, 118

| | |
|--|---------------|
| Reset values | |
| Remote | 535 |
| Resolving network problems | 140 |
| Restart delay | |
| BER/BLER test generator | 207 |
| Restart function | |
| BER/BLER measurement | 187 |
| Restart network | |
| Setting | 140 |
| Restart signal connector | 203 |
| Result | |
| Bit error rate | 190 |
| Block error rate | 198 |
| Resulting CW Frequency - AWGN | 314 |
| Retrace | |
| LF frequency sweep | 271 |
| RF frequency sweep | 284 |
| RF level sweep | 290 |
| Retrigger | 393 |
| DM | 375 |
| Reverse power protection | 241 |
| Revisions | 122 |
| RF frequency | |
| Multiplier | 213 |
| Settings | 211 |
| RF Frequency | |
| Set frequency (dialog) | 212 |
| RF frequency sweep | |
| Retrace | 284 |
| RF frequency vs. RF output frequency | 210 |
| RF level | |
| Mode | 223 |
| RF Level | |
| limit | 224, 232 |
| RF level sweep | |
| use digital attenuation | 289, 817 |
| RF Level Sweep | |
| Retrace | 290 |
| RF OFF | 208, 857 |
| RF off state | |
| Reference oscillator | 217 |
| RF ON | 208 |
| RF ON/OFF key | 208 |
| RF output | |
| Power-on state | 226 |
| RF Output | 208 |
| RF output level | 223 |
| RF output state | 209 |
| RF section | 68 |
| RF signal | |
| Frequency | 210 |
| Frequency dialog | 211 |
| Frequency offset | 212 |
| Multiplier | 213 |
| Offset | 212 |
| Phase | 213, 214 |
| Phase adjustment | 214 |
| Set frequency (status bar) | 211 |
| User variation | 213 |
| RF State | 209 |
| RF sweep | |
| Step lin | 284 |
| Step log | 284 |
| Step width | 284 |
| RFI signal generator, switching on | 312 |
| RFSweep | 859 |
| Rise Delay | 374 |
| rms Level - Baseband Input | 725 |
| RMS power | 484 |
| Roll off factor | |
| DM | 363 |
| Rotary knob | 27 |
| RS232 | |
| Baud rate | 144 |
| Parity | 144 |
| Serial interface | 144 |
| Stop bits | 144 |
| Run Update | 129 |
| Running | 394, 473 |
| DM | 376 |
| S | |
| Safety instructions | 18 |
| SAMBA/SMB | |
| How to | 172 |
| Sample Rate Source | 482 |
| Sample Rate Source - Digital I/Q Output Settings | 323 |
| Sample Rate Value | 483 |
| Sample Rate Value- Digital I/Q Output Settings | 324 |
| Sample-and-Hold mode | 790 |
| Sample&Hold mode | 227 |
| Samples | 418 |
| Samples per Period | 408 |
| Samples per Period - Test Signal | 624 |
| Samples per Period - Test Signal ARB | 407 |
| Save | |
| Control list, DM | 372 |
| DM | 368 |
| Save As | |
| Control list, DM | 372 |
| Save immediate | 162 |
| Save instrument settings | 162, 536, 580 |
| Save intermediate | 536 |
| Save List | 421 |
| Save Sequencing List | 425 |
| Save/Recall | 428 |
| Scan | |
| NRP sensor mapping | 242 |
| SCPI | |
| LAN Services | 151 |
| Parameters | 514 |
| Syntax | 512 |
| Version | 488 |
| SCPI - error messages | 861 |
| SCPI confirmed commands | 489 |
| SCPI remote trace | |
| LXI | 60 |
| Screen Saver | 142 |
| SDC | 495 |
| Search Once - ALC | 229 |
| Secure update policy | |
| All packages | 154 |
| Confirm unsigned | 154 |
| R&S signed packages | 154 |
| Security | |
| Accept settings | 154 |
| Annotation amplitude (setup) | 152 |
| Annotation frequency (setup) | 152 |
| Change password (setup) | 150 |
| Confirm password (setup) | 150 |
| Confirm user password (setup) | 150 |
| Display lock (setup) | 152 |
| New password (setup) | 150 |

| | |
|---|--------------------|
| New user password (setup) | 149 |
| Old password (setup) | 150 |
| Secure update policy | 154 |
| Security password | 150 |
| User interface | 152 |
| User password | 149 |
| Security password | |
| Security | 150 |
| Setup | 150 |
| Security Password | |
| Setup | 154 |
| Security settings | |
| LAN services | 150 |
| Security Settings | |
| Security Password | 154 |
| USB storage | 152 |
| User Name | 149 |
| Volatile Mode | 152 |
| Segment # | 417 |
| Segment Down | 418, 424 |
| Segment Marker | 419 |
| Segment Up | 418, 424 |
| Select ASCII Destination | |
| User Correction data | 238 |
| Select ASCII Destination - List Mode data | 298 |
| Select ASCII Source | |
| User Correction data | 238 |
| Select file | 167 |
| Select List | 295 |
| Select NRP File | 129 |
| Select Preset Type | 371 |
| Select Ramp to Edit | 370 |
| Select sensor | |
| Power viewer | 245 |
| Self-test | |
| Remote | 537 |
| Selftest | 133 |
| Active IQ ext. device | 133 |
| Sensor | |
| NRP level control | 231 |
| Power viewer | 245 |
| Sequencing Graphic | 425 |
| Sequencing List | 403, 421, 423 |
| Sequential commands | 520 |
| Serial | |
| Remote control interface | 487 |
| Serial bus | 122 |
| Serial interface | |
| RS232 | 144 |
| Serial numbers | 122 |
| Service manual | 18 |
| Service request (SRQ) | 526, 529 |
| Service request enable register (SRE) | 526 |
| Remote | 536 |
| Set acc. to Standard | |
| DM | 358 |
| Set frequency | |
| RF signal | 212 |
| Set IDN and OPT to default | |
| Emulation mode | 146 |
| Set Noise power via | 314 |
| Set Synchronization Settings | 405, 477 |
| DM | 380 |
| Set to default | 389, 427 |
| DM | 355 |
| Set to default - MCCW | 466 |
| Setting commands | 489 |
| Setting not possible | 88 |
| Setting parameters | 90 |
| Settings | |
| BER/BLER test generator | 205 |
| Bit error rate | 189 |
| Block error rate | 197 |
| Check front panel | 134 |
| NRP sensor mapping | 242 |
| Pulse generator | 272 |
| Reference oscillator | 216 |
| Setup | |
| Accept security settings | 154 |
| Annotation amplitude (security) | 152 |
| Annotation frequency (security) | 152 |
| BER/BLER test generator | 204 |
| Change password (security) | 150 |
| Confirm password (security) | 150 |
| Confirm password (user) | 150 |
| Date | 136 |
| Display lock (security) | 152 |
| Internal adjustments | 120 |
| LAN services | 150 |
| New password (security) | 150 |
| New password (user) | 149 |
| Old password (security) | 150 |
| Old password (user) | 149 |
| Performing the front panel test | 134 |
| Secure update policy | 154 |
| Security password | 150 |
| Time | 136 |
| Timezone | 136 |
| User interface (security) | 152 |
| User password | 149 |
| Setup key | 119 |
| Shape | |
| LF generator | 255, 258, 261, 266 |
| RF Level Sweep | 289 |
| Shape - LF Frequency Sweep | 270 |
| Shape - RF Sweep | 284 |
| Show level permanent - Power Sensors | 588 |
| Signal + Interferer PEP | 318 |
| Signal + Interferer Power | 318 |
| Signal + Noise PEP | 318 |
| Signal + Noise Power | 318 |
| Signal Duration | 394, 431, 473 |
| Signal Duration Unit | 394 |
| Signal Duration Unit - Trigger | 614 |
| Signal Period Mode | 431 |
| Signal valid as pulse sync | |
| pulse generator | 278 |
| pulse modulation | 278 |
| Signal/Noise Ratio | 315 |
| Sine test signal | 383 |
| Sine Test Signals | 407 |
| Single Pulse | 273 |
| Slope | |
| Pulse trigger input | 277 |
| Slope - External baseband trigger | 141 |
| SMB (Samba) | |
| LAN Services | 151 |
| Softkey | 87 |
| Software options | 123 |
| Source | |
| FM | 257 |
| Level Sweep Trigger | 286 |
| LF sweep trigger | 267 |
| List Mode | 293 |

| | |
|---|----------|
| PhiM | 260 |
| Power sensors | 248 |
| Pulse modulation | 264 |
| Reference oscillator | 217 |
| RF frequency sweep trigger | 280 |
| Source - AM | 254 |
| Source - Power Sensors | 593 |
| Source impedance - LF output | 266 |
| Source Import/Export | |
| User Correction data | 238 |
| Source Power Ramp Control | 373 |
| Spacing | |
| Level Sweep | 290 |
| Spacing - LF Sweep | 270 |
| Spacing - RF Sweep | 283 |
| Span (RF sweep) | 283 |
| SPD | 494 |
| SPE | 494 |
| Spectrum display | 183 |
| SRE | 523 |
| SRE (service request enable register) | 526 |
| SRQ | 866 |
| SRQ (service request) | 526, 529 |
| SSH | |
| LAN Services | 151 |
| Standard | |
| DM | 358 |
| Standard settings | 389, 427 |
| DM | 355 |
| Standard settings - MCCW | 466 |
| Standby mode | 22 |
| Start | |
| Power Sensors | 586 |
| Start delay | 436, 627 |
| Start Freq | 283 |
| Start Freq - LF sweep | 270 |
| Start Level | 289 |
| Start phase | 435, 628 |
| Start phase - MCCW | 469 |
| Start select, data editor | 368 |
| Start/Stop Display Update | 132 |
| Starting gain | 435 |
| Starting power | 628 |
| Starting power - MCCW | 469 |
| State | 388, 482 |
| Adjustment (reference oscillator) | 217 |
| ALC | 228 |
| BER/BLER test generator | 206 |
| Bit error rate | 190 |
| Block error rate | 198 |
| DM | 355 |
| LF Output | 265 |
| List mode | 292 |
| NRP level control | 231 |
| PhiM | 260 |
| Power sensors | 246 |
| Pulse modulation | 263 |
| Video-Sync signal | 273 |
| State - AWGN | 312 |
| State - Baseband Input | 727 |
| State - digital Impairments | 309, 697 |
| State - MCCW | 465 |
| State - User Correction | 234 |
| State Power Ramp Control | 373 |
| State: | |
| Bit error rate | 191 |
| Block error rate | 199 |
| Status | |
| Network settings | 138 |
| Queries | 529 |
| Status byte | |
| Remote | 533, 536 |
| Status byte (STB) | 526 |
| Status information | 857 |
| Status Information | 128 |
| status messages | |
| FREQ OFFSET | 857 |
| MOD OFF | 857 |
| OVERLOAD | 858 |
| RF OFF | 857 |
| Status messages | |
| ALC On | 860 |
| AttFixed | 860 |
| Auto | 860 |
| BUSY | 858 |
| EXT REF | 858 |
| LEVEL OFFSET | 858 |
| LevelSweep | 859 |
| LFSweep | 859 |
| ListMode | 860 |
| LOC-LLO | 859 |
| OvenCold | 860 |
| REM-LLO | 859 |
| REMOTE | 859 |
| RFSweep | 859 |
| S&H | 860 |
| SYS CTRL | 859 |
| Table | 860 |
| UCorr | 860 |
| Status registers | 523 |
| CONDITION | 525 |
| ENABLE | 525 |
| EVENT | 525 |
| model | 525 |
| NTRansition | 525 |
| parts | 525 |
| PTRansition | 525 |
| Status reporting system | 522 |
| Application | 528 |
| Common commands | 533 |
| STB | 523 |
| Step | |
| Level Sweep | 290 |
| Step lin | |
| LF sweep | 271 |
| RF sweep | 284 |
| Step log | |
| LF sweep | 271 |
| RF sweep | 284 |
| Step width | |
| Frequency | 213 |
| Level Sweep | 290 |
| LF sweep | 271 |
| RF sweep | 284 |
| Stop bits | |
| RS232 interface | 144 |
| Stop Freq - LF Sweep | 270 |
| Stop Freq - RF Sweep | 283 |
| Stop Level | 289 |
| Stopped | 394, 473 |
| DM | 376 |
| Storing | 856 |
| String in remote commands | 516 |

| | |
|--------------------------------------|-------------------------|
| Subnet mask | |
| Network settings | 139 |
| Suffixes | 513 |
| Support | 864 |
| Sweep | |
| Retrace (LF frequency) | 271 |
| Retrace (RF frequency) | 284 |
| Retrace (RF level) | 290 |
| RF frequency sweep | 280 |
| Start Level | 289 |
| Stop Level | 289 |
| Trigger | 282, 289 |
| use digital attenuation | 289, 817 |
| Sweep - Center frequency | 283 |
| Sweep - LF start frequency | 270 |
| Sweep - LF stop frequency | 270 |
| Sweep - Trigger | 269 |
| Sweep shape | |
| RF Level Sweep | 289 |
| Sweep shape - LF Frequency Sweep | 270 |
| Sweep shape - RF Sweep | 284 |
| Sweep spacing | |
| Level Sweep | 290 |
| Sweep spacing - RF Sweep | 283 |
| Symbol Clock Multiplier | |
| DM | 381 |
| Symbol Rate | |
| DM | 359 |
| Sync. Output to External Trigger | 377, 395, 474 |
| Synchronization bandwidth | |
| reference oscillator | 217 |
| Synchronization mode | 405, 477 |
| Synchronization Mode | 719 |
| DM | 380 |
| Syntax elements | |
| SCPI | 517 |
| SYS CTRL | 859 |
| System | |
| Identification | 146 |
| IDN string | 146 |
| Language | 146 |
| Network Mac address | 139 |
| Set IDN and OPT to default | 146 |
| System Bandwidth - AWGN | 313 |
| System directory | 567 |
| T | |
| Tag type | |
| Clock | 442 |
| Control length | 442, 454 |
| Emptytag length | 443 |
| Level offset | 444 |
| Magic | 440 |
| Marker mode | 445 |
| Samples | 446 |
| Segment count | 449 |
| Segment duration | 443 |
| Segment length | 449 |
| Segment level mode | 451 |
| Segment start | 449 |
| Settings file | 452 |
| Trace list | 446, 455 |
| Waveform length | 447 |
| Tag Type | 450 |
| Comment | 441 |
| Control List Width4 | 452 |
| Copyright | 441 |
| Data Bitlength | 453 |
| Data List | 454 |
| Date | 441 |
| Segment Clock Mode | 449 |
| Segment Comment | 452 |
| Segment Files | 452 |
| Segment Level Offset | 451 |
| Target Crest Factor | 430 |
| Target CW Frequency - AWGN | 314 |
| Target level | |
| NRP level control | 232 |
| Terminated by | |
| Bit error rate | 191 |
| Block error rate | 198 |
| Test | |
| Check front panel | 134 |
| Test generator | |
| BER/BLER | 203 |
| Test setup | |
| BER/BLER measurement | 184 |
| Test signal | |
| ARB generator | 383 |
| Test Signal | 407, 408 |
| Text paramters in remote commands | 516 |
| Threshold | |
| Bit error rate | 196 |
| Block error rate | 202 |
| Threshold trigger/clock signal input | 140 |
| Time | |
| Setup | 136 |
| UTC | 136 |
| Timeout | |
| Bit error rate | 197 |
| Block error rate | 202 |
| Timezone | |
| Setup | 136 |
| UTC | 136 |
| Trigger | |
| BER/BLER test generator | 206 |
| BERT | 550 |
| Bit error rate | 193 |
| BLER | 550 |
| Block error rate | 200 |
| Event (remote) | 536 |
| Trigger Delay | 397, 475 |
| Actual | 379, 397 |
| Expressed in time | 378, 396 |
| Resulting | 379, 397 |
| Unit | 378, 396 |
| Trigger Delay External | |
| DM | 378 |
| Trigger Delay Other Baseband | |
| DM | 378 |
| Trigger Example | 403 |
| Trigger Inhibit | 379, 397, 476 |
| Trigger Input Slope | 141, 272, 285, 291, 296 |
| Trigger mode | |
| Pulse modulation | 274 |
| Trigger Mode | 393 |
| Armed | 472 |
| Auto | 472 |
| DM | 375 |
| Retrigger | 472 |
| Single | 472 |
| Trigger parameters | |
| DM | 375 |

- Trigger Signal Duration 376
- Trigger signals 338
- Trigger source
 - LF sweep 267
 - RF frequency sweep 280
- Trigger Source 395, 474
 - DM 377
 - Level Sweep 286
 - List Mode 293
- Trigger Source - Graphics 177
- Triggering
 - Multi segment waveform 413
 - Segment 413
- Triggering sweep manually 289
- Troubleshooting 857
- TS-USB1
 - USB adapter 144
- Type
 - Power sensors 246
 - Type - Power Sensors 594
- U**
 - UCorr 860
 - Ultr@VNC 49
 - Uninterrupted level setting 224
 - Unit
 - Bit error rate 190
 - Block error rate 198
 - Power sensors 247
 - Units
 - Input 26
 - UNIX controller 49
 - Unmodulated signal 336
 - UP 515
 - Up-conversion
 - Important parameters 479
 - Update sensor 129
 - USB
 - Adapter TS-USB1 144
 - Interfaces 492
 - Remote control interface 487
 - USB Storage - Setup 152
 - Use default aperture time
 - Power sensors 250
 - Use digital attenuation
 - Level Sweep 289, 817
 - Use peak power
 - NRP level control 233
 - Use SParameter
 - NRP power viewer 233, 250
 - Use SParameters - Power Sensors 587
 - User Clock 419, 646
 - User Correction 233
 - User Correction Data 235
 - User Filter
 - Catalog 364
 - Delete 364
 - Load 364
 - User interface
 - Lock (security) 152
 - User manual 17
 - User Mapping
 - Catalog, DM 360
 - Delete, DM 360
 - Load, DM 360
- User name
 - Map network share 170
- User Name - Setup 149
- User password
 - Security 149
 - Setup 149
- User variation
 - RF frequency settings 213
 - Variation active 213
 - Variation step 213
- V**
 - Value - User Correction 234
 - Variable FSK
 - Deviation 362
 - Variation Active 213
 - Variation step 213
 - Variation Step 213, 226
 - Vector diagram 181
 - Vector modulation 299
 - Vertical stroke 517
 - Video-Sync signal state
 - Pulse generator 273
 - VISA 487, 490
 - Libraries 488
 - Resource string 488, 490
 - VISA resource string
 - Ethernet 144
 - GPIB 144
 - HISLIP 144
 - Serial 144
 - Socket 144
 - USB 144
 - Visual check of signal characteristics 175
 - VNC
 - LAN Services 151
 - VNC connection 49
 - Volatile mode
 - Setup 152
 - VXI protocol 491
- W**
 - Wait
 - Remote 537
 - Wait Time 143
 - Warnings 84, 860
 - Waveform
 - Edit, rules 464
 - Maximum length 385
 - optimizing 385
 - Waveform file
 - Corrupted, reasons 464
 - Waveform File 389
 - Waveform Info 390, 417, 424
 - Web Control
 - LXI 59
 - White papers 19
 - White space 517
 - Wideband setting - I/Q 302
 - Width
 - Double pulse 274
 - Pulse generator 274
 - Winbar 87
 - Workgroup
 - Network settings 138

Z

| | |
|----------------------------|----------|
| Zero | |
| Power sensors | 232, 247 |
| Zero - Power Sensors | 594 |
| Zeroconf | |
| IP address | 863 |
| Zoom | 372 |