

R&S® TS7121x

Shielded RF Test Box

User Manual



1506948108

This manual describes the following R&S®TS7121x models:

- R&S®TS7121A (automatic version, order number 1152.5700.04/.05)
- R&S®TS7121M (manual version, order number 1152.5800.02)

© 2018 Rohde & Schwarz GmbH & Co. KG

Mühlhofstr. 15, 81671 München, Germany

Phone: +49 89 41 29 - 0

Fax: +49 89 41 29 12 164

Email: info@rohde-schwarz.com

Internet: www.rohde-schwarz.com

Subject to change – Data without tolerance limits is not binding.

R&S® is a registered trademark of Rohde & Schwarz GmbH & Co. KG.

Trade names are trademarks of the owners.

1506.9481.08 | Version 05 | R&S®TS7121x

Throughout this manual, products from Rohde & Schwarz are indicated without the ® symbol , e.g. R&S®TS7121x is indicated as R&S TS7121x.

Contents

1	Preface	5
1.1	Key Features.....	5
1.2	Documentation Overview.....	5
2	Specific Safety Instructions	7
2.1	Explanation of Symbols.....	8
2.2	Intended Use.....	9
2.3	Authorized Operators.....	9
2.4	Safety Instructions for Unpacking and Transport.....	10
2.5	Safety Instructions for Setup.....	10
2.5.1	Positioning the Chamber.....	11
2.6	Safety Instructions for Operation.....	12
2.7	Safety Instructions for Maintenance.....	13
3	System Overview and Usage	14
3.1	Important User Information.....	14
3.2	Functions of the Shielded RF Test Box.....	14
3.3	Usage of the Shielded RF Test Box.....	16
4	System Hardware Description	17
4.1	Hardware Overview.....	17
4.1.1	Front Tour.....	17
4.1.2	Rear Tour.....	18
4.1.3	25-Pin D-Sub Connector for Pneumatic Control and Sensor Reading.....	20
4.1.4	25 and 9-Pin D-Sub Feedthrough Connectors.....	21
4.2	Accessories.....	21
4.2.1	USB Feedthrough Filter R&S TS-F21FU2.....	21
5	Setting Up the System	23
5.1	Unpacking and Checking the Equipment.....	23
5.2	Installation.....	24
5.2.1	Connecting the R&S TS7121A to Compressed Air Supply.....	24
5.3	Adjustments of the R&S TS7121A.....	26
6	Maintenance	28

6.1	Important User Instructions.....	28
6.2	General.....	28
6.3	Maintenance Intervals.....	29
6.4	Greasing Moving Parts of the Handle.....	30
6.5	Cleaning the Shielded RF Test Box.....	30
6.5.1	Cleaning the Chamber.....	30
6.5.2	Cleaning the Gasket Contact Area.....	31
7	Spare Parts Lists R&S TS7121.....	32
	Glossary: List of Frequently Used Terms and Abbreviations.....	38
	Index.....	39

1 Preface

1.1 Key Features

The use of a Shielded RF Test Box is a prerequisite for reliable and reproducible radio interface tests. It ensures that devices under test (DUTs) are not affected by interference from external test systems that would distort the measurement results. The shielding also prevents other external instruments or test systems from being affected by the radiation tests.

The Shielded RF Test Box family R&S TS7121 is designed to meet the requirements of automatic production lines, optionally with pneumatic opening and closing. It performs tests on modules and devices with a radio interface in accordance with a wide variety of standards such as ISM, GSM/CDMA2000/WCDMA, WLAN, Bluetooth, ZigBee, WiMAX, Wi-Fi and LTE.

Features of the Shielded RF Test Box include:

- Wide frequency range from 300 MHz to 6 GHz
- High shielding efficiency across a wide frequency range
- Low reflection due to use of absorbent material
- Rugged design and long lifetime
- Integrated RF connectors and filter feedthroughs
- Automatically and manually operated versions
- Antenna couplers for diverse technologies

1.2 Documentation Overview

The technical documentation for the Shielded RF Test Box is made up of the following parts:

- This user manual with important specific safety instructions (printed or in electronic format)
- General safety instructions (separate, printed or in electronic format)
- A CD-ROM that contains
 - The user manual
 - The general safety instructions
 - A product brochure

The entire user manual must be carefully read, understood and observed by the following persons:

- Operators, assigned to work with the Shielded RF Test Box, before switching it on for the first time
- Service engineers, before performing any maintenance or service tasks

Compliance to the user manual achieves the following goals:

- Prevent hazards during transport, positioning and assembly
- Prevent hazards during operation
- Prevent hazards during configuration
- Prevent hazards during maintenance
- Prevent hazards during repair
- Increase operation efficiency
- Avoid or reduce downtime
- Increase the reliability and lifetime of the Shielded RF Test Box

The operating instructions must always be available in the location where the Shielded RF Test Box is used. The operating organization must supplement the operating instructions, as appropriate, with information on national health, safety and environmental regulations.

2 Specific Safety Instructions

WARNING

Risk of injury

Operation and handling of a Shielded RF Test Box implies risks.

To reduce these risks and prevent accidents, carefully read the following chapter and the rest of the operating manual as well as the general safety instructions.

The Shielded RF Test Box has been manufactured in accordance with accepted engineering practices and the latest scientific and technical findings. Nevertheless, any Shielded RF Test Box generates risks that cannot be prevented by design. To provide sufficient safety for personnel using the Shielded RF Test Box, additional safety instructions have been defined. A satisfactory level of safety while using the Shielded RF Test Box is assured only if these instructions are observed.

Handling and operating the Shielded RF Test Box requires some in-depth knowledge and skills.

Personnel assigned to work with the Shielded RF Test Box must first read and understand the entire manual, particularly this chapter, before starting to work.

Operators must be trained and instructed on safety aspects and have to comply with:

- National law and local regulations on health, safety, and environmental protection
- Applicable standard procedures for health and safety
- Technical standards, rules and instructions for the safe operation of test systems
- Specific organizational obligations (e.g. regarding supervision, reporting, the organization of work, schedules, human resources, etc.)

Internal precautions of the operating organization must ensure the following:

- Only authorized persons are allowed to work on the Shielded RF Test Box, see [Chapter 2.3, "Authorized Operators"](#), on page 9.
- Only authorized persons are allowed to enter the operating area near the Shielded RF Test Box.
- During operation of the Shielded RF Test Box, all safety regulations and operating instructions must be adhered to strictly.
- It is not permitted to make any changes, modifications or additions to the Shielded RF Test Box that could affect safety.

Carefully read the following chapters:



- [Explanation of Symbols](#).....8
- [Intended Use](#).....9
- [Authorized Operators](#).....9
- [Safety Instructions for Unpacking and Transport](#)..... 10

- [Safety Instructions for Setup](#)..... 10
- [Safety Instructions for Operation](#).....12
- [Safety Instructions for Maintenance](#)..... 13

2.1 Explanation of Symbols

Labels with the following symbols point out areas of risk on the chamber. In addition, sections in this chapter which describe a specific risk are marked with the associated symbol in the margin. The symbols have the following meaning:

Symbol	Explanation
	<p>WARNING!</p> <p>Indicates the risk of personal injury</p> <p>To prevent personal injury, observe and follow safety instructions.</p>
	<p>WARNING!</p> <p>Indicates the risk of contusion of hand and fingers</p> <p>To prevent contusion of the hand and fingers, follow the safety instructions on how to operate the chamber.</p>
	<p>WARNING!</p> <p>Indicates the risk of toes / foot injury due to the heavy chamber and its door.</p> <p>To prevent toes or foot injury, follow the safety instructions for transport, unpacking and operation.</p>
	<p>CAUTION!</p> <p>Indicates a weight for heavy units >18 kg</p> <p>To prevent personal injury, follow the safety instructions for transport, unpacking and operation.</p>
	<p>NOTICE</p> <p>Indicates a risk of malfunction</p> <p>To achieve correct measurement results, observe the operating instructions.</p>
	<p>NOTICE</p> <p>Indicates the risk of ESD</p> <p>In order to prevent electrostatic discharge effects, follow the instructions in "Risk of damaging electrical parts" on page 24. Electrostatic sensitive devices require special care.</p>

	<p>NOTICE</p> <p>Indicates a risk of damage to the installation</p> <p>To prevent damage to the Shielded RF Test Box or incorrect measurement results, follow the safety instructions.</p>
	<p>Ground (protective earth, PE)</p>

2.2 Intended Use

The Shielded RF Test Box is intended for radiation testing of electronic devices. Any other use is regarded as improper use, which can result in safety hazards and damage. Always use the appropriate, specially manufactured cables and adapters for testing the device under test (DUT).

The Shielded RF Test Box is only permitted to be operated within the permissible parameter ranges as specified in the data sheet (included in the delivery).

The Shielded RF Test Box is intended for industrial use and must be installed, operated, configured, maintained and repaired by trained personnel, only.

2.3 Authorized Operators

An authorized operator is a person who, as a result of special instruction or training courses, is familiar with handling the Shielded RF Test Box. The operator must have read and understood the operating instructions. Only trained personnel with the proper instruction is permitted to carry out work on the Shielded RF Test Box.

The duties of personnel responsible for the following must be clearly defined:

- Installation
- Operation
- Configuration
- Maintenance
- Repair

When instructing personnel, you must lay particular emphasis on possible hazards and on the safety procedures. Proper use also includes the observance of this manual and the observance of the inspection and maintenance requirements (see [Chapter 6, "Maintenance"](#), on page 28).

2.4 Safety Instructions for Unpacking and Transport



Risk of contusion due to heavy moving parts

For transportation, the Shielded RF Test Box is originally contained in a special transport protection packaging. After unpacking, there is no additional protection to prevent opening of the drawer (door). Especially when the chamber is tilted, the door can slide open unintentionally. This movement can cause personal injuries, especially contusion.



Risk of injury due to heavy weight

Handling the heavy Shielded RF Test Box (e.g. lifting or transporting it) can result in personal injury. To prevent this risk, handle the Shielded RF Test Box in an ergonomic way. For example, carry it while maintaining a straight back and optionally with the help of a second person. The R&S TS7121A (automatic version) must be mounted by fixing it to a stable bench/support with 4 screws, see [Chapter 5, "Setting Up the System"](#), on page 23.



Risk of injury due to unstable mounting

The support (bench, table, rack, or the like), onto which the Shielded RF Test Box is mounted, must be sufficiently stable to bear the chamber's weight and to withstand the door's momentum during operation. The screws that fix the mounting brackets to the support, must hold a tight grip in the support's material. The screws must be strong enough to withstand a dynamic long-term load. If the support or the screws fail, the chamber can become destabilized and eventually tip out of place. This failing could cause personal injuries, especially contusion.

2.5 Safety Instructions for Setup

Prerequisites for the installation of the Shielded RF Test Box:

- Provide a stable mounting space (see weight and dimensions specified in the data sheet).
Make sure that the location, in which the Shielded RF Test Box is mounted, leaves sufficient room for the following: You must be able to open the door, to access the door easily from all sides and to access all connectors and mounting brackets on the front and rear side.
- R&S TS7121A (automatic version): Provide external control circuitry (not included in the delivery) that complies with the circuit diagram shown in [Figure 4-3](#) and includes a 24 VDC power supply.
- R&S TS7121A (automatic version): Provide compressed air by a 6 mm push-in tube that supplies 6 bar (max. 8 bar) of filtered, grease-free compressed air.



Risk of injury due to excess pressure of the compressed air supply

If the pressure in the compressed air supply system exceeds the limit of 0.8 MPa (8 bar), the door operates under unspecified conditions (see data sheet). The excess pressure can cause uncontrolled situations, which can lead to personal injuries, especially contusion.

To avoid this risk, only use the Shielded RF Test Box in a site that features an air preparation unit or service unit. This unit must limit the pressure of the compressed air supply to 6 bar (max. 8 bar) and provide filtered, grease-free compressed air.

2.5.1 Positioning the Chamber



Risk of injury due to heavy moving parts

Failure to fix the chamber properly before the first usage leads to a risk of injury as described in [Chapter 2.6, "Safety Instructions for Operation"](#), on page 12. To avoid this risk, mount the chamber securely, as described below.

Fix the Shielded RF Test Box in place by screwing the four mounting holes ([Figure 4-2](#)) on the front and rear side of the chamber to a stable bench or support.



Risk of collision and contusion within the danger zone

The opening door can collide with a person or an obstacle that is present in a specific area in front of the chamber. This area, which is utilized by the opened door, must be regarded as a danger zone of the Shielded RF Test Box.

To avoid the risk of damage or personal injury, especially due to collision and contusion, everything and everybody must stay out of the danger zone.

Mark the danger zone on the ground below the chamber's opened door, as shown in [Figure 2-1](#).

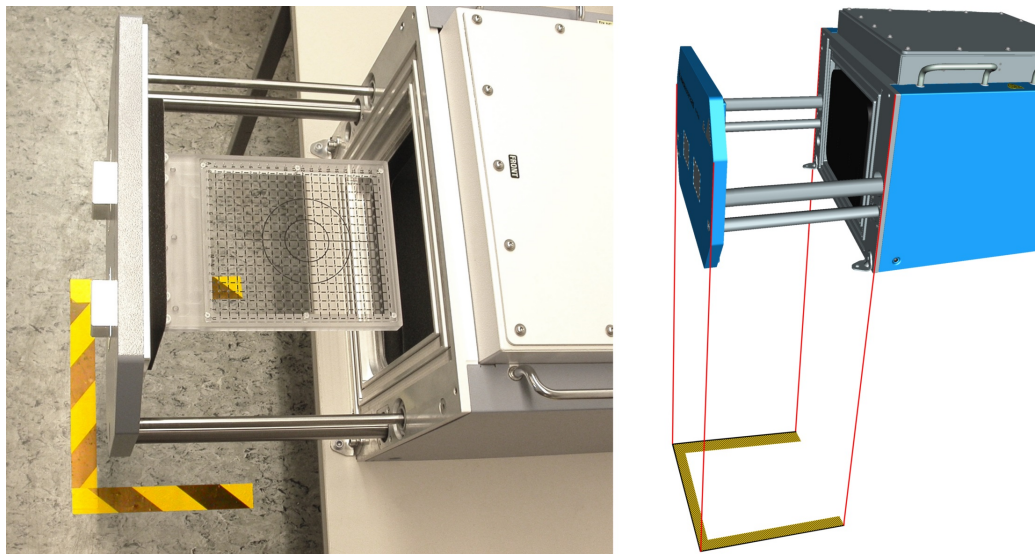

Figure 2-1: Danger zone of the door marked on the ground, as illustrated on the right (here shown with a similar RF test box)

If you must remove the box from this location, for example to open the top cover, observe the [Safety Instructions for Unpacking and Transport](#). Only operate the door while the Shielded RF Test Box is securely mounted to a stable support.

2.6 Safety Instructions for Operation



Risk of injury due to pneumatic door operation

The heavy Shielded RF Test Box features a solid metal door that can be automatically opened and closed. Automatic operation is required for short measurement cycle times and is realized with the R&S TS7121A (automatic) version. The heavy weight is required to achieve high levels of electromagnetic shielding. This combination of automation and massive construction implies some inevitable risk of injury for the operators. The risk of contusion when closing the Shielded RF Test Box occurs at the movable lever mechanism (R&S TS7121M), at the movable pressure cylinder, and between the Shielded RF Test Box door part and the Shielded RF Test Box. To avoid potential risk of contusion, keep away from the gap between the door and the chamber, when the door is about to be closed.



Risk of injury due to remote operation

If the chamber's door is closed by a remote operator from a distant position, a local operator near by the chamber can be injured. Especially the operator's hands can suffer contusion while placing a DUT into the chamber or taking a DUT out of the chamber. To avoid this risk, make sure that the remote operator has a good view of the Shielded RF Test Box and observes it while operating the door.



Risk of contusion due to heavy moving parts

If the chamber comes into an unstable position, this situation can lead to personal injury, especially contusion. Without the pneumatic system keeping the door closed, such a tilting movement could even contribute to a faster opening. To avoid this risk, make sure that the chamber is securely mounted to a stable support.



Risk of injury due to high pressure

Setting up the Shielded RF Test Box can lead to a risk of personal injury due to the pneumatic system. To avoid this risk, respect the following:

- Before initially connecting the chamber to the compressed air supply, switch off the compressed air supply.
- When connecting the chamber to the compressed air supply, be aware of the possibility of a sudden opening or closing of the chamber door.
- Observe all local and national regulations applicable for pneumatic systems.
- Any work on the pneumatic system is a service task, which must only be carried out by properly qualified service personnel.



Risk of injury due to excess pressure of the compressed air supply

If the pressure in the compressed air supply system exceeds the limit of 0.8 MPa (8 bar), the door operates under unspecified conditions (see data sheet). The excess pressure can cause uncontrolled situations, which can lead to personal injuries, especially contusion.

To avoid this risk, only use the Shielded RF Test Box in a site that features a suitable air preparation unit or service unit. This unit must limit the pressure of the compressed air supply to 6 bar (max. 8 bar) and provide filtered, grease-free compressed air.



Risk of injury in case of malfunction

If the Shielded RF Test Box is operated without being in proper working order, malfunctions could lead to unpredictable events.

To avoid risks in the event of a malfunction:

- immediately take the chamber out of service,
- report the malfunction to the responsible department,
- eliminate any faults before work is continued.



Risk of mechanical damage due to high pressure

Malfunction of the pneumatic system could cause mechanical damage. Make sure that during operation, the air pressure is within its specifications of 6 bar (max. 8 bar). For staying within these specifications, it is recommended to use an air pressure control.



Other safety instructions

Persons not trained in handling the Shielded RF Test Box must be kept out of the range of operation, as they do not know about all potential hazards of injury. Observe internal instructions and ensure that the area of operation is always clear and clean. All areas for handling, service and maintenance must be kept easy to access.

2.7 Safety Instructions for Maintenance



Risk of injury in case of uninformed maintenance

Servicing the pneumatic system of the R&S TS7121A can lead to a risk of personal injury.

To avoid this risk, respect the following:

- Work on the pneumatic system must be carried out by properly qualified service personnel, only.
- Before working on the pneumatic system, terminate the supply of compressed air and verify that the system is de-pressurized.
- Observe all regulations applicable for work on pneumatic systems.



Risk of damaging electrical or mechanical parts

Malfunction of the pneumatic system could cause mechanical damage. Make sure that during operation, the air pressure is within its specifications of 6 bar (max. 8 bar). To stay within these specifications, we highly recommend using an air pressure control.

Protect surrounding area

When maintenance tasks are carried out on the Shielded RF Test Box, the surrounding area must be protected by appropriate measures. This protection includes:

- Erecting barriers
- Putting up warning signs
- Other similar measures

3 System Overview and Usage

- [Important User Information](#)..... 14
- [Functions of the Shielded RF Test Box](#)..... 14
- [Usage of the Shielded RF Test Box](#)..... 16

3.1 Important User Information

The Shielded RF Test Box is controlled via the program in the test system that is connected.

⚠ WARNING

Risk of injury from insufficient qualification of personnel



Only trained persons are permitted to operate the Shielded RF Test Box.

Before switching on the Shielded RF Test Box the first time, the operator must read and understand [Chapter 2, "Specific Safety Instructions"](#), on page 7.

3.2 Functions of the Shielded RF Test Box

The Shielded RF Test Box is built for the testing of electronic devices, especially the radiation test. The door in front of the Shielded RF Test Box is used for insertion of the DUT (device under test). The cover of the Shielded RF Test Box is for service issues. All interfaces are at the back of the Shielded RF Test Box.

The Shielded RF Test Box is available in two base models that differ mainly in width and a manual and an automatic version of each model.

Product spectrum

Figure 3-1: Overview of the different models of the R&S TS712x family

Manual Shielded RF Test Box R&S TS7121M and R&S TS7124M

You can use the manual versions completely without air pressure or electric power supply.

Table 3-1: R&S TS7121M and R&S TS7124M

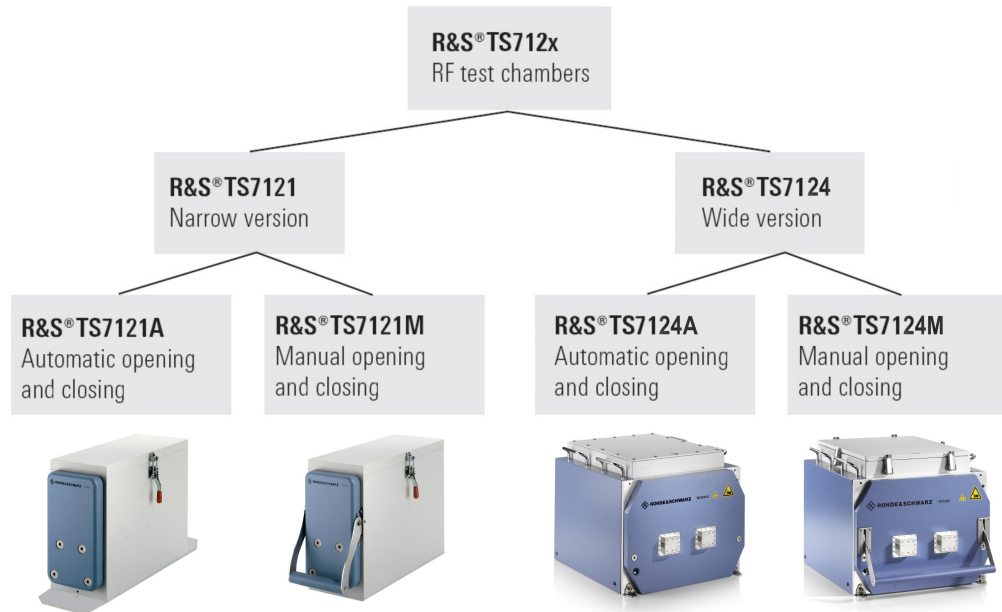

Automatic Shielded RF Test Box R&S TS7121A and R&S TS7124A

The automatic version has a pneumatic cylinder for opening and closing the door and a rear 25-pin D-Sub connector. This connector is used for controlling the pneumatic cylinder and for checking the open and close sensors. The Shielded RF Test Box can be

controlled by an operator using a switching unit or is controlled by software. No operator is needed during production.

The automatic version of the Shielded RF Test Box contains a larger base plate for fixing.

Table 3-2: R&S TS7121A and R&S TS7124A

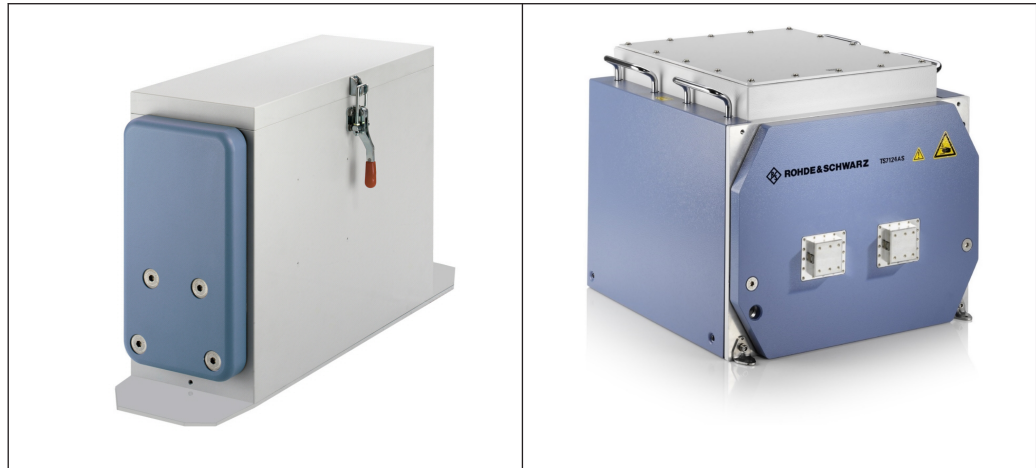

3.3 Usage of the Shielded RF Test Box

The screened Shielded RF Test Box is an adaptation platform for testing devices with radio interfaces, e.g.:

- Mobile telephones
- PDAs
- Radio keys
- WLAN, Bluetooth modules, etc.

The Shielded RF Test Box can be used in production, service, for repairs and in other applications. In the Shielded RF Test Box, the assemblies to be tested are adapted to suit the specific device. Thus, control and measured signals can reach the DUT from the controlling test system.

The Shielded RF Test Box can be controlled using the following test systems:

- Rohde & Schwarz RF test system R&S TS7810
- Rohde & Schwarz test platform for mobile phone production R&S TS 7180
- Any test system using a USB interface or TTL signals

4 System Hardware Description

- [Hardware Overview](#).....17
- [Accessories](#).....21

4.1 Hardware Overview

This chapter describes all components used in the Shielded RF Test Box.

- [Front Tour](#).....17
- [Rear Tour](#).....18
- [25-Pin D-Sub Connector for Pneumatic Control and Sensor Reading](#).....20
- [25 and 9-Pin D-Sub Feedthrough Connectors](#).....21

4.1.1 Front Tour

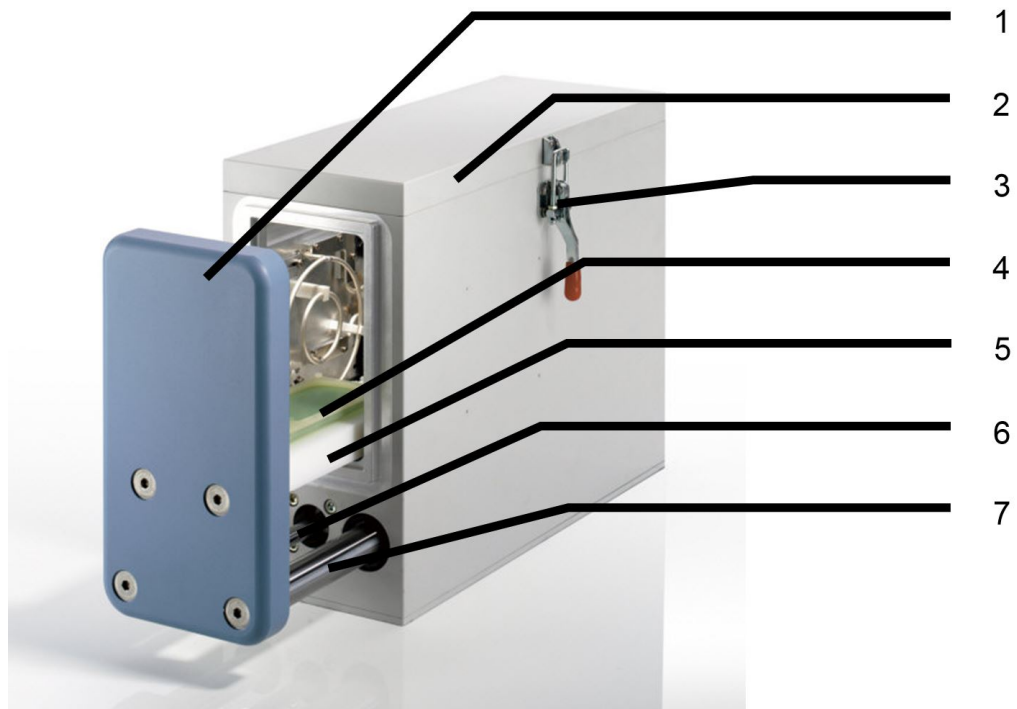

Figure 4-1: Front view of the opened Shielded RF Test Box

- 1 = Door for DUT change
- 2 = Cover for service issues
- 3 = Closing mechanism for cover (manual and semiautomatic versions only)
- 4 = Customer-specific DUT holder
- 5 = Plate with guiding pins for DUT holder
- 6 = Pneumatic cylinder
- 7 = Door guide rail

The front door (1) of the Shielded RF Test Box is used for insertion of the DUT. The DUT can be fixed on the plate (5) with guiding pins for DUT holder. Two pneumatic cylinders (6, one on each side) open and close the door, with guide rails (7) providing additional stability. The cover (2) of the Shielded RF Test Box is fixed by two clamping fixtures (3). It can be removed for service issues.

4.1.2 Rear Tour

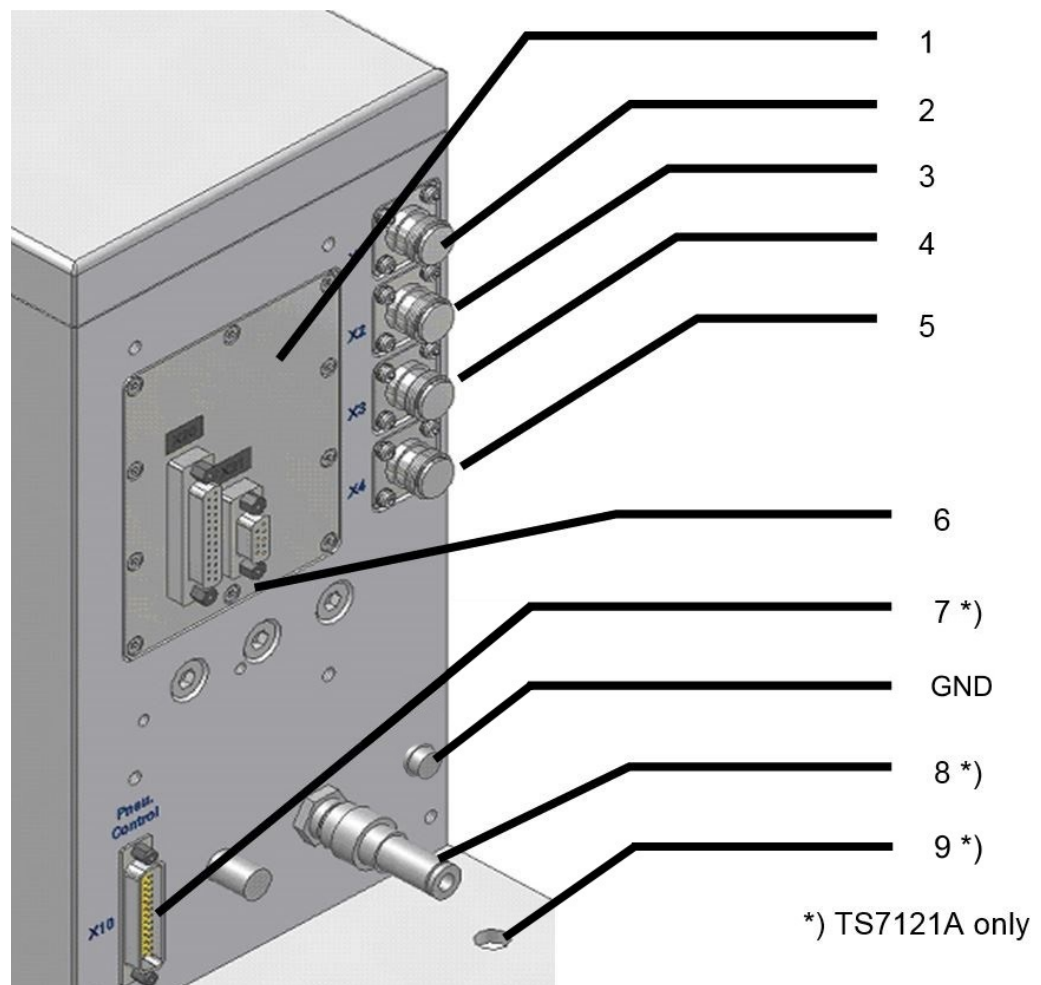

Figure 4-2: Back view of the Shielded RF Test Box

- 1 = Exchangeable connector plate
 - 2 = RF 1 N-connector (X1, reserved for GSM antenna coupler)
 - 3 = RF 2 N-connector (X2, spare)
 - 4 = RF 3 N-connector (X3, spare)
 - 5 = RF 4 N-connector (X4, reserved for Bluetooth antenna coupler)
 - 6 = 25 and 9-pin D-Sub connectors (X20 and X21) with RF filter (3 dB cut-off at 3 MHz) as a feedthrough for power supply, RS-232-C, etc.
 - 7 = 25-pin D-Sub connector (X10) for power supply, pneumatic control and sensor reading
 - 8 = Air pressure connector for pneumatic supply (see [chapter 5.2.1](#))
 - 9 = One of four mounting holes on the front and rear side of the chamber
- GND = Grounding contact

*) TS7121A only

On the rear side (also shown in [Figure 5-1](#)), the Shielded RF Test Box has components for the installation, including a grounding contact (GND). The automatic version Shielded RF Test BoxA also has an air pressure connector (8) and a 25-pin D-Sub connector (7). This connector is used for controlling the automatic opening/closing, reading out the current state and input for the 24V DC power supply.

For the pneumatic installation of the automatic Shielded RF Test Box, refer to [Chapter 5.2.1, "Connecting the R&S TS7121A to Compressed Air Supply"](#), on page 24.



The items labeled with an asterisk (*) in [Figure 4-2](#) are only available with the automatic version R&S TS7121A. In the manual version R&S TS7121M, these items do not exist.

You can adapt the exchangeable connector plate (1) on the rear panel for your special needs. In our example (6), it is equipped with a 25-pin and 9-pin D-Sub connector.

The four RF N-connectors, labeled (2) to (5) in [Figure 4-2](#), allow feeding RF signals into the Shielded RF Test Box towards internal antennas or directly towards the DUT.

NOTICE

Risk of reduced shielding effectiveness



If you install additional feedthroughs into the exchangeable connector plate, consider the components' shielding effectiveness. If you install the feedthroughs incorrectly, the shielding effectiveness can deteriorate dramatically. Rohde & Schwarz assumes no liability for these modifications.

4.1.3 25-Pin D-Sub Connector for Pneumatic Control and Sensor Reading

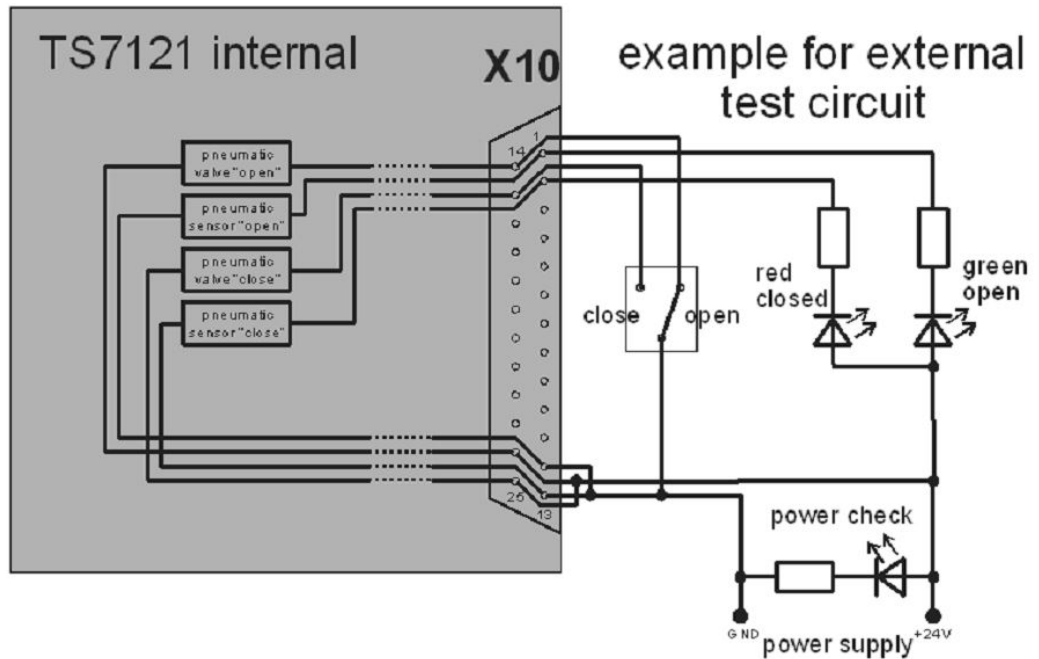

Figure 4-3: Circuit diagram of automatic open/close mechanism

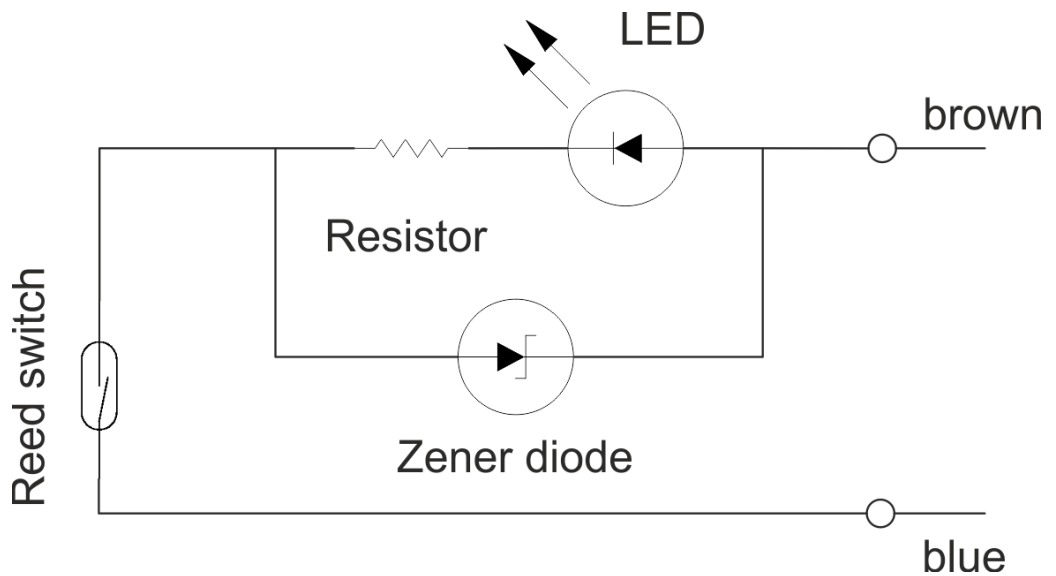

Figure 4-4: Internal circuit diagram pneumatic sensor

Operating voltage	24 VDC
Maximum current	5 mA to 20 mA
Voltage drop	2.4 V

4.1.4 25 and 9-Pin D-Sub Feedthrough Connectors

The connectors X20 (25 pin) and X21 (9 pin) are fully customer-specific. These feedthroughs are typically used for power supply, RS-232-C, IO signals, etc.

The feedthrough connectors have RF filters with a 3 dB cut-off at 3 MHz.

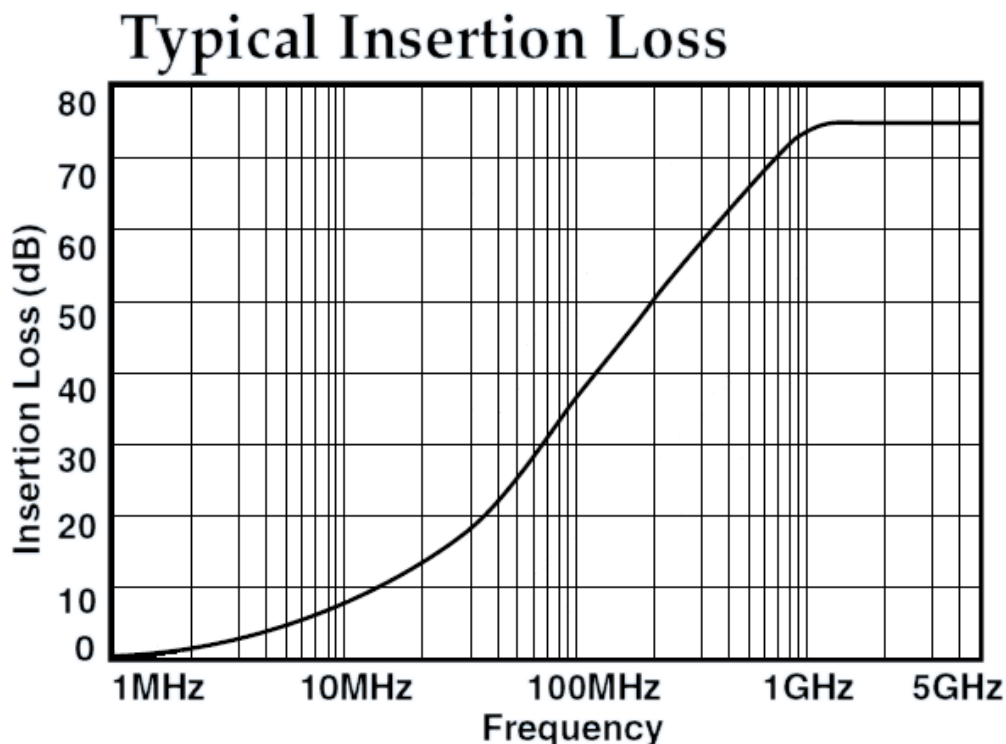

Figure 4-5: Typical insertion loss of filter connector

For more technical data, refer to the data sheet.

4.2 Accessories

This chapter describes the accessories for the Shielded RF Test Box.

- [USB Feedthrough Filter R&S TS-F21FU2](#)..... 21

4.2.1 USB Feedthrough Filter R&S TS-F21FU2

The USB feedthrough filter for R&S TS7121 consists of:

- Filtered feedthrough for USB 1.1 and USB 2.0 data rates
- Exchangeable R&S TS7121 connector plate for
 - D-Sub feedthrough (9-pin and 25-pin connectors)
 - USB feedthrough

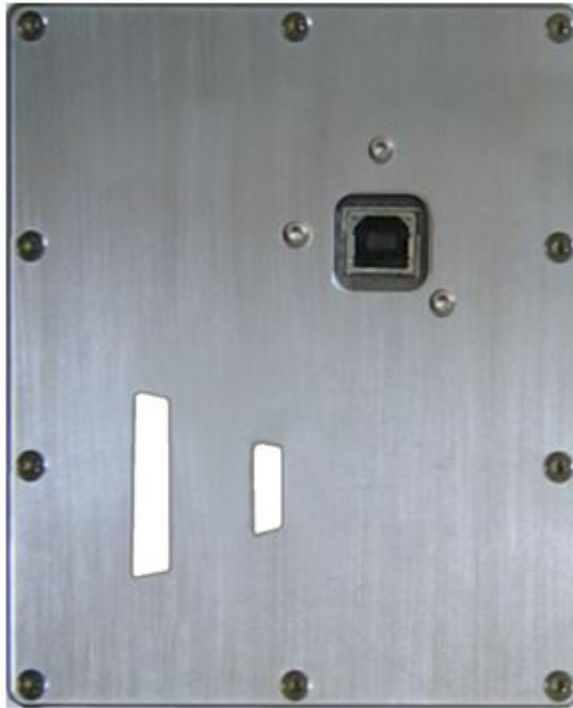

Figure 4-6: Exchangeable connector plate with USB filter connector (top right)

Type	Designation	Order No.
R&S TS-F21FU2	Feedthrough filter USB 2.0 for R&S TS7121	1506.9181.02

5 Setting Up the System

Prerequisites for the installation of the Shielded RF Test Box (only R&S TS7121A):

- Stable mounting space (see weight and dimensions in the data sheet)
- Power supply (24 V DC voltage)
- Compressed air supply: 6 mm push-in tube, providing 6 bar of grease-free compressed air

5.1 Unpacking and Checking the Equipment

Check the equipment for completeness using the delivery note and the accessory lists of the delivered items. Check the Shielded RF Test Box for any damage. If there is damage, immediately contact the carrier who delivered it.



Retain the original packaging material. If the Shielded RF Test Box needs to be transported or shipped later, you can use the material to protect the equipment.

NOTICE

Risk of damage during transportation and shipment

Insufficient protection against mechanical and electrostatic effects during transportation and shipment can damage the Shielded RF Test Box.

- When shipping the Shielded RF Test Box, we recommend using the original packaging material. If it is not available, use sufficient padding to prevent the chamber from moving around inside the box.
 - Secure the chamber to prevent any movement and other mechanical effects during transportation.
 - Always provide sufficient mechanical and electrostatic protection.
-

5.2 Installation

NOTICE

Risk of damaging electrical parts



To secure testing devices and equipment against static charging or discharging, provide appropriate ESD protection for the area surrounding the Shielded RF Test Box. Operators must observe all applicable ESD regulations.

To install the Shielded RF Test Box, perform the following steps (for interfaces and connections, see [Figure 4-2](#)):

1. Fix the Shielded RF Test Box in place by screwing the chamber to a stable bench or support.
This step is only available for the R&S TS7121A (automatic version).
2. Ground the Shielded RF Test Box using the electrical grounding contact on rear side.
3. Connect the Shielded RF Test Box via the 25-pin D-Sub connector to an external control unit. This connector is also the input for the 24 VDC supply.
This step is only available for the R&S TS7121A (automatic version).
4. Connect the Shielded RF Test Box via the air pressure connector to a compressed air supply, as described in [chapter 5.2.1](#).
This step is only available for the R&S TS7121A (automatic version).
5. Connect the interfaces according to the requirements of your application.

5.2.1 Connecting the R&S TS7121A to Compressed Air Supply

This chapter describes how to connect the R&S TS7121A (automatic version with pneumatic system) to a compressed air supply, and how to disconnect it. Note that connecting a pneumatic system is not possible with the manual version R&S TS7121M.

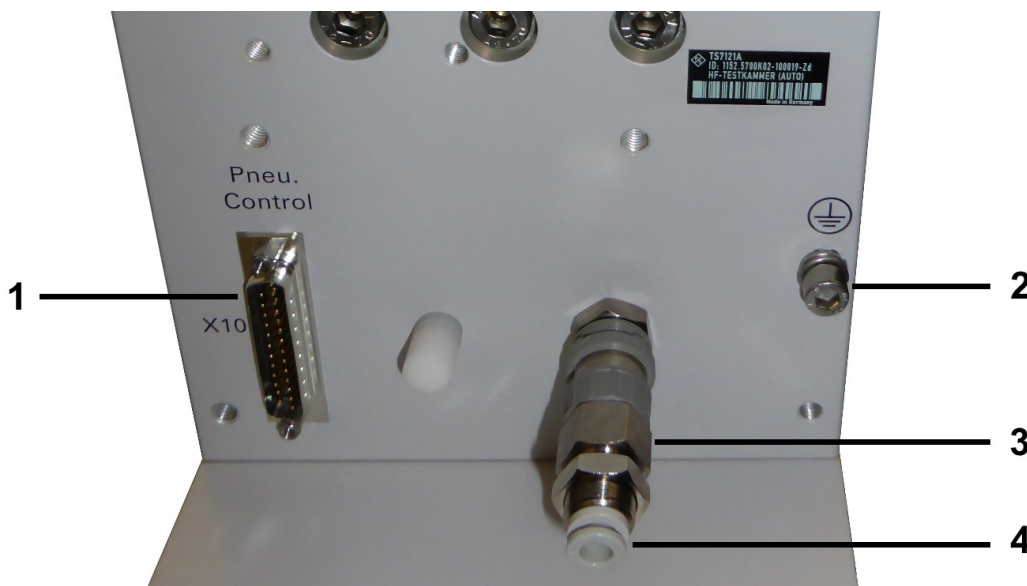

Figure 5-1: Lower rear panel of the R&S TS7121A

- 1 = 25-pin D-Sub connector (X10) for power supply, pneumatic control and sensor reading
- 2 = Grounding contact
- 3 = Air pressure connector for pneumatic supply with 6 mm plastic tubing
- 4 = Movable ring for releasing the pressure tube

To **connect** the R&S TS7121A to a compressed air supply, proceed as follows:

1. Ground the chamber using the electrical grounding connection on the rear side (2 in [Figure 5-1](#)).
2. Switch off the compressed air supply.
3. Insert the 6 mm tube of the compressed air supply into the chamber's air pressure connector (3 in [Figure 5-1](#)), as shown in the left-hand side (1) of [Figure 5-2](#).
4. Switch on the compressed air supply. (If you have multiple chambers, switch on the compressed air supply after you have connected all chambers.)
5. Make sure to provide an air pressure of 6 bar. Do not exceed the maximum input pressure of 8 bar.

To **disconnect** the R&S TS7121A from the compressed air supply, proceed as follows:

1. Switch off the compressed air supply.
2. Push the gray plastic ring (4 in [Figure 5-1](#)) at the end of the connector towards the chamber, away from the tube, as shown in the right-hand side (2) of [Figure 5-2](#). (That figure shows a similar connector with a blue instead of a gray ring.)
3. While keeping the gray ring pushed in, gently pull the 6 mm tube out of the connector.
4. By some means, which is not within the scope of this description, make sure to close the open pressure tube, before you switch on the compressed air supply.

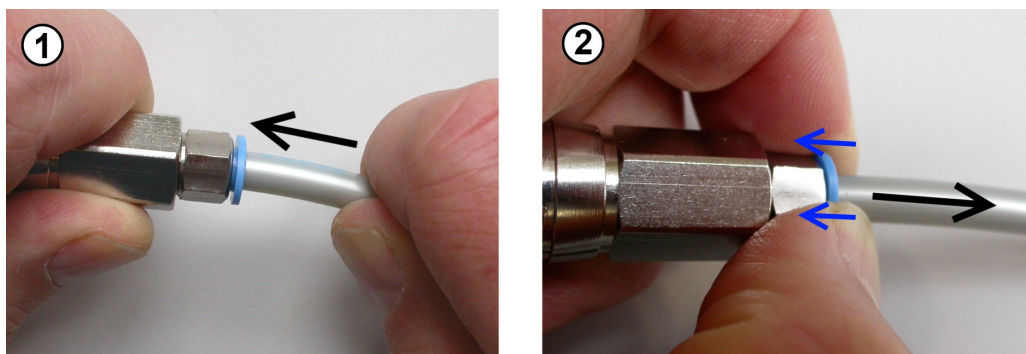

Figure 5-2: Assembly and disassembly of the air pressure connector (left in both pictures) and a 6 mm tube (right in both pictures)

- 1 = To insert the 6 mm tube into the connector, push the tube all the way in. For best results, we recommend a straight cut rather than an angled cut end of the tube.
- 2 = To disconnect the 6 mm tube from the connector, first switch off the compressed air supply. Then gently pull the tube out of the adapter while firmly pushing in the blue (or gray) ring in the opposite direction, as indicated by the blue arrows.

5.3 Adjustments of the R&S TS7121A

On the right-hand side of the R&S TS7121A (automatic version), there are two control screws for adjusting the door speed (see [Figure 4-2](#)). These screws limit the pressure and hence control the flow rate of the compressed air.

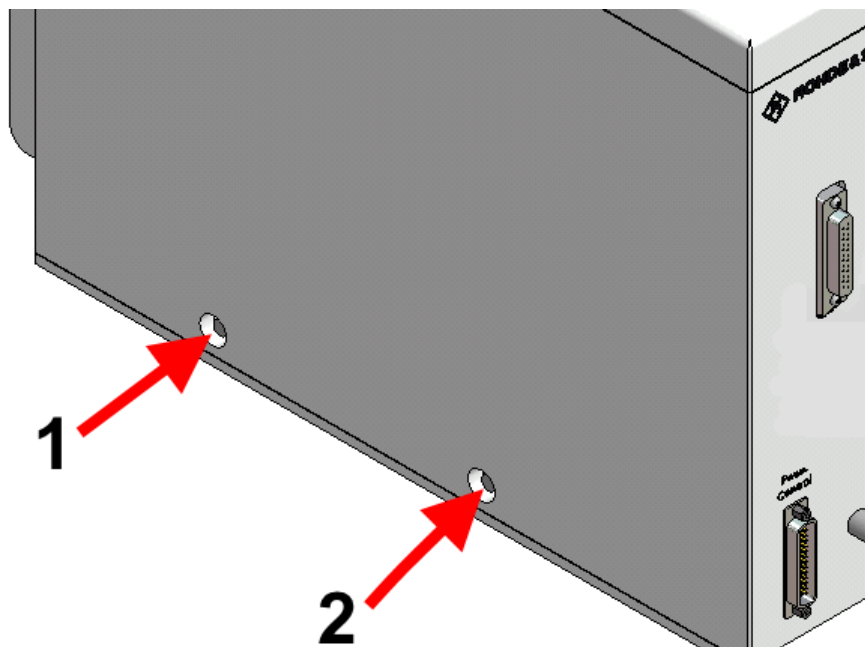

Figure 5-3: Side view of the Shielded RF Test Box

- 1 = Speed adjustment screw for the door closing movement
- 2 = Speed adjustment screw for the door opening movement

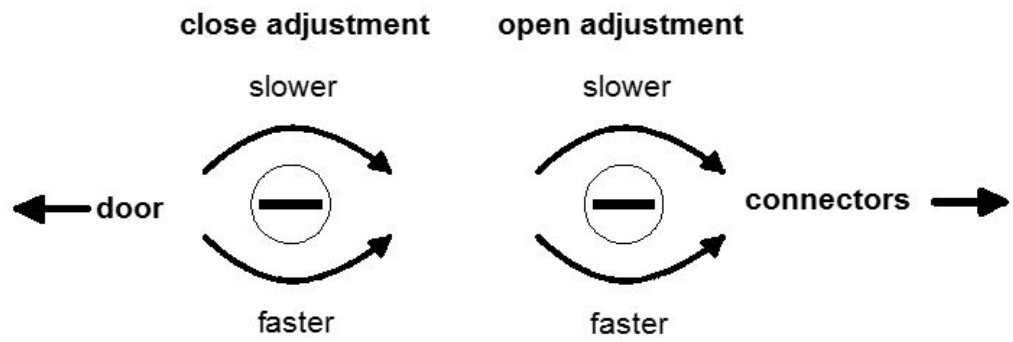

Figure 5-4: Speed adjustment screw for the pneumatic door operation



Do not exceed the maximum input air pressure of 8 bar.

6 Maintenance

- Important User Instructions..... 28
- General..... 28
- Maintenance Intervals..... 29
- Greasing Moving Parts of the Handle..... 30
- Cleaning the Shielded RF Test Box..... 30

6.1 Important User Instructions

WARNING

Risk of injury due to an operative system



Make sure that the test system is switched off before you perform maintenance tasks. Service and inspection tasks must be performed by trained personnel, only.

When work is carried out on the Shielded RF Test Box, the surrounding area must be protected by appropriate measures. These measures typically include:

- Erecting barriers
- Putting up warning signs
- Other similar measures

6.2 General

To retain the functional readiness and long lifetime of the Shielded RF Test Box, maintenance and inspection tasks must be performed carefully at the intervals specified.



To prevent damage to the environment, carefully dispose all waste and expendables produced during the use of the Shielded RF Test Box.

6.3 Maintenance Intervals

The following table shows the various service, maintenance and inspection tasks that are to be carried out in the stated intervals on the Shielded RF Test Box. The intervals are valid for a single work shift corresponding to about 160 hours per month. Calibration of test instruments must be carried out by a certified laboratory (for example Rohde & Schwarz [calibration service](#)).

Table 6-1: Scheduled maintenance

Maintenance interval	Maintenance tasks
Daily	Complete Shielded RF Test Box <ul style="list-style-type: none"> Check the Shielded RF Test Box for damage and proper function Check the handle for proper function (manual version) Check the door's gasket for soiling, damage and wear
Weekly	Cables, connectors and absorber checking <ul style="list-style-type: none"> Check connecting cables and connectors for damage and correct cable connections Check the absorber material on the inside of the door and around the chamber's door opening for damage or wear
Weekly	Safety precautions <ul style="list-style-type: none"> Check the safety precautions described in Chapter 2, "Specific Safety Instructions", on page 7
Depending on amount of soiling	Complete Shielded RF Test Box <ul style="list-style-type: none"> Clean the R&S TS7121, if it is soiled
Half year or 10 000 cycles	Grease moving parts of the handle
Every 100 000 cycles ¹⁾	Gasket <ul style="list-style-type: none"> Change of the door gasket is required every 100 000 cycles or at least every 6 months. This exchange ensures a continuous quality of the RF attenuation Contact the Rohde & Schwarz service.
1 year	Test instruments <ul style="list-style-type: none"> A calibration of the test instruments is required every year Contact the Rohde & Schwarz calibration service

¹⁾The attainable shielding effectiveness of the RF gaskets depends on how long the gaskets remain in a relaxed state. The door gaskets were tested in a 2:1 time ratio of opened versus closed state. A longer period of relaxation results in even higher shielding effectiveness than specified or a longer life. This improvement can be achieved, for example, by leaving the door open between production periods. With reverse ratios, maintenance is necessary at shorter intervals.

6.4 Greasing Moving Parts of the Handle



Figure 6-1: Additional points for greasing (manual version)



Do not remove the screws of the handles (2), they are attached with glue.

6.5 Cleaning the Shielded RF Test Box

6.5.1 Cleaning the Chamber

NOTICE

Risk of damaging electrical or mechanical parts



Do not apply liquid cleaning agents such as contact spray to electrical interfaces.

You can clean all areas inside the Shielded RF Test Box by using a vacuum cleaner.

6.5.2 Cleaning the Gasket Contact Area

For a constant level of high radiation shielding efficiency, the gasket must be cleaned.

The following equipment and materials are recommended for cleaning:

- Soft, lint-free cleaning cloth
- Soft brush
- Alcohol

The following cleaning steps must be performed.

1. Carefully use the soft brush in a dry condition to pre-clean the gasket.
2. Clean the chromated aluminum contact area of the gasket using soft, lint-free cleaning cloths and alcohol.

7 Spare Parts Lists R&S TS7121

Fig.	Quantity	Unit	Description	Order number
--	1.0	Piece	Air supply connector bushing	1504.3505.00
--	1.0	Piece	Air supply connector plug	1504.3511.00
--	1.0	Piece	125 grams absorber glue	0016.8741.00
1	1.0	Piece	Absorber set	1504.3728.00
4	2.0	Piece	Clamping fixture	1504.3370.00
5	4.0	Piece	N-connector N-male/SMA-male	0614.5111.00
6	4.0	Piece	Gasket f. N connector	1504.3305.00
7a	1.0	Piece	25-pin D-Sub filter connector 3 MHz cut-off	1504.3711.00
7b	1.0	Piece	9-pin D-Sub filter connector 3 MHz cut-off	1506.6247.00
8a	1.0	Piece	Gender changer 25-pin. male/female	1504.3270.00
8b	1.0	Piece	Gender changer 9-pin. male/female	1506.6253.00
9a	1.0	Piece	Exchangeable connector plate	1507.0388.00
9b	1.0	Piece	Gasket f. exchangeable connector plate	1507.0407.00
10	2.0	Piece	DUT holder centering	1504.3157.00
11	1.0	Piece	Support plate (door) for DUT holder plate	1504.3070.00
12	1.0	Piece	Rear plate	1504.3092.00
13	2.0	Piece	Centering during door closing	1504.3086.00
14	2.0	Piece	One-way restrictor	1504.3492.00
16	1.0	Piece	Pneumatic cylinder	1519.1761.00
17	1.0	Piece	Sound absorber 1/8	1504.3528.00
18	1.2	Meter	Pneumatic line I4/A6	1504.3611.00
19	1.0	Piece	Magnetic valve	1504.3486.00
20	2.0	Piece	Sound absorber M5	1504.3534.00
21	4.0	Piece	Pneumatic plug connection / wound	1504.3605.00
22	1.0	Piece	Wiring cable for pneumatic valve	1504.3992.00
24	2.0	Piece	Pneumatic sensor	1519.1910.00
25	1.0	Piece	Pneumatic plug connection / straight	1504.3563.00
26	2.0	Piece	Axle ø25	1504.3063.00
27	1.0	Piece	Gasket 4X8X600 (door)	1504.3840.00
28	4.0	Piece	Linear roller bearing / self-regulating	1504.3463.00

Fig.	Quantity	Unit	Description	Order number
29	1.0	Piece	Gasket 5X5X1100 (cap)	1504.3857.00
30	1.0	Piece	Washer	1504.3034.00
31	1.0	Piece	O-Ring 30x2	1506.6299.00
32	1.0	Piece	Bolt (door) for handle	1504.3934.00
33a	1.0	Piece	Left part of handle	1504.3886.00
33b	1.0	Piece	Right part of handle	1504.3870.00

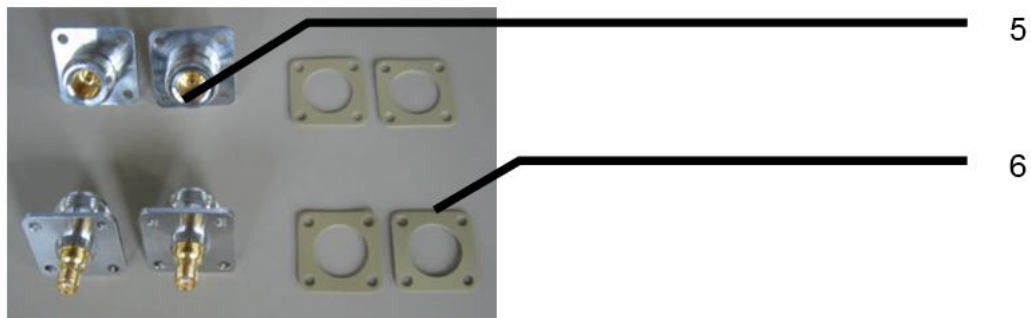
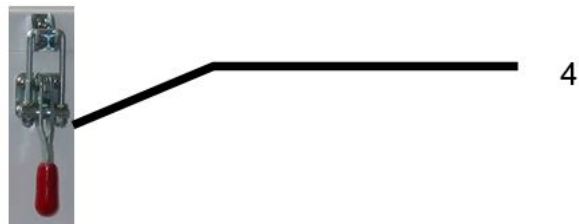
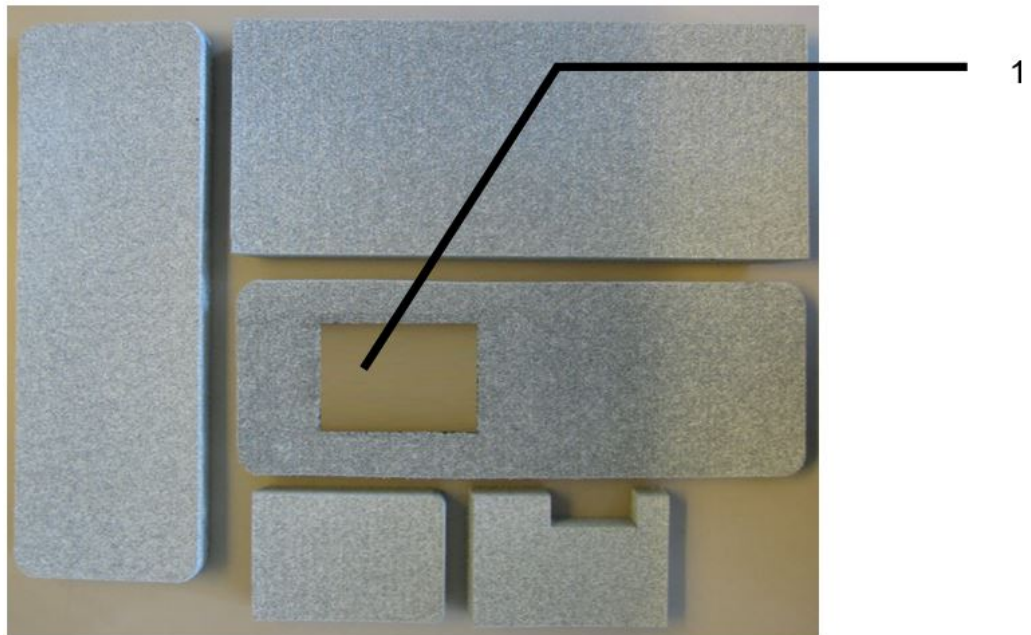

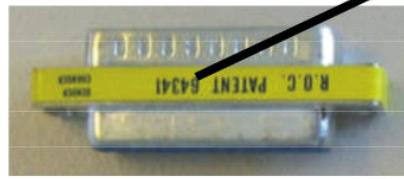

7a

7b

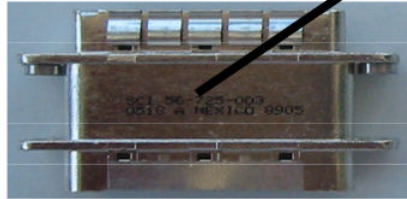

8a

8b

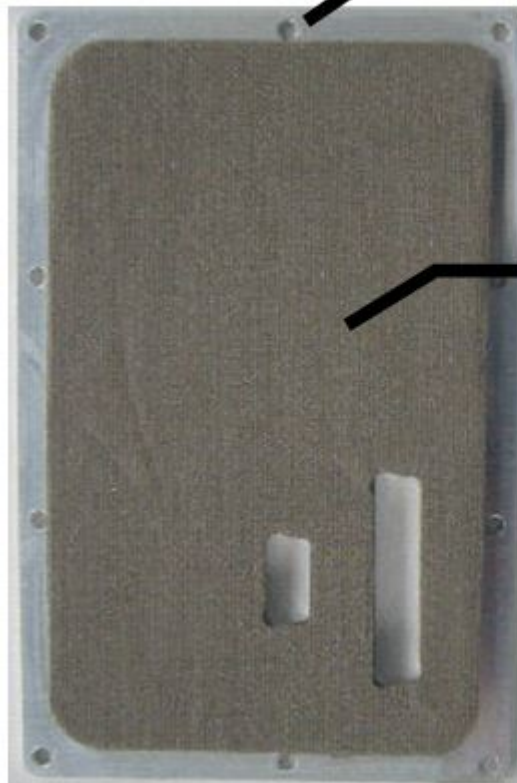

9a

9b

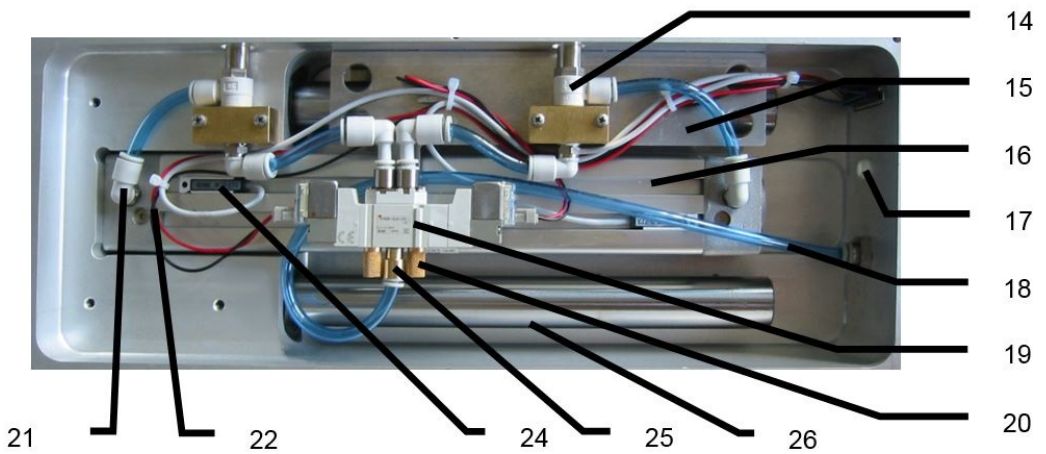
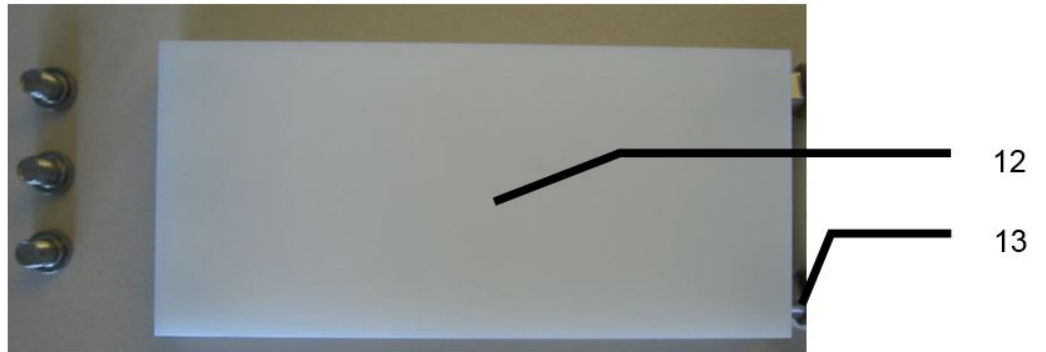
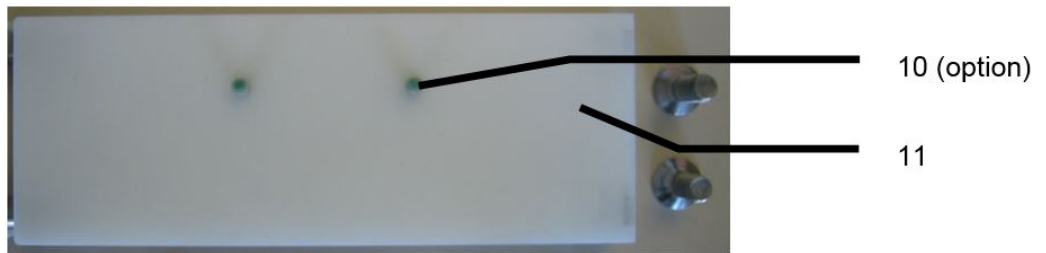



27

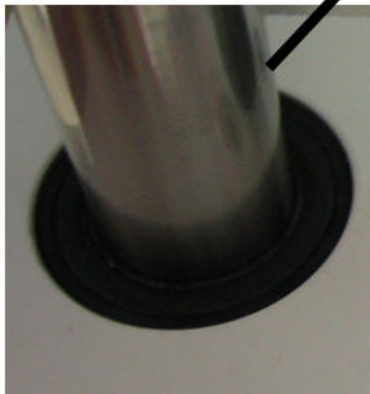

28



29

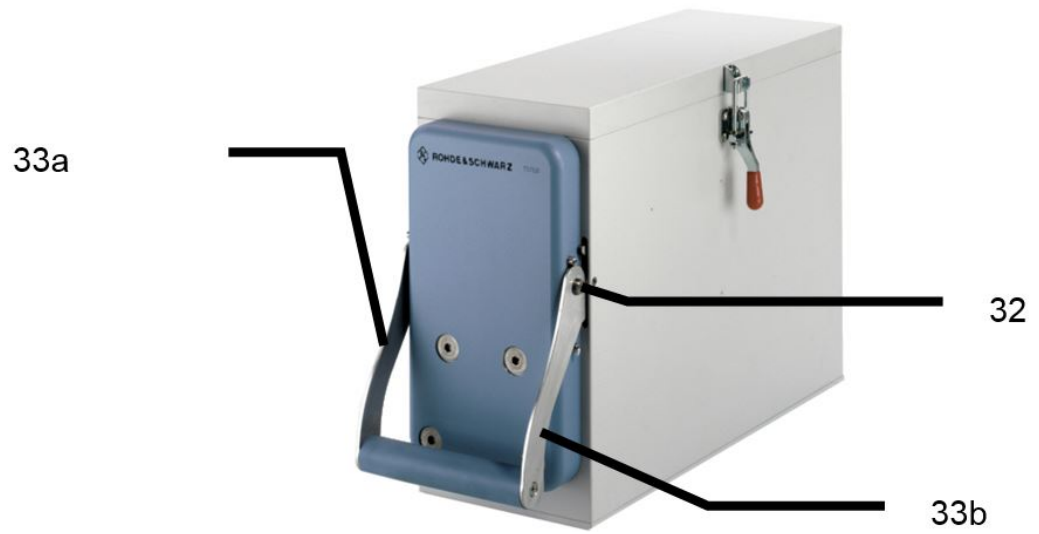
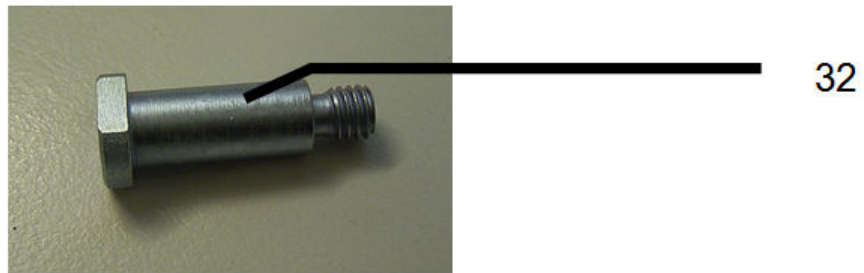
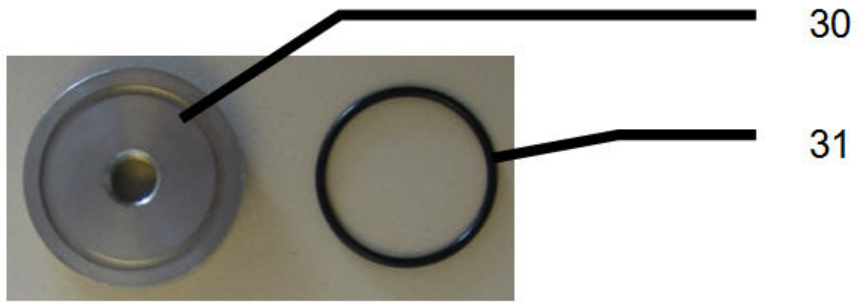

Glossary: List of Frequently Used Terms and Abbreviations

B

Bluetooth: A wireless mobile technology standard for radio communication over short distances of up to 60 m, using RF frequencies from 2.4 to 2.485 GHz

D

D-Sub: Electrical D-subminiature connector, surrounded by a D-shaped metal support

DUT: Device under test

E

ESD: Electrostatic discharge

G

Gasket: A mechanical seal

P

PDA: Personal digital assistant

R

Radio key: Car key with remote control features

RF: Radio frequency, electromagnetic oscillation in the frequency range of around 3 kHz to 300 GHz

S

SMA connector: SubMiniature coaxial RF connector, version A (standard)

U

USB: Universal Serial Bus, industrial connector standard

V

VSWR: Voltage standing wave ratio, ratio of the maximum standing wave amplitude over the minimum standing wave amplitude

W

Wi-Fi: A wireless internet connectivity technology for electronic devices (synonymical with WLAN)

WLAN: Wireless local area network (synonymical with Wi-Fi)

Index

C

CD-ROM	5
Cleaning	30

D

D-Sub control connector (25 pin)	18
D-Sub feedthrough (25 and 9 pin)	21
Danger zone	11

E

ESD	24
-----------	----

F

Feedthrough for USB, R&S TS-F21FU2	21
Feedthrough, D-Sub (25 and 9 pin)	21

H

Hazards	
Door	12, 13
Pneumatics	12, 13
Remote operation	12
Weight	12

M

Maintenance intervals	29
Malfunction	12

O

Operators	
Authorization	9
Instruction	9

P

Pneumatic adjustment	26
----------------------------	----

R

R&S TS 7180	16
R&S TS 7810	16
R&S TS7121A	
automatic opening and closing	14
R&S TS7121M	
manual opening and closing	14
Risks	7, 8, 10, 12, 13

S

Safety	
Door	12, 13
Hazards	10, 12
Instruction	9, 12
Pneumatics	13
Regulations	7
Setup	10
Symbols	8
Spare parts	32

U

USB feedthrough, R&S TS-F21FU2	21
--------------------------------------	----