

R&S® PowerTSVP

Industrial High-Power and Switching Application Chassis

User Manual



1157814312
Version 19

ROHDE & SCHWARZ
Make ideas real



This manual describes the following R&S®PowerTSVP models:

- R&S®PowerTSVP 1157.8043.02

© 2022 Rohde & Schwarz GmbH & Co. KG
Muehldorfstr. 15, 81671 Muenchen, Germany
Phone: +49 89 41 29 - 0
Email: info@rohde-schwarz.com
Internet: www.rohde-schwarz.com

Subject to change – data without tolerance limits is not binding.
R&S® is a registered trademark of Rohde & Schwarz GmbH & Co. KG.
All other trademarks are the properties of their respective owners.

1157.8143.12 | Version 19 | R&S®PowerTSVP

Throughout this manual, products from Rohde & Schwarz are indicated without the ® symbol , e.g. R&S®PowerTSVP is indicated as R&S PowerTSVP.

Contents

1	Safety and regulatory information.....	9
1.1	Safety instructions.....	9
1.2	Labels on the product.....	12
1.3	Warning messages in the documentation.....	12
1.4	Where to find key documents on Rohde & Schwarz.....	13
1.5	Korea certification class A.....	13
2	Documentation overview.....	14
2.1	Getting started manual.....	14
2.2	User manuals.....	14
2.3	System manual.....	15
2.4	Service manual.....	15
2.5	Printed safety instructions.....	15
2.6	Brochures and specifications.....	15
2.7	Release notes and open source acknowledgment.....	15
3	Getting Started.....	16
3.1	Product overview.....	16
3.1.1	Production test platforms.....	16
3.1.1.1	R&S CompactTSVP.....	16
3.1.1.2	R&S PowerTSVP.....	17
3.1.2	Software components.....	17
3.1.3	Plug-in test modules.....	18
3.1.4	In-system calibration.....	18
3.2	Preparing for use.....	19
3.2.1	Lifting and carrying.....	19
3.2.2	Unpacking and checking.....	19
3.2.3	Choosing the operating site.....	19
3.2.4	Setting up the product.....	20
3.2.4.1	Placing the product on a bench top.....	20
3.2.4.2	Mounting the product in a rack.....	21
3.2.5	Designing the plug-in module configuration.....	23
3.2.5.1	Compatibility.....	23

3.2.5.2	R&S CompactTSVP configuration.....	23
3.2.5.3	R&S PowerTSVP configuration.....	29
3.2.5.4	Considerations for module installation.....	33
3.2.6	Installing the shielding kit (R&S TS-PSK1).....	33
3.2.7	Installing and uninstalling plug-in modules.....	36
3.2.8	Connecting an R&S CompactTSVP and an R&S PowerTSVP.....	38
3.2.9	Connecting the R&S CompactTSVP to a control PC.....	39
3.2.10	Connecting the R&S PowerTSVP to a control PC.....	41
3.2.11	Considerations for test setup.....	42
3.2.12	Connecting to power.....	43
3.2.13	Switching on or off.....	43
3.2.14	Operating the R&S PowerTSVP.....	44
3.3	Instrument tour.....	45
3.3.1	Front panel view.....	45
3.3.2	Rear panel view.....	46
3.3.2.1	AC power supply (1).....	47
3.3.2.2	Power switch (2).....	47
3.3.2.3	Analog bus connector X2 (4).....	47
3.3.2.4	Signal output connectors X3, X4 (5, 6).....	47
3.3.2.5	Signal output connector X30 for system module R&S TS-PSYS (7).....	48
3.4	R&S GTSL download from GLORIS.....	48
3.4.1	Registering for GLORIS and the R&S TSVP software.....	48
3.4.2	Download area.....	49
3.4.3	Required version.....	51
3.4.4	Installation package contents.....	51
4	Mechanical layout.....	53
4.1	Plug-in modules.....	53
4.1.1	Supported module types.....	53
4.1.2	Slot layout.....	54
4.2	Backplanes.....	55
4.2.1	Control Backplane.....	55
4.2.2	Analog bus backplane.....	57
4.2.3	Power backplane (option).....	59

4.2.4	Backplane extension R&S TS-PXB2 (option).....	59
4.3	Cabling.....	60
4.3.1	Concept.....	60
4.3.2	Analog bus.....	61
4.3.3	PXI trigger bus.....	62
4.3.4	External cabling.....	62
4.4	Ground concept.....	62
4.5	Geographical addressing of the slots.....	63
4.6	CAN bus.....	64
4.7	Configurations with several frames or option R&S TS-PXB2.....	65
4.8	Switching the PSU.....	66
4.9	Cooling.....	66
4.10	Option R&S TS-PK04P.....	67
4.11	System module R&S TS-PSYS2.....	67
4.11.1	General.....	67
4.11.2	Characteristics.....	68
4.11.3	Circuit diagram of the R&S TS-PSYS2.....	68
4.11.4	Structure of the R&S TS-PSYS2.....	69
4.11.5	Functional description of the R&S TS-PSYS2.....	71
4.11.5.1	Control.....	71
4.11.5.2	System functions.....	71
4.11.5.3	System clock.....	73
4.11.5.4	Signal looping.....	73
4.11.5.5	Local signal outputs.....	73
4.11.5.6	User CAN controller.....	73
4.11.6	Driver software.....	74
4.11.7	Self-Test.....	74
5	Interface description.....	75
5.1	Control backplane.....	75
5.1.1	Position of interfaces.....	75
5.1.2	Connector p20 (slots 1 to 16).....	76
5.1.3	Connector X0 (P47).....	78
5.1.4	ATX connectors.....	79

5.1.5	Fan connectors X90, X91, X92, X93.....	80
5.1.6	Expansion connector X80.....	80
5.1.7	Jumper field.....	80
5.2	Analog bus backplane.....	81
5.2.1	Position of interfaces.....	81
5.2.2	Analog bus connectors X1 to X16.....	81
5.2.3	Analog bus connector X21.....	82
5.2.4	Analog bus connector X22.....	82
5.3	Power backplane (option).....	83
5.3.1	Position of interfaces.....	83
5.3.2	Power backplane utility connector X13.....	83
5.3.3	Power backplane ATX connector X12.....	84
5.3.4	Power backplane connector X16.....	84
5.3.5	Connector X1 (p47).....	84
5.4	Interfaces of the R&S TS-PSYS2.....	86
5.4.1	R&S TS-PSYS2 connector X20.....	86
5.4.2	R&S TS-PSYS2 connector X30.....	87
5.4.3	R&S TS-PSYS2 jumper field X40.....	88
5.4.4	R&S TS-PSYS2 jumper JP2.....	88
5.4.5	R&S TS-PSYS2 jumper JP6 and JP7.....	88
5.4.6	R&S TS-PSYS2 jumper JP8.....	88
5.5	External analog interface - Analog bus connector X2.....	89
5.6	Backplane extension R&S TS-PXB2 (option).....	89
5.6.1	Jumpers.....	89
5.6.2	Rear panel slot A4 / CAN.....	90
5.6.3	Rear panel slot A4 / DIO of slot A2.....	90
5.6.4	Rear panel X1 of slot A1.....	91
6	Transporting.....	93
7	Maintenance, storage and disposal.....	94
7.1	Self-test.....	94
7.2	Cleaning.....	94
7.3	Changing fuses.....	94
7.4	Storage.....	95

7.5 Disposal..... 95

8 Contacting customer support.....97

Glossary.....98

1 Safety and regulatory information

The product documentation helps you use the product safely and efficiently. Follow the instructions provided here and in the following chapters.

Intended use

The product is intended for development, production and verification of electronic components and devices in industrial, administrative, and laboratory environments. Use the product only for its designated purpose.

Observe the operating conditions and performance limits stated in the data sheet.

Target audience

This manual describes the tasks required to set up, operate or maintain an R&S PowerTSVP. It is written for electrically skilled persons who have training or experience in the use of electronic equipment. Skilled persons are expected to use their training and experience to recognize energy sources capable of causing pain or injury and to protect themselves from injury from those sources.

Where do I find safety information?

Safety information is part of the product documentation. It warns you of potential dangers and gives instructions on how to prevent personal injury or damage caused by dangerous situations. Safety information is provided as follows:

- In [Chapter 1.1, "Safety instructions"](#), on page 9. The same information is provided in many languages as printed "Safety Instructions". The printed "Safety Instructions" are delivered with the product.
- Throughout the documentation, safety instructions are provided when you need to take care during setup or operation.

1.1 Safety instructions

Products from the Rohde & Schwarz group of companies are manufactured according to the highest technical standards. To use the products safely, follow the instructions provided here and in the product documentation. Keep the product documentation nearby and offer it to other users.

Use the product only for its intended use and within its performance limits. Intended use and limits are described in the product documentation such as the data sheet, manuals and the printed "Safety Instructions". If you are unsure about the appropriate use, contact Rohde & Schwarz customer service.

Using the product requires specialists or specially trained personnel. These users also need sound knowledge of at least one of the languages in which the user interfaces and the product documentation are available.

Reconfigure or adjust the product only as described in the product documentation or the data sheet. Any other modifications can affect safety and are not permitted.

Never open the casing of the product. Only service personnel authorized by Rohde & Schwarz are allowed to repair the product. If any part of the product is damaged or broken, stop using the product. Contact Rohde & Schwarz customer service at <https://www.rohde-schwarz.com/support>.

Lifting and carrying the product

The product is heavy. Do not move or carry the product by yourself. A single person can only carry a maximum of 18 kg safely depending on age, gender and physical condition. Look up the maximum weight in the data sheet. Use the product handles to move or carry the product. Do not lift by the accessories mounted on the product. Accessories are not designed to carry the weight of the product.

To move the product safely, you can use lifting or transporting equipment such as lift trucks and forklifts. Follow the instructions provided by the equipment manufacturer.

Choosing the operating site

Only use the product indoors. The product casing is not waterproof. Water that enters can electrically connect the casing with live parts, which can lead to electric shock, serious personal injury or death if you touch the casing. If Rohde & Schwarz provides accessories designed for your product, e.g. a carrying bag, you can use the product outdoors.

Unless otherwise specified, you can operate the product up to an altitude of 2000 m above sea level. The product is suitable for pollution degree 2 environments where nonconductive contamination can occur. For more information on environmental conditions such as ambient temperature and humidity, see the data sheet.

Setting up the product

Always place the product on a stable, flat and level surface with the bottom of the product facing down. If the product is designed for different positions, secure the product so that it cannot fall over.

If the product has foldable feet, always fold the feet completely in or out to ensure stability. The feet can collapse if they are not folded out completely or if the product is moved without lifting it. The foldable feet are designed to carry the weight of the product, but not an extra load.

If stacking is possible, keep in mind that a stack of products can fall over and cause injury.

If you mount products in a rack, ensure that the rack has sufficient load capacity and stability. Observe the specifications of the rack manufacturer. Always install the products from the bottom shelf to the top shelf so that the rack stands securely. Secure the product so that it cannot fall off the rack.

Connecting to power

The product is an overvoltage category II product. Connect the product to a fixed installation used to supply energy-consuming equipment such as household appliances and similar loads. Keep in mind that electrically powered products have risks, such

as electric shock, fire, personal injury or even death. Replace parts that are relevant to safety only by original parts, e.g. power cables or fuses.

Take the following measures for your safety:

- Before switching on the product, ensure that the voltage and frequency indicated on the product match the available power source. If the power adapter does not adjust automatically, set the correct value and check the rating of the fuse.
- If a product has an exchangeable fuse, its type and characteristics are indicated next to the fuse holder. Before changing the fuse, switch off the product and disconnect it from the power source. How to change the fuse is described in the product documentation.
- Only use the power cable delivered with the product. It complies with country-specific safety requirements. Only insert the plug into an outlet with protective conductor terminal.
- Only use intact cables and route them carefully so that they cannot be damaged. Check the power cables regularly to ensure that they are undamaged. Also ensure that nobody can trip over loose cables.
- If you connect the product to an external power supply, use the one delivered with the product or recommended in the product documentation. The external power supply must conform to the country-specific regulations.
- Only connect the product to a power source with a fuse protection of maximum 20 A.
- Ensure that you can disconnect the product from the power source at any time. Pull the power plug to disconnect the product. The power plug must be easily accessible. If the product is integrated into a system that does not meet these requirements, provide an easily accessible circuit breaker at the system level.

Working with hazardous voltages

Voltages higher than 30 V RMS, or 42 V peak, or 60 V DC are regarded as hazardous contact voltages. Direct contact with them can cause serious injuries.

Make sure that only electrically skilled persons use the products for measurements on hazardous contact voltages. These working conditions require special education and experience to perceive risks and to avoid hazards which electricity can create.

When working with hazardous contact voltages, use protective measures to preclude direct contact with the measurement setup:





- Do not touch exposed connections and components when power is applied.
- Switch off the test circuit while connecting and disconnecting probe leads.
- Use only insulated voltage probes, test leads and adapters.
- Do not use 4 mm banana plugs without protection against contact.

Cleaning the product

Use a dry, lint-free cloth to clean the product. When cleaning, keep in mind that the casing is not waterproof. Do not use liquid cleaning agents.

Meaning of safety labels

Safety labels on the product warn against potential hazards.



	<p>Potential hazard</p> <p>Read the product documentation to avoid personal injury or product damage.</p>
	<p>Heavy product</p> <p>Be careful when lifting, moving or carrying the product. Carrying the product requires a sufficient number of persons or transport equipment.</p>
	<p>Electrical hazard</p> <p>Indicates live parts. Risk of electric shock, fire, personal injury or even death.</p>
	<p>Hot surface</p> <p>Do not touch. Risk of skin burns. Risk of fire.</p>
	<p>Protective conductor terminal</p> <p>Connect this terminal to a grounded external conductor or to protective ground. This connection protects you against electric shock if an electric problem occurs.</p>

1.2 Labels on the product

Labels on the casing inform about:

- Personal safety, see "[Meaning of safety labels](#)" on page 12
- Product and environment safety, see [Table 1-1](#)
- Device information is provided on a sticker attached to the rear panel of the instrument. The sticker contains a barcode and the device ID. The device ID is a combination of the order number, the serial number and a checksum.

Table 1-1: Labels regarding product and environment safety

	<p>Labeling in line with EN 50419 for disposal of electrical and electronic equipment after the product has come to the end of its service life.</p> <p>For more information, see "Disposing electrical and electronic equipment" on page 96.</p>
	<p>Take care when handling electrostatic sensitive devices.</p>

1.3 Warning messages in the documentation

A warning message points out a risk or danger that you need to be aware of. The signal word indicates the severity of the safety hazard and how likely it will occur if you do not follow the safety precautions.

WARNING

Potentially hazardous situation. Could result in death or serious injury if not avoided.

NOTICE

Potential risks of damage. Could result in damage to the supported product or to other property.

1.4 Where to find key documents on Rohde & Schwarz

Certificates issued to Rohde & Schwarz that are relevant for your country are provided at www.rohde-schwarz.com/key-documents, e.g. concerning:

- Quality management
- Environmental management
- Information security management
- Accreditations

1.5 Korea certification class A



이 기기는 업무용(A급) 전자파 적합기기로서 판매자 또는 사용자는 이 점을 주의하시기 바라며, 가정외의 지역에서 사용하는 것을 목적으로 합니다.

2 Documentation overview

This section provides an overview of the R&S TSVP (test system versatile platform) user documentation.

All documents are delivered with the Generic Test Software Library ("R&S GTSL") installation package. After installing the software, you can open all the documentation from the Windows "Start" menu. Additionally, you can find detailed information about the software interfaces in the "R&S GTSL Help" folder in the Windows "Start" menu.

The user documentation and "R&S GTSL" installation package are also available for download in GLORIS at:

<https://gloris.rohde-schwarz.com/>

For details, see the R&S TSVP Getting Started manual.

2.1 Getting started manual

Introduces the R&S TSVP (test system versatile platform) and describes how to set up and start working with the product. It includes safety information.

A printed version is delivered with the instrument.

2.2 User manuals

Separate manuals are provided for the base units, the individual plug-in module types, as well as for the control software and the calibration tool:

- Base unit manual
The base unit user manuals introduce the base units and describes how to set up and operate the product. It includes safety information and information on maintenance and instrument interfaces. It includes the contents of the getting started manual.
- Plug-in module manuals
Contain the description of the specific modules. Basic information on setting up the R&S TSVP (test system versatile platform) is not included.
- In-System calibration user manuals
Provide all the information required for installation and operation of the in-system calibration R&S TS-ISC solution.
- Control software
 - R&S GTSL
Generic Test Software Library
 - R&S EGTSL
Enhanced Generic Test Software Library
 - R&S IC-Check

Generic Test Software Library

2.3 System manual

Describes the complete R&S TSVP (test system versatile platform) as a whole, including the combined use of R&S CompactTSVP and R&S PowerTSVP, plug-in modules and generic test software. It also includes typical use cases.

Additionally, it describes known installation problems (hardware and software) along with possible solutions.

2.4 Service manual

Describes the self-test to check correct operation, troubleshooting and fault elimination, and contains mechanical drawings and spare part lists.

2.5 Printed safety instructions

Provides safety information in many languages. The printed document is delivered with the product.

2.6 Brochures and specifications

Separate brochures are provided for the base unit, the individual plug-in module types, as well as for the control software. The brochures provide an overview of the base units and each additional module, and also contain the technical specifications. They also list the hardware options and their order numbers, and optional accessories.

2.7 Release notes and open source acknowledgment

The release notes list new features, improvements and known issues of the current software version. In addition, the available firmware versions and the firmware update procedure for plug-in modules are described.

The open-source acknowledgment document provides verbatim license texts of the used open source software.

3 Getting Started

3.1 Product overview

3.1.1 Production test platforms

The Test System Versatile Platform R&S TSVP is a standardized modular platform for program-controlled testing of modules and terminals in a factory or laboratory. With its flexible configuration and the use of worldwide standards, it can be perfectly adapted to suit your needs. You can create larger ATE (Automatic Test Equipment) systems by combining R&S CompactTSVP and R&S PowerTSVP.

3.1.1.1 R&S CompactTSVP

The R&S CompactTSVP production test platform is intended for use with a control processor, which performs the test on the unit under test (UUT) using peripheral modules. This control processor is referred to as the system controller and is usually installed in the R&S CompactTSVP. However, you can also use a standard PC connected to the R&S CompactTSVP by a suitable interface. The system controller executes custom sequences that define the test procedures and specification limits.

The functionality of the R&S CompactTSVP depends essentially on the installed plug-in modules and the related software. The R&S CompactTSVP is suitable for all types of production tests.

The modules plugged into the R&S CompactTSVP can be used to create test and control signals for the UUT, and to measure and evaluate the response from the UUT. Thus, they are able to pass signals between each other, to select signals under program control, and pass them to external measuring systems.

The peripheral modules can be quickly and flexibly adapted to the test devices using an adapter frame mounted to the R&S CompactTSVP. The adapter frame connects the signals securely and with a low rate of wear.

If the production test requires switching functions with many channels or switching high currents, then the R&S CompactTSVP can be supplemented by a R&S PowerTSVP. The R&S PowerTSVP is controlled via the CAN bus of the R&S CompactTSVP by the system controller.

System characteristics

The use of standard industrial PCs as system controllers makes it possible to run a wide range of software packages, including:

- **Operating system:** Microsoft Windows
- **Test software:** LabWindows/CVI(™), Visual Studio®, TestStand(™)
- **Card drivers:** Drivers based on VISA/IVI

Key features

- Modular instrument chassis for CompactPCI and PXI modules
- CompactPCI backplane conforming to PICMG 2.0 Rev. 3.0 specification
- Rear I/O support for easy system cabling (IEEE 1101.11-1998)
- Sophisticated analog measurement bus subsystem
- Support of PXI trigger concept
- 14 peripheral slots for versatile instrumentation
- Mass interconnect interface in different sizes (optional)
- High pin count switching expansion by cascading an R&S PowerTSVP chassis

3.1.1.2 R&S PowerTSVP

The R&S PowerTSVP is primarily intended as a flexible switching unit for measurement signals, signal sources and UUT loads. Thus, you can easily migrate existing and proprietary "rack and stack" systems to a production test platform.

By combining R&S CompactTSVP and R&S PowerTSVP, you can create larger ATE (Automatic Test Equipment) systems with many test pins. All modules in the R&S PowerTSVP are controlled by a serial bus system (CAN bus). If the R&S PowerTSVP is connected to a R&S CompactTSVP, the modules are controlled by the system controller of the R&S CompactTSVP. Otherwise, the R&S PowerTSVP is connected to an external PC with a CAN bus controller installed.

The R&S PowerTSVP can be fitted with special Rohde & Schwarz switching and load modules. The unit provides an analog bus that can be used to make complex connections.

Key features

- Modular switching instrument chassis
- Chassis extension for R&S@CompactTSVP
- Standard 19" rackmount 4 HU enclosure
- 16 peripheral slots for switching instrumentation and dedicated further instrumentation
- Rear I/O support for easy system cabling (IEEE 1101.11-1998)
- Sophisticated analog measurement bus subsystem
- Support of system-wide trigger concept
- Easily expandable ATE instrumentation and switching
- High pin count switching applications, e.g. for in-circuit test (ICT)
- High-power switching

3.1.2 Software components

The R&S PowerTSVP is controlled entirely by the additionally installed software.

For details on the software and its operation, see the specific user manuals provided with the installation. For information on installing the software, see [Chapter 3.4, "R&S GTSL download from GLORIS"](#), on page 48.

R&S GTSL

The Generic Test Software Library R&S GTSL is a collection of libraries for specific test tasks like measurements, switching and signal generation. An ASCII file contains the relevant configuration data which can be assigned to certain test sequences. So measurement parameters can be changed and adjusted easily and quickly with a standard editor.

You can use any test sequencer software to control the test sequence. This software combines the individual test sequences to form an executable test program. It also adds all other functions important to the production operation, such as user administration, execution of multiple test sequences in multi-threading or parallel operation, collection and storage of relevant measurement results and report generation.

R&S EGTSL

The Enhanced Generic Test Software Library R&S EGTSL is part of an extension to the Generic Test Software Library R&S GTSL. Using R&S EGTSL, you can prepare and perform in-circuit tests.

R&S IC-Check

Using Generic Test Software Library R&S IC-Check you can prepare and perform tests on pins of ICs or other mounted electronic circuit devices.

3.1.3 Plug-in test modules

The functionality of the R&S PowerTSVP depends essentially on the installed plug-in modules and the related software. The R&S PowerTSVP is suitable for all types of production tests.

The modules plugged into the R&S CompactTSVP can be used to create test and control signals for the UUT, and to measure and evaluate the response from the UUT. Thus, they are able to pass signals between each other, to select signals under program control, and pass them to external measuring systems.

For details on the individual module types, see the module documentation.

3.1.4 In-system calibration

The R&S TSVP in-system calibration R&S TS-ISC enables the modules of the R&S CompactTSVP and R&S PowerTSVP production testing platforms to be calibrated in the system and readjusted if required. This means that it is no longer necessary to remove the modules.

For details on the in-system calibration tool, see the R&S TS-ISC user manual.

3.2 Preparing for use

Here, you can find basic information about setting up the product for the first time.

3.2.1 Lifting and carrying

You can carry the R&S PowerTSVP by its handles on the side. Do not apply excessive external force to the handles.

See "[Lifting and carrying the product](#)" on page 10.

3.2.2 Unpacking and checking

1. Unpack the product carefully.
2. Retain the original packing material. Use it when transporting or shipping the product later.
3. Using the delivery notes, check the equipment for completeness.
4. Check the equipment for damage.

If the delivery is incomplete or equipment is damaged, contact Rohde & Schwarz.

3.2.3 Choosing the operating site

Specific operating conditions ensure proper operation and avoid damage to the product and connected devices. For information on environmental conditions such as ambient temperature and humidity, see the data sheet.

See also "[Choosing the operating site](#)" on page 10.

Electromagnetic compatibility classes

The electromagnetic compatibility (EMC) class indicates where you can operate the product. The EMC class of the product is given in the data sheet.

- Class B equipment is suitable for use in:
 - Residential environments
 - Environments that are directly connected to a low-voltage supply network that supplies residential buildings
- Class A equipment is intended for use in industrial environments. It can cause radio disturbances in residential environments due to possible conducted and radiated disturbances. It is therefore not suitable for class B environments. If class A equipment causes radio disturbances, take appropriate measures to eliminate them.

3.2.4 Setting up the product

See also:

- "Setting up the product" on page 10
- "Intended use" on page 9

3.2.4.1 Placing the product on a bench top

To place the product on a bench top

1. Place the product on a stable, flat and level surface. Ensure that the surface can support the weight of the product. For information on the weight, see the data sheet.
2. **WARNING!** A stack of products can fall over and cause injury. Never stack more than two products. Otherwise, mount them in a rack.

Stack as follows:

- All products must have the same dimensions (width and length).
- Do not exceed a total load of 50 kg placed on the product at the bottom of the stack.

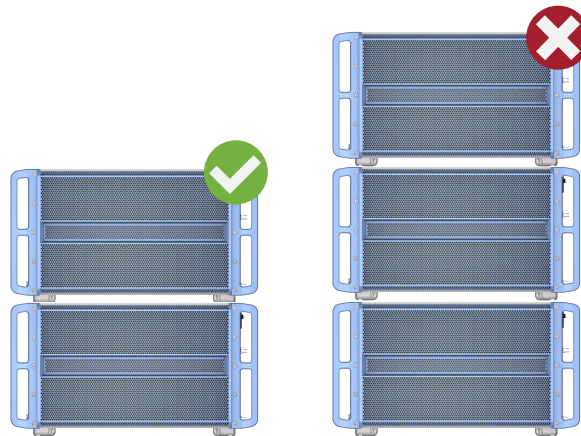

Left = Stacked correctly
Right = Stacked incorrectly, too many products

3. **NOTICE!** Overheating can damage the product.
To prevent overheating, leave a space of at least 22 mm (the height of the chassis feet) above and below each chassis.

Operating positions

The R&S PowerTSVP can be set up in the following positions:

- Horizontally, with the bottom of the device facing down.
- Upright, standing on the 4 feet on the rear panel.



In particular for the upright position, note the information in [Chapter 4.9, "Cooling"](#), on page 66.

If the instrument is mounted securely in an appropriate rack, it can also be operated in a tilted position.

3.2.4.2 Mounting the product in a rack

To prepare the rack

1. Observe the requirements and instructions in ["Setting up the product"](#) on page 10.
2. **NOTICE!** Insufficient airflow can cause overheating and damage the product.
Design and implement an efficient ventilation concept for the rack.

Ensure a minimum clearance of half a height unit above and below the R&S PowerTSVP for ventilation. You can use the space to fit filter mats in front of the ventilation perforations.

To mount the product in a rack

The handles remain on the casing when it is mounted in the rack.

1. Use an adapter kit to prepare the product for rack mounting.
 - a) Order the rack adapter kit designed for the product. For the order number, see the data sheet.
 - b) Unscrew the 4 feet from the bottom of the instrument casing [1].

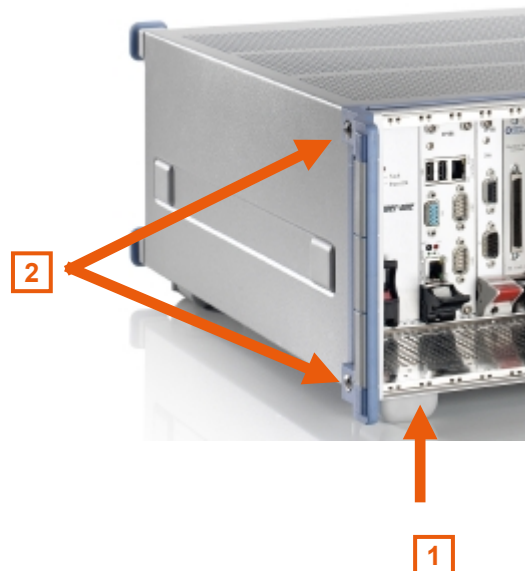

- c) Unscrew the side handles of the instrument, without removing the handles [2].
- d) Place the 19-inch brackets contained in the rack adapter kit over the side handles of the instrument.

- e) Replace the old handle screws with the longer screws from the rack adapter kit [3].

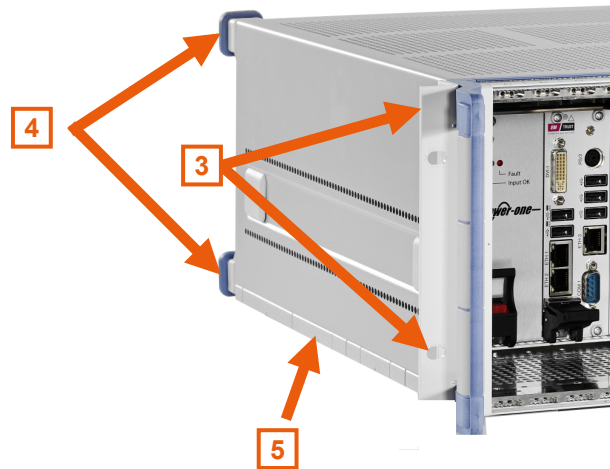

- f) Screw on the brackets and the handles.
 g) Remove the 4 rubber tips from the feet at the rear of the instrument [4].
 Do not unscrew the 4 feet on the rear panel to avoid loosening the body of the casing.
 h) Affix the self-adhesive plastic slide rails [5].

Note: Check the position of the locknuts in the rack before sliding in the R&S PowerTSVP.

2. **WARNING!** The product is heavy. Use lifting equipment, see also "[Lifting and carrying the product](#)" on page 10.
Lift the product to shelf height.
3. Place the unit in the rack on the prepared aluminum rails. Push it onto the shelf until the rack brackets fit closely to the rack.
4. Fix the R&S PowerTSVP by screwing the 19-inch side brackets to the rack.
5. Tighten all screws on the rack brackets with a tightening torque of 1.2 Nm to secure the product in the rack.
6. Optionally, insert and attach filter mats above and below the instrument.

To unmount the product from a rack

1. Loosen the screws at the rack brackets.
2. **WARNING!** The product is heavy. Use lifting equipment, see also "[Lifting and carrying the product](#)" on page 10.
Bring the lifting equipment to shelf height.
3. Remove the product from the rack.
4. If placing the product on a bench top again, unmount the adapter kit from the product in reverse sequence as in "[To mount the product in a rack](#)" on page 21.

Remember to re-attach the 4 feet at the bottom of the casing to ensure the minimum distance for ventilation.

3.2.5 Designing the plug-in module configuration

Although the test system platform is very versatile, not all modules can be installed in every slot of the instrument. There are some dependencies between components you need to consider in advance.

Before you start installing modules, design an installation concept of which modules to install in which slots.



The plug-in modules used in the R&S PowerTSVP are described in separate documents.

3.2.5.1 Compatibility

R&S PowerTSVP supports the following types of plug-in modules:

- 32-bit standard cPCI system controller in slot 1
- All 32-bit standard cPCI modules (without J2 connector)
- All 32-bit standard cPCI modules (with/without rear I/O and J2 connector) in slot 3 and 4
- All 32-bit PXI modules in slots 5 to 14. For slot 15, check the signal compatibility against the interface description, as only parts of the PXI concepts are supported. See [Chapter 5.1, "Control backplane"](#), on page 75.
- All Rohde & Schwarz specific cPCI modules in slots 5 to 15
- Rohde & Schwarz plug-in module only with J20 connectors in slots 3 to 16 (CAN module)

The star trigger and the local bus of the PXI specification are not supported.

3.2.5.2 R&S CompactTSVP configuration

Up to 13 cPCI/PXI modules can be fitted in the R&S CompactTSVP in addition to the system controller (slot 1). A further slot (slot 16) is provided for special Rohde & Schwarz plug-in modules (without J1 connector).

Slots A3 and A4 are fitted with a power supply by default.

An optional R&S TS-PCPA power pack or the optional R&S TS-PXB2 backplane extension are installed into slots A1 and A2 at the factory only, if ordered.

Slots 1 to 16 provide access to the analog bus. The CAN bus is available at slots 5 to 16 (starting with backplane version V4.x in slots 3 and 4 as well).

If an optional R&S TS-PXB2 is used, the CAN bus is also available at slots A1 and A2.

There is space for rear I/O modules in the rear section of the R&S PowerTSVP.

The case is suitable for plug-in boards with a height of 3 units.

Unused slots are covered by front subpanels that maintain the integrity of the HF-immunity. Contact springs are mounted between the individual front subpanels for this purpose.

Figure 3-1 shows the configuration of the R&S CompactTSVP slots.



When using an interface adapter, remember that the count sequence for connectors P1 and P20 on the back of the cPCI backplane is the mirror image of the front.

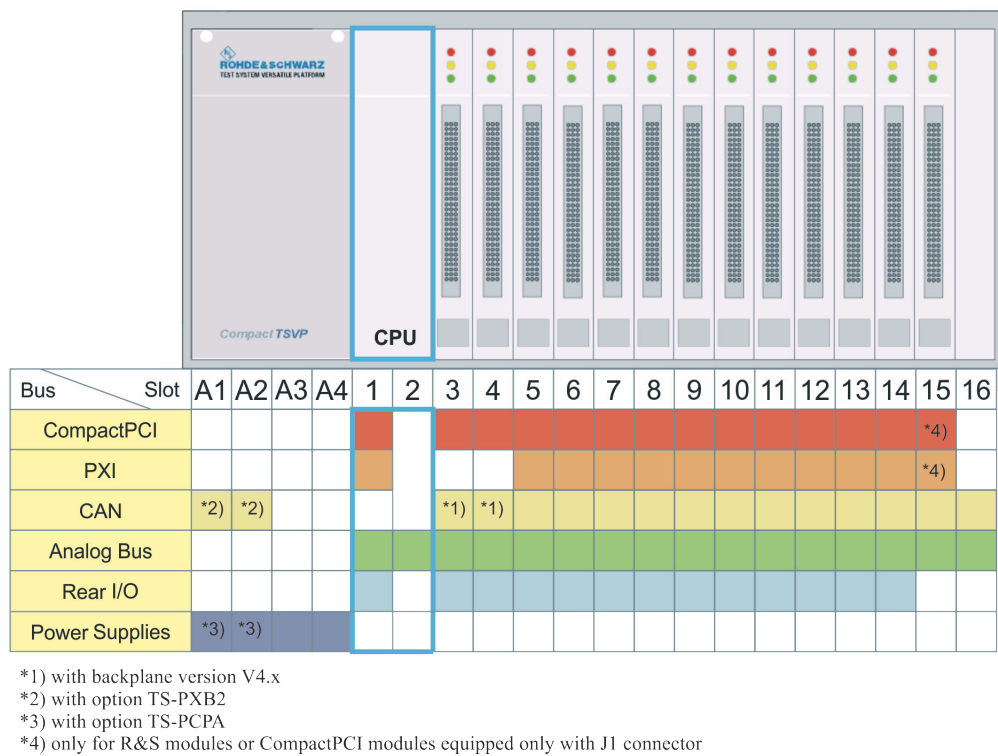

Figure 3-1: Configuration of the R&S CompactTSVP slots

You can use the remaining space in the casing to adapt to the standard UUT connector or for concealed (cross) cabling.

Permitted module configuration

Because of the different properties of plug-in modules, there are restrictions on the use of plug-in slots.

Table 3-1 and Table 3-2 show an overview of which modules can be operated in which plug-in slots.

Table 3-1: R&S CompactTSVP backplane V4.0 (for instrument part no. 1152.2518.02, starting with serial no. 100109, as of September 2005)

Front side	A1	A2	A3	A4	1	2	3	4	5	6	7	8	9	10	11	12	13	14	15	16	
Power supply			X		-		-	-	-	-	-	-	-	-	-	-	-	-	-	-	-
Power supply ext.	X ⁵⁾		-		-		-	-	-	-	-	-	-	-	-	-	-	-	-	-	-
System controller			-		X ²⁾		-	-	-	-	-	-	-	-	-	-	-	-	-	-	-
TS-PSAM			-		-		-	-	X	X	X	X	X	X	X	X	X	X	X	X	X
TS-PICT			-		-		-	-	X	X	X	X	X	X	X	X	X	X	X	X	X
TS-PFG			-		-		-	-	X	X	X	X	X	X	X	X	X	X	X	X	X
TS-PAM			-		-		-	-	X	X	X	X	X	X	X	X	X	X	X	X	X
TS-PDFT			-		-		-	-	X	X	X	X	X	X	X	X	X	X	X	X	X
TS-PIO4 / TS-PIO5			-		-		-	-	X	X	X	X	X	X	X	X	X	X	X	X	X
TS-PHDT ³⁾			-		-		-	-	X	X	X	X	X	X	X	X	X	X	X	X	X
TS-PMB (V. ≥ 3.0)			-		-		X ¹⁾	X	X	X	X	X	X	X	X	X	X	X	X	X	X ⁸⁾
TS-PMB (V. 2.x)			-		-		-	-	X ⁹⁾	X ⁹⁾	X ⁹⁾	X ⁹⁾	X ⁹⁾	X ⁹⁾	X ⁹⁾	X ⁹⁾	X ⁹⁾	X ⁹⁾	X ⁹⁾	X ⁹⁾	X ⁹⁾
TS-PSM1			-		-		-	-	X ¹⁰⁾	X ¹⁰⁾	X ¹⁰⁾	X ¹⁰⁾	X ¹⁰⁾	X ¹⁰⁾	X ¹⁰⁾	X ¹⁰⁾	X ¹⁰⁾	X ¹⁰⁾	X ¹⁰⁾	X ¹⁰⁾	X ¹⁰⁾
TS-PSM2			-		-		X ¹⁾	X	X	X	X	X	X	X	X	X	X	X	X	X	X ⁸⁾
TS-PSM3 / TS-PSM4 / TS-PSM5 ¹⁷⁾			-		-		-	-	X ¹⁰⁾	X ¹⁰⁾	X ¹⁰⁾	X ¹⁰⁾	X ¹⁰⁾	X ¹⁰⁾	X ¹⁰⁾	X ¹⁰⁾	X ¹⁰⁾	X ¹⁰⁾	X ¹⁰⁾	X ¹⁰⁾	X ¹⁰⁾
TS-PIO2			-		-		X ¹⁾	X	X	X	X	X	X	X	X	X	X	X	X	X	X
TS-PSU / PSU12			-		-		X ¹⁾	X	X	X	X	X	X	X	X	X	X	X	X	X	X
TS-PIO3B / PTR	X ⁴⁾	X ⁴⁾	-		-		X	X	X	X	X	X	X	X	X	X	X	X	X	X	X

Rear side	A1	A2	A3	A4	1	2	3	4	5	6	7	8	9	10	11	12	13	14	15	16	
TS-PSYS1					-		-	-	-	-	-	-	-	-	-	-	-	-	-	X	
TS-PSYS2 ⁷⁾					-		-	-	-	-	-	-	-	-	-	-	-	-	-	-	
TS-PDC (V. ≥ 1.4) ¹¹⁾					-		X	X	X	X	X	X	X	X	X	X	X	X	X	-	
TS-PSCx-RIO					x ⁶⁾		-	-	-	-	-	-	-	-	-	-	-	-	-	-	
TS-PSC0/TS-PSC07/ TS-PSC08					x ²⁾		-	-	-	-	-	-	-	-	-	-	-	-	-	-	
TS-PAC ¹³⁾					-		X	X	X	X	X	X	X	X	X	X	X	X	X	-	
TS-PRIO ¹⁵⁾					-		X	X	X	X	X	X	X	X	X	X	X	X	X	-	
TS-PRIO4 ¹⁶⁾					-		X	X	X	X	X	X	X	X	X	X	X	X	X	-	
TS-PK04																					X

- 1) Module solder side must be isolated against left neighbor slot if a system controller is installed (see "Installing modules" on page 36)
- 2) Front slot must remain empty if a bridge module (R&S TS-PSC0, R&S TS-PSC07, R&S TS-PSC08) is installed on the rear
- 3) Only in slot 9 to 15 if system controller R&S TS-PSC3 is used
- 4) Only with optional backplane extension R&S TS-PXB2; Cannot be combined with power supply extension R&S TS-PCPA
- 5) Only with optional backplane extension R&S TS-PCPA; Cannot be combined with R&S TS-PXB2
- 6) System controller RIO module must match CPU type in front slot
- 7) R&S TS-PSYS2 is not allowed in a R&S CompactTSVP with backplane Version 4
- 8) Only if option R&S TS-PK04 is not installed
- 9) Only with R&S TS-PRIO or R&S TS-PRIO4 and R&S TS-PMB versions 02.14 or later
- 10) Only with R&S TS-PRIO or R&S TS-PRIO4
- 11) Only for R&S TS-PSAM, R&S TS-PICT, R&S TS-PFG, R&S TS-PAM, R&S TS-PSU12, R&S TS-PIO2
- 13) Only for R&S TS-PSU
- 14) Only for R&S TS-PMB
- 15) Only for R&S TS-PMB, R&S TS-PSM2; the relays of the R&S TS-PRIO can not be controlled by the R&S TS-PMB
- 16) Only for R&S TS-PMB, R&S TS-PIO3B, R&S TS-PTR, R&S TS-PSM1/3/4/5
- 17) R&S TS-PSM3 and R&S TS-PSM5 need two slots

Table 3-2: R&S CompactTSVP Backplane V2.1 and V3.x (for instrument part no. 1152.2518.02, up to serial no. 100108, before September 2005)

Front side	A1	A2	A3	A4	1	2	3	4	5	6	7	8	9	10	11	12	13	14	15	16	
Power supply			X		-		-	-	-	-	-	-	-	-	-	-	-	-	-	-	-
Power supply ext.	X ⁵⁾		-		-		-	-	-	-	-	-	-	-	-	-	-	-	-	-	-
System controller			-		X ²⁾		-	-	-	-	-	-	-	-	-	-	-	-	-	-	-
TS-PSAM			-		-		-	X	X	X	X	X	X	X	X	X	X	X	X	X	X
TS-PICT			-		-		-	X	X	X	X	X	X	X	X	X	X	X	X	X	X
TS-PFG			-		-		-	X	X	X	X	X	X	X	X	X	X	X	X	X	X
TS-PAM			-		-		-	X	X	X	X	X	X	X	X	X	X	X	X	X	X
TS-PDFT			-		-		-	X	X	X	X	X	X	X	X	X	X	X	X	X	X
TS-PIO4 / TS-PIO5			-		-		-	X	X	X	X	X	X	X	X	X	X	X	X	X	X
TS-PHDT ³⁾			-		-		-	X	X	X	X	X	X	X	X	X	X	X	X	X	X
TS-PMB			-		-		-	X	X	X	X	X	X	X	X	X	X	X	X	X	X ⁸⁾
TS-PSM1			-		-		-	X	X	X	X	X	X	X	X	X	X	X	X	X	X
TS-PSM2			-		-		-	X	X	X	X	X	X	X	X	X	X	X	X	X	X ⁸⁾
TS-PSM3 / TS-PSM4 / TS-PSM5 ⁴⁾			-		-		-	X	X	X	X	X	X	X	X	X	X	X	X	X	X
TS-PIO1			-		-		-	X	X	X	X	X	X	X	X	X	X	X	X	X	X
TS-PIO2			-		-		-	X	X	X	X	X	X	X	X	X	X	X	X	X	X
TS-PSU / PSU12			-		-		-	X	X	X	X	X	X	X	X	X	X	X	X	X	X
TS-PIO3B / PTR	X ⁴⁾	X ⁴⁾	-		-		X	X	X	X	X	X	X	X	X	X	X	X	X	X	X

Rear side	A1	A2	A3	A4	1	2	3	4	5	6	7	8	9	10	11	12	13	14	15	16
TS-PSYS1					-		-	-	-	-	-	-	-	-	-	-	-	-	X	
TS-PSYS2 ⁷⁾					-		-	-	X	-	-	-	-	-	-	X	X	X	-	
TS-PDC ⁹⁾					-		-	-	X	X	X	X	X	X	X	X	X	X	-	
TS-PSCx-RIO ⁶⁾					X		-	-	-	-	-	-	-	-	-	-	-	-	-	
TS-PSC0 ²⁾					X		-	-	-	-	-	-	-	-	-	-	-	-	-	
TS-PAC ¹⁰⁾					-		-	-	X	X	X	X	X	X	X	X	X	X	-	
TS-PCAL2 ¹¹⁾					-		-	-	X	X	X	X	X	X	X	X	X	X	-	
TS-PRIO ¹²⁾					-		-	-	X	X	X	X	X	X	X	X	X	X	-	
TS-PRIO4 ¹³⁾					-		-	-	X	X	X	X	X	X	X	X	X	X	-	
TS-PK04																				X

1) Module solder side must be isolated against left neighbor slot if a system controller is installed (see "Installing modules" on page 36)

2) Either a bridge card (R&S TS-PSC0) OR a CPU module (R&S TS-PSC3, R&S TS-PSC4) can be used; R&S TS-PSC4 only for backplane version 3.x

3) Only in slot 9 to 15 if system controller R&S TS-PSC3 is used; Not allowed in backplane Version 3.x

4) Only with optional backplane extension R&S TS-PXB2; Cannot be combined with power supply extension R&S TS-PCPA

5) Only with optional backplane extension R&S TS-PCPA; Cannot be combined with R&S TS-PXB2

6) System controller RIO module must match CPU type in front slot

8) For versions 3.0 and later: Only if option R&S TS-PK04 is not installed

9) Only for R&S TS-PSAM, R&S TS-PICT, R&S TS-PFG, R&S TS-PAM, R&S TS-PIO2, R&S TS-PSU12

10) Only for R&S TS-PSU

11) Only for R&S TS-PMB

12) Only for R&S TS-PMB, R&S TS-PSM2; the relays of the R&S TS-PRIO can not be controlled by the R&S TS-PMB

13) Only for R&S TS-PMB, R&S TS-PIO3B, R&S TS-PTR

14) R&S TS-PSM3 and R&S TS-PSM5 need two slots

3.2.5.3 R&S PowerTSVP configuration

The R&S PowerTSVP contains 16 slots for front plug-in modules conforming to Rohde & Schwarz format. The connector P2 that is defined in the cPCI standard is referred to as P20 here, because of a different assignment.

Slots A3, A4 are fitted with a PSU by default.

An optional R&S TS-PCPA power pack or the optional R&S TS-PXB2 backplane extension are installed into slots A1 and A2 at the factory only, if ordered.

Slots 1 to 16 provide access to the PXI trigger bus, CAN bus and analog bus. If you use an optional R&S TS-PXB2, the CAN bus is also available at slots A1 and A2.

There is space for rear I/O modules in the rear section of the R&S PowerTSVP.

Unused slots are covered by front subpanels that maintain the integrity of the HF-immunity. Contact springs are mounted between the individual front subpanels for this purpose.

Figure 3-2 shows the configuration of the R&S PowerTSVP slots.



When using an interface adapter, remember that the count sequence for connector P20 on the back of the control backplane is the mirror image of the front.

Bus \ Slot	A1	A2	A3	A4	1	2	3	4	5	6	7	8	9	10	11	12	13	14	15	16
PXI Trigger																				
CAN	*1)	*1)																		
Analog Bus																				
Rear I/O																				
Power Supplies	*2)	*2)																		

*1) with option TS-PXB2
 *2) with option TS-PCPA

Figure 3-2: Configuration of the R&S PowerTSVP slots

You can use the remaining space in the casing to adapt to the standard UUT connector or for concealed (cross) cabling.

Permitted module configuration

Because of the different properties of plug-in modules, there are restrictions on the use of plug-in slots.

[Table 3-3](#) shows an overview of which modules can be operated in which plug-in slots.

Table 3-3: R&S PowerTSVP backplane

Front side	A1	A2	A3	A4	1 ¹⁾	2	3	4	5	6	7	8	9	10	11	12	13	14	15	16	
Power supply			X		-	-	-	-	-	-	-	-	-	-	-	-	-	-	-	-	-
Power supply ext.	X ²⁾		-		-	-	-	-	-	-	-	-	-	-	-	-	-	-	-	-	-
TS-PMB			-		X	X	X	X	X	X	X	X	X	X	X	X	X	X	X	X	X ⁴⁾
TS-PSM1			-		X	X	X	X	X	X	X	X	X	X	X	X	X	X	X	X	X
TS-PSM2			-		X	X	X	X	X	X	X	X	X	X	X	X	X	X	X	X	X ⁴⁾
TS-PSM3 / TS-PSM4 / TS-PSM5 ¹³⁾			-		X	X	X	X	X	X	X	X	X	X	X	X	X	X	X	X	X
TS-PIO1			-		X	X	X	X	X	X	X	X	X	X	X	X	X	X	X	X	X
TS-PIO2			-		X	X	X	X	X	X	X	X	X	X	X	X	X	X	X	X	X
TS-PSU / PSU12			-		X	X	X	X	X	X	X	X	X	X	X	X	X	X	X	X	X
TS-PIO3B / PTR	X ³⁾	X ³⁾	-		X	X	X	X	X	X	X	X	X	X	X	X	X	X	X	X	X

Rear side	A1	A2	A3	A4	1	2	3	4	5	6	7	8	9	10	11	12	13	14	15	16
TS-PSYS2																			X	
TS-PSYS2 (1157.8508.02 only)					-		X	X	X	X	X	X	X	X	X	X	X	X		-
TS-PDC ⁵⁾					X	X	X	X	X	X	X	X	X	X	X	X	X	X		-
TS-PAC ⁶⁾					X	X	X	X	X	X	X	X	X	X	X	X	X	X		-
TS-PCAL2 ⁷⁾					X	X	X	X	X	X	X	X	X	X	X	X	X	X		-
TS-PRIO ⁸⁾					X	X	X	X	X	X	X	X	X	X	X	X	X	X		-
TS-PRIO2 ⁹⁾																				
TS-PRIO3 ¹⁰⁾																				
TS-PRIO4 ¹¹⁾																				
TS-PRIO5 ¹²⁾																				
TS-PK04P																				X

1) Module solder side must be isolated against left neighbor slot (see "Installing modules" on page 36)

2) Only with optional backplane extension R&S TS-PCPA; Cannot be combined with R&S TS-PXB2

3) Only with optional backplane extension R&S TS-PXB2; Cannot be combined with power supply extension R&S TS-PCPA

4) For version 3.0 and later: only if option R&S TS-PK04 is not installed

5) Only for R&S TS-PIO2, R&S TS-PSU12

6) Only for R&S TS-PSU

7) Only for R&S TS-PMB

8) Only for R&S TS-PMB, R&S TS-PSM2

9) Only for R&S TS-PSM4

10) Only for R&S TS-PSM3

11) Only for R&S TS-PIO3B, R&S TS-PTR

12) Only for R&S TS-PSM5

13) R&S TS-PSM3 and R&S TS-PSM5 need two slots

3.2.5.4 Considerations for module installation

When installing modules, consider the following:

- Cover unused slots by front subpanels that maintain the integrity of the HF-immunity. Contact springs are mounted between the individual front subpanels for this purpose.
- Observe EMC regulations. You can only achieve sufficient shielding using sectional front panels and shield springs on the inner and outer fastening level. Connect the 2 levels of module front panels using option R&S TS-PSK1 (HF shield wall kit). One slot is lost in this process. See also [Chapter 3.2.6, "Installing the shielding kit \(R&S TS-PSK1\)"](#), on page 33.
- If long cards are plugged in next to short ones, make sure that the sectional front panel of the short module cannot touch the lines of the adjacent module to prevent the risk of short circuiting. For safe operation, insert the insulation plate that is part of the delivery between the modules (see ["Installing modules"](#) on page 36).

3.2.6 Installing the shielding kit (R&S TS-PSK1)

The shielding kit provides sufficient shielding to comply to EMC regulations.

1. Switch off the R&S TSVP.
2. **WARNING!** Risk of electric shock. UUT or additional power supplies connected to a module can apply hazardous active voltages to the module. If you touch a module with hazardous voltages applied, you risk an electric shock. Never install or uninstall modules while the instrument is connected to an external power supply or a UUT providing high voltages.

Disconnect the R&S TSVP from the power supply.

3. Remove the slot covers or modules from the required slots.

The number of slots you have to clear depends on the shielding kit version.

- Version 01 requires at least slots A1 to 4.
- Version 02 requires at least slots A1 to 8.
- Version 03 requires at least slots A1 to 12.
- Version 04 requires all slots.

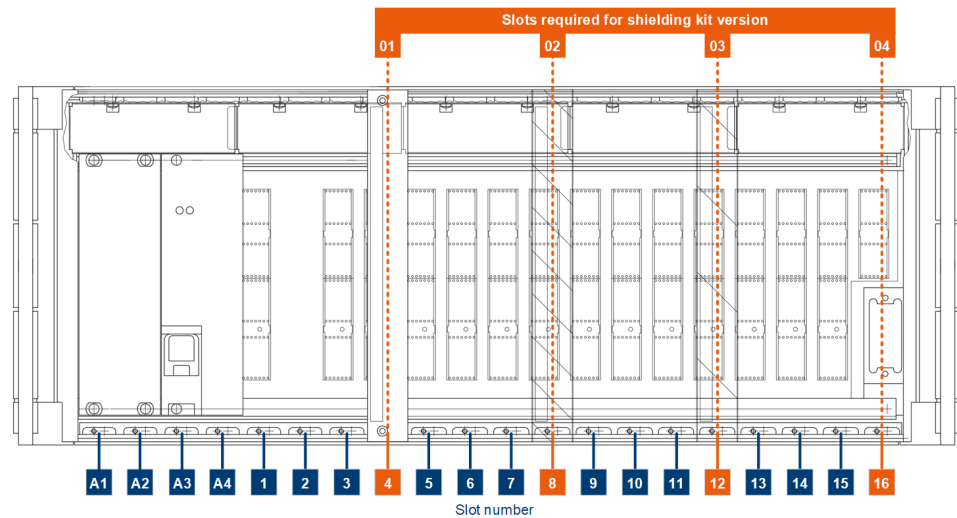

Figure 3-3: Slot requirement for installation of shielding kit

A1 to 16 = Front panel slot number

01 to 04 = Slot requirement for shielding kit versions 01 to 04

4. Screw in the screws that hold the elements to the backplane with two turns. The number of screws you have to use depends on the number of shielding kit elements you have to install. The number of shielding kit elements depends on the shielding kit version.

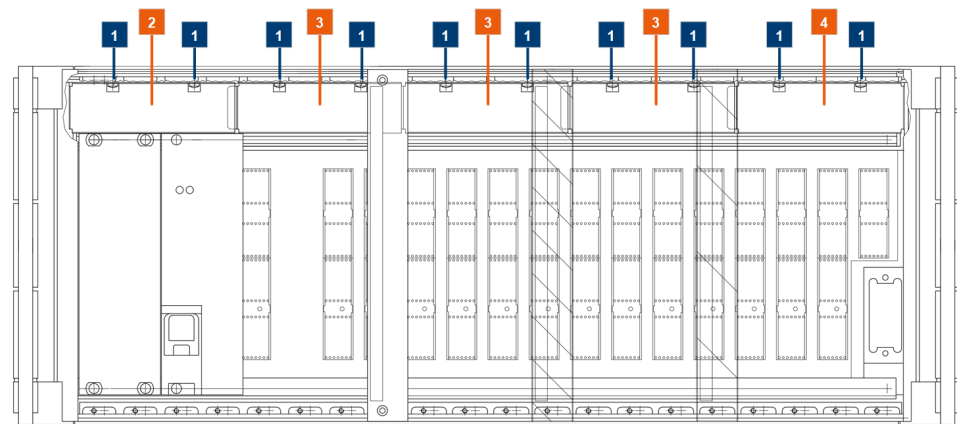

Figure 3-4: Mount shielding kit covers (front view)

1 = Screws that hold the shielding kit elements

2 = Shielding kit elements

5. Attach the shielding kit elements to the screws. Each element spans over two slots. Start with the element on the left and finish with the one on the right.
 - Version 01: Elements in slots A1 to 4.
 - Version 02: Elements in slots A1 to 8.
 - Version 01: Elements in slots A1 to 12.
 - Version 01: Elements in slots A1 to 16.

Note that the delivery has three different shielding kit elements.

- 1 x element for slots A1 to A4
- 3 x element for slots 1 to 12
- 1 x element for slots 13 to 16

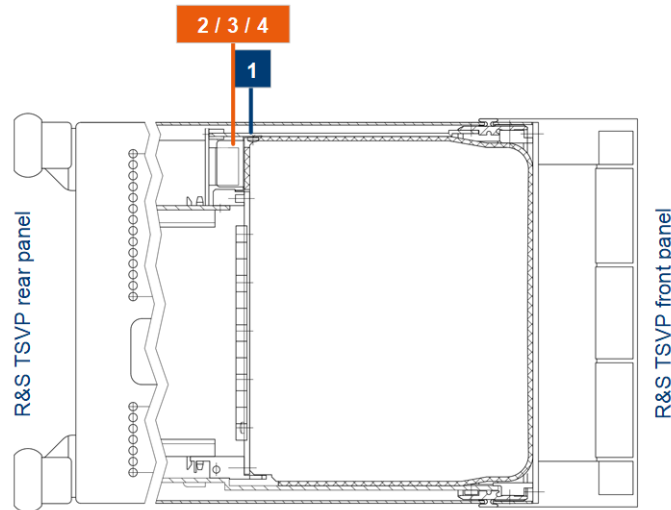

Figure 3-5: Mount shielding kit element (side view)

- 1 = Screws that hold the shielding kit elements
- 2 = Shielding kit elements

6. Tighten the screws to fasten the shielding kit elements to the R&S TSVP.
7. Finish the installation of shielding kit versions **01 to 03**:



Figure 3-6: Finish shielding kit installation

- 1 = Shielding kit wall (required in version 01 to 03 only)
- 2 = Slot covers for shielding kit wall (required in version 01 to 03 only)
- 3 = Slot cover for slots next to power supply

- a) Insert the shielding kit wall (slightly diagonally) into the intended slot.
The slot depends on the shielding kit version.
 - For version 01: Insert the wall in slot 4.
 - For version 02: Insert the wall in slot 8.
 - For version 03: Insert the wall in slot 12.
 - b) Fasten the shielding kit wall to the backplane.
 - c) Screw the slot cover over the slot next to the shielding kit wall (slot 4, 8 or 12).
 - d) Screw the slot cover to the slot to left of the power supply (slot A1 and A2).
The slot covers are part of the base unit.
8. Finish the installation of shielding kit **version 04**:
Screw the slot cover to the slot next to the power supply (slot A1 and A2). The shielding kit wall is not required, because the shielding kit elements cover the whole instrument.
The slot cover is part of the base unit.
 9. Insert modules as required or close the slots with their covers.

3.2.7 Installing and uninstalling plug-in modules

Before installing modules, read the information in [Chapter 3.2.5, "Designing the plug-in module configuration"](#), on page 23.

Design an installation concept of which modules to install in which slots.

Installing modules

1. Switch off the R&S TSVP.
2. **WARNING!** Risk of electric shock. UUT or additional power supplies connected to a module can apply hazardous active voltages to the module. If you touch a module with hazardous voltages applied, you risk an electric shock. Never install or uninstall modules while the instrument is connected to an external power supply or a UUT providing high voltages.
Disconnect the R&S TSVP from the power supply.
3. Unscrew the cover of the slot that you want to use for the module.
4. **NOTICE!** Risk of instrument damage. Insert the module carefully to avoid damage to the connecting pins on the backplane.
When mounting short and long modules into adjacent slots, the front panel of the short module can cause short circuits on the long module. Ensure adequate clearance between the modules and insert the plastic insulation plate that is part of the delivery between the modules.



Figure 3-7: Install insulation plate

Push in the module using moderate pressure until you feel it snap into place.

5. Secure the module by tightening the screws at the top and bottom of the module.



Installing rear I/O modules

Install rear I/O modules the same way as modules on the front. Make sure to use the matching rear panel slot when you install such modules.

Uninstalling modules

1. Switch off the R&S TSVP.
2. **WARNING!** Risk of electric shock. UUT or additional power supplies connected to a module can apply hazardous active voltages to the module. If you touch a mod-

ule with hazardous voltages applied, you risk an electric shock. Never install or uninstall modules while the instrument is connected to an external power supply or a UUT providing high voltages.

Disconnect the R&S TSVP from the power supply.

3. Unscrew the screws at the top and bottom of the module.
4. Press the ejection lever at the bottom of the module to disconnect it from the back-plane.
5. Remove the module from the slot.
6. Replace the cover of the slot if you do not insert another module.

Driver installation

The drivers for Rohde & Schwarz modules are installed together with the R&S GTSL software. The installation procedure is described in [Chapter 3.4, "R&S GTSL download from GLORIS"](#), on page 48 and in the R&S GTSL manual.

For third-party or customized modules, consult the documentation supplied by the module manufacturer.

Cabling the modules

For general recommendations on cabling, see [Chapter 4.3, "Cabling"](#), on page 60.

For details on cabling the modules, see the module documentation.

3.2.8 Connecting an R&S CompactTSVP and an R&S PowerTSVP

You can create larger ATE (Automatic Test Equipment) systems by combining R&S CompactTSVP and R&S PowerTSVP. You connect the two instruments via the X2 connector on the rear panel of the instruments and the X30 connector on the R&S PSYS modules in the rear.



Figure 3-8: R&S CompactTSVP to R&S PowerTSVP connection

Only use the R&S TS-PK01 cable (order no. 1166.4147.02) and R&S TS-PK02 cable (order no. 1166.4160.02) to connect the R&S CompactTSVP and R&S PowerTSVP to ensure EMC compatibility.

1. Switch off the R&S CompactTSVP and the R&S PowerTSVP.
2. **WARNING!** Risk of electric shock. The test environment, e.g the UUT or additional power supplies, can supply high voltages to the instruments. In this case, the voltage can also apply to the signal output connectors of the R&S TSVP, in particular the analog bus connector X2.
Therefore, do not connect or disconnect devices from the X2 connectors while connected to an external power supply or UUT.

Always connect both ends of the cable connecting the R&S CompactTSVP and R&S PowerTSVP. Thus, you avoid the risk of touching the X2 connector with a possibly hazardous voltage applied.

Disconnect both instruments from any external power supply or UUTs providing high voltages.
3. Connect the R&S TS-PK01 cable to the X2 connector on the rear panel of the R&S CompactTSVP.
4. Connect the other end of the R&S TS-PK01 cable to the X2 connector on the rear panel of the R&S PowerTSVP.
5. Configure the jumpers of the CAN bus for the R&S TSPSYS modules as required. For details, see [Chapter 4.6, "CAN bus"](#), on page 64.
6. Connect the end of the R&S TS-PK02 cable that contains the ferrite to the X30 connector on the R&S PSYS1 module in the rear of the R&S CompactTSVP.
7. Connect the other end of the R&S TS-PK02 cable to the X30 connector on the R&S PSYS2 module in the rear of the R&S PowerTSVP.

Both instruments can be controlled by the same control software and used for the same measurement setup.

3.2.9 Connecting the R&S CompactTSVP to a control PC

The R&S PowerTSVP is intended for use with a control processor. This control processor is referred to as the system controller and is usually installed in the R&S CompactTSVP. However, you can also use a standard PC connected to the controller by a suitable interface (PCI-to-PCI bridge).

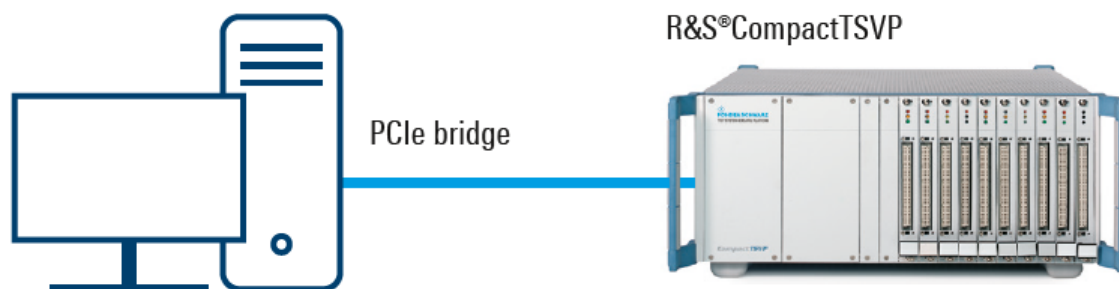

Figure 3-9: R&S CompactTSVP to external PC connection

For this solution, a PCI card is installed on an external PC. In the R&S CompactTSVP, one of the following R&S CompactPCI modules is installed in rear slot 1:

- R&S TS-PSC08
- R&S TS-PSC0 (deprecated)
- R&S TS-PSC07 (deprecated)

For details and prerequisites, see the module documentation.



If the R&S CompactTSVP is connected to an external control PC, always switch on the R&S PowerTSVP first. Then switch on the control PC. Otherwise, the PC cannot detect and initialize the R&S CompactTSVP modules correctly.

See also [Chapter 3.2.13, "Switching on or off"](#), on page 43.

To install a PCI-to-PCI bridge connection using R&S TS-PSC08

1. On the external PC, install a PCI card.
2. On the R&S PowerTSVP, install the R&S TS-PSC08 module in rear slot 1. Do not plug any other module into slot 1 on the front panel.
3. Connect the "Upstream" connector on the R&S PowerTSVP to the external PC using the supplied cable.



Figure 3-10: Cabling of the R&S TS-PSC08 components.

3.2.10 Connecting the R&S PowerTSVP to a control PC

If the R&S PowerTSVP is not connected to a R&S CompactTSVP, the modules must be controlled by an external PC. In this case, a CAN bus interface supported by the IXXAT VCI software is required (e.g. IXXAT USB-to-CAN).



Figure 3-11: R&S PowerTSVP to external PC connection

To set up a CAN bus connection to the R&S PowerTSVP

1. Connect the CAN interface to the external PC.
2. Connect the CAN bus lines of the interface to the CAN bus pins on the X30 connector of the R&S TS-PSYS2 module on the R&S PowerTSVP.

3.2.11 Considerations for test setup

Connecting high-voltage UUT

A connected UUT can apply hazardous active voltages (above 30 V_{RMS} and 42.4 V_{peak} or 60 V DC) to the instrument. In this case, the voltage is also available at the signal output connectors on the rear panel of the R&S PowerTSVP. You risk an electric shock if you touch any of the output connectors with hazardous voltages applied. Only electrically skilled persons must operate test setups using hazardous active voltages. See also "[Target audience](#)" on page 9.

Ensure that all measurement equipment in the test setup is designed for the applied voltages. The R&S CompactTSVP and R&S PowerTSVP instruments are designed to cope with operating voltages up to 120 V DC, 50 V AC (RMS).

Always connect both ends of the TS-PK01 cable to connect the R&S CompactTSVP and R&S PowerTSVP via the analog bus and the X2 connectors. Thus, you avoid the risk of touching the X2 connector with a possibly hazardous voltage applied.

Cable selection and electromagnetic interference (EMI)

Electromagnetic interference (EMI) can affect the measurement results.

To suppress electromagnetic radiation during operation:

- Use high-quality shielded cables, for example, double-shielded RF and LAN cables.
- Always terminate open cable ends.
- Ensure that connected external devices comply with EMC regulations.

Preventing electrostatic discharge (ESD)

Electrostatic discharge is most likely to occur when you connect or disconnect a DUT.

- ▶ **NOTICE!** Electrostatic discharge can damage the electronic components of the product and the device under test (DUT).

Ground yourself to prevent electrostatic discharge damage:

- a) Use a wrist strap and cord to connect yourself to ground.
- b) Use a conductive floor mat and heel strap combination.

Ensuring repeatability

To ensure repeatability of measurements, note the ambient conditions recommended for the installation site of a R&S PowerTSVP:

- Temperature variance within 24 hours not to exceed approximately 3 °C.
- Maximum temperature variance within one hour not to exceed approximately 0.5 °C.
- Avoid extreme vibrations from mechanical or dynamic sources such as presses or power punches.

- Warm up the R&S PowerTSVP for approximately 15 minutes before starting measurements. The duration depends on the type of measuring modules and can be longer.

3.2.12 Connecting to power

The R&S PowerTSVP is equipped with an AC power supply connector. The R&S PowerTSVP can be used with different AC power voltages and adapts itself automatically to it. Refer to the data sheet for requirements of voltage and frequency.

For safety information, see "[Connecting to power](#)" on page 10.

1. Plug the AC power cable into the AC power connector on the rear panel of the product. Only use the AC power cable delivered with the product.
2. Plug the AC power cable into a power outlet with ground contact.

The required ratings are listed next to the AC power connector and in the data sheet.

3.2.13 Switching on or off

To switch on the product

The product is off but connected to power.

1. If the R&S PowerTSVP is connected to an external control PC via a PCI-to-PCI bridge, always switch on the R&S PowerTSVP before you switch on the control PC. Otherwise, the PC cannot detect and initialize the R&S PowerTSVP modules correctly.
2. **WARNING!** Risk of electric shock. When you switch on the R&S PowerTSVP, any plugged in modules are initialized. If a connected UUT applies hazardous active voltages (above $30 V_{\text{RMS}}$ and $42.4 V_{\text{peak}}$ or 60 V DC) to the instrument, the voltage is also available at the signal output connectors on the rear panel of the R&S PowerTSVP.

You risk an electric shock if you touch any of the output connectors with hazardous voltages applied. Only skilled persons must operate test setups using such hazardous voltages. See also "[Target audience](#)" on page 9.

Ensure all measurement equipment in the test setup is designed for the applied voltages. The R&S CompactTSVP and R&S PowerTSVP instruments are designed to cope with operating voltages up to 120 V DC, 50 V AC (RMS).

Set the switch on the power supply to position [I]. See [Chapter 3.3.2.2, "Power switch \(2\)"](#), on page 47.

The plug-in modules are initialized and the R&S PowerTSVP is ready for operation.

To disconnect from power

The operating system of the controller is shut down.

1. **NOTICE!** Risk of data loss. If you disconnect the product from power when it is in the ready state, you can lose settings and data. Shut it down first.
Set the switch on the power supply to position [0]. See [Chapter 3.3.2.2, "Power switch \(2\)"](#), on page 47.
2. Disconnect the product from the power source.

3.2.14 Operating the R&S PowerTSVP

The R&S PowerTSVP is controlled entirely by the installed generic test software, e.g.:

- Generic Test Software Library (R&S GTSL), including tools (e.g. instrument soft panels, self-test application)
- Enhanced Generic Test Software Library (R&S EGTSL), including tools (e.g. Automatic Test Generator, ICT Correction, EGTSL Debugger, ICT Fixture Compensation)
- R&S IC-Check

For details on the software and their operation, see the corresponding user manuals provided with the installation. For installation, see [Chapter 3.4, "R&S GTSL download from GLORIS"](#), on page 48.

To operate the R&S PowerTSVP via the optional internal system controller

1. Connect a monitor, keyboard and mouse to the system controller module of the R&S PowerTSVP.
2. Switch on the R&S PowerTSVP.
3. Log on to Windows. You do not require a password.
4. Select "Start" > "R&S GTSL TSVP Self Test".

The self-test checks whether the instrument is operating properly.

For information on starting and performing the self-test, and a detailed description of the tested parameters and procedures, refer to the R&S PowerTSVP service manual.

To operate the R&S PowerTSVP via an external control PC

Prerequisites:

The R&S PowerTSVP is connected to the computer as described in [Chapter 3.2.9, "Connecting the R&S CompactTSVP to a control PC"](#), on page 39 and [Chapter 3.2.10, "Connecting the R&S PowerTSVP to a control PC"](#), on page 41.

The R&S GTSL software is installed on the control PC. See the R&S GTSL user manual for details.

1. Switch on the R&S PowerTSVP.

2. Switch on the control PC *after* you switched on the R&S PowerTSVP.
3. Select "Start" > "R&S GTSL Instrument Soft Panels".
The R&S TSVP soft panel starts and all installed R&S TSVP modules are listed in the main window.
4. In the instrument soft panels application, select "Tools" > "Create Physical.ini..." to generate the configuration file automatically.
For details, see the R&S GTSL software manual.
5. Select "Start" > "R&S GTSL TSVP Self Test".
The self-test checks whether the instrument is operating properly.
For information on starting and performing the self-test, and a detailed description of the tested parameters and procedures, refer to the R&S PowerTSVP service manual.

3.3 Instrument tour

3.3.1 Front panel view

The front panel of the R&S PowerTSVP does not provide any connectors or interfaces other than the slots for the system and user-specific plug-in modules.

The plug-in modules are described in the individual plug-in module manuals. General information on the slot configuration is provided in [Chapter 3.2.5, "Designing the plug-in module configuration"](#), on page 23.

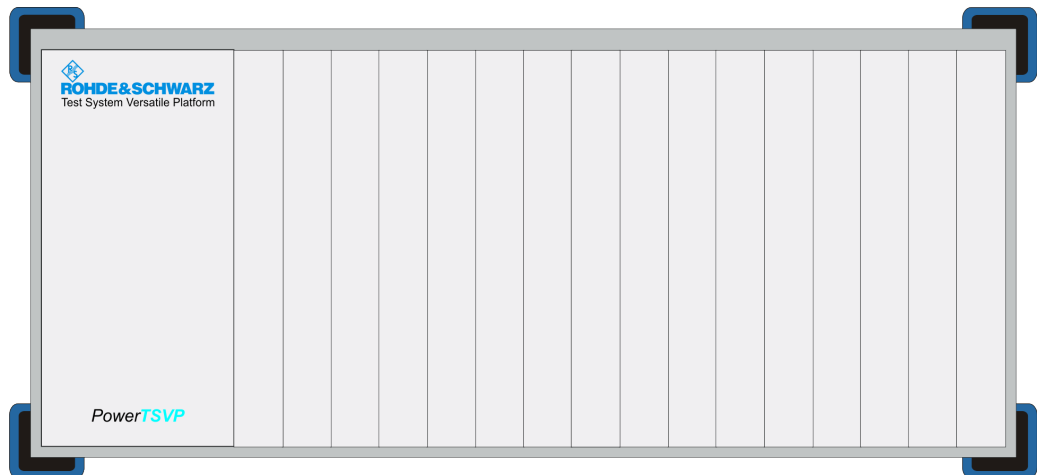

Figure 3-12: R&S PowerTSVP front panel view

You can mount an adapter frame to the front panel by a flange to connect the test devices to the R&S PowerTSVP securely, quickly, and with a low rate of wear.

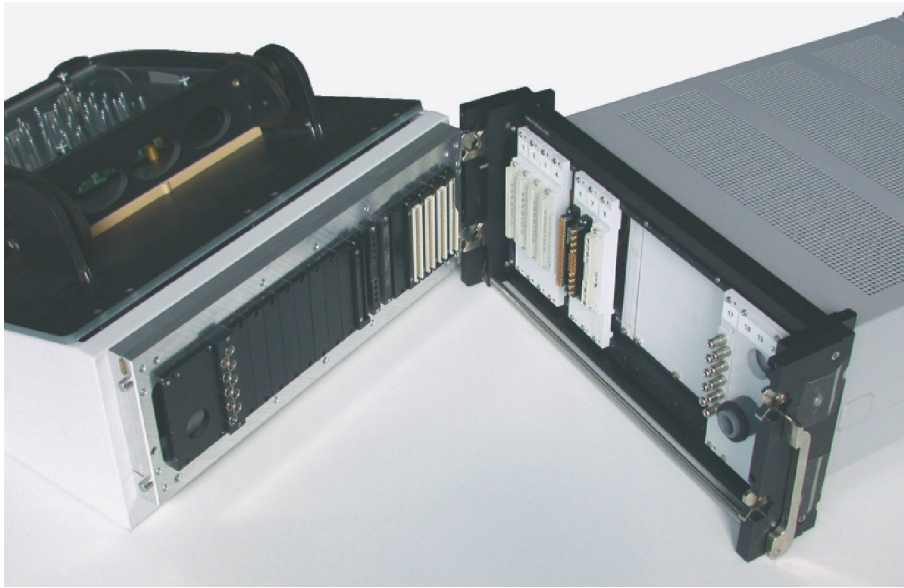

Figure 3-13: Example of R&S PowerTSVP with a flange-mounted adapter interface

3.3.2 Rear panel view

The rear panel of the R&S PowerTSVP provides various interfaces and connectors.

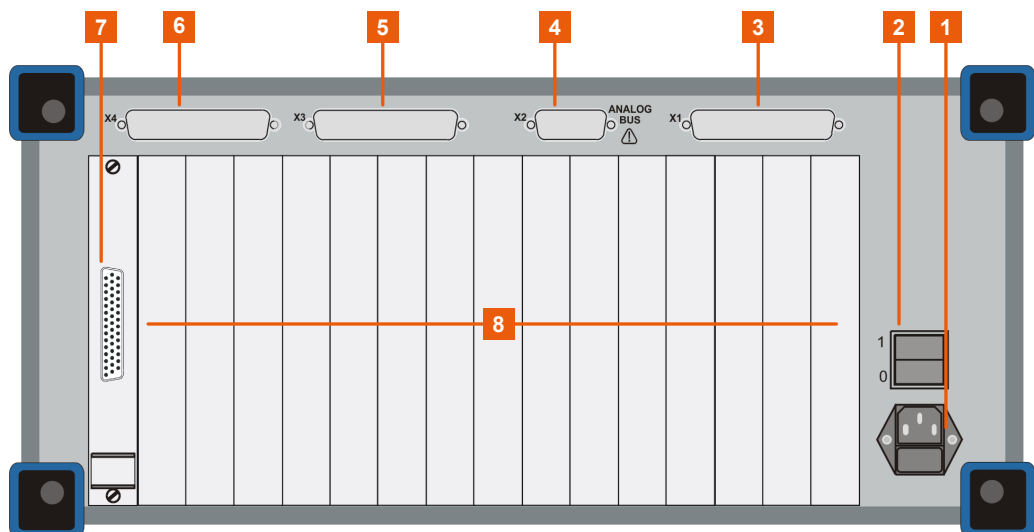

Figure 3-14: R&S PowerTSVP rear panel view with covered slots

- 1 = AC power supply (1) with fuse
- 2 = Power switch (2)
- 3 = X1, for system and user-specific connections
- 4 = Analog bus connector X2 (4)
- 5+6 = Signal output connectors X3, X4 (5, 6)
- 7 = Signal output connector X30 for system module R&S TS-PSYS (7)
- 8 = Slots for plug-in modules



The numbers in parenthesis refer to the legend of [Figure 3-14](#).

In its basic configuration, the R&S PowerTSVP only provides a power connection (1), the analog bus connection (4) and the connector for the system module (7). All other connections are system and user-specific.

The modules and slot configuration are described in [Chapter 4.1, "Plug-in modules"](#), on page 53.

- [AC power supply \(1\)](#).....47
- [Power switch \(2\)](#).....47
- [Analog bus connector X2 \(4\)](#).....47
- [Signal output connectors X3, X4 \(5, 6\)](#)..... 47
- [Signal output connector X30 for system module R&S TS-PSYS \(7\)](#)..... 48

3.3.2.1 AC power supply (1)

The R&S PowerTSVP requires a supply within the range of 110 VAC / 60 Hz or 230 VAC / 50 Hz. The power supply requires fuse protection no higher than 16 A.

The power supply used in the R&S PowerTSVP has **automatic voltage selection** between 100 Volt AC and 240 Volt AC (see the data sheet).

3.3.2.2 Power switch (2)

Main power switch function:

Position 1: The instrument is connected to the AC power supply and in operation.

Position O: The entire instrument is disconnected from the AC power supply.

For details, refer to ["Connecting to power"](#) on page 10 and [Chapter 3.2.12, "Connecting to power"](#), on page 43.

3.3.2.3 Analog bus connector X2 (4)

The analog bus connector X2 is located at the back of the R&S PowerTSVP and is connected to analog bus connector X21 on the analog bus backplane.

You can combine an R&S CompactTSVP and an R&S PowerTSVP by connecting them via their analog bus connectors X2. See [Chapter 3.2.8, "Connecting an R&S CompactTSVP and an R&S PowerTSVP"](#), on page 38 for details about connecting the two base units and the safety instructions to follow when doing so.

Analog bus lines are designed for a maximum current strength of 1 A.

3.3.2.4 Signal output connectors X3, X4 (5, 6)

Connectors X3 and X4 on the rear panel can provide signal output from the optional R&S TS-PSM1 to R&S TS-PSM5 modules. The output is provided in slot 15 or 16.

Output requires the optional cabling kit R&S TS-PK04 (order no. 1157.9104.02) or R&S TS-PK04P (1157.9104.03).

For more details, refer to the documentation of the modules.

3.3.2.5 Signal output connector X30 for system module R&S TS-PSYS (7)

The connector X30 on the rear panel is used to control combined R&S CompactTSVP and R&S PowerTSVP setups. Using the X30 connectors, the R&S TS-PSYS1 module in slot 15 of the rear I/O on the R&S CompactTSVP is connected to the R&S TS-PSYS2 module on the R&S PowerTSVP. The R&S TS-PSYS1 module provides system functions such as voltage and temperature monitoring, switchable trigger signals and an optocoupler interface.

Connect an R&S TS-PK02 cable to this connector to control a R&S PowerTSVP (see [Chapter 3.2.8, "Connecting an R&S CompactTSVP and an R&S PowerTSVP"](#), on page 38).

For details, see [Chapter 4.11, "System module R&S TS-PSYS2"](#), on page 67.

3.4 R&S GTSL download from GLORIS

The R&S PowerTSVP is controlled entirely by the installed generic test software. The software is installed either on the optional internal system controller of the R&S PowerTSVP, or on an external control PC.

The Generic Test Software Library ("R&S GTSL") installation package contains the software to control the R&S PowerTSVP, and all product manuals. The installation package is available from the global Rohde & Schwarz information system (GLORIS) after registration.

3.4.1 Registering for GLORIS and the R&S TSVP software

You need to register before you can use GLORIS. The procedure is quick and simple.

1. Start a browser and go to <https://gloris.rohde-schwarz.com/>.
2. Select "Register for GLORIS".

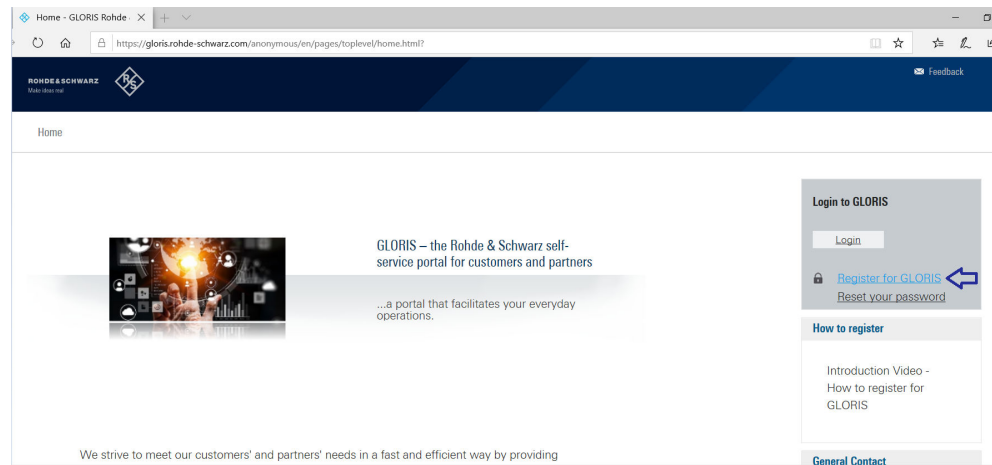

3. Enter all required information.
4. Enter your business email address (check carefully for typing errors) and all other required fields.
5. Enter your password.

The password rules are:

 - Minimum 9 characters
 - At least one upper case letter
 - At least one lower case letter
 - At least one of these special characters: * % = ? !/ + - . #
 - Only use English letters, numbers and the specified characters.
6. Use the "Remark" field to enter your required applications. Ask for activation of the "T&M Production Download" for the R&S TSVP.
7. Optionally, subscribe to our newsletter service, which is tailored to your selected interests.
8. Accept the "Terms and Conditions".
9. Select "Register".

After you submit your registration, you receive a confirmation email, which you must confirm within 48 h. Once you submit your application, we verify it and send you an email again to state that the account is ready.

In case you need assistance during the process, contact our customer support (see [Chapter 8, "Contacting customer support"](#), on page 97).

3.4.2 Download area

Log in to GLORIS using your credentials (email address and password) and go to the download area as described here:

1. Place the cursor over "Support&Services".

2. Select "Service Portfolio".
3. Select "T&M Production Download".

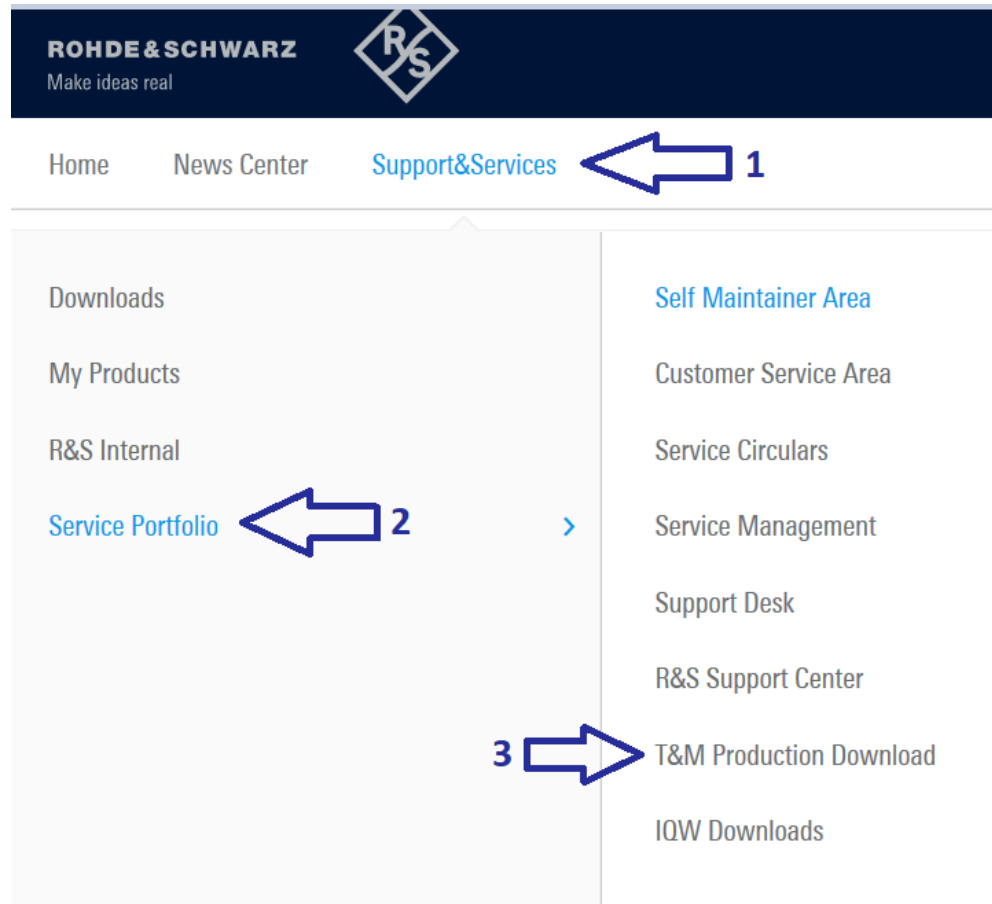

Note: If "T&M Production Download" is not visible, contact customer support asking for activation of the "T&M Production Download" for the R&S TSVP (see [Chapter 3.4.1, "Registering for GLORIS and the R&S TSVP software"](#), on page 48).

4. Navigate through the folder structure: CompactTSVP -> GTSL.

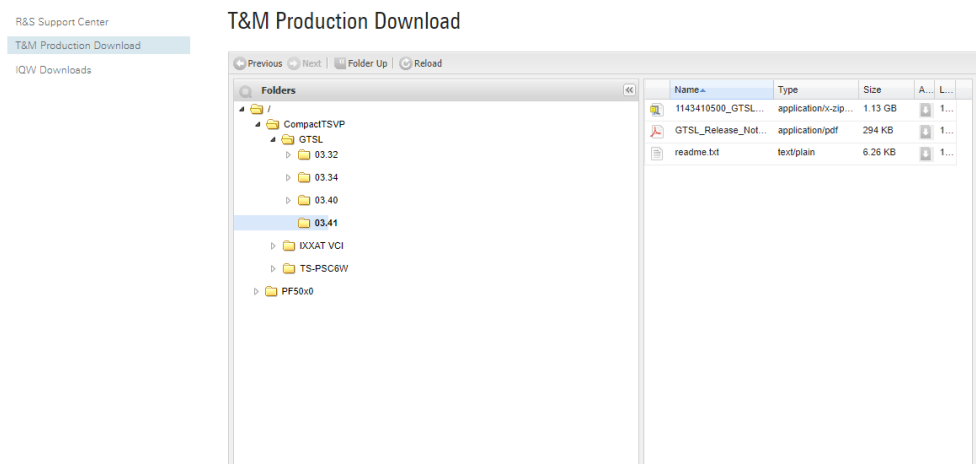

5. Select the required version of the R&S GTSL, as described in [Chapter 3.4.3, "Required version"](#), on page 51.

3.4.3 Required version

Install the latest R&S GTSL version supported for the Microsoft Windows version running on the controller or external PC of your R&S TSVP System.

Table 3-4: Overview of the dependencies with Microsoft Windows

Windows version	R&S GTSL version	Date of first support
Windows XP Windows 7	03.32	09.2016
Windows 7 Windows 10	03.33 03.34	10.2017 09.2018
Windows 10 with secure boot feature activated	03.40 03.41	01.2020 07.2021

For details on the software, refer to the R&S TSVP "System Manual". The manuals are included in the documentation folder (ZIP file).

3.4.4 Installation package contents

The installation package contains at least the following 3 files (see [Figure 3-15](#)):

- ZIP file: includes the installer and all product manuals
- PDF file: R&S GTSL release notes
- `Readme.txt`: installation instructions

T&M Production Download

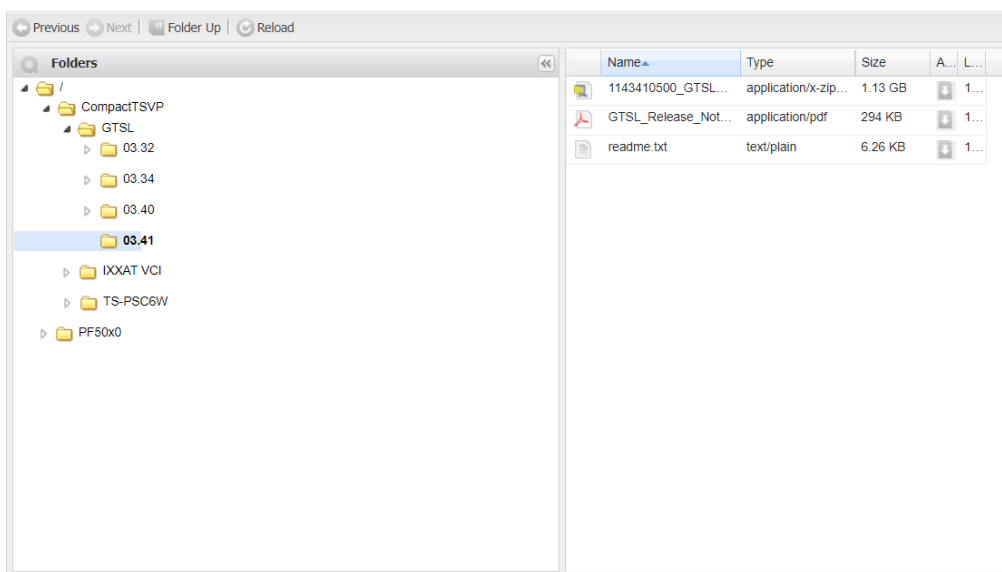

Figure 3-15: Installation package contents

The ZIP file is rather large, so depending on the speed of your internet connection, it can take some time to download.

Follow the instructions in the `Readme.txt` file to install the R&S GTSL software.

4 Mechanical layout

4.1 Plug-in modules

The R&S PowerTSVP has a modular structure that allows for a range of system configurations tailored to the specific needs of the user.

For information on compatibility and prerequisites concerning configuration, see [Chapter 3.2.5, "Designing the plug-in module configuration"](#), on page 23.

4.1.1 Supported module types

The following types of plug-in modules can be used in the R&S PowerTSVP:

- Extended R&S PowerTSVP ATE modules (fitted depth 300 mm)
- Rear I/O modules

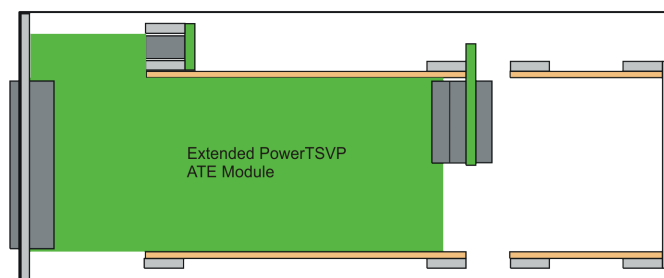
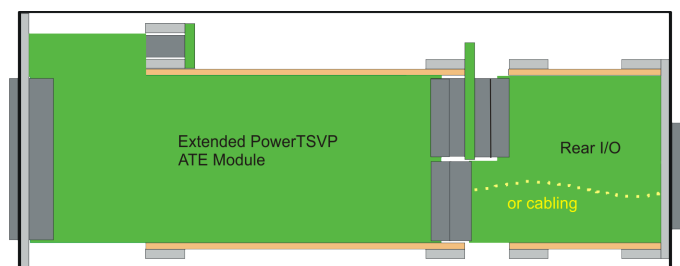

Figure 4-1: Plug-in modules in the R&S PowerTSVP

Only Rohde & Schwarz-specific modules with CAN bus interface are supported by the R&S PowerTSVP.

4.1.2 Slot layout

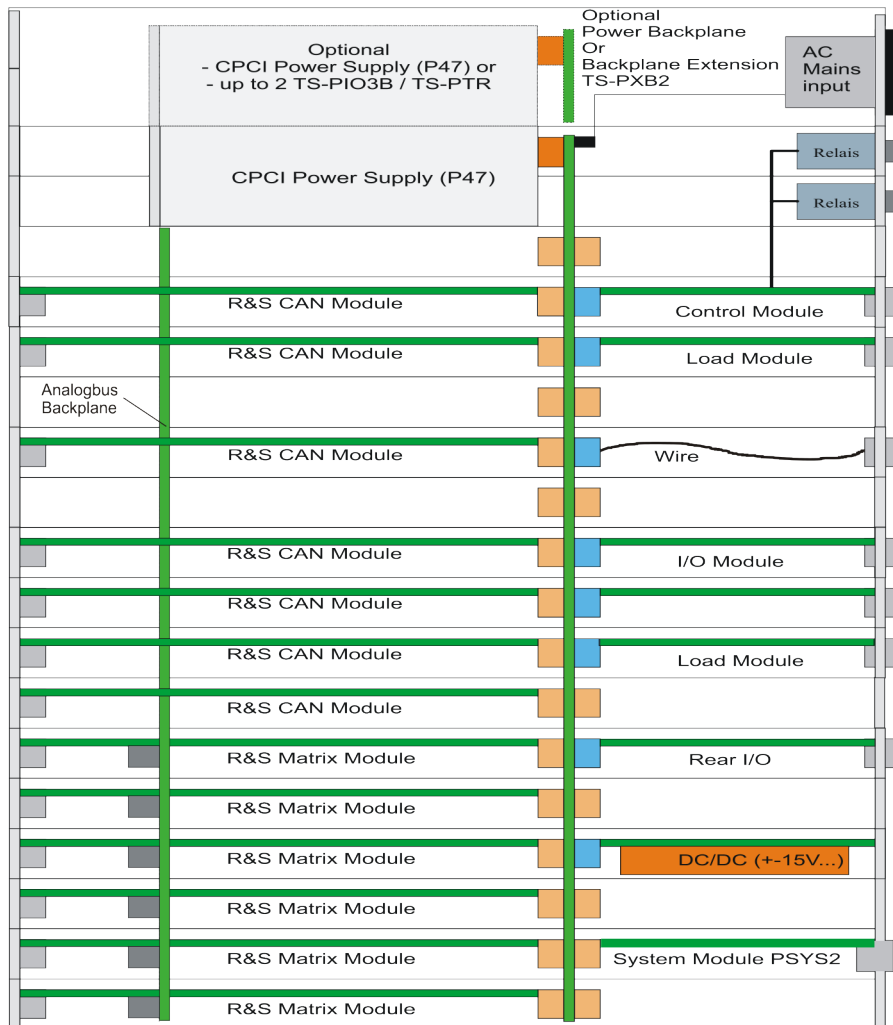

Figure 4-2: Plan view (example)

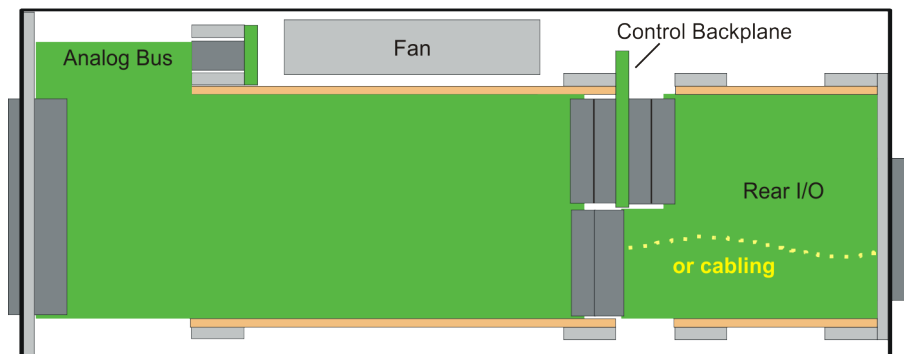

Figure 4-3: Side view

4.2 Backplanes

The R&S PowerTSVP contains the following backplanes:

- Control backplane with PICMG power interface and rear I/O support
- Analog bus backplane

Figure 4-4 shows the backplanes with the bus systems. The assignment of the connectors is described in detail in Chapter 5, "Interface description", on page 75.

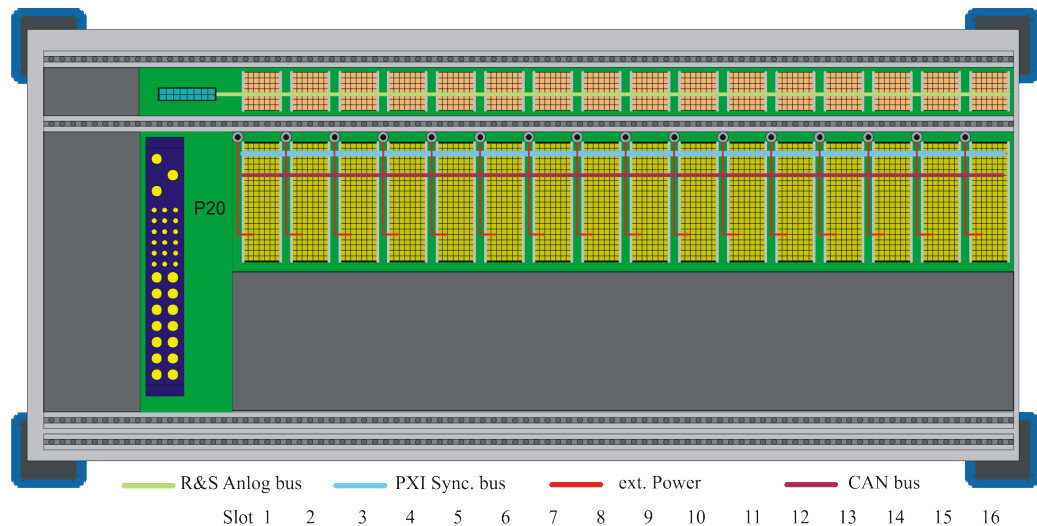

Figure 4-4: Backplanes and Bus Systems

4.2.1 Control Backplane

The control backplane is designed for 16 plug-in modules in Rohde & Schwarz format with front slots. The P2 connector of the cPCI system is used for the control interface. Pin assignment is Rohde & Schwarz-specific (designation: P20) and compatible with the R&S CompactTSVP. Thus, plug-in modules for the R&S PowerTSVP can also be operated in the R&S CompactTSVP.

Connector "X0" (P47) serves as a power interface for a cPCI standard PSU. You can plug an additional PSU onto an optional power backplane. In this case, the control backplane is connected by an ATX power supply cable.

Support for the rear I/O concept according to standard IEEE 1101.11-1998 is implemented for P20. Voltages up to 120 VDC can be routed in the rear I/O area.

The PXI trigger bus according to PXI R2.0 is also implemented.

The **CAN bus** (according to standard CAN 2.0b (1Mbit)) is integrated as the management bus, and is available at all slots. Signals CAN_L and CAN_H can be terminated with jumpers and resistors (Table 4-1). Instead of being terminated, the bus can be extended externally using the extension connector X80.

If the optional R&S TS-PXB2 backplane extension is used, the CAN bus is also available at slots A1 and A2. The R&S TS-PXB2 is connected to the main backplane via X80. Using the backplane extension does not change the termination principle.

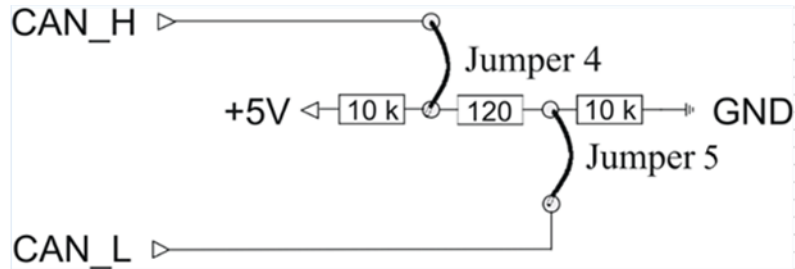

Figure 4-5: CAN bus termination

Table 4-1: CAN bus termination

Number of lines	U_{\max} (VDC)	Pin
2	5	CAN_H: P20/C1 CAN_L: P20/D1

Two additional **external signals** (e.g. supply voltages) can be fed in via a plug-in module in P20. This input can come from an internal AC/DC module or from other external signal sources. You can use this feature, for example, to provide a primary voltage for generating local supply voltages (DC/DC converter).

Table 4-2: External additional signals

Number of lines	U_{\max} (VDC)	$I_{\max}/\text{slot(ADC)}$	Pin
2	60	2	input for ext. signals: P20: AUX1 B20, E19 P20: AUX2 A20, D19

Lines with +5 V and +12 V are taken from connector X0 (P47) to optional threaded studs. This makes it easy to connect AUX1 to +5 V and AUX2 to +12 V, e.g. using an optional bus bar or cable (see [Figure 4-6](#)).

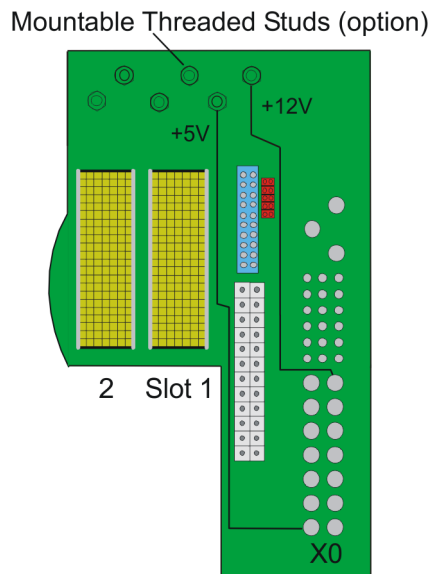

Figure 4-6: Mountable threaded studs on the control backplane

4.2.2 Analog bus backplane

To simplify cabling, the R&S PowerTSVP contains an analog bus with 8 signals. The analog bus backplane is located in the front above the cPCI backplane. A special layout meets the need for high crosstalk damping and low capacitance of the signal lines to GND.

The C module (2 mm connector system) is used as the connectors (X1...X16). Plug-in modules with no analog bus connector access the analog bus via a 26-pin connector (X22) and R&S switch modules. Signals IL1_x and IL2_x (Instrument Line) are passed from slots 5 to 16 to connector X22.

The analog bus signals pass from connector X21 to connector X2 at the back of the R&S PowerTSVP (see [Chapter 3.3.2, "Rear panel view"](#), on page 46). The electrical characteristics of the analog lines are:

- Voltage 120 VDC max.
- Current 1 A max.

Concept of the Analog Bus

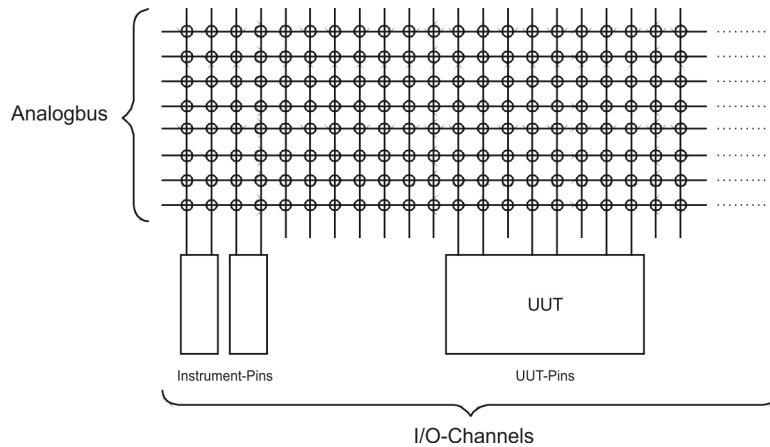

Figure 4-7: Principle of the Analog Bus

The analog bus in the R&S PowerTSVP connects I/O channels of different plug-in modules to each other. These I/O channels can be connections of instruments (measuring and stimuli devices) and connections of the test device. Up to 8 signals can be connected simultaneously (see [Figure 4-7](#)).

The analog bus can be used flexibly with the Rohde & Schwarz specific plug-in modules. 8 equivalent lines are available (ABa1, ABa2, ABb1, ABb2, ABc1, ABc2, ABd1, ABd2). External instruments are usually connected to the R&S PowerTSVP with a rear I/O connection. The signals for the test device are made available at the front-end connector of the various plug-in modules on the R&S PowerTSVP.

The analog bus can be used in different ways:

- As 1 bus with 8 lines
- As 2 partial buses with 4 lines each

Splitting the analog bus into partial buses depends on the used plug-in modules and the required application.

The analog bus concept of the R&S PowerTSVP fully meets the requirements that are frequently made in metrology:

- A small number of bus lines for a high number of I/O channels (e.g. In-Circuit-Test with 3 to 6 bus lines.)
- As many signals as possible simultaneously for a moderate number of I/O channels (e.g. function test with 8 lines of 50 to 100 I/O channels).
- Parallel test with split analog bus.

Line paths or higher-frequency signals are usually connected locally by special switching modules and not via the analog bus.

Typical use of the analog bus

The use of the analog bus and individual bus lines is illustrated with available Rohde & Schwarz modules and standard modules (see [Figure 4-8](#))

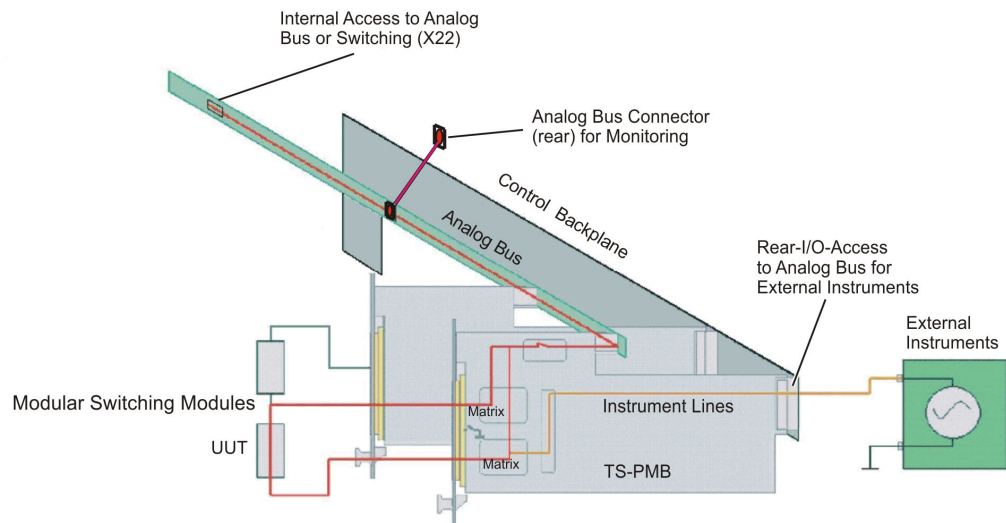

Figure 4-8: Use of the analog bus in the R&S PowerTSVP (example)

4.2.3 Power backplane (option)

The use of a second cPCI PSU in slots A1, A2 requires the optional Power Backplane (conforms to standard PICMG 2.0). From the Power Backplane, a cable with three connectors leads to a 24-pin ATX connector on the cPCI backplane. The three connectors are as follows (see also [Chapter 5.3, "Power backplane \(option\)"](#), on page 83):

- X12, 20-pin
- X13, 10-pin
- X16, 4-pin

The second PSU can be used to boost the power of the standard PSU when connected in parallel. Alternatively it can be used to supply the device on test.

4.2.4 Backplane extension R&S TS-PXB2 (option)

The R&S TS-PXB2 option expands the R&S PowerTSVP by 2 CAN bus slots (A1 and A2). It can be integrated ex works only.

The two slots are intended for the R&S TS-PIO3B or R&S TS-PTR options. The R&S TS-PIO3B is an 8-channel, 8-bit Open Collector Digital I/O card with additional functions.

The R&S TS-PTR is a passive feedthrough circuit board. It can be used to feed as many as 24 signals through the device.

Ports 5, 6 and 7 of the R&S TS-PIO3B in slot A1 are routed to connector X1 on the rear panel.

Ports 5, 6 and 7 of the R&S TS-PIO3B in slot A2 are available on connector DIO on the rear I/O slot A4.

In addition, the system CAN bus is available at the CAN connector on the rear I/O slot A4.

The option R&S TS-PXB2 cannot be used together with the power backplane. The jumpers and the assignment of the connectors in the rear I/O area are described in [Chapter 5.6, "Backplane extension R&S TS-PXB2 \(option\)"](#), on page 89.

4.3 Cabling

4.3.1 Concept

You can connect the plug-in modules to the R&S PowerTSVP and with each other using one of the following methods:

- **Inner cabling:** Cabling by bus systems permanently installed in the R&S PowerTSVP, e.g.
 - CAN bus on the control backplane
 - PXI Trigger bus on the control backplane
 - Analog bus on separate backplane
- **Internal cabling:** plug-in modules are connected to connectors inside the R&S PowerTSVP casing, e.g.
 - Cabling of Rohde & Schwarz modules to rear connectors or to each other
 - Cabling of the analog bus

Internal cabling requires the optional cabling kit R&S TS-PK04P (order no. 1157.9104.03) to be installed. The option can only be installed by Rohde & Schwarz service personnel at the factory.

- **External cabling:** Cabling outside the casing.

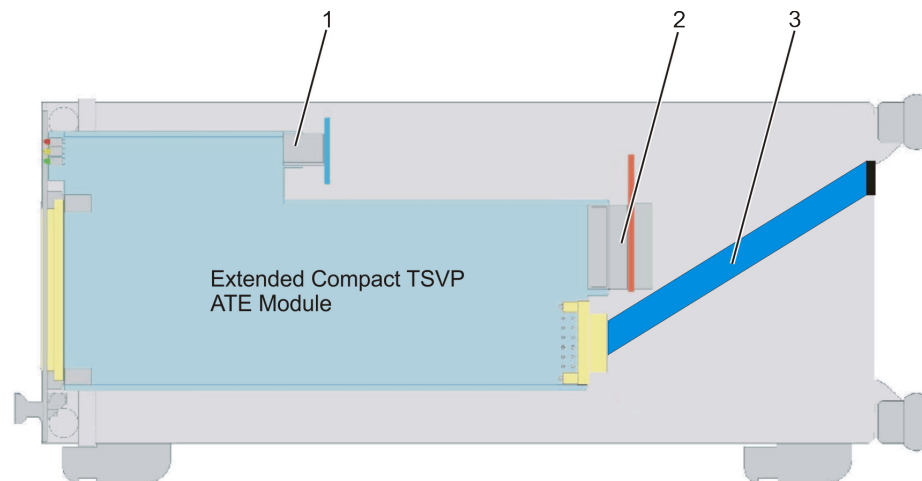

Figure 4-9: Inner and Internal Cabling Variants

- 1 = Analog bus
- 2 = PXI Trigger Bus
- 3 = Cabling of Rohde & Schwarz modules to rear connectors

These various cabling options provide various benefits:

- Separating the adapter side (front) from the input of external devices (rear) creates a clear signal concept with no cross-wiring outside the casing.
- Wiring is kept safe from inadvertent changes.
- The simple inner cabling concept means that modules can be quickly replaced during servicing. Bus connections are used instead of cable connections.
- System-specific connectors (e.g. D-sub) can be installed at the rear, where signals are connected to the analog bus or the adapter interface. HF signals can also be transferred this way, for example.

4.3.2 Analog bus

The analog bus is available at all slots of the R&S PowerTSVP with its own backplane. Access for plug-in modules is implemented by connectors X1 ... X16 at the various slots and is described in [Chapter 4.2.2, "Analog bus backplane"](#), on page 57. The following are available

- **8 bus-structured lines** for user-defined signal paths up to max. 120 VDC (1 A) between Rohde & Schwarz specific plug-in modules.



Only the Rohde & Schwarz plug-in modules use the analog bus directly. However external access to the analog bus is possible using the analog bus connector at the back of the unit.

4.3.3 PXI trigger bus

Measurement and switching modules can be synchronized with the PXI trigger bus. The external output of the signals is provided by the system module.

The following signals are available:

- **Trigger bus with 8 lines** (PXI_TRIG0 to 7)

4.3.4 External cabling

External cabling is used to connect measuring and stimuli devices as well as the UUT to the R&S PowerTSVP.

Consider the following concept to ensure a clear external cabling design:

- **The cabling to the UUT is at the front of the R&S PowerTSVP.**
The UUT adapter is located here; an adapter interface can also be flange-mounted, if necessary.
- **The cabling to measuring and input devices is at the rear of the R&S PowerTSVP.**
Install system and user-specific terminals and plug and socket connectors at the rear (see [Chapter 3.3, "Instrument tour"](#), on page 45).

This concept ensures a high degree of clarity, rapid adaption to different test tasks and allows the simple replacement of plug-in modules.

4.4 Ground concept

An electrically conductive CHA-GND (casing GND) pad in the mounting area on the cPCI backplane provides an impedance grounding to the casing. Screw connections and a busbar on the cPCI backplane are used to make a low-resistance connection for GND and CHA-GND, while a star connection between GND and CHA-GND using a busbar prevents unwanted ground loops.

A capacitor creates the HF connection between GND and CHA-GND at each slot. A 1 M Ω resistor discharges the capacitors and dissipates static.

A 3-pin connector provides the 230 VAC supply for the PSU on the control backplane (at X0).

The optional power backplane is supplied with AC voltage parallel to the cPCI backplane.

The PE conductor must be bonded to the casing with a grounding cable.

The GND signal of the analog bus backplane is connected by a cable and screw terminal to the GND on the cPCI backplane. This prevents the large induction loops that would occur if a return via casing were to be used.

The ground screen of the analog bus between two basic frames is connected to CHA-GND (casing).

In the second frame, CHA-GND must not be connected to GND to prevent ground loops. The connections are indicated in [Figure 4-10](#).

GND sense of +5 V and +3.3 V (of the second PSU as well) are connected to GND at the grounding star point.

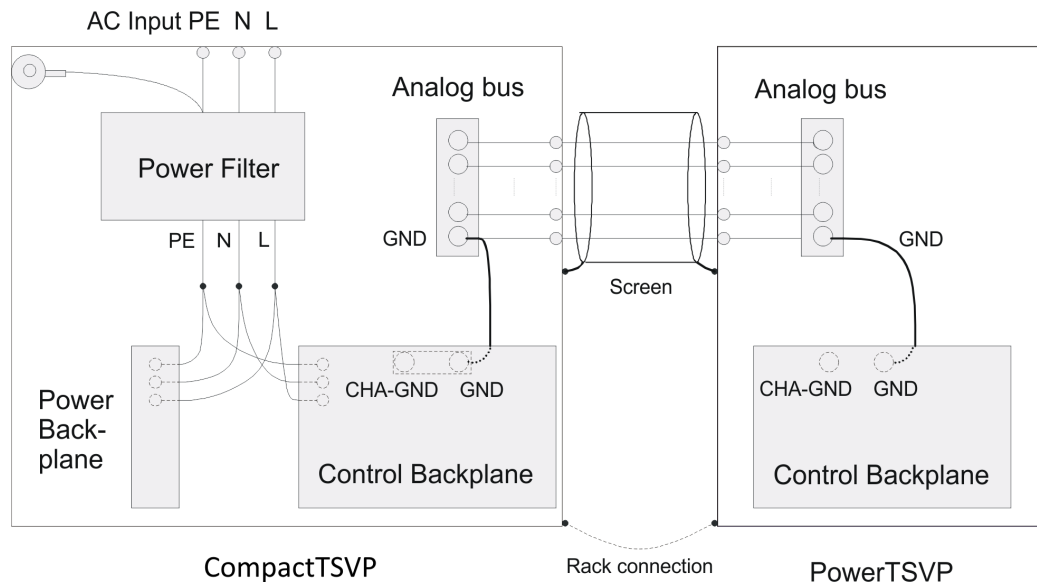

Figure 4-10: Ground Concept

4.5 Geographical addressing of the slots

The physical slot addresses are coded by the signals GA0 to GA5 (see the cPCI specification). For slot 1, GA0 to GA3 are connected to "GND". To distinguish between slots of different connected R&S PowerTSVP basic units, GA4 and GA5 are configured with jumpers (see jumper field in [Chapter 5.4, "Interfaces of the R&S TS-PSYS2"](#), on page 86).

The coding for slot recognition is carried out with GA0 to GA3 as follows:

Slot	Code
1	0000
2	0001
3	0010
4	0011
5	0100
6	0101
7	0110
8	0111

Slot	Code
9	1000
10	1001
11	1010
12	1011
13	1100
14	1101
15	1110
16	1111

Note:

0: Pin connected to GND via resistor

1: Pin open

4.6 CAN bus

Some Rohde & Schwarz modules are controlled by the CAN bus in R&S PowerTSVP.

The CAN bus is numbered according to the following scheme:

CANu::v::w::x

where:

- u = Board number
- v = Controller number
- w = Device number
- x = Slot number

Board number and controller number are always 0. The device number of the frame is determined by the settings of the jumpers on the backplane (see [Chapter 4.7, "Configurations with several frames or option R&S TS-PXB2"](#), on page 65). For rear-I/O modules like R&S TS-PSYS1 and R&S TS-PSYS2, add a 4 to the device number.

Example:

CAN0::0::5::15

Board number: 0

Controller number: 0

Device number: 5 (device 1, rear-I/O)

Slot number: 15

The following table shows the jumper configuration for the bus terminations CAN1 (System) and CAN2 (User).

Configurations with several frames or option R&S TS-PXB2

Table 4-3: CAN bus termination

Module	CAN bus	Open	Terminated
R&S PowerTSVP	CAN1 (System)	Jumper J3 Jumper J4 open	Jumper J3 Jumper J4 closed
R&S PowerTSVP	CAN1 (System)	Jumper J4 Jumper J5 open	Jumper J4 Jumper J5 closed
R&S TS-PSYS1, R&S TS-PSYS2	CAN1 (System)	Jumper JP6 open	Jumper JP6 closed
R&S TS-PSYS1, R&S TS-PSYS2	CAN2 (User)	Jumper JP7 open	Jumper JP7 closed

4.7 Configurations with several frames or option R&S TS-PXB2

In [Figure 4-11](#), the terminating resistors are indicated in yellow.

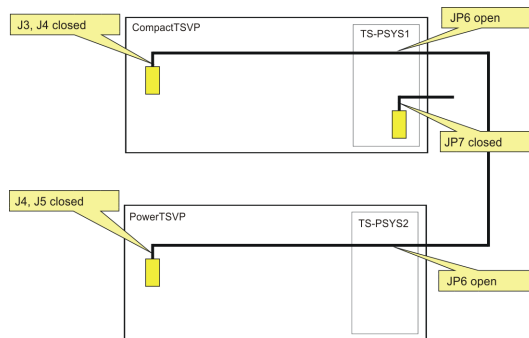
**Figure 4-11: Configuration example R&S CompactTSVP and R&S PowerTSVP**

CAN1 (System) is connected between the two frames using an optional R&S TS-PK02 cable. The termination is carried out on both backplanes. The jumpers on the system modules R&S TS-PSYS1 and R&S TS-PSYS2 have to be left open.

According to [Chapter 4.5, "Geographical addressing of the slots"](#), on page 63, the jumpers for device addressing must be set as follows:

R&S CompactTSVP: J1 set -> Device 1

R&S PowerTSVP: J1 not set, J2 set -> Device 2

Table 4-4: Device addressing R&S PowerTSVP

J1 (GA4)	J2 (GA5)	Device
set	set	1
not set	set	2

J1 (GA4)	J2 (GA5)	Device
set	not set	3
not set	not set	4

The optional R&S TS-PXB2 backplane extension also uses the CAN bus. For the modules plugged there (only R&S TS-PIO3B or R&S TS-PTR permitted), GA4 and GA5 can also be configured via jumpers. Thus, the optional R&S TS-PXB2 backplane extension behaves like a complete device for the CAN bus.

[Table Device addressing for R&S TS-PXB2](#) is applicable to the optional R&S TS-PXB2 backplane extension:

Table 4-5: Device addressing for R&S TS-PXB2

X11 (GA4)	X10 (GA5)	Device
set	set	1
not set	set	2
set	not set	3
not set	not set	4

If the optional R&S TS-PXB2 backplane extension is used in the R&S CompactTSVP, X10 (GA5) can remain set. X11 (GA4) can be plugged in the same way as on the main backplane. Thus, the addressing range of the CAN bus is expanded to slot codes 0000 (slot A1) and 0001 (slot A2).

If the optional R&S TS-PXB2 backplane extension is used in the R&S CompactTSVP, the R&S TS-PXB2 must be configured as a new "device" to prevent addressing collisions with slots 1 and 2.

4.8 Switching the PSU

Signal PS-ON is used to switch the PSU outputs on and off. To do so, remove jumper 3 (see jumper field in Section 8) and replacing it by an external switch. Signal PS-ON is available at expansion connector X80.

4.9 Cooling

The R&S PowerTSVP features a powerful cooling concept.

The slots at the front (and optionally, in the rear I/O area) are cooled by a vertical flow of air. The fans are located above the slots and are connected by inline contact connectors to the backplane. The fan speed is regulated by the internal temperature.

For the rear I/O area, fans can be retrofitted in the factory using the R&S TS-RFAN option.

The R&S TS-RFAN fan unit is especially required in the following cases:

- If specific modules in the rear I/O area require extra cooling.
- If the R&S PowerTSVP is not operated in standard horizontal position.

4.10 Option R&S TS-PK04P

If the optional R&S TS-PK04P (1157.9104.03) cable set is installed in the casing, some channels of suitable switch modules (R&S TS-PSM1, R&S TS-PSM3, R&S TS-PSM4 and R&S TS-PSM5) are accessible via the connectors X3 and X4 on the rear side of the casing. For this purpose, the switch module must be installed in slot 16.

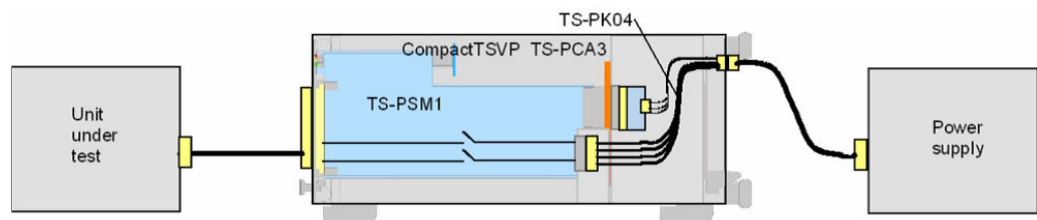

Figure 4-12: R&S TS-PSM1 with equivalent cable set in a R&S CompactTSVP

With installed option R&S TS-PK04P, the switch modules R&S TS-PMB and R&S TS-PSM2 cannot be operated in slot 16.

4.11 System module R&S TS-PSYS2

4.11.1 General

The R&S TS-PSYS2 is in the **Rear I/O slot 15** of the R&S PowerTSVP.

System functions such as voltage and temperature monitoring, switchable trigger signals and optocoupler interface are used to integrate the R&S CompactTSVP and R&S PowerTSVP in a complete system.

The module is available in two variants:

- R&S TS-PSYS2 1157.8508.02 (obsolete)
- R&S TS-PSYS2 1157.9910.20

The R&S TS-PSYS2 1157.9910.20 module is constructed identically to the R&S TS-PSYS1 1157.9910.10 module. The difference is in the programming of the flash memory. If the module operates in a R&S PowerTSVP, the function of the PCI port is automatically deactivated. Also in this mode the CAN controller is not available.

4.11.2 Characteristics

Characteristics of the R&S TS-PSYS2

- RTM type
- System functions via CAN node (microcontroller)
 - Voltage monitor
 - Temperature measuring (internal)
 - Output of the PXI trigger signals to the exterior
 - 4 optocoupler outputs
 - 4 optocoupler inputs
 - 2 switchable, short-circuit proof output voltages
 - System identification
- Available CAN Controller (CAN2 User)
- Manual selection of the local or external system clock, and its buffering with jumper

4.11.3 Circuit diagram of the R&S TS-PSYS2

Figure 4-13 shows the circuit diagram of the R&S TS-PSYS2.

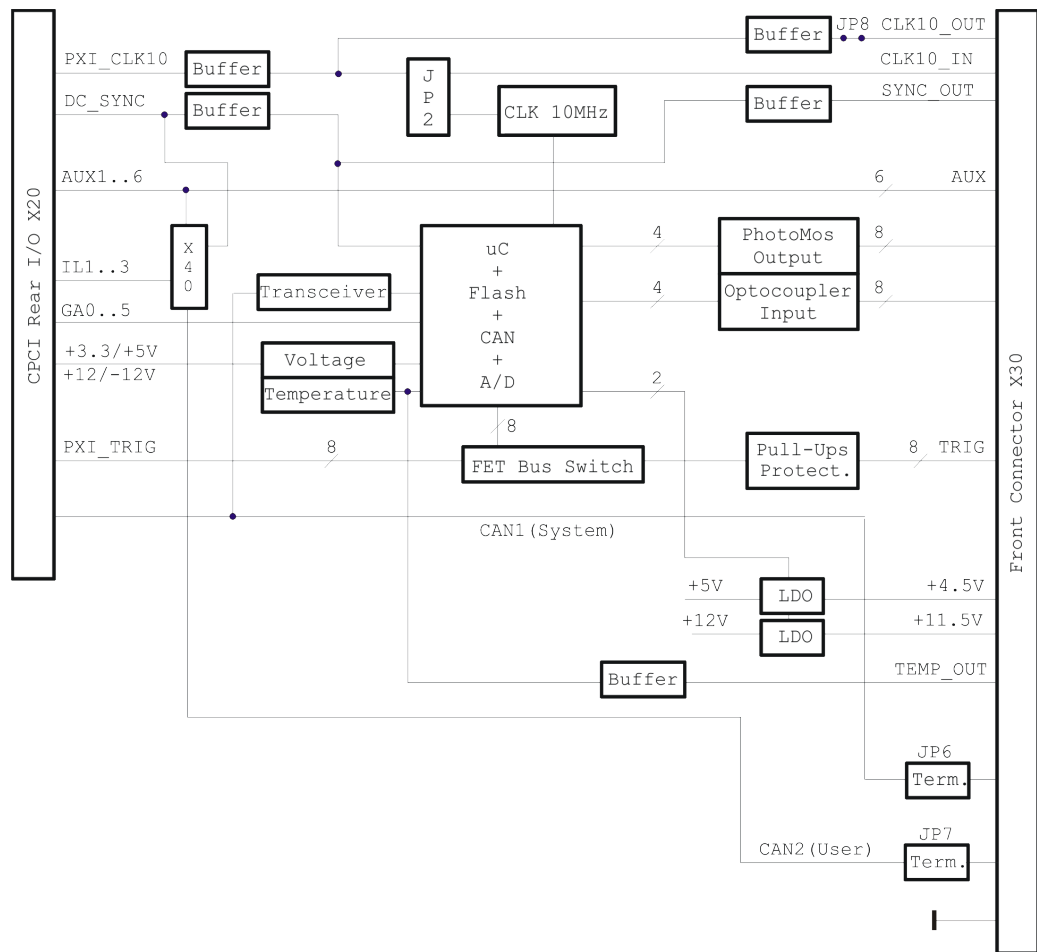

Figure 4-13: Circuit Diagram of the R&S TS-PSYS2

4.11.4 Structure of the R&S TS-PSYS2

The R&S TS-PSYS2 is the size of a standard cPCI-RTM (Rear Transmission Module) and is mounted in slot 15 at the rear of the R&S TSVP chassis.

Connector X20 is used to make the connections to the rear I/O side of the control backplane in the R&S PowerTSVP. Connector X30 is a 44-pin D-sub socket (High Density).

Jumper field X40 as well as the Jumpers JP2, JP6, JP7 and JP8 are placed on the circuit board.

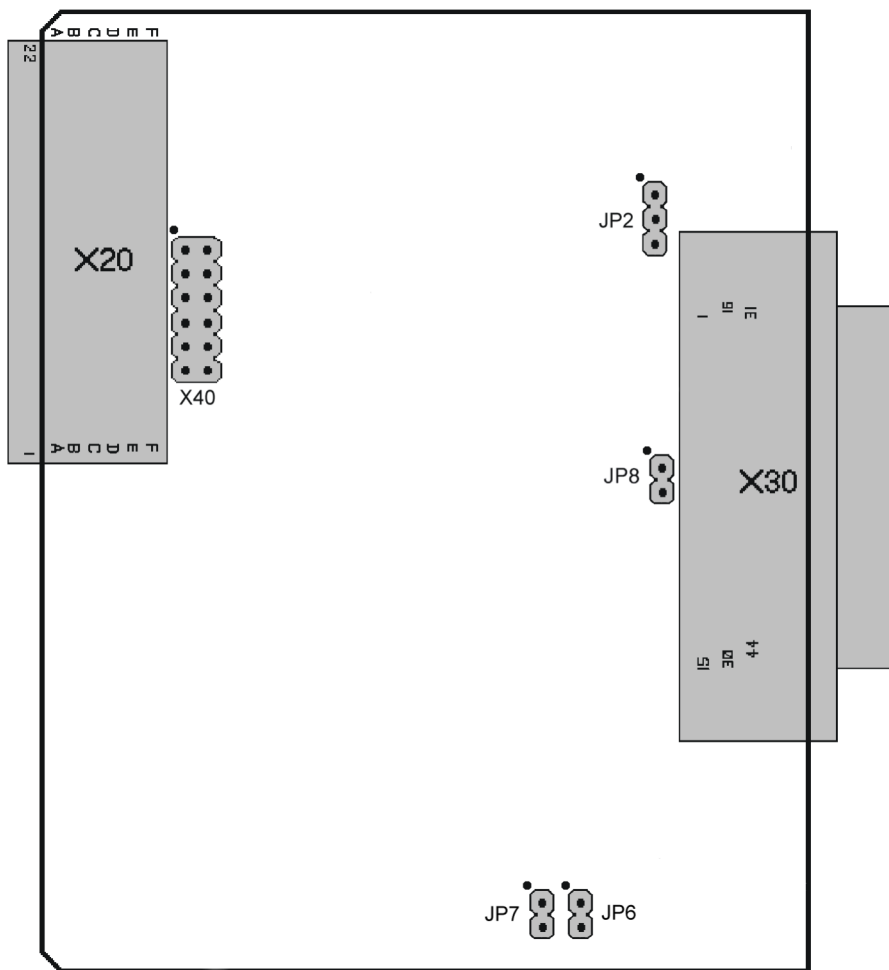

Figure 4-14: Connectors and Jumpers on the R&S TS-PSYS2 1157.8508.02

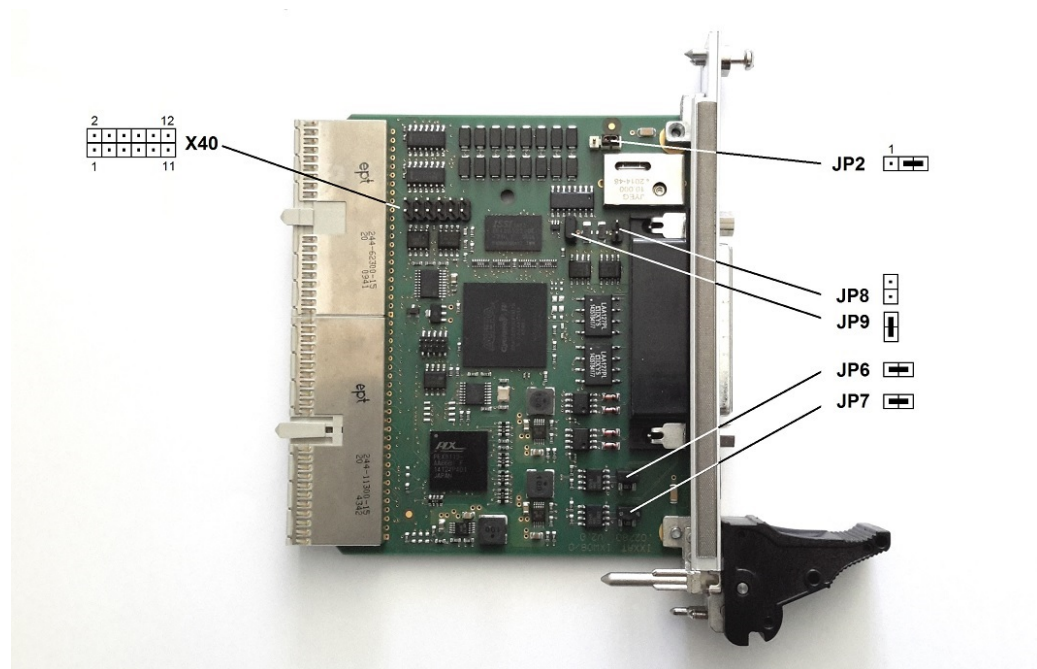

Figure 4-15: Jumper R&S TS-PSYS2 (1157.9910.20)

Table 4-6: Connectors on the R&S TS-PSYS2

Symbol	Use
X20	Rear I/O
X30	Front Connector
X40	Jumper field Rear I/O signals

4.11.5 Functional description of the R&S TS-PSYS2

See also [Figure 4-13](#).

4.11.5.1 Control

The R&S TS-PSYS2 is controlled via CAN.

The CAN lines are terminated manually with a jumper on the R&S TS-PSYS2 (see [Chapter 5.4, "Interfaces of the R&S TS-PSYS2"](#), on page 86).

4.11.5.2 System functions

The system functions are implemented by an 8-bit microcontroller which operates at a 10 MHz system speed. It communicates with the system controller in the R&S CompactTSVP or PC across the CAN1 port. The following functions are available:

- 8 x enable of PXI trigger signals to the outside (e.g. R&S PowerTSVP)

- 4 x optocoupler outputs (for PLC or handling systems)
- 4 x optocoupler inputs (for PLC or handling systems)
- 2 x enable for additional supply voltages
- 4 x measurement of the cPCI supply voltages
- 1 x measurement of the internal temperature

PXI trigger

The input/output of trigger signals (X20) is controlled separately for each signal. On the output side, the signals are terminated by pullup resistors and protected by self-healing fuses and d.c. clamp diodes. The external trigger lines are available at connector X30.

Floating outputs

4 PhotoMos relays (with internal current limiter) are triggered by a μ C port. The signals are available at connector X30.

Floating inputs

A μ C port reads the status of 4 optocoupler inputs (2 x 2-pin). The current at the inputs is limited so that inputs signals can be fed in unconditioned within a wide voltage range. These inputs are available at connector X30.

Output voltages

Two voltage regulators with output-enable control generate switchable, short-circuit proof voltages at X30. These voltages can be used to supply external components (e.g. signal lamps).

Dependent on variant, the following voltages are provided:

Table 4-7: R&S TS-PSYS2 1157.8508.02

X30.20	4.5 V
X30.21	11.5 V

Table 4-8: R/S TS-PSYS2 1157.9910.20

X30.20	5.0 V
X30.21	12.0 V

Measuring the cPCI supply voltages

The supply voltages present at connector X20 (+5 V / +12 V / -12 V) are measured with the A/D ports of the microcontroller.

Temperature measurement

An A/D port of the microcontroller is used to measure the ambient temperature of the plug-in module. A temperature-to-voltage converter is used as the sensor. The temperature-proportional analog voltage is also output at connector X30 for monitoring purposes (TEMP_OUT).

Geographical addressing

Each slot is assigned its own digital slot code (GA code). This code is used internally to address the μ C directly.

4.11.5.3 System clock

A local quartz crystal generates the 10 MHz system clock for the system (PXI_CLK10). Alternatively a very accurate reference clock can be fed in across X30. Jumper JP2 is used to select an internal or external clock source. The jumper functions are shown in [Chapter 5.4, "Interfaces of the R&S TS-PSYS2"](#), on page 86.

4.11.5.4 Signal looping

Several signal lines are looped from connector X30 to connector X20. They are used to input/output Rear I/O signals (e.g. for the Rohde & Schwarz switching modules R&S TS-PMB, R&S TS-PSAM).

Number Lines	Signal Name	Current Carrying Capacity
2	AUX1 to 2	3 A
4	AUX3 to 6	1.5 A

4.11.5.5 Local signal outputs

Special signals of the R&S PowerTSVP can be connected to connector X20 (Rear I/O) with the help of jumper field X40. The jumper functions are described in [Chapter 5.4, "Interfaces of the R&S TS-PSYS2"](#), on page 86.



Jumpers only permitted when system voltages are < 60 VDC.

Number Lines	Signal Name	Current Carrying Capacity
3	AUX4 to 6	1.5 A
3 (6)	IL1 to 3	1.5 A
2	CAN2	

4.11.5.6 User CAN controller

The bus lines of the CAN2 controller are available for the X30 connector (CAN2_H, CAN2_L).

In addition, with the jumpers on X40, the lines can be brought to the front-module R&S TS-PMB in the slot 15, see [Chapter 5.4, "Interfaces of the R&S TS-PSYS2"](#), on page 86.

The user CAN controller in the R&S CompactTSVP can be operated via the RSCAN software module.

4.11.6 Driver software

The local microcontroller is controlled by the CAN1 bus and the Rohde & Schwarz-specific protocol.

The following software modules are installed during R&S GTSL installation:

- RSCAN
- RSPSYS

The CAN2-bus can be used for user-specific setups with the help of the RSCAN functions.

4.11.7 Self-Test

The module R&S TS-PSYS2 has no built-in self-test capability. The function of the internal CAN bus can be checked with the local CAN node.

5 Interface description

5.1 Control backplane

5.1.1 Position of interfaces

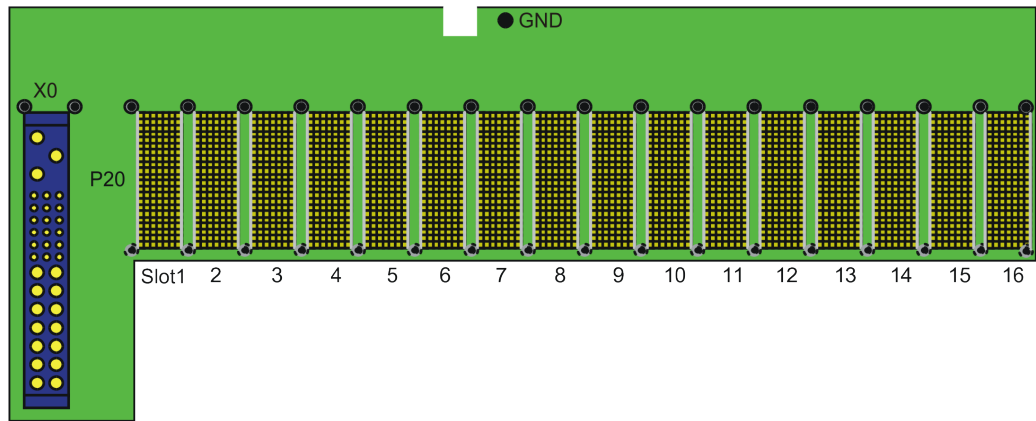

Figure 5-1: Control backplane (front view)

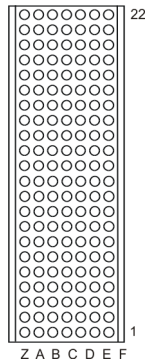

Figure 5-2: Connector P20 rear (mating side)

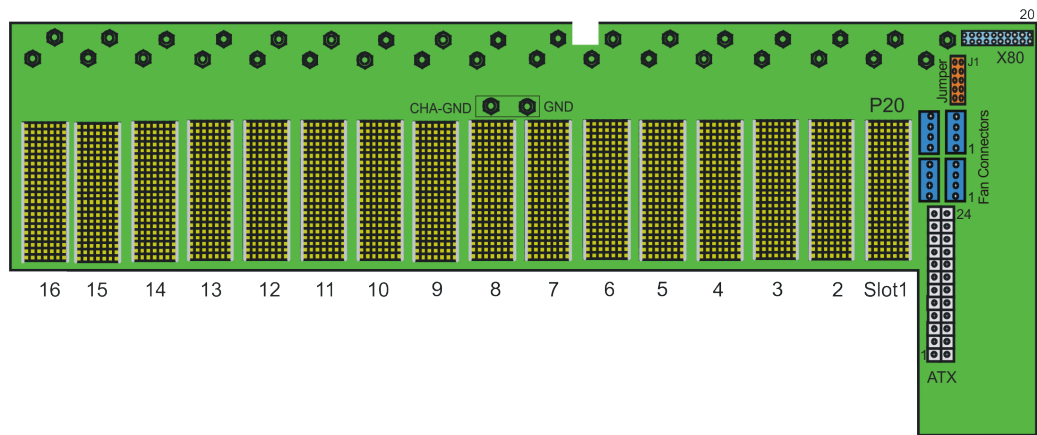

Figure 5-3: Control backplane (rear view)

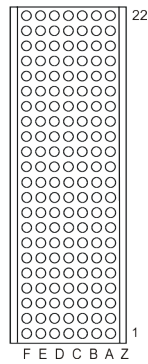

Figure 5-4: Connector P20 rear (mating side)

Note: The count sequence is the mirror image of the front.

5.1.2 Connector p20 (slots 1 to 16)

NC = not connected, NP = not populated, BPIO = Backpanel I/O

Pin	Z	A	B	C	D	E	F	
22	GND	GA4	GA3	GA2	GA1	GA0	GND	P20
21	GND	PXI_LBR0	GA5	PXI_LBR1	PXI_LBR2	PXI_LBR3	GND	
20	GND	PXI_LBR4 AUX2	PXI_LBR5 AUX1	PXI_LBL0	GND	PXI_LBL1	GND	
19	GND	PXI_LBL2	GND	PXI_LBL3	PXI_LBL4 AUX2	PXI_LBL5 AUX1	GND	
18	GND	PXI_TRIG3	PXI_TRIG4	PXI_TRIG5	GND	PXI_TRIG6	GND	
17	GND	PXI_TRIG2	GND	RSV AUX3	PXI_STAR AUX4	PXI_CLK10	GND	
16	GND	PXI_TRIG1	PXI_TRIG0	RSV AUX5	GND	PXI_TRIG7	GND	
15	GND	PXI_BRVSV DCSYNC	GND	RSV AUX6	PXI_LBL6 +5V	PXI_LBR6 +5V	GND	
14	NC	AD[35] BPIO	AD[34] BPIO	AD[33] BPIO	GND BPIO	AD[32] BPIO	NC	
13	NC	AD[38] BPIO	GND BPIO	V(I/O) BPIO	AD[37] BPIO	AD[36] BPIO	NC	
12	NP	AD[42] BPIO	AD[41] BPIO	AD[40] BPIO	GND BPIO	AD[39] BPIO	NP	
11	NP	AD[45] BPIO	GND BPIO	V(I/O) BPIO	AD[44] BPIO	AD[43] BPIO	NP	
10	NC	AD[49] BPIO	AD[48] BPIO	AD[47] BPIO	GND BPIO	AD[46] BPIO	NC	
9	NC	AD[52] BPIO	GND BPIO	V(I/O) BPIO	AD[51] BPIO	AD[50] BPIO	NC	
8	NC	AD[56] BPIO	AD[55] BPIO	AD[54] BPIO	GND BPIO	AD[53] BPIO	NC	
7	NC	AD[59] BPIO	GND BPIO	V(I/O) BPIO	AD[58] BPIO	AD[57] BPIO	NC	
6	NC	AD[63] BPIO	AD[62] BPIO	AD[61] BPIO	GND BPIO	AD[60] BPIO	NC	
5	NC	C/BE[5]# BPIO	GND BPIO	V(I/O) BPIO	C/BE[4]# BPIO	PAR64 BPIO	NC	
4	NC	V(I/O) BPIO	PXI_BRVSV BPIO	C/BE[7]# BPIO	GND BPIO	C/BE[6]# BPIO	NC	
3	GND	PXI_LBR7 BPIO	GND	PXI_LBR8 +12V	PXI_LBR9 BPIO	PXI_LBR10 BPIO	GND	
2	GND	PXI_LBR11 BPIO	PXI_LBR12 +5V	UNC BPIO	PXI_LBL7 1-WIRE	PXI_LBL8 +12V	GND	
1	GND	PXI_LBL9 BPIO	GND	PXI_LBL10 CAN_H	PXI_LBL11 CAN_L	PXI_LBL12 +5V	GND	

Figure 5-5: Connector P20 up to serial number 100020 (slots 1 to 16)

Pin	Z	A	B	C	D	E	F	
22	GND	GA4	GA3	GA2	GA1	GA0	GND	P20
21	GND	BPIO	GA5	BPIO	BPIO	BPIO	GND	
20	GND	AUX2	AUX1	+5V	GND	+5V	GND	
19	GND	-12V	GND	+5V	AUX2	AUX1	GND	
18	GND	PXI_TRIG3	PXI_TRIG4	PXI_TRIG5	GND	PXI_TRIG6	GND	
17	GND	PXI_TRIG2	GND	AUX3	AUX4	PXI_CLK10	GND	
16	GND	PXI_TRIG1	PXI_TRIG0	AUX5	GND	PXI_TRIG7	GND	
15	GND	PXI_BRVSVA15	GND	AUX6	+5V	BPIO	GND	
14	NC	BPIO	BPIO	BPIO	BPIO	BPIO	NC	
13	NC	BPIO	BPIO	BPIO	BPIO	BPIO	NC	
12	NP	BPIO	BPIO	BPIO	BPIO	BPIO	NP	
11	NP	BPIO	BPIO	BPIO	BPIO	BPIO	NP	
10	NC	BPIO	BPIO	BPIO	BPIO	BPIO	NC	
9	NC	BPIO	BPIO	BPIO	BPIO	BPIO	NC	
8	NC	BPIO	BPIO	BPIO	BPIO	BPIO	NC	
7	NC	BPIO	BPIO	BPIO	BPIO	BPIO	NC	
6	NC	BPIO	BPIO	BPIO	BPIO	BPIO	NC	
5	NC	BPIO	BPIO	BPIO	BPIO	BPIO	NC	
4	NC	BPIO	PXI_BRVSVB4	BPIO	BPIO	BPIO	NC	
3	GND	RSDO	GND	BPIO	RRST#	RSA0	GND	
2	GND	RSCLK	RSA2	RSA1	RSDI	+12V	GND	
1	GND	RCS#	GND	CAN_H	CAN_L	+5V	GND	

Figure 5-6: Connector P20 as from serial number 100021 (slots 1 to 16)

5.1.3 Connector X0 (P47)

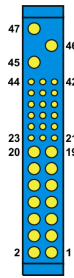

Figure 5-7: Connector X0 (P47)

Table 5-1: Assignment X0 (P47)

Pin ¹	²	Signal Name	Description
1-4	M	V1	V1 Output
5-12	M	RTN	V1 and V2 Return
13-18	M	V2	V2 Output
19	M	RTN	V3 Return
20	M	V3	V3 Output
21	M	V4	V4 Output
22	M	RTN	Signal Return
23	M	Reserved	Reserved
24	M	RTN	V4 Return
25	M	Reserved ³	
26	M	Reserved	Reserved
27	S	EN#	Enable
28	M	Reserved ³	
29	M	NC	Not connected
30	M	V1SENSE	V1 Remote Sense
31	M	Reserved ³	
32	N	NC	Not connected
33	M	V2SENSE	V2 Remote Sense
34	M	S RTN	Sense Return
35	M	V1SHARE	V1 Current Share
36	M	V3SENSE	V3 Remote Sense
<p>¹ Pin numbers illustrated are of the female backplane connector ² L=long length pins, M=medium length pins, S=short length pins ³ For future options</p>			

Pin ¹	²	Signal Name	Description
37	M	Reserved ³	
38	M	DEG#	Degrade Signal
39	M	INH#	Inhibit
40	M	Reserved ³	
41	M	V2SHARE	V2 Current Share
42	M	FAL#	Fail Signal
43	M	Reserved ³	
44	M	V3SHARE	V3 Current Share
45	L	CGND	Chassis Ground
46	M	CAN	AC Input Neutral
47	M	ACL	AC Input Line
<p>1 Pin numbers illustrated are of the female backplane connector 2 L=long length pins, M=medium length pins, S=short length pins 3 For future options</p>			

5.1.4 ATX connectors

Table 5-2: ATX connector assignment

Pin	Signal	Signal	Pin
12	V3 Current Share	V2 Current Share	24
11	5 V Sense	3.3 V Sense	23
10	+12 V	+5 V	22
9	FAL-	V1 Current Share	21
8	PW-OK	PRST-	20
7	GND Sense	GND	19
6	+5 V	GND	18
5	GND	GND	17
4	+5 V	PS-ON	16
3	GND	GND	15
2	+3.3 V	-12 V	14
1	+3.3 V	+3.3 V	13

5.1.5 Fan connectors X90, X91, X92, X93

Table 5-3: Assignment of X90 to X93

Pin	Signal
4	FANCTRL
3	+12 V
2	NC
1	GND

5.1.6 Expansion connector X80

Table 5-4: Assignment of X80

Pin	Signal	Signal	Pin
1	PS-ON	GND	2
3	PW OK	GND	4
5	RESERVED	GND	6
7	CAN_H	CAN_L	8
9	IPMB_SCL(I2C)	IPMB_SDA (I2C)	10
11	+3.3 V	GND	12
13	+5V	GND	14
15	-12V	GND	16
17	+12V	GND	18
19	+12V	GND	20

5.1.7 Jumper field

Table 5-5: Jumper field assignment

J1	GA4
J2	GA5
J3	PS-ON
J4	TERM_CAN_L
J5	TERM_CAN_H

5.2 Analog bus backplane

5.2.1 Position of interfaces

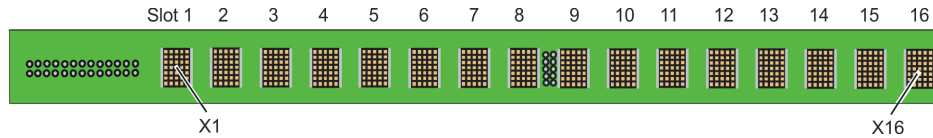

Figure 5-8: Analog bus backplane (front view)

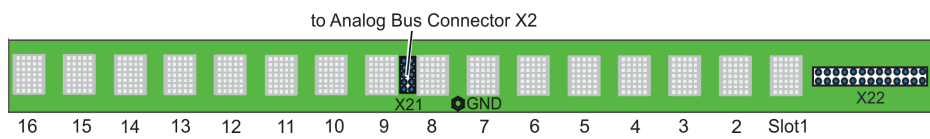

Figure 5-9: Analog bus backplane (rear view)

5.2.2 Analog bus connectors X1 to X16

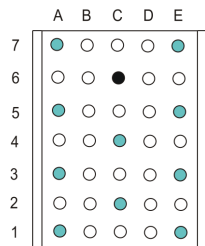

Figure 5-10: Connectors X1 to X16 (mating side)

Table 5-6: Assignment of X1 to X16

Pin	A	B	C	D	E
7	IL1_x				IL2_x *)
6			GND		
5	ABa1				ABc1
4			ABb1		
3	ABb2				ABc2
2			ABa2		
1	ABd1				ABd2

*)IL1_x = IL1 of the slot

5.2.3 Analog bus connector X21

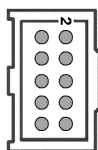

Figure 5-11: Connector X21 (mating side)

Table 5-7: Assignment of X21

Pin	Signal	Pin	Signal
1	GND	2	GND
3	ABc1	4	ABa1
5	ABc2	6	ABb1
7	ABa2	8	ABb2
9	ABd2	10	ABd1

5.2.4 Analog bus connector X22

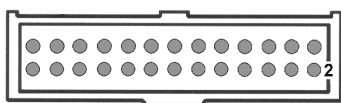

Figure 5-12: Connector X22 (mating side)

Table 5-8: Assignment of X22

Pin	Signal	Pin	Signal
1	IL1_5	2	IL2_5
3	IL1_6	4	IL2_6
5	IL1_7	6	IL2_7
7	IL1_8	8	IL2_8
9	IL1_9	10	IL2_9
11	IL1_10	12	IL2_10
13	IL1_11	14	IL2_11
15	IL1_12	16	IL2_12
17	IL1_13	18	IL2_13
19	IL1_14	20	IL2_14
21	IL1_15	22	IL2_15
IL1_5 = IL1 of slot 5			

Pin	Signal	Pin	Signal
23	IL1_16	24	IL2_16
25	GND	26	GND
IL1_5 = IL1 of slot 5			

5.3 Power backplane (option)

5.3.1 Position of interfaces

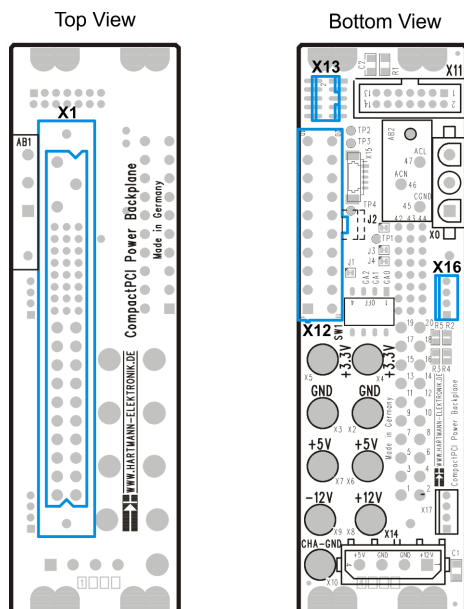

Figure 5-13: Power backplane

5.3.2 Power backplane utility connector X13

Table 5-9: Assignment of X13

Pin	Signal	Signal	Pin
1	PRST-	FAL-	6
2	DEG-	+3.3 V Sense	7
3	+3.3 V	GND Sense (3.3V)	8
4	+5V	+5V Sense	9
5	GND	GND Sense (5V)	10

5.3.3 Power backplane ATX connector X12

Table 5-10: Assignment of X12

Pin	Signal	Signal	Pin
10	+12 V	+5 V	20
9	NC	+5 V	19
8	PW-OK	NC	18
7	GND	GND	17
6	+5 V	GND	16
5	GND	GND	15
4	+5 V	PS-ON	14
3	GND	GND	13
2	+3.3 V	-12 V	12
1	+3.3 V	+3.3 V	11

5.3.4 Power backplane connector X16

Table 5-11: Assignment of X16

Pin	Signal
1	V1 Current Share
2	V2 Current Share
3	V3 Current Share
4	NC

5.3.5 Connector X1 (p47)

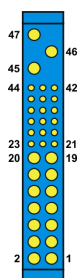

Figure 5-14: Connector X1 (P47)

Table 5-12: Assignment of X1 (p47)

Pin ¹	²	Signal Name	Description
1-4	M	V1	V1 Output
5-12	M	RTN	V1 and V2 Return
13-18	M	V2	V2 Output
19	M	RTN	V3 Return
20	M	V3	V3 Output
21	M	V4	V4 Output
22	M	RTN	Signal Return
23	M	Reserved	Reserved
24	M	RTN	V4 Return
25	M	Reserved ³	
26	M	Reserved	Reserved
27	S	EN#	Enable
28	M	Reserved ³	
29	M	NC	Not connected
30	M	V1SENSE	V1 Remote Sense
31	M	Reserved ³	
32	N	NC	Not connected
33	M	V2SENSE	V2 Remote Sense
34	M	S RTN	Sense Return
35	M	V1SHARE	V1 Current Share
36	M	V3SENSE	V3 Remote Sense
37	M	Reserved ³	
38	M	DEG#	Degrade Signal
39	M	INH#	Inhibit
40	M	Reserved ³	
41	M	V2SHARE	V2 Current Share
42	M	FAL#	Fail Signal
43	M	Reserved ³	
44	M	V3SHARE	V3 Current Share
45	L	CGND	Chassis Ground
<p>1 Pin numbers illustrated are of the female backplane connector 2 L=long length pins, M=medium length pins, S=short length pins 3 For future options</p>			

Pin ¹	²	Signal Name	Description
46	M	CAN	AC Input Neutral
47	M	ACL	AC Input Line

1 Pin numbers illustrated are of the female backplane connector
 2 L=long length pins, M=medium length pins, S=short length pins
 3 For future options

5.4 Interfaces of the R&S TS-PSYS2

5.4.1 R&S TS-PSYS2 connector X20

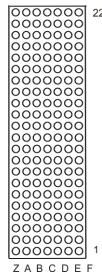

Figure 5-15: R&S TS-PSYS2 connector X20 (mating side)

NC = not connected, NP = not populated

Pin	Z	A	B	C	D	E	F	
22	GND	GA4	GA3	GA2	GA1	GA0	GND	X20 C O N N E C T O R
21	GND	PXI_LBR0	GA5	PXI_LBR1	PXI_LBR2	PXI_LBR3	GND	
20	GND	AUX2	AUX1	+5 V	GND	+5 V	GND	
19	GND	-12 V	GND	+5 V	AUX2	AUX1	GND	
18	GND	PXI_TRIG3	PXI_TRIG4	PXI_TRIG5	GND	PXI_TRIG6	GND	
17	GND	PXI_TRIG2	GND	AUX3	AUX4	PXI_CLK10	GND	
16	GND	PXI_TRIG1	PXI_TRIG0	AUX5	GND	PXI_TRIG7	GND	
15	GND	DC_SYNC	GND	AUX6	+5 V		GND	
14	NC						NC	
13	NC						NC	
12	NP						NP	
11	NP			IL1			NP	
10	NC						NC	
9	NC			IL3			NC	
8	NC						NC	
7	NC			IL2			NC	
6	NC						NC	
5	NC						NC	
4	NC						NC	
3	GND		GND				GND	
2	GND					+12 V	GND	
1	GND		GND	CAN1_H	CAN1_L	+5 V	GND	

Figure 5-16: R&S TS-PSYS2 assignment X20

5.4.2 R&S TS-PSYS2 connector X30

To connect a R&S PowerTSVP to the R&S TSPSYS2 connector X30 of a R&S CompactTSVP, only use the cable R&S TSPK02 (order no. 1166.4160.02). The ferrite must be faced toward the R&S TSPSYS1 module located in the R&S CompactTSVP.

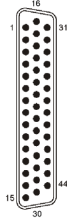

Figure 5-17: R&S TS-PSYS2 connector X30 (mating side)

Table 5-13: Assignment of X30

Pin	Signal	Pin	Signal	Pin	Signal
1	AUX1	16	CLK10_IN	31	TRIG0
2	AUX2	17	CLK10_OUT	32	TRIG1
3	AUX3	18	Reserved	33	TRIG2
4	AUX4	19	GND	34	TRIG3
5	AUX5	20	+4.5 V	35	TRIG4
6	AUX6	21	+11.5 V	36	TRIG5
7	TEMP_OUT	22	GND	37	TRIG6
8	OUT1_COM	23	OUT1_NO	38	TRIG7
9	OUT2_COM	24	OUT2_NO	39	CAN2_H
10	OUT3_COM	25	OUT3_NO	40	CAN2_L
11	OUT4_COM	26	OUT4_NO	41	CAN1_H
12	IN1_H	27	IN1_L	42	CAN1_L
13	IN2_H	28	IN2_L	43	GND
14	IN3_H	29	IN3_L	44	CHA-GND
15	IN4_H	30	IN4_L		

5.4.3 R&S TS-PSYS2 jumper field X40

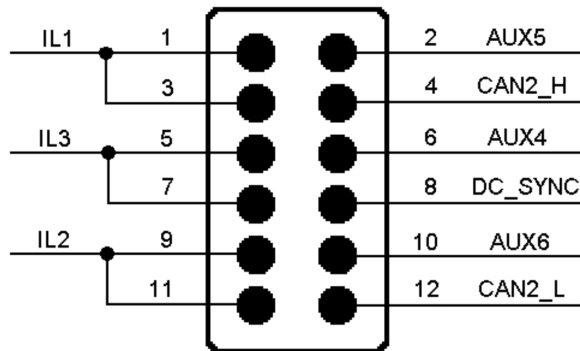

Figure 5-18: Signals at the R&S TS-PSYS2 jumper field X40

5.4.4 R&S TS-PSYS2 jumper JP2

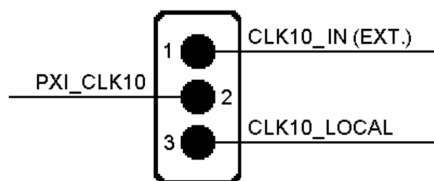

Figure 5-19: Signals at the R&S TS-PSYS2 Jumper JP2

5.4.5 R&S TS-PSYS2 jumper JP6 and JP7

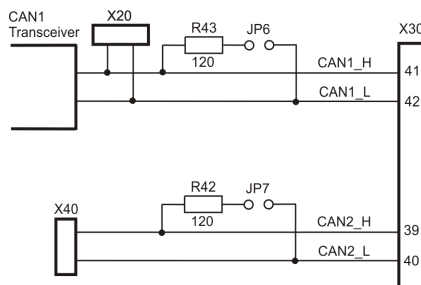

Figure 5-20: R&S TS-PSYS2 Jumper JP6 and JP7

5.4.6 R&S TS-PSYS2 jumper JP8



Figure 5-21: Signal at the R&S TS-PSYS2 Jumper JP8

5.5 External analog interface - Analog bus connector X2

The analog bus connector X2 is located at the back of the R&S PowerTSVP and is connected to analog bus connector X21 on the analog bus backplane.

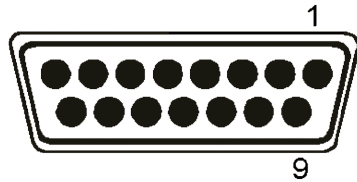

Figure 5-22: Analog bus connector X2 (mating side)

Table 5-14: Assignment of X2

Pin	Signal
1	GND
2	ABc1
3	GND
4	ABc2
5	GND
6	ABa2
7	GND
8	ABd2
9	GND
10	ABa1
11	GND
12	ABb1
13	GND
14	ABb2
15	ABd1

5.6 Backplane extension R&S TS-PXB2 (option)

5.6.1 Jumpers

X10: GA5: "0" if plugged

X11: GA4: "0" if plugged

X12: +5 V available at the rear I/O slot A4 / CAN available if plugged

5.6.2 Rear panel slot A4 / CAN

Type: 9-pin socket.

Pin	Signal
2	CAN_L
3	GND
6	GND
7	CAN_H
9	+5V

5.6.3 Rear panel slot A4 / DIO of slot A2

Type: 25-pin socket

Pin	Signal
1	A2_P5.IO0
2	A2_P5.IO2
3	A2_P5.IO4
4	A2_P5.IO6
5	A2_P6.IO0
6	A2_P6.IO2
7	A2_P6.IO4
8	A2_P6.IO6
9	A2_P7.IO0
10	A2_P7.IO2
11	A2_P7.IO4
12	A2_P7.IO6
13	GND
14	A2_P5.IO1
15	A2_P5.IO3

Pin	Signal
16	A2_P5.IO5
17	A2_P5.IO7
18	A2_P6.IO1
19	A2_P6.IO3
20	A2_P6.IO5
21	A2_P6.IO7
22	A2_P7.IO1
23	A2_P7.IO3
24	A2_P7.IO5
25	A2_P7.IO7

5.6.4 Rear panel X1 of slot A1

Type: 25-pin socket

Pin	Signal
1	A1_P5.IO0
2	A1_P5.IO2
3	A1_P5.IO4
4	A1_P5.IO6
5	A1_P6.IO0
6	A1_P6.IO2
7	A1_P6.IO4
8	A1_P6.IO6
9	A1_P7.IO0
10	A1_P7.IO2
11	A1_P7.IO4
12	A1_P7.IO6
13	GND

Backplane extension R&S TS-PXB2 (option)

Pin	Signal
14-19	not wired
20	A1_P5.IO1
21	A1_P5.IO3
22	A1_P5.IO5
23	A1_P5.IO7
24	A1_P6.IO1
25	A1_P6.IO3
26	A1_P6.IO5
27	A1_P6.IO7
28	A1_P7.IO1
29	A1_P7.IO3
30	A1_P7.IO5
31	A1_P7.IO7
32-37	not wired

6 Transporting

Lifting and carrying

See:

- ["Lifting and carrying the product"](#) on page 10
- [Chapter 3.2.1, "Lifting and carrying"](#), on page 19

Packing

Use the original packaging material. It consists of antistatic wrap for electrostatic protection and packing material designed for the product.

If you do not have the original packaging, use similar materials that provide the same level of protection.

Securing

When moving the product in a vehicle or using transporting equipment, make sure that the product is properly secured. Only use items intended for securing objects.

Transport altitude

Unless otherwise specified in the data sheet, the maximum transport altitude without pressure compensation is 4500 m above sea level.

7 Maintenance, storage and disposal

The product does not require regular maintenance. It only requires occasional cleaning. It is however advisable to check the nominal data from time to time.

We also recommend checking all electrical equipment fitted to the R&S PowerTSVP in regular intervals. Remedy any defects such as loose connections or broken cables immediately.

7.1 Self-test

As part of the R&S PowerTSVP self-test, an extensive test of the modules is performed and an exhaustive protocol generated. This is done with the "Self-Test Support Library".

The R&S TS-PSAM module is used as a measurement unit in the self-test. The functionality of the modules in the system is ensured by measurements via the analog measurement bus.

For information on starting and performing the self-test, and a detailed description of the tested parameters and procedures, refer to the service manual.

7.2 Cleaning

How to clean the product is described in "[Cleaning the product](#)" on page 11.

Do not use any liquids for cleaning. Cleaning agents, solvents, acids and bases can damage the front panel labeling, plastic parts and display.

If necessary, remove the individual plug-in modules from the R&S PowerTSVP and clean them with a vacuum cleaner.

7.3 Changing fuses

If the product does not start, a blown fuse can be the cause. The product is protected by 2 fuses of type IEC 127-T6.3H/250V (order no. 1153.6217.00). The fuse is located in the socket of the power supply (see [Chapter 3.3.2.1, "AC power supply \(1\)"](#), on page 47).

1. **WARNING!** The fuse is part of the main power supply. Handling the fuse while the power is on can lead to electric shock.

Before changing the fuse:

- a) Set the switch on the power supply to position [0].

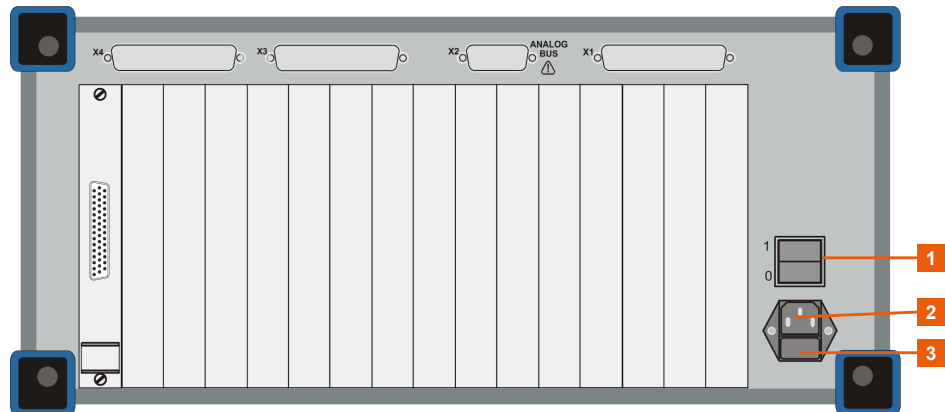

Figure 7-1: R&S PowerTSVP rear panel power supply and fuse

- 1 = Power switch
 2 = AC power supply
 3 = Fuse holder

- b) Disconnect the product from the power source.
2. Remove the fuseholder from the built-in plug.
 3. Check the condition of the fuse. Possibly, you can tell a blown fuse just by looking at it. If in doubt, test the fuse with a multimeter.
 4. Identify the cause of the problem and rectify it before replacing the fuse.
 5. Replace the blown fuse. Only use a fuse of the specified type.
 The fuse type and its characteristics are indicated next to the fuse holder.
 6. Insert the fuse holder into the mains power inlet.

7.4 Storage

Protect the product against dust. Ensure that the environmental conditions, e.g. temperature range and climatic load, meet the values specified in the data sheet.

7.5 Disposal

Rohde & Schwarz is committed to making careful, ecologically sound use of natural resources and minimizing the environmental footprint of our products. Help us by disposing of waste in a way that causes minimum environmental impact.

Disposing electrical and electronic equipment

A product that is labeled as follows cannot be disposed of in normal household waste after it has come to the end of its service life. Even disposal via the municipal collection points for waste electrical and electronic equipment is not permitted.



Figure 7-2: Labeling in line with EU directive WEEE

Rohde & Schwarz has developed a disposal concept for the eco-friendly disposal or recycling of waste material. As a manufacturer, Rohde & Schwarz completely fulfills its obligation to take back and dispose of electrical and electronic waste. Contact your local service representative to dispose of the product.

8 Contacting customer support

Technical support – where and when you need it

For quick, expert help with any Rohde & Schwarz product, contact our customer support center. A team of highly qualified engineers provides support and works with you to find a solution to your query on any aspect of the operation, programming or applications of Rohde & Schwarz products.

Contact information

Contact our customer support center at www.rohde-schwarz.com/support, or follow this QR code:



Figure 8-1: QR code to the Rohde & Schwarz support page

Glossary

C

CAN: Controller Area Network

A serial bus system whose high system and configuration flexibility is achieved by a content-oriented addressing scheme, i.e. it defines "message identifiers" and not device addresses. Systems can be added to an existing network without the need for hardware or software modifications. The CAN protocol is defined in ISO 11898.

CompactPCI: also: cPCI

An open standard of the PICMG (PCI Industrial Manufacturers Group) that adapts the PCI standard for industrial applications. It uses high-grade connection techniques and mechanical components, and applies the same electrical specifications as the PCI standard. Thus, inexpensive components and existing PCI developments can be used even under industrial conditions. Other features include a high integration density, the option of a 19" installation and shielding for the plug-in modules. Its definition as an open standard means that a large, worldwide variety of cards is available.

cPCI: [CompactPCI](#)

P

PCI-PCI bridges: Used to connect several [cPCI](#) or [PXI](#) segments, thus increasing the number of peripheral slots in cPCI or PXI systems.

PXI: PCI eXtensions for Instrumentation

A standard defined by National Instruments which expands the [CompactPCI](#), using its mechanical specifications and the connection with the system controller. The PXI standard is fully compatible and also defines various additional signals which are useful for measuring applications, such as the PXI trigger bus.

R

Rear I/O: A design that allows input and output lines of the [cPCI](#) connectors P1 and P2 to be accessed from the rear of a backplane. Pluggable Rear I/O modules can be used for this purpose in the R&S CompactTSVP and the R&S PowerTSVP.