

R&S® ZVH

Cable and Antenna Analyzer

Operating Manual



1309.6946.12 – 13

ROHDE & SCHWARZ

Make ideas real



The Operating Manual describes the following R&S®ZVH models and options

- R&S ZVH4 (1309.6800.24)
- R&S ZVH8 (1309.6800.28)
- R&S ZVH-K1 (1309.6823.02)
- R&S ZVH-K9 (1309.6852.02)
- R&S ZVH-K19 (1304.5987.02)
- R&S ZVH-K14 (1309.7007.02)
- R&S ZVH-K29 (1304.0491.02)
- R&S ZVH-K39 (1309.6830.02)
- R&S ZVH-K42 (1309.6846.02)
- R&S ZVH-K45 (1309.6998.02)

The contents of this manual correspond to firmware version 2.00 and higher.

© 2022 Rohde & Schwarz GmbH & Co. KG
Muehldorfstr. 15, 81671 Munich. Germany
Phone: +49 89 4129-0
E-mail: info@rohde-schwarz.com
Internet: <http://www.rohde-schwarz.com>

81671 Munich, Germany

Subject to change – Data without tolerance limits is not binding.

R&S® is a registered trademark of Rohde & Schwarz GmbH & Co. KG.

Trade names are trademarks of the owners.

Throughout this manual, products from Rohde & Schwarz are indicated without the ® symbol, e.g. R&S®ZVH is indicated as R&S ZVH.

Table of Contents

1	Safety Instructions	6
2	Customer Support	11
3	Documentation Overview	12
4	Conventions Used in the Documentation	14
5	Operating the R&S ZVH	15
5.1	Screen Layout and Elements	15
5.2	Means of Input	16
5.2.1	Using the Alphanumeric Keys	17
5.2.2	Confirming and Cancelling Entries	18
5.2.3	Using the Rotary Knob	18
5.2.4	Using the Cursor Keys	19
5.2.5	Remote Operation	19
5.3	Presetting the R&S ZVH	20
5.4	Configuring Measurements	20
5.5	Configuring the Instrument	21
5.6	Taking Screenshots	24
5.7	Saving Events	25
5.8	Using Antennas	27
5.9	Connecting the R&S ZVH to a PC	28
5.9.1	Connecting the R&S ZVH in a LAN	29
5.9.2	Connecting the R&S ZVH in an Existing LAN	32
5.9.3	Connecting the R&S ZVH via USB	33
5.10	Managing Datasets	34
5.10.1	Saving Datasets	36
5.10.2	Restoring Datasets	41
5.10.3	Deleting Datasets	42
5.11	Updating the Firmware	43
5.12	Installing Firmware Options	43

6	Cable and Antenna Test Mode	44
6.1	Performing Cable and Antenna Measurements	47
6.1.1	Reflection Measurements	47
6.1.2	Distance to Fault Measurements	48
6.1.3	Split Screen	49
6.1.4	1-Port Cable Loss Measurements	51
6.1.5	Transmission Measurements (R&S ZVH-K39)	52
6.1.6	Waveguide Measurements	53
6.1.7	Selecting the Measurement Format	55
6.1.8	Calibrating Measurements	56
6.2	Configuring Cable and Antenna Tests	61
6.2.1	Selecting the Cable Model	61
6.2.2	Configuring the Horizontal Axis	64
6.2.3	Configuring the Amplitude Characteristics	67
6.2.4	Configuring the Tracking Generator	69
6.2.5	Setting and Triggering the Sweep	70
6.3	Analyzing Measurement Results	73
6.3.1	Working with Traces	73
6.3.2	Using Markers	75
6.3.3	Using Display and Limit Lines	80
7	Working with the Measurement Wizard	81
7.1	Preparing the Measurement	82
7.1.1	Creating a Measurement Set	82
7.1.2	Uploading Measurement Sets	86
7.2	Using the Measurement Wizard	87
7.2.1	Starting the Measurement Wizard	87
7.2.2	Performing a Sequence of Measurements	90
7.3	Evaluating Results	93
8	Spectrum Analyzer Mode (R&S ZVH-K1)	94
8.1	Performing Spectrum Measurements	94
8.1.1	Measuring Basic Signal Characteristics	94
8.1.2	Measuring the Channel Power of Continuously Modulated Signals	95
8.1.3	Measuring the Occupied Bandwidth	99

8.1.4	Power Measurements on TDMA Signals.....	103
8.1.5	Measuring the Adjacent Channel Leakage Ratio (ACLR)	106
8.1.6	Measuring the Spectrum Emission Mask	115
8.1.7	Measuring the Harmonic Distortion	119
8.1.8	Measuring the AM Modulation Depth	121
8.1.9	Measuring Spurious Emissions	123
8.1.10	Working with the Spectrogram Result Display (R&S ZVH-K14).....	126
8.1.11	Using Isotropic Antennas.....	137
8.2	Configuring Spectrum Measurements	139
8.2.1	Configuring the Horizontal Axis	139
8.2.2	Configuring the Vertical Axis.....	143
8.2.3	Setting Bandwidths	148
8.2.4	Configuring and Triggering the Sweep	152
8.2.5	Working with Traces	158
8.2.6	Using Markers.....	163
8.2.7	Using Display Lines	167
8.2.8	Using Limit Lines.....	168
8.3	Working with Channel Tables.....	171
8.4	Using Transducer Factors	172
8.4.1	Unit for Measurements with Transducers	173
8.4.2	Setting the Reference Level	173
8.4.3	Frequency Range of Transducer.....	174
8.4.4	Data Sets Containing Transducer Factors	174
9	Power Meter (R&S ZVH-K9).....	175
9.1	Using a Power Sensor	175
9.1.1	Connecting a Power Sensor	177
9.1.2	Performing and Configuring Measurements.....	178
9.2	Using a Directional Power Sensor	181
9.2.1	Connecting a Directional Power Sensor	182
9.2.2	Performing and Configuring Measurements.....	183
9.3	Using the Internal Power Meter (R&S ZVH-K19).....	186
9.4	Performing Pulse Power Measurements (R&S ZVH-K29).....	187
9.4.1	Configuring the Numerical Result Display	189

9.4.2	Configuring the Power vs Time Result Display	190
10	Network Analyzer Mode (R&S ZVH-K42).....	194
10.1	Calibrating Measurements.....	196
10.2	Performing Scalar Measurements.....	200
10.2.1	Measuring the Transmission.....	200
10.2.2	Measuring the Reflection	202
10.3	Performing Vector Measurements	204
10.3.1	Measuring the Transmission.....	205
10.3.2	Measuring the Reflection	208
10.4	Evaluating the Results	210
10.4.1	Selecting the Measurement Format.....	210
10.4.2	Configuring the Vertical Axis.....	217
10.4.3	Using Markers.....	219
10.4.4	Working with Channel Tables	219
10.4.5	Using Limit Lines.....	220
10.4.6	Using Trace Mathematics	220
10.5	Vector Voltmeter (R&S ZVH-K45).....	221
10.5.1	Calibrating Measurements.....	222
10.5.2	Performing Measurements	223
10.5.3	Evaluating the Results	224
11	Menu and Softkey Overview	226
11.1	General Functions	226
11.1.1	General R&S ZVH Setup	226
11.1.2	File Management	227
11.1.3	Operating Mode Selection	227
11.2	Functions of the Cable and Antenna Analyzer	228
11.2.1	Frequency and Distance Parameters	228
11.2.2	Amplitude Parameters	228
11.2.3	Sweep Configuration	229
11.2.4	Markers.....	229
11.2.5	Measurement Selection and Configuration	230
11.2.6	Measurement Format Selection.....	230
11.2.7	Measurement Calibration.....	230

11.3 Functions of the Spectrum Analyzer (R&S ZVH-K1)	231
11.3.1 Measurement Selection	231
11.3.2 Frequency Parameters	233
11.3.3 Span Selection	234
11.3.4 Amplitude Parameters	234
11.3.5 Sweep Configuration and Bandwidth Selection	234
11.3.6 Trace Functionality	235
11.3.7 Display and Limit Lines	235
11.3.8 Markers	235
11.4 Functions of the Network Analyzer (R&S ZVH-K42)	237
11.4.1 Measurement Configuration	237
11.4.2 Frequency Parameters	237
11.4.3 Measurement Format Selection	237
11.4.4 Amplitude Parameters	238
11.4.5 Sweep Configuration	238
11.4.6 Trace Functionality	238
11.4.7 Limit Lines	238
11.4.8 Markers	239
11.5 Functions of the Vector Voltmeter	240
11.5.1 Vector Voltmeter Measurements	240
11.5.2 Frequency Parameters	240
11.5.3 Amplitude Parameters	240
11.5.4 Sweep Configuration	240
11.5.5 Trace Functionality	241
11.6 Functions of the Power Meter	242
11.6.1 Power Meter Measurements	242
11.6.2 Frequency Parameters	242
11.6.3 Amplitude Parameters	243
11.6.4 Sweep Configuration	243
12 How a Spectrum Analyzer Works	244
Index	249

1 Safety Instructions

The product documentation helps you to use the R&S ZVH safely and efficiently. Follow the instructions provided here and in the "Basic Safety Instructions" brochure.

Keep the product documentation nearby and offer it to other users.

Intended use

The R&S ZVH is designated for the development, production and verification of electronic components and devices in industrial, administrative, and laboratory environments. Use the R&S ZVH only for its designated purpose. Observe the operating conditions and performance limits stated in the data sheet.

Where do I find safety information?

Safety information is part of the product documentation. It warns you about the potential dangers and gives instructions how to prevent personal injuries or damage caused by dangerous situations. Safety information is provided as follows:

- The printed "Basic Safety Instructions" brochure provides safety information in many languages and is delivered with the R&S ZVH.
- Throughout the documentation, safety instructions are provided when you need to take care during setup or operation.

Safety instructions

WARNING

Risk of injury and instrument damage

The instrument must be used in an appropriate manner to prevent personal injury or instrument damage.

- Do not open the instrument casing.
 - Read and observe the "Basic Safety Instructions" delivered as printed brochure with the instrument or in electronic format on the documentation CD-ROM.
 - Read and observe the safety instructions in the following sections. Note that the data sheet may specify additional operating conditions.
 - Keep the "Basic Safety Instructions" and the product documentation in a safe place and pass them on to the subsequent users.
-

The R&S ZVH has been designed for lab operation as well as for service and maintenance applications in outdoor areas. Thus, the following safety instructions apply in addition to or contrary to the "Basic Safety Instructions" leaflet.

1. The R&S ZVH is protected against dripping water and dust (IP degree 51) and can thus be used in outdoor areas to a certain degree.
2. The R&S ZVH's max. operating altitude is 4600 m above sea level and its max. transport altitude is 12000 m above sea level.

Instrucciones de seguridad

ADVERTENCIA

Riesgo de lesiones y daños en el instrumento

El instrumento se debe usar de manera adecuada para prevenir descargas eléctricas, incendios, lesiones o daños materiales.

- No abrir la carcasa del instrumento.
- Lea y cumpla las "Instrucciones de seguridad elementales" suministradas con el instrumento como folleto impreso o en formato electrónico en el CD-ROM de documentación.
- Lea y cumpla las instrucciones de seguridad incluidas en las siguientes secciones. Se debe tener en cuenta que las especificaciones técnicas pueden contener condiciones adicionales para su uso.
- Guarde bien las instrucciones de seguridad elementales, así como la documentación del producto, y entréguelas a usuarios posteriores.

El R&S ZVH está diseñado tanto para el uso en el laboratorio como para aplicaciones de servicio y mantenimiento al aire libre. En consecuencia, las instrucciones de seguridad siguientes son aplicables de manera adicional a las "Informaciones elementales de seguridad" (folleto) o en lugar de estas en los puntos en los que diverjan.

1. El R&S ZVH está protegido contra las salpicaduras de agua y contra el polvo (IP 51), por lo que hasta cierto punto se puede usar en exteriores sin problemas.
2. La altitud máxima de funcionamiento del R&S ZVH es de 4600 m sobre el nivel del mar, mientras que su altitud máxima de transporte es de 12 000 m sobre el nivel del mar.

Sicherheitshinweise

WARNUNG

Gefahr von Verletzungen und Schäden am Gerät

Betreiben Sie das Gerät immer ordnungsgemäß, um elektrischen Schlag, Brand, Verletzungen von Personen oder Geräteschäden zu verhindern.

- Öffnen Sie das Gerätegehäuse nicht.
 - Lesen und beachten Sie die "Grundlegenden Sicherheitshinweise", die als gedruckte Broschüre dem Gerät beiliegen oder elektronisch auf der Dokumentation CD-ROM zu finden sind.
 - Lesen und beachten Sie die Sicherheitshinweise in den folgenden Abschnitten; möglicherweise enthält das Datenblatt weitere Hinweise zu speziellen Betriebsbedingungen.
 - Bewahren Sie die "Grundlegenden Sicherheitshinweise" und die Produktdokumentation gut auf und geben Sie diese an weitere Benutzer des Produkts weiter.
-

Der R&S ZVH wurde für den Einsatz im Labor sowie für Service- und Wartungseinsätze im Freien entwickelt. Deshalb gelten zusätzlich oder im Gegensatz zur Broschüre „Grundlegende Sicherheitshinweise“ die folgenden Sicherheitshinweise.

3. Der R&S ZVH ist gegen Spritzwasser und Staub geschützt (IP-Schutzart 51) und kann daher bis zu einem gewissen Grad im Freien verwendet werden.
4. Die maximale Betriebshöhe des R&S ZVH beträgt 4600 m ü. NN und die maximale Transporthöhe 12000 m ü. NN

Consignes de sécurité

AVERTISSEMENT

Risque de blessures et d'endommagement de l'appareil

L'appareil doit être utilisé conformément aux prescriptions afin d'éviter les électrocutions, incendies, dommages corporels et matériels.

- N'ouvrez pas le boîtier de l'appareil.
 - Lisez et respectez les "consignes de sécurité fondamentales" fournies avec l'appareil sous forme de brochure imprimée ou disponibles en format électronique sur le CD-ROM de documentation.
 - Lisez et respectez les instructions de sécurité dans les sections suivantes. Il ne faut pas oublier que la fiche technique peut indiquer des conditions d'exploitation supplémentaires.
 - Gardez les consignes de sécurité fondamentales et la documentation produit dans un lieu sûr et transmettez ces documents aux autres utilisateurs.
-

Le R&S ZVH a été conçu pour le fonctionnement en laboratoire ainsi que pour les applications de service et de maintenance en extérieur. Par conséquent, les instructions de sécurité suivantes s'appliquent en plus de la fiche « Consignes fondamentales de sécurité » ou s'opposent à elles.

5. Le R&S ZVH est protégé contre les projections d'eau et la poussière (niveau de protection IP 51) et peut par conséquent être utilisé en extérieur dans une certaine mesure.
6. Le R&S ZVH est utilisable jusqu'à une altitude maximale de 4600 m au-dessus du niveau de la mer, et peut être transporté à une altitude maximale de 12000 m au-dessus du niveau de la mer.

2 Customer Support

Technical support – where and when you need it

For quick, expert help with any Rohde & Schwarz product, contact our customer support center. A team of highly qualified engineers provides support and works with you to find a solution to your query on any aspect of the operation, programming or applications of Rohde & Schwarz products.

Contact information

Contact our customer support center at www.rohde-schwarz.com/support, or follow this

QR code:



3 Documentation Overview

The user documentation for the R&S ZVH is divided as follows:

Quick start guide

The quick start guide provides basic information on the instrument's functions.

It covers the following topics:

- overview of all elements of the front and rear panels
- basic information on how to set up the R&S ZVH
- information on how to operate the R&S ZVH in a network
- instructions on how to perform measurements

Operating manual

The operating manual provides a detailed description on the instrument's functions

It covers the following topics:

- instructions on how to set up and operate the R&S ZVH in its various operating modes
- instructions on how to perform measurements with the R&S ZVH
- instructions on how to work with the available software options and applications

Service manual

The service manual provides information on maintenance.

It covers the following topics:

- instructions on how to perform a performance test
- instructions on how to repair the R&S ZVH including a spare parts list
- mechanical drawings

Release notes

The release notes describe the installation of the firmware, new and modified functions, eliminated problems, and last minute changes to the documentation. The corresponding firmware version is indicated on the title page of the release notes. The current release notes are provided on the internet.

Internet site

The internet site at: <http://www.rohde-schwarz.com/product/zvh.html> provides the most up to date information on the R&S ZVH. The most recent manuals are available as printable PDF files in the download area.

Also provided for download are firmware updates including the corresponding release notes, instrument drivers, current data sheets, application notes and image versions.

Calibration certificate

The calibration certificates of your device are available online. Visit the R&S ZVH product page and select the item to download the calibration certificate. You will be forwarded to a Gloris page.

<https://gloris.rohde-schwarz.com/calcert>

Enter the device ID of your R&S ZVH and download the certificate. You can find the device ID either in the "Setup" menu or on the label on the rear panel.

4 Conventions Used in the Documentation

The following conventions are used throughout the R&S R&S ZVH operating manual:

Typographical conventions

Convention	Description
"Graphical user interface elements"	All names of graphical user interface elements both on the screen and on the front and rear panels, such as dialog boxes, softkeys, menus, options, buttons etc., are enclosed by quotation marks.
"KEYS"	Key names are written in capital letters and enclosed by quotation marks.
<i>Input</i>	Input to be entered by the user is displayed in italics.
File names, commands, program code	File names, commands, coding samples and screen output are distinguished by their font.
"Links"	Links that you can click are displayed in blue font.
"References"	References to other parts of the documentation are enclosed by quotation marks.

Other conventions

- **Remote commands:** Remote commands may include abbreviations to simplify input. In the description of such commands, all parts that have to be entered are written in capital letters. Additional text in lower-case characters is for information only.

5 Operating the R&S ZVH

This chapter provides information about basic functionality and about the user interface of the R&S ZVH.

5.1 Screen Layout and Elements

The following figure shows the screen layout in cable and antenna test operating mode. It shows all elements that are the same for all operating modes of the R&S ZVH. Screen layouts that show specifics for each operating mode or measurement are provided in the corresponding sections of this manual.



1	Measurement information	13	Trace
2	GPS status	14	Reference Position
3	Date and time	15	Active menu item
4	Battery status	16	Selectable menu item
5	Hardware settings	17	Currently selected menu item
6	GPS information	18	Unavailable menu item
7	Marker information	19	Vertical axis labeling
8	Status line	20	Selectable softkey
9	Invalid trace indicator	21	Active softkey
10	Diagram	22	Unavailable softkey
11	Horizontal axis labeling	23	Selected softkey
12	Marker		

5.2 Means of Input

The user interface of the R&S ZVH provides several elements for you to input data.

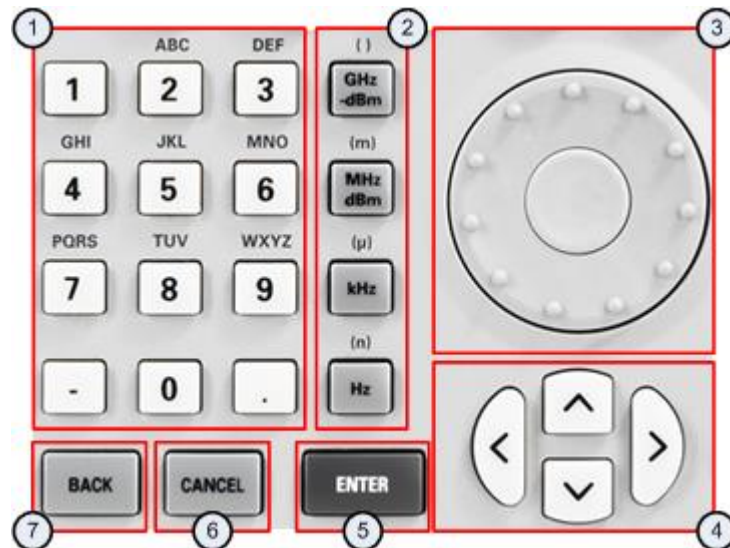

- 1 Alphanumeric keys
- 2 Unit keys
- 3 Rotary knob
- 4 Cursor keys
- 5 Enter key
- 6 Cancel key
- 7 Back key

5.2.1 Using the Alphanumeric Keys

Using the alphanumeric keys, you can enter numeric values or characters. The alphanumeric keys include the numbers from 0 to 9, the alphabet, a minus sign and dot.

If you have to enter a numeric value, press the corresponding key. In case of numeric values, each key covers just the number that's printed on it.

You can enter negative values with the minus sign key and enter values that contain decimal places with the dot key.

If the R&S ZVH asks you to enter a character or you need to enter a character (e.g. file names), the key assignment changes. Each key covers one number and more than one character with the first choice being a character. If you need to enter a character, press the key several times until the character you require is selected. The following table shows an overview of character assignment.

You can correct entries with the BACK key. The BACK key moves the cursor one position backwards and deletes the character that was in that place.

Key	1.	2.	3.	4.	5.	6.	7.	8.	9.
1	1								
2	a	b	c	2	A	B	C		
3	d	e	f	3	D	E	F		
4	g	h	i	4	G	H	I		
5	j	k	l	5	J	K	L		
6	m	n	o	6	M	N	O		
7	p	q	r	s	7	P	Q	R	S
8	t	u	v	8	T	U	V		
9	w	x	y	z	9	W	X	Y	Z
0	0	blank	_						
-	-	+							
.	.								

5.2.2 Confirming and Cancelling Entries

Depending on the input you have made, there are several ways to confirm entries.

- Values without unit or values that have a fixed unit that you enter in an input field can be confirmed with the ENTER key or by pressing the center of the rotary knob.

Alternatively, you can confirm such an entry by pressing the softkey that has opened the input field in question.

- Values that have flexible units, like frequency or time, can be confirmed with one of the unit keys.

If you confirm a such a value with the ENTER key, the R&S ZVH always uses the smallest possible unit (e.g. Hz).

- If you have opened a submenu or input field by accident, you can close it without making any changes with the CANCEL key.

5.2.3 Using the Rotary Knob

Using the rotary knob, you can do several things.

- The rotary knob works like a cursor key in dialog boxes or softkey submenus. In that case you can navigate to one of the items with the rotary knob. If the dialog box covers more than one screen page, it also scrolls through the dialog box.

Turning it to the right corresponds to a downward movement. Moving it to the left to an upward movement.

- The rotary knob increases or decreases any kind of numeric value if an input field is active.

Turning it to the right corresponds to an increase, turning it to the left to a decrease of a numeric value.

In most cases, the rotary knob changes numeric values with a fixed step size.

- The rotary knob moves markers around.

Again the step size is fixed.

- Pressing the rotary knob has the same effect as pressing the ENTER key as it confirms an entry or selection.

5.2.4 Using the Cursor Keys

Using the cursor keys, you can do several things.

- The cursor keys navigate through dialog boxes or softkey submenus.
- The up and down keys increase or decrease any kind of numeric value if an input field is active.

The cursor keys change numeric values with a fixed step size.

- The up and down keys move markers around.

The step size is fixed.

- The left and right keys move the cursor in an input field in the corresponding direction.

5.2.5 Remote Operation

Remote operation is a way to control the R&S ZVH from another device like a PC. To use the R&S ZVH this way, you have to establish a connection between both devices via the LAN or USB interfaces of the R&S ZVH.

The product range of the R&S ZVH provides several tools for remote operation.

Remote control with R&S ZVH-K40

The R&S ZVH-K40 is a firmware option to control the R&S ZVH with remote control commands that are compatible to the SCPI standard.

You can download the user manual for the R&S ZVH-K40 from the Rohde & Schwarz website.

Remote desktop with R&S InstrumentView

The remote desktop is an application provided by the R&S InstrumentView software. You can use it to access and control the R&S ZVH in the R&S InstrumentView environment.

While the R&S ZVH is running and connected to the control computer, the screen contents and control elements (keys, softkeys etc.) are displayed. Thus, you can operate the R&S ZVH just like the hardware itself.

- ▶ Connect the R&S ZVH to the control computer.
- ▶ Start the R&S InstrumentView software.
- ▶ Select "Instrument" > "Remote Display".

The software opens the remote display to operate the R&S ZVH remotely.

5.3 Presetting the R&S ZVH

Before you prepare a measurement, it is recommended to preset the R&S ZVH. During a preset, the R&S ZVH resets all settings to their default state. Restoring the default configuration has the advantage that old settings do not affect measurements.

The default setup is specific to the operating mode.

- ▶ Press the PRESET key.

The R&S ZVH restores its default setup.

You can also define your own default settings via a dataset. These are then loaded after pressing the PRESET key instead of the factory default.

- ▶ Press the SETUP key.
- ▶ Press the "User Preferences" softkey.
- ▶ Select the "Preset Dataset" menu item.

The R&S ZVH opens a dialog box to select the dataset that contains the settings you would like to have as the preset settings.

- ▶ Select the dataset with the settings you want.
- ▶ Select the "Preset Mode" menu item in the "User Preferences" dialog box.
- ▶ Select the "User Defined" item from the dropdown menu.

The R&S ZVH now loads the settings of the dataset after you press PRESET.

5.4 Configuring Measurements

The "Measurement Setup" dialog box provides an overview of the current configuration of the R&S ZVH. In addition, you can also change the configuration in this dialog box.

- ▶ Press the SETUP key.
- ▶ Press the "Measurement Setup" softkey.
- ▶ Select one of the menu items and change the settings as you like.

Note that the contents of the "Measurement Setup" dialog box are customized for each operating mode of the R&S ZVH. Therefore, the order and number of displayed settings is different in each mode.

5.5 Configuring the Instrument

The "Instrument Setup" dialog box contains functionality that is independent of the operating mode.

For more information see the "Quick Start Guide".

Protecting the R&S ZVH with a PIN

The R&S ZVH features a PIN protection system that protects the R&S ZVH from unauthorized access. If PIN protection is on, you have to enter the PIN whenever you turn the R&S ZVH on.

The protection system provides three levels of security.

- PIN made up of four digits
- Master PIN made up out of 10 digits.

When you enter the wrong PIN three times in a row, you have to enter the master PIN to unlock the R&S ZVH. By default, the master PIN is the same as the OEM master PIN, but you can define a user master PIN.

If you unlock the R&S ZVH with the user master PIN, the PIN is automatically reset to its default value ('0000').

- OEM master PIN code made up out of 10 digits.

If you

- have defined a user master PIN and enter the wrong user master PIN five times in a row or
- have not defined a user master PIN and enter the wrong PIN three times in a row,

the only remaining way to unlock the R&S ZVH is with the OEM master PIN. The OEM master PIN is a fix PIN that you receive upon delivery of your R&S ZVH. You cannot change the OEM master PIN.

NOTICE

OEM master PIN

Make sure not to lose the OEM master PIN that is delivered with the R&S ZVH and keep it in a safe place away from the instrument itself.

If you use PIN protection and forget the user PINs, the OEM master PIN is the only way you can unlock and use the R&S ZVH.

If you unlock the R&S ZVH with the OEM master PIN, the PIN and, if defined, the user master PIN are automatically reset to their default values:

'0000' (PIN) and '0000000000' (User Master PIN).

If you fail to unlock the R&S ZVH with the OEM master PIN, the R&S ZVH will force a reboot of the software until you enter the correct OEM master PIN.



Firmware update

If the R&S ZVH is protected with a PIN, a firmware update is only possible after you have entered the correct PIN.

In the initial state after delivery, PIN protection is turned off. So if you want to protect the R&S ZVH, you have to turn it on manually.

- ▶ Press the SETUP key.
- ▶ Press the "Instrument Settings" softkey.

The R&S ZVH shows the "Instrument Settings" dialog box.

PIN Code Protection	
PIN Code Protection	Off
New PIN Code	
Master PIN Code	OEM Master
New User Master PIN Code	

- ▶ Select the "PIN Code Protection" menu item.
- ▶ Press ENTER

The R&S ZVH opens an input field to define a new PIN.

PIN Code Protection New PIN:

- ▶ Enter a 4-digit PIN.

The R&S ZVH opens an input field to confirm the PIN.

PIN Code Protection Confirm PIN:

- ▶ Enter the 4-digit PIN again.

If the PIN confirmation was successful, the R&S ZVH shows a corresponding message and activates PIN protection. In that case, you have to enter the PIN every time the R&S ZVH boots.

If the PIN confirmation was not successful, the R&S ZVH shows a corresponding message and does not activate PIN protection. In that case repeat the last steps.

You can change the PIN any time you want.

- ▶ Select the "New PIN Code" menu item.

The R&S ZVH opens an input field to define a new PIN.

New PIN Code PIN Code:

- ▶ Enter the new PIN.
- ▶ Confirm the new PIN.

The R&S ZVH changes the PIN accordingly.

You can define a user master PIN the same way. By default, the user master PIN is the OEM master PIN as shown in the "Instrument Settings" dialog box.

- ▶ Select the "Master PIN Code" menu item.

The R&S ZVH opens an input field to define a user master PIN.



- ▶ Enter a 10-digit number for the user master PIN.

The R&S ZVH opens an input field to confirm the user master PIN.

- ▶ Confirm the PIN.

The R&S ZVH shows a message if the change was successful or not.

- ▶ Alternatively, select the "User Master PIN Code" menu item and enter a 10-digit PIN in the input field that opens.



5.6 Taking Screenshots

You can take and store a screenshot of the current screen anytime with the  key.

- ▶ Press the  key.

The R&S ZVH takes a screenshot.

If available, the R&S ZVH stores the screenshot on an external storage device (USB memory stick or SD card). If both are connected, the R&S ZVH uses the SD card.

If no external device is available, the R&S ZVH stores the screenshot in its internal memory (if there is enough left). In that case you can transfer the pictures with the R&S InstrumentView software to your computer.

Saving screenshot and dataset at the same time



Depending on the "Capture" settings available in the "User Preference" menu, using the  key also saves a dataset in addition to the screenshot.

For more information see "[Managing Datasets](#)" on page 34.

Screenshot file name

All screenshots get a default file name "Screenshot####". The files also get numbers (####) in ascending order, beginning with 0000. You can select a default file name and start number in the "User Preference" menu.

- ▶ Press the SETUP key.
- ▶ Press the "User Preference" softkey.
- ▶ Select the "Default Filename" and "File Name Counter Starts At" items and assign a file name and number as you wish.

Screenshot file format

The file format of screenshots is either *.png or *.jpg, depending on your configuration in the "User Preference" menu.

- ▶ Press the SETUP key.
- ▶ Press the "User Preference" softkey.
- ▶ Select the "Capture Screen Format" item to select the screenshot file format.

Previewing screenshots

If you want to make sure if a screenshot you took contains the wanted information, you can preview screenshots on the R&S ZVH.

- ▶ Press the SAVE/RECALL key.
- ▶ Press the "Recall Screenshot" softkey.

The R&S ZVH opens a dialog box to select a screenshot for the preview.

5.7 Saving Events

The R&S ZVH provides functionality that automatically saves measurement information if a certain situation or event occurs.

Saving events is possible in all operating modes.

- ▶ Press the SETUP key.
- ▶ Press the "User Preference" softkey.
- ▶ Select the "Save on Event" menu item.
- ▶ Select "On" from the "Save on Event" dropdown menu.

The R&S ZVH turns on automatic event recognition. You can select one of several events that trigger the storage of measurement data.

Data types

You can select several data types to save when an event occurs.

- A screenshot of the sweep that contains the event (.png or .jpg file)
- A dataset of the sweep that contains the event (.set file)
- ▶ Press the SETUP key.
- ▶ Press the "User Preference" softkey.
- ▶ Select the "Capture Screen" or "Capture Dataset."

If on, the corresponding information is included in the saved data.



Timing of the data capture

Note that the R&S ZVH evaluates the measured data after a sweep is done and thus detects and saves an event only after a sweep has been completed.

Event types

To use the "Save on Event" functionality, you have to select an event type that triggers the capture of the selected data. The R&S ZVH supports several event types.

- ▶ Press the SETUP key.
- ▶ Press the "User Preference" softkey.
- ▶ Select the "Event Source" menu item and select an event type from the dropdown menu.
- Time interval
Saves measurement data every <x> seconds.

You can define the duration of the time interval via the "Time Interval" menu item.

Single sweeps and sweep time



Note that it is not possible to save measurement data every $<x>$ seconds in single sweep mode, because the R&S ZVH only performs one sweep and then stops.

Note also that the time interval must be longer than the sweep time. If the time interval would be shorter, the R&S ZVH would not be able to save data, because a sweep has to be complete before the R&S ZVH is able to save the data.

- Limit failure

Saves measurement data if a limit line is violated.

The R&S ZVH provides different modes for handling limit check failures. You can select one via the "Limits Save Mode"

- Start on failure: starts to save measurement data if a limit line is violated.
- Stop on failure: stops to save measurement data if a limit line is violated.
- Save only failure: saves only the sweeps that actually fail a limit check.

- Distance interval

Saves measurement data after you have covered a certain distance.

You can define the distance that must be covered before data is saved via the "Distance Interval" menu item.

- Every sweep

Saves the data of all measurement sweeps that are performed.

Storage device

To use the "Save on Event" functionality, you need an SD card or USB stick to store the data on. The internal memory would probably not be sufficient.

- ▶ Press the SETUP key.
- ▶ Press the "User Preference" softkey.
- ▶ Select the "Recording Storage" menu item.
- ▶ From the dropdown menu, select the storage device you prefer (SD card or USB device)

5.8 Using Antennas

You can use antennas, for example, to locate the source of interferers. The R&S ZVH supports several antenna models.

- R&S HL300
Connected to the R&S ZVH at the AUX port and the RF input.
- R&S HE300
Connected to the R&S ZVH at the power sensor jack and the RF input.
- R&S HE400
Connected to the R&S ZVH at the power sensor jack and the RF input.

You can control the antenna functionality in several ways in the general setup of the R&S ZVH. For more information see the quick start guide of the R&S ZVH.

5.9 Connecting the R&S ZVH to a PC

The R&S ZVH comes with the R&S InstrumentView software package. This software package features several tools that allow you to document measurement results or create and edit limit lines or channel tables among other things.

Note that the .NET Framework 2.0 (or higher) is required on the PC to run the software properly.

You can set up a connection between the R&S ZVH and R&S InstrumentView either via its LAN port or its mini USB port.

You have to install the R&S InstrumentView software on the PC before you are able to establish a connection.

- ▶ Run the CD-ROM delivered with the R&S ZVH.
- ▶ Navigate to the "Software" section and start the setup file.
- ▶ Follow the instructions on the screen.

Alternatively, you can download the latest R&S InstrumentView from the R&S ZVH product homepage.

<http://www.rohde-schwarz.com/product/zvh.html>



Firewall settings

If no connection can be established between the software and the R&S ZVH after successful configuration, check the firewall settings on your PC.

5.9.1 Connecting the R&S ZVH in a LAN

You can connect the R&S ZVH directly to the PC with the LAN cable that is supplied with the R&S ZVH. The LAN port is located on the left side of the R&S ZVH behind a protective cap.

You can set up the LAN connection in the "Instrument Settings" dialog box.

LAN Port	
MAC Address	00-90-b8-18-d2-3f
DHCP	On
IP Address	10.114.10.174
Subnet Mask	255.255.0.0
Gateway	10.114.0.1

For a direct connection between a PC and the R&S ZVH, DHCP (Dynamic Host Configuration Protocol) has to be turned off (which is the default state).

- ▶ In the "Instrument Setup" dialog box, select the "DHCP" item.
- ▶ Press the ENTER key.
A dropdown menu to select the DHCP state opens.
- ▶ Turn DHCP on or off as required.

Setting an IP address and subnet mask

To establish a connection, the PC and the R&S ZVH have to be in the same subnet.

- ▶ Identify the subnet mask of your PC, for example in the Microsoft Windows "TCP/IP Properties".

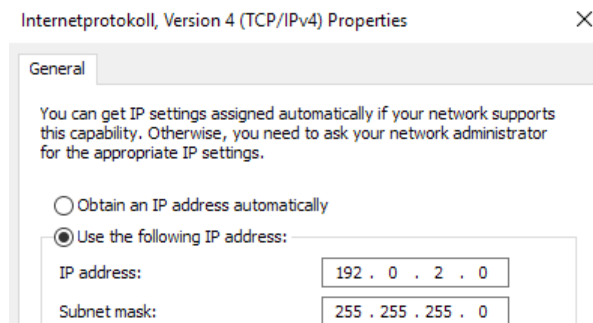

- ▶ In the "Instrument Setup" dialog box, select the "Subnet Mask" item.
 - ▶ Press the ENTER key.
 - ▶ Enter the subnet mask of the PC with the numeric keys.
- Subnet Mask** 255.255.255.0
- ▶ Confirm the entry with the ENTER key.

After you have matched the subnet mask, you can define the IP address. When both devices are in the same subnet, the first three digits of the IP address are usually the same ('192' in the example below).

Example

IP address PC	192.0.2.0
IP address R&S ZVH	192.0.2.10

- ▶ Identify the IP address of your PC, for example in the Microsoft Windows "TCP/IP Properties".

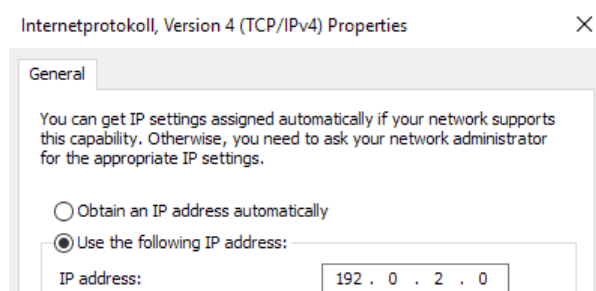

- ▶ In the "Instrument Setup" dialog box, select the "IP Address" item.



- ▶ Press the ENTER key.
- ▶ Enter the IP address of the PC with the numeric keys.
- ▶ Confirm the entry with the ENTER key.

Configuring the R&S InstrumentView software

- ▶ Start R&S InstrumentView.
- ▶ Select the "LAN" tab in the "Instrument Connect" dialog box.

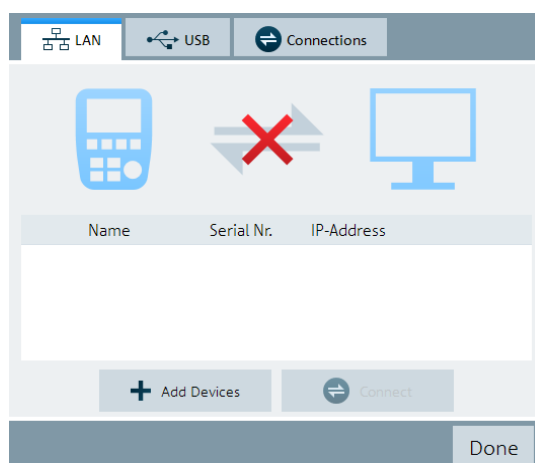

- ▶ Press the "Add Devices" button to create a new network connection.

The screenshot shows a dialog box titled "Add Single Device" with the following fields and options:

- Name:** Spectrum Analyzer
- IP Address:** 192.0.2.10 (with a "Default" button next to it)
- Network Adapter:** Ethernet (with a search icon)
- Buttons:** Ok, Cancel

- ▶ Specify a name for the new network connection, for example "Spectrum Analyzer".
- ▶ Enter the IP address for the R&S ZVH (in this case 192.0.2.10)
- ▶ Confirm the entry with the "OK" button.

The connection is now created, configured and appears in the device list.

The screenshot shows the "Connections" screen with a table of network connections:

Name	Serial Nr.	IP-Address
Spectrum Analyz	---	192.0.2.10

Buttons at the bottom: Add Devices, Connect, Done.

- ▶ Select the new connection labeled "Spectrum Analyzer".
- ▶ Press the "Connect" button to establish the connection.

5.9.2 Connecting the R&S ZVH in an Existing LAN

You can either draw the R&S ZVH IP address automatically from the DHCP server or manually assign a fixed address. With manual allocation, a fixed IP address and subnet mask must be assigned to the R&S ZVH as described in the chapter on direct LAN connection. Then the R&S InstrumentView software has to be configured as described with the assigned IP address.



Free IP address

Contact your IT system manager to get a free IP address.

In networks with a DHCP server, DHCP permits automatic allocation of the network configuration to the R&S ZVH connected via LAN cable. For this purpose, DHCP has to be active on the R&S ZVH.

DHCP is off by default. Turn it on like this:

- ▶ In the "Instrument Setup" dialog box, select the "DHCP" item.
- ▶ Press the ENTER key.

A dropdown menu to select the DHCP state opens.

- ▶ Select "On" to activate DHCP.

The R&S ZVH is now allocated an IP address and the subnet mask by the DHCP server. This can take several seconds.

The IP address and subnet mask are automatically set in the corresponding input fields and are no longer available for editing.

Configure the R&S InstrumentView software with the IP address and subnet mask as defined by the DHCP server. For more information see "[Connecting the R&S ZVH in a LAN](#)" on page 29.

5.9.3 Connecting the R&S ZVH via USB

Alternatively, you can connect the R&S ZVH to the PC with the USB cable that is supplied with the delivery. The Mini USB interface is located on the left side of the R&S ZVH behind a protective cap.

When you connect the R&S ZVH to a computer for the first time, Windows tries to install the new hardware automatically. The required drivers are installed along with the R&S InstrumentView software package.

When the drivers have been found on your system and the hardware has been successfully installed, Windows shows a corresponding message.

- ▶ Connect the R&S ZVH via the Mini USB port to your computer.
- ▶ Start R&S InstrumentView on the PC.
- ▶ Select the "USB" tab in the "Instrument Connect" dialog box.

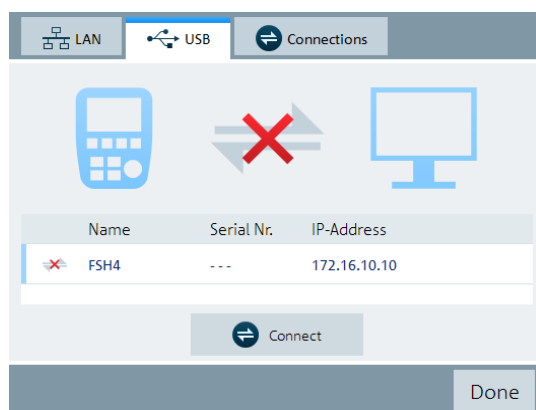

- ▶ Select the R&S ZVH connection.
- ▶ Confirm the selection with the "Connect" button.

R&S ZVH IP address



The R&S ZVH internally emulates a LAN connection. The IP address displayed by R&S InstrumentView for the USB connection is for information only. It is fixed to 172.16.10.10 and cannot be changed.

5.10 Managing Datasets

The R&S ZVH provides functionality to manage (save, restore etc.) datasets available in its internal memory or an external storage device.

Read-only files

If a file is labeled with a lock symbol in the "Stat" column of the file manager, it is read-only and therefore cannot be edited.

You can remove the read-only attribute in several ways.

- Connect the R&S ZVH to a PC and start the R&S InstrumentView software.

In the software, start the "Synchronization Control", select a file and lock or unlock the file with the corresponding buttons.



- Copy the file to a computer and remove the attribute with the Windows functionality (right click on the file, select "Properties" and remove the check from the "Read-only" checkbox).

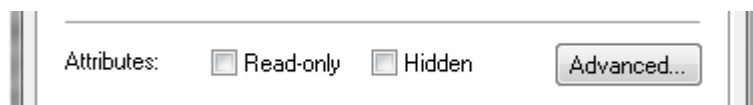

- Use the `SYSTEM:SET:UNLock` command to remove the read-only attribute. Note that you might have to select the correct directory first with `MMEM:CDIR`.

```
MMEM:CDIR '\Public\Cable Models'
SYST:SET:UNL 'xyz.cblmod'
```

Datasets

Basically, the R&S ZVH supports various types of datasets. The instructions below primarily describe managing datasets that you create on the R&S ZVH during measurements, for example measurement results and configurations. Note that these datasets have the file extension `.set`.

Datasets with the file extension `.set` are an image of measurement results and configurations. Thus, you can subsequently reproduce the context of the measurement.

You can use datasets for documentation, for example, or use them for a more detailed analysis later on (for example with the R&S InstrumentView software). Note that datasets also contain calibration data if calibration has been performed.

Templates

The R&S ZVH also supports various other types of datasets (or templates). Such templates mainly contain additional requirements for a particular measurement, like limit lines or channel tables.

Creating and editing these templates is only possible with the functionality provided by the R&S InstrumentView software package. Note that the file extension depends on the application of the template. For example, a template containing a channel table has the extension `.chnTAB`.

For more information on working with templates refer to the documentation of the R&S InstrumentView software package.

Data synchronization

The R&S InstrumentView features a data synchronization that matches the data available on the R&S ZVH and that on the computer with the R&S InstrumentView installation.

- ▶ Select "Instrument" > "Synchronization".

The software opens another dialog box to control synchronization.

By default, the software synchronizes a selected set of data, depending on the synchronization direction.

- Synchronization from PC to R&S ZVH: "To Remote" button
Updates all files on the R&S ZVH that have been created or edited with the R&S InstrumentView software package (cable models, limit lines, transducers, channel tables etc.).
- Synchronization from R&S ZVH to PC: "To Local" button
Updates all files on the PC that have been created on the R&S ZVH (datasets, screenshots and wizard results).
- Synchronization in both directions: "Synchronize" button
Updates all files on both the R&S ZVH and the PC.



Removing outdated files

When you turn on "Remove Orphans", the software removes all files from the R&S ZVH that it cannot find on the PC.

5.10.1 Saving Datasets

The R&S ZVH allows you to save the data that is currently analyzed at any time.

- ▶ Press the SAVE/RECALL key.

The R&S ZVH opens the file manager.

- ▶ Press the "Save" softkey.

The R&S ZVH opens the "Save Dataset" dialog box.



- 1 Available datasets and folder structure
- 2 Dataset name input field
- 3 Remaining memory on selected data storage device
- 4 File manager softkey menu

The folder structure shows all available data storage devices. Possible storage devices are the internal memory of the R&S ZVH, an SD card or a memory stick.

The default storage device depends on which devices are connected to the R&S ZVH.

- If an SD card is connected, datasets are always stored there first.
- If a memory stick is connected, datasets are stored there only if no SD card is connected.
- The internal memory is used only if neither SD card or memory stick are connected.

The internal memory provides approximately 20 MB of data, therefore the number of datasets you can save on the R&S ZVH is limited. Each dataset needs about 100 kB of memory, but this value can vary.

If you are using an external storage device, the number of datasets you can save is limited only by the size of the storage device.

The R&S ZVH shows the remaining memory on the storage device in the dialog box.

- ▶ Select the storage device you want to save the data to.
- ▶ Select the folder you want to save the data to.
- ▶ Enter a file name in the corresponding input field.

The default file name for datasets is "Dataset###.set" with a new number in ascending order for each new dataset. The file extension for datasets is `.set`.

If you enter another name, the R&S ZVH uses that name and assigns a new number to the file name if you save the data set the next time. This function allows you to assign consecutive dataset file names without entering a new name every time you want to save a dataset.

You can enter the file name with the alphanumeric keypad. Each key covers more than one character. To get the character you want, press the key in question the appropriate number of times.

Instead of entering a file name character by character, you can also put a name together using the quick naming feature. For more information see "[Quick Naming of Datasets](#)" on page 38.

- ▶ Press the "Save" softkey.

The R&S ZVH saves the dataset.

5.10.1.1 Saving Datasets in a .csv File

In the spectrum application, you can also export datasets as `.csv` files that you can open and evaluate with a text editor or spreadsheet. Export to `.csv` files is not supported for spectrograms.

- ▶ Press the "Save Recall" key to open the file menu.
- ▶ Select the "Export CSV" menu item to open the file manager.

When you save a dataset, the R&S ZVH automatically opens the \Datasets folder.

- ▶ If you want to save the dataset in a different folder or an external memory device, navigate to the folder you like.
- ▶ Enter the file name in the "Save As" input field.
- ▶ Confirm saving the dataset with the "Save" menu item.

5.10.1.2 Alternative Ways to Save Datasets

The R&S ZVH provides alternative and more comfortable ways to save datasets.

Using the key

You can configure the  key to take a screenshot as well as saving a dataset.

- ▶ Press the SETUP key.
- ▶ Press the "User Preference" softkey.
- ▶ Select the "Capture Dataset" item and turn it on.

If on, pressing the  key saves a dataset of the current measurement.

Pressing the  key saves the selected data of the current measurement.

Saving events

You can configure the R&S ZVH to save a dataset when an event occurs.

- ▶ Press the SETUP key.
- ▶ Press the "User Preference" softkey.
- ▶ Select the "Capture Dataset" item and turn it on.

If on, the R&S ZVH saves a dataset of the current measurement if an event occurs. For more information on events see "[Saving Events](#)" on page 25.

5.10.1.3 Renaming File Names

If necessary, you can rename files or file directories directly on the R&S ZVH.

- ▶ Enter the "File Manager".
- ▶ Select the file or directory you want to rename.
- ▶ Press the "Select Action" softkey.
- ▶ Select the "Rename" menu item.

The R&S ZVH opens an input field to change the name of the file.

5.10.1.4 Quick Naming of Datasets

The R&S ZVH provides a quick naming feature that speeds up the process of naming a file.

Putting together a file name

Basically, using the quick naming feature is a way of compiling a file name by putting one or more predefined text modules or terms together in a logical way.

The various terms are combined in a table, each cell of which contains one term. The table consists of 120 cells. You can define the contents of each cell freely.

- ▶ Press the SAVE/RECALL key.
- ▶ Press the "Save" softkey.
- ▶ Press the "Quick Naming" softkey.

The R&S ZVH opens a dialog box that contains the terms.

- ▶ Select the term you want to add with the cursor keys.

- ▶ Press ENTER to add the term to the file name.

The current file name is displayed in the line above the table.

So, if you perform, for example, an ACLR measurement of an uplink LTE signal at a certain location, you might want that information in the file name:

'Site_LTE_UL_ACLR'

Site_LTE_UL					
Location	Site	RL	Sector	UL	
		IL	A	DL	450
		VSWR	B		700
		DTF	C	GSM	850
		ISOL	D	UMTS	900
		POW	E	CDMA2000	1800
		SPECTR		EVDO	1900
		ACLR		LTE	2100
				TD-SCDMA	

- ▶ Press the "OK" softkey to exit the quick naming table.

After you have exited the table, the file name appears in the "Save as:" field in the "Save Dataset" dialog box. If necessary, you can then add additional characters.

Note that by default, the R&S ZVH adds a term without separators between each term. If you need a separator between the term, you can add a blank space or an underscore.

- ▶ After having added a term, press the "_" softkey or the "Space" softkey.

Or to add a separator automatically upon adding a term.

- ▶ Press the "Auto Insert" softkey.
- ▶ Select the "Off" menu item to add no separator, the "_" menu item to add an underscore or the "Space" menu item to add a blank space.

Designing a quick naming table

The firmware of the R&S ZVH already has some basic mobile communication terms in the table. However, you can add up to 120 terms to the table.

- ▶ Press the SAVE/RECALL key.
- ▶ Press the "Save" softkey.
- ▶ Press the "Quick Naming" softkey.
- ▶ Select one of the table cells with the cursor keys.
- ▶ Press the "Change Table Item" softkey.

The R&S ZVH opens an input field to define a term for the cell.

- ▶ Define a term with the number keys and confirm the term with ENTER.

The R&S ZVH adds the term to the table.

You can create and edit quick naming tables with the R&S InstrumentView software package and then transfer them into the internal memory of the R&S ZVH.

- ▶ In the "Quick Naming" softkey menu, press the "Import" softkey.
- ▶ Select the "Import Quick Naming Table" menu item.

The R&S ZVH opens a dialog box to select a file to import.

The same way, you can also export a quick naming table.

- ▶ In the "Quick Naming" softkey menu, press the "Export" softkey.
- ▶ Select the "Export Quick Naming Table" menu item.

5.10.2 Restoring Datasets

You can preview and load previously saved measurement results with the recall function of the R&S ZVH. This function also provides easy access to previous measurement settings so that you do not have to set up the R&S ZVH again.

- ▶ Press the SAVE/RECALL key.

The R&S ZVH opens the file manager.

- ▶ Select the dataset you want to use.

The R&S ZVH restores the configuration that the dataset contains.

By default, the most recently saved dataset is highlighted. If you need another dataset, navigate to the folder or storage device that contains the dataset you need.

5.10.2.1 Previewing a Dataset

The R&S ZVH provides a preview of datasets. The preview is like a screenshot and lets you take a quick look at that measurement and its settings. The R&S ZVH does not yet activate the measurement settings of that dataset.

- ▶ Browse through the available datasets and select the one you want.
- ▶ Press the "Recall" softkey.

The R&S ZVH shows a preview of the measurement contained in the selected dataset. The preview shows the measurement results as well as the measurement settings.

- ▶ Use the rotary knob to browse the previews of all datasets available in the selected folder.
- ▶ Press the "Exit" softkey to return to the "Recall Dataset" dialog box.

5.10.2.2 Loading a Dataset

If you find a dataset whose settings you need for your current measurement task, you can load it.

- ▶ Press the "Activate" softkey.

The R&S ZVH loads the dataset in question and adjusts its measurement settings to those of the dataset.

5.10.3 Deleting Datasets

If you have to delete a dataset, you can do so with the file manager.

- ▶ Press the SAVE/RECALL key.
- ▶ Press the "File Manager" softkey.

The R&S ZVH opens the file manager.

- ▶ In order to delete a single dataset, press the "Select Action" softkey. Select "Delete" and the dataset currently selected is deleted after your confirmation.

In order to delete multiple data sets, the respective datasets have to be marked first.

- ▶ Press the "Mark" softkey to mark files for deletion
- ▶ Select the dataset you'd like to delete.
- ▶ Mark the data sets with the ENTER key.

The selected data sets should be checked in the "Status" column.

Repeat the selection by moving the cursor with the rotary knob or the cursor key and marking more data sets with the ENTER key.

- ▶ Press the "Select Action" softkey.
- ▶ Select the "Delete" menu item and confirm with the ENTER key or the "Select Action" softkey.

Before deleting the data set, the R&S ZVH shows a warning message that you need to confirm. After confirming the deletion process the R&S ZVH deletes the selected data sets from its memory.

5.11 Updating the Firmware

You can download new firmware versions from the R&S ZVH website.

<http://www.rohde-schwarz.com/product/zvh.html>

The website also provides release notes for each new firmware version. The release notes include instructions on how to perform a firmware update.

5.12 Installing Firmware Options

You can equip the R&S ZVH with several firmware options to enable additional operating modes or special measurements.

For more information, refer to the R&S ZVH quick start guide.

6 Cable and Antenna Test Mode

The cable and antenna test (CAT) mode provides functionality to measure cables, waveguides and antennas of transmission equipment in wireless telecommunication systems.

In a perfect system, the signal would arrive at the antenna without any losses and be transmitted with the required power and frequency. In reality, however, you can encounter many possible mechanical defects in the system that cause a deterioration of the transmission quality. The figure below shows some typical defects in a transmission system.

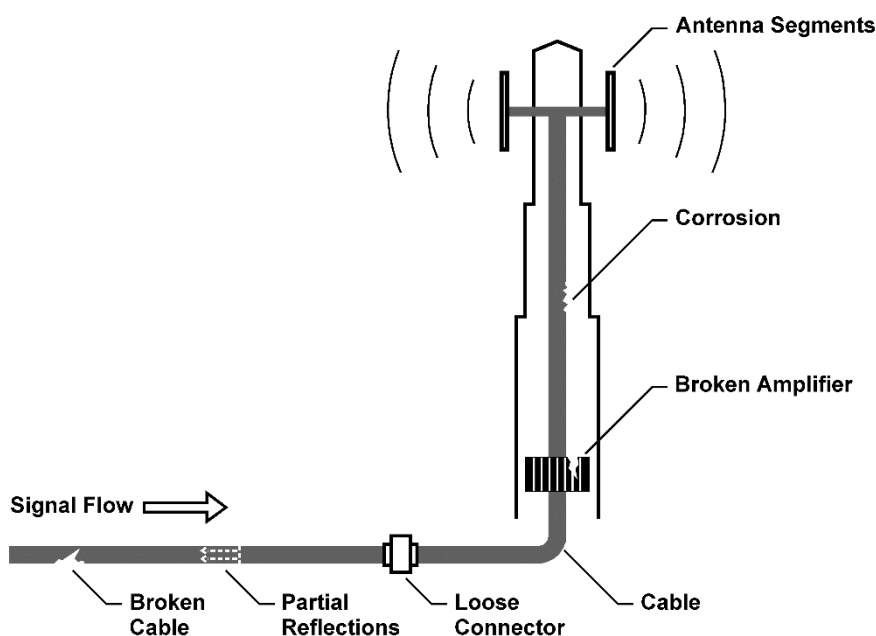

The R&S ZVH provides the necessary functionality to test the system equipment for its characteristics and identify faults when it is being installed or maintained. Each measurement provides different aspects of the test you are performing.

- [Reflection Measurements](#) on page 47
- [Distance to Fault Measurements](#) on page 48
- [1-Port Cable Loss Measurements](#) on page 51
- [Transmission Measurements \(R&S ZVH-K39\)](#) on page 52
- [Waveguide Measurements](#) on page 53

Test setup

A typical test setup to test cables and antennas includes the R&S ZVH, an RF cable (e.g. R&S FSH-Z320, order no. 1309.6600.00), a calibration standard (R&S FSH-Z28 or R&S FSH-Z29, order no. 1300.7804.03 and 1300.7504.03) and the cable under test.

Cable and antenna tests also require a tracking generator which is already part of the R&S ZVH hardware. The tracking generator transmits a reference signal through the internal VSWR bridge to the test port.

- ▶ Connect the RF cable to the RF input (port 1 or 2).
- ▶ Connect the test cable to the RF cable.
- ▶ For measurement on DUTs that need an external voltage supply (e.g. power amplifiers), you can connect the supply voltage from a suitable AC power supply to the BIAS port 1 or use the internal bias.

By default, the R&S ZVH is in cable test mode after you have turned it on. To switch to the CAT mode from another operating mode, proceed as follows.

- ▶ Press the MODE key.
- ▶ Press the "Antenna & Cable Test" softkey.

The R&S ZVH starts the antenna and cable test mode.

By default, the R&S ZVH performs measurements on port 1. It however, also supports measurements on port 2, but you have to configure those first.

- ▶ Press the MEAS key.
- ▶ Press the "Select Driving Port" softkey.
- ▶ Select either the "Port 1" or "Port 2" menu item.

Screen layout of the cable and antenna analyzer

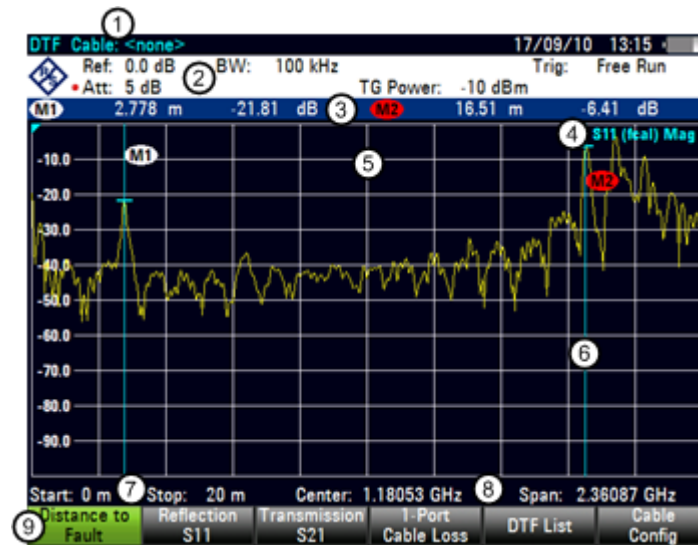

- 1 Cable model
- 2 Hardware settings
- 3 Marker information
- 4 Status line:
 - S-matrix
 - Calibration status
 - Measurement format
- 5 Trace window
- 6 Marker (blue line)
- 7 Cable length information
- 8 Cable frequency information
- 9 Cable test softkey menu

6.1 Performing Cable and Antenna Measurements

In order to get an idea about problems in a transmission system that is as exact as possible, the R&S ZVH features several measurements. Each measurement shows another aspect of the cable characteristics.

6.1.1 Reflection Measurements

The reflection (S11) measurement is a good way to get an idea if the transmission system works properly. If unusual amounts of signal power are being reflected, you can guess that there is something wrong in the system. This measurement helps to find reflections by displaying the magnitude of the reflections in dB in a specified frequency range.

The reflection measurement is the default measurement.

- ▶ Press the MEAS key.
- ▶ Press the "Reflection (S11)" softkey.

The R&S ZVH starts the reflection measurement over its entire frequency range.

The figure shows an example of a reflection measurement without any major faults in the cable or the antenna.

You can perform reflection measurements on the complete system or on individual components of the system. If you measure while two or more system components are connected, the results of the reflection measurement are an aggregate over these components. Therefore you can only see the aggregated magnitude of the reflected power in a specified frequency range.

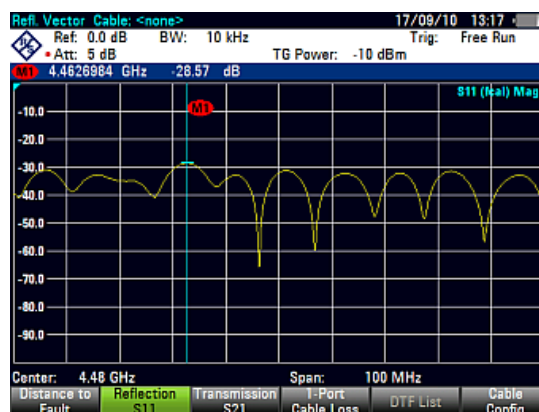

To draw conclusions about which component is affected and determine the location of the fault, you need to perform further analysis using other measurements.

6.1.2 Distance to Fault Measurements

The distance to fault (DTF) measurement determines the exact location of possible faults in a transmission system. If you connect the end of the cable to the R&S ZVH, the DTF measurement shows you the exact distance to the fault (in meter or feet), regardless by what the fault is caused. In addition, the measurement shows the degree of the fault in dB. From this information, you can determine the component that has the fault and its seriousness.

In order to determine the distance to a cable fault, the R&S ZVH measures the reflections of the cable under test in the frequency domain. The R&S ZVH first determines the magnitude of the reflections for a particular frequency by comparing the phase of the reflected signal and a reference signal created by the tracking generator. It then performs inverse fast fourier transformation (IFFT) on the signal that has been received. In combination with the characteristics of the cable model, the R&S ZVH is able to determine the distance the reflections have been travelling.

Because of its sensitivity by first measuring in the frequency domain and subsequent IFFT, the measurement is able to locate faults in a cable accurately. To keep this accuracy, the R&S ZVH also accounts for any attenuation that occurs over distance in a cable.

If you are measuring the cable only, make sure to terminate the other end into a load.

- ▶ Press the MEAS key.
- ▶ Press the "Distance to Fault" softkey.

The R&S ZVH calculates the distance to cable faults.

The figure shows the results of a DTF measurement. The peaks that the trace shows at the marker positions are possible faults. Depending on the distance, you can also get an idea of the component that is defective.

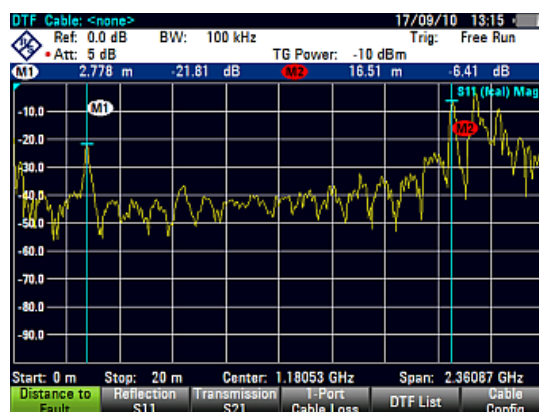

Marker 1, for example, shows a defect in the cable. Marker 2 shows a fault at the end of the cable, probably a bad or loose connection.

6.1.3 Split Screen

The split screen display shows the results of the DTF measurement and the reflection measurement at the same time in the separate diagrams. Both results (DTF and reflection) are results from the same measurement.

- ▶ Press the MEAS key.
- ▶ Press the "Other Meas" softkey.
- ▶ Select the "Distance to Fault + Reflection" menu item.

The R&S ZVH shows both the DTF and reflection results at the same time. The upper diagram contains the results for the DTF measurement. The lower diagram contains the results for the reflection measurement.



Alternatively, you can activate split screen as follows:

- ▶ Press the MEAS key.
- ▶ Press the "Distance to Fault" softkey.
- ▶ Press the TRACE key.
- ▶ Press the "Split Screen" softkey.

Configuring split screen measurements

While some settings apply to both diagrams (or traces), you can configure some settings separately for each of the two traces.

- ▶ Press the TRACE key.
- ▶ Press the "Select Trace" softkey to select either trace 1 or trace 2.

Trace 1 corresponds to the DTF results (upper diagram), trace 2 to the reflection results (lower diagram). The currently selected trace is highlighted in the area below the diagrams.

All settings are the same as in the spectrum measurement with the following benefits and restrictions.

Measurement configuration

- Calibration is the same for both diagrams.
- Cable configuration and DTF list settings only have an effect on the DTF results.
- Waveguide settings are the same for both diagrams.

Frequency characteristics:

- Frequency settings are the same for both diagrams.

Amplitude characteristics:

- Amplitude and unit settings are the same for both diagrams.
- Scale settings can be different in the two diagrams.

Bandwidths:

- Bandwidth settings are the same for both diagrams.

Sweep characteristics:

- Sweep configuration is the same in both diagrams.
- Trigger configuration is the same in both diagrams.

Trace characteristics:

- Trace mode is the same in the two diagrams.
- Memory traces and trace mathematics can be applied separately in the two diagrams.

Limit and display lines:

- Limit lines and checks can be applied separately in the two diagrams.
- Display lines can be applied separately in the two diagrams.
- If you use limit lines, the limits lines have to be on or off in both diagrams and the audio beep is also on globally.

Markers:

- Markers are positioned on the currently selected trace. For each trace, you can use up to 6 markers (markers or deltamarkers).
- Marker positioning functions are available separately.

6.1.4 1-Port Cable Loss Measurements

The cable loss measurement is a reflection measurement on an open cable. It evaluates the amount of energy that a signal loses while traveling through a cable. The amount of lost energy depends on the frequency and the length of the cable

- ▶ Press the MEAS key.
- ▶ Press the "Other Meas" softkey.

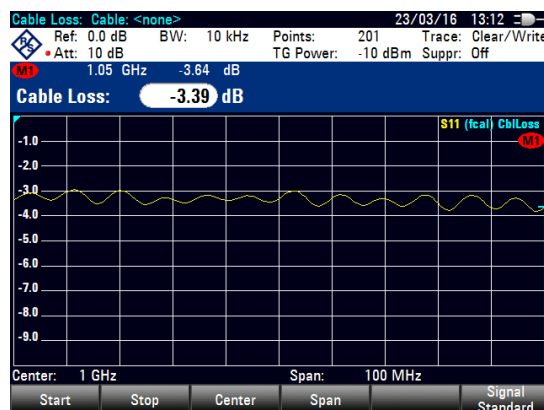

- ▶ Select the "1-Port Cable Loss" menu item.

The R&S ZVH shows the result (graphically) over the specified frequency range (span) in dB. The numerical result is the average cable loss over the specified span. The image above shows a typical cable loss result, with a steadily declining loss over the selected frequency range and several maximums and minimums.

By default, the R&S ZVH evaluates the cable loss over its entire frequency range (full span of the R&S ZVH). When you reduce the span, make sure to define a span that is appropriate for the measurement, especially for high center frequencies, and consider the cable length and the wavelength of the selected center frequency. For a typical cable loss trace, you should select a span that is large enough to evaluate at least one peak and one minimum. Otherwise, the result might not be valid.

If the cable loss is constant over a large span (for example in case of low center frequencies), you can select any span.

Note that if the cable loss is greater than 20 dB, you are better off using the S21 measurement, because the cable loss measurement might yield invalid results.

6.1.5 Transmission Measurements (R&S ZVH-K39)

You can equip the R&S ZVH with option R&S ZVH-K39 (order no 1309.6830.02) to enable forward transmission measurements (S21).

With the forward transmission measurement you can test if a radio signal can travel through the line without losses. The transmission measurement helps to find faults by displaying the magnitude of the reflections in dB in a specified frequency range.

Typically you perform transmission measurements on a filter to test if it works alright or test the isolation of two antennas (e.g. two receiving antennas or a receiving and a transmitting antenna).

- ▶ Press the MEAS key.
- ▶ Press the "Transmission (S21)" softkey.

The R&S ZVH starts the forward transmission measurement over its entire frequency range.

The figure shows the results of a transmission measurement on a filter. The results show that the filter works as it's supposed to.

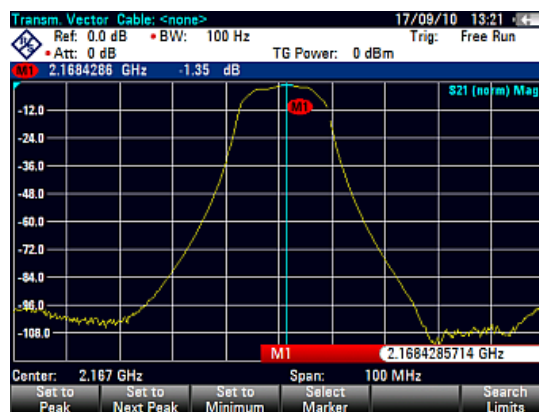

6.1.6 Waveguide Measurements

The waveguide measurement is a modification of the cable measurement, with a waveguide being the DUT instead of a cable. The main difference to cable measurements is that waveguide measurements take into account the different speed of wave propagation in a waveguide, depending on the frequency. The test setup and purpose is similar to other cable measurements.

The purpose is to find possible faults in the waveguide, for example broken parts in the waveguide or loose connections between waveguide elements. A test setup consists of the R&S ZVH, a waveguide and an adapter to connect the analyzer's RF input to the waveguide at its reference plane. Like other reflection measurements, the RF input also feeds a signal into the waveguide.

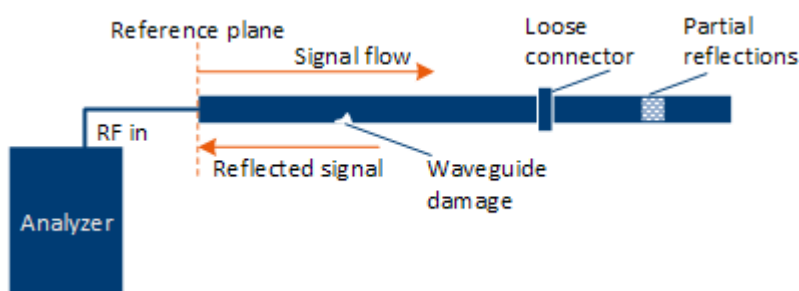

Selecting waveguide measurements

Like cable measurements, you can

- determine the distance to a fault in the waveguide ("Distance-to-Fault" result),
- check how much energy is reflected ("Reflection" result display)
- ▶ Press the MEAS key.
- ▶ Press the "DTF Settings" softkey.
- ▶ Press the "Waveguide" softkey.

The R&S ZVH starts the waveguide measurement over its entire frequency range. As long as the "Waveguide" measurement is selected, the results (distance-to-fault, reflection or frequency spectrum) refer to a waveguide. When you want to measure cables again, deselect the waveguide measurement.

A waveguide measurement consists of three steps in the following order:

- Configuration
- Calibration
- Measurement

Configuring waveguide measurements

Basically, the configuration is the same as for cable measurements. For a detailed description of the available parameters, see "[Configuring Cable and Antenna Tests](#)" on page 61. Note that you can select a cable model, but this setting has currently no effect.

In addition to the waveguide length and the frequency span, you have to define the waveguide's cut-off frequency.

The cutoff frequency is the frequency below which the wave does not propagate. The cutoff frequency depends on the geometry of the waveguide and should be provided in the waveguide's datasheet.

- ▶ Press the MEAS key.
- ▶ Press the "DTF Settings" softkey.
- ▶ Press the "Config" softkey.
- ▶ Select the "Cutoff Frequency" menu item to define the cutoff frequency.

Calibrating waveguide measurements

Testing waveguides also requires a calibration before the actual measurement. Waveguides, however, require a special calibration kit. A calibration kit for waveguide measurements consists of the following calibration standards:

- A short, an offset short and a match
- or
- A short and two offset shorts.

You can define the characteristics of this calibration kit with the R&S InstrumentView software ("Calibration Kits" feature). Otherwise, the calibration method is the same as for cable measurements (a full 1-port calibration).

- ▶ Disconnect the DUT.
- ▶ Start the calibration.
- ▶ Connect all calibration standards one after another as instructed.

For an exemplary description of a calibration procedure, see "[Performing a Full 2-Port Calibration](#)" on page 59.

6.1.7 Selecting the Measurement Format

You can select several measurement formats for each measurement. The measurement format selects the way the results are displayed on the vertical axis.

The R&S ZVH provides the following measurement formats in CAT mode.

- Magnitude (dB Mag)

This is the default format. It shows the magnitude of the results in dB.

- SWR

The VSWR shows the standing wave ratio in a cartesian diagram. The VSWR is the ratio of the maximum voltage and the minimum voltage that occur in an electrical transmission line. The VSWR format is available for DTF and reflection measurements.

- Reflection coefficient

Shows the reflection coefficient of the DUT.

The reflection coefficient is the ratio of the amplitude of a reflected wave and that of the incidental wave that occur in an electrical transmission line.

- Cable loss (short + open) / 2

This format is a refined method to calculate the cable loss.

When you select the format, the R&S ZVH asks you to calibrate the measurement with a short and a open. This calculation method of cable loss results in a more accurate display of the cable loss curve and helps to avoid measurement errors.

For more information on the cable loss measurement see "[1-Port Cable Loss Measurements](#)" on page 51.

The following pictures show the results of a reflection measurement in magnitude format (left side) and VSWR format (right side).

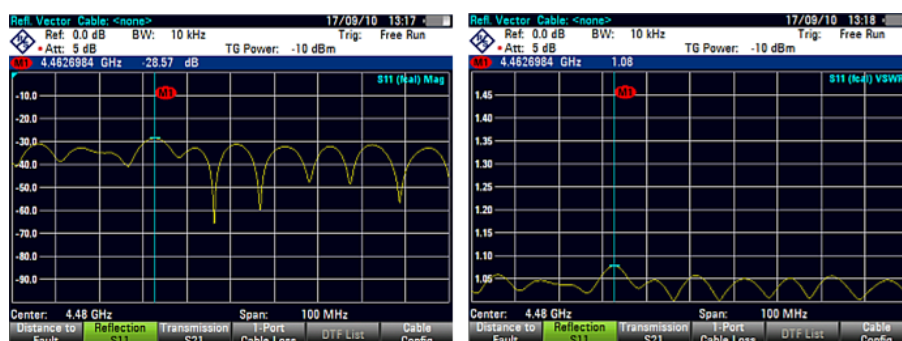

6.1.8 Calibrating Measurements

To get the best and most accurate results, you have to calibrate the measurement. The R&S ZVH provides several calibration methods. You will need one of the available calibration standards R&S FSH-Z28, -Z29 (order no. 1300.7804.03 and 1300.7504.03) or R&S ZV-Z121 (order no. 1164.0496.02/.03).

Alternatively, when you work with the network analyzer, you can create customized calibration kits with the functionality of the R&S InstrumentView software package and use them on the R&S ZVH.

To successfully calibrate the test setup, you have to connect the calibration standard at the reference plane, usually the output of the RF measurement cable.

Calibration is performed over the R&S ZVH's entire frequency range (full span). This eliminates the need for recalibration when you change a parameter or select a different cable or DUT.

Calibration also remains valid after turning off the R&S ZVH or changing into another operating mode as calibration data is saved in the internal memory of the R&S ZVH. If you save the measurement in a dataset, calibration data is part of that dataset. When you restore the dataset and perform the same measurement again, you do not have to recalibrate the R&S ZVH.

6.1.8.1 Calibration States

The R&S ZVH features several calibration states that it displays in the status line. The possible states depend on the calibration type (see below).

- (fcal)

The R&S ZVH uses factory calibration. Factory calibration is restored after a preset or self alignment.

The calibration data for the factory calibration is already in the memory of the R&S ZVH when it is delivered. The factory calibration is a full two-port calibration.

You can restore the factory calibration manually any time.

- Press the CAL key.
- Press the "Cal Settings" softkey.
- Select the "User Calibration Off" menu item.

Note that the R&S ZVH discards user calibration over the complete frequency range after a preset has been done in CAT mode. However, you can also define that the R&S ZVH keeps user calibration after a preset.

- Press the SETUP key.
- Press the "User Preference" softkey.
- Select the "Discard User Calibration" menu item.
- Turn it "Off" to keep user calibration after a preset.

- (fcal?)
The R&S ZVH uses factory calibration. However, the calibration is not accurate because the TG power and receiver attenuation are not in line with the default settings. In that case you should perform calibration.
- (cal)
The R&S ZVH uses user calibration. To get that state you have to perform either a full 1-port or a full 2-port calibration.
- (cal?)
The R&S ZVH uses user calibration. However, the calibration is not accurate because the TG power and receiver attenuation are not in line with the settings at the time it has been calibrated. In that case you should perform calibration.
- (norm)
The R&S ZVH uses normalization. To get that state you have to normalize the transmission.
- (norm?)
The R&S ZVH uses normalization. However, the normalization is not accurate because the TG power and receiver attenuation are not in line with the settings at the time it has been calibrated. In that case you should perform calibration.
- (interp) (network analysis only)
The R&S ZVH interpolates the correction data between the reference points of the calibration. Interpolation is used when you change one of the frequency parameters (start, stop or center frequency). In that case the distribution of the measurement points is different to the distribution during calibration. This could result in an increasing measurement uncertainty.

When calibration has become invalid for any reason or the calibration data has changed, you can restore the most recent calibration that was valid.

- ▶ Press the CAL key.
- ▶ Press the "Cal Settings" softkey.
- ▶ Select the "Restore Calibration Settings" menu item.

The R&S ZVH restores the calibration data and the frequency settings that were active.

6.1.8.2 Calibration Methods

The following calibration types are available in antenna and cable test mode.

- Full 2-Port

Both test ports are calibrated for a complete set of measurements. The calibration routine therefore requires the connection of the standards load, open and short to both test ports, and a through connection of the test ports. The influences of the test setup and of the isolation between the test ports are thereby determined and taken into account in the subsequent measurement of the device under test.

While this method is the most time-consuming during calibration, it does provide the greatest accuracy for all measurements at both test ports without recalibration and is thus the most flexible.

- Full 2-Port High Accuracy

Both test ports are calibrated like the full 2-port calibration. In addition, the load match is taken into account more accurately and correction data is applied in both directions, forward and reverse.

This method provides even more accurate results than the normal full 2-port calibration but takes a while longer to finish.

- Full 1-Port

Test port 1 is calibrated for measurements on that port. The calibration routine requires the calibration standards open, short and load to be connected one after another.

- Easy 1-Port

Test port 1 is calibrated for measurements on that port. The calibration procedure requires no calibration standards as the R&S ZVH calibrates an open only.

- Normalize Transmission

Both test ports are calibrated for transmission measurements. The calibration routine requires only a through connection. In the subsequent measurement, the isolation between the test ports is not taken into account, a possible cross-talk between the test ports in the test setup is not eliminated.

- Normalize Transmission Isolation

This calibration method works like the normalization. However, to take isolation into account, a load match is also required.

6.1.8.3 Performing a Full 2-Port Calibration

The procedure below shows a full 2-port calibration routine. All other calibration methods basically work the same way, except for the type and number of calibration standards you are going to need.

- ▶ Disconnect the DUT from the RF cable.

After disconnecting the DUT, the R&S ZVH is ready for calibration.

- ▶ Press the CAL key.
- ▶ Press the "Full 2-Port" softkey.

The R&S ZVH asks you to connect an "Open" to port 1.

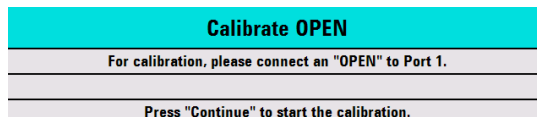

- ▶ Firmly connect the "Open" of the calibration standard to port 1.
- ▶ You can abort the calibration any time by pressing the "Cancel" softkey.
- ▶ Press the "Continue" softkey to start calibration.

The R&S ZVH calibrates the "Open".

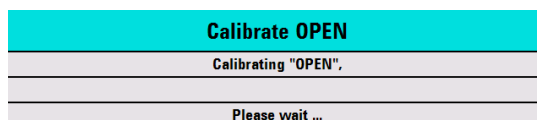

- ▶ Disconnect the "Open".
- Next, the R&S ZVH asks you to connect a "Short" to port 1.

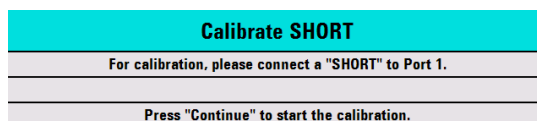

- ▶ Firmly connect the "Short" of the calibration standard to port 1.
 - ▶ Press the "Continue" softkey to start calibration.
- The R&S ZVH calibrates the "Short".

- ▶ Disconnect the "Short".

Next, the R&S ZVH asks you to connect a "Load" (50 Ω termination) to port 1.

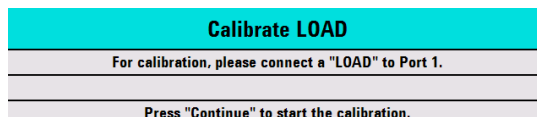

- ▶ Firmly connect the "Load" of the calibration standard to port 1.
 - ▶ Press the "Continue" softkey to start calibration.
- The R&S ZVH calibrates the "Load".

- ▶ Disconnect the "Load".

Next, the R&S ZVH asks you to set up a "Through" connection from port 1 to port 2.

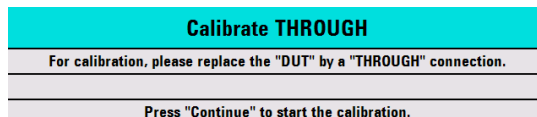

- ▶ Firmly connect the "Through" connection to port 1 and port 2.

- ▶ Press the "Continue" softkey to start calibration.

The R&S ZVH calibrates the "Through" connection.

After finishing the calibration routine, the R&S ZVH shows that calibration is finished for a short time (**Calibration done!**). The status line now says (Cal) to indicate successful calibration.

6.1.8.4 Performing calibration with the calibration unit R&S ZN-Z103

For measurements in the frequency range from 2 MHz to 4 GHz, you can use the calibration unit R&S ZN-Z103 calibration unit (order no. 1321.1828.02) to calibrate 1-port measurements.

Using this unit is more comfortable, because it combines all standards in one piece – connecting different standards is no longer necessary.

- ▶ Connect the calibration unit to the RF input (port 1) and the USB interface on the R&S ZVH.

When the LED on the calibration unit turns green, it is ready to use. If the LED is illuminated in a different color, try to reconnect the unit.

- ▶ Enter the SETUP menu and turn on "Auto Accessory Detection".

- ▶ Wait a few seconds until the label in the measurement information bar turns green.

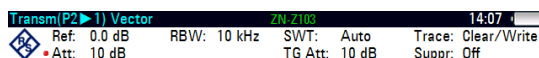

Transm[P2] Vector ZN-Z103 14:07
 Ref: 0.0 dB RBW: 10 kHz SWT: Auto Trace: Clear/Write
 Att: 10 dB TG Att: 10 dB Suppr: Off

- ▶ Press the MEAS to key.
- ▶ Press the "Calibration" softkey.
- ▶ Select the calibration method you want to use.

If the selected calibration method is not possible with R&S ZN-Z103, the R&S ZVH shows an error message (usually the case for calibration methods that require a "Through" connection).

For more information about the calibration unit, refer to its user manual.

6.2 Configuring Cable and Antenna Tests

For valid measurement results, you need to specify the characteristics of the cable under test like model or frequency range.

6.2.1 Selecting the Cable Model

To determine the speed of propagation, and therefore the precise distance to any faults, you have to specify the cable model that you want to test.

The R&S ZVH already comes with an assortment of predefined cable models that you can use without doing anything. If you want to test a cable that is not listed, you can also define cable models manually, either directly on the R&S ZVH or with the "Cable Model Editor" of the R&S InstrumentView software package that is delivered with the R&S ZVH.

Selecting cable models is unavailable for waveguide measurements.

6.2.1.1 Selecting a Predefined Cable Model

- ▶ Press the MEAS key.
- ▶ Press the "DTF Settings" softkey.
- ▶ Press the "Cable Config" softkey.

- ▶ Select the "Select Cable Model" menu item.

The R&S ZVH opens the file manager to select the cable model.

- ▶ Select the cable model that you are testing.
- ▶ Confirm the selection with the "Select" softkey.

Stat	Name	Size	Date	Time
	\Public\Cable Models\...			
	\Public			
	5088-HLFR.cbimod	1 kB	31/05/2010	15:21
	5092-HLFR.cbimod	1 kB	31/05/2010	15:21
	5128-HLFR.cbimod	1 kB	31/05/2010	15:21
	5168-HLFR.cbimod	1 kB	31/05/2010	15:21
	5228-HLFR.cbimod	1 kB	31/05/2010	15:21
	5328-HLFR.cbimod	1 kB	31/05/2010	15:21
	5438-HLFR.cbimod	1 kB	31/05/2010	15:21
	5628-HLFR.cbimod	1 kB	31/05/2010	15:21
	FLC114-50J.cbimod	1 kB	31/05/2010	15:21
	FLC12-50J.cbimod	1 kB	31/05/2010	15:21
	FLC158-50J.cbimod	1 kB	31/05/2010	15:21
	FLC78-50J.cbimod	1 kB	31/05/2010	15:21
	HCC12-50J.cbimod	1 kB	31/05/2010	15:21
	HCC158-50J.cbimod	1 kB	31/05/2010	15:21
	HCC300-50J.cbimod	1 kB	31/05/2010	15:21
	HCC78-50J.cbimod	1 kB	31/05/2010	15:21
	HCF12-50.cbimod	1 kB	31/05/2010	15:21
	HJ12-50.cbimod	1 kB	31/05/2010	15:21

The R&S ZVH shows the currently selected cable model in the diagram header.

- ▶ Select the "Deselect Cable Model" item from the "Cable Config" menu if you want to perform measurements without using a particular cable model.

6.2.1.2 Creating a Cable Model

The R&S ZVH provides two ways to define customized cable models.

The first way is to define a cable model with the "Cable Model Editor" that is part of the R&S InstrumentView software package. The R&S InstrumentView is delivered with the R&S ZVH. With this software, you can define a cable model on a PC and then transfer it to the R&S ZVH. Then you can select it just like any other predefined cable model.

For more information see "[Managing Datasets](#)" on page 34.

If you do not have access to a PC, but still need a cable model that is not stored on the R&S ZVH, you can also define the characteristics of a cable temporarily on the R&S ZVH itself. It is not possible to save these in a data set, however. They are lost as soon as you change them or load another cable model.

- ▶ Press the MEAS key.
- ▶ Press the "DTF Settings" softkey.
- ▶ Press the "Cable Config" softkey.
- ▶ Select the "Define User Model" menu item.

A submenu opens.

- ▶ Select the "Frequency" menu item.
- ▶ Enter the frequency of the cable you are testing.
- ▶ Select the "Velocity" menu item.
- ▶ Enter the cable velocity.
- ▶ Select the "Loss" menu item.
- ▶ Enter the cable loss.

You can now perform measurements on the temporary cable definition.

Note that as soon as you change any cable parameter or load another cable model, the temporary data is lost and you have to define it again if you have to perform further measurements.

After you have defined the cable characteristics, you still have to activate the use of the customized cable.

- ▶ Press the "Cable Config" softkey.
- ▶ Select the "[] User Model" menu item.

If the R&S ZVH uses the customized cable model, it shows an [X] at the "User Model" menu item.

6.2.1.3 Working with a DTF List

The DTF list shows the results of the distance to fault measurement in numerical form.

- ▶ Press the MEAS key.
- ▶ Press the "DTF Settings" softkey.
- ▶ Press the "DTF List" softkey.

The R&S ZVH opens a table that lists the peaks it has found during the measurement.

The table contains the following information.

- Peak
Shows the peak the results refer to.
- Distance
Shows the distance from the measurement plane to the peak.
- Return Loss
Shows the magnitude of the peak.

To limit the information in the list, you can define a threshold for the DTF list, so that only peaks above a certain level are included in the list.

- ▶ Press the MEAS key.
- ▶ Press the "DTF Settings" softkey.
- ▶ Press the "DTF List Threshold" softkey.

The R&S ZVH opens an input field to define a threshold in dB.

- ▶ Enter the threshold you want.

The R&S ZVH now only shows the peaks that are above the level you have entered.

6.2.2 Configuring the Horizontal Axis

The **FREQ/DIST** key contains all necessary functions to define frequency and distance parameters when performing cable measurements.

The contents of the menu depend on the currently selected measurement.

Coupling frequency and span settings across measurements

By default, the DTF measurement has its own configuration regarding frequency and span settings. The other measurements (reflection, transmission and cable loss) share the same frequency and span settings.

If required, you can couple the frequency and span settings across all measurements.

- ▶ Press the **SETUP** key.
- ▶ Press the "User Preference" softkey.
- ▶ Turn off the "Use Dedicated DTF Frequency Settings".

The R&S ZVH couples the frequency and span settings across all measurements.

6.2.2.1 Setting the Frequency Range for DTF Measurements

In the default setting, the R&S ZVH automatically selects a center frequency of 1 GHz and a distance of 50 m. The R&S ZVH optimizes the settings for the best resolution, if you change the stop distance.

If you have to keep the current frequency settings, it is best to define a manual span.

Setting the frequency span

When setting the frequency range, it is best to first set the span and then the center frequency.

- ▶ Press the **FREQ/DIST** key.
- ▶ Press the "DTF Span" softkey.

By default, the R&S ZVH automatically calculates the best span ("Auto Span") for the best length resolution. If the required span is too large for the current center frequency, the R&S ZVH sets the center frequency to the smallest possible frequency.

- ▶ Select the "Manual Span..." menu item
- ▶ Enter the span you need manually.

The R&S ZVH sets the new span. Note that the maximum span you can set depends on the maximum cable distance you have defined and is never greater than the span calculated by the "Auto Span" function. The minimum span that you can set is 10 MHz.

Setting the displayed frequency range

After you have selected the span, you can set a particular frequency range whose results the R&S ZVH displays.

In the default configuration, the R&S ZVH adjusts the DTF start and DTF stop frequency according to the span and the center frequency. The distance from center frequency to the start and stop frequency is the same. Alternatively, you can directly set a DTF start and DTF stop frequency.

- ▶ Press the **FREQ/DIST** key.
- ▶ Press the **"DTF Center Freq"** softkey.
- ▶ Enter the frequency that you'd like to be in the center of the horizontal axis.

The R&S ZVH adjusts the frequency range according to span and center frequency.

- ▶ Press the **FREQ/DIST** key.
- ▶ Press the **"DTF Start Freq"** or the **"DTF Stop Freq"** softkey.
- ▶ Enter the start frequency and stop frequency you need.

The R&S ZVH adjusts the frequency range according to your settings.

Note that the distance from start to stop frequency has to be equal to the span. The R&S ZVH adjusts the values if you enter a frequency range that is not the same as the span.

6.2.2.2 Setting the Start and Stop Distance for DTF Measurements

The start and stop distance define the scaling of the horizontal axis.

In the default setting, the horizontal axis start at 0 m and covers the maximum or stop distance you have set. By adjusting the start and stop distance, you can zoom in to a particular section of the cable for further analysis.

- ▶ Press the **FREQ/DIST** key.
- ▶ Press the **"Start Dist"** or **"Stop Dist"** softkey.
- ▶ Enter the distance you want the display to start from and to end at.

In auto span mode, the R&S ZVH adjusts the frequency settings in order to get the best display resolution.

If you have set the span manually, the R&S ZVH zooms in to the section of the cable you have defined. The results maintain their accuracy in that case.

6.2.2.3 Setting the Frequency Range for CAT Measurements (except DTF)

If you measure the reflection, transmission or cable loss, the displayed frequency range is defined by the span, the center frequency or start and stop frequencies.

Defining the span

The span you should select depends on the frequency band you are analyzing and the frequency range you need information about.

The minimum span for both measurements is 10 Hz, the maximum span depends on the R&S ZVH and is either 3.6 GHz (R&S ZVH4) or 8 GHz (R&S ZVH8).

- ▶ Press the **FREQ/DIST** key.
- ▶ Press the **"Span"** softkey.
- ▶ Enter the span you need.

The R&S ZVH sets the span you have entered.

Setting the displayed frequency range

In the default configuration, the R&S ZVH adjusts the start and stop frequency according to the span and the center frequency, with the center frequency being in the middle of the horizontal axis. Alternatively, you can directly set the start and stop frequency.

- ▶ Press the **FREQ/DIST** key.
- ▶ Press the **"Center"** softkey.
- ▶ Enter the center frequency you need.

Alternatively, set the frequency range independent of span and center frequency.

- ▶ Press the **FREQ/DIST** key.
- ▶ Press the **"Start"** softkey and enter a start frequency.
- ▶ Press the **"Stop"** softkey and enter a stop frequency.

6.2.2.4 Selecting a Signal Standard for CAT Measurements (except DTF)

When you measure the reflection, transmission or cable loss, the R&S ZVH provides several configurations for measurements on a particular signal standard. When you select one of these, the R&S ZVH loads the corresponding parameters like center frequency or span and you do not have set those anymore.

- ▶ Press the **FREQ/DIST** key.
- ▶ Press the **"Signal Standard"** softkey.
- ▶ Select either the **"Select Uplink"** or **"Select Downlink"** menu items.

The R&S ZVH opens a dialog box to select the standard.

- ▶ Select the standard you need.

The R&S ZVH loads the settings of the standard you have selected.

6.2.3 Configuring the Amplitude Characteristics

The amplitude menu contains all settings related to the level display.

6.2.3.1 Adjusting the Scale of the Diagram

The R&S ZVH provides several options to improve the vertical scaling of the measurement diagram.

The unit of the level axis is dB.

Setting the reference value

The reference value defines the amplitude of the reference line. The unit of the reference is dB.

The R&S ZVH indicates the position of the reference value with a yellow triangle at the vertical axis (0.0).

When you change the reference value, the R&S ZVH adjusts the labels of the vertical axis. Changing the reference value changes the vertical position of the trace. It does not change the position of the reference line.

- ▶ Press the SCALE/AMPT key.
- ▶ Press the "Ref" softkey.
- ▶ Enter the reference value you want or move the reference with the rotary knob.

The R&S ZVH sets up the display accordingly.

Defining the display range

The display range defines the scale of the vertical axis and therefore the amplitude between two horizontal grid lines. The unit depends on the measurement format.

When you change the display range, you can increase or decrease the amplitude the R&S ZVH displays and, e.g. include signal parts that are outside the displayed screen area. The position of the reference value and the trace do not change.

- ▶ Press the SCALE/AMPT key.
- ▶ Press the "Range/Ref Pos" softkey.
- ▶ Select one of the menu items to select the display range you want.

Adjusting the vertical axis automatically

The R&S ZVH provides an automatic scaling routine that scales the vertical axis in a way that the results fit ideally on the display. The R&S ZVH does this by determining the minimum and maximum trace values and scaling the vertical axis according to these values.

- ▶ Press the SCALE/AMPT key.
- ▶ Press the "Auto Scale" softkey.

The R&S ZVH performs automatic adjustment of the vertical axis.

Setting the reference position

The reference position defines the position of the reference line in the diagram. The reference position is a linear value between 0 and 10. Each value represents one horizontal grid line of the diagram. 0 corresponds to the top grid line and 10 corresponds to the bottom grid line.

When you change the reference position, the R&S ZVH also shifts the position of the trace by the magnitude of the reference position change. It has no effect on the reference value itself.

- ▶ Press the SCALE/AMPT key.
- ▶ Press the "Range/Ref Pos" softkey.
- ▶ Select the "Ref Position:" menu item.
- ▶ Enter the reference position you want.

The R&S ZVH moves the trace accordingly.

6.2.3.2 Setting the Attenuation

The R&S ZVH provides functions to attenuate the signal at the RF input.

- ▶ Press the "Receiver Att" softkey.
- ▶ Enter the attenuation of the signal at the RF input.

You can set an RF attenuation in the range from 0 dB to 40 dB in 5 dB steps.

6.2.4 Configuring the Tracking Generator

If your R&S ZVH features a tracking generator, you can define several characteristics of the generated signal.

- ▶ Press the SCALE/AMPT key.
- ▶ Press the "TG Power" softkey.
- ▶ Enter the desired output level of the signal in dBm.

Tracking generator output level



Using an output level of 0 dBm (or a receiver attenuation of 0 dB) for S12 or S21 measurements can cause an overload at the RF input. It is therefore recommended to use an output level of -10 dBm (default) or lower for these measurements.

This especially applies to measurements on amplifiers.

6.2.5 Setting and Triggering the Sweep

When setting up the sweep you have to deal with several parameters that are interdependent. For easy and quick access, most of these parameters are combined in the sweep menu.

6.2.5.1 Setting the Measurement Bandwidth

The measurement bandwidth determines the noise figure of the receiver. Small bandwidths result in higher measurement dynamics for S21 measurements. However, small bandwidths cause longer measurement times because of the settling time of the filter.

Possible bandwidths are between 100 Hz and 100 kHz in a 1-3 sequence.

- ▶ Press the SWEEP/BW key.

In its default state, the R&S ZVH selects the bandwidth automatically ("Auto Meas BW" softkey). In that state, the bandwidth is coupled to the span.

The default setting is a compromise between measurement speed and good performance.

- ▶ Press the "Manual Meas BW" softkey.

The R&S ZVH opens an input field to define the measurement bandwidth.

- ▶ Enter the measurement bandwidth you want to work with.

As an indicator that the BW is no longer coupled to the span, the R&S ZVH displays a red dot in front of the BW item in the hardware settings.

6.2.5.2 Selecting the Sweep Mode

The sweep mode is the way the R&S ZVH performs the measurement.

In its default state, the R&S ZVH measures continuously. In this mode, the R&S ZVH automatically repeats the sweep in the defined range of the horizontal axis (frequency or time) and updates the trace accordingly after it has finished with one sweep.

In some cases it may be sufficient to get the results over a single sweep only, e.g. if a particular trigger condition is met. In single sweep mode, the R&S ZVH performs the sweep a certain number of times (depending on the number of averages you have set) over the defined range of the horizontal axis (frequency or time) and then stops measuring. It performs another sweep only after you tell it to.

For more information on setting the number of sweeps included in a single sweep see "[Selecting the Trace Mode \(Average\)](#)".

- ▶ Press the SWEEP/BW key.
- ▶ Press the "Trigger" softkey.
- ▶ Select the "Single Sweep" menu item.
The R&S ZVH activates single sweep mode.
- ▶ Select the "Continuous Sweep" menu item.
The R&S ZVH again starts to measure continuously.

6.2.5.3 Changing the Number of Measurement Points

The number of (measurement) points defines the number of measurements performed during a sweep. Thus, it indirectly sets the frequencies of those measurements. The distance from one measurement point to the next depends on the currently set frequency range (span divided by number of points). However, the measurement points are spread evenly over the selected frequency range.

The number of points also defines the resolution and, therefore, the accuracy of the measurement and affects the measurement time. In the default state, the R&S ZVH evaluates 201 measurement points. This number allows for fast measurement times and sufficient accuracy. For measurements with a higher or lower frequency resolution, you can change the number of measurement points. Note that measurement times increase if you set a higher number of measurement points.

- ▶ Press the SWEEP/BW key.
- ▶ Press the "Number of Points" softkey.
- ▶ Select the number of measurement points you require from the menu.

6.2.5.4 Holding Measurements

The measurement starts as soon as you start the R&S ZVH. As the cable and antenna tester measures continuously, the R&S ZVH provides a hold function that stops the display update and leaves room for further analysis of the measurement results.

- ▶ Press the SWEEP/BW key.
- ▶ Press the "Hold" softkey.
The R&S ZVH interrupt the display update.

To resume the display update, press the "Hold" softkey again.

6.2.5.5 Working with Triggers

To respond to events, the R&S ZVH has a variety of trigger functions. The trigger event can either be an external event or generated internally.

- ▶ Press the SWEEP key.
- ▶ Press the "Trigger" softkey.

The submenu for setting the trigger opens. By default, free run mode is active.

In CAT mode, the R&S ZVH provides the following trigger sources.

Free Run

A new sweep starts on completion of the previous sweep. This is the default setting for the R&S ZVH.

External Rise / External Fall

A sweep starts on the rising edge ("Rise") or on the falling edge ("Fall") of an external trigger signal. The external trigger signal is fed in via the BNC connector "Ext Trigger". The switching threshold is 1.4 V, i.e. a TTL signal level.

- ▶ Select the trigger you need for your measurement.

The "Trig" label in the hardware settings indicates the current trigger source.

When external trigger are selected, you can delay the start of the measurement with respect to the trigger event by entering a delay time. In this way, time differences between the trigger event and the measurement can be allowed for.

- ▶ Press the "Trigger" softkey.
- ▶ Select the "Trigger Delay..." menu item.

The R&S ZVH opens an input field to specify the trigger delay.

- ▶ Enter the trigger delay you require.

The range for the trigger delay is 0 μ s to 100 s. The step size depends on the length of the delay time.

Trigger delay	Step size
0 s to 1 ms	10 μ s
1 ms to 10 ms	100 μ s
10 ms to 100 ms	1 ms
100 ms to 1 s	10 ms
1 s to 10 s	100 ms
10 s to 100 s	1 s

6.3 Analyzing Measurement Results

6.3.1 Working with Traces

6.3.1.1 Selecting the Trace Mode

The R&S ZVH provides several trace modes. The trace mode defines the way the R&S ZVH writes the trace.

For information on the trace modes see "[Selecting the Trace Mode](#)".

- ▶ Press the TRACE key.
- ▶ Press the "Trace Mode" softkey.
- ▶ Select the "Clear/Write" or "Average:" menu item.

6.3.1.2 Suppressing Interfering Signals

When performing measurements in the field, you may encounter interfering signals from surrounding signal sources like other antennas. These signals could distort the actual measurement and therefore lead to false assumptions about faults in the system you are measuring.

The R&S ZVH provides a method to suppress signals resulting from interfering sources without affecting the accuracy of the actual measurement.

- ▶ Press the TRACE key.
- ▶ Press the "Trace Mode" softkey.
- ▶ Select the "Suppression On" menu item to activate suppression of interference.

The R&S ZVH looks for signals that interfere with the measurement and suppresses them in the result display. Faults in the system you are measuring are, however, still displayed correctly.

The R&S ZVH automatically determines the aperture for the suppression. If you want to apply a particular aperture, you can also set it manually.

- ▶ Press the TRACE key.
- ▶ Press the "Trace Mode" softkey.
- ▶ Select the "Aperture Manual" menu item.

The R&S ZVH turns automatic aperture calculation off. The default aperture is 1.

- ▶ Press the "Trace Mode" softkey.
- ▶ Select the "Aperture Size: 1" menu item.
- ▶ Enter a different aperture size according to your measurement.

6.3.1.3 Working with Memory Traces

The R&S ZVH can transfer a trace to the trace memory and also display the current trace and the trace in the trace memory for comparison. The saved trace is always displayed in white to distinguish it from the current trace.

- ▶ Press the TRACE key.
- ▶ Press the "Trace ▶ Memory" softkey.

The R&S ZVH transfers the trace to the trace memory.

- ▶ Press the "Show Memory" softkey.

The R&S ZVH displays the saved trace in white.

You can remove the memory trace by pressing the "Show Memory" softkey again.

The memory traces are bit-mapped into the picture memory. Therefore, when the memory trace is recalled, it will not be adapted to any modifications of the reference level or span that may have been made in the meantime.

When you load a data set, the R&S ZVH stores the corresponding trace in the trace memory. You can view that trace with the "Show Memory" softkey.

6.3.1.4 Using Trace Mathematics

For more information see "[Using Trace Mathematics](#)" on page 162.

6.3.2 Using Markers

The R&S ZVH has six markers, five of which can be used as either markers or delta markers.

The markers cannot leave the trace and indicate the horizontal and vertical coordinates of the point they are positioned on. The horizontal position of a marker is shown by a vertical line which extends from the top to the bottom of the measurement diagram. The marker list above the diagram area shows the exact coordinates of all markers in use.

When measuring the distance-to-fault, the horizontal unit is meter or feet. For all other measurements the horizontal axis is the frequency axis. The unit of the vertical axis is dB for distance-to-fault and cable loss measurements and dBm for all others.

The position of a delta marker is indicated by a dashed line to distinguish it from a normal marker. The delta marker level is always a relative to the main marker level and so the delta marker level unit is always dB. The delta marker frequency is always relative to the main marker – in other words, the delta marker frequency is the frequency difference between the frequency at the point marked by the main marker and the frequency at the point marked by the delta marker.

To measure complex signals, you can activate up to six markers. Marker 1 is always a normal marker and the reference of all delta markers. Markers 2 to 6 are either markers or delta markers depending on your set up.

Screen Layout with Active Markers

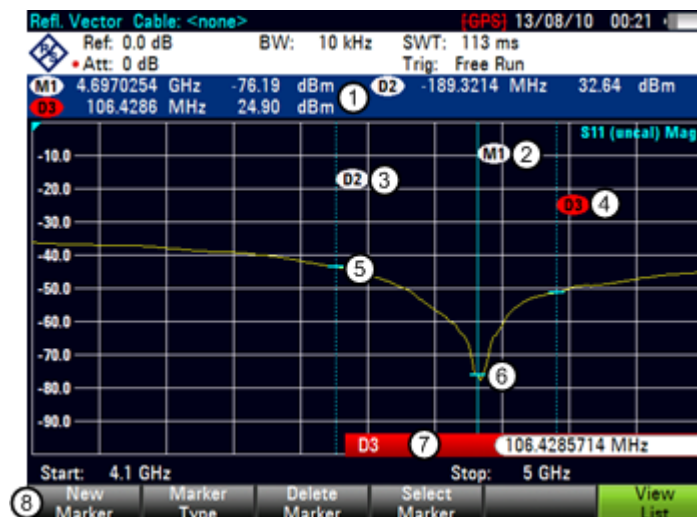

- 1 Marker list
- 2 Marker label: M(x)
- 3 Delta marker label: D(x)
- 4 Active marker label (red label)
- 5 Delta marker (blue dotted line)
- 6 Marker (blue line)
- 7 Marker input field
- 8 Marker menu

6.3.2.1 Positioning Markers

- ▶ Press the MARKER key.

The marker menu opens.

If, as yet, no marker has been activated, the R&S ZVH automatically activates the main marker and positions it on the maximum level that has been measured. In addition, the marker frequency input field opens.

You can perform the following actions:

- Position the marker with the cursor keys.
When positioning the marker with the cursor keys, the step size is 10% of the span.
- Position the marker with the rotary knob
When positioning the marker with the rotary knob, the step size is one pixel.
- Enter a marker position with the number keys and confirm the entry with one of the unit keys.
- ▶ Confirm the marker position with the ENTER key.

The marker input field closes.

By default, the marker list above the diagram area is active. The marker list shows the horizontal position of all markers and the corresponding vertical value. If inactive, the list shows only the coordinates of markers 1 and 2.

You can turn it off and on again whenever you like.

- ▶ Press the "View List" softkey.
The marker list turns off or on, depending on its original state.

Positioning markers with the rotary knob

The marker mode selects the distance the marker moves when you change its position with the rotary knob (marker step size). The marker step size is either one pixel (default) or one measurement point.

- ▶ Press the MARKER key.
- ▶ Press the "Marker Mode" softkey.
- ▶ Select the "Discrete" menu item to move the marker by one measurement point in discrete steps. The step size thus depends on the number of measurement points and the scale of the x-axis.

6.3.2.2 Positioning a Delta Marker

When a normal marker is already in use, you can add delta markers.

- ▶ Press the MARKER key.
- ▶ Press the "New Marker" softkey.

The R&S ZVH activates a delta marker and positions it on the next maximum level that has been measured. In addition, the delta marker input field opens.

The R&S ZVH adds the delta marker to the marker list and shows the marker position relative to the normal marker (M1).

You can perform the following actions:

- Enter a delta marker position with the number keys and confirm the entry with one of the unit keys.
- Change the delta marker position with the rotary knob or the cursor keys.
- ▶ Confirm the delta marker position with the ENTER key.

The delta marker input field closes.

- ▶ To add more markers, press the "New Marker" softkey several times until you have the number of markers you want in the display.

6.3.2.3 Selecting the Marker Type

When you add new markers, they will be delta markers by default. Their coordinates are relative to the first marker (M1). You can turn delta markers into normal markers if you need absolute information about the marker position.

- ▶ Press the MARKER key.
- ▶ Select the delta marker you want to convert with the "Select Marker" softkey.
The corresponding marker symbol turns red and the marker input field opens.
- ▶ Press the "Marker Type" softkey.

The delta marker turns into a normal marker. Its label changes accordingly (e.g. D2 to M2) and its coordinates are now absolute values.

6.3.2.4 Automatic Positioning of Markers

The R&S ZVH offers functions that make setting the markers easier or allow to make instrument settings on the basis of the current marker position:

- "Set to Peak"
The Peak function places the active marker or the delta marker on the highest level value of the trace.
 - "Set to Next Peak"
The Next Peak function places the active marker or delta marker on the next highest level value of the trace, relative to its current position.
 - "Set to Minimum"
The Minimum function places the active marker or delta marker on the lowest value of the trace.
- ▶ Press the MKR→ key.
 - ▶ Press the "Set to Peak", "Set to Next Peak" or "Set to Minimum" softkey.
- The R&S ZVH positions the marker accordingly.

Sorting markers

A special marker function available for distance-to-fault measurements is that you can sort them in ascending order.

- ▶ Press the MKR→ key.
- ▶ Press the "Sort Markers" softkey.

The R&S ZVH sorts the markers in ascending order with marker 1 being positioned on the lowest distance. The marker values remain the same.

6.3.2.5 Removing Markers

Remove markers any time you want.

Removing selected markers

- ▶ Select the marker you want to delete with the "Select Marker" softkey.
The corresponding marker symbol turns red and the marker input field opens.
 - ▶ Press the MARKER key.
 - ▶ Press the "Delete Marker" softkey.
 - ▶ Select the "Delete Selected" menu item.
 - ▶ Confirm the selection with the ENTER key.
- The R&S ZVH deletes the marker.



Deactivating markers

If you delete marker 1 (M1), all delta markers that are relative to that marker are also deleted.

Removing delta markers only

- ▶ Press the MARKER key.
- ▶ Press the "Delete Marker" softkey.
- ▶ Select the "Delete All Delta" menu item.
- ▶ Confirm the selection with the ENTER key.

The R&S ZVH deletes all delta markers.

Removing all markers at the same time.

- ▶ Press the MARKER key.
- ▶ Press the "Delete Marker" softkey.
- ▶ Select the "Delete All" menu item.
- ▶ Confirm the selection with the ENTER key.

The R&S ZVH deletes all markers and delta markers.

6.3.2.6 Using Marker Search Limits

The R&S ZVH allows you to use only a limited section of the trace for the "Set to Peak", "Set to Next Peak" and "Minimum" functions.

- ▶ Press the MKR→ key.
- ▶ Press the "Search Limits" softkey.
- ▶ Select the "Search Limits On/Off" menu item.
- ▶ Confirm the selection with the ENTER key.

The R&S ZVH activates the marker search limits.

An [X] indicates an active search limit. Two vertical red lines show the lower and upper limits in the diagram.

By default, the search limit range is over the whole span.

- ▶ Press the "Search Limits" softkey
- ▶ Select the "Lower Limit" menu item.
- ▶ Confirm the selection with the ENTER key.

The R&S ZVH opens an input field to define the lower limit of the search range.

- ▶ Enter the lower limit.

- ▶ Confirm the entry with one of the unit keys.
If the span is wide enough, the R&S ZVH displays a red vertical line to indicate the lower limit.
- ▶ Define the upper search limit the same way.

Deactivating marker search limits

- ▶ Press the "Search Limits" softkey.
- ▶ Select the "Search Limits On/Off" menu item.
- ▶ Confirm the selection.

The "Search Limits" softkey turns grey again and in the "Search Limits" menu, the [X] is no longer displayed.

6.3.3 Using Display and Limit Lines

The display and limit line functionality in CAT mode is the same as that of the spectrum analyzer mode.

For more information on using the display line see "[Using Display Lines](#)" on page 167.

For more information on using limit lines see "[Using Limit Lines](#)" on page 168.

7 Working with the Measurement Wizard

When testing antennas and cables it is often necessary to perform a sequence of standardized and recurring measurements, often in an environment that is not easily accessible. To make sure that measurements are performed as required and to avoid a constant adjustment of parameters, the R&S ZVH features a measurement wizard.

The measurement wizard allows you to combine several individual measurement configurations to a sequence of measurements (or measurement set). Because all relevant parameters have been set prior to the actual measurement and cannot be changed once the measurement procedure has begun, the wizard is a good way to avoid mistakes and save time when setting up measurements.

This chapter describes the functionality of the measurement wizard. For details on the individual measurements you can perform with the wizard, refer to the corresponding chapters.

- [Cable and Antenna Test Mode](#) on page 44
- [Spectrum Analyzer Mode \(R&S ZVH-K1\)](#) on page 94
- [Power Meter \(R&S ZVH-K9\)](#) on page 175
- [Network Analyzer Mode \(R&S ZVH-K42\)](#) on page 194

You can use the wizard for measurements in all operating modes.

Note that it is necessary to install and use the R&S InstrumentView software package if you want to access the measurement wizard.

7.1 Preparing the Measurement

Before you can use the measurement wizard you have to define a measurement set with the R&S InstrumentView software package and transfer it to the R&S ZVH.

The latest version of the R&S InstrumentView is available for download on the R&S ZVH website at

<http://www.rohde-schwarz.com/product/zvh.html>

7.1.1 Creating a Measurement Set

A measurement set consists of several datasets. A dataset is a file that contains the settings of a specific R&S ZVH configuration, for example frequency, scaling etc. To get hold of a dataset, set up the R&S ZVH as you need and save the configuration or use one of the predefined datasets.

For more information on datasets see "[Saving Datasets](#)" on page 36.

- ▶ Start the R&S InstrumentView software on your PC.
- ▶ Select the "Wizard Set Editor" ("Preparation" ▶ "Wizard Sets").

The R&S ZVH opens a dialog that provides all functionality to manage measurement sets.

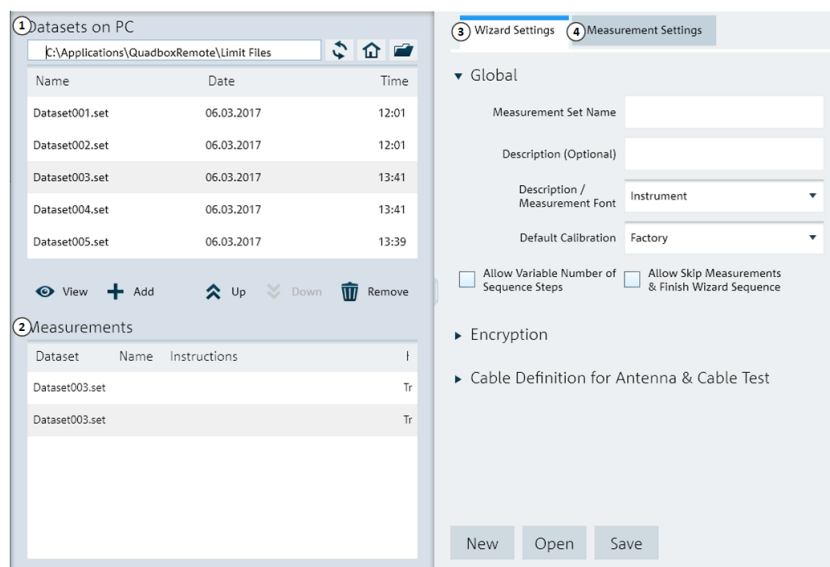

- 1 List of datasets that are available via the PC
- 2 List of datasets that are currently part of the measurement set
- 3 Settings for the measurement set
- 4 Settings of the selected measurement (dataset)

The "Wizard Settings" tab contains several setting categories.

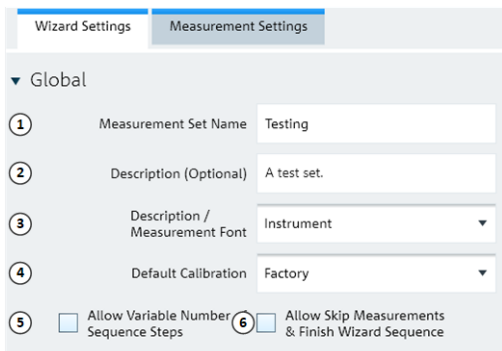

- 1 Name of the measurement set
- 2 Description of the measurement task
- 3 Font type for on-screen instructions (latin and some asian fonts are supported)
- 4 Calibration method
- 5 Measurement sequence control
- 6 Measurement sequence control

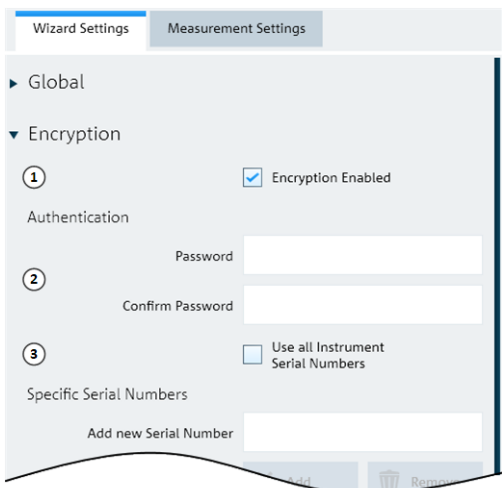

- 1 Measurement set password protection state
- 2 Password definition
- 3 Restriction of encryption to certain instruments

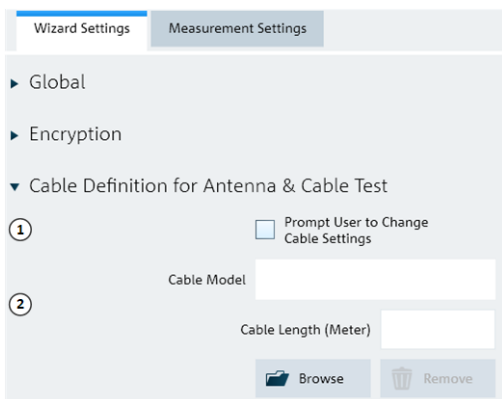

- 1 Control of cable characteristics (model and length) after individual measurements
- 2 Cable characteristics (length and model)

- ▶ Set up the measurement set as you like by adding or removing datasets.

The editor also allows you to add comments to each measurement that is part of the measurement set. You can also rename the measurement.

- ▶ Select one of the datasets and select the "Measurement Settings" tab.

The screenshot shows the 'Measurement Settings' dialog box. It has two tabs: 'Wizard Settings' and 'Measurement Settings'. The 'Measurement Settings' tab is active. The dialog is organized into three main sections, each with a dropdown arrow on the left:

- Measurement:** Contains a 'Measurement Name' text field, a 'Linked Dataset' dropdown menu (currently showing 'Dataset001.set'), an 'Instructions' text area, and an 'Instruction Picture' section with a 'Picture Name' text field. Below these are three buttons: 'Browse' (with a folder icon), 'Preview' (with an eye icon), and 'Remove' (with a trash can icon).
- Hardware Settings:** Contains a 'BNC 1' dropdown menu (currently showing 'Trigger Input') and a 'Default' button (with a list icon).
- Calibration Settings:** Contains a 'Specific Calibration' dropdown menu (currently showing 'Factory').

In this dialog box, you can

- see the name of the selected dataset
- define a name for the corresponding measurement
- include instructions (verbal or graphical) about performing the measurement
- define several hardware settings as described in the Quick Start Guide.
- select a calibration method specific for that measurement

You can add instructions for every measurement that you include in the set to avoid handling measurements incorrectly.

The R&S ZVH shows these instructions before the measurement starts.

Password protection for measurement sets

It is possible to protect the contents of measurement sets with a password from unauthorized access.



If you protect a measurement set, you are able to edit the contents of the measurement set only after you have entered the correct password.

In addition, you can control who is using the measurement sets by limiting its access to a particular set of R&S ZVH serial numbers only. All other devices will not be able to process these wizard files.

7.1.2 Uploading Measurement Sets

In order to perform the actual measurements, you have to upload the wizard definition file that contains the set of measurements to the R&S ZVH.

- ▶ Select the file transfer workspace ("Instrument" ▶ "File Transfer").
- ▶ Select the measurement set you want to upload.
- ▶ Copy the files with the "<<" button.

The software stores a copy of the measurement set in the memory of the R&S ZVH.

Alternatively, you can use a memory stick or SD card to transfer and access a measurement set on the R&S ZVH.

7.2 Using the Measurement Wizard

Now that the measurement set is available on the R&S ZVH you can start performing measurements.

7.2.1 Starting the Measurement Wizard

- ▶ Press the WIZARD key.

The R&S ZVH opens the "Wizard" dialog box. This dialog box contains information about the measurement set, including several parameters whose values you can change during the measurement (for example the site name).

- ▶ Press the "Load Meas Set" softkey.

The R&S ZVH opens the file manager.

- ▶ Select the file that contains the measurement set that you require.
- ▶ Confirm the selection with the "Select" softkey.

The R&S ZVH returns to the measurement wizard dialog box. It now displays information about the measurement set you have just loaded.



The dialog box contains the following information:

- Measurement Definition
 - Name of the wizard definition file currently in use. Pressing the ENTER key on this field has the same effect as the "Load Meas Set" softkey.
- Measurement Description
 - Short description of the measurement task. This is a read only field that shows the description as defined with the R&S InstrumentView software.
- User
 - Name of the person that performs the measurement.
- Name
 - Additional name option for the user running the measurement.
- Number of Sequence Steps to Perform
 - Number of individual measurements in the measurement sequence.

The field allows you to reduce the number of individual measurements and perform only those measurements that are really necessary. If you reduce the number of measurements, the R&S ZVH omits the last measurements in the sequence.

You can edit this field only if you have turned on the "Allow Variable Number of Sequence Steps" in the "Wizard Set Editor" of the R&S InstrumentView software.

- **Site Name**
Location of the measurement.
- **Comments**
Comments about the measurement, e.g. the external conditions during the measurement.
- **GPS Position**
Shows the GPS position, if you have connected a GPS receiver. Pressing the ENTER key on this field results in an update of the GPS coordinates.
- **Use Wizard Cable Settings**
Determines if you want to use the cable characteristics as defined in the measurement set or if you want to be able change cable characteristics on site. Select "Yes" to use the predefined cable characteristics. In That case the parameters below will be locked.
- **Cable Model**
Cable model that you perform the measurement on. You can define a cable model with the R&S InstrumentView software, but can also change the cable model on short notice, if necessary.
- **Clear Cable Model**
Deactivates the currently active cable model.
- **Cable Length**
Length of the cable that you perform the measurement on.
- **Calibration**
Calibration method to use before the measurement starts. This is a read only field, the calibration method has to be defined with R&S InstrumentView.

You have to calibrate the R&S ZVH before you can begin with the measurement sequence defined in the wizard. If the R&S ZVH has already been calibrated with the defined routine prior to starting the wizard, the R&S ZVH skips the calibration and directly starts the measurement.
- **Measurements**
List of all individual measurements (datasets) that need to be performed for successful completion of the measurement task. The list also shows the measurements that still need to be performed.

Some parameters of the measurement setup you can still change directly on the R&S ZVH. These are mainly parameters whose details may not be available when you define the measurement set or whose details may differ depending on the measurement site, e.g. the cable length or the cable model if it is different to the one defined previously.

- ▶ To change a parameter, select it with the cursor keys and activate the corresponding input field with the ENTER key.
- ▶ Update all parameters that are not correct for the current measurement.

7.2.2 Performing a Sequence of Measurements

Now that you have updated all parameters concerning the measurement task, you can start the measurement procedure.

- ▶ Press the "Start Meas Set" softkey.

If you have not yet calibrated the R&S ZVH for the measurement, it asks you to perform the calibration routine. The stages of the calibration depend on the defined calibration routine.

For more information see "[Calibrating Measurements](#)" on page 56.

Calibration pool

The R&S ZVH adds the calibration data of each calibration you perform to a calibration pool available on its internal memory. Each dataset in the calibration pool is unique for a particular calibration method and a particular measurement configuration.

Note that the calibration is only valid for the instrument it has been performed on.

Before you start a measurement sequence with the measurement wizard, the R&S ZVH compares the contents of the calibration pool to the measurement configurations and required calibration methods in the measurement sequence.

- If the R&S ZVH has already been calibrated for a particular configuration, it restores that data. Another calibration is not necessary.
- If the R&S ZVH has not been calibrated for a particular configuration yet, calibration becomes necessary. The new calibration data is added to the pool.

Therefore, calibration is necessary only for calibration methods that have not been used for a particular measurement configuration before.

However, it is recommended to perform calibration on a regular basis to keep measurements as accurate as possible.

You can delete obsolete calibration data from the folder:

```
\Public\CalibrationPool.
```

Measurement sequence

After having successfully calibrated the R&S ZVH, it starts to go through the measurements that are part of the measurement set. The sequence of measurements is as defined with R&S InstrumentView.

Before each measurement, the R&S ZVH shows a message box.

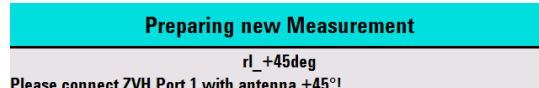

The message box contains the information and instructions on how to prepare and perform the measurement that you have defined with the R&S InstrumentView software.

- ▶ Make the necessary preparations, like connecting the cable.
- ▶ Press the "Confirm" softkey.

The R&S ZVH performs the measurement as defined in the dataset and measurement set. When finished, it shows the measurement results and says

Measurement Done.

Note that it is not possible to change any measurement parameters while using the measurement wizard. Marker functionality, scaling parameters and (if configured that way) cable settings are, however, available.

Changing cable characteristics

If necessary, you can define different cable characteristics (cable model and length) after each individual measurement. This is useful, for example, if you want to do the same measurements on different cables at one go.



This feature is available when you turn on "Prompt User to Change Cable Settings" in the "Wizard Set Editor" of the R&S InstrumentView software.

When this function is on, the R&S ZVH asks you to select new cable characteristics during the preparation of a measurement.

- ▶ Press the "Yes" softkey if changes are required and select new cable characteristics before proceeding with the measurement.
- ▶ Press the "No" softkey if changes are not required and proceed with the measurement.

After each measurement step, you have several options:

- Continue with the next measurement ("Continue" softkey).
Finishes the current measurement and begins with the next measurement by showing the necessary preparations.
- Repeat the current measurement ("Repeat Meas" softkey).
Repeats the current measurement, e.g. if the results don't match your expectations and you want to validate the results.
- Interrupt the measurement set sequence ("Interrupt Wizard" softkey).

Interrupting the sequence of measurements may become necessary if the measurement doesn't yield the expected results (e.g. violated limit lines).

In that case, you can interrupt the measurement sequence and try to find the origin of the problem by using different settings or measurements than those defined in the wizard.

When you interrupt the wizard sequence, the complete functionality is available as if you would not use the wizard.

When you interrupt a measurement sequence, the R&S ZVH keeps the results of measurements you have already performed.

When you are finished reconfiguring the measurement, press the WIZARD key and resume the measurement sequence with the "Resume Sequence" softkey.

- Skip a measurement ("Skip Meas" softkey).
Skips a single measurement and initiates the subsequent measurement.
Skipping individual measurements is possible when you turn on "Allow to skip measurements and finish wizard sequence" in the "Wizard Set Editor" of the R&S InstrumentView software.
- End the measurement sequence ("Finish Wizard" softkey).
Ends the measurement sequence and returns to the "Measurement Wizard" dialog box. The results of the measurements you have already finished are kept in the memory of the R&S ZVH.
Ending the sequence is possible when you turn on "Allow to skip measurements and finish wizard sequence" in the "Wizard Set Editor" of the R&S InstrumentView software.
- Abort the measurement sequence ("Cancel" softkey).
Aborts the measurement and returns to the "Measurement Wizard" dialog box. The results of the measurements you have already finished are lost.

When you have finished all measurements that are part of the measurement set, the R&S ZVH asks you if you want to save the measurement results.

- ▶ Press the "Save Meas Results" softkey.

The R&S ZVH saves the results on the selected storage device.

Limited internal memory



If you have to store the results on the internal memory, make sure that it has enough space left to store them. Else the results might get lost. If the space is not enough, you can delete old data with the file manager.

For more information see "[Deleting Datasets](#)" on page 42.

The results for a measurement set consist of a number of files, each file corresponding to one of the performed measurements. For easy evaluation, the R&S ZVH includes the name of the measurement as defined in the wizard dialog or R&S InstrumentView in the file name.

All result files that belong to a measurement set are stored in the same directory. The directory is named after the measurement name and site. The syntax is 'sitename_measurement_#'.

The R&S ZVH adds numbers in ascending order to files as well as directories if you perform a measurement or measurement set more than once.

7.3 Evaluating Results

The R&S InstrumentView software provides functionality to evaluate results and compile measurement reports. However, before you can start to evaluate the results you have to download the results to your computer.

- ▶ Select the "Report Generator" function.
 - The R&S ZVH opens a dialog box to select the measurement set(s) to download.
- ▶ Select the measurement set you want to download.
- ▶ Copy the files you want to include in the report with the "Add" button.

Now that the results are available, you can start to compile a measurement report with the R&S InstrumentView. The report generator provides the following features.

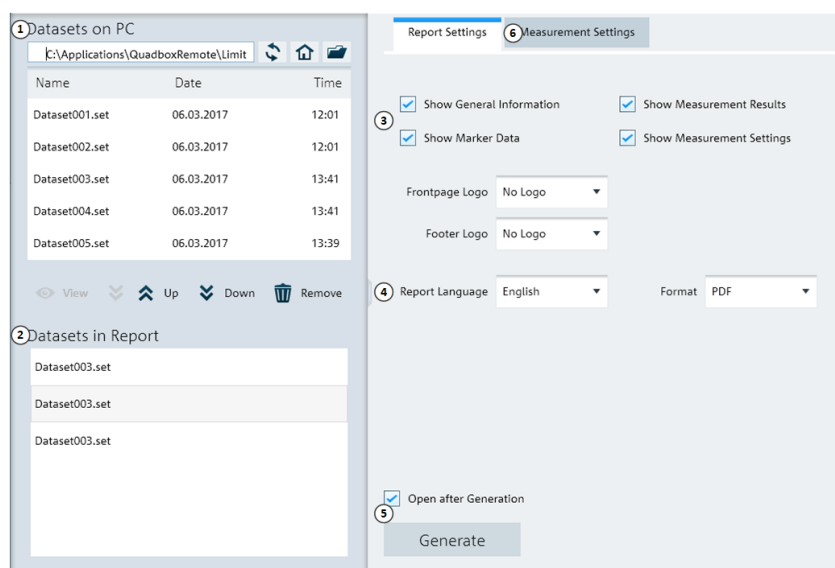

- 1 Source folder of the datasets
- 2 Measurement data to be included in the report
- 3 Selection of the included information on each report page
- 4 Selection of the output format
- 5 Save/load a report
- 6 Settings for the measurement set

With the report editor, you can create measurement reports for the full measurement set or a selection of dataset only. You can also perform simple tasks like activating or deactivating markers that have been set during the measurement.

- ▶ Add the results you want to include in the report by setting a checkmark or removing the checkmark in the report pane.
- ▶ Select the report format you would like.
- ▶ Create the report with the "Generate" button.

8 Spectrum Analyzer Mode (R&S ZVH-K1)

If you equip the R&S ZVH with firmware option R&S ZVH-K1, you are able to perform spectrum measurements. This measurement mode provides the functionality to perform e.g. channel power measurements.

8.1 Performing Spectrum Measurements

In addition to basic spectrum measurements, the R&S ZVH provides several specific measurements. These measurements, also in combination with one of the available accessories, allow you to perform advanced and more complex measurement tasks.

8.1.1 Measuring Basic Signal Characteristics

Basic spectrum measurements determine the spectrum of a signal in the frequency domain or keep track of a signal in the time domain. They provide a basic overview of the input signal characteristics.

Frequency domain

In the frequency domain, the R&S ZVH analyzes the input signal characteristics over a particular span. You can use it, for example, to obtain basic measurement results like peak levels and the shape of the spectrum.

The horizontal axis shows the frequency, the vertical axis shows the signal levels.

The measurement in the frequency domain is the default measurement mode.

Time domain

In the time domain, the R&S ZVH analyzes the characteristics of a signal at a particular frequency over time. The span during time domain measurements is 0 (zero span mode). You can use time domain measurements, for example to monitor the characteristics of a signal.

The horizontal axis shows the time, the vertical axis shows the signal levels.

To perform a time domain measurement, you have to set the span to zero manually.

8.1.2 Measuring the Channel Power of Continuously Modulated Signals

The channel power measurement selectively measures the power of modulated signals. Unlike a power meter that performs measurements over its entire frequency range, the channel power measurement measures the power of a specific transmission channel. Other signals in the frequency spectrum don't show in the results.

When measuring the spectrum within a channel, the R&S ZVH uses a resolution bandwidth that is small compared to the channel bandwidth. It then determines the total power of the channel by integrating the results on the trace. The R&S ZVH takes the following parameters into account:

- display mode (absolute or relative)
- detector
- resolution bandwidth

That means that you can compare the result to the result that would have been obtained from a thermal power meter. The small resolution bandwidth acts like a narrow channel filter and so prevents out-of-channel emissions from affecting the result.

- ▶ Press the MEAS key.
- ▶ Press the "Meas Mode" softkey.
- ▶ Select the "Channel Power" menu item.

The R&S ZVH starts to measure the channel power.

By default, the 3GPP WCDMA standard is active. Two vertical lines show the channel bandwidth.

Screen layout for channel power measurements

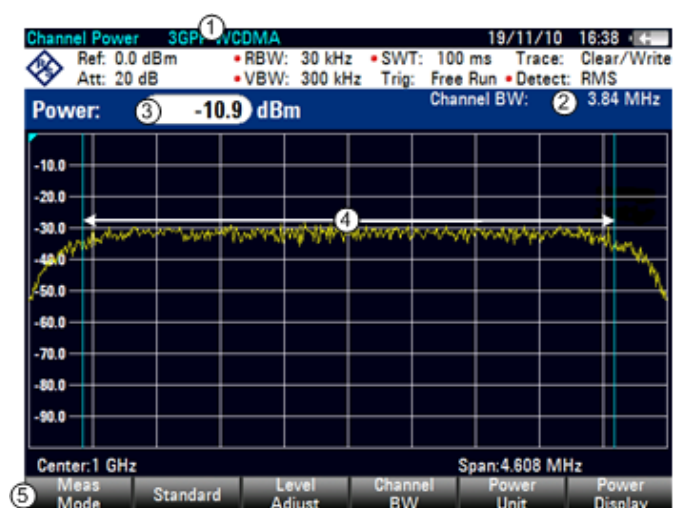

- 1 Standard
- 2 Channel bandwidth
- 3 Channel power numerical
- 4 Channel bandwidth graphical (blue lines)
- 5 Channel power measurement softkey menu

8.1.2.1 Selecting the Standard

If you need to perform measurements that conform to a telecommunications standard, you can activate one of the predefined standards that are already stored in the R&S ZVH memory. However, you can create new configurations to perform measurements on other standards as well.

- ▶ Press the MEAS key.
- ▶ Press the "Standard" softkey.

The R&S ZVH opens a dialog box to select the standard.

- ▶ Select one of the available standards.
- ▶ Confirm the selection with the "Select" softkey.

The R&S ZVH loads the configuration of the selected standard. It automatically sets the optimal span, resolution bandwidth, video bandwidth, sweep time and detector for the standard.

If the measurement is not according to the selected standard anymore (e.g. if you make changes to a parameter), the R&S ZVH puts a red dot in front of the standard display (• **3GPP WCDMA**).

You can create and edit standards with the R&S InstrumentView software and transfer them to the R&S ZVH via the USB or the LAN interface. The number of standards the R&S ZVH can store in its memory depends on the number of other data sets stored on the R&S ZVH.

For measurements on NB-IoT signals, you can use an FFT sweep instead of the frequency sweep, which is faster. In addition to predefined standards with FFT sweep, you can select the FFT sweep while creating or editing a standard file in R&S InstrumentView.

For more information see "[Managing Datasets](#)" on page 34.

8.1.2.2 Setting the Reference Level

The reference level is the power level that the R&S ZVH expects at the RF input. When selecting the reference level, make sure that you do not overload the R&S ZVH by applying a signal whose power exceeds the maximum reference level.

As the power is measured with a small resolution bandwidth compared to the signal bandwidth, it is still possible to overload the R&S ZVH, even if the trace is within the measurement diagram. To prevent an overload, perform the measurement with the largest resolution bandwidth possible using the peak detector. If you set these parameters, it is not possible for the trace to exceed the reference level.

To simplify operation and to prevent incorrect measurements, the R&S ZVH has an automatic routine for setting the reference level.

- ▶ Press the SCALE/AMPT key.
- ▶ Press the "Level Adjust" softkey.

The R&S ZVH performs a measurement to determine the optimal reference level.

Level Adjust:
Adjusting Level for Measurement
Please Wait...

It uses a resolution bandwidth of 1 MHz, a video bandwidth of 1 MHz and the peak detector. After finishing the automatic measurement, the R&S ZVH sets the optimal reference level.

8.1.2.3 Setting the Channel Bandwidth

The channel bandwidth specifies the frequency range around the center frequency, over which the R&S ZVH performs the power measurement.

- ▶ Press the MEAS key.
- ▶ Press the "Chan BW" softkey.

The R&S ZVH opens an input field to specify the channel bandwidth.

- ▶ Enter the channel bandwidth you need.

The R&S ZVH sets the appropriate span for the channel bandwidth that you have entered (span = 1.2 x channel bandwidth). This ensures that no incorrect channel power measurements are made.

The minimum channel bandwidth that you can set is 833 Hz at a span of 1 kHz.

8.1.2.4 Changing the Span

Usually, the span the R&S ZVH sets yields optimal results. But sometimes you also need to see the spectrum outside the current span to detect other signal components that you need to include in the measurement. Therefore, you can adjust the span to up to ten times the channel bandwidth and hence still be able to see the spectrum outside the measurement channel.

- ▶ Press the FORMAT/SPAN key.

In the default configuration, "Auto Span" is active. The R&S ZVH automatically sets the optimal span for the channel power measurement.

- ▶ Press the "Manual Span" softkey.

The R&S ZVH opens an input field to define the span manually.

- ▶ Enter the span you need.

The largest possible span for the channel power measurement is ten times the channel bandwidth. At larger spans, the result of the channel power measurement would be increasingly imprecise, because too few points of the trace would be in the channel you are measuring.

- ▶ Press the "Auto Span" softkey.

The R&S ZVH again calculates the span automatically.

8.1.2.5 Measuring the Maximum Channel Power

If signal levels fluctuate significantly, you can define the maximum channel power with the Max Hold function.

- ▶ Press the MEAS key.
- ▶ Press the "Power Display" softkey.
- ▶ Select the "Max Hold" menu item.

The power display switches from "Power" to "Max Power".

If you want to deactivate the Max Hold function and return to the normal power display, activate Clear/Write.

- ▶ To deactivate the Max Hold function, press the "Power Display" softkey.
- ▶ Select the "Clear/Write" menu item.

The power display returns to "Power" display.

8.1.2.6 Unit for Power Display

The R&S ZVH can apply different units to the power output. The default unit is dBm.

- ▶ Press the MEAS key.
- ▶ Press the "Power Unit" softkey.
- ▶ Select the unit you want from the submenu.

The R&S ZVH displays the power level in the selected unit.

8.1.3 Measuring the Occupied Bandwidth

The proper operation of a transmission network requires that all transmitters adhere to the bandwidths assigned to them. The occupied bandwidth is defined as the bandwidth that contains a specified percentage of the entire power of the transmitter.

Numerous standards require a occupied bandwidth of 99 %. Therefore this is the default setting. If you need another percentage for the occupied bandwidth you can set values from 10 % to 99.9 %.

After entering the channel bandwidth, the R&S ZVH automatically selects the measurement parameters so that you can attain the best result.

- ▶ Press the MEAS key.
- ▶ Press the "Meas Mode" softkey.

The R&S ZVH opens the measurement menu.

- ▶ Select the "Occupied BW" menu item.

The R&S ZVH starts to measure the occupied bandwidth.

Two vertical lines show the occupied bandwidth.

Screen layout for the occupied bandwidth

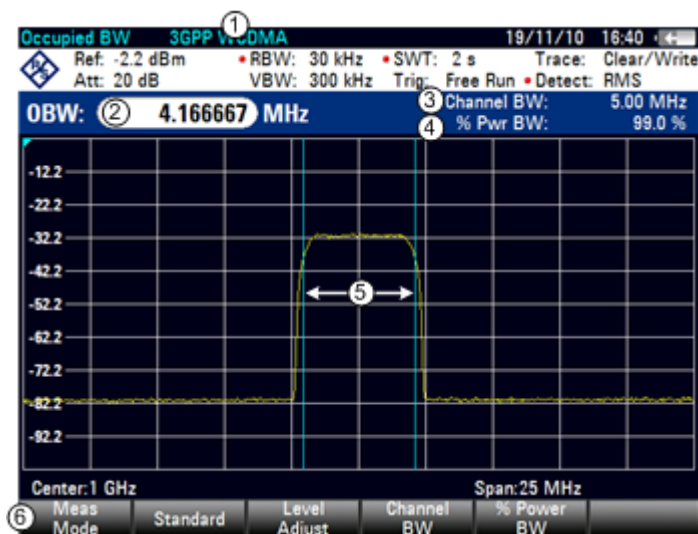

- 1 Standard
- 2 Occupied bandwidth numerical
- 3 Channel bandwidth
- 4 Power percentage
- 5 Occupied bandwidth graphical (blue lines)
- 6 Occupied bandwidth measurement softkey menu

8.1.3.1 Selecting a Standard

If you need to perform measurements that conform to a telecommunications standard, you can activate one of the predefined standards that are already stored in the R&S ZVH memory. However, you can create new configurations to perform measurements on other standards as well.

- ▶ Press the MEAS key.
- ▶ Press the "Standard" softkey.

The R&S ZVH opens a dialog box to select the standard.

- ▶ Select one of the available standards.
- ▶ Confirm the selection with the "Select" softkey.

The R&S ZVH loads the configuration of the selected standard. It automatically sets the optimal span, resolution bandwidth, video bandwidth, sweep time and detector for the standard.

You can create and edit standards with the R&S InstrumentView software and transfer them to the R&S ZVH via the USB or the LAN interface. The number of standards the R&S ZVH can store in its memory depends on the number of other data sets stored on the R&S ZVH.

For more information see "[Managing Datasets](#)" on page 34.

If you make changes to the settings or create datasets, note that

- the span is always coupled to the channel bandwidth. Changes to either of those automatically adjust the other (= 5 x channel bandwidth).
- the resolution bandwidth should be between 1 % and 4 % of the channel bandwidth. This ensures that the occupied bandwidth is measured with high accuracy.
- the video bandwidth must be at least three times the resolution bandwidth. This prevents incorrect results due to the compression of signal peaks by the video filter.
- you use the RMS detector if possible. This ensures that the power measurement is always correct irrespective of the waveform being investigated.
- the sweep time must be set so that the result is stable. If you increase the sweep time, the R&S ZVH also increases the integration time for the RMS detector and thus ensures more stable measured values.

8.1.3.2 Setting the Reference Level

The reference level is the power level that the R&S ZVH expects at the RF input. When selecting the reference level, make sure that you do not overload the R&S ZVH by applying a signal whose power exceeds the maximum reference level.

As the power is measured with a small resolution bandwidth compared to the signal bandwidth, it is still possible to overload the R&S ZVH, even if the trace is within the measurement diagram.

To prevent an overload, perform the measurement with the largest resolution bandwidth possible using the peak detector. If you set these parameters, it is not possible for the trace to exceed the reference level.

To simplify operation and to prevent incorrect measurements, the R&S ZVH has an automatic routine for setting the reference level.

- ▶ Press the SCALE/AMPT key.
- ▶ Press the "Level Adjust" softkey.

The R&S ZVH performs a measurement to determine the ideal reference level.

It uses a resolution bandwidth of 1 MHz, a video bandwidth of 1 MHz and the peak detector. After finishing the automatic measurement, the R&S ZVH sets the ideal reference level.

8.1.3.3 Setting the Channel Bandwidth

The channel bandwidth specifies the frequency range around the center frequency, over which the R&S ZVH performs the power measurement.

- ▶ Press the MEAS key.
- ▶ Press the "Chan BW" softkey.

The R&S ZVH opens an input field to specify the channel bandwidth.

- ▶ Enter the channel bandwidth you need.

The R&S ZVH sets the appropriate span for the channel bandwidth that you have entered (span = 5 x channel bandwidth). This ensures that no incorrect channel power measurements are made.

The minimum channel bandwidth that you can set is 2 kHz at a span of 1 kHz.

8.1.3.4 Defining the Percentage of Occupied Bandwidth

By default, the power percentage inside the occupied bandwidth is 99 %, a number most standards require. If you measure standards that specify another power percentage you can change that value.

- ▶ Press the MEAS key.
- ▶ Press the "% Power BW" softkey.

The R&S ZVH opens an input field to define the power percentage.

- ▶ Enter the power percentage you need.

The value you enter here is the power percentage that has to be inside the channel bandwidth relative to the power over the total span (the percentage of the total power).

The R&S ZVH now displays the occupied bandwidth graphically in the trace window and numerically above the trace window.

8.1.3.5 Changing the Span

Usually, the span the R&S ZVH sets yields optimal results. But sometimes you also need to see the spectrum outside the current span to detect other signal components that you need to include in the measurement. Therefore, you can adjust the span to up to ten times the channel bandwidth and still be able to see the spectrum outside the measurement channel.

- ▶ Press the FORMAT/SPAN key.

In the default configuration, "Auto Span" is active. The R&S ZVH automatically sets the optimal span for the channel power measurement.

- ▶ Press the "Manual Span" softkey.

The R&S ZVH opens an input field to define the span manually.

- ▶ Enter the span you need.

The largest possible span for the channel power measurement is ten times the channel bandwidth. At larger spans, the result of the channel power measurement would be increasingly imprecise, because too few points of the trace occur in the channel to be measured.

- ▶ Press the "Auto Span" softkey.

The R&S ZVH again calculates the span automatically.

8.1.4 Power Measurements on TDMA Signals

When TDMA (time division multiple access) methods are used, e.g. for GSM, several users share a channel. Each user is assigned a period of time or timeslot. With the TDMA power measurement, you can determine the power over one of the timeslots.

The TDMA power measurement is a measurement in the time domain (span = 0 Hz). You can start it on an external or video trigger and specify the power measurement time.

To prevent incorrect power measurements in the time domain, make sure that the whole signal is within the selected resolution bandwidth. If the resolution bandwidth is too small, the displayed power will be lower than the actual power.

- ▶ Press the MEAS key.
- ▶ Press the "Meas Mode" softkey.
The R&S ZVH opens the measurement menu.
- ▶ Select the "TDMA Power" menu item.
The R&S ZVH starts to measure the TDMA power.
Two vertical lines define the measurement range.

Screen layout for TDMA power measurements

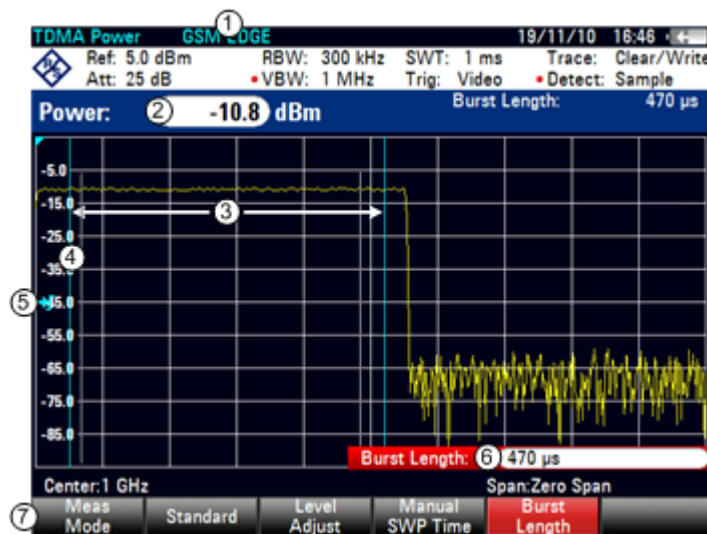

- 1 Standard
- 2 TDMA power
- 3 Measurement limits
- 4 Trigger delay
- 5 Trigger level
- 6 Measurement time
- 7 TDMA power measurement softkey menu

8.1.4.1 Selecting a Standard

If you need to perform measurements that conform to a telecommunications standard, you can activate one of the predefined standards that are already stored in the R&S ZVH memory. When starting the measurement in the default configuration, the R&S ZVH automatically activates the GSM/EDGE standard. However, you can create new configurations to perform measurements on other standards as well.

- ▶ Press the MEAS key.
- ▶ Press the "Standard" softkey.

The R&S ZVH opens a dialog box to select the standard.

- ▶ Select one of the available standards.
- ▶ Confirm the selection with the "Select" softkey.

The R&S ZVH loads the configuration of the selected standard. It automatically sets the optimal settings for the selected standard.

You can create and edit standards with the R&S InstrumentView software and transfer them to the R&S ZVH via the USB or the LAN interface. The number of standards the R&S ZVH can store in its memory depends on the number of other data sets stored on the R&S ZVH.

For more information see "[Managing Datasets](#)" on page 34.

8.1.4.2 Setting the Burst Length

The burst length is the measurement time that the R&S ZVH performs measurements with. The burst length can be equal or less than the sweep time.

- ▶ Press the MEAS key.
- ▶ Press the "Burst Length" softkey.

The R&S ZVH opens an input field to define the burst length.

- ▶ Enter the length of the burst you need.

The R&S ZVH performs the measurement over the time you have entered.

If the measurement time you have entered was greater than the sweep time, the R&S ZVH sets a burst length equal to the sweep time. To work with a greater burst length, you have to increase the sweep time first.

The minimum burst length is the time corresponding to one trace pixel (= sweep time / 631).

8.1.4.3 Setting the Reference Level

The reference level is the power level that the R&S ZVH expects at the RF input. When selecting the reference level, make sure that you do not overload the R&S ZVH by applying a signal whose power exceeds the maximum reference level.

Because the resolution bandwidths of the R&S ZVH are implemented digitally after the A/D converter, the signal level at the A/D converter can be higher than the level indicated by the trace, depending on the selected resolution bandwidth.

To prevent the A/D converter from being overloaded, the signal must be measured at the widest resolution bandwidth and video bandwidth with the peak detector. The trace maximum then determines the best reference level.

To simplify operation and to prevent incorrect measurements, the R&S ZVH has an automatic routine for setting the reference level.

- ▶ Press the SCALE/AMPT key.
- ▶ Press the "Level Adjust" softkey.

The R&S ZVH performs a measurement to determine the ideal reference level.

It uses a resolution bandwidth of 3 MHz, a video bandwidth of 3 MHz and the peak detector. After finishing the automatic measurement, the R&S ZVH sets the ideal reference level.

8.1.4.4 Using a Trigger

Usually you will apply a trigger when measuring bursts.

If a trigger is active, the R&S ZVH uses the video trigger for TDMA measurements by default. The video trigger level is at 50 % of the range of the vertical axis but is variable. This means, the R&S ZVH triggers a measurement if the rising edge of the burst exceeds this 50 % line.

If the DUT features some sort of trigger equipment, you can also use an external trigger to trigger measurements.

- ▶ Connect the DUT trigger output to the R&S ZVH trigger input.
- ▶ Press the SWEEP/BW key.
- ▶ Press the "Trigger" softkey.
- ▶ Select either the "External Rise" or "External Fall" menu item (rising or falling edge).

The R&S ZVH activates the trigger and shows the results of the measurement.

It may be that the burst is not completely visible on the display. To correct that and make the whole burst visible, you can set a trigger delay.

- ▶ Press the "Trigger" softkey.
- ▶ Select the "Trigger Delay" menu item.

The R&S ZVH opens an input field to define the trigger delay.

- ▶ Adjust the trigger delay until the burst is visible inside the vertical lines that show the measurement range.

8.1.5 Measuring the Adjacent Channel Leakage Ratio (ACLR)

The adjacent channel leakage ratio (ACLR) measurement is a method to measure the power over more than one transmission channel and also evaluate the power of the adjacent (or alternate) channels of the transmission channel. The ACLR performs measurements according to a specific channel configuration, e.g. a particular radio communications standard.

- ▶ Press the MEAS key.
- ▶ Press the "Meas Mode" softkey.

The R&S ZVH opens the measurement menu.

- ▶ Select the "ACLR" menu item.

The R&S ZVH starts to measure the adjacent channel leakage ratio.

In principle, the ACLR measurement works like the channel power measurement in that it determines the spectrum within the channel using a resolution bandwidth that is small compared to the channel bandwidth. In addition to the channel bandwidth, the ACLR measurement is also defined by the channel spacing, the bandwidth of adjacent channels and the adjacent channel spacing. The R&S ZVH supports measurements on up to 12 carrier channels and 12 adjacent channels to either side of the carrier. When measuring more than one carrier or adjacent channels, the R&S ZVH shows the powers of each channel in a list below the marker list. The channel itself is marked by red (transmission channels) or green (adjacent channels) vertical lines.

Screen Layout for ACLR measurements

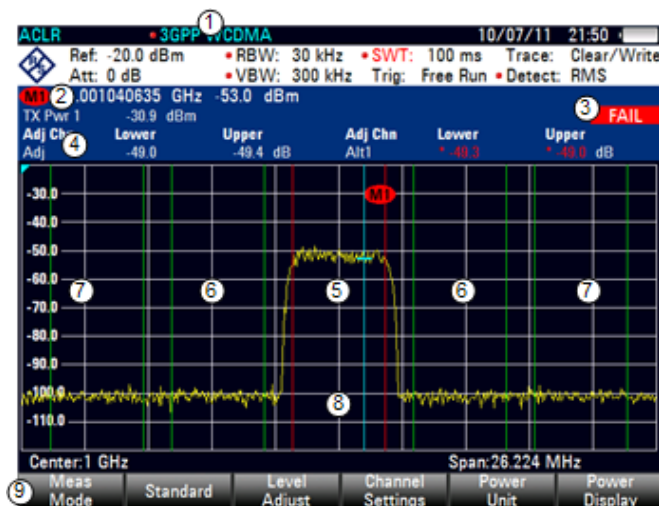

- 1 Standard
- 2 Marker information
- 3 Limit check information
- 4 Channel information
- 5 TX channel (red line)
- 6 Adjacent channel (green line)
- 7 Alternate channels (green lines)
- 8 Marker (blue line)
- 9 ACLR softkey menu

The predefined standards are the same as for channel power measurements (3GPP WCDMA, cdmaOne and CDMA2000 1x systems). However, you can also customize the settings to set up the R&S ZVH for other radio communication standards. You can define the settings directly on the R&S ZVH or define and manage them using the R&S InstrumentView software.

When customizing settings, make sure to consider the following points to get valid and accurate measurement results:

- Reference level

Make sure not to overload the R&S ZVH as the power is measured with a resolution bandwidth that is small in comparison with the signal bandwidth. As with Channel Power measurements, automatically set the reference to an optimal level with the "Level Adjust" softkey.

- Setting the span

The frequency span must at least cover the carriers and the adjacent channels plus a measurement margin of about 10 % to get valid results.

If the span is automatically calculated by the R&S ZVH with the "Auto Span" function, the span is calculated as follows:

$$(No. \text{ of transmission channels} - 1) \times \text{transmission channel spacing} + 2 \times \text{transmission channel bandwidth} + \text{measurement margin}$$

with the measurement margin being approx. 10 % of the value obtained by adding the channel spacing and the channel bandwidth.

Selecting the frequency span



If the frequency span is too large in comparison to the channel bandwidth (or the adjacent-channel bandwidths) being examined, only a few points on the trace are available per channel. This reduces the accuracy of the waveform calculation for the channel filter used, which has a negative effect on the measurement accuracy. It is therefore strongly recommended that the formulas mentioned be taken into consideration when selecting the frequency span.

- Setting the resolution bandwidth:

The RBW should not be too high or too small to get both an acceptable measurement speed and a suppression of spectral components outside the channels. As a rule of thumb, it is recommended to set it to about 1 % to 4 % of the channel bandwidth.

You can select a larger resolution bandwidth if the spectrum within the channel to be measured and around it has a flat characteristic. In the standard setting, e.g. for standard cdmaOne at an adjacent channel bandwidth of 30 kHz, a resolution bandwidth of 30 kHz is used. This yields correct results since the spectrum in the neighborhood of the adjacent channels normally has a constant level.

For standard NADC/IS136 this would not be possible, for example, since the spectrum of the transmit signal penetrates into the adjacent channels and a too large resolution bandwidth causes a too low selection of the channel filter. The adjacent-channel power would thus be measured too high.

If the RBW is automatically calculated by the R&S ZVH with the "Auto RBW" function, the RBW is calculated as follows:

$$RBW \leq 1/40 \text{ of channel bandwidth}$$

The R&S ZVH then selects the maximum possible resolution bandwidth resulting from the available RBW steps (1, 3).

- Setting the video bandwidth

To obtain correct power measurements, the video signal must not be limited in bandwidth. A restricted bandwidth of the logarithmic video signal would cause signal averaging and thus result in a too low indication of the power (-2.51 dB at very low video bandwidths). Therefore, the VBW should be at least three times the resolution bandwidth.

If the VBW is automatically calculated by the R&S ZVH with the "Auto VBW" function, the VBW is calculated as follows:

$$VBW \geq 3 \times RBW$$

The R&S ZVH then selects the smallest possible VBW with regard to the available step size.

- Selecting the detector:

It is best to use the RMS detector. This detector correctly indicates the power irrespective of the characteristics of the signal to be measured. The whole IF envelope is used to calculate the power for each measurement point. The IF envelope is digitized using a sampling frequency which is at least five times the resolution bandwidth which has been selected. Based on the sample values, the power is calculated for each measurement point using the following formula:

$$P_{RMS} = \sqrt{\frac{1}{N} \cdot \sum_{i=1}^N s_i^2}$$

with

s_i = linear digitized video voltage at the output of the A/D converter

N = number of A/D converter values per measurement point

P_{RMS} = power represented by a measurement point

When the power has been calculated, the power units are converted into decibels and the value is displayed as a measurement point.

In principle, the sample detector would be possible as well. Due to the limited number of measurement points used to calculate the power in the channel, the sample detector would yield less stable results.

8.1.5.1 Selecting a Standard

If you need to perform measurements that conform to a telecommunications standard, you can activate one of the predefined standards that are already stored in the R&S ZVH memory. Those predefined standards have already been set up to yield the best results. However, the R&S ZVH provides functionality to create new configurations to perform measurements on other test setups as well.

- ▶ Press the MEAS key.
- ▶ Press the "Standard" softkey.

The R&S ZVH opens a dialog box to select the standard.

- ▶ Select one of the available standards.
- ▶ Confirm the selection with the "Select" softkey.

The R&S ZVH loads the configuration of the selected standard. It automatically sets the optimal span, resolution bandwidth, video bandwidth, sweep time and detector for the standard.

You can create and edit standards with the R&S InstrumentView software and transfer them to the R&S ZVH via the USB or the LAN interface. The number of standards the R&S ZVH can store in its memory depends on the number of other data sets stored on the R&S ZVH. For more information see "[Managing Datasets](#)" on page 34.

8.1.5.2 Configuring the Measurement

In addition to creating and editing standards with the R&S InstrumentView software, the R&S ZVH also provides functionality to set up a measurement configuration.

Setting the number of transmission channels

- ▶ Press the MEAS key.
- ▶ Press the "Channel Settings" softkey.
- ▶ Select the "Tx Channels" menu item.

The R&S ZVH opens an input field to define the number of transmission channels.

- ▶ Enter the number of transmission channels you need for the measurement.

Setting the number of adjacent channels

- ▶ Press the "Channel Settings" softkey.
- ▶ Select the "Adj Channels" menu item.

The R&S ZVH opens an input field to define the number of adjacent channels.

- ▶ Enter the number of adjacent / alternate channels you need for the measurement.

The borders of Tx channels are displayed red in the trace diagram, the borders of adjacent and alternate channels are displayed green.

Setting the channel bandwidth

The channel bandwidth specifies the frequency range around the center frequency, over which the R&S ZVH performs the power measurement.

- ▶ Press the MEAS key.
- ▶ Press the "Channel BW" softkey.
The R&S ZVH opens a dialog box to specify the channel bandwidth for all channels.
- ▶ Select the channel you want to change the bandwidth for.
- ▶ Activate the input by pressing the ENTER key.

TX / ACP Channel Bandwidth	
TX	14 kHz
Adj	14 kHz
Alt1	14 kHz
Alt2	14 kHz
Alt3	14 kHz
Alt4	14 kHz
Alt5	14 kHz
Alt6	14 kHz
Alt7	14 kHz
Alt8	14 kHz
Alt9	14 kHz
Alt10	14 kHz
Alt11	14 kHz

- ▶ Enter the channel bandwidth you need.

The R&S ZVH sets the appropriate span for the channel bandwidth that you have entered according to the criteria described above. This ensures that no incorrect channel power measurements are made.

The minimum channel bandwidth that you can set is 833 Hz at a span of 1 kHz.

Setting the channel spacing

In case of the R&S ZVH, the channel spacing is defined as the distance between the center frequency of the transmission channel and the center frequency to the next transmission channel or the distance between the center frequency of the transmission channel and the center frequency of the adjacent channel.

Specific channel spacing definitions



Note that some radio communication standards, e.g. CDMA2000 DS / MC1 / MC3 and IS95 B / C, IS97 B / C, IS98 B / C, define the channel spacing differently, namely the distance from the center of the transmission channel to the closest border of the adjacent channel. The R&S ZVH does not consider these specifics. It always regards the channel spacing as the distance between the center of a channel and the center of its neighboring channel.

- ▶ Press the MEAS key.
- ▶ Press the "Channel Settings" softkey.
- ▶ Select the "Channel Spacing" menu item.

The R&S ZVH opens a dialog box to define the spacings for all transmission channels and adjacent / alternate channels.

- ▶ Select the channel you want to change the spacing for.
- ▶ Activate the input by pressing the ENTER key.
- ▶ Enter the channel spacing you need.

The R&S ZVH now takes the new values into account for future measurements.

TX / ACP Channel Spacing	
TX1-2	20 kHz
TX2-3	20 kHz
TX3-4	20 kHz
TX4-5	20 kHz
TX5-6	20 kHz
TX6-7	20 kHz
TX7-8	20 kHz
TX8-9	20 kHz
TX9-10	20 kHz
TX10-11	20 kHz
TX11-12	20 kHz
Adj	20 kHz
Alt1	20 kHz
Alt2	20 kHz
Alt3	20 kHz
Alt4	20 kHz
Alt5	20 kHz

When performing measurements on multi-carrier signals, you can define the spacing of the transmission (Tx) channels to one another. By default, the R&S ZVH assumes equal spacing between all Tx channels in the system. Therefore, the spacing you enter for the first two Tx channels is automatically applied to all other Tx channels.

If you do measurements on systems with a different channel spacing for each Tx channel, you can also set the channel spacing for each Tx channel separately by entering the respective number in the fields.

If the spacings are not equal, the channel distribution according to the center frequency is as follows:

- Odd number of TX channels

The middle TX channel is centered to center frequency.

- Even number of TX channels

The two TX channels in the middle are used to calculate the frequency between those two channels. This frequency is aligned to the center frequency.

Adjacent or alternate channel spacing is also available for single-carrier measurements. The R&S ZVH can perform measurements on up to 12 adjacent channels. Usually the first adjacent channel to the Tx channel is referred to as the Adjacent Channel (ADJ). All others are called Alternate Channels (ALT1 to ALT11).

By default, the R&S ZVH assumes that the distance of the adjacent channels to each other is the same. In that case, you only have to enter the first spacing value. The R&S ZVH then calculates all higher adjacent channels from that value. If you change the spacing of one of the higher channels, the R&S ZVH only updates the channel spacings above the one you have changed, but not those below.

So, for example, if you set the first adjacent channel spacing (ADJ) to 20 kHz, the following spacings are 40 kHz (ALT1), 60 kHz (ALT2), 80 kHz (ALT3), 100 kHz (ALT4), 120 kHz (ALT5) and so on.

If you then change the spacing of the third alternate channel (ALT3) to 100 kHz, the R&S ZVH adjusts the alternate channels above the third one accordingly: 125 kHz (ALT4), 150 kHz (ALT5) and so on.

8.1.5.3 Normalization of Measurement Results

By default, the power of the channels and adjacent channels is displayed in the unit dBm. It is also possible to display the power density of the signal to, for example, measure the signal/noise power density or obtain the signal to noise ratio.

- ▶ Press the MEAS key.
- ▶ Press the "Channel Settings" softkey.
- ▶ Select the "Channel Pwr/Hz" menu item.

The R&S ZVH activates normalization and switches the unit from dBm to dBm/Hz.

The channel power density in dBm/Hz corresponds to the power inside a bandwidth of 1 Hz and is calculated as follows:

$$\text{channel power density} = \text{channel power} - \log_{10}(\text{channel bandwidth})$$

8.1.5.4 Displaying Absolute and Relative Results

You can set up the result display to either show the absolute power of the adjacent channels or the power relative to one of the transmission channels.

- ▶ Press the MEAS key.
- ▶ Press the "Power Display" softkey.
- ▶ Select either the "Absolute" menu item to display the absolute results or the "Relative" menu item to display the power relative to one of the transmission channels.

8.1.5.5 Selecting the Reference Channel

When determining relative power values for the adjacent channels, you can set a specific transmission channel as the reference channel.

- ▶ Press the MEAS key.
- ▶ Press the "Channel Settings" softkey.
- ▶ Select the "ACLR Ref Setting" menu item.

The R&S ZVH opens a another submenu to select the reference channel.

- ▶ Select the method of determining the reference channel.

The following methods are available:

- Tx Channel

Select a specific transmission channel by entering its number as the reference.

- Min Power Tx Channel

The channel with the lowest power level is the reference channel.

- Max Power Tx Channel
The channel with the highest power level is the reference channel.
- Lowest Highest Channel
The outer left-hand transmission channel is the reference channel for the lower adjacent channels. The outer right-hand transmission channel is the reference channel for the upper adjacent channels.

8.1.5.6 Setting and Checking the Limits

Limit checks in ACLR measurement mode are independent of limit line handling. You can define a limit for each of the adjacent channels. Limits for adjacent channels can be set either in absolute or relative terms.

Defining relative limits

- ▶ Press the MEAS key.
- ▶ Press the "Channel Settings" softkey.
- ▶ Select the "Channel Limit Relative" menu item.

The R&S ZVH opens a dialog box to define the relative limits for each adjacent channel.

Channel Limit Relative	
<input checked="" type="checkbox"/> Adj	0.0 dB
<input checked="" type="checkbox"/> Alt1	-10.0 dB
<input type="checkbox"/> Alt2	0.0 dB
<input type="checkbox"/> Alt3	0.0 dB
<input type="checkbox"/> Alt4	0.0 dB
<input type="checkbox"/> Alt5	0.0 dB
<input type="checkbox"/> Alt6	0.0 dB
<input type="checkbox"/> Alt7	0.0 dB
<input type="checkbox"/> Alt8	0.0 dB
<input type="checkbox"/> Alt9	0.0 dB
<input type="checkbox"/> Alt10	0.0 dB
<input type="checkbox"/> Alt11	0.0 dB

- ▶ Select the channel you want to define a limit for.
- ▶ Activate the input by pressing the "Select" softkey.
The channel turns green and the check box in the first column is marked.
- ▶ Enter the limit value you need.
The R&S ZVH automatically activates the check flag, so that the limit is included in future limit checks.
- ▶ To deactivate the limit check for a specific channel, move the cursor to the channel in question with the rotary knob or the cursor keys and deselect it with the "Select" softkey.

Defining absolute limits

- ▶ Press the "Channel Settings" softkey.
- ▶ Select the "Channel Limit Absolute" menu item.

The R&S ZVH opens a dialog box to define the absolute limits for each adjacent channel.

- ▶ The procedure of defining absolute limits is analogous to that of defining relative limits.

Performing a limit check

- ▶ Press the "Channel Settings" softkey.
- ▶ Select the "Check Channel Limits" menu item.

The R&S ZVH automatically performs limit checks.

Power 1 (r)	-91.6	dBm			
Adj Chn	Lower	Upper	Adj Chn	Lower	Upper
Adj	* 0.2	-0.7 dB	Alt1	* -0.0	* -1.4 dB

The results of the limit check are displayed in the table above the trace. If a result fails the limit check, it turns red and has a star (*) in front of its power level.

8.1.6 Measuring the Spectrum Emission Mask

The spectrum emission mask (SEM) measurement is a method to detect spurious emissions or intermodulation products of a signal. When performing a SEM measurement, the R&S ZVH checks the signal against a spectral mask to see whether the signal complies with a specific standard or not. Therefore, the R&S ZVH provides predefined spectrum emission masks for various telecommunications standards.

However, you can define your own spectral masks with the R&S InstrumentView software to perform measurements in frequency ranges other than the predefined ones. To learn how to define spectrum emission masks, refer to the R&S InstrumentView manual.

- ▶ Press the MEAS key.
- ▶ Press the "Meas Mode" softkey.

The R&S ZVH opens the measurement menu.

- ▶ Select the "Spectrum Emission Mask" menu item.

The R&S ZVH starts to measure the spectrum emission mask.

Note that the frequency range of the actual measurement depends on the start and stop frequency you have set on the R&S ZVH. Correct measurement results are therefore only possible if the frequency ranges of the SEM are inside the current span of the R&S ZVH.

Screen Layout for the SEM measurement



- 1 Standard
- 2 Marker information
- 3 SEM list
- 4 Limit check result
- 5 Spectrum emission mask (red line)
- 6 Trace (yellow line)
- 7 Peak (P<x>) and normal markers (M<x> and D<x>) (blue line)
- 8 SEM softkey menu

Markers in the SEM measurement

In addition to the normal marker functionality of the R&S ZVH, the SEM measurement provides special markers labeled P1 to Px.

The R&S ZVH activates and positions these special markers automatically after displaying the trace. Each of these markers marks the peak level in each SEM subrange. Thus, the number of markers depends on the number of subranges defined for the spectrum emission mask and in turn depends on the standard you are measuring against.

The numerical marker information (frequency and level) for these markers is part of the SEM list.

Markers P1 to Px are fix and always remain on the peak level of the corresponding subrange. If you'd like to analyze other locations on the trace, use normal marker and deltamarker functionality. For more information see "[Using Markers and Deltamarkers](#)" on page 163.

8.1.6.1 Selecting a Standard

If you need to perform measurements that are conform to a telecommunications standard, you can activate one of the predefined standards that are already stored in the R&S ZVH memory. However, you can create new configurations to perform measurements on other standards as well.

- ▶ Press the MEAS key.
- ▶ Press the "Standard" softkey.

The R&S ZVH opens a dialog box to select the standard.

- ▶ Select one of the available standards.
- ▶ Confirm the selection with the "Select" softkey.

The R&S ZVH loads the configuration of the selected standard. It automatically sets the optimal span, resolution bandwidth, video bandwidth, sweep time and detector for the standard.

You can create and edit standards with the R&S InstrumentView software and transfer them to the R&S ZVH via the USB or the LAN interface. The number of standards the R&S ZVH can store in its memory depends on the number of other data sets stored on the R&S ZVH.

For measurements on NB-IoT signals, you can use an FFT sweep instead of the frequency sweep, which is faster. In addition to predefined standards with FFT sweep, you can select the FFT sweep while creating or editing a standard file in R&S InstrumentView.

For more information see "[Managing Datasets](#)" on page 34.

8.1.6.2 Optimizing Measurement Settings

After selecting the standard and applying the signal to the R&S ZVH, you can optimize measurement settings to avoid overloading the R&S ZVH.

- ▶ Press the "Adjust Settings" softkey.

The R&S ZVH performs a measurement to determine the ideal reference level and span..

8.1.6.3 Viewing the Results in a Table

You can add a table to the display that shows the measurement results in numerical form. Each line in the table corresponds to a SEM range with the results of each range referring to the reference range. The reference range is suppressed unless it has to be checked against an absolute limit.

- ▶ Press the MEAS key.
- ▶ Press the "View List" softkey.

The R&S ZVH shows a list above the trace diagram.

Tx Power	-29.6 dBm	Tx Bw	5 MHz			PASS
Range [Hz]	RBW [Hz]	Peak	Freq [Hz]	Power Abs	Power Rel	Δ Limit
-12.750 M	-8.500 M	1 M	869.828095 M	-85.85 dBm	-56.35 dB	-48.48 dB
-8.500 M	-7.500 M	1 M	870.030476 M	-86.06 dBm	-56.55 dB	-37.87 dB
-7.500 M	-3.500 M	1 M	874.078095 M	-85.93 dBm	-56.43 dB	-47.78 dB
-3.500 M	-2.500 M	30 k	875.778095 M	-99.93 dBm	-70.43 dB	-52.79 dB

If the list contains more than four entries, you can scroll through the list with the rotary knob or the cursor keys to see the other results. Note that scrolling works only if there is no active input field.

The list contains the following information:

- Tx Power
Power level of the transmission channel.
- Tx Bandwidth
Bandwidth of the transmission channel.
- PASS / FAIL information
If the signal is within the limits of the spectral mask, the R&S ZVH shows **PASS**, if not it shows **FAIL**.
- Range [Hz]
Frequency range. The first number is the start frequency, the second number the stop frequency of each defined frequency range. The character following the number indicates the unit (k = kHz, M = MHz, G = GHz)
- RBW [Hz]
Resolution bandwidth the corresponding frequency range is measured with.
- Peak
Number of the peak marker (Px).
- Freq [Hz]
Frequency of the peak level that has been measured in each frequency range

- Power Abs
Absolute peak power in the corresponding frequency range.
- Power Rel
Relative peak power in relation to the channel power of the reference channel.
- Δ Limit
Minimum distance from the limit line to the trace in the corresponding frequency range. Negative values or a zero indicate a passed SEM limit check, positive values indicate a violation of the limit check.

8.1.7 Measuring the Harmonic Distortion

The harmonic distortion measurement is an easy way to identify the harmonics of a DUT. In addition to the graphic display of the harmonics, this measurement mode also calculates the total harmonic distortion (THD) and shows the results.

You can perform a harmonic distortion measurement in frequency sweep (span > 0) and zero span mode (span = 0). When starting the measurement, the R&S ZVH looks for the first harmonic of the signal (= the highest signal) in the defined frequency range. It then adjusts the frequency axis so that all harmonics are visible. In zero span mode, the center frequency remains the same.

- ▶ Press the MEAS key.
- ▶ Press the "Meas Mode" softkey.
- ▶ Select the "Harmonic Distortion" menu item.

The R&S ZVH starts to measure the harmonic distortion.

The search for harmonics starts as soon as you enter the harmonic distortion measurement. Upon entering the measurement, the R&S ZVH automatically adjusts the settings in order to display the selected number of harmonics (default = 2) on the screen.

Screen layout for the harmonic distortion measurement



- 1 Harmonics list
- 2 Total harmonic distortion in %
- 3 Total harmonic distortion in dB
- 4 Trace
- 5 Markers indicating harmonics (blue lines)
- 6 Harmonic distortion softkey menu

8.1.7.1 Defining the Number of Harmonics

By default, the R&S ZVH shows the signal and its first harmonic. Each harmonic is indicated by a marker that the R&S ZVH places on the harmonic (here M1 and M2). Note that all of the markers that have been set are normal markers that show the absolute frequency of the harmonic.

At the same time, the R&S ZVH also calculates the values for the total harmonic distortion (THD) and shows the results in a box above the trace diagram. The values are output in % as well as dB.

If you want to see more than one harmonic, the R&S ZVH can show up to six harmonics.

- ▶ Press the MEAS key.
- ▶ Press the "Harmonics" softkey.
- ▶ Enter the number of harmonics you'd like to see.

8.1.7.2 Optimizing the Display of Harmonics

The R&S ZVH places the markers on the other harmonics even if they are outside of the display range.

- ▶ Press the MEAS key.
- ▶ Press the "Adjust Settings" softkey.

The R&S ZVH performs a measurement to determine the ideal reference level, frequency and span in order to display all harmonics.

8.1.7.3 Activating the Harmonics List

To see the exact frequency of the harmonic, you can activate the marker list that shows the value for each harmonic or marker.

- ▶ Press the MKR key.
- ▶ Press the "View List" softkey.

The R&S ZVH displays the marker list that contains the values for each harmonic.

8.1.8 Measuring the AM Modulation Depth

The AM modulation depth measurement analyzes AM modulated signals and calculates the modulation depth of the signal using the measurement results. Note that the measurement works properly only if you apply an AM modulated signal.

- ▶ Press the MEAS key.
- ▶ Press the "Meas Mode" softkey.
The R&S ZVH opens the measurement menu.
- ▶ Select the "AM Modulation Depth" menu item.

The R&S ZVH starts to measure the AM modulation depth.

After you have started the measurement, the R&S ZVH places three markers on the trace. The first marker is placed on the peak power level. The R&S ZVH assumes that position as the level of the carrier. The second and third markers are delta markers. These are placed symmetrically on the adjacent peak values to the left and right of the carrier.

Screen layout for the AM modulation depth measurement

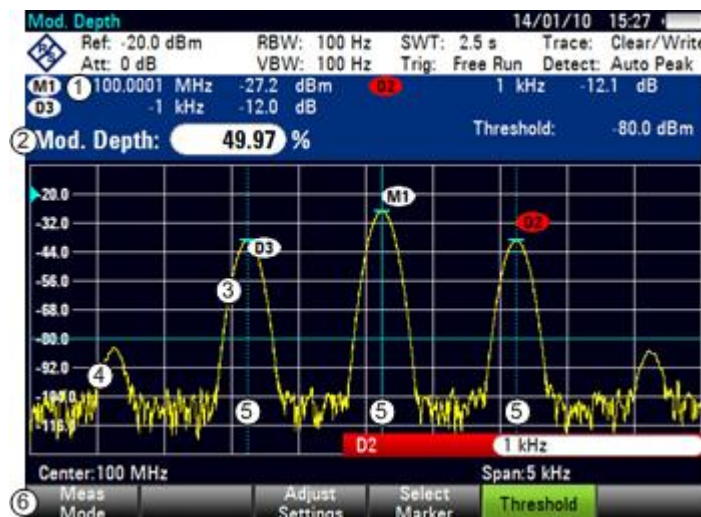

- 1 Marker list
- 2 Modulation depth
- 3 Trace
- 4 Threshold line
- 5 Markers (blue lines)
- 6 AM modulation depth softkey menu

By default, delta marker 2 is active for editing. If you move the delta marker to another position, the other delta marker will be moved by the same distance relative to the normal marker. Note that this happens only if you move delta marker 2 (D2). When moving delta marker 3 (D3), only this marker is repositioned.

From the values of the markers, the R&S ZVH then calculates the AM modulation depth. The AM modulation depth is the ratio between the power values at the reference marker and at the delta markers. When the powers of the two AM side bands are not the same, the R&S ZVH uses the mean value of the two sideband values.

If the R&S ZVH is unable to find any AM modulated carriers, it shows the message **No AM modulated carrier found.**

8.1.8.1 Setting a Threshold

You can set a threshold that defines the minimum power level the signal must have. If the power of the signal is below the threshold, the R&S ZVH will not set the markers and therefore will not calculate the modulation depth.

- ▶ Press the MEAS key.
- ▶ Press the "Threshold" softkey
The R&S ZVH opens an input field to set the threshold.
- ▶ Enter the threshold value you need.

The threshold is represented as a horizontal blue line in the diagram area.

8.1.8.2 Optimizing the Settings

In order to get the best results, you can use the automatic adjustment routine that the R&S ZVH offers.

- ▶ Press the MEAS key.
- ▶ Press the "Adjust Settings" softkey.

The R&S ZVH performs a sweep and repeats the peak search sequence for the three markers.

8.1.8.3 Activating the Marker List

To see the exact frequency of the carrier and its sidebands, you can activate the marker list that shows the value for each marker.

- ▶ Press the MKR key.
- ▶ Press the "View List" softkey.

The R&S ZVH displays the marker list that contains the values for carrier and sideband.

8.1.9 Measuring Spurious Emissions

The spurious emission measurement is a tool to monitor unwanted emissions in the frequency spectrum outside of an assigned channel (carrier). When performing a spurious emission measurement, the R&S ZVH checks the spectrum that you have defined against a limit line to see whether the signal complies with a specific standard or not.

Spurious emission measurements are usually performed over a wide frequency spectrum. To avoid long measurement times, the spectrum is split into several smaller ranges. Each of those ranges has a different configuration (for example a different RBW).

The spurious emission measurement available on the R&S ZVH is designed for measurements on category A 3GPP base stations with the appropriate configuration in each measurement range.

- ▶ Press the MEAS key.
- ▶ Press the "Meas Mode" softkey.
 - The R&S ZVH opens the measurement menu.
- ▶ Select the "3GPP BTS Spurious Emission" menu item.
- ▶ Press the "Start Meas" softkey.

The R&S ZVH starts the measurement.

Screen Layout for the Spurious Emission measurement



- 1 Result display
- 2 Limit check
- 3 List of spurious emissions
- 4 Limit line (red line)
- 5 Trace (yellow line)
- 6 Spurious emission softkey menu

Note that the frequency range of the actual measurement depends on the start and stop frequency you have set for the carrier. Correct measurement results are therefore only possible if the frequency ranges of the measurement are inside the current span of the R&S ZVH.

Markers in the spurious emission measurement

In addition to the normal marker functionality of the R&S ZVH, the spurious emission measurement provides special markers labeled P1 to Px.

The R&S ZVH activates and positions these special markers automatically after displaying the trace. Each of these markers marks the peak level in each spurious emission range.

The numerical marker information (frequency and level) for these markers is part of the result table.

Markers P1 to P4 are fix and always remain on the peak level of the corresponding subrange. If you'd like to analyze other locations on the trace, use normal marker and deltamarker functionality. For more information see "[Using Markers and Deltamarkers](#)" on page 163.

8.1.9.1 Defining the Channel Bandwidth

Several frequency bands have been defined for 3GPP transmissions. Depending on the frequency band you are testing, you have to adjust the start and stop frequencies of the carriers.

- ▶ Press the MEAS key.
- ▶ Press the "Carrier Start" softkey.

The R&S ZVH opens an input field to define the lower frequency of the channel.

- ▶ Press the "Carrier Stop" softkey.

The R&S ZVH opens an input field to define the upper frequency of the channel.

Note that the standard defines spurious emissions as transmission outside the frequency band 12.5 MHz below the first carrier and 12.5 MHz above the last carrier. Keep these values in mind when defining the start and stop frequencies of the carrier.

8.1.9.2 Viewing the Results in a Table

You can add a table to the display that shows the measurement results in numerical form.

- ▶ Press the MEAS key.
- ▶ Press the "View List" softkey.

The R&S ZVH shows a list above the trace diagram.

Limit Line: 3GPP BTS Category A				PASS
Range [Hz]	RBW [Hz]	Peak Freq [Hz]	Peak Power	
9.000 k	150.000 k	1 k	9.993 k	-43.54 dBm
150.000 k	30.000 M	10 k	159.997 k	-45.88 dBm
30.000 M	1.000 G	100 k	950.521701 M	-24.66 dBm
1.000 G	8.000 G	1 M	1.8110000 G	-15.06 dBm

The list contains information for each frequency range that the measurement covers. Thus, the number of entries in the list depends on the overall frequency span you are using for the measurement. The following ranges have been defined:

- 9 kHz to 150 kHz (with an RBW of 1 kHz)
- 150 kHz to 30 MHz (with an RBW of 10 kHz)
- 30 MHz to 1 GHz (with an RBW of 100 kHz)
- > 1 GHz (with an RBW of 1 MHz)

The spurious list contains the following information for each range.

- Frequency range
Start and stop frequencies of the range.
- RBW
Resolution bandwidth that the R&S ZVH uses within that range.
- Peak Frequency
Frequency at which the peak power has been measured in a particular range.
- Peak Power
Peak power that has been measured in a particular range.

8.1.10 Working with the Spectrogram Result Display (R&S ZVH-K14)

With option R&S ZVH-K14, you can view measurement results in a spectrogram.

The spectrogram result display shows the spectral density of a signal in the frequency domain and over time simultaneously.

Screen layout for the spectrogram



- 1 Result display
- 2 Marker and time line information
- 3 Spectrum result display (optional)
- 4 Marker/ delta marker (vertical lines)
- 5 Spectrogram
- 6 Time lines T1 and T2 (horizontal lines)
- 7 Scroll direction
- 8 Spectrogram softkey menu

Like other result displays, the horizontal axis represents the frequency span. The vertical axis represents time. Time in the spectrogram runs chronologically from top to bottom. Therefore, the top of the diagram is the present. A third dimension shows the amplitude for each frequency by mapping different colors to every power level. The result is therefore a two dimensional diagram.

The color the R&S ZVH assigns to a power level that was measured depends on:

- the color table you have selected
- the spectrogram reference level
- the spectrogram level range

The spectrogram consists of horizontal lines, each one pixel high, that are called frames. In the default state, a frame is added to the spectrogram after each sweep. This means that the amount of data in a frame depends on the sweep time. As the spectrogram in the R&S ZVH runs from top to bottom, the outdated time line(s) move down one position, so that the present frame is always on top of the diagram. Therefore, the sequence of frames is chronological.

- ▶ Press the MEAS key.
- ▶ Press the "Meas Mode" softkey.
- ▶ Select the "Spectrogram" menu item.

The R&S ZVH starts the spectrogram result display.

By default, the spectrogram result display consists of two windows. The upper window shows the measured spectrum as a trace line. The lower window shows the measurement results in a spectrogram. The chronological information in the spectrogram is restricted by the internal memory of the R&S ZVH. The R&S ZVH stores 1024 frames or spectrums that have been measured in its memory. As the height of the display is smaller, some of the data becomes invisible after a time.

For measurements with a GPS receiver, the R&S ZVH saves the GPS coordinates at which each frame / spectrum that has been measured was recorded. This feature allows you to link spectral events to a certain location when you analyze the data after the measurement sequence is finished.

8.1.10.1 Controlling the Spectrogram Update

The spectrogram starts running as soon as you enter the spectrogram mode, if you are in continuous sweep mode.

If you are in single sweep mode, the R&S ZVH does not add a line to the spectrogram until you initiate the next single sweep.

You can stop the update of the spectrogram in continuous sweep mode.

- ▶ Press the MEAS key.
- ▶ Press the "Hold" softkey.

Note that in continuous sweep mode the measurement in the spectrum result display does not stop. The trace in the upper window still updates continuously. Only the spectrogram view stops.

- ▶ Press the "Hold" softkey again.

The R&S ZVH resumes updating the spectrogram.

The spectrogram result display is filled with results until you change a measurement setting. As soon as a setting is changed, the spectrogram clears and starts to fill again.

You can also clear the spectrogram manually.

- ▶ Press the MEAS key.
- ▶ Press the "Clear" softkey.

8.1.10.2 Browsing Through the Signal History

There are two ways to view parts of the measurement result history that have moved outside the visible area of the spectrogram.

- ▶ Press the MEAS key.
- ▶ Press the "Spectrogram Settings" softkey.
- ▶ Select the "[] Spectrogram Full Screen" menu item.

The R&S ZVH now uses the full diagram area of the screen for the spectrogram. The number of lines in the spectrogram and therefore the displayed time period more than doubles.

- ▶ The "Spectrogram Full Screen" menu item is marked by an [X].

It may, however, be necessary that the spectrum result display is still visible to evaluate measurement results. For this purpose, the spectrogram has an (invisible) scrollbar that you can use to scroll up and down the spectrogram to the frame that you'd like to see.

Scrolling through the spectrogram

Turn the rotary knob or use the UP and DOWN cursor keys whenever you are viewing the spectrogram.

The R&S ZVH scrolls through the spectrogram history.

Note that this is only possible as long as no input field or menu is active. To resume the spectrogram scroll function in this case,

- ▶ Press the CANCEL key
- ▶ Use the rotary knob or the UP and DOWN cursor keys again.

The R&S ZVH resumes scrolling through the spectrogram history.

The symbols on the right side of the spectrogram indicate the position of the spectrogram part currently displayed on the screen:

- A single down arrow in the right lower corner of the spectrogram indicates that the uppermost frame still represents the most recently recorded trace.
- Two arrows (one up, one down) indicate that the spectrogram area displayed is somewhere in the middle of the available history.
- A single up arrow in the upper right corner of the spectrogram indicates that the lowest line of the spectrogram represents the end of the history buffer.

8.1.10.3 Configuring the Display

As colors are an important part of the spectrogram, the R&S ZVH offers various ways to customize the display for best viewing results.

The first and most obvious way to configure the display is to select a different color scheme.

- ▶ Press the "Spectrogram Settings" softkey.
- ▶ Select the "Spectrogram Color Table" menu.

The R&S ZVH opens a submenu that contains several color schemes.

- Default
- Green-Yellow
- Green-Blue
- Black-White
- Red-Purple
- Blue-Black

The following examples are based on the green-yellow color scheme.

- ▶ Select the color scheme you are most comfortable with.

The R&S ZVH adjusts the screen colors according to your selection.

It is possible that the color distribution is not ideal in the current configuration. You have two ways to set things straight.

By cutting the reference level, you can eliminate amplitudes from the color map that are not part of the signal.

Example: By default, the spectrogram reference level is 30 dBm.

That means that signal parts with an amplitude of 30 dBm would be yellow in the spectrogram, and signal parts with a very small amplitude would be dark green. Everything in between is a shade of the colors between. As the colors are distributed over a very large range (about a 150 dBm or more), it is likely that you can not distinguish details in the signal you have measured.

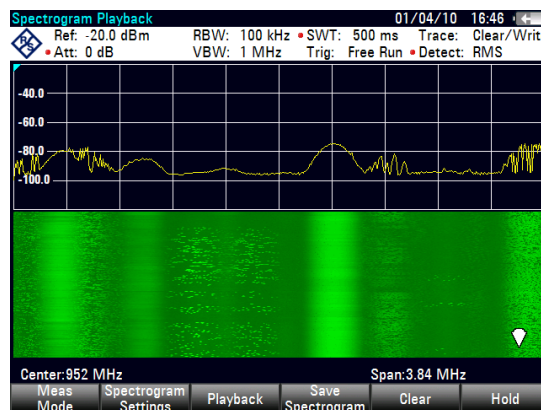

Therefore you should adjust the color map to the overall shape of the signal you are measuring. Let's say, for example, that the signal has an amplitude range of about 30 dB with the maximum amplitude at about -60 dBm and the minimum amplitude at about -100 dBm and the "Green-Yellow" color scheme. With the default settings, the spectrogram is made up exclusively of green colors and it's not easy to distinguish amplitude levels. That's because the yellow color shades are completely out of range.

To get a better result, change the spectrogram reference level to a level near the maximum power level that has been measured first.

- ▶ Press the "Spectrogram Settings" softkey.
- ▶ Select the "Spectrogram Reference Level" menu item.

The R&S ZVH opens an input field to enter the spectrogram reference level.

The reference level should be near the maximum level that has been measured while the spectrogram was running. In the example, the reference level should be at about -60 dBm.

- ▶ Enter the reference level you need.

The R&S ZVH now shifts the reference level of the spectrogram to the value you have entered.

Note that the spectrogram reference level does not affect the spectrum result display, as well as the spectrum reference level ("Amplitude" menu) does not affect the spectrogram. In the screenshot the spectrum trace is therefore exactly the same as in the previous picture.

The result however, still does not show signal differences in detail. The only thing that happened is that the colors have shifted, in the example to yellow, because the color that corresponds to the reference level has shifted from green to yellow. All other colors that are part of the color scheme are still unused, because the spectrogram level range is still the same (150 dB).

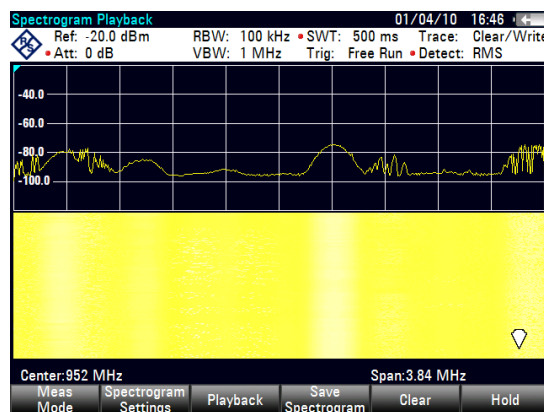

- ▶ Press the "Spectrogram Settings" softkey.
- ▶ Select the "Spectrogram Level Range" menu item.

The R&S ZVH opens an input field to enter the spectrogram level range.

In the example, the level range of the signal is from about -60 dBm to about -100 dBm.

- ▶ Therefore set the level range to 40 dB to get the whole signal.

As the level range is now adjusted, the R&S ZVH is able to map its complete color range to the level range of the signal.

This means that signal parts with a low amplitude are in a shade of green while signal parts with a high amplitude are yellow.

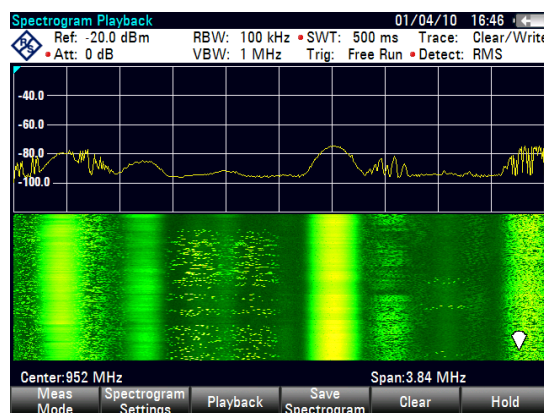

The best way to display a spectrogram is therefore to reduce the level range until the lowest signal part is mapped to the lower end of the color map and the highest signal part to the upper end of the color map.

In a last step you can configure the spectrogram in a way that it only shows signal peaks in color and the noise floor in black. To get a result like that you have to reduce the level range, until the noise floor is outside the displayed range.

- ▶ Instead of entering a level range of 40 dB, enter a level range of 35 dB or even 30 dB.

This will provide a high contrast between signal parts that are above the noise floor, and the noise floor, which is drawn in black.

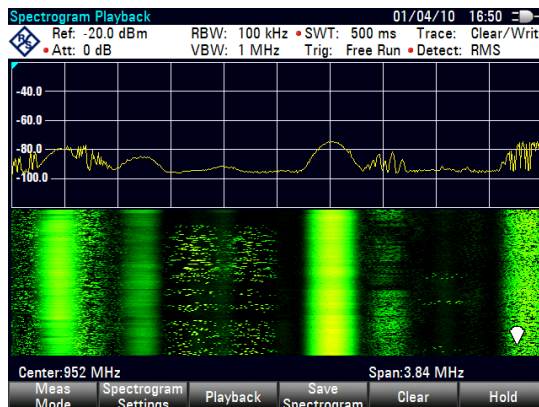

To show details of the noise floor and exclude the peak levels you have to lower the spectrogram reference level, until it is just above the noise floor.

The R&S ZVH will then display the signal parts that are above the reference level in only one color, which is the color at the upper border of the color map.

8.1.10.4 Recording a Spectrogram

You can save the data of the spectrogram for documentation or for further analysis of the recorded data.

- ▶ Press the MEAS key.
- ▶ Press the "Save Spectrogram" softkey.

The R&S ZVH opens a dialog box to save the current spectrogram.

- ▶ Enter the name of the spectrogram with the alphanumeric keys.

By default, the R&S ZVH saves the spectrogram as 'Spectrogram###' with ascending numbers.

- ▶ Press the "Save" softkey to store the spectrogram.



Now that you have saved the spectrogram, you can replay it any time you want.

The number of spectrograms that you can store on the R&S ZVH internal memory depends on the other datasets that are currently on the R&S ZVH.

8.1.10.5 Playback of a Spectrogram

If you have recorded a spectrogram and have saved it in internal memory, a memory stick or the SD card, you can view the results of that measurement at a later time.

- ▶ Press the "Playback" softkey
- or
- ▶ Press the "Meas Mode" softkey.
- ▶ Select the "Spectrogram Playback" menu item.

Recalling a previously stored spectrogram

- ▶ Press the "Recall Spectrogram" softkey.

The R&S ZVH opens a dialog box to select a file that contains the spectrogram data. The file extension for spectrogram data is *.spm.

- ▶ Select the file you need.
- ▶ Confirm the selection with the "Select" softkey.

The R&S ZVH loads the spectrogram and shows the data in the display.

In general you can do the same things on a recalled spectrogram as in the spectrogram recording mode, e.g. customize the display to your needs.

In addition to that functionality, it is possible to view not only the spectrum that belongs to the currently selected spectrogram frame, but also the spectrums of all frames that are in the memory of the R&S ZVH.

Working with time lines in playback mode

To find a particular point in time and display the corresponding spectrum you can use two time lines:

When entering the playback mode the R&S ZVH displays two time lines in the spectrogram.

The first time line (T1) corresponds to an absolute time value, the second (T2) is a time relative to the first time line. Both time lines are positioned on the most recent spectrogram line at the top of the result display.

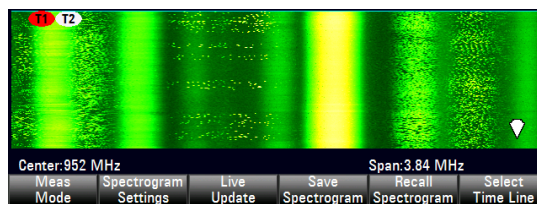

You can now select a specific spectrogram frame that is in the memory of the R&S ZVH.

- ▶ Press the "Select Time Line" softkey.

The R&S ZVH opens an input field to define the position of the first time line (T1).

- ▶ Position the time line by entering a number or moving it with the rotary knob.

Entering 0 sets the time line marker on the most recent frame. The maximum value that you can enter is 1024 (the maximum number of frames the R&S ZVH can store in its memory).

Note that not all frames are visible on the screen. If a frame is part of the history outside the visible area, the time line is also not visible and you have to scroll through the spectrogram to be able to see it again.

The upper window will display the spectrum of the frame at the time line position. By moving the time line you can thus browse through the history of spectra stored in memory.

In the marker information field, the R&S ZVH shows the time stamp of the time line.

The time stamp of the first time line T1 is always referred to the top-most frame (e.g. a time stamp of 00:00:50:000 means that the data was measured 50 seconds prior to the top-most frame).

- ▶ Press the "Select Time Line" softkey again.

The R&S ZVH opens an input field to define the position of the second time line (T2).

- ▶ Enter a number with the number keys, the rotary knob or the cursor keys.

The R&S ZVH positions the second time line on the selected frame. Again it shows the time stamp of the time line in the marker information field (ΔT value). For the second time line (T2), the information is relative to the first one (T1). This means that the time stamp of the second time line can be negative, if you have set it on a frame above the first time line.

If you scroll the time line through the frames of the spectrogram with the rotary knob or the cursor keys, the R&S ZVH will show the spectrum corresponding to the selected frame in the upper window of the display.

You can use the spectrogram playback for a detailed analysis of the signal levels over time and compare signal details in the spectrum result display, e.g. with the help of markers.

In addition to the time line (horizontal marker), you can also use (vertical) markers in the spectrogram.

With the help of the marker and the time line, you are able to find the exact moment when a specific event has occurred in the spectrum.

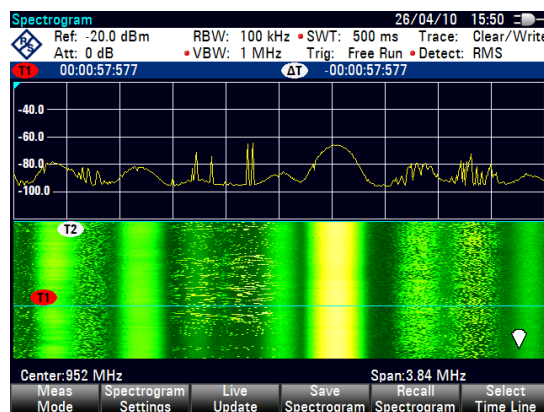

- ▶ Press the MARKER key.
The R&S ZVH activates a marker and sets it on the peak level of the currently displayed spectrum.
- ▶ Use the rotary knob or the cursor keys to move the marker on the horizontal axis to the frequency you want to analyze, or enter the frequency directly with the number keys.

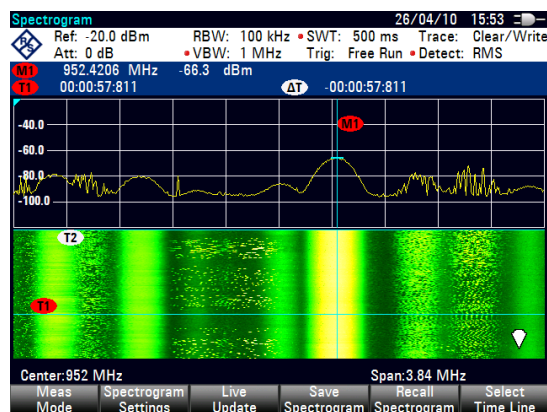

- ▶ Press the "Select Time Line" softkey and browse through the spectrums using the rotary knob or the cursor keys until the spectrum of interest is displayed in the upper window.

The time stamp of the selected time line gives you a precise indication on when the event shown in the spectrum occurred.

For more information on marker functionality, see

- ["Using Markers"](#) on page 75

Switching back to active spectrogram recording

To resume recording of a new spectrogram

- ▶ Press the "Live Update" softkey at any time you are in playback mode.
The R&S ZVH switches back to performing live measurements.

Long time spectrograms

The R&S ZVH can record spectrogram data up to 999 hours (although the maximum time actually depends on the measurement settings and available storage space).

- ▶ Press the SETUP key.
- ▶ Press the "Measure Setup" softkey and look for the "Spectrogram Long Time Recording" settings.
- ▶ Connect the storage device (necessary for long time recording).
- ▶ Select the storage device you would like to use from the "Recording Storage" menu item (USB or SD card).
- ▶ Turn on the long time spectrogram with the "Long Time Recording" menu item.

The R&S ZVH starts the spectrogram measurement. The data is written directly to the connected storage device in one or more files, depending on the overall length of the spectrogram. The longer the recording lasts, the more files are created.

When you stop the recording, the R&S ZVH shows a message containing the directory where the measurement data has been saved.

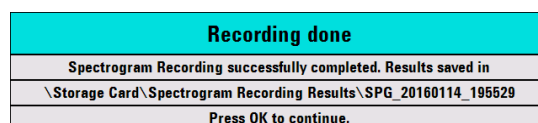

When you playback the spectrogram, the currently used file is indicated in the display.

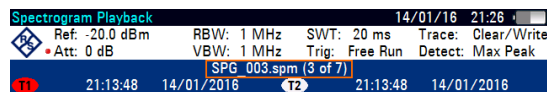

Note that it might take a little while to access a new file during spectrogram playback (a corresponding message is shown).

Configuring long time spectrograms

You can define several characteristics of the long time spectrogram in the "Measure Setup" menu:

- Recording mode: Selects the way the spectrogram is controlled.
 - "Timer": Recording starts and stops on a certain date and time. You can define the date via the "Start / Stop Date" and "Start / Stop Time" menu items (for example from 6:00 am to 6:00 pm on January 1st in the year 3000. You can also define a "Duration" instead of specifying a stop time.
 - "Immediately": Recording begins immediately, and you can define a "Duration" (for example 6 hours). Otherwise the recording stops when you deliberately so.
 - "Limits Failure": Recording starts or stops when a limit has been violated. Select the details with the "Limits Save Mode" menu item.

In any case, you can stop the recording deliberately any time by turning the long time spectrogram off.

 - "Stop Recording If Battery Low": Recording stops when the battery level runs low.
- Recording Speed: Selects if the spectrogram measurement time is defined automatically by the R&S ZVH or manually. In the latter case, define the measurement time with the "Manual Recording Interval" menu item (Example: a spectrogram line is added every 100 ms).

Analyzing long time spectrograms with the R&S InstrumentView software

Long spectrograms can be difficult to read on the R&S ZVH. However, the R&S InstrumentView software package provides a tool called the "Long Time Recording Viewer" that allows you to conveniently display and analyze very long spectrograms.

- ▶ Select "Analysis" > "Spectrogram" to open the viewer.

In the viewer, you can do several things.

- Display spectrograms that you have previously saved via the "File" menu. The compressed view shows the complete spectrogram, while the main window shows a detailed view of the measured data.
- Apply different color schemes via the "Colors" menu. The color schemes are the same as those available within the firmware. See "[Configuring the Display](#)" on page 129.
- Select a certain time line in the spectrogram and view the corresponding spectrum in the diagram area below the spectrogram.
- Zoom into and out of the measurement results.

- Position markers in the spectrogram via the "Show" menu and the "Measurement" panel on the right side of the user interface.
- Configure markers via the "Setup" panel on the right side of the user interface.
- View the measurement setup via the "Measurement" panel.

**Prerequisites**

Using the "Long Time Recording Viewer" requires you to install .NET framework version 4.0 or higher on the PC you are running the R&S InstrumentView software on.

8.1.11 Using Isotropic Antennas

The R&S ZVH supports measurements with an isotropic antenna.

You can use any isotropic antenna available with the R&S TS-EMF system (order no. 1158.9295.05). Each of those antennas supports a different frequency range between 9 kHz and 6 GHz.

Test setup

The test setup consists of an R&S ZVH and one of the isotropic antennas. The necessary cables are provided with the antennas.

- ▶ Connect the RF cable with the N coaxial connector to the RF input (port 1).
- ▶ Connect the control cable to the power sensor interface (9-pin D-Sub connector) with the adapter cable that comes with the antenna.

If necessary, you can connect an additional extension cable (R&S TS-EMFZ2, order no. 1166.5708.02).

Starting the measurement

- ▶ Press the MEAS key.
- ▶ Press the "Meas Mode" softkey.
- ▶ Select the "Isotropic Antenna" menu item.

After you have turned the isotropic antenna on, the R&S ZVH uses the isotropic antenna for all measurements.

Note that when you turn the isotropic antenna on without having selected a transducer factor first, the R&S ZVH asks you to select a transducer factor.

Using transducer factors

The isotropic antenna is in effect a transducer. Because it has a characteristic frequency response, it is necessary to correct the measurement results by these characteristics.

The transducer factors for each of the supported isotropic antennas are provided with the R&S ZVH. The factors contain typical correction values for all three antenna elements as well as the correction values for the cable.

- ▶ Press the AMPT key.
- ▶ Press the "Transducer" softkey

The R&S ZVH opens a dialog box to select the transducer factor.

- ▶ Select the "Primary Transducer" menu item.
- ▶ Select the transducer factor.

The file you have to select depends on the antenna you are using. The file type of transducer factors for isotropic antennas is *.isotrd.

- ▶ Confirm the selection with the "Select" softkey.

If you are using the extension cable R&S TS-EMFZ2, you have to take this into account as a secondary transducer.

- ▶ Press the "Transducer" softkey.
- ▶ Select the "Select Secondary Transducer" menu item.

The R&S ZVH opens a dialog box to select transducer factors with the unit dB.

- ▶ Select the transducer factor for the extension cable.
- ▶ Confirm the selection with the "Select" softkey.

For more information see ["Using Transducer Factors"](#) on page 172.

You can create and edit transducer factor with the R&S InstrumentView software package and then transfer them into the internal memory of the R&S ZVH. Each transducer factor may consist of up to 1000 reference values.

Display of the antenna directions

An isotropic antenna consists of three orthogonal elements. Each of these elements measures the field strength from a different direction (x-, y- and z-axis).



Decrease of measurement speed

Because the R&S ZVH performs a measurement on each of the three antenna axes, the update rate of the results decreases slightly.

You can select to display different aspects of the measurement.

- ▶ Press the "Meas Mode" softkey.
- ▶ Select the "Iso Direction []" menu item.

The R&S ZVH opens a new menu to select the measurement aspect.

- "Auto"

Shows the total field strength over all three antenna axes.

The displayed result is a combination of the results for each antenna element. After measuring each of the three directions individually, the R&S ZVH calculates the total field strength (E_r) based on the results for each antenna element.

$$E_r = \sqrt{E_x^2 + E_y^2 + E_z^2}$$

- "X"

Shows the field strength measured on the antenna's x-axis only.

- "Y"

Shows the field strength measured on the antenna's y-axis only.

- "Z"

Shows the field strength measured on the antenna's z-axis only.

8.2 Configuring Spectrum Measurements

8.2.1 Configuring the Horizontal Axis

The **FREQ/DIST** key contains all necessary functions to configure the horizontal axis for spectrum measurements.

The contents of the menu depend on the currently selected measurement.

Usually, the horizontal axis contains frequency information in spectrum mode. You can specify the frequency in terms of the center frequency or by defining a start and stop frequency for a particular span.

If you know the frequency of the signal you are measuring, it is best to match the center frequency to the signal's frequency. If you are investigating signals, e.g. harmonics, that are within a particular frequency range, the best option is to enter a start and stop frequency to define the span.

8.2.1.1 Defining the Center Frequency

The center frequency represents the frequency at the center of the horizontal axis in the diagram area.

- ▶ Press the **FREQ/DIST** key.

The R&S ZVH opens the frequency menu.

When you press the **FREQ/DIST** key, the R&S ZVH automatically opens an input field to define the center frequency. If the input field is inactive, you can open it with the "Center Freq" softkey.

- ▶ Enter the center frequency you need.

The frequency you have entered becomes the new center frequency.

While adjusting the center frequency, you may obtain a value that is outside the R&S ZVH maximum span. If this happens, the R&S ZVH automatically reduces the span.

8.2.1.2 Defining a Frequency Step Size

If you set the center frequency with the rotary knob or the cursor keys, the distance of each step that you take depends on the span. With the rotary knob, the smallest possible step is a pixel. As the trace consists of 631 pixels, each step is equal to 1/630 of the span. With the cursor keys, the step is 10% of the span or one division of the grid.

You can set another step size.

- ▶ Press the **FREQ/DIST** key.
- ▶ Press the "CF Step Size" softkey.

The R&S ZVH opens a submenu that contains possible step sizes.

- 0.1 x Span
The step size equals 10% of the span or 1 division of the horizontal axis.
 - =Center
The step size equals the center frequency.
This step size is ideal for measurements on harmonics. When you increase or decrease the center frequency, the center frequency automatically moves to the next harmonic.
 - Manual...
Define any step size you want.
This step size makes it easy to investigate a spectrum with frequencies at constant intervals.
- ▶ Select the step size you need from the menu.
- The R&S ZVH adjusts the step size accordingly.

If you set the step size to 10% of the span or to the center frequency, the R&S ZVH sets the step size internally. Manually defining the step size opens an input field to define the step size.

8.2.1.3 Setting a Frequency Offset

For measurements on frequency converters such as satellite downconverters, it is often convenient to reference the results to the frequency prior to conversion. For this purpose, the R&S ZVH offers a frequency offset that arithmetically shifts the center frequency to higher or lower frequencies. Thus, the R&S ZVH displays the input frequency of the DUT.

Positive frequency offset is possible in the range from 1 Hz to 100 GHz, in steps of 1 Hz. The maximum negative frequency offset depends on the start frequency you have set. The start frequency, taking into account the frequency offset, is always ≥ 0 Hz.

- ▶ Press the **FREQ/DIST** key.
- ▶ Press the "Freq Offset" softkey.
The R&S ZVH opens an input field to set the frequency offset.
- ▶ Enter the frequency offset you need.

The R&S ZVH adds the frequency offset to the center frequency you have set. A red dot at the center frequency display indicates that a frequency offset has been set.

8.2.1.4 Defining a Start and Stop Frequency

Defining a start and stop frequency is best suited for example for measurements on harmonics or signals whose exact frequency is unknown.

- ▶ Press the **FREQ/DIST** key.

- ▶ Press the **"Start Freq"** softkey.

The R&S ZVH opens an input field to define the start frequency.

- ▶ Enter the start frequency you need.

- ▶ Set a stop frequency with the **"Stop Freq"** softkey.

The R&S ZVH adjusts the horizontal axis according to your input, beginning with the start frequency and ending with the stop frequency.

If you have entered a stop frequency that is outside the maximum frequency range, the R&S ZVH sets the stop frequency to the possible maximum.

The label of the horizontal axis changes from **"Center"** and **"Span"** to **"Start"** and **"Stop"**.

8.2.1.5 Setting the Span

The span is the frequency range around the center frequency that a spectrum analyzer displays on the screen. The span you should select depends on the signal and the measurement that you are performing. A rule of thumb is that it should be at least twice the bandwidth occupied by the signal.

The available span for frequency domain measurements depends on the instrument model.

- R&S ZVH4: 10 Hz to 3.6 GHz
- R&S ZVH8: 10 Hz to 8 GHz

If you set a span of 0 Hz (zero span), the R&S ZVH performs measurements in the time domain.

- ▶ Press the **FORMAT/SPAN** key.

When you press the **FORMAT/SPAN** key, the R&S ZVH automatically opens an input field to define the span. If the input field is inactive, you can open it with the **"Manual Span"** softkey.

- ▶ Enter the span you need.

The R&S ZVH adjusts the span of the horizontal axis.

If you have to switch between full span and a smaller span, you can do so without having to enter the numeric values.

- ▶ Press the **FORMAT/SPAN** key.

- ▶ Press the **"Full Span"** softkey.

The R&S ZVH displays the spectrum over its entire frequency range.

- ▶ Press the **"Last Span"** softkey.

The R&S ZVH restores the span that you have set just before displaying the entire frequency range.

Time domain measurements

You can also activate time domain measurements without having to enter the value manually. When measuring in the time domain, the span is 0 Hz. In that state, the R&S ZVH measures the signal at the current center frequency only. Instead of displaying the spectrum, the R&S ZVH shows the signal power over a certain time period. The horizontal axis becomes the time axis. The display always starts at 0 s and stops after the currently set sweep time.

- ▶ Press the FORMAT/SPAN key.
- ▶ Press the "Zero Span" softkey.

The R&S ZVH sets a span of 0 Hz and performs the measurement in the time domain.

8.2.2 Configuring the Vertical Axis

All relevant settings to configure the vertical axis are available in the amplitude menu. You can access it via the SCALE/AMPT key.

8.2.2.1 Setting the Reference Level

The reference level is represented graphically by the grid line at the top of the diagram.

The reference level sets the input signal gain up to the display stage. If the reference level is low, the gain is high. That means that even weak signals are displayed clearly.

If you are measuring strong signals, you have to set a high reference level in order to prevent an overload of the signal path of the analyzer and to keep the signal within the display range. If you are measuring the spectrum of a composite signal, make sure that the reference level is high enough to cover all signals and that all signals are within the measurement diagram.

- ▶ Press the SCALE/AMPT key.

When you press the AMPT key, the R&S ZVH automatically opens an input field to define the center frequency. If the input field is inactive, you can open it with the "Ref Level" softkey.

- ▶ Enter the reference level you require.

If you change the reference level, the R&S ZVH adjusts the position of the trace as you make the changes.

By default, the reference level corresponds to the grid line at the top of the diagram. You can also change the position of the reference level to another grid line if you have a signal that would otherwise overlap with the top of the diagram area. The R&S ZVH indicates the current reference level position with a triangle at the corresponding grid line on the vertical axis (▶0.0).

- ▶ Press the SCALE/AMPT key.
- ▶ Press the "Range / Ref Pos" softkey.

The R&S ZVH opens a submenu.

- ▶ Select the "Ref Position 10..." menu item.

The R&S ZVH opens an input field to define the reference position.

- ▶ Enter the number of the grid line you want the reference level at.

The range is from 0 to 10. "0" corresponds to the lowest grid line, "10" corresponds to highest grid line.

8.2.2.2 Setting a Display Range

The display range determines the scaling or resolution of the vertical axis. In the default state, the display range is a logarithmic scaling over a 100 dB. This corresponds to 10 dB per grid division. The R&S ZVH provides other display ranges that either increase or decrease the resolution of the vertical axis.

However, increasing resolution does not increase the accuracy of, for example, the marker level readout, but only makes it easier to read values off the trace.

You can also select a linear scale for the vertical axis. In that case, the power levels are expressed as a percentage of the reference level. Linear scaling is useful to display AM modulated carriers in the time domain, for example.

- ▶ Press the SCALE/AMPT key.
- ▶ Press the "Range / Ref Pos" softkey.

The R&S ZVH opens a submenu to select the display range.

- ▶ Select the display range you need ("Manual Range" allows you to select a custom range).

The R&S ZVH adjusts the vertical axis accordingly.

8.2.2.3 Selecting the Display Unit

By default, the vertical axis (and therefore the reference level) is scaled in dBm. However, the units dBmV, dB μ V, Watt and Volt are also available. Selecting the right unit is relevant for the marker level display because the unit of the marker level is the same as that of the reference level.

- ▶ Press the SCALE/AMPT key.
- ▶ Press the "Unit" softkey.

The R&S ZVH opens a submenu to select the display unit.

- ▶ Select one of the available units.

The R&S ZVH adjusts the labels of the vertical axis accordingly.

8.2.2.4 Setting a Reference Offset

You can define a reference offset for the reference level. With a reference offset, you can increase the reference level by a certain amount. This is useful, for example, if an attenuator or amplifier has been inserted before the RF input. The R&S ZVH automatically takes the loss or gain into account when the level is displayed and no manual calculations are necessary. A loss introduced at the RF input must be entered as a positive number and a gain as a negative number.

- ▶ Press the SCALE/AMPT key.
- ▶ Press the "Ref Offset" softkey.

The R&S ZVH opens an input field to

- ▶ Enter the offset you need.

The R&S ZVH includes the offset in the measurement.

To indicate an offset other than 0, the R&S ZVH puts a red dot at the "Ref:" hardware setting (• Ref: -20.0 dBm).

8.2.2.5 Setting the RF Attenuation

RF attenuation adjusts the input range inside the analyzer. It is coupled directly to the reference level. If you have set a high reference level, RF attenuation is turned on in 10 dB steps according to the table below so that the input mixer always remains in the linear range.

The R&S ZVH provides three attenuation modes.

- Auto Low Distortion

If this mode is active, the R&S ZVH sets the RF attenuation 10 dB higher according to the table below, making the stress of the input mixer 10 dB less at the specified reference level. If the spectrum is densely occupied with signals, e.g. in a television cable network, the input mixer reduces the R&S ZVH inherent spurious products. However, the inherent noise display of the R&S ZVH increases due to the increased attenuation in front of the input mixer.

- Auto Low Noise

If this mode is active, the R&S ZVH sets the RF attenuation 10 dB lower. This increases the sensitivity of the R&S ZVH, which means that the inherent noise display decreases due to the lower attenuation in front of the input mixer.

- Manual

Manual selection of the attenuation.

You can check the status of the RF attenuation and the preamplifier in the measurement setup dialog and the hardware settings area of the display.

Reference Level	Preamplifier OFF		Preamplifier ON	
	RF Attenuation		RF Attenuation	
	Low Noise	Low Distortion	Low Noise	Low Distortion
≤-30 dBm	0 dB	0 dB	0 dB	0 dB
-29 to -25 dBm	0 dB	0 dB	0 dB	5 dB
-24 to -20 dBm	0 dB	0 dB	0 dB	10 dB
-19 to -15 dBm	0 dB	5 dB	5 dB	15 dB
-14 to -10 dBm	0 dB	10 dB	10 dB	20 dB
-9 to -5 dBm	5 dB	15 dB	15 dB	25 dB
-4 to 0 dBm	10 dB	20 dB	20 dB	30 dB
1 to 5 dBm	15 dB	25 dB	25 dB	35 dB
6 to 10 dBm	20 dB	30 dB	30 dB	40 dB
11 to 15 dBm	25 dB	35 dB	35 dB	40 dB
16 to 20 dBm	30 dB	40 dB	40 dB	40 dB
21 to 25 dBm	35 dB	40 dB	40 dB	40 dB
26 to 30 dBm	40 dB	40 dB	40 dB	40 dB

- ▶ Press the SCALE/AMPT key.
- ▶ Press the "RF Att / Amp / Imp" softkey.
- ▶ Select either the "Auto Low Distortion" or the "Auto Low Noise" menu item.
The R&S ZVH sets the attenuation according to the table above.
- ▶ Select the "Manual: 0 dB" menu item for manual selection of the RF attenuation.
The R&S ZVH opens an input field to set the RF attenuation. You can set the attenuation from 0 dB to 40 dB in 5 dB steps.
To indicate a manual attenuation, the R&S ZVH puts a red dot at the "Att:" hardware setting (• Att: 10 dB).

8.2.2.6 Using the Preamplifier

To increase the input sensitivity, the R&S ZVH provides an integrated 20 dB preamplifier after the input mixer.

In the default state of the R&S ZVH, the preamplifier is turned off. If you want to measure signals with low powers, you can turn it on.

- ▶ Press the SCALE/AMPT key.
- ▶ Press the "RF Att / Amp / Imp" softkey.
- ▶ Select either the "Preamp On" or "Preamp Off" menu item.

The R&S ZVH turns the preamplifier on and off.

8.2.2.7 Setting the Input Impedance

In the default state, the input impedance is 50 Ω .

The R&S ZVH can also handle 75 Ω systems. The R&S ZVH does not select a 75 Ω RF input per se. Instead it selects a 75 Ω matching pad connected at the RF input. The 50/75 Ω matching pad R&S RAZ is recommended for 75 Ω matching (see recommended accessories). The R&S ZVH automatically considers the conversion factor when a value of 75 Ω is set.

- ▶ Press the SCALE/AMPT key.
- ▶ Press the "RF Att / Amp / Imp" softkey.
- ▶ Select the impedance you need.

You can also use other matching pads (e.g. R&S RAM or R&S FSH-Z38) by activating transducer factors.

8.2.2.8 Using Transducer Factors

For more information see "[Using Transducer Factors](#)".

8.2.3 Setting Bandwidths

The bandwidth menu contains all settings to set up filter bandwidths available in the R&S ZVH. You can access it with the SWEEP/BW key.

8.2.3.1 Setting the Resolution Bandwidth

The resolution bandwidth in a spectrum analyzer determines the frequency resolution for frequency domain measurements and therefore determines how well it can separate adjacent frequencies. The results as you see them on the display depend on the passband of a resolution filter.

The resolution bandwidth (RBW) has several effects on measurements.

- To be able to display two or more signals whose frequencies are close together separately, you need a (resolution) filter whose bandwidth is small enough. The frequency difference between two sinusoidal carriers can not be less than the selected resolution bandwidth if the carriers are to be resolved, for example.
- The bandwidth of the resolution filter also affects the noise that is displayed by the R&S ZVH. The smaller the bandwidth, the less noisy the results are. The rule is, that if you increase or decrease the bandwidth by a factor of 3, the noise goes down or up by 5 dB. If you change the bandwidth by a factor of 10, the displayed noise changes by 10 dB.
- The resolution bandwidth affects the speed of the measurement. If you want to display the true spectrum, the resolution filters have to settle at all frequencies that are of interest. Narrow bandfilters have a longer settling time compared to wide ones. Therefore the sweep time increases the smaller the resolution bandwidth gets. The rule is, that if you reduce the bandwidth by a factor of 3, the sweep time goes up by a factor of 9. If you reduce the bandwidth by a factor of 10, the sweep time goes up by a factor of 100.

The R&S ZVH has resolution bandwidths from 1 Hz to 3 MHz in a 1-3-10 sequence and an additional 5 MHz bandwidth. Additionally, the R&S ZVH provides a 200 kHz resolution bandwidth that you have to select and enter manually.

The R&S ZVH has resolution bandwidths from 1 Hz to 3 MHz in a 1-3-10 sequence and an additional 5 MHz bandwidth. Additionally, the R&S ZVH provides a 200 kHz resolution bandwidth that you have to select and enter manually.

Setting the 200 kHz resolution bandwidth



The 200 kHz bandwidth is not coupled to the span, so it will not be selected if automatic selection of the RBW is on.

In fact, you have to enter the 200 kHz resolution bandwidth with the number keys.

When using the rotary knob or the cursor keys, the 200 kHz bandwidth will be skipped.

In zero span mode, you can also select a 10 MHz and 20 MHz bandwidth. Note that in zero span, you have to select the 5 MHz with the number keys. When using the rotary knob or the cursor keys, the 200 kHz bandwidth will be skipped.

In the R&S ZVH's default state, the resolution bandwidth is coupled to the span, i.e. if you change the span, the R&S ZVH adjusts the resolution bandwidth. Therefore, you do not have to set the resolution bandwidth manually in many cases, because the R&S ZVH automatically sets the resolution bandwidth if you change the span.

- ▶ Press the SWEEP/BW key.

By default, the resolution bandwidth is coupled to the span.

- ▶ Press the "Manual RBW" softkey.

The R&S ZVH opens an input field to define the resolution bandwidth.

- ▶ Enter the resolution bandwidth you need.

The R&S ZVH uses the resolution bandwidth you have entered for the measurement.

If the resolution bandwidth is no longer coupled to the span, the R&S ZVH puts a red dot at the "RBW" hardware setting (• RBW: 30 kHz).

- ▶ Press the "Auto RBW" softkey to again couple the resolution bandwidth to the span.

Automatic adjustment of the sweep time



In its default mode, the R&S ZVH automatically adjusts the sweep time as soon as you change the resolution bandwidth. This is to make sure that the settling time required for the selected resolution filter is properly taken into account. The maximum allowed sweep time is 1000 s. For narrow resolution filters this value would be exceeded for large spans. In order to avoid this, the R&S ZVH adjusts the span automatically as soon as the maximum sweep time is reached.

8.2.3.2 Setting the Video Bandwidth

The video bandwidth (VBW) basically smoothes the trace by reducing the noise and therefore making power levels easier to see.

The noise reduction is a result of the video filter. This lowpass filter defines the video bandwidth and filters the higher frequency parts of the voltage from the signal. Video voltage is the (DC) voltage that results from the IF signal passing through the envelope detector which removes the IF components and outputs the envelope only. This output is also known as the video signal.

The figure below shows that process on an AM modulated signal in the time domain.

In case of an AM modulated signal, the envelope (or video) signal contains a DC component that corresponds to the level of the carrier. The video signal also contains an AC component whose frequency is the same as the AM frequency.

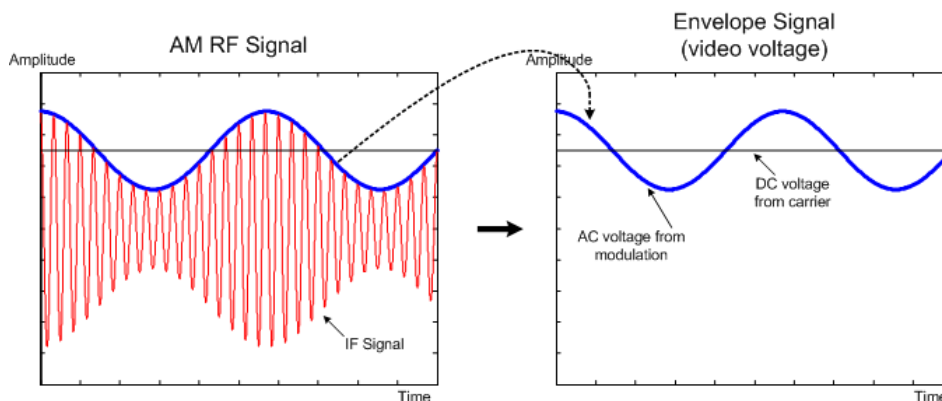

If the bandwidth of the video filter is less than the frequency of the AC component, it is suppressed depending on its maximum frequency. If the AM component should be displayed truly, the cutoff frequency of the filter has to be greater than the modulation frequency.

If there is noise on the sine signal, the modulation signal can be thought of as noise. If the video bandwidth is reduced, the high-frequency noise components above the cutoff frequency of the video filter will be rejected. The smaller the video bandwidth, the smaller the noise amplitude at the video filter output.

The R&S ZVH provides video bandwidths from 1 Hz to 3 MHz in a 1-3-10 sequence. In its default state, the video bandwidth is coupled to the resolution bandwidth and is the same as the resolution bandwidth. If you change the resolution bandwidth, the R&S ZVH adjusts the video bandwidth accordingly.

The effects of the video bandwidth on measurements are as follows.

- if you are performing measurements on modulated signals, the video bandwidth must be sufficiently large so that significant modulation components are not rejected (\geq RBW)
- if you want to keep signals free of noise, you should select the smallest video bandwidth possible ($\leq 0.1 \times$ RBW)
- if you are performing measurements on pulsed signals, the video bandwidth should be at least three times greater than the resolution bandwidth so that the pulse edges are not distorted

Like the resolution bandwidth, the video bandwidth has an effect on sweep speed. Before each measurement, the video filter has to settle.

- ▶ Press the SWEEP/BW key.
- ▶ Press the "VBW" softkey.
- ▶ Select the "Manual" menu item.

The R&S ZVH opens an input field to define the video bandwidth.

- ▶ Enter the video bandwidth you need.

The R&S ZVH uses the video bandwidth you have entered for the measurement.

If the video bandwidth is no longer coupled to the resolution bandwidth, the R&S ZVH puts a red dot at the "VBW" hardware setting (• VBW: 300 kHz).

- ▶ Press the "VBW" menu item.
- ▶ Select the "Auto" menu item to again couple the video bandwidth to the RBW.

8.2.4 Configuring and Triggering the Sweep

You can find all necessary settings to configure the sweep itself in the sweep menu. To access it, press the SWEEP/BW key.

8.2.4.1 Setting the Sweep Time

The sweep time is the time it takes the R&S ZVH to get the results that are contained in one trace.

In the frequency domain (span > 0), the sweep time is the time it takes the R&S ZVH to measure the spectrum in the specified span. To avoid the display of spurs in the spectrum, the sweep time has to meet some conditions.

- The sweep time depends on the resolution bandwidth. If the sweep time is too short, the resolution filter has no time to settle. In that case, the displayed levels will be too low. For more information see "[Setting the Resolution Bandwidth](#)".
- The sweep depends on the span. If you increase the span, you also have to increase the sweep time.

In its default state, the R&S ZVH couples the sweep time to the span and the resolution bandwidth to avoid invalid settings. If the coupling is active, the R&S ZVH always sets the shortest possible sweep time to make sure that the display of the spectrum is correct and valid.

The R&S ZVH requires a minimum sweep time of 20 ms for every 600 MHz of span. If you increase the span, the R&S ZVH will also increase the sweep time.

In the time domain (span = 0), the R&S ZVH shows the video voltage over time. The horizontal axis becomes a time axis that starts at 0 s and ends at the sweep time that you selected. The range of the sweep time in the time domain is from 200 μ s to 1000 s.

- ▶ Press the SWEEP/BW key.

In the default state, "Auto SWP Time" is active.

- ▶ Press the "SWP Time" softkey.
- ▶ Select the "Manual" menu item.

The R&S ZVH opens an input field to set the sweep time.

- ▶ Enter the sweep time you need.

If the video bandwidth is no longer coupled to the span or the resolution bandwidth, the R&S ZVH puts a red dot at the "SWT" hardware setting (•SWT: 2.5 s).

8.2.4.2 Selecting the Sweep Mode

The sweep mode is the way the R&S ZVH performs the measurement.

In its default state, the R&S ZVH measures continuously. In this mode, the R&S ZVH automatically repeats the sweep in the defined range of the horizontal axis (frequency or time) and updates the trace accordingly after it has finished with one sweep.

In some cases it may be sufficient to get the results over a single sweep only, e.g. if a particular trigger condition is met. In single sweep mode, the R&S ZVH performs the sweep a certain number of times (depending on the number of averages you have set) over the defined range of the horizontal axis (frequency or time) and then stops measuring. It performs another sweep only after you tell it to. For more information on setting the number of sweeps included in a single sweep see "[Selecting the Trace Mode \(Average\)](#)".

- ▶ Press the SWEEP/BW key.
- ▶ Press the "Trigger" softkey.
- ▶ Select the "Single Sweep" menu item to perform measurements in single sweep mode or the "Continuous Sweep" menu item to perform measurement continuously.

8.2.4.3 Working with Trigger Functionality

If you have to perform measurements according to certain signal conditions, you can use a trigger. A trigger responds to certain events. If a trigger is active, the R&S ZVH starts to measure if the trigger conditions are met. The trigger can be generated either externally or internally.

Selecting the trigger source

- ▶ Press the SWEEP/BW key.
- ▶ Press the "Trigger" softkey.

The R&S ZVH opens a submenu to select the trigger source.

- ▶ Select the trigger source you need.

The R&S ZVH activates the trigger.

The R&S ZVH provides the following trigger functions.

- **Free run**

A new sweep starts on completion of the previous sweep. This is the default state of the R&S ZVH.

- **Video trigger**

A sweep starts when the video voltage exceeds a certain level. The video trigger is available only in the time domain (span = 0).

In the frequency domain, the R&S ZVH would never start a measurement with the video trigger because there is no guarantee that there is a signal that generates video voltage present at the start frequency.

- **External trigger** (rising or falling slope)

A sweep starts on the rising edge ("Rise") or on the falling edge ("Fall") of an external trigger signal. The external trigger signal is fed in via the BNC connector "Ext Trigger". The switching threshold is 1.4 V, i.e. a TTL signal level.

- **Gated trigger**

When the gated trigger is active, a gate signal that is applied to the R&S ZVH trigger input controls the sweep. The R&S ZVH starts measuring when the applied gate signal becomes active and the set gate delay has expired, and it interrupts the measurement as soon as the defined gate length is reached. With the gate signal becoming active the next time the measurement is resumed etc.

Pulsed signals can be measured by this method, if the gate delay and gate length are selected in a way that the measurement is only performed while the pulse is active. Gated measurements are possible in the frequency domain (span > 0) and the time domain (span = 0), but it is available only in combination with an external gate signal.

Note that gated trigger is not available if you are using a forced FFT sweep (see "[Selecting the Sweep Type](#)").

Including a Delay Time

When you are using a video trigger in the time domain or an external trigger, you can delay the start of the measurement with respect to the trigger event by entering a delay time. In this way, you can include time differences between the trigger event and the measurement.

The range of the trigger delay is from 0 μ s to 100 s. The resolution depends on the subrange.

Trigger delay	Resolution
0 to 1 ms	10 μ s
1 ms to 10 ms	100 μ s
10 ms to 100 ms	1 ms
100 ms to 1 s	10 ms
1 s to 10 s	100 ms
10 s to 100 s	1 s

- ▶ Press the SWEEP key.
- ▶ Press the "Trigger" softkey.
- ▶ Select the "Trigger Delay..." menu item.
The R&S ZVH opens an input field to define the trigger delay.
- ▶ Enter the delay time you need.

Defining the Trigger Level

When you are using the video trigger, you have to define a trigger level. The trigger level is a percentage of the reference level. A trigger level of 100 % is the same as the reference level. A trigger level of, e.g. 50% corresponds to the middle of the vertical axis. The R&S ZVH indicates the video trigger level with a triangle.

- ▶ Press the SWEEP/BW key.
- ▶ Press the "Trigger" softkey.
- ▶ Select the "Trace Video" menu item.
The R&S ZVH opens an input field to define the trigger level.
- ▶ Enter the trigger level.

The R&S ZVH shows the trigger level by adding a horizontal line to the diagram area.

Performing Gated Sweeps

When the external trigger is active, it is possible to perform a gated sweep.

- ▶ Press the SWEEP/BW key.
- ▶ Press the "Trigger" softkey.
- ▶ Activate an external trigger.
Now that the external trigger is active, the "Gated Trigger" menu item becomes available.
- ▶ Press the "Trigger" softkey again.
- ▶ Select the "Gated Trigger" menu item.

In order to get appropriate results, you have to set the gate delay and gate length in a way that the measurement is active during the interesting part of the signal. You can also modify the sweep time in order to match the horizontal axis to the length of the signal and thus set the gate delay and gate length parameters more accurately.

The gate delay parameter defines the time between the trigger event and the beginning of the actual measurement. The gate length defines the duration of the measurement, before it is interrupted and the next gate signal is anticipated to resume the measurement.

- ▶ Press the SWEEP/BW key.
- ▶ Press the "Trigger" softkey.
- ▶ Select the "Gate Settings" menu item.

The R&S ZVH opens a softkey submenu to control the gate settings. At the same time, the R&S ZVH switches into time domain, as indicated in the display.

- ▶ Press the "Manual SWP Time" softkey and set the sweep time in a way that the portion of interest of the signal is visible on the screen.
- ▶ Press the "Gate Delay" softkey.

The R&S ZVH opens an input field to define the trigger delay.

- ▶ Enter the delay time you need.

The measurement now starts after the delay time has passed.

- ▶ Press the "Gate Length" softkey.

The R&S ZVH opens an input field to define the gate length.

- ▶ Enter the length of the gate.

The R&S ZVH now measures over the period of the gate length. After the gate has closed, the R&S ZVH waits with the measurement until the next gate signal happens.

The delay time and gate length are represented by vertical red lines in the diagram area.

- ▶ After setting the gate delay and gate length, exit the gate settings menu with the "Exit" softkey.

The R&S ZVH returns to the frequency domain provided it was active before setting up the gated trigger. The original span is restored. The R&S ZVH is ready to perform measurements with an accurately set gate.

8.2.4.4 Selecting the Sweep Type

The sweep type defines the way how the R&S ZVH captures and processes the data.

- ▶ Press the SETUP key.
- ▶ Press the "User Preferences" softkey.
- ▶ Select the "Sweep / FFT" menu item.

The R&S ZVH opens a dropdown menu to select the sweep type.

Which sweep type is appropriate for the current measurement depends on the span, RBW, VBW and sweep time settings.

- Auto

The R&S ZVH automatically selects the fastest sweep type for the current measurement configuration.

- Always Sweep

The R&S ZVH uses the local oscillator to provide the spectrum quasi analog from the start to the stop frequency.

- Prefer FFT

The R&S ZVH samples the signal levels over time on a defined frequency value and transforms it to the spectrum by fast Fourier transformation (FFT).

Note that an FFT sweep is not possible under the following circumstances:

- For measurements in the time domain (zero span).
- For TDMA power, spectrum emission mask and spurious emission measurements.
- For measurements with a gated trigger.
- If the frequency span is smaller than the resolution bandwidth (RBW).
- If the the resolution bandwidth (RBW) is greater than 300 kHz.

8.2.4.5 Capturing I/Q Data

In addition of doing a frequency sweep to analyze a signal, you can also capture and analyze the real (in-phase) and imaginary (quadrature) parts of the signal. Capturing the I/Q data can be useful to analyze signals with a complex digital modulation scheme used in most modern telecommunication systems.

I/Q analysis is available in the spectrum analyzer application. Note that you can only control it via remote control using SCPI commands.

For a comprehensive description about remote controlling the R&S ZVH and the SCPI commands required to capture I/Q data, refer to the R&S ZVH-K40 user manual.

- ▶ Establish a remote connection to the R&S ZVH.
- ▶ Turn on the I/Q capture mode.
- ▶ Define a sample rate.

The sample rate defines the number of I/Q samples that the R&S ZVH captures in one second. The maximum sample rate is 38.4 MHz. The sample rate also defines the analysis bandwidth: Analysis BW = 0.8 * sample rate.

- ▶ Define a record length.

The record length defines the number of samples the R&S ZVH captures. The maximum record length is 524288 samples.

- ▶ Select "Single Sweep" mode and initiate a measurement.
- ▶ Wait until the measurement is done.
- ▶ Select the data format in which you want to query the I/Q data (REAL or ASCII).
- ▶ Query the I/Q data. For each sample, two values are returned: the real part and the imaginary part of the signal. You can either query the complete capture buffer, or select a certain range of samples.

8.2.5 Working with Traces

The trace menu contains all functions available to customize the trace display.

8.2.5.1 Selecting the Trace Mode

The R&S ZVH provides several trace modes. The trace mode defines the way the R&S ZVH writes the trace.

- **Clear/Write**

In its default state, the R&S ZVH overwrites the trace after each sweep.

You can apply all detectors in this mode.

- **Average**

The trace is the result of the moving average over several sweeps.

The R&S ZVH calculates the (moving) average of the power levels for each pixel over a particular number of sweeps in the range from 2 to 999.

Averaging reduces the effects of noise, but has no effects on sine signals. Using the trace averaging therefore is a good way to detect signals in the vicinity of noise.

You can apply all detectors in this mode.

- **Max Hold**

The trace shows the maximum power levels that have been measured at each pixel.

To overwrite a max hold trace, change a parameter in a way that the results can not be compared any more, e.g. the span. Using the max hold trace mode is a good way to detect intermittent signals or the maximum values of fluctuating signals, for example.

Using the max hold trace mode automatically activates the max peak detector.

- **Min Hold**

The trace shows the minimum power levels that have been measured at each pixel.

To overwrite a min hold trace, change a parameter in a way that the results can not be compared any more, e.g. the span. Using the min hold trace mode is a good way to highlight signals within noise or suppress intermittent signals.

Using the min hold trace mode automatically activates the min peak detector.

- **View**

The view trace mode freezes the current trace and aborts the measurement.

Using the view trace mode is a good way to evaluate the trace, for example with markers.

- ▶ Press the TRACE key.
- ▶ Press the "Trace Mode" softkey.

The R&S ZVH opens a submenu to select the trace mode.

- ▶ Select the trace mode you want to work with.

If you have selected the average trace mode ("Average: 10" menu item), the R&S ZVH opens an input field to set the number of sweeps the R&S ZVH includes in the averaging.

- ▶ Enter the number of sweeps to include in the averaging.

In continuous sweep mode, the R&S ZVH now calculates the moving average over the number of sweeps you have specified. In single sweep mode, it stops the measurement after finishing the sweeps and averages the traces.

8.2.5.2 Selecting the Detector

The number of measurement results collected in a single sweep usually is very high, especially if the span is large. However, the display of the R&S ZVH can display only 631 results in horizontal direction, as it is limited by the number of pixels that are available on the display. Therefore, it has to combine measurement results to fit them on the display. In that case, one pixel represents a frequency range = span/631.

The detector determines the way the R&S ZVH combines and displays the results for one pixel. The data base is the video voltage of the analyzer.

The R&S ZVH provides several types of detectors.

- **Auto Peak**

If the auto peak detector is active, the R&S ZVH displays both the maximum and the minimum power levels that were measured in the frequency range covered by a pixel.

Therefore, the auto peak detector loses no information. If a signal power level fluctuates (e.g. noise), the width of the trace depends on the magnitude of the signal fluctuation.

The auto peak detector is the default detector.

- **Max Peak**

If the max peak detector is active, the R&S ZVH displays only the maximum power levels that were measured in the frequency range covered by a pixel.

The max peak detector is useful for measurements on pulse or FM signals, for example.

- **Min Peak**

If the min peak detector is active, the R&S ZVH displays only the minimum power level that were measured in the frequency range covered by a pixel.

The min peak detector displays sine signals with the correct level and suppresses noise. Therefore it is useful to find sine signals in the vicinity of noise.

- **Sample**

If the sample detector is active, the R&S ZVH shows one random power level that was measured in the frequency range covered by a pixel.

The sample detector is useful for measurements in the time domain (span = 0 Hz) as it provides the only way to represent the timing of the video signal correctly.

In the frequency domain, the sample detector is a good way to measure noise power because noise usually has a uniform spectrum with a normal amplitude distribution.

Signals may get lost if you are using the sample detector for measurements with a span that is greater than "RBW*631".

- **RMS**

If the RMS detector is active, the R&S ZVH measures the spectral power over one pixel. In case of power measurements, the RMS detector always shows the true power of a signal, regardless of the shape of the signal.

The RMS detector is best for measurements on digitally modulated signals because it provides stable and true power readings. In combination with a high sweep time you can increase the display stability even more because the measurement time for each pixel increases.

Noise measurements also provide stable results if you apply the RMS detector in combination with a high sweep time.

However, the bandwidth occupied by the signal to be measured should at least equal the frequency covered by a trace pixel or the selected resolution bandwidth (whichever is larger). Otherwise, the power the R&S ZVH shows is too low because there are spectral components within the frequency range covered by the pixel that do not originate from the signal you want to observe (e.g. noise).

To get the true power, the video bandwidth (VBW) should also be greater than the resolution bandwidth (RBW). Otherwise, an averaging effect caused by video bandlimiting comes into play before the RMS value is calculated.

The R&S ZVH provides automatic selection of the detector. In that case, the R&S ZVH selects the detector that is most suitable for the current trace mode.

Trace mode	Detector
Clear/Write	Auto Peak
Average	Sample
Max Hold	Max Peak
Min Hold	Min Peak

If you select the detector manually, the detector is independent of the trace mode and will not change.

- ▶ Press the TRACE key.
- ▶ Press the "Detector" softkey.
- ▶ Select the detector you want to use.

If you automatic detector selection is active, the corresponding menu item is marked by an [X].

8.2.5.3 Working with a Second Trace

In spectrum mode, you can use two traces. Both traces are based on the same settings, except the trace settings like the trace mode or the detector. You can use the second trace to compare, for example, two different detector settings.

In the default state, only trace 1 is active.

- ▶ Press the TRACE key.
- ▶ Press the "Show" softkey.
- ▶ Select the "Trace 2" menu item.

The R&S ZVH shows the second trace. The second trace is in a different color. To show that the second trace is active, the R&S ZVH labels the "Trace 2" menu item with an [X].

After you have activated the second trace, this is also the active one. All actions (like changing the detector or trace mathematics) apply to the active trace.

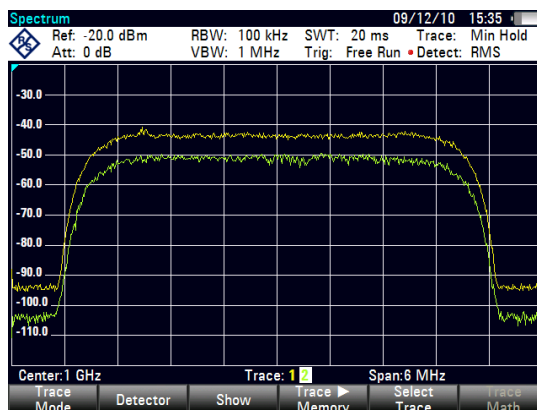

The trace indicator shows the currently active trace with a white background.

Trace: 1 2 |

- ▶ Press the "Select Trace" softkey.

Trace 1 becomes the active trace.

You can put both traces into the internal memory of the R&S ZVH and restore them later. Note that the memory trace 1 and memory trace 2 have the same color (i.e. white).

8.2.5.4 Working with Memory Traces

You can save the image of both traces to the memory of the R&S ZVH and later restore it and compare it to a live trace. The memory trace is always colored white to distinguish it from the live trace.



Measurement settings

Because the memory trace is just a bitmap, any modifications to measurement settings like span or reference level are not reflected in the memory trace.

When you save a data set, the R&S ZVH also stores the associated trace in the trace memory. If you restore it at a later time, you can display the memory trace as if it is a normal memory trace.

- ▶ Press the TRACE key.
- ▶ Select the trace you want to store in the trace memory with the "Select Trace" softkey.
- ▶ Press the "Trace ▶ Memory" softkey.

The R&S ZVH saves the active trace.

- ▶ Press the "Show" softkey.
- ▶ Select the "Memory <x>" menu item.

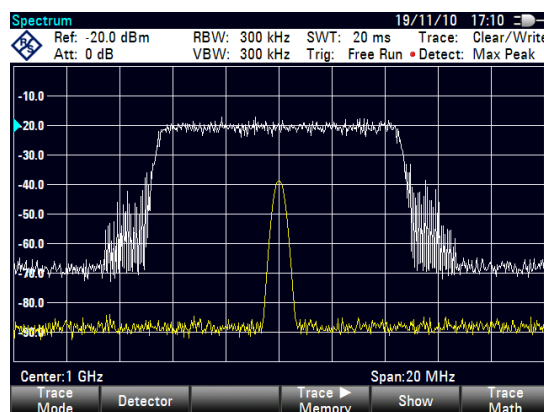

The R&S ZVH shows the corresponding memory trace. If active, it labels the "Memory <x>" menu item with an [X].

8.2.5.5 Using Trace Mathematics

Trace mathematics subtract the memory trace from the live trace and vice versa and then display the results.

- ▶ Press the TRACE key.
- ▶ Press the "Trace ▶ Memory" softkey.
- ▶ Press the "Show" softkey.
- ▶ Press the "Trace Math" softkey.
- ▶ Select the "Trace-Memory" or "Memory-Trace" menu item.

The R&S ZVH calculates and shows the resulting trace.

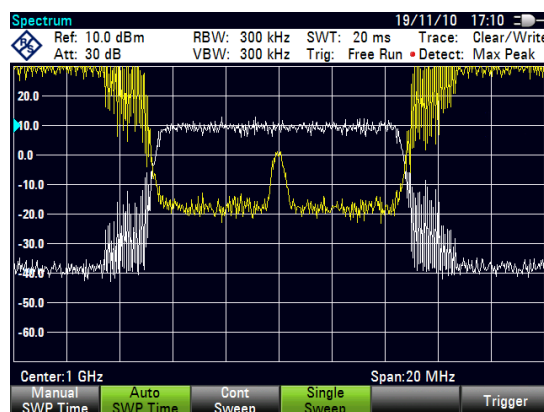

- ▶ To turn off trace mathematics, select the "Off" menu item.

8.2.6 Using Markers

The spectrum analyzer mode provides marker and deltamarker functionality. In addition, you can use several marker functions.

8.2.6.1 Using Markers and Deltamarkers

Marker and deltamarker functionality in the spectrum analyzer mode is the same as that of the cable and antenna analyzer.

For more information see "Using Markers" on page 75.

8.2.6.2 Using Marker Functions

In addition to the frequency and level readout, the R&S ZVH provides several, more complex, marker functions in spectrum analyzer mode.



Deactivating marker functions

Selecting a marker function again while it is still active turns that marker function off.

Measuring the Noise Power Density

The marker noise function calculates the noise power density at the marker position in dBm/Hz. The R&S ZVH includes several variables in the calculation of the noise power density, including the trace pixel values, the resolution bandwidth, the detector and the level display mode (absolute or relative). To stabilize the noise power display, the R&S ZVH uses the pixel the marker is on and four pixels to the right and four pixels to the left of the marker pixel.

Noise power density can provide useful information when you are measuring noise or digitally modulated signals. However, you will get valid results only if the spectrum in the vicinity of the marker has a flat frequency response. When measuring the noise power density on discrete signals, results are not valid.

- ▶ Press the MARKER key.
- ▶ Press the "Marker Function" softkey.
- ▶ Select the "Noise" menu item.

The R&S ZVH shows the level at the marker frequency in dBm/Hz. If you are using a delta marker for the measurement, the results have the unit dBc/Hz with marker 1 being the reference.

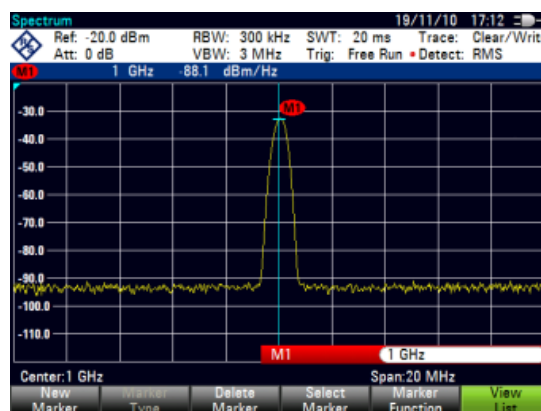

Measuring the Frequency

The R&S ZVH provides a frequency counter. The frequency counter accurately measures the frequency at the marker position.

When calculating the horizontal position of the marker, the R&S ZVH includes the current span, center frequency and the frequency of the pixel the marker is on. As the trace only has 631 pixels, the marker position is just an approximation, especially if the span is very wide.

With the frequency counter, however, you can get a more accurate result of the horizontal marker position. If the frequency counter is active, the R&S ZVH stops the measurement at the marker position for a short time and measures the frequency using the internal reference frequency.

The accuracy of the results therefore depends only on the accuracy of the internal reference frequency (TCXO). The frequency counter has a resolution of 0.1 Hz and therefore provides far more accurate results. Despite the accuracy, the measurement is still fast (because of a special algorithm for the I/Q baseband signal).

The frequency counter only gives completely accurate readings for sine signals that are at least 20 dB above the noise floor. If the S/N ratio is less, noise affects the results.

- ▶ Press the MARKER key.
- ▶ Press the "Marker Function" softkey.
- ▶ Select the "Frequency Count" menu item

The R&S ZVH displays the counted marker. If the frequency counter is on, the marker symbol changes from M1 to C.

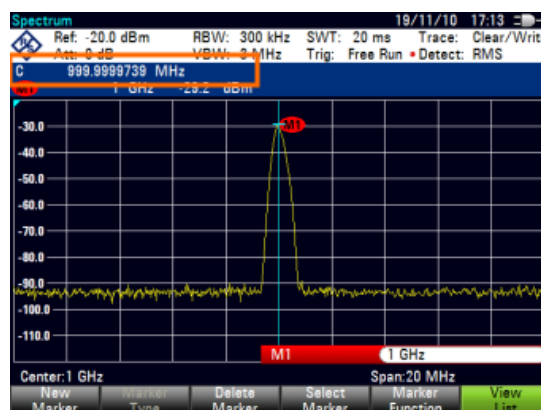

The resolution with which the frequency is measured depends on your selection.

- ▶ Select the desired frequency resolution with "Frequency Count Resolution" menu item. "Low" has a resolution of 0.1 Hz, "High" a resolution of 0.1 mHz.

Measuring the Signal Bandwidth

The "n dB Down" marker function places two temporary markers to the left and to the right of the reference marker and measures the bandwidth between the two temporary markers. The function therefore is a good way to measure the bandwidth of a signal or the bandwidth of a filter, for example. The temporary markers are represented as two vertical lines.

The distance to the reference marker is by default 3 dB below the reference marker. You can also adjust this value manually. Entering a positive value sets the temporary markers below the reference marker. If it is, for any reason, not possible to calculate the frequency spacing, dashes are displayed instead of a value.

Upon entering a negative value, the function turns into a n dB up function. You can use a n dB up function, for example, for measurements on notch filters.

- ▶ Press the MARKER key.
- ▶ Press the "Marker Function" softkey.
- ▶ Select the "n dB Down" menu item

The R&S ZVH displays two temporary markers on the left and on the right of the reference marker M1. It also shows the bandwidth between the n dB down markers.

You can then adjust the distance of the temporary markers.

- ▶ Press the "Marker Function" softkey.
 - ▶ Select the "n dB Down" menu item
- The R&S ZVH opens an input field
- ▶ Enter a different distance (in this case 6 dB).

The R&S ZVH again shows the temporary markers, this time with a broader bandwidth.



Demodulating Signals

The R&S ZVH features an AM and FM demodulator to demodulate and monitor audio signals. It demodulates the signal at the marker frequency.

You can listen to the demodulated signal with the internal speaker or headphones that you can connect to the 3.5 mm headphone jack on the top of the R&S ZVH.

When demodulating an AM modulated signal, the R&S ZVH turns the video voltage into an audible sound. You should therefore set the reference level to about the level of the signal that you are demodulating.

If you perform measurements in the time domain, the R&S ZVH demodulates continuously. In the frequency domain, you can define a time period the R&S ZVH demodulates the signal at the marker frequency. The frequency sweep then stops at the marker frequency for that time before finishing the sweep.

- ▶ Press the MARKER key.
- ▶ Press the "Marker Function" softkey.
- ▶ Select the demodulation scheme you require from the menu.

The R&S ZVH starts to demodulate the signal.

**Demodulating signals**

If you turn on the demodulator, the R&S ZVH automatically turns off the noise marker or the frequency counter.

Defining the demodulation time period

- ▶ Press the MARKER key.
- ▶ Press the "Marker Function" softkey.
- ▶ Select the "Time..." menu item.

The R&S ZVH opens an input field to define the demodulation time.

- ▶ Enter the demodulation time you need.

The range is from 100 ms to 500 s. In time domain the R&S ZVH demodulates continuously, i.e. the demodulation time is not relevant.

Controlling the volume

- ▶ Press the MARKER key.
- ▶ Press the "Marker Function" softkey.
- ▶ Select the "Volume..." menu item.

The R&S ZVH opens an input field to define the demodulation volume.

- ▶ Enter the volume you are comfortable with.

The demodulation volume is a percentage (0 % to 100 %) with 100 % being full volume.

For more information on general volume control see the quick start guide.

8.2.7 Using Display Lines

Like markers, display lines help you to determine the level of the signal.

A display line is a straight line that runs horizontally and corresponds to a certain level value. You can move the display line to each pixel in the display. This means that the accuracy and exact vertical position of the display line depends on the resolution of the vertical axis. With a display range of 100 dB, for example, each pixel corresponds to 0.3 dB. In that case, the accuracy of the display line is 0.3 dB. If you enter a value with a higher resolution, the R&S ZVH rounds that value.

You can also move the display line with the rotary knob or the cursor keys. The step size for movement with the rotary knob is one pixel. The step size for the cursor keys is 10 % of the display range.

- ▶ Press the LINES key.
- ▶ Press the "Display Line" softkey.

The R&S ZVH displays the display line as a blue horizontal line. It shows the vertical position of the line in a table above the diagram area.

When you activate the display line, the R&S ZVH also opens an input field to define the vertical position of the line.

- ▶ Enter the level value you need.

The R&S ZVH positions the display line accordingly.

Alternatively you can also move the display line with the rotary knob or the cursor keys.

8.2.8 Using Limit Lines

Limit lines help you to identify if a signal complies with certain level characteristics.

A limit line is made up out of two or more points that are connected to a line. Each of the points that define the shape of the limit line consists of two coordinates. One coordinate defines the horizontal position (e.g. frequency), the other one the vertical position. With the R&S ZVH you can build limit lines that consist of up to 1000 points.

Values that define the horizontal characteristics of the limit line can be either absolute values (e.g. frequency in MHz) or relative values whose reference is the center of the measurement trace (e.g. the center frequency). Relative values are of advantage if you, for example, measure modulated output signals and you change the center frequency but need the limit line to remain the same. Absolute limit lines have the file extension ".abslim" while relative limit lines have the file extension ".rellim"

Values that define the vertical characteristics are always level values in dB. If the scaling of the vertical axis is currently a linear one (units V or W), the R&S ZVH automatically switches to a logarithmic scaling after you turn on the limit line.

After turning on a limit line, the R&S ZVH checks if the signal violates the shape of the limit line. If one or more signal levels exceed the limit value, the R&S ZVH features several indicators that the limit check has failed.

- A general message in the diagram header that indicates if the signal violates the limit line, including the trace that violates the limit: **Trace 1 FAIL**
- An audio signal that sounds every time a limit is violated
- The trace color turns red in areas of the spectrum that violate a limit

You can create and edit limit lines with the R&S InstrumentView software package and then transfer them into the internal memory of the R&S ZVH. The number of limit lines you can store in the memory depends on other datasets available on the R&S ZVH or, if you are using an external storage device (e.g. memory stick), the size of it.

For more information see "[Managing Datasets](#)" on page 34.

8.2.8.1 Selecting a Limit Line

Before selecting a limit line, you need to decide if you want to use it as an upper or lower limit line. In case of upper limit lines, the R&S ZVH checks if the signal is above the limit line. In case of lower limit lines, the R&S ZVH checks if the signal is below the limit line.

You also have to make sure that the limit line is compatible to the scale of the horizontal axis (linear in absolute or relative terms or logarithmic).

- ▶ Press the LINES key.
- ▶ Depending on the application, press the "Upper Limit" or "Lower Limit" softkey.
The R&S ZVH opens a dialog box to select the limit line.
- ▶ Select the "Load From File..." menu item.
- ▶ Press the "Sort/Show" softkey.

- ▶ Select the "Show Compatible" menu item.

The R&S ZVH shows all limit lines that are compatible to the current settings.

- ▶ Select one of the available limit lines.
- ▶ Press the "Select" softkey.

The R&S ZVH activates the limit line. In the diagram, the limit line is displayed as a red line.

If you have already selected a limit line, you can turn the limit line on and off with the "Limits On/Off" softkey.

Alternatively, you can define a threshold that works like a limit line. A threshold is a simple horizontal limit line.

- ▶ Press the "Upper Limit" or "Lower Limit" softkey.
- ▶ Select the "Threshold" menu item.

The R&S ZVH opens a input field to define the threshold.

- ▶ Enter the threshold you need.

The R&S ZVH displays the line and performs a limit check for that threshold.

Threshold line and display line

Like the display line, a threshold line is a straight horizontal line. The difference is that the R&S ZVH performs a limit check for threshold lines, but not for display lines.



A failed limit check may be an issue if you want to create a measurement report, because measurements with failed limits are not included in this report.

Using a display line, you can use a line and are able to create a measurement report at the same time, regardless if any limits have been violated or not.

The process of turning off a limit line completely is similar to that of selecting a line.

- ▶ Press the "Upper Limit" or "Lower Limit" softkey
- ▶ Select the "Unselect Limit" menu item.

The R&S ZVH deactivates the limit line.

8.2.8.2 Performing Limit Checks

If limit lines are active, the R&S ZVH automatically checks the trace for limit violations after each frequency sweep. As long as the signal does not violate the limit line, the R&S ZVH shows a "Pass" message in the measurement diagram. As soon as one single value (i.e. one pixel) is outside of the limits, the R&S ZVH displays a "Fail" message in the diagram area and, in addition, sounds a beep.

A limit checks relates only to the frequency range defined by the limit line, not the span.

Audio signal

You can turn the acoustic signal that sounds in case of a limit violation on and off.

- ▶ Press the "Options" softkey.
- ▶ Select the "Audio Beep" menu item.

An [X] in front of the "Audio Beep" menu item indicates that the beeper is active. If the audio beep is active, the R&S ZVH beeps each time a limit is violated.

**Limit violation**

Note that a limit check fails only if the signal *exceeds* the limit line. If the signal level is the same as the limit value, the limit check passes.

8.3 Working with Channel Tables

Almost all transmission systems divide their assigned frequency ranges into channels. Each channel corresponds to a specific frequency. To keep the handling of such systems simple, you can use channel tables instead of entering frequencies manually.

The R&S ZVH already comes with an assortment of channel tables that you can use without doing anything. If you want to test transmission standards that are not listed, you can also build channel tables manually with the "Channel Table Editor" of the R&S InstrumentView software package that is delivered with the R&S ZVH. To use one of those, you just have to copy the channel table to the R&S ZVH.

For more information see "[Managing Datasets](#)" on page 34.

Selecting a channel table

- ▶ Press the **FREQ/DIST** key.
- ▶ Press the "Frequency Mode" softkey.
- ▶ Select the "Channel" menu item.

The R&S ZVH opens a dialog box to select a channel table.

- ▶ Select one of the available channel tables.

After activating the channel table, the R&S ZVH is set up according to the information contained in the channel table. Instead of a center frequency, the R&S ZVH shows the currently active channel number including the name of the channel. The center frequency of a channel is defined in the channel table and is the frequency corresponding to the selected channel.

Selecting a channel

Entering a center, start or stop frequency is not possible anymore. Instead you select a channel. The R&S ZVH then adjusts the center, start and stop frequency according to the channel table.

- ▶ Press the **FREQ/DIST** key.
- ▶ Press the "Center Frequency" softkey.

The R&S ZVH opens an input field to select the channel.

- ▶ Enter the channel you want to perform measurements on.

The R&S ZVH changes the channel according to the channel table.

Channel numbers are assigned to frequencies as follows:

- The first channel is assigned a channel number and a frequency.
- All subsequent channels have ascending numbers.
- The frequency spacing between channels is fixed. It can also be negative, i.e. the center frequency of the R&S ZVH decreases with ascending channel number.
- In transmission systems containing gaps in the frequency range (as in the case of television, for example), a channel table can comprise multiple ranges.

8.4 Using Transducer Factors

The frequency-dependent transducer factor of transducers and antennas can be directly considered in the measurement result. A transducer factor consists of a numeric value and a unit. The R&S ZVH corrects the level values of the trace by the values of the transducer. At the same time, the unit of the transducer is assigned to the level axis. When field-strength measurements are performed with the aid of antennas, for instance, the electrical field strength is directly indicated in dB μ V/m on the R&S ZVH. A transducer factor can also be used to correct a frequency-dependent attenuation, e.g. of a cable between DUT and RF input of the R&S ZVH.

You can create and edit transducer factor with the R&S InstrumentView software package and then transfer them into the internal memory of the R&S ZVH. Each transducer factor may consist of up to 1000 reference values.

For more information see "[Managing Datasets](#)" on page 34.

Interpolation between the values is performed with the aid of a modified spline algorithm. Even if only relatively few values such as maxima, minima and turning points are available, this algorithm can easily simulate the correction factors of common transducers. Two transducers can be switched on at a time. The second transducer must be assigned the unit dB. The R&S ZVH adds the two transducers to a total transducer.

Units supported for transducer factors:

- dB
- dB μ V/m
- dB μ A/m
- W/m²

The unit dB does not change the unit set on the R&S ZVH. It can be used, for instance, to compensate for frequency-dependent loss and gain at the input of the R&S ZVH. The units dB μ V/m and dB μ A/m convert the output power of an antenna into electric or magnetic field strength. The unit W/m² is used to calculate and display the power flux density.

For example, to compensate for the cable loss between the transducer and the RF input, the R&S ZVH can use two transducers at the same time. One of them must have the unit dB, however, i.e. it must correspond to one loss or gain value.

- ▶ Press the SCALE/AMPT key.
- ▶ Press the "Transducer" softkey.



Transducer factor availability

Transducer factors are not available for measurements with the tracking generator or the Power Sensors. The "Transducer" softkey is therefore inactive.

You can select two transducer factors, a primary transducer and a secondary transducer. If a transducer factor is active, the menu item has an [X] in front of it.

- ▶ Select the "Select Primary Transducer" menu item.

The R&S ZVH opens a dialog box to select the transducer factor.

- ▶ Select the transducer factor you need.
- ▶ Confirm the selection with the "Select" softkey.

The R&S ZVH shows the name of the active transducer on the display.

An example would be the transducer factor of the R&S HL223 antenna that is defined between 200 MHz and 1300 MHz. The R&S ZVH therefore displays the noise in this frequency range as a function of frequency incremented by the transducer factor. Outside the transducer range, the R&S ZVH sets the transducer factor at zero, i.e. measurements in this range do not yield conclusive results.

You can select a second transducer factor with the "Select Secondary Transducer" menu item. The secondary transducer factor in that case is added to the first. The unit of the second transducer factor must always be the relative unit dB as otherwise an addition would not be useful. When you select a secondary transducer factor, the dialog box shows only those transducer factors that have dB as their unit.

8.4.1 Unit for Measurements with Transducers

If the unit of the transducer is dB, the units dBm, dBmV or dB μ V remain unchanged. The linear units Volt and Watt are not permissible. They are deactivated in the units menu.

If the unit of the transducer is dB μ V/m or dB μ A/m, this unit is also used for the R&S ZVH level display. This means that both the level axis of the diagram and the level at the marker position are assigned the unit of the transducer. If dB μ V/m is selected as the transducer unit, a switch to absolute level indication in V/m is possible.

- ▶ Press the SCALE/AMPT key.
- ▶ Press the "Unit" softkey.
- ▶ Select the V(olt) menu item.

If you are using a transducer with the unit dB μ A/m, it is not possible to select another unit. Level indication is entirely in dB μ A/m.

8.4.2 Setting the Reference Level

The transducer shifts the trace by its value as a function of frequency. Positive transducer values increase the level, negative values reduce it. To ensure that the trace is always within the diagram, the R&S ZVH adjusts the reference level accordingly. The reference level is shifted by the maximum transducer value in the positive or negative direction.

8.4.3 Frequency Range of Transducer

If the set frequency range is wider than the span in which a transducer is defined, the R&S ZVH assumes the transducer values outside the defined range to be zero.

8.4.4 Data Sets Containing Transducer Factors

The R&S ZVH stores data sets together with any transducer factors that may have been active for the measurement in question. When such a dataset is recalled, the associated transducer factor(s) are switched on as well. Transducer factors recalled as part of a data set do however not appear in the list of transducer factors.

9 Power Meter (R&S ZVH-K9)

For highly accurate power measurements, you can connect a power sensor to the R&S ZVH and perform measurements.

9.1 Using a Power Sensor

The power sensor function turns the R&S ZVH into a wideband power meter. It then always measures the power of the whole signal in the frequency range of the power sensor. In most cases the signal shape has no effect on the measurement.

- ▶ Press the MODE key.
- ▶ Press the "Power Meter" softkey

The R&S ZVH activates the mode for power measurements.

Screen layout of the power meter mode



- 1 Connected power sensor model
- 2 Reference for relative power measurements
- 3 Power offset
- 4 Measurement time
- 5 Readout of the measured power
- 6 Analog readout of the measured power
- 7 Measurement frequency
- 8 Power sensor softkey menu

A power sensor measures the power in the frequency range defined in the data sheet of the power sensor. This means that you can measure both sine signals and modulated signals precisely over a large dynamic range.

For a complete list of supported power sensors, refer to the data sheet.

If you are using one of the NRP power sensors you also need a passive USB adapter (R&S NRP-Z4) to connect the power sensor to the R&S ZVH.

For more information on the characteristics of the supported power sensors see

- the datasheet of the R&S ZVH
- the website for R&S power sensors

http://www.rohde-schwarz.com/en/products/test_and_measurement/power_volt_meter/NRPZ.html

9.1.1 Connecting a Power Sensor

The R&S ZVH controls and powers the power sensors via a special interface on the top of the instrument. You can also connect a power sensor via the USB interface on the right.

If you are using the R&S FSH-Z1 and -Z18 power sensors, connect the power sensor cable to the power sensor interface and screw it into position. Power sensors of the R&S NRP product line are controlled via the USB interface with a passive USB adapter.

After connecting the power sensor to the R&S ZVH, you can connect the DUT to the N-connector of the power sensor.

NOTICE

Risk of damage to the power sensor

Before you start to work with the power sensor, make sure that the continuous power applied to the input of the power sensor does not exceed a certain level.

Refer to the documentation of the power sensor for more information on the maximum input power.

If the R&S ZVH recognizes a power sensor, it sets up a connection via the interface and after a few seconds shows the measured power. It displays the type of the power sensor in the display header.

If no power sensor has been connected or it is not connected appropriately, the R&S ZVH shows nothing.

If there are communication problems between the R&S ZVH and the power sensor, the R&S ZVH displays one of the following error messages that indicate the possible cause.

Message	Cause	Remedy
Error in zeroing: signal at sensor	A signal was present at the power sensor when zeroing was performed.	Unscrew the power sensor from the device under test and repeat zeroing.
Warning: Input overloaded	The power at the input of the power sensor exceeds the permitted power (23 dBm = 200 mW).	Reduce the power at the sensor input.
Power sensor hardware error	Communication error between the R&S ZVH and the power sensor.	Unscrew the sensor from the R&S ZVH and check the connectors. If the problem persists, contact a Rohde & Schwarz service center.
Power sensor error	The power sensor signals an error to the R&S ZVH.	Contact a Rohde & Schwarz service center.
Unknown power sensor model connected	The R&S ZVH cannot identify the device connected to the power sensor interface.	

9.1.2 Performing and Configuring Measurements

After you have connected a power sensor, the R&S ZVH immediately starts to measure the signal power.

Defining the center frequency

Power sensors have a memory containing correction values that are dependent on the frequency. Hence, measurement results are the most accurate for signals whose frequency you know.

Note that the R&S ZVH maintains the center frequency that you have set in another operating mode. In that case it uses that frequency as the power sensor frequency.

If you want to perform measurements on another known signal, you can change the power sensor frequency manually.

- ▶ Press the MEAS key
- ▶ Press the "Freq" softkey.

An input field to define the frequency opens.

- ▶ Enter the frequency of the signal.

The R&S ZVH transfers the new frequency to the power sensor which then corrects the measured power readings.

Zeroing the power sensor

Offset voltages and currents have most effect on the power readout when measuring low powers. You can compensate for these offsets by zeroing the power sensor.

Do not apply power during the zeroing process, as the power sensor cannot distinguish between external powers and internal offsets.

- ▶ Press the "Zero" softkey.

The R&S ZVH asks you not to apply any signals to the power sensor during the zeroing process.

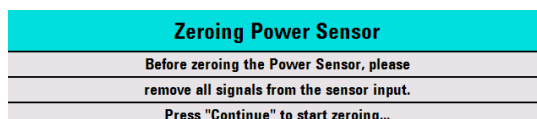

- ▶ Disconnect the power sensor from any signal sources.
- ▶ Press the "Continue" softkey to start zeroing.
- ▶ Press "Cancel" to abort zeroing, for example, if you cannot disconnect the signal source.

The R&S ZVH immediately starts power sensor zeroing.

While zeroing is in progress, the R&S ZVH shows the message "Zeroing power sensor, please wait..".

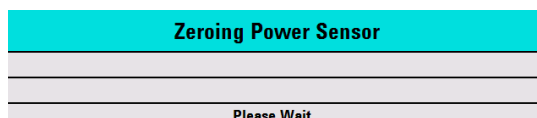

When zeroing is over, the R&S ZVH shows the message **Power Sensor Zero OK!** and switches back to the softkey menu for the power sensor.

Selecting the unit for the power readout

The R&S ZVH can display measured power in relative units (dBm) or in absolute units (W, mW, μ W, nW and pW). It is also possible to set a reference level in dB.

- ▶ Press the "Unit" softkey.

A submenu to select the unit opens.

- ▶ Select the unit you want.

The R&S ZVH adjusts the result display accordingly.

Setting the reference level

If you have selected the unit dB Rel, the R&S ZVH opens an input field to set the reference level. The R&S ZVH shows the currently set reference level in the diagram header.

- ▶ Enter the reference level you want.

Alternatively, you can set the current level readout as the reference level.

- ▶ Press the "▶Ref" softkey.

The R&S ZVH sets the current result as the reference level.

It then displays the measured level relative to the reference level in dB. The unit is automatically set to dB Rel...

Setting the averaging time

The averaging time determines the length of the measurement. The longer the averaging time, the more stable the display, particularly if signals have low power or are noisy.

The averaging time is either "Short", "Normal" or "Long".

- A short measurement time provides stable and accurate results for stationary sine signals with high levels (> -40 dBm). It is also appropriate for measurements that require a high repetition rate.
- A normal measurement time increases the stability of results for signals with low levels or modulated signals.
- A long measurement time is appropriate for signals with very low power levels (< -50 dBm)

To eliminate noise and the effects of noise on the measurement effectively, use the R&S FSH-Z1 power sensor.

- ▶ Press the "Meas Time" softkey.

- ▶ Select the measurement time most suitable for your test setup.

Taking additional loss or gain into account

At high powers that cause the power sensor maximum input level to be exceeded or at very low levels that are below the R&S ZVH minimum sensitivity, the R&S ZVH can take additional loss or gain between the DUT and the power sensor into account. These are defined in terms of an offset in dB relative to the measured level. A positive offset corresponds to a loss and a negative offset to a gain.

The R&S ZVH shows the current offset in the diagram header.

- ▶ Press the SCALE/AMPT key.
- ▶ Press the "Ref Offset" softkey.

The value entry box for the reference offset opens.

- ▶ Enter the required offset.

The offset is taken into account in the power or level display.

9.2 Using a Directional Power Sensor

For power measurements in both directions (forward and reverse), you can connect directional power sensors to the R&S ZVH. The R&S ZVH supports the following directional power sensors:

- R&S FSH-Z14
- R&S FSH-Z44

With a directional power sensor, the R&S ZVH measures the power of a signal from source to load (forward power) and from load to source (reverse power). The ratio of forward and reverse power is a measure of the load matching. The R&S ZVH displays the results as the return loss or the standing wave ratio.

- ▶ Press the MODE key.
- ▶ Press the "Power Meter" softkey

The R&S ZVH activates the mode for power measurements.

Screen layout of the power meter mode with a directional power sensor

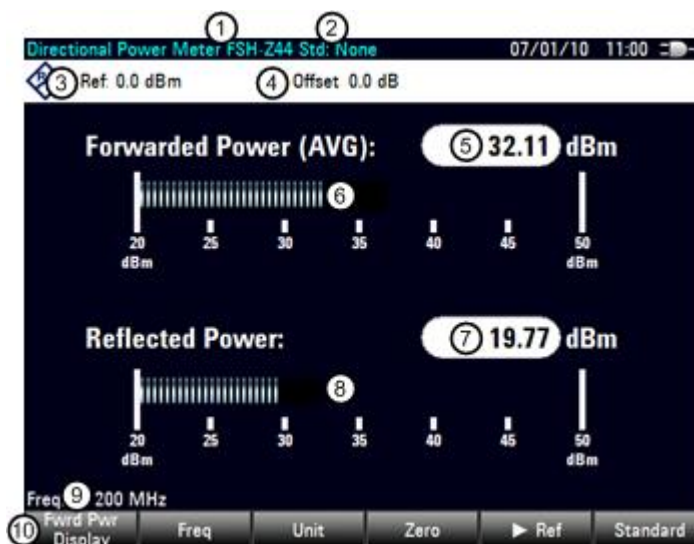

- 1 Connected power sensor model
- 2 Selected transmission standard
- 3 Reference for relative power measurements
- 4 Power offset
- 5 Readout of the forward power
- 6 Analog readout of the forward power
- 7 Readout of the matching value
- 8 Analog readout of the matching value
- 9 Measurement frequency
- 10 Directional power sensor softkey menu

9.2.1 Connecting a Directional Power Sensor

The R&S ZVH controls and powers the directional power sensors via a special interface on the top of the instrument.

Connect the power sensor cable to the power sensor interface and screw it into position. The power sensor itself is located between the source and the load of the test setup. The figure below shows the way a test setup would look like.

The power sensors for the R&S ZVH have an asymmetrical design. Hence, you have to insert them into the test setup in such a way that the "Forward" arrow (1⇨2) on the sensor points toward the load (= in the direction of the power flux).

If the R&S ZVH recognizes a power sensor, it sets up a connection via the interface and after a few seconds shows the results. It displays the type of the power sensor in the display header. If an error occurs, the R&S ZVH shows a corresponding message.

For more information, see "[Connecting a Power Sensor](#)".

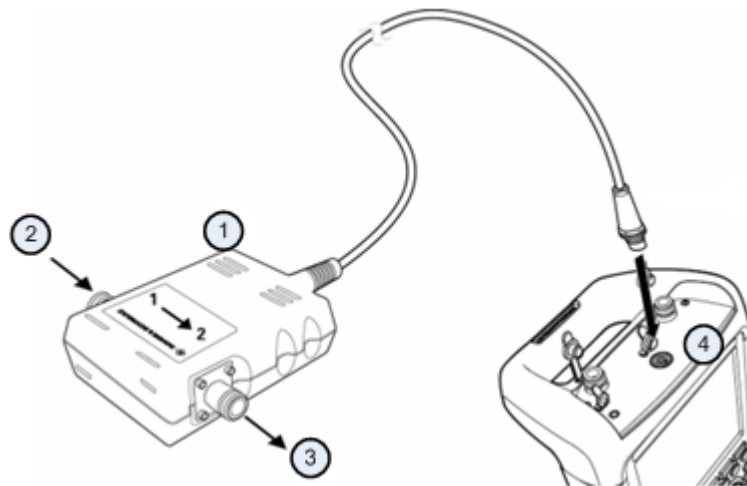

- 1 Directional power sensor R&S FSH-Z14 or -Z44
- 2 Source
- 3 Load
- 4 Power sensor jack

9.2.2 Performing and Configuring Measurements

After you have connected a power sensor, the R&S ZVH immediately starts to measure the signal power.

When measuring high powers, pay strict attention to the following instructions to avoid personal injury and to prevent the power sensor from being destroyed

CAUTION

Risk of skin burns and / or damage to the R&S ZVH

Measuring high powers may lead to skin burns and / or damage to the R&S ZVH. You can avoid it by:

- Never exceeding the permissible continuous power. The permissible continuous power is indicated on a diagram on the back of the power sensor.
 - Turning off the the RF power when connecting the power sensor.
 - Connecting the RF connectors tightly.
-

Defining the center frequency

To get the most accurate results, you should synchronize the frequency to that of the signal.

Note that the R&S ZVH maintains the center frequency that you have set in another operating mode. In that case it uses that frequency as the power sensor frequency.

If you want to perform measurements on another known signal, you can change the power sensor frequency manually.

- ▶ Press the MEAS key
- ▶ Press the "Freq" softkey.

An input field to define the frequency opens.

- ▶ Enter the frequency of the signal.

The R&S ZVH transfers the new frequency to the power sensor which then corrects the measured power readings.

Zeroing the power sensor

For more information see "[Zeroing the power sensor](#)".

Setting the power measurement weighting mode

For forward power display, the R&S ZVH provides both average power and peak envelope power.

- ▶ Press the MEAS key.
- ▶ Press the "FwrD Pwr Display" softkey.
- ▶ Select the weighting mode you require.

The R&S ZVH indicates the weighting mode at the Forward Power heading.

- Forward power (AVG) = average power
- Forward power (PEP) = peak envelope power

Selecting the unit for the power readout

When using a directional power sensor, the R&S ZVH displays the forward power as a logarithmic level value in dBm (relative value) or as a linear value in W or mW (absolute value). In addition you can define a reference level relative to which the R&S ZVH indicates the level difference in dB. Load matching is indicated as return loss in dB or as voltage standing wave ratio (VSWR). In addition, the absolutely reflected power can be displayed in W, or the reflected level in dBm.

For more information see "[Selecting the unit for the power readout](#)".

Setting the reference level

If you have selected the unit dB Rel for the forward power, the R&S ZVH opens an input field to set the reference level. The R&S ZVH shows the currently set reference level in the diagram header.

For more information see "[Setting the reference level](#)".

Selecting a standard

To ensure that true results are output when measuring modulated signals, the R&S ZVH offers the possibility of taking correction values into account for a number of common telecommunications standards.

- ▶ Press the "Standard" softkey.
A menu to select a standard opens.
- ▶ Select the required standard.

The R&S ZVH takes the selected standard into account. The currently active standard is displayed in the display header.

Taking additional attenuation into account

When the directional power sensor is connected to a test point not directly but via a cable, the influence of cable attenuation can be taken into account. For this purpose, the cable attenuation for the measurement frequency in question is to be entered, i.e. as a positive dB value if the power and matching are to be measured at the source and the cable is connected between the source and the power sensor, and as a negative dB value if the power and matching are to be measured at the load and the cable is connected between the load and the power sensor. The directional power sensor then corrects the power and matching values to produce the results that would have been obtained if it had been directly connected to the test point.

- ▶ Press the SCALE/AMPT key.
- ▶ Press the "Ref Offset" softkey.

The input field to enter the reference offset opens.

- ▶ Enter the offset you need.

The selected offset is displayed in the diagram header and is taken into account in the power (level) and matching results.

If high powers are applied that exceed the maximum input level of the R&S FSH-Z14 or R&S FSH-Z44, a directional coupler or an attenuator has to be connected ahead of the power sensor. In such cases, the coupling attenuation of the directional coupler or the attenuation value of the attenuator are to be entered as positive dB values (see above) into the R&S ZVH to ensure true measured power readout. In both cases, a termination or an attenuator of sufficient power-handling capacity has to be connected to the power sensor at the load end. The matching readout is irrelevant in such case since it is likewise corrected by taking into account the attenuation value of the termination or attenuator.

9.3 Using the Internal Power Meter (R&S ZVH-K19)

The R&S ZVH also supports power measurements without using a power sensor. In that case, you can connect the DUT directly to the R&S ZVH and still perform accurate channel power measurements.

The screen layout is the same as is described in "[Using a Power Sensor](#)" on page 175.

Performing and configuring channel power measurements

The configuration of channel power measurements without a power sensor is similar to measurements with a power meter.

The following features are available:

- Defining the frequency
- Zeroing the measurement
- Selecting the unit
- Defining the reference level
- Taking additional loss or gain into account

For more information see "[Performing and Configuring Measurements](#)" on page 178.

Defining the channel bandwidth

In addition, you can select the channel bandwidth.

- ▶ Press the MEAS key.
- ▶ Press the "Channel BW" softkey.

The R&S ZVH opens an input field.

- ▶ Enter the required channel bandwidth.

The R&S ZVH performs a measurement on the selected channel. Note that it is not possible to change the measurement time, resolution bandwidth and frequency span.

9.4 Performing Pulse Power Measurements (R&S ZVH-K29)

When you equip the R&S ZVH with firmware option R&S ZVH-K29, and connect one of the wideband power sensors available from Rohde & Schwarz (R&S NRP-Z81, -Z85 or -Z86), you can perform pulse power measurements with your R&S ZVH.

Support of the application for R&S ZVH models



For R&S ZVH with a serial number <115331 (model .04) or serial number <115239 (model .08), it's mandatory to use Y adapter cable R&S FSH-Z129 (order no. 1304.5887.00).

Make sure to connect this cable to the USB port and the AUX port on the left side of the R&S ZVH.

Like the normal power meter application, the pulse power application measures the power of the whole signal in the frequency range of the (wideband) power sensor.

- ▶ Press the MODE key.
- ▶ Press the "Power Meter" softkey.

Connecting the power sensor

You can connect the wideband power sensors to the USB port of the R&S ZVH. For more information see "[Connecting a Power Sensor](#)" on page 177.

The measurement starts as soon as the power sensor is connected.

Numerical result display

- ▶ Press the MEAS key.
- ▶ Press the "Meas Mode" softkey.
- ▶ Select the "Average" menu item.

The layout and contents of the numerical result display are the same as those described in chapter "[Using a Power Sensor](#)" on page 175.

Graphical result display (Power vs Time)

The graphical representation of the results is a special feature only available with the firmware option R&S ZVH-K29.

- ▶ Press the MEAS key.
- ▶ Press the "Meas Mode" softkey.
- ▶ Select the "Power vs Time" menu item.

Performing Pulse Power Measurements (R&S ZVH-K29)



- 1 Connected power sensor model
- 2 Header table showing various hardware settings
- 3 Marker table
- 4 Numerical results showing the pulse characteristics
- 5 Diagram showing the pulse characteristics in a graphical format (trace display)
- 6 Measurement frequency
- 7 Scale of the x-axis
- 8 Softkey menu of the pulse power measurement application

The following power characteristics are calculated and displayed as numerical values (see also the figure below for a graphical representation of the parameters).

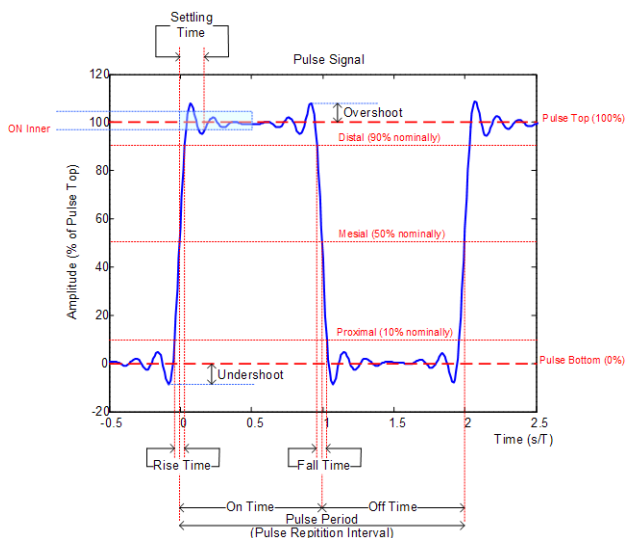

Pulse characteristic	Description
Pulse Width	Time that the pulse remains at the top level ("ON"). This is the time between the first positive edge and the subsequent negative edge of the pulse in seconds, where the edges occur at crossings of the mid threshold.
Pulse Period	Time that is elapsing from the beginning of one pulse to the beginning of the next pulse.
Pulse Off Time	Time in the displayed trace that is not occupied by the pulse.
Rise Time	Time required for the pulse to transition from the base to the top level. This is the difference between the time at which the pulse exceeds the lower and upper thresholds.
Fall Time	Time required for the pulse to transition from the top to the base level. This is the difference between the time at which the pulse drops below the upper and lower thresholds.
Duty Cycle	Ratio of the "Pulse Width" to "Pulse Repetition Interval" expressed as a percentage (requires at least two measured pulses).
Start Time	Time offset, relative to the beginning of the trace (0 sec), where the pulse begins (start of the rise time).
Stop Time	Time offset, relative to the beginning of the trace (0 sec), where the pulse stops (end of the fall time).
Pulse Top	Median pulse ON power. The value of this parameter is used as a reference (100%) to determine other parameter values such as the rising / falling thresholds.
Pulse Base	Median pulse OFF power. The value of this parameter is used as a reference (0%) to determine other parameter values such as the rising / falling thresholds.
Trace Avg	Average power of the signal displayed in the diagram.
Trace Peak	Maximum power of the signal displayed in the diagram.
Trace Min	Minimum power of the signal displayed in the diagram.
Positive Overshoot	Height of the local maximum after a rising edge, divided by the pulse amplitude. The result is a percentage of the pulse amplitude.
Negative Overshoot	Height of the local minimum after a rising edge, divided by the pulse amplitude. The result is a percentage of the pulse amplitude.

9.4.1 Configuring the Numerical Result Display

The functions available for the numerical result display are the same as those available for normal power sensor measurements. For more information see "[Performing and Configuring Measurements](#)" on page 178.

9.4.2 Configuring the Power vs Time Result Display

The R&S ZVH allows you to configure several aspects of the power vs time result display and the way the pulse is measured.

9.4.2.1 Determining Pulse Characteristics

Selecting an algorithm for base and top power calculation

The R&S ZVH provides several methods (or algorithms) to calculate the base and top power of a pulse.

- "Histogram"

Calculates the top and base power of the pulse by analyzing the histogram of the trace data. The level of the pulse top calculated by the mean value of all points representing the pulse top. Similarly the level of the pulse base is calculated by the points representing the pulse base.

This algorithm is recommended for analyzing most of the pulse signals
- "Integration"

Calculates the top power of the pulse by fitting a rectangle pulse of same energy into the pulse signal as a reference.

This algorithm is recommended for modulated pulse signals or when the pulse energy must be taken into account, for example when you want to compare the measurement result with that of a thermal power sensor.
- "Peak"

Assumes that the peak power of the pulse is also the top level of the pulse.

The top and base power are also the reference point for the calculation of pulse timing characteristics.

- ▶ Press the MEAS key.
- ▶ Press the "Algorithm" softkey.
- ▶ Select the algorithm you prefer for your measurement.

The R&S ZVH adjusts the results accordingly.

Defining reference levels for pulse timing calculation

To calculate pulse timing parameters, like the rise and fall time of the pulse, you have to define several reference levels. All reference levels are a percentage of the pulse amplitude, either expressed in terms of power (Watt) or voltage (Volt).

The "Low Reference Power" and "High Reference Power" are required to calculate the fall and rise times of the measured pulse. The "Low Reference Power" defines the level at the start of the rising edge and the level at the end of the falling edge of the pulse. The "High Reference Power" defines the level at end of the rising edge and the level at the start of the falling edge.

The "Reference Power" is required to calculate the pulse width, its start time and its stop time.

- ▶ Press the MEAS key.
- ▶ Press the "Ref Power Config" softkey.
- ▶ Define the reference levels as required.

You can always reset the reference levels to their default value with the "Set to Default" menu item.

All the reference levels can be relative to the power or the voltage of the signal. Depending on this selection, different measurement points are being analyzed, so the results may be different.

- ▶ Press the MEAS key.
- ▶ Press the "Ref Power Config" softkey.
- ▶ Select either the "Power" or the "Voltage" menu item as the reference.

9.4.2.2 Selecting the Video Bandwidth

When you are using a wideband power sensor, you can change the video bandwidth used for the measurement. The main effect of using a small video bandwidth is that it reduces the displayed inherent noise.

Using a small video bandwidth thus increases the measurement sensitivity and allows you to accurately determine the pulse peak power even for weak pulses. Reducing the video bandwidth also increases the trigger sensitivity of the power sensor.

Note however that the video bandwidth should not be smaller than the RF bandwidth of the measured signal. Otherwise, measurement results may become invalid.

9.4.2.3 Averaging Traces

Selecting the trace mode

The Power vs Time result display provides two trace modes.

- The "Clear / Write" mode overwrites the trace data after each measurement.
- The "Average" mode forms an average over several measurement and displays the data according to the selected detector.

When you select this mode, you can define the number of measurements over which the trace data is calculated.

- ▶ Press the TRACE key.
- ▶ Press the "Trace Mode" softkey.
- ▶ Select the trace mode you prefer for the measurement.

Selecting the detector

When you are averaging traces, you can also select a detector. The detector defines the way the measured data is evaluated and which data is displayed.

In the Power vs Time result display, you can select the "Average" detector or the "Max Peak" detector. The "Average" detector displays the averaged measurement data, while the "Max Peak" detector displays the highest values that have been measured on each pixel.

- ▶ Press the TRACE key.
- ▶ Press the "Detector" softkey.
- ▶ Select the detector you prefer.

9.4.2.4 Triggering Measurements

In its default state, the R&S ZVH starts a measurement on completion of the previous measurement ("Free Run" measurements).

However, you can also perform triggered measurements with the power sensor. When you choose to do so, the trigger event (the moment when the actual measurement starts) is either a rising slope in the signal or a falling slope ("Positive" or "Negative" trigger).

- ▶ Press the SWEEP key.
- ▶ Press the "Trigger" softkey.
- ▶ Select either the "Positive" or "Negative" menu item.

The R&S ZVH stops measuring the signal until a trigger event occurs.

In case of triggered measurements, you have to define a trigger level by which the signal must rise or fall in order to be recognized.

- ▶ Press the SWEEP key.
- ▶ Press the "Trigger" softkey.
- ▶ Select the "Trigger Level" menu item and define a trigger level.

In addition, you can define a trigger delay time. The trigger delay time defines a time that must pass after the trigger event has occurred before the measurement starts. A negative trigger delay time is called a pretrigger.

- ▶ Press the SWEEP key.
- ▶ Press the "Trigger" softkey.
- ▶ Select the "Trigger Delay" menu item and define a delay time.

When a trigger event occurs, the R&S ZVH takes the delay time into account when drawing the trace.

9.4.2.5 Selecting the Result Unit

In the pulse measurement application, the R&S ZVH can display measured power in relative units (dBm) or in absolute units (W).

- ▶ Press the AMPT key.
- ▶ Press the "Unit" softkey.
- ▶ Select the unit you prefer.

The R&S ZVH adjusts the y-axis accordingly.

9.4.2.6 Scaling the Y-Axis

The functionality to scale the y-axis is similar to that of the spectrum application.

For more information see "[Setting a Display Range](#)" on page 144.

9.4.2.7 Using Markers

The power vs time diagram supports markers. The functionality is similar to that of the spectrum application.

For more information see "[Using Markers](#)" on page 163 (note that marker functions are not available in the power meter mode).

10 Network Analyzer Mode (R&S ZVH-K42)

The network analyzer mode provides the functionality to characterize networks with one or two ports.

All R&S ZVH models already have a tracking generator and VSWR bridge that are necessary to use the network analyzer.

The network analyzer mode becomes available if you equip the R&S ZVH with firmware option R&S ZVH-K42 (order no 1309.6846.02). This option enables vector measurements to determine the reflection or transmission characteristics in both directions of the device under test (DUT). In addition to the magnitude of the transmitted and reflected power, vector measurements also determine the phase characteristics of the DUT.

Although the accuracy of measurements is high in the default factory calibration, the R&S ZVH also provides all necessary calibration methods to correct the magnitude for these kinds of measurements and make results even more accurate.

- ▶ Press the MODE key.
- ▶ Press the "Network Analyzer" softkey.

The R&S ZVH turns on the tracking generator. Frequency and level settings are inherited from the previous operating mode.

Screen layout of the network analyzer



- 1 Result display
- 2 Measurement mode
- 3 0 dB reference
- 4 Status line
 - S-matrix
 - Calibration status
 - Measurement format
- 5 Trace window
- 6 Network analyzer softkey menu

Defining the output level of the tracking generator

The tracking generator generates a signal at the current R&S ZVH frequency. The nominal output level of the signal is adjustable from 0 dBm to -40 dBm in steps of 1 dB.

- ▶ Press the SCALE/AMPT key.
- ▶ Press the "TG Power" softkey.

The R&S ZVH opens an input field to set the output level.

The output power of the tracking generator is in the range from -40 dBm and 0 dBm.

Tracking generator output level



Using an output level of 0 dBm (or a receiver attenuation of 0 dB) for S12 or S21 measurements can cause an overload at the RF input. It is therefore recommended to use an output level of -10 dBm (default) or lower for these measurements.

This especially applies to measurements on amplifiers.

10.1 Calibrating Measurements

In its default state, the R&S ZVH uses factory calibration. Factory calibration is a full 2-port calibration over the complete frequency range of the R&S ZVH model. When factory calibration is active, the status line reads **[fcal]**. In many cases, this calibration already provides accurate results.

To get the best and most accurate results, however, you have to calibrate the measurement itself manually, because factory calibration does not take the actual test setup into account (e.g. cables). The R&S ZVH provides several calibration methods. You will need one of the available calibration standards R&S FSH-Z28, -Z29 (order no. 1300.7804.03 and 1300.7504.03) or R&S ZV-Z121 (order no. 1164.0496.02/03).

Alternatively, you can create customized calibration kits with the functionality of the R&S InstrumentView software package and transfer those to the R&S ZVH.

Before you calibrate the R&S ZVH for the current measurement, you should set the frequency parameters, reference level and attenuation levels. If you change one of these parameters after a successful calibration, it may become invalid.

To successfully calibrate the test setup, you have to connect the calibration standard at the reference plane, usually the output of the RF measurement cable.

During calibration, the R&S ZVH removes systematic errors from the measurement. This process is based on correction data it gets while performing the calibration.

The correction data for transmission measurements is based on the results of comparing the transmission characteristics of the test setup to the frequency response of the tracking generator. The correction data for reflection measurements is based on the results of a reflection measurement at a short and an open on the bridge.

Calibration remains valid after turning off the R&S ZVH or changing into another operating mode as calibration data is saved in the internal memory of the R&S ZVH. If you save the measurement in a dataset, calibration data is part of that dataset. When you restore the dataset and perform the same measurement again, you do not have to recalibrate the R&S ZVH.

10.1.1.1 Calibration States

The calibration states are the same as in the cable and antenna analyzer. For more information see "[Calibration States](#)" on page 56.

10.1.1.2 Calibration Methods

The R&S ZVH provides several calibration methods for vector measurements.

2-port calibrations or calibrations that require a "Through" connection are unavailable if you are calibrating with the R&S ZN-Z103 calibration unit.

- Full 2-Port
For more information see "[Calibration Methods](#)" on page 58.
- Full 2-Port High Accuracy
For more information see "[Calibration Methods](#)" on page 58.
- Full 1-Port
For more information see "[Calibration Methods](#)" on page 58.
- Normalize Transmission
For more information see "[Calibration Methods](#)" on page 58.
- Normalize Transmission with Isolation
For more information see "[Calibration Methods](#)" on page 58.

Each calibration method is suitable for certain kinds of measurement tasks.

- For high isolation measurements, use the normalization and isolation calibration methods.
- For filter measurements requiring high standards (for example S11 in passband better than -20 dB), use the full 2-port high accuracy calibration.
- For full s-parameter measurements on attenuators or amplifiers, use the full 2-port calibration.

10.1.1.3 Performing Calibration

The procedure is similar for all calibration methods, except that you are going to need different type and number of calibration standards. You can find an example of a full 2-port calibration procedure in the description of the cable and antenna analyzer. For more information see "[Performing a Full 2-Port Calibration](#)" on page 59.

Selecting a calibration kit

To avoid phase errors, you have to define the characteristics of the calibration kit you'd like to use and then select the calibration kit in use. The R&S ZVH then corrects the measurement results accordingly.

You can either use one of the calibration kits specifically designed for use with the R&S ZVH, e.g. the R&S FSH-Z28 and -Z29 calibration kits. Those provide an "Open", "Short" and "Load" calibration standard in one piece. The characteristics of these calibration kits are already part of the R&S ZVH firmware.

You can create and edit calibration kits with the R&S InstrumentView software and transfer them to the R&S ZVH via the USB or the LAN interface. The number of standards the R&S ZVH can store in its memory depends on the number of other data sets stored on the R&S ZVH.

For more information see "[Managing Datasets](#)" on page 34.

- ▶ Press the CAL key.
- ▶ Press the "Cal Kit" softkey.

The R&S ZVH opens a dialog box to select the calibration kit. The list of supported calibration kits covers those supported by the R&S ZVH and those that you have customized.

- ▶ Select the calibration kit you are using.

The R&S ZVH uses the characteristics specified for the calibration kit.

You can also use calibration kits other than the R&S FSH-Z28 or -Z29 in combination with their characteristics. However, make sure that the electrical length of the calibration kit in use is similar to that of the R&S FSH-Z28 or -Z29. The electrical length of the "Open" and "Short" of the R&S ZVH calibration kits is 5.27 mm. If the electrical length is different, it may cause additional phase error.

Some measurement setups may include additional cables or adapters that may have an additional electrical length. To correct their phase error, you can include the electrical length of additional test equipment. The R&S ZVH distinguishes if the equipment is connected to port 1 or port 2.

- ▶ Press the CAL key.
- ▶ Press the "Cal Settings" softkey.
- ▶ Select the "Offset Length Port 1" or "Offset Length Port 2" menu item.

The R&S ZVH opens an input field to define the electrical length of the accessory.

- ▶ Enter the electrical length.

The R&S ZVH now includes the electrical length of the accessory for phase measurements.

10.1.1.4 Performing calibration with the calibration unit R&S ZN-Z103

For measurements in the frequency range from 2 MHz to 4 GHz, you can use the calibration unit R&S ZN-Z103 calibration unit (order no. 1321.1828.02) to calibrate 1-port measurements.

Using this unit is more comfortable, because it combines all standards in one piece – connecting different standards is no longer necessary.

- ▶ Connect the calibration unit to the RF input (port 1) and the USB interface on the R&S ZVH.

When the LED on the calibration unit turns green, it is ready to use. If the LED is illuminated in a different color, try to reconnect the unit.

- ▶ Enter the SETUP menu and turn on "Auto Accessory Detection".

- ▶ Wait a few seconds until the label in the measurement information bar turns green.

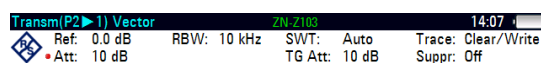

- ▶ Press the MEAS key.
- ▶ Press the "Calibration" softkey.
- ▶ Select the calibration method you want to use.

If the selected calibration method is not possible with R&S ZN-Z103, the R&S ZVH shows an error message (usually the case for calibration methods that require a "Through" connection).

For more information about the calibration unit, refer to its user manual.

10.2 Performing Scalar Measurements

With scalar measurements, you can measure the magnitude of transmission characteristics of a device under test. To calibrate the measurements, only normalization is available.

10.2.1 Measuring the Transmission

The example included here is based on a transmission measurement of a two-port filter. The filter has a center frequency of 2060 MHz and a bandwidth of about 11 MHz.

Test setup

- ▶ Connect the input of the DUT to the tracking generator output (port 2).
- ▶ Connect the output of the DUT to the RF input (port 1).

Preset the R&S ZVH

Before starting the measurement procedure, preset the R&S ZVH to restore the default configuration and connect the filter between the measurement ports.

- ▶ Press the PRESET key.
- ▶ Connect the DUT.

Define the frequency parameters

Before calibrating the measurement, you should define the frequency parameters to avoid inaccurate results because of invalid calibration.

- ▶ Press the FREQ key.
The R&S ZVH opens an input field to set the center frequency.
- ▶ Enter a frequency of 2060 MHz.
- ▶ Press the SPAN key.
The R&S ZVH opens an input field to define the span.
- ▶ Enter a span of 50 MHz to get a high resolution of the results.

Calibrate the measurement for scalar transmission measurements.

Scalar measurements provide normalization only. Normalization is not as accurate as a full calibration, but yields pretty accurate results nonetheless. In addition, normalization needs one calibration standard only and therefore is faster than a full calibration.

- ▶ Press the "Calibration" softkey.
- ▶ Select the "Normalize Transmission Rev (Port 1 ▶ 2)" menu item.
- ▶ Perform normalization. For more information see "[Performing Calibration](#)".
- ▶ Reconnect the DUT.

The R&S ZVH shows the results of the scalar transmission measurement on the filter.

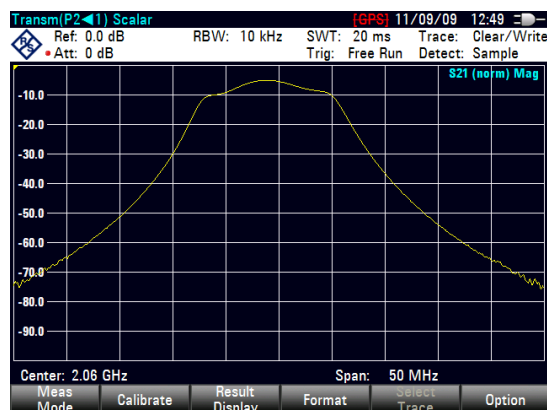

You can change the measurement configuration (e.g. select another sweep time or detector) without affecting the accuracy of the measurement except the frequency parameters and attenuation.

10.2.2 Measuring the Reflection

The example included here is based on a reflection measurement of the same two-port filter used for the transmission measurement. The filter has a center frequency of 2060 MHz and a bandwidth of about 11 MHz.

You can skip the preset, scalar measurement selection and frequency settings if you have already set up the R&S ZVH for the measurement. You can also skip the calibration, if you have performed the appropriate calibration already.

Preset the R&S ZVH

Before starting the measurement procedure, preset the R&S ZVH to restore the default configuration and connect the filter between the measurement ports.

- ▶ Press the PRESET key.
- ▶ Connect the DUT.

Start scalar measurements

- ▶ Press the MEAS key.
- ▶ Press the "Meas Mode" softkey.
- ▶ Select the "Scalar" menu item.

Select the type of reflection measurement

- ▶ Press the "Result Display" softkey.
- ▶ Select the "Reflection Port 1" menu item for reflection measurements on port 1 or the "Reflection Port 2" menu item for reflection measurements on port 2.

Define the frequency parameters

Before calibrating the measurement, you should define the frequency parameters to avoid inaccurate results because of invalid calibration.

- ▶ Press the FREQ key.
The R&S ZVH opens an input field to set the center frequency.
- ▶ Enter a frequency of 2060 MHz.
- ▶ Press the SPAN key.
The R&S ZVH opens an input field to define the span.
- ▶ Enter a span of 50 MHz to get a high resolution of the results.

Calibrate the measurement for scalar transmission measurements.

Scalar measurements provide normalization only. Normalization is not as accurate as a full calibration, but yields pretty accurate results. In addition, normalization needs one calibration standard only and therefore is faster than a full calibration.

- ▶ Press the MEAS key.
- ▶ Press the "Calibration" softkey.
- ▶ Select the appropriate menu item (normalization on one or two ports).
- ▶ Perform normalization. For more information see "[Performing Calibration](#)".
- ▶ Reconnect the DUT.

The R&S ZVH shows the results of the scalar reflection measurement on the filter.

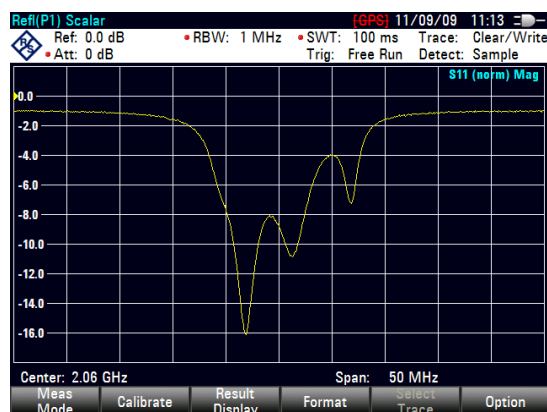

You can change the measurement configuration (e.g. select another sweep time or detector) without affecting the accuracy of the measurement except the frequency parameters and attenuation.

10.3 Performing Vector Measurements

If you equip the R&S ZVH with option R&S ZVH-K42, vector measurements become available.

Unlike scalar measurements, vector measurements also measure the phase characteristics of a DUT. Vector measurements also have a higher dynamic range and accuracy because of the advanced calibration methods that vector measurements provide.

In addition to normalization, vector measurements feature full calibration methods that require a 50 Ω termination in addition to an open or short circuit. Instead of the characteristics of the VSWR bridge, the decisive factor of the quality of results is the quality of the calibration standards.

Because of the higher dynamic range, vector measurements allow more accurate measurements of well matched DUTs at a higher display resolution.

Vector measurements also unlock more measurement formats and therefore provide more information from different perspectives about the DUT.

Supplying DC voltage to active DUTs



If you are performing measurements on active DUTs (e.g. amplifiers), you can supply them with DC voltage by connecting an RF cable to the BIAS ports. The DC voltage is fed in from a suitable external power supply (max. 600 mA/max. 50 V).

To measure the antenna coupling of mobile radio base stations, the DC voltage must be supplied to two tower-mounted amplifiers (TMA). This is done by applying a suitable voltage at the BIAS 1 and BIAS 2 BNC ports.

10.3.1 Measuring the Transmission

The example included here is based on a transmission measurement of a two-port filter. The filter works in the frequency from of 1920 MHz to 1980 MHz.

Test setup

- ▶ Connect the input of the DUT to the tracking generator output (port 2).
- ▶ Connect the output of the DUT to the RF input (port 1).

Preset the R&S ZVH

Before starting the measurement procedure, preset the R&S ZVH to restore the default configuration and connect the filter between the measurement ports.

- ▶ Press the PRESET key.
- ▶ Connect the DUT.

Select the type of transmission measurement

- ▶ Press the MEAS key.
- ▶ Press the "Transmission S21" or "Transmission S12" softkey for transmission measurements in forward or reverse direction.

Simultaneous display of several results

You can also display two results simultaneously in a single diagram. In that case, the R&S ZVH shows two traces with a different color in the result display.

- ▶ Press the MEAS key.
- ▶ Press the "Other Meas" softkey.
- ▶ Select one of the result combinations to be displayed in a single diagram.
 - Reflection S11 + S22
 - Transmission S21 + S12
 - Transmission / Reflection S21 + S11
 - Transmission / Reflection S12 + S22

The information, which trace carries which result, is indicated by a label in the diagram area.

S21 S12 (cal HA) Mag

Note that the simultaneous display of more than one result in a single diagram is only possible with a high accuracy calibration.

In addition, you can display two diagrams, so that you can view all four results at the same time (S11, S12, S21, S22).

- ▶ Press the TRACE key.
- ▶ Press the "Split Screen" softkey.
- ▶ Press the "Select Trace" softkey to select the diagram.
- ▶ Trace 1 corresponds to the upper diagram (contains trace 1 and trace 3).
- ▶ Trace 2 corresponds to the lower diagram (contains trace 2 and trace 4).

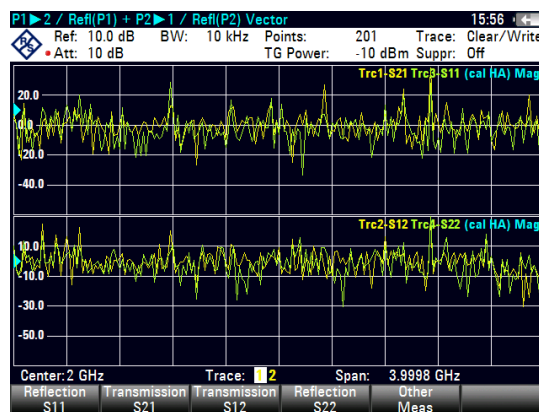

- ▶ Select the contents from the "Measurement" menu as required.

When you are measuring with two diagrams, you can configure the scale of the y-axis for each diagram separately, depending on the trace you have currently selected. You can also select a different measurement format for each diagram (phase, magnitude etc.). Markers on the other hand are coupled. When you move them, they change the position in both diagrams. See also "[Working with the Dual Trace Mode](#)".

Define the frequency parameters

Before calibrating the measurement, you should define the frequency parameters to avoid interpolation of the results.

- ▶ Press the FREQ/DIST key.
 - The R&S ZVH opens an input field to set the center frequency.
- ▶ Enter a frequency of 1950 MHz.
- ▶ Press the FREQ/DIST key.
- ▶ Press the "Span" softkey.
 - The R&S ZVH opens an input field to define the span.
- ▶ Enter a span of 130 MHz to get a high resolution of the results.

Calibrate the measurement for vector transmission measurements.

Vector measurements provide the full range of calibration methods for more accurate results. Most full calibration methods require more than one calibration standard.

- ▶ Press the CAL key.
- ▶ Select the appropriate calibration.
- ▶ Perform calibration. For more information see "[Performing Calibration](#)".
- ▶ Reconnect the DUT.

The R&S ZVH shows the results of the vector transmission measurement on the filter.

The R&S ZVH shows the results of the vector transmission measurement and therefore the filter characteristics.

You can change the measurement configuration (e.g. the sweep time or detector) or format (e.g. view phase characteristics) without affecting the accuracy of the measurement.

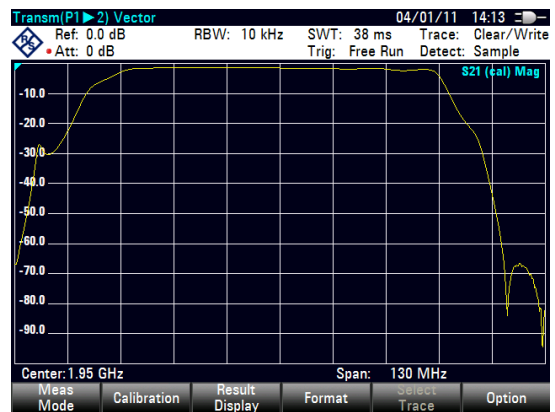

For more information see "[Selecting the Measurement Format](#)" on page 210.

Note that for calibration to remain valid, frequency parameters, bandwidth and attenuation have to remain the same.

Depending on the calibration method, you can also select other result displays (e.g. reflection measurements) without having to recalibrate the R&S ZVH.

10.3.2 Measuring the Reflection

The example included here is based on a reflection measurement of the two-port filter that was also used for the transmission measurement.

You can skip the preset, vector measurement selection and frequency settings if you have already set up the R&S ZVH for the measurement. You can also skip the calibration, if you have performed the appropriate calibration already.

Preset the R&S ZVH

Before starting the measurement procedure, preset the R&S ZVH to restore the default configuration and connect the filter between the measurement ports.

- ▶ Press the PRESET key.
- ▶ Connect the DUT.

Select the type of reflection measurement

- ▶ Press the MEAS key.
- ▶ Press the "Reflection S11" or "Reflection S22" softkey for reflection measurements on port 1 or reflection measurements on port 2.

Simultaneous display of several results

You can also display two results simultaneously in a single diagram. In that case, the R&S ZVH shows two traces with a different color in the result display.

See "[Measuring the Transmission](#)" for more information.

Define the frequency parameters

Before calibrating the measurement, you should define the frequency parameters to avoid interpolation of the results.

- ▶ Press the FREQ/DIST key.
The R&S ZVH opens an input field to set the center frequency.
- ▶ Enter a frequency of 1950 MHz.
- ▶ Press the FREQ/DIST key.
- ▶ Press the "Span" softkey.
The R&S ZVH opens an input field to define the span.
- ▶ Enter a span of 130 MHz to get a high resolution of the results.

Calibrate the measurement for vector reflection measurements.

Vector measurements provide the full range of calibration methods for more accurate results. Most full calibration methods require more than one calibration standard.

- ▶ Press the CAL key.
- ▶ Select the appropriate calibration (calibration on one or two ports).
- ▶ Perform calibration. For more information see "[Performing Calibration](#)".
- ▶ Reconnect the DUT.

The R&S ZVH shows the results of the vector reflection measurement on the filter.

You can change the measurement configuration (e.g. the sweep time or detector) or format (e.g. view phase characteristics) without affecting the accuracy of the measurement. For more information see "[Selecting the Measurement Format](#)" on page 210.

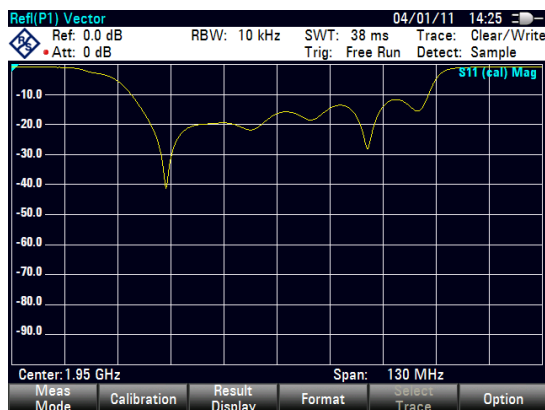

Depending on the calibration method, you can also select another result display.

10.4 Evaluating the Results

10.4.1 Selecting the Measurement Format

Depending on the measurement mode (scalar or vector) and result display (reflection or transmission), you can select one of several measurement formats. Each of the measurement formats shows a different aspect of the measurement results.

Note that some of the measurement formats become available only after you have calibrated the measurement.

- ▶ Press the FORMAT/SPAN key.
- ▶ Select the measurement format from the menu.

The R&S ZVH displays the results in the new measurement format and adjusts the trace and the scale of the vertical axis accordingly. The current measurement format is part of the status line information (**\$11 (cal) Phase**)

Magnitude / dB Mag

Shows the magnitude of the transmission or reflection in dB. The diagram is a Cartesian diagram with a logarithmic vertical axis. The horizontal axis represents the measured frequency range.

The magnitude format is the default format for all measurements.

Available for all measurements.

Phase

Shows the phase characteristics of the DUT in degrees. The diagram is a Cartesian diagram with a linear vertical axis. The horizontal axis represents the measured frequency range.

In the default state, the R&S ZVH shows the phase only from -200° to $+200^{\circ}$. In that case, the R&S ZVH displays measurement results correctly only if the phase difference between two adjacent test points is less than 180° .

You can unwrap the phase to expand the range of the phase.

- ▶ Press the FORMAT/SPAN key.
- ▶ Press the "Format Settings" softkey.
- ▶ Select the "Phase Wrap" or "Phase Unwrap" menu item.

Available for all vector measurements.



Simultaneous display of magnitude and phase characteristics

Selecting the "Magnitude + Phase" format results in a split screen that shows the magnitude characteristics in the upper screen and the phase in the lower screen.

VSWR

Shows the (voltage) standing wave ratio of the DUT.

The VSWR is the ratio of the maximum to the minimum voltage that occur in an electrical transmission line. It is a measure of the reflected power at the input of the DUT. The results are displayed in a Cartesian diagram with a logarithmic vertical axis.

Available for vector reflection measurements.

Reflection coefficient

Shows the reflection coefficient of the DUT.

The reflection coefficient is the ratio of the amplitude of a reflected wave and that of the incidental wave that occur in an electrical transmission line.

You can set the unit for the reflection coefficient.

- ▶ Press the FORMAT/SPAN key.
- ▶ Press the "Format Settings" softkey.
- ▶ Select the "rho" or "mrho" menu item.

Available for vector reflection measurements.

Smith chart

Shows the measurement results in the Smith chart.

The Smith chart is a circular diagram that primarily shows impedance or reflection characteristics of a DUT.

Available for vector reflection measurements.

For more information see "[Working with the Smith Chart](#)" on page 212

Group delay

Shows the group delay characteristics of the DUT.

The group delay is a measure that describes the time period or delay of the signal as it goes through the DUT.

Available for vector measurements.

Electrical length

Shows the electrical length of a DUT.

The electrical length is a numerical result that displayed in addition to another measurement format. As long as it is active, the electrical length is displayed regardless of the currently selected format.

The electrical length is calculated from the phase delay.

$$\tau_{\Phi} = \frac{\Delta\Phi}{2\pi\Delta f}$$

with $\Delta\Phi$ being the phase deviation over the entire frequency range. The electrical length is then derived by

$$l_{\Phi} = \tau_{\Phi} c_0$$

with c_0 being the velocity of light.

By definition, the electrical length is calculated from the vacuum velocity of light and the differential group delay (τ_g). Here, the group delay is replaced by the phase delay for two reasons:

- An electrical length needs to be specified only for non-dispersive DUTs in which phase delay and group delay match.
- Due to the significantly wider aperture, the measurement certainty is an order of magnitude higher in the phase delay measurement than in the group delay measurement.

The result for the electrical length is correct only if the phase difference between two adjacent test points does not exceed 180°.

Available for vector measurements.

Delay time

Shows the delay time of a cable.

The delay time is a numerical result that is displayed in addition to another measurement format.

The delay time is the propagation time of the wave or the time it takes the wave to reach its destination..

Available for the vector phase measurements.

10.4.1.1 Working with the Smith Chart

If you are displaying measurement results in a Smith chart (available for vector reflection measurements), the R&S ZVH provides several special functionality.

- ▶ Press the FORMAT/SPAN key.
- ▶ Press the "Smith Chart" softkey.

The R&S ZVH shows the reflection of the DUT in the Smith chart.

Zooming the Smith chart

To take a better look at the results, you can zoom and enlarge a particular part of the Smith chart.

The R&S ZVH provides a 2x, 4x and 8x zoom.

- ▶ Press the SCALE/AMPT key.
- ▶ Press the "Zoom" softkey.

The R&S ZVH opens a submenu to control the zoom function. It also draws a rectangle on the display that corresponds to the parts of the display about to be zoomed in.

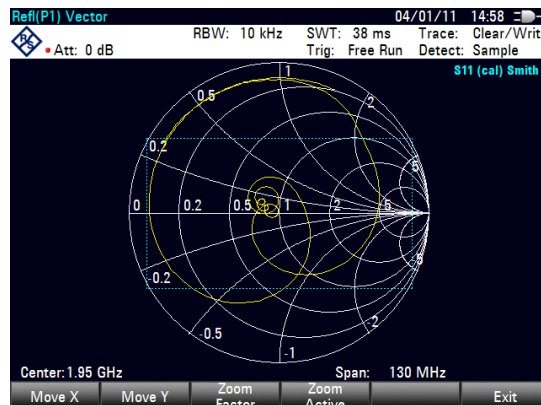

The size of the rectangle depends on the zoom factor.

- ▶ Press the "Zoom Factor" softkey.
- ▶ Select the menu item with the zoom factor you want.

The R&S ZVH adjusts the size of the rectangle.

By default, the position of the rectangle is the area in the center of the display. You can also change the position of the rectangle.

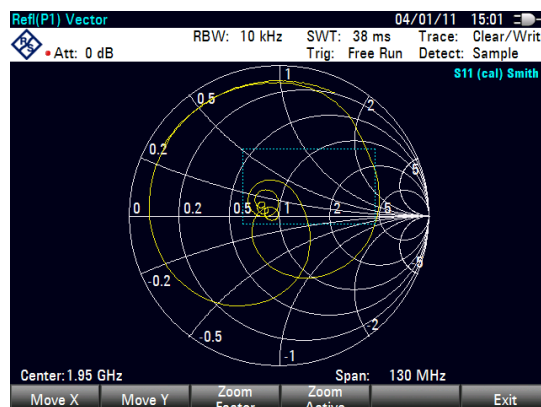

The magnitude of the shift is a percentage and ranges from -50 % to +50 % for both vertical and horizontal directions. The zero point (0 %) in vertical and horizontal direction is the center of the Smith diagram.

- ▶ Press the "Move X" softkey.
The R&S ZVH opens an input field.
- ▶ Enter a value between -50 % and 50 % to shift the window horizontally.
Entering negative values moves the rectangle to the left, positive values move it to the right.
- ▶ Press the "Move Y" softkey.
The R&S ZVH opens an input field.
- ▶ Enter a value between -50 % and 50 % to shift the window vertically.
Entering negative values moves the rectangle up, positive values move it down.

- ▶ Press the "Zoom Active" softkey.

The R&S ZVH now zooms in on the area covered by the zoom window. You can position the zoom window more accurately with the "Move X" and "Move Y" softkeys as described.

- ▶ To deactivate the zoom functionality, press the "Zoom Active" softkey again.

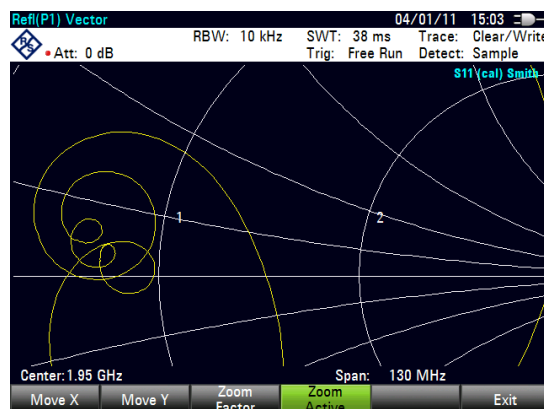

Using markers

In addition to the standard marker functionality, the Smith chart also features several marker output formats.

- dB Magnitude + Phase
Shows the magnitude (in dB) and the phase at the current marker position.
- Lin Magnitude + Phase (Rho)
Shows the converted magnitude (in %) and the phase (in rho) at the current marker position.
- Real + Imag (Rho)
Shows the real and imaginary components at the current marker position.
- R + jX
Shows the real and imaginary components of the impedance at the marker position. The imaginary component is converted to inductance or capacitance. Marker frequency and sign are taken into account.
- G + jB
Shows the real and imaginary components of the admittance at the marker position. The imaginary component is converted to inductance or capacitance. Marker frequency and sign are taken into account.
- $(R + jX/Z_0)$
Shows the real and imaginary components of the standardized impedance.
- $(G + jB/Z_0)$
Shows the real and imaginary components of the standardized admittance.
- ▶ Press the MARKER key.
The R&S ZVH activates a marker and opens the marker softkey menu. Like usual traces, you can move the marker around with the rotary knob or the cursor keys, or enter a specific marker position.

In its default state, the marker position is specified by the marker frequency and complex resistance in Ω . The complex resistance in that case is calculated according to: *(real component) + j (imaginary component)*

- ▶ Press the "Marker Mode" softkey.
- ▶ Select one of the marker formats.

The R&S ZVH adjusts the marker information accordingly.

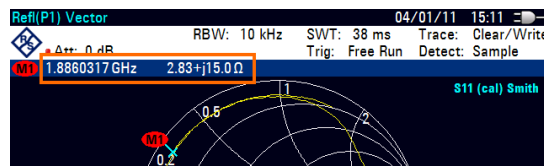

Selecting the reference impedance

The default reference impedance (the matching point in the center of the Smith chart) is 50 Ω . It is, however, also possible to perform reflection measurements on networks with another impedance.

- ▶ Press the MARKER key.
- ▶ Press the "Marker Mode" softkey.
- ▶ Select the "Ref Impedance: ..." menu item.

The R&S ZVH opens an input field to select the reference impedance.

- ▶ Enter the reference impedance you need.

The value range is from 1 m Ω to 10 k Ω .

10.4.1.2 Working with the Dual Trace Mode

When performing measurements, it is possible to perform and display two measurements simultaneously. After activating this function, the R&S ZVH shows the two traces in two separate diagrams. This allows you to view any combination of two results and measurement formats on the display.

Note that the "Magnitude + Phase" measurement format is an exception to this rule. This format counts as one trace. To display the magnitude and phase as two separate traces, assign the phase format to trace 1 and the magnitude format to trace 2.

- ▶ Press the TRACE key.
- ▶ Press the "Split Screen" softkey.

The R&S ZVH splits the screen. The upper screen shows trace 1, the bottom screen shows trace 2. You can configure some aspects of the diagram independently, like y-axis scale or displayed measurement format.

For vector measurements, you can also display two traces in each diagram. This way, you can view four results at the same time (S11, S12, S21, S22). For more information on how to configure such a screen layout, see "[Measuring the Transmission](#)".

Screen layout in dual trace mode



- 1 Result display trace 1
- 2 Result display trace 2
- 3 Measurement mode
- 4 Trace window 1
- 5 Trace information trace 1
 - S-matrix
 - calibration status
 - measurement format
- 6 Trace window 2
- 7 Measurement format trace 2
- 8 Active trace indicator

After activating the second trace, trace 1 is always the active trace. Only the active trace can be configured, while the other is passive.

- To activate trace 2, press the "Select Trace" softkey in the trace menu.

When pressing the "Select Trace" softkey, the R&S ZVH switches between trace 1 and 2. The trace indicator shows the currently active trace:

Trace: 1 2 |

After selecting trace 2, you can set the measurement parameters for trace 2, while the first trace is passive.

Note that you can display all four S-parameters at the same time in dual trace mode by displaying the transmission measurement in both directions in one window and displaying the reflection measurement on both ports in the other window.

For more information see "[Performing Vector Measurements](#)" on page 204.

Restoring a saved trace is possible only for the currently active trace (i.e. screen 1 or screen 2). For more information see "[Working with Memory Traces](#)" on page 162.

10.4.2 Configuring the Vertical Axis

Some results may not fit in the diagram area as it is configured in the default state of the R&S ZVH (for example measurements on amplifiers).

If you are performing measurements on an amplifier, you most likely have to change the scaling of the vertical axis in order to see the complete transmission function.

The R&S ZVH provides several ways to adjust the scaling of the vertical axis.

Changing the reference value

Changing the reference value works like an attenuation or gain in that it moves the trace to another level. The R&S ZVH adjusts the scale of the vertical axis accordingly. The R&S ZVH indicates the value and position of the current reference value with a triangle at the vertical axis (0.0). In the default state, it is 0 dB and its position is the grid line at the top of the diagram.

The reference value only changes the 0 dB reference without actually attenuating or amplifying the signal level.

When changing the reference value, make sure that you do not overload the R&S ZVH. As long as the trace is completely within the diagram area and the reference position at the top of the diagram, the risk of an overload is eliminated.

- ▶ Press the SCALE/AMPT key.
- ▶ Press the "Ref" softkey.

The R&S ZVH opens an input field.

- ▶ Enter the reference value you need to see the trace completely.

The R&S ZVH moves the trace accordingly, relabels the vertical axis and shows the new 0 dB reference in the hardware settings display.

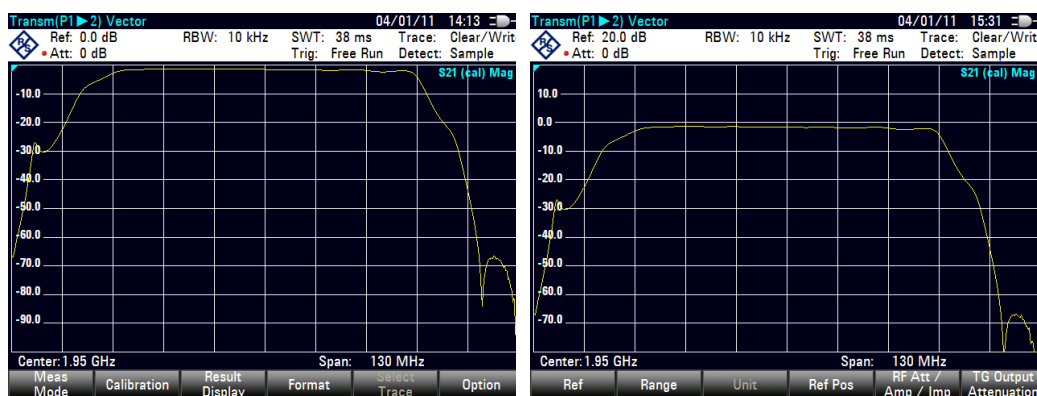

Changing the reference position

Changing the reference position moves the position of the reference value up or down. The reference position also moves the trace up or down. The levels and the reference value, however, remain the same. The default reference position is the grid line at the top of the diagram. The reference position is indicated by a triangle at the vertical axis (0.0).

The reference position is a number between 0 and 10 with 0 being the grid line at the bottom and 10 being the grid line at the top of the diagram.

- ▶ Press the SCALE/AMPT key.
- ▶ Press the "Range/Ref Pos" softkey.
- ▶ Select the "Ref Position:" menu item.

The R&S ZVH opens an input field.

- ▶ Enter the new position of the reference value.

The R&S ZVH moves the trace accordingly and moves the triangle to the new position.

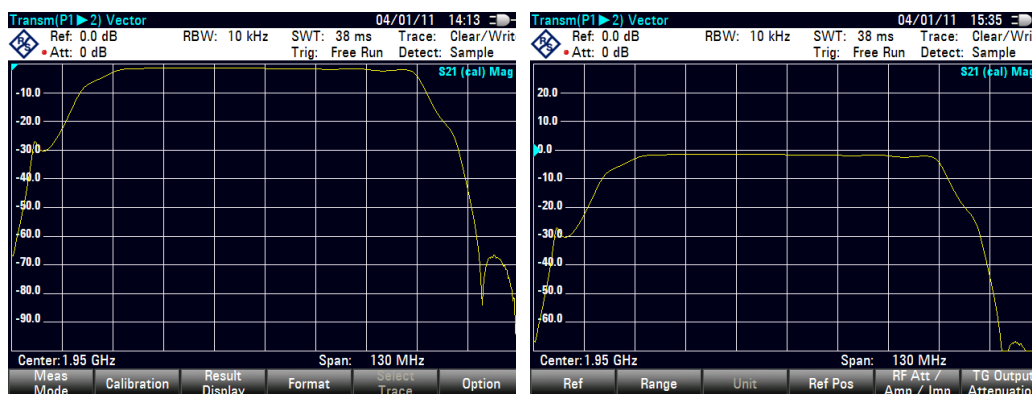

Changing the display range

The display range is the value range the vertical axis covers. The default display range depends on the measurement format. For more information see "[Selecting the Measurement Format](#)" on page 210.

When you change the display range, the reference value and position remain the same. Merely the scale of the vertical axis is compressed or expanded.

- ▶ Press the SCALE/AMPT key.
- ▶ Press the "Range/Ref Pos" softkey.
- ▶ Select the display range you need from the submenu.

The R&S ZVH adjusts the vertical axis accordingly.

Automatic scaling of the vertical axis



All measurement formats except the Smith chart feature an automatic scale function.

If you use automatic scaling, the R&S ZVH automatically sets the display range in a way that the trace best fits on the display.

- ▶ Press the "Auto Scale" softkey.

For the SWR measurement format, instead of selecting one of the predefined ranges, you can also define the exact top and bottom values of the vertical axis.

- ▶ Press the SCALE/AMPT key.
- ▶ Press the Range/Ref Pos softkey.
- ▶ Select the "Scale Max" or "Scale Min" menu items to define the top or bottom values of the vertical axis.

The R&S ZVH adjusts the vertical axis accordingly.

10.4.3 Using Markers

The network analyzer mode also features markers. The functionality is similar to that of the spectrum analyzer.

For more information see "[Markers](#)" on page 229.

10.4.4 Working with Channel Tables

The R&S ZVH allows you to use channel tables in network analyzer mode.

- ▶ Press the FREQ/DIST key.
- ▶ Press the "Signal Standard" softkey.
- ▶ Select the signal path you need from the menu.

The R&S ZVH opens the list of channel tables loaded into the R&S ZVH via R&S InstrumentView.

- ▶ Select the channel table you need.

The R&S ZVH scans the channel table for the channels with the lowest and highest frequencies and sets those as the start and stop frequency.

The R&S ZVH already comes with an assortment of channel tables that you can use without doing anything. If you want to test telecommunications standards that are not listed, you can also build channel tables manually with the "Channel Table Editor" of the R&S InstrumentView software package that is delivered with the R&S ZVH. To use one of those, you just have to copy the channel table to the R&S ZVH.

10.4.5 Using Limit Lines

When working with the magnitude format in the network analyzer, you can use limit lines to set limits for level characteristics on the display that must not be exceeded.

You can create and edit limit lines with the R&S InstrumentView software and load them into the R&S ZVH via the USB or the LAN interface. The number of limit lines the R&S ZVH can store in its memory depends on the number of other data sets on the R&S ZVH.

For more information see "[Managing Datasets](#)" on page 34 und "[Using Limit Lines](#)" on page 168.

10.4.6 Using Trace Mathematics

Trace mathematics that subtract one trace from another are available for most measurement formats in the network analyzer mode.

For more information see "[Using Trace Mathematics](#)" on page 162.

10.5 Vector Voltmeter (R&S ZVH-K45)

With firmware option R&S ZVH-K45 (order no. 1304.5658.02) you can use a R&S ZVH with tracking generator and VSWR bridge as a vector voltmeter.

A vector voltmeter performs reflection (S11) and transmission measurements (S21). The tracking generator provides the signal source that generates an unmodulated sinewave signal on a single frequency. Typical applications for a vector voltmeter are:

- adjustment of the electrical length of cables with a reflection measurement
- testing of the antenna elements of a phase-controlled antenna-array relative to a reference antenna with a transmission measurement

- ▶ Press the MODE key.
- ▶ Press the "Vector Voltmeter" softkey.

The R&S ZVH starts the vector voltmeter mode. It turns on the tracking generator and the zero span mode.

Screen layout of the vector voltmeter.



- 1 Result display
- 2 Hardware settings
- 3 Results: magnitude
- 4 Results: phase
- 5 Vector voltmeter softkey menu

10.5.1 Calibrating Measurements

To get the best and most accurate results, you have to calibrate the measurement. The reflection and transmission measurement of the vector voltmeter each have their own calibration procedures. To successfully calibrate the test setup, you have to connect one or more calibration standards at the reference plane.

The process of calibration including the selection of a calibration kit works like that for scalar or vector measurement. For more information see "[Calibrating Measurements](#)" on page 196.

10.5.2 Performing Measurements

With the vector voltmeter you can measure the reflection on port 1 and the transmission in reverse direction.

The example included here is based on a transmission measurement of a two-port filter. The filter works in the frequency from of 1920 MHz to 1980 MHz.

Select the type of reflection measurement

- ▶ Press the MEAS key.
- ▶ Press the "Reflection S11" softkey for reflection measurements on port 1 or the "Transmission S21" softkey for transmission measurements in reverse direction.

Define the frequency parameters

Before calibrating the measurement, you should define the frequency parameters to avoid interpolation of the results.

- ▶ Press the FREQ/DIST key.
The R&S ZVH opens an input field to set the center frequency.
- ▶ Enter a frequency of 1950 MHz.

10.5.2.1 Performing Transmission Measurements

Calibrate the measurement for transmission measurements.

- ▶ Press the CAL key.
- ▶ Press the "Full 2-Port" softkey.
- ▶ Perform calibration. For more information see "[Performing Calibration](#)".
- ▶ Reconnect the DUT.

The R&S ZVH shows the characteristics of the DUT (magnitude and phase) as numerical values.

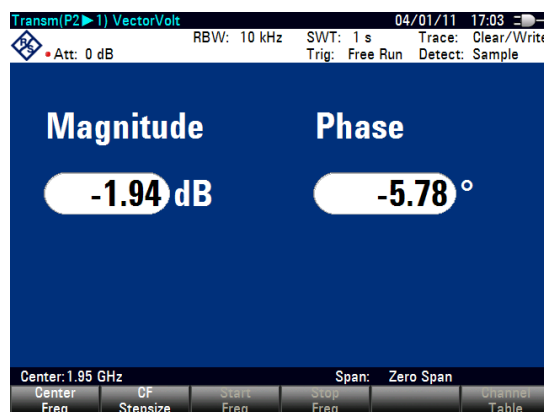

10.5.2.2 Performing Reflection Measurements

Calibrate the measurement for reflection measurements.

- ▶ Press the CAL key.
- ▶ Press the "Full 1-Port" softkey (for calibration on port 1).
- ▶ Perform calibration. For more information see "[Performing Calibration](#)".
- ▶ Reconnect the DUT.

The R&S ZVH shows the characteristics of the DUT (magnitude and phase) as numerical values.

Note that for calibration to remain valid, frequency parameters, bandwidth and attenuation have to remain the same.

10.5.3 Evaluating the Results

10.5.3.1 Selecting the Measurement Format

You can select one of several measurement formats. Each of the measurement formats shows a different aspect of the measurement results.

Vector Voltmeter

In addition to the measurement formats also available for scalar and vector measurement, the vector voltmeter provides the vector voltmeter format. This shows the results as numerical values and is the default format.

VSWR

Shows the (voltage) standing wave ratio of the DUT.

The VSWR is the ratio of the maximum to the minimum voltage that occur in an electrical transmission line. It is a measure of the reflected power at the input of the DUT. The results are displayed in a Cartesian diagram with a logarithmic vertical axis.

10.5.3.2 Comparing Results

If you perform measurements on different DUTs whose results you'd like to compare, you can save the current results as reference values.

- ▶ Press the MEAS key.
- ▶ Press the "▶Ref" softkey.

The R&S ZVH saves the results that it got prior to pressing the softkey as the reference result for future measurements.

The results show the difference of the current measurement and the reference measurement. The unit for reference measurements is always dB.

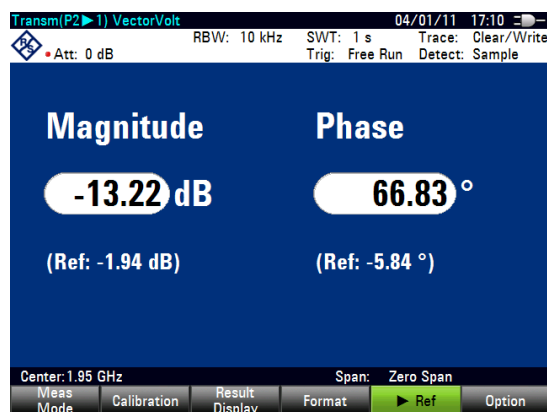

The reference measurement results are always displayed below the current measurement results for better orientation.

Note that reference measurements are only available for the "Vector Voltmeter" measurement format.

11 Menu and Softkey Overview

This chapter shows an overview of all instrument functions in the form of softkey and menu overviews.

11.1 General Functions

General functions are those that are available for all operating modes.

11.1.1 General R&S ZVH Setup

The SETUP key opens the setup menu that contains functionality to set up the R&S ZVH in general and functionality to set up the measurement.

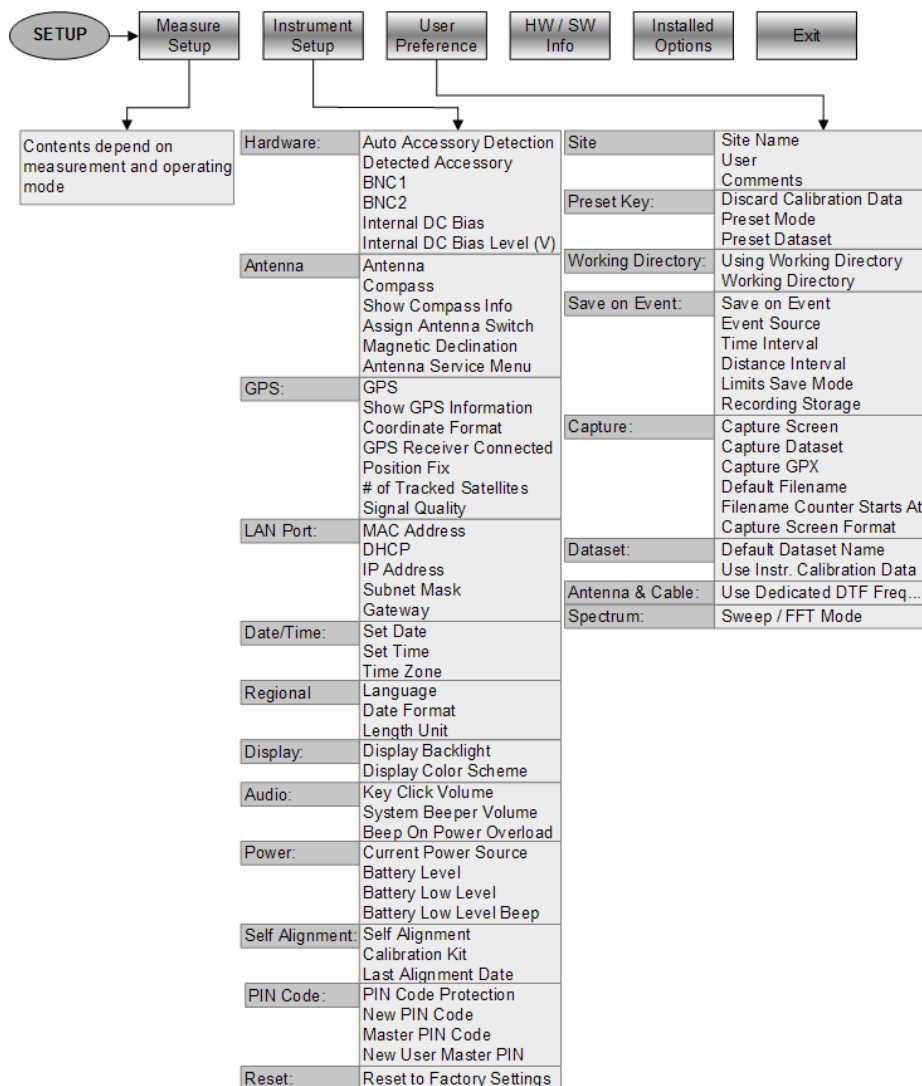

11.1.2 File Management

The SAVE/RECALL key opens the file manager that contains functionality to manage datasets and other files.

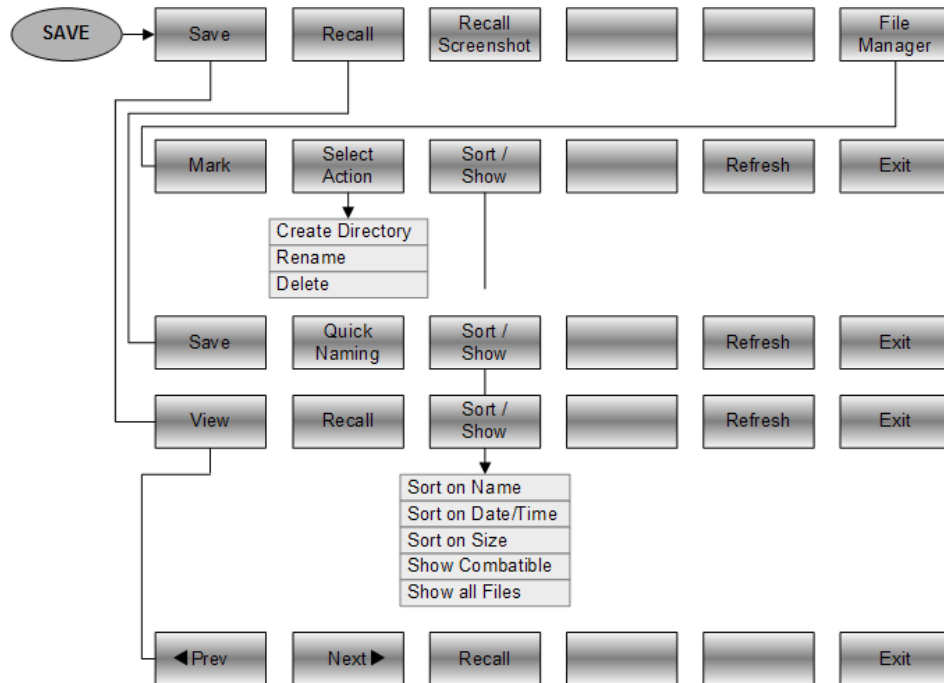

11.1.3 Operating Mode Selection

The MODE key opens the mode menu that contains functionality to select the operating mode of the R&S ZVH.



11.2 Functions of the Cable and Antenna Analyzer

This sections contains all softkeys and menus that are available in cable and antenna test operating mode.

11.2.1 Frequency and Distance Parameters

The **FREQ/DIST** key opens the frequency menu that contains functionality to set up the horizontal axis of the measurement diagram.

The contents of the frequency menu depend on the measurement you have currently selected.

This is what the frequency menu looks like for distance-to-fault measurements.

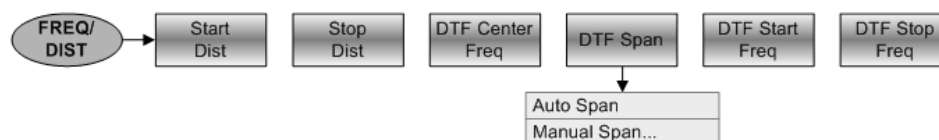

This is what the frequency menu looks like for reflection, transmission and cable loss measurements.

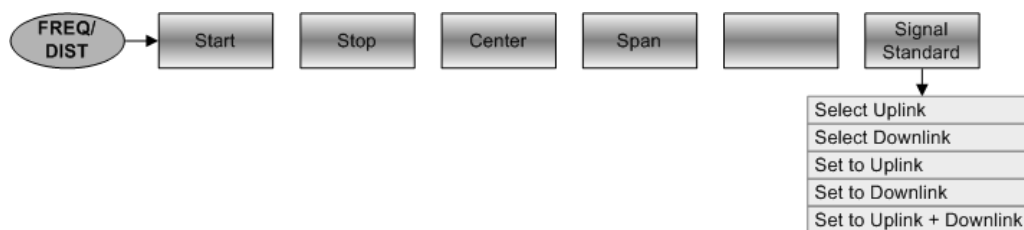

11.2.2 Amplitude Parameters

The **SCALE/AMPT** key opens the amplitude menu that contains functionality to set up the vertical axis of the measurement diagram.

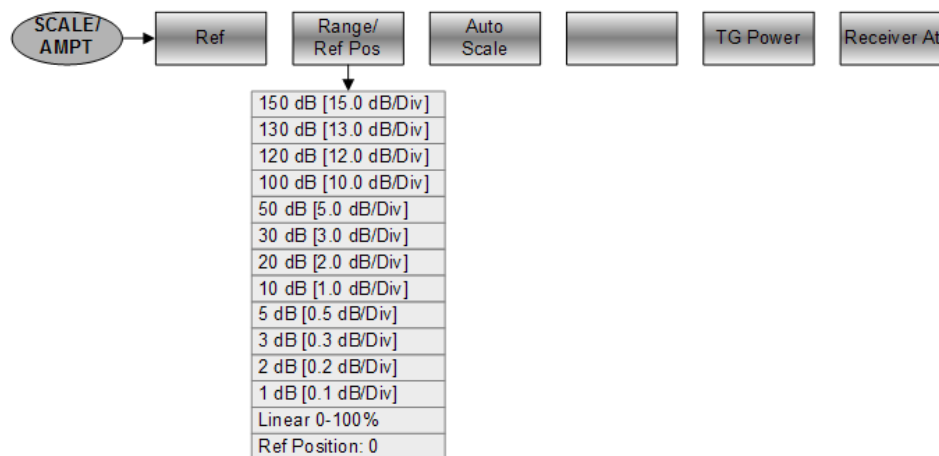

11.2.3 Sweep Configuration

The SWEEP/BW key opens the sweep menu that contains functionality to set up and trigger the sweep.

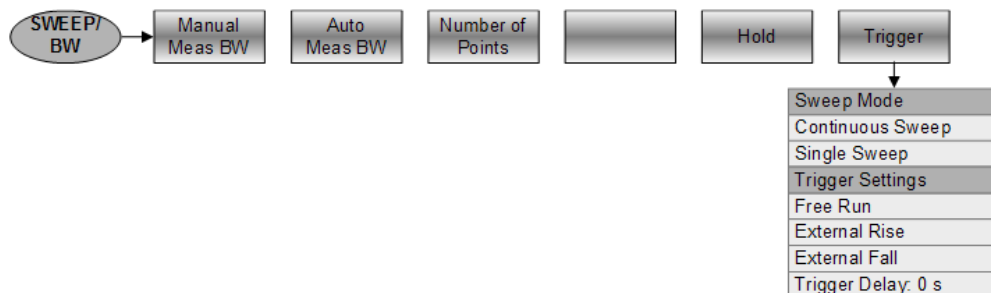

11.2.4 Markers

The MARKER and MKR → keys open the marker menu and marker to menu that contain functionality to use markers.

This is what the marker menu looks like.

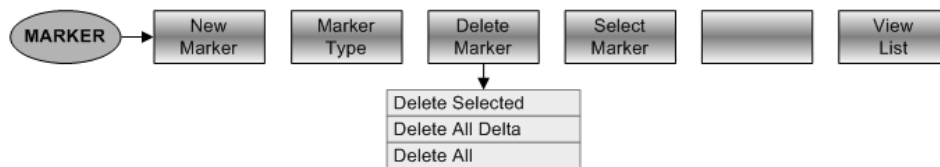

This is what the marker to menu looks like.

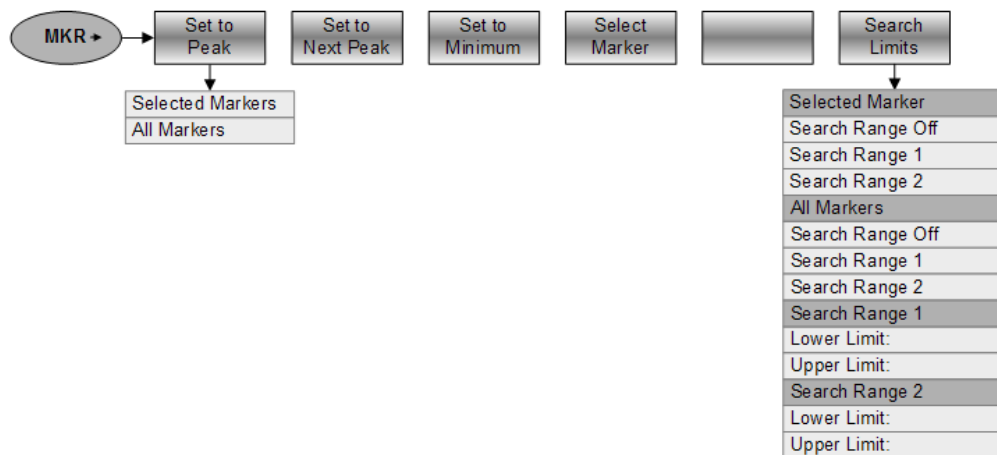

11.2.5 Measurement Selection and Configuration

The MEAS key opens the measurement menu that contains functionality to select and configure the measurement.

Transmission S21 is available only if you have installed option R&S ZVH-K39.

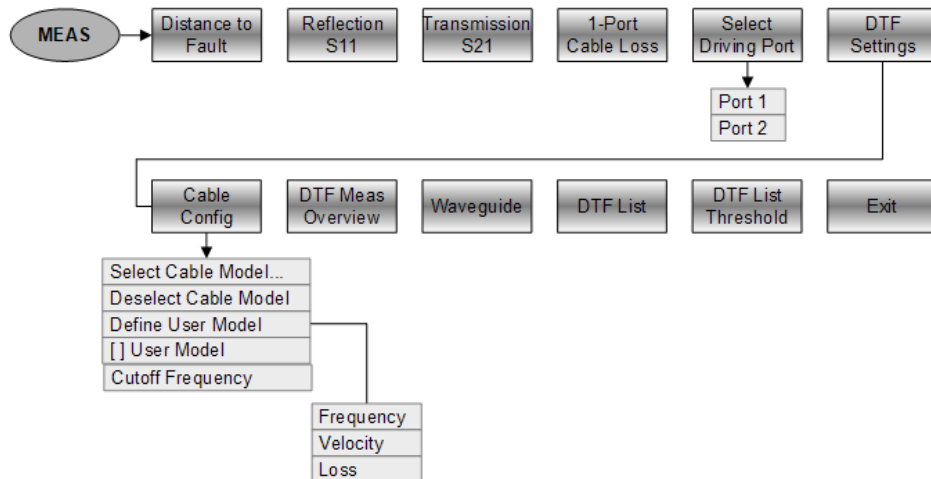

11.2.6 Measurement Format Selection

The FORMAT/SPAN key opens the span menu that contains functionality to select the measurement format.

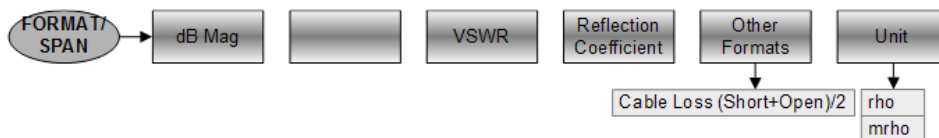

11.2.7 Measurement Calibration

The CAL key opens the calibration menu that contains functionality to calibrate the R&S ZVH.

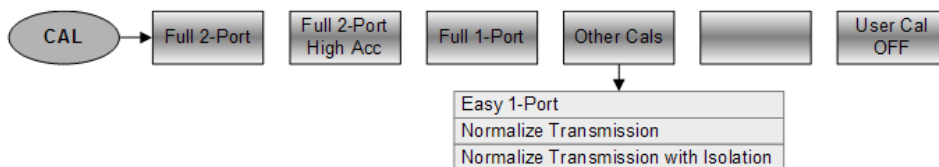

11.3 Functions of the Spectrum Analyzer (R&S ZVH-K1)

This section contains all softkeys and menus that are available in spectrum analyzer mode.

11.3.1 Measurement Selection

The MEAS key opens the measurement menu that contains functionality to select and configure the measurement.

The spectrogram is available only if you have installed option R&S ZVH-K14.

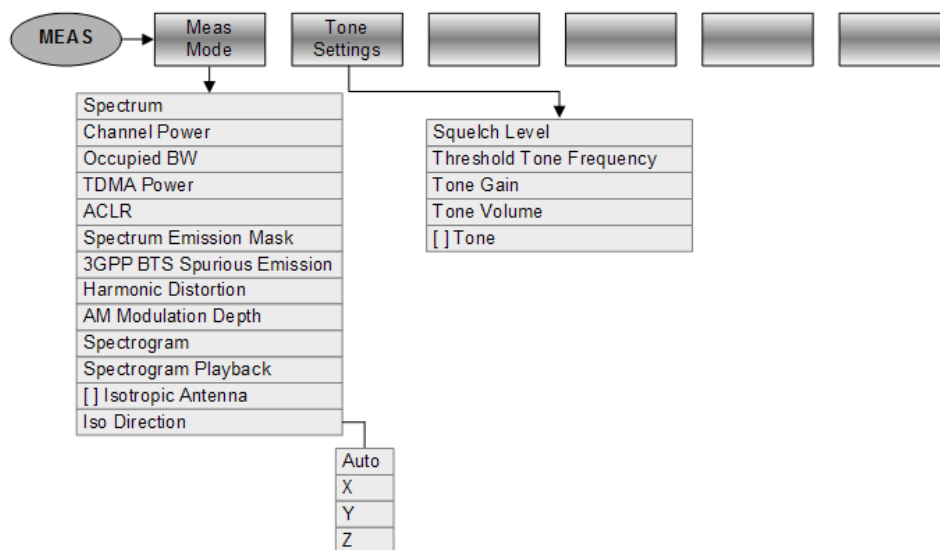

Channel Power

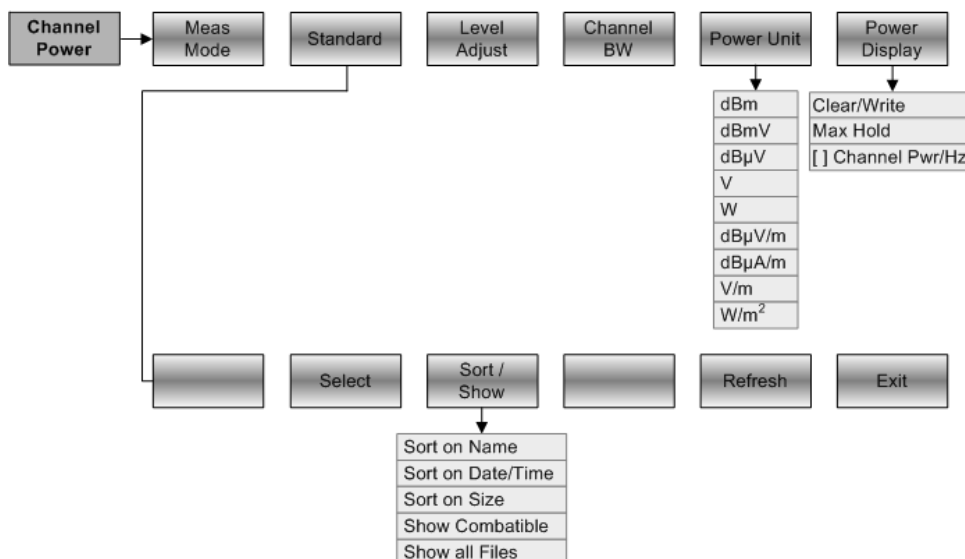

Occupied Bandwidth

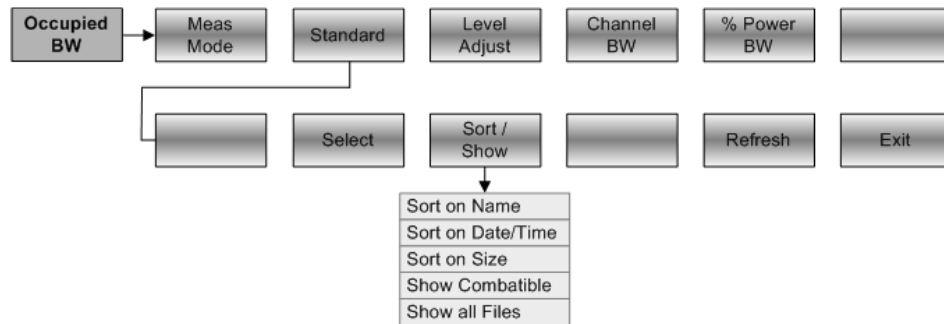

TDMA Power

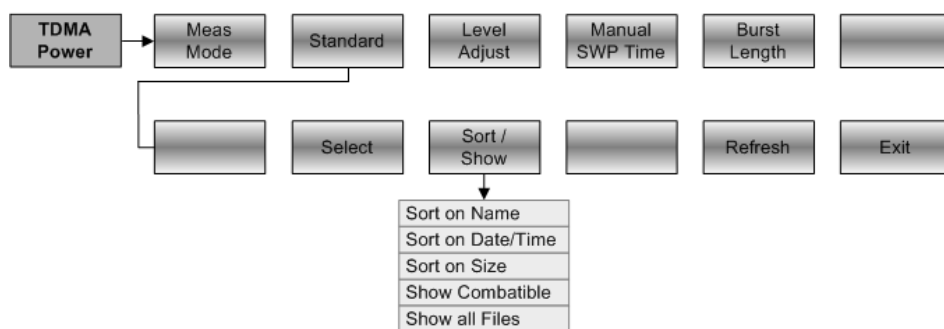

Spectrum Emission Mask

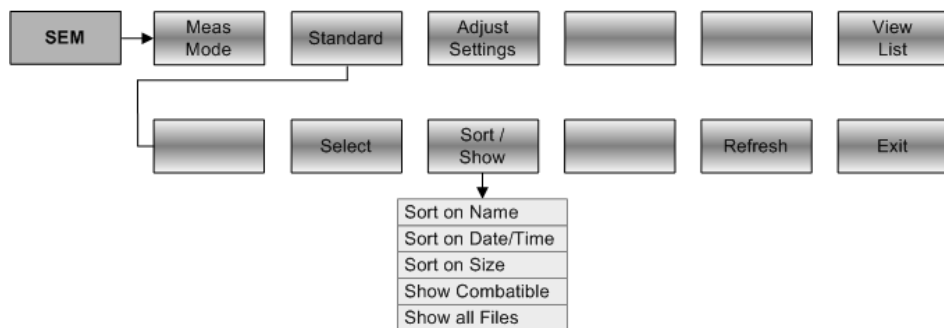

Spurious Emission



Harmonic Distortion

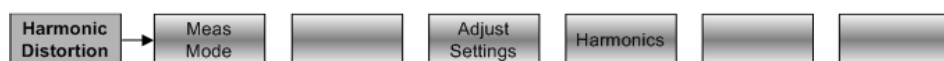

AM Modulation Depth

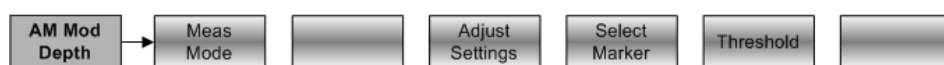

Spectrogram

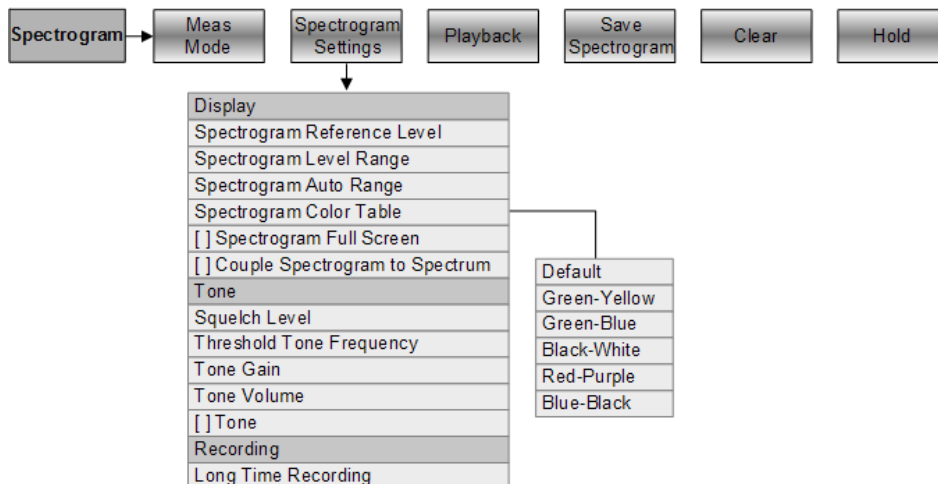

Spectrogram Playback

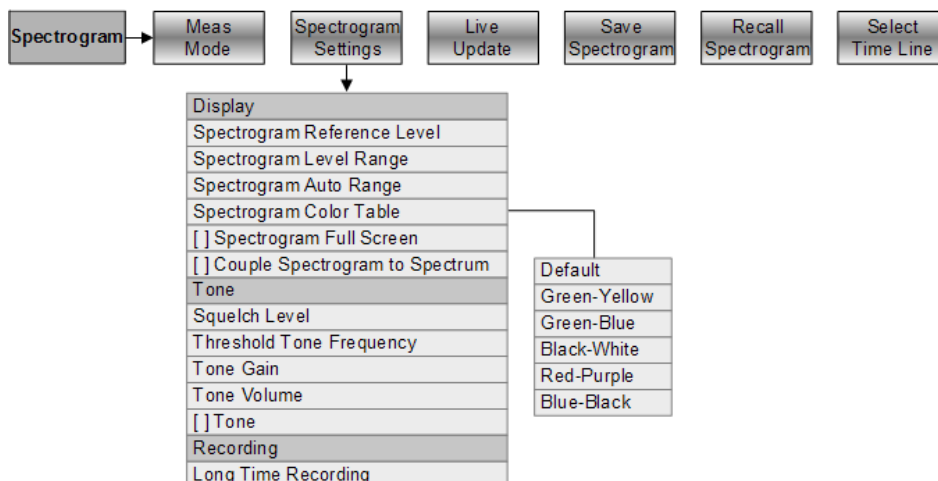

11.3.2 Frequency Parameters

The **FREQ/DIST** key opens the frequency menu that contains functionality to set up the horizontal axis of the measurement diagram.

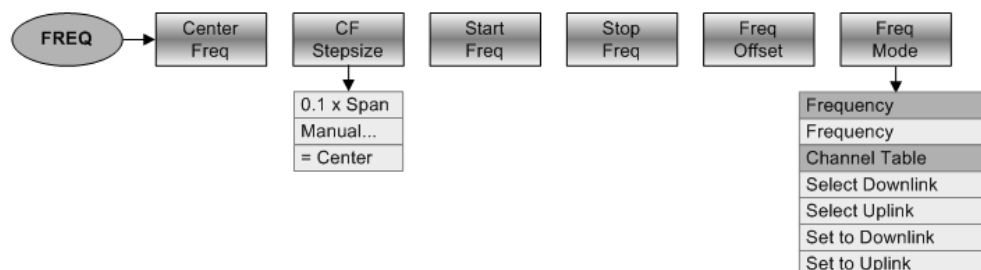

11.3.3 Span Selection

The FORMAT/SPAN key opens the span menu that contains functionality to set the span.



11.3.4 Amplitude Parameters

The SCALE/AMPT key opens the amplitude menu that contains functionality to set up the vertical axis of the measurement diagram.

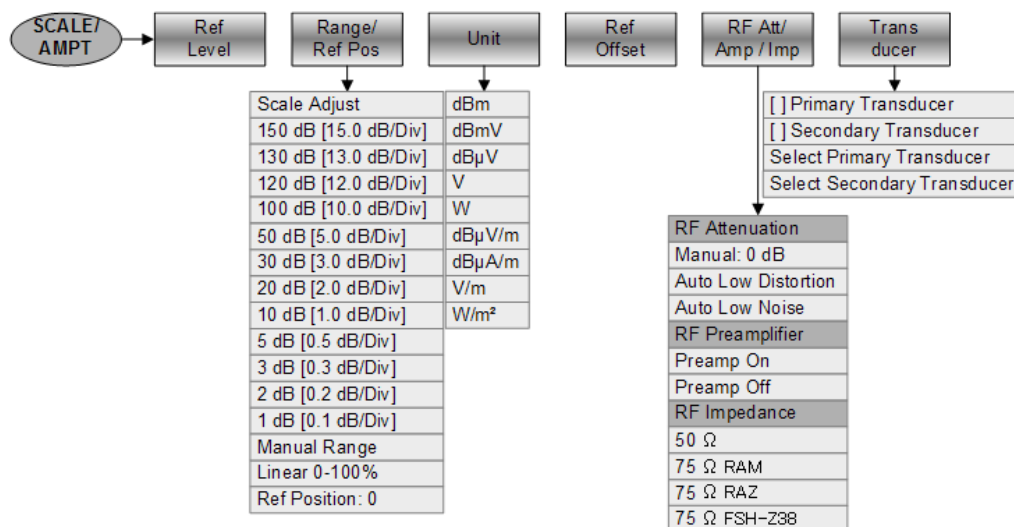

11.3.5 Sweep Configuration and Bandwidth Selection

The SWEEP/BW key opens a menu that contains all functionality to configure the sweep including the bandwidths.

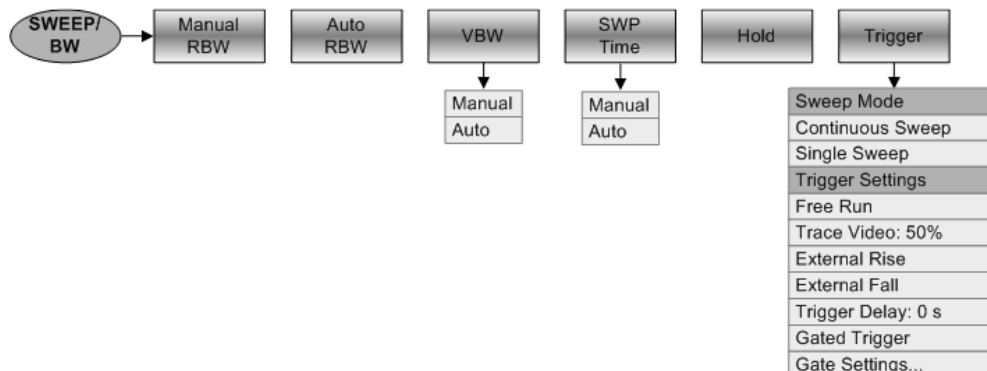

11.3.6 Trace Functionality

The TRACE key opens the trace menu that contains functionality to set up the traces.

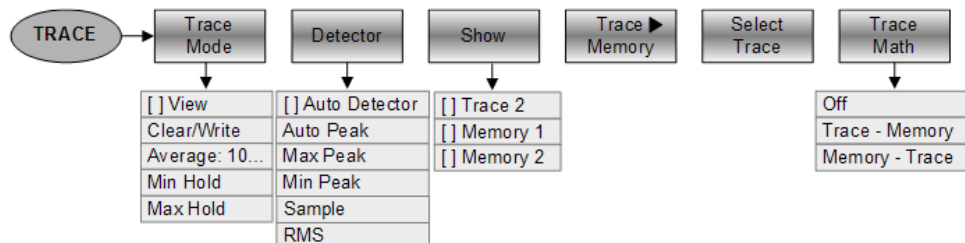

11.3.7 Display and Limit Lines

The LINES key opens a menu that contains the functionality to control display and limit lines.

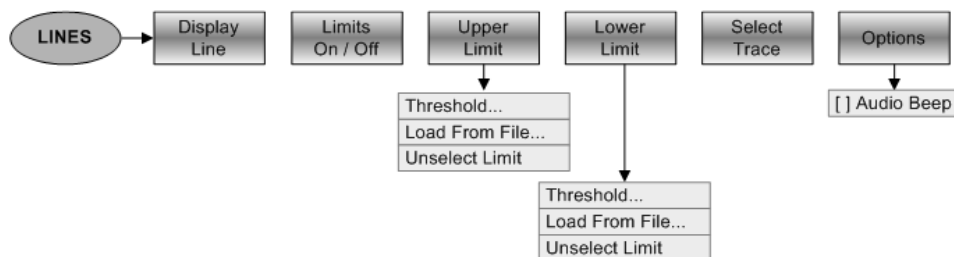

11.3.8 Markers

The MARKER and MKR→ keys open a menus to control markers and use marker functions.

Softkey in the Marker Menu

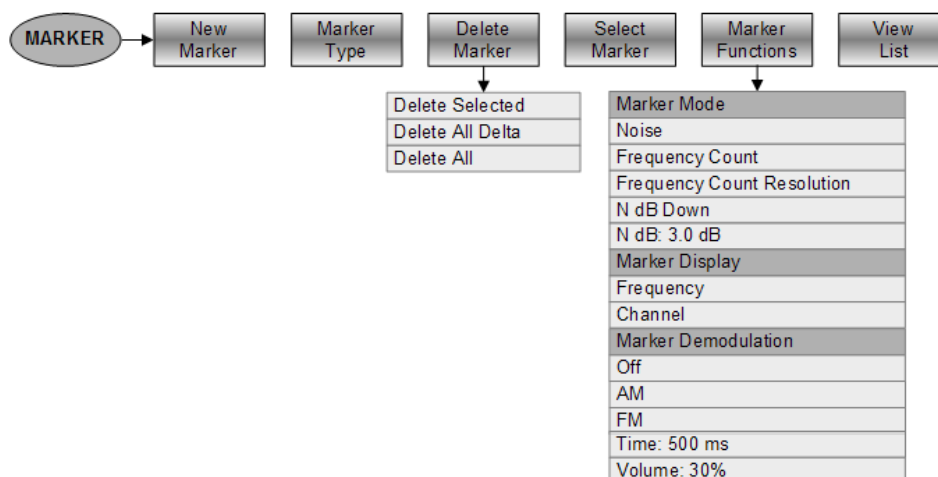

Softkeys in the Marker To Menu

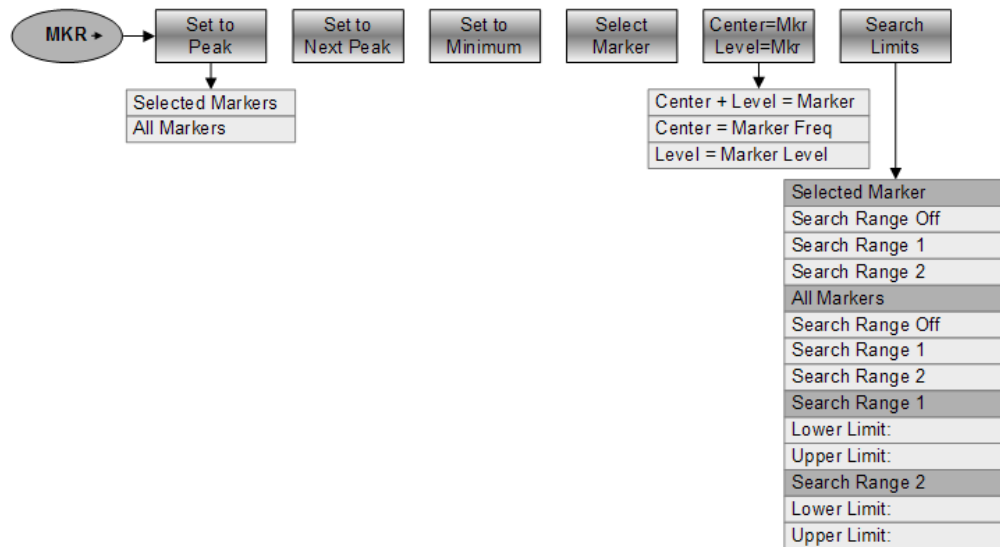

11.4 Functions of the Network Analyzer (R&S ZVH-K42)

This section contains all softkeys and menus that are available in network analyzer mode.

Vector network analyzer functionality is available only with option R&S ZVH-K42.

11.4.1 Measurement Configuration

The MEAS key opens the measurement menu that contains functionality to select and configure the measurement.

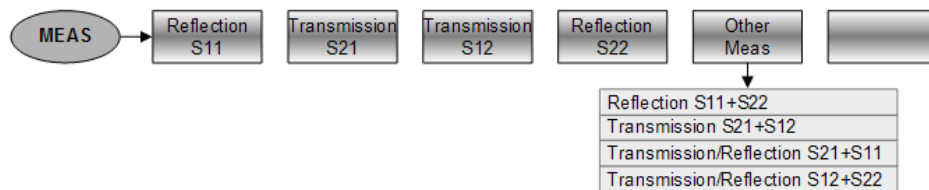

11.4.2 Frequency Parameters

The FREQ/DIST key opens the frequency menu that contains functionality to set up the horizontal axis of the measurement diagram.

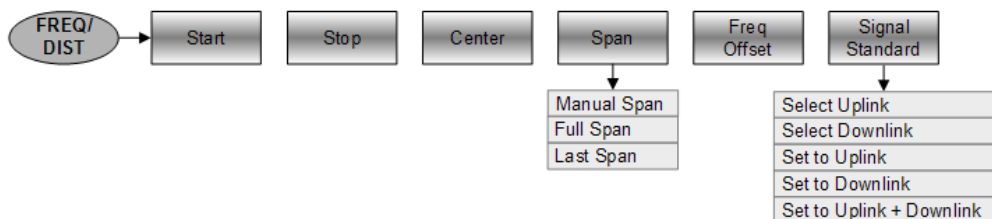

11.4.3 Measurement Format Selection

The FORMAT/SPAN key opens the span menu that contains available measurement formats.

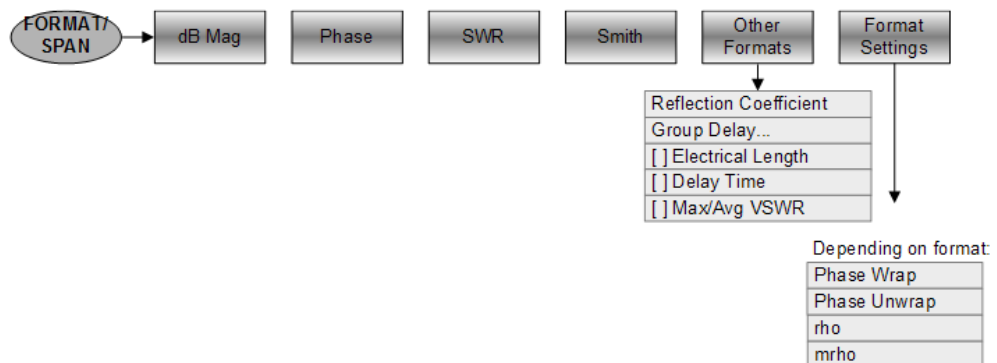

11.4.4 Amplitude Parameters

The SCALE/AMPT key opens the amplitude menu that contains functionality to set up the vertical axis of the measurement diagram.

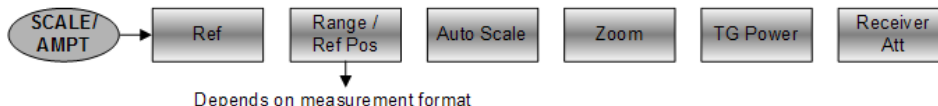

11.4.5 Sweep Configuration

The SWEEP/BW key opens a menu that contains all functionality to configure the sweep.

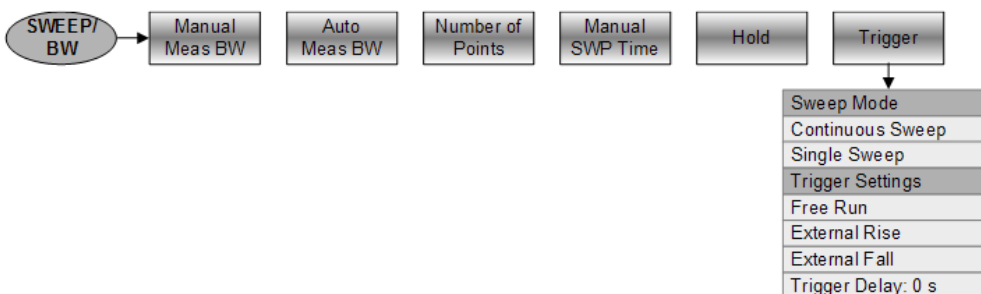

11.4.6 Trace Functionality

The TRACE key opens the trace menu that contains functionality to set up the traces.

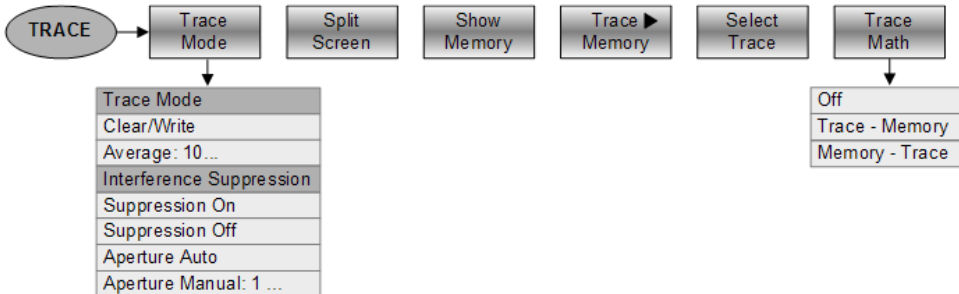

11.4.7 Limit Lines

The LINES key opens a menu that contains the functionality to control limit lines.

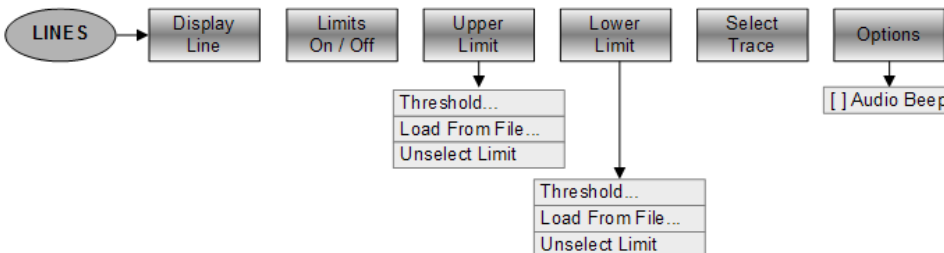

11.4.8 Markers

The MARKER and MKR→ keys open a menus to control markers and use marker functions.

Softkey in the Marker Menu

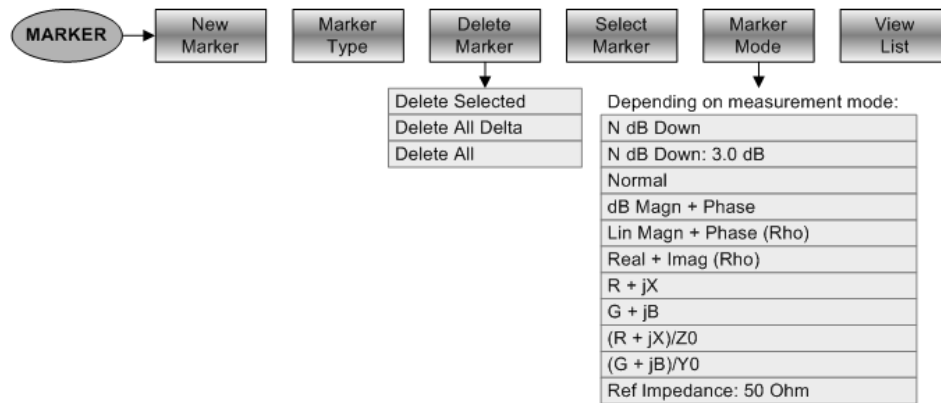

Softkeys in the Marker To Menu

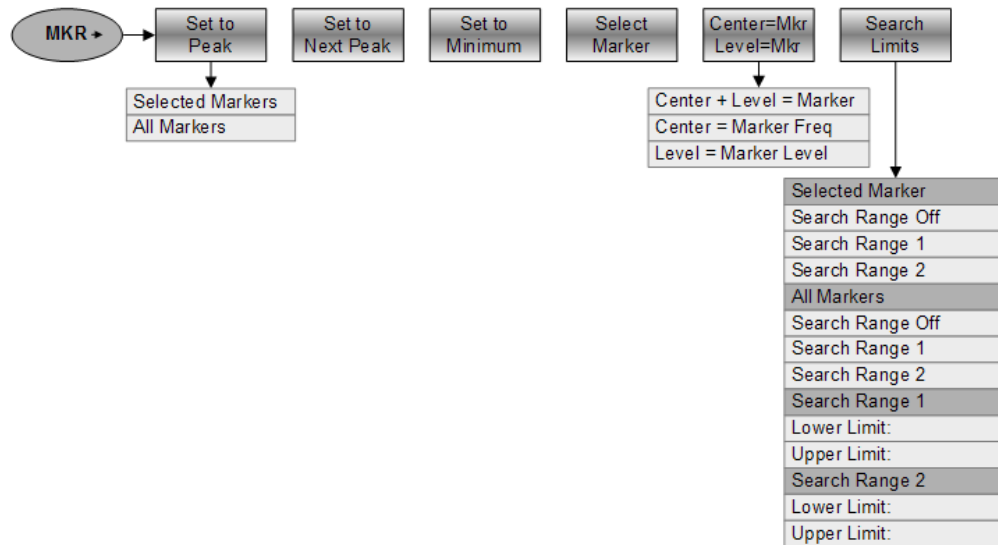

11.5 Functions of the Vector Voltmeter

This section contains all softkeys and menus that are available in vector voltmeter mode.

11.5.1 Vector Voltmeter Measurements

The MEAS key opens a menu that contains the functionality to configure measurements with the vector voltmeter.



11.5.2 Frequency Parameters

The FREQ/DIST key opens a menu that contains the functionality to set the frequency.



11.5.3 Amplitude Parameters

The SCALE/AMPT key contains functionality to configure level parameters.



11.5.4 Sweep Configuration

The SWEEP/BW key opens a menu that contains functionality to configure the sweep.



11.5.5 Trace Functionality

The TRACE key opens the trace menu that contains functionality to set up result evaluation.

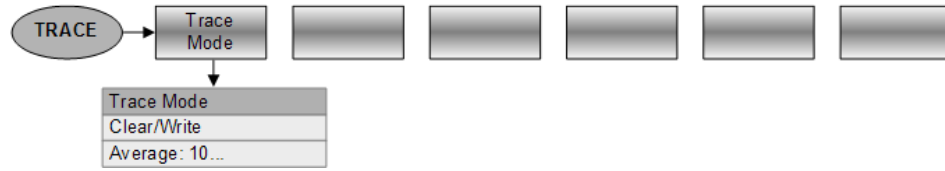

11.6 Functions of the Power Meter

This section contains all softkeys and menus that are available in power meter mode.

11.6.1 Power Meter Measurements

The MEAS key opens a menu that contains the functionality to configure measurements with the power meter.

Power Meter

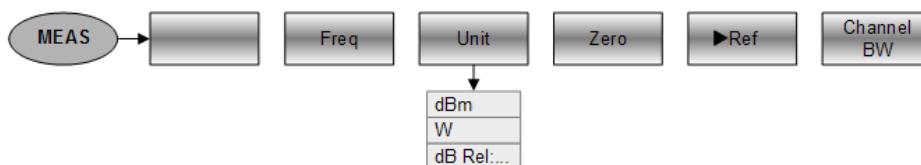

Directional Power Meter

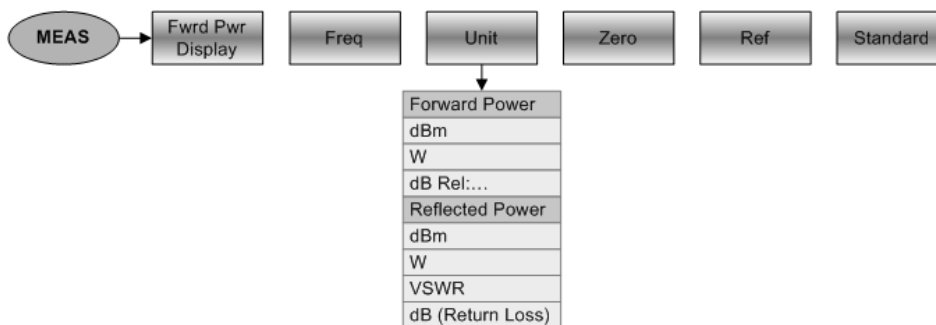

11.6.2 Frequency Parameters

The FREQ/DIST key opens a menu that contains the functionality to set the frequency.



11.6.3 Amplitude Parameters

The SCALE/AMPT key contains functionality to configure level parameters.

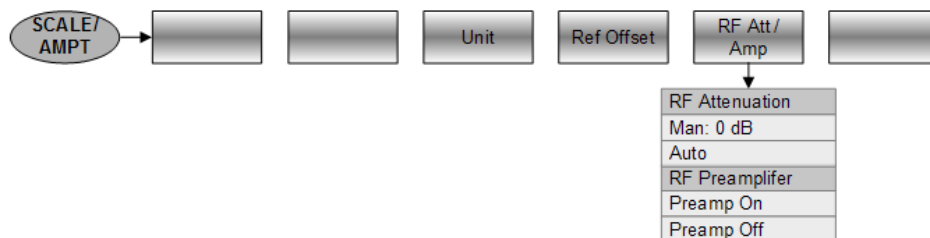

11.6.4 Sweep Configuration

The SWEEP/BW key opens a menu that contains functionality to configure the sweep.



12 How a Spectrum Analyzer Works

Basically, it is possible to measure and analyze RF signals either in the time domain or the frequency domain.

Measurements in the time domain show signal variations over time. You can perform these with an oscilloscope, for example. Measurements in the frequency domain show the frequency components of a signal. To perform measurements in the frequency domain, you can use a spectrum analyzer.

Both modes are essentially equivalent because applying the Fourier transform to any signal converts it into its spectral components. Depending on the signal characteristic to be measured, one method is usually more appropriate than the other. With an oscilloscope, it is possible to tell whether a signal is a sine wave, a square wave with a certain on/off ratio or a sawtooth wave. However, detecting superimposed low-level signals or monitoring the harmonic content of the signal is easier with a spectrum or signal analyzer.

Figure 12-1 shows the theoretical basis of the two measurement methods. In the time domain, an oscilloscope would, for example, show a section of the signal that is a square wave. The same signal, when viewed with a spectrum analyzer, would show a line spectrum (the fundamental and its harmonics).

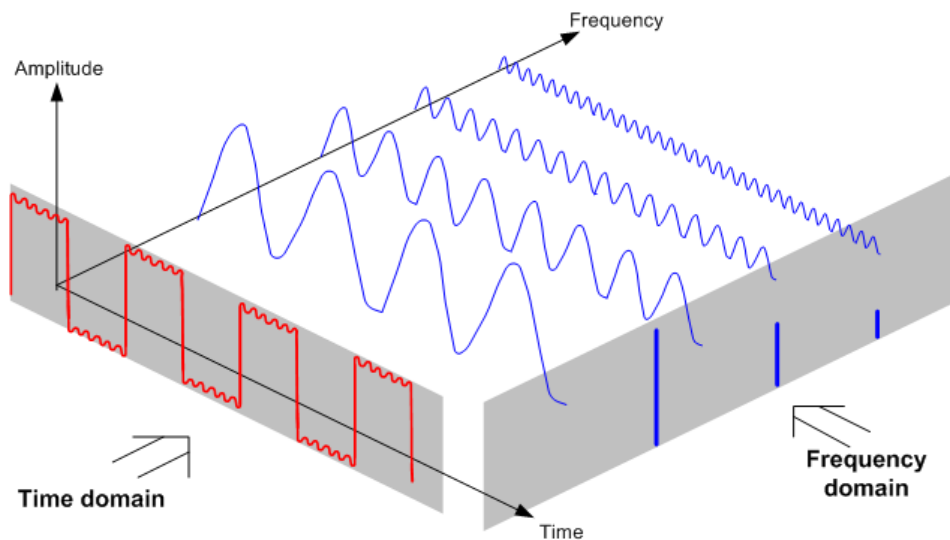

Figure 12-1: Visualization of time domain and frequency domain

Applying the Fourier transform to the periodic square wave transforms it into the frequency domain. The spectrum analyzer would show the fundamental (or frequency of the square wave) and its harmonics.

The spectrum analyzer uses a narrow bandpass filter for measurements in the frequency domain. Only at frequencies containing a signal there is a reading that gives the amplitude of the frequency component.

Figure 12-2 shows the basic principle of how a spectrum analyzer works.

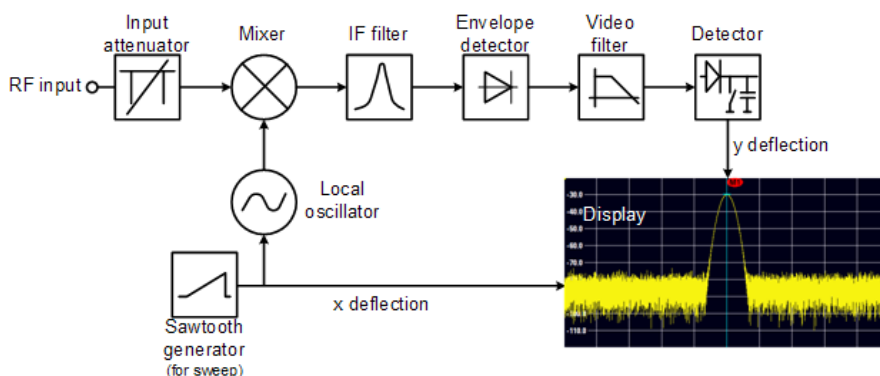

Figure 12-2: Block diagram showing the basic functionality of a spectrum analyzer

The precision attenuator at the R&S ZVH input attenuates the signal to a level that the mixer can handle without overdriving the mixer. The attenuator is directly coupled to the reference level. You can attenuate the signal in the range from 0 dB to 40 dB in steps of 5 dB.

The mixer converts the RF signal to a fixed intermediate frequency (IF). This process usually involves several stages. It lasts until you get an IF for which good narrowband filters are available. The R&S ZVH needs three mixing stages to get an IF that the filter can handle. Figure 12-3 graphically shows the mixing process.

For models with a frequency limit of 3.6 GHz, the IFs are 4892.8 MHz, 860.8 MHz and 54.4 MHz. The conversion from a specific input frequency to the first IF is done by a local oscillator (LO). This LO can be tuned from 4.8 GHz to 8.4 GHz. All other conversions are handled by single-frequency oscillators.

In case of models with a frequency limit of 8 GHz, the IFs are 8924.8 MHz, 860.8 MHz and 54.4 MHz. The conversion from the first to the second IF for these models is done by a second local oscillator.

The frequency of the local oscillator determines the input frequency at which the spectrum analyzer performs measurements:

$$f_{in} = f_{LO} - f_{IF}$$

The first mixer produces the sum frequency $f_{LO} + f_{in}$ (= image frequency f_{image}) as well as the difference frequency $f_{LO} - f_{in}$.

The image frequency is rejected by the bandpass at the IF so that it does not interfere with the subsequent frequency conversions.

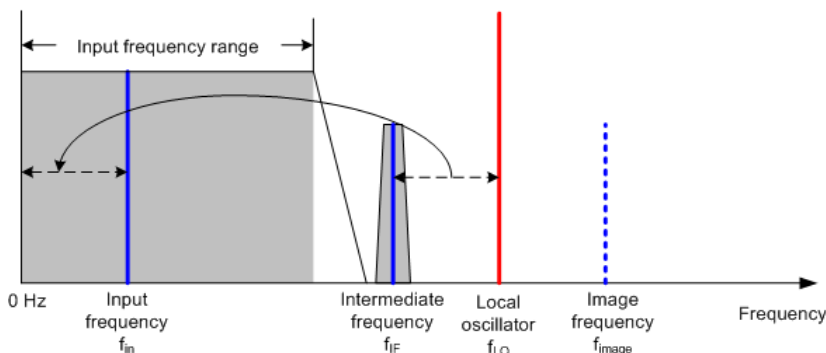

Figure 12-3: Mixing process

The first local oscillator is tuned with a sawtooth which simultaneously acts as the x deflection voltage for the display. In practice, synthesizer technology is used to generate the frequency of the first local oscillator and for a digital display.

The instantaneous sawtooth voltage therefore determines the input frequency of the spectrum analyzer.

The bandwidth of the IF filter at the IF determines the bandwidth that is used for measurements. Pure sine signals are passed by the IF filter characteristics. This means that signals closer together than the bandwidth of the IF filter cannot be resolved. This is why the bandwidth of the IF filter in a spectrum analyzer is referred to as the resolution bandwidth. The R&S ZVH has resolution bandwidths from 1 Hz to 3 MHz.

The bandlimited IF is passed to the envelope detector. The envelope detector removes the IF from the signal and outputs its envelope. The output signal from the envelope detector is referred to as the video signal. As it has been demodulated, it only contains amplitude information. The phase information is lost.

With RF sine signals, the video signal is a DC voltage. With AM signals the video signal contains a DC component whose amplitude corresponds to the carrier power and an AC component whose frequency is equal to the modulation frequency, provided the modulation frequency is inside the resolution bandwidth.

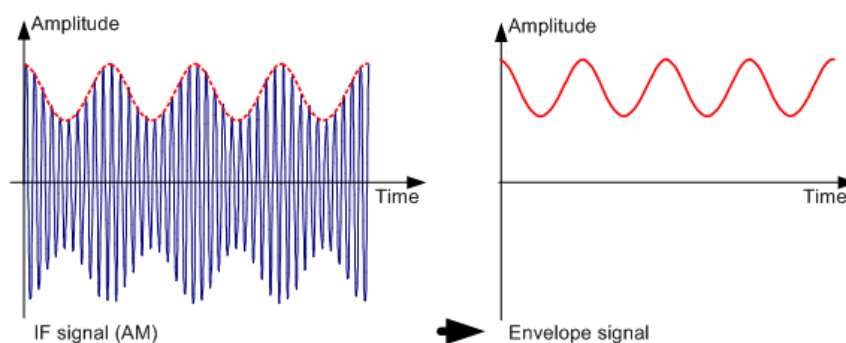

The video filter comes after the envelope detector. The filter is a lowpass with an adjustable cutoff frequency which limits the bandwidth of the video signal. It is particularly useful when sine signals are to be measured in the vicinity of the spectrum analyzer's intrinsic noise. The sine signal produces a video signal that is a DC voltage. At the IF, however, the noise is distributed over the whole bandwidth or, in the case of the video signal, over half the bandwidth of the resolution filter. By selecting a narrow video bandwidth relative to the resolution bandwidth, the noise can be suppressed, while the sine signal to be measured (= DC) is not affected.

The figures below show a weak sine signal. In the first picture, it is measured with a large video bandwidth and in the second with a narrow video bandwidth.

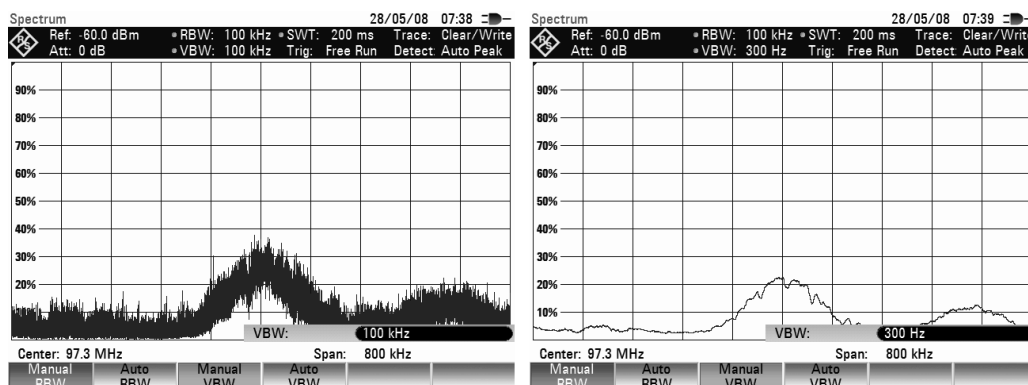

Limiting the video bandwidth smoothes the trace considerably. This makes it much easier to determine the level of the measured signal.

The detector comes after the video filter. The detector combines the measured spectrum so that it can be represented as one pixel in the trace. The R&S ZVH uses 631 pixels to form the trace, i.e. the whole measured spectrum has to be represented using just 631 pixels. Common types of spectrum analyzer detectors are the peak detector (PEAK), the sample detector (SAMPLE) and the RMS detector (RMS). An Auto Peak detector which simultaneously displays the maximum peak and the minimum peak is usually also provided. The Fig. below explains how these detectors work.

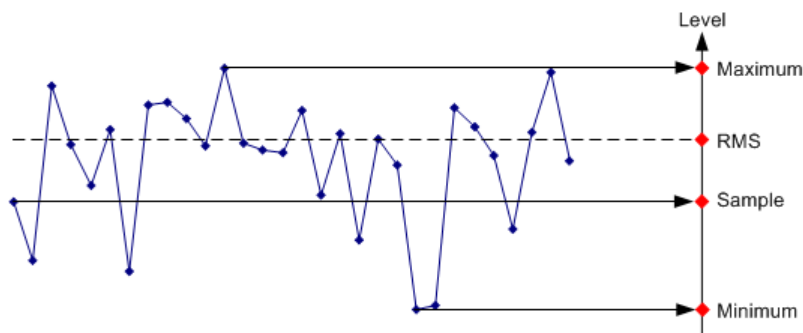

The figure above shows 30 measured values which are represented by a single pixel. The peak detector determines and displays the maximum measured value. The Auto Peak detector takes the maximum and minimum and displays them together. The two values are joined by a vertical line segment. This gives a good indication of the level variation over the measured values represented by a single pixel. The RMS detector is used by the spectrum analyzer to determine the RMS value of the measured values. It is therefore a measure of the spectral power represented by a pixel. The sample detector takes an arbitrary measurement value and displays it (in the Fig. above, the first). The other measured values are ignored.

On the basis of the operating principles of detectors, a few recommendations can be made as to their use.

- It is best to use the Auto Peak detector or the peak detector for spectrum analysis over large frequency ranges. This ensures that all signals are displayed.
- The RMS detector is recommended for power measurements on modulated signals. However, the display range should be chosen so as not to exceed 100 times the bandwidth of the signal or the resolution bandwidth, whichever is larger.
- The sample detector or the RMS detector (preferred) should be used for noise measurements. Only these two detectors are capable of measuring noise power correctly.
- When measurements are made on sine signals, the level display does not depend on the detector. However, if you use the RMS detector or the sample detector, ensure that the span is not too great. Otherwise, the displayed levels of sine signals may be lower than their true value.

Index

ACLR	
absolute results	112
adjacent channel	109
channel bandwidth	110
channel spacing	110
limit check	113
measurement configuration	109
measurement settings	107
normalization	112
reference channel	112
relative results	112
standard	109
transmission channel	109
Adjacent channel	109
Adjacent channel leakage ratio (ACLR)	106
Adjust level	
channel power	96
occupied bandwidth	100
TDMA power	104
Adjust settings	
AM modulation depth	122
harmonic distortion	120
AM demodulator	165
AM modulation depth	121
adjust settings	122
threshold	122
Amplitude	143, 217
Antenna tests	44
Attenuation	68, 145, 185
Audio demodulation	
time	166
volume	166
Audio demodulator	165
Auto low noise/distortion	145
Auto peak	159
Auto span	64
Automatic scaling	67
Average trace	158
Averaging time	179
Bandwidth	70, 148
resolution	148
video	149
Beeper	169
Burst length	104
Cable loss	51
Cable measurement	
test setup	45
Cable model	61
Cable tests	44
Calibration	56, 196, 222
procedure	197
state	196
Calibration kit	56, 196, 197
Calibration method	197
Calibration procedure	59
Center frequency	65, 139, 178, 183
CF step size	139
Channel bandwidth	
ACLR	110
channel power	97
occupied bandwidth	101
Channel power	95
adjust level	96
channel bandwidth	97
display mode	98
reference level	96
span	97
standard	96
unit	98
Channel spacing	110
Channel table	171, 219
Clear / write	158
Clear spectrogram	127
Color schemes	
spectrogram	129
Continuous sweep	70, 153
Conventions	14
Correction data	196
Cursor keys	19
Data management	34
Delay time	154
Deltamarker	163
Detector	159
Directional power sensor	181
Display configuration (spectrogram)	129
Display elements	15
Display line	167
Display mode	98
Display range	67, 144, 218
spectrogram	130
Distance parameters	64
Distance-to-fault	48
Dual trace	215
Events	25
External trigger	72, 153
Factory calibration	56
File management	34
Firmware	43
FM demodulator	165
Forward power display	184
Frame	132
spectrogram	132
Free run	72, 153
Frequency	
counter	164
mode	171
offset	140
range	64, 141
settings	64, 139, 178, 183
start/stop	65, 140

Full span	141
Gate settings	156
Gated sweep	153, 155
Harmonic distortion	119
adjust settings	120
harmonics	120
harmonics list	120
THD	120
History	128
Hold spectrogram	127
Horizontal axis	64, 139
Impedance	147
Smith chart	215
Input	
cancellation	18
characters	17
confirmation	18
numbers	17
Instrument setup	21
InstrumentView	
limit lines	168
Isotropic antenna	137
Key	
Ampt (CAT)	67
Ampt (NA)	217
Ampt (SA)	143
BW	148
Cal	56, 196
Freq (CAT)	64
Freq (SA)	139
Marker	75
Meas (CAT)	47
Meas (NA)	196, 200, 204, 210
Meas (PM)	178, 183
Meas (SA)	94
MKR ->	75
Sweep	152
Sweep (CAT)	70
Trace	74, 158
Last span	141
Limit check	169
ACLR	113
Limit lines	168, 220
Manual span	64
Marker	75, 163, 219
automatic positioning	78
delta marker	77
discrete steps	76
distance	164
format	214
functions	163
list	76
mode	214
position	76, 164
removal	78
search limit	79
selection	77
Smith chart	214
spectrogram	132
step size	76
type	77
Marker list	
AM modulation depth	122
harmonic distortion	120
spectrogram	132
Mathematics	162
Max hold	158
Max peak	159
Measurement	152
ACLR	106
AM modulation depth	121
audio demodulation	165
cable loss (CAT)	51
channel power	95
directional power sensor	183
distance-to-fault	48
electrical length	211
frequency counter	164
group delay	211
harmonic distortion	119
isotropic antenna	137
magnitude	210
n dB down	164
noise power density	163
occupied bandwidth	99
phase	210
power sensor	178
reflection	47
reflection (VV)	224
reflection coefficient	211
reflection scalar	202
reflection vector	208
scalar	200
Smith chart	211
spectrogram	126
spectrum analyzer	94
spectrum emission mask	115
spurious emissions	123
TDMA power	103
transmission (CAT)	52
transmission (VV)	223
transmission scalar	200
transmission vector	205
vector	204
vector voltmeter	221, 224
VSWR	211, 224
Measurement bandwidth	70
Measurement format	55, 210, 224
Measurement setup	20
Measurement wizard	81
dataset	82
evaluation	93
measurement set	82
measurements	90
Memory trace	74, 162, 216
Menus	226
cable and antenna tests	228
general	226
network analyzer	237
power meter	242

spectrum analysis	231	spectrogram	129
vector voltmeter	240	TDMA power	104
Min hold	158	transducer	173
Min peak	159	Reference position	68, 143, 217
Multiple traces	161	Reference value	67, 217
n dB down	164	Reflection	47
Network analysis	194	Resolution bandwidth	148, 152
Noise power	163	Result table	
Normalization (SA)	112	spectrum emission mask	117
Number of harmonics	120	spurious emission	124
Occupied bandwidth	99	RF attenuation	145
adjust level	100	RMS	160
channel bandwidth	101	Rotary knob	18
power percentage	101	Sample	160
reference level	100	Save on event	25
span	102	Scaling	67, 144, 218
standard	100	horizontal axis	139
Offset		Screen layout	15
frequency	140	ACLR	106
reference level	145	AM modulation depth	121
Operating mode		CAT mode	46
cable and antenna test	44	channel power	95
network analyzer	194	file manager	36
spectrum analyzer	94	harmonic distortion	119
Options	43	measurement wizard	87
Pausing measurements	71	occupied bandwidth	99
Playback	132	power meter	175
Power meter	175	power meter (directional)	181
Power percentage	101	power meter (pulse)	188
Power sensor	177	report generator	93
attenuation	185	spectrogram	126
averaging time	179	spectrum emission mask	115
directional	181	spurious emission	123
errors	177	TDMA power	103
reference level	179	w/ active markers	75
standard	184	wizard set editor	83
unit	179, 184	Screenshot	24
weighting mode	184	Search limits	79
zeroing	178	Secondary transducer	172
Preamplifier	146	Signal standard	66
Preset	20	Single sweep	70, 153
Preview dataset	41	Smith chart	212
Primary transducer	172	Softkey	
R&S InstrumentView		new marker	77
ACLR	107	Softkeys	226
calibration kit	198	cable and antenna tests	228
creating standards	96, 100, 104, 109, 116	general	226
isotropic antenna	138	network analyzer	237
spectrum emission mask	115	power meter	242
RBW	148	spectrum analysis	231
Record spectrogram	131	vector voltmeter	240
Reference channel	112	Span	64, 141
Reference frequency	164	channel power	97
Reference impedance	215	occupied bandwidth	102
Reference level	143	Spectrogram	126
channel power	96	clear	127
directional power sensor	184	display configuration	129
occupied bandwidth	100	display range	130
offset	145	hold	127
power sensor	179	marker	132

playback	132
record	131
reference level	129
time line	132
Spectrogram colors	129
Spectrogram history	128
Spectrum analyzer	94
Spectrum emission mask	115
adjust settings	117
result table	117
standard	116
Split screen	215
Spurious emission	
result table	124
Spurious emissions	123
Standard	
ACLR	109
channel power	96
directional power sensor	184
occupied bandwidth	100
power sensor	184
spectrum emission mask	116
TDMA power	104
Start length	65
Start/stop frequency	65, 140
Step size	139
Stop length	65
Sweep	152, 159
Sweep mode	70, 153
Sweep number	70, 153, 158
Sweep time	152
Synchronization	35
TDMA power	103
adjust level	104
burst length	104
reference level	104
standard	104
THD	120
Threshold	
AM modulation depth	122
Time domain	103, 142, 154
Time line	132
Total harmonic distortion	120
Trace	158
Trace (second)	161
Trace average	158
Trace mathematics	162
Trace memory	162
Trace mode	73, 158
Trace selection	161
Tracking generator	195
Tracking generator power	68
Transducer	147, 172
unit	173
Transmission (CAT)	52
Transmission channel	109
Trigger	72, 153
Trigger delay	154
Trigger level	155
Unit	144
channel power	98
directional power sensor	184
power sensor	179
transducer	173
User interface	15
VBW	149
Vector measurement	194
Vertical axis	143, 217
Video bandwidth	149
Video trigger	153
View trace	158
Volume	166
Weighting mode	184
X axis	64, 139
Y axis	143, 217
Zero span	142
Zeroing	178
Zoom	213
ZVHView	
cable model	62
channel table	171, 219
limit lines	220