

R&S[®] CLIPSTER Mk2

Mastering Station

User Manual (Hardware)



2904.4460.02

Version 04

ROHDE & SCHWARZ

Make ideas real



© 2022 Rohde & Schwarz GmbH & Co. KG

Hanomaghof 1, 30449 Hanover, Germany

Phone: +49-511-67807-0

Internet: <https://www.rohde-schwarz.com>

Support: <https://www.rohde-schwarz.com/support>

Subject to change – Data without tolerance limits is not binding.

R&S® is a registered trademark of Rohde & Schwarz GmbH & Co. KG.

Trade names are trademarks of the owners.

Throughout this manual, products from Rohde & Schwarz are indicated without the ® symbol, e.g. R&S®CLIPSTER is indicated as CLIPSTER.

Contents

About	5
About this Documentation	5
Required Reading	5
Additional Documentation	5
Chapters Overview	6
Safety and Regulatory Information	7
Safety Instructions	8
Lifting and Carrying the Product	8
Choosing the Operating Site	9
Setting Up the Product	9
Connecting to Power	9
Cleaning the Product	10
Connecting to a Network	10
Meaning of Safety Labels	11
Handling Batteries Safely	11
Labels on the Product	12
Warning Messages in the Documentation	13
Korea Certification Class A	13
CE Declaration of Conformity	14
FC Declaration of Conformity	15
Product Description	17
Overview of the Front	17
Front Cover	17
The Front of the System	18
Overview of the Rear	21
The Rear of the System	22
Main Connector Panel	23
Digital Video I/Os	24
ATX Panel	27
Slot Panel Connectors	28
Power Supply	30
Important Notes	31
.....	32
Installation and Operation	33
Lifting and Carrying	33
Unpacking the System	33
Choosing the Operating Site	34
Mounting the System into a Rack	34
Rack System Precautions	34
Mounting the System	35
Connecting Monitor, Mouse and Keyboard	38
Connecting to Power	39

Operating the System	39
Starting the System	39
First Login	40
Shutting Down the System	41
IPMI Login	42
Maintenance	43
Safety during Maintenance	43
SSD Disk Maintenance	44
RAID Storage Protection	45
Removing the Front Cover	46
Identifying a Defective SSD Disk	46
SSD Disk Replacement	47
Removing the Top Cover	50
Recovery of the System Disk	51
Fan Maintenance	55
Preparations	55
Replacing the Fan	57
Power Supply Maintenance	58
Power Supply	58
Replacing a Power Supply Unit	59
Cleaning	59
Storage	59
Disposal	60
Appendix	61
Troubleshooting	61
Technical Data	62
General Technical Data	63
Dimensions	63
Hardware Performance Specifications	64
Signal In- and Outputs	67
Packing Instructions	71
Index	77

About

This documentation describes how to use the hardware of CLIPSTER, the real-time conforming and mastering system by Rohde & Schwarz.

This chapter contains the following sections:

- About this Documentation (page 5)
- Chapters Overview (page 6)

About this Documentation

This documentation contains installation, operation and maintenance instructions as well as safety instructions which must be followed by the client company and the system operator. For this reason, the manual should always be accessible in the immediate vicinity of the system.

Required Reading

The client company and operator of the system are advised to read this manual, and to follow the instructions.

Each person who is responsible for installation, operation, maintenance or setting of the system must read and understand this manual.

Additional Documentation

Additional documentation can be downloaded from <https://gloris.rohde-schwarz.com> after registering/logging in to access restricted information. There you may find updated manual versions as well as further information about your product.

Chapters Overview

The chapters contain the following information:

Chapter "About" (page 5)	States the audience this manual is written for, and provides information on additional documentation.
Chapter "Safety and Regulatory Information" (page 7)	Provides all required safety instructions and important notes you must adhere to protect your equipment and avoid personal injury.
Chapter "Product Description" (page 17)	This chapter gives an overview of the front and rear panel of the system detailing the respective controls, connectors and interfaces.
Chapter "Installation and Operation" (page 33)	Describes the hardware installation of the system. Explains how to operate the system, i.e. how to start and shut down the device.
Chapter "Maintenance" (page 43)	Details basic maintenance work that can be done by the customer, for example, in case of a disk, fan or power supply unit failure.
"Appendix" (page 61)	Provides technical details and general information about the hardware of the system. Furthermore, it gives hints how to resolve irregularities during operation.

Safety and Regulatory Information

The product documentation helps you use the product safely and efficiently. Follow the instructions provided here and in section "Safety Instructions" (page 8).

Intended use

The R&S system may only be used according to its intended function as described in "Product Description" (page 17) and within the specified environmental conditions as described in the data sheet. Any other use or extension of this function is considered inappropriate. Inappropriate use may lead to situations resulting in personal injury or property damage.

Observe the operating conditions and performance limits stated in the data sheet.

Target audience

Each person who is responsible for installation, operation, maintenance or setting of the system must read and understand this manual.

To use this manual you should know how to handle computer equipment. Furthermore, to connect the R&S system to a network you should have experience as a network administrator and know how to set up the required network connections on the installation site both in hard- and software.

When performing maintenance tasks on the hardware of the R&S system, you must be qualified to work on, repair and test electrical equipment.

Where do I find safety information?

Safety information is part of the product documentation. It warns you of potential dangers and gives instructions on how to prevent personal injury or damage caused by dangerous situations. Safety information is provided as follows:

- In chapter "Safety Instructions" on page 8. General safety information is provided in many languages as printed "Safety Instructions". The printed "Safety Instructions" are delivered with the product.
- Throughout the documentation, safety instructions are provided when you need to take care during setup or operation.

This chapter contains the following sections:

- Safety Instructions (page 8)
- Labels on the Product (page 12)
- Warning Messages in the Documentation (page 13)
- Korea Certification Class A (page 13)
- CE Declaration of Conformity (page 14)
- FC Declaration of Conformity (page 15)

Safety Instructions

Products from the Rohde & Schwarz group of companies are manufactured according to the highest technical standards. To use the products safely, follow the instructions provided here and in the product documentation. Keep the product documentation nearby and offer it to other users.

Use the product only for its intended use and within its performance limits. Intended use and limits are described in the product documentation such as the data sheet, manuals and the printed safety instructions. If you are unsure about the appropriate use, contact Rohde & Schwarz customer service.

Using the product requires specialists or specially trained personnel. These users also need sound knowledge of at least one of the languages in which the user interfaces and the product documentation are available.

If any part of the product is damaged or broken, stop using the product. Only service personnel authorized by Rohde & Schwarz are allowed to repair the product. Contact Rohde & Schwarz customer service at: <http://www.customersupport.rohde-schwarz.com>.

The following topics are covered:

- Lifting and Carrying the Product (page 8)
- Choosing the Operating Site (page 9)
- Setting Up the Product (page 9)
- Connecting to Power (page 9)
- Cleaning the Product (page 10)
- Connecting to a Network (page 10)
- Meaning of Safety Labels (page 11)
- Handling Batteries Safely (page 11)

Lifting and Carrying the Product

The system can weigh up to 45kg (99lbs). Use appropriate lifting methods. Follow the instructions provided by the equipment manufacturer.

The product is heavy. Do not move or carry the product by yourself. A single person can only carry a maximum of 18 kg safely depending on age, gender and physical condition. Use the product handles to move or carry the product. Do not lift by the accessories mounted on the product. Accessories are not designed to carry the weight of the product.

When closing any drawers, do so firmly, ensuring the latches are engaged.

Choosing the Operating Site

Only use the product indoors. The product casing is not waterproof. Water that enters can electrically connect the casing with live parts, which can lead to electric shock, serious personal injury or death if you touch the casing. If Rohde & Schwarz provides a carrying bag designed for your product, you can use the product outdoors.

Unless otherwise specified, you can operate the product up to an altitude of 2000 m above sea level. The product is suitable for pollution degree 2 environments where nonconductive contamination can occur. This equipment is to be installed for operation in an environment with ambient temperature below 35°C (95°F), and humidity 5 - 95%.

The system is to be operated only when mounted and mechanically secured into a 19-inch wide rack.

Setting Up the Product

Always place the product on a stable, flat and level surface with the bottom of the product facing down. If the product is designed for different positions, secure the product so that it cannot fall over.

If stacking is possible, keep in mind that a stack of products can fall over and cause injury.

If you mount products in a rack, ensure that the rack has sufficient load capacity and stability. Observe the specifications of the rack manufacturer. Always install the products from the bottom shelf to the top shelf so that the rack stands securely. Secure the product so that it cannot fall off the rack.

Unplug the system before you move it or if you think it has become damaged in any way.

Connecting to Power

The product is an overvoltage category II product and has to be connected to a fixed installation used to supply energy-consuming equipment such as household appliances and similar loads. Be aware that electrically powered products have risks, such as electric shock, fire, personal injury or even death.

Maintenance inside the system should only be performed by personnel qualified for handling and testing electrical equipment. Exercise utmost care when performing any kind of work inside the system while it is on.

Take the following measures for your safety:

- The enclosure must only be operated from a power supply input voltage range of 100-127 VAC and 200-240 VAC, frequency is 50 to 60 Hz.

Safety Instructions

- The plug on the power supply cord is used as the main disconnect device. Ensure that the socket outlets are located near the equipment and are easily accessible.
- A safe electrical earth connection must be provided to the power supply cords. Check the grounding of the casing before applying power.
- Provide a suitable power source with electrical overload protection to meet the requirements laid down in the technical specification.
- Before switching on the product, ensure that the voltage and frequency indicated on the product match the available power source. If the power adapter does not adjust automatically, set the correct value and check the rating of the fuse.
- If a product has an exchangeable fuse, its type and characteristics are indicated next to the fuse holder. Before changing the fuse, switch off the instrument and disconnect it from the power source. How to change the fuse is described in the product documentation.
- Only use the power cable delivered with the product. It complies with country-specific safety requirements. Only insert the plug into an outlet with protective conductor terminal.
- Only use intact cables and route them carefully so that they cannot be damaged. Check the power cables regularly to ensure that they are undamaged. Also ensure that nobody can trip over loose cables.
- If the product needs an external power supply, use the power supply that is delivered with the product or that is recommended in the product documentation or a power supply that conforms to the country-specific regulations.
- Ensure that you can disconnect the product from the power source at any time. Pull the power plug to disconnect the product. The power plug must be easily accessible. If the product is integrated into a system that does not meet these requirements, provide an easily accessible circuit breaker at the system level.

Cleaning the Product

Use a dry, lint-free cloth to clean the product. When cleaning, keep in mind that the casing is not waterproof. Do not use liquid cleaning agents.

Connecting to a Network





Before connecting the product to a local area network (LAN), consider the following:

- Always install the latest firmware for the components of your system to reduce security risks.
- For Internet or remote access, use secured connections if applicable, such as HTTPS, SFTP, FTPS instead of HTTP, FTP.
- Ensure that the network settings comply with the security policies of your company. Contact your local system administrator or IT department before connecting your product to your company network.

- When connected to a network, the product may potentially be accessed from the Internet, which may be a security risk. For example, attackers might misuse a network to remotely access and damage the product.

Meaning of Safety Labels

Safety labels on the product warn against potential hazards.

	<p>Potential hazard</p> <p>Read the product documentation to avoid personal injury or product damage.</p>
	<p>Heavy product</p> <p>Be careful when lifting, moving or carrying the product. Carrying the product requires at least two people or transport equipment.</p>
	<p>Electrical hazard</p> <p>Indicates live parts. Risk of electric shock, fire, personal injury or even death.</p>
	<p>Hot surface</p> <p>Do not touch. Risk of skin burns. Risk of fire.</p>
	<p>Protective conductor terminal</p> <p>Connect this terminal to a grounded external conductor or to protective ground. This protects you against electric shock should an electric problem occur.</p>

Handling Batteries Safely

The product contains lithium polymer or lithium ion cells or batteries. The use of the word battery in the following always means all types. Only the battery contents are potentially hazardous. As long as a battery is undamaged and the seals remain intact, there is no danger.

Impact, shock or heat can cause damage such as dents, punctures and other deformations. A damaged battery poses a risk of personal injury. Handle a damaged or leaking battery with extreme care. Immediately ventilate the area since the battery releases harmful gases. If you come into contact with the battery fluid, immediately remove all contaminated clothing. Irritation can occur if the battery fluid comes in contact with your skin or eyes. Immediately and thoroughly rinse your skin or eyes with water and seek medical aid.

For safe handling, follow these rules:

- Do not short-circuit the battery.

Labels on the Product

- Do not mechanically damage the battery. Do not open or disassemble the battery.
- Do not expose the battery to high temperatures such as open flames, hot surfaces and sunlight.
- Only use the battery with the designated product.
- Only use the appropriate charger to charge the batteries. If the batteries are improperly charged, there is a risk of explosion.
- Store the battery at room temperature (approximately 20°C | 68°F) enclosed in the original packaging.
- Dispose of batteries separately from normal household waste as specified by the local waste disposal agency.

If you disregard these safety regulations, you risk serious personal injury or even death due to explosion, fire or hazardous chemical substances

When replacing a defective battery, only use the same battery type. When returning batteries to Rohde & Schwarz subsidiaries, choose a carrier qualified to transport dangerous goods and follow the carrier's transport stipulations in line with IATA-DGR, IMDG-Code, ADR or RID. If you need assistance, contact the carrier or customer service.

California, USA Only

The Lithium battery adopted on the motherboard of this system contains Perchlorate, a toxic substance controlled in Perchlorate Best Management Practices (BMP) regulations passed by the California Legislature.

When you discard the Lithium battery in California, USA, please follow the related regulations in advance. Perchlorate Material-special handling may apply, see www.dtsc.ca.gov/hazardouswaste/perchlorate.

Labels on the Product

Labels on the casing inform about:

- Personal safety, see "Meaning of Safety Labels" on page 11
- Product and environment safety, see table below.
- Identification of the product

Labels regarding product and environment safety

	<p>Labeling in line with EN 50419 for disposal of electrical and electronic equipment after the product has come to the end of its service life. For more information, see "Disposal" on page 60.</p>
-------------------------------------------------------------------------------------	-------------------------------------------------------------------------------------------------------------------------------------------------------------------------------------------------------

Warning Messages in the Documentation

A warning message points out a risk or danger that you need to be aware of. The signal word indicates the severity of the safety hazard and how likely it will occur if you do not follow the safety precautions.

DANGER

Imminently hazardous situation. Will result in death or serious injury if not avoided.

WARNING

Potentially hazardous situation. Could result in death or serious injury if not avoided.

CAUTION

Potentially hazardous situation. Could result in minor or moderate injury if not avoided.

NOTICE

Potential risks of damage. Could result in damage to the supported product or to other property.

Korea Certification Class A



이 기기는 업무용 (A 급) 전자파 적합기기로서 판매자 또는 사용자는 이 점을 주의하시기 바라며, 가정외의 지역에서 사용하는 것을 목적으로 합니다.

CE Declaration of Conformity

ROHDE & SCHWARZ



Declaration of Conformity

This is to certify that:

Equipment type	Stock No.	Designation
CLP-6MK2	2904.4201.02/03	CLIPSTER 6MK2 Base Unit

complies with the provisions of the Directive of the Council of the European Union on the approximation of the laws of the Member States

- relating to electrical equipment for use within defined voltage limits (2014/35/EU) [LVD]
- relating to electromagnetic compatibility (2014/30/EU) [EMCD]
- relating to restriction of the use of hazardous substances in electrical and electronic equipment (2011/65/EU) [RoHS]

Conformity is proven by compliance with the following standards

- EN 62368-1:2014 + AC:2015
- EN 55032: 2015 / A11: 2020
- EN 55035: 2017
- EN IEC 63000:2018 (ROHS)

For the assessment of electromagnetic compatibility, the limits of radio interference for Class A equipment as well as the immunity to interference for operation in industry have been used as a basis.

Template: CE_EMCD_LVD_3572.7805.00.docx 3572.7805.00 / A1 01.00

ROHDE & SCHWARZ GmbH & Co. KG
Mühldorfstr. 15, D-81671 Munich

Munich, 2021-09-02
3632.1307.02

03.00

CE

EN

i.v. Kemmet
Corporate Quality Management GF QP1 / Kemmet
WK Page 1 / 1

ROHDE & SCHWARZ



Declaration of Conformity

Manufacturer: Rohde & Schwarz GmbH & Co. KG
Mühldorfstraße 15
81671 München, Germany

Model: CLP-6MK2

This device complies with Part 15 of the FCC Rules.

Operation is subject to the following to conditions:

- (1) This device may not cause harmful interference, and
- (2) This device must accept any interference received, including interference that may cause undesired operation.

Classification: Class A Digital Device subject to Part 15

We hereby declare that the equipment bearing the trade name and model number specified above was tested conforming to the applicable FCC rules under the most accurate measurement standards possible, and that the necessary steps have been taken and are in force to assure that production units of the same equipment will continue to comply with the Commission's requirements.

U.S. Responsible Party: Rohde & Schwarz USA, Inc.
6821 Benjamin Franklin Drive
Columbia, MD 21046

Contact: SDoC.Info@rsa.rohde-schwarz.com

ROHDE & SCHWARZ GmbH & Co. KG
Mühldorfstr. 15, D-81671 Munich

Munich, 2021-12-02
3632.1307.22

01.00

FCC SDoC

EN

Page 1 / 1

FC Declaration of Conformity

Product Description

CLIPSTER is a powerful high-resolution video workstation with enormous flexibility, designed to meet the demands of modern post production workflows. CLIPSTER processes both compressed and uncompressed single image and container files in any resolution up to 4K in RGB 16 bit as well as numerous audio and metadata formats. Arbitrary combinations of codecs, resolution, bit depth and color volume can be assembled on the timeline and will be processed without mezzanine conversion to the designated output format, ensuring the preservation of quality and creative intent.

The hardware allows for real-time in- and output of monoscopic or stereoscopic video in combination with up to 16 channels of audio.

This chapter is divided into following sections:

- Overview of the Front (page 17)
- Overview of the Rear (page 21)
- Important Notes (page 31)

Overview of the Front

This section gives an overview of the front of the system.

The following topics are covered:

- Front Cover (page 17)
- The Front of the System (page 18)
- Operation Panel (page 19)
- SSD Disk Array (page 20)

Front Cover

The front of the system is equipped with a front cover for mechanical protection and sufficient air circulation.



CLIPSTER chassis front view

Overview of the Front

The front plate covers the SSD disk array, and the operating panel. If you need access to one of the SSD disks, or to the operating elements, the front plate has to be unlocked and removed, see also "Removing the Front Cover" (page 46).

The Front of the System

Once the front cover is removed you have access to the operation panel, the SSD disk array and the USB ports:

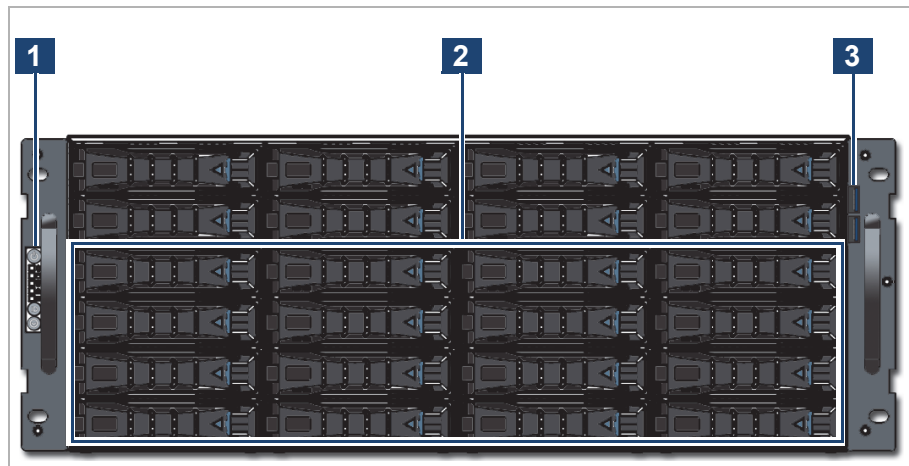

Front view without front cover

Operation items

No.	Item	Description
1	Operation Panel	Provides access to all operating items, see "Operation Panel" (page 19)
2	SSD Disk Array	When purchased with an internal storage option, the Solid State Disks will be mounted in these drive trays. See also "SSD Disk Array" (page 20).
3	USB 3.0 Ports	2 x USB 3.0 Type A port to connect external devices to the system.

Operation Panel

With the operation items at the system's front the hardware of CLIPSTER can be controlled (e.g. turned on or off). There you can also find LEDs that allow you to assess the state of the system.

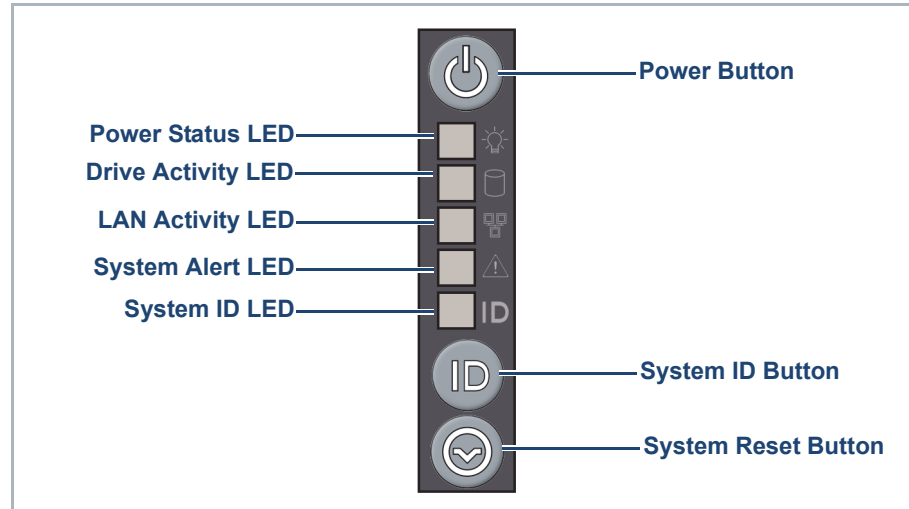

Operation Items

The System ID Button is linked to the ID button on the ATX connector panel on the rear of the system (see "ATX Panel" on page 27). Pressing either button once will illuminate the System ID LED on the Front Operation Panel and an LED located inside of the ID button on the rear. Pressing either button again will turn both LEDs off.

Overview of the Front

SSD Disk Array

The SSD disks of the disk array are used to store your video and audio data. It is the main storage of the R&S system. To prevent data loss in case an SSD disk fails, it is RAID protected.



Further information about RAID can be found in section “RAID Storage Protection” on page 45.

The system disks are not among the SSD disks of the SSD disk array. They are installed on the back of the system.

Once the front cover is removed, you have access to the SSD disk array:

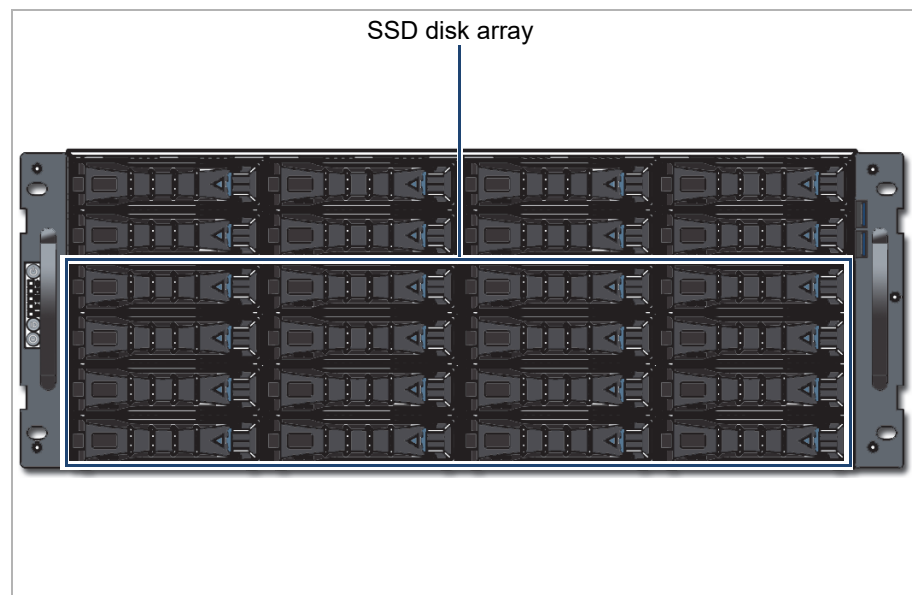

SSD disk array

The status of a single disk is indicated by two LEDs on the front of the disk carrier:

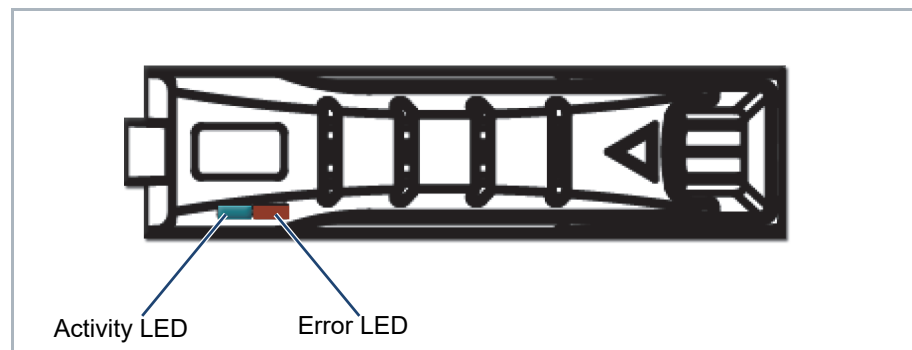

Status LEDs on Disk Drive

Activity LED	ON	Disk is present
	Blinking	Disk activity is detected or disk is being currently located.
	OFF	Not connected or power is off.
Error LED	OFF	Idle
	Blinking	Indicates a failure/repair/maintenance state such as rebuild, remap, abort process, etc.
	ON	Disk complete failure.



For information on how to remove the front cover, see section “Removing the Front Cover” on page 46.



Further information about how to remove and exchange an SSD disk can be found in section “SSD Disk Maintenance” on page 44.

Overview of the Rear

This section describes the rear of the system.

The following topics are covered:

- The Rear of the System (page 22)
- Main Connector Panel (page 23)
- Digital Video I/Os (page 24)
- ATX Panel (page 27)
- Slot Panel Connectors (page 28)
- Power Supply (page 30)

The Rear of the System

This section provides an overview of the rear of the system.

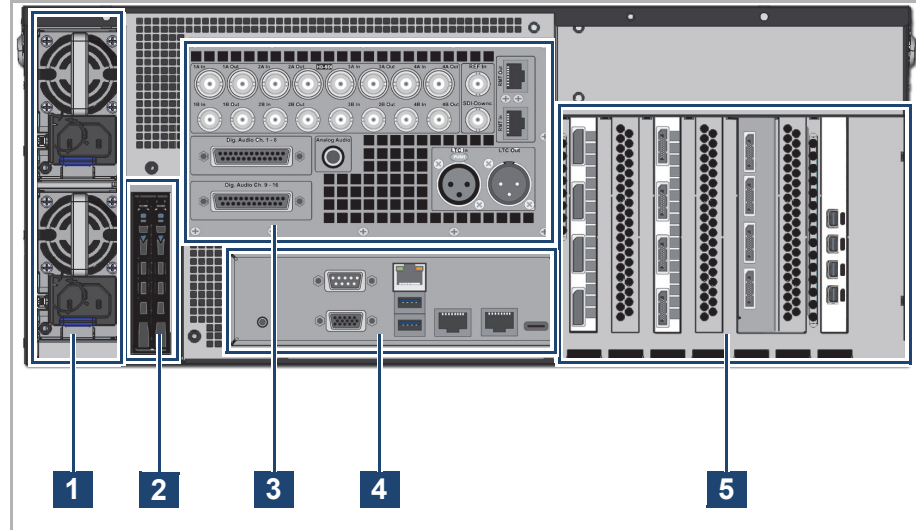

Rear view

Operation items

No.	Item	Description
1	Power Supply Units	2 x 1600W redundant power supply. Even if one fails the other will still supply enough power to keep the system operational. Further information about the power supply can be found in "Power Supply" (page 30).
2	System and Backup Drives	The left drive tray, located closer to the PSU modules, is supposed to contain the SSD with the System Backup Image. The right drive tray, located closer to the Main Connector Panel, is supposed to contain the SSD the active Operating System is booted from.
3	Main Connector Panel	The main connector panel provides interfaces for connections to peripheral A/V equipment see "Main Connector Panel" (page 23).
4	ATX Connector Panel	On this panel you can find the standard connectors of the computer system, see "ATX Panel" (page 27).
5	Slot Panel Connectors	Additional PCIe board interfaces, e.g. to connect to GUI monitors or to external storage devices, are located in this area. For more information see "Slot Panel Connectors" (page 28)

Main Connector Panel

Peripheral equipment can be connected to the CLIPSTER workstation using the interfaces located on the main connector panel.

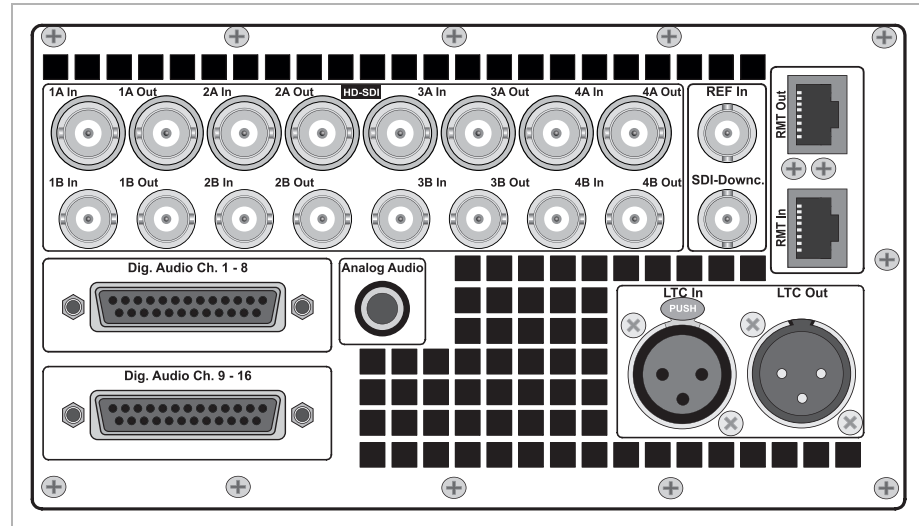

Main connector panel

Item	Description
LTC In	XLR connector (female) for an input of longitudinal time-code
LTC Out	XLR connector (male) for an output of longitudinal time-code
Analog	6.3 mm (1/4") unbalanced analog stereo headphone jack to monitor the audio of CLIPSTER.
Digital Audio Ch. 1-8	DB-25 connector (female) for a balanced audio signal in-and output of the digital audio channels 1 to 8 (AES/EBU).
Digital Audio Ch. 9-16	DB-25 connector (female) for a balanced audio signal in-and output of the digital audio channels 9 to 16 (AES/EBU).
RJ-45 Top	RMT-1: Serial interface for input / output of control signals using the RS-422 protocol, see "RMT In and RMT Out (RJ-45)" (page 68).
RJ-45 Bottom	RMT-2: Serial interface for input / output of control signals using the RS-422 protocol, see "RMT In and RMT Out (RJ-45)" (page 68).
HD-SDI In/Out	BNC connectors for input/output of digital HD video signals, see also "Digital Video I/Os" below.
REF In	BNC connector for a synchronization of video signals, i.e. the reference input; input of horizontal or composite sync depending on software settings
SDI Downconvert	BNC connector for down-scaled SDI signal from UHD/4K to 1080p/2K. The frame rate (up to 60 Hz) is not affected.

Overview of the Rear



Pin-outs of most connectors can be found in section “Signal In- and Outputs” on page 67.

For the availability of connectors not present at the rear of the system (blind panels) please contact Rohde & Schwarz.

Digital Video I/Os

CLIPSTER supports several SDI modes, which can be selected through the user interface in the software. Different SDI modes may require different connections to the digital video I/Os located on the main connector panel.

The I/O ports are divided into four quadrants, each of them having a row for the A and B links as well as two In and Out ports.

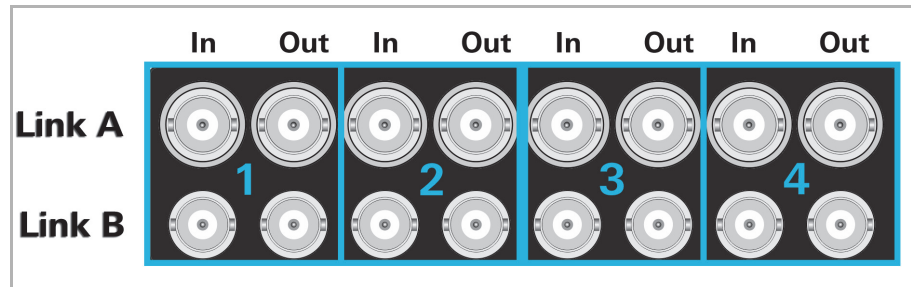

SDI general layout

R&S names the input/output ports of the digital video signals alphabetically: the main video link is available on the A ports and the secondary video link on the B ports. The numbers specify the quadrant those ports belong to. For example, a connection of 4K 1.5-Gbit/s SDI output will have the following layout:

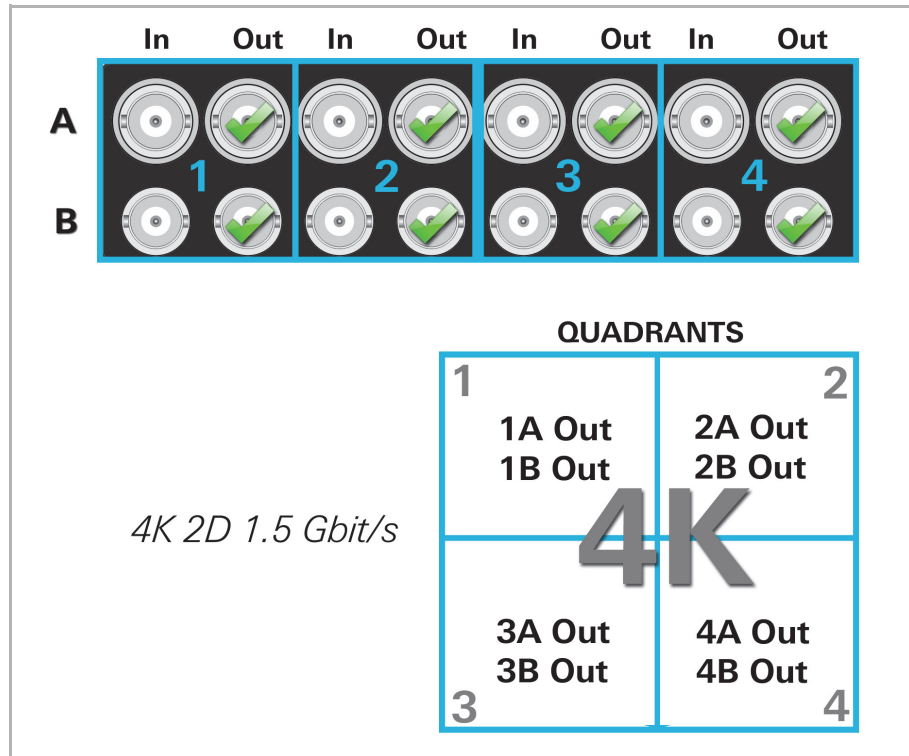

Layout of 4K SDI output at 1.5 Gbit/s

For in- and output CLIPSTER also supports 3-Gbit/s SDI which provides all features of a standard dual-link connection, but requires only one connector instead of two (SMPTE 425, level A and B). In the example above, only the A ports would be connected. A 3-Gbit/s input signal can be automatically detected by the software. For an output it has to be enabled via the software.

The following table gives an overview on the signal assignment on the SDI (serial digital interface) for different color modes and with a different connection speed (SDTV, 1.5 Gbit/s and 3 Gbit) considering also the fps:

Overview of the Rear

SDI supported data formats

Color Mode	Bit Depth	Frame Rate (Hz)	1.5G Link		3G Link	
			Monoscopic (2D)	Stereo-scopic (3D)	Monoscopic (2D)	Stereo-scopic (3D)
YUV 4:2:2	10	24 - 30	"A" connector	"A"+"B" connector		
		48 -60				
YUV 4:4:4 RGB 4:4:4 YUVA 4:2:2:4 YUVA 4:4:4:4 RGBA 4:4:4:4	10	24 - 30	"A"+"B" connector	n/a	"A" connector	"A"+"B" connector
YUV 4:2:2 YUV 4:4:4 RGB 4:4:4	12					



The type of video link used (single or dual) depends on the SDI mode, the fps mode applied and the selected connection speed.

In case of working with stereoscopic material, for input the user has to select special rasters in the software (I/O Tool) tagged with **STEREO**. For an output, the option **dual stream** must be selected in the user interface. The selected raster will be output at two ports (A+B) if available for the 3D stereoscopic workflow. The video stream assignment for left and right eye can be configured in the software.

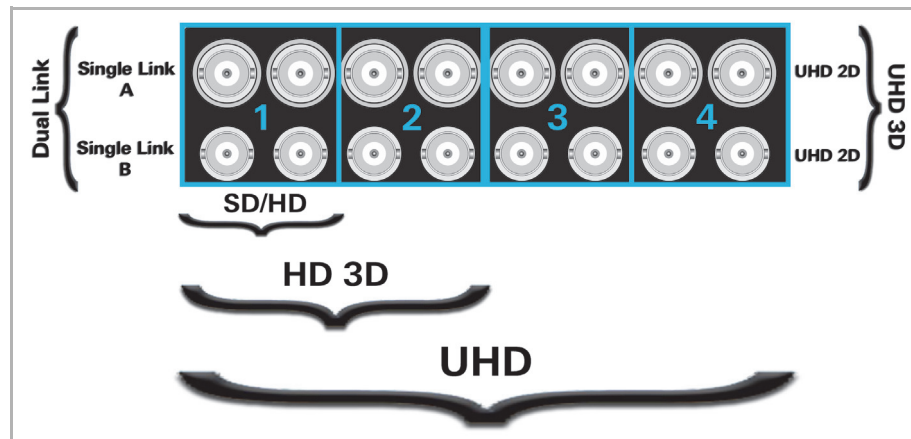

Layout of the Quadrants



The selected resolution determines the number of quadrants in use.

ATX Panel

The ATX connector panel on the rear of the R&S system holds the connectors of the computer system. It provides the following connections:

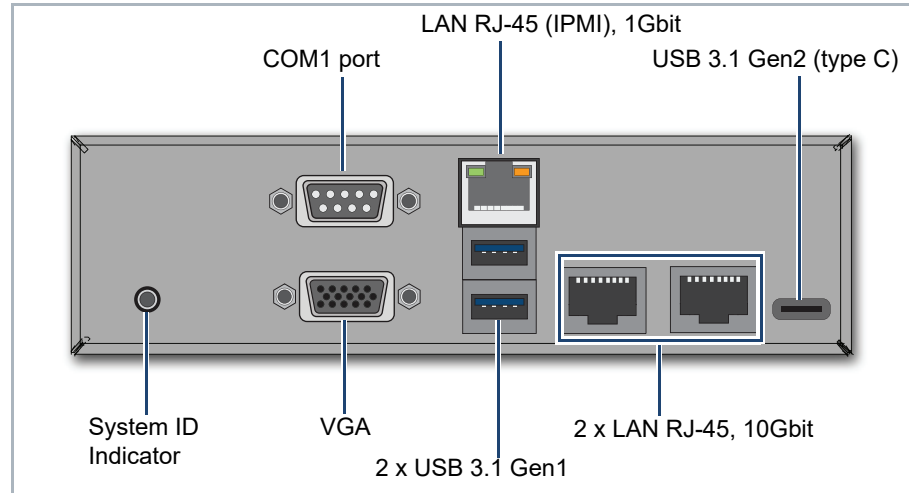

ATX Panel Connectors

COM1 Port	RS232 connector for the connection of serial interface devices.
LAN RJ-45 (IPMI)	1 Gb Ethernet connection port to connect the system to a network.
USB 3.1 Gen2 (type C)	A type-C USB to connect external devices to the system.
System ID Indicator	Press to trigger the ID LED located on the front of the system. Useful e.g. to locate the system within a rack among many other systems, see also informative section in "Operation Panel" on page 19.
VGA	DB-15 connector (female) to connect a monitor to the system.
USB 3.1 Gen1	USB connectors to connect external devices to the system.
2 x LAN RJ-45	2 x 10 Gb Ethernet connection ports to connect the system to a network.

Overview of the Rear

Slot Panel Connectors

CLIPSTER provides on its slot panel connector area various connections, such as the graphics card panel and the video I/O panel. Furthermore, if applicable, some additional panels may be present for internal reasons or on customer request.

Overview

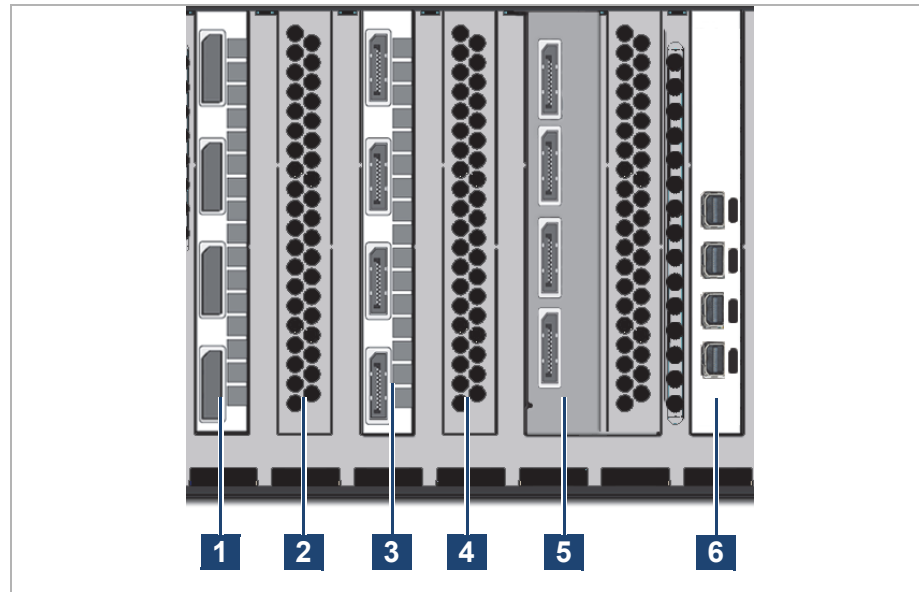

Slot panels on rear

No	Name
1	Option slot for JPEG2000 de-/encoding accelerator
2	Options slot for either a 100 GB network adapter or Fiber Channel
3	Video output panel (4 x DisplayPort or HDMI 2.0 via adapters).
4	Option slot for internal RAID controller.
5	Option slot for floating point processing unit (GPU)
6	Video graphics card to connect a display to your system



The layout of the slot panel area on your system may differ from the figure above: The position of the individual slot panels may vary and additional panels may be installed for internal reasons or on customer request.

Video Panel

The video output panel of CLIPSTER holds four video interfaces (Display-Port by default, or HDMI 2.0 via adapters) for an output of digital video signals. Pin-outs of the connectors can be found in "Signal In- and Outputs" (page 67).

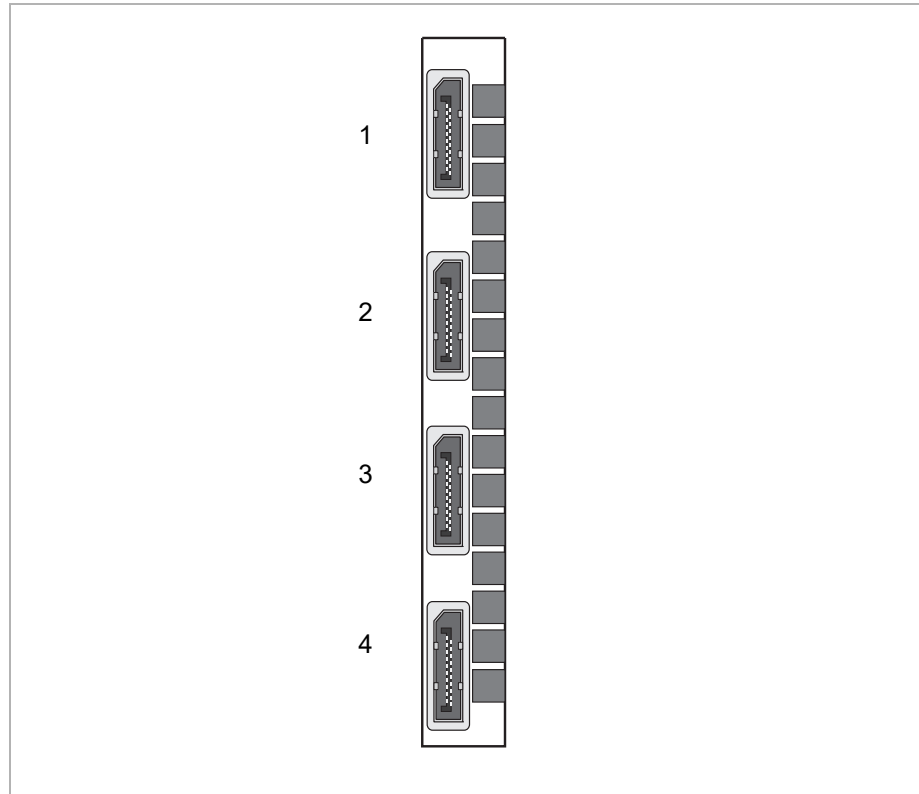

Video I/O panel

Item	Description
DisplayPort	DisplayPort connector for an output of digital RGB video signals (quadrants 1/2, either two independent single-link or one dual-link connection)
DisplayPort	DisplayPort connector for an output of digital RGB video signals (quadrants 3/4, either two independent single-link or one dual-link connection)

HDMI 2.0 supported data formats (via optional adapter 2904.1060.03)

Color mode	Bit Depth	FPS
YUV 4:2:0	8 bit	up to 60p
YUV 4:2:2	8, 10, 12 bit	up to 60p
RGB	8 bit	up to 60p
	10, 12 bit	up to 30p

Overview of the Rear

Graphics Card

The monitor for the CLIPSTER software has to be connected here. The panel provides four Mini-DisplayPort connections.

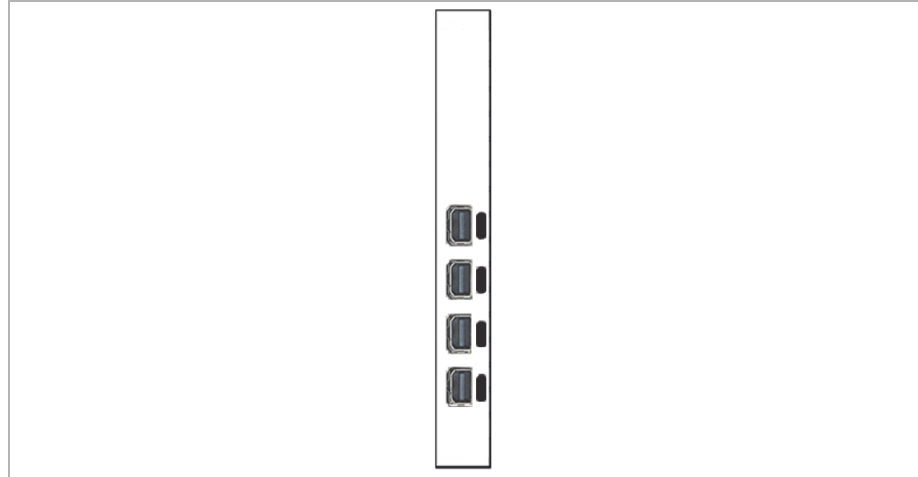

Graphics Card

For further information about the graphics card, please refer to the original manufacturer's documentation.

Power Supply

The redundant power supply consists of two independent power supply modules: Even if one fails, the other should output sufficient current to keep the system working.

NOTICE**System Damage**

The system can be operated with one power supply unit out of order. However, if the other one fails, a continued operation of the system cannot be guaranteed.

Change a failed power supply unit immediately (see section "Power Supply Maintenance" on page 58).

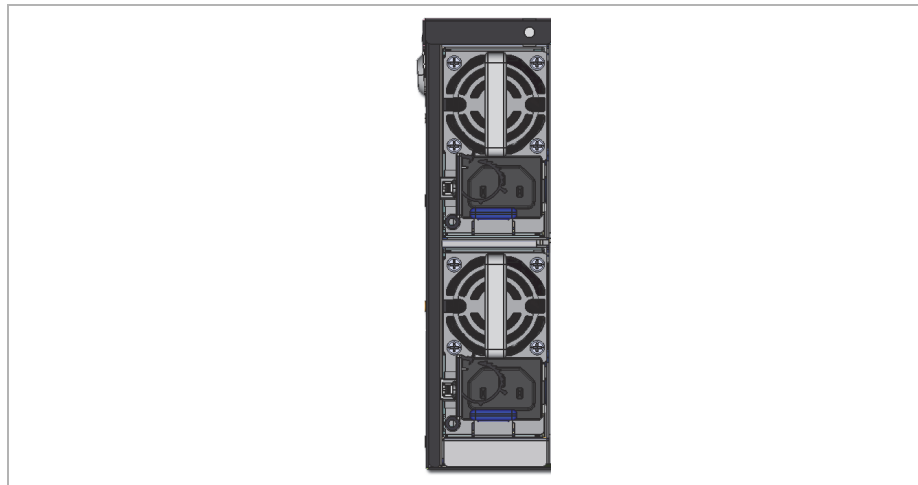

Power supply units

Power supply

1600W 1+1 redundant power supply

- AC INPUT:

- 100..127V, 50..60Hz, 13A

- 200..240V, 50..60Hz, 10A

- The IEC C14 AC connector requires a C13 AC jack.



To pull out a power supply unit you have to remove the security bar of the power supply first, see section “Power Supply Maintenance” on page 58.

Important Notes

Please observe the following general important notes:

NOTICE**Performance Loss**

This system has been delivered to you fully preconfigured and optimized for a real-time in- and output of uncompressed video streams. Changing any of the settings (e.g. the hardware, software and/or BIOS settings) may lead to a loss of performance or may even render the system unusable. Re-configuring the system anew is in most cases a lengthy procedure.

Do not change any of the settings unless you are absolutely sure of what you are doing and what the results would be.

Important Notes

NOTICE**Windows Updates**

So far there are no known issues with Windows updates provided by Microsoft and we do recommend installing those patches. However, Rohde & Schwarz cannot be held responsible for unexpected problems arising due to updates of the operating system.

It is the customer's responsibility to update the Windows operating system and install security patches.

NOTICE**Third-party Software**

Your R&S system has been tested thoroughly to ensure its reliability when running R&S software. The effects of installation and use of third party software and drivers may disrupt the real-time capability and/or limit the functionality of your system.

NOTICE**SSD Power Supply**

Leaving the system without power supply for long periods of time may have adverse effect on the SSD storage.

We recommend not leaving the system without power supply for long periods of time.

NOTICE**Designated Data Storage Locations**

Other data storage locations may only provide insufficient bandwidth and latency for real-time operations.

Only use the designated data storage locations to store video and audio data.

NOTICE**Potential Video Board Oil Leak**

The heat-conducting pads enclosed in the air duct of the video board may leak some oil over time due to the mechanical process involved. This does not lead to any deterioration of the cooling performance, and any potential leakage of this oil film will not affect CLIPSTER's functionality in any way.

Installation and Operation

This chapter describes the installation and operation of the CLIPSTER hardware. The system must be installed properly before you can start working with it.

This chapter is divided into the following topics:

- Unpacking the System (page 33)
- Mounting the System into a Rack (page 34)
- Connecting Monitor, Mouse and Keyboard (page 38)
- Operating the System (page 39)

Lifting and Carrying



Risk of Injury

Lifting the system by yourself may result in serious injury and property damage.

Do not attempt to lift the system by yourself, always get others to assist you.

We recommend to use lifting equipment, see also "Lifting and Carrying the Product" on page 8.

Unpacking the System

Perform the following steps:

1. Unpack the product carefully.
2. Retain the original packing material. Use it to protect the control elements and connectors when transporting or shipping the product later.
3. Check your delivery and compare it with the delivery note. In case of missing items, please contact your vendor or R&S immediately.
4. Place the system on a flat surface to prepare it for mounting into the rack.

The system is unpacked and ready for installation.

Choosing the Operating Site

Specific operating conditions ensure proper operation and avoid damage to the product and connected devices. For information on environmental conditions such as ambient temperature and humidity, see the data sheet.

See also "Choosing the Operating Site" on page 9.

Electromagnetic compatibility classes

The electromagnetic compatibility (EMC) class indicates where you can operate the product. The EMC class of the product is given in the data sheet under "General data".

- Class B equipment is suitable for use in:
 - Residential environments
 - Environments that are directly connected to a low-voltage supply network that supplies residential buildings
- Class A equipment is intended for use in industrial environments. It can cause radio disturbances in residential environments due to possible conducted and radiated disturbances. It is therefore not suitable for class B environments.

If class A equipment causes radio disturbances, take appropriate measures to eliminate them.

Mounting the System into a Rack

The system is to be operated in a 19-inch wide rack.

Rack System Precautions

The following safety requirements must be considered when the unit is mounted in a rack.

- The rack construction must be capable of supporting the total weight of the installed enclosure(s) and the design should incorporate stabilizing features suitable to prevent the rack from tipping or being pushed over during installation or in normal use.
- The system must be operated with low pressure rear exhaust installation [back pressure created by rack doors and obstacles not to exceed 5 pascals (0.5mm water gauge)].
- The rack design should take into consideration the maximum operating ambient temperature for the unit, which is 35°C.
- The rack should have a safe electrical distribution system. It must provide over-current protection for the unit and must not be overloaded by the total number of units installed in the rack. When addressing these concerns consideration should be given to the electrical power consumption rating shown on the nameplate.
- The electrical distribution system must provide a reliable earth for each unit in the rack.

Mounting the System into a Rack

- The design of the electrical distribution system must take into consideration the total earth leakage current from all the power supplies in all the units. The rack may require labeling with "HIGH LEAKAGE CURRENT. Earth connection essential before connecting supply".
- The rack when configured with the units must meet the safety requirements of current UL and IEC specifications.

⚠ WARNING**Rack Toppling Over**

Racks may topple over due to a massive overweight in the upper part.

Do not slide more than one enclosure out of the rack at a time. When loading a rack with enclosures, fill from the bottom up; empty from the top down. Close all enclosures before loading.

⚠ CAUTION**Risk of Injury**

The weight of the system is around 45kg (99lbs), or more.

Do not attempt to lift the system by yourself, always get others to assist you.

Mounting the System

Perform the following steps:

1. Make sure the system is unpacked and placed on a flat surface, see "Unpacking the System" (page 33).
2. Pull the inner rail out of the slide rail until it clicks and detach the inner rail completely from the slide rail by pulling the tab forward.

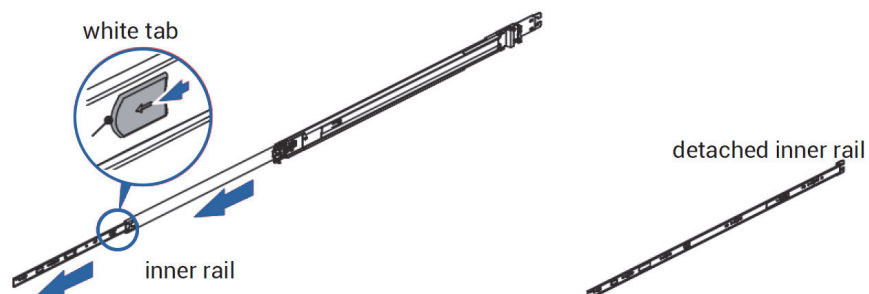

Mounting the System into a Rack

3. After the inner rail is dislodged, adjust the middle rail back to its original position by pushing the tab on the middle rail.



4. Install the inner rail onto the system casing. Lock the keyholes and secure the screws.

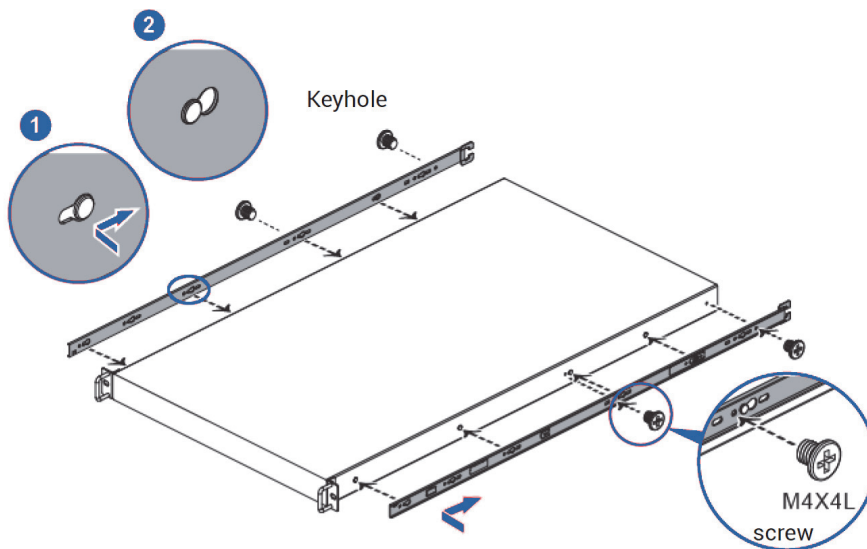

Mounting the System into a Rack

5. Continue installing the outer rail bracket to the mounting frame. Attach the outer rail assembly to the frame and press the bracket to fix the rail onto the frame.

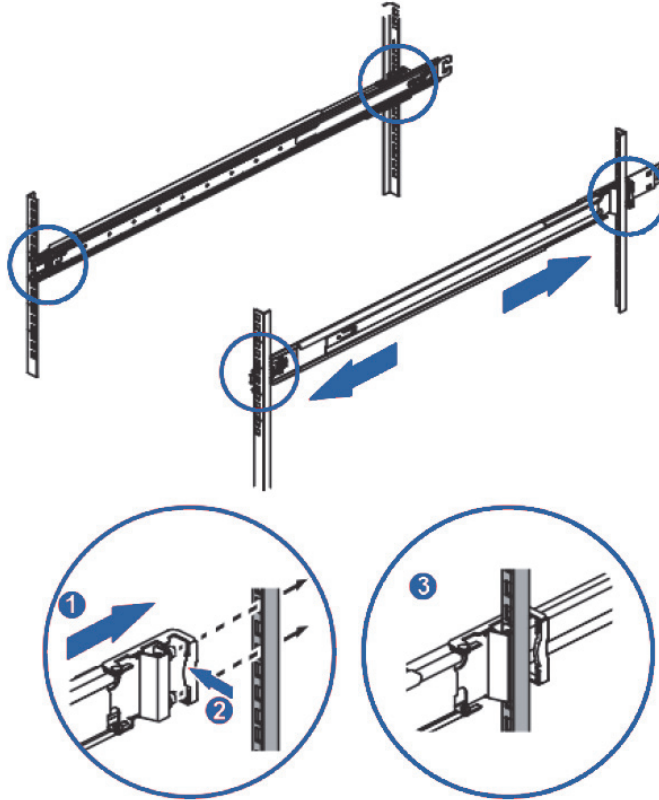

6. Pull out the middle channel until the ball bearing retainer is locked forward.

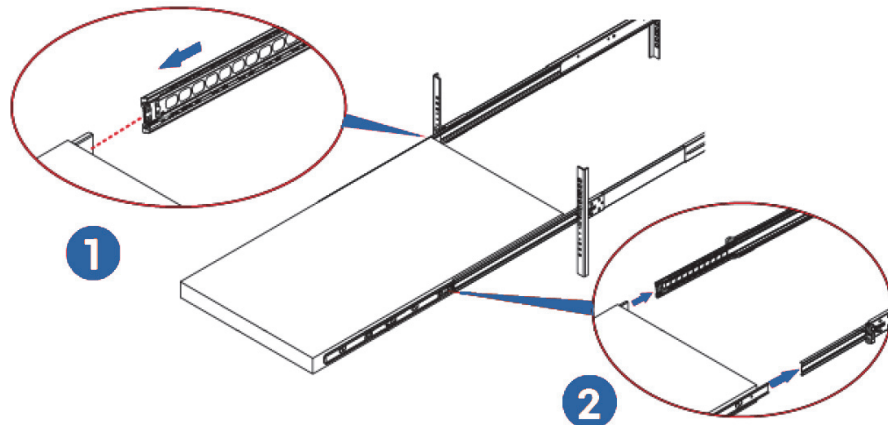

7. **CAUTION!** Verify the ball bearing retainer is locked.

Connecting Monitor, Mouse and Keyboard

8. Slide the release tab and push the system into the rack.

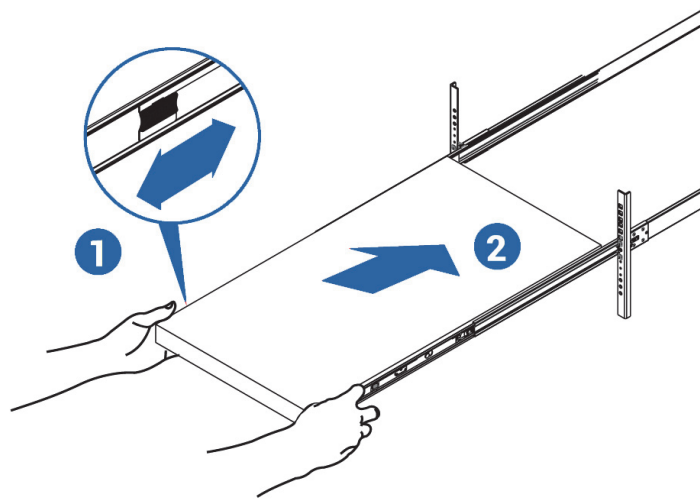

CLIPSTER is now mounted into the rack.

Connecting Monitor, Mouse and Keyboard

Perform the following steps:

1. Connect at least the following computer peripherals:
 - mouse
 - keyboard and
 - a monitor that is operable at a resolution of at least 1920 x 1080 pixels (default manufacturing setting).



The recommended resolution to run the R&S software is between 1920 x 1080 and 2560 x 1440 pixels.

2. Connect any other peripheral computer and video equipment. For an overview of the panels and connectors at the system's rear, see section "Overview of the Rear" on page 21.

Connecting to Power

For safety information, see "Connecting to Power" on page 9.

Perform the following steps:

1. Plug the AC power cable into the AC power connector on the rear panel of the product. Only use the AC power cable delivered with the product.
2. Plug the AC power cable into a power outlet with ground contact. The required ratings are listed in the data sheet.
3. If necessary, also ground the product using the grounding terminal.
4. Install any other remaining cables before switching on the product.

Operating the System

This chapter describes how to operate the CLIPSTER hardware, i.e. it is explained how to start the system and how to shut it down. For both procedures you have to use the power switch of the operation items at the front of the system.

The following topics are covered:

- Starting the System (page 39)
- First Login (page 40)
- Shutting Down the System (page 41)
- IPMI Login (page 42)

Starting the System

After a proper installation of the system you may start the R&S system at any time.

Perform the following steps:

- Press the power switch to turn on the system.

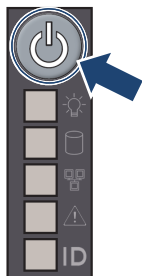

- ▶ The system will be started. As with any standard computer after initial booting, the system begins to load the installed operating system. When the operating system has finished its loading, you can begin to work with the R&S system right away.

Operating the System

First Login

CLIPSTER is shipped with an individual factory default password for the Windows user account "admin". This password follows the pattern:

win[6-digit serial number].

The serial number of the system is located on the back of the system.

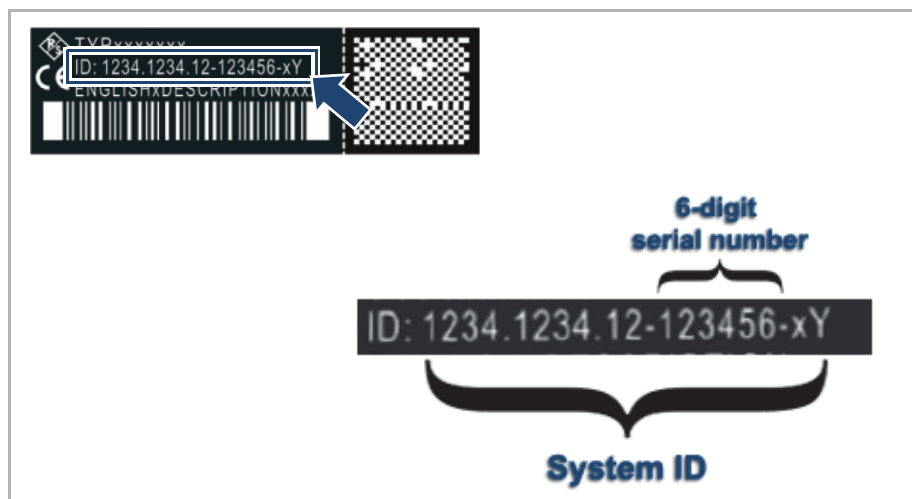

Serial number of the system

Please change this password immediately after the first login by pressing **Ctrl+Alt+Delete** on your keyboard and selecting **Change password** from the menu, or go to **Start > Settings > Accounts > Sign-in options**. Under "Password", select the **Change** button.



For a reasonable level of system security, all user accounts should be set up with an individual password. The CLIPSTER application only requires a standard Windows user account (not a local admin account), therefore we also recommend to add one or more standard user accounts to the system to increase system security.

Shutting Down the System

There are several possibilities to shut down the system. It depends on whether the operating system is already loaded, frozen or not completely loaded. Please act accordingly.

Shut down with operating system fully loaded

If the operating system is up and running, there are two ways to shut down your system.

NOTICE**System Damage**

It takes a while to safely erase all memory banks of the system.

After a shut-down wait at least ten seconds before starting the system again.

Perform the following steps:

1. Turn the system off by shutting down the operating system through the Windows menu.
 - ▶ The operating system will then save your personal settings and once it has ended, the system will turn off.
2. Alternatively, you can initiate a fast shut down by pressing the power switch briefly.
 - ▶ Some settings will be saved and afterwards the system turns off.

NOTICE**Data Loss**

The fast shut-down may not save all your system data and personal settings before the system turns off.

System is shut down.

Shut down with operating system frozen or not completely loaded

If the operating system is not responding anymore or not completely loaded, do as follows:

NOTICE**Corrupted Data**

Shutting down the system while frozen or not completely loaded may lead to corrupted system data.

Use this procedure only if absolutely necessary.

Operating the System

Perform the following steps:

- Shut down the system by pressing the power switch until the system turns off.

The system will then shut down immediately.

IPMI Login

The system is accessible and configurable via the IPMI interface. The IPMI IP address is displayed at boot time. The pre-configured IPMI login name is "admin", and its password is:

ipmi[6-digit serial number of the system]

Maintenance

This chapter explains the maintenance work that you can perform on your own. For each work a detailed procedure description is given. If you experience trouble with the system that cannot be resolved with the work described here, please contact your local vendor or Rohde & Schwarz directly.

This chapter is divided into the following sections:

- Safety during Maintenance (page 43)
- SSD Disk Maintenance (page 44)
- Removing the Top Cover (page 50)
- Recovery of the System Disk (page 51)
- Fan Maintenance (page 55)
- Power Supply Maintenance (page 58)
- Cleaning (page 59)
- Storage (page 59)
- Disposal (page 60)

Safety during Maintenance

This section provides safety instructions to be especially observed during maintenance work.

NOTICE

Electronic Discharge

Computer hardware contains components that are sensitive to electrostatic discharge. If you touch them without precautionary measures, they can be destroyed.

It is recommended that you fit and check a suitable anti-static wrist or ankle strap and observe all conventional ESD precautions when handling plug-in modules and components. Avoid contact with midplane components and module connectors.

CAUTION

Risk of Cutting Injury

Maintenance inside the system should be performed with caution especially near internal chassis edges or when working with sharp hardware components to avoid cuts on fingers, hands or arms. Wear appropriate protective cloths, when applicable.

⚠ CAUTION**Risk of Burn Injury**

Some of the components inside the system could get very hot (e.g. CPU, PCI cards, etc.) and thus pose danger of burning your skin.

Wait for those components to cool down before maintenance is started.

⚠ CAUTION**Noise Protection**

Working in noisy environments may damage your hearing.

When performing maintenance task in loud areas use personal hearing protective devices, and ensure they are worn correctly.

⚠ CAUTION**Postural Deformities**

Maintenance shall only be done after it was made sure that postural deformities can not arise from working on the product.



When replacing an electrical module, always have available a replacement or blank module before removing the old one. When you replace a module, you must never leave an empty bay in the rear of the enclosure.

SSD Disk Maintenance

This section deals with the possible event of a SSD disk failure.

The following topics are covered:

- RAID Storage Protection (page 45)
- Removing the Front Cover (page 46)
- Identifying a Defective SSD Disk (page 46)
- SSD Disk Replacement (page 47)
- SSD Disk Removal (page 48)
- Replacing the SSD Disk in the Carrier (page 49)
- Reassembling the SSD Disk (page 49)

RAID Storage Protection

In a system with huge amounts of data processed, large storage capacities combined with high data throughputs are mandatory. To provide both at the same time it is common practice in the area of video and digital film to configure several SSD disks together into a stripe set or RAID.

The RAID feature makes the R&S system tolerant of disk failures. Even with a broken disk operations can still be continued and, once the failed disk has been replaced, the missing data can be easily recovered. The data protection is provided by a RAID controller installed inside the system. The controller administers the data protection for the sets of SSD disks connected to it.

The optional internal storage of the R&S system comprises one or more SSD disk packs. These are connected to RAID controllers in a RAID 5 setup. With this, the data is striped across these SSD disks during write procedures. At the same time the information necessary to rebuild a failed disk (parity information) is generated and written across the disks as well. With the parity information written, one SSD disk per disk set (RAID pack) can fail and your data will still be recoverable as the information is stored on the other disks.

NOTICE**Data Loss**

If a second disk within the same disk set fails in the meantime, the data will be unrecoverable.

You can identify the SSD disks that are connected to a RAID controller easily at the R&S system because every two rows represent one disk set/RAID pack:



Disk sets (RAID packs) of the SSD disk array

With the available RAID feature the R&S system can withstand disk failures without losing data or access to data.

Removing the Front Cover

To get access to the disk arrays you will have to first remove the front cover.

NOTICE **Electromagnetic Compatibility**

The system must be operated only with the front cover closed to ensure electromagnetic compatibility.

Perform the following steps:

1. Unlock the front cover on both sides.
2. Push both levers inwards to detach the cover and remove it.



To attach the front cover reverse the above steps.

The front cover is now removed.

Identifying a Defective SSD Disk

In case of an alert or when suspecting a defective SSD disk, you have to identify the broken SSD disk first in order to replace it.

NOTICE **Alert**

An alert can be caused by a number of reasons. Please refer to section “Troubleshooting” on page 61 first for further details about what to do in case of an alert.

If a SSD disk fails, the alert will be triggered by the RAID controller. Data accesses to the SSD disk array are still possible because any missing data will be recalculated from the parity information stored on the other SSD disks of the disk set. This can limit the overall performance and real-time operations may no longer be possible.

NOTICE**Data Loss**

If you do not replace a defective disk in time and another disk fails in the meantime, your data may be unrecoverable.

Before replacing a SSD disk you have to gather the log files of the RAID controller. If you do not know how to do this, please contact the Rohde & Schwarz service department first.

Replace the failed disk as soon as possible.

In most cases you can find the broken disk by simply observing the LEDs of the disk array, see section “SSD Disk Array” on page 20. The status of a single disk is indicated by two LEDs on the front of the disk carrier:

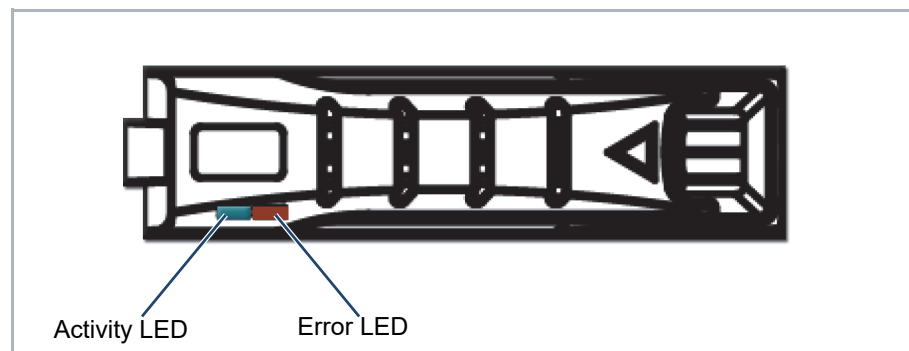

Status LEDs on Disk Drive

Once the defective disk has been identified, you can replace it as described in section “Replacing the SSD Disk in the Carrier” on page 49.

NOTICE**Total Loss of Data**

Replacing the wrong SSD disk, i.e. a good one instead of the defective one, may result in a total loss of data.

If you are unsure about having detected the correct SSD disk please contact the Rohde & Schwarz service department.

SSD Disk Replacement

As soon as the broken SSD disk has been identified (see section “Identifying a Defective SSD Disk” on page 46), it can be replaced easily. The replacement of a broken SSD disk can be divided into three steps:

- 1 Removing the SSD disk from the system.
- 2 Replacing the SSD disk.
- 3 Reassembling it into the system

NOTICE**Log Files**

Before replacing a SSD disk you have to collect the log files of the RAID controller. If you know how to do this you may proceed on your own. If not, please contact the Rohde & Schwarz service department first.

SSD Disk Removal

The SSD disks that are accessible at the front of the system are connected to the system with the help of disk carriers. They can be removed easily, even when the system is running (hot-swappable).

Perform the following steps:

1. If applicable, stop all accesses to the SSD disk array of your system, for example, by exiting the video system software and severing the network connections.
2. Remove the front cover of the system, see section "Removing the Front Cover" on page 46.
3. Unlatch the disk carrier of the defective SSD disk by pressing the release button of the tray lever to loosen the lever.
 - ▶ This will cause the lever to come out of the disk carrier so that it protrudes from the rest of the disk carriers.

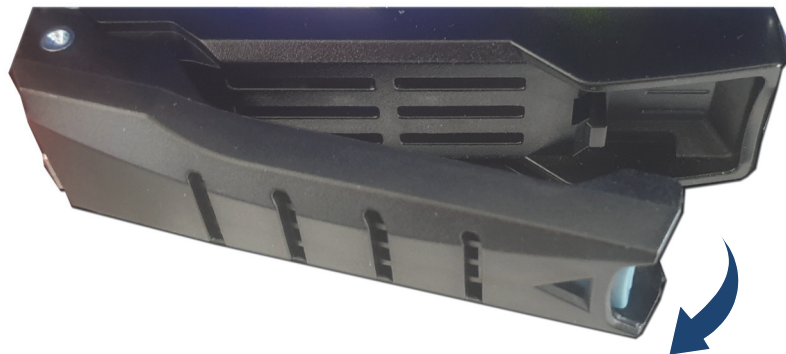

4. Pull the tray lever outward completely and remove the disk carrier out of the system.

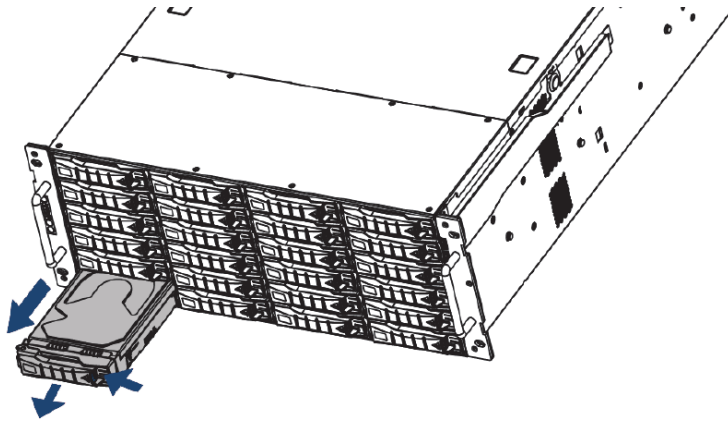

Replacing the SSD Disk in the Carrier

NOTICE

System Damage

Significant environmental changes, for example, altitude, voltage, temperature, shock, vibration, etc., can damage a SSD disk.

Handle SSD disks with great care.



It is best to use the same brand and type of SSD disk again. Otherwise a loss of performance might occur.

Perform the following steps:

1. Unscrew the screws that fix the SSD disk to the disk carrier.
2. Exchange the defective disk with a new one and assemble it in the disk carrier with the screws.

Reassembling the SSD Disk

After replacing the SSD disk, the disk carrier with the new disk has to be reassembled in the system.

Perform the following steps:

1. Slide the disk carrier back into its shaft at the disk array.
2. Push the disk carrier completely back into the shaft. Move it until you feel the resistance of the SSD disk interface inside the system and until the lever retracts.
3. Close the lever until it snaps back in place which as a result will slide the carrier completely back in.

Removing the Top Cover



The disk carrier of the replaced disk should be level with the others of the array.

4. Once the front cover of the system is back in place, the replacement of the SSD disk is finished. After several minutes the replaced SSD disk will be automatically recognized by the system. Then the rebuild of the data will be initiated automatically. When the system has finished the rebuild, the system will be fully operational again.

NOTICE**File Access to the Disk Array**

During a rebuild, real-time processing may not be possible. It is recommended to restrict file access to the SSD disk array until the rebuild is finished, as it takes several hours.

Avoid file access operations to the disk array during this time, otherwise it may take considerably longer.

Removing the Top Cover

This section guides you through the process of opening the casing. This is required e.g. in case you have to replace a defective PCI board or a cooling fan.

DANGER**High Voltage**

The system you are working on operates with voltages that can be hazardous to your health.

Do not work on the system or access its interior with the power cables being plugged in.

Make sure the power supply is disconnected from the components you intend to work on.

NOTICE**System Damage**

The system must be operated only with the chassis' cover installed to ensure proper cooling.

Perform the following steps:

1. Shut down the system as described in section "Shutting Down the System" on page 41. and remove all power cords.
2. Press the release button x 2 on both sides of the chassis.

3. Slide the top cover towards the rear end of the system.

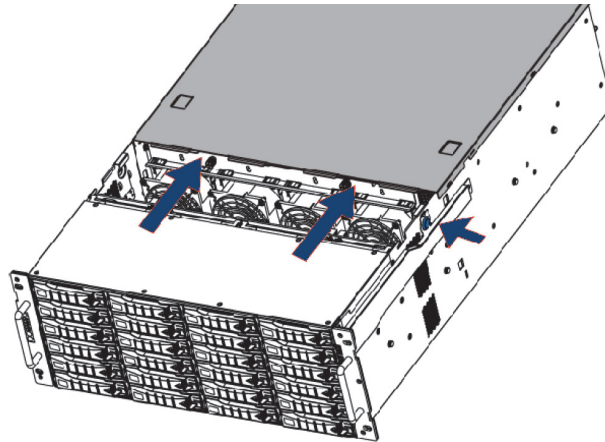

- ▶ Once the cover is slid backward, it can be taken off the system

4. Lift the cover upwards to remove.

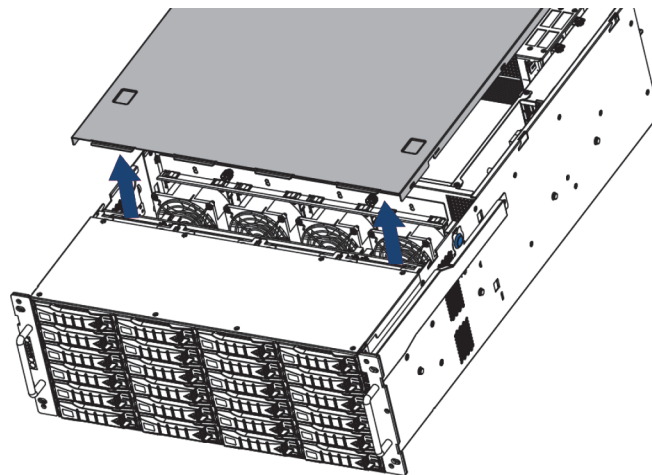

5. To close the casing, simply put the cover back on and slide it into place until it locks.

Recovery of the System Disk

The R&S system provides a backup SSD drive (see "Overview of the Rear" on page 21) that can be used to restore the operating system on the system disk back to its manufacturing state. Once selected as a boot device, it will launch a Live Linux which in turn will restore the system disk.

NOTICE**Total Loss of Data**

Selecting the wrong device can lead to a total loss of data.

Do not execute any commands if you are not sure about the correct target device.

Recovery of the System Disk

Perform the following steps:

1. If appropriate, disconnect all Fibre Channel cables and all externally connected storage devices from the system.
2. Turn on or restart the system and at the indicated moment during start-up press **[F11]** on your keyboard to enter the boot menu.
3. Once the boot menu is displayed on the screen, select the SSD backup drive (SATA_1 AHCI) as the boot device and then press **[Enter]** on your keyboard.

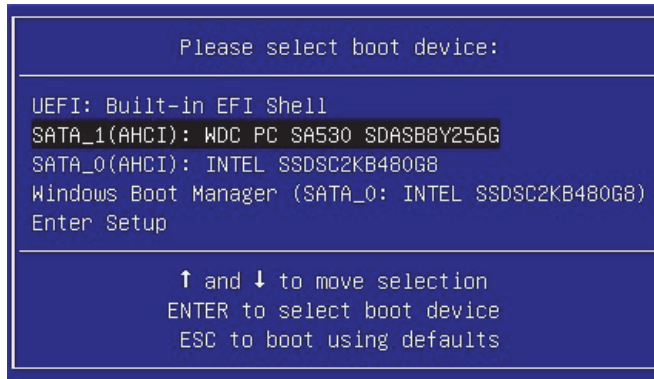

- ▶ The system will now boot from the backup drive and you will see a window on the screen where you can select the R&S Rescue environment for loading.



To complete the loading of the R&S Rescue environment some user entries are required. For this follow the instructions given on the screen.

The loading of the environment and the process itself will both try to initialize hardware that may not be present on your system. Any error messages displayed during loading/initialization, e.g. Failed or Warning, can be disregarded. The backup/recovery process should work nonetheless.

- Select RuS Rescue and press **[Enter]** on your keyboard.

```

Rohde & Schwarz Rescue Tools

RuS Rescue
Local operating system in harddrive (if available)
Memory test using Memtest86+

Press [Tab] to edit options

Automatic boot in 26 seconds...

* RuS Rescue Tools based on Clonezilla Live Version.
* Please observe that the RuS backup and recovery feature
  was developed exclusively for R&S hardware and is not
  intended for devices of other manufacturers.
* For possible malfunctions, damages or losses associated
  with the usage of the feature on non-DVS hardware,
  R&S offers no support and cannot be held liable.

```

- ▶ Once the loading has finished, you will see the R&S Rescue menu with its options on the screen:

```

--- RuS Rescue ---

01 - Backup on internal USB device
02 - Restore from internal USB device
03 - Backup on self selected external device
04 - Restore from self selected external device
05 - Reboot the system
06 - Poweroff the system

0 - Exit

Enter selection: 2

```

- To restore your system disk from the backup drive, press **[2]** and then **[Enter]** on your keyboard.
 - ▶ A list of possible target devices will be detailed on the screen. The system disk normally is the 'ATA' disk with, for example, 'sda', 'sdb' or 'sdc' as its device name:

```
[1:0:0:0 disk ATA <device info> /dev/sda
Please enter the System-Device ( for example sda )
```

NOTICE

Data Loss

The actual device name of the system disk depends on the manufacturing process. A recovery will overwrite all your data.

Continue with the following steps only when you are able to identify the correct target device.

- Enter the name of the system disk: Type in e.g. **sda** (or in other cases **sdb**, **sdc**, etc.) and press **[Enter]** on your keyboard.
 - ▶ Another list will be displayed on the screen detailing the possible source images. If there is only the recovery image on the backup drive, this one will be listed. If there are several images, all will be displayed.

Recovery of the System Disk

7. Select the image you want to use for the recovery. Usually, it provides the serial number of the system in its name. To confirm your choice press **[Enter]** on your keyboard.
 - ▶ The system will ask you to confirm your selection and whether you want to continue:
8. To start the recovery process type in **y** for 'yes' and press **[Enter]** on your keyboard.
 - ▶ The program will now start the recovery process. Its progress will be indicated on the screen.



To abort the process at this point enter **n** for 'no' and press **[Enter]** on your keyboard. You will be redirected to the R&S Rescue menu.

After starting the process a termination is no longer possible.



The recovery process may take some time.

If during the process the screen turns black, press **[Space]** to get it back again.

When the system has finished the recovery process, you will be notified. Then after pressing **[Enter]** on your keyboard, you will be redirected to the R&S Rescue menu once more where you can choose, for example, 'reboot' or 'poweroff' to restart or turn off the system. The next time the system is started, it will load the restored operating system.

Fan Maintenance

The system is equipped with several fans that can be exchanged in case of a failure easily. This section describes what to do if a fan fails.

The following topics are covered:

- Preparations (page 55)
- Replacing the Fan (page 57)

Preparations

DANGER

High Voltage

The system you are working on operates with voltages that can be hazardous to your health

Never work on the system or access its interior with the power cable(s) being plugged in.

Make sure the power supply is disconnected from the components you intend to work on.

Maintenance inside the system should only be performed by personnel qualified for handling and testing electrical equipment.

NOTICE

Electrostatic Discharge

Computer hardware contains components that are sensitive to electrostatic discharge. If you touch them without precautionary measures, they can be destroyed.

Avoid touching the internal components of the computer system.

⚠ DANGER**Serious Injury**

Testing the fans is possible only with an opened casing and the power turned back on.

Once the power cables are plugged in again do not touch anything else than the external power cords or the power switch at the front of the system.

Under no circumstances reach inside the system.

After testing the fans switch off the power and disconnect the power cables immediately.

Perform the following steps:

1. Shut down the system and unplug all power cables.
2. Open the casing of the system as described in section "Removing the Top Cover" on page 50.
3. With the casing of the system open, you can now test the fans. For this you have to plug in the power supply again.
4. Reconnect the power cords.
5. Press the power switch to turn on the system.
6. Observe the fans and memorize the failed one (the fan not revolving is the broken one).
7. Press the power switch until the system turns off.
8. Disconnect the power cables once again.

Replacing the Fan

NOTICE**System Damage**

Third-party spare parts might damage your system.

Only use original manufacturer spare parts.

Perform the following steps:

1. Pull the fan module from the node. Pay attention to carefully dislodge the rubber connectors from the attached bracket.

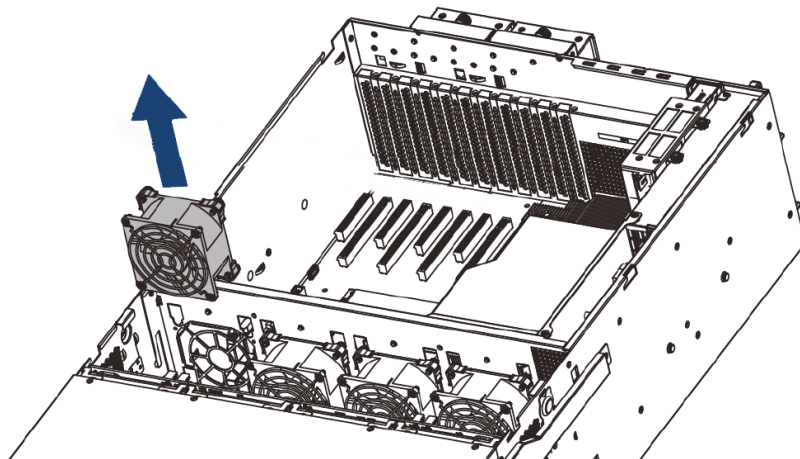

2. Insert the replacement fan into the node. Make sure to align the rubber connectors with the appropriate slot in the bracket.

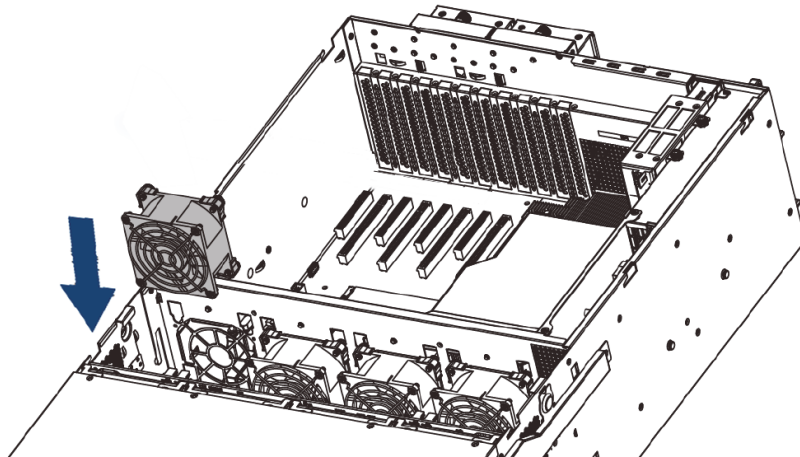

With the last step finished you have successfully replaced the defective fan module.

Power Supply Maintenance

This section describes the maintenance of the power supply.

The following topics are covered:

- Power Supply (page 58)
- Replacing a Power Supply Unit (page 59)

Power Supply

The redundant power supply provides the system with power. It is a reliable and enduring part of the system because it consists of several independent power supply units: Even if one fails the other will still offer enough power to keep the system working.

NOTICE**System Damage**

The system can be operated with one power supply unit out of order. However, if another one fails, a continued operation of the system cannot be guaranteed.

Change a failed power supply unit immediately.

Each power supply unit in the R&S system is hot-swappable, so you can safely replace it with the system running, if necessary.



For an overview of a power supply unit see section “Power Supply” on page 30.

CAUTION**Injury**

Do not reach inside the system when removing a power supply unit or when the unit is out of the system.

NOTICE**System Damage**

Third-party spare parts might damage your system.

Only use original manufacturer spare parts.

Replacing a Power Supply Unit

Perform the following steps:

1. Unplug the power cord from this power supply unit.
2. Push the ejector to release the module.
3. Pull the handle to remove the module out of the chassis.

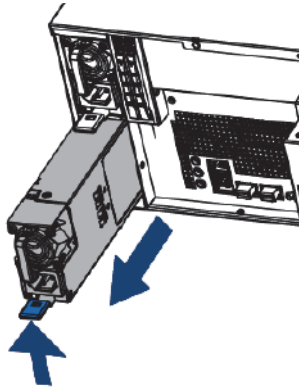

4. Slide the new unit into the power supply until it clicks into place.



When completely inserted please observe that the ejector latch is truly in place and locking the unit.

5. Connect the power source (power cord) to the newly installed power supply unit.

The power supply unit has been replaced.

Cleaning

How to clean the product is described in "Cleaning the Product" on page 10.

Do not use any liquids for cleaning. Cleaning agents, solvents (thinners, acetone), acids and bases can damage the front panel labeling, plastic parts and display.

Storage

Protect the product against dust. Ensure that the environmental conditions, e.g. temperature range and climatic load, meet the values specified in the data sheet.

Disposal

Rohde & Schwarz is committed to making careful, ecologically sound use of natural resources and minimizing the environmental footprint of our products. Help us by disposing of waste in a way that causes minimum environmental impact.

Disposing electrical and electronic equipment

A product that is labeled as follows cannot be disposed of in normal household waste after it has come to the end of its service life. Even disposal via the municipal collection points for waste electrical and electronic equipment is not permitted.



Labeling in line with EU directive WEEE

Rohde & Schwarz has developed a disposal concept for the eco-friendly disposal or recycling of waste material. Rohde & Schwarz completely fulfills its obligation to take back and dispose of electrical and electronic waste. Contact your local service representative to dispose of the product.

Appendix

This chapter gives some hints how to resolve irregularities during operation. Also, technical data and general information about the R&S system are provided.

This chapter is divided into the following sections:

- Troubleshooting (page 61)
- Technical Data (page 62)
- Packing Instructions (page 71)

Troubleshooting

The table below lists some errors that may occur during the operation of the R&S system and details how to resolve them. If you experience trouble that cannot be resolved with the solutions described here or in chapter "Maintenance" (page 43), please contact your local vendor or Rohde & Schwarz directly.

Error	Cause	Solution
Accesses to the main storage are slow. AND/OR Drops occurred during playout/capture	The data storage is too full.	It is recommended to use only 85% of the overall disk capacity to ensure real-time capability. If the storage is too full, delete some of your data.
	Configurations of the system have been altered.	Contact the Rohde & Schwarz customer support.
	One or more SSD disks of the SSD disk array are worn.	Try to identify the worn disk and replace it as described in section "SSD Disk Maintenance" on page 44.
	A RAID controller is defective.	If you can rule out the above mentioned causes, a RAID controller may be defective. Contact the Rohde & Schwarz customer support.
The alert LED is lit.	One of the power supply units has been disconnected from power during operation.	Examine the power cord of the unit. See to it that it is in good technical order, correctly plugged in at both ends and that the mains current is operating properly.
	One of the power supply units has failed.	Replace the broken unit as described in section "Power Supply Maintenance" on page 58.
	A fan has failed.	If necessary replace the broken module as described in section "Fan Maintenance" on page 55.

Technical Data

Error	Cause	Solution
	The system is overheated.	If you can rule out the above mentioned causes, the alert must be due to overheating. See to it that the ambient temperature at the front of the system does not exceed the operating temperature specified in section "Technical Data" on page 62. If the temperature is within the range, check the ventilation holes of the system and free them from all obstructions (e.g. dust). In case the problem persists, contact the Rohde & Schwarz customer support.
	An SSD disk or an SSD disk carrier got loose/jammed (e.g. after transport) or is not mounted correctly.	Shut down the system as described in section "Shutting Down the System" on page 41. Then perform the following: Pull all disk carriers partially out of the chassis and afterwards install them again. See to it that they are pulled out and reassembled correctly as described in section "Replacing the SSD Disk in the Carrier" on page 49. After that start the system again.
	An SSD disk of the SSD disk array is defective.	Replace the defective disk as explained in section "Replacing the SSD Disk in the Carrier" on page 49.
	A RAID controller is defective.	If you can rule out the above mentioned causes, a RAID controller may be defective. Contact the customer support.

Technical Data

This section provides technical data of CLIPSTER.

The following topics are covered:

- General Technical Data (page 63)
- Dimensions (page 63)
- Hardware Performance Specifications (page 64)
- Signal In- and Outputs (page 67)

General Technical Data

Technical data

Weight	approx. 45 kg
Environment (also during transport)	No exposure to heat No exposure to strong electric or magnetic fields No vibrations/shocks allowed
Operating temperature	0°C(32°F) ~ 35°C(95°F)
Storage temperature	-10°C(14°F) ~ 60°C(140°F)
Humidity	5 - 95%, non-condensing at all times
Air	Dust-free
Power consumption	max. 1600W (primary)
AC power	100-127V 200~240V, 50/60Hz

Dimensions

The following figures show the dimensions of the system.

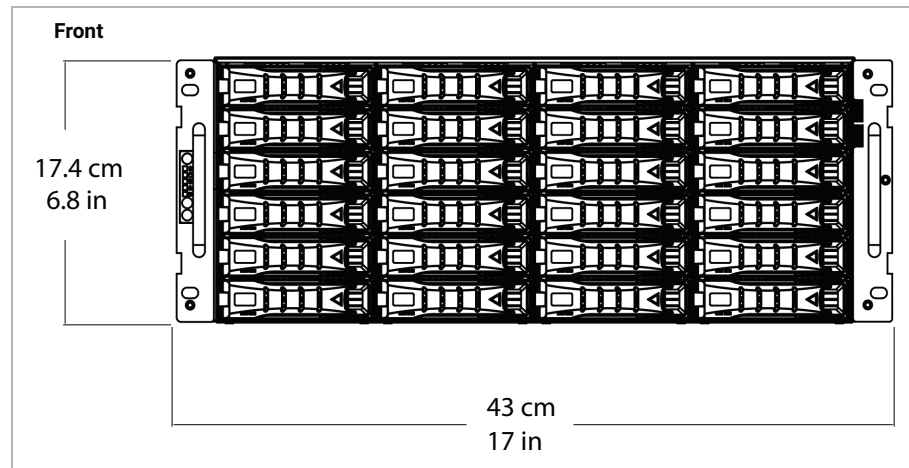

Dimensions of the system, front view

Technical Data

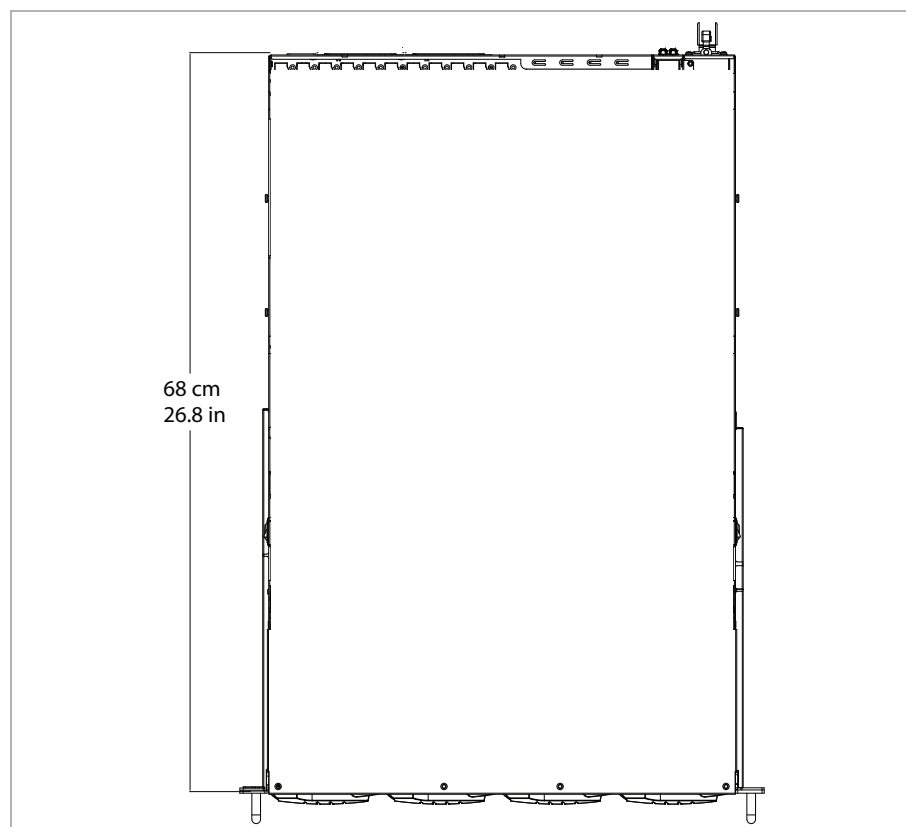

Dimensions of the system, top view

Hardware Performance Specifications

The following tables show the performance specifications.

J2K

Format	Frames per Second
JPEG2000 Encode UHD 10 bit	60 fps
JPEG2000 Encode HD 10 bit	200 fps
JPEG2000 Playout UHD 10 bit	60 fps
JPEG2000 Playout HD 10 bit	120 fps
DPX Playout UHD 10 bit	60 fps (with processing) 120 fps (without processing, only with CLIPSTER 4K 120p Playout option)

SDI supported data formats

Color Mode	Bit Depth	Frame Rate (Hz)	1.5G Link		3G Link	
			Mono-scopic (2D)	Stereo-scopic (3D)	Mono-scopic (2D)	Stereo-scopic (3D)
YUV 4:2:2	10	24 - 30	"A" connector	"A"+"B" connector		
		48 -60				
YUV 4:4:4 RGB 4:4:4 YUVA 4:2:2:4 YUVA 4:4:4:4 RGBA 4:4:4:4	10	24 - 30	"A"+"B" connector	n/a	"A" connector	"A"+"B" connector
YUV 4:2:2 YUV 4:4:4 RGB 4:4:4	12					

Video interfaces

Video	Input	Output
Digital video interface via Display-Port/HDMI		4 x Display-Port/HDMI
HD Serial Digital 4:2:2/4:4:4 8/10/12 bit (Single/Dual Link, 1.5/3 Gbit/s)	8 x BNC	8 x BNC

HDMI 2.0 supported data formats

Color mode	Bit Depth	FPS
YUV 4:2:0	8 bit	up to 60p
YUV 4:2:2	8, 10, 12 bit	up to 60p
RGB	8 bit	up to 60p
	10, 12 bit	up to 30p

References

Reference	Input	Output
Analog Reference Genlock	1 BNC	1 BNC

Technical Data

Audio interfaces

Audio	Input	Output
Embedded Audio, 8 Digital Stereo Channels	2 BNC (via Video In)	1 BNC (via Video Out)
AES/EBU, 8 Digital Stereo Channels	2 DB-25 (XLR via breakout cable)	2 DB-25 (XLR via breakout cable)
Analog Audio		1 stereo head-phone jacks (6.3 mm/¼")

Timecode

Timecode	Input	Output
Longitudinal (LTC)	1 XLR female	1 XLR male

Data and Control Interfaces

Data and Control Interfaces	Input	Output
RJ-45 (RS-422 protocol)	RMT-1	RMT-2
Color Modes	YUV 4:2:2 YUV 4:4:4 RGB 4:4:4 YUVA 4:2:2:4 YUVA 4:4:4:4 RGBA 4:4:4:4	
Internal Processing	Color volume conversion Encoding range conversion (Head/Full) Frame repetition Real-time mixer Real-time scaler Input raster detection JPEG2000 compression/decompression Optionally: AES en- and decryption RSA en- and decryption Forensic Watermarking Floating Point Processing	
Audio Formats	48 kHz, 96 kHz (DCI and IMF only)	

Signal In- and Outputs

This section provides pin-out information about some of the connectors provided by the CLIPSTER system.

DisplayPort

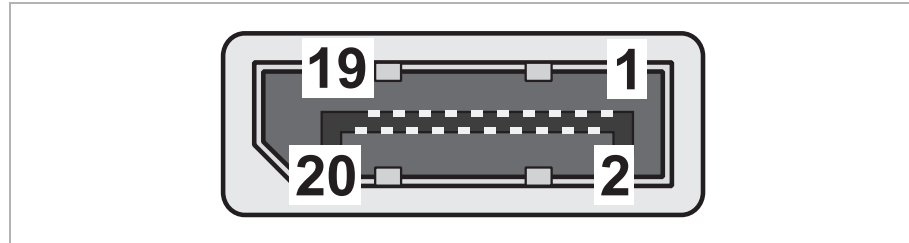

DisplayPort

Pin No.	Signal	Pin No.	Signal
1	ML_Lane 0 (p)	11	GND
2	GND	12	ML_Lane 3 (n)
3	ML_Lane 0 (n)	13	CONFIG1
4	ML_Lane 1(p)	14	CONFIG2
5	GND	15	AUX CH (p)
6	ML_Lane 1 (n)	16	GND
7	ML_Lane 2 (p)	17	AUX CH (n)
8	GND	18	Hot Plug Detect
9	ML_Lane 2 (n)	19	Return for Power
10	ML_Lane 3(p)	20	DP_PWR

HDMI (via adapters)

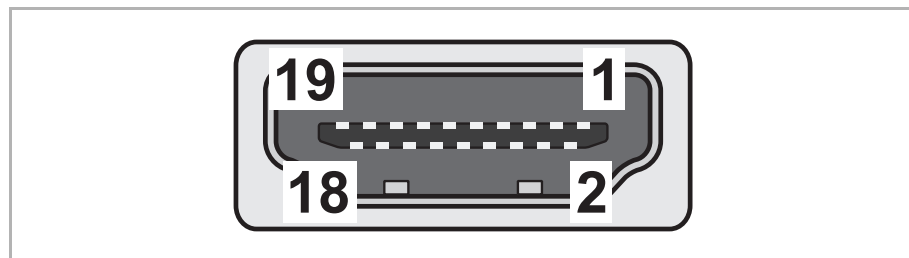

HDMI port

Pin No.	Signal	Pin No.	Signal
1	TMDS Data2+	11	TMDS Clock Shield
2	TMDS Data2 Shield	12	TMDS Clock-
3	TMDS Data2-	13	CEC
4	TMDS Data1+	14	Reserved (N.C. on device)

Technical Data

Pin No.	Signal	Pin No.	Signal
5	TMDS Data1 Shield	15	SCL
6	TMDS Data1–	16	SDA
7	TMDS Data0+	17	DDC/CEC Ground
8	TMDS Data0 Shield	18	+5 V Power (max 50 mA)
9	TMDS Data0–	19	Hot Plug Detect
10	TMDS Clock+		

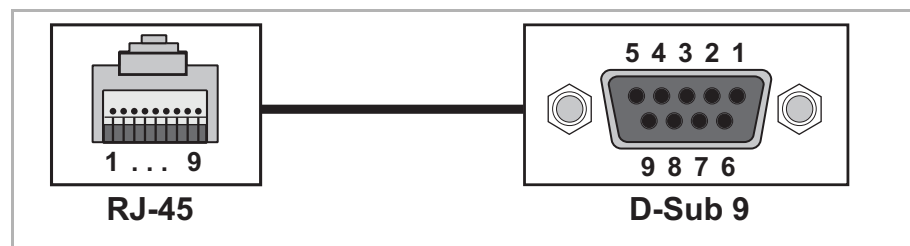
RMT In and
RMT Out (RJ-45)

RS-422 (RJ-45 [RIB7.0] male to D-Sub 9 female, external view)

Output		
RJ-45 Pin No.	Signal	D-Sub 9 Pin No.
3	TX (+)	3
6	TX (-)	8
5	RX (+)	7
4	RX (-)	2
1	Ground	4, 6
2	Reserved	5
7, 8	not connected	1, 9

For RS-422 control R&S systems support the standard industrial 9-pin protocol.

Analog Audio
(6.3 mm (¼")
Headphone
Jack)

Analog Audio

Output Impedance	75 Ohm
Output Level	1.55 V (at 600 Ohm)

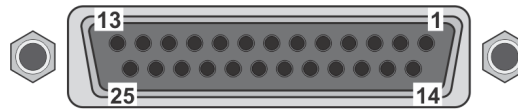
**Digital Audio
(25-Pin D-Sub
Connector)**

(external view;
female on interface, male on cable)

External view: female on interface, male on cable

Digital Audio Ch. 1-8

Pin No.	Signal	Pin No.	Signal
1	Audio OUT CH 7/8	14	/Audio OUT CH 7/8
2	GND	15	Audio OUT CH 5/6
3	/Audio OUT CH 5/6	16	GND
4	Audio OUT CH 3/4	17	/Audio OUT CH 3/4
5	GND	18	Audio OUT CH 1/2
6	/Audio OUT CH 1/2	19	GND
7	Audio IN CH 7/8	20	/Audio IN CH 7/8
8	GND	21	Audio IN CH 5/6
9	/Audio IN CH 5/6	22	GND
10	Audio IN CH 3/4	23	/Audio IN CH 3/4
11	GND	24	Audio IN CH 1/2
12	/Audio IN CH 1/2	25	GND
13	–		

Digital Audio Ch. 9-16

Pin No.	Signal	Pin No.	Signal
1	Audio OUT CH 15/16	14	/Audio OUT CH 15/16
2	GND	15	Audio OUT CH 13/14
3	/Audio OUT CH 13/14	16	GND
4	Audio OUT CH 11/12	17	/Audio OUT CH 11/12
5	GND	18	Audio OUT CH 9/10
6	/Audio OUT CH 9/10	19	GND
7	Audio IN CH 15/16	20	/Audio IN CH 15/16
8	GND	21	Audio IN CH 13/14
9	/Audio IN CH 13/14	22	GND
10	Audio IN CH 11/12	23	/Audio IN CH 11/12
11	GND	24	Audio IN CH 9/10

Technical Data

Digital Audio Ch. 9-16 (Forts.)

Pin No.	Signal	Pin No.	Signal
12	/Audio IN CH 9/10	25	GND
13	–		

Packing Instructions

The following describes the best way to pack a R&S system.

Safety

NOTICE

Transportation Damage

If you do not have the original packing anymore, use a similar structured packing for transportation. Rohde & Schwarz cannot be held liable for transportation damages.

Keep the original packing and use it in case of transportation. Otherwise the warranty will be void.



Fragile. Avoid shocks or vibrations. For longer distances use a lifting device.



Keep dry.

Packing the System

Perform the following steps:

1. Prepare the original box by placing the left and right padding foams at the bottom.



Packing Instructions

2. Wrap the front cover in bubble foil and place it in the middle between the two foams.

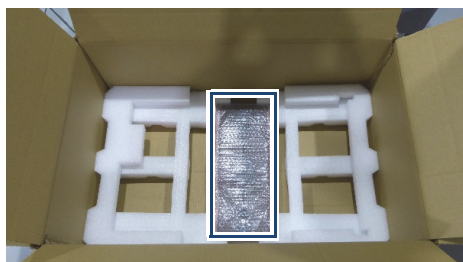

3. Place ESD foil on top of the front cover and the bottom foams.



4. Place the system into the box with the front pointing to the right and wrap it completely with the ESD foil.



5. Place the front foam at the front of the system.



6. Place the smaller padding foam and the back foam to secure the back of the system.



7. Place the power cable, mouse and keyboard as shown below.



8. Place any storage drives accessories as shown below.

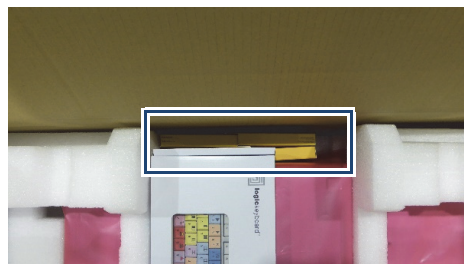

9. Put the data cables into an ESD bag.



Packing Instructions

10. Place the ESD bag with the data cables as shown below.



11. Place some crumpled paper between the keyboard and the front foam.



12. Pack all remaining accessories in a box and place it as shown below.



13. Close the box, seal it with adhesive tape and place the entire box on a pallet.



14. Place the edge protectors at each side of the top surface.

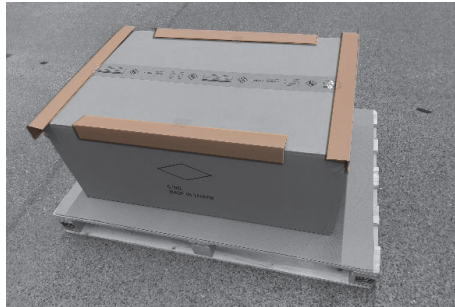

15. Secure the box to the pallet as shown.



The system is packed and ready for transportation.

Packing Instructions

Index

Numerisch

25-pin D-Sub connector pin-out69

A

alarm

disk failure46
overheating62
RAID controller46

Analog Audio Out

Mon. 123
specifications68

appropriate use7

atx panel27

audio

analog audio23, 68
digital (AES/EBU)23
pin-out69

C

CE14

CLIPSTER

specifications64
technical data62

color modes25

composite sync23

connectors

DisplayPort29
HDMI29
main connector panel23
naming conventions24
slot panels28

conventions

naming of connectors24

D

data protection45

DB-25 connector69

Digital Audio

Ch. 1-823, 69
Ch. 9-1623

digital video29

dimensions63

disk(s)

failure44

Display Port67

DisplayPort connector29

Documentation5

downconvert23

dual link29

E

environmental conditions63

exchanging

fan55
power supply unit58, 59
SSD disk47

F

fan failure55

FCC15

front overview17

front plate

lifting46

G

graphics card30

H

hardware

variants64

HDMI connector29

HD-SDI23

horizontal sync23

I

important notes31

installation38

instructions

packing71

intended use7

IPMI42

L

lifting the front palte46

LTC

In23

Out23

M

main connector panel23

maintenance43

N

naming conventions (connectors)24

notes (important)	31	T	
O		target audience	7
operation items	19	technical data	62
overheating	62	dimensions	63
overview		general	63
front	17	troubleshooting	61
rear	21	U	
P		unpacking	33
packing instructions	71	V	
pin-out		variants	64
25-pin D-Sub connector	69	video I/O panel	29
audio	69	video workstation	17
power supply			
replacing	59		
unit failure	58		
R			
RAID	45		
rear overview	21		
REF In	23		
reference input	23		
replacing a SSD disk	47		
Required reading	5		
RJ-45	23		
RS422	23		
S			
Safety			
Maintenance	43		
safety	7		
SDI (serial digital interface)			
signal distribution	25		
SDI downconvert	23		
shut down	41		
shutting down	41		
signal distribution (SDI)	25		
single link	29		
slot panel connectors	28		
specification(s)	64		
analog audio	68		
SSD	44		
SSD disk(s)	20		
removal	48		
replace	47, 49		
start	39		
starting	39		