

CERTIUM ANALYSIS

Air traffic control test and measurement solutions



Product Brochure
Version 02.00

ROHDE & SCHWARZ

Make ideas real



AT A GLANCE

Rohde & Schwarz provides a range of test, measurement and quality assurance equipment for civil air traffic control. The CERTIUM ANALYSIS portfolio from Rohde & Schwarz increases safety under critical conditions and ensures safe and secure service at every level.

A well-balanced suite

CERTIUM is an advanced ATC communications suite from a single source that increases safety and efficiency beyond existing standards. The suite's test and measurement component, CERTIUM ANALYSIS, is a solution-oriented family of precise quality assurance tools designed to help you keep your equipment in check and provide consistent, high-quality service.

Made-to-measure

Terrestrial navigation and communications systems are subject to regular inspections and maintenance in the field. For these measurements, Rohde & Schwarz offers a versatile suite of flexible laboratory quality measurement solutions. The portable, lightweight and weather-proof equipment is suitable for even the most demanding applications.

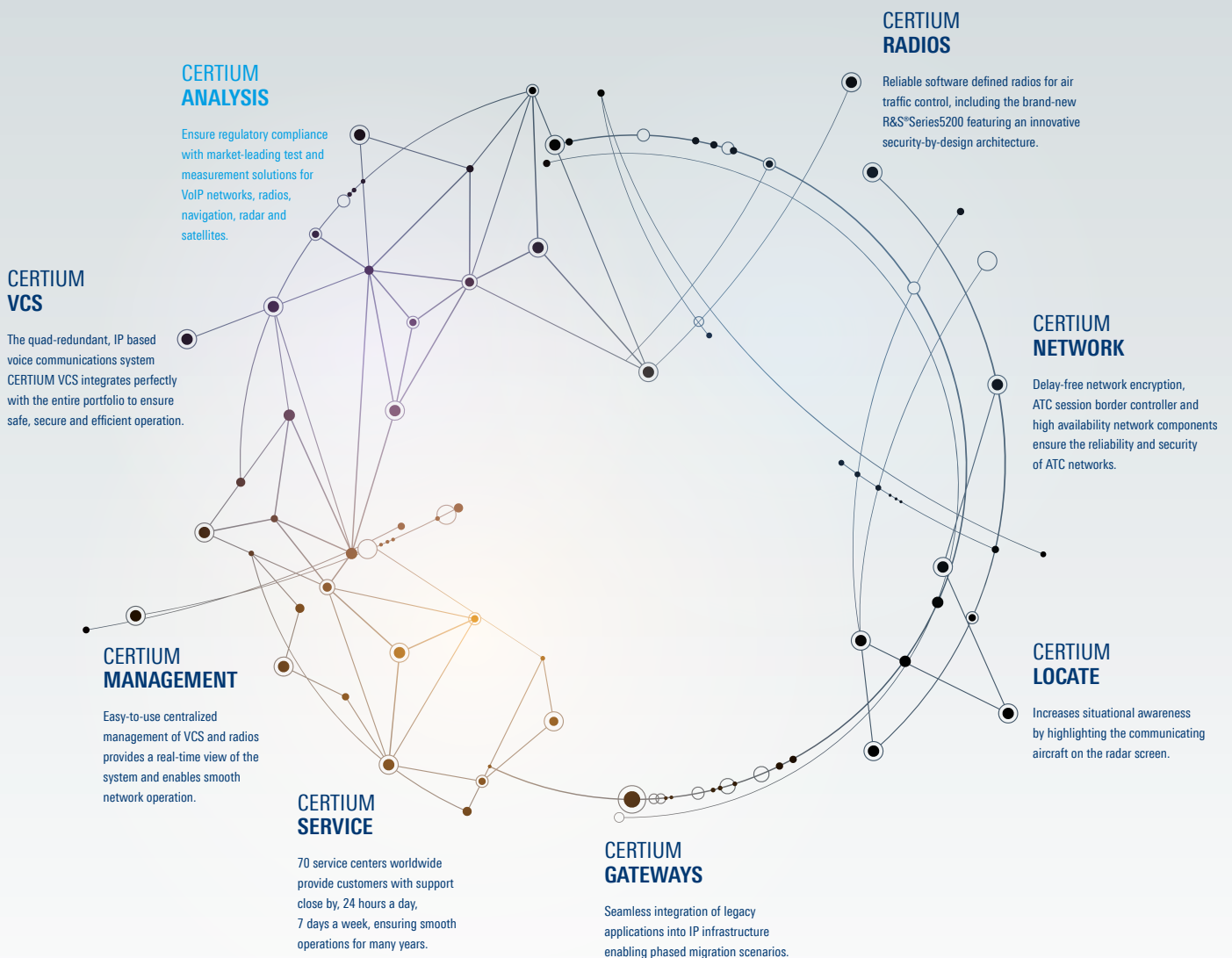

Targeted applications

- ▶ Ground, flight and drone based inspection of terrestrial navigation signals with accurate, high speed and lightweight instruments
- ▶ Ground inspection calibration and quality assurance of ground-ground and air-ground communications systems
- ▶ Spectrum and signal analysis in development, production and maintenance
- ▶ Consistent test signal generation and simulation – essential for receiver testing and calibration
- ▶ Accurate power measurement using standalone sensors
- ▶ Easy-to-use handheld cable and antenna analysis for antenna site setup and maintenance
- ▶ Interference hunting systems for quick and effective troubleshooting

Cost-effective solution

Adequate monitoring and precise diagnostics allow many failures to be prevented. However, if they do occur, CERTIUM ANALYSIS ensures fast detection, precise localization and reliable qualitative and quantitative feedback. All of this contributes to quick repairs, minimum downtime and, ultimately, high-quality service.

Place within the CERTIUM ecosystem

Every component within the ecosystem has a defined role and they all harmonize with each other to offer a truly balanced solution that is ready for any situation. To further support intermodal coordination within the ecosystem, the CERTIUM ANALYSIS range offers a wide spectrum of measurement capabilities. This specifically and successfully addresses the relevant CERTIUM system links and corresponding parameters.

CERTIUM ANALYSIS increases safety and efficiency in ATC communications.

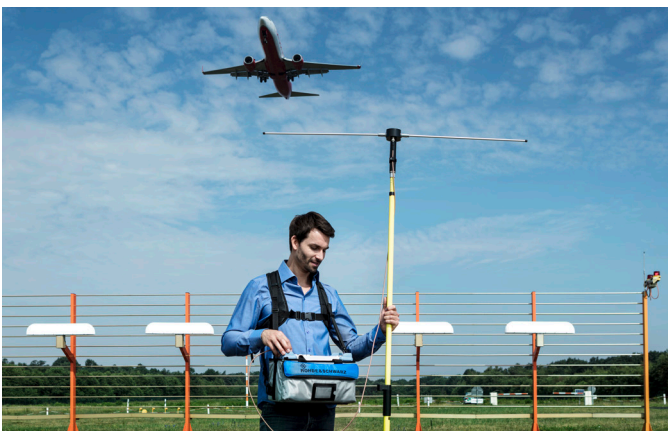

KEY FACTS

Rohde & Schwarz offers CERTIUM ANALYSIS as a versatile, all-in-one test and measurement package for ATC. It allows ANSP operators to keep their equipment in check to ensure reliable, long-term operation.

NAVIGATION

- ▶ ILS/MB
- ▶ VOR/DVOR
- ▶ GBAS
- ▶ DME
- ▶ TACAN

COMMUNICATIONS

- ▶ RF transmission
- ▶ Voice over IP

MONITORING

- ▶ Radar
- ▶ Interference hunting

FLEXIBLE AND COMPREHENSIVE

- ▶ A turnkey solution
- ▶ Versatile configurations
- ▶ Intersystem synergies
- ▶ Reliable service

INSTRUMENT LANDING SYSTEM, MARKER BEACON

The instrument landing system (ILS) provides aircraft pilots with landing approach data relative to the ideal landing course. Marker beacon (MB) receivers decode audio data and provide signaling output to identify one of three marker beacons installed near the runway.

ILS/MB solutions from Rohde & Schwarz

- ▶ Field measurements at airports, e.g. runway measurements (R&S®EVSG1000 VHF/UHF airnav/com analyzer)
- ▶ Conducted measurements on installations (R&S®EVSG1000 VHF/UHF airnav/com analyzer, R&S®RTO/R&S®RTE/R&S®RTM oscilloscopes)

High-accuracy measurements in hard to reach locations thanks to the drone based setup.



- ▶ Flight inspection (R&S®EVSF1000 VHF/UHF nav/flight analyzer)
- ▶ Drone based measurements of airport air navigation signals (R&S®EVSD1000 VHF/UHF nav/drone analyzer)
- ▶ Vector voltmeter measurements for ILS antennas (R&S®FSH handheld spectrum analyzer, R&S®ZVH handheld cable and antenna analyzer)
- ▶ Lab measurements and calibration for ILS/MB sources, e.g. ramp testers (R&S®FSW signal and spectrum analyzer with R&S®FSW-K15)
- ▶ Signal generation for receiver tests, e.g. onboard equipment (CMA radio test set, R&S®SMBV100B and R&S®SMA100B vector signal generators)
- ▶ Interference analysis (R&S®Spectrum Rider FPH and R&S®FSH handheld spectrum analyzers)
- ▶ Cable measurement (VSWR, DTF and return loss) (R&S®FSH handheld spectrum analyzer, R&S®Cable Rider ZPH and R&S®ZVH handheld cable and antenna analyzers)

Application example

- ▶ R&S®EVSD1000 mounted to a drone with an ILS/VOR antenna on top

VHF OMNIDIRECTIONAL RADIO RANGE, DOPPLER VOR

The VHF omnidirectional radio range (VOR) – conventional VOR and Doppler VOR (DVOR) – operates at VHF frequencies from 108 MHz to 118 MHz to provide aircraft with a bearing to a ground station at a known reference location.

VOR solutions from Rohde & Schwarz

- ▶ Ground measurements and monitoring (R&S®EVSG1000 VHF/UHF airnav/com analyzer)
- ▶ Flight inspection, e.g. orbit measurements (R&S®EVSF1000 VHF/UHF nav/flight analyzer)
- ▶ Drone based measurements of airport VOR ground stations (R&S®EVSD1000 VHF/UHF nav/drone analyzer)
- ▶ Interference analysis (R&S®Spectrum Rider FPH and R&S®FSH handheld spectrum analyzers)
- ▶ Cable measurement (VSWR, DTF and return loss) (R&S®FSH handheld spectrum analyzer, R&S®CableRider ZPH and R&S®ZVH handheld cable and antenna analyzers)
- ▶ Lab measurements and calibration for VOR sources, e.g. ramp testers (R&S®FSW signal and spectrum analyzer with R&S®FSW-K15)
- ▶ Signal generation for receiver tests (CMA radio test set, R&S®SMBV100B and R&S®SMA100B vector signal generators)

Configuration of VOR generator.

Application example

- ▶ The CMA radio test set is an extremely versatile solution for ATC and avionics test applications. It can generate ILS and VOR signals with the R&S®CMA-K130 option.

GROUND BASED AUGMENTATION SYSTEM

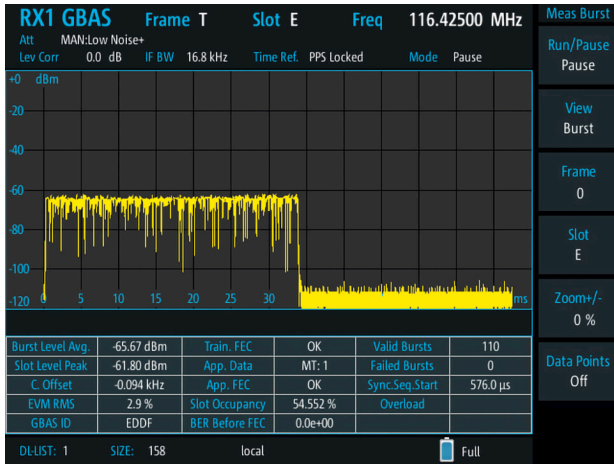

GBAS burst view on the R&S®EVSG1000 with the R&S®EVSG-K4 GBAS analysis option.

A ground based augmentation system (GBAS) is a landing system that transmits GPS corrections via a VHF data link (VDL) to approaching planes. The ground equipment consists of reference GNSS receivers at exactly defined positions around the airport, a GBAS ground station and a VHF data broadcast transmitter.

GBAS solutions from Rohde & Schwarz

- ▶ Ground measurements and monitoring at airports (R&S®EVSG1000 VHF/UHF airnav/com analyzer)
- ▶ Flight inspection, e.g. coverage measurements (R&S®EVSF1000 VHF/UHF nav/flight analyzer)
- ▶ Drone based measurements of airport GBAS air navigation signals (R&S®EVSD1000 VHF/UHF nav/drone analyzer)
- ▶ Signal generation for receiver tests, e.g. multimode receivers (R&S®SMBV100B vector signal generator)

GBAS components and signals (simplified representation).

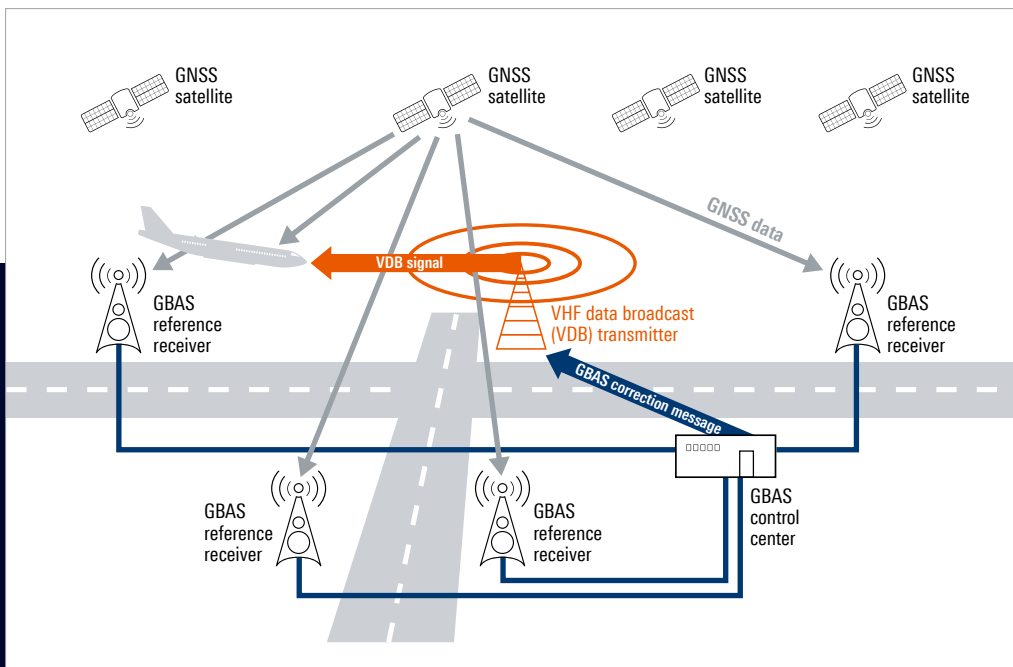

Application example

- ▶ 24/7 measurement of GBAS level and monitoring of pseudo-range correction values at GBAS stations

DISTANCE MEASURING EQUIPMENT

Distance measuring equipment (DME) is a transponder based radio navigation technology used to determine the slant range of an aircraft (DME interrogator) to a ground station (DME transponder).

DME solutions from Rohde & Schwarz

- ▶ Commissioning and regular maintenance of DME stations, e.g. conducted and radiated measurements, main delay measurements and on-channel peak power and frequency measurements (R&S®EDST300 TACAN/DME station tester)
- ▶ Cable measurement (VSWR, DTF and return loss) (R&S®FSH handheld spectrum analyzer, R&S®CableRider ZPH and R&S®ZVH handheld cable and antenna analyzers)
- ▶ Flight inspection and far field monitoring, e.g. simultaneous measurement of up to 10 DME stations (R&S®EDS300 DME/pulse analyzer)
- ▶ Signal generation for interrogator/receiver tests (R&S®SMBV100B vector signal generator and R&S®NRP-Z81 power sensor)
- ▶ Verification of DME transponders in test laboratories (R&S®SMBV100B vector signal generator and R&S®NRP-Z81 power sensor, R&S®RTO/R&S®RTE/R&S®RTM oscilloscopes)

The R&S®EDST300 facilitates quick and precise measurements thanks to an intuitive interface.



Application example

- ▶ Sensitivity measurement on a DME station with the R&S®EDST300 TACAN/DME station tester

TACAN

Along with the distance information supplied by DME, TACAN additionally provides the user with a bearing to the ground station. The method used for distance measurement is identical to DME, allowing TACAN to be used for civilian planes (e.g. for RNAV).

TACAN solutions from Rohde & Schwarz

- ▶ Conducted and radiated measurements (R&S®EDST300 TACAN/DME station tester, R&S®EDST-K1 TACAN option and R&S®EDST-Z1 test antenna)
- ▶ Cable measurement (VSWR, DTF and return loss) (R&S®FSH handheld spectrum analyzer, R&S®Cable Rider ZPH and R&S®ZVH handheld cable and antenna analyzers)
- ▶ Power measurements (R&S®NRP power sensors)
- ▶ Flight inspection, e.g. orbit measurements (R&S®EDS300 DME/pulse analyzer and R&S®EDS-K1 TACAN option)
- ▶ TACAN time domain analysis (R&S®EDST300 TACAN/DME station tester, R&S®EDS300 DME/pulse analyzer, R&S®RTO/R&S®RTE/R&S®RTM oscilloscopes)

A state-of-the-art TACAN beacon tower.



Application example

- ▶ Azimuth, peak power and distance measurement during orbital flight around a TACAN ground installation

RF VOICE COMMUNICATIONS

Even the most sophisticated communications platforms between aircraft and ground still rely on a classic radio link. To address this, Rohde & Schwarz has come up with an RF-focused suite of T&M equipment within the all-encompassing CERTIUM ANALYSIS portfolio.

ATC voice communications is based on double-sided AM modulated VHF signal transmission from geographically distributed radio sites. To ensure consistent transmission levels and signal quality, active radio equipment requires periodic maintenance and monitoring. Additionally, passive equipment such as antennas and cabling must also be checked after installation and periodically thereafter. Finally, any interference in the transmission band requires accurate analysis and localization for quick elimination.

Radio testing and calibration

The CMA radio test set has made a name for itself as the market standard for ATC radio testing of both Rohde & Schwarz and its competitors' radios. The test set is an all-in-one platform that performs in-depth analysis of ATC radios as well as NavAid systems such as ILS, VOR and MB. The integrated signal generator and spectrum and vector analyzer in the CMA allow you – among other things – to analyze signal quality, perform power measurements, measure the modulation frequency response and carry out squelch sensitivity tests on both the transmitter and receiver side. The battery and antenna of the CMA allow it to also be used as a standalone instrument, which is ideal for aircraft maintenance. These functions may also be automated with the R&S®CMArun software extension and documented in a single report. The CMA features an analog and an ED-137B/C-compatible IP interface.

R&S®CMArun running on the CMA.

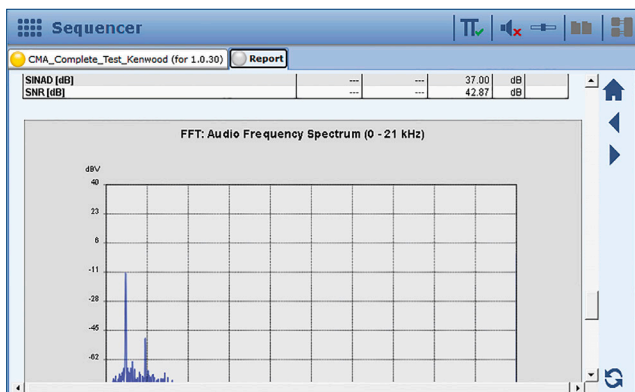

The I/Q recorder allows RF signals to be recorded via the dedicated RF ports. The wide dynamic range of the CMA allows signals to be recorded over a wired line or via an antenna. The signals are recorded and stored as I/Q data. The recorded data can be replayed on the ARB generator or analyzed with the R&S®VSE vector signal explorer software. Triggers and variable sample rates turn the I/Q recorder into a universal tool to simulate real-world scenarios in the lab or to generate reference signals.

Configuration of R&S®CMArun test items.

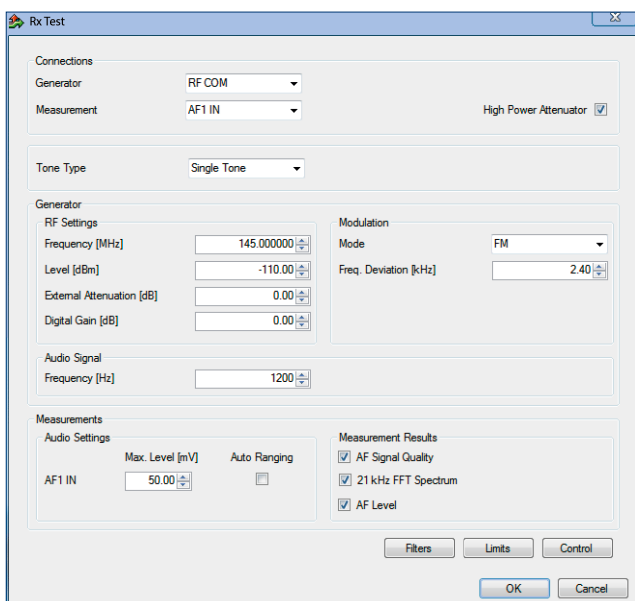

Recording RF signals for playback in the lab.

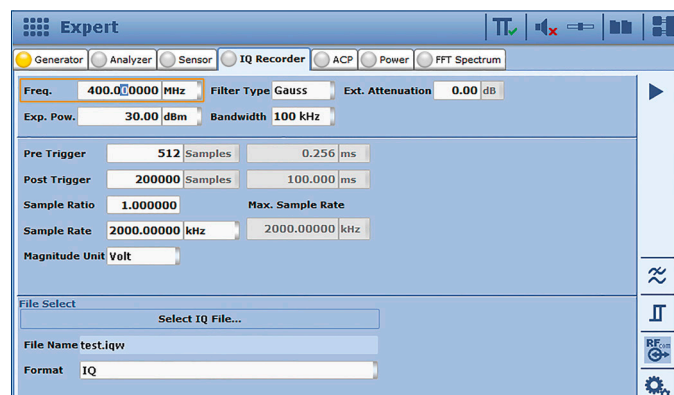

Antenna and cable testing

RF communications for ATC has specific requirements. To address these, Rohde&Schwarz has prepared a special set of measurement tools. The R&S®CableRider ZPH is a case in point, aimed at VHF band antenna and cable testing. It provides cable loss and distance-to-fault measurements, antenna and filter matching, power measurements as well as entry-level interference hunting features. Other handhelds such as the R&S®FSH or R&S®ZVH complement its already versatile profile.

Key metrics

The R&S®AVQA advanced voice quality assurance system from Rohde&Schwarz provides leading intersystem synergies for monitoring with ATC equipment, offering indispensable insights at the interface between RF and VoIP communications. A prime example of this is the system's built-in radio link assessment function. This compares signal patterns received from various antennas and singles out irregularities, which often indicate a malfunctioning or underperforming system component such as a misplaced antenna or an interrupted cable. This considerably speeds up error localization and saves time and effort.

The R&S®AVQA enables long-term noise and signal monitoring by collecting the RSSI information from the ATC radios. This provides aggregated statistics on the channel signal noise and utilization of the ATC channels.

Additionally, the R&S®AVQA loopback monitor compares ground based reception patterns with corresponding ground based transmission signals and performs an end-to-end functional check on each radio channel.

RF signal monitoring

Rohde&Schwarz is proud to offer an extensive portfolio of handheld devices. The R&S®Spectrum Rider FPH provides comprehensive spectrum monitoring functions for interference hunting. When combined with a directional antenna, the R&S®Spectrum Rider FPH can pinpoint the source of a signal on a map and listen in to the AM or FM modulated signal.

For more advanced interference hunting applications, the R&S®PR200 gives you the edge. It offers real-time continuous spectrum monitoring of the entire ATC voice band at once. Even the shortest bursts can be effectively visualized. At the same time, it can also demodulate the signal on one frequency and play it out to provide acoustic feedback about the magnitude of the interference.

Together with a high-precision direction finding antenna, the R&S®PR200 provides a fully automated, dynamic estimation of the interference location during drive tests.

Loopback monitor of R&S®AVQA

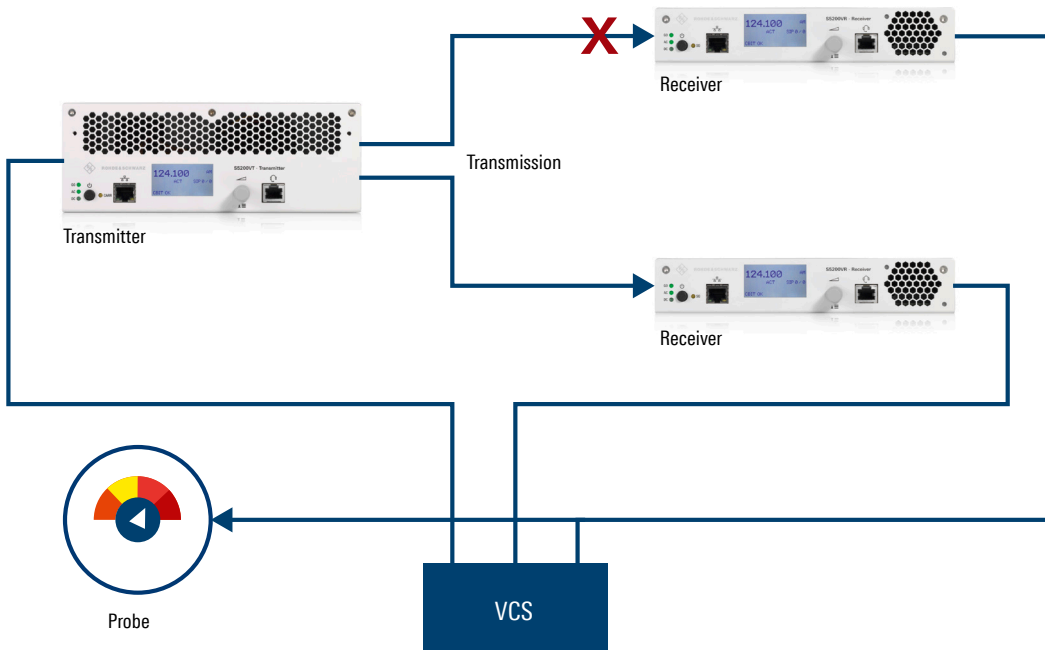

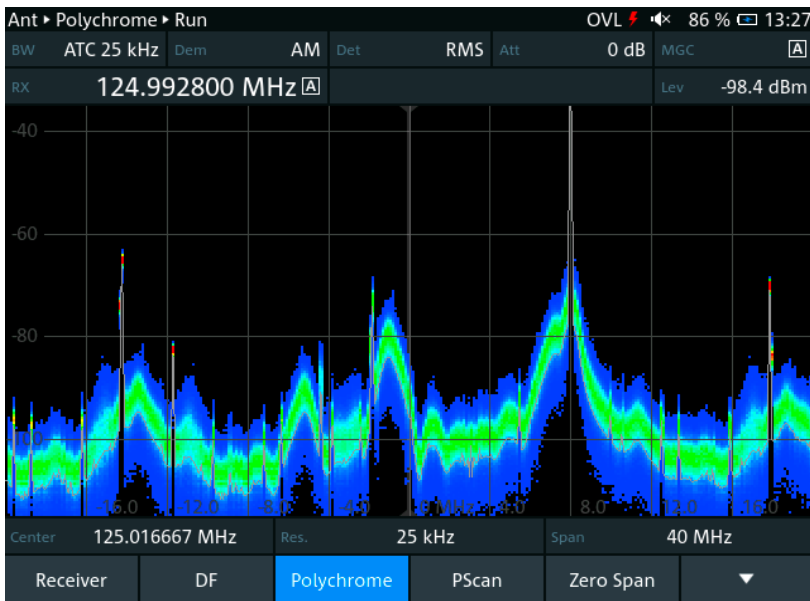

R&S®PR200 – the precision of a high-end spectrum analyzer in the compact package of a handheld.



Locating a signal with the R&S®FPH-K15 interference analysis option.



The R&S®AVQA loopback monitor indicates an RSSI level drop on one of the receivers.

VOICE OVER IP COMMUNICATIONS

The CERTIUM suite from Rohde & Schwarz represents a major step forward for ATC. Fully IP based communications promotes safety and flexibility. The CERTIUM ANALYSIS IP package helps keep communications in check, ensuring consistent performance and unbeatable reliability.

Intersystem synergies are a staple of the CERTIUM ecosystem and its individual components. CERTIUM ANALYSIS is a great example of this with two highly versatile elements – the CMA and R&S®AVQA test and measurement systems.

VoIP test

The R&S®CMA-K610 and R&S®CMA-Z610A options for the CMA provide an extensive set of VoIP measurement capabilities. VoIP is seamlessly integrated into the user interface and users can quickly switch between the analog and digital audio interfaces.

Avionics VoIP generator and analyzer

The CMA incorporates a VoIP generator and analyzer in line with EUROCAE ED-137B/C. The VoIP interface is fully integrated in the CMA, and users can switch between analog audio and VoIP testing at the push of a button. This allows easy and extensive testing of airborne radios via the VoIP (LAN) interface and the analog audio (RF COM) interface. Configuration of the VoIP connection is straightforward and intuitive, and the status displays for the connection provide an excellent overview. The radio to be tested is connected to the test set via the integrated LAN interface. Multiple transmitters or receivers can also be connected via an optional LAN switch that is powered via a USB cable, meaning that the CMA can be operated independently of the mains supply.

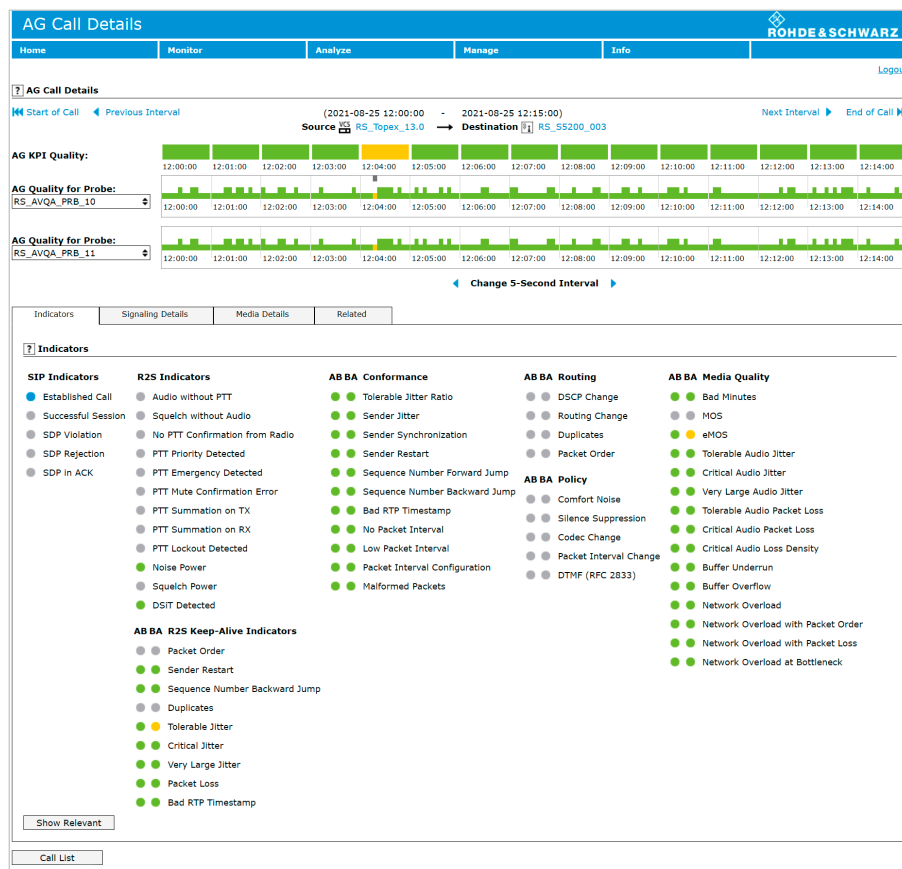

The R&S®AVQA air-ground monitor indicates the exact timing and root cause of an impairment.

ATC call details

The R&S®AVQA provides VoIP analytics for ground-to-ground and air-to-ground calls. The user-friendly graphical interface of the R&S®AVQA shows an overview of relevant performance metrics to give the operator real-time quantitative feedback about the state of the system and highlight particular aspects.

Quality assurance

The user expects uncompromising quality from end to end. To achieve this, the provider has to ensure that every element is fully functional all of the time. The R&S®AVQA provides this kind of accurate and selective monitoring by using probes to capture raw data at multiple network nodes and then aggregating it for analysis, interpretation and trend recognition.

VoIP generator test setup

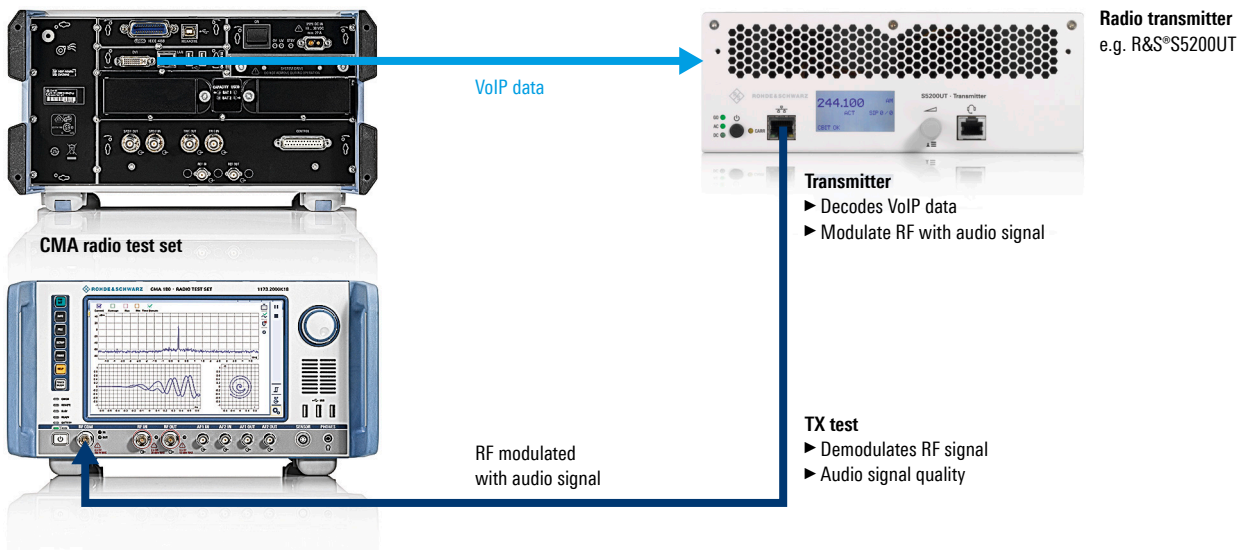

VoIP analyzer test setup

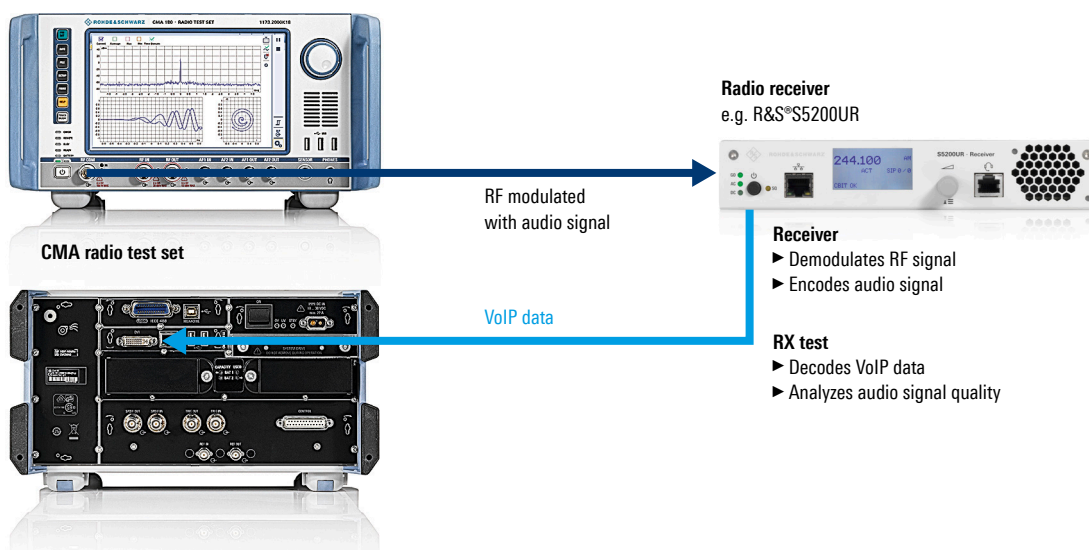

RADAR MONITORING

Radar is one of the most important elements of aviation navigation. The two principal configurations – primary and secondary radar – give ground controllers an accurate estimate of the position and velocity of an aircraft. Rohde & Schwarz offers a range of radar test and measurement solutions from its comprehensive portfolio.

Versatile options

The R&S®ZNH handheld vector network analyzer is an excellent example of the Rohde & Schwarz design paradigm of modular extension. Several of its numerous add-ons are used for testing and measuring radar equipment. One example is the R&S®ZNH-K45 vector voltmeter option. A simple setup makes it ideal for field use in a number of scenarios involving comparison measurements between two devices, including for calibration of monopulse radar installations. The option's pulse measurement capability is complemented by the R&S®ZNH-K29 option. This is another modular add-on that allows the R&S®ZNH to perform precise pulse and peak measurements in combination with an additional wideband power sensor. This is useful during the installation and maintenance of radar systems since the R&S®ZNH can measure pulses as short as 50 ns.

Application focus: radar remote site maintenance

A radar system typically operates 24/7 in a setting where downtime is critical. The R&S®ZNH handheld vector network analyzer from Rohde & Schwarz helps field engineers identify potential points of failure as quickly as possible for a minimal total MTBF. The R&S®ZNH achieves this by offering a variety of add-on extensions that cover the following key radar measurements.

Key radar measurement parameters

Measurement parameter	Purpose	System components
Distance to fault (DTF)	identify transmission line discontinuities	cables, waveguides
S-parameter	identify degraded performance in transmission and reflection parameters	antenna, filter, rotary joint
Power	detect wanted power level	source, STALO, COHO oscillators
Pulse	verify wanted pulse width, pulse period, peak power	transmitter, receiver
Ratio/wave quantities	verify phase and amplitude	phase array antenna

Power measurement

The R&S®FSH-Z14 and R&S®FSH-Z44 directional power sensors transform the R&S®ZNH into a full-featured directional power meter. The R&S®ZNH can then simultaneously measure the output power and the matching of transmitter system antennas under operating conditions. The power sensors measure average power up to 120 W and eliminate the need for extra attenuators. In addition, the peak envelope power (PEP) can be determined up to 300 W. A common application is the combined monitoring of the transmitter output and antenna reflected power of critical systems.

Pulse analysis with the R&S®ZNH-K29 and R&S®NRP-Z81 wideband power sensors.

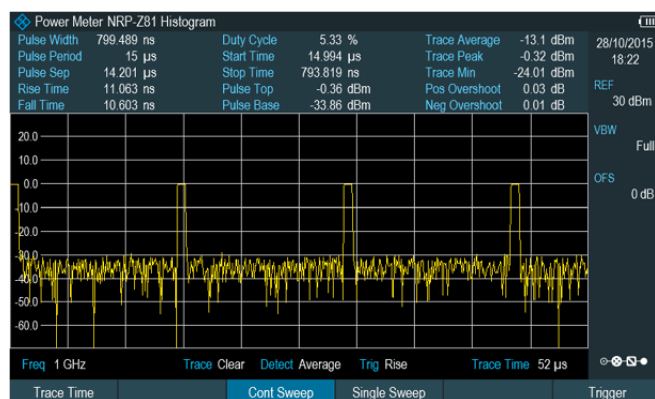

Forward and reflected power measurement with the R&S®FSH-Z44.

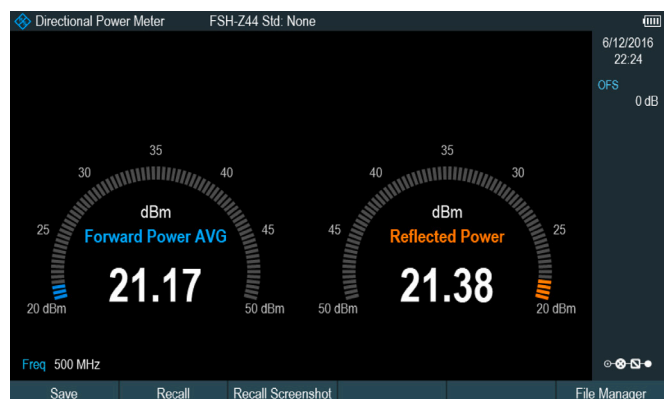

INTERFERENCE HUNTING

Interference hunting is a wide application area, and it is crucial for aviation. First, ATC hardware is sensitive to interference and, second, aviation safety is so important that there is no room for compromise.

R&S®PR200 portable monitoring receiver

The R&S®PR200 is part of the portable interference hunting solutions offered by Rohde&Schwarz. It is complemented by a vast range of handheld antennas and sensors that allow it to be used in a number of spectrum monitoring applications from localizing an illegal radio transmitter to finding a technical malfunction that is causing EMI spurs. The spectrum monitoring, signal analysis and geolocation measurement capabilities of the R&S®PR200 make it ideal for meeting the needs of ATC communications. Relevant extension packages include the R&S®CS-DF direction finding module and the R&S®CS-IR trace recording and replay module.

R&S®Spectrum Rider FPH handheld spectrum analyzer

With massive performance from a tiny footprint, the R&S®Spectrum Rider FPH truly punches above its weight. This compact spectrum analyzer benefits from the Rohde&Schwarz signature modular design paradigm, since it offers a cost-optimized spectrum monitoring solution through many ATC-specific add-on extensions from Rohde&Schwarz. These include the R&S®FPH-K15 interference analysis and R&S®FPH-K16 signal strength mapping options.

Gapless capture

The crown jewel in the Rohde&Schwarz handheld spectrum monitoring range – the R&S®PR200 – offers high speed digital signal processing that enables the industry's first seamless capturing and processing of signals in real time. Its state-of-the-art design incorporates a level of features and capabilities typically associated with the most advanced spectrum monitoring sensors in a fully portable form factor. The receiver's powerful FPGA can employ gapless fast Fourier transform (FFT) for truly real-time, zero-delay signal processing. Thanks to this, the R&S®PR200 boasts a 100% probability of intercept for transmissions as short as 1.5 μ s.



Automatic direction finding with DF upgrade (requires R&S®CS-DF option and Rohde & Schwarz compact DF antenna) and PC based R&S®MobileLocator software.

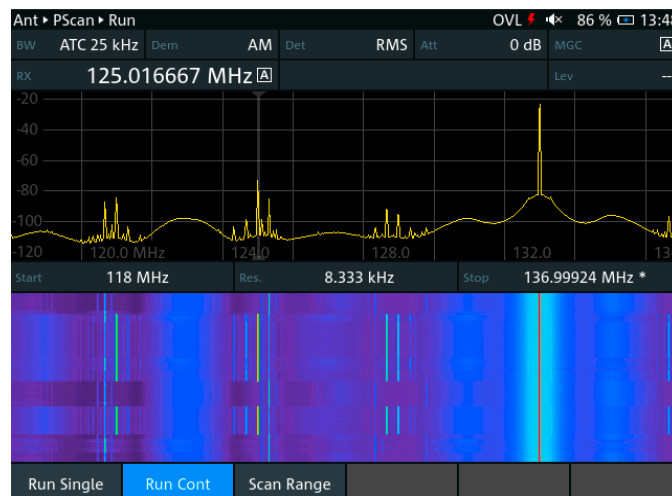

Intuitive spectrum monitoring with the R&S®PR200.

RELIABLE SERVICE

However advanced our technology might be, it is our exceptional quality of service, long-term engagement and responsible support that gives you the confidence of having a reliable partner by your side every step of the way.



On-site services

Downtime is a major cost factor you want to avoid. We therefore do everything we can to minimize the time your instruments have to be offline, e.g. for calibration. Precision is not a question of location, since we come to you, saving you time and simplifying logistics.

Service level agreement

Standard contracts are a thing of the past. With a tailored service level agreement, you define the scope of service that best matches your business and technical requirements. An SLA is an all-encompassing service solution that offers you the full range of support packages from expert repair commitment to obsolescence management.

Single source

Seamless coordination, priority processing and 100% involvement – these are some of the key benefits for users who opt for a CERTIUM turnkey solution from a single source. The same applies to support solutions from Rohde&Schwarz. A dedicated contact partner makes sure you get top-notch service every time.

No surprises

An SLA is a priority support service on a flat-rate basis. This means no unexpected expenses, which eliminates uncertainty and simplifies budget planning. We at Rohde&Schwarz are proud to offer you a hassle-free experience, allowing you to focus your time and effort on what needs your attention the most.

Service packages from a reliable partner.

PORTFOLIO OVERVIEW

	Navigation						Communications		Surveillance and monitoring	
	ILS	VOR	MB	GBAS	DME	TACAN	RF	VoIP	Radar	Interference hunting
R&S®EVSG1000 VHF/UHF airnav/com analyzer	•	•	•	•			•			
R&S®EVSF1000 VHF/UHF nav/flight analyzer	•	•	•	•			•			
R&S®EVSD1000 VHF/UHF nav/drone analyzer	•	•	•	•			•			
R&S®EDS300 DME/pulse analyzer					•	•				
R&S®EDST300 TACAN/DME station tester					•	•				
R&S®FSW-K15 VOR/ILS measurements	•	•								
R&S®ZNH full two-port handheld vector network analyzer	•								•	
R&S®PR200 portable monitoring receiver							•			• + real-time processing
R&S®Spectrum Rider FPH handheld spectrum analyzer							•		•	•
R&S®FSH handheld spectrum analyzer	•						•		•	•
R&S®Cable Rider ZPH cable and antenna analyzer	•						•		•	•
R&S®SMA100B vector signal generator	•	•								
R&S®SMBV100B vector signal generator	•	•	•	•	•					
CMA radio test set	•	•	•				•	•		
R&S®NPR-Z81 power sensor					•	•				
R&S®RTO/R&S®RTE/ R&S®RTM oscilloscopes					•	•				
R&S®AVQA advanced voice quality assurance system							•	•		

DEVICE RANGE OF THE CERTIUM ANALYSIS PACKAGE



R&S®EVSG1000
VHF/UHF airnav/com analyzer

Portable signal level and modulation analyzer specifically designed for commissioning and servicing ILS, GBAS, VOR and marker beacon ground stations and for analyzing ATC COM signals.



R&S®EVSF1000
VHF/UHF nav/flight analyzer

Signal level and modulation analyzer for installation in flight inspection aircraft. It performs measurements on ILS, GBAS, VOR and marker beacon ground stations during startup, maintenance and servicing, and analyzes ATC COM signals.



R&S®EVSD1000
VHF/UHF nav/drone analyzer

Efficient drone inspection of ILS, GBAS, VOR, MB ground stations and ATC COM signal analysis as well as course and clearance signal analysis in one receiver.



R&S®EDS300
DME/pulse analyzer

DME/TACAN analyzer for installation in flight inspection systems and for far field monitoring tasks.



R&S®EDST300
TACAN/DME station tester

Portable and battery-powered TACAN/DME station tester for commissioning, testing and servicing pulsed terrestrial navigation systems.



R&S®FSW-K15
VOR/ILS measurements

The R&S®FSW-K15 option is a firmware application that adds VOR and ILS measurement functions to the R&S®FSW.



R&S®ZNH
full two-port handheld vector network analyzer

Full two-port handheld vector network analyzer offering one-port cable and antenna measurements as well as full two-port S-parameter measurements.



R&S®PR200
portable monitoring receiver

A portable monitoring receiver that effectively supports spectrum monitoring, interference hunting and site testing applications in the frequency range from 8 kHz to 8 GHz.



R&S® Spectrum Rider FPH and R&S® FSH handheld spectrum analyzers

Rugged handheld spectrum analyzers for testing and service in the field; special option for vector voltmeter measurements (R&S® FSH-K45).



R&S® Cable Rider ZPH and R&S® ZVH handheld cable and antenna analyzers

A compact and durable cable and antenna analyzer for installation and service; special option for vector voltmeter measurements (R&S® ZVH-K45).



R&S® SMA100B signal generator

Signal generator with excellent SSB phase noise characteristics for all common types of analog modulation (AM, FM, ϕ M, PM); the optional R&S® SMAB-K25 package allows precise generation of ILS/VOR signals.



R&S® SMBV100B signal generator

Vector signal generator with avionic options for ILS, VOR, MB, DME and GBAS; the ARB function of the R&S® SMBV100B can also play back recorded I/Q files (e.g. of NavAid scenarios) to test the stability of onboard receivers.

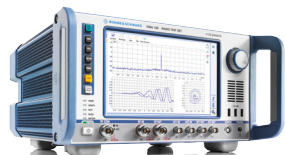

CMA radio test set

Radiocommunications tester for radio systems in the frequency range from 100 kHz to 3 GHz; R&S® CMA-K130 for ILS, VOR and MB signal generation.



R&S® NRP-Z81 power sensor

Wideband power sensor for time domain analysis and automatic pulse analysis for DME applications and universal use.



R&S® RTO/R&S® RTE/R&S® RTM oscilloscopes

Time domain measurements and pulse shape analysis on DME transponders.

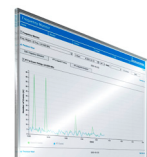

R&S® AVQA advanced voice quality assurance system

A non-intrusive voice assurance system that provides a broad range of integrated monitoring functions for an ATC communications system.

Service at Rohde & Schwarz You're in great hands

- ▶ Worldwide
- ▶ Local and personalized
- ▶ Customized and flexible
- ▶ Uncompromising quality
- ▶ Long-term dependability

Rohde & Schwarz

The Rohde & Schwarz technology group is among the trailblazers when it comes to paving the way for a safer and connected world with its leading solutions in test & measurement, technology systems and networks & cybersecurity. Founded more than 85 years ago, the group is a reliable partner for industry and government customers around the globe. The independent company is headquartered in Munich, Germany and has an extensive sales and service network with locations in more than 70 countries.

www.rohde-schwarz.com

Sustainable product design

- ▶ Environmental compatibility and eco-footprint
- ▶ Energy efficiency and low emissions
- ▶ Longevity and optimized total cost of ownership

Certified Quality Management

ISO 9001

Certified Environmental Management

ISO 14001

Rohde & Schwarz training

www.training.rohde-schwarz.com

Rohde & Schwarz customer support

www.rohde-schwarz.com/support

