

ROHDE & SCHWARZ

Make ideas real



R&S[®]TSVP **TEST SYSTEM VERSATILE PLATFORM**

Open test platform for high-performance ATE applications

Product Brochure | Version 03.00

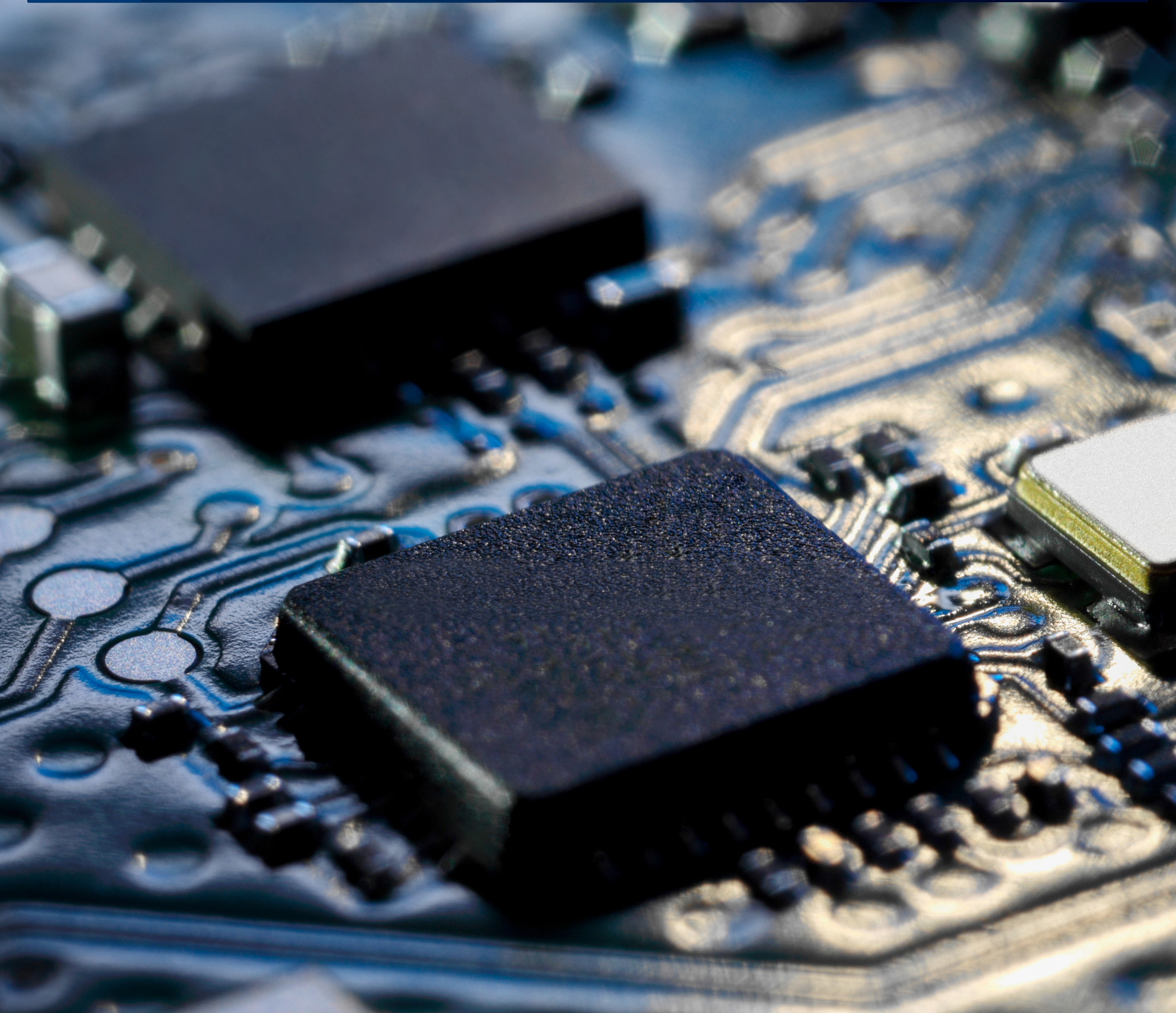

AT A GLANCE

In various industries, especially automotive (but also communications technology, IoT and A&D), all need production testing. Test departments must cope with increasingly complex electronic systems, all while keeping test times short, reducing costs and meeting ambitious reliability goals. Production testing identifies defects, while also examining complete electronic component integrity and verifying overall performance and functionality.

Application areas

The R&S®TSVP is mainly used together with sophisticated Rohde & Schwarz RF instruments in automotive manufacturing testing for telematics control units (TCU), car access (RKE/PEPS), zone control units (ZCU), high performance computers (HPC) or wireless battery management systems (w-BMS).

Open test platform based on PCI Express and PXI-1

The Rohde & Schwarz open test platform is ideal for high-performance automated test equipment (ATE). The architecture supports all relevant electrical test methods:

- ▶ Analog in-circuit test (ICT)
- ▶ Boundary scan test (BS)
- ▶ Functional test (FCT)

The R&S®TSVP chassis has a mechanical frame, digital backplane, analog backplane, mains switching and filtering, power supply and diagnostic extensions. One highlight is the analog bus for transferring measurement signals between different slots without additional external wiring. Three device versions are available:

- ▶ R&S®ExpressTSVP based on PXIe/PXI-1/cPCI bus for test and measurement tasks that require a flexible use of third-party PXIe modules
- ▶ R&S®CompactTSVP based on cPCI/PXI bus for general test and measurement tasks
- ▶ R&S®PowerTSVP based on CAN bus for dedicated high-power or switching applications

The R&S®ExpressTSVP can be combined with the R&S®PowerTSVP to create a larger system.



R&S®CompactTSVP with mass interconnect interface from Virginia Panel Corporation



KEY FACTS

- ▶ Comprehensive systematic approach
 - System-oriented, compact basic unit and modular instruments for DC and LF signals
 - Floating stimulus and measurement technology
 - Optimized signal concept (analog measurement bus, rear I/O modules)
 - Modules that handle up to 100 V and 50 A
 - Modules that supply or load DUTs
 - Highly reliable mass interconnect interface to quickly change application specific fixtures and adapters
 - Systematic approach combines functional and in-circuit testing in a single chassis
 - Wide range of functions in a compact system design, ideal for inline applications
- ▶ High test speed thanks to intelligent modules
- ▶ Standardized and powerful software components (R&S®GTS, R&S®EGTSL) for instrument simulation while developing and tracing
- ▶ Integration of third-party cPCI/PXI/ PXIe modules
- ▶ Integrated self-test to ensure the system is ready for use, and detailed diagnostics in the event of a system fault
- ▶ In-system calibration option for high system availability in mass production lines

R&S®TSVP system layouts

R&S®ExpressTSVP/R&S®CompactTSVP

The R&S®ExpressTSVP/R&S®CompactTSVP chassis with embedded computers are a more compact solution with unimpeded CPU usage. The 16 or 21 peripheral slots, ATE systems with medium pin counts and up to 990 channels are available in a single box solution.

R&S®ExpressTSVP/
R&S®CompactTSVP



R&S®ExpressTSVP/R&S®CompactTSVP with external PC

The R&S®ExpressTSVP/R&S®CompactTSVP can also be controlled by an external computer with a PCIe bridge for more flexibility in selecting and configuring the control computer.

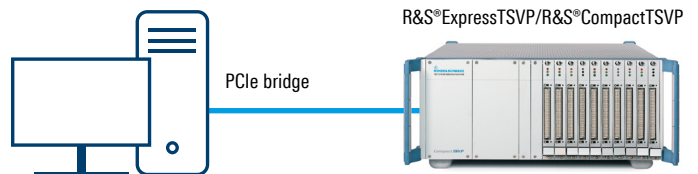

R&S®ExpressTSVP/R&S®CompactTSVP and R&S®PowerTSVP

The R&S®ExpressTSVP/R&S®CompactTSVP can be combined with the R&S®PowerTSVP for high-performance and high-pin-count ATE systems. The parts of a system with high current or high voltage signals up to 120 V can be separated to ensure a safe distance from the R&S®CompactTSVP so that it can be a dedicated measurement unit for high-power applications.

R&S®ExpressTSVP/
R&S®CompactTSVP

R&S®PowerTSVP



R&S®PowerTSVP

A medium-pin-count ATE with a standard external PC can use a CAN bus interface to control the R&S®PowerTSVP chassis. The CAN interface can use various standard interfaces such as USB to CAN. In this application scenario, appropriately dimensioned switching applications can be used for general purpose signals, high power load and power supply switching and analog and digital signal stimulus and acquisition with sample rates up to 5 ksamples/s.



R&S® ExpressTSVP UNIVERSAL TEST AND MEASUREMENT CHASSIS



Key facts

- ▶ 21-slot multi-standard chassis
- ▶ 1 cPCI serial system slot (rear)
- ▶ 1 cPCI serial slot (rear)
- ▶ 5 PXI express slots
- ▶ 13 R&S®PXI/cPCI/CAN slots with rear I/O
- ▶ 1 CAN slot with rear I/O
- ▶ Compact 4 HU 19" design
- ▶ PXI express slots with up to PCIe x4 link
- ▶ cPCI serial slot with PCIe x8 link
- ▶ Sophisticated analog measurement bus subsystem
- ▶ Compatible to R&S®CompactTSVP chassis, R&S®PowerTSVP chassis and R&S®Test and measurement modules for R&S®TSVP

Open test platform based on PXI and PXI Express

The R&S®ExpressTSVP concept is a true innovation in state-of-the-art PC based instrumentation that still offers the traditional capabilities found in high-performance ATE systems. The versatile platform accelerates PXI and PXI Express (PXIe) usage in all major fields of automotive test and measurement applications. The additional PXIe standard enables the use of several third-party modules.

R&S®ExpressTSVP – PXIe and extended PXI system functionality functionality

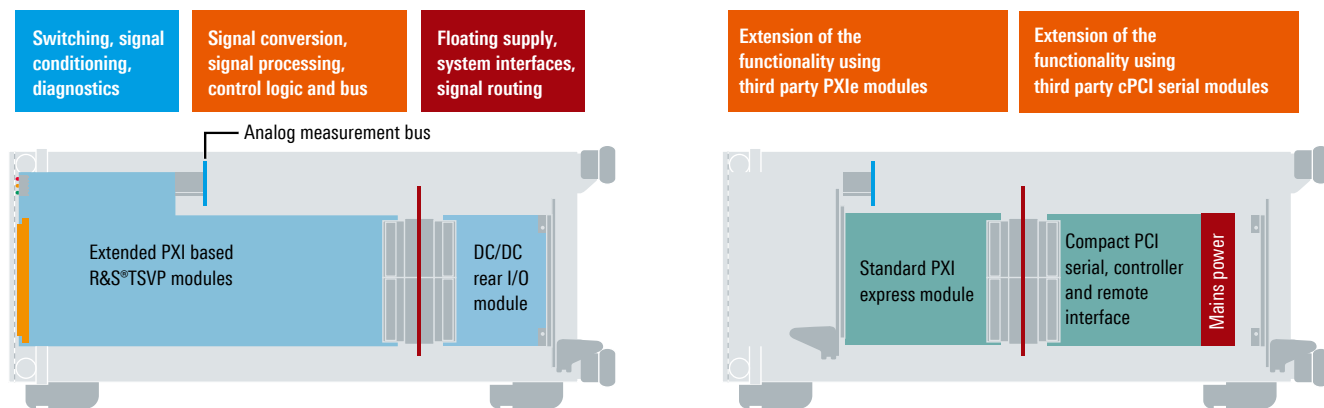

Analog measurement bus

The analog measurement bus offers short signal routing to measurement modules and electrical immunity to digital PCI backplanes. The highly sophisticated analog signal handling led to the interconnection solution for the R&S®TSVP analog bus. The analog bus is directly above the front connector area with space for onboard signal conditioning and signal routing with coupling relays for the analog bus. The eight lines of the system-wide analog measurement bus are available at extended PXI based R&S®TSVP module slots. They are used to temporarily connect DUT signals routed via switching modules and various measurement or stimulus modules that have access to the analog measurement bus.

R&S® CompactTSVP INDUSTRIAL TEST AND MEASUREMENT CHASSIS

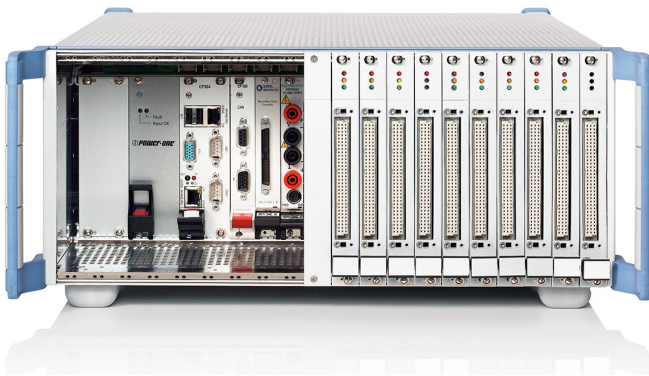

Open test platform based on CompactPCI and PXI

The R&S® CompactTSVP concept is a true innovation in state-of-the-art PC based instrumentation that offers the traditional capabilities in high-performance ATE systems. The versatile platform accelerates CompactPCI and PXI adoption in all major industrial test and measurement application fields.

Key facts

- ▶ Modular instrument chassis for CompactPCI and PXI modules
- ▶ Standard 19" 4 HU rackmount enclosure for 3 HU CompactPCI modules
- ▶ CompactPCI backplane conforming to PICMG 2.0 Rev. 3.0 specification
- ▶ Rear I/O support for easy system cabling (IEEE 1101.11-1998)
- ▶ Sophisticated analog measurement bus subsystem
- ▶ Support of PXI trigger concept
- ▶ 14 peripheral slots for versatile instrumentation
- ▶ Mass interconnect interface in different sizes (optional)
- ▶ High pin count switching expansion by cascading an R&S® PowerTSVP chassis
- ▶ Rohde & Schwarz commitment to industrial standards

R&S® CompactTSVP – Extended cPCI/PXI system functionality

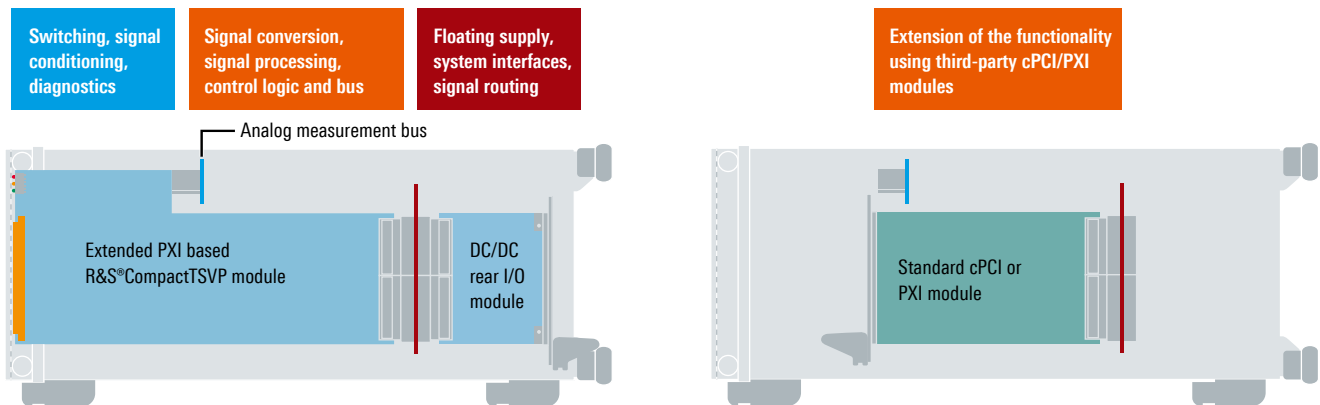

Analog measurement bus

The analog measurement bus offers short signal routing to measurement modules and electrical immunity to digital PCI backplanes. The highly sophisticated analog signal handling led to the interconnection solution for the analog bus of the R&S® CompactTSVP and R&S® PowerTSVP. The analog bus is located directly above the front connector area where space is provided for onboard signal conditioning and signal routing using coupling relays for the analog bus. The eight lines of the system-wide analog measurement bus are available at all peripheral slots. They are used to temporarily interconnect DUT signals routed via switching modules and various measurement or stimulus modules that have access to the analog measurement bus. It is implemented on a physically dedicated backplane located 160 mm from the digital CompactPCI/PXI backplane.

R&S® PowerTSVP INDUSTRIAL HIGH-POWER AND SWITCHING APPLICATION CHASSIS



Key facts

- ▶ Modular switching instrument chassis
- ▶ Chassis extension for R&S®CompactTSVP or standalone
- ▶ Standard 19" rackmount 4 HU enclosure
- ▶ 16 peripheral slots for switching instrumentation and further dedicated instrumentation
- ▶ Rear I/O support for easy system cabling (IEEE 1101.11-1998)
- ▶ Sophisticated analog measurement bus subsystem
- ▶ Support of system-wide trigger concept
- ▶ Easily expandable ATE instrumentation and switching
- ▶ High pin count switching applications, e.g. for in-circuit test (ICT)
- ▶ High-power switching

Open test platform based on CAN bus

The R&S®PowerTSVP chassis was created as a cost-efficient subsystem for high-power and switching applications. It can be used to build systems ranging from dedicated switching instruments to more complex switching applications in test and measurement systems.

The chassis contains a mechanical frame, digital back-plane, analog measurement bus, mains switching and filtering, power supply and diagnostic extensions controlled via CAN bus.

General concept of the R&S®PowerTSVP module format

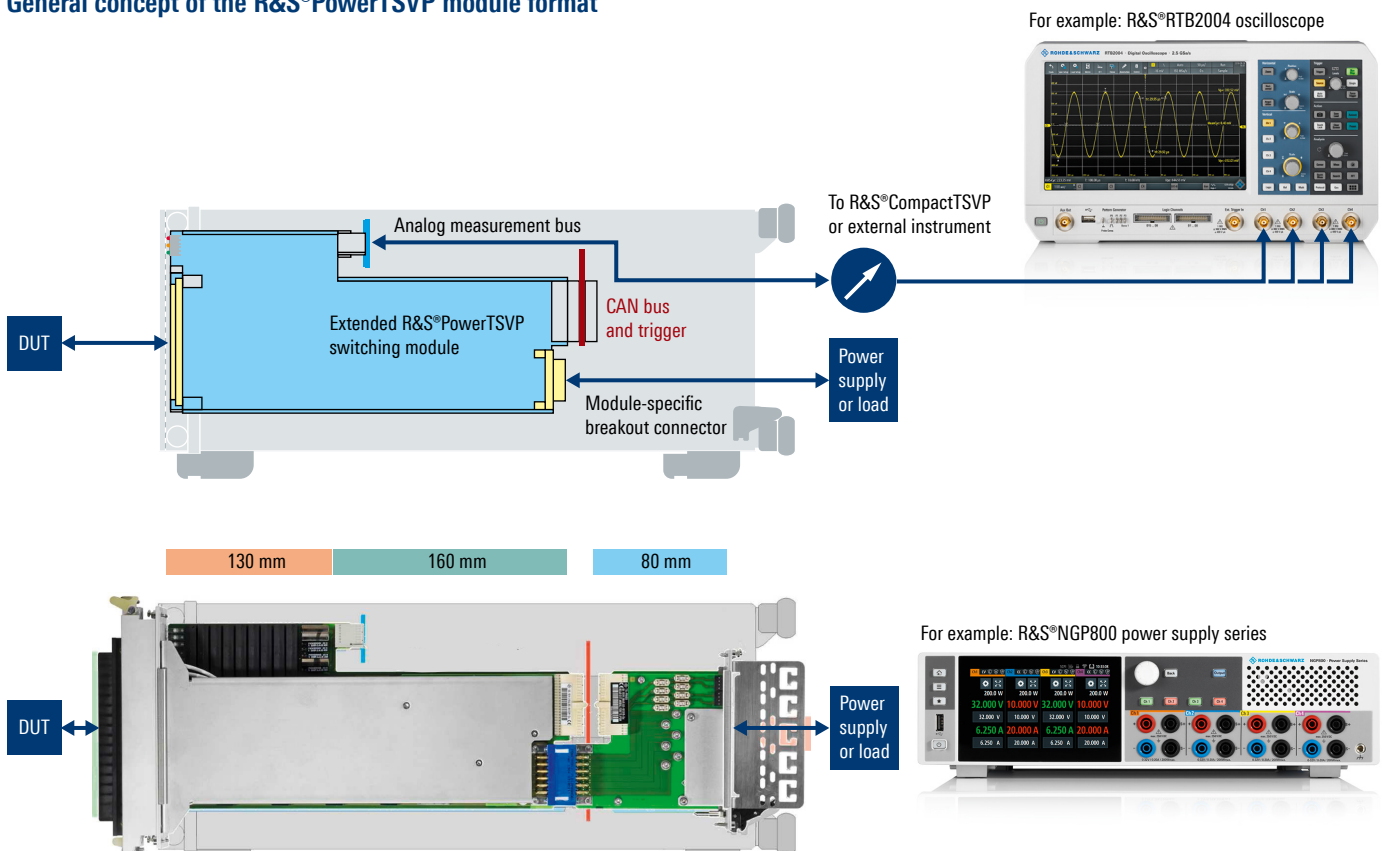

R&S®TSVP MODULES

System controller, bridges and extensions

R&S®TS-PSCE1x System Controller

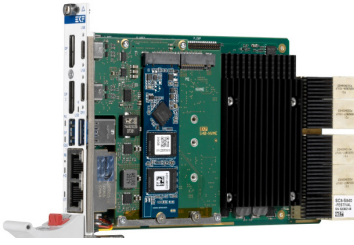

CompactPCI serial embedded system controller for R&S®ExpressTSVP

Users can configure the system by choosing the hardware, operating system and software that meets their specific requirements. The configuration can be extended at any time.

Key facts

- ▶ Intel® Xeon® E3 1505MV6 processor
- ▶ 256 Gbyte SSD (R&S®TS-PSCE1S)
- ▶ Windows 10 operating system (R&S®TS-PSCE1W)

Specifications in brief

- ▶ Packaging:
 - 3 HU single-slot CompactPCI serial CPU board
- ▶ Processor: Intel® Xeon® E3 1505MV6 3.0 GHz/4.0 GHz
- ▶ RAM: 16 Gbyte DDR4 ECC
- ▶ SSD: M.2 2280, 256 Gbyte, SATA
- ▶ Computer interfaces
 - 2 x USB type C 3.1 Gen. 1
 - 2 x USB 3.0
 - 2 x 1 Gbit Ethernet
 - 2 x DisplayPort
- ▶ Operating system: Windows 10

R&S®TS-PSC7x System Controller



CompactPCI embedded system controller for R&S®CompactTSVP

Users can configure the system by choosing the hardware, operating system and software that meets their specific requirements. The configuration can be extended at any time.

Key facts

- ▶ Intel® Core™ i5-8400H processor
- ▶ Includes rear I/O module
- ▶ 256 Gbyte SSD (R&S®TS-PSC7S)
- ▶ Windows 10 operating system (R&S®TS-PSC7W)

Specifications in brief

- ▶ Packaging:
 - 3 HU dual-slot CompactPCI CPU board
- ▶ Processor: Intel® Core™ i5-8400H 2.5 GHz
- ▶ RAM: 16 Gbyte DDR4 SDRAM
- ▶ SSD: 2.5", 256 Gbyte, SATA
- ▶ Computer interfaces
 - 2 x USB 2.0
 - 1 x USB 3.0
 - 3 x 1 Gbit Ethernet
 - 1 x RS-232
 - 2 x DisplayPort
 - 1 x VG
- ▶ Operating system: Windows 10
- ▶ Suitable for R&S®CompactTSVP

Accessories

R&S®TSVP accessory products

See supplement order number 5040.7266.02

Mass interconnect receiver for the R&S®TSVP family

See user manual order number 5046.4023.02

R&S®TSVP MODULES

R&S®TS-PSC08 PCIe-to-cPCI Bridge



Remote control via PCIe bridge

Desktop and industrial PCs equipped with PCIe extension slots can also be used as a system controller for the R&S®ExpressTSVP/R&S®CompactTSVP chassis.

The transparent downstream PCIe cable interface is ready to run without software driver installation and provides outstanding system performance.

Specifications in brief

- ▶ Remote interface: PCIe express
- ▶ External host PC: PCIe express bus
- ▶ Implementation: transparent PCIe bridge
- ▶ Interface location: rear panel of R&S®ExpressTSVP/R&S®CompactTSVP chassis, controller slot 1

R&S®TS-PXB2 Backplane Extension Module

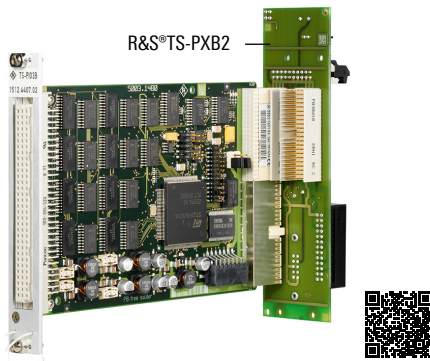

Flexible expansion of the R&S®CompactTSVP and R&S®PowerTSVP with two additional CAN bus slots

The R&S®TS-PXB2 is a backplane extension module for slots A1 and A2.

As a result, PXI slots can be kept free so that they can be equipped with measurement modules. The cabling kit for the backplane option also includes a breakout of the system CAN bus on rear I/O slot 4 for controlling remote modules directly in the test fixture.

Furthermore, the R&S®TS-PXB2 option can have 24 signals routed to the backplane of the instrument, to the digital I/O ports 5, 6 and 7 of the R&S®TS-PIO3B option.

Specifications in brief

- ▶ Expansion by means of two CAN bus slots at slots A1, A2 without linkup to the analog bus
- ▶ Breakout of the CAN bus to the rear panel
- ▶ Breakout of each of the 24 digital I/O channels of slots A1 and A2 on the rear panel
- ▶ Suitable for R&S®CompactTSVP and R&S®PowerTSVP

R&S®TSVP MODULES

Instrumentation

R&S®TS-PSAM Analog Source and Measurement Module

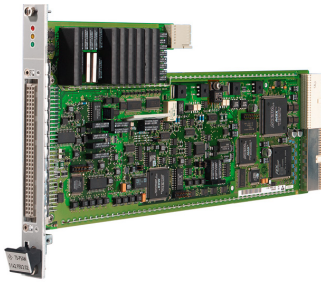

Scanning multimeter and data acquisition unit

- ▶ Floating measurement of voltage, current (AC/DC) and resistance in 2 and 4 wire mode
- ▶ Analog in-circuit test with short, contact and continuity test
- ▶ Test of resistors, diodes, bipolar transistors, jumpers/switches and discharge of capacitors
- ▶ Measurement synchronization via PXI clock and trigger

Specifications in brief

- ▶ Voltage measurements
 - DC: up to ± 120 V
 - AC: up to 50 V (RMS)
- ▶ Current ranges
 - DC: up to ± 1 A
 - AC: up to 1 A (RMS)
- ▶ Resistance ranges: 1 Ω to 10 M Ω
- ▶ Sample rate: 0.01 sample/s to 200 ksample/s
- ▶ DC source: ± 5 V, 100 mA, 4-quadrant
- ▶ Discharge unit: max. 120 V DC, 400 mA
- ▶ Suitable for R&S®ExpressTSVP/R&S®CompactTSVP

R&S®TS-PICT In-Circuit Test Extension

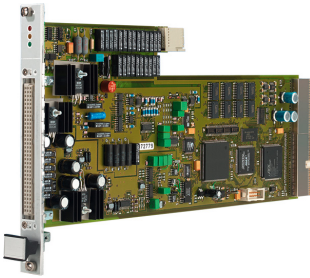

Analog ICT in conjunction with the R&S®TS-PSAM

- ▶ Testing of R, L, C, diodes, transistors, parallel R-C
- ▶ For guarded measurements in 3, 4 and 6 wire technology
- ▶ Measurement of inductors, capacitors and impedances

Specifications in brief

- ▶ AC source: referenced to GND
- ▶ Voltage: 0.1 V, 0.2 V, 1.0 V
- ▶ Voltage offset: off, pos., neg.
- ▶ Impedance: 1 Ω , 10 Ω , 1 k Ω , 10 k Ω
- ▶ Frequency: DC, 100 Hz, 1 kHz, 10 kHz
- ▶ Measurement unit: referenced to GND
- ▶ Current ranges: 1 μ A to 200 mA
- ▶ Sample rate: max. 200 ksample/s
- ▶ Working voltage: max. 60 V DC
- ▶ Suitable for R&S®ExpressTSVP/R&S®CompactTSVP

R&S®TS-PI02 Analog and Digital I/O Module

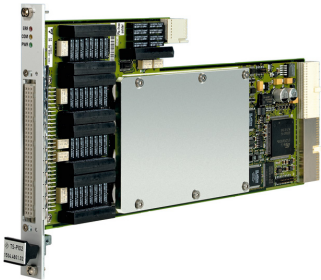

Analog and digital 16-channel stimulus and measurement unit for mixed signal DUT testing

- ▶ Analog and digital signal acquisition with high measurement resolution of 24 bit for level ranges up to ± 27 V
- ▶ Sampling rate of up to 5 ksample/s for inputs and outputs
- ▶ Autocorrection feature for all input and output channels
- ▶ Analog and digital stimulus outputs, offering static and dynamic signal outputs
- ▶ 16 bit resolution, high output level up to ± 27 V
- ▶ Versatile signal switching and DUT interconnection
- ▶ Stimulus and acquisition channels providing floating operation

Specifications in brief

- ▶ Output channels: 16, in 4 groups, floating high/low voltage: ± 27 V/ ± 27 V (L per group)
- ▶ Current/channel: 12 \times 15 mA, 4 \times 100 mA
- ▶ Modes: analog, digital, frequency
- ▶ Input channels: 16, in 4 groups, floating
- ▶ High/low threshold: ± 27 V/ ± 27 V (both per group)
- ▶ Data buffer: 4 \times 5 ksample ($A_{out}/D_{out}/A_{in}/D_{in}$)
- ▶ Sample rate: 0.01 sample/s to 5 ksample/s
- ▶ Suitable for R&S®CompactTSVP and R&S®PowerTSVP

R&S®TSVP MODULES

R&S®TS-PIO3B Digital I/O Module and R&S®TS-PTRF Signal Port and Transmission Module

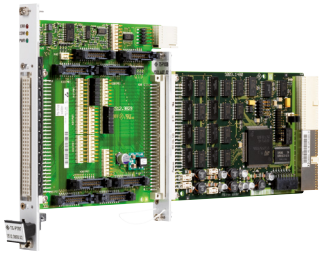

Digital control and coil driver with power outputs

The R&S®TS-PIO3B is a versatile digital I/O module with 64 (model .02) or 40 (model .04) channels. It offers eight ports with eight digital I/O lines each that have MOSFET output drivers. The circuitry is designed to drive RF relays with all common control voltages. The high current-carrying capacity makes the module a universal coil driver. An SPI interface allows users to control external SPI modules.

Transmission to the R&S®TS-PTRF front module is designed to either route digital signals to the front connector or distribute digital ports to control auxiliary modules, e.g. R&S®TS-PXM1.

Specifications in brief

- ▶ Digital I/O channels
 - 64, in 8 groups (model .02)
 - 40, in 5 groups (model .04)
- ▶ Voltage: 0 V to 35 V
- ▶ Current output: max. 200 mA per bit, 1 A per port
- ▶ Analog inputs: 8
- ▶ Level range : 0 V to 5 V
- ▶ Resolution: 10 bit
- ▶ Accuracy: $\pm(100 \text{ mV} + 5\%)$
- ▶ SPI interface: SPI SCLK MOSI 5 V TTL output with 300 Ω series MISO 5 V TTL input
- ▶ Suitable for R&S®ExpressTSVP/ R&S®CompactTSVP and R&S®PowerTSVP

Easy deployment by sophisticated software

- ▶ Self-test software
- ▶ Soft front panels for immediate use
- ▶ LabWindows/CVI device driver support
- ▶ Test software library R&S®GTSL in DLL format

R&S®TS-PIO4 32-Channel Programmable Digital I/O Module

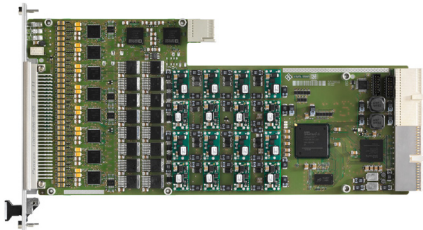

Flexibly programmable 32 bit digital inputs and 32 bit digital outputs that are able to acquire and generate static or dynamic digital patterns

- ▶ 32 digital input and 32 digital output channels
- ▶ 40 MHz sample rate, depending on levels and number of channels
- ▶ FPGA based flexibility and real-time task execution independent of operating system
- ▶ 8 groups of 4 channels each: –6 V to +10 V
- ▶ Tristate control for every output channel in dynamic mode
- ▶ Programmable DIO level (high and low) per group with 14 bit resolution
- ▶ Two programmable input threshold levels per group for hysteresis or level monitoring
- ▶ High output current with 150 mA per channel
- ▶ Synchronization/trigging (bidirectional) via PXI trigger bus or XTI (TTL)
- ▶ External clock input via EXT_CLK input pin (TTL)

Specifications in brief

- ▶ Output channels: 32, in 8 groups of 4 bit
- ▶ Voltage/group: –6 V to +10 V, tristate
- ▶ High output current with 150 mA per channel
- ▶ Input channels: 32, in 8 groups of 4 bit
- ▶ Threshold/group: –6.0 V to 7.1 V
- ▶ Sample rate: 0.01 sample/s to 40 Msample/s
- ▶ Resolution: 12.5 ns
- ▶ Data buffer: 2 Msample at 32 bit
- ▶ Suitable for R&S®ExpressTSVP/ R&S®CompactTSVP

Easy deployment by sophisticated software

- ▶ Self-test software
- ▶ Soft front panels for immediate use
- ▶ LabWindows/CVI device driver support
- ▶ Test software library R&S®GTSL in DLL format

R&S®TSVP MODULES

R&S®TS-PI05 LVDS Digital Functional Test Module

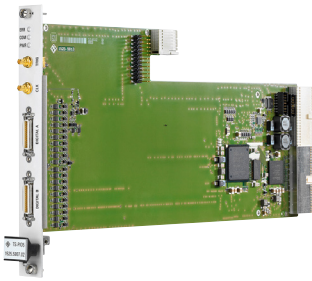

Very flexibly programmable bidirectional LVDS channels to acquire and generate static or dynamic digital patterns

- ▶ Two MDR connectors with 10 LVDS channels each (8 × data, 1 × general purpose, 1 × clock); bidirectional LVDM with fixed termination (100 Ω) onboard
- ▶ Two single-ended control lines per connector
- ▶ 10 RS-485 (RS-422) compatible I/O channels with interface connector onboard
- ▶ Stimulation with digital real-time data streams with 2 Mpattern (32 bit) memory onboard
- ▶ Acquisition of real-time digital data streams
- ▶ LVDS transceivers with internal ESD protection
- ▶ FPGA based flexibility and simultaneous task operation independent of the operating system

Specifications in brief

- ▶ 5 V/max. 0.30 A power supply available at each digital connector, protected by a diode and fuse
- ▶ Pattern rate up to 200 Mbit, 5 ns resolution
- ▶ Triggering (bidirectional) via PXI trigger bus; resolution based on PXI or external clock, ≥ 10 ns
- ▶ Synchronization via
 - TTL external clock input (SMB plug)
 - LVDS clock lines (MDR connector)
 - PXI clock 10 MHz
- ▶ Jitter and signal delay compensation in steps of typically 2.5 ns, 180° phase shift or delay of numerous clock cycles (combination possible)
- ▶ Suitable for R&S®ExpressTSVP/
R&S®CompactTSVP

Easy deployment by sophisticated software

- ▶ Self-test software
- ▶ Software front panels for immediate use
- ▶ LabWindows/CVI device driver support
- ▶ Test software library R&S®GTSL in DLL format

R&S®TS-PFG Function Generator Module

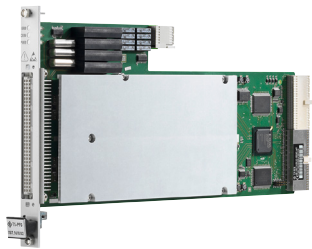

Dual-channel arbitrary waveform generator with isolated outputs

- ▶ Arbitrary waveform generator module with two floating signal outputs and independent channel isolation
- ▶ High output level range up to 40 V (V_{pp})
- ▶ High sampling rate of 25 Msample/s per channel
- ▶ Output of standard waveforms up to 1 MHz sine, square, triangle, arbitrary waveform
- ▶ Sequencing of multiple memory sections and multiple repetitions

Specifications in brief

- ▶ Channels: 2, fully independent, floating, cascadable
- ▶ Voltage ranges: ±1 V, ±5 V, ±10 V, ±20 V
- ▶ Voltage resolution: 16 bit
- ▶ Output current: max. 250 mA
- ▶ Data buffer: 1 Msample per channel
- ▶ Sample rate: 0.01 sample/s to 25 Msample/s
- ▶ Standard waveforms: sine wave, triangle, square wave (1 Hz to 1 MHz), DC static
- ▶ Pulse: min. 500 ns (1% to 99%)
- ▶ Output ranges: ±1 V to ±20 V, max. 40 V (V_{pp})
- ▶ Output current: max. ±250 mA
- ▶ Suitable for R&S®ExpressTSVP/
R&S®CompactTSVP

R&S®TS-PAM Signal Analyzer Module

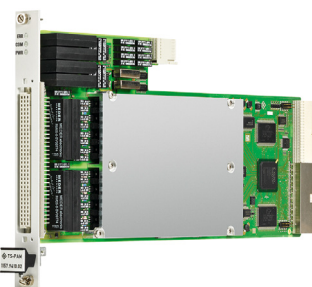

Eight-channel digitizer and waveform analyzer

- ▶ Digitizer module featuring two fully independent, floating acquisition units
- ▶ Acquisition modes with up to eight single-ended or four differential channels
- ▶ High sampling rate of 20 Msample/s for each acquisition unit
- ▶ Multichannel signal recording for up to eight channels at 5 Msample/s
- ▶ Synchronous acquisition of eight programmable comparator signals and PXI trigger
- ▶ Wide dynamic range with 14 bit resolution

Specifications in brief

- ▶ Acquisition units: 2, fully independent and floating
- ▶ Data buffer: 1 Msample per acquisition unit
- ▶ Channels per unit: 4
- ▶ Voltage ranges: ±0.2 V to 100 V (per channel)
- ▶ Resolution: 14 bit
- ▶ Sample rate: 0.02 sample/s to 20 Msample/s
- ▶ Relay multiplexer: 3:1 per channel
- ▶ Suitable for R&S®ExpressTSVP/
R&S®CompactTSVP

R&S®TSVP MODULES

R&S®TS-PSU Power Supply and Load Module



Four-quadrant source with integrated measurement unit

- ▶ Two independent, floating channels of four-quadrant sources with separate sensing per channel
- ▶ Programmable current and voltage limiting
- ▶ Integrated voltage and current measurement unit per channel
- ▶ Electronic load simulation of 20 W per channel
- ▶ Output and recording of voltage and current profiles
- ▶ Protection against overvoltage, overcurrent, overtemperature and short circuits
- ▶ 4-to-1 relay multiplexer for force and sense lines of each channel

Specifications in brief

- ▶ Output channels: 2, floating, fully independent, 4 quadrants, cascadable
- ▶ Voltage ranges: ± 15 V, ± 50 V (16 bit)
- ▶ Current ranges: 10 mA, 100 mA, 3 A (16 bit)
- ▶ Data buffer: 2×10 ksample (V_{out}/I_{out})
- ▶ Measurement unit: voltage or current
- ▶ Data buffer: 10 ksample
- ▶ Sample rate: 0.01 sample/s to 10 ksample/s
- ▶ Suitable for R&S®ExpressTSVP/
R&S®CompactTSVP and R&S®PowerTSVP

R&S®TS-PSU12 Power Supply and Load Module

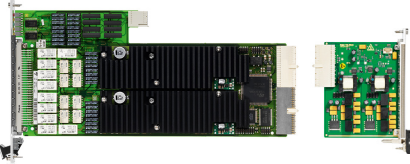

Four-quadrant source with integrated measurement unit

- ▶ Two independent, floating channels of four-quadrant sources with separate sensing per channel
- ▶ Programmable current and voltage limiting
- ▶ Same feature set as the R&S®TS-PSU but with R&S®TS-PDC internal primary power supply

Specifications in brief

- ▶ Output channels: 2, floating, fully independent, 4 quadrants, cascadable
- ▶ Voltage ranges: ± 12 V (16 bit)
- ▶ Current ranges: 10/100/500 mA (16 bit)
- ▶ Data buffer: 2×10 ksample (V_{out}/I_{out})
- ▶ Measurement unit: voltage or current
- ▶ Data buffer: 10 ksample
- ▶ Sample rate: 0.01 sample/s to 10 ksample/s
- ▶ Suitable for R&S®ExpressTSVP/
R&S®CompactTSVP and R&S®PowerTSVP

Signal routing and switching

R&S®TS-PMB Switch Matrix Module

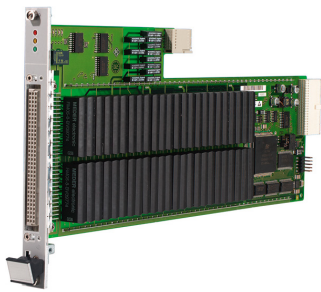

High-density, 90-channel, full matrix relay-multiplexer module

The R&S®TS-PMB sets up test channels for functional and in-circuit tests. It provides all signal routing between DUT and measurement modules via the R&S®CompactTSVP analog bus.

The general-purpose switch matrix module can handle input signals up to 1 A. It provides self-test capability and fast switching of signal paths.

Specifications in brief

- ▶ Switching: relay, full matrix
- ▶ Configuration: 90 channels to 2×4 buses
- ▶ Deployed as
 - Single matrix: 90 pins to 4 bus lines
 - Single matrix: 45 pins to 8 bus lines
 - Dual matrix: 45 pins to 4 bus lines
- ▶ Analog measurement bus access to 8 bus lines
- ▶ Voltage: max. 120 V DC
- ▶ Current: max. 1 A
- ▶ Power: max. 10 W
- ▶ Switch time: 0.5 ms (incl. bouncing)
- ▶ Suitable for R&S®ExpressTSVP/
R&S®CompactTSVP and R&S®PowerTSVP

R&S®TSVP MODULES

R&S®TS-PSM1 Power Switching Module

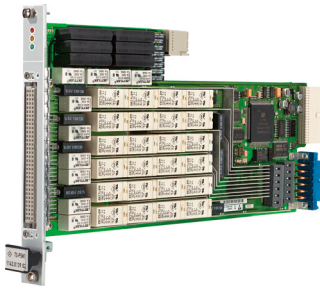

High-power multiplexer and multiple DUT power switching module

- ▶ Power switching module for supplies and loads
- ▶ Can handle voltages up to 70 V with
 - 8 high-power channels with max. 16 A
 - 10 power channels with max. 2 A
 - 4 high-power 4-to-1 multiplexer channels with max. 16 A
- ▶ Indirect high-current measurements on high-power channels via shunt resistors; routing of corresponding voltage via analog measurement bus
- ▶ Self-test of all relays via analog measurement bus and R&S®TS-PSAM

Specifications in brief

- ▶ Switching: high-power (HP) and medium-power (MP) relays
- ▶ Configuration MP:
 - 10 × SPST front – front/rear
- ▶ Configuration HP
 - 8 × SPST rear – front, shunt
 - 2 × SP 4:1 MUX front – front
 - 2 × SP 4:1 MUX rear – rear
- ▶ Voltage: max. 60 V DC
- ▶ Current MP/HP: max. 2 A/16 A
- ▶ Power MP/HP: max. 150 W/480 W
- ▶ Switch time MP: 5 ms (incl. bouncing)
- ▶ Switch time HP: 10 ms (incl. bouncing)
- ▶ Suitable for R&S®ExpressTSVP/
R&S®CompactTSVP and R&S®PowerTSVP

R&S®TS-PSM2 Multiplex and Switch Module

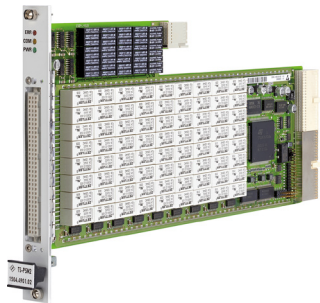

Medium-power multiplexer and switching module

- ▶ Medium-power switching module for voltages up to 2 A
- ▶ Eight independent groups of 3 SPST/1 SPDT relay channels or 4-to-1 DPST relay multiplexers
- ▶ Relay multiplexers can be cascaded via local power buses
- ▶ Indirect current measurements on each SPxT channel via shunt resistors
- ▶ Direct current measurements up to 1 A on all channels via R&S®CompactTSVP analog measurement bus and R&S®TS-PSAM

Specifications in brief

- Switching: 8 independent relay groups
- ▶ Configuration
 - 3 × SPST + SPDT, shunt or
 - DP 4:1 MUX
- ▶ Voltage: max. 120 V DC
- ▶ Current: max. 2 A
- ▶ Power: max. 60 W
- ▶ Switch time: 5 ms (incl. bouncing)
- ▶ Suitable for R&S®ExpressTSVP/
R&S®CompactTSVP and R&S®PowerTSVP

R&S®TS-PSM3 High-Power Switching Module

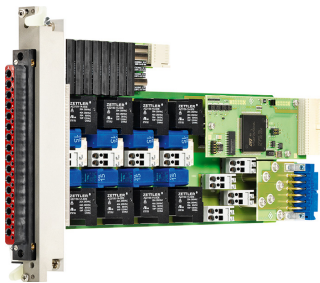

Automotive DUT supply and load switching up to 30 A

- ▶ 8 high-power channels for currents up to 30 A
- ▶ 8 medium-power channels for currents up to 2 A
- ▶ Integrated current measurement via current sensors and analog bus coupling
- ▶ Rear I/O access to the power signals for unique flexibility during system integration and seamless adaptation to power supplies and loads within a system paradigm based on R&S®PowerTSVP
- ▶ Unique comprehensive self-test and measurement of relay contact resistance

Specifications in brief

- ▶ Maximum operating voltage
 - Channel to channel, max. 87 V DC
 - Channel to GND, max. 63 V DC
- ▶ High-power channels
 - Switching current: max. 30 A
 - Switching power: max. DC: 900 W
 - Operate/release time: typ. < 8 ms
- ▶ Medium-power channels
 - Switching current: max. 2 A
 - Switching power: max. DC: 60 W
 - Operate/release time: typ. < 6 ms
- ▶ Adaptation to R&S®TS-PRI03 rear I/O module
- ▶ All high-power and medium-power channels
- ▶ Suitable for R&S®ExpressTSVP/
R&S®CompactTSVP and R&S®PowerTSVP

R&S®TSVP MODULES

R&S®TS-PSM4 Multiplex and Switch Module

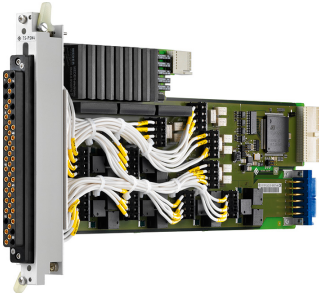

Power multiplexer and DUT power switching module

- ▶ 12 high-power channels for currents up to 16 A
- ▶ 8 medium-power channels for currents up to 2 A
- ▶ Integrated current measurement via shunt resistors and analog bus coupling
- ▶ Rear I/O access to the power signals for unique flexibility during system integration and seamless adaptation to power supplies and loads within a system paradigm based on R&S®PowerTSVP
- ▶ Unique comprehensive self-test and measurement of relay contact resistance

Specifications in brief

- ▶ Maximum operating voltage
 - Channel to channel, max. 117 V DC
 - Channel to GND, max. 105 V DC
- ▶ High-power channels
 - Switching current: max. 16 A
 - Switching power: max. DC: 480 W
 - Operate/release time: typ. < 4 ms
- ▶ Medium-power channels
 - Switching current: max. 2 A
 - Switching power: max. DC: 60 W
 - Operate/release time: typ. < 6 ms
- ▶ Adaptation to R&S®TS-PRIO2 rear I/O module
 - All high-power and medium-power channels

R&S®TS-PSM5 High-Power Switching Module

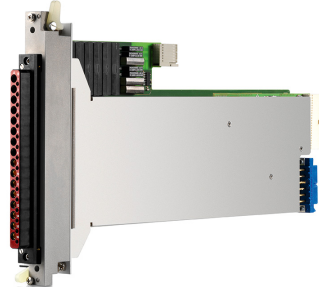

Automotive DUT supply and load switching up to 50 A

- ▶ 4 high-power channels for currents up to 50 A
- ▶ 4 medium-power channels for currents up to 2 A
- ▶ Integrated current measurement via current sensors and analog bus coupling
- ▶ Rear I/O access to the power signals for unique flexibility during system integration and seamless adaptation to power supplies and loads within a system paradigm based on R&S®PowerTSVP
- ▶ Unique comprehensive self-test and measurement of relay contact resistance

Specifications in brief

- ▶ Maximum operating voltage
 - Channel to channel, max. 87 V DC
 - Channel to GND, max. 63 V DC
- ▶ High-power channels
 - Switching current: max. 50 A
 - Switching power: max. DC: 1120 W
 - Operate/release time: typ. < 14 ms
- ▶ Medium-power channels
 - Switching current: max. 2 A
 - Switching power: max. DC: 60 W
 - Operate/release time: typ. < 6 ms
- ▶ Adaptation to R&S®TS-PRIO5 rear I/O module
 - All high-power and medium-power channels

R&S®TS-PXM1 Switching Extension Module



General-purpose switching extension of the R&S®TS-PIO3B digital I/O module

- ▶ Breakout and routing of internal signals from adjacent PXI modules, e.g. boundary scan lines
- ▶ Discrete wiring of DUTs with auxiliary voltages in the functional test
- ▶ Connection of load resistances to DUT outputs
- ▶ Simple control via one R&S®TS-PIO3B control port each for up to eight R&S®TS-PXM1 switching extension modules
- ▶ Can be used on slots A1 to A4, which in the past were ordinarily not used for DUT connections and in front of controller slots 1 and 2; if needed, PXI slots can be kept free for additional measurement modules

Specifications in brief

- ▶ Relay organization: 8 x 4PDT
- ▶ Switching voltage: max. 30 V DC
- ▶ Switching current: max. 2 A
- ▶ Switching power: max. 60 W
- ▶ Relay control: 8 bit, low active
- ▶ Suitable for R&S®ExpressTSVP/ R&S®CompactTSVP and R&S®PowerTSVP

R&S®TSVP MODULES AND ACCESSORY PRODUCTS

Rear I/O instrument extensions

R&S®TS-PRIOx rear I/O instrument extensions

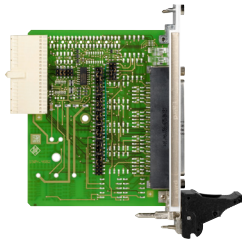

R&S®TS-PRIO4, rear I/O transmission module for R&S®TS-PIO3B and R&S®TS-PMB

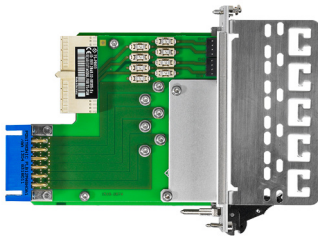

R&S®TS-PRIO3, rear I/O module for R&S®TS-PSM3

The R&S®TS-PRIOx modules are a ruggedized implementation of modular rear I/O switching module extensions to make high-current switching an intrinsic part of the test system.

- ▶ Distribution of one power supply to multiple DUTs
- ▶ Flexible distribution of power supplies to DUTs including sense lines via medium-power relays
- ▶ Connection of test loads, original loads or simulated and electronic actuators in automotive test scenarios
- ▶ Multiplexing of power supplies and electronic loads

Switching modules

R&S®TS-PIO3B, R&S®TS-PTR
R&S®TS-PMB, R&S®TS-PSM2
R&S®TS-PSM3
R&S®TS-PSM4
R&S®TS-PSM5

Suitable rear I/O

R&S®TS-PRIO4
R&S®TS-PRIO
R&S®TS-PRIO3
R&S®TS-PRIO2
R&S®TS-PRIO5

Specifications in brief

- ▶ Feedthrough from rear panel to switching module
- ▶ All switching lines typically supported
- ▶ In conjunction with power switch modules, both force and sense lines are supported
- ▶ High-power rear I/O provides mounting brackets for ground terminals

Suitable rear I/O for PXI based R&S®TSVP models

R&S®TS-PRIO4
R&S®TS-PRIO
R&S®TS-PRIO4 (mandatory for slots 5/6 to 13/14)
R&S®TS-PRIO4 (mandatory for slots 5 to 14)
R&S®TS-PRIO4 (mandatory for slots 5/6 to 13/14)

In-system calibration

R&S®TS-ISC In-System Calibration Kit



On-site calibration solution for the R&S®CompactTSVP

The R&S®TS-ISC in-system calibration kit contains the basic tools needed to calibrate any of the modular instruments in the R&S®TSVP product family.

The most important benefit for factory systems being able to calibrate while the modules remain in the instrument chassis slots. A dedicated, highly accurate multimeter is also needed for corresponding measuring accuracy during calibration.

Specifications in brief

The R&S®TS-ISC in-system calibration kit includes the following:

- ▶ R&S®TS-PCAL2 calibration module
- ▶ Calibration adapters
 - R&S®TS-PCALA
 - R&S®TS-PCALB
 - R&S®TS-PCALC
- ▶ R&S®TS-PKL cable for connecting the adapters to the external multimeter

R&S®TS-PCAL2 Calibration Module

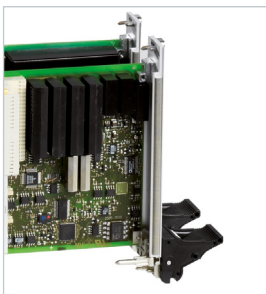

On-site calibration module for chassis rear I/O

The R&S®TS-PCAL2 calibration module provides traceable calibration signals and can be integrated into multiple chassis on the factory floor so that each R&S®CompactTSVP can be calibrated on site without changing the module configuration.

An onboard relay multiplexer connects components to analog bus lines on an R&S®TS-PMB module installed in front of the R&S®TS-PCAL2 module.

Specifications in brief

The R&S®TS-PCAL2 has the following functions:

- ▶ Floating 5 V reference source
- ▶ Three reference resistors for resistance measurements
- ▶ Ground-referenced current source, adjustable up to 1 A current measurements
- ▶ Floating signal generator for dynamic measurements of
 - DC: -40 V to +40 V
 - AC, sinusoidal: 2 V to 80 V (V_{pp}) in frequency range from 20 Hz to 50 kHz; 0.2 V to 2 V (V_{pp}) in frequency range from 50 kHz to 1 MHz

SLOTS AND BACKPLANE ARCHITECTURE

R&S®ExpressTSVP front view

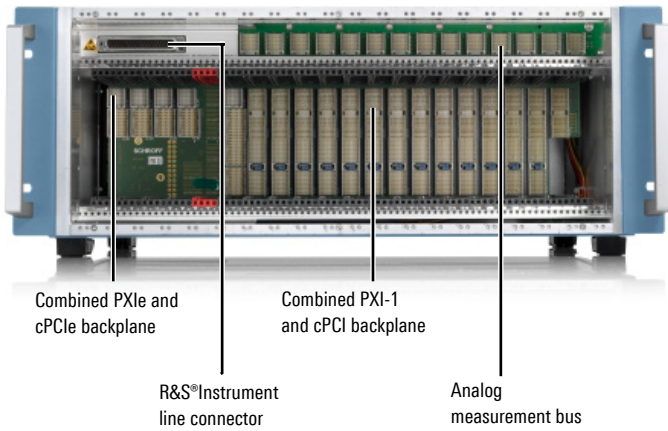

R&S®ExpressTSVP rear view

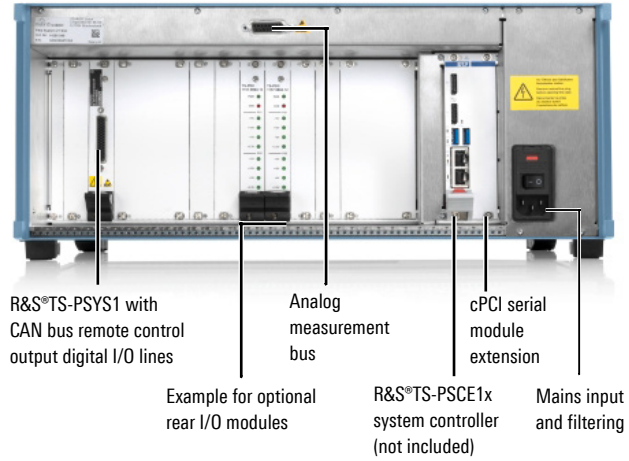

Versatile backplane architecture

The R&S®ExpressTSVP test and measurement chassis includes the control backplane with a total of 21 peripheral slots.

Slots A1 to A4 and A6 have a combined PXI Express/CompactPCI express interface, while slot A5 can have a 2-slot module.

Slots S3 to S16 contain a PXI-1/CompactPCI interface in combination with a CAN, analog bus and rear I/O connection known from the R&S®CompactTSVP, while slot S16 is limited to CAN and analog bus interfaces only.

A cPCI serial system slot reserved for the controller and one free cPCI serial slot are positioned in the rear.

The rear cabling is very helpful with the 19" rackmountable standard test adapter available for the R&S®ExpressTSVP as a set of off-the-shelf products, ready for use in production testing.

The backplane concept offers maximum flexibility when integrating the ATE instrumentation modules in the R&S®TSVP product line or commonly used off-the-shelf cPCIe/cPCI based products.

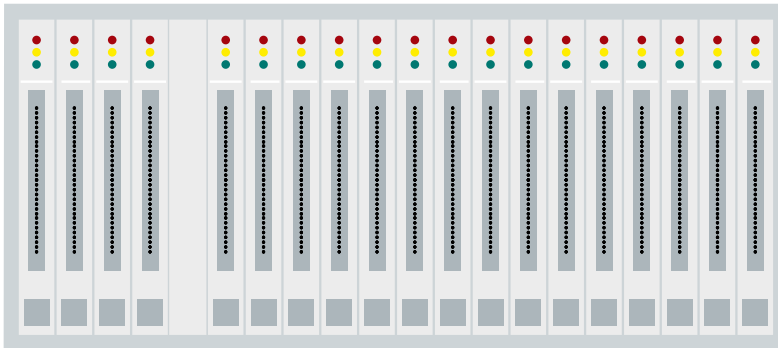

	A1	A2	A3	A4	A5	A6	S3	S4	S5	S6	S7	S8	S9	S10	S11	S12	S13	S14	S15	S16	
Front																					
PXIe	█					█															
cPCI							█														
PXI							█														
CAN							█														
Analog bus							█														
Rear					S2	S1	S3	S4	S5	S6	S7	S8	S9	S10	S11	S12	S13	S14	S15	S16	
Rear I/O							█														
cPCI serial						█ CPU															
Power supplies	█																				

System backplane architecture for the R&S®ExpressTSVP

SLOTS AND BACKPLANE ARCHITECTURE

R&S®CompactTSVP front view

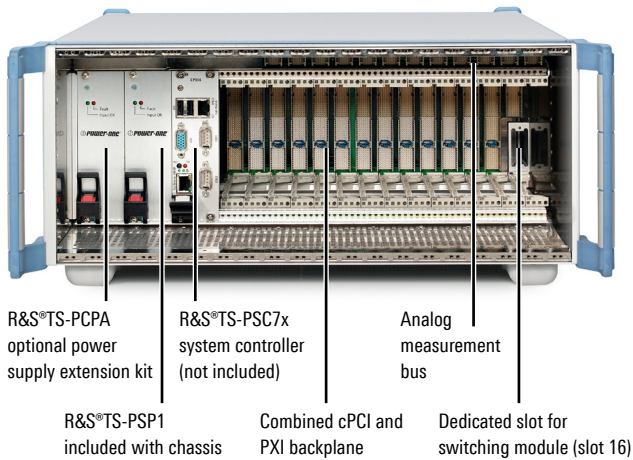

R&S®CompactTSVP rear view

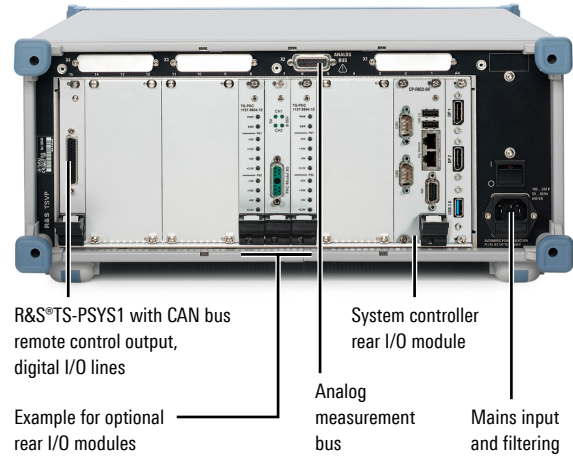

Versatile backplane architecture

The R&S®CompactTSVP test and measurement chassis forms the control backplane with 14 peripheral slots in line with the CompactPCI specification PICMG 2.0 rev. 3.0 with CompactPCI rear I/O support for RTM modules.

Eleven slots also support special PXI features (PCI eXtensions for Instrumentation).

The CompactPCI standard 32 bit design makes it possible to route module-specific signals via the RTM concept to the rear of the test platform without special cabling. Slots 3 and 4 support the RTM feature instead of PXI, making

the feature possible. The rear side cabling is a big help when using a 19" rackmountable standard test adapter, available for the R&S®CompactTSVP as a set of off-the-shelf products, ready for use in production testing. Slots 5 to 15 have PXI triggering features and a high-precision 10 MHz system clock for synchronization.

The backplane concept is very flexible when integrating either the ATE instrumentation modules in the R&S®CompactTSVP product line or common off-the-shelf CompactPCI based products.

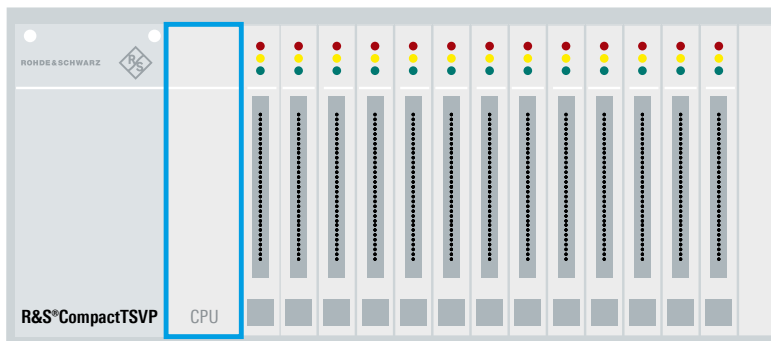

Bus \ Slot	A1	A2	A3	A4	1	2	3	4	5	6	7	8	9	10	11	12	13	14	15	16
CompactPCI					█		█	█	█	█	█	█	█	█	█	█	█	█	█	█
PXI					█															
CAN bus																				
Analog bus					█		█	█	█	█	█	█	█	█	█	█	█	█	█	█
Rear I/O					█		█	█	█	█	█	█	█	█	█	█	█	█	█	█
DC/DC rear I/O																				
Power supplies	█	█	█	█																

System backplane architecture for the R&S®CompactTSVP

FROM PRESALES TO SERVICE. AT YOUR DOORSTEP.

The Rohde & Schwarz network in over 70 countries ensures optimum on-site support by highly qualified experts.

User risks are reduced to a minimum at all project stages:

- ▶ Solution finding/purchase
- ▶ Technical startup/application development/integration
- ▶ Training
- ▶ Operation/calibration/repair



ORDERING INFORMATION

Designation	Type	Order No.
Modular instrument chassis		
R&S®ExpressTSVP universal test and measurement chassis	R&S®TSVP	1158.1542K02
R&S®CompactTSVP industrial test and measurement chassis	R&S®TSVP	1152.2518.02
R&S®PowerTSVP industrial high-power and switching application chassis	R&S®TSVP	1157.8043.02
System controller and extension		
System controller, for R&S®ExpressTSVP	R&S®TS-PSCE1	1544.7701.02
System controller, for R&S®ExpressTSVP with SSD	R&S®TS-PSCE1S	1544.7701.04
System controller, for R&S®ExpressTSVP with SSD and WIN10 IoT	R&S®TS-PSCE1W	1544.7701.06
System controller, for R&S®CompactTSV	R&S®TS-PSC7	1512.4771.02
System controller, for R&S®CompactTSVP with SSD	R&S®TS-PSC7S	1512.4771.04
System controller, for R&S®CompactTSVP with SSD and WIN10 IoT	R&S®TS-PSC7W	1512.4771.06
Interface panel	R&S®TS-PSCX	1152.4240.06
Backplane extension module, for R&S®CompactTSVP and R&S®PowerTSVP	R&S®TS-PXB2	1512.3600.02
PCIe-to-cPCI bridge		
PCIe interface card, for PC	R&S®TS-PSC08-A	1512.4759.12
cPCI remote controller, for R&S®ExpressTSVP	R&S®TS-PSC08-E	1544.7699.02
cPCI remote controller, for R&S®CompactTSVP	R&S®TS-PSC08-B	1512.4759.22
PCIe X4 cable, length: 1 m	R&S®TS-PSC08-C	3660.2110.10
PCIe X4 cable, length: 2 m	R&S®TS-PSC08-C	3660.2110.20
Instrumentation		
Analog source and measurement module	R&S®TS-PSAM	1142.9503.02
In-circuit test extension	R&S®TS-PICT	1158.0000.02
Analog and digital I/O module	R&S®TS-PIO2	1504.4801.02
Digital I/O module	R&S®TS-PIO3B	1512.4407.02
Signal port and transmission module	R&S®TS-PTRF	1512.3800.02
Signal transmission module	R&S®TS-PTR	1512.4407.03
32-channel programmable digital I/O module	R&S®TS-PIO4	1525.5559.02
LVDS digital functional test module	R&S®TS-PIO5	1525.5807.02
Function generator module	R&S®TS-PFG	1157.9610.02
Signal analyzer module	R&S®TS-PAM	1157.9410.02
Power supply and load module	R&S®TS-PSU	1504.4530.02
Power supply and load module	R&S®TS-PSU12	1504.4530.03
Signal routing and switching		
Switch matrix module	R&S®TS-PMB	1143.0039.02
Power switching module	R&S®TS-PSM1	1143.0139.02
Multiplex and switch module	R&S®TS-PSM2	1504.4901.02
High-power switching module	R&S®TS-PSM3	1519.2516.03
Multiplex and switch module	R&S®TS-PSM4	1519.2622.03
High-power switching module	R&S®TS-PSM5	1519.2768.03
Switching extension module	R&S®TS-PXM1	1512.4007.02
Rear I/O instrument extensions		
Rear I/O instrument extension, for R&S®TS-PIO3B, R&S®TS-PTR	R&S®TS-PRIO4	1510.8005.04
Rear I/O instrument extension, for R&S®TS-PMB, R&S®TS-PSM2	R&S®TS-PRIO	1510.8005.02
Rear I/O instrument extension, for R&S®TS-PSM3	R&S®TS-PRIO3	1519.2845.02
Rear I/O instrument extension, for R&S®TS-PSM4	R&S®TS-PRIO2	1519.3070.02
Rear I/O instrument extension, for R&S®TS-PSM5	R&S®TS-PRIO5	1519.3112.02
In-system calibration		
In-system calibration kit	R&S®TS-ISC	1505.2502.02
Calibration module	R&S®TS-PCAL2	1505.2519.02

Your local Rohde & Schwarz expert will help you find the best solution for your requirements. To find your nearest Rohde & Schwarz representative, visit www.sales.rohde-schwarz.com

Rohde & Schwarz

The Rohde & Schwarz technology group is among the trailblazers when it comes to paving the way for a safer and connected world with its leading solutions in test & measurement, technology systems and networks & cybersecurity. Founded more than 85 years ago, the group is a reliable partner for industry and government customers around the globe. The independent company is headquartered in Munich, Germany and has an extensive sales and service network with locations in more than 70 countries.

www.rohde-schwarz.com

Service at Rohde & Schwarz You're in great hands

- ▶ Worldwide
- ▶ Local and personalized
- ▶ Customized and flexible
- ▶ Uncompromising quality
- ▶ Long-term dependability

Sustainable product design

- ▶ Environmental compatibility and eco-footprint
- ▶ Energy efficiency and low emissions
- ▶ Longevity and optimized total cost of ownership

Certified Quality Management

ISO 9001

Certified Environmental Management

ISO 14001

Rohde & Schwarz training

www.training.rohde-schwarz.com

Rohde & Schwarz customer support

www.rohde-schwarz.com/support

