

R&S® ZNA67EXT

Vector Network Analyzer

System 110 GHz

Getting Started

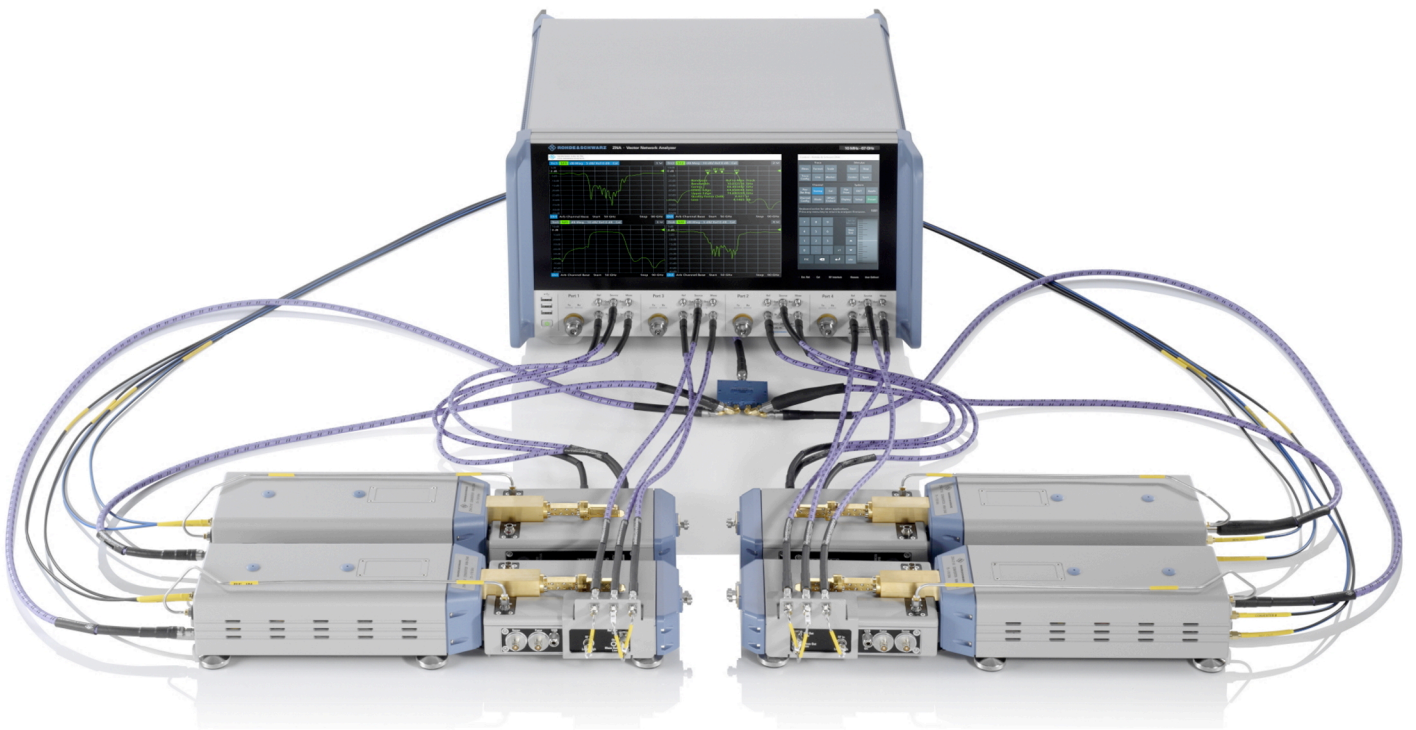

1179629502

Version 02

ROHDE & SCHWARZ

Make ideas real



This manual describes the R&S®ZNA67EXT family of 110 GHz VNA systems, order nos. 1352.1888Kxx, xx = 02, ..., 07. These systems are based on:

- A vector network analyzer R&S®ZNA67, order no. 1332.4500Kyy, either with two ports (yy=62) or with four ports (yy=64).
- Two or four external test sets, each consisting of:
 - A frequency converter R&S®ZVA-Z110, WM-2540 (WR10), order no. 1352.1642.yy, either standard power (yy=40) or high power (yy=50)
 - A diplexer R&S®ZVA-ZD110, order no. 1314.4002.zz, either with connectors on the left side (zz=12) or on the right side (zz=18)

The following systems are available:

- Variant 02, order no. 1352.1888K02
2-port VNA, 2 standard power converters and 2 diplexers (1 x left, 1 x right)
- Variant 03, order no. 1352.1888K03
4-port VNA, 2 standard power converters and 2 diplexers (1 x left, 1 x right)
- Variant 04, order no. 1352.1888K04
4-port VNA, 4 standard power converters and 4 diplexers (2 x left, 2 x right)
- Variant 05, order no. 1352.1888K05
2-port VNA, 2 high power converters and 2 diplexers (1 x left, 1 x right)
- Variant 06, order no. 1352.1888K06
4-port VNA, 2 high power converters and 2 diplexers (1 x left, 1 x right)
- Variant 07, order no. 1352.1888K07
4-port VNA, 4 high power converters and 4 diplexers (2 x left, 2 x right)

© 2023 Rohde & Schwarz GmbH & Co. KG
Muehldorfstr. 15, 81671 Muenchen, Germany
Phone: +49 89 41 29 - 0
Email: info@rohde-schwarz.com
Internet: www.rohde-schwarz.com

Subject to change – data without tolerance limits is not binding.

R&S® is a registered trademark of Rohde & Schwarz GmbH & Co. KG.

All other trademarks are the properties of their respective owners.

1179.6295.02 | Version 02 | R&S®ZNA67EXT

Throughout this manual, products from Rohde & Schwarz are indicated without the ® symbol, e.g. R&S®ZNA67EXT is indicated as R&S ZNA67EXT.

1 Safety information (multilingual)

This option or accessory is designed for a specific Rohde & Schwarz product. Multilingual safety information is delivered with the product. Follow the provided installation instructions.

Esta opción o este accesorio están diseñados para un producto Rohde & Schwarz concreto. El producto va acompañado de información de seguridad en varios idiomas. Siga las instrucciones de instalación puestas a disposición.

Diese Option oder dieses Zubehör ist für ein bestimmtes Rohde & Schwarz Produkt vorgesehen. Mit dem Produkt werden mehrsprachige Sicherheitsinformationen geliefert. Befolgen Sie die mitgelieferten Installationsanweisungen.

Cette option ou cet accessoire est conçu pour un produit Rohde & Schwarz spécifique. Des informations de sécurité multilingues sont fournies avec le produit. Suivez les instructions d'installation fournies.

Questa funzione opzionale o accessoria è progettata per un prodotto Rohde & Schwarz specifico. Con il prodotto sono fornite informazioni sulla sicurezza in formato multilingue. Seguire le istruzioni di installazione allegate.

Esta(e) opção ou acessório foi concebida(o) para um produto específico da Rohde & Schwarz. Serão fornecidas informações de segurança multilingues com o produto. Siga as instruções de instalação fornecidas.

Αυτή η προαιρετική επιλογή ή εξάρτημα έχει σχεδιαστεί για συγκεκριμένο προϊόν Rohde & Schwarz. Μαζί με το προϊόν παρέχονται πληροφορίες ασφαλείας σε πολλές γλώσσες. Ακολουθήστε τις παρεχόμενες οδηγίες εγκατάστασης.

Din l-għażla jew aċċessorju huma mfassla għal prodott Rohde & Schwarz speċifiku. L-informazzjoni multilingwi dwar is-sikurezza hija pprovduta mal-prodott. Segwi l-istruzzjonijiet iprovduti għall-installazzjoni.

Deze optie of dit accessoire is ontwikkeld voor een specifiek product van Rohde & Schwarz. Het product wordt geleverd met veiligheidsinformatie in meerdere talen. Volg de meegeleverde installatie-instructies.

Denne mulighed eller tilbehørsdel er designet til et specifikt Rohde & Schwarz produkt. En flersproget sikkerhedsanvisning leveres sammen med produktet. Følg de medfølgende installationsanvisninger.

Detta tillval eller tillbehör är avsett för en särskild produkt från Rohde & Schwarz. Säkerhetsinformation på flera språk medföljer produkten. Följ de medföljande installationsanvisningarna.

Tämä vaihtoehto tai lisävaruste on suunniteltu tietyille Rohde & Schwarz -yrityksen tuotteelle. Tuotteen mukana on toimitettu monikieliset turvallisuusohjeet. Noudata annettuja asennusohjeita.

Dette alternativet eller ekstrautstyret er utformet for et spesifikt Rohde & Schwarz produkt. Flerspråklig sikkerhetsinformasjon leveres med produktet. Overhold installasjonsveiledningen som følger med.

See valik või lisaseade on mõeldud konkreetsele Rohde & Schwarz tootele. Tootege on kaasas mitmekeelne ohutusteave. Järgige kaasasolevaid paigaldusjuhiseid.

Šī opcija vai piederums ir izstrādāts īpaši Rohde & Schwarz produktam. Produktam pievienota drošības informācija vairākās valodās. Ievērojiet sniegtos uzstādīšanas norādījumus.

Ši parinktis ar priedas skirti konkrečiam Rohde & Schwarz gaminiui. Su gaminiu pateikiama saugos informacijos keliomis kalbomis. Laikykitės pateikiamų montavimo nurodymų.

Þessi auka- eða fylgibúnaður er hannaður fyrir tiltekna Rohde & Schwarz vöru. Öryggisupplýsingar á mörgum tungumálum fylgja með vörunni. Fylgið meðfylgjandi uppsetningarleiðbeiningum.

Tá an rogha nó an oiriúint seo ceaptha le haghaidh táirge Rohde & Schwarz sonrach. Cuirtear eolas sábháilteachta ilteangach ar fáil leis an táirge. Lean na treoracha suiteála a thugtar.

Эта опция или принадлежность предназначена для конкретного продукта Rohde & Schwarz. В комплект поставки продукта входят инструкции по технике безопасности на нескольких языках. Соблюдайте прилагаемые инструкции по установке.

Ця опція або приладдя призначені для конкретного виробу Rohde & Schwarz. Інструкції з техніки безпеки кількома мовами постачаються разом із виробом. Дотримуйтеся наданих інструкцій зі встановлення.

Ta opcja lub akcesorium jest przeznaczona do określonego produktu Rohde & Schwarz. Dostarczany produkt zawiera informacje w wielu językach dotyczące bezpieczeństwa. Należy postępować zgodnie z dostarczonymi instrukcjami instalacji.

Tato varianta nebo příslušenství je určeno pro konkrétní produkt Rohde & Schwarz. S produktem jsou dodávány vícejazyčné bezpečnostní informace. Řiďte se příloženými pokyny k instalaci.

Táto verzia alebo príslušenstvo je navrhnutá pre špecifický výrobok Rohde & Schwarz. S výrobkom sa dodávajú viacjazyčné bezpečnostné pokyny. Riadte sa dodanými pokynmi na inštaláciu.

Ta možnost ali dodatek je zasnovan za določen izdelek podjetja Rohde & Schwarz. Izdelku so priložena varnostna navodila v več jezikih. Upoštevajte priložena navodila za namestitvev.

Ezt a beállítást vagy tartozékot egy adott Rohde & Schwarz termékhez tervezték. A termékhez többnyelvű biztonsági információkat mellékelünk. Kövesse a mellékelt szerelési utasításokat.

Тази опция или аксесоар са проектирани за специфичен продукт на Rohde & Schwarz. Многоезикова информация за безопасност се доставя с продукта. Следвайте предоставените инструкции за монтаж.

Ova opcija ili oprema namijenjena je za određeni proizvod tvrtke Rohde & Schwarz. Uz proizvod su dostavljene sigurnosne napomene na više jezika. Pratite isporučene upute za ugradnju.

Ova opcija ili pribor je dizajniran za određeni Rohde & Schwarz proizvod. Proizvodu su priložene sigurnosne informacije na više jezika. Slijedite priložena uputstva za instalaciju.

Ova opcija ili dodatni pribor je projektovan za određeni Rohde & Schwarz proizvod. Bezbednosne informacije na više jezika se isporučuju uz proizvod. Sledite dostavljena uputstva za instalaciju.

Această opțiune sau acest accesoriu a fost conceput pentru un produs specific Rohde & Schwarz. Informațiile multilingve privind siguranța sunt livrate împreună cu produsul. Urmați instrucțiunile de instalare furnizate.

Ky opsion ose aksesori është krijuar për një produkt specifik Rohde & Schwarz. Bashkë me produktin jepen edhe informacionet e sigurisë në shumë gjuhë. Ndiqni udhëzimet e dhëna të instalimit.

Оваа опција или додаток се наменети за одреден производ на Rohde & Schwarz. Со производот се испорачани повеќејазични безбедносни упатства. Следете ги дадените упатства за инсталација.

Bu opsiyon veya aksesuar, belirli bir Rohde & Schwarz ürünü için tasarlanmıştır. Çok dilli güvenlik uyarıları ürünle birlikte teslim edilir. Size sağlanan kurulum talimatlarına uyun.

Şu opsiya ýa-da esbap Rohde & Schwarz anyk önüm üçin niýetlenilen. Dürli dil-däki howpsuzlyk barada maglumat önüm bilen bile üpjün edilyär. Üpjün edilen gurnama ugrukdymalaryny ýerine ýetiriň.

इस विकल्प या एक्सेसरी को एक विशेष Rohde & Schwarz उत्पाद के लिए डिज़ाइन किया गया है. उत्पाद के साथ बहुभाषी सुरक्षा जानकारी दी जाती है. प्रदान किए गए इंस्टालेशन अनुदेशों का पालन करें.

本选项或附件专门设计用于特定的 Rohde & Schwarz 产品。产品随附多种语言版本的安全资讯。谨遵文件中的安装说明。

本オプションアクセサリは、特定の Rohde & Schwarz 製品向けに設計されています。多言語で記載された安全情報が製品に付属します。付属のインストール手順に従ってください。

이 옵션 또는 액세서리는 특정 Rohde & Schwarz 제품용으로 설계되었습니다. 제품과 함께 다국어로 작성된 안전 정보가 제공됩니다. 함께 제공된 설치 지침을 따르십시오.

本選配或配件專門設計用於特定的 Rohde & Schwarz 產品。產品隨附多種語言版本的安全資訊。遵守文件中的安裝說明。

Tùy chọn hoặc phụ kiện này dành riêng cho một sản phẩm Rohde & Schwarz cụ thể. Thông tin an toàn đa ngôn ngữ được cung cấp kèm theo sản phẩm. Thực hiện theo hướng dẫn lắp đặt kèm theo.

ตัวเลือกหรืออุปกรณ์เสริมนี้ออกแบบมาสำหรับผลิตภัณฑ์ Rohde & Schwarz โดยเฉพาะ โดยจะมีการจัดส่งข้อมูลด้านความปลอดภัยหลายภาษามาให้พร้อมกับผลิตภัณฑ์ ปฏิบัติตามคำแนะนำในการติดตั้งที่ให้ไว้

Pilihan atau aksesori ini direka bentuk untuk produk Rohde & Schwarz yang tertentu. Maklumat keselamatan berbilang bahasa disertakan bersama produk. Ikut arahan pemasangan yang diberikan.

Opsi atau aksesori ini dirancang untuk produk Rohde & Schwarz tertentu. Informasi keamanan dalam beberapa bahasa juga disertakan bersama produk. Ikuti petunjuk pemasangan yang disediakan.

Esta opción o este accesorio están diseñados para un producto Rohde & Schwarz en concreto. El producto va acompañado de información de seguridad en varios idiomas. Siga las instrucciones de instalación proporcionadas con el producto.

Esta opção ou acessório foi desenvolvido para um produto Rohde & Schwarz específico. Informações de segurança em vários idiomas acompanham o produto. Siga as instruções de instalação disponibilizadas.

אפשרות זו או האביזר מיועדים למוצר ספציפי של Rohde & Schwarz. מידע רב-לשוני בנושא בטיחות מצורף למוצר. יש לפעול בהתאם להנחיות ההתקנה המצורפות.

تم تصميم هذا الخيار أو الملحق لمنتج معين من منتجات Rohde & Schwarz. يتم تزويد معلومات السلامة متعددة اللغات مع المنتج. اتبع تعليمات التركيب الموضحة.

این قابلیت یا وسیله جانبی منحصراً برای محصول به خصوص Rohde & Schwarz طراحی شده است. اطلاعات ایمنی چندزبانه همراه این دستگاه ارائه شده است. دستور العمل‌های نصب ارائه شده را دنبال کنید.

اس اختیار یا حصے کو مخصوص Rohde & Schwarz پروڈکٹ کے لئے تیار کیا گیا ہے۔ پروڈکٹ کے ساتھ کثیر السانی زبانوں میں تحفظ کی معلومات فراہم کی جاتی ہیں۔ فراہم کردہ تنصیب کی ہدایات پر عمل کریں۔

2 Safety and regulatory information

The product documentation helps you use the product safely and efficiently. Follow the instructions provided here and in the following chapters.

Intended use

Rohde & Schwarz vector network analyzers and millimeterwave converters R&S ZNA67EXT are intended for the development, production and verification of electronic components and devices in industrial, administrative, and laboratory environments. Only use them for their designated purpose. Observe the operating conditions and performance limits stated in the data sheet.

Where do I find safety information?

Safety information is part of the product documentation. It warns you of potential dangers and gives instructions on how to prevent personal injury or damage caused by dangerous situations. Safety information is provided as follows:



- Multilingual safety information is provided in [Chapter 1, "Safety information \(multilingual\)"](#), on page 3, and delivered with the system's R&S ZNA67.
- Throughout the documentation, safety instructions are provided when you need to take care during setup or operation.

2.1 Labels on the external test sets

Labels on the frequency converters and diplexers inform about:

- Product and environment safety
- Identification of the product

Table 2-1: Labels regarding product and environment safety

	<p>Labeling in line with EN 50419 for disposal of electrical and electronic equipment after the product has come to the end of its service life. For more information, see "Disposing electrical and electronic equipment" on page 50.</p>
	<p>Take care when handling electrostatic sensitive devices.</p>

2.2 Warning messages in the documentation

A warning message points out a risk or danger that you need to be aware of. The signal word indicates the severity of the safety hazard and how likely it will occur if you do not follow the safety precautions.

NOTICE

Potential risks of damage. Could result in damage to the supported product or to other property.

3 Documentation overview

This section provides an overview of the R&S ZNA user documentation. Unless specified otherwise, you find the documents at:

<https://www.rohde-schwarz.com/manual/ZNA>

3.1 Getting started manual

The getting started manual of the R&S ZNA describes how to set up and start working with the system's vector network analyzer R&S ZNA67. It includes basic operations, typical measurement examples, and general information, e.g. safety instructions. A printed version is delivered with the R&S ZNA67. A PDF version is available for download on the Internet.

The getting started manual of the VNA system R&S ZNA67EXT (this document) describes how to set up and start working with the R&S ZNA67EXT. It describes the setup and basic operation of the VNA system as a system. A printed version is delivered with the system. A PDF version is available for download on the Internet.

3.2 User manual and help

The R&S ZNA user manual contains the description of the modes and functions of the system's vector network analyzer R&S ZNA67. It also provides an introduction to remote control, a complete description of the remote control commands with programming examples, and information on maintenance, instrument interfaces and error messages. Includes the contents of the R&S ZNA getting started manual.

The contents of the R&S ZNA user manual are available as help in the instrument. The help offers quick, context-sensitive access to the complete information for the instrument and its firmware.

The R&S ZNA user manual is also available for download or for immediate display on the Internet.

3.3 Service manual

Describes the performance test for checking the rated specifications, module replacement and repair, firmware update, troubleshooting and fault elimination, and contains mechanical drawings and spare part lists.

The service manual is available for registered users on the global Rohde & Schwarz information system (GLORIS):

<https://gloris.rohde-schwarz.com>

3.4 Instrument security procedures

Deals with security issues when working with a R&S ZNA in secure areas. It is available for download on the Internet.

3.5 Printed safety instructions

Provides safety information in many languages. The printed document is delivered with the system's R&S ZNA67.

3.6 Data sheets and brochures

The data sheet contains the technical specifications of the VNA system R&S ZNA67EXT. It also lists the available hardware and software options, and optional accessories.

The R&S ZNA67EXT brochure provides an overview and describes the features and applications of the VNA system. The product brochure of the R&S ZNA provides an overview of the VNA functionality and deals with the specific characteristics.

See <https://www.rohde-schwarz.com/brochure-datasheet/ZNA>

Application notes, application cards, white papers, etc.

3.7 Release notes and open source acknowledgment (OSA)

The release notes list new features, improvements and known issues of the current R&S ZNA firmware version, and describe the firmware installation.

The firmware makes use of several valuable open source software packages. An open-source acknowledgment document provides verbatim license texts of the used open source software.

See <https://www.rohde-schwarz.com/firmware/ZNA>

3.8 Application notes, application cards, white papers, etc.

These documents deal with special applications or background information on particular topics.

See <https://www.rohde-schwarz.com/application/ZNA>

4 Key features

The 1.0 mm VNA system R&S ZNA67EXT can sweep through a frequency range from 10 MHz to 110 GHz continuously. It supports two different measurement modes:

- Measurements with internal test sets cover a frequency range between 10 MHz and 67 GHz.
The R&S ZNA67EXT is based on a vector network analyzer R&S ZNA67. Connect the DUT to any of the test ports of the R&S ZNA and measure its properties as described in this user manual or help system.
- Measurements with external test sets cover an extended frequency range between 10 MHz and 110 GHz. The DUT is connected to the 1 mm connectors at the front of the diplexers R&S ZVA-ZD110. This measurement mode is described in the present manual.

The following sections describe the external test sets and their connection to the DUT and to the R&S ZNA. A typical measurement example is presented in [Chapter 9, "Basic operation"](#), on page 40.



The measurement mode of each VNA port is selected in the "Converter Configuration" dialog of the R&S ZNA GUI (System – [Setup] > "Frequency Converter" > "Frequency Converter...").

- "Converter Type" > "None": internal test sets
- "Converter Type" > "ZNA67EXT-TS": external test sets
- Selecting another "Converter Type" allows you to measure within the selected converter's frequency range.

Operation with external test sets

The external test sets enable a frequency range between 10 MHz and 110 GHz. The analyzer combines two different measurement methods to achieve this extended range.

- At frequencies below approx. 67 GHz (i.e. in "low frequency" mode), the frequency converter in the external test set is bypassed. The source signal of the respective analyzer port is directly fed to the 1 mm test port connector of the diplexer. The network analyzer measures the a-waves and b-waves from the Ref Out and Meas Out on the diplexer, respectively. The RF connectors LO

IN, RF IN, REF OUT, and MEAS OUT on the connector panel of the converter are not used.

- To achieve frequencies above approx. 67 GHz (i.e. to measure in "high frequency" mode), the frequency converter in the external test set is used. The source signal of the respective analyzer port is fed to the frequency converter, and the converted signal is routed to the 1 mm test port connector of the diplexer. The frequency converter uses frequency multipliers to transform the source signal into a high-frequency stimulus signal. A local oscillator (LO) signal from the Converter LO output of the analyzer (R&S ZNA-B8) is used for down-conversion of the reference and measurement channels. If more than one converter is used, a power divider feeds the LO signal to the converters. This test setup ensures a stable phase relationship between the LO IN signals of the converters.

The analyzer measures the a-waves from REF OUT and the b-waves from MEAS OUT on the converters. The RF connectors REF OUT, MEAS OUT on the rear panel of the diplexers are not used.

The network analyzer automatically switches between low frequency and high frequency mode, depending on the stimulus frequency; see [Chapter 6.3.2, "H/L SWITCH"](#), on page 28. There is no need to change the test setup and cabling.

5 Preparing for use

Here, you can find basic information about setting up the product for the first time.

5.1 Unpacking and checking

When you receive your VNA system, please take the following steps:

1. Unpack the contents from the cardboard shipping boxes.
2. Retain the original packing material. Use it when transporting or shipping the product later.
3. Using the delivery notes, check the equipment for completeness. The shipment must include the items listed in [Table 5-1](#).
4. Follow the instructions given in the "Preparing for use" chapter of the R&S ZNA's Getting Started guide.
5. Remove the protective caps from the 1 mm test ports at the front of the diplexer elements. Carefully inspect the converters and diplexers. If you notice any damage, immediately notify the shipping company.

Unpacking and checking

Table 5-1: Shipment of VNA system R&S ZNA67EXT, order no. 1352.1888Kxx (Variants xx = 02, ..., 07)

	Variant 02	Variant 05	Variant 03	Variant 06	Variant 04	Variant 07
VNA R&S ZNA67, 1.85 mm order no. 1332.4500Kyy Shipment: see R&S ZNA Getting Started ¹	2-port (variant 62)	4-port (variant 64)				
Converter R&S ZVA-Z110, WM-2540 (WR10) order no. 1352.1642.yy ^{2,3,4}	2 x std. power (variant 40)	2 x high power (variant 50)	2 x std. power (variant 40)	2 x high power (variant 50)	4 x std. power (variant 40)	4 x high power (variant 50)
Diplexer R&S ZVA-ZD110 order no. 1314.4002.yy ^{2,4,5}	1 x left (variant 12), 1 x right (variant 18)	1 x right (variant 18)	2 x left (variant 12), 2 x right (variant 18) ⁵			
Torque wrench for diplexer test port	1 x R&S ZN-ZTW variant 12, 1 mm, 0.34 Nm, order no. 1328.8534.12					
LO power divider SMA (f) 27 GHz + angled SMA adapters (m/f) R&S ZV-Z1218 (order no. 1314.5380.00)	1 x 1:2 R&S ZV-Z1227 (order no. 1307.0886.02) + 2 adapters	1 x 1:4 R&S ZV-Z1228 (order no. 3626.4937.02) + 4 adapters				
H/L SWITCH control cable	1 x for control of 2 diplexers, 2.5 m, order no. 1312.6643.00	1 x for control of 4 diplexers, 2.5 m, order no. 1352.1688.00				
VNA R&S ZNA67EXT Getting Started (this document)	1 x					

1: For mandatory options, see [Chapter 6.1, "Vector network analyzer R&S ZNA67"](#), on page 19.
2: The converters are pre-mounted to the diplexers.
3: Each converter is delivered with an external 9 V DC power supply, and with IF cables R&S CABLE EXT REF and R&S CABLE EXT MEAS.
4: The required RF and LO cables are not part of the standard delivery. They can be ordered separately, see "[Cable sets \(optional\)](#)" on page 37.
5: With cable deflectors premounted to the "outer" diplexer

Adjusting the feet of the test set

i RF and LO cables between VNA test ports and diplexers are not part of the standard delivery. See "[Cable sets \(optional\)](#)" on page 37.

5.2 Choosing the operating site

Specific operating conditions ensure proper operation and avoid damage to the product and connected devices. For information on environmental conditions such as ambient temperature and humidity, see data sheet.

5.3 Adjusting the feet of the test set

The frequency converter can be used with three or four feet attached to the bottom side. If possible, use three feet: two in front and one in the middle of the rear.



Figure 5-1: Setup with one rear foot (left) and two rear feet (right)

Two additional feet support the diplexer. Typically, the external test set can be aligned as follows:

1. Screw the diplexer feet and the front feet into the instrument as far as possible.

Considerations for test setup

2. Use the rear foot to align the entire test set parallel to the surface of the bench top.
3. When you connect a DUT in-between two test sets (see [Chapter 9.6, "Mounting a DUT"](#), on page 47), use the diplexer feet for further alignment.

5.4 Considerations for test setup

Cable selection and electromagnetic interference (EMI)

Electromagnetic interference (EMI) can affect the measurement results.

To suppress electromagnetic radiation during operation:

- Use high-quality shielded RF cables.
- Always terminate open cable ends.

Signal input and output levels

Information on signal levels is provided in the data sheet. Keep the signal levels within the specified ranges to avoid damage to the product and connected devices.

Preventing electrostatic discharge (ESD)

Electrostatic discharge is most likely to occur when you connect or disconnect a DUT.

- ▶ **NOTICE!** Electrostatic discharge can damage the electronic components of the product and the device under test (DUT).

Ground yourself to prevent electrostatic discharge damage:

- a) Use a wrist strap and cord to connect yourself to ground.
- b) Use a conductive floor mat and heel strap combination.

6 System tour

6.1 Vector network analyzer R&S ZNA67

The VNA system R&S ZNA67EXT is based on a two- or four-port vector network analyzer R&S ZNA67, order no. 1332.4500Kyy, either with two ports (yy=62) or with four ports (yy=64), and equipped with:

- Dedicated LO output connector (HW option R&S ZNA-B8)
- Direct generator/receiver access (HW option R&S ZNA67-B16)
- Direct IF access (HW option R&S ZNA-B26)
- Receiver step attenuators R&S ZNA67-B3y at all test ports
- SW option R&S ZNA-K8 "Frequency converter control"
- SW option R&S ZNA67-K110 "Continuous Sweep up to 110 GHz for R&S ZNA67"

For details on its functionality and other HW and SW options, see R&S ZNA user manual or instrument help.

 SW option R&S ZNA67-K110 is only available with the R&S ZNA67EXT. It cannot be installed on a regular R&S ZNA67.



Figure 6-1: R&S ZNA67 front and rear panel

Vector network analyzer R&S ZNA67

- 1 = RF port
- 2 = Direct source/recveiver access (R&S ZNA67-B16)
- 3 = Converter LO output (R&S ZNA-B8)
- 4 = Direct IF access (R&S ZNA-B26)
- 5 = User Port (Aux)

The front and rear panel controls and the connectors of the analyzer are described in the getting started guide, user manual and in the help system of the R&S ZNA. The following sections describe special aspects for measurements with external test sets.

6.1.1 Test ports

The R&S ZNA67 of a R&S ZNA67EXT is equipped with two or four test ports with direct generator/receiver access (R&S ZNA67-B16). Each port consists of a bidirectional, ruggedized 1.85 mm (m) connector and 3 pairs of 1.85 mm (f) connectors for direct access.

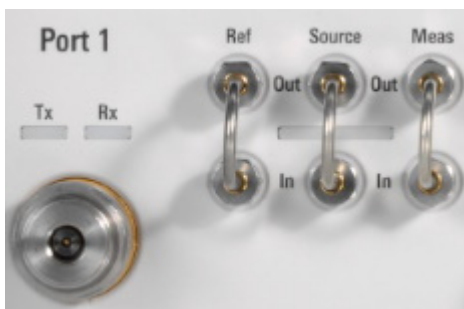

The connectors are used alternatively:

- The ruggedized 1.85 mm connector serves as a test port connector for measurements with **internal** test set. The three 1.85 mm connector pairs allow for extended measurement functionality (see R&S ZNA user manual or help system). Out/In loops that are not connected to external devices must be jumpered as shown in the figure above.
- The Source Out connector provides the RF source signal for the **external** test set. Source Out is connected to the rear panel of the diplexer. In the low frequency range below approx. 67 GHz, Ref In and Meas In receive the reference waves and measured waves from the diplexer, respectively. The 1 mm connector of the diplexer serves as a test port connector; the ruggedized 1.85 mm connector of the VNA test port is not used.

Vector network analyzer R&S ZNA67

See also "Operation with external test sets" on page 13 and Chapter 8, "Connecting the external test sets", on page 33.

6.1.2 IF Reference and IF Meas

The R&S ZNA hardware option R&S ZNA-B26 enables direct access to the IF signal paths of the R&S ZNA67EXT via rear panel connectors IF Reference <i> <i> and IF Meas <i> <i>.

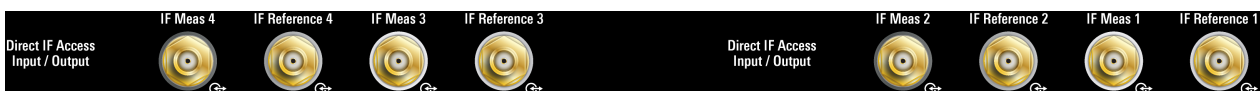

Figure 6-2: Direct IF Access (4-port R&S ZNA)

For the VNA system R&S ZNA67EXT, MEAS OUT and REF OUT of an external test set's converter must be connected to the IF Meas and IF Reference of the corresponding VNA port. See Chapter 6.2.1.5, "IF output", on page 24.

6.1.3 Converter LO output

The Converter LO Out 2.92 mm connector of HW option R&S ZNA-B8 provides the LO source for the frequency converters. The signal is distributed via the 1:2 or 1:4 splitter shipped with the R&S ZNA67EXT.



6.1.4 User port

The 25-pin D-Sub connector on the rear panel of the R&S ZNA is used as an input and output for control signals (LV-TTL 3.3 V, 5 V tolerant).

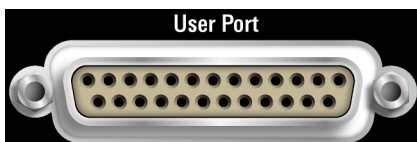

For the VNA system R&S ZNA67EXT, it is used to control the high/low frequency switch of the connected diplexers. See ["Operation with external test sets"](#) on page 13 and [Chapter 6.3.2, "H/L SWITCH"](#), on page 28.

6.2 Frequency converters

The R&S ZNA67EXT is delivered with two or four fully assembled external test sets, as described in [Chapter 6.3, "Diplexers"](#), on page 25. The open connectors of the converter are described in the following sections.

6.2.1 Rear panel

The rear panel of the frequency converter provides the connectors and control elements shown below.

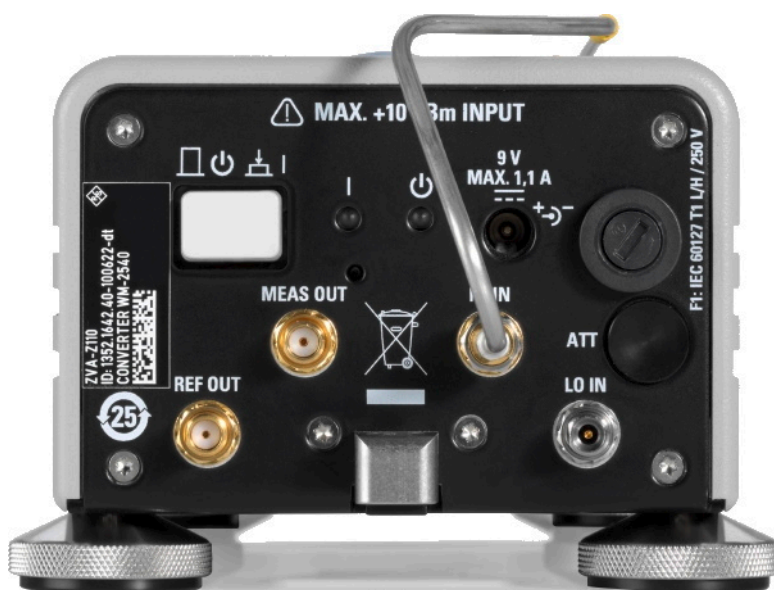

Figure 6-3: Rear view of the frequency converter

The connectors are described in the following sections.

6.2.1.1 Standby switch

The standby toggle switch connects (ready state) or disconnects (standby state) the internal modules of the frequency converter from the power supply. In standby

state also the output connector for the diplexer power supply (see [Figure 6-5](#)) is disconnected.



Figure 6-4: Standby switch and LEDs

A green light-emitting diode (LED) next to the switch indicates that the instrument is in ready state. An orange LED further to the right indicates that the instrument is in standby state. These LEDs are only lit when the converter is properly connected to the power supply and the fuse of the instrument is intact.

6.2.1.2 Power supply connector



To supply the frequency converter, connect the external DC power supply provided with the converter to the 9 V / 1.1 A DC input. For details, see [Chapter 8.4, "DC power supply"](#), on page 39.

Always switch the instrument to standby state before removing the power supply.

NOTICE

Risk of instrument damage

The input voltage and current must not exceed the maximum values according to the rear panel labeling or the data sheet.

Always use the DC power supply included in the delivery to power your frequency converter.

6.2.1.3 Fuse holder



A fuse of type IEC60127 T1 L/H protects the frequency converter from excess input voltages at the power supply connector. A fuse of different type protects the diplexer (see [Chapter 6.3.4, "Fuse panel"](#), on page 30).

For fuse replacement, see [Chapter 10.2, "Replacing fuses"](#), on page 49.

6.2.1.4 RF input



Two 3.5 mm input connectors, only used in high frequency mode:

- RF IN receives the RF source signal from the diplexer. A semi-rigid cable connects RF IN to the RF HIGH OUT connector on the top side of the diplexer.
- LO IN receives the local oscillator signal from the R&S ZNA67 network analyzer.

The complete RF connection of the external test set is described in [Chapter 8, "Connecting the external test sets"](#), on page 33.

NOTICE

Risk of instrument damage

The RF input power at the connectors RF IN and LO IN must not exceed the maximum values quoted in the data sheet. The maximum values are below the maximum RF source power of the network analyzer. The "ZNA67EXT-TS" converter type configuration ensures compatible source powers.

Before you connect your external test set to the network analyzer, always select the "ZNA67EXT-TS" converter type for the respective converter port in the "Frequency Converter" dialog (see [Chapter 9.2, "Converter configuration"](#), on page 41).

6.2.1.5 IF output



Two SMA output connectors, only used in high frequency mode:

- MEAS OUT provides the measured signal (b-wave) to the R&S ZNA67EXT67 network analyzer.
- REF OUT provides the reference signal (a-wave) to the R&S ZNA67EXT67 network analyzer. IF Reference and IF Meas

REF OUT and MEAS OUT must be connected to the corresponding [IF Reference and IF Meas](#) connectors at the R&S ZNA. The complete RF connection of the external test set is described in [Chapter 8.2, "RF and LO cabling"](#), on page 36.

6.3 Diplexers

The R&S ZNA67EXT is delivered with two or four fully assembled external test sets, each consisting of a frequency converter R&S ZVA-Z110 and a diplexer R&S ZVA-ZD110.



Figure 6-5: Connection between frequency converter and diplexer (var. 18)

The connection of the diplexer and the frequency converter includes conducting lines for waves and power supply:

- The RF High Out connector on the top side of the diplexer is connected to RF IN on the rear panel of the converter using a semi-rigid RF cable.
- The waveguide connector on the top side of the diplexer is connected to the waveguide flange of the converter.

- The connection underneath the waveguide flange ensures the power supply of the diplexer.

An additional metal clamp at the bottom ensures mechanical stability.

Left vs. right model variant

The diplexer R&S ZVA-ZD110 is available in a left variant and a right variant.

- The left variant (Var 12) is designed for the left side of the standard arrangement **with two external test sets**. Its connector panel is located on the left side of the diplexer, i.e. it is oriented towards the VNA.
The RF High Out and H/L SWITCH switch connectors are located on the top left and top right, respectively.
- The right diplexer variant (Var 18) is designed for the right side of the standard arrangement with two test sets. Its connector panel is located on the right of the diplexer, i.e. it is oriented towards the VNA.

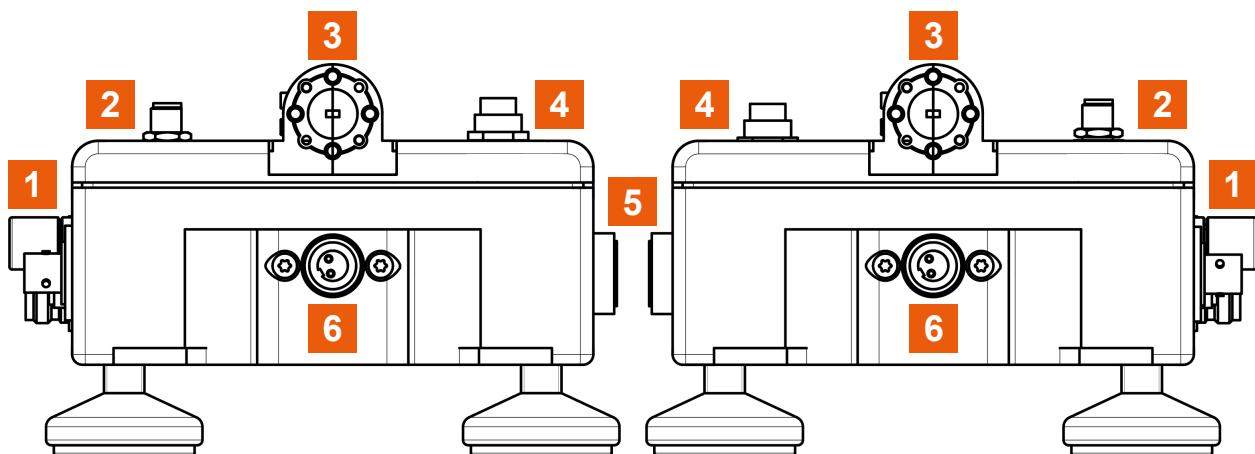

Figure 6-6: Left vs. right model variant (rear view)

Left = Left variant (Var 12)

Right = Right variant (Var 18)

1 = Connector panel

2 = RF High Out connector

3 = Waveguide connector

4 = H/L SWITCH

5 = Fuse panel

6 = Power supply connector

RF High Out, waveguide, and power supply connector can also be seen and are described below [Figure 6-5](#).

Standard arrangement with 4 external test sets

With four external test sets, using 2 times the left diplexer variant (Var 12) on the left side would be impractical. If their 1 mm connectors must be placed close to each other, e.g. for on-wafer probing, the RF cables connected to the [connector panel](#) of the outer test set would have to be bent unduly to bypass the inner test set. Same problem with 2 times Var 18 (right) on the right side.

For this reason, the R&S ZNA67EXT with four external test sets uses a Var 18 diplexer for the outer left test set, and a Var 12 diplexer for the outer right set.

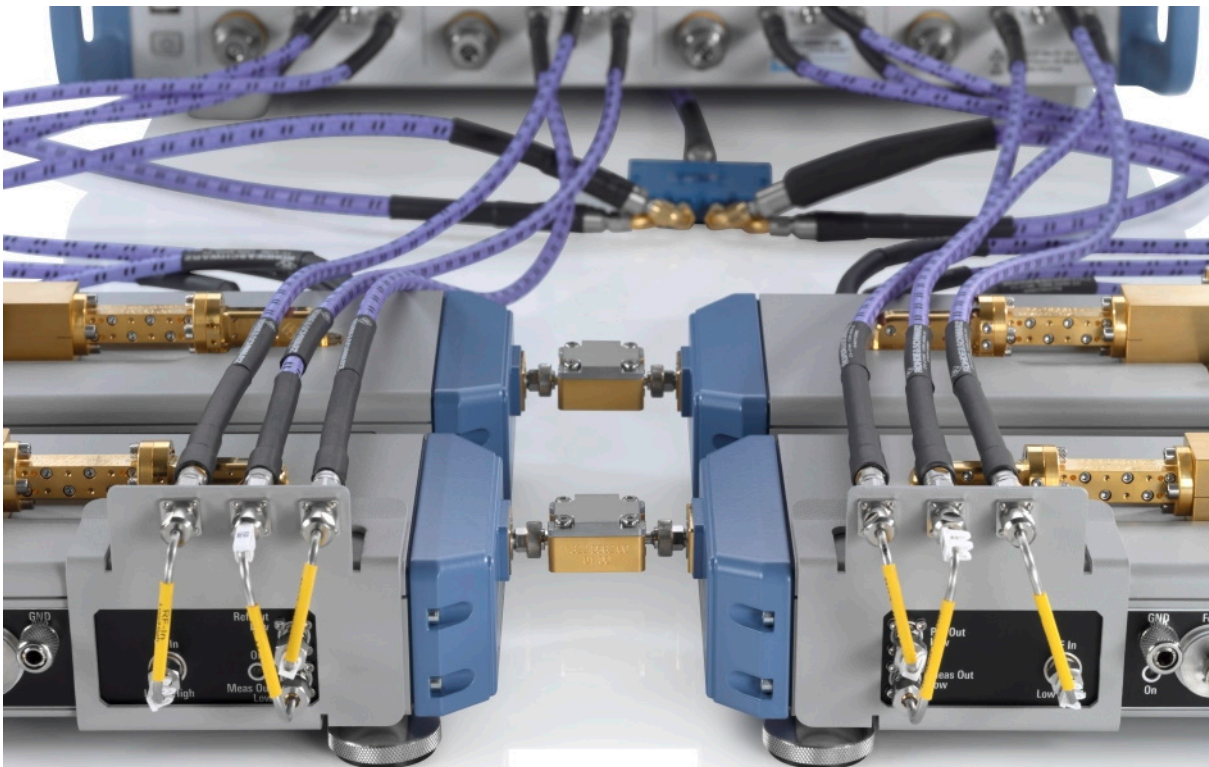

Figure 6-7: Standard arrangement for 4 external test sets

For both outer test sets, a cable deflector is mounted on the connector panel. Semi-rigid cables redirect the corresponding RF connectors towards the VNA.

6.3.1 Test port



1 mm (m) connector on the front side of the diplexer, serves as an output for RF stimulus signals and as an input for the measured RF signals from the DUT (response signals).

- With a single external test set, you can generate a stimulus signal and measure the reflected response signal.
- With $n = 2, 3, 4$ external test sets, a full n -port measurement is possible.

NOTICE**Maximum input level, mechanical damage**

Do not exceed the damage level at the test port according to the data sheet, especially when using active DUTs or external amplifiers.

To avoid mechanical damage when connecting devices to the 1 mm connector, always use the torque wrench supplied with the R&S ZNA67EXT. See [Table 5-1](#).

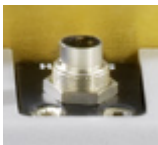
6.3.2 H/L SWITCH

The H/L SWITCH connectors on the top side of each diplexer are input connectors for the User Port signals from the R&S ZNA67; see [Chapter 8.3, "Diplexer control"](#), on page 38. They allow the VNA firmware to switch the diplexer from low to high frequency mode and vice versa.

vice versa.

A suitable cable is shipped with the VNA system.

6.3.3 Connector panel

The connector panel of the diplexer provides input and output connectors for RF signals and a DC input. Connectors labeled Low are used in low frequency mode only; see ["Operation with external test sets"](#) on page 13.



Figure 6-8: Connector panel of R&S ZVA-ZD110 Var 18

 The picture above shows the connector panel of the "right" diplexer variant (Var 18). For the "left" variant (Var 12), the horizontal order of the connectors is exactly opposite.

- The Sense and Force triaxial BNC female connectors and the 4 mm GND socket implement the bias tee. Bias is applied via the Force input, which is protected by an exchangeable fuse (see [Chapter 6.3.4, "Fuse panel"](#), on page 30).
The Sense output is connected to the bias tee via a 1 k Ω resistor, which allows measuring the bias voltage close to the DUT without the uncertainty caused by a voltage drop on a long bias line.
- RF In Low / High is a 1.85 mm female connector, which receives the RF source signal from the R&S ZNA67EXT network analyzer unit. This connector is used in low frequency and in high frequency mode.
- Ref Out Low is a 1.85 mm female connector, which provides the reference signal (a-wave) in low frequency mode.
- Meas Out Low is a 1.85 mm female connector, which provides the measured signal (b-wave) in low frequency mode.

RF In, Ref Out, and Meas Out are connected to the corresponding direct access connectors of the related VNA port. The complete RF and IF connection of the external test set is described in [Chapter 8, "Connecting the external test sets"](#), on page 33.

NOTICE**Maximum input power at RF IN**

The RF input power at the RF IN connector must not exceed the maximum value quoted in the data sheet. The maximum value is below the maximum RF source power of the network analyzer. The "ZNA67EXT-TS" converter type ensures compatible source powers.

Before you connect your external test set to the network analyzer, always select the "ZNA67EXT-TS" converter type for the related port using the "Converter Configuration" dialog (see [Chapter 9.2, "Converter configuration"](#), on page 41).

NOTICE**Maximum input voltage at FORCE and EMI suppression**

The maximum nominal input voltage and current for the FORCE bias input connector must not exceed the value quoted in the data sheet. Use a double-shielded cable and terminate open cable ends with 50 Ω to ensure successful control of electromagnetic radiation during operation.

The LED labeled ON lights when the diplexer is properly power-supplied. If the LED does not light, check the following:

- The power connection between the diplexer and the converter must be in place (see [Figure 6-5](#)).
- The converter must be power-supplied and switched on.
- The fuse at the converter must be intact.

6.3.4 Fuse panel

The other side panel of the diplexer gives access to the bias fuse. Furthermore, it holds the type label and visualizes the power supply from the converter (pre-mounted).

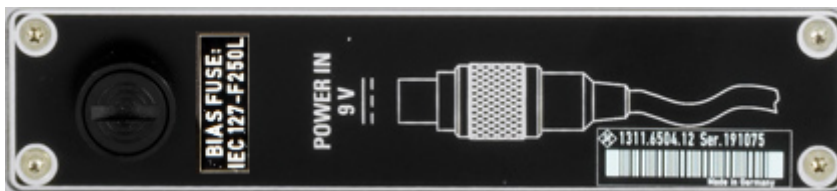

Figure 6-9: Fuse panel R&S ZVA-ZD110 Var 12

A fuse of type IEC 127-F250L protects the diplexer from excess input current at the Force connector (see [Figure 6-8](#)). A fuse of different type protects the frequency converter (see [Chapter 6.2.1.3, "Fuse holder"](#), on page 23).

For fuse replacement, see [Chapter 10.2, "Replacing fuses"](#), on page 49.



- The picture above shows the fuse panel of the "left" diplexer variant (Var 12). For the "right" variant (Var 18), the horizontal order is exactly opposite.
- The bias tee functionality is provided by Sense, Force and GND on the connector panel, see [Figure 6-8](#).

7 Putting the system into operation

The initial setup of the R&S ZNA67EXT is described in the R&S ZNA Getting Started and instrument help. This section gives additional information related to operation with external test sets.

7.1 Configure the external test sets in the analyzer firmware

Before connecting the RF cables, make sure that the converter configuration is set up correctly on the R&S ZNA (see [Chapter 9.2, "Converter configuration"](#), on page 41).

7.2 Connect the external test sets

Each of the external test sets must be connected to the R&S ZNA, the power supply and the DUT. Please refer to the following sections for details.

- H/L SWITCH (control connection): [Chapter 8.3, "Diplexer control"](#), on page 38
- RF and IF connections: See [Chapter 8.2, "RF and LO cabling"](#), on page 36
- Power supply: See [Chapter 8.4, "DC power supply"](#), on page 39
- DUT (usually connected after calibration): See [Chapter 9.6, "Mounting a DUT"](#), on page 47

7.3 Switch on the external test sets

The standby toggle switch is located at the rear panel (see [Chapter 6.2.1.1, "Standby switch"](#), on page 22). To switch the external test set to ready state, press the key. The green LED next to the switch must be lit now.

After switching the external test set to the ready state, a warm-up time of one hour is required to ensure accurate measurements. The instrument is only warmed-up in ready state, not in standby state.

8 Connecting the external test sets

The R&S ZNA67EXT is delivered with fully assembled external test sets, each consisting of a diplexer R&S ZVA-ZD110 and a frequency converter R&S ZVA-Z110. The "internal" connection between the diplexers and frequency converters is described in [Chapter 6.3, "Diplexers"](#), on page 25.

System component information

A label on the rear panel of the network analyzer shows the diplexer and converter units with their position. The label contains the following information.

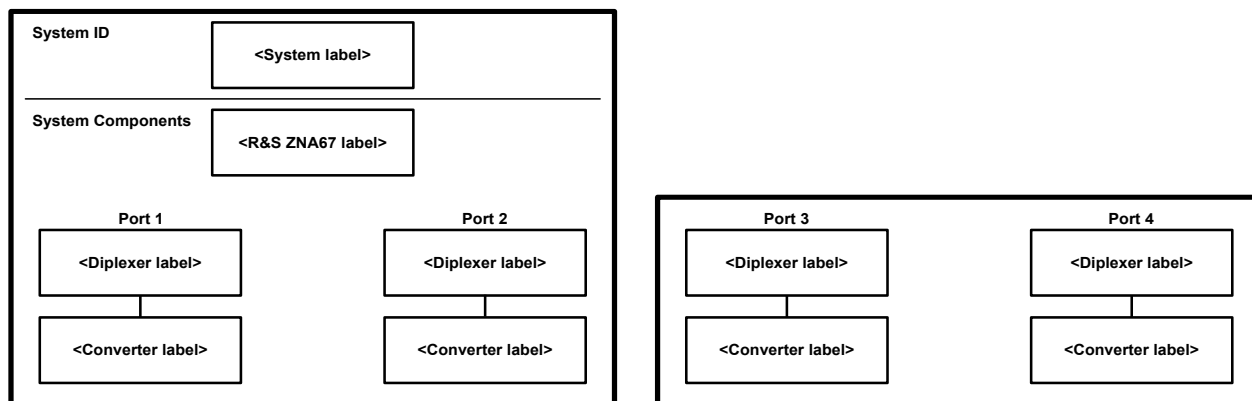

Figure 8-1: System component information

i Compliance with rated specifications

Compliance with the rated specifications requires a system setup according to the rear panel labeling at the R&S ZNA67. If you interchange the delivered test sets, or if you use test sets from other R&S ZNA67EXT VNA systems, the rated specifications cannot be guaranteed.

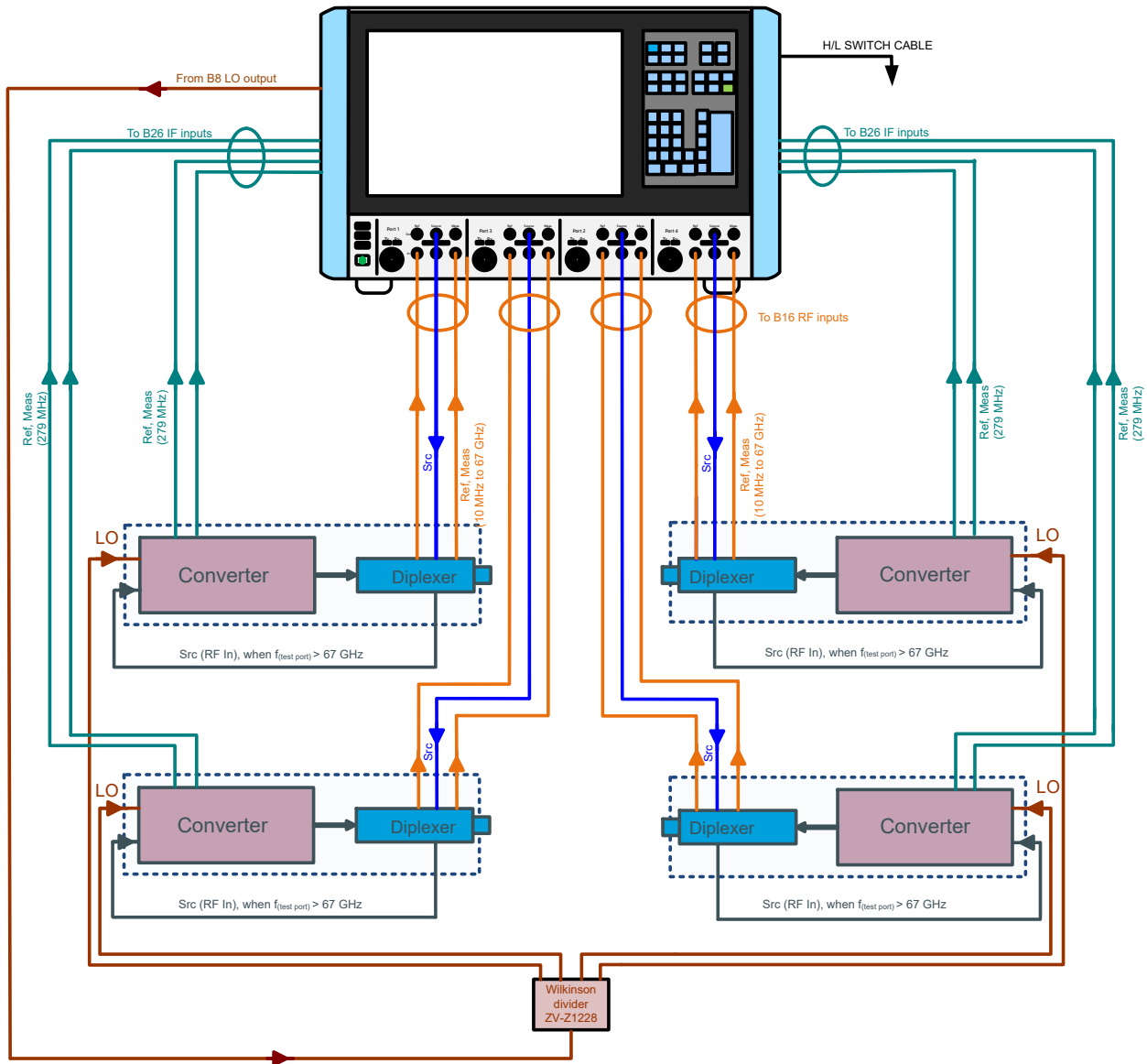

Figure 8-2: Test set connections (4 external test sets)

The following figure shows the cabling of external test set *p*.

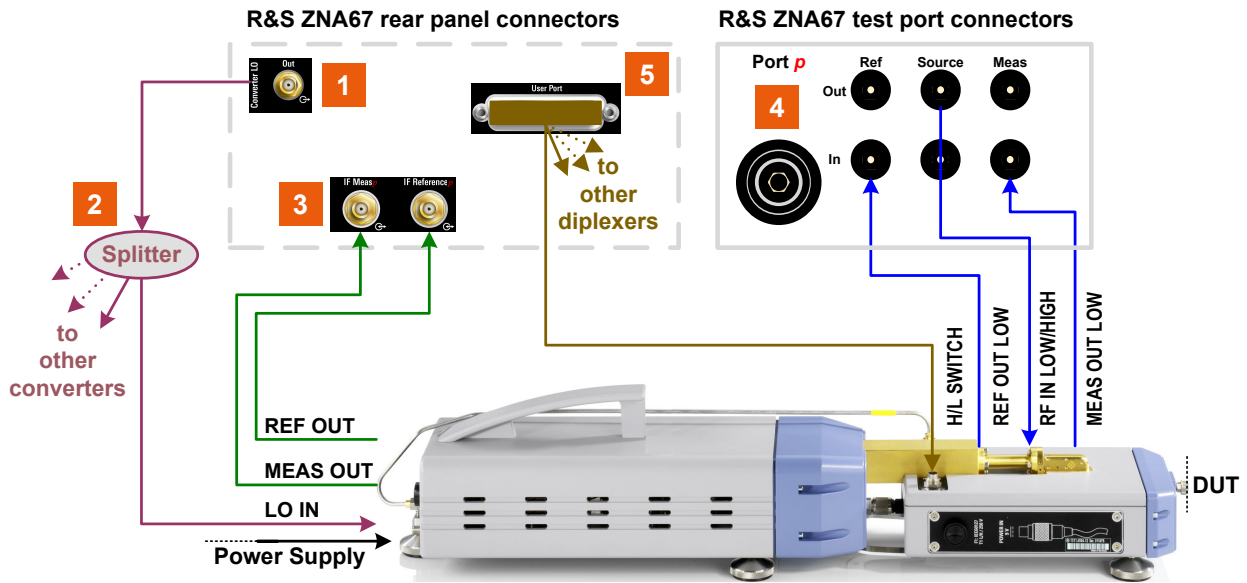

Figure 8-3: Connections of external test set p

- 1 = Converter LO output (R&S ZNA-B8)
- 2 = Splitter
- 3 = Direct IF access for port p (R&S ZNA-B26)
- 4 = RF port p with Direct source/receiver access (R&S ZNA67-B16)
- 5 = User Port with H/L SWITCH control cable

8.1 IF cabling

The required IF cables are included in the delivery of the test sets.

Table 8-1: IF connections for converters

Connections	Cable	Used at frequencies
Converter <i>p</i> REF OUT to R&S ZNA67 IF Reference <i>p</i>	R&S CABLE EXT REF, 1.55 m order no. 1307.8770.00	HIGH
Converter <i>p</i> MEAS OUT to R&S ZNA67 IF Meas <i>p</i>	R&S CABLE EXT MEAS, 1.55 m order no. 1307.8764.00	

8.2 RF and LO cabling

The following RF and LO connections must be established for each external test set.

Table 8-2: RF and LO connections

R&S ZNA67 connector	Ext. test set connector	Used at frequencies
Port p Source Out	Diplexer p RF IN	LOW / HIGH
Port p Ref In	Diplexer p REF OUT	LOW
Port p Meas In	Diplexer p MEAS OUT	LOW
Conv LO Out	Converter p LO IN via power divider	HIGH
$p = 1, 2$ for systems with 2 external test sets $p = 1, \dots, 4$ for systems with 4 external test sets		



Some of the RF connections are only used while the network analyzer operates in the low frequency range (below approx. 67 GHz) or in the high frequency range (above approx. 67 GHz). However, to ensure full flexibility and maximum accuracy, it is recommended to establish all RF connections.

To get accurate measurement results, use high-quality cables with low attenuation and excellent phase stability. Rohde&Schwarz offers suitable cable sets from GORE®, see "[Cable sets \(optional\)](#)" on page 37.

NOTICE

RF input power

The RF input power at the connectors RF IN and LO IN of the converters must not exceed the maximum values quoted in the data sheet. Because these maximum values are below the maximum RF source power of the R&S ZNA, the R&S ZNA has to be configured carefully, before establishing these connections. Selecting the "ZNA67EXT-TS" converter type ensures compatible source powers (see [Chapter 9.2, "Converter configuration"](#), on page 41).

Proceed as follows:

1. Ensure that the converter is in standby state or disconnected from the power supply (see [Chapter 6.2.1.1, "Standby switch"](#), on page 22).
2. Make sure to select the "ZNA67EXT-TS" converter type for each converter port of the VNA (see [Chapter 9.2, "Converter configuration"](#), on page 41).
3. Connect the RF input and output connectors of the diplexers and the frequency converters as shown in [Figure 8-3](#).

Repeat this procedure whenever you are not sure whether a suitable converter configuration is already active. Switching the VNA off and on preserves the converter configuration.



Converter configurations can be saved and loaded via the graphical user interface of the R&S ZNA.

Cable sets (optional)

The required RF and LO cables listed in [Table 8-2](#) are **not** part of the standard delivery. However, it is recommended to order the suitable cable set for 2 or 4 external test sets together with your R&S ZNA67EXT VNA system.

Currently, Rohde & Schwarz offers cable sets R&S ZN-ZCASGO manufactured by GORE®:

- Variant 02, order no. 1352.1659.02 for 2 external test sets
- Variant 04, order no. 1352.1659.04 for 4 external test sets

Table 8-3: Cable set R&S ZN-ZCASGO

Connection	Cable type	# in Var 02	# in Var 04
<ul style="list-style-type: none"> • R&S ZNA67 port p Source Out to diplexer p RF IN • Diplexer p REF OUT to R&S ZNA67 port p Ref In • Diplexer p MEAS OUT to R&S ZNA67 port p Meas In 	R&S ZV-Z196, 67 GHz, order no. 1306.4736.00 1.85 mm (m) / 1.85 mm (m), 61 cm	x 6 $p = 1, 2$	
	R&S ZV-Z196, 67 GHz, order no. 1306.4807.00 1.85 mm (m) / 1.85 mm (m), 91 cm	–	x 6 $p = 3, 4$ (outer test sets)

Connection	Cable type	# in Var 02	# in Var 04
R&S ZNA67 Conv LO Out to LO power divider	R&S ZV-Z195 26.5 GHz 2.92 mm (m) / 2.92 mm (m), 91 cm	x 1	
LO power divider (+ Adapters R&S ZV-Z1218) to converter p LO IN	R&S ZV-Z193, 26.5 GHz 3.5 mm (m) / 3.5 mm (m), 152 cm	x 2 $p = 1, 2$	x 4 $p = 1, \dots, 4$

Tightening RF cables

Tightening RF cables too strongly, can damage cables and connectors. Loose tightening can result in inaccurate measurement results.

Therefore always use an appropriate torque wrench, suitable for the type of connector. Rohde & Schwarz offers an optional 5/16" torque wrench that fits for SMA, 3.5 mm, 2.92 mm and 1.85 mm connectors (R&S ZN-ZTW variant 35). Similar wrenches are available for other sizes of spanner, too. For ordering information, see the R&S ZN-ZTW data sheet or product brochure.

8.3 Diplexer control

Switchover between low frequency and high frequency mode is automatically controlled from the R&S ZNA67EXT network analyzer unit. Use the "H/L Switch" cable to connect the User Port connector on the rear panel of the analyzer to the H/L SWITCH connectors on the top side of the diplexers.

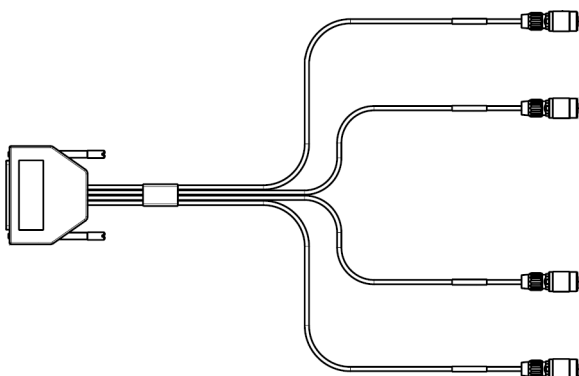

Figure 8-4: H/L SWITCH cable for 4 test sets

The H/L SWITCH cable is supplied with the R&S ZNA67EXT. The cable end labeled H/L SWITCH PORT p is intended for the diplexer connected to analyzer port no. p . The H/L switch mechanism is controlled by drive port bit no. p (pin 15 + p) of the USER CONTROL connector.

For a detailed description of the connector, refer to the R&S ZNA user manual or help system.



Low frequency mode

In low frequency mode, the control cable is not needed – even if the DUT is connected to the 1 mm test port connectors of the diplexers.

8.4 DC power supply

An external DC power supply with country-specific AC cable is provided with each of the external test sets. Connect the power supply to the 9 V / 1.1 A DC input at the rear panel of the frequency converter (see [Chapter 6.2.1.2, "Power supply connector"](#), on page 23) and to a power outlet. The power supply supports input AC voltages between 100 V and 240 V and frequencies between 47 Hz and 63 Hz.

A lit LED next to the standby switch indicates that the power supply operates appropriately. If neither of the two LEDs is lit, check the fuse of the instrument (see [Chapter 10.2, "Replacing fuses"](#), on page 49).

9 Basic operation

This chapter describes how to configure the standard setup with two external test sets, for 2-port transmission measurements.



On delivery, the R&S ZNA67EXT is already preconfigured for the number of external tests sets included in the ordered VNA system variant. A preset does not affect the converter configuration.

After a factory reset, however, the R&S ZNA67 comes up with its regular VNA setup, without frequency converter configuration.

To put the VNA system into operation, follow the steps described in [Chapter 7, "Putting the system into operation"](#), on page 32.

Configuration and measurement steps

Configuring the measurement setup and measuring the DUT involves the following steps:

1. Configuring the converters in the R&S ZNA firmware
See [Chapter 9.2, "Converter configuration"](#), on page 41
2. Establishing the required connections between the R&S ZNA and the test sets
See [Chapter 8, "Connecting the external test sets"](#), on page 33
3. Power calibration (optional for S parameter measurements)
See [Chapter 9.4, "Scalar power calibration and leveling \(optional\)"](#), on page 43
4. System error correction, using a suitable calibration kit
See [Chapter 9.5, "System error correction"](#), on page 47
5. Connecting the DUT
See [Chapter 9.6, "Mounting a DUT"](#), on page 47
6. Measuring the DUT
See [Chapter 9.7, "Measurement"](#), on page 47

9.1 Required equipment

The cabling of the external test sets is described in [Chapter 8, "Connecting the external test sets"](#), on page 33.

To calibrate the measurement setup, the following equipment is required:

- For power calibration and leveling at the 1 mm port of the external test set, a power meter that covers the measured frequency range, such as the thermal power sensor R&S NRP110T.
(for the latter an additional 1 mm f/f adapter is required)
- Suitable adapters for scalar power calibration of the LO IN and RF IN signals at the external test set
- For system error correction, a 1 mm calibration kit that covers the measured frequency range, e.g the R&S ZV-Z210

9.2 Converter configuration

Convenient converter configuration is provided with software option R&S ZNA-K8, which is already preinstalled on your R&S ZNA.

1. At the graphical user interface of the R&S ZNA , open the "Converter Configuration" dialog (System – [Setup] key > "Frequency Converter" tab > "Frequency Converter ...").

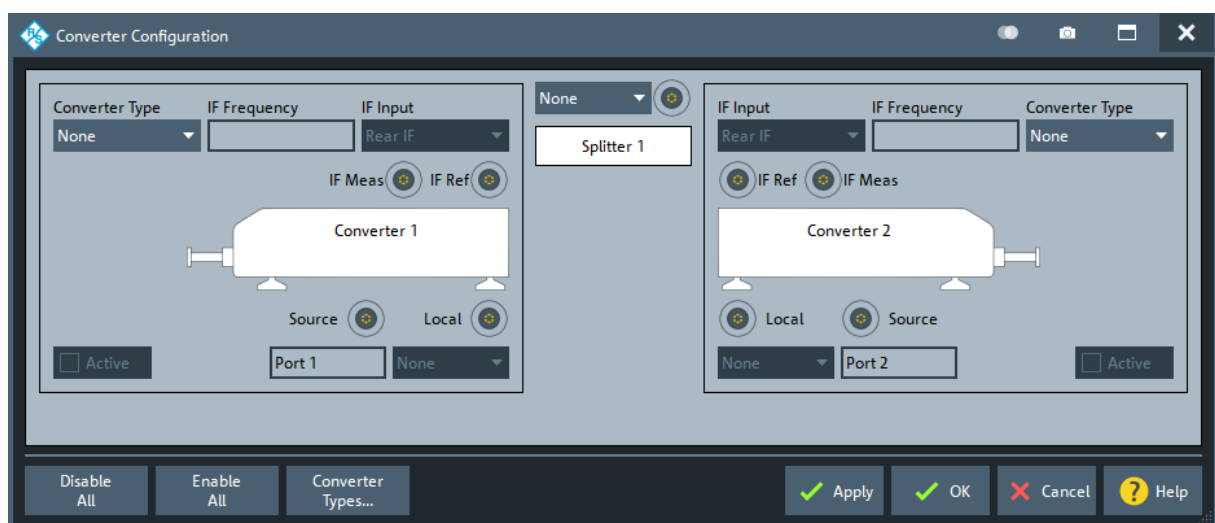

Converter configuration

"Converter 1" is the converter connected to VNA port 1, "Converter 2" the converter connected to VNA port 2.

2. In the "Converter Configuration" dialog, configure the standard setup with two converters:
 - a) For both converter ports, set "Converter Type" to "ZNA67EXT-TS"
The firmware automatically fixes "IF Input" to "Rear & Dir" (rear IF access for high, direct access for low frequencies).
 - b) In the combo box above the "Splitter 1" symbol, select "Conv. LO" as LO source.
 - c) For both converter ports, select "Splitter 1" as the source for the "Local" port.

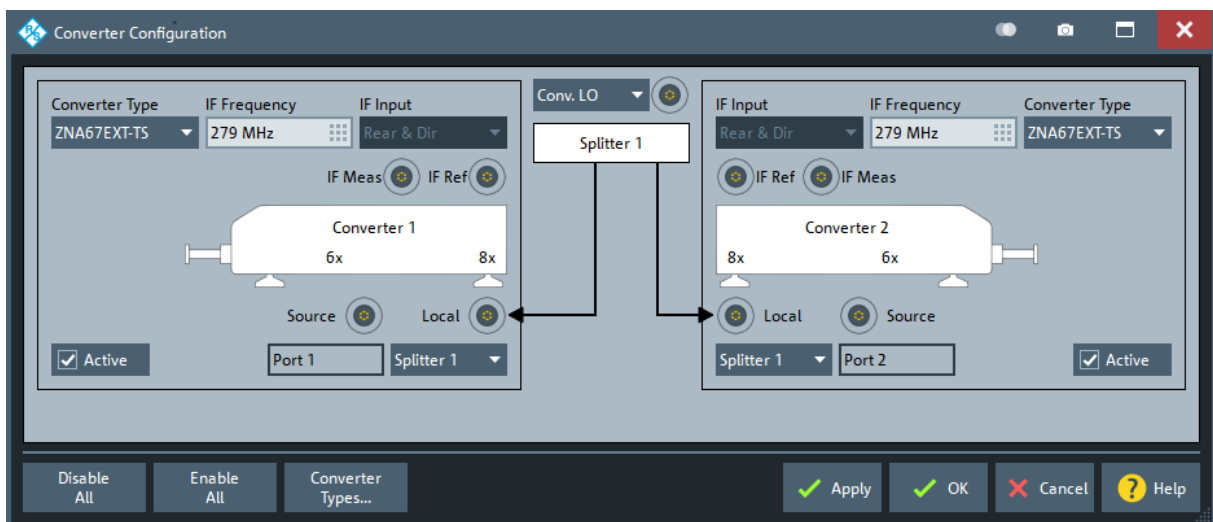

Figure 9-1: Standard setup with two external test sets

3. Select "OK" to apply the converter configuration and close the dialog.
The R&S ZNA now sets the involved ports to their maximum frequency range (10 MHz to 110 GHz). It sets the related receiver step attenuators to 0 dB, activates low phase noise mode and deactivates automatic level control (see the R&S ZNA user manual or instrument help). In addition, the firmware adjusts the source power levels according to the properties of the "Rear & Dir" signal paths and the configured cable and splitter losses.



Converter configurations can be saved and loaded via the graphical user interface of the R&S ZNA.

(System – [Setup] key > "Frequency Converter" tab > "Save Converter Topology"/"Load Converter Topology").

Scalar power calibration and leveling (optional)

Cable and splitter losses

Check the cable and splitter losses:

1. Open the "Default Cable and Splitter Losses" dialog (System – [Setup] key > "Frequency Converter" tab > "Default Cable and Splitter Losses ...").
2. Adjust "Cable & Splitter Loss" and "Slope", if your cables and splitter losses deviate significantly from the default settings, which fit for cable sets R&S ZCASGO.

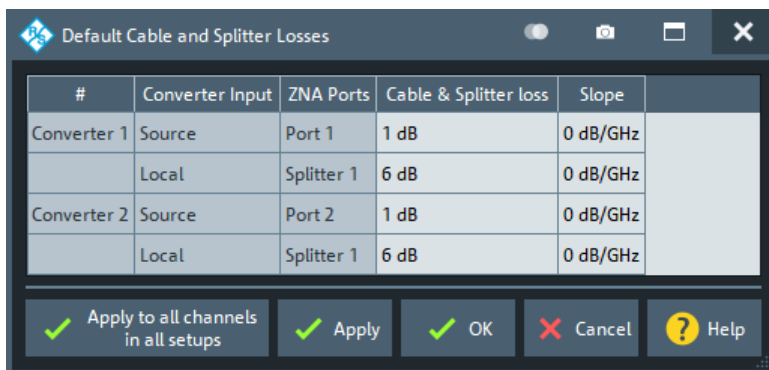

3. Select "OK" to apply your settings and close the dialog.

The resulting frequency and source power levels can be viewed – and tweaked – in the port settings dialog (Channel – [Channel Config] key > "Port Config" tab > "Port Settings ..."). For details, see the R&S ZNA help system or user manual.

9.3 Establishing the RF and IF connections

Refer to [Chapter 8.2, "RF and LO cabling"](#), on page 36.

9.4 Scalar power calibration and leveling (optional)

For standard S parameter measurements which do not require precise power levels at the DUT, a power calibration is not required.

Scalar power calibration and leveling (optional)

To take control of the converter input and output levels, proceed as follows:

1. At the graphical user interface of the R&S ZNA, run the scalar power calibration wizard (Channel – [Cal] key > "Start Cal" tab > "Scalar Power Cal ...")
2. On the first page of the wizard, you can perform source flatness calibrations at the converter inputs.



Perform a source flatness calibration, if the configured values for cable and splitter losses cannot describe the actual ones with sufficient accuracy (sum deviation > 2 dB). See [step 2](#) in [step 2](#).

3. The second page of the wizard offers several calibration types:

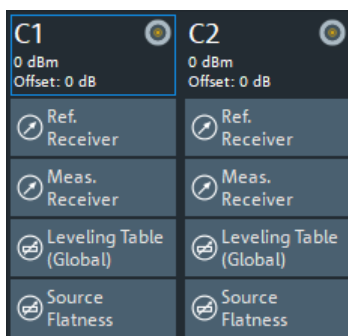

a) "Ref. Receiver"

To perform a reference receiver calibration, connect a power meter with suitable frequency range to the 1 mm port of the respective external test set. During the calibration, the R&S ZNA performs a frequency sweep and uses the power meter readings to correct the readings of the related reference receiver (transfer calibration). We recommend using the Rohde&Schwarz thermal power meter R&S NRP110T.

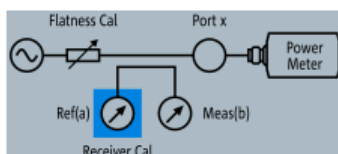

With the default power calibration method of the R&S ZNA, subsequent measurement receiver and source flatness calibrations rely on an existing reference receiver calibration. For output power leveling, an existing reference receiver calibration of the respective port is a prerequisite.

Scalar power calibration and leveling (optional)

b) "Meas. Receiver"

A measurement receiver calibration adjusts the power readings at the receive port, by default based on an existing reference receiver calibration. With an existing reference receiver calibration for port 1, to calibrate the measurement receiver of port 1, connect an Open to the 1 mm port of converter 1 and select port 1 as source.

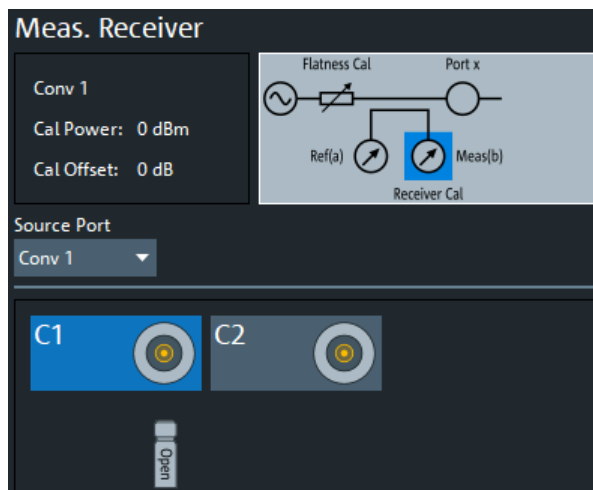

To calibrate the measurement receiver of port 2, connect the 1 mm ports of the test sets directly, and again use port 1 as source.

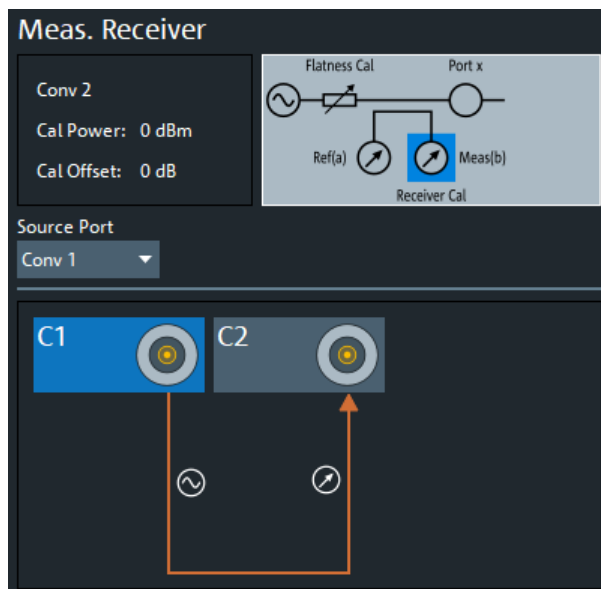

Scalar power calibration and leveling (optional)

c) "Leveling Table (Global)"

Perform leveling if you want the power levels at the waveguide port to be constant over frequency. Also perform leveling if you want to have frequency-independent, variable, known absolute power levels at the waveguide port. The latter is necessary for power sweeps, but also for automatic level control (ALC).

Use ALC for measurements that require precise power levels at the 1 mm port, in particular for measuring non-linear characteristics of a DUT (compression, intermodulation, spectrum...). For details on ALC, see the R&S ZNA help system or user manual.

Based on an existing reference receiver calibration, the leveling procedure records the output power on a two-dimensional power/frequency grid. The VNA firmware then uses Interpolation to determine the appropriate RF IN level for the desired output level at a given frequency.

d) "Source Flatness"

Based on an existing reference receiver calibration, the R&S ZNA varies the frequency and adjusts its source power so that the reference receiver readings correspond to the desired output power at the waveguide port of the converter.

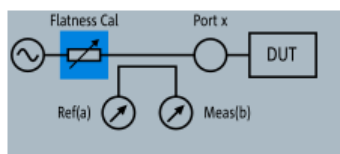

For operation with external test sets, make sure that the convergence factor is 0.3 or lower (Channel – [Cal] key > "Power Cal Settings" tab > "Convergence").

If leveling data is available for a port, a source flatness calibration is not necessary unless you want to achieve a higher precision at a particular frequency. To get even higher precision within the whole frequency range, use the automatic level control (ALC) feature of the R&S ZNA. Note that ALC at a converter port requires leveling data for this port. Refer to the R&S ZNA help system or user manual for details.

9.5 System error correction

For precise S-parameter measurements, a system error correction is recommended. System error correction requires a calibration kit that is suitable for the measured frequency range. For the R&S ZNA67EXT we recommend the 1 mm calibration kit R&S ZV-Z210. The standards in these calibration kits allow for OSM, TOSM, UOSM and TOM calibrations.

The characteristic data of a particular R&S ZV-Z210 is stored on a USB stick shipped with the kit, and must be installed manually, before the kit can be used.



With an additional reference receiver calibration at one of the converter ports, a full n-port system error correction at $n > 1$ converter ports of the same waveguide band can be extended to a SMARTerCal. A SMARTerCal enables (relative) phase *and* (absolute) power accurate measurements of all involved a- and b-waves.

Refer to the documentation of your calibration kit and to the R&S ZNA help system or user manual for more information.

9.6 Mounting a DUT

The DUT must be screwed to the 1 mm test port connector at the front of the diplexer. A tight connection is essential to ensure precise calibration and measurement results. Depending on the connectors of the DUT, possibly additional adapters are required.

For n -port measurements, n external test sets must be connected to one DUT. Use the adjustable feet of the test sets to align the DUT accurately.

9.7 Measurement

After power calibration and system error correction, mount the DUT (see [Chapter 9.6, "Mounting a DUT"](#), on page 47).

Measurements involving converters can be performed like other measurements. All measured quantities (S parameters, wave quantities, ratios etc.) are available.

Power sweeps and ALC can only be activated, if leveling data are available (see [Chapter 9.4, "Scalar power calibration and leveling \(optional\)"](#), on page 43).

The "Port Settings" dialog (Channel – [Channel Config] key > "Port Config" tab > "Port Settings ...") shows the frequency and power sweep ranges of all implied signals, including RF IN, LO IN and IF output. Refer to the R&S ZNA help system or user manual for details.



- After power-up, a warm-up time of one hour is required to ensure accurate measurements.
- Measurement results can be degraded if the setup is exposed to an electromagnetic field at the IF frequency (default: 279 MHz).
- For pulsed signals, the default IF frequency of 279 MHz cannot be used, because a narrow-band filter is applied at this frequency. Use the "Converter Configuration" dialog to select an IF frequency in the direct path between 30 kHz and 30 MHz instead (see [Figure 9-1](#)).
- If a power splitter is used and the phases of S_{ij} and S_{ji} deviate or drift by equal magnitude, but opposite sign, check the phase stability of the LO paths of the converters.

9.8 Additional information

For a comprehensive description of the frequency converter mode, including remote control, refer to the R&S ZNA help system or user manual.

More information is available on the R&S ZNA product pages (<https://www.rohde-schwarz.com/product/zna/>).

10 Maintenance and disposal

The product does not require regular maintenance. It only requires occasional cleaning. It is however advisable to check the nominal data from time to time.

Make sure that the air vents of the frequency converters are not obstructed.

10.1 Cleaning

Cleaning the product

Use a dry, lint-free cloth to clean the product. When cleaning, keep in mind that the casing is not waterproof. Do not use liquid cleaning agents.

Do not use any liquids for cleaning. Cleaning agents, solvents (thinners, acetone), acids and bases can damage the front panel labeling, plastic parts and display.

10.2 Replacing fuses

The frequency converter is protected by a fuse of type IEC60127 T1 L/H, see [Chapter 6.2.1.3, "Fuse holder"](#), on page 23.

The diplexer is protected by a fuse of type IEC127-F250L, see [Chapter 6.3.4, "Fuse panel"](#), on page 30.

To replace a fuse, open the fuse holder by slightly turning the lid counter-clockwise, preferably using a small coin. Replacement fuses are provided with the instrument.

10.3 Recalibration and repair

For accurate measurements, the product must be recalibrated by Rohde & Schwarz service after the calibration interval in the data sheet has elapsed.

Calibration involves all components of the test system, including the R&S ZNA67 network analyzer and all external test sets.

 The R&S ZNA67EXT has to be considered a system. For recalibration and repair, all shipped components and cables must be sent to the Rohde & Schwarz service. See [Table 5-1](#).

- Observe the label on the rear panel of the R&S ZNA67, to ensure you include the correct test sets in your shipment. See "[System component information](#)" on page 33.
- Also include additional cable sets ordered with the system. See "[Cable sets \(optional\)](#)" on page 37.

10.4 Storing and packing

The R&S ZNA67EXT network analyzer unit and the external test sets can be stored in the temperature range quoted in the data sheet. When stored for a longer period of time, the devices must be protected against dust.

Transport and store the external test sets in their original boxes. The 1 mm test port of the diplexer must be protected by its cap; see also [Table 5-1](#).

10.5 Disposal

Rohde & Schwarz is committed to making careful, ecologically sound use of natural resources and minimizing the environmental footprint of our products. Help us by disposing of waste in a way that causes minimum environmental impact.

Disposing electrical and electronic equipment

A product that is labeled as follows cannot be disposed of in normal household waste after it has come to the end of its service life. Even disposal via the municipal collection points for waste electrical and electronic equipment is not permitted.



Figure 10-1: Labeling in line with EU directive WEEE

Rohde & Schwarz has developed a disposal concept for the eco-friendly disposal or recycling of waste material. As a manufacturer, Rohde & Schwarz completely

Disposal

fulfills its obligation to take back and dispose of electrical and electronic waste.
Contact your local service representative to dispose of the product.

11 Contacting customer support

Technical support – where and when you need it

For quick, expert help with any Rohde & Schwarz product, contact our customer support center. A team of highly qualified engineers provides support and works with you to find a solution to your query on any aspect of the operation, programming or applications of Rohde & Schwarz products.

Contact information

Contact our customer support center at www.rohde-schwarz.com/support, or follow this QR code:



Figure 11-1: QR code to the Rohde & Schwarz support page