

R&S®ZND

Vector Network Analyzers Getting Started

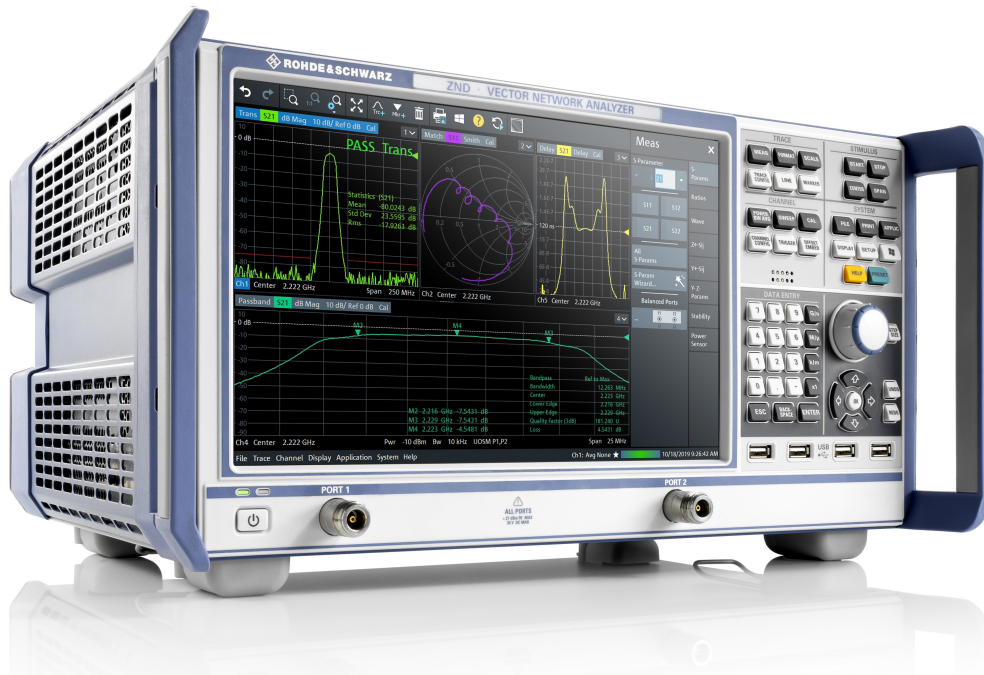

1316240702
Version 64

ROHDE & SCHWARZ
Make ideas real



This manual describes the R&S®ZND (2 ports, 9 kHz to 4.5 GHz, unidirectional, N connectors), order no. 1328.5170K92 and its options.

Hardware Options

- R&S®ZND-B7 "High Output Power", order no. 1338.1578.02
- R&S®ZND-B10 "GPIB Interface", order no. 1328.5358.02
- R&S®ZND-B14 "Handler I/O", order no. 1316.2459.05

Software Options

- R&S®ZND-K1 "Frequency range extension to 8.5 GHz for unidirectional instrument", order no. 1328.5306.02
(not compatible with R&S®ZND-K5 and R&S®ZND-K8)
- R&S®ZND-K2 "Time Domain (TDR)", order no. 1328.5393.02
- R&S®ZND-K5 "Bidirectional measurements 9 kHz to 4.5 GHz", order no. 1328.5312.02
(not compatible with R&S®ZND-K1 and R&S®ZND-K6)
- R&S®ZND-K6 "Bidirectional measurements 9 kHz to 8.5 GHz", order no. 1328.5329.02
(requires R&S®ZND-K1; not compatible with R&S®ZND-K5 and R&S®ZND-K8)
- R&S®ZND-K8 "Frequency range extension to 8.5 GHz for bidirectional instrument", order no. 1328.5412.02
(requires R&S®ZND-K5; not compatible with R&S®ZND-K1 and R&S®ZND-K6)
- R&S®ZND-K7 "Extended Power Range", order no. 1328.5335.02
- R&S®ZND-K19 "1 mHz Frequency Resolution", order no. 1326.8089.02

© 2023 Rohde & Schwarz GmbH & Co. KG
Muehldorfstr. 15, 81671 Muenchen, Germany
Phone: +49 89 41 29 - 0
Email: info@rohde-schwarz.com

Internet: www.rohde-schwarz.com

Subject to change – data without tolerance limits is not binding.

R&S® is a registered trademark of Rohde & Schwarz GmbH & Co. KG.

Trade names are trademarks of the owners.

1316.2407.02 | Version 64 | R&S®ZND

Throughout this manual, R&S® is abbreviated as R&S.

Contents

1	Safety and regulatory information.....	7
1.1	Safety instructions.....	7
1.2	Warning messages in the documentation.....	9
1.3	Korea certification class A.....	10
2	Documentation overview.....	11
2.1	Getting started manual.....	11
2.2	User manual and help.....	11
2.3	Service manual.....	11
2.4	Instrument security procedures.....	12
2.5	Printed safety instructions.....	12
2.6	Data sheets and brochures.....	12
2.7	Release notes and open source acknowledgment (OSA).....	12
2.8	Application notes, application cards, white papers, etc.....	12
3	Preparing for use.....	13
3.1	Lifting and carrying.....	13
3.2	Unpacking and checking.....	13
3.3	Choosing the operating site.....	13
3.4	Setting up the product.....	14
3.4.1	Placing the product on a bench top.....	14
3.4.2	Mounting the product in a rack.....	15
3.5	Considerations for test setup.....	16
3.6	Connecting the analyzer to the AC supply.....	17
3.7	Switching the instrument on and off.....	17
3.8	Standby and ready state.....	18
3.9	Windows operating system.....	18
3.10	Minimizing the VNA application.....	20
3.11	Connecting external accessories.....	21
3.11.1	Connecting a monitor.....	21
3.11.2	Connecting a keyboard.....	21
3.11.3	Connecting a mouse.....	22
3.11.4	Connecting a printer.....	22

3.11.5	Connecting a LAN cable.....	23
4	Instrument tour.....	24
4.1	Front panel.....	24
4.1.1	Touchscreen.....	24
4.1.2	Function keys.....	25
4.1.3	Data entry keys.....	26
4.1.4	Rotary knob.....	27
4.1.5	Navigation keys.....	27
4.1.6	Standby key.....	28
4.1.7	Front panel connectors.....	28
4.2	Rear panel.....	29
5	Operating the instrument.....	31
5.1	Manual operation.....	31
5.2	Control elements of the application window.....	36
5.2.1	Title bar.....	37
5.2.2	Toolbar.....	37
5.2.3	Softtools.....	38
5.2.4	Menu bar.....	39
5.2.5	Menu structure.....	40
5.2.6	Hardkey panel.....	41
5.2.7	Status bar.....	41
5.3	Working with dialogs.....	42
5.4	Handling diagrams, traces, and markers.....	43
5.4.1	Adding new traces and diagrams.....	43
5.4.2	Adding new markers.....	45
5.4.3	Deleting display elements.....	46
5.4.4	Using drag and drop.....	46
5.5	Entering data.....	47
5.5.1	Using front panel keys.....	47
5.5.2	Using the numeric editor.....	48
5.5.3	Using the analyzer's on-screen keyboard.....	49
5.5.4	Using the Windows® on-screen keyboard.....	49
5.6	Scaling diagrams.....	50

5.6.1	Using the graphical zoom.....	50
5.6.2	Setting the sweep range.....	52
5.6.3	Reference value and position.....	53
5.6.4	Auto scale.....	53
5.6.5	Circular diagrams.....	54
5.6.6	Set by marker.....	54
5.6.7	Enlarging a diagram.....	55
6	Performing measurements.....	56
6.1	Transmission S-parameter measurement.....	56
6.1.1	Connecting the instrument for transmission measurements.....	56
6.1.2	Selecting the sweep range and other parameters.....	57
6.1.3	Calibrating the instrument.....	58
6.1.4	Evaluating data.....	61
6.1.5	Saving and printing data.....	62
6.2	Reflection S-parameter measurement.....	63
7	Administrative tasks.....	65
7.1	Firmware installation.....	65
7.2	Remote operation in a LAN.....	66
7.2.1	Assigning an IP address.....	66
7.2.2	Using computer names.....	68
7.2.3	Remote Desktop connection.....	68
7.2.4	Windows® firewall settings.....	69
8	Contacting customer support.....	70
	Index.....	71

1 Safety and regulatory information

The product documentation helps you use the product safely and efficiently. Follow the instructions provided here and in the following chapters.

Intended use

The product is intended for the development, production and verification of electronic components and devices in industrial, administrative, and laboratory environments. Use the product only for its designated purpose. Observe the operating conditions and performance limits stated in the data sheet.

Where do I find safety information?

Safety information is part of the product documentation. It warns you of potential dangers and gives instructions on how to prevent personal injury or damage caused by dangerous situations. Safety information is provided as follows:

- In [Chapter 1.1, "Safety instructions"](#), on page 7. The same information is provided in many languages as printed "Safety Instructions". The printed "Safety Instructions" are delivered with the product.
- Throughout the documentation, safety instructions are provided when you need to take care during setup or operation.

1.1 Safety instructions

Products from the Rohde & Schwarz group of companies are manufactured according to the highest technical standards. To use the products safely, follow the instructions provided here and in the product documentation. Keep the product documentation nearby and offer it to other users.

Use the product only for its intended use and within its performance limits. Intended use and limits are described in the product documentation such as the data sheet, manuals and the printed "Safety Instructions". If you are unsure about the appropriate use, contact Rohde & Schwarz customer service.

Using the product requires specialists or specially trained personnel. These users also need sound knowledge of at least one of the languages in which the user interfaces and the product documentation are available.

Never open the casing of the product. Only service personnel authorized by Rohde & Schwarz are allowed to repair the product. If any part of the product is damaged or broken, stop using the product. Contact Rohde & Schwarz customer service at <http://www.customersupport.rohde-schwarz.com>.

Lifting and carrying the product

The maximum weight of the product is provided in the data sheet. You can lift or carry the product by yourself, if you can manage the weight on your own. Alternatively, you

can use lifting or transporting equipment. Follow the instructions provided by the equipment manufacturer.

Choosing the operating site

Only use the product indoors. The product casing is not waterproof. Water that enters can electrically connect the casing with live parts, which can lead to electric shock, serious personal injury or death if you touch the casing. If Rohde & Schwarz provides accessories designed for your product, e.g. a carrying bag, you can use the product outdoors.

Unless otherwise specified, you can operate the product up to an altitude of 2000 m above sea level. The product is suitable for pollution degree 2 environments where nonconductive contamination can occur. For more information on environmental conditions such as ambient temperature and humidity, see the data sheet.

Setting up the product

Always place the product on a stable, flat and level surface with the bottom of the product facing down. If the product is designed for different positions, secure the product so that it cannot fall over.

If the product has foldable feet, always fold the feet completely in or out to ensure stability. The feet can collapse if they are not folded out completely or if the product is moved without lifting it. The foldable feet are designed to carry the weight of the product, but not an extra load.

If stacking is possible, keep in mind that a stack of products can fall over and cause injury.

If you mount products in a rack, ensure that the rack has sufficient load capacity and stability. Observe the specifications of the rack manufacturer. Always install the products from the bottom shelf to the top shelf so that the rack stands securely. Secure the product so that it cannot fall off the rack.

Connecting to power

The product is an overvoltage category II product. Connect the product to a fixed installation used to supply energy-consuming equipment such as household appliances and similar loads. Keep in mind that electrically powered products have risks, such as electric shock, fire, personal injury or even death. Replace parts that are relevant to safety only by original parts, e.g. power cables or fuses.

Take the following measures for your safety:

- Before switching on the product, ensure that the voltage and frequency indicated on the product match the available power source. If the power adapter does not adjust automatically, set the correct value and check the rating of the fuse.
- Only use the power cable delivered with the product. It complies with country-specific safety requirements. Only insert the plug into an outlet with protective conductor terminal.
- Only use intact cables and route them carefully so that they cannot be damaged. Check the power cables regularly to ensure that they are undamaged. Also ensure that nobody can trip over loose cables.





- If you connect the product to an external power supply, use the one delivered with the product or recommended in the product documentation. The external power supply must conform to the country-specific regulations.
- Only connect the product to a power source with a fuse protection of maximum 20 A.
- Ensure that you can disconnect the product from the power source at any time. Pull the power plug to disconnect the product. The power plug must be easily accessible. If the product is integrated into a system that does not meet these requirements, provide an easily accessible circuit breaker at the system level.

Cleaning the product

Use a dry, lint-free cloth to clean the product. When cleaning, keep in mind that the casing is not waterproof. Do not use liquid cleaning agents.

Meaning of safety labels

Safety labels on the product warn against potential hazards.

	<p>Potential hazard</p> <p>Read the product documentation to avoid personal injury or product damage.</p>
	<p>Electrical hazard</p> <p>Indicates live parts. Risk of electric shock, fire, personal injury or even death.</p>
	<p>Hot surface</p> <p>Do not touch. Risk of skin burns. Risk of fire.</p>
	<p>Protective conductor terminal</p> <p>Connect this terminal to a grounded external conductor or to protective ground. This connection protects you against electric shock if an electric problem occurs.</p>

1.2 Warning messages in the documentation

A warning message points out a risk or danger that you need to be aware of. The signal word indicates the severity of the safety hazard and how likely it will occur if you do not follow the safety precautions.

WARNING

Potentially hazardous situation. Could result in death or serious injury if not avoided.

NOTICE

Potential risks of damage. Could result in damage to the supported product or to other property.

1.3 Korea certification class A



이 기기는 업무용(A급) 전자파 적합기기로서 판매자 또는 사용자는 이 점을 주의하시기
바라며, 가정외의 지역에서 사용하는 것을 목적으로 합니다.

2 Documentation overview

This section provides an overview of the R&S ZND user documentation. Unless specified otherwise, you find the documents at:

<https://www.rohde-schwarz.com/manual/ZND>

2.1 Getting started manual

Introduces the R&S ZND and describes how to set up and start working with the product. Includes basic operations, typical measurement examples, and general information, e.g. safety instructions, etc.

A printed version is delivered with the instrument. A PDF version is available for download on the Internet.

2.2 User manual and help

The user manual contains the description of all instrument modes and functions. It also provides an introduction to remote control, a complete description of the remote control commands with programming examples, and information on maintenance, instrument interfaces and error messages. Includes the contents of the getting started manual.

The contents of the user manual are available as help in the R&S ZND. The help offers quick, context-sensitive access to the complete information for the instrument and its firmware.

The user manual is also available for download or for immediate display on the Internet.

2.3 Service manual

Describes the performance test for checking the rated specifications, module replacement and repair, firmware update, troubleshooting and fault elimination, and contains mechanical drawings and spare part lists.

The service manual is available for registered users on the global Rohde & Schwarz information system (GLORIS):

<https://gloris.rohde-schwarz.com>

Application notes, application cards, white papers, etc.

2.4 Instrument security procedures

Deals with security issues when working with the R&S ZND in secure areas. It is available for download on the internet.

2.5 Printed safety instructions

Provides safety information in many languages. The printed document is delivered with the product.

2.6 Data sheets and brochures

The data sheet contains the technical specifications of the R&S ZND. It also lists the firmware applications and their order numbers, and optional accessories.

The brochure provides an overview of the instrument and deals with the specific characteristics.

See <https://www.rohde-schwarz.com/brochure-datasheet/ZND>

2.7 Release notes and open source acknowledgment (OSA)

The release notes list new features, improvements and known issues of the current firmware version, and describe the firmware installation.

The software makes use of several valuable open source software packages. An open source acknowledgment document provides verbatim license texts of the used open source software.

2.8 Application notes, application cards, white papers, etc.

These documents deal with special applications or background information on particular topics.

See <https://www.rohde-schwarz.com/brochure-datasheet/ZND>

3 Preparing for use

Here, you can find basic information about setting up the product for the first time.

3.1 Lifting and carrying

The carrying handles are designed to lift or carry the instrument. Do not apply excessive external force to the handles.

See "[Lifting and carrying the product](#)" on page 7.

3.2 Unpacking and checking

1. Unpack the R&S ZND carefully.
2. Retain the original packing material. Use it when transporting or shipping the R&S ZND later.
3. Using the delivery notes, check the equipment for completeness.
4. Check the equipment for damage.

If the delivery is incomplete or equipment is damaged, contact Rohde & Schwarz.

3.3 Choosing the operating site

Specific operating conditions ensure proper operation and avoid damage to the product and connected devices. For information on environmental conditions such as ambient temperature and humidity, see the data sheet.

See also "[Choosing the operating site](#)" on page 8.

Electromagnetic compatibility classes

The electromagnetic compatibility (EMC) class indicates where you can operate the product. The EMC class of the product is given in the data sheet.

- Class B equipment is suitable for use in:
 - Residential environments
 - Environments that are directly connected to a low-voltage supply network that supplies residential buildings
- Class A equipment is intended for use in industrial environments. It can cause radio disturbances in residential environments due to possible conducted and radiated disturbances. It is therefore not suitable for class B environments.

If class A equipment causes radio disturbances, take appropriate measures to eliminate them.

3.4 Setting up the product

See also:

- "Setting up the product" on page 8
- "Intended use" on page 7

3.4.1 Placing the product on a bench top

To place the product on a bench top

1. Place the product on a stable, flat and level surface. Ensure that the surface can support the weight of the product. For information on the weight, see the data sheet.
2. **CAUTION!** Foldable feet can collapse. See "Setting up the product" on page 8. Always fold the feet completely in or out. With folded-out feet, do not place anything on top or underneath the product.
3. **WARNING!** A stack of products can fall over and cause injury. Never stack more than three products on top of each other. Instead, mount them in a rack.

Stack as follows:

- If the products have foldable feet, fold them in completely.
- It is best if all products have the same dimensions (width and length). If the products have different dimensions, stack according to size and place the smallest product on top.
- Do not exceed the permissible total load placed on the product at the bottom of the stack:
 - 50 kg when stacking products of identical dimensions (left figure).
 - 25 kg when stacking smaller products on top (middle figure).

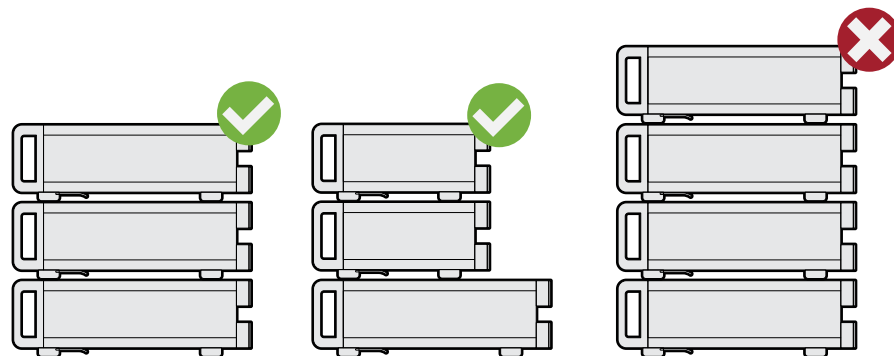

Left = Stacked correctly, same dimensions
Middle = Stacked correctly, different dimensions
Right = Stacked incorrectly, too many products

4. **NOTICE!** Overheating can damage the product.

Prevent overheating as follows:

- Keep a minimum distance of 10 cm between the fan openings of the product and any object in the vicinity to provide sufficient airflow and ventilation.
- Do not place the product next to heat-generating equipment such as radiators or other products.

3.4.2 Mounting the product in a rack

To prepare the rack

1. Observe the requirements and instructions in "[Setting up the product](#)" on page 8.
2. **NOTICE!** Insufficient airflow can cause overheating and damage the product. Design and implement an efficient ventilation concept for the rack.

To mount the R&S ZND in a rack

1. Use an adapter kit to prepare the R&S ZND for rack mounting.
 - a) Order the rack adapter kit R&S ZZA-KN5 (order number 1175.3040.00).
 - b) Mount the adapter kit. Follow the assembly instructions provided with the adapter kit.
2. Lift the R&S ZND to shelf height.
3. Grab the handles and push the R&S ZND onto the shelf until the rack brackets fit closely to the rack.
4. Tighten all screws in the rack brackets with a tightening torque of 1.2 Nm to secure the R&S ZND in the rack.

To unmount the R&S ZND from a rack

1. Loosen the screws at the rack brackets.
2. Remove the R&S ZND from the rack.
3. If placing the R&S ZND on a bench top again, unmount the adapter kit from the R&S ZND. Follow the instructions provided with the adapter kit.

3.5 Considerations for test setup

Cable selection and electromagnetic interference (EMI)

Electromagnetic interference (EMI) can affect the measurement results.

To suppress electromagnetic radiation during operation:

- Use high-quality shielded cables, for example, double-shielded RF and LAN cables.
- Always terminate open cable ends.
- Ensure that connected external devices comply with EMC regulations.

Regarding cable length and quality, the following requirements have to be met:

Table 3-1: Cable Requirements

Cable Type (Connector)	Requirement
RF cables (PORT 1, ..., PORT N)	Double shielded
BNC cables (various)	Double shielded
DB-25 (USER PORT)	Double shielded
GPIB	Standard cable
Handler I/O	Standard cable
DVI-D (Monitor)	2 ferrite cores
LAN	At least CAT6, S/FTP
USB	Standard cables, length ≤ 3m

Signal input and output levels

Information on signal levels is provided in the data sheet. Keep the signal levels within the specified ranges to avoid damage to the product and connected devices.

Preventing electrostatic discharge (ESD)

Electrostatic discharge is most likely to occur when you connect or disconnect a DUT.

- ▶ **NOTICE!** Electrostatic discharge can damage the electronic components of the product and the device under test (DUT).

Ground yourself to prevent electrostatic discharge damage:

- Use a wrist strap and cord to connect yourself to ground.
- Use a conductive floor mat and heel strap combination.

During operation, if the firmware observes a serious unexpected disturbance (e.g. due to ESD), it resets all hardware components to ensure proper instrument functioning. It then restores the user settings to the state before the disturbance and indicates the foregone hardware reset by an "Hardware communication problem [...]" information popup.

3.6 Connecting the analyzer to the AC supply

For safety information, see ["Connecting to power"](#) on page 8.

The network analyzer is automatically adapted to the AC supply voltage, which must be in the range of 100 V to 240 V at 50 Hz to 60 Hz. The AC power connector is located in the upper part of the rear panel (see [Chapter 4.2, "Rear panel"](#), on page 29).

1. Plug the AC power cable into the AC power connector on the rear panel of the product. Only use the AC power cable delivered with the product.
2. Plug the AC power cable into a power outlet with ground contact.

The required ratings are listed next to the AC power connector and in the data sheet.

3. If necessary, also ground the product using the grounding terminal \perp .

The maximum power consumption and the typical power consumption of the individual analyzer models are listed in the data sheet.

3.7 Switching the instrument on and off

To switch on the R&S ZND

1. Switch the AC power switch to position I (On).

The AC power switch is located in the upper part of the rear panel, together with the mains connector; see [Chapter 4.2, "Rear panel"](#), on page 29.

After power-on, the analyzer automatically goes to standby or ready state, depending on the state of the standby toggle key at the front panel when the instrument was switched off last time.

2. If necessary, press the standby toggle key on the front panel to switch the instrument to ready state.

See [Chapter 3.8, "Standby and ready state"](#), on page 18

The instrument automatically performs a system check, boots the Windows® operating system and then starts the vector network analyzer (VNA) application. If it was terminated regularly, the VNA application restores all recall sets and instrument settings of the previous analyzer session.

To shut down the instrument

1. Press the standby toggle key.

Pressing the standby toggle key causes the instrument to save all loaded recall sets, to close the VNA application, to shut down Windows®, and to go to standby state (see [Chapter 3.8, "Standby and ready state"](#), on page 18).

Of course, you can also perform these steps manually, like in any Windows session.

2. If desired, set the AC power switch to position **O** (Off).

To disconnect from power

The R&S ZND is in standby state.

1. **NOTICE!** Risk of data loss. If you disconnect the product from power when it is in the ready state, you can lose settings and data. Shut it down first.

Set the switch on the power supply to position [0].

The LED of the standby toggle key is switched off.

2. Disconnect the R&S ZND from the power source.

3.8 Standby and ready state



The standby toggle key is located in the bottom-left corner of the front panel.

In standby state, the right, amber LED is on. The standby power only supplies the power switch circuits. In this state, it is safe to switch the AC power off and disconnect the instrument from the power supply.

In ready state, the left, green LED is on and all modules are power-supplied. When switched to ready state, the analyzer initiates its startup procedure.

Observe the instructions for startup and shutdown in [Chapter 3.7, "Switching the instrument on and off"](#), on page 17.

3.9 Windows operating system

The analyzer is equipped with a Windows 10 operating system, which has been configured according to the instrument's features and needs. Changes in the system configuration can be necessary to:

- Establish a LAN connection
- Customize the properties of the external accessories connected to the analyzer
- Call up additional software tools

All necessary settings can be accessed from the Windows "Start" menu, in particular from the "Control Panel". To open the "Start" menu, press the Windows key in the toolbar or on an external keyboard.

NOTICE**Modifications of the operating system**

The operating system is adapted to the network analyzer. To avoid impairment of instrument functions, only change the settings described in this manual. Existing software must be modified only with update software released by Rohde & Schwarz. Likewise, only programs authorized by Rohde & Schwarz for use on the instrument must be executed.

User accounts and password protection

The analyzer uses a user name and password as credentials for remote access. Two user accounts with different levels of access are available on the instrument:

- "instrument" is the default account with standard rights to change system settings. Use this account for normal operation of the analyzer.
- "Admin" is the account for administering the operating system. This account is required, for instance, if you wish to install programs on the analyzer.
[For instruments running Windows 7, this account is named "Administrator".]
In the factory configuration, "894129" is preset as a password for both users. To protect the analyzer from unauthorized access, it is recommended to change the preset passwords.

To switch from one user account to another, log off from Windows and then log on again. The "switch user" functionality is disabled on the R&S ZND.

Security updates and patches

Microsoft regularly creates security updates and other patches to protect Windows-based operating systems. They are released through the Microsoft Update website and associated update server. Update instruments using Windows regularly, especially instruments that connect to a network.

The analyzer is equipped with a Windows 10 IoT Enterprise LTSC/LTSC operating system, which is the embedded version of Windows 10 with long-term support for Windows security updates and patches. The firmware is tested with the following OS versions:

- Windows 10 IoT Enterprise 2016 LTSC
- Windows 10 IoT Enterprise 2019 LTSC
- Windows 10 IoT Enterprise 2021 LTSC

Firewall settings

A firewall protects an instrument by preventing unauthorized users from gaining access to it through a network. Rohde & Schwarz highly recommends using the firewall on your instrument. Rohde & Schwarz instruments are shipped with the Windows firewall enabled. All ports and connections for remote control are enabled.

Note that changing firewall settings requires administrator rights.

Virus protection

Take appropriate steps to protect your instruments from infection. Use strong firewall settings and scan any removable storage device used with a Rohde & Schwarz instrument regularly. It is also recommended that you install anti-virus software on the instrument. Rohde & Schwarz does NOT recommend running anti-virus software in the background ("on-access" mode) on Windows-based instruments, due to potentially degrading instrument performance. However, Rohde & Schwarz does recommend running it during non-critical hours.

For details and recommendations, see the following Rohde & Schwarz white paper:

- [1EF96: Malware Protection Windows 10](#)
- Windows 7: [1DC01: Malware Protection Windows 7](#)

3.10 Minimizing the VNA application

With a minimized VNA application, you can access your analyzer's Windows® desktop or run other applications.

To exit the default full-screen mode of the VNA application, deselect SYSTEM – [DISPLAY] > "View Bar" > "Title Bar Task Bar". Then use the standard Windows® titlebar functions to minimize/maximize/close the application window.

To start the VNA application with a minimized window

1. Right-click the Vector Network Analyzer shortcut icon on the desktop and open the "Properties" dialog.
2. In the "Shortcut" tab, select "Run: Minimized".

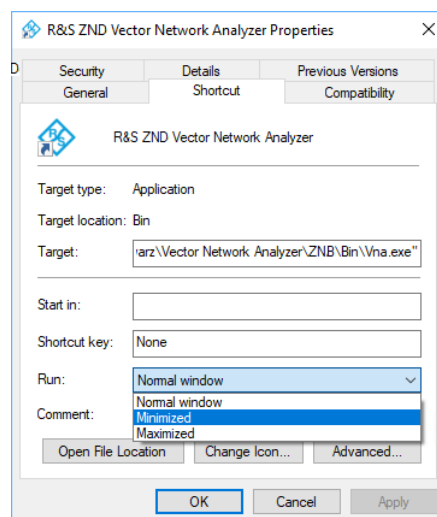



A software update restores the original shortcut properties.

3.11 Connecting external accessories

The analyzer's standard PC interfaces (Monitor, USB, LAN) can be used to connect various accessories:

- An external monitor expands/displays the Windows® desktop, which is, by default, covered by the vector network analyzer (VNA) (VNA) application window in full-screen mode.
- External keyboard and mouse simplify local control, in particular manual (GUI) operation of the VNA application.
- A printer can be used to create hard copies of the measurement diagrams and traces from within the VNA application.
- A LAN connection can be established to access the analyzer's mass storage or control the analyzer from an external PC.



External monitor, keyboard and mouse are not required for local operation. A R&S ZND can be fully controlled by tapping the touchscreen and front panel keys.

3.11.1 Connecting a monitor



A standard monitor can be connected to the DVI-D connector of the R&S ZND. No extra configuration is required.

Select SYSTEM > [DISPLAY] > "View Bar" > "Hard Key Panel On" from the menu bar of the VNA application window to add the (virtual) "Hard Key Panel" to the application window.

3.11.2 Connecting a keyboard

A keyboard can be connected to any of the USB connectors. After being auto-detected by the operating system, it can safely be disconnected and reconnected even during measurements.

Keyboard configuration

The default input language is English – US. Select "Settings" > "Time & language" > "Region & language" from the Windows® Start menu to manage languages and keyboards.

Windows 7: select "Control Panel" > "Clock, Language, and Region" > "Region and Language" > "Keyboards and Languages" from the Windows® Start menu to configure the keyboard properties.



To access Windows®, use the  button in the **toolbar** of the application window.

3.11.3 Connecting a mouse

A USB mouse can be connected to any of the USB connectors. After being auto-detected by the operating system, it can safely be disconnected and reconnected even during measurements.

Mouse configuration

Select "Settings" > "Devices" > "Mouse & touchpad" from the Windows® "Start" menu to configure the mouse properties.

Windows 7: select "Control Panel" > "Hardware and Sound" > "Devices and Printers" > "Mouse" from the Windows® "Start" menu to configure the mouse properties.



To access Windows®, use the  button in the **toolbar** of the application window.

3.11.4 Connecting a printer

A printer can be connected to any of the USB connectors. After successful installation, it can safely be disconnected and reconnected even during measurements.

Before printing (SYSTEM – [PRINT]), the analyzer checks whether a printer is connected and turned on and whether the appropriate printer driver is installed.

Printer driver installation

If necessary, the printer driver installation is initiated using the operating system's "Add Printer Wizard". The wizard is self-explanatory. A printer driver must be installed only once.

A great variety of printer drivers is available on the analyzer. To obtain the complete list, select "Settings" > "Devices" > "Printers & scanners" from the Windows® "Start" menu.

Windows 7: select "Control Panel" > "Hardware and Sound" > "Devices and Printers" from the Windows® "Start" menu.



To access Windows®, use the  button in the **toolbar** of the application window.

You can load updated and improved driver versions or new drivers from an installation disk, USB memory stick or another external storage medium. Alternatively, if the analyzer is integrated in a network, you can install driver data stored in a network directory. In either case, use the "Add Printer" wizard to complete the installation.

Printer configuration

Use the "Printer Setup" dialog of the firmware (SYSTEM – [PRINT] > "Print...") or the Windows® printer management to configure the printer properties and printing preferences.

3.11.5 Connecting a LAN cable

A LAN cable can be connected to the LAN connector on the rear panel of the analyzer. To establish a LAN connection, proceed as follows:

1. Refer to [Chapter 7.2.1, "Assigning an IP address"](#), on page 66.
2. Connect a CAT6 or CAT7 LAN cable to the LAN port.

The LAN port of the analyzer is an auto-crossover Ethernet port. You can connect it to a network, but you can also set up a direct connection to a computer or another instrument. For both connection types, you can use either crossover or straight through (patch) cables.

The IP address information is displayed in the SYSTEM – [SETUP] > "Remote Settings" softtool tab.

4 Instrument tour

This chapter gives an overview of the control elements and connectors of the R&S ZND and gives all information that is necessary to put the instrument into operation and connect external devices.

The meanings of the labels on the product are described in "[Meaning of safety labels](#)" on page 9.

4.1 Front panel

The front panel of the network analyzer consists of the touchscreen with the diagrams and softtool panels (left side), the hardkey area (right side) and the test port area below. Brief explanations on the controls and connectors, the hardkey area and the rear panel can be found on the next pages.

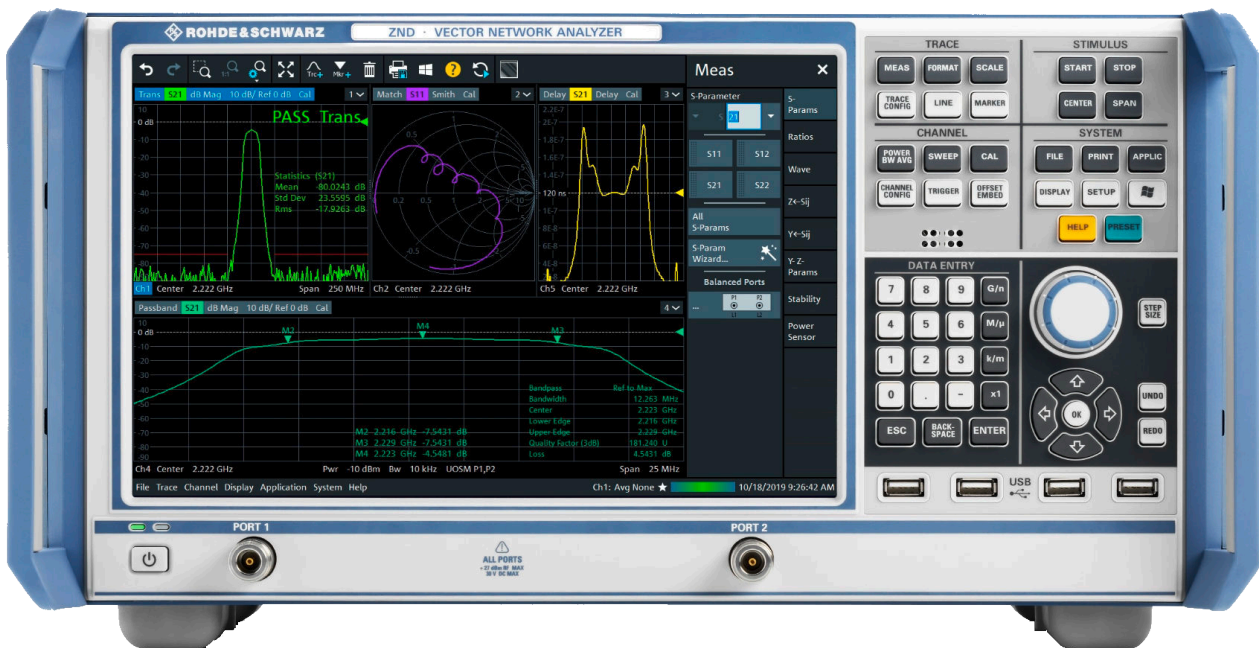

Figure 4-1: Front View of R&S ZND

4.1.1 Touchscreen

The analyzer is equipped with a 12.1" XGA color touchscreen. The touchscreen presents all measurement results, mostly in the form of diagrams. Besides, all instrument functions can be accessed and operated by tapping the control elements on the touchscreen. For an introduction to touchscreen operation, refer to [Chapter 5.1, "Manual operation"](#), on page 31.

The following sections contain further useful information about manual control of the instrument.

- Refer to the other sections in chapter [Chapter 5, "Operating the instrument"](#), on page 31 to learn how to handle traces and diagrams, and how to use menus, keys and softtools.
- Refer to chapter "Concepts and Features" in the user manual or help system to obtain information about the results in the diagram.
- Refer to section "Display Menu" in the user manual or help system to learn how to customize the screen.
- Refer to the data sheet for the technical specifications of the display.



Screen saver

The screen saver function of the operating system can be used to switch off the display if the analyzer receives no command for a selectable period of time. The display is switched on again if any front panel key is pressed.

To enable the screen saver, access the Windows® operating system (e.g. by pressing the Windows key in the SYSTEM keypad) and tap "Control Panel > Power Options > Change Plan Settings > Turn off the display".

(Windows 7: "Control Panel > Hardware and Sound > Power Options > Edit Plan Settings > Turn off the display").

4.1.2 Function keys

Most of the keys in the TRACE, CHANNEL, STIMULUS, and SYSTEM keypads call up a related softtool of the analyzer GUI. Every softtool provides access to a group of related measurement settings.



The TRACE keys give access to all trace settings, to the limit check settings, and to the marker functions including marker search.

- The [MEAS] settings select the measured and displayed quantity.
- The [FORMAT] settings define how measured data (traces) are presented.
- The [SCALE] settings define how traces are scaled.
- The [TRACE CONFIG] settings store traces to the memory and perform mathematical operations on traces.
- The [LINES] settings define limits for the measurement results, visualize them in the diagrams and activate/deactivate the limit check.
- The [MARKER] settings position markers on a trace, configure their properties and select the format of the numerical readout. Markers can also be used to locate specific points on the trace, define the sweep range, and scale the diagram.



The CHANNEL keys give access to the hardware-related (channel) settings.

- The [POWER BW AVG] settings define the power of the internal signal source, the IF bandwidth, and the sweep average.
- The [SWEEP] settings define the scope of measurement, including the sweep type and the number of measured sweeps.

- [CAL] provides all functions that are necessary to perform a system error correction (calibration).
- [CHANNEL CONFIG] provides functions for channel management.
- The [TRIGGER] settings control the start of the measurement sequence.
- [OFFSET EMBED] provides a selection of length offset parameters to shift the measurement plane.



The STIMULUS keys ([START], [STOP], [CENTER], [SPAN]) define the sweep range, depending on the sweep type.



The SYSTEM keys provide general system settings.

- [FILE] provides standard Windows® functions used to create, save, recall or print recall sets, to copy the active screen and to shut down the application.
- The [PRINT] settings control an external printer that is used to print a hardcopy of the current recall set.
- [APPLIC] gives access to external software tools and optional extensions of the analyzer firmware.
- [DISPLAY] gives access to all display settings and to the functions which activate, modify and arrange different diagrams.
- [SETUP] provides general system settings which are not restricted to a particular recall set.
- The Windows® key opens the startup menu of the Windows® operating system from where you can perform system configurations and call up additional software utilities.
- [HELP] opens the context-sensitive help system of the analyzer.
- [PRESET] performs a preset of the instrument settings.

4.1.3 Data entry keys

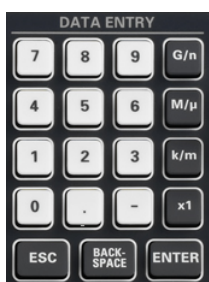

The keys in the DATA ENTRY keypad are used to enter numbers, units, and characters. The data entry keys are only enabled while the cursor is placed on a data input field in a dialog or in the Help navigation pane.

- The keys 0 to 9 enter the corresponding numbers.
- The function of the "." and "-" keys depends on the data type of the active input field:
 - In numeric input fields, the keys enter the decimal point and a negative sign for the entered numeric value. Multiple entries have no effect.
 - In character input fields, the keys enter a dot and a hyphen, respectively. Both entries can be repeated as often as desired.
- The function of the four unit keys depends on the data type of the active input field; see [Chapter 5.5, "Entering data"](#), on page 47.
 - In numeric input fields, the G/n, M/μ, k/m or x1 keys multiply the entered value with factors of $10^{(-)9}$, $10^{(-)6}$, $10^{(-)3}$ or 1 and add the appropriate physical unit. x1 is equivalent to ENTER and confirms the previous entry.

- In character input fields, the G/n, M/ μ , k/m keys enter the letters G, M, K, respectively. x1 is equivalent to ENTER and confirms the previous entry.
- ESC is used to:
 - Cancel entries / close dialogs without activating the entries made (equivalent to the "Close" button).
 - Close the Help system.
- ENTER is used to:
 - Activate the selected active control element, e.g. a button in a dialog or a link in the "Contents" page of the Help system.
 - Confirm selections and entries made and close dialogs (equivalent to the "OK" button).
 - Compress or expand menus or the Help table of contents
- BACKSPACE deletes the last character before the cursor position or the selected character sequence or numeric value.

4.1.4 Rotary knob



The rotary knob increases and decreases numerical values, scrolls within lists, activates controls and confirms entries. Turning or pressing the rotary knob is equivalent to the action of the "Cursor Up" and "Cursor Down" navigation keys or of the ENTER key in the DATA ENTRY keypad, respectively.

STEP SIZE opens an input box to select the steps (in units of the current physical parameter) between two consecutive numerical values. The step size is also valid for value changes using the "Cursor Up" and "Cursor Down" keys. See also [Chapter 5.5.2, "Using the numeric editor"](#), on page 48.

4.1.5 Navigation keys

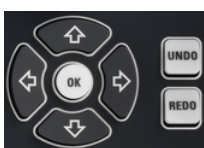

The keys in the NAVIGATION keypad are used to navigate within the touchscreen and the help system, to access and control active elements.

The "Cursor Up" and "Cursor Down" keys are used to:

- Scroll up and down in lists, e.g. among menu items, in a list of keywords, in the Help table of contents, or in the Help index
- Navigate between table rows in diagrams. Press "OK" to toggle between navigation mode and data entries.
- Increase and decrease numerical input values

"Cursor Up" (Down) become inactive as soon as the beginning of the list is reached. "Cursor Up" (Down) is equivalent to a rotation of the rotary knob to the right (left).

The "Cursor Left" and "Cursor Right" keys are used to:

- Move the cursor to the left or right within input fields
- Navigate between table columns in diagrams. Press "OK" to toggle between navigation mode and data entries.

- Compress or expand menus or the Help table of contents
- Move the highlighted item in the menu bar of the active application

ENT OK is equivalent to the action of the ENTER key in the DATA ENTRY keypad.

UNDO reverses the last action, if possible. REDO reverses the action of the UNDO button.

4.1.6 Standby key



The standby toggle switch is located in the bottom-left corner of the front panel.

The key serves two main purposes:

- Toggle between standby and ready state; see [Chapter 3.8, "Standby and ready state"](#), on page 18.
- Shut down the instrument; see [Chapter 3.7, "Switching the instrument on and off"](#), on page 17.

4.1.7 Front panel connectors

The test ports and four USB connectors are located on the front panel of the analyzer.

4.1.7.1 Test ports



Numbered type N female connectors.

The test ports serve as outputs for the RF stimulus signal and as inputs for the measured RF signals from the DUT (response signals).

- With a single test port, it is possible to generate a stimulus signal and measure the response signal in reflection. For a measurement example, refer to [Chapter 6.2, "Reflection S-parameter measurement"](#), on page 63.
- With 2 test ports, full two-port measurements are possible; see [Chapter 6.1, "Transmission S-parameter measurement"](#), on page 56.

However, to use port 2 of a R&S ZND as driving port, you need one of the "bidirectional measurements" options:

- R&S ZND-K5, for a R&S ZND without "extended frequency range" option
R&S ZND-K1
- R&S ZND-K6, for a R&S ZND with "extended frequency range" option
R&S ZND-K1



- Use a torque wrench when screwing RF cables on the test port connectors.
- See also [Chapter 3.5, "Considerations for test setup"](#), on page 16.

4.1.7.2 USB connectors

Four USB 2.0 connectors of type A (master USB).



The USB ports can be used to connect:

- External PC accessories such as mouse or other pointing devices, a keyboard, printer or external storage device (USB stick, CD-ROM drive etc.).
- External measurement equipment such as a calibration unit, power meter or switch matrix.

4.2 Rear panel

This section gives an overview of the rear panel controls and connectors of the network analyzer.



Figure 4-2: Rear Panel R&S ZND

The following connectors are available on all instruments:

- LAN is an RJ-45 connector. Use this connector to integrate the instrument to a Local Area Network, primarily for remote control purposes; see [Chapter 7.2.1, "Assigning an IP address"](#), on page 66.
- Connector DVI can be used to connect an external monitor; see [Chapter 3.11.1, "Connecting a monitor"](#), on page 21.
- USER PORT is a 25-pin D-Sub connector used as an input and output for low-voltage (3.3 V) TTL control signals.
- EXT TRIG IN and EXT TRIG OUT are two BNC connectors for 5 V TTL external trigger signals.
- REF OUT is a BNC output for the internal reference frequency of the R&S ZND. Use this connector to synchronize other instruments to the analyzer.

- REF IN is a BNC input for an external reference frequency. Use this connector to synchronize the R&S ZND to another device.
- SYSTEM DRIVE contains the removable system drive of the R&S ZND, containing all software (including the operating system and the VNA application) and data. Do not remove the system drive during operation. Option R&S ZND-B19 provides an additional removable system drive (including operating system and firmware).
- The ground connector in the lower left corner of the rear panel provides the ground of the analyzer's supply voltage. Use this connector for ESD protection; see "[Preventing electrostatic discharge \(ESD\)](#)" on page 16.

The following optional connectors can be installed in addition:

- Option R&S ZND-B10 provides a GPIB bus connector according to standard IEEE 488 / IEC 625.
- Option R&S ZN-B14, Handler I/O (Universal Interface), provides a Centronics 36 input/output connector.

Match signals with 50 Ω to comply with EMC directives. See also [Chapter 3.5, "Considerations for test setup"](#), on page 16.

5 Operating the instrument

The following sections describe the basics of manual operation, i.e. how to access instrument functions and settings via the analyzer GUI. Manual operation is particularly useful for getting to know the instrument and for trouble shooting.

Manual and remote control of the instrument

Manual control of the R&S ZND is possible either via its touchscreen and frontpanel keys, via locally connected keyboard and mouse (see [Chapter 3.11, "Connecting external accessories"](#), on page 21), or via Remote Desktop (see also [Chapter 7.2, "Remote operation in a LAN"](#), on page 66). Alternatively it can be remote-controlled via the GPIB interface or a LAN connection.

To their full extent, manual operation and remote control are described in the GUI Reference and Command Reference chapters of the user manual, respectively. GUI functions and related remote commands are linked bidirectionally. Background information is provided in the Concepts and Features chapter of the user manual.

5.1 Manual operation

The analyzer functions are accessible via several tabbed softtools, each presenting related functions and settings. The keys on the front panel or the on-screen "Hard Key Panel" open the most frequently used softtools.

Manual operation via function keys and softtools provides touch-friendly access to the instrument functions and settings, avoiding complicated menu structures and long operating sequences. In general, this approach is recommended. However, sometimes the toolbar or an object's context menu can offer a shortcut. As a full-fledged alternative for manual operation via mouse and keyboard, also the menu bar provides access to all instrument functions and settings.



Figure 5-1: Function Keys



Customizing the screen

The contents of the screen and the size and position of many display and control elements are not fixed. You can display or hide most elements. You can also drag and drop traces, info fields, and even the softtool panel to your preferred position; see [Chapter 5.4.4, "Using drag and drop"](#), on page 46.

For example, you can show/hide the on-screen hardkey panel by selecting/deselecting "Display" > "View Bar" > "Hard Key Panel On" from the main menu.

The following table shows possible touchscreen operations with the corresponding mouse operations.

Touchscreen	Mouse	Typical task
Tap control element for a short time	Click control element (left mouse button)	Select button or tab
Tap for an extended time (tap and hold)	Click (right button)	Open context menu
Tap twice (double-tap)	Double-click (left button)	Open on-screen keyboard

Using the Front Panel

To access an instrument function:

1. Press a (virtual) key, e.g. the [MEAS] key in the TRACE section.
The corresponding softtool expands at the current docking position.



left = unidirectional R&S ZND
right = bidirectional R&S ZND

2. Activate the desired softtool tab, e.g. "Z←Sij".

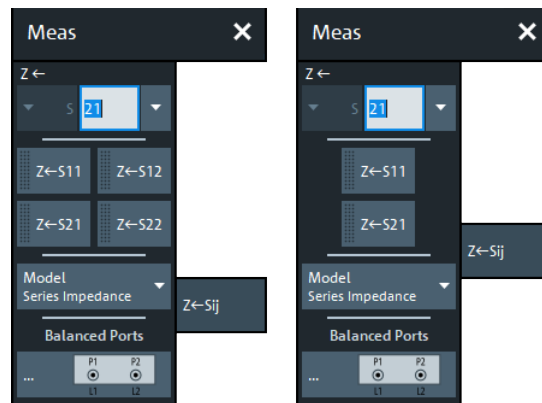

left = unidirectional R&S ZND
right = bidirectional R&S ZND

3. Select a control element, e.g. "Z←S11".

The diagram immediately reflects your selection. The active trace shows the measurement results for the selected measured quantity.

A control element with three dots (e.g. SYSTEM – [SETUP] > "Setup" > "System Config...") opens a dialog, containing a group of related settings, a wizard or additional information.

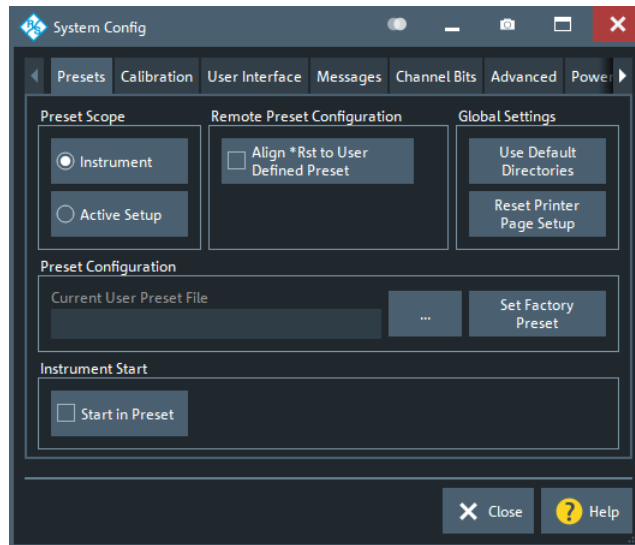

Using the menu bar

The menu bar at the bottom of the application screen provides alternative access to **all** instrument functions. To repeat the measured quantity selection described above,

- ▶ Select TRACE – [MEAS] > "Z←Sij" > "Z←S11".

The diagram immediately reflects your selection. The active trace shows the measurement results for the selected measured quantity. At the same time, the related softtool tab is opened.

Using context menus

Context menus are another alternative for quick access to instrument settings.

1. Touch and hold (right-click) the measured quantity section in the trace info for a couple of seconds until the context menu appears.

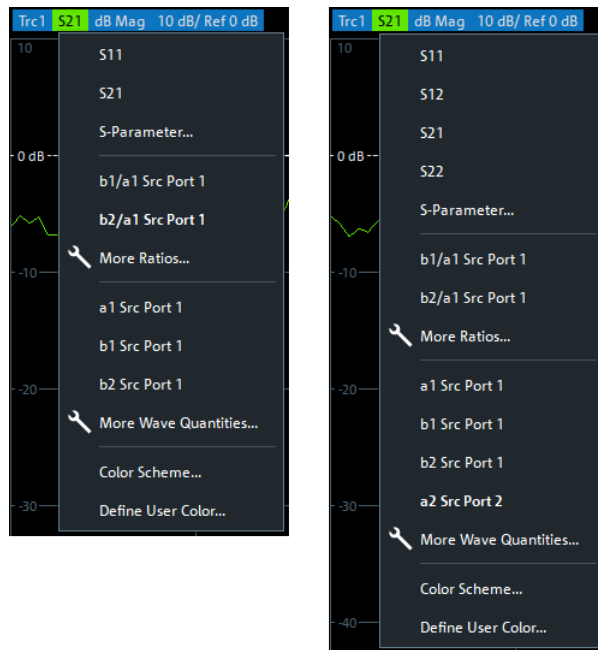

left = unidirectional R&S ZND
 right = bidirectional R&S ZND

2. Select "S-Parameter" to open the "Meas" > "S-Params" softtool tab.

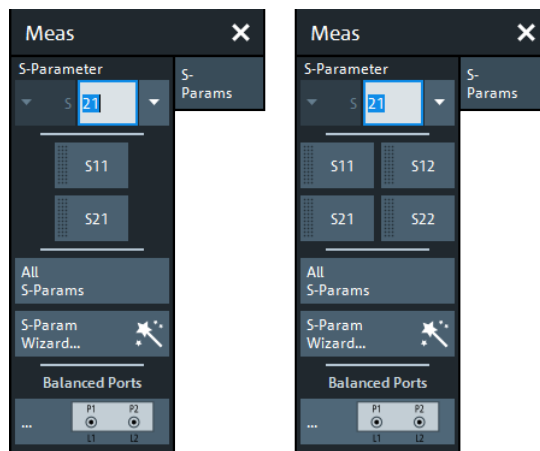

left = unidirectional R&S ZND
 right = bidirectional R&S ZND

3. Select "Z←Sij" > "Z←S11".

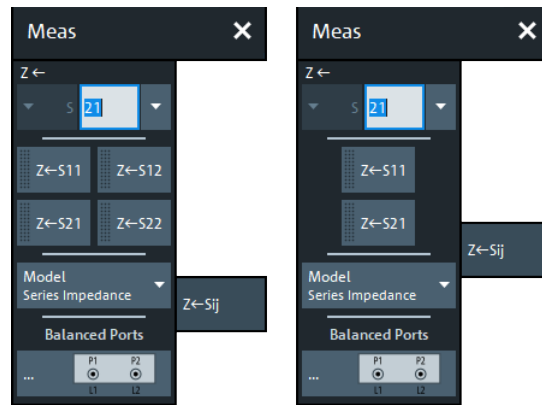

left = unidirectional R&S ZND
 right = bidirectional R&S ZND

5.2 Control elements of the application window

The application window of the analyzer provides all control elements for the measurements and contains the diagrams for the results. There are several alternative ways for accessing an instrument function:

- Using a function key on the (virtual) hardkey panel to open the related softtool (recommended, provides all settings)
- Using the menus and submenus of the menu bar (alternative to the previous method)
- Using the context menus of certain display objects (for important actions in the context of this object)
- Using the icons in the toolbar above the diagram area (for frequent global actions)

Control elements of the application window

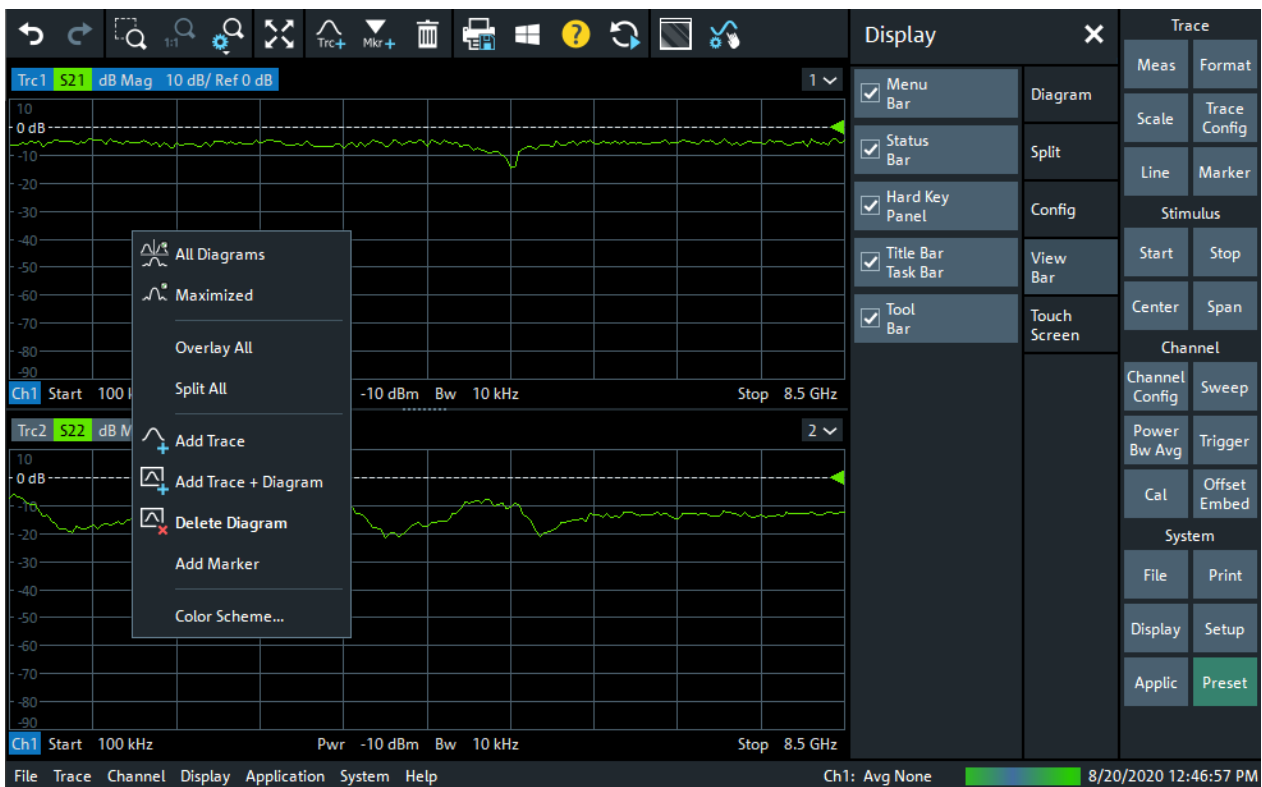

These methods are described in more detail in the following sections.

5.2.1 Title bar

By default, the analyzer GUI is shown in full screen mode, covering the whole screen and hiding the Windows taskbar. However, you can toggle the full screen mode using **SYSTEM – [DISPLAY] > "View Bar" > "Title and Task Bar On"**.

If full screen mode is switched off, the main application window of the vector network analyzer application provides a standard Windows® title bar.

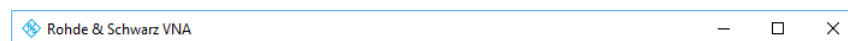





5.2.2 Toolbar

The toolbar above the diagram area contains the most frequently used control elements of the user interface. All controls are also accessible via [Softtools](#).

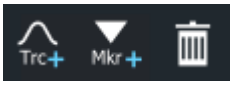

The toolbar is divided into several icon groups, separated by vertical lines.

Control elements of the application window

	<p>These icons represent the undo and redo actions that are also available via the menu bar items "System" > "Undo" / "Redo".</p> <p>Undo reverses the last action, redo reverses the last undo action (if possible).</p>
	<p>These icons control the zoom function (TRACE – [SCALE] > "Zoom").</p>
	<p>If multiple diagrams are configured, this icon toggles the "Maximize Diagram" action for the active diagram (SYSTEM – [DISPLAY] > "Diagram" > "Maximize Diagram").</p>
	<p>These icons implement the following actions, from left to right:</p> <ul style="list-style-type: none"> • Add a clone of the active trace to the active diagram (single tap; same as TRACE – [TRACE CONFIG] > "Traces" > "Add Trace") or to an arbitrary/new one (drag & drop the "Trc+" icon to the diagram area). • Add a new marker to the active diagram (single tap; similar to TRACE – [MARKER] > "Markers" > "Mkr<i>+</i>") or to an arbitrary one (drag & drop the "Mkr+" icon). • Delete the active trace (single tap the trash icon), or an arbitrary trace (drag & drop its trace info field to the trash icon). Or delete all markers of a trace (drag & drop the marker info field to the trash icon).
	<p>These icons provide the following actions, from left to right:</p> <ul style="list-style-type: none"> • Print the current diagrams to a bitmap file (same as SYSTEM – [FILE] > "Print" > "To File..."). <p>By default, all diagrams are printed, no matter if displayed or not. However you can also choose to print only the active diagram (see SYSTEM – [FILE] > "Print" > "Print...").</p> <ul style="list-style-type: none"> • Open the Windows® Start menu. • Open the context-sensitive help. • Restart the sweep in all channels (same as CHANNEL – [SWEEP] > "Sweep Control" > "Restart Sweep")
	<p>These icons provide the following actions, from left to right:</p> <ul style="list-style-type: none"> • Toggle advanced diagram area editing, which makes rearranging and/or deleting diagrams a breeze. • Toggle other measurements (except the active trace) OFF ON



You can hide the toolbar using SYSTEM – [DISPLAY] > "View Bar".

5.2.3 Softtools

Softtools display groups of related settings as a tabbed panel. They can be opened via function keys on the front panel or the on-screen "Hard Key" panel, or via menu bar and context menu items.

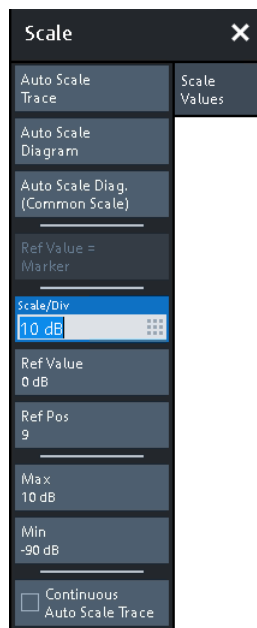

Figure 5-2: Scale softtool

A softtool consists of a title area with a close/re-open icon and a tabbed panel below it. The title area remains displayed when the softtool is closed, which allows you to reopen a closed softtool at any time.

Some controls on the softtool tabs allow you to read and modify settings (e.g. "Ref Value" in the screenshot above), some perform actions (e.g. "Auto Scale Trace"), while others open additional dialogs (button label ends with "...").

5.2.4 Menu bar

You can also access the analyzer functions via textual menus. The menu bar is located below the diagram area:

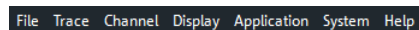

As in any Windows® application, menus can be controlled with the touchscreen or a mouse. A short tap (left mouse click) expands a menu or submenu. If a menu command has no submenu assigned, a short tap (left mouse click) opens a dialog or directly activates the menu command. When a (sub)menu is selected, the R&S ZND displays the corresponding softtool.

Overview of menu functions

- The "File" menu provides functions to handle recall sets and trace files, to print or save diagram content, and to shut down the VNA application.
- The "Trace" menu provides all trace settings, the limit check settings, and the marker functions including marker search.
- The "Channel" menu provides all channel settings and activates, modifies or stores different channels.

- The "Display" menu provides all display settings and the functions for activating, modifying and arranging different diagrams.
- The "Application" menu gives access to applications and tools that extend the functionality of the analyzer firmware.
- The "System" menu provides functions that can be used to return to a defined instrument state, reverse operations, access service functions and define various system-related settings.
- The "Help" menu provides assistance with the network analyzer and its operation.



You can toggle the visibility of the menu bar using SYSTEM – [DISPLAY] > "View Bar" > "Menu Bar".

5.2.5 Menu structure

All menus show an analogous structure.

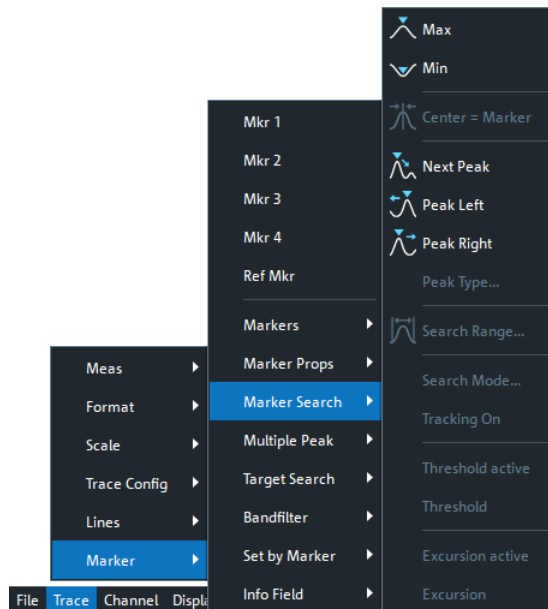

- A menu command with a right arrow expands a submenu with further related settings.
Example: "Marker" expands a submenu with marker-related properties.
- A menu command with three dots appended calls up a dialog providing several related settings.
Example: "Search Range" opens a dialog to define the search range for the marker search.
- A menu command with no arrow or dots initiates an immediate action.
Example: "Max" sets the active marker to the maximum of the active trace.

5.2.6 Hardkey panel

The (virtual) "Hard Key" panel provides on-screen access to the function keys (plus the [UNDO] and [REDO] key) of the R&S ZND. Most of the function keys open a related softtool. For a short description, refer to section [Chapter 4.1.2, "Function keys"](#), on page 25.

Trace	
Meas	Format
Scale	Trace Config
Line	Marker
Stimulus	
Start	Stop
Center	Span
Channel	
Channel Config	Sweep
Power Bw Avg	Trigger
Cal	Offset Embed
System	
File	Print
Display	Setup
Applic	Preset



The "Hard Key" panel is particularly useful if the analyzer is controlled from an external monitor or Remote Desktop.

For the R&S ZND, it is hidden by default.

You can display the "Hard Key" panel using one of the following methods:

- Select SYSTEM – [DISPLAY] > "View Bar" > "Hard Key Panel".
- Select "Display"> "View Bar" > "Hard Key Panel On" from the menu bar.
- Select "Hard Key" from the context menu of the softtool panel.

5.2.7 Status bar

The status bar shows

- the active channel
- the current channel's sweep averaging counter (e.g. "Ch<i>: Avg 9/10"), or "Ch<i>: Avg None" if averaging is disabled
- the progress of the sweep
The progress bar also shows when the R&S ZND prepares a sweep with new channel settings
- the "EXT REF" symbol, if an external reference clock is used for synchronization

- the switch matrix status symbol, if a switch matrix is configured (See the R&S ZND User Manual)
- the current date and time

Ch1: Avg None   1/3/2018 6:33:23 PM

Figure 5-3: R&S ZND with switch matrix



The progress bar shows a moving color gradient if the current sweep is too fast to be monitored, e.g. because the number of sweep points is low. You can hide/show the status bar using SYSTEM – [DISPLAY] > "View Bar" > "Status Bar".

5.3 Working with dialogs

Dialogs provide groups of related settings and allow to make selections and enter data in an organized way. The settings are visualized, if possible. An example is shown below.

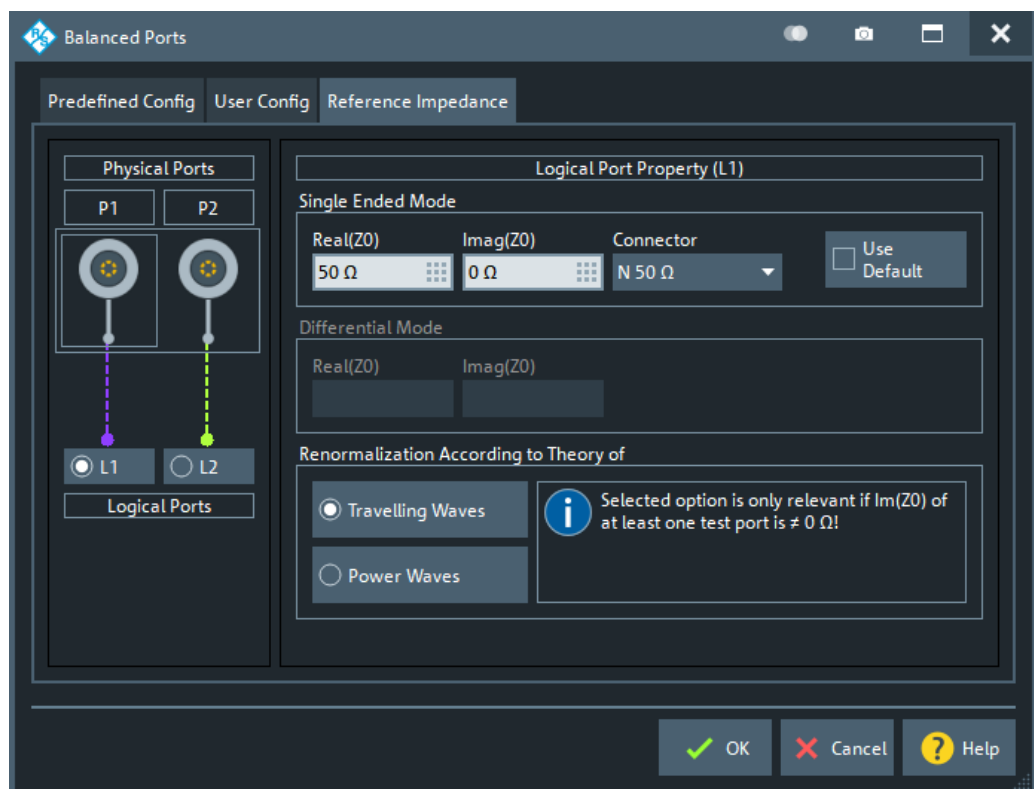

All dialogs are operated in a similar way.

- To open a dialog, select a softtool button with three dots appearing in its label (e.g. "Start... (Manual)").
- The title bar of each dialog contains some convenience functions:

- Use the "Dialog Transparency" function to make the display elements behind the dialog visible.

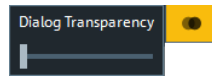

Note: The "Dialog Transparency" is a global setting, i.e. it applies to all dialogs.

- Use the  icon to create a screenshot of the dialog.
- Drag and drop the lower right corner of the dialog to modify its size.
- Some dialogs are subdivided into tabs, containing groups of related settings. Activate a tab to access those settings.



The Help system provides useful information about each dialog's specific settings. Select "Help" to open the Help.

5.4 Handling diagrams, traces, and markers

The analyzer displays measurement results as traces in rectangular diagrams. Markers are used to read specific numerical values and to search for points or regions on a trace. The following section presents some of the graphical tools the R&S ZND provides for trace and marker handling.



For further reference

Refer to chapter "Concepts and Features" in the R&S ZND Help or in the User Manual to learn more about traces, channels, and screen elements.

5.4.1 Adding new traces and diagrams

A new trace is required if you want to measure and display an additional quantity.

Typical scenario: The transmission coefficient S_{21} is measured as described in [Chapter 6.1, "Transmission S-parameter measurement"](#), on page 56. A trace is added to display the reflection coefficient S_{11} for comparison.



To create a trace:

1. Drag the "Trc+" icon from the toolbar into a diagram.

The diagram changes its color scheme and contents as shown below.

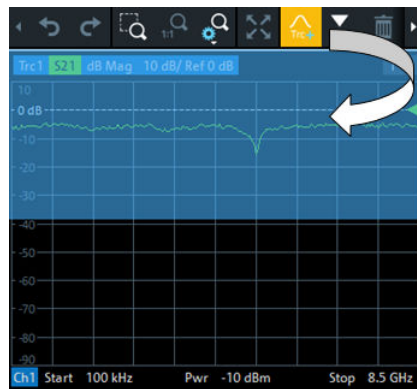

2. Select the adequate drop position, depending on whether you want to display the new trace in the existing diagram, or whether you want to add a new diagram. The highlighted area indicates the target diagram.

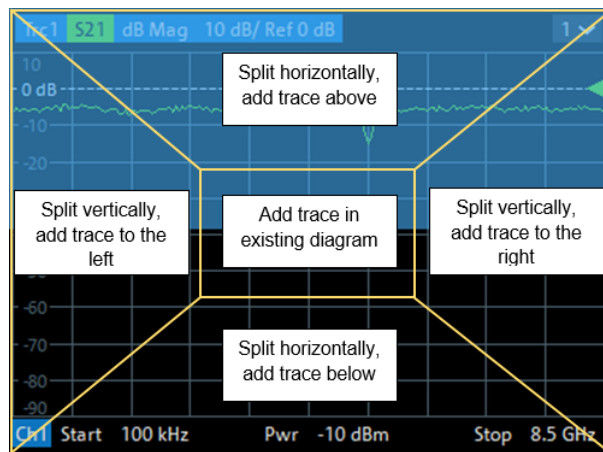

3. In the dialog box that is opened when you release the "New Trace" icon, select the S-parameter to be measured.

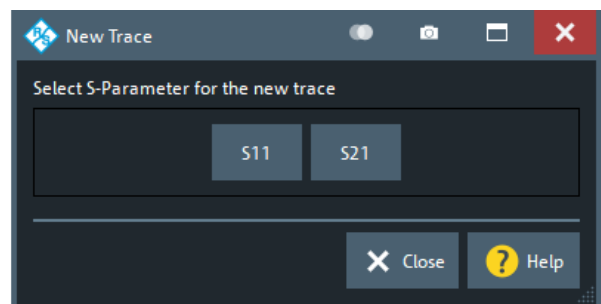
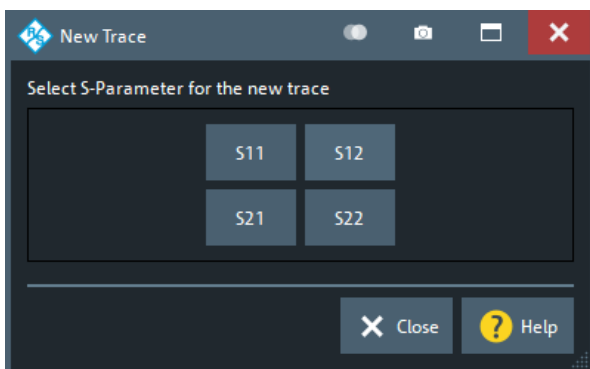

left = bidirectional R&S ZND
 right = unidirectional R&S ZND

The R&S ZND generates a new trace for the selected S-parameter.



Alternative control elements

To measure a different quantity, select TRACE – [MEAS]. Drag and drop a softkey representing a measured quantity to create a trace. Or simply select another softkey to change the measured quantity of the active trace.

Select TRACE – [TRACE CONFIG] to access more trace handling functions. Select SYSTEM – [DISPLAY] to access more diagram handling functions.

5.4.2 Adding new markers

A marker is needed, for instance, to read a particular numerical trace value.



To add a new marker:

- Drag and drop the "New Marker" icon from the toolbar to the desired position in the target diagram.

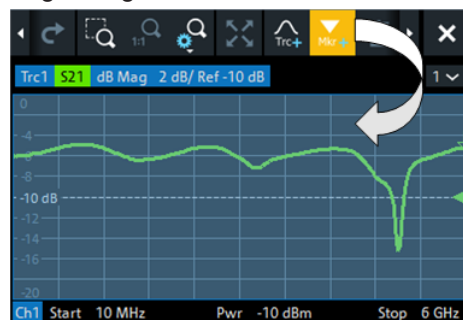

The marker appears on the target diagram's active trace. The marker info field displays the stimulus value (x-axis value) and response value (y-axis value) at the marker position. The response value varies as the analyzer continues performing sweeps.

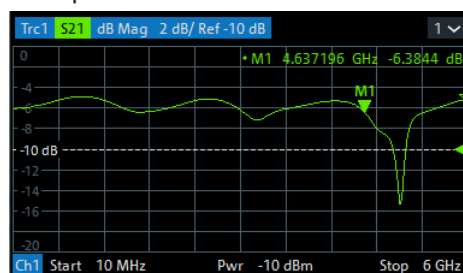

Active trace, alternative control elements

The trace line of the active trace in the upper part of the diagram is highlighted. If the diagram contains several traces, first activate the target trace, then add the marker.

The TRACE – [MARKER] softtool provides more functions for marker handling. In particular, any marker offered in the "Markers" tab can be positioned on the active trace using drag & drop.

5.4.3 Deleting display elements



Markers, traces, diagrams, and other display elements are most conveniently deleted using the "Delete" icon in the toolbar above the diagram area.

- To delete a single marker, drag it into vertical direction to release it from the trace and drop it onto the "Delete" icon.
To delete a set of markers, drag and drop their marker info field onto the "Delete" icon.
Deleting a marker and its info field also disables the associated marker function.
- To delete a trace, drag and drop its trace line onto the "Delete" icon. The active trace can also be deleted by tapping/clicking the "Delete" icon.
Note however, that the last remaining trace cannot be deleted.
- To delete a diagram, drag and drop its diagram number label onto the "Delete" icon.
Note however, that the last remaining diagram cannot be deleted.
- To delete a channel, drag and drop all associated traces onto the "Delete" icon.
Note however, that the last remaining channel cannot be deleted.
- To hide the limit lines and disable the limit check, drag and drop the PASS / FAIL message onto the "Delete" icon. The limit line itself is not deleted; you can re-use it any time.

The context menu of some display elements also provides the "Delete" function.



Undo function

If you happen to delete a display element unintentionally, you can restore it using the "Undo" toolbar icon.

5.4.4 Using drag and drop

You can drag and drop many of the R&S ZND's control and display elements to change their size and position. The drag and drop functionality is often more convenient to use than the equivalent buttons of the softtool panels. The following table gives an overview.

Table 5-1: Drag and drop functionality for various screen elements

Screen element	Action	Drag and drop...
Diagram	Create	See Chapter 5.4.1, "Adding new traces and diagrams" , on page 43
	Resize	Separator between adjacent diagrams
	Delete	See Chapter 5.4.3, "Deleting display elements" , on page 46
Trace	Create	See Chapter 5.4.1, "Adding new traces and diagrams" , on page 43
	Move vertically	Reference line marker (right diagram edge)
	Move into other or new diagram	Trace line
	Delete	See Chapter 5.4.3, "Deleting display elements" , on page 46

Screen element	Action	Drag and drop...
	Reset / suspend graphic zoom	"Zoom" element in additional trace line --> "Delete" icon; see Chapter 5.6.1, "Using the graphical zoom" , on page 50
Marker	Create	See Chapter 5.4.2, "Adding new markers" , on page 45
	Move horizontally	Marker symbol
	Delete	Marker or marker info field --> "Delete" icon; see Chapter 5.4.3, "Deleting display elements" , on page 46
Marker info field	Add	See Chapter 5.4.2, "Adding new markers" , on page 45
	Move within diagram	Marker info field (move to one of several pre-defined positions)
	Delete	See Chapter 5.4.3, "Deleting display elements" , on page 46

5.5 Entering data

The analyzer provides dialogs with various types of input fields where you can enter numeric values and character data. Data entry with a mouse and an external keyboard is a standard procedure known from other Windows® applications. However, there are various other ways to enter data.

5.5.1 Using front panel keys

You can use the keys in the DATA ENTRY keypad to enter numbers, units, and characters.



To enter a numeric value:

1. Select a numeric data input field to activate it.
2. Press the data entry keys.
 - Use [0] to [9] to enter the corresponding numbers.

- Use [.] to enter a decimal point.
- Use [-] to change the sign of the value.
- Use [G/n], [M/μ], [k/m], or [x1] to multiply the entered value with factors of $10^{(-9)}$, $10^{(-6)}$, $10^{(-3)}$ or 1 and to add the appropriate physical unit.

To enter a character string:

1. Tap a character data input field to activate it.
2. Press the DATA ENTRY keys as if you were writing a short message on your mobile phone.
 - Use [0] to [9] to enter the corresponding numbers.
 - Use [.] and [-] to enter a dot or hyphen.
 - Use Use [G/n], [M/μ], or [k/m] to enter the letters G, M or K (case-insensitive).
 - Use the [←] key to correct wrong entries, deleting the character to the left of the current cursor position.
 - Press [ENTER] to complete an entry.
 - Press [ESC] to discard the entries made.
3. To enter letters other than G, M or K, you can also use one of the methods described in the following sections:
 - [Chapter 5.5.3, "Using the analyzer's on-screen keyboard"](#), on page 49
 - [Chapter 5.5.4, "Using the Windows® on-screen keyboard"](#), on page 49

5.5.2 Using the numeric editor

The "Numeric Editor" is a tool for convenient entry and modification of numeric values. It is available for all numeric input fields in the analyzer GUI.

Operation with touchscreen or mouse:

1. Double-tap (double-click) a numeric input field in a dialog or on a softtool to open the numeric editor.

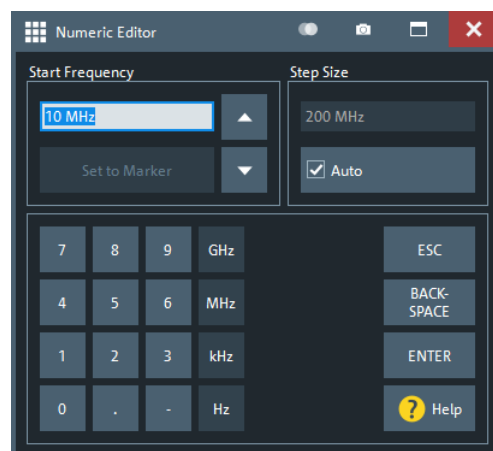

2. Use the buttons in the numeric keypad to compose the numeric input value.

3. If desired, select a "Step Size" and use the cursor up/down buttons to increment/decrement the current value. If a marker is active, you can also set the numeric value to the current marker value ("Set to Marker").
4. After completing the input string, select "ENTER" to apply your selection and close the numeric editor.



[STEP SIZE] key

If a numeric input field is active, the [STEP SIZE] front panel key opens a dialog box containing the "Step Size" panel of the numeric editor. Use this box for efficient operation of the rotary knob (and mouse wheel).

5.5.3 Using the analyzer's on-screen keyboard

The on-screen "Keyboard" allows you to enter characters, in particular letters, without an external keyboard. It is available for all text input fields in the analyzer GUI.

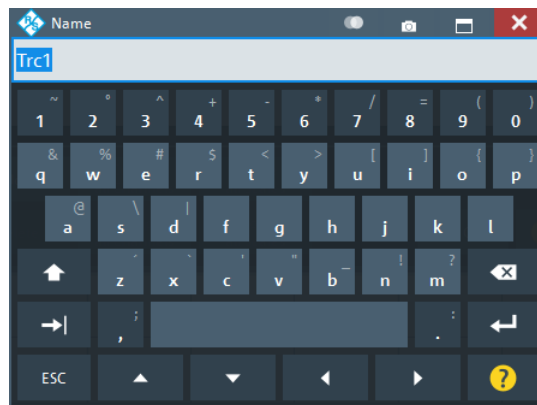

1. Activate a character data input field in a softtool or a dialog.
2. Double-tap/click the input field to open the on-screen keyboard.
3. Select character buttons to compose the input string.
4. Select "Enter" to apply your selection and close the keyboard.

5.5.4 Using the Windows® on-screen keyboard

The Windows® on-screen keyboard allows you to enter characters, in particular letters, even if an input field cannot call up the analyzer's own on-screen keyboard. Examples are input fields in standard Windows® dialogs.

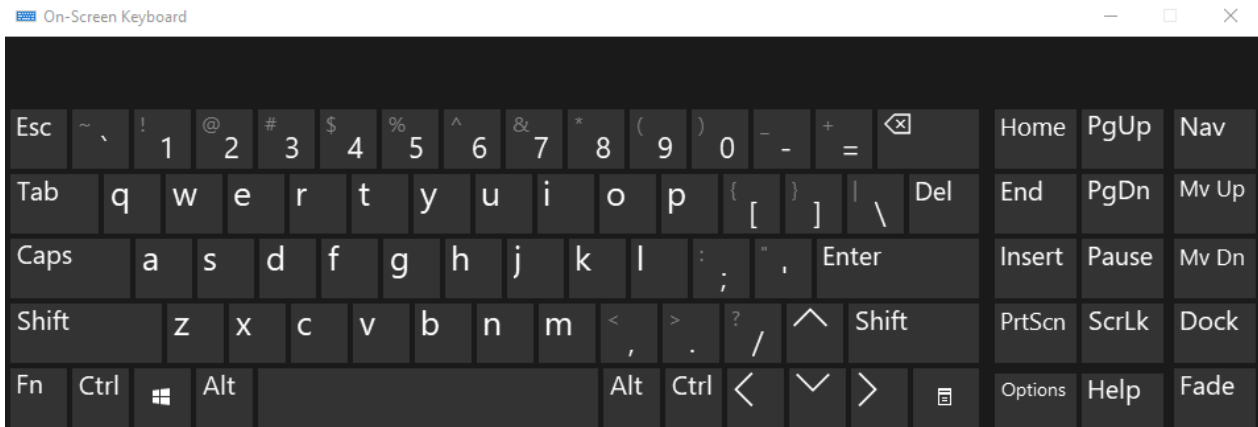

Figure 5-4: Windows 10 on-screen keyboard

To call up the on-screen keyboard:

1. Open the SYSTEM – [APPLIC] softtool.
2. In the "External Tools" tab, select "Screen Keyboard".

5.6 Scaling diagrams

The analyzer provides various tools for customizing the diagrams and for setting the sweep range. Choose the method that is most convenient for you.

5.6.1 Using the graphical zoom

The graphical zoom function magnifies a rectangular portion of the diagram (zoom window) to fill the entire diagram area. The sweep points are not affected.



The graphical zoom function is only supported for cartesian trace formats. For (inverted) Smith and polar diagrams, it is not available.



To activate the graphical zoom:

- Select the "Zoom Config" icon in the toolbar above the diagram area and make sure that the graphical zoom mode is active:

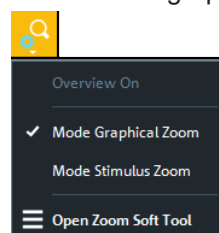

- Select the "Zoom Select" toggle button in the toolbar above the diagram area.



The icon changes its background color from black to blue.

- In the active diagram area, select an appropriate rectangular area.

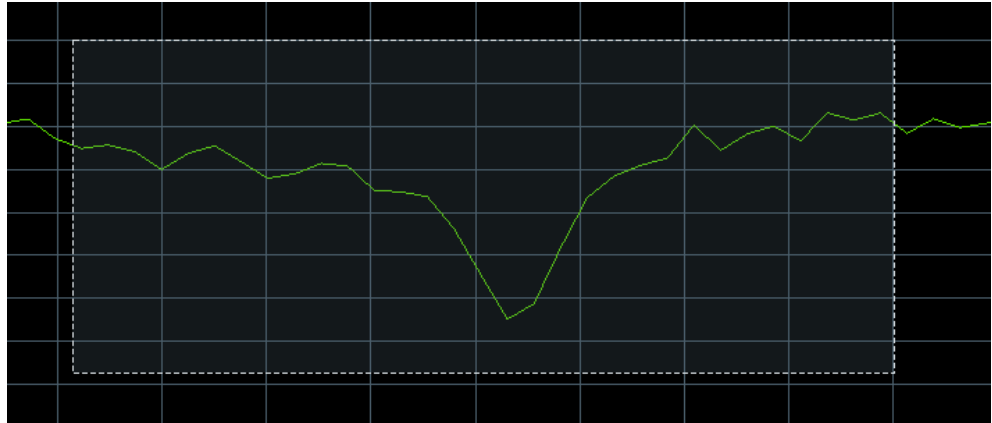

The zoomed view shows the selected rectangle, scaled in both horizontal and vertical direction. In general, the zoom window covers only a part of the sweep range; the horizontal distance between the sweep points increases. The reduced display range is indicated in an additional zoom line in the channel info area.

Ch1	Start	1 GHz	Pwr	-10 dBm	Stop	6 GHz
	Start	3.92 GHz	Zoom	Trc1	Stop	5.96 GHz



Use the "Zoom Reset" icon to restore the original diagram. Alternatively, you can drag and drop the "Zoom" label from the additional channel info line onto the  toolbar button.



Alternative settings

- The TRACE – [SCALE] > "Zoom" softtool tab allows you to define the displayed zoom range numerically. It can also be opened from the menu of the "Zoom Config" toolbar icon.
- If the active diagram is graphically zoomed, "Overview On" in the "Zoom" softtool tab toggles an overview. The upper part of the diagram then shows a small version of the unzoomed diagram. You can move the zoomed part of the trace by moving the rectangular area in the overview.

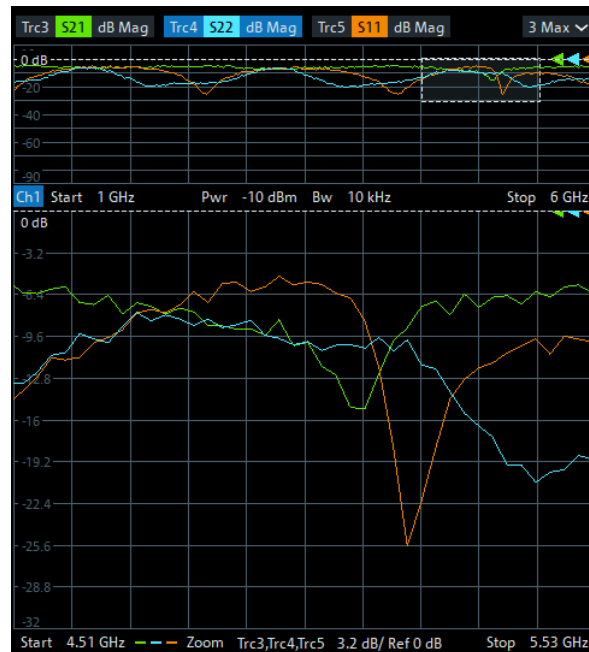

- To zoom the stimulus range (keeping the number of sweep points constant), use the "Zoom Config" toolbar icon and select "Mode Stimulus Zoom". Then use the "Zoom Select" icon to narrow the sweep range and adjust the vertical scaling.

5.6.2 Setting the sweep range

The sweep range for all related channels is displayed in the channel info area at the bottom of each diagram:

Ch1	Start	10 MHz	Pwr	-10 dBm	Bw	10 kHz	Stop	4 GHz
Ch2	Start	1 GHz	Pwr	-10 dBm	Bw	10 kHz	Stop	6 GHz
Ch3	Start	5 GHz	Pwr	-10 dBm	Bw	10 kHz	Stop	8.5 GHz
Trc4	Start	-1 ns		Time Domain			Stop	4 ns

To change the sweep range of the active channel, use one of the following methods:

- Use the [START], [STOP], [CENTER], and [SPAN] function keys from the STIMULUS section.
- Double-tap (with a mouse: double-click) the "Start" or "Stop" label in the channel list.

- Tap and hold (with a mouse: right-click) the "Start" or "Stop" label in the channel list and select "Start Frequency", "Stop Frequency", "Center Frequency", or "Frequency Span" from the context menu.
- Select "Start Frequency", "Stop Frequency", "Center Frequency", "Span Frequency" from the "Channel" > "Stimulus" menu.
- Use the "Set by Marker" functions (TRACE – [MARKER] > "Set by Marker"; see [Chapter 5.6.6, "Set by marker"](#), on page 54).

5.6.3 Reference value and position

The analyzer provides three parameters for changing the scale of the vertical (response) axis:

- Changing the "Ref Value" or "Ref Pos" shifts the trace in vertical direction and adjusts the labels of the vertical axis. "Ref Value" also works for radial diagrams.
- Changing the "Scale/Div" modifies the value of the vertical or radial diagram divisions and thus the entire range of response values displayed.

The "Scale/Div" and the "Ref Value" are indicated in the scale section of the trace info. In the example below, a "Scale/Div" of 10 dB and a "Ref Value" of 0 dB is used.

Trc1 521 dB Mag 10 dB/ Ref 0 dB Math

To change such a scale parameter, use one of the following methods:

- Open the TRACE – [SCALE] > "Scale Values" softtool tab and proceed from there.
- Tap and hold (with a mouse: right-click) the scale section in the trace info and select a setting from the context menu.
- Select a setting from the "Trace" > "Scale" menu.
- Use "Set by Marker" functions (TRACE – [MARKER] > "Set by Marker"; see [Chapter 5.6.6, "Set by marker"](#), on page 54).

5.6.4 Auto scale

The "Auto Scale" function adjusts the scale divisions and the reference value so that the entire trace fits into the diagram. To access "Auto Scale", use one of the following methods:

- Open the TRACE – [SCALE] > "Scale Values" softtool tab and select "Auto Scale Trace" or "Auto Scale Diagram".
- Tap and hold (with a mouse: right-click) the scale section in the trace info and select "Auto Scale Trace" from the context menu.
- Select "Auto Scale Trace" or "Auto Scale Diagram" from the "Trace" > "Scale" menu.

5.6.5 Circular diagrams

The radial scale of a circular diagram ("Polar", "Smith" or "Inverted Smith") can be changed with a single linear parameter, the "Ref Value". The reference value defines the radius of the outer circumference.

- Increasing the "Ref Value" scales down the polar diagram.
- Decreasing the "Ref Value" magnifies the polar diagram.

The "Ref Value" is indicated in the scale section of the trace info.

Trc1 S21 Polar 400 mU / Ref 2 U

To change the "Ref Value" setting, use one of the following methods:

- Locate it on the TRACE – [SCALE] > "Scale Values" softtool tab.
- Tap and hold (with a mouse: right-click) the scale section in the trace info and select the parameter from the context menu.
- Select the parameter from the "Trace" > "Scale" menu.
- Use the "Set by Marker" functions; see [Chapter 5.6.6, "Set by marker"](#), on page 54.

5.6.6 Set by marker

The "Set by Marker" functions are a convenient tool for scaling (in particular: magnifying) diagrams without entering explicit numeric values. You simply place a marker to a trace point and use the marker values to change the sweep range or move the trace relative to the vertical axis. The touchscreen or a mouse makes it easier to activate (touch/click) or move (drag and drop) markers.

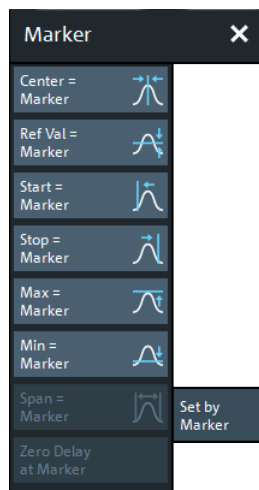

To set the sweep range using markers, use one of the following methods.

Set "Start" and "Stop" values in the diagram:

1. Create two normal markers, e.g. the markers "Mkr 1" (default label "M1") and "Mkr 2" (default label "M2").

See [Chapter 5.4.2, "Adding new markers"](#), on page 45.

2. Place "M1" to the start value of the desired sweep range and tap TRACE – [MARKER] > "Set by Marker" > "Start = Marker".
3. Place "M2" to the stop value of the desired sweep range and tap TRACE – [MARKER] > "Set by Marker" > "Stop = Marker".

Use a definite "Span:"

1. Create a marker.
2. Enable "Delta Mode" for this marker.
The analyzer automatically creates an additional reference marker.
3. Place the reference marker to the start value of the desired sweep range.
4. Set the value of the delta marker to the desired sweep range and tap TRACE – [MARKER] > "Set by Marker" > "Span = Marker".

To move the trace in vertical direction, proceed as follows:

1. Create a normal marker, e.g. the marker "Mkr 1" (default label "M1").
2. Place "M1" to a particular trace point, e.g. use the "Marker Search" functions to locate a maximum or minimum on the trace.
3. Select TRACE – [MARKER] > "Set by Marker" > "Max = Marker" to move the trace towards the upper diagram edge, leaving the values of the vertical divisions ("Scale/Div") and the overall vertical scale unchanged. Analogously, select "Min = Marker" to move the trace towards the lower diagram edge, or select "Ref Val = Marker" to move the trace towards the "Ref Value".



You can also use marker values in the "Numeric Editor"; see [Chapter 5.5.2, "Using the numeric editor"](#), on page 48.

5.6.7 Enlarging a diagram

The analyzer provides different tools for customizing the contents and size of the diagrams:

- Select  from the toolbar to maximize the active diagram. Or, equivalently, select SYSTEM – [DISPLAY] > "Diagram" > "Maximize Diagram".
If enabled the active diagram is always maximized.
- The "Menu Bar", the "Status Bar", the "Hard Key Panel", and the "Title Bar" can be hidden to gain space for the diagrams (SYSTEM – [DISPLAY] > "View Bar").
- The SYSTEM – [DISPLAY] > "Config" softtool tab defines optional display elements for the interior of the diagrams.

Use the context menu of the diagram, the SYSTEM – [DISPLAY] key or the "Display" menu to access the display settings.

6 Performing measurements

This chapter takes you through a sample session with a R&S ZND network analyzer and describes basic operation tasks.



Prerequisite

The instrument is set up, connected to the mains system, and started up as described in [Chapter 3, "Preparing for use"](#), on page 13.



Use the "S-Parameter Wizard" accessible via TRACE – [MEAS] > "S-Params" > "S-Param Wizard..." to measure S-parameters in a straightforward way. The wizard provides a series of dialogs where you can select the test setup, screen configuration and measurement parameters, configure the essential channel settings and perform a guided calibration.

Measurement stages in the wizard

The individual dialogs of the "S-Parameter Wizard" correspond to the typical stages of any measurement:

1. Select the test setup.
2. Define port impedances.
3. Select the measurement parameters and the diagrams.
4. Define the sweep range.
5. Adjust the receiver and source settings (measurement bandwidth, source power).
6. Perform a calibration.

6.1 Transmission S-parameter measurement

In a transmission measurement, the analyzer transmits a stimulus signal to the input port of the device under test (DUT) and measures the transmitted wave at the DUT's output port. The trace settings allow you to select the measured quantities and display formats, depending on what you want to learn from the data. A minimum of two analyzer test ports are required for transmission measurements.

In the following example, the analyzer is set up for a two-port transmission measurement. A frequency sweep range is selected, the instrument is calibrated and the measurement result is analyzed using various display formats.

6.1.1 Connecting the instrument for transmission measurements

To prepare a transmission measurement, you have to connect your DUT (which for simplicity we assume to have appropriate connectors) in-between a pair of analyzer

test ports. It is recommended that you preset the R&S ZND to start from a well-defined instrument state.

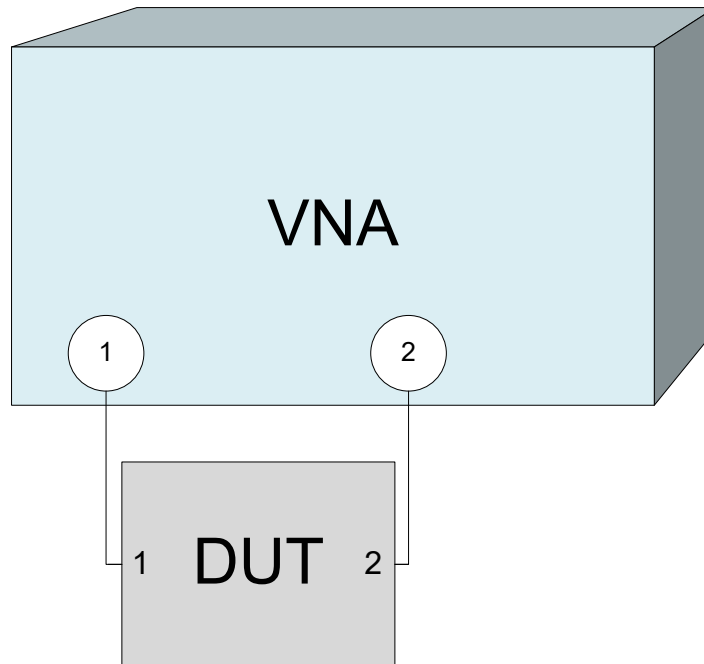

1. Connect the DUT between test ports 1 and 2 of the network analyzer as shown above.
2. Use the [PRESET] key to restore a well-defined instrument state.

The analyzer is now set to its default state. The default measured quantity is the transmission S-parameter S_{21} .

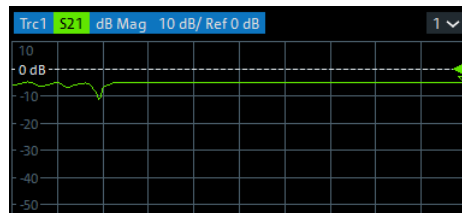

Select TRACE – [TRACE CONFIG] and use the control elements in the "Traces" soft-tool tab if you wish to create additional traces and diagrams.

6.1.2 Selecting the sweep range and other parameters

After a system preset the display shows a diagram with a dB magnitude scale, and the S-parameter S_{21} is selected as a measured quantity. This S-parameter is the forward transmission coefficient of the DUT. It is defined as the ratio of the transmitted wave at the DUT's output port (port no. 2) to the incident wave at the DUT's input port (port no. 1).

The R&S ZND automatically adjusts its internal source and receiver to the selected measured quantities: For an S_{21} measurement, a stimulus signal (termed a_1) is transmitted at the analyzer port no. 1; the transmitted wave (termed b_2) is measured at port 2. The stimulus signal from the analyzer port no. 2 is not needed except for some calibration types.

By default the sweep range is set to the frequency range of the analyzer, which can be unsuitable for your DUT. The following procedure shows you how to configure a smaller sweep range.

1. Select STIMULUS – [START] and set the "Start Frequency" to the lowest frequency you want to measure (e.g. 1.77 GHz). For convenient numeric entry, open the "Numeric Editor" (see [Chapter 5.5.2, "Using the numeric editor"](#), on page 48).

Tip: If you use the DATA ENTRY keys at the front panel for data entry, type [1][.][7][7] and terminate the entry with the [G/n] key.

Refer to [Chapter 5.5, "Entering data"](#), on page 47 to learn more about entering numeric values and characters.

2. In the "Stop Frequency" input field, enter the highest frequency you want to measure (e.g. 2.5 GHz).
3. Select TRACE – [SCALE] > "Scale Values" and activate the "Auto Scale Trace" function. The analyzer adjusts the scale of the diagram to fit in the entire S_{21} trace, leaving an appropriate display margin.

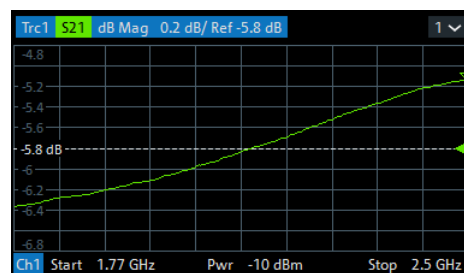

Tip: Refer to [Chapter 5.6, "Scaling diagrams"](#), on page 50 to learn more about the different methods and tools for diagram scaling.

6.1.3 Calibrating the instrument

Calibration (system error correction) is the process of eliminating systematic, reproducible errors from the measurement results. E.g., in the current test setup, the connecting cables between the analyzer ports and the DUT introduce an attenuation and a phase shift of the waves. Both effects impair the accuracy of the S-parameter measurement.

The analyzer provides a wide range of sophisticated calibration methods for all types of measurements. The calibration method to select depends on the expected system errors, the accuracy requirements of the measurement, on the test setup and on the types of calibration standards available.

The following example requires a calibration kit with a male Through standard with known transmission characteristics for the related test port connector type and gender. With a single Through, it is possible to perform a transmission normalization, compensating for a frequency-dependent attenuation and phase shift in the signal paths.

Due to the R&S ZND's calibration wizard, calibration is a straightforward, guided process.

1. Replace the DUT by the Through standard of your calibration kit. Make sure to disconnect all calibration units.
2. Select CHANNEL – [CAL] > "Start... (Manual)" to open the "Calibration Setting" wizard.
3. Select the port combination Port 1 (P1) and Port 2 (P2) and the calibration type "Trans Norm". Make sure to define port 1 as the source port.

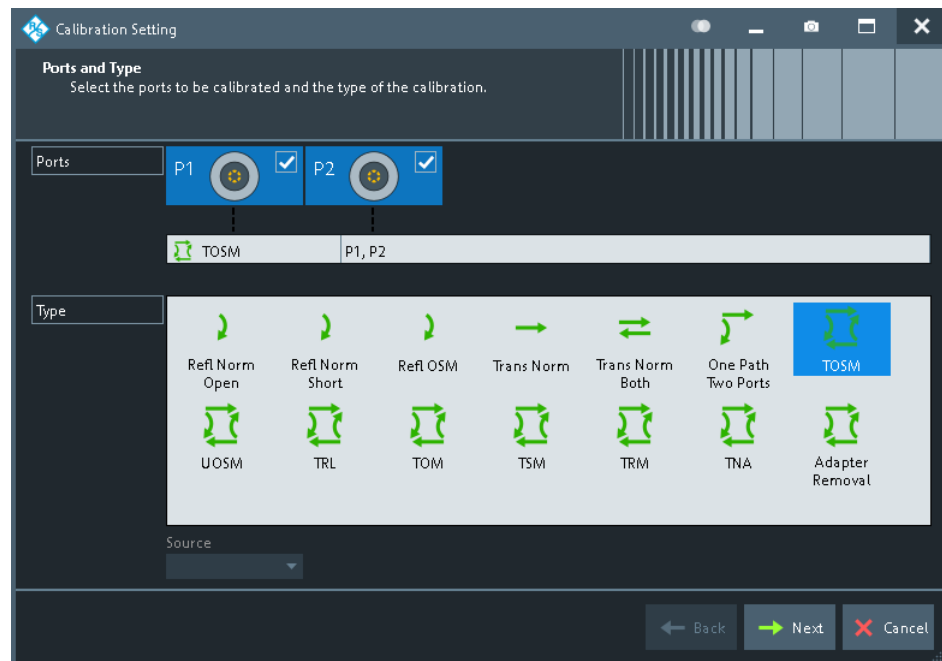

Tip: For a unidirectional R&S ZND, only port 1 can be the source port. Hence calibrations that require both ports as driving port are not available.

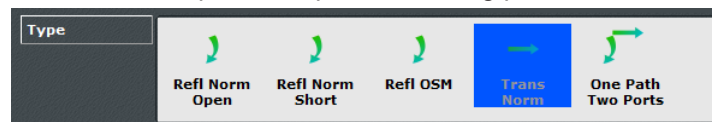

4. Select "Next" to proceed to the next page of the "Calibration Setting" wizard.
5. Select the test port connector type and gender (here: N 50 Ω , female, corresponding to a male Through standard), and the calibration kit (here: R&S ZV-Z121).



6. Tap "Start".

7. The calibration dock widget indicates the standard measurements that make up a "Trans Norm" calibration.

Select "Through (mm)" to initiate the measurement of the connected Through standard. Measuring the isolation between ports 1 and 2 is optional. Skip it for now.



The analyzer performs a calibration sweep for the measured quantity S_{21} . The magnitude and phase of the result is displayed in two diagrams, together with the expected typical result for a Through standard. The similarity of real and expected traces indicates that the Through standard has been properly connected. After the R&S ZND has completed the calibration sweep and calculated the correction data, the "Apply" button is enabled.

8. Select "Apply" to close the wizard.

The system error correction is calculated and applied to the current channel. A "Cal" label appears in the trace list.

To proceed with the measurement, remove the Through standard and connect the DUT again.

6.1.4 Evaluating data

The analyzer provides various tools to optimize the display and analyze the measurement data. For instance, you can use markers to determine maxima and minima on the trace, and change the display format to obtain information about the group delay of the transmitted wave.

1. Select TRACE – [MARKER] > "Markers" > "Mkr 1".

This places marker "M1" to its default position (center of the sweep range). A marker symbol (triangle) appears on the trace, a marker info field in the upper right corner of the diagram. The marker info field displays the stimulus value (frequency) and response value (magnitude of the transmission coefficient converted to a dB value) at the marker position.

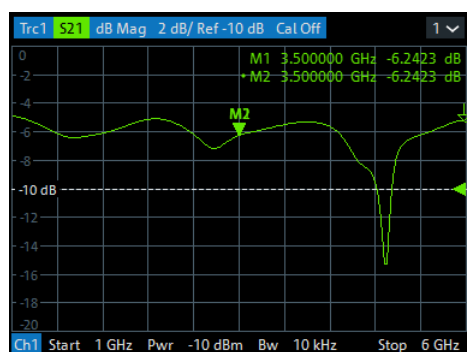

2. Select TRACE – [MARKER], activate the "Marker Search" softtool tab and activate "Min" search.

The marker jumps to the absolute minimum of the curve in the entire sweep range. The marker info field shows the coordinates of the new marker position.

3. Select TRACE – [FORMAT] and choose the "Delay" of the transmission coefficient as displayed quantity.

The group delay represents the propagation time of the wave through the DUT; it is displayed in a Cartesian diagram. The marker info field shows the frequency and group delay at the marker position.

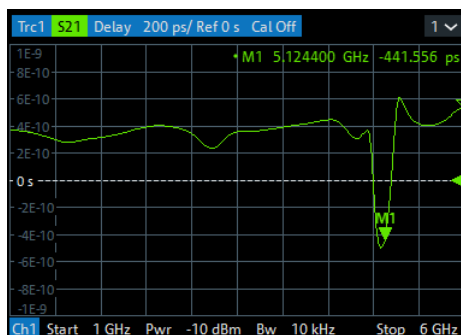

Refer to the information on trace formats in the help system or in the user manual to learn more about the diagram properties.

6.1.5 Saving and printing data

The analyzer provides standard functions for saving measurement settings and for saving or printing the results. You can use these functions as if you were working on a standard PC. Moreover you can export your trace data to an ASCII file and reuse it in a later session or in an external application.



Data transfer is made easier if external accessories are connected to the analyzer or if the instrument is integrated into a LAN. Refer to [Chapter 3.11, "Connecting external accessories"](#), on page 21, and [Chapter 7.2, "Remote operation in a LAN"](#), on page 66 to obtain information about the necessary steps.

1. Activate the SYSTEM – [FILE] > "Trace Data" softtool tab.
2. In the "Trace Data" softtool tab, select "Export" – "ASCII..." to open the "Export Data - ASCII Files" dialog.
3. In the "Export Data - ASCII Files" dialog:
 - a) Select a file location ("Look in:").
 - b) Enter a file name ("File name:").
 - c) Select "Save".

The analyzer writes the data of the active trace to an ASCII file and closes the dialog.

4. Activate the "Print" softtool tab (SYSTEM – [FILE] > "Print").
5. In the "Print" softtool tab, select "Print" to print the diagram area or "To Clipboard" to copy it to the Windows clipboard.

6. Select SYSTEM – [FILE] > "Recall Sets" > "Save..." to open the "Save" dialog for recall sets.
7. In the "Save" dialog:
 - a) Select a file location ("Look in:").
 - b) Enter a name for the recall set file ("File name:").
 - c) Select "Save".

The analyzer saves the active recall set, containing channel, stimulus and trace settings, to a `znx` file. This recall set can be restored in a later session.

6.2 Reflection S-parameter measurement

In a reflection measurement, the analyzer transmits a stimulus signal to the input port of the device under test (DUT) and measures the reflected wave. Different trace formats allow you to express and display the results, depending on what you want to learn from the data. Only one analyzer test port is required for reflection measurements.

In principle, a reflection measurement involves the same steps as a transmission measurement. Note the following differences:

- The basic test setup for reflection measurements involves a single DUT and analyzer port. For instance, you can connect the input of your DUT to port 1 of the analyzer as shown below.

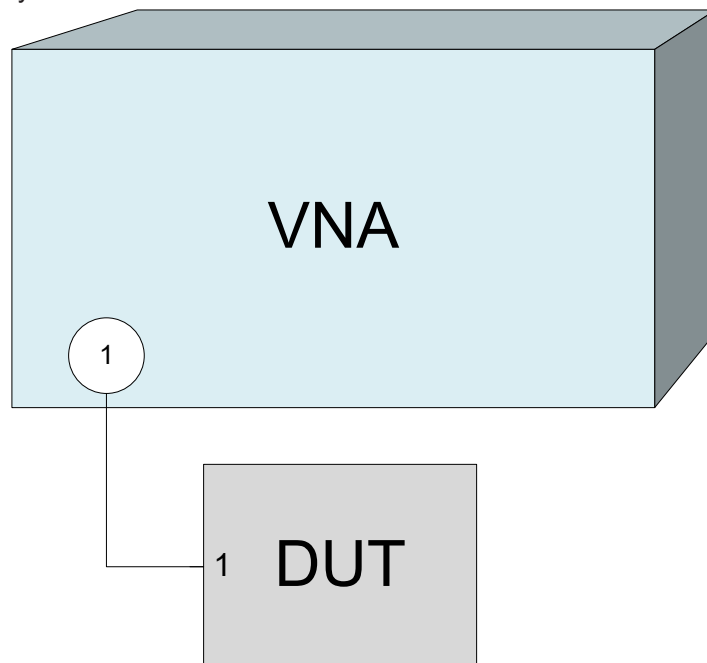

You can also use the basic transmission test setup, e.g. if you want to measure reflection and transmission parameters in parallel.

- The analyzer provides special calibration types for reflection measurements. Use the calibration wizard and select an appropriate type.

A full 2-port calibration (TOSM, UOSM, TNA ...) corrects the system errors for all transmission and reflection S-parameters.

- Some of the trace formats are particularly suited for reflection measurements. For instance, you can display the measured reflection coefficient S_{11} in a Smith chart to obtain the complex input impedance at port 1.

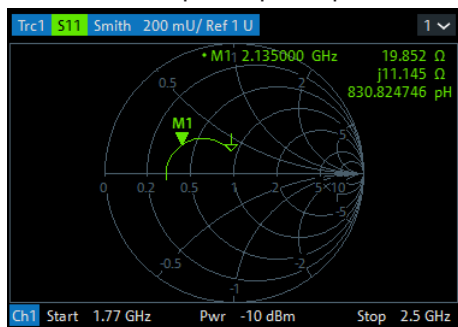

Proceed as described in [Chapter 3.7, "Switching the instrument on and off"](#), on page 17 to shut down your analyzer.

7 Administrative tasks

This chapter describes some topics that are only needed occasionally, or if a special instrument configuration is required.

7.1 Firmware installation

Upgrade versions of the analyzer firmware are supplied as single executable setup files (*.exe).



64-bit only

Since version 3.00 of the analyzer firmware, 32-bit Windows is no longer supported. Only 64-bit firmware is available.

To upgrade your instrument to 64-bit Windows 10, contact Rohde & Schwarz service.



Admin account

You need administrator rights to install a new firmware. See [Chapter 3.9, "Windows operating system"](#), on page 18 for details.

To perform a firmware update:

1. Copy the setup file to any storage medium accessible from the analyzer. This can be either the internal mass storage drive, an external storage medium (USB memory stick, external CD-ROM drive) or a network connection (LAN).
The default name of the internal drive is C : . External storage devices are automatically mapped to the next free drive, i.e. D : , E : etc.
2. Run the setup file from the Windows® Explorer. Follow the instructions of the setup wizard.
Setup files can be reinstalled.



Factory calibration

A firmware update does not affect the factory calibration.



Downgrade to a firmware version < 3.00

To downgrade the firmware from a version ≥ 3.00 to a version < 3.00 , it is required to uninstall the firmware using Windows 10 "Apps & features" (Windows 7 "Programs and Features") before proceeding with the installation.

7.2 Remote operation in a LAN

A LAN connection is used to integrate the analyzer into a home/company network. LAN connectivity offers several applications, e.g.:

- Transfer data between a controller and the analyzer, e.g. to run a remote control program.
- Control the measurement from a remote computer using Remote Desktop or a similar application.
- Use external network devices (e.g. printers).

The analyzer uses a user name and password as credentials for remote access; see [Chapter 3.9, "Windows operating system"](#), on page 18 for details. To protect the analyzer from unauthorized access, it is recommended to change the factory setting.

7.2.1 Assigning an IP address

Depending on the network capacities, the TCP/IP address information for the analyzer can be obtained in different ways.

- If the network supports dynamic TCP/IP configuration using the Dynamic Host Configuration Protocol (DHCP), all address information can be assigned automatically.
- If the network does not support DHCP, or if the analyzer is set to use alternate TCP/IP configuration, the addresses must be set manually.

By default, the analyzer is configured to use dynamic TCP/IP configuration and obtain all address information automatically. Hence it is safe to establish a physical connection to the LAN without any previous analyzer configuration.

NOTICE

Manual TCP/IP configuration

If your network does not support DHCP, or if you choose to disable dynamic TCP/IP configuration, you must assign valid address information **before** you connect the analyzer to the LAN. Contact your network administrator to obtain a valid IP address, because connection errors can affect the entire network.



Admin account

You need administrator rights to change the TCP/IP configuration. See [Chapter 3.9, "Windows operating system"](#), on page 18 for details.

To enter the TCP/IP address information manually

1. Obtain the IP address and subnet mask for the analyzer and the IP address for the local default gateway from your network administrator. If necessary, also obtain the name of your DNS domain and the IP addresses of the DNS and WINS servers on your network.

2. Press the Windows key in the SYSTEM keypad or on an external keyboard to access Windows®.
3. Open the "Control Panel" > "Network and Sharing Center" > "Change adapter settings" dialog and right-click the local connection.
Windows 7: open the "Control Panel" > "Network and Internet" > "Network and Sharing Center" > "Local Area Connection Status" dialog.
4. Select "Properties" and confirm the user account control message, depending on your current user account.
 - If your current account is an administrator account, select "Yes".
 - If your account is an account with standard user rights, enter the password of the administrator account and select "Yes".

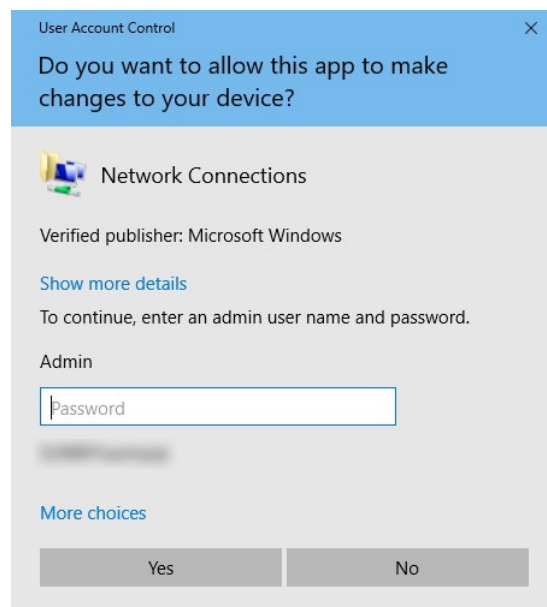
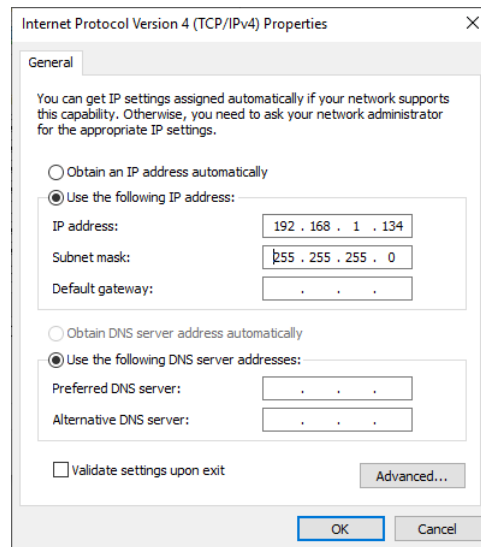

Figure 7-1: User Account Control dialog

5. In the "Connection Properties" dialog opened, select "Internet Protocol Version 4 (TCP/IPv4) > Properties" and enter the IP address information.



7.2.2 Using computer names

In a LAN that uses a DNS server (Domain Name System server), each PC or instrument connected in the LAN can be accessed via an unambiguous computer name instead of the IP address. The DNS server translates the host name to the IP address, which is especially useful when a DHCP server is used, as a new IP address can be assigned each time the instrument is restarted.

Each instrument is delivered with an assigned computer name, but this name can be changed. The default instrument name is a case-insensitive string with the following syntax:

ZND-<serial_number>

The serial number can be found on the rear panel of the instrument. It is the third part of the device ID printed on the bar code sticker:



ZND-102030, for example

7.2.3 Remote Desktop connection

Remote Desktop is a Windows® application which you can use to access and control the analyzer from a remote computer through a LAN connection. While the measurement is running, the analyzer screen contents are displayed on the remote computer, and Remote Desktop provides access to all applications, files, and network resources of the analyzer.



At the R&S ZND, by default remote connections are enabled using a local group policy and remote access is granted to users instrument and administrator.

For detailed information about Remote Desktop and the connection, refer to the Windows® Help ("Windows Start Menu > Help and Support").

To establish a remote desktop connection, proceed as follows:

1. Connect remote Windows PC and VNA to the LAN and make sure that an IP connection can be established.
2. At the remote Windows PC, open a remote desktop connection (type *Remote Desktop Connection* at the Windows Start/Search menu and hit enter).
3. In the "Remote Desktop Connection" dialog, enter the VNA's computer name or IP address and select "Connect"

7.2.4 Windows® firewall settings

A firewall protects an instrument by preventing unauthorized users from gaining access to it through a network. In the default configuration of the R&S ZND, the firewall is enabled. A remote desktop connection does not require any changes in the firewall settings.



Admin account

You need administrator rights to change the firewall settings. See [Chapter 3.9, "Windows operating system"](#), on page 18 for details.

Some actions require a different firewall configuration, e.g.:

- To transfer data with other hosts in the LAN, you have to allow "File and Printer Sharing".

To change the firewall settings, proceed as follows:

1. Access the operating system by pressing the Windows® key on the external keyboard. Open the "Control Panel".
2. Select "Windows Defender Firewall" ("System and Security > Windows Firewall" in Windows 7)
 - Select "Allow an app or feature through Windows Defender Firewall" to enable "File and Printer Sharing". (Windows 7: select "Change Settings > Allow a program or feature through Windows Firewall" to enable "File and Printer Sharing").
 - Select "Turn Windows Firewall on or off" to enable or disable the firewall.

Confirm the user account control message to allow the desired changes (see [Figure 7-1](#)). For detailed information about the firewall, refer to the Windows® Help.

8 Contacting customer support

Technical support – where and when you need it

For quick, expert help with any Rohde & Schwarz product, contact our customer support center. A team of highly qualified engineers provides support and works with you to find a solution to your query on any aspect of the operation, programming or applications of Rohde & Schwarz products.

Contact information

Contact our customer support center at www.rohde-schwarz.com/support, or follow this QR code:



Figure 8-1: QR code to the Rohde & Schwarz support page

Index

A

AC supply	17
Accessories (connect)	21
Administrative tasks	65
Application cards	12
Application notes	12
Auto scale	53

B

Basic tasks	31
Brochures	12

C

CHANNEL	25
Circular diagrams	54
Computer name	
Changing	68
Control elements	36
Customer support	70

D

Data entry	47
DATA ENTRY	26
Data sheets	12
DHCP server	
LAN configuration	68
Diagram	43
Dialogs	42
Display	24
DNS server	
LAN configuration	68
Drag and drop	46

E

Electrostatic discharge (ESD)	29
EMI suppression	16
Evaluation of data	61
EXT TRIG OUT / IN	29

F

Factory calibration	65
Firewall	69
Firmware	
Setup file	65
Firmware installation	65
Front panel	24
Front panel keys	31

G

Getting started	11
GPIB	29
Graphic zoom	50
Ground connector	29

H

Hardkey panel	41
---------------------	----

I

Instrument calibration	58
Instrument security procedures	12
Instrument tour	24
IP address setting	66

K

Keyboard	21
----------------	----

L

LAN	29
connection	23
Remote operation	66

M

Marker	43
set by	54
Measurement examples	56
Menu bar	39
Menus	40
Minimize application	20
Monitor	21
MONITOR (DVI-D)	29
Mouse	22

N

Navigation keys	27
Navigation tools	36
Numeric Editor (dialog)	48

O

On-screen keyboard	
analyzer	49
Windows	49
Operating system	18

P

Password	66
Power on and off	17
Printer	22
Printing data	62

R

Rear panel	29
REF OUT / IN	29
Reference position	53
Reference value	53
Reflection measurement (example)	63
Release notes	12
Remote desktop	68
Rotary knob	27

S

S-Parameter Wizard	56
Safety instructions	7, 12
Saving data	62

Scaling diagrams	50
Screen saver	24
Security procedures	12
Service manual	11
Setup keys	25
Softtools	38
Standby and ready state	18
Standby key	28
Startup and shutdown	17
Status bar	41
Step Size (dialog)	49
STIMULUS	26
Sweep range selection	57
Sweep range setting	52
SYSTEM	26

T

Test port	28
Title bar	37
Toolbar	37
Touchscreen	24
Trace	43
TRACE	25
Transmission measurement (example)	56

U

USB	28
USER PORT	29

V

Virus protection	66
------------------------	----

W

White papers	12
Windows	18
Wizard	56

Z

Zoom	50
------------	----