

R&S®FPS

Signal and Spectrum Analyzer

Getting Started



1319336202
Version 10

ROHDE & SCHWARZ
Make ideas real



This manual applies to the following R&S®FPS models with firmware version 1.70 and higher:

- R&S®FPS4 (1319.2008K04)
- R&S®FPS7 (1319.2008K07)
- R&S®FPS13 (1319.2008K13)
- R&S®FPS30 (1319.2008K30)
- R&S®FPS40 (1319.2008K40)

In addition to the base unit, the following options are described:

- R&S FPS-B4, OCXO (1321.4291.02)
- R&S FPS-B10, external generator control (1321.4256.02)
- R&S FPS-B22, preamplifier (1321.4027.02)
- R&S FPS-B25, electronic attenuator (1321.4033.02)
- R&S FPS-B40 bandwidth extension (1321.4040.02)
- R&S FPS-B160 bandwidth extension (1321.4285.xx)

© 2021 Rohde & Schwarz GmbH & Co. KG

Mühldorfstr. 15, 81671 München, Germany

Phone: +49 89 41 29 - 0

Email: info@rohde-schwarz.com

Internet: www.rohde-schwarz.com

Subject to change – data without tolerance limits is not binding.

R&S® is a registered trademark of Rohde & Schwarz GmbH & Co. KG.

Trade names are trademarks of the owners.

1319.3362.02 | Version 10 | R&S®FPS

The following abbreviations are used throughout this manual: R&S®FPS is abbreviated as R&S FPS.

R&S®MultiView is abbreviated as MultiView.

Contents

1 Safety and Regulatory Information.....	9
1.1 Safety Instructions.....	9
1.2 Warning Messages in the Documentation.....	12
1.3 Korea Certification Class A.....	13
2 Documentation Overview.....	14
2.1 Getting Started Manual.....	14
2.2 User Manuals and Help.....	14
2.3 Service Manual.....	15
2.4 Instrument Security Procedures.....	15
2.5 Printed Safety Instructions.....	15
2.6 Data Sheets and Brochures.....	15
2.7 Release Notes and Open-Source Acknowledgment (OSA).....	16
2.8 Application Notes, Application Cards, White Papers, etc.....	16
3 Key Features.....	17
4 Preparing for Use.....	18
4.1 Lifting and Carrying.....	18
4.2 Unpacking and Checking.....	18
4.3 Choosing the Operating Site.....	19
4.4 Setting Up the Product.....	19
4.4.1 Placing the Product on a Bench Top.....	20
4.4.2 Mounting the R&S FPS in a Rack.....	21
4.5 Connecting the AC Power.....	21
4.6 Switching the Instrument On and Off.....	22
4.7 Connecting to LAN.....	23

4.8	Connecting a Keyboard.....	25
4.9	Connecting an External Monitor.....	25
4.10	Windows Operating System.....	26
4.11	Logging On.....	28
4.12	Checking the Supplied Options.....	31
4.13	Performing a Self-Alignment.....	32
4.14	Considerations for Test Setup.....	33
4.15	Protecting Data Using the Secure User Mode.....	33
5	Instrument Tour.....	37
5.1	Front Panel View.....	37
5.1.1	Power Key.....	38
5.1.2	USB.....	38
5.1.3	Mini Display.....	38
5.1.4	Navigation Controls.....	38
5.1.5	Data Input Controls.....	39
5.1.6	Status LEDs.....	39
5.1.7	Removable Solid State Drive (SSD).....	40
5.1.8	RF Input 50 Ohm.....	40
5.2	Rear Panel View.....	40
5.2.1	RF Input 50 Ohm.....	42
5.2.2	NOISE SOURCE CONTROL.....	42
5.2.3	REF INPUT / REF OUTPUT.....	42
5.2.4	GPIB (SCPI) Remote Control Connector.....	43
5.2.5	TRIGGER INPUT / OUTPUT.....	43
5.2.6	IF/VIDEO OUTPUT.....	43
5.2.7	Display Port and DVI.....	44
5.2.8	LAN.....	44

5.2.9	USB.....	44
5.2.10	AC Power Supply Connection and Main Power Switch.....	44
5.2.11	Labels on R&S FPS.....	45
5.2.12	Device ID.....	45
5.3	Additional Hardware Options Without External Connectors.....	46
5.3.1	OCXO Option (R&S FPS-B4).....	46
5.3.2	Bandwidth Extension 160 MHz (R&S FPS-B160).....	46
6	Mini Display.....	47
6.1	Functions and Settings in the Mini Display Menu.....	47
6.2	Working with the Mini Instrument Display.....	54
6.3	Configuring the Display Settings.....	55
7	Controlling the R&S FPS Remotely.....	57
7.1	Remote Control Interfaces and Protocols.....	58
7.1.1	LAN Interface.....	59
7.1.2	GPIB Interface (IEC 625/IEEE 418 Bus Interface).....	65
7.1.3	USB Interface.....	68
7.1.4	VISA Libraries.....	69
7.2	How to Configure a Network.....	70
7.2.1	How to Connect the Instrument to the Network.....	71
7.2.2	How to Assign the IP Address.....	72
7.2.3	How to Configure the LAN Using the Web Browser Interface.....	73
7.2.4	How to Change the GPIB Instrument Address.....	76
7.3	How to Log on to the Network.....	76
7.3.1	How to Create Users.....	77
7.3.2	How to Change the User Password.....	78
7.3.3	How to Configure the Automatic Login Mechanism.....	79
7.4	How to Share Directories (only with Microsoft Networks).....	80

7.5	How to Start a Remote Control Session from a PC.....	81
7.6	How to Set Up Remote Desktop.....	82
7.6.1	How to Configure the R&S FPS for Remote Operation via Remote Desktop.....	82
7.6.2	How to Configure the Controller.....	84
7.6.3	How to Start and Close the Remote Desktop.....	86
7.6.4	How to Shut Down the R&S FPS via Remote Desktop.....	88
7.6.5	How to Add or Remove Users to the Remote Desktop Users Group...	88
7.7	How to Control the R&S FPS via the Web Browser Interface.....	91
7.8	How to Deactivate the Web Browser Interface.....	93
8	Operating the Instrument in Manual Mode.....	95
8.1	Graphical User Interface Elements (Soft Front Panel).....	95
8.1.1	Toolbar.....	96
8.1.2	Softkeys.....	98
8.1.3	Front Panels.....	98
8.2	Understanding the Display Information.....	106
8.2.1	Channel Bar.....	108
8.2.2	Window Title Bar.....	110
8.2.3	Trace Information in Window Title Bar.....	111
8.2.4	Marker Information.....	111
8.2.5	Frequency and Span Information in Diagram Footer.....	112
8.2.6	Instrument and Status Information.....	113
8.2.7	Error Information.....	114
8.3	Changing the Focus.....	115
8.4	Entering Data.....	116
8.5	Displaying Results.....	116
8.5.1	Activating channels.....	116

8.5.2 Laying out the Result Display with the SmartGrid.....	117
8.5.3 Changing the Size of Windows.....	122
8.5.4 Switching Between a Split and Maximized Window Display.....	123
8.5.5 Changing the Display.....	123
8.6 Getting Help.....	123
8.6.1 Calling Up Help.....	124
8.6.2 Using the Help Window.....	124
9 Contacting Customer Support.....	127
Index.....	128

1 Safety and Regulatory Information

The product documentation helps you use the product safely and efficiently. Follow the instructions provided here and in the [Chapter 1.1, "Safety Instructions"](#), on page 9.

Intended use

The product is intended for the development, production and verification of electronic components and devices in industrial, administrative, and laboratory environments. Use the product only for its designated purpose. Observe the operating conditions and performance limits stated in the data sheet.

Where do I find safety information?

Safety information is part of the product documentation. It warns you of potential dangers and gives instructions on how to prevent personal injury or damage caused by dangerous situations. Safety information is provided as follows:

- In [Chapter 1.1, "Safety Instructions"](#), on page 9. The same information is provided in many languages as printed "Safety Instructions". The printed "Safety Instructions" are delivered with the product.
- Throughout the documentation, safety instructions are provided when you need to take care during setup or operation.

1.1 Safety Instructions

Products from the Rohde & Schwarz group of companies are manufactured according to the highest technical standards. To use the products safely, follow the instructions provided here and in the product documentation. Keep the product documentation nearby and offer it to other users.

Use the product only for its intended use and within its performance limits. Intended use and limits are described in the product documentation such as the data sheet, manuals and the printed safety instructions. If you are unsure about the appropriate use, contact Rohde & Schwarz customer service.

Using the product requires specialists or specially trained personnel. These users also need sound knowledge of at least one of the languages in which the user interfaces and the product documentation are available.

If any part of the product is damaged or broken, stop using the product. Never open the casing of the product. Only service personnel authorized by Rohde & Schwarz are allowed to repair the product. Contact Rohde & Schwarz customer service at <http://www.customersupport.rohde-schwarz.com>.

Lifting and carrying the product

The maximum weight of the product is provided in the data sheet. To move the product safely, you can use lifting or transporting equipment such as lift trucks and forklifts. Follow the instructions provided by the equipment manufacturer.

Choosing the operating site

Only use the product indoors. The product casing is not waterproof. Water that enters can electrically connect the casing with live parts, which can lead to electric shock, serious personal injury or death if you touch the casing. If Rohde & Schwarz provides a carrying bag designed for your product, you can use the product outdoors.

Unless otherwise specified, you can operate the product up to an altitude of 2000 m above sea level. The product is suitable for pollution degree 2 environments where nonconductive contamination can occur. For more information on environmental conditions such as ambient temperature and humidity, see the data sheet.

Setting up the product

Always place the product on a stable, flat and level surface with the bottom of the product facing down. If the product is designed for different positions, secure the product so that it cannot fall over.

If the product has foldable feet, always fold the feet completely in or out to ensure stability. The feet can collapse if they are not folded out completely or if the product is moved without lifting it. The foldable feet are designed to carry the weight of the product, but not an extra load.

If stacking is possible, keep in mind that a stack of products can fall over and cause injury.

If you mount products in a rack, ensure that the rack has sufficient load capacity and stability. Observe the specifications of the rack manufacturer. Always install the products from the bottom shelf to the top shelf so that the rack stands securely. Secure the product so that it cannot fall off the rack.

Connecting to power

The product is an overvoltage category II product and has to be connected to a fixed installation used to supply energy-consuming equipment such as household appliances and similar loads. Be aware that electrically powered products have risks, such as electric shock, fire, personal injury or even death.

Take the following measures for your safety:

- Before switching on the product, ensure that the voltage and frequency indicated on the product match the available power source. If the power adapter does not adjust automatically, set the correct value and check the rating of the fuse.
- If a product has an exchangeable fuse, its type and characteristics are indicated next to the fuse holder. Before changing the fuse, switch off the instrument and disconnect it from the power source. How to change the fuse is described in the product documentation.
- Only use the power cable delivered with the product. It complies with country-specific safety requirements. Only insert the plug into an outlet with protective conductor terminal.
- Only use intact cables and route them carefully so that they cannot be damaged. Check the power cables regularly to ensure that they are undamaged. Also ensure that nobody can trip over loose cables.
- If the product needs an external power supply, use the power supply that is delivered with the product or that is recommended in the product documentation or a power supply that conforms to the country-specific regulations.
- Only connect the product to a power source with a fuse protection of maximum 20 A.
- Ensure that you can disconnect the product from the power source at any time. Pull the power plug to disconnect the product. The power plug must be easily accessible. If the product is integrated into a system that does not meet these requirements, provide an easily accessible circuit breaker at the system level.





Cleaning the product

Use a dry, lint-free cloth to clean the product. When cleaning, keep in mind that the casing is not waterproof. Do not use liquid cleaning agents.

Meaning of safety labels

Safety labels on the product warn against potential hazards.

Warning Messages in the Documentation

	Potential hazard Read the product documentation to avoid personal injury or product damage.
	Electrical hazard Indicates live parts. Risk of electric shock, fire, personal injury or even death.
	Hot surface Do not touch. Risk of skin burns. Risk of fire.
	Protective conductor terminal Connect this terminal to a grounded external conductor or to protective ground. This protects you against electric shock should an electric problem occur.

1.2 Warning Messages in the Documentation

A warning message points out a risk or danger that you need to be aware of. The signal word indicates the severity of the safety hazard and how likely it will occur if you do not follow the safety precautions.

WARNING

Potentially hazardous situation. Could result in death or serious injury if not avoided.

CAUTION

Potentially hazardous situation. Could result in minor or moderate injury if not avoided.

NOTICE

Potential risks of damage. Could result in damage to the supported product or to other property.

1.3 Korea Certification Class A



이 기기는 업무용(A급) 전자파 적합기기로서 판매자 또는 사용자는 이 점을 주의하시기 바라며, 가정외의 지역에서 사용하는 것을 목적으로 합니다.

2 Documentation Overview

This section provides an overview of the R&S FPS user documentation. Unless specified otherwise, you find the documents on the R&S FPS product page at:

www.rohde-schwarz.com/manual/FPS

2.1 Getting Started Manual

Introduces the R&S FPS and describes how to set up and start working with the product. Includes basic operations, typical measurement examples, and general information, e.g. safety instructions, etc.

A printed version is delivered with the instrument. A PDF version is available for download on the Internet.

2.2 User Manuals and Help

Separate user manuals are provided for the base unit and the firmware applications:

- **Base unit manual**
Contains the description of all instrument modes and functions. It also provides an introduction to remote control, a complete description of the remote control commands with programming examples, and information on maintenance, instrument interfaces and error messages. Includes the contents of the getting started manual.
- **Firmware application manual**
Contains the description of the specific functions of a firmware application, including remote control commands. Basic information on operating the R&S FPS is not included.

The contents of the user manuals are available as help in the R&S FPS. The help offers quick, context-sensitive access to the complete information for the base unit and the firmware applications.

All user manuals are also available for download or for immediate display on the Internet.

2.3 Service Manual

Describes the performance test for checking the rated specifications, module replacement and repair, firmware update, troubleshooting and fault elimination, and contains mechanical drawings and spare part lists.

The service manual is available for registered users on the global Rohde & Schwarz information system (GLORIS):

<https://gloris.rohde-schwarz.com>

2.4 Instrument Security Procedures

Deals with security issues when working with the R&S FPS in secure areas. It is available for download on the Internet.

2.5 Printed Safety Instructions

Provides safety information in many languages. The printed document is delivered with the product.

2.6 Data Sheets and Brochures

The data sheet contains the technical specifications of the R&S FPS. It also lists the firmware applications and their order numbers, and optional accessories.

The brochure provides an overview of the instrument and deals with the specific characteristics.

See www.rohde-schwarz.com/brochure-datasheet/FPS

Application Notes, Application Cards, White Papers, etc.

2.7 Release Notes and Open-Source Acknowledgment (OSA)

The release notes list new features, improvements and known issues of the current firmware version, and describe the firmware installation.

The open-source acknowledgment document provides verbatim license texts of the used open source software.

See www.rohde-schwarz.com/firmware/FPS

2.8 Application Notes, Application Cards, White Papers, etc.

These documents deal with special applications or background information on particular topics.

See www.rohde-schwarz.com/application/FPS

3 Key Features

The R&S FPS Signal and Spectrum Analyzer sets standards in RF performance and usability. Outstanding key features are:

- Unmatched phase noise
- Excellent dynamic range
- High sensitivity even at low frequencies
- High measurement rates and fast sweep times with sweep rates up to 1000 sweeps per second
- Multiple measurement applications can be run and displayed in parallel
- Integrated support of R&S®NRP-Zxx power sensors

For a detailed specification refer to the data sheet.

Due to these features the R&S FPS is ideal for various measurement tasks, for instance:

- Measuring oscillators for radar and communications applications due to the low phase noise
- Identifying and analyzing spurious emissions due to the large spurious-free dynamic range and low DANL
- Measuring harmonics due to integrated highpass filters
- Measuring wide-band modulated or frequency-agile signals due to the large bandwidth
- Detecting errors caused by interaction between signals by measuring multiple standards simultaneously

4 Preparing for Use

Here, you can find basic information about setting up the instrument for the first time.

• Lifting and Carrying	18
• Unpacking and Checking	18
• Choosing the Operating Site	19
• Setting Up the Product	19
• Connecting the AC Power	21
• Switching the Instrument On and Off	22
• Connecting to LAN	23
• Connecting a Keyboard	25
• Connecting an External Monitor	25
• Windows Operating System	26
• Logging On	28
• Checking the Supplied Options	31
• Performing a Self-Alignment	32
• Considerations for Test Setup	33
• Protecting Data Using the Secure User Mode	33

4.1 Lifting and Carrying

The carrying handles are designed to lift or carry the instrument. Do not apply excessive external force to the handles.

See "[Lifting and carrying the product](#)" on page 10.

4.2 Unpacking and Checking

1. Unpack the R&S FPS carefully.
2. Retain the original packing material. Use it when transporting or shipping the R&S FPS later.
3. Using the delivery notes, check the equipment for completeness.

4. Check the equipment for damage.

If the delivery is incomplete or equipment is damaged, contact Rohde & Schwarz.

4.3 Choosing the Operating Site

Specific operating conditions ensure proper operation and avoid damage to the product and connected devices. For information on environmental conditions such as ambient temperature and humidity, see the data sheet.

See also "[Choosing the operating site](#)" on page 10.

Electromagnetic compatibility classes

The electromagnetic compatibility (EMC) class indicates where you can operate the product. The EMC class of the product is given in the data sheet under "General data".

- Class B equipment is suitable for use in:
 - Residential environments
 - Environments that are directly connected to a low-voltage supply network that supplies residential buildings
- Class A equipment is intended for use in industrial environments. It can cause radio disturbances in residential environments due to possible conducted and radiated disturbances. It is therefore not suitable for class B environments. If class A equipment causes radio disturbances, take appropriate measures to eliminate them.

4.4 Setting Up the Product

The R&S FPS is designed for use on a bench top or in a rack.

See also:

- "[Setting up the product](#)" on page 10
- "[Intended use](#)" on page 9

4.4.1 Placing the Product on a Bench Top

To place the product on a bench top

1. Place the product on a stable, flat and level surface. Ensure that the surface can support the weight of the product. For information on the weight, see the data sheet.
2. **CAUTION!** Foldable feet can collapse. See "[Setting up the product](#)" on page 10.

Always fold the feet completely in or out. With folded-out feet, do not place anything on top or underneath the product.

3. **WARNING!** A stack of products can fall over and cause injury. Never stack more than three products on top of each other. Instead, mount them in a rack. Stack as follows:

- It is best if all products have the same dimensions (width and length).
- The overall load on the lowest product must not exceed 500 N.
- With smaller products on top of the lowest product, the overall load on the lowest product must not exceed 250 N.

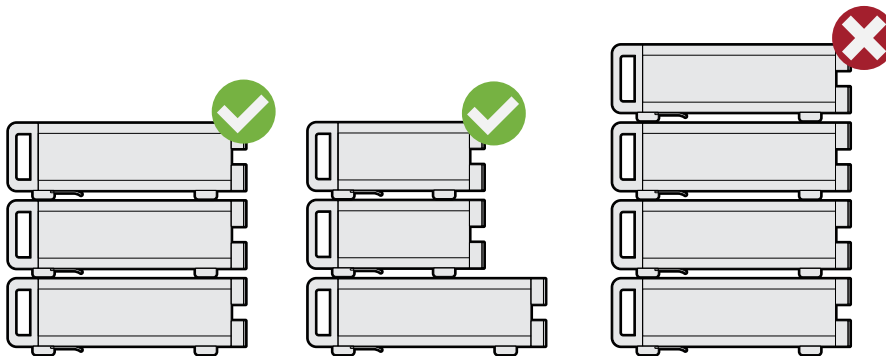

4. **NOTICE!** Overheating can damage the product.

Prevent overheating as follows:

- Keep a minimum distance of 10 cm between the fan openings of the product and any object in the vicinity.
- Do not place the product next to heat-generating equipment such as radiators or other products.

4.4.2 Mounting the R&S FPS in a Rack

To prepare the rack

1. Observe the requirements and instructions in "[Setting up the product](#)" on page 10.
2. **NOTICE!** Insufficient airflow can cause overheating and damage the product. Design and implement an efficient ventilation concept for the rack.

To mount the R&S FPS in a rack

1. Use an adapter kit to prepare the R&S FPS for rack mounting.
 - a) Order the rack adapter kit designed for the R&S FPS. For the order number, see the data sheet.
 - b) Mount the adapter kit. Follow the assembly instructions provided with the adapter kit.
2. Lift the R&S FPS to shelf height.
3. Grab the handles and push the R&S FPS onto the shelf until the rack brackets fit closely to the rack.
4. Tighten all screws in the rack brackets with a tightening torque of 1.2 Nm to secure the R&S FPS in the rack.

To unmount the R&S FPS from a rack

1. Loosen the screws at the rack brackets.
2. Remove the R&S FPS from the rack.
3. If placing the R&S FPS on a bench top again, unmount the adapter kit from the R&S FPS. Follow the instructions provided with the adapter kit.

4.5 Connecting the AC Power

In the standard version, the R&S FPS is equipped with an AC power supply connector.

Switching the Instrument On and Off

The R&S FPS can be used with different AC power voltages and adapts itself automatically to it. Refer to the datasheet for the requirements of voltage and frequency.

For safety information, see ["Connecting to power"](#) on page 11.

To connect the AC power

1. Plug the AC power cable into the AC power connector on the rear panel of the instrument. Only use the AC power cable delivered with the R&S FPS.



2. Plug the AC power cable into a power outlet with ground contact.
The required ratings are listed next to the AC power connector and in the data sheet.

For details on the connector, refer to [Chapter 5.2.10, "AC Power Supply Connection and Main Power Switch"](#), on page 44.

4.6 Switching the Instrument On and Off

Table 4-1: Overview of power states

Status	LED on Power key	Position of main power switch
Off	● gray	[0]
Standby	● orange	[I]
Ready	● green	[I]

To switch on the R&S FPS

The R&S FPS is off but connected to power.

1. Set the switch on the power supply to position [I].
See [Chapter 5.2.10, "AC Power Supply Connection and Main Power Switch"](#), on page 44.
The LED of the Power key is orange.
See [Chapter 5.1.1, "Power Key"](#), on page 38.

2. Press the Power key.

See [Table 4-1](#).

The LED changes to green.

The R&S FPS boots.

After booting, the instrument is ready for operation.

To shut down the product

The product is in the ready state.

- ▶ Press the [Power] key.

The operating system shuts down. The LED changes to orange.



If the instrument temperature exceeds the limit specified in the data sheet, the R&S FPS automatically shuts down to protect the instrument from damage.

To disconnect from power

The R&S FPS is in the standby state.

1. **NOTICE!** Risk of data loss. If you disconnect the product from power when it is in the ready state, you can lose settings and data. Shut it down first.

Set the switch on the power supply to position [0].

See [Chapter 5.2.10, "AC Power Supply Connection and Main Power Switch"](#), on page 44.

The LED of the standby key is switched off.

2. Disconnect the R&S FPS from the power source.

4.7 Connecting to LAN

You can connect the instrument to a LAN for remote operation via a PC.

For details on the connector, see [Chapter 5.2.8, "LAN"](#), on page 44.

Provided the network administrator has assigned you the appropriate rights and adapted the Windows firewall configuration, you can use the interface, for example:

- To transfer data between a controlling device and the test device, e.g. to run a remote control program
- To access or control the measurement from a remote computer using the "Remote Desktop" application (or a similar tool)
- To connect external network devices (e.g. printers)
- To transfer data from a remote computer and back, e.g. using network folders

Network environment

Before connecting the product to a local area network (LAN), consider the following:

- Install the latest firmware to reduce security risks.
- For internet or remote access, use secured connections, if applicable.
- Ensure that the network settings comply with the security policies of your company. Contact your local system administrator or IT department before connecting your product to your company LAN.
- When connected to the LAN, the product may potentially be accessed from the internet, which may be a security risk. For example, attackers might misuse or damage the product. For more information about IT security and how to operate the product in a secure LAN environment, see the Rohde & Schwarz white paper [1EF96: Malware Protection Windows 10](#).

► **NOTICE!** Risk of network failure.

Consult your network administrator before performing the following tasks:

- Connecting the instrument to the network
- Configuring the network
- Changing IP addresses
- Exchanging hardware

Errors can affect the entire network.

Connect the R&S FPS to the LAN via the LAN interface on the rear panel of the instrument.

Windows automatically detects the network connection and activates the required drivers.

By default, the R&S FPS is configured to use DHCP and no static IP address is configured.



The default instrument name is <Type><variant>-<serial_number>, for example, FPS4-123456. For information on determining the serial number, see [Chapter 5.2.12, "Device ID"](#), on page 45.

For more information on LAN configuration, see the R&S FPS user manual.

4.8 Connecting a Keyboard

The keyboard is detected automatically when it is connected. The default input language is English – US.

However, you can also connect foreign language keyboards; currently the following languages are supported for the R&S FPS:

- German
- Swiss
- French
- Russian

To configure the keyboard language

1. To access the Windows operating system, press the Windows key on the external keyboard.
2. Select "Start > Settings > Time & language > Region & language > Add a language" .

4.9 Connecting an External Monitor

You can connect an external monitor (or projector) to the "DVI" or "Display port" connector on the rear panel of the R&S FPS (see also [Chapter 5.2.7, "Display Port and DVI"](#), on page 44).



Manual operation using an external monitor and keyboard

Since the R&S FPS does not have a built-in measurement screen, it is recommended that you connect an external monitor to the instrument initially. Thus, you can get familiar with the instrument and its manual operation before using it in pure remote mode. This manual also describes in detail how to operate the instrument manually using an external monitor and keyboard.

4.10 Windows Operating System

The instrument contains the Windows 10 operating system which has been configured according to the instrument's features and needs. Changes in the system setup are only required when peripherals like a keyboard or a printer are installed or if the network configuration does not comply with the default settings. After the R&S FPS is started, the operating system boots and the instrument firmware is started automatically.

Tested software

The drivers and programs used on the instrument under Windows 10 are adapted to the instrument. Only install update software released by Rohde & Schwarz to modify existing instrument software.

You can install additional software on the instrument; however, additional software can impair instrument function. Thus, run only programs that Rohde & Schwarz has tested for compatibility with the instrument software.

The following program packages have been tested:

- Symantec Endpoint Security – virus-protection software
- FileShredder - for reliable deletion of files on the hard disk

Service packs and updates

Microsoft regularly creates security updates and other patches to protect Windows-based operating systems. These are released through the Microsoft Update website and associated update server. Instruments using Windows, especially those that connect to a network, should be updated regularly.

Firewall settings

A firewall protects an instrument by preventing unauthorized users from gaining access to it through a network. Rohde & Schwarz highly recommends the use of the firewall on your instrument. Rohde & Schwarz instruments are shipped with the Windows firewall enabled and preconfigured in such a way that all ports and connections for remote control are enabled.

Note that changing firewall settings requires administrator rights.

Virus protection

Take appropriate steps to protect your instruments from infection. Use strong firewall settings and scan any removable storage device used with a Rohde & Schwarz instrument regularly. It is also recommended that you install anti-virus software on the instrument. Rohde & Schwarz does NOT recommend running anti-virus software in the background ("on-access" mode) on Windows-based instruments, due to potentially degrading instrument performance. However, Rohde & Schwarz does recommend running it during non-critical hours.

For details and recommendations, see the following Rohde & Schwarz white paper:

- [1EF96: Malware Protection Windows 10](#)



Error message display

Note that any error messages caused by the Windows 10 operating system are only visible on an external monitor or via remote desktop from a controller PC. Thus, if operation of the R&S FPS seems to fail for no obvious reason, try connecting a monitor or a controller PC to check for any messages awaiting confirmation or action.

(See [Chapter 4.9, "Connecting an External Monitor"](#), on page 25 or [Chapter 7.6, "How to Set Up Remote Desktop"](#), on page 82)

To access the "Start" menu

The Windows "Start" menu provides access to the Windows 10 functionality and installed programs.

- ▶ Select the "Windows" icon in the toolbar, or press the "Windows" key or the [CTRL + ESC] key combination on the (external) keyboard.



The "Start" menu and the Windows taskbar are displayed.



The Windows taskbar also provides quick access to commonly used programs, for example Paint or WordPad. IECWIN, the auxiliary remote control tool provided free of charge and installed by Rohde & Schwarz, is also available from the taskbar or "Start" menu.

For details on the IECWIN tool, see the "Network and Remote Control" chapter of the R&S FPS user manual.

All necessary system settings can be defined in the "Start > Settings" menu.

For required settings, refer to the Windows 10 documentation and to the hardware description.

4.11 Logging On

Windows 10 requires that users identify themselves by entering a user name and password in a login window. By default, the R&S FPS provides two user accounts:

- **"Instrument"**: an administrator account with unrestricted access to the computer/domain
- **"NormalUser"**: a standard user account with limited access

Some administrative tasks require administrator rights (e.g. the configuration of a LAN network). Refer to the description of the basic instrument Setup ([Setup] menu) to find out which functions are affected.



Secure user mode

If the secure user mode option (R&S FPS-K33) is installed, an additional account is provided: the "**SecureUser**".

The "SecureUser" is a standard user account with limited functionality. In particular, administrative tasks such as LAN configuration or general instrument settings are not available. Furthermore, for a "SecureUser", data that the R&S FPS normally stores on the solid-state drive is redirected to volatile memory instead. You can access data that is stored in volatile memory during the current instrument session. However, when the instrument's power is removed, all data in volatile memory is erased.

For details, see [Chapter 4.15, "Protecting Data Using the Secure User Mode"](#), on page 33.

Passwords

For all default user accounts, the initial password is *894129*. Note that this password is very weak, and it is recommended that you change the password for both users after initial login. An administrator can change the password in Windows 10 for any user at any time via "Start > Settings > Account > SignIn Options > Password > Change".

Auto-login

When shipped, the instrument automatically logs on the default "Instrument" user to Windows 10 (with full access) using the default password. This function is active until an administrator explicitly deactivates it or changes the password.



Changing the password and use of auto-login function

Note that when you change the default password, the default auto-login function no longer works!

In this case, you must enter the new password manually to log on.

To change the settings for the automatic login function for the R&S FPS, a controller PC or an external monitor and keyboard must be connected to the R&S FPS. See [Chapter 7.6, "How to Set Up Remote Desktop"](#), on page 82.

Be aware if the auto-login function is deactivated or does not work and the R&S FPS is rebooted: since the R&S FPS has no real display, you require an external monitor and keyboard or a Remote Desktop access to the R&S FPS to enter the password. Otherwise, the Windows operating system does not complete login and the R&S FPS remains inoperable.

Adapting the auto-login function to a new password

If you change the password that is used during auto-login, this function no longer works. Adapt the settings for the auto-login function first.

If the SecureUser or the NormalUser are enabled, those passwords are used for autologin. In that case, if you change any of the passwords, the autologin function must be adapted each time you change the user account.

1. Open the `C:\R_S\INSTR\USER\user\AUTOLOGIN.REG` file in any text editor (e.g. Notepad).
2. In the line `"DefaultPassword"="894129"`, replace the default password (894129) by the new password for automatic login.
3. Save the changes to the file.
4. In the Windows "Start" menu, select "Run".
The "Run" dialog box is displayed.
5. Enter the command `C:\R_S\INSTR\USER\user\AUTOLOGIN.REG`.
6. Press the [ENTER] key to confirm.
The auto-login function is reactivated with the changed password. It will be applied the next time the instrument is switched on.

Switching users when using the auto-login function

Which user account is used is defined during login. If auto-login is active, the login window is not displayed. However, you can switch the user account to be used even when the auto-login function is active.

1. Select the "Windows" icon in the toolbar to access the operating system of the R&S FPS (see also ["To access the "Start" menu"](#) on page 28).



2. Press [CTRL] + [ALT] + [DEL], then select "Sign out".

The "Login" dialog box is displayed, in which you can enter the different user account name and password.

For information on deactivating and reactivating the auto-login function, see the R&S FPS user manual.

4.12 Checking the Supplied Options

The instrument can be equipped with both hardware and firmware options. To check whether the installed options correspond to the options indicated on the delivery note, proceed as follows.

 Checking the supplied options via Remote Desktop requires a controller pc or an external monitor, mouse and keyboard to be connected, see [Chapter 7.6, "How to Set Up Remote Desktop"](#), on page 82.

1. Press the [SETUP] key.
2. Press the "System Config" softkey.
3. Switch to the "Versions + Options" tab in the "System Configuration" dialog box.

A list with hardware and firmware information is displayed.

4. Check the availability of the hardware options as indicated in the delivery note.

4.13 Performing a Self-Alignment

When strong temperature changes occur in the environment of the R&S FPS, or after updating the firmware, you have to perform a self-alignment to align the data to a reference source.

During self-alignment, do not connect a signal to the RF input connector. Running a self-alignment with a signal connected to the RF input can lead to false measurement results.

To perform a self alignment directly on the R&S FPS

- ▶ In the R&S FPS's mini display, navigate to "System commands" > "Self align". For details on working with the mini display, see [Chapter 6, "Mini Display"](#), on page 47.

To perform a self alignment via Remote Desktop

Performing a self alignment via Remote Desktop requires a controller PC to be connected, see [Chapter 7.6, "How to Set Up Remote Desktop"](#), on page 82.

Before performing this functional test, make sure that the instrument has reached its operating temperature (for details, refer to the data sheet).

A message in the status bar ("Instrument warming up...") indicates that the operating temperature has not yet been reached.

Depending on the installation settings, an automatic self-alignment is performed each time the instrument is switched on. A dialog is displayed indicating how much warm-up time is still required before self-alignment can be performed.

1. Select the [SETUP] key in the soft front panel on the Remote Desktop.
2. Select the "Alignment" softkey.
3. Select the "Start Self Alignment" button in the "Alignment" dialog box.

Once the system correction values have been calculated successfully, a message is displayed.

To display the alignment results again later

1. Select the [SETUP] key in the soft front panel on the Remote Desktop.
2. Select the "Alignment" softkey.

4.14 Considerations for Test Setup

Cable selection and electromagnetic interference (EMI)

Electromagnetic interference (EMI) can affect the measurement results.

To suppress electromagnetic radiation during operation:

- Use high-quality shielded cables, for example, double-shielded RF and LAN cables.
- Always terminate open cable ends.
- Ensure that connected external devices comply with EMC regulations.

Preventing electrostatic discharge (ESD)

Electrostatic discharge is most likely to occur when you connect or disconnect a DUT.

- ▶ **NOTICE!** Risk of electrostatic discharge. Electrostatic discharge can damage the electronic components of the product and the device under test (DUT).

Ground yourself to prevent electrostatic discharge damage:

- a) Use a wrist strap and cord to connect yourself to ground.
- b) Use a conductive floor mat and heel strap combination.

Signal input and output levels

Information on signal levels is provided in the data sheet. Keep the signal levels within the specified ranges to avoid damage to the R&S FPS and connected devices.

4.15 Protecting Data Using the Secure User Mode

During normal operation, the R&S FPS uses a solid-state drive to store its operating system, instrument firmware, instrument self-alignment data, and any user data created during operation.

Protecting Data Using the Secure User Mode

Redirecting storage to volatile memory

Alternatively, to avoid storing any sensitive data on the R&S FPS permanently, the *secure user mode* was introduced (option R&S FPS-K33). In secure user mode, the instrument's solid-state drive is write-protected so that no information can be written to memory permanently. Data that the R&S FPS normally stores on the solid-state drive is redirected to volatile memory instead, which remains available only until the instrument is switched off. This data includes:

- Windows operating system files
- Firmware shutdown files containing information on last instrument state
- Self-alignment data
- General instrument settings such as the IP address
- Measurement settings
- User data created during operation
- Any data created by other applications installed on the R&S FPS, for example, text editors (Notepad), the clipboard, or drawing tools.

Users can access data that is stored in volatile memory just as in normal operation. However, when the instrument's power is switched off, all data in this memory is cleared. Thus, in secure user mode, the instrument always starts in a defined, fixed state when switched on.

To store data such as measurement results permanently, it must be stored to an external storage device, such as a memory stick.

 **Limited storage space**

The volatile memory used to store data in secure user mode is restricted to 256 MB. Thus, a "Memory full" error can occur although the hard disk indicates that storage space is still available.

Storing required data permanently

Any data that is to be available for subsequent sessions with the R&S FPS must be stored on the instrument permanently, *before activating the secure user mode*. This includes predefined instrument settings, transducer factors and self-alignment data.



Self-alignment data

Note that self-alignment data becomes invalid with time and due to temperature changes. Therefore, to achieve optimal accuracy, it can be preferable to perform a new self-alignment at the start of each new session on the R&S FPS.

Restricted operation

Since permanent storage is not possible, the following functions are not available in secure user mode:

- Firmware update
- Activating a new option key

Furthermore, since the "SecureUser" used in secure user mode does not have administrator rights, **administrative tasks** such as LAN configuration and some general instrument settings are not available. Refer to the description of the basic instrument setup ([SETUP] menu) to find out which functions are affected.



Remote Desktop restricted for "SecureUser" by default

For security reasons, the "SecureUser" is not allowed Remote Desktop access to the R&S FPS by default. You must explicitly add the "SecureUser" to the Remote Desktop group (see [Chapter 7.6.5, "How to Add or Remove Users to the Remote Desktop Users Group"](#), on page 88). If you do not allow this user Remote Desktop access, the "SecureUser" can only operate the R&S FPS using remote commands or via the mini display.

Activating and deactivating secure user mode

Only a user with administrator rights can activate (and deactivate) the secure user mode. Once activated, a restart is required. The special user "SecureUser" is then logged on to the R&S FPS automatically using the auto-login function. While the secure user mode is active, a message is displayed in the status bar at the bottom of the screen, and in the mini display "SecUsr" is displayed.

To deactivate the secure user mode, the "SecureUser" must log off and a user with administrator rights must log on.

**Switching users when using the auto-login function**

In the "Start" menu, select the arrow next to the "Shut down" button and then "Log off".

The "Login" dialog box is displayed, in which you can enter the different user account name and password.

The secure user mode setting and auto-login is automatically deactivated when another user logs on. The "SecureUser" is no longer available.

For users with administrator rights, the secure user mode setting is available in the general system configuration settings ([Setup] key > "System Configuration" softkey > "Config" tab > "Secure User Mode": "ON", see the R&S FPS user manual).

Alternatively, you can activate or deactivate the secure user function via the mini display (see ["Enable SecureUser/Disable SecureUser"](#) on page 51. In this case, enter the administrator ("Instrument" user) password.

Remote control

Initially after installation of the R&S FPS-K33 option, secure user mode must be enabled manually once before remote control is possible.

5 Instrument Tour

5.1 Front Panel View

This chapter describes the front panel, including all function keys and connectors.

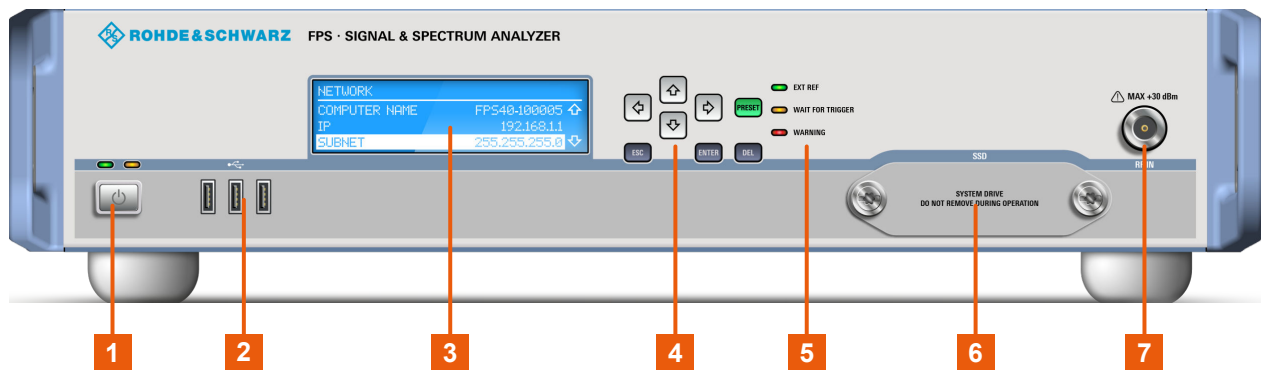

Figure 5-1: Front panel view

- 1 = POWER key
- 2 = USB connectors
- 3 = Mini display
- 4 = Navigation and data input controls
- 5 = Status LEDs
- 6 = Solid State Disk (SSD) containing instrument firmware
- 7 = RF Input 50 Ω connector (optionally front or rear panel)

● Power Key	38
● USB	38
● Mini Display	38
● Navigation Controls	38
● Data Input Controls	39
● Status LEDs	39
● Removable Solid State Drive (SSD)	40
● RF Input 50 Ohm	40

5.1.1 Power Key



The power key is on the lower left corner of the front panel. It starts up and shuts down the instrument.

See also "[Connecting to power](#)" on page 11.

5.1.2 USB

The front panel provides three female USB connectors (USB-A) to connect devices like a keyboard or a mouse. In addition, a memory stick can be connected to store and reload instrument settings and measurement data.

The USB connectors support standard 2.0.

 The rear panel provides further USB connectors, including some that support USB standard 3.0.

5.1.3 Mini Display



The R&S FPS is equipped with a mini display on the front panel that provides basic information and allows for very basic instrument configuration (such as changing the IP address). For details see [Chapter 6, "Mini Display"](#), on page 47.

5.1.4 Navigation Controls

The navigation controls allow you to navigate within the display or within dialog boxes.

Arrow Up/Arrow Down Keys

The <arrow up> or <arrow down> keys do the following:

- For numeric entries: increments (Arrow Up) or decrements (Arrow Down) the instrument parameter at a defined step width
- In a list: scrolls forward and backward through the list entries
- In a table: moves the selection bar vertically
- In windows or dialog boxes with a vertical scroll bar: moves the scroll bar

Arrow Left/Arrow Right Keys

The <arrow left> or <arrow right> keys do the following:

- In an alphanumeric edit dialog box, move the cursor.
- In a list, scroll forward and backward through the list entries.
- In a table, move the selection bar horizontally.
- In windows or dialog boxes with horizontal scroll bar, move the scroll bar.

5.1.5 Data Input Controls

The data input controls support you while entering data on the display or within dialog boxes.

Type of key	Description
ESC key	Exits the current function without storing changes
[ENTER] key	Stores the current entry and closes the edit mode
[DEL] key	Deletes the character to the left of the cursor

5.1.6 Status LEDs

Indicate the instrument's operating status:

Table 5-1: Status LEDs

Label	Description
[EXT REF]	External reference connected and active
[WAIT FOR TRIGGER]	Measurement waiting for trigger
[WARNING]	Warning or system error

5.1.7 Removable Solid State Drive (SSD)

The removable solid state drive contains the instrument firmware and all measurement data from the R&S FPS, allowing you to store the data securely in an external location.

5.1.8 RF Input 50 Ohm

Provides RF input from a connected device under test (DUT) to the R&S FPS, which is then analyzed in an RF measurement. Connect the DUT to the "RF Input" connector on the R&S FPS. Do not overload the input. For maximum allowed values, see the data sheet.

The RF Input connector may be provided on the front or rear panel, as requested by the customer.

The RF input can be coupled to the DUT by alternating current (AC) or direct current (DC). AC coupling blocks any DC voltage from the input signal. This is the default setting to prevent damage to the instrument. However, some specifications require DC coupling. In this case, you must protect the instrument from damaging DC input voltages manually. For details, refer to the data sheet. For details on coupling, see the chapter on radio frequency input in the R&S FPS user manual.

See also [Chapter 4.14, "Considerations for Test Setup"](#), on page 33.

5.2 Rear Panel View

This figure shows the rear panel view of the R&S FPS. The individual elements are described in more detail in the subsequent sections.

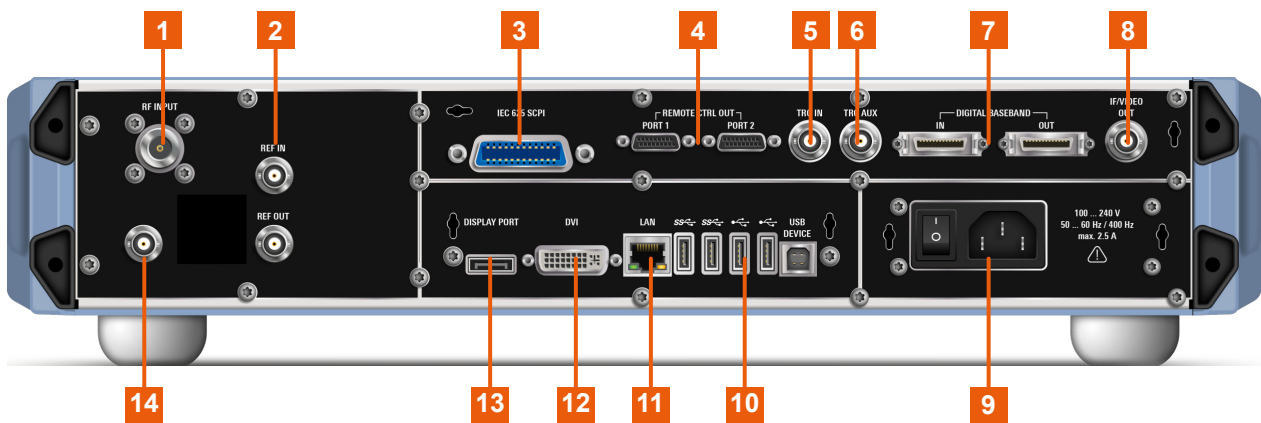

Figure 5-2: Rear panel view

- 1 = RF Input 50 Ω connector (optionally front or rear panel)
- 2 = REF INPUT/OUTPUT connectors
- 3 = IEC 625 (GPIB) SCPI interface
- 4 = Remote Control Out Ports 1/2 (currently not available)
- 5 = TRG IN connector
- 6 = TRG AUX connector
- 7 = DIGITAL BASEBAND INPUT/OUTPUT connectors (option B17, currently not available)
- 8 = IF/VIDEO out connector
- 9 = AC Power Supply Connection and Main Power Switch
- 10 = USB (DEVICE) connectors
- 11 = LAN connector
- 12 = DVI connector for external display
- 13 = DISPLAY PORT for external display
- 14 = NOISE SOURCE CONTROL

- [RF Input 50 Ohm](#).....42
- [NOISE SOURCE CONTROL](#).....42
- [REF INPUT / REF OUTPUT](#).....42
- [GPIB \(SCPI\) Remote Control Connector](#).....43
- [TRIGGER INPUT / OUTPUT](#).....43
- [IF/VIDEO OUTPUT](#).....43
- [Display Port and DVI](#).....44
- [LAN](#).....44
- [USB](#).....44
- [AC Power Supply Connection and Main Power Switch](#).....44
- [Labels on R&S FPS](#).....45
- [Device ID](#).....45

5.2.1 RF Input 50 Ohm

Provides RF input from a connected device under test (DUT) to the R&S FPS, which is then analyzed in an RF measurement. Connect the DUT to the "RF Input" connector on the R&S FPS. Do not overload the input. For maximum allowed values, see the data sheet.

The RF Input connector may be provided on the front or rear panel, as requested by the customer.

The RF input can be coupled to the DUT by alternating current (AC) or direct current (DC). AC coupling blocks any DC voltage from the input signal. This is the default setting to prevent damage to the instrument. However, some specifications require DC coupling. In this case, you must protect the instrument from damaging DC input voltages manually. For details, refer to the data sheet. For details on coupling, see the chapter on radio frequency input in the R&S FPS user manual.

See also [Chapter 4.14, "Considerations for Test Setup"](#), on page 33.

5.2.2 NOISE SOURCE CONTROL

The noise source control female connector is used to provide the supply voltage for an external noise source, e.g., to measure the noise figure and gain of amplifiers and frequency converting devices.

Conventional noise sources require a voltage of +28 V in order to be switched on and 0 V to be switched off. The output supports a maximum load of 100 mA.

5.2.3 REF INPUT / REF OUTPUT

The [REF INPUT] connector is used to provide an external reference signal to the R&S FPS.

The [REF OUTPUT] connector can be used to provide an external reference signal (or the OCXO reference signal) from the R&S FPS to other devices that are connected to this instrument.

Connector	Reference signal	Usage
REF INPUT	1...20 MHz 0...10 dBm	To provide an external reference signal on the R&S FPS.
REF OUTPUT	10 MHz 10 dBm	To provide the internal reference signal from the R&S FPS to another device continuously. Also used to provide OCXO reference signal to another device.

5.2.4 GPIB (SCPI) Remote Control Connector

The IEC 625 GPIB interface is in compliance with IEEE488 and SCPI. A computer for remote control of the R&S FPS can be connected via this interface. To set up the connection, a shielded cable is recommended. For more details refer to [Chapter 7, "Controlling the R&S FPS Remotely"](#), on page 57.

5.2.5 TRIGGER INPUT / OUTPUT

The female [TRG IN] connector for external trigger or gate input is used to control the measurement by means of an external signal. The voltage levels can range from 0.5 V to 3.5 V. The default value is 1.4 V. The typical input impedance is 10 k Ω .

The female BNC [TRG AUX] connector can be used to receive a second external signal or to provide a signal to another device. The signal is TTL compatible (0 V / 5 V). You can control the connector usage in the "Trigger" settings ([TRIG] key).

5.2.6 IF/VIDEO OUTPUT

The female BNC connector can be used for various outputs:

- Intermediate frequency (IF) output of approximately 20 MHz
- Video output (1 V)

Which output is provided is defined in the application settings ([INPUT/OUTPUT] key).

For details see the User Manual.

5.2.7 Display Port and DVI

You can connect an external monitor or other display device to the R&S FPS to provide an enlarged display. Two different types of connectors are provided for this purpose:

- Display Port
- DVI (digital visual interface)

For details, see [Chapter 4.9, "Connecting an External Monitor"](#), on page 25.

5.2.8 LAN

The R&S FPS is equipped with a 1 GBit Ethernet IEEE 802.3u network interface with Auto-MDI(X) functionality. The assignment of the RJ-45 connector supports twisted-pair category 5 UTP/STP cables in a star configuration (UTP stands for *unshielded twisted pair*, and STP for *shielded twisted pair*).

For details, see [Chapter 7, "Controlling the R&S FPS Remotely"](#), on page 57.

5.2.9 USB

The rear panel provides four additional female USB (USB-A) connectors to connect devices like a keyboard, a mouse or a memory stick (see also [Chapter 5.1.2, "USB"](#), on page 38). The two left-most connectors provide USB 3.0 interfaces.

Furthermore, a male [USB DEVICE] connector (USB-B) is provided, for example to connect a printer.

5.2.10 AC Power Supply Connection and Main Power Switch

An AC power supply connector and main power switch are located in a unit on the rear panel of the instrument.

Main power switch function:

Position 1: The instrument can be started via the Power key on the front panel. The (optional) OCXO reference frequency is warmed up.

Position O: The entire instrument is disconnected from the AC power supply.

For details, refer to "[Connecting to power](#)" on page 11 and [Chapter 4.5, "Connecting the AC Power"](#), on page 21.

5.2.11 Labels on R&S FPS

Labels on the casing inform about:

- Personal safety, see "[Meaning of safety labels](#)" on page 11
- Product and environment safety, see [Table 5-2](#)
- Identification of the product, see [Chapter 5.2.12, "Device ID"](#), on page 45

Table 5-2: Labels regarding R&S FPS and environment safety

	<p>Labeling in line with EN 50419 for disposal of electrical and electronic equipment after the product has come to the end of its service life. For more information, see the product user manual, chapter "Disposal".</p>
---	---

5.2.12 Device ID

The unique device identifier is provided as a barcode sticker on the rear panel of the R&S FPS.

It consists of the device order number and a serial number.



The serial number is used to define the **default instrument name**, which is:
`<Type><variant>-<serial_number>`

For example, FPS4-123456.

The instrument name is required to establish a connection to the instrument in a LAN.

5.3 Additional Hardware Options Without External Connectors

Some additional hardware options are available which have no external connectors and are not visible on the outside of the R&S FPS.

- [OCXO Option \(R&S FPS-B4\)](#).....46
- [Bandwidth Extension 160 MHz \(R&S FPS-B160\)](#).....46

5.3.1 OCXO Option (R&S FPS-B4)

This option generates a 10 MHz reference signal with a very precise frequency. If installed, and if no external signal is used, this signal is used as an internal reference.



Warm-up time for OCXO

When the instrument is switched on, the OCXO requires an extended warm-up time (see data sheet).

5.3.2 Bandwidth Extension 160 MHz (R&S FPS-B160)

The signal analysis bandwidth of the R&S FPS can be extended by a hardware option (R&S FPS-B160). The bandwidth extension allows for a linear bandwidth up to a maximum of 160 MHz with an output sample rate of up to 10 GHz. While the extension can be activated or deactivated manually in the R&S FPS base unit (I/Q Analyzer application), it is activated automatically in some applications that also support I/Q data analysis. See the application-specific documentation for details.

6 Mini Display

The R&S FPS is equipped with a mini display on the front panel (see also [Chapter 5.1.3, "Mini Display"](#), on page 38).

The display provides the following information:

- The serial number, firmware version and model of the instrument
- The IP address of the instrument
- The GPIB address of the instrument
- System messages, for example when errors occur

Furthermore, it provides the following functions directly on the instrument:

- Configuring network settings, including LAN and GPIB parameters
- Performing selftests, self alignment
- Resetting the instrument to a predefined state
- Changing display settings

 The mini front panel display is meant as a service interface, not for measurement display. If the display fails for any reason, switch the instrument off and back on again to restore the display.

Note that any error messages *caused by the Windows 10 operating system* are not displayed on the mini front panel display. They are only visible on an external monitor or via RemoteDesktop from a controller PC. Thus, if operation of the R&S FPS seems to fail for no obvious reason, try connecting a monitor or a controller PC to check for any messages awaiting confirmation or action.

(See [Chapter 4.9, "Connecting an External Monitor"](#), on page 25 or [Chapter 7.6, "How to Set Up Remote Desktop"](#), on page 82.)

6.1 Functions and Settings in the Mini Display Menu

The following functions and settings are available via the menu in the R&S FPS's mini display.

Functions and Settings in the Mini Display Menu

 Some of the following functions are also available in manual mode via the softfrontpanel, see the "General Instrument Setup" and "Network and Remote Operation" sections in the R&S FPS User Manual.

Network.....	48
L Computer Name.....	49
L DHCP.....	49
L IP Address.....	49
L Subnet Mask.....	49
System commands.....	50
L Preset.....	50
L Self align.....	50
L Selftest.....	50
L LAN Reset.....	50
L Clear All Messages	50
L Reboot.....	51
L Enable NormalUser/Disable NormalUser.....	51
L Enable SecureUser/Disable SecureUser.....	51
GPIB.....	52
L GPIB Address.....	52
LAN parameters.....	52
L Computer Name.....	52
L MAC.....	53
L IP.....	53
L Password.....	53
System messages.....	53
Display.....	53
L Backlight saving.....	53
L Normal/inverse color.....	53
Info.....	53
L Serial.....	54
L FW version.....	54
L Model.....	54
L uC version.....	54

Network

Configures the settings for operation in a local area network (LAN), for example to control the instrument from a remote PC or use a network printer.

Functions and Settings in the Mini Display Menu

NOTICE! Risk of network problems. All network parameters can be edited by the administrator ("Instrument" user) only. Beware that changing the computer name has major effects in a network.

For details, see [Chapter 7, "Controlling the R&S FPS Remotely"](#), on page 57.

Computer Name ← Network

Each instrument is delivered with an assigned computer name, but this name can be changed. The naming conventions of Windows apply. If too many characters and/or numbers are entered, an error message is displayed in the status line.

The default instrument name is a non-case-sensitive string with the following syntax:

<Type><variant>-<serial_number>

For example FPS13-123456

The serial number can be found on the rear panel of the instrument. It is the third part of the device ID printed on the bar code sticker:



DHCP ← Network

Switches between DHCP server available (On) or not available (Off). If a DHCP server is available in the network, the IP address and subnet mask of the instrument are obtained automatically from the DHCP server.

IP Address ← Network

Defines the IP address. The TCP/IP protocol is preinstalled with the IP address 10.0.0.10. If the DHCP server is available ("DHCP On"), the setting is read-only.

The IP address consists of four number blocks separated by dots. Each block contains 3 numbers in maximum (e.g. 100.100.100.100), but also one or two numbers are allowed in a block (as an example see the preinstalled address).

Subnet Mask ← Network

Defines the subnet mask. The TCP/IP protocol is preinstalled with the subnet mask 255.255.255.0. If the DHCP server is available ("DHCP On"), this setting is read-only.

Functions and Settings in the Mini Display Menu

The subnet mask consists of four number blocks separated by dots. Each block contains 3 numbers in maximum (e.g. 100.100.100.100), but also one or two numbers are allowed in a block (as an example see the preinstalled address).

System commands

Provides basic system functions.

Preset ← System commands

When delivered, the R&S FPS has a default configuration. You can restore this defined initial state at any time as a known starting point for measurements. This is often recommendable as a first step in troubleshooting when unusual measurement results arise.

Remote command:

*RST or SYSTem:PRESet

Self align ← System commands

Starts recording correction data for the instrument. If the correction data acquisition fails or if the correction values are deactivated, a corresponding message is displayed in the status field.

Selftest ← System commands

If the R&S FPS fails, you can perform a self test of the instrument to identify any defective modules.

Once the self test is started, all modules are checked consecutively and the test result is displayed.

LAN Reset ← System commands

Resets the "LAN" configuration to its default settings (LCI function).

Parameter	Value
TCP/IP Mode	DHCP + Auto IP Address
Dynamic DNS	Enabled
ICMP Ping	Enabled
Password for "LAN" configuration	LxiWebIfc

Clear All Messages ← System commands

Deletes all system messages.

Functions and Settings in the Mini Display Menu

Reboot ← System commands

Reboots the instrument, including the operating system.

Enable NormalUser/Disable NormalUser ← System commands

Activates or deactivates the "NormalUser" account.

The NormalUser can only be activated by a user with administrator rights.

If enabled, the R&S FPS requires a reboot and then automatically logs in using the "NormalUser" account (indicated by "NormUsr" in the mini display.).

The "NormalUser" is a standard user account with limited functionality. In particular, administrative tasks such as LAN configuration or general instrument settings are not available. Refer to the description of the basic instrument setup ([SETUP] menu) to find out which functions are affected.

If disabled, the R&S FPS requires a reboot. The R&S FPS attempts to log in using the "Instrument" (administrator) account. Enter the administrator ("Instrument" user) password on the R&S FPS (default: "894129"). For details, see ["To enter a password"](#) on page 55.

Note: Deactivated auto-login function. If the auto-login function is deactivated and the R&S FPS is rebooted, you require an external monitor and keyboard and a RemoteDesktop access on the R&S FPS to enter the password. Otherwise, the Windows operating system does not complete login and the R&S FPS remains inoperable.

For details, see [Chapter 4.11, "Logging On"](#), on page 28.

Enable SecureUser/Disable SecureUser ← System commands

Activates or deactivates the secure user mode.

The secure user mode can only be activated or deactivated by a user with administrator rights. Enter the administrator ("Instrument" user) password on the R&S FPS (default: "894129"). For details, see ["To enter a password"](#) on page 55.

If enabled, the R&S FPS requires a reboot and then automatically logs in using the "SecureUser" account (indicated by "SecUsr" in the mini display.)

For a "SecureUser", data that the R&S FPS normally stores on the solid-state drive is redirected to volatile memory instead. Data that is stored in volatile memory can be accessed by the user during the current instrument session. However, when the instrument's power is removed, all data in volatile memory is erased. Administrative tasks are not allowed by the "SecureUser".

Functions and Settings in the Mini Display Menu

Before you activate secure user mode, store any instrument settings that are required beyond the current session, such as predefined instrument settings, transducer files, or self-alignment data.

If disabled, the R&S FPS requires a reboot and then automatically logs in using the "Instrument" (administrator) account.

Note: Deactivated auto-login function. If the auto-login function is deactivated and the R&S FPS is rebooted, you require an external monitor and keyboard and a RemoteDesktop access on the R&S FPS to enter the password. Otherwise, the Windows operating system does not complete login and the R&S FPS remains inoperable.

For details, see ["Auto-login"](#) on page 29.

For details on the secure user mode, see [Chapter 4.15, "Protecting Data Using the Secure User Mode"](#), on page 33.

GPIB

Alternatively to connecting the R&S FPS to a LAN, the GPIB interface can be used to connect a remote PC.

GPIB Address ← GPIB

Defines the GPIB address. Values from 0 to 30 are allowed. The default address is 20.

LAN parameters

In a LAN network, the R&S FPS can be accessed via any web browser (e.g. the Microsoft Internet Explorer) to change the LAN settings using the web browser interface.

Note that LAN parameters are not available for the "SecureUser" or "NormalUser" accounts (see ["Enable NormalUser/Disable NormalUser"](#) on page 51 and ["Enable SecureUser/Disable SecureUser"](#) on page 51). See also the restrictions mentioned in [Chapter 7.1.1.4, "LAN Web Browser Interface"](#), on page 62.

Computer Name ← LAN parameters

Each instrument is delivered with an assigned computer name, but this name can be changed. The naming conventions of Windows apply. If too many characters and/or numbers are entered, an error message is displayed in the status line.

The default instrument name is a non-case-sensitive string with the following syntax:

<Type><variant>-<serial_number>

For example FPS13-123456

Functions and Settings in the Mini Display Menu

The serial number can be found on the rear panel of the instrument. It is the third part of the device ID printed on the bar code sticker:

**MAC ← LAN parameters**

Media Access Control address (MAC address), a unique identifier for the network card in the R&S FPS

IP ← LAN parameters

IP address of the R&S FPS as defined in the operating system (see also "[IP Address](#)" on page 49).

Password ← LAN parameters

Password for "LAN" configuration (Default: *LxiWebIfc*)

System messages

Displays the system messages generated by the R&S FPS.

The messages are displayed in the order of their occurrence; the most recent messages are placed at the top of the list.

Display

Provides functions for the display itself.

Backlight saving ← Display

If enabled, the backlight of the display is turned off to save energy.

Normal/inverse color ← Display

Switches between a display with light characters on a dark background (normal) or dark characters on a light background (inverted).

Info

Provides information on the R&S FPS installation.

This information can be useful when problems occur with the instrument and you require support from Rohde & Schwarz.

Serial ← Info

Serial number of the R&S FPS

FW version ← Info

Currently installed firmware version

Model ← Info

Instrument model

uC version ← Info

Microcontroller version

6.2 Working with the Mini Instrument Display

Using the mini display on the front panel of the R&S FPS, you can change basic instrument settings and perform hardware functions directly on the instrument. You do not require any additional devices such as a controller PC or external monitor.

To display a particular setting in the menu

The information and configuration settings are displayed in a hierarchical menu structure.

- ▶ To navigate within the menu structure, do one of the following:
 - Press the <Up Arrow> and <Down Arrow> keys to scroll through the menus.
 - Press the [Enter] key to select a particular menu item (either to edit a setting or to select the submenu).
 - Press the [ESC] key to move back up in the menu structure.

To edit a configuration value

1. Navigate to the required menu item as described in "[To display a particular setting in the menu](#)" on page 54.
2. Press the [Enter] key to select the displayed configuration setting and switch to edit mode.

Configuring the Display Settings

3. To change the value, do one of the following:
 - Press the <Up Arrow> and <Down Arrow> keys to scroll through the available entry values (e.g. digits in an IP address).
 - Press the <Left Arrow> and <Right Arrow> keys to scroll within the entry (e.g. to the second or third part of the IP address).
 - Press the [DEL] key to delete the character to the left of the cursor.
4. Press the [Enter] key again to store the entry and exit the edit mode.

To enter a password

For some functions, you must enter the administrator ("Instrument" user) password on the R&S FPS (default: "894129").

1. Navigate to the required menu item as described in ["To display a particular setting in the menu"](#) on page 54.
2. Press the [Enter] key to select the function.
3. For each character in the password:
 - a) Press the <Up Arrow> and <Down Arrow> keys to scroll through the available characters.
 - b) When the required character appears, press the <Right Arrow> key to move to the next character.
The currently selected character is displayed normally, all others are hidden by asterisks (*) for discretion.
4. When the password is complete, press the [Enter] key again to store the entry and exit the edit mode.

6.3 Configuring the Display Settings

This section describes how to configure basic display settings on the R&S FPS. For further basic instrument settings, see the R&S FPS user manual.

To change the display colors

You can switch between a display with light characters on a dark background (normal) or dark characters on a light background (inverted).

1. In the R&S FPS's mini display menu, navigate to "Display" > "Normal/inverse colors" and press the [Enter] key.

Configuring the Display Settings

2. Use the <Left Arrow> and <Right Arrow> keys to toggle the setting.
3. Press the [Enter] key again to store the entry and exit the edit mode.

To turn off the display backlight

You can turn off the backlight of the display to save energy.

1. In the R&S FPS's mini display menu, navigate to "Display" > "Backlight saving" and press the [Enter] key.
2. Use the <Left Arrow> and <Right Arrow> keys to toggle the setting.
3. Press the [Enter] key again to store the entry and exit the edit mode.

7 Controlling the R&S FPS Remotely

Since the R&S FPS was designed without a screen (except for the mini display for basic information and settings), it will typically be used to perform measurements under remote control. However, the developers of such programs will find it convenient to get familiar with the instrument and its functions using manual operation initially, and then design the programs accordingly. Once developed and tested, the programs can be executed from a remote PC, with no manual interaction required. The computer that is used for remote control is called "controller" here.

 All instrument functions and settings, as well as any background information, are described for manual operation, assuming an external keyboard, mouse and monitor are connected, or a controller PC with Remote Desktop is being used.

Various methods for remote control are supported:

- Connecting the instrument to a (LAN) network (see [Chapter 7.2, "How to Configure a Network"](#), on page 70)
- Using the web browser interface in a LAN network (see [Chapter 7.2.3, "How to Configure the LAN Using the Web Browser Interface"](#), on page 73)
- Using the Windows Remote Desktop application in a LAN network (see [Chapter 7.6, "How to Set Up Remote Desktop"](#), on page 82)

Remote operation

Remote operation of the instrument from a connected computer is possible using SCPI commands. Sending remote commands requires the instrument to be configured in a LAN network or connected to a PC via the GPIB interface as described in [Chapter 7.2, "How to Configure a Network"](#), on page 70 and [Chapter 7.5, "How to Start a Remote Control Session from a PC"](#), on page 81.

Manual operation via Remote Desktop

Remote Desktop is a Windows application which can be used to access and control the instrument from a remote computer through a LAN connection. While the R&S FPS is in operation, the instrument's graphical results and control elements are displayed on the remote computer, and Remote Desktop provides access to all of the applications, files, and network resources of the instrument. Thus,

remote (manual) operation of the instrument is possible. The following tasks can be performed using Remote Desktop:

- Access to the control functions via a virtual front panel
- Printout of measurement results directly from the controller
- Storage of measured data on the controller's hard disk

This documentation provides basic instructions on setting up the Remote Desktop for the R&S FPS. For details refer to the Windows 10 operating system documentation.

7.1 Remote Control Interfaces and Protocols

The instrument supports different interfaces and protocols for remote control. The following table gives an overview.

Table 7-1: Remote control interfaces and protocols

Inter- face	Protocols, VISA ^{*)} address string	Remarks
Local Area Network (LAN)	<ul style="list-style-type: none"> • HiSLIP High-Speed LAN Instrument Protocol (IVI-6.1) TCPIP::<host address="">::hislip0[::INSTR]</host> • VXI-11 TCPIP::<host address="">::inst0[::INSTR] Library: VISA</host> • socket communication (Raw Ethernet, simple Telnet) TCPIP::<host address="">:: LAN device name>::<port>::SOCKET Library: VISA or socket controller</host> 	<p>A LAN connector is located on the rear panel of the instrument.</p> <p>The interface is based on TCP/IP and supports various protocols.</p> <p>For a description of the protocols refer to:</p> <p>7.1.1.1 VXI-11 Protocol 7.1.1.2 HiSLIP Protocol 7.1.1.3 Socket Communication</p>
GPIB (IEC/ IEEE Bus Inter- face)	<p>VISA^{*)} address string: GPIB::<primary address="">[::INSTR] (no secondary address)</primary></p>	<p>A GPIB bus interface according to the IEC 625.1/IEEE 488.1 standard is located on the rear panel of the instrument.</p> <p>For a description of the interface refer to 7.1.2 GPIB Interface (IEC 625/IEEE 418 Bus Interface).</p>

Interface	Protocols, VISA ^{*)} address string	Remarks
USB	VISA ^{*)} address string: <pre>USB::<vendor id="">:::product_ID>::: serial_number>:::INSTR]</vendor></pre>	USB connectors are located on the front and rear panel of the instrument. For a description of the interface refer to 7.1.3 USB Interface .
^{*)} VISA is a standardized software interface library providing input and output functions to communicate with instruments. A VISA installation on the controller is a prerequisite for remote control using the indicated interfaces. (See also Chapter 7.1.4, "VISA Libraries" , on page 69).		

 Within this interface description, the term GPIB is used as a synonym for the IEC/IEEE bus interface.

7.1.1 LAN Interface

To be integrated in a LAN, the instrument is equipped with a LAN interface, consisting of a connector, a network interface card and protocols. The network card can be operated with the following interfaces:

- 10 Mbit/s Ethernet IEEE 802.3
- 100 Mbit/s Ethernet IEEE 802.3u
- 1Gbit/s Ethernet IEEE 802.3ab

For remote control via a network, the PC and the instrument must be connected via the LAN interface to a common network with TCP/IP network protocol. They are connected using a commercial RJ45 cable (shielded or unshielded twisted pair category 5). The TCP/IP network protocol and the associated network services are preconfigured on the instrument. Software for instrument control and the VISA program library must be installed on the controller.

VISA library

Instrument access is usually achieved from high level programming platforms using VISA as an intermediate abstraction layer. VISA encapsulates the low level VXI, GPIB, LAN or USB function calls and thus makes the transport interface transparent for the user. See [Chapter 7.1.4, "VISA Libraries"](#), on page 69 for details.

The R&S FPS supports various LAN protocols such as VXI11, RSIB, raw socket or the newer HiSLIP protocol.

IP address

Only the IP address or a valid DNS host name is required to set up the connection. The host address is part of the "VISA resource string" used by the programs to identify and control the instrument.

The VISA resource string has the form:

```
TCPIP::host address[::LAN device name][::INSTR]
```

or

```
TCPIP::host address::port::SOCKET
```

where:

- **TCPIP** designates the network protocol used
- **host address** is the IP address or host name of the device
- **LAN device name** defines the protocol and the instance number of a sub-instrument;
 - `inst0` selects the VXI-11 protocol (default)
 - `hislip0` selects the newer HiSLIP protocol
- **INSTR** indicates the instrument resource class (optional)
- **port** determines the used port number
- **SOCKET** indicates the raw network socket resource class

Example:

- Instrument has the IP address `192.1.2.3`; the valid resource string using VXI-11 protocol is:

```
TCPIP::192.1.2.3::INSTR
```

- The DNS host name is `FPS7-123456`; the valid resource string using HiSLIP is:

```
TCPIP::FPS7-123456::hislip0
```

- A raw socket connection can be established using:

```
TCPIP::192.1.2.3::5025::SOCKET
```

Identifying instruments in a network

If several instruments are connected to the network, each instrument has its own IP address and associated resource string. The controller identifies these instruments by the resource string.

For details on configuring the LAN connection, see [Chapter 7.2, "How to Configure a Network"](#), on page 70.

- [VXI-11 Protocol](#)..... 61
- [HiSLIP Protocol](#)..... 61
- [Socket Communication](#)..... 62
- [LAN Web Browser Interface](#)..... 62

7.1.1.1 VXI-11 Protocol

The VXI-11 standard is based on the ONC RPC (Open Network Computing Remote Procedure Call) protocol which in turn relies on TCP/IP as the network/transport layer. The TCP/IP network protocol and the associated network services are preconfigured. TCP/IP ensures connection-oriented communication, where the order of the exchanged messages is adhered to and interrupted links are identified. With this protocol, messages cannot be lost.

7.1.1.2 HiSLIP Protocol

The HiSLIP (**H**igh **S**peed **L**AN **I**nstrument **P**rotocol) is the successor protocol for VXI-11 for TCP-based instruments specified by the IVI foundation. The protocol uses two TCP sockets for a single connection - one for fast data transfer, the other for non-sequential control commands (e.g. `Device Clear` or `SRQ`).

HiSLIP has the following characteristics:

- High performance as with raw socket network connections
- Compatible IEEE 488.2 support for Message Exchange Protocol, Device Clear, Serial Poll, Remote/Local, Trigger, and Service Request
- Uses a single IANA registered port (4880), which simplifies the configuration of firewalls
- Supports simultaneous access of multiple users by providing versatile locking mechanisms
- Usable for IPv6 or IPv4 networks

 Using VXI-11, each operation is blocked until a VXI-11 device handshake returns. However, using HiSLIP, data is sent to the device using the "fire and forget" method with immediate return. Thus, a successful return of a VISA operation such as `viWrite()` does not guarantee that the instrument has finished or started the requested command, but is delivered to the TCP/IP buffers.

For more information see also the application note:

[1MA208: Fast Remote Instrument Control with HiSLIP](#)

7.1.1.3 Socket Communication

An alternative way for remote control of the software is to establish a simple network communication using sockets. The socket communication, also referred to as "Raw Ethernet communication", does not necessarily require a VISA installation on the remote controller side. It is available by default on all operating systems.

The simplest way to establish socket communication is to use the built-in telnet program. The telnet program is part of every operating system and supports a communication with the software on a command-by-command basis. For more convenience and to enable automation by means of programs, user-defined sockets can be programmed.

Socket connections are established on a specially defined port. The socket address is a combination of the IP address or the host name of the instrument and the number of the port configured for remote-control. All R&S FPS use port number 5025 for this purpose. The port is configured for communication on a command-to-command basis and for remote control from a program.

7.1.1.4 LAN Web Browser Interface

The LAN web browser interface allows for easy configuration of the LAN and remote control of the R&S FPS without additional installation requirements.

The instrument's LAN web browser interface works correctly with all W3C compliant browsers.

Via the web browser interface to the R&S FPS you can control the instrument remotely from another PC. Manual instrument controls are available via the front

panel simulation. File upload and download between the instrument and the remote PC is also available. Using this feature, several users can access *and operate* the R&S FPS simultaneously. This is useful for troubleshooting or training purposes.

For details, see [Chapter 7.2.3, "How to Configure the LAN Using the Web Browser Interface"](#), on page 73 and [Chapter 7.7, "How to Control the R&S FPS via the Web Browser Interface"](#), on page 91.

 If you do not want other users in the LAN to be able to access and operate the R&S FPS you can deactivate this function.
See [Chapter 7.8, "How to Deactivate the Web Browser Interface"](#), on page 93.

Restrictions

Only user accounts with administrator rights can use the LAN web browser functionality.

To configure the LAN interface using the web browser Interface, a controller PC or an external monitor, mouse and keyboard must be connected to the R&S FPS. The settings required to set up this function are available directly on the R&S FPS, via the mini display.

If no external monitor is connected to the R&S FPS, an additional driver is required on the instrument in order to control the R&S FPS via its web browser interface. If the driver is not available, the browser shows only a black screen.

Download the **TightVNC DFMirage driver** from the official TightVNC website (<http://www.tightvnc.com/download.php>) and install it on the R&S FPS as described on the website.

The current R&S FPS firmware was tested with the TightVNC DFMirage driver version 2.0.301.

To display the LAN web browser interface

- ▶ In the address field of the browser on your PC, type the host name or IP address of the instrument, for example: `http://10.113.10.203`.

The instrument home page (welcome page) opens.

Note: If only a black screen is displayed in the browser, install the required driver (see ["Restrictions"](#) on page 63).

The screenshot shows a web browser window displaying the LXI Instrument Home Page. The browser address bar shows the URL `http://10.██████████/web/html/ihp.php`. The page features the Rohde & Schwarz logo and the LXI logo. A navigation pane on the left contains the following sections:

- LXI**
 - Home
 - Lan Configuration
 - Status
 - Utilities
- Instrument Control**
 - Web Control
 - File Download
 - File Upload
- License Manager**
 - Manage Licenses
- Help**
 - Glossary
 - www.rohde-schwarz.com

The main content area is titled "Instrument Properties" and displays the following information:

Instrument Model	R&S FPS Spectrum Analyzer
Manufacturer	Rohde & Schwarz GmbH & Co. KG
Serial Number	100005
Description	R&S FPS-100005
LXI Version	1.4 LXI Core 2011
LXI Extended Features	LXI HiSLIP
DNS Host Name(s)	██████████
MAC Address	██████████
IP Address	10.██████████
Firmware Revision	1.40a 28 Beta
Current Time	Wednesday, 2015/06/03, 10:36:46
Current Time source	Operating System
VISA resource string	TCPIP::10.██████████:inst0::INSTR TCPIP::10.██████████:hislip0::INSTR
Device Indicator	<input type="button" value="INACTIVE (press to toggle)"/>

At the bottom of the page, there is a "Status" section showing "No error" and a copyright notice: "© 2015 ROHDE&SCHWARZ. All rights reserved."

The navigation pane of the browser interface contains the following elements:

- "LAN"
 - "Home" opens the instrument home page. The home page displays device information, including the VISA resource string in read-only format. The "Device Indicator" button allows you to physically identify the instrument. This is useful if you have several instruments and want to know which instrument the LAN home page belongs to. To identify the instrument, activate the "Device Indicator". Then check the "LAN Status" indicator of the instruments.
 - "LAN Configuration" allows you to configure LAN parameters and to initiate a ping. (See "Ping Client" on page 75.)
 - "Utilities" provides access to an event log.
- "Instrument Control"

Remote Control Interfaces and Protocols

- "Web Control" provides remote access to the instrument via VNC (no installation required). Manual instrument controls are available via the front panel simulation.
- "File Download" downloads files from the instrument.
- "File Upload" uploads files to the instrument.

(See [Chapter 7.7, "How to Control the R&S FPS via the Web Browser Interface"](#), on page 91.)

- "License Manager"
 - "License Manager" allows you to install or uninstall license keys and to activate, register or unregister licenses.
- "Help"
 - "www.rohde-schwarz.com" opens the Rohde & Schwarz home page.

7.1.2 GPIB Interface (IEC 625/IEEE 418 Bus Interface)

By connecting a PC to the R&S FPS via the GPIB connection you can send remote commands to control and operate the instrument.

To be able to control the instrument via the GPIB bus, the instrument and the controller must be linked by a GPIB bus cable. A GPIB bus card, the card drivers and the program libraries for the programming language used must be provided in the controller. The controller must address the instrument with the GPIB bus address (see [Chapter 7.2.4, "How to Change the GPIB Instrument Address"](#), on page 76). You can set the GPIB address and the ID response string. The GPIB language is set as SCPI by default and cannot be changed for the R&S FPS.

Notes and Conditions

In connection with the GPIB interface, note the following:

- Up to 15 instruments can be connected
- The total cable length is restricted to a maximum of 15 m or 2 m times the number of devices, whichever is less; the cable length between two instruments should not exceed 2 m.
- A wired "OR"-connection is used if several instruments are connected in parallel.
- Any connected IEC-bus cables should be terminated by an instrument or controller.

7.1.2.1 GPIB Interface Messages

Interface messages are transmitted to the instrument on the data lines, with the attention line (ATN) being active (LOW). They are used for communication between the controller and the instrument and can only be sent by a computer which has the function of a GPIB bus controller. GPIB interface messages can be further subdivided into:

- **Universal commands:** act on all instruments connected to the GPIB bus without previous addressing
- **Addressed commands:** only act on instruments previously addressed as listeners

The following figure provides an overview of the available communication lines used by the GPIB interface.

Remote Control Interfaces and Protocols

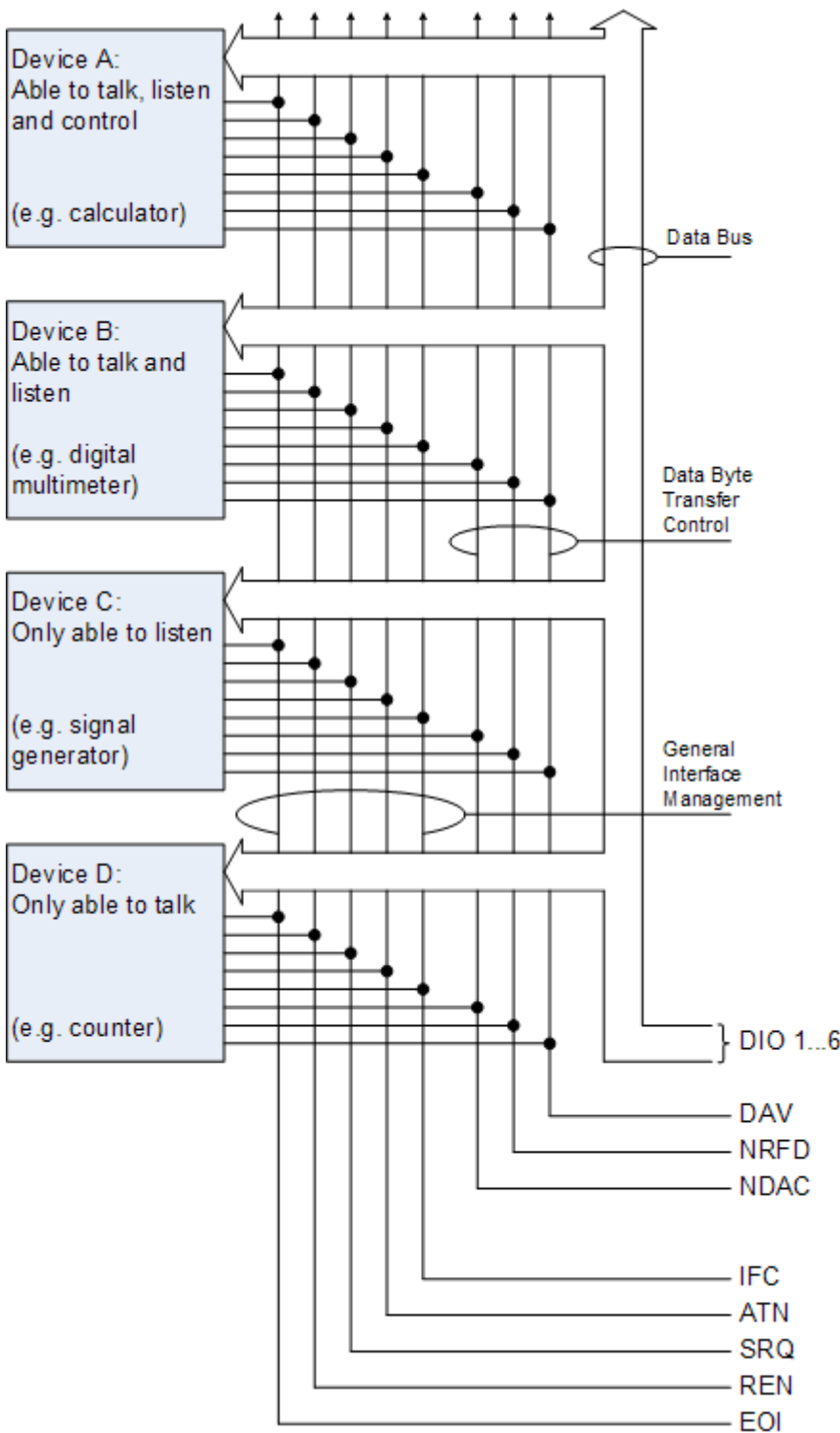

Figure 7-1: Communication lines used by the GPIB interface

Universal Commands

Universal commands are encoded in the range 10 through 1F hex. They affect all instruments connected to the bus and do not require addressing.

Command	Effect on the instrument
DCL (Device Clear)	Aborts the processing of the commands just received and sets the command processing software to a defined initial state. Does not change the instrument settings.
IFC (Interface Clear) *)	Resets the interfaces to the default setting.
LLO (Local Lockout)	The "Local" softkey is disabled. Manual operation is no longer available until <code>GTL</code> is executed.
SPE (Serial Poll Enable)	Ready for serial poll.
SPD (Serial Poll Disable)	End of serial poll.
PPU (Parallel Poll Unconfigure)	End of the parallel-poll state.
*) IFC is not a real universal command, it is sent via a separate line; however, it also affects all instruments connected to the bus and does not require addressing	

Addressed Commands

Addressed commands are encoded in the range 00 through 0F hex. They only affect instruments addressed as listeners.

Command	Effect on the instrument
GET (Group Execute Trigger)	Triggers a previously active instrument function (e.g. a sweep). The effect of the command is the same as with that of a pulse at the external trigger signal input.
GTL (Go to Local)	Transition to the "local" state (manual control).
GTR (Go to Remote)	Transition to the "remote" state (remote control).
PPC (Parallel Poll Configure)	Configures the instrument for parallel poll.
SDC (Selected Device Clear)	Aborts the processing of the commands just received and sets the command processing software to a defined initial state. Does not change the instrument setting.

7.1.3 USB Interface

For remote control via the USB connection, the PC and the instrument must be connected via the USB type B interface. A USB connection requires the VISA library to be installed. VISA detects and configures the R&S instrument automati-

cally when the USB connection is established. You do not have to enter an address string or install a separate driver.

USB address

The used USB address string is:

```
USB::::<product ID>::[::INSTR]
```

where:

- <vendor ID> is the vendor ID for Rohde & Schwarz (0x0AAD)
- <product ID> is the product ID for the Rohde & Schwarz instrument
- <serial number> is the individual serial number on the rear of the instrument

Table 7-2: Product IDs for R&S FPS

Instrument model	Product ID
FPS4	F9
FPS7	FA
FPS13	FB
FPS30	FC
FPS40	FD

Example:

```
USB::0x0AAD::0x00FB::100001::INSTR
```

0x0AAD is the vendor ID for Rohde & Schwarz

0x00FB is the product ID for the R&S FPS13

100001 is the serial number of the particular instrument

7.1.4 VISA Libraries

VISA is a standardized software interface library providing input and output functions to communicate with instruments. The I/O channel (LAN or TCP/IP, USB, ...) is selected at initialization time by one of the following:

- The channel-specific address string ("VISA resource string") indicated in [Table 7-1](#)
- An appropriately defined VISA alias (short name).

A VISA installation is a prerequisite for remote control using the following interfaces:

- [Chapter 7.1.2, "GPIB Interface \(IEC 625/IEEE 418 Bus Interface\)"](#), on page 65
- [Chapter 7.1.1, "LAN Interface"](#), on page 59
- [Chapter 7.1.3, "USB Interface"](#), on page 68

For more information about VISA, refer to the user documentation.

7.2 How to Configure a Network

NOTICE

Risk of network failure

Consult your network administrator before performing the following tasks:

- Connecting the instrument to the network
- Configuring the network
- Changing IP addresses
- Exchanging hardware

Errors can affect the entire network.

The R&S FPS is equipped with a network interface and can be connected to an Ethernet LAN (local area network). Provided the appropriate rights have been assigned by the network administrator and the Windows 10 firewall configuration is adapted accordingly, the interface can be used, for example:

- To transfer data between a controller and the tester, e.g. in order to run a remote control program; see the "Remote Control" chapter in the R&S FPS User Manual
- To access or control the measurement from a remote computer using the "Remote Desktop" application (or a similar tool); see [Chapter 7.6, "How to Set Up Remote Desktop"](#), on page 82
- To connect external network devices (e.g. printers)
- To transfer data from a remote computer and back, e.g. using network folders

A precondition for operating or monitoring the R&S FPS remotely is that it is connected to a LAN network or a PC connected to the GPIB interface. This is described here.

Windows Firewall Settings

A firewall protects an instrument by preventing unauthorized users from gaining access to it through a network. Rohde & Schwarz highly recommends the use of the firewall on your instrument. R&S instruments are shipped with the Windows firewall enabled and preconfigured in such a way that all ports and connections for remote control are enabled. For more details on firewall configuration see the Rohde & Schwarz White Paper [1DC01: Malware Protection](#) and the Windows 10 help system.

7.2.1 How to Connect the Instrument to the Network

There are two methods to establish a LAN connection to the instrument:

- A non-dedicated network (Ethernet) connection from the instrument to an existing network made with an ordinary RJ-45 network cable. The instrument is assigned an IP address and can coexist with a computer and with other hosts on the same network.
- A dedicated network connection (Point-to-point connection) between the instrument and a single computer made with a (crossover) RJ-45 network cable. The computer must be equipped with a network adapter and is directly connected to the instrument. The use of hubs, switches, or gateways is not required, however, data transfer is still performed using the TCP/IP protocol. An IP address has to be assigned to the instrument and the computer, see [Chapter 7.2.2, "How to Assign the IP Address"](#), on page 72.

Note: As the R&S FPS uses a 1 GBit LAN, a crossover cable is not necessary (due to Auto-MDI(X) functionality).

- ▶ To establish a non-dedicated network connection, connect a commercial RJ-45 cable to one of the LAN ports.
To establish a dedicated connection, connect a (crossover) RJ-45 cable between the instrument and a single PC.

If the instrument is connected to the LAN, Windows 10 automatically detects the network connection and activates the required drivers.

The network card can be operated with a 1 GBit Ethernet IEEE 802.3u interface.

7.2.2 How to Assign the IP Address

Depending on the network capacities, the TCP/IP address information for the instrument can be obtained in different ways.

- If the network supports dynamic TCP/IP configuration using the Dynamic Host Configuration Protocol (DHCP), all address information can be assigned automatically.
- If the network does not support DHCP, or if the instrument is set to use alternate TCP/IP configuration, the addresses must be set manually.

By default, the instrument is configured to use dynamic TCP/IP configuration and obtain all address information automatically. This means that it is safe to establish a physical connection to the LAN without any previous instrument configuration.

NOTICE

Risk of network errors

Connection errors can affect the entire network. If your network does not support DHCP, or if you choose to disable dynamic TCP/IP configuration, you must assign valid address information before connecting the instrument to the LAN. Contact your network administrator to obtain a valid IP address.

Assigning the IP address directly on the R&S FPS

1. In the R&S FPS's mini display, navigate to "Network" > "DHCP".
2. If DHCP is "Off", you must enter the IP address manually, as described in the following steps.

Note: When DHCP is changed from "On" to "Off", the previously set IP address and subnet mask are retrieved.

If DHCP is "On", the IP address of the DHCP server is obtained automatically. The configuration is saved, and you are prompted to restart the instrument. You can skip the remaining steps.

Note: When a DHCP server is used, a new IP address may be assigned each time the instrument is restarted. This address must first be determined on the instrument itself. Thus, when using a DHCP server, it is recommended that you use the permanent computer name, which determines the address via the DNS server.

3. In the R&S FPS's mini display, navigate to "Network" > "IP".
4. Enter the "IP Address", for example *10.0.0.10*. The IP address consists of four number blocks separated by dots. Every block contains 3 numbers in maximum.
Enter the required address: Use the <Up Arrow> and <Down Arrow> keys to scroll through the digits 1-10 and the <Left Arrow> and <Right Arrow> keys to move between the individual numbers and blocks.
5. Enter the "Subnet Mask", for example *255.255.255.0*. The subnet mask consists of four number blocks separated by dots. Every block contains 3 numbers in maximum.
6. Press the [Enter] key to store the entry and exit the edit mode.
7. In the R&S FPS's mini display, navigate to "System commands" > "Reboot system" to restart the system.

7.2.3 How to Configure the LAN Using the Web Browser Interface

The instrument's "LAN" web browser interface works correctly with all W3C compliant browsers.

 If no external monitor is connected to the R&S FPS, an additional driver is required on the instrument in order to control the R&S FPS via its web browser interface. If the driver is not available, the browser shows only a black screen.

Download the **TightVNC DFMirage driver** from the official TightVNC website (<http://www.tightvnc.com/download.php>) and install it on the R&S FPS as described on the website.

The current R&S FPS firmware was tested with the TightVNC DFMirage driver version 2.0.301.

- ▶ In the web browser, open the `http://<instrument-hostname>` or `http://<instrument-ip-address>` page, e.g. `http://10.113.10.203`. The default password to change "LAN" configurations is *LxiWebIfc*. The "Instrument Home Page" (welcome page) opens.

The screenshot shows the Instrument Home Page in a web browser. The browser address bar displays `http://10.██████████/web/html/ihp.php`. The page header includes the R&S logo and the LXI logo. A left-hand navigation pane contains the following sections:

- LXI**
 - Home
 - Lan Configuration
 - Status
 - Utilities
- Instrument Control**
 - Web Control
 - File Download
 - File Upload
- License Manager**
 - Manage Licenses
- Help**
 - Glossary
 - www.rohde-schwarz.com

The main content area is titled "Instrument Properties" and displays the following information:

Instrument Model	R&S FPS Spectrum Analyzer
Manufacturer	Rohde & Schwarz GmbH & Co. KG
Serial Number	100005
Description	R&S FPS-100005
LXI Version	1.4 LXI Core 2011
LXI Extended Features	LXI HiSLIP
DNS Host Name(s)	██████████
MAC Address	██████████
IP Address	10.██████████
Firmware Revision	1.40a 28 Beta
Current Time	Wednesday, 2015/06/03, 10:36:46
Current Time source	Operating System
VISA resource string	TCPIP::10.██████████:inst0::INSTR TCPIP::10.██████████:hislip0::INSTR
Device Indicator	<input type="button" value="INACTIVE (press to toggle)"/>

At the bottom of the main content area, there is a "Status" section showing "No error". The footer of the page contains the copyright notice: "© 2015 ROHDE&SCHWARZ. All rights reserved."

The instrument home page displays device information, including the VISA resource string, in read-only format.



- ▶ Press the "Device Indicator" button on the "Instrument Home Page" to activate or deactivate the "LAN" status icon on the status bar of the R&S FPS. A green "LAN" status symbol indicates that a LAN connection has been established; a red symbol indicates an error, for example, that no LAN cable is connected. When a device is connecting to the instrument, the "LAN" icon blinks. The "Device Indicator" setting is not password-protected.

The most important control elements in the navigation pane of the browser interface are the following:

- "LAN Configuration" opens the menu with configuration pages.
- "Status" displays information about the "LAN" status of the instrument.

7.2.3.1 LAN Configuration

The LAN configuration consists of three parts:

- "IP configuration" provides all mandatory LAN parameters.
- "Advanced LAN Configuration" provides further LAN settings.
- "Ping Client" provides the ping utility to verify the connection between the instrument and other devices.

IP Configuration

The "LAN Configuration > IP configuration" web page displays all mandatory LAN parameters and allows their modification.

The "TCP/IP Mode" configuration field controls how the IP address for the instrument gets assigned (see also [Chapter 7.2.2, "How to Assign the IP Address"](#), on page 72).

For the manual configuration mode, the static IP address, subnet mask, and default gateway are used to configure the LAN. The automatic configuration mode uses DHCP server or Dynamic Link Local Addressing (Automatic IP) to obtain the instrument IP address.

 Changing the LAN configuration is password-protected. The default password is *LxiWebIfc* (notice upper and lower case characters).

Advanced LAN Configuration

The "LAN Configuration > Advanced LAN Configuration" parameters are used as follows:

- The "Negotiation" configuration field provides different Ethernet speed and duplex mode settings. In general, the "Auto Detect" mode is sufficient.
- "ICMP Ping" must be enabled to use the ping utility.
- "VXI-11" is the protocol that is used to detect the instrument in the LAN.
- mDNS and DNS-SD are two additional protocols: Multicast DNS and DNS Service Discovery. They are used for device communication in zero configuration networks working without DNS and DHCP

Ping Client

Ping is a utility that verifies the connection between the instrument and another device. The ping command uses the ICMP echo request and echo reply packets

to determine whether the LAN connection is functional. Ping is useful for diagnosing IP network or router failures. The ping utility is not password-protected.

To initiate a ping between the instrument and a second connected device:

1. Enable "ICMP Ping" on the "Advanced LAN Configuration" page (enabled after an LCI).
2. Enter the IP address of the second device **without the ping command and without any further parameters** into the "Destination Address" field (e.g. *10.113.10.203*).
3. Select "Submit".

7.2.4 How to Change the GPIB Instrument Address

In order to operate the instrument via remote control, it must be addressed using the GPIB address. The remote control address is factory-set to 20, but it can be changed if it does not fit in the network environment. For remote control, addresses 0 through 30 are allowed. The GPIB address is maintained after a reset of the instrument settings.

To change the GPIB address

1. In the R&S FPS's mini display menu, navigate to "GPIB" > "GPIB address" and press the [Enter] key.
2. Enter the required address: Use the <Up Arrow> and <Down Arrow> keys to scroll through the digits 1-10 and the <Left Arrow> and <Right Arrow> keys to move between the first and second digits.
3. Press the [Enter] key again to store the entry and exit the edit mode.

Remote command:

```
SYST:COMM:GPIB:ADDR 18
```

7.3 How to Log on to the Network

Windows 10 requires that users identify themselves by entering a user name and password in a login window. You can set up two types of user accounts, either an

How to Log on to the Network

administrator account with unrestricted access to the computer/domain or a standard user account with limited access. The instrument provides an auto-login function for the administrator account, i.e. login with unrestricted access is carried out automatically in the background. By default, the user name for the administrator account is "Instrument", and the user name for the standard user account is "NormalUser". In both cases the initial password is "894129". You can change the password in Windows 10 for any user at any time. Some administrative tasks require administrator rights (e.g. firmware updates or the configuration of a LAN network).

At the same time you log on to the operating system, you are automatically logged on to the network. As a prerequisite, the user name and the password must be identical on the instrument and on the network.

7.3.1 How to Create Users

After the software for the network has been installed, the instrument issues an error message the next time it is switched on because there is no user named "instrument" (= default user ID for Windows 10 automatic login) in the network. Thus, a matching user must be created in the R&S FPS and in the network, the password must be adapted to the network password, and the automatic login mechanism must then be deactivated.

 In order to configure users for the R&S FPS, a controller pc or an external monitor, mouse and keyboard must be connected to the R&S FPS. See [Chapter 7.6, "How to Set Up Remote Desktop"](#), on page 82.

The network administrator is responsible for creating new users in the network. A new user can be created on the instrument using the "User Account" dialog box:

1. 
Select the "Windows" icon in the toolbar to access the operating system of the R&S FPS.
2. In the "Start" menu, select "Control Panel" and then select "User Accounts."
3. Select "Give other users access to this computer" and then "Add".
The "Add New User" dialog box is displayed.
4. Enter the name of the new user in the text field and select "Next".

5. Define the level of access you want to allow the new user:
 - Select "Standard" to create an account with limited rights.
 - Select "Administrator" to create an account with administrator rights.

Note: Full firmware functionality requires administrator rights.
6. Select the "Finish" button.
The new user is created.

7.3.2 How to Change the User Password

 In order to change the user passwords for the R&S FPS, a controller pc or an external monitor, mouse and keyboard must be connected to the R&S FPS. See [Chapter 7.6, "How to Set Up Remote Desktop"](#), on page 82.

After the new user has been created on the instrument, the password must be adapted to the network password. This is also done using the "User Accounts" dialog box.

1. 

Select the "Windows" icon in the toolbar to access the operating system of the R&S FPS.

2. Select [Ctrl + Alt + Delete], then select "Change a password".
3. Enter the user account name.
4. Enter the old password.
5. Enter the new password in the upper text line and repeat it in the following line.
6. Select [Enter].
The new password is now active.

7.3.3 How to Configure the Automatic Login Mechanism

 In order to activate or deactivate the automatic login mechanism on the R&S FPS, a controller pc or an external monitor, mouse and keyboard must be connected to the R&S FPS. See [Chapter 7.6, "How to Set Up Remote Desktop"](#), on page 82.

Adapting the auto-login function to a new password

If you change the password that is used during auto-login, this function no longer works. Adapt the settings for the auto-login function first.

If the SecureUser or the NormalUser are enabled, those passwords are used for autologin. In that case, if you change any of the passwords, the autologin function must be adapted each time you change the user account.

1. Open the `C:\R_S\INSTR\USER\user\AUTOLOGIN.REG` file in any text editor (e.g. Notepad).
2. In the line `"DefaultPassword"="894129"`, replace the default password (894129) by the new password for automatic login.
3. Save the changes to the file.
4. In the Windows "Start" menu, select "Run".
The "Run" dialog box is displayed.
5. Enter the command `C:\R_S\INSTR\USER\user\AUTOLOGIN.REG`.
6. Press the [ENTER] key to confirm.
The auto-login function is reactivated with the changed password. It will be applied the next time the instrument is switched on.

Switching users when using the auto-login function

Which user account is used is defined during login. If auto-login is active, the login window is not displayed. However, you can switch the user account to be used even when the auto-login function is active.

1. Select the "Windows" icon in the toolbar to access the operating system of the R&S FPS (see also ["To access the "Start" menu"](#) on page 28).



How to Share Directories (only with Microsoft Networks)

2. Press [CTRL] + [ALT] + [DEL], then select "Sign out".

The "Login" dialog box is displayed, in which you can enter the different user account name and password.

Deactivating the auto-login function

When shipped, the instrument is already configured to automatically log on the "instrument" user under Windows 10. To deactivate the auto-login function, perform the following steps:

1. In the "Start" menu, select "Run".
The "Run" dialog box is displayed.
2. Enter the command `C:\R_S\INSTR\USER\user\NO_AUTOLOGIN.REG`.
3. Press the [ENTER] key to confirm.
The auto-login function is deactivated. The next time you switch on the instrument, you are prompted to enter your user name and password before the firmware is started.

Reactivating the auto-login function

To reactivate the auto-login function after manually deactivating it, perform the following steps:

1. In the "Start" menu, select "Run".
The "Run" dialog box is displayed.
2. Enter the command `C:\R_S\INSTR\USER\user\AUTOLOGIN.REG`.
3. Press the [ENTER] key to confirm.
The auto-login function is reactivated. It will be applied the next time the instrument is switched on.

7.4 How to Share Directories (only with Microsoft Networks)

Sharing directories makes data available for other users. This is only possible in Microsoft networks. Sharing is a property of a file or directory.

How to Start a Remote Control Session from a PC

 In order to configure shared directories on the R&S FPS, a controller pc or an external monitor, mouse and keyboard must be connected to the R&S FPS. See [Chapter 7.6, "How to Set Up Remote Desktop"](#), on page 82.

1. 

Select the "Windows" icon in the toolbar to access the operating system of the R&S FPS.

2. In the "Start" menu, select "Programs", "Accessories" and then select "Windows Explorer".
3. Select the desired folder with the right mouse button.
4. In the context menu, select "Sharing with > Specific people".
The dialog box for sharing a directory is displayed.
5. Select a user from the list or add a new name and select the "Add" button.
6. Select the "Share" button.
7. Select "Done" to close the dialog box.
The drive is shared and can be accessed by the selected users.

7.5 How to Start a Remote Control Session from a PC

When you switch on the instrument, it is always in manual operation state ("local" state) and can be operated via Remote Desktop from an external PC.

1. Send an addressed command (G_{TR} - Go to Remote) from a controller to the instrument.

The instrument is switched to remote control ("remote" state). Operation via the soft front panel (on the Remote Desktop) is disabled. (The keys on the R&S FPS remain enabled.) The instrument remains in the remote state until it is reset to the manual state via the remote control interface.

Switching from manual operation to remote control and vice versa does not affect the other instrument settings.

2. To obtain optimum performance during remote control, send the `SYSTEM:DISPLAY:UPDATE OFF` command to hide the display of results and diagrams on the controller PC or external monitor (default setting in remote control).
3. To enable manual operation via the soft front panel on the Remote Desktop again, switch the instrument to local mode using the remote command `GTL` (Go to Local), that is, deactivate the `REN` line of the remote control interface.

7.6 How to Set Up Remote Desktop

Remote Desktop is a Windows application which can be used to access and control the instrument from a remote computer through a LAN connection. While the instrument is in operation, the instrument uses the display on the remote computer, and Remote Desktop provides access to all of the applications, files, and network resources of the instrument. Thus, remote operation of the R&S FPS is possible.

With Windows 10, Remote Desktop Client is part of the operating system. For other versions of Windows, Microsoft offers the Remote Desktop Client as an add-on.

This section provides basic instructions on setting up the Remote Desktop for the R&S FPS. For details refer to the Windows 10 operating system documentation.

7.6.1 How to Configure the R&S FPS for Remote Operation via Remote Desktop

 By default, the R&S FPS is configured to allow Remote Desktop access by any user (except for the "SecureUser", see [Chapter 7.6.5, "How to Add or Remove Users to the Remote Desktop Users Group"](#), on page 88).

To change the settings for remote operation, you must connect an external monitor, mouse and keyboard, or connect a controller PC and set up a Remote Desktop connection with the default settings as described in [Chapter 7.6.3, "How to Start and Close the Remote Desktop"](#), on page 86.

To change the settings for Remote Desktop access

1. 

Select the "Windows" icon in the toolbar to access the operating system of the R&S FPS.

2. In the "Start" menu, select the "Control Panel" and then "System and Security".

3. In the "System" area, select "Allow remote access".

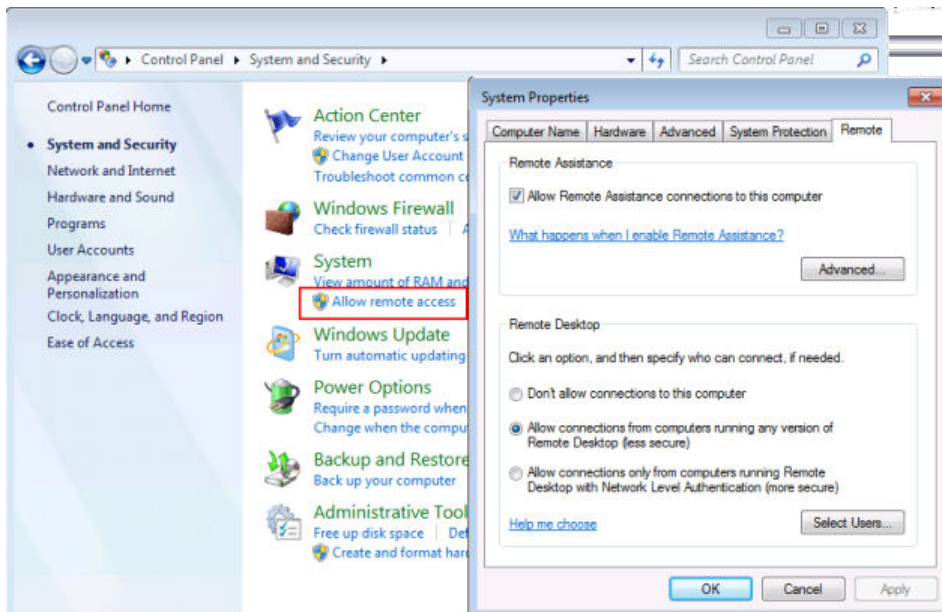

4. In the "Remote" tab, in the "Remote Desktop" area, activate the "Allow connections from computers running Remote Desktop" option.

5. Define which users are to be given access to the R&S FPS via Remote Desktop.

If the secure user mode is deactivated, the "SecureUser" account is also deactivated. Thus, the procedure described here will not work for the "SecureUser". Instead, see [Chapter 7.6.5, "How to Add or Remove Users to the Remote Desktop Users Group"](#), on page 88.

Note: Administrator user accounts (e.g. "Instrument") are automatically enabled for Remote Desktop.

- Select the "Select Users" button.
- Select the users or create new user accounts as described in [Chapter 7.3.1, "How to Create Users"](#), on page 77.
- Select "OK" to confirm the settings.

6. The R&S FPS is now ready for connection setup with the Remote Desktop program of the controller.

7.6.2 How to Configure the Controller



Remote Desktop Client

With Windows 10, Remote Desktop Client is part of the operating system and can be accessed via "Start > Programs > Accessories > Remote Desktop Connection".

For other versions of Windows, Microsoft offers the Remote Desktop Client as an add-on.

1. In the "Start" menu of the controller, select "All Programs > Accessories > Remote Desktop Connection".
The "Remote Desktop Connection" dialog box is displayed.
2. Select the "Options >>" button.
The dialog box is expanded to display the configuration data.

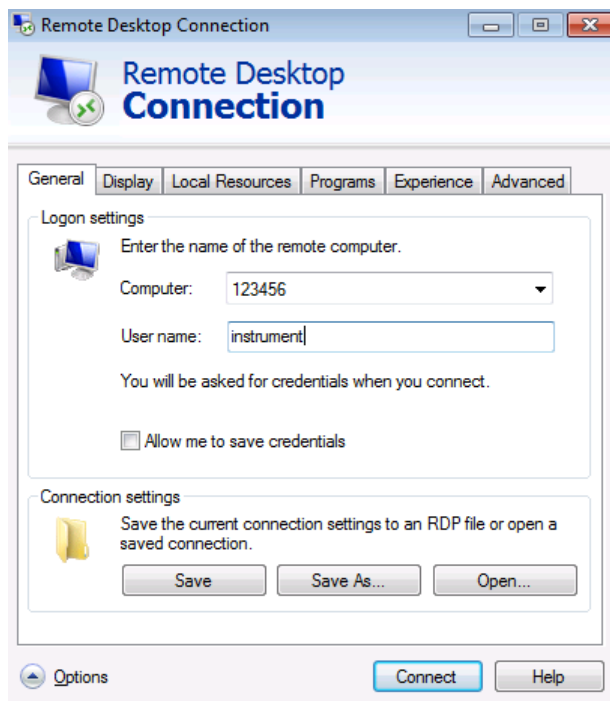

3. Open the "Experience" tab.
The settings on this tab are used to select and optimize the connection speed.

How to Set Up Remote Desktop

4. In the list, select the appropriate connection (for example: LAN (10 Mbps or higher)).
Depending on your selection (and how powerful the connection is), the options are activated or deactivated.
5. To improve the performance, you can deactivate the "Desktop background", "Show window contents while dragging" and "Menu and window animation" options.
6. Open the "Local Resources" tab to enable printers, local drives and serial interfaces.
7. If you will need to access drives of the controller from the R&S FPS (e.g. in order to store settings or to copy files from the controller to the R&S FPS), activate the "Disk drives" option.
Windows will then map drives of the controller to the corresponding network drives.
8. To use printers connected to the controller while accessing them from the R&S FPS, activate the "Printers" options. Do not change the remaining settings.
9. Open the "Display" tab.
The options to configure the R&S FPS screen display are displayed.
10. Under "Remote desktop size", you can set the size of the R&S FPS window on the desktop of the controller.
11. Under "Colors", do not change the settings.
12. Set the "Display the connection bar when I use the full screen" option:
If activated, a bar showing the network address of the R&S FPS will appear at the top edge of the screen. You can use this bar to reduce, minimize or close the window.
If deactivated, the only way you can return to the controller desktop from the R&S FPS screen in full screen mode is to select "Disconnect" from the "Start" menu.

7.6.3 How to Start and Close the Remote Desktop

To set up a connection from the controller to the R&S FPS

1. On the controller, in the "Remote Desktop Connection" dialog box (see [Chapter 7.6.2, "How to Configure the Controller"](#), on page 84), open the "General" tab.
2. In the "Computer" field, enter the IP address of the R&S FPS (see [Chapter 7.2.2, "How to Assign the IP Address"](#), on page 72 to determine the IP address).
In the "User name" field, enter *instrument* to log in as an administrator, or *Normal User* to log in as a standard user.
In the "Password" field, enter 894129.
3. To save the connection configuration for later use:
 - a) Select the "Save As" button.
The "Save As" dialog box is displayed.
 - b) Enter the name for the connection information (*.RDP).
4. To load an existing connection configuration:
 - a) Select the "Open" button.
The "Open" dialog box is displayed.
 - b) Select the *.RDP file.
5. Select the "Connect" button.
The connection is set up.
6. If the "Disk drives" option is activated on the "Local Resources" tab, a warning is displayed indicating that the drives are enabled for access from the R&S FPS.
Select "OK" to confirm the warning.
7. After a few moments, the R&S FPS screen is displayed and manual operation is possible.
For details on manual operation see [Chapter 8, "Operating the Instrument in Manual Mode"](#), on page 95.
8. If a dark screen appears or a dark square appears in the upper left-hand corner of the screen, you must restart the R&S FPS in order to see the modified screen resolution.

How to Set Up Remote Desktop

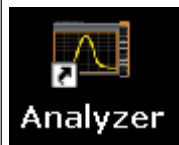

Analyzer

- Select the key combination [ALT] + [F4].
- The R&S FPS firmware is shut down, which may take a few seconds.
- On the desktop, double-click the "Analyzer" icon.

The firmware restarts and then automatically opens the graphical user interface from which you can access all instrument functions and settings.

For more information see [Chapter 8.1.3, "Front Panels"](#), on page 98.

9. After the connection is established, the R&S FPS screen is displayed in the "Remote Desktop" application window.

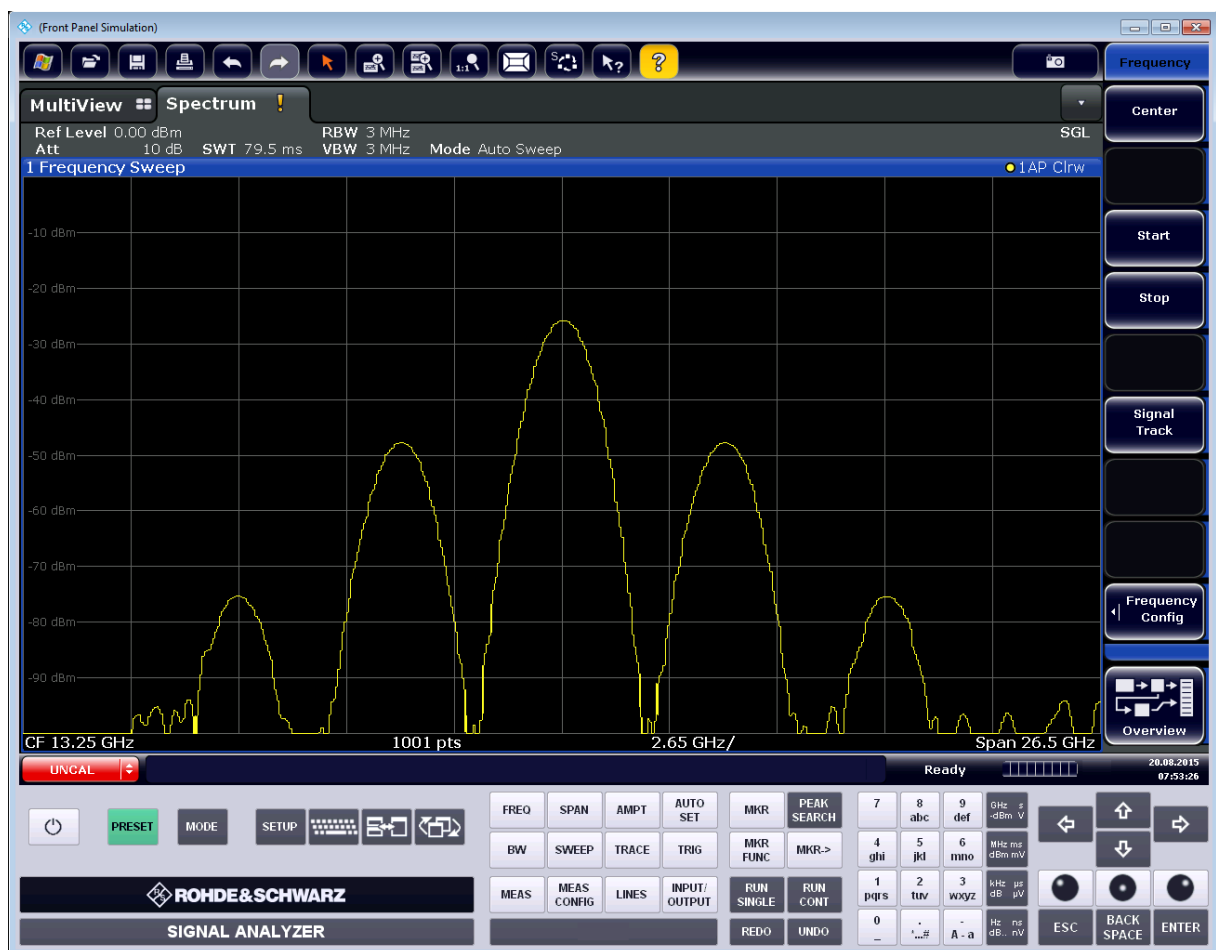

To terminate Remote Desktop control

- ▶ On the controller, close the "Remote Desktop" window at any time. The connection to the R&S FPS is terminated.

Restoring the connection to the R&S FPS

Follow the instructions above for setting up a connection to the R&S FPS. If the connection is terminated and then restored, the R&S FPS remains in the same state.

7.6.4 How to Shut Down the R&S FPS via Remote Desktop

1. 

Select the "Windows" icon in the toolbar to access the operating system of the R&S FPS.

2. In the "Start" menu, enter `cmd` to start a command prompt window.
3. In the command prompt window, enter `shutdown /s`.

The connection with the controller is terminated and the R&S FPS is shut down.

7.6.5 How to Add or Remove Users to the Remote Desktop Users Group

Only users in the Remote Desktop Users Group are allowed to connect to the R&S FPS via Remote Desktop. You can add the users to this group directly when you allow remote access on the R&S FPS, as described in [Chapter 7.6, "How to Set Up Remote Desktop"](#), on page 82. Furthermore, you can add or remove users to this group at any time.

 In order to add or remove users to the Remote Desktop users group for the R&S FPS, a controller pc or an external monitor, mouse and keyboard must be connected to the R&S FPS. See [Chapter 7.6, "How to Set Up Remote Desktop"](#), on page 82.

Secure User Mode

For security reasons, the "SecureUser" used in secure user mode is not allowed Remote Desktop access to the R&S FPS by default (see [Chapter 4.15, "Protecting Data Using the Secure User Mode"](#), on page 33). You must explicitly add the "SecureUser" to the Remote Desktop group. If you do not allow this user RemoteDesktop access, the "SecureUser" will only be able to operate the R&S FPS using remote commands or via the mini display.

1. If necessary, disable the "SecureUser" on the R&S FPS (mini display: "System commands > Disable SecureUser").
2. Login using the administrator ("Instrument" user) account.
3. Start a RemoteDesktop connection to the R&S FPS as described in ["To set up a connection from the controller to the R&S FPS"](#) on page 86.



Select the "Windows" icon in the toolbar to access the operating system of the R&S FPS.

5. Open the Windows Explorer.
6. Select the directory:
Control Panel\All Control Panel Items\
Administrative Tools.
7. Double-click "Computer Management".

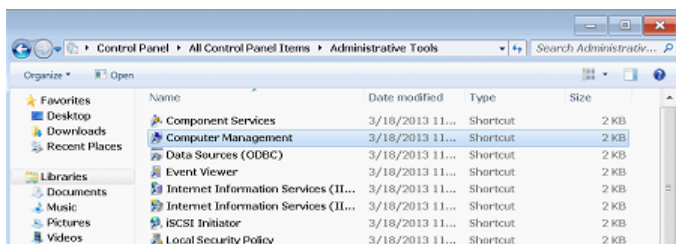

8. In the "Computer Management" dialog box, select "Local Users and Groups \Users" on the left side.

How to Set Up Remote Desktop

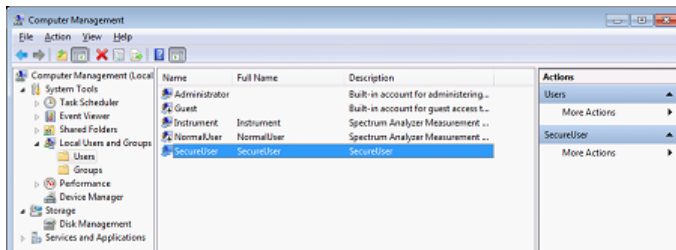

9. Double-click the user to be added, for example: "SecureUser".

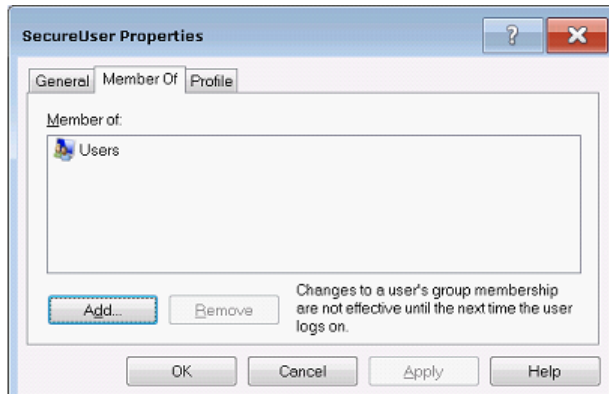

10. In the "SecureUser Properties" dialog box, switch to the "Member of" tab and click "Add".

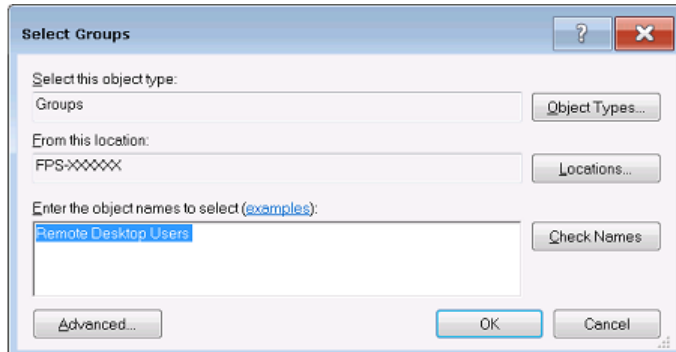

11. In the "Select Groups" dialog box, enter the "Remote Desktop Users" group and select "OK".

How to Control the R&S FPS via the Web Browser Interface

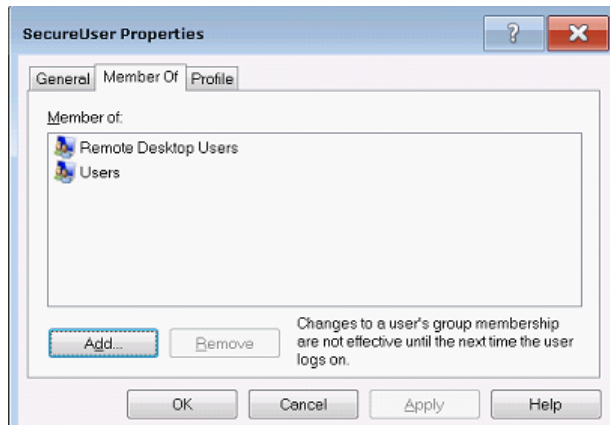

12. Select "Apply".

13. Select "OK" and close all dialog boxes.

14. Reboot the R&S FPS firmware so the changes become effective.

The new user (e.g. "SecureUser") should now be able to access the R&S FPS via RemoteDesktop.

7.7 How to Control the R&S FPS via the Web Browser Interface

Via the LAN web browser interface to the R&S FPS, one or more users can control the instrument remotely from another PC without additional installation. Most instrument controls are available via the front panel simulation. File upload and download between the instrument and the remote PC is also available.

i If no external monitor is connected to the R&S FPS, an additional driver is required on the instrument in order to control the R&S FPS via its web browser interface. If the driver is not available, the browser shows only a black screen.

Download the **TightVNC DFMirage driver** from the official TightVNC website (<http://www.tightvnc.com/download.php>) and install it on the R&S FPS as described on the website.

The current R&S FPS firmware was tested with the TightVNC DFMirage driver version 2.0.301.

How to Control the R&S FPS via the Web Browser Interface

To access the R&S FPS via the web browser interface

1. Start a web browser that supports html5 (W3C compliant).
2. Enter the IP address of the R&S FPS in the browser's address bar.
The R&S FPS's Welcome page is displayed.
3. In the navigation pane, select "Instrument Control > Web Control".
The instrument's display is shown in a new browser window, with a software front panel displayed beside or below it.
4. Use the mouse cursor to access the functionality in the software front panel or in the display as you would directly on the instrument's front panel.

To exchange files with the R&S FPS

You can download files, for example stored measurement data, from the R&S FPS to the remote PC, or upload files, for example limit line definitions, from the PC to the R&S FPS.

1. In the web browser, select the Welcome window.
2. In the navigation pane, select "Instrument Control" > "File Upload" or "File Download".

The screenshot displays the web interface of the R&S FPS. On the left is a navigation pane with sections: LAN (Home, Lan Configuration, Utilities), Instrument Control (Web Control, File Download, File Upload), License Manager (Manage Licenses), and Help (Glossary, www.rohde-schwarz.com). The 'File Download' option under 'Instrument Control' is highlighted. The main content area shows a 'File Download' header, a prompt to 'Select a file and click the button 'Download File'', and a list of folders: Log Files, Temporary Files, User Data, and My Computer. Below this, the 'Selected File' is 'LicenseInfo.1312.8000K26-100005-xx.txt' with a 'Download File' button. A 'Status' section at the bottom indicates 'No error'. The footer contains the copyright notice '© 2020 ROHDE&SCHWARZ, A'.

How to Deactivate the Web Browser Interface

The most commonly used folders on the instrument are displayed, for example those that contain user data, as well as the top-most `My Computer` folder, from which you can access all other folders on the instrument.

3. To download a file from the R&S FPS, select the file from the displayed folders and then select "Download File".
4. To upload a file to the R&S FPS:
 - a) From the displayed folders in the web browser window, select the folder on the R&S FPS to which you want to copy a file.
 - b) Under "File to Upload", select "Browse" to open a file selection dialog box and select the required file on the PC.
 - c) Select "Upload" to copy the file from the PC to the defined folder on the R&S FPS.

7.8 How to Deactivate the Web Browser Interface

If you want to prevent other users in the LAN from accessing or operating the R&S FPS via its LAN web browser interface, you must deactivate this function. Note that **after a firmware update** the function is **automatically active** again until you deactivate it manually.

To deactivate the LAN web browser interface



Select the "Windows" icon in the toolbar to access the operating system.

2. In the "Start" menu, select "Control Panel".
3. Select "System and Security" > "Administrative Tools".
4. From the list on the right, select "Services".
5. From the list of local services, select "R&S TightVNC Server".

How to Deactivate the Web Browser Interface

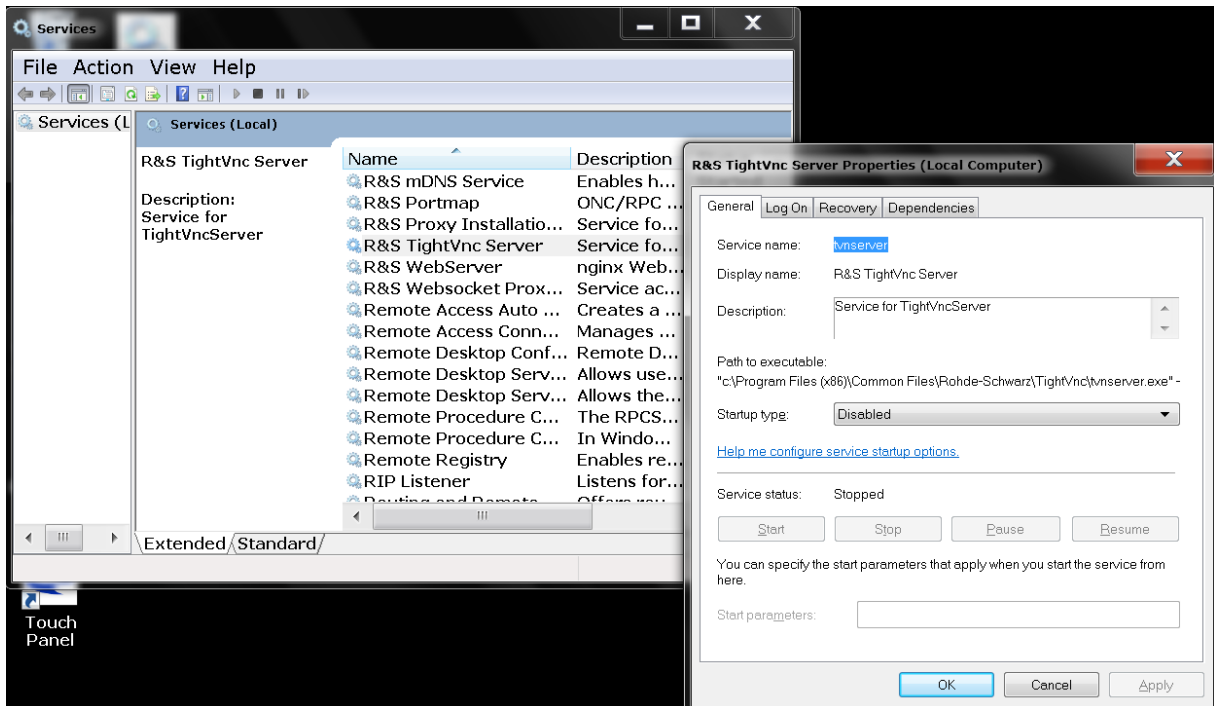

6. Set "Startup type" to "Disabled".
7. Select "Stop".
8. Select "Apply".

The next time a user enters the IP address of the instrument in a web browser, an error message is displayed:

```
Failed to connect to server (code. 1006)
```

8 Operating the Instrument in Manual Mode

The R&S FPS is completely remote-controlled; it does not provide a display for manual measurement control. The mini display on the front panel of the R&S FPS allows only for very basic instrument configuration (see [Chapter 6, "Mini Display"](#), on page 47).

However, although the R&S FPS does not have a built-in display for manual measurement control, it is possible to operate it interactively in manual mode using a graphical user interface on an external monitor or a controller PC.

It is recommended that you use the manual mode initially to get familiar with the instrument and its functions before using it in pure remote mode. Thus, this section describes in detail how to operate the instrument manually using a controller PC and mouse, or an external monitor, mouse and keyboard. It describes what kind of information is displayed in the diagram area, how to use the soft front panel keys and other interface elements, and how to use the Online Help.

- [Graphical User Interface Elements \(Soft Front Panel\)](#)..... 95
- [Understanding the Display Information](#)..... 106
- [Changing the Focus](#)..... 115
- [Entering Data](#)..... 116
- [Displaying Results](#)..... 116
- [Getting Help](#)..... 123

8.1 Graphical User Interface Elements (Soft Front Panel)

All tasks necessary to operate the instrument can be performed using the graphical user interface provided by the soft front panel, a virtual front panel displayed on the external monitor or the Remote Desktop.

All measurement results are displayed. Additionally, the display provides status and setting information, allows you to switch between various measurement tasks, and provides access to all measurement functions.

Graphical User Interface Elements (Soft Front Panel)

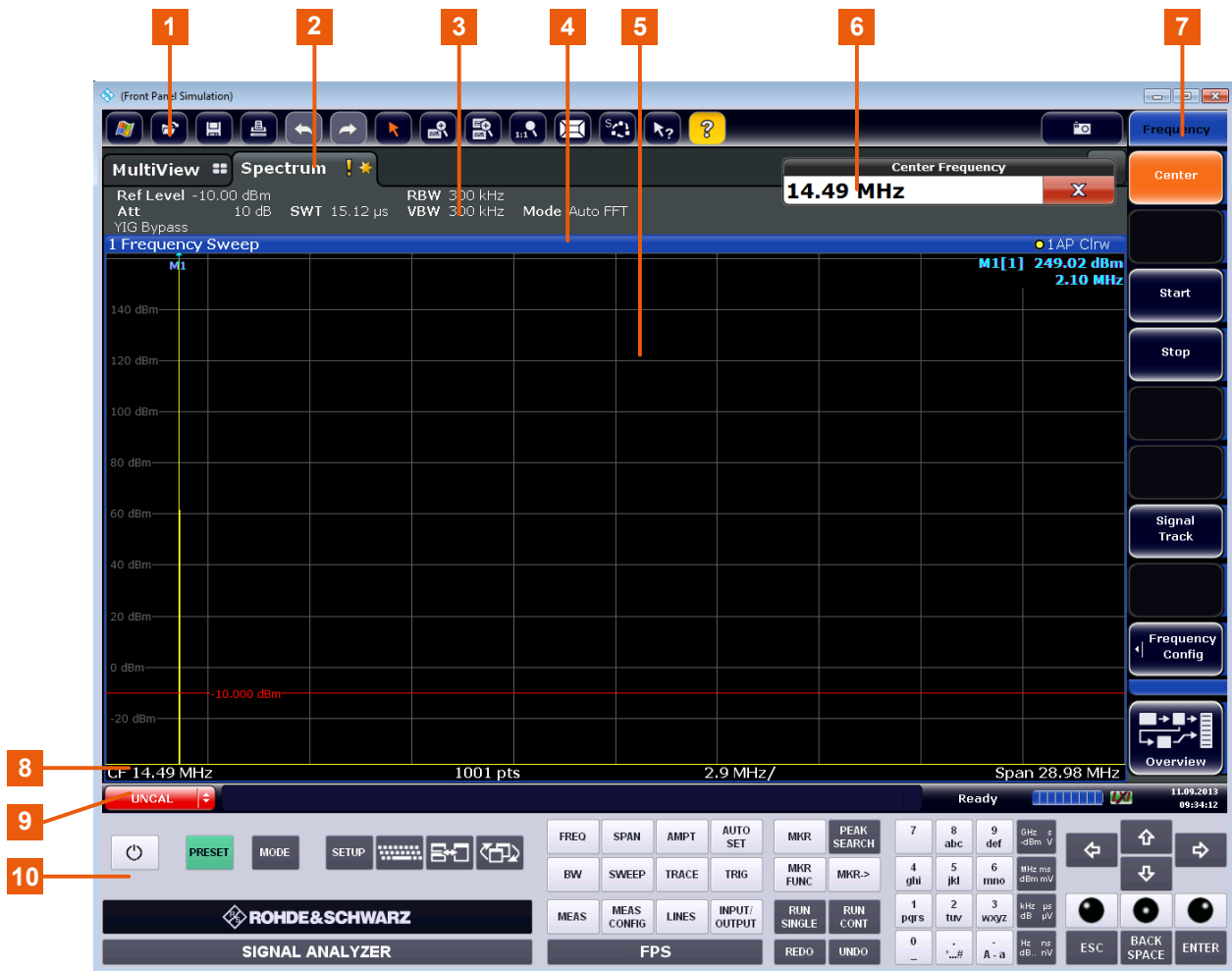



Figure 8-1: Graphical user interface elements in the R&S FPS's soft front panel

- 1 = Toolbar with standard application functions, e.g. print, save/open file etc.
- 2 = Tabs for individual measurement channels
- 3 = Channel bar for firmware and measurement settings
- 4 = Window title bar with diagram-specific (trace) information
- 5 = Measurement results area
- 6 = Input field for measurement setting
- 7 = Softkeys for function access
- 8 = Diagram footer with diagram-specific information, depending on application
- 9 = Instrument status bar with error messages, progress bar and date/time display
- 10 = Front panel with keys, keypad, navigation elements

8.1.1 Toolbar

Standard functions can be performed via the icons in the toolbar at the top of the screen.













Graphical User Interface Elements (Soft Front Panel)



 You can hide the toolbar display to enlarge the display area for the measurement results ("Setup > Display > Displayed Items"). See the R&S FPS user manual for details.



The following functions are available:

Table 8-1: Standard application functions in the toolbar

Icon	Description
	Windows: displays the Windows "Start" menu and task bar
	Open: opens a file from the instrument ("Save/Recall" menu)
	Store: stores data on the instrument ("Save/Recall" menu)
	Print: defines print settings ("Print" menu)
	Undo: reverts last operation
	Redo: repeats previously reverted operation
	Selection mode: the cursor can be used to select (and move) markers in a zoomed display
	Zoom mode: displays a dotted rectangle in the diagram that can be expanded to define the zoom area
	Multiple zoom mode: multiple zoom areas can be defined for the same diagram
	Zoom off: displays the diagram in its original size
	SmartGrid: activates "SmartGrid" mode to configure the screen layout
	Sequencer: opens the "Sequencer" menu to perform consecutive measurements
	Help (+ Select): allows you to select an object for which context-specific help is displayed
AL	Analysis line (MSRA mode only): opens a dialog box to display and position an analysis line in MSRA measurements (see R&S FPS MSRA user manual)

Icon	Description
	Help: displays context-sensitive help topic for currently selected element
	Print immediately: prints the current display (screenshot) as configured
In "SmartGrid" mode only:	
	Exit "SmartGrid" mode

8.1.2 Softkeys

Softkeys are virtual keys provided by the software. Softkeys are dynamic, i.e. depending on the selected function key, a different list of softkeys is displayed on the right side of the screen.

A list of softkeys for a certain function key is also called a menu. Softkeys can either perform a specific function or open a dialog box.

The "More" softkey indicates that the menu contains more softkeys than can be displayed at once on the screen. When selected, it displays the next set of softkeys.

Recognizing the softkey status by color

A softkey is highlighted orange when its associated dialog box is open. If it is a toggle softkey, the current state is highlighted blue. If an instrument function is not available temporarily due to a specific setting, the associated softkey is deactivated and its text is colored gray.

Some softkeys belong to a certain (firmware) option. If this option is not installed in your instrument, the associated softkeys are not displayed.



You can hide the softkey display to enlarge the display area for the measurement results ("Setup > Display > Displayed Items"). See the user manual for details.

8.1.3 Front Panels

The virtual "front panel" provides (static) function keys to access basic instrument functions and softkey menus, as well as a keypad and navigation keys.

Graphical User Interface Elements (Soft Front Panel)

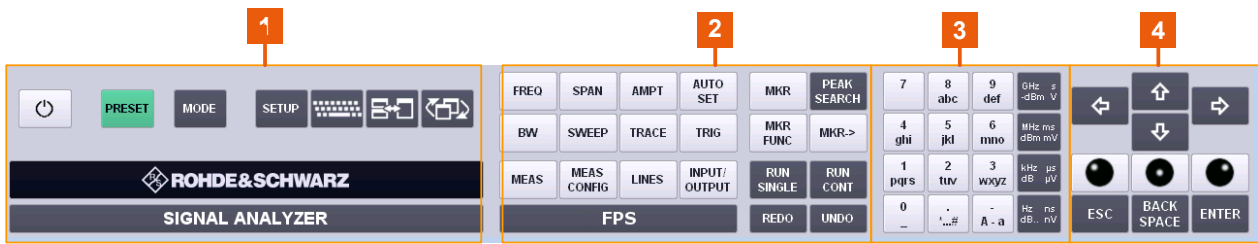

Figure 8-2: Front panel elements

- 1 = System keys
- 2 = Function keys
- 3 = Keypad
- 4 = Navigation keys

The measurement and instrument functions and settings can be accessed by selecting the corresponding keys in the front panel. To activate a key, select the key in the display using the mouse pointer.

The virtual front panel is displayed by default when you connect an external monitor or use Remote Desktop with the R&S FPS.

To toggle the front panel display, press the [F6] key on the controller PC or an external keyboard.

Mini front panel

The mini front panel displays only the basic system and function keys in a detached dialog box that can be moved around the screen.

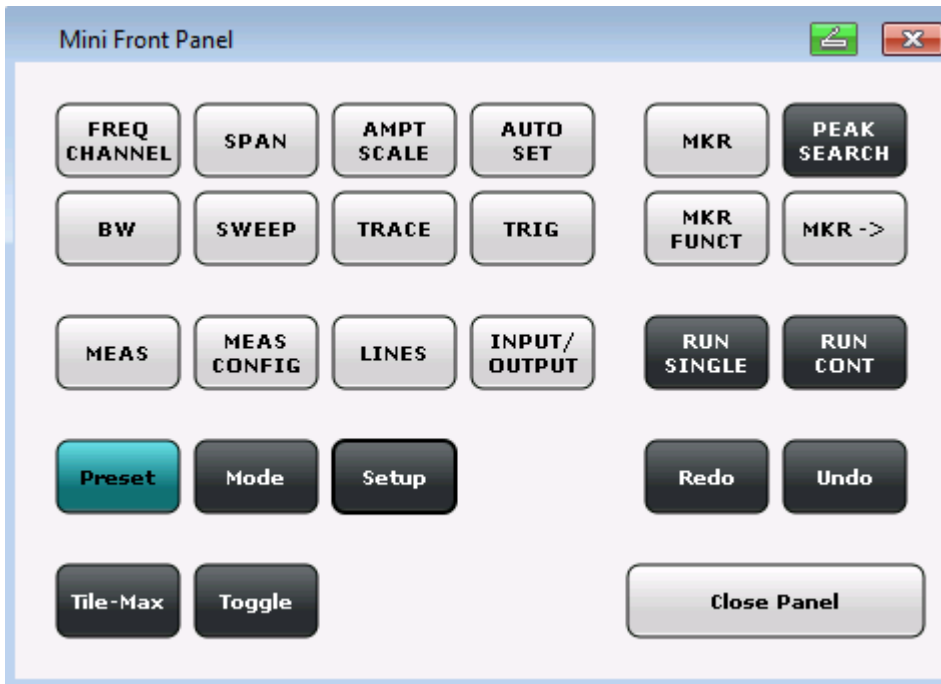

Figure 8-3: Mini front panel

You can close the window by selecting "Close Panel" or the key combination [ALT + M] (be aware of the keyboard language defined in the operating system!).

To display the front panel or mini front panel

1. If neither the default front panel nor the mini front panel are displayed, press the [F6] key on the controller pc or external keyboard to access the virtual system keys.
2. Select the [Setup] key and then the "Display" softkey.
3. Select the "Displayed Items" tab.
4. Select "Front Panel: On" or "Mini Front Panel: On".



- [SYSTEM Keys](#)..... 101
- [Function Keys](#)..... 101
- [Keypad](#)..... 104
- [Navigation Controls](#)..... 104

8.1.3.1 SYSTEM Keys

The virtual [SYSTEM] keys set the instrument to a defined state, change basic settings, and provide print and display functions.

A detailed description of the corresponding functions is provided in the R&S FPS user manual.

Table 8-2: SYSTEM keys

SYSTEM key	Assigned functions
PRESET	Resets the instrument to the default state.
MODE	Provides the selection between applications
SETUP	Provides basic instrument configuration functions, e.g.: <ul style="list-style-type: none"> • Reference frequency (external/internal) • Date, time, display configuration • Firmware update and enabling of options • Information about instrument configuration incl. firmware version and system error messages • Service support functions
	Switches between the on-screen keyboard display: at the top of the screen at the bottom of the screen off
 (Tile-Max)	Switches between maximized and split (tiled) display of the focused area
 (Toggle)	Toggles the focus area between windows.

8.1.3.2 Function Keys

The virtual function keys provide access to the most common measurement settings and functions.

A detailed description of the corresponding functions is provided in the R&S FPS user manual.

Graphical User Interface Elements (Soft Front Panel)

Table 8-3: Function keys

Function key	Assigned functions
Basic measurement settings	
FREQ	Sets the center frequency and the start and stop frequencies for the frequency range under consideration. This key is also used to set the frequency offset and the signal track function.
SPAN	Sets the frequency span to be analyzed.
AMPT	Sets the reference level, the displayed dynamic range, the RF attenuation and the unit for the level display. Sets the level offset and the input impedance. Activates the preamplifier (option RF preamplifier, R&S FPS-B22).
AUTO SET	Enables automatic settings for level, frequency or sweep type mode.
BW	Sets the resolution bandwidth and the video bandwidth.
SWEEP	Sets the sweep time and the number of measurement points. Selects continuous measurement or single measurement.
TRACE	Configures the measured data acquisition and the analysis of the measurement data.
TRIG	Sets the trigger mode, the trigger threshold, the trigger delay, and the gate configuration for gated sweep.
Marker functions	
MKR	Sets and positions the absolute and relative measurement markers (markers and delta markers).
PEAK SEARCH	Performs a peak search for active marker. If no marker is active, normal marker 1 is activated and the peak search is performed for it.
MKR FUNC	Provides additional analysis functions of the measurement markers: Frequency counter (Sig Count) Fixed reference point for relative measurement markers (Ref Fixed) Noise marker (Noise Meas) Phase noise (Phase Noise) n dB down function Peak list

Graphical User Interface Elements (Soft Front Panel)

Function key	Assigned functions
MKR->	Used for search functions of the measurement markers (maximum/minimum of the trace). Assigns the marker frequency to the center frequency, and the marker level to the reference level. Restricts the search area (Search Limits) and characterizes the maximum points and minimum points (Peak Excursion).
Measurement and evaluation functions	
MEAS	Provides the measurement functions. Measurement of multicarrier adjacent channel power (Ch Power ACLR) Carrier to noise spacing (C/N C/No) Occupied bandwidth (OBW) Spectrum emission mask measurement (Spectrum Emission Mask) Spurious emissions (Spurious Emissions) Measurement of time domain power (Time Domain Power) Signal statistics: amplitude probability distribution (APD) and cumulative complementary distribution function (CCDF) Third-order intercept point (TOI) AM modulation depth (AM Mod Depth)
MEAS CONFIG	Provides access to measurement configuration.
LINES	Configures display lines and limit lines.
INPUT/OUTPUT	Displays softkeys for input/output functions.
Measurement start functions	
RUN SINGLE	Starts a single new measurement (Single Sweep Mode).
RUN CONT	Starts a continuous measurement (Continuous Sweep Mode).
Function execution	
UNDO	Reverts last operation
REDO	Repeats previously reverted operation.

UNDO/REDO keys

- The virtual [UNDO] key reverts the previously performed action, i.e. the status before the previous action is retrieved.
The undo function is useful, for example, if you are performing a zero span measurement with several markers and a limit line defined and accidentally click the "ACP" softkey. In this case, many settings would be lost. However, if

Graphical User Interface Elements (Soft Front Panel)

you select [UNDO] immediately afterwards, the previous status is retrieved, i.e. the zero span measurement and all settings.

- The virtual [REDO] key repeats the previously reverted action, i.e. the most recently performed action is repeated.

 The [UNDO] function is not available after a [PRESET] or "RECALL" operation. When these functions are used, the history of previous actions is deleted.

The [UNDO]/[REDO] functions are not available for some applications; see Release Notes for details.

8.1.3.3 Keypad

The virtual keypad is used to enter alphanumeric parameters, including the corresponding units (see also [Chapter 8.4, "Entering Data"](#), on page 116). It contains the following keys:

Table 8-4: Keys on the keypad

Type of key	Description
Alphanumeric keys	Enter numbers and (special) characters in edit dialog boxes.
Decimal point	Inserts a decimal point "." at the cursor position.
Sign key	Changes the sign of a numeric parameter. In the case of an alphanumeric parameter, inserts a "-" at the cursor position.
Unit keys (GHz/-dBm MHz/dBm, kHz/dB and Hz/dB)	These keys add the selected unit to the entered numeric value and complete the entry. In the case of level entries (e.g. in dB) or dimensionless values, all units have the value "1" as multiplying factor. Thus, they have the same function as an [ENTER] key.

8.1.3.4 Navigation Controls

The navigation controls include a virtual rotary knob, navigation keys, and data input function keys. They allow you to navigate within the display or within dialog boxes.

Rotary knob simulation



The virtual rotary knob has several functions:

Graphical User Interface Elements (Soft Front Panel)

- Increments (clockwise direction) or decrements (counter-clockwise direction) the instrument parameter at a defined step width in the case of a numeric entry.
- Shifts the selection bar within focussed areas (e.g. lists).
- Shifts markers, limit lines, etc on the screen.
- Moves the scroll bar vertically, if the scroll bar is focussed.
- Acts like the [ENTER] key, when it is selected.

To simulate the use of a rotary knob, use the keys displayed beneath the arrow keys:

Table 8-5: Rotary knob simulation keys

Icon	Function
	Turn left
	Enter
	Turn right

Navigation keys

The virtual navigation keys can be used alternatively to the rotary knob to navigate through dialog boxes, diagrams or tables.

Arrow Up/Arrow Down Keys

The <arrow up> or <arrow down> keys do the following:

- In a numeric edit dialog box, increase or decrease the instrument parameter.
- In a list, scroll forward and backward through the list entries.
- In a table, move the selection bar vertically.
- In windows or dialog boxes with vertical scroll bar, move the scroll bar.

Arrow Left/Arrow Right Keys

The <arrow left> or <arrow right> keys do the following:

- In an alphanumeric edit dialog box, move the cursor.
- In a list, scroll forward and backward through the list entries.
- In a table, move the selection bar horizontally.
- In windows or dialog boxes with horizontal scroll bar, move the scroll bar.

Data input keys

Some additional virtual keys are provided for data input in dialog boxes and input fields.

Table 8-6: Data input keys

Type of key	Description
ESC key	<p>Closes all kinds of dialog boxes, if the edit mode is not active. Quits the edit mode, if the edit mode is active. In dialog boxes that contain a "Cancel" button it activates that button.</p> <p>For "Edit" dialog boxes the following mechanism is used:</p> <ul style="list-style-type: none"> • If data entry has been started, it retains the original value and closes the dialog box. • If data entry has not been started or has been completed, it closes the dialog box.
[BACKSPACE] key	<p>If an alphanumeric entry has already been started, this key deletes the character to the left of the cursor.</p>
[ENTER] key	<ul style="list-style-type: none"> • Concludes the entry of dimensionless entries. The new value is accepted. • With other entries, this key can be used instead of the "Hz/dB" unit key. • In a dialog box, selects the default or focussed element.

8.2 Understanding the Display Information

The following figure shows a measurement diagram during manual analyzer operation. All different information areas are labeled. They are explained in more detail in the following sections.

Understanding the Display Information

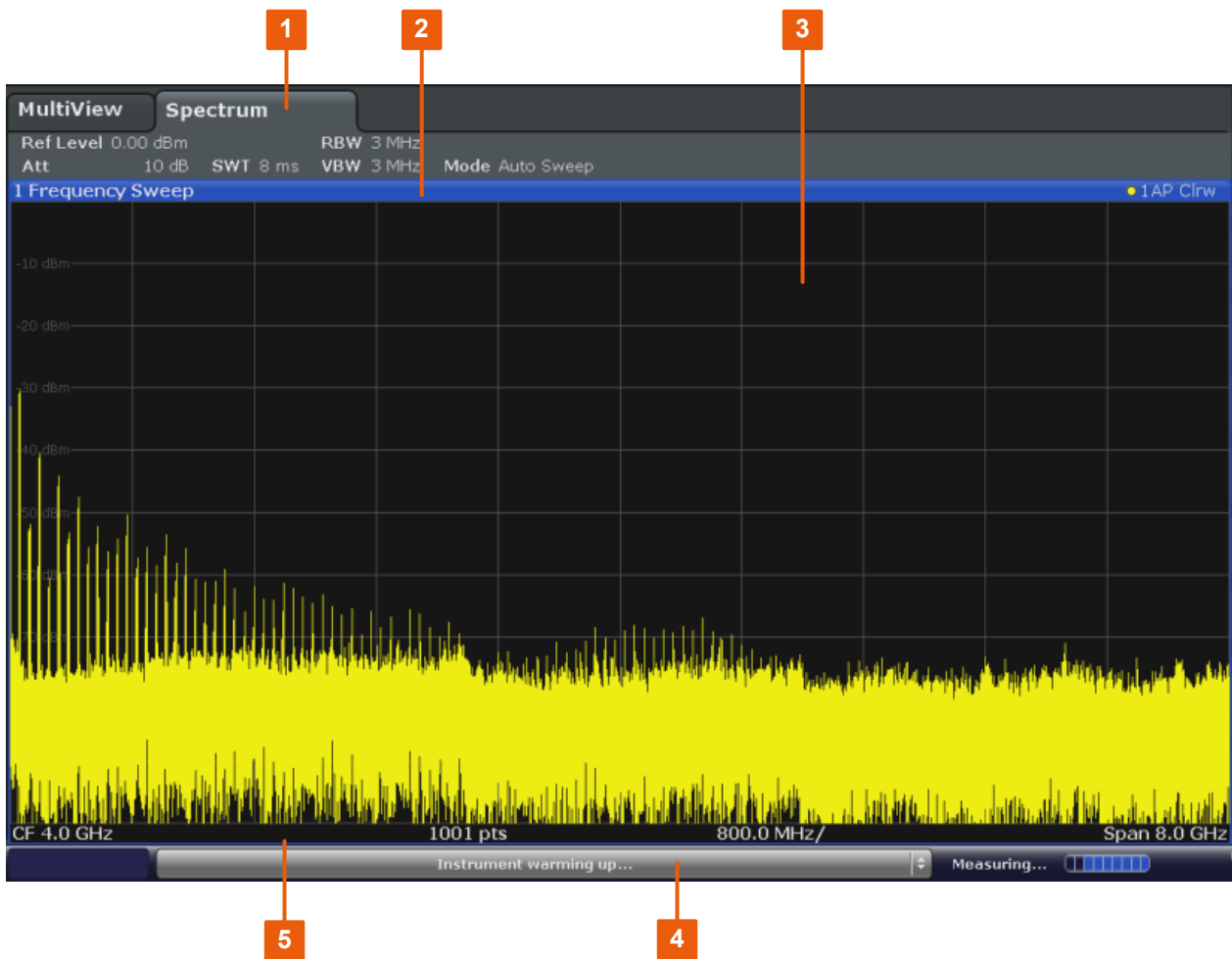



- 1 = Channel bar for firmware and measurement settings
 2 = Window title bar with diagram-specific (trace) information
 3 = Diagram area with marker information
 4 = Instrument status bar with error messages, progress bar and date/time display
 5 = Diagram footer with diagram-specific information, depending on measurement application

• Channel Bar.....	108
• Window Title Bar.....	110
• Trace Information in Window Title Bar.....	111
• Marker Information.....	111
• Frequency and Span Information in Diagram Footer.....	112
• Instrument and Status Information.....	113
• Error Information.....	114

8.2.1 Channel Bar

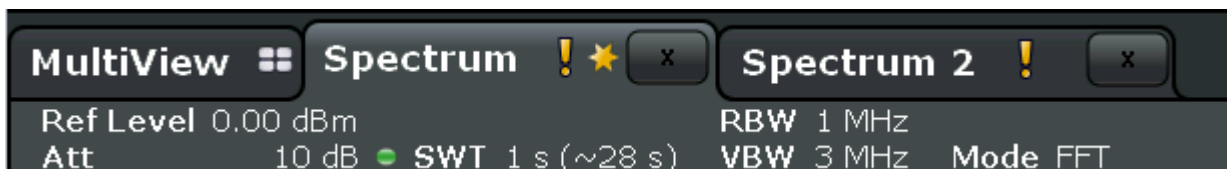
Using the R&S FPS you can handle several different measurement tasks (channels) at the same time (although they can only be performed asynchronously). For each channel, a separate tab is displayed on the screen. In order to switch from one channel display to another, simply select the corresponding tab.



 The  icon on the tab label indicates that the displayed trace no longer matches the current instrument settings. This may be the case, for example, if a trace is frozen and the instrument settings are changed. As soon as a new measurement is performed, the icon disappears.

An orange "IQ" (in MSRA mode only) indicates that the results displayed in the MSRA slave application(s) no longer match the data captured by the MSRA Master. The "IQ" disappears after the results in the slave application(s) are refreshed.

Alternatively, if many tabs are displayed, select the tab selection list icon at the right end of the channel bar and select the channel you want to switch to from the list.

Channel-specific settings

Beneath the channel name, information on channel-specific settings for the measurement are displayed in the **channel bar**. A bullet next to the setting indicates that user-defined settings are used, not automatic settings. A green bullet indicates this setting is valid and the measurement is correct. A red bullet indicates an invalid setting that does not provide useful results. Channel information varies depending on the active application.

In the Spectrum application, the R&S FPS shows the following settings:

Table 8-7: Channel settings displayed in the channel bar in the Spectrum application

Ref Level	Reference level
m.+el.Att	Mechanical and electronic RF attenuation that has been set.
Ref Offset	Reference level offset

Understanding the Display Information

SWT	Sweep time that has been set. If the sweep time does not correspond to the value for automatic coupling, a bullet is displayed in front of the field. The color of the bullet turns red if the sweep time is set below the value for automatic coupling. In addition, the UNCAL flag is shown. In this case, the sweep time must be increased.
Meas Time	Measurement time, calculated from analysis bandwidth and number of samples (for statistics measurements)
RBW	Resolution bandwidth that has been set. If the bandwidth does not correspond to the value for automatic coupling, a green bullet appears in front of the field.
VBW	Video bandwidth that has been set. If the bandwidth does not correspond to the value for automatic coupling, a green bullet is displayed in front of the field.
AnBW	Analysis bandwidth (for statistics measurements)
Compatible	Compatible device mode (default not displayed)
Mode	Indicates which sweep mode type is selected: <ul style="list-style-type: none"> • "Auto FFT": automatically selected FFT sweep mode • "Auto sweep": automatically selected swept sweep mode • "Sweep": manually selected frequency sweep mode • "FFT": manually selected FFT sweep mode

Common settings

In addition to the channel-specific settings, the channel bar above the diagram also displays information on instrument settings that affect the measurement results even though this is not immediately apparent from the display of the measured values. This information is displayed in gray font and only when applicable for the current measurement, as opposed to the channel-specific settings that are always displayed.

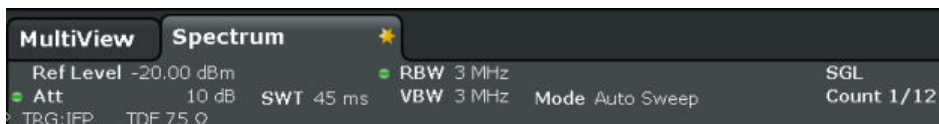

The following types of information may be displayed, if applicable.

Table 8-8: Common settings displayed in the channel bar

SGL	The sweep is set to single sweep mode.
Sweep Count	The current signal count for measurement tasks that involve a specific number of subsequent sweeps (see "Sweep Count" setting in "Sweep settings" in the User Manual)

TRG	Trigger source (for details see "Trigger settings" in the User Manual) <ul style="list-style-type: none"> • EXT: External • IFP: IF power (+trigger bandwidth) • RFP: RF power • VID: Video
6dB/RRC/CHN	Filter type for sweep bandwidth (see "Bandwidth settings" in the User Manual)
YIG Bypass	The YIG filter is deactivated.
PA	The preamplifier is activated.
GAT	The frequency sweep is controlled via the [TRIGGER INPUT] connector.
TDF	The specified transducer factor is activated.
75 Ω	The input impedance of the instrument is set to 75 Ω.
FRQ	A frequency offset ≠ 0 Hz is set.
DC/AC	An external DC or AC calibration signal is in use.
<NOR APX> Ext. Gen	An external generator is being controlled by the R&S FPS. NOR : the measurements are normalized with the results of the external generator calibration APX (approximation): the measurements are normalized with the results of the external generator calibration; however, the measurement settings have been changed since calibration If neither label is displayed, no calibration has been performed yet or normalization is not active. For details see the "External Generator Control" section in the R&S FPS User Manual.
LVL	A level offset is applied to the external generator signal (only if external generator control is active).

8.2.2 Window Title Bar

Each channel in the R&S FPS display may contain several windows. Each window can display either a graph or a table as a result of the channel measurement. Which type of result evaluation is displayed in which window is defined in the display configuration (see [Chapter 8.5, "Displaying Results"](#), on page 116). The window's title bar indicates which type of evaluation is displayed.

8.2.3 Trace Information in Window Title Bar

Information on the displayed traces is indicated in the window title bar.

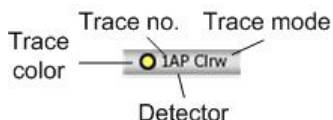

Trace color		Color of trace display in diagram
Trace no.		Trace number (1 to 6)
Detector		Selected detector:
	AP	AUTOPEAK detector
	Pk	MAX PEAK detector
	Mi	MIN PEAK detector
	Sa	SAMPLE detector
	Av	AVERAGE detector
	Rm	RMS detector
Trace Mode		Sweep mode:
	Clrw	CLEAR/WRITE
	Max	MAX HOLD
	Min	MIN HOLD
	Avg	AVERAGE (Lin/Log/Pwr)
	View	VIEW
Norm/NCor		Correction data is not used.

8.2.4 Marker Information

Marker information is provided either in the diagram grid or in a separate marker table, depending on the configuration.

Marker information in diagram grid

Within the diagram grid, the x and y-axis positions of the last 2 markers or delta markers that were set, if available, as well as their index are displayed. The value in the square brackets after the index indicates the trace to which the marker is

Understanding the Display Information

assigned. (Example: M2[1] defines marker 2 on trace 1.) For more than 2 markers, a separate marker table is displayed beneath the diagram by default.

Marker information in marker table

In addition to the marker information displayed within the diagram grid, a separate marker table may be displayed beneath the diagram. This table provides the following information for all active markers:

Type	Marker type: N (normal), D (delta), T (temporary, internal)
Ref	Reference (for delta markers)
Trc	Trace to which the marker is assigned
X-value	x-value of the marker
Y-value	y-value of the marker
Func	Activated marker or measurement function
Func. Result	Result of the active marker or measurement function

The functions are indicated with the following abbreviations:

FXD	Fixed reference marker
PHNoise	Phase noise measurement
CNT	Signal count
TRK	Signal tracking
NOise	Noise measurement
MDepth	AM modulation depth
TOI	Third order intercept measurement

8.2.5 Frequency and Span Information in Diagram Footer

The diagram footer (beneath the diagram) contains the following information, depending on the current application:

Label	Information
CF	Center frequency
Span	Frequency span (frequency domain display)

Label	Information
ms/	Time per division (time domain display)
Pts	Number of sweep points or (rounded) number of currently displayed points in zoom mode

8.2.6 Instrument and Status Information

Global instrument settings, the instrument status and any irregularities are indicated in the status bar beneath the diagram.



Hiding the status bar

You can hide the status bar display, e.g. in order to enlarge the display area for the measurement results ("Setup > Display > Displayed Items").

See the User Manual for details.

The following information is displayed:

Instrument status

	The instrument is configured for operation with an external reference.
---	--

Progress

The progress of the current operation is displayed in the status bar.



Date and time

The date and time settings of the instrument are displayed in the status bar.



You can hide the date and time display in the status bar, or the entire status bar ("Setup > Display > Displayed Items").

For details see the R&S FPS User Manual.

8.2.7 Error Information

If errors or irregularities are detected, a keyword and an error message, if available, are displayed in the status bar.



i Note that the status bar is only visible on an external monitor or via Remote-Desktop from a controller PC (see [Chapter 4.9, "Connecting an External Monitor"](#), on page 25 or [Chapter 7.6, "How to Set Up Remote Desktop"](#), on page 82).

Depending on the type of message, the status message is indicated in varying colors.

Table 8-9: Status bar information - color coding

Color	Type	Description
red	Fatal	A serious error occurred in the application; regular operation is no longer possible.
red	Error	An error occurred during a measurement, e.g. due to missing data or wrong settings, so that the measurement cannot be completed correctly.
orange	Warning	An irregular situation occurred during measurement, e.g. the settings no longer match the displayed results, or the connection to an external device was interrupted temporarily.
gray	Information	Information on the status of individual processing steps.
gray	Message	An event or state has occurred that may lead to an error during further operation.
green	No errors	No messages displayed.

i If any error information is available for a measurement channel, the  icon is displayed next to the channel name.

This is particularly useful when the MultiView tab is displayed, as the status bar in the MultiView tab always displays the information for the currently selected measurement only.

The following keywords are used:

IF OVLD	Overload of the IF signal path after the input mixer. <ul style="list-style-type: none"> • Increase the reference level.
INPUT OVLD	The signal level at the RF input connector exceeds the maximum. The RF input is disconnected from the input mixer to protect the device. In order to re-enable measurement, decrease the level at the RF input connector and reconnect the RF input to the mixer input.
LOUNL	Error in the instrument's frequency processing hardware was detected.
NO REF	Instrument was set to an external reference but no signal was detected on the reference input.
OVEN	OCXO reference frequency (option R&S FPS-B4) has not yet reached its operating temperature. The message usually disappears a few minutes after power has been switched on.
RF OVLD	Overload of the input mixer. <ul style="list-style-type: none"> • Increase the RF attenuation (for RF input).
UNCAL	One of the following conditions applies: <ul style="list-style-type: none"> • Correction data has been switched off. • No correction values are available, for example after a firmware update. • Record the correction data by performing a self alignment
WRONG_FW	The firmware version is out-of-date and does not support the currently installed hardware. Until the firmware version is updated, this error message is displayed and self-alignment fails. (For details refer to the R&S FPS User Manual).

8.3 Changing the Focus

Any selected function is always performed on the currently focused element in the display, e.g. a dialog field, diagram, or table row. Which element is focused is indicated by a blue frame (diagram, window, table) or is otherwise highlighted (soft-key, marker etc.). Moving the focus is most easily done by selecting the element in the display using the mouse pointer. Alternatively, use the "Tab" key on the on-screen keyboard to move the focus from one element to the next on the display.



To move the focus between any displayed diagrams or tables in a window, select the "Change focus" key. The focus moves from the diagram to the first table to the next table etc. and then back to the diagram, within the same window.

8.4 Entering Data

Data can be entered in dialog boxes using an external keyboard or the keyboard of the controller PC.

8.5 Displaying Results

The R&S FPS provides several instrument applications for different analysis tasks and different types of signals, e.g. 3G FDD, I/Q analysis or basic spectrum analysis. For each application, a new measurement channel is created and displayed in a separate tab on the screen.

The results of a measurement channel can be evaluated in many different ways, both graphically and numerically. For each evaluation method the results are displayed in a separate window in the tab.

The R&S FPS allows you to configure the display to suit your specific requirements and optimize analysis.

8.5.1 Activating channels

When you activate an application, a new measurement channel is created which determines the measurement settings for that application. The same application can be activated with different measurement settings by creating several channels for the same application. Whenever you switch channels, the corresponding measurement settings are restored. Each channel is displayed in a separate tab on the screen.

An additional tab ("MultiView") provides an overview of all currently active channels at once.

Only one measurement can be performed at any time, namely the one in the currently active channel. However, in order to perform the configured measurements consecutively, a Sequencer function is provided.

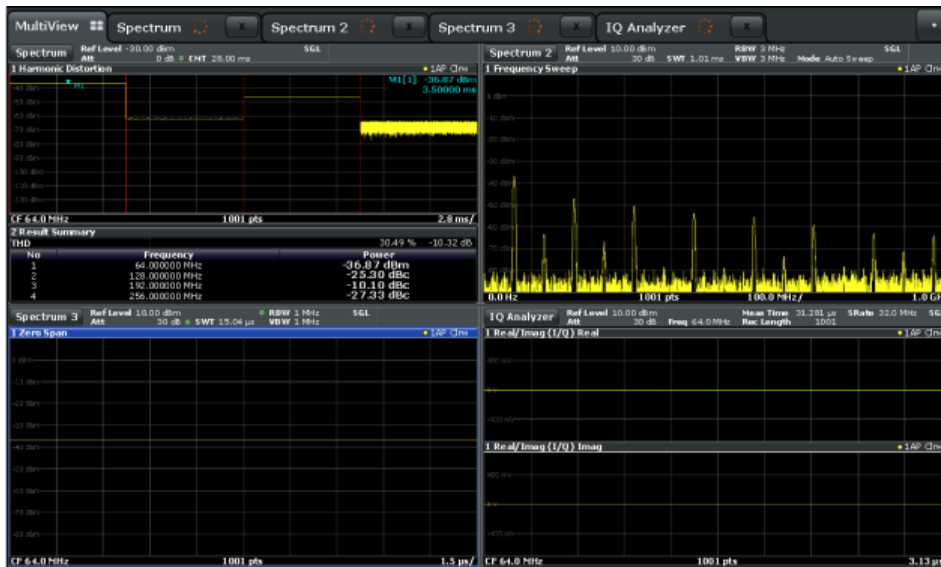

To start a new channel

1. Select the [Mode] key in the soft front panel.
2. In the "Mode" dialog box, select the required application on the "New Channel" tab.
A new tab is displayed for the new channel.

To change the application in an active channel

1. Select the tab of the channel you want to change.
2. Select the [Mode] key.
3. In the "Mode" dialog box, select the new application to be displayed on the "Replace Current Channel" tab.
The selected application is displayed in the current channel.

8.5.2 Laying out the Result Display with the SmartGrid

Measurement results can be evaluated in many different ways, for example graphically, as summary tables, statistical evaluations etc. Each type of evaluation is displayed in a separate window in the channel tab. Up to 16 individual windows can be displayed per channel (i.e. per tab). To arrange the diagrams and tables on the screen, the Rohde & Schwarz SmartGrid function helps you find the target position simply and quickly.

(For details on evaluation methods see the User Manual.)

Principally, the layout of the windows on the screen is based on an underlying grid, the SmartGrid. However, the SmartGrid is dynamic and flexible, allowing for many different layout possibilities. The SmartGrid functionality provides the following basic features:

- Windows can be arranged in columns or in rows, or in a combination of both.
 - Windows can be arranged in up to four rows and four columns.
 - Windows are moved simply by dragging them to a new position on the screen, possibly changing the layout of the other windows, as well.
 - All evaluation methods available for the currently selected measurement are displayed as icons in the evaluation bar. If the evaluation bar contains more icons than can be displayed at once on the screen, it can be scrolled vertically. The same evaluation method can be displayed in multiple windows simultaneously.
 - New windows are added by dragging an evaluation icon from the evaluation bar to the screen. The position of each new window depends on where you drop the evaluation icon in relation to the existing windows.
 - All display configuration actions are only possible in SmartGrid mode. When SmartGrid mode is activated, the evaluation bar replaces the current softkey menu display. When the SmartGrid mode is deactivated again, the previous softkey menu display is restored.
- [Background Information: The SmartGrid Principle](#)..... 118
 - [How to Activate SmartGrid Mode](#)..... 120
 - [How to Add a New Result Window](#)..... 121
 - [How to Close a Result Window](#)..... 121
 - [How to Arrange the Result Windows](#)..... 121

8.5.2.1 Background Information: The SmartGrid Principle

SmartGrid display

During any positioning action, the underlying SmartGrid is displayed. Different colors and frames indicate the possible new positions. The position in the SmartGrid where you drop the window determines its position on the screen.

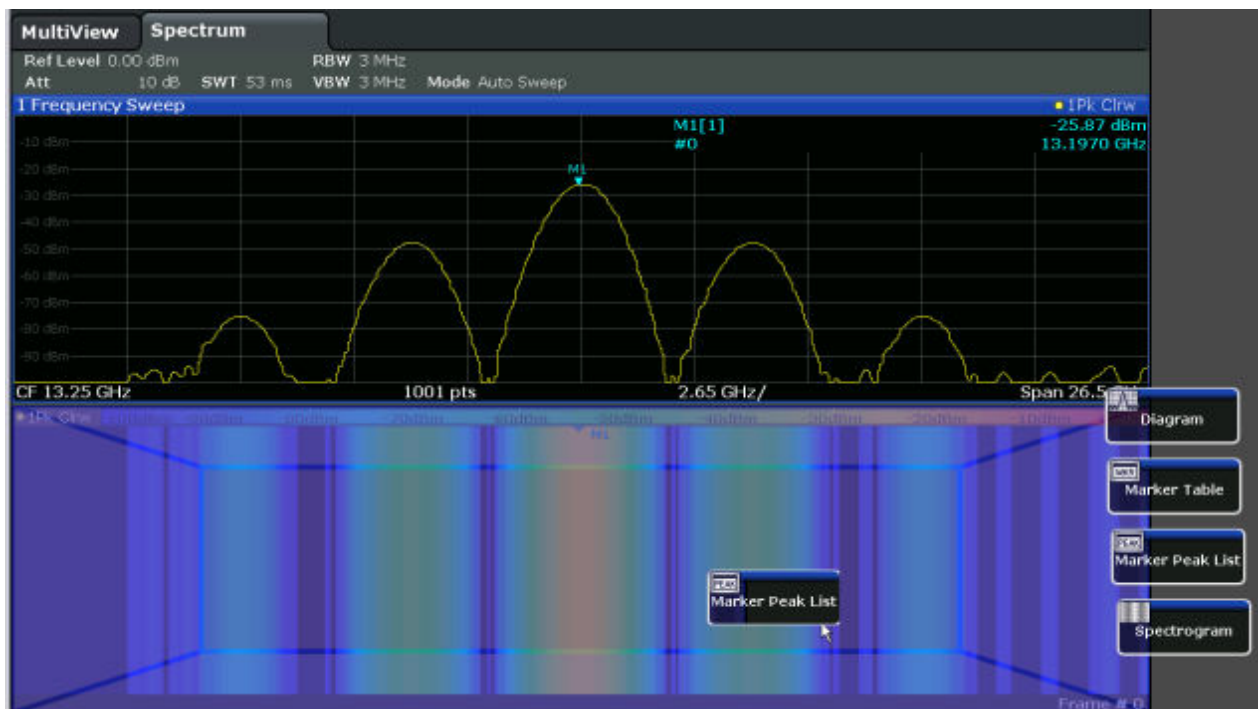

Figure 8-4: Moving a window in SmartGrid mode

The brown area indicates the possible "drop area" for the window, i.e. the area in which the window can be placed. A blue area indicates the (approximate) layout of the window as it would be if the icon were dropped at the current position. The frames indicate the possible destinations of the new window with respect to the existing windows: above/below, right/left or replacement (as illustrated in [Figure 8-5](#)). If an existing window would be replaced, the drop area is highlighted in a darker color shade.

Positioning the window

The screen can be divided into up to four rows. Each row can be split into up to four columns, where each row can have a different number of columns. However, rows always span the entire width of the screen and may not be interrupted by a column. A single row is available as the drop area for the window in the Smart-Grid. The row can be split into columns, or a new row can be inserted above or below the existing row (if the maximum of 4 has not yet been reached).

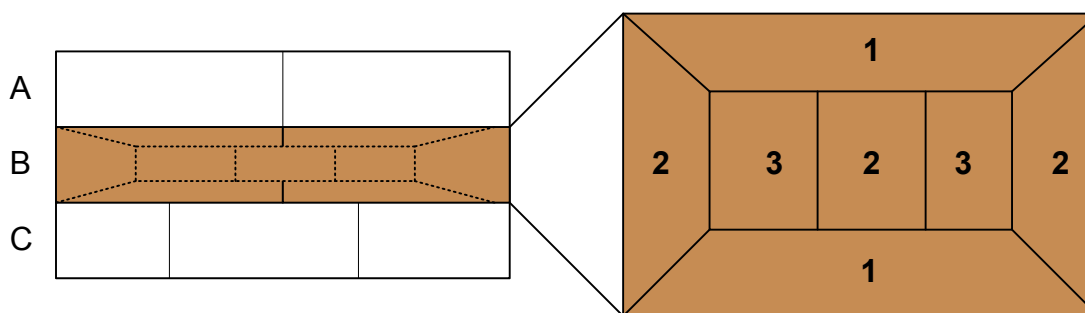

Figure 8-5: SmartGrid window positions

1 = Insert row above or below the existing row

2 = Create a new column in the existing row

3 = Replace a window in the existing row

SmartGrid functions

Once the evaluation icon has been dropped, icons in each window provide delete and move functions.



The "Move" icon allows you to move the position of the window, possibly changing the size and position of the other displayed windows.



The "Delete" icon allows you to close the window, enlarging the display of the remaining windows.

8.5.2.2 How to Activate SmartGrid Mode

All display configuration actions are only possible in SmartGrid mode. In SmartGrid mode the evaluation bar replaces the current softkey menu display. When the SmartGrid mode is deactivated again, the previous softkey menu display is restored.

► To activate SmartGrid mode, do one of the following:



Select the "SmartGrid" icon from the toolbar.

- Select the "Display Config" button in the configuration "Overview" .
- Select the "Display Config" softkey from the [Meas Config] menu.

The SmartGrid functions and the evaluation bar are displayed.



To close the SmartGrid mode and restore the previous softkey menu select the "Close" icon in the right-hand corner of the toolbar, or press any key.

8.5.2.3 How to Add a New Result Window

Each type of evaluation is displayed in a separate window. Up to 16 individual windows can be displayed per channel (i.e. per tab).

1. Activate SmartGrid mode.

All evaluation methods available for the currently selected measurement are displayed as icons in the evaluation bar.

2. Select the icon for the required evaluation method from the evaluation bar. If the evaluation bar contains more icons than can be displayed at once on the screen, it can be scrolled vertically. Set the mouse pointer in the evaluation bar between the icons and move it up or down until the required icon appears.
3. Drag the required icon from the evaluation bar to the SmartGrid, which is displayed in the diagram area, and drop it at the required position. (See [Chapter 8.5.2.5, "How to Arrange the Result Windows"](#), on page 121 for more information on positioning the window).

8.5.2.4 How to Close a Result Window

- ▶ To close a window, activate SmartGrid mode and select the "Delete" icon for the window.



8.5.2.5 How to Arrange the Result Windows

1. Select an icon from the evaluation bar or the "Move" icon for an existing evaluation window.



2. Drag the evaluation over the SmartGrid.
A blue area shows where the window will be placed.
3. Move the window until a suitable area is indicated in blue.
4. Drop the window in the target area.
The windows are rearranged to the selected layout, and "Delete" and "Move" icons are displayed in each window.
5. To close a window, select the corresponding "Delete" icon.



8.5.3 Changing the Size of Windows

Each channel tab may contain several windows to evaluate the measurement results using different methods. A "splitter" allows you to change the size of neighboring windows.

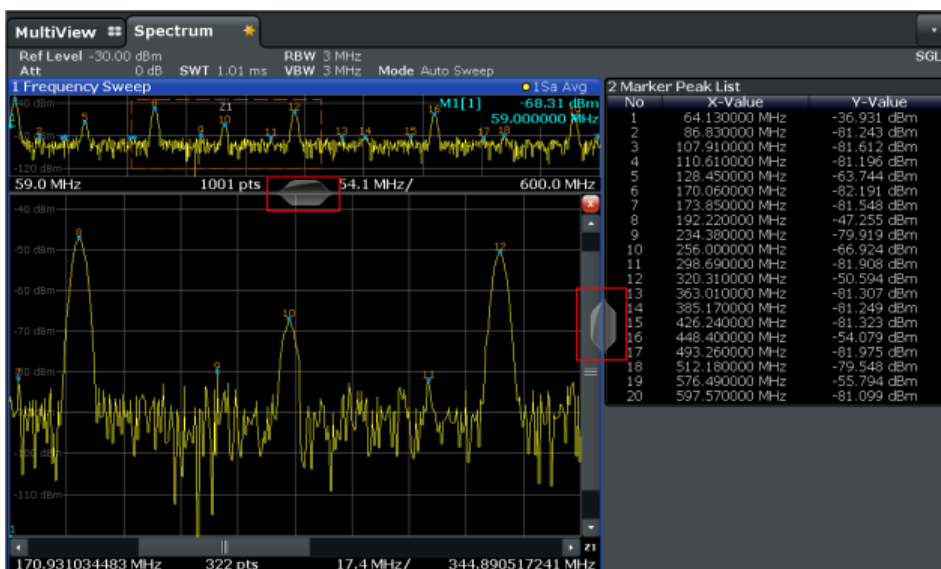

The splitters are not available in SmartGrid mode.

- ▶ To change the size of two neighboring windows, drag the splitter between the windows in either direction.

8.5.4 Switching Between a Split and Maximized Window Display

To get an overview of the results, displaying several windows at the same time may be helpful. However, the individual windows may become rather small. In this case it is useful to maximize an individual window to the entire screen temporarily in order to analyze the results in more detail.



To switch between a split and a maximized display without having to close and re-open windows, select the [SPLIT/MAXIMIZE] key. In maximized display, the currently focused window is maximized. In split display, all active windows are displayed.

8.5.5 Changing the Display

The display can be optimized for your individual needs. The following display functions are available and are described in detail in the User Manual.

- Displaying or hiding a simulation of the entire front panel of the instrument on the screen ("Soft Front Panel")
- Displaying the main function hardkeys in a separate window on the screen ("Mini Front Panel")
- Hiding or showing various screen elements
- Selecting a display theme and colors
- Changing the display update rate
- Zooming into the diagram

8.6 Getting Help

If any questions or problems concerning the R&S FPS arise, an extensive online help system is provided on the instrument and can be consulted at any time. The help system is context-sensitive and provides information specifically for the cur-

rent operation or setting to be performed. In addition, general topics provide an overview on complete tasks or function groups as well as background information.

8.6.1 Calling Up Help

The online help can be opened at any time by selecting one of the "Help" icons on the toolbar or by selecting the F1 key on an external or the online keyboard.

Calling context-sensitive help

- ▶ To display the "Help" dialog box for the currently focused screen element, e.g. a softkey or a setting in an opened dialog box, select the "Help" icon on the toolbar.



The "Help" dialog box "View" tab is displayed. A topic containing information about the focused screen element is displayed.

If no context-specific help topic is available, a more general topic or the "Contents" tab is displayed.

-  For standard Windows dialog boxes (e.g. File Properties, Print dialog etc.), no context-sensitive help is available.

- ▶ To display a help topic for a screen element not currently focused:
 - a) Select the "Help pointer" icon on the toolbar.



The pointer changes its shape to a "?" and an arrow.

- b) Select the screen element to change the focus.

A topic containing information about the selected (now focused) screen element is displayed.

8.6.2 Using the Help Window

The Help window contains several tabs:

- "View" - shows the selected help topic

- "Contents" - contains a table of help contents
- "Index" - contains index entries to search for help topics
- "Search" - provides text search



The Help toolbar provides some buttons:

- To browse the topics in the order of the table of contents: Up arrow = previous topic, Down arrow = next topic
- To browse the topics visited before: Left arrow = back, Right arrow = forward
- To increase or decrease the font



To search for a topic in the index

The index is sorted alphabetically. You can browse the list, or search for entries in the list.

1. Switch to the "Index" tab.
2. Select the "Keyboard" icon beside the entry field.
3. Enter the first characters of the keyword you are interested in.
The entries containing these characters are displayed.
4. Double-click the suitable index entry.
The "View" tab with the corresponding help topic is displayed.

To search topics for a text string

1. Switch to the "Search" tab.
2. Select the "Keyboard" icon beside the entry field.
3. Enter the string you want to find.
If you enter several strings with blanks between, topics containing all words are found (same as AND operator).

For advanced search, consider the following:

- To find a defined string of several words, enclose it in quotation marks. For example, a search for *"trigger qualification"* finds all topics with exactly

"trigger qualification". A search for *trigger qualification* finds all topics that contain the words *trigger* and *qualification*.

- Use "Match whole word" and "Match case" to refine the search.
- Use operators AND, OR, and NOT.

To close the Help window

- ▶ Select the "Close" icon in the upper right corner of the help window.
Or: Press the [ESC] key.

9 Contacting Customer Support

Technical support – where and when you need it

For quick, expert help with any Rohde & Schwarz product, contact our customer support center. A team of highly qualified engineers provides support and works with you to find a solution to your query on any aspect of the operation, programming or applications of Rohde & Schwarz products.

Contact information

Contact our customer support center at www.rohde-schwarz.com/support, or follow this QR code:



Figure 9-1: QR code to the Rohde & Schwarz support page

Index

Symbols

75 Ω (channel bar) 110

A

AC (channel bar) 110
 AnBW (channel setting) 109
 AP (trace information) 111
 Application cards 16
 Application notes 16
 APX (channel bar) 110
 Arranging
 Windows 121
 Arrow keys 39, 105
 Att (channel setting) 108
 Automatic login mechanism
 Activating/Deactivating 79
 AV (trace information) 111

B

Brochures 15

C

Channel bar
 Information 108
 Channel settings
 Display 108
 Channels
 Activating 116
 Switching 108
 Closing
 Windows 121
 CLRW (trace information) 111
 CNT (marker functions) 112
 Commands
 GBIP, addressed 68
 GBIP, universal 68
 Compatible mode (channel setting) 109
 Computer name 49, 52
 Connector
 AC power supply 44
 Display Port 44
 DVI 44
 IF/VIDEO/DEMODO 43
 LAN 44
 Noise source control 42
 OCXO 46

REF INPUT 42
 RF Input 50 Ω 40, 42
 TRIGGER INPUT / OUTPUT 43
 USB 38, 44

Customer support 127

D

Data sheets 15
 DC (channel bar) 110
 DCL 68
 DHCP 49, 72
 Diagram area
 Channel settings 108
 Status display 113
 Trace information 111
 Diagram footer 112
 Display
 Changing - see User Manual 123
 Deactivating - see User Manual 123
 Evaluation bar 121
 Information 106
 SmartGrid 117
 Display colors 55
 Changing - see User Manual 123
 Display Port
 Connector 44
 Display theme
 Selecting - see User Manual 123
 DVI
 Connector 44

E

Entering data 116
 Error messages
 see User Manual 114
 Status bar 114
 Errors
 IF OVLD 115
 LOUNL 115
 NO REF 115
 OVEN 115
 RF OVLD 115
 UNCAL 115
 WRONG_FW 115
 Evaluation
 Modes, adding 121

- Evaluation bar
 - Using 121
- EXREF (status display) 115
- EXT REF
 - Status message 113
- Ext.Gen (channel bar) 110
- External monitor
 - Connectors 44
- External reference
 - Status message 113
- F**
- Focus
 - Changing 115
- Focus area
 - Switching between windows 101
- Front Panel
 - Displaying - see User Manual 123
- Front panels
 - Using 98
- Frq (channel bar) 110
- Function keys
 - Details - see user manual 101
 - Overview 101
- FXD (marker functions) 112
- G**
- GAT (channel bar) 110
- GET 68
- Getting started 14
- GPIB 59
 - Address 52, 76
 - Characteristics 65
 - interface messages 66
- Graphical user interface
 - Overview 95
- GTL 68
- H**
- Hard drive
 - Removable 40
- Help 123
 - Search for topic 125
 - Using 124
- Hiding
 - Screen elements - see User Manual 123
- HiSLIP 59
 - Protocol 61
 - Resource string 60
- I**
- IEC/IEEE bus
 - see GPIB 59
- IF OVLD
 - Error 115
- IF OVLD (status display) 115
- IF/VIDEO/DEMODO
 - Connector 43
- IFC 68
- INPUT OVLD (status display) 115
- Instrument security procedures 15
- Instrument Settings
 - see User Manual 55
- Interfaces
 - GPIB 65
 - LAN 59
 - USB 68
- IP address 60
 - Assigning 72
 - Network 49
- IP configuration
 - LAN 75
- K**
- Key
 - DOWN 39, 105
 - LEFT 39, 105
 - POWER 38
 - REDO 103
 - RIGHT 39, 105
 - UNDO 103
 - UP 39, 105
- Keypad
 - Overview 104
- L**
- LAN
 - Configuring 73
 - Connector 44
 - Interface 59
 - IP address 60
 - LAN configuration 75
 - Ping 75
 - Remote control interface 58
 - Reset 50
 - VISA 59
 - VXI protocol 61
 - Web browser interface 73
- LLO 68

- Login
 - Network 76
 - Secure user mode 29
- LOUNL
 - Error 115
- LOUNL (status display) 115
- LVL (channel bar) 110
- M**
- Marker
 - Information 111
- Marker table
 - Information 112
- MAXH (trace information) 111
- Maximize
 - Window 123
- Maximizing
 - Display 101
- Meas Time (channel setting) 109
- MI (trace information) 111
- MINH (trace information) 111
- Mini front panel
 - Using 99
- Mini Front Panel
 - Displaying - see User Manual 123
- MOD (marker functions) 112
- Mode (channel setting) 109
- N**
- NCor (enhancement label) 111
- Network
 - Automatic login 79
 - Changing user passwords 78
 - Configuring 70
 - Connecting the instrument 71
 - Creating users 77
 - Login 76
 - Setting up 57
 - Sharing directories 80
- NO REF
 - Error 115
- NOI (marker functions) 112
- Noise source control
 - Connector 42
- NOR (channel bar) 110
- NormalUser 51
- O**
- OCCO
 - Connector 46
- Offset (channel setting) 108
- Online help
 - Working with 123
- Options
 - Secure user mode (K33) 34
- OVEN
 - Error 115
- OVEN (status display) 115
- Overheating
 - Shutdown 23
- P**
- Pa (channel bar) 110
- Passwords
 - Changing 78
- PHN (marker functions) 112
- Ping 75
- PK (trace information) 111
- POWER
 - Key 38
- Power supply
 - Connector 44
- Power-save mode
 - Activating - see User Manual 123
- PPC 68
- PPU 68
- Print colors
 - Changing - see User Manual 123
- Product IDs 69
- Protocol
 - VXI 61
- R**
- RBW (channel setting) 109
- Rear panel
 - Overview 40
- REDO
 - Key 103
- REF INPUT
 - Connector 42
- Ref Level (channel setting) 108
- Release notes 16
- Remote control
 - Interfaces 58
 - Protocols 58
- Remote Desktop 57, 82
 - Client 84
 - Ending session 86
 - Setting up a connection 86

- Setting up controller 84
- Setting up instrument 82
- Remote operation
 - Deactivating the instrument 88
 - GPIB address 76
 - Setting up 57
 - Starting 81
- Removable hard drive 40
- Restricted operation
 - Secure user mode 35
- Restrictions
 - Storage space 34
- Results
 - Displaying 116
- RF Input
 - Connector 40, 42
- RF OVLD
 - Error 115
- RF OVLD (status display) 115
- RM (trace information) 111
- S**
- SA (trace information) 111
- Safety instructions 15
- Saving
 - Classified data 34
- SDC 68
- Searching
 - In help 125
- Secure user mode
 - Activating/deactivating 35
 - Background information 33
 - Login 29
 - Redirecting storage 34
 - Restricted operation 35
 - Self-alignment data 35
- SecureUser 35, 51
- Security procedures 15
- Self-alignment
 - Secure user mode 35
- Sequencer 108
- Service manual 15
- Sgl (channel bar) 109
- SmartGrid
 - Activating 120
 - Arranging windows 121
 - Display 117
 - Evaluation bar 121
 - Features 117
 - Mode 120
- Soft front panel
 - Overview 95
- Softkeys
 - Status 98
- SPD 68
- SPE 68
- Split
 - Window 123
- Split display 101
- Splitters
 - Window size 122
- Status bar
 - Color coding 114
 - Error messages 114
 - Secure user mode 35
- Status display 113
- Subnet Mask 49
- Switching
 - Focus area 101
 - Keyboard display 101
 - Maximized/split display 101
- SWT (channel setting) 109
- SYSTEM
 - Keys 101
- System messages
 - Deleting 50
- T**
- Tabs
 - All 116
 - Switching 108
- Tdf (channel bar) 110
- Temperature
 - Excessive 23
- TOI (marker functions) 112
- Toolbar
 - Overview 96
- Trace information 111
 - Detector type 111
 - Trace number 111
 - Window title bar 111
- TRG (channel bar) 110
- TRIGGER INPUT / OUTPUT
 - Connectors 43
- TRK (marker functions) 112
- Troubleshooting
 - see User Manual 114

U

UNCAL	
Error	115
UNCAL (status display)	115
UNDO	
Key	103
USB	
Address	68
Connector	44
Connectors	38
Interfaces	68
Users	
Network	77
Password	78

V

VBW (channel setting)	109
Vendor ID	
Rohde & Schwarz	69
VISA	59
Libraries	69
Resource string	60, 69
Volatile memory	
Secure user mode	34
VXI protocol	61

W

Web browser	
Configuration interface	73
White papers	16
Window title bar	110
Windows	
Adding	121
Arranging	121
Closing	121
Size	122
Windows 10	
Access	26
WRONG_FW	
Error	115

Y

YIG filter	
Channel bar	110

Z

Zooming	
see User Manual	123