

R&S[®]ZNH

Handheld Vector Network Analyzer

Getting Started



1334597902

Version 05

ROHDE & SCHWARZ

Make ideas real



This manual applies to the following R&S®ZNH models with firmware version 1.20 and higher

- R&S®ZNH4 (1321.1611.04)
- R&S®ZNH8 (1321.1611.08)
- R&S®ZNH18 (1321.1611.18)
- R&S®ZNH26 (1321.1611.26)
- R&S®ZNH4 (1321.1611.54, equivalent to 1321.1611.04)
- R&S®ZNH8 (1321.1611.58, equivalent to 1321.1611.08)
- R&S®ZNH18 (1321.1611.68, equivalent to 1321.1611.18)
- R&S®ZNH26 (1321.1611.76, equivalent to 1321.1611.26)

© 2022 Rohde & Schwarz GmbH & Co. KG
Muehldorfstr. 15, 81671 Muenchen, Germany
Phone: +49 89 41 29 - 0
Email: info@rohde-schwarz.com
Internet: www.rohde-schwarz.com

Subject to change – data without tolerance limits is not binding.

R&S® is a registered trademark of Rohde & Schwarz GmbH & Co. KG.

Trade names are trademarks of the owners.

1334.5979.02 | Version 05 | R&S®ZNH

The following abbreviations are used throughout this manual: R&S®ZNH is abbreviated as R&S ZNH.

Contents

1 Safety information.....	5
2 Korea certification class B.....	6
3 Documentation overview.....	7
3.1 Manuals.....	7
3.2 Data sheet.....	8
3.3 Calibration certificate.....	8
3.4 Release notes, open source acknowledgment.....	8
3.5 Application notes, application cards, videos.....	8
4 Welcome to the R&S ZNH.....	9
5 Preparing for use.....	10
5.1 Putting into operation.....	10
5.1.1 Unpacking and checking the instrument.....	11
5.1.2 Accessory list.....	12
5.1.3 Setting up the R&S ZNH.....	12
5.1.4 Using the AC adapter.....	14
5.1.5 Battery operation.....	15
5.1.6 Battery maintenance.....	17
5.2 Switching the instrument on and off.....	18
6 Instrument tour.....	20
6.1 Front view.....	20
6.2 Top view.....	21
6.3 Left view.....	25
6.4 Right view.....	25
6.5 Rear view.....	26

6.6 Display overview..... 26

7 Contacting customer support..... 28

Index..... 29

1 Safety information

The product documentation helps you use the R&S ZNH safely and efficiently. Follow the instructions provided here and in the printed "Basic Safety Instructions". Keep the product documentation nearby and offer it to other users.

Intended use

The R&S ZNH is intended for the development, production and verification of electronic components and devices in industrial, administrative, and laboratory environments. Use the R&S ZNH only for its designated purpose. Observe the operating conditions and performance limits stated in the data sheet.

Where do I find safety information?

Safety information is part of the product documentation. It warns you about the potential dangers and gives instructions how to prevent personal injuries or damage caused by dangerous situations. Safety information is provided as follows:

- The printed "Basic Safety Instructions" provide safety information in many languages and are delivered with the R&S ZNH.
- Throughout the documentation, safety instructions are provided when you need to take care during setup or operation.

2 Korea certification class B



이 기기는 가정용(B급) 전자파 적합기기로서 주로 가정에서 사용하는 것을 목적으로 하며, 모든 지역에서 사용할 수 있습니다.

3 Documentation overview

This section provides an overview of the R&S ZNH user documentation.

3.1 Manuals

You find the documents on the R&S ZNH product page at:

<http://www.rohde-schwarz.com/manual/znh>

Getting started manual

Introduces the R&S ZNH and describes how to set up and start working with the product. The printed document is delivered with the instrument.

User manual

Contains the description of all instrument modes and functions. It also provides an introduction to remote control, a complete description of the remote control commands with programming examples, and information on maintenance and instrument interfaces. Includes the contents of the getting started manual.

The *online version* of the user manual provides the complete contents for immediate display on the internet.

Basic safety instructions

Contains safety instructions, operating conditions and further important information. The printed document is delivered with the instrument.

Instrument security procedures manual

Deals with security issues when working with the R&S ZNH in secure areas.

Service manual

Describes the performance test for checking the rated specifications, module replacement and repair, firmware update, troubleshooting and fault elimination, and contains mechanical drawings and spare part lists. The service manual is

Application notes, application cards, videos available for registered users on the global Rohde & Schwarz information system (GLORIS, <https://gloris.rohde-schwarz.com>).

3.2 Data sheet

The data sheet contains the technical specifications of the R&S ZNH. It also lists the options and their order numbers as well as optional accessories.

The brochure provides an overview of the R&S ZNH and shows its specific characteristics.

<http://www.rohde-schwarz.com/brochure-datasheet/znh>

3.3 Calibration certificate

The document is available on <https://gloris.rohde-schwarz.com/calcert>. You need the device ID of your instrument, which you can find on a label on the rear panel.

3.4 Release notes, open source acknowledgment

The release notes list new features, improvements and known issues of the current firmware version, and describe the firmware installation.

The open source acknowledgment document provides verbatim license texts of the used open source software.

<http://www.rohde-schwarz.com/firmware/znh>

3.5 Application notes, application cards, videos

These documents contain information about possible applications and background information on various topics, see www.rohde-schwarz.com/appnotes

4 Welcome to the R&S ZNH

The R&S ZNH is a new generation Rohde & Schwarz vector network analyzer developed to meet demanding customer requirements. Offering touchscreen input, the analyzer enhances user experience in making measurements fast and easy.

This user manual contains a description of the functionality that the instrument provides. The latest version is available for download at the product homepage (<http://www.rohde-schwarz.com/product/znh.html>).

5 Preparing for use

5.1 Putting into operation

This chapter describes the basic steps to be taken when setting up the R&S ZNH for the first time.

⚠ WARNING**Risk of injury due to disregarding safety information**

Observe the information on appropriate operating conditions provided in the data sheet to prevent personal injury or damage to the instrument. Read and observe the basic safety instructions provided with the instrument, in addition to the safety instructions in the following sections. In particular:

- Do not open the instrument casing.
-

NOTICE**Risk of instrument damage due to inappropriate operating conditions**

Specific operating conditions are required to ensure accurate measurements and to avoid damage to the instrument. Observe the information on appropriate operating conditions provided in the basic safety instructions and the instrument's data sheet.

NOTICE**Instrument damage caused by electrostatic discharge**

Electrostatic discharge (ESD) can damage the electronic components of the instrument and the device under test (DUT). Electrostatic discharge is most likely to occur when you connect or disconnect a DUT or test fixture to the instrument's test ports. To prevent electrostatic discharge, use a wrist strap and cord and connect yourself to the ground, or use a conductive floor mat and heel strap combination.

NOTICE**Risk of instrument damage during operation**

An unsuitable operating site or test setup can cause damage to the instrument and to connected devices. Ensure the following operating conditions before you switch on the instrument:

- The instrument is dry and shows no sign of condensation.
- The instrument is positioned as described in the following sections.
- The ambient temperature does not exceed the range specified in the data sheet.
- Signal levels at the input connectors are all within the specified ranges.
- Signal outputs are correctly connected and are not overloaded.

 **EMI impact on measurement results**

Electromagnetic interference (EMI) may affect the measurement results.

To suppress generated electromagnetic interference (EMI):

- Use suitable shielded cables of high quality. For example, use double-shielded RF and LAN cables.
- Always terminate open cable ends.
- Note the EMC classification in the data sheet.

5.1.1 Unpacking and checking the instrument

Check the equipment for completeness using the delivery note and the accessory lists for the various items. Check the instrument for any damage. If there is damage, immediately contact the carrier who delivered the instrument. Make sure not to discard the box and packing material.

 **Packing material**

Retain the original packing material. If the instrument needs to be transported or shipped later, you can use the material to protect the control elements and connectors.

NOTICE**Risk of damage during transportation and shipment**

Insufficient protection against mechanical and electrostatic effects during transportation and shipment can damage the instrument.

- Always make sure that sufficient mechanical and electrostatic protection is provided.
- When shipping an instrument, the original packaging should be used. If you do not have the original packaging, use sufficient padding to prevent the instrument from moving around inside the box. Pack the instrument in antistatic wrap to protect it from electrostatic charging.
- Secure the instrument to prevent any movement and other mechanical effects during transportation.

5.1.2 Accessory list

The instrument comes with the following accessories:

- Power supply cable and adapter set
- Li-ion rechargeable battery
- USB2.0 cable A-Mini
- Side strap
- "Getting Started" printed manual
- Document folder containing safety instructions, KC and CE certificate

Optional accessories and their order numbers are listed in the data sheet.

5.1.3 Setting up the R&S ZNH

The R&S ZNH is mainly used for diagnostic purpose during the installation of RF feeder cables and antennas for all kinds of radio transmitters. It can also be used to characterize both amplitude and phase measurements on complex test devices and discrete components with its S-parameters measurements.

Depending on the environment, you can adjust the viewing angle of the display and either lay it out horizontally or prop it up using the support on the back of the R&S ZNH.



When laid out horizontally for operation from above, the R&S ZNH is tilted slightly due to the micro-stand at the back. This position provides the optimum viewing angle for the display.

To allow easy operation from the front and still be able to read the display, you can swing out the support on the back of the R&S ZNH.

Before you turn on the R&S ZNH, you should insert the lithium ion battery included in the delivery into the battery compartment located at the back of the R&S ZNH.

Insert battery

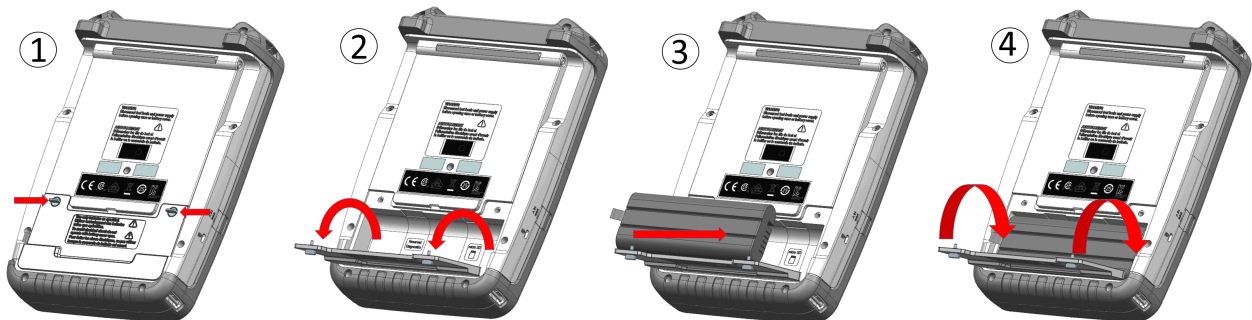

1. Unscrew the two thumb screws located on the battery compartment.
2. Open the cover.
3. Insert the battery into the R&S ZNH.
4. Close the cover and screw back the thumb screws.

You can operate the R&S ZNH with the AC adapter or the battery. Both are included in the delivery.

5.1.4 Using the AC adapter

NOTICE

Risk of instrument damage

To avoid instrument damage:

- Only use the power supply (R&S HA-Z301, order number 1321.1386.02) included in the delivery.
- Make sure that the AC supply voltage is compatible to the voltage specified on the power supply unit.
- Attach the appropriate adapter to the power supply.

Connect the AC adapter to the DC port on the left side of the R&S ZNH (item 1 of [Figure 5-1](#)). Make sure to fully insert the AC adapter plug into the DC port.

Depending on the system you need, firmly connect the appropriate power cable included in the delivery to the AC adapter (item 2 of [Figure 5-1](#)).

Finally, connect the power cable plug to an AC power outlet.



Figure 5-1: AC adapter

- 1 = AC adapter
2 = Power cable

The voltage range of the AC power supply is 100 V to 240 V AC.

After the R&S ZNH is connected to the power supply, you can turn it on with the [Power] key on the front panel.

5.1.5 Battery operation

The R&S ZNH has a smart battery indicator which displays the battery charging status on the [Power] key as well as the battery icon shown at the top right corner of the display screen. See [Chapter 6.6, "Display overview"](#), on page 26.

The lithium ion battery has a capacity of 6.9Ah / 74Wh (at nominal voltage of 10.80V) and it allows operation at preset condition of up to 4 hours when it is fully charged.

The actual operation time depends on the current charged status (see [Figure 5-2](#)), the ambient temperature and the operating mode of the R&S ZNH.

For a summary of the LED indication of the [Power] key, see [Table 5-1](#).

The battery charging and discharging process of the battery icon indicated in the display screen is illustrated below:

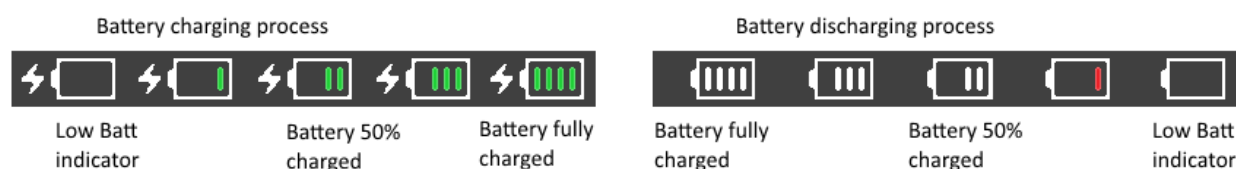

Figure 5-2: Battery charging and discharging process

Charging time is about three hours when the R&S ZNH is in inactive mode (i.e. R&S ZNH is switched off). If the instrument is in active mode (i.e. R&S ZNH is switched on), the charging time is extended to about five hours because the charging current is reduced as the power is partially drained by the usage of the R&S ZNH.

During operation in the field, you can also charge the battery with the car adapter (R&S HA-Z302, order number 1321.1340.02). You can connect the car adapter to the DC port. With the car adapter, you are able to charge the R&S ZNH via the car's cigarette lighter socket. A replacement battery (R&S HA-Z306, order number 1321.1334.02) with the same capacity and charging time as the battery included in the standard delivery is also available if necessary.

i Battery dispatched during delivery is not fully charged, for battery operation you have to charge it first.

To charge the battery, connect the charger to AC power adapter included in the delivery. For more information, see "[Using an external battery charger](#)" on page 16.

Using an external battery charger

You can also use an external battery charger (R&S HA-Z303, order number 1321.1328.02) to charge the battery.

To charge the battery externally, put the battery into the external charger and supply it with power via the AC power adapter.

An amber LED on the charger indicates the charging process. The LED turns to green when the battery is fully charged. A red LED on the charger indicates that the battery is not charging or the charging failed.

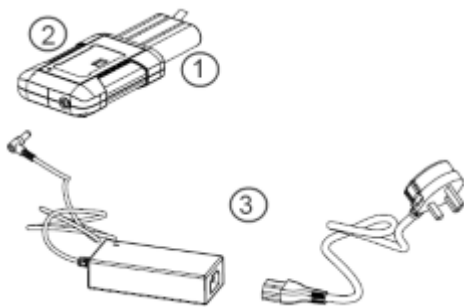

Figure 5-3: External battery charger

1 = Lithium ion battery R&S HA-Z306

2 = External charger R&S HA-Z303

3 = Power supply unit R&S HA-Z301 or car adapter R&S HA-Z302

⚠ WARNING

Risk of traffic accidents, physical injury and property damage

- Turn off the R&S ZNH while driving or while the engine is on.
- Operation of the R&S ZNH via the cigarette lighter socket while driving or while the engine on is prohibited.

5.1.6 Battery maintenance

The R&S ZNH comes with a lithium-ion battery. In general, these batteries are easy to handle. When you handle the battery, follow the instruction mentioned in the safety instructions and in the following chapters.

5.1.6.1 Handling

- The battery has been designed for a specific application. Do not use it for any other applications.
- Do not connect batteries in series or parallel as it can cause serious damage.
- Observe correct polarities during installation and charging.
- Do not heat over 70°C. The battery contains thermal fuses that could activate and render the battery inoperable.
- The battery contains an electronic device for protection against deep discharge, overcharge and short-circuiting between the terminals.
 - If you cannot discharge the battery, it may be deep discharged. Charge the battery for 0.5 hours and check again.
 - If you cannot charge the battery, it may be overcharged. Discharge the battery and check again.
 - If the battery has been short-circuited, charge it to reset the electronics.
 - If the battery still does not work, contact the Rohde & Schwarz customer support.
- Do not allow metallic objects to come into contact with the terminals.
- Do not solder directly to the battery.

5.1.6.2 Storage

The battery self-discharges while not in use. When storing the battery for an extended period of time, make sure to

- Handle the battery carefully to avoid short circuits. Make sure that leads and terminals are insulated.
- Keep the battery in the supplied packaging before use. The temperature should be between -20°C to 50°C.
- Store the battery at an initial state of charge between 15% and 50% of its capacity. When calculating the initial state of charge, consider

Switching the instrument on and off

- The maximum consumption of electronic devices
- The self-discharge of the battery - the higher the state of charge, the higher the rate of self-discharge
- Avoid a deep discharge of the battery. A deep discharge occurs when the state of charge falls below 5% of the battery's capacity.
- Recharge the battery at least every six months.

Should the battery voltage be low or even 0 V, the battery protection circuit may have gone into a sleep mode. In that case, reset the battery with an approved charger.

5.1.6.3 Transportation

No special regulations apply for transporting the battery. The battery cells contain no metallic lithium.

5.1.6.4 End of life

The capacity of the battery decreases after it has gone through numerous charge cycles and nearing its end of life. When the battery is dead, do not open the battery. Do not dispose battery in fire.

5.2 Switching the instrument on and off

The instrument can be powered with an AC or DC (battery operated or via car adapter) input. See [Chapter 5.1.4, "Using the AC adapter"](#), on page 14.

- ▶ Press [Power] key to switch on the instrument.
During booting, the R&S ZNH displays a splash screen to indicate the operable frequency range of the instrument. Depending on the frequency upgrade option installed, the respective splash screen is loaded.
After booting, the instrument is ready for operation.
Refer to the instrument brochure for the list of options available.
- ▶ Press [Power] key to switch off the instrument.





NOTICE**Risk of losing data**

If a running instrument (without battery) is disconnected directly from the power cord, the instrument loses its current settings. Furthermore, program data may be lost.

Press [Power] key first to shut down the application properly.

The following shows the [POWER] key behavior in different operation modes.

Table 5-1: Summary of LED indication on POWER key

LED indication on [Power] key		Descriptions
Green LED		Instrument is in operation mode.
Blue LED		Instrument is in switch off mode with a fully charged battery. A blinking blue LED indicates that the battery charging is in process.
Amber LED		Instrument is in switch off mode with AC supply and there is no battery in it.
Red LED		There is an error in the battery charging.
LED "OFF"		This is an indication that there is no AC or DC supply to the instrument. The instrument is in a switch off mode.

6 Instrument tour

This chapter describes the instrument in different views.

6.1 Front view



Figure 6-1: Front view of R&S ZNH

- 1 = RF port 1
- 2 = BNC connector
- 3 = Headphone jack
- 4 = USB ports
- 5 = RF port 2
- 6 = Touch-sensitive screen area
- 7 = Softkey labels (on display)
- 8 = Softkey
- 9 = Systems keys
- 10 = DC port (behind protective cap)
- 11 = Kensington lock
- 12 = Function keys
- 13 = On/off key
- 14 = Alphanumeric key
- 15 = Unit keys
- 16 = Back key

- 17 = Cancel key
- 18 = Rotary knob
- 19 = Screenshot key
- 20 = LAN and mini USB port (behind protective cap)
- 21 = Micro-SD card slot (not visible as it is located behind the battery compartment)

For a description of the keys, see "Front Panel Keys" in the R&S ZNH user manual.

NOTICE

Instrument damage caused by cleaning agents

Cleaning agents contain substances that may damage the instrument. For example, cleaning agents that contain a solvent may damage the front panel labeling, plastic parts, or the display.

Never use cleaning agents such as solvents (thinners, acetone, etc.), acids, bases, or other substances.

The outside of the instrument can be cleaned sufficiently using a soft, lint-free dust cloth.

6.2 Top view



- 1 = RF port 1
- 2 = BNC connector
- 3 = Headphone jack
- 4 = USB type A connector
- 5 = RF port 2

RF port 1 / RF port 2

Depending on the instrument models, different RF connectors are used.

- Type N connectors for model 04 / 08 / 18
- RPC 3.5 mm connectors for model 26

The RF ports serve as output for the RF stimulus signal and as input for the measured RF signals from the DUT (response signals). Maximum permissible power at the RF input port is 0 dBm, maximum 50 Vdc. Depending on the models, connect a cable or DUT to the RF input with a respective connector. Use a cable to connect the DUT to the R&S ZNH, if necessary.

- With a single RF port, it is possible to generate a stimulus signal and measure the response signal in reflection. For measurement examples, see CAT measurements in the R&S ZNH user manual.
- With two RF ports, it is possible to perform a full two-port measurement. For measurement examples, see VNA measurements in the R&S ZNH user manual.

⚠ WARNING**Risk of electrical shock**

To avoid electrical shock, the DC input voltage must never exceed the value specified on the housing.



NOTICE**Risk of instrument damage**

To avoid damage to the coupling capacitor, input attenuator or the mixer, the DC input voltage must never exceed the value specified in the data sheet.

NOTICE**Risk of DUT damage**

The R&S ZNH displays a signal source indicator on the [title bar](#). When the indicator shows a full green circle, signal source is present on the RF out connector.

To prevent damage on DUT, it is important to consider maximum input power on DUT before connection.

-  : Signal source is present on the RF out connector
-  : Signal source is not present on the RF out connector

BNC connector

You can connect the BNC connector for various applications. It supports an external trigger signal or an external reference signal. It can also be configured as a BIAS port.

When the BNC connector is configured as a trigger input, it controls the start of a measurement. The trigger mode is selected in the SWEEP menu. The trigger threshold is similar to that of TTL signals.

When the BNC connector is configured as reference input, you can apply a 10 MHz external reference signal to it for frequency synchronization. The external reference label  is displayed at the top right corner of the [title bar](#) to indicate that the reference signal is supplied via external signal input. The label turns green when the reference signal is detected.

The level of the reference signal must be larger than 0 dBm. If there is no reference signal present at the BNC connector, the R&S ZNH displays an appropriate message. Thus, measurements without a valid reference can be avoided.

With R&S ZNH-K10 (order number 1334.6846.02), the BNC connector can be configured as an internal DC bias port providing direct current output. Active equipment under test can be supplied with power via the bias port.

NOTICE**Risk of instrument damage**

To avoid damage to the tracking generator output, never apply currents greater than 600 mA or voltages greater than 20 V to the BNC connectors if the BNC connectors are not configured as BIAS output ports.

If they are configured as BIAS ports, never apply currents greater than 600 mA or voltages greater than 50 V.

Headphone jack

The 3.5 mm connector for headphones has an internal impedance of approximately 10 Ω .

USB type A connector

The USB port provides the USB interface to connect a memory stick and store data sets or screenshots. It can also be used to control the operation of the external power sensor.

⚠ WARNING**Risk of electrical shock**

To avoid electrical shock, the DC input voltage must never exceed the value specified on the housing.

NOTICE**Risk of instrument damage**

- Make sure not to overload the RF input and keep within the maximum allowed signal levels. Refer to the datasheet for the maximum allowed signal levels.
- To avoid damage to the coupling capacitor, input attenuator or the mixer, the DC input voltage of 50 V must never be exceeded.

6.3 Left view

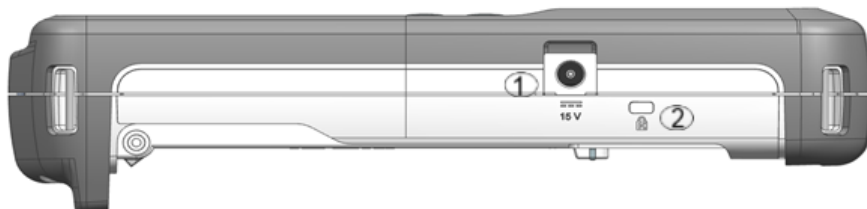

1 = DC input

2 = Kensington lock slot

DC input

The R&S ZNH is supplied with power by the AC/DC transformer power supply via the DC connector. You can also use the DC connector to charge the battery.

Kensington lock slot

A Kensington lock can be anchored to the R&S ZNH housing to secure it to a workstation mechanically.

6.4 Right view

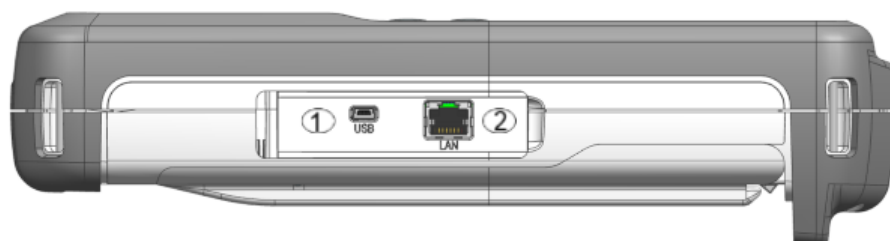

1 = Min USB port

2 = LAN port

LAN connector

RJ-45 connector to connect the instrument to a Local Area Network (LAN) and transfer data in both directions. It supports up to 100 Mbit/s.

USB type B connector (mini USB)

Mini USB connector to connect a computer for remote control of the instrument and transfer data in both directions.

6.5 Rear view

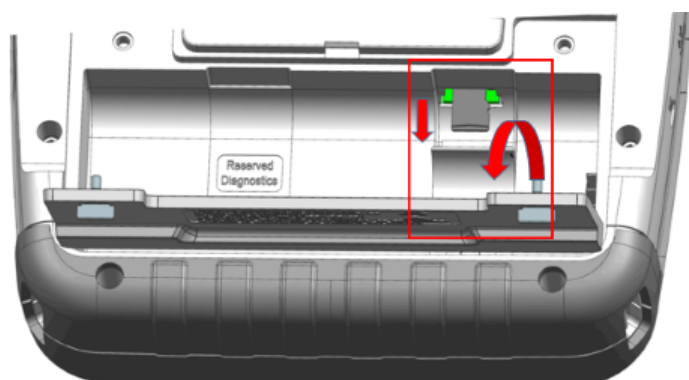

The micro-SD card slot is located behind the battery compartment of the R&S ZNH.

Peel open the micro-SD card protective cap to access to the micro-SD card slot. You can use the micro-SD card to store datasets or screenshots.

6.6 Display overview

The display area has a touch-sensitive screen, the touch functionality can be turned on or off in the instrument setup menu.

For information on the different sections of the display area and touchscreen gestures, see "Screen Layout and Elements" and "Touchscreen Gesture Elements" in the R&S ZNH user manual.

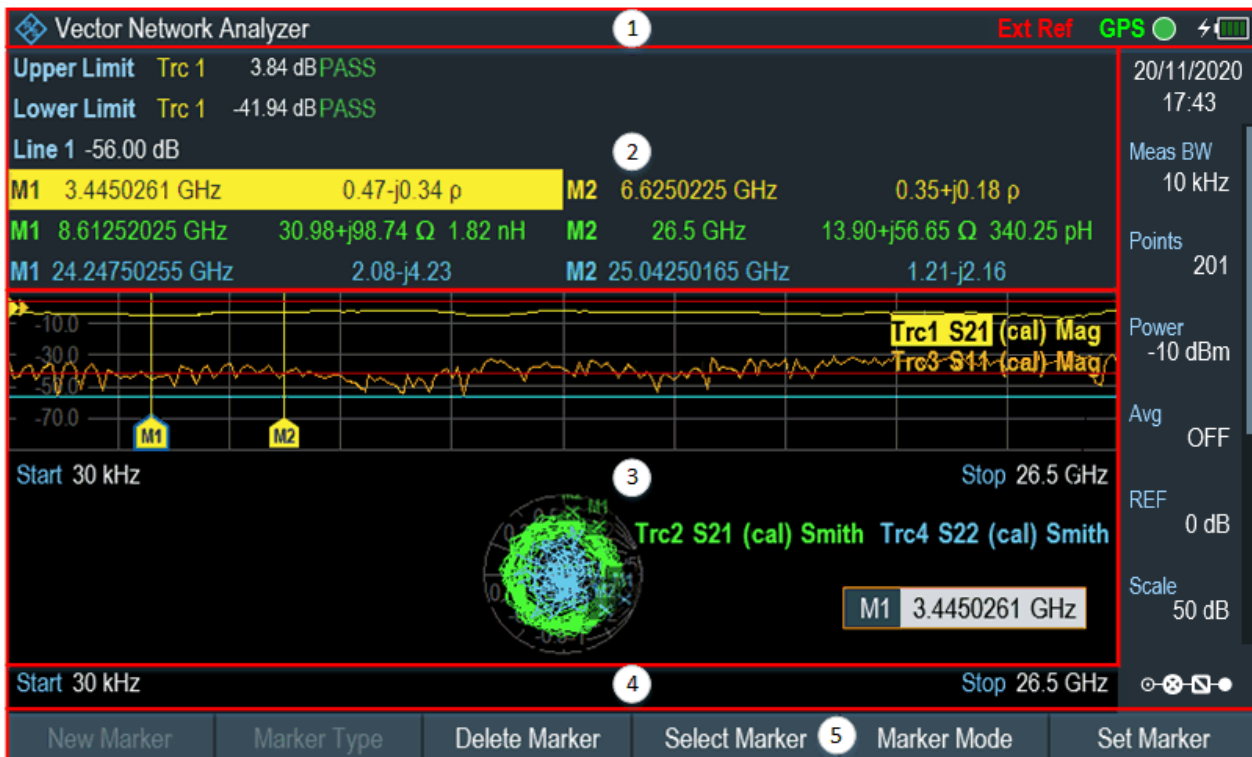

Figure 6-2: Display overview

- 1 = Title bar
- 2 = Measurement result view
- 3 = Measurement trace window
- 4 = Parameter view
- 5 = Softkey functions

NOTICE

Risk of touchscreen damage during operation

- Never touch the screen with ball point pens or other pointed objects with sharp edges.
- It is recommended that you operate the touchscreen by finger only. As an alternative, you may use a stylus pen with a smooth soft tip.
- Never apply excessive force to the screen. Touch it gently.
- Never scratch the screen surface, e.g. with a finger nail. Never rub it strongly, for example with a dust cloth.

7 Contacting customer support

Technical support – where and when you need it

For quick, expert help with any Rohde & Schwarz product, contact our customer support center. A team of highly qualified engineers provides support and works with you to find a solution to your query on any aspect of the operation, programming or applications of Rohde & Schwarz products.

Contact information

Contact our customer support center at www.rohde-schwarz.com/support, or follow this QR code:



Figure 7-1: QR code to the Rohde & Schwarz support page

Index

A

AC adapter	14
Application cards	8
Application notes	8

B

Battery insertion	12
Battery maintenance	17
Battery operation	
Battery (car adapter)	15
Battery (charging)	15
Battery (external charger)	15
Battery (replacement)	15
Brochure	8

C

Calibration certificate	8
Customer support	28

D

Data sheet	8
Documentation overview	7

E

Electrostatic discharge	10
ESD	10

G

Getting started	7
-----------------------	---

I

Instrument tour	20
Intended use	5

O

Open source acknowledgment (OSA)	8
--	---

P

Package contents	12
Positioning	
Support	12
Putting into operation	10

R

Release notes	8
---------------------	---

S

Safety information	5
Safety instructions	7
Switching on and off the instrument	18

U

Unpacking and checking the instrument ..	11
User manual	7

W

White papers	8
--------------------	---