

NRP

Power Sensors

Getting Started



1419017002

Version 22

ROHDE & SCHWARZ

Make ideas real



This manual gives an introduction to the NRP power sensors:

- R&S®NRPxxA(N) average power sensors
- R&S®NRPxxP pulse power sensors
- R&S®NRPxxS(N) three-path diode power sensors
- R&S®NRP18S-xx high-power three-path diode power sensors
- R&S®NRPxxT(N) thermal power sensors
- R&S®NRPxxTWG(N) thermal waveguide power sensors

© 2023 Rohde & Schwarz

Muehldorfstr. 15, 81671 Muenchen, Germany

Phone: +49 89 41 29 - 0

Email: info@rohde-schwarz.com

Internet: www.rohde-schwarz.com

Subject to change – data without tolerance limits is not binding.

R&S® is a registered trademark of Rohde & Schwarz GmbH & Co. KG.

All other trademarks are the properties of their respective owners.

1419.0170.02 | Version 22 | NRP

Throughout this manual, R&S® is indicated as R&S.

Contents

1 Safety and regulatory information.....	5
1.1 Safety instructions.....	5
1.2 Labels on the product.....	6
1.3 Warning messages in the documentation.....	7
2 Welcome.....	8
2.1 Documentation overview.....	8
2.1.1 Getting started manual.....	8
2.1.2 User manuals.....	8
2.1.3 CD-ROM.....	9
2.1.4 Instrument security procedures.....	9
2.1.5 Printed safety instructions.....	9
2.1.6 Specifications documents and product brochures.....	9
2.1.7 Release notes and open-source acknowledgment (OSA).....	10
2.1.8 Application notes, application cards, white papers, etc.....	10
2.2 Key features.....	10
3 Preparing for use.....	12
3.1 Unpacking and checking.....	12
3.2 Choosing the operating site.....	12
3.3 Considerations for test setup.....	13
3.4 Connecting to a DUT.....	14
3.5 Powering the power sensor.....	15
3.6 Connecting a cable to the host interface.....	16
3.7 Connecting to a controlling host.....	17
3.7.1 Computer.....	17
3.7.2 Android smartphone or tablet.....	21

3.7.3 Base unit.....	22
3.7.4 Using a LAN connection.....	23
4 Power sensor tour.....	30
4.1 RF connector.....	31
4.2 Status information.....	33
4.3 Host interface.....	34
4.4 Trigger I/O connector.....	34
4.5 LAN PoE interface.....	34
5 Operating concepts.....	36
5.1 R&S NRP Toolkit.....	36
5.1.1 Versions and downloads.....	36
5.1.2 System requirements.....	37
5.1.3 R&S NRP Toolkit for Windows.....	37
5.2 Browser-based user interface.....	39
5.3 Remote control.....	41
5.4 R&S NRPV.....	41
5.5 R&S Power Viewer.....	43
5.6 R&S Power Viewer Mobile.....	45
5.7 R&S NRX.....	46
6 Remote control interfaces and protocols.....	48
6.1 USB interface.....	48
6.2 Ethernet interface.....	52
6.2.1 VISA resource strings.....	52
7 Contacting customer support.....	54
Index.....	55

1 Safety and regulatory information

The product documentation helps you use the product safely and efficiently. Follow the instructions provided here and in the following chapters.

Intended use

The power sensors are intended for accurate and uncomplicated power measurements in production, R&D and calibration labs as well as for installation and maintenance tasks. The supported base units are listed in the data sheet. Observe the operating conditions and performance limits stated in the data sheet.

Target audience

The target audience is developers and technicians. The required skills and experience in power measurements depend on the used operating concept.

The power sensors are suitable for numerous power measurement applications. Their application depends on the power sensor type and the frequency range of the power sensor. For details, see the user manual or the data sheet.

Where do I find safety information?

Safety information is part of the product documentation. It warns you of potential dangers and gives instructions on how to prevent personal injury or damage caused by dangerous situations. Safety information is provided as follows:

- In [Chapter 1.1, "Safety instructions"](#), on page 5. The same information is provided in many languages as printed "Safety Instructions". The printed "Safety Instructions" are delivered with the product.
- Throughout the documentation, safety instructions are provided when you need to take care during setup or operation.

1.1 Safety instructions

Products from the Rohde & Schwarz group of companies are manufactured according to the highest technical standards. To use the products safely, follow the instructions provided here and in the product documentation. Keep the product documentation nearby and offer it to other users.

Labels on the product

Use the product only for its intended use and within its performance limits. Intended use and limits are described in the product documentation such as the data sheet, manuals and the printed "Safety Instructions". If you are unsure about the appropriate use, contact Rohde & Schwarz customer service.

Using the product requires specialists or specially trained personnel. These users also need sound knowledge of at least one of the languages in which the user interfaces and the product documentation are available.

Reconfigure or adjust the product only as described in the product documentation or the data sheet. Any other modifications can affect safety and are not permitted.

Never open the casing of the product. Only service personnel authorized by Rohde & Schwarz are allowed to repair the product. If any part of the product is damaged or broken, stop using the product. Contact Rohde & Schwarz customer service at <https://www.rohde-schwarz.com/support>.



Operating the product

Only use the product indoors. The product casing is not waterproof.

Observe the ambient conditions such as altitude, operating temperature and climatic loads; see the data sheet.

Meaning of safety labels

Safety labels on the product warn against potential hazards.

	Potential hazard Read the product documentation to avoid personal injury or product damage.
	Hot surface Do not touch. Risk of skin burns. Risk of fire.

1.2 Labels on the product

Labels on the product inform about:

- Personal safety
See "[Meaning of safety labels](#)" on page 6.
- Environment safety
See [Table 1-1](#).

Warning messages in the documentation

- Identification of the product
See "[Default hostname](#)" on page 27.

Table 1-1: Labels regarding environment safety



	<p>Labeling in line with EN 50419 for disposal of electrical and electronic equipment after the product has come to the end of its service life. For more information, see the user manual.</p>
---	---

Table 1-2: Labels regarding sensitive components

	<p>Electrostatically sensitive components Indicates sensitivity to touch. Follow the instructions in the product documentation to avoid product damage. See "Preventing electrostatic discharge (ESD)" on page 14.</p>
---	--

1.3 Warning messages in the documentation

A warning message points out a risk or danger that you need to be aware of. The signal word indicates the severity of the safety hazard and how likely it will occur if you do not follow the safety precautions.

CAUTION

Potentially hazardous situation. Could result in minor or moderate injury if not avoided.

NOTICE

Potential risks of damage. Could result in damage to the supported product or to other property.

2 Welcome

This chapter provides an overview of the user documentation and an introduction to the NRP power sensor.

2.1 Documentation overview

This section provides an overview of the NRP power sensor user documentation. Unless specified otherwise, you find the documents at:

www.rohde-schwarz.com/manual/nrp-a-an

www.rohde-schwarz.com/manual/nrpxxp

www.rohde-schwarz.com/manual/nrp_s_sn

www.rohde-schwarz.com/manual/nrp-t-tn

Further documents are available at:

www.rohde-schwarz.com/product/nrp-a-an

www.rohde-schwarz.com/product/nrpxxp

www.rohde-schwarz.com/product/nrp_s_sn

www.rohde-schwarz.com/product/nrp-t-tn

2.1.1 Getting started manual

Introduces the NRP power sensor and describes how to set up and start working with the product. Includes basic operations and general information, e.g. safety instructions, etc. A printed version is delivered with the power sensor.

2.1.2 User manuals

Contains the description of all instrument modes and functions. It also provides an introduction to remote control, a complete description of the remote control commands with programming examples, and information on maintenance and interfaces. Includes the contents of the getting started manual.

The user manual is also available for download or for immediate display on the Internet.

2.1.3 CD-ROM

Provides quick access to information. Most of the information is also provided at the R&S internet site, but on different pages. Delivered with the product.

- Links to useful sites on the Rohde & Schwarz website
- Product documentation such as manuals, specifications documents, application notes, security procedures, ...
- Open-source acknowledgment documents

2.1.4 Instrument security procedures

Deals with security issues when working with the NRP power sensor in secure areas. It is available for download on the internet.

2.1.5 Printed safety instructions

Provides safety information in many languages. The printed document is delivered with the product.

2.1.6 Specifications documents and product brochures

The specifications document, also called data sheet, contains the technical specifications of the NRP power sensor. It also lists the options and their order numbers, and optional accessories.

The brochure provides an overview of the instrument and deals with the specific characteristics.

www.rohde-schwarz.com/brochure-datasheet/nrp-a-an

www.rohde-schwarz.com/brochure-datasheet/nrpxxp

www.rohde-schwarz.com/brochure-datasheet/nrp_s_sn

www.rohde-schwarz.com/brochure-datasheet/nrp-t-tn

2.1.7 Release notes and open-source acknowledgment (OSA)

The release notes list new features, improvements and known issues of the current firmware version, and describe the firmware installation.

The software makes use of several valuable open source software packages. An open-source acknowledgment document provides verbatim license texts of the used open source software.

The open-source acknowledgment document is provided on the user documentation CD-ROM, included in the delivery.

www.rohde-schwarz.com/firmware/nrp-a-an

www.rohde-schwarz.com/firmware/nrp-xxp

www.rohde-schwarz.com/firmware/nrp_s_sn

www.rohde-schwarz.com/firmware/nrp-t-tn

2.1.8 Application notes, application cards, white papers, etc.

These documents deal with special applications or background information on particular topics.

www.rohde-schwarz.com/application/nrp_s_sn

www.rohde-schwarz.com/application/nrp-t-tn

2.2 Key features

The NRP power sensors are the successors of the established R&S NRP-Z power sensors from Rohde & Schwarz.

They provide a high-speed USB interface that constitutes both the communication port and the power supply connection.

Also, most power sensors are available with an additional Gigabit Ethernet interface with Power-over-Ethernet (PoE) power supply. The power sensors with networking capabilities, the NRP LAN power sensors, are marked with a trailing N in their names:

- R&S NRPxxSN

- R&S NRPxxAN
- R&S NRPxxTN
- R&S NRPxxTWGN

The NRP power sensors are compatible with the R&S NRP-Z power sensors in both the interface (USB) and a common command subset. This compatibility makes the replacement of the old power sensors easy.

For a detailed specification, refer to the specifications document and the brochure.

3 Preparing for use

Here, you can find basic information about setting up the product for the first time.

- [Unpacking and checking](#)..... 12
- [Choosing the operating site](#)..... 12
- [Considerations for test setup](#)..... 13
- [Connecting to a DUT](#)..... 14
- [Powering the power sensor](#)..... 15
- [Connecting a cable to the host interface](#)..... 16
- [Connecting to a controlling host](#)..... 17

3.1 Unpacking and checking

1. Unpack the product carefully.
2. Retain the original packing material. Use it when transporting or shipping the product later.
3. Using the delivery notes, check the equipment for completeness.
4. Check the equipment for damage.

If the delivery is incomplete or equipment is damaged, contact Rohde & Schwarz.

3.2 Choosing the operating site

Specific operating conditions ensure proper operation and avoid damage to the product and connected devices. For information on environmental conditions such as ambient temperature and humidity, see the specifications document.

Electromagnetic compatibility classes

The electromagnetic compatibility (EMC) class indicates where you can operate the product. The EMC class of the product is given in the data sheet.

- Class B equipment is suitable for use in:

Considerations for test setup

- Residential environments
- Environments that are directly connected to a low-voltage supply network that supplies residential buildings
- Class A equipment is intended for use in industrial environments. It can cause radio disturbances in residential environments due to possible conducted and radiated disturbances. It is therefore not suitable for class B environments. If class A equipment causes radio disturbances, take appropriate measures to eliminate them.

3.3 Considerations for test setup

Give particular attention to the following aspects when handling power sensors.

Handling the R&S NRP18S-xx power sensor

- ▶ **CAUTION!** Hot surfaces. Under certain conditions, the maximum surface temperatures of the power sensor can exceed the limits defined in the EN 61010-1 standard, safety requirements for electrical equipment for measurement, control and laboratory use.

Provide protection as follows:

- a) Ensure that unintentional contact with the power sensor is impossible.
- b) Wear heat-protective gloves when touching the power sensor after operation.

Handling the TVAC-compliant power sensor

1. **NOTICE!** Avoid contamination.

Always wear clean protective gloves when handling the TVAC-compliant power sensor to protect the power sensor and its environment from contamination.

2. **NOTICE!** Reduce outgassing to a minimum by following this bake-out procedure.

Vacuum bake the TVAC-compliant power sensor for 100 hours at 85 °C at a pressure lower than 10^{-5} mbar.

Preventing electrostatic discharge (ESD)

Electrostatic discharge is most likely to occur when you connect or disconnect a device under test (DUT). It can damage the electronic components of the product and the DUT. To prevent electrostatic discharge damage, do not touch the inner conductor of the RF connector.

EMI impact on measurement results

Electromagnetic interference (EMI) can affect the measurement results.

To suppress electromagnetic radiation during operation:

- Use high-quality shielded cables, for example, double-shielded RF and interface cables.
- Always terminate open cable ends.
- Ensure that connected external devices comply with EMC regulations.

Signal input and output levels

Information on signal levels is provided in the specifications document. Keep the signal levels within the specified ranges to avoid damage to the product and connected devices.

The following applies only to the R&S NRP18S-xx power sensors:

The test limits specified on the name plate apply only if the power sensor is operated together with the RF power attenuator supplied. If the power sensor is operated without attenuator, the lower test limits of the R&S NRP18S power sensor apply, as specified in the specifications document.

3.4 Connecting to a DUT

For connecting the power sensor to a DUT, use the RF connector. See [Chapter 4.1, "RF connector"](#), on page 31.

To connect to the DUT

1. Ensure that the RF connector of your DUT is compatible with the RF connector of the power sensor.
2. **NOTICE!** Do not touch the inner conductor of the RF connector. See ["Preventing electrostatic discharge \(ESD\)"](#) on page 14.

Powering the power sensor

Inspect both RF connectors carefully. Look for metal particles, contaminants and defects.

If either RF connector is damaged, do not proceed, because the risk of damaging the mating connector is too high.

3. Insert the RF connector straight into the RF output of your DUT. Take care not to tilt it.

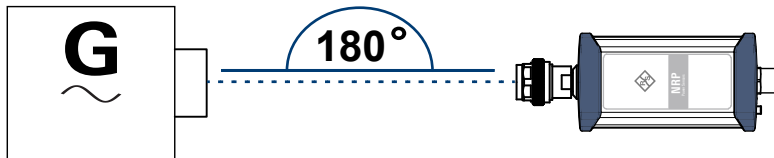

4. **NOTICE!** Risk of damaging the center pin of the RF connector. Only rotate the hex nut of the RF connector. Never rotate the power sensor itself.
Tighten the RF connector manually.
5. Tighten the RF connector using a torque wrench with the nominal torque recommended in [Chapter 4.1, "RF connector"](#), on page 31 to ensure maximum measurement accuracy.

To disconnect from the DUT

1. **NOTICE!** Risk of damaging the center pin of the RF connector. Only rotate the hex nut of the RF connector. Never rotate the power sensor itself.
Carefully loosen the union nut at the front of the RF connector of the power sensor.
2. Remove the power sensor.

3.5 Powering the power sensor

The electrical power for the NRP power sensor is supplied over one of the following interfaces:

- Host interface
See [Chapter 4.3, "Host interface"](#), on page 34.
- LAN PoE interface
Available only for LAN power sensors. See [Chapter 4.5, "LAN PoE interface"](#), on page 34.

Connecting a cable to the host interface

 If you use the Ethernet interface of the LAN power sensors, you have to provide the electrical power by power over Ethernet (PoE). In this case, you *cannot* provide the electrical power over the host interface instead.

Choose the PoE power sourcing equipment (PSE) with care

Only use PoE power sourcing equipment (PSE) as specified in the IEEE standards 802.3af or IEEE 802.3at. Otherwise, the following can happen:

- If too much power is supplied, the LAN power sensor can get overheated and become damaged as a result.
- If the supplied power is not sufficient, the LAN power sensor does not work properly or not at all.

3.6 Connecting a cable to the host interface

For connecting the power sensor to a USB host, use the host interface. See [Chapter 4.3, "Host interface"](#), on page 34.

The required cable depends on the USB host, see the required equipment in [Chapter 3.7, "Connecting to a controlling host"](#), on page 17.

The available cable lengths are listed in the specifications document.

To connect a cable to the host interface of the power sensor

1. Insert the screw-lock cable connector into the host interface connector of the power sensor.
2. Tighten the union nut manually.

To disconnect the host interface of the power sensor

1. Loosen the union nut of the screw-lock cable connector.
2. Remove the cable.

3.7 Connecting to a controlling host

As a controlling host, you can use:

- [Computer](#)
- [Android smartphone or tablet](#)
- [Base unit](#)

For operating the power sensor, you can choose from various possibilities. For details, see [Chapter 5, "Operating concepts"](#), on page 36.

3.7.1 Computer

If the controlling host is a computer, you can operate the power sensor in several ways. For details, see [Chapter 5, "Operating concepts"](#), on page 36.

- ▶ Establish the connection using:
 - Host interface
See [Chapter 3.7.1.1, "USB connection"](#), on page 17.
See [Chapter 3.7.1.2, "R&S NRP-Z5 sensor hub setup"](#), on page 18.
 - LAN interface, if the power sensor is a LAN power sensor
See [Chapter 3.7.4, "Using a LAN connection"](#), on page 23.

3.7.1.1 USB connection

All NRP power sensors can be connected to the USB interface of a computer.

Required equipment

- NRP power sensor
- R&S NRP-ZKU cable or R&S NRP-ZKC cable
- Computer with USB-A or USB-C interface

Setup

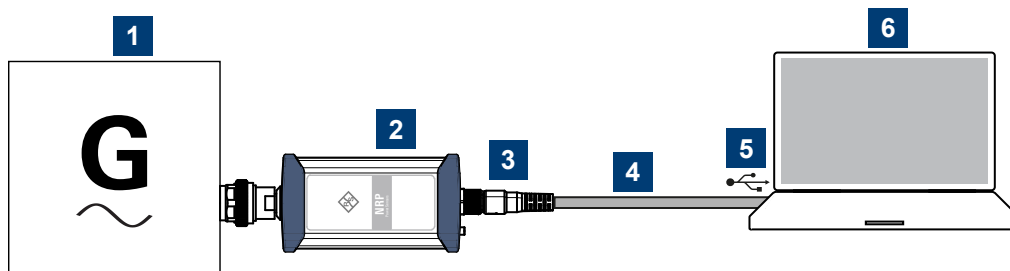

Figure 3-1: Setup with an R&S NRP-ZKU cable

- 1 = Signal source
- 2 = NRP power sensor
- 3 = Host interface connector
- 4 = R&S NRP-ZKU cable or R&S NRP-ZKC cable
- 5 = USB connector
- 6 = Computer with installed VISA driver or R&S NRP Toolkit

Set up as shown in [Figure 3-1](#).

1. Connect the R&S NRP-ZKU cable or R&S NRP-ZKC cable to the power sensor. See ["To connect a cable to the host interface of the power sensor"](#) on page 16.
2. Connect the R&S NRP-ZKU cable or R&S NRP-ZKC cable to the computer.
3. **NOTICE!** Incorrectly connecting or disconnecting the power sensor can damage the power sensor or lead to erroneous results. Ensure that you connect or disconnect the power sensor as described in [Chapter 3.4, "Connecting to a DUT"](#), on page 14.
Connect the power sensor to the signal source.
4. On the computer, start a software application to view the measurement results. See [Chapter 5, "Operating concepts"](#), on page 36.

3.7.1.2 R&S NRP-Z5 sensor hub setup

The R&S NRP-Z5 sensor hub (high-speed USB 2.0) can host up to four NRP power sensors and provides simultaneous external triggering to all connected power sensors.

Required equipment

- 1 to 4 NRP power sensors
- 1 R&S NRP-ZK6 cable per power sensor
- R&S NRP-Z5 sensor hub
- External power supply, delivered with the R&S NRP-Z5 sensor hub. The supplied external power supply is short-circuit proof and is also protected by an internal fuse. It is not possible to change the fuse or open the unit.

You can use an alternative DC voltage source, but it must fulfill the following requirements:

- Supplies an output voltage of 12 V to 24 V and a power output of at least 24 W. Do not use an extra low-voltage supply system.
- Is in the same building as the R&S NRP-Z5.
- Is connected to the R&S NRP-Z5 by a cable that is no longer than 30 m.
- USB cable, delivered with the R&S NRP-Z5 sensor hub.
Alternatively, you can use any other USB-2.0-certified USB connector type A to USB connector type B cable with a maximum length of 5 m.
If a locking connection is required at the instrument end, you can use the passive R&S NRP-Z4 interface adapter instead of a standard USB cable.
- Computer
- Optional: BNC cables to connect the trigger input and trigger output signals.

Setup

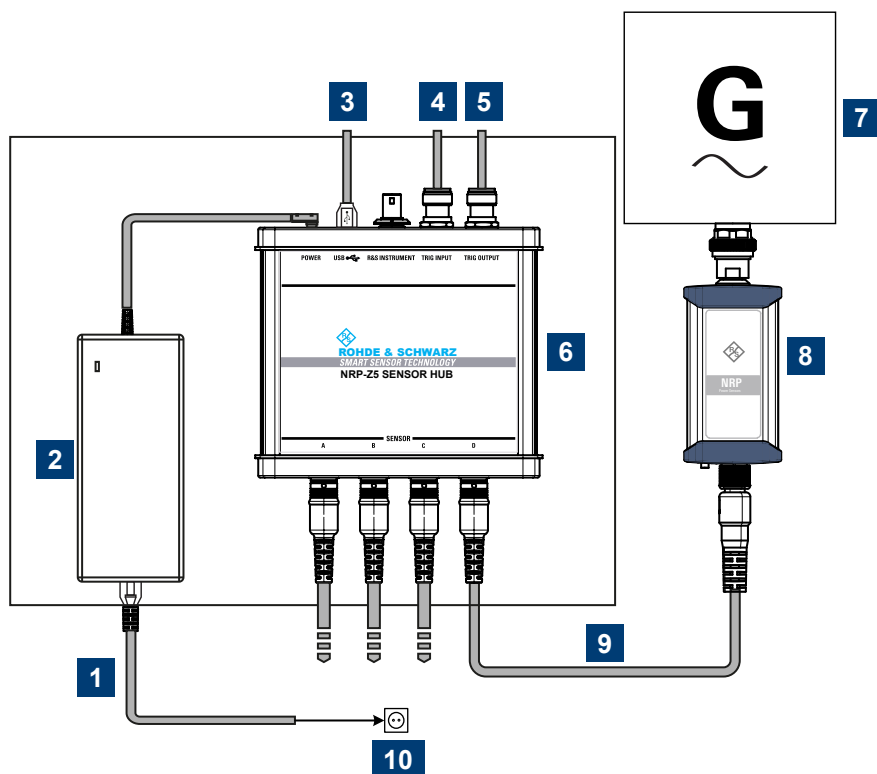

Figure 3-2: Setup with an R&S NRP-Z5 sensor hub

- 1 = Connect to AC power supply.
- 2 = External power supply unit
- 3 = Connect to computer.
- 4 = Optional: Connect to trigger source.
- 5 = Optional: Connect to triggered device.
- 6 = R&S NRP-Z5 sensor hub
- 7 = Signal source (DUT)
- 8 = NRP power sensor
- 9 = R&S NRP-ZK6 cable
- 10 = AC power supply

Set up as shown in [Figure 3-2](#).

1. Connect the R&S NRP-ZK6 cable to the power sensor. See ["To connect a cable to the host interface of the power sensor"](#) on page 16.
2. Connect the power sensors to the R&S NRP-Z5 sensor hub. You can connect up to four power sensors.
3. Connect the R&S NRP-Z5 to the computer.

Connecting to a controlling host

4. **NOTICE!** Incorrectly connecting or disconnecting the power sensor can damage the power sensor or lead to erroneous results. Ensure that you connect or disconnect the power sensor as described in [Chapter 3.4, "Connecting to a DUT"](#), on page 14.
Connect the power sensors to the signal sources.
5. Connect the external power supply unit to the R&S NRP-Z5 and to an AC supply connector.
6. Connect the trigger input of the R&S NRP-Z5 with a BNC cable to the trigger source (optional).
7. Connect the trigger output of the R&S NRP-Z5 with a BNC cable to the trigger device (optional).
8. On the computer, start a software application to view the measurement results. See [Chapter 5, "Operating concepts"](#), on page 36.

3.7.2 Android smartphone or tablet

You can operate the power sensor using R&S Power Viewer Mobile. For details, see [Chapter 5, "Operating concepts"](#), on page 36.

Required equipment

- NRP power sensor
- R&S NRP-ZKC cable
- Android smartphone or tablet

Setup

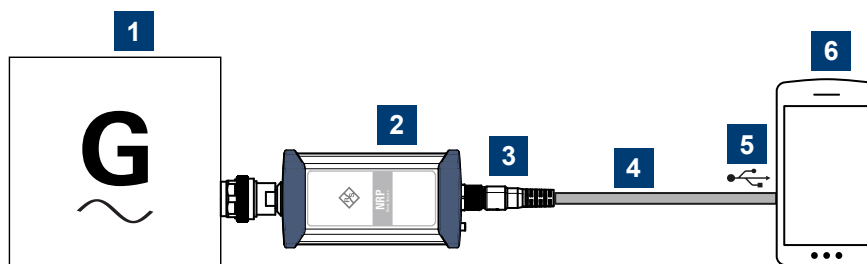

Figure 3-3: Setup with an R&S NRP-ZKC cable

Connecting to a controlling host

- 1 = Signal source
- 2 = NRP power sensor
- 3 = Host interface connector
- 4 = R&S NRP-ZKC cable
- 5 = USB-C connector
- 6 = Android smartphone with installed R&S Power Viewer Mobile

Set up as shown in [Figure 3-3](#).

1. Connect the R&S NRP-ZKC cable to the power sensor. See ["To connect a cable to the host interface of the power sensor"](#) on page 16.
2. Connect the R&S NRP-ZKC cable to the Android smartphone or tablet with USB-C connector.
3. **NOTICE!** Incorrectly connecting or disconnecting the power sensor can damage the power sensor or lead to erroneous results. Ensure that you connect or disconnect the power sensor as described in [Chapter 3.4, "Connecting to a DUT"](#), on page 14.

Connect the power sensor to the signal source.

4. On the smartphone/tablet, start a software application to view the measurement results. See [Chapter 5, "Operating concepts"](#), on page 36.

3.7.3 Base unit

As a controlling host, you can use an R&S NRX base unit.



You can also operate the power sensor using other supported Rohde & Schwarz instruments with a sensor connector. Use with a push-pull type connector. For details, see also the user manual of the instrument.

- ▶ Establish the connection with the base unit using:
 - Host interface, see [Chapter 5.7, "R&S NRX"](#), on page 46.
 - LAN interface, if:
 - Base unit is an R&S NRX
 - Power sensor is a LAN power sensor
 - See [Chapter 3.7.4, "Using a LAN connection"](#), on page 23.

3.7.4 Using a LAN connection

i Requires a power sensor with networking capabilities, a LAN power sensor.

3.7.4.1 Connecting a LAN power sensor to the LAN

Depending on the available equipment, you can choose from different ways to connect a LAN power sensor to a controlling host.

i The Ethernet interface of a LAN power sensor requires PoE (power over Ethernet). See [Chapter 4.5, "LAN PoE interface"](#), on page 34.

Electromagnetic interference (EMI) can affect the measurement results. To avoid any impact, use category 5 cables or better.

Setup with a PoE Ethernet switch

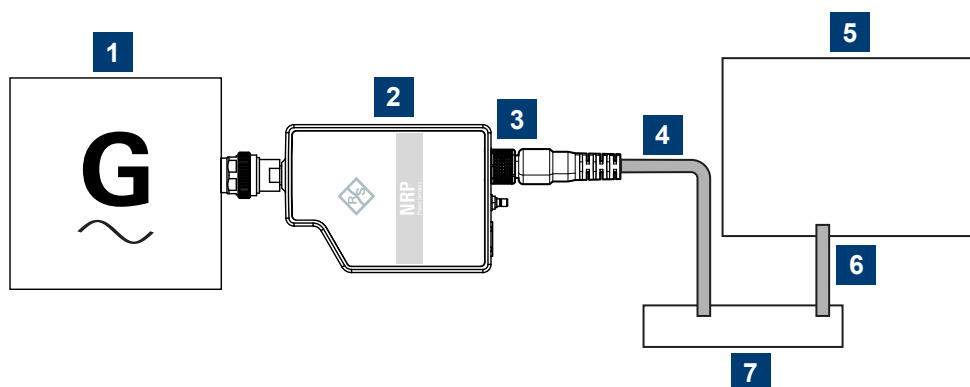

Figure 3-4: Setup with a PoE Ethernet switch

- 1 = Signal source
- 2 = LAN power sensor
- 3 = RJ-45 Ethernet connector
- 4, 6 = RJ-45 Ethernet cable
- 5 = Controlling host
- 7 = Ethernet switch supporting PoE power delivery, e.g. R&S NRP-ZAP1

1. **NOTICE!** Incorrectly connecting or disconnecting the power sensor can damage the power sensor or lead to erroneous results. Ensure that you connect or

Connecting to a controlling host

disconnect the power sensor as described in [Chapter 3.4, "Connecting to a DUT"](#), on page 14.

Connect the power sensor to the signal source.

2. **NOTICE!** Risk of damaging the power sensor. Only use PoE power sourcing equipment (PSE) as described in ["Choose the PoE power sourcing equipment \(PSE\) with care"](#) on page 16.

Connect the RJ-45 Ethernet connector of the power sensor to an Ethernet switch that supports PoE power delivery.

3. Connect the controlling host to the Ethernet switch.
4. Establish a connection between the power sensor and the network.
See [Chapter 3.7.4.2, "Establishing a connection to the network"](#), on page 26.

Setup with a PoE injector and a non-PoE Ethernet switch

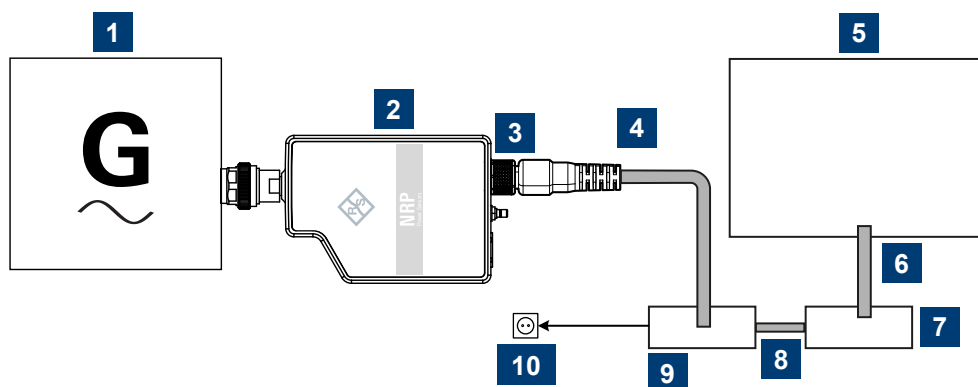

Figure 3-5: Setup with a PoE injector and a non-PoE Ethernet switch

- 1 = Signal source
- 2 = LAN power sensor
- 3 = RJ-45 Ethernet connector
- 4,6,8 = RJ-45 Ethernet cable
- 5 = Controlling host
- 7 = Non-PoE Ethernet switch
- 9 = PoE injector
- 10 = AC supply

1. **NOTICE!** Incorrectly connecting or disconnecting the power sensor can damage the power sensor or lead to erroneous results. Ensure that you connect or disconnect the power sensor as described in [Chapter 3.4, "Connecting to a DUT"](#), on page 14.

Connect the power sensor to the signal source.

Connecting to a controlling host

2. **NOTICE!** Risk of damaging the power sensor. Only use PoE power sourcing equipment (PSE) as described in "[Choose the PoE power sourcing equipment \(PSE\) with care](#)" on page 16.

Connect the RJ-45 Ethernet connector of the power sensor to the output of the PoE injector.

3. Connect the PoE injector to a power supply.
4. Connect the input of the PoE injector to the non-PoE Ethernet switch.
5. Connect the controlling host to the non-PoE Ethernet switch.
6. Establish a connection between the power sensor and the network.
See [Chapter 3.7.4.2, "Establishing a connection to the network"](#), on page 26.

Setup with a PoE injector

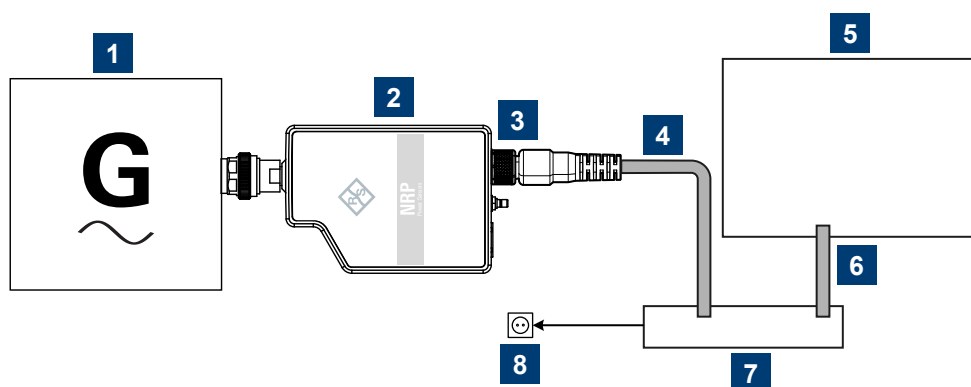

Figure 3-6: Setup with a PoE injector

- 1 = Signal source
- 2 = LAN power sensor
- 3 = RJ-45 Ethernet connector
- 4, 6 = RJ-45 Ethernet cable
- 5 = Controlling host
- 7 = PoE injector
- 8 = AC supply

1. **NOTICE!** Incorrectly connecting or disconnecting the power sensor can damage the power sensor or lead to erroneous results. Ensure that you connect or disconnect the power sensor as described in [Chapter 3.4, "Connecting to a DUT"](#), on page 14.

Connect the power sensor to the signal source.

Connecting to a controlling host

2. **NOTICE!** Risk of damaging the power sensor. Only use PoE power sourcing equipment (PSE) as described in ["Choose the PoE power sourcing equipment \(PSE\) with care"](#) on page 16.

Connect the RJ-45 Ethernet connector of the power sensor to the output of the PoE injector.

3. Connect the PoE injector to a power supply.
4. Connect the controlling host to the input of the PoE injector.
5. Establish a network connection between the power sensor and the controlling host.

3.7.4.2 Establishing a connection to the network

There are two methods to establish a network connection:

- Power sensor and controlling host are connected to a common network (infrastructure network).
- Power sensor and controlling host are connected only over the switch (peer-to-peer network).

In both cases, you can address the LAN power sensor as follows:

- [Chapter 3.7.4.3, "Using hostnames"](#), on page 27
- [Chapter 3.7.4.4, "Assigning the IP address"](#), on page 28

To set up a network Ethernet connection

1. Connect the power sensor as described in [Chapter 3.7.4.1, "Connecting a LAN power sensor to the LAN"](#), on page 23.

By default, the power sensor is configured to use dynamic TCP/IP configuration (DHCP) and to obtain the address information automatically.

If both LAN status LEDs are illuminated in green color, the power sensor is correctly connected to the network.

Note: Establishing a connection can take up to 2 minutes per device.

2. If the LAN status LEDs show another state, no connection is possible. For possible solutions, see:
 - ["Network status LED"](#) on page 35
 - ["Troubleshooting for peer-to-peer connections"](#) on page 27

Troubleshooting for peer-to-peer connections

1. Allow a waiting time, especially if the computer was used in a network before.
2. Check that only the main network adapter is active on the computer. If the computer has more than one network interfaces, explicitly disable all other network interfaces if you plan to utilize a peer-to-peer connection to the power sensor.
3. Check that the IP address assigned to the remaining main network adapter starts with 169.254. The IANA (Internet assigned numbers authority) has reserved the range 169.254.0.0 to 169.254.255.255 for the allocation of automatic private IP addresses (APIPA). Addresses from this range assuredly cause no conflicts with any routable IP address.
4. Try to establish a connection to the power sensor with both the default hostname and the hostname extended with `.local`, for example:

```
nrp18sn-101441
nrp18sn-101441.local
```

3.7.4.3 Using hostnames

In a LAN that uses a domain name system (DNS) server, each connected computer or instrument can be accessed via a unique hostname instead of an IP address. The DNS server translates the hostname to the IP address. Using the hostname is especially useful when a DHCP server is used, as a new IP address can be assigned each time the instrument is restarted.

Each power sensor is delivered with a default hostname assigned. You can change the default hostname.

Default hostname

The default hostname follows the syntax:

`<device name>-<serial number>`, where:

- `<device name>` is the short name of your power sensor.
For example, the `<device name>` of R&S NRP18SN is `nrp18sn`.
- `<serial number>` is the individual serial number of the power sensor. The serial number is printed on the name plate at the rear side of the power sensor. It is part of the device ID printed above the barcode:

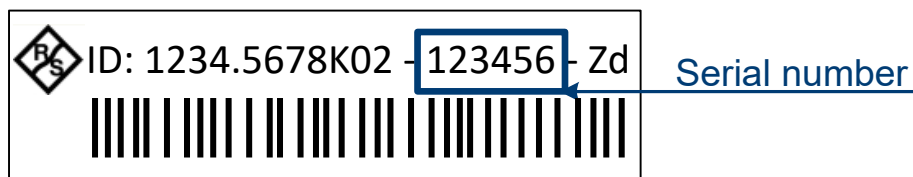

Figure 3-7: Serial number on the name plate

Example:

Serial number of the power sensor: 101441

Default hostname: nrp18sn-101441

Hostname in zero configuration networks, including peer-to-peer networks

The power sensor supports zero configuration networking, used in networks without DHCP server, such as peer-to-peer networks. Thus, you can connect the power sensor to a network without setting up services such as dynamic host configuration protocol (DHCP) and domain name system (DNS), or configuring the network settings manually.

For establishing a connection to the power sensor, try the default hostname and the hostname extended with `.local` as shown in the example below. All communication for resolving names in the top-level-domain (TLD) `.local` are defined to be executed using dedicated local services and ports if no other DNS (domain name server) is available.

Example:

Default hostname: nrp18sn-101441

Extended hostname: nrp18sn-101441.local

3.7.4.4 Assigning the IP address

Depending on the network capabilities, the TCP/IP address information for the LAN power sensor can be obtained in different ways:

- If the network supports dynamic TCP/IP configuration using the dynamic host configuration protocol (DHCP), the address information can be assigned automatically.
- If the network does not support DHCP, the LAN power sensor tries to obtain the IP address via the zeroconf (APIA) protocol. If this attempt does not suc-

Connecting to a controlling host

ceed or if the instrument is set to using alternate TCP/IP configuration, the IP address must be set manually.

For a description on how to set the IP address manually, refer to the user manual.

**Use hostnames to identify the power sensor**

In networks using a DHCP server, it is recommended that you address the power sensor by its unique hostname, see [Chapter 3.7.4.3, "Using hostnames"](#), on page 27.

A *hostname* is a unique identifier of the power sensor that remains permanent as long as it is not explicitly changed. Hence, you can address a power sensor by the same identification, irrespectively if a network or a point-to-point connection is used.

4 Power sensor tour

This chapter provides an overview of the available connectors and LEDs of the power sensor.

In the following figure, the USB power sensor is shown on the left, the LAN power sensor is shown on the right.

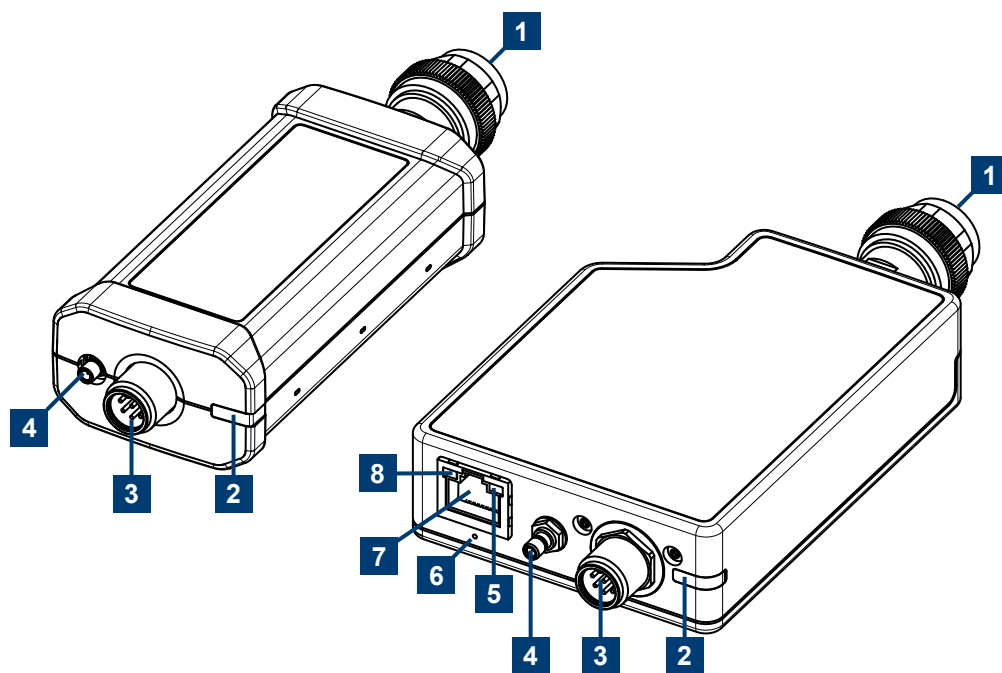

Figure 4-1: NRP power sensors (example)

- 1 = RF connector, see [Chapter 4.1, "RF connector"](#), on page 31
- 2 = Status LED, see [Chapter 4.2, "Status information"](#), on page 33
- 3 = Host interface connector, see [Chapter 4.3, "Host interface"](#), on page 34
- 4 = Trigger I/O connector, see [Chapter 4.4, "Trigger I/O connector"](#), on page 34
- 5 = Network status LED, see ["Network status LED"](#) on page 35
- 6 = LAN reset button, see ["LAN reset button"](#) on page 35
- 7 = LAN connector, see [Chapter 4.5, "LAN PoE interface"](#), on page 34
- 8 = Power over Ethernet status LED, see ["Power over Ethernet status LED"](#) on page 35

4.1 RF connector

The RF connector is used for connecting the power sensor to a device under test (DUT) or a signal generator. See [Chapter 3.4, "Connecting to a DUT"](#), on page 14.

For maximum measurement accuracy, tighten the RF connector using a torque wrench with a nominal torque as specified in the following table.

Table 4-1: R&S NRPxxA(N) RF connector characteristics

Power sensor	Male connector	Matching female connector	Tightening torque
R&S NRP6A	N	N	1.36 Nm (12" lbs)
R&S NRP6AN			
R&S NRP18A			
R&S NRP18AN			

Table 4-2: R&S NRPxxP RF connector characteristics

Power sensor	Male connector	Matching female connector	Tightening torque	Color code
R&S NRP18P	N	N	1.36 Nm (12" lbs)	Red
R&S NRP40P	2.92 mm	3.50 mm/ 2.92 mm/ SMA	0.90 Nm (8" lbs)	Yellow
R&S NRP50P	2.4 mm	2.4 mm/ 1.85 mm		Green

Table 4-3: R&S NRPxxS(N) RF connector characteristics

Power sensor	Male connector	Matching female connector	Tightening torque
R&S NRP8S	N	N	1.36 Nm (12" lbs)
R&S NRP8SN			
R&S NRP18S			
R&S NRP18SN			
R&S NRP33S	3.50 mm	3.50 mm/ 2.92 mm/ SMA	0.90 Nm (8" lbs)
R&S NRP33SN			
R&S NRP33SN-V			
R&S NRP40S	2.92 mm	3.50 mm/ 2.92 mm/ SMA	

Power sensor	Male connector	Matching female connector	Tightening torque
R&S NRP40SN	2.4 mm	2.4 mm/ 1.85 mm	
R&S NRP50S			
R&S NRP50SN			
R&S NRP67S	1.85 mm	1.85 mm	
R&S NRP67SN			
R&S NRP67SN-V			
R&S NRP90S, model 03	1.0 mm	1.0 mm	0.23 Nm (2" lbs)
R&S NRP90S, model 02	1.35 mm	1.35 mm	0.90 Nm (8" lbs)
R&S NRP90SN			

Table 4-4: R&S NRP18S-xx RF connector characteristics

Power sensor	Male connector	Matching female connector	Tightening torque
R&S NRP18S	N	N	1.36 Nm (12" lbs)

Table 4-5: R&S NRPxxT(N) RF connector characteristics

Power sensor	Male connector	Matching female connector	Tightening torque
R&S NRP18T	N	N	1.36 Nm (12" lbs)
R&S NRP18TN			
R&S NRP33T	3.50 mm	3.50 mm/ 2.92 mm/ SMA	0.90 Nm (8" lbs)
R&S NRP33TN			
R&S NRP40T	2.92 mm		
R&S NRP40TN			
R&S NRP50T	2.4 mm	2.4 mm/ 1.85 mm	
R&S NRP50TN			
R&S NRP67T	1.85 mm		
R&S NRP67TN			
R&S NRP90T	1.35 mm	1.35 mm	

Power sensor	Male connector	Matching female connector	Tightening torque
R&S NRP90TN			
R&S NRP110T	1.0 mm	1.0 mm	0.23 Nm (2" lbs)

Table 4-6: R&S NRPxxTWG(N) RF connector characteristics

Power sensor	Waveguide size	Frequency range	Tightening torque*
R&S NRP75TWG	WR-15	50 GHz to 75 GHz	0.58 Nm (5" lbs)
R&S NRP75TWGN			
R&S NRP90TWG	WR-12	60 GHz to 90 GHz	
R&S NRP90TWGN			
R&S NRP110TWG	WR-10	75 GHz to 110 GHz	
R&S NRP110TWGN			
R&S NRP170TWG	WR-6.5	110 GHz to 170 GHz	
R&S NRP170TWGN			



* Use the torque wrench for waveguide flanges, R&S ZCTW, part number 1175.2014.02.

4.2 Status information

The status LED shows the state of the sensor by color and blinking frequency.

Table 4-7: Possible states

	Color	Illumination	State
○	White	Steady	Idle The sensor performs no measurement and is ready for use.
☀	White	Fast flashing	Firmware update or reboot is in progress. When the firmware update or reboot is finished, the LED changes to glowing white steadily, indicating the idle state.
🌀	White	Slow flashing	Sanitizing in progress.
●	Yellow	Steady	Waiting for trigger state.
●	Green	Steady	Measurement is running.

	Color	Illumination	State
	Turquoise blue	Steady	Zeroing is in progress.
	Red	Slow flashing	Static error
	Red	Fast flashing	Critical static error Note: If this state occurs after a firmware update, the update was not successful. Perform the firmware update again.

Further information:

- Troubleshooting in the user manual.

4.3 Host interface

The host interface is used for establishing a connection between the power sensor and a USB host. For this purpose, an external cable is needed. See [Chapter 3.6, "Connecting a cable to the host interface"](#), on page 16.

4.4 Trigger I/O connector

The trigger I/O is an SMB type connector.

It is used as an input for signals if the trigger source parameter is set to `EXTERNAL2`. It is used as an output for trigger signals if the power sensor is operated in the trigger sender mode.

Further information:

- For details on configuration, see the user manual.

4.5 LAN PoE interface

Available only for LAN power sensors.

An Ethernet RJ45 connector is used to connect the LAN connector to a local area network (LAN).

 Supply the electrical power over the LAN PoE interface. See [Chapter 3.5, "Powering the power sensor"](#), on page 15.

LAN reset button

The LAN reset button is used for resetting the Ethernet connection parameters of the power sensor to their default values.



Power over Ethernet status LED

The power status LED shows whether the power sensor is correctly powered over PoE or not.

Indication		State
	Green	The power sensor is powered over PoE. You can operate it using the Ethernet interface.
Off	Not illuminated	No PoE power is present.

Network status LED

The network status LED shows whether the LAN connection to the network is established properly or not.

Indication		State
	Green	The power sensor is correctly connected to the network. It has been assigned a valid IP address, either manually or via DHCP.
	Red	The power sensor is not connected to the network correctly. Either the connection is erroneous or the power sensor has not been assigned a valid IP address yet.

5 Operating concepts

For operating the power sensor, you can choose from various possibilities:

- [Chapter 5.1, "R&S NRP Toolkit"](#), on page 36
- [Chapter 5.2, "Browser-based user interface"](#), on page 39
- [Chapter 5.3, "Remote control"](#), on page 41
- [Chapter 5.4, "R&S NRPV"](#), on page 41
- [Chapter 5.5, "R&S Power Viewer"](#), on page 43
- [Chapter 5.6, "R&S Power Viewer Mobile"](#), on page 45
- [Chapter 5.7, "R&S NRX"](#), on page 46

5.1 R&S NRP Toolkit



Before you start using the power sensor, we recommend installing the latest R&S NRP Toolkit.

The R&S NRP Toolkit is the basic software package that supplies low-level drivers and tools for all power sensors. The components of the R&S NRP Toolkit depend on the operating system.

5.1.1 Versions and downloads

The R&S NRP Toolkit is available for:

- Microsoft Windows operating systems, as listed in [Chapter 5.1.2, "System requirements"](#), on page 37
- macOS

The latest versions for Windows and macOS are available at:

- www.rohde-schwarz.com/software/nrp-a-an
- www.rohde-schwarz.com/software/nrp_s_sn
- www.rohde-schwarz.com/software/nrp-t-tn

To obtain an R&S NRP Toolkit for other operating systems, contact the Rohde & Schwarz customer support, see [Chapter 7, "Contacting customer support"](#), on page 54.

5.1.2 System requirements

Hardware requirements:

- Desktop computer or laptop, or an Intel-based Apple Mac
- LAN interface and equipment for setting up a LAN connection.
See [Chapter 3.7.4, "Using a LAN connection"](#), on page 23.

For supported Microsoft Windows versions, see the release notes.

5.1.3 R&S NRP Toolkit for Windows

The R&S NRP Toolkit installer for Windows-based systems contains the components described in the release notes.

To install the R&S NRP Toolkit

1. Start the R&S NRP Toolkit installer on the Windows-based computer.
In the "NRP-Toolkit Setup" dialog, the correct R&S NRP Toolkit version for your operating system, 32-bit or 64-bit, is already selected.
2. Enable the components that you want to install.
 - "NRP-Toolkit (SDK)"
The software development kit (SDK) provides programming examples for the R&S power sensors.
 - "IVI Shared Components"
Installs the USBTMC driver. Enabled by default because the installation is recommended.
See also [Table 6-1](#).

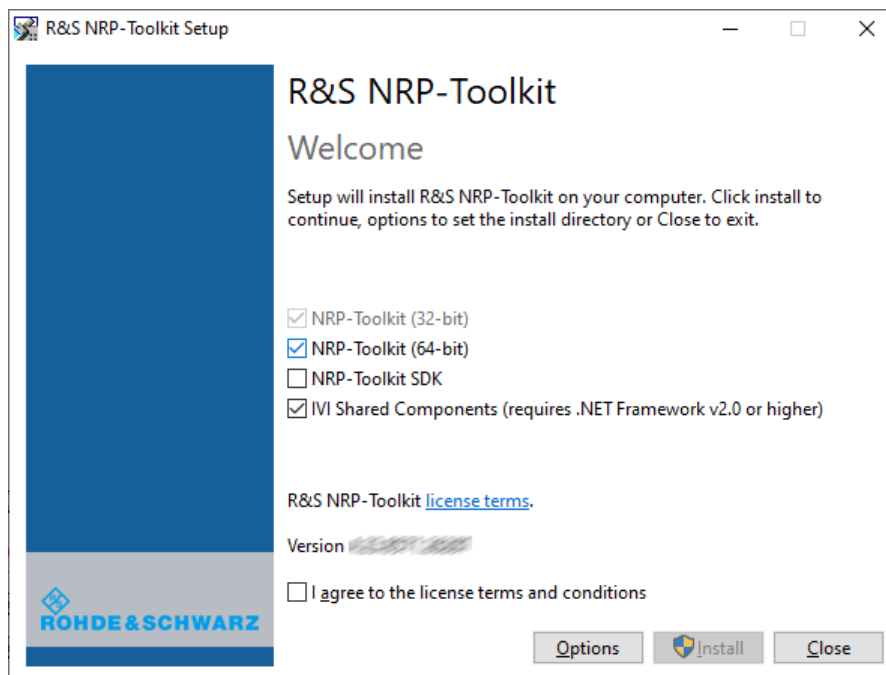

3. Accept the license terms to continue with the installation.
4. Click "Next" and complete the installation process.

5.1.3.1 Components of the R&S NRP Toolkit

Access: "Start" > "NRP-Toolkit"

The following tools are part of the R&S NRP Toolkit for Windows.

Configure Network Sensor

Useful if you have trouble establishing a LAN connection with a LAN power sensor. The tool provides the following functions:

- Configuring the network settings by (temporary) connecting the selected power sensor to the computer using USB.
- Discovering the power sensors that have been configured via the Zeroconf (APIA) protocol.

The tool comes with a guide (PDF) that is also available in the "Start" menu. The guide explains the network setup.

Firmware Update

You can use the Firmware Update for NRP Family program, firmware update program for short, to load new firmware for the power sensors.

For further details, see the user manual.

NRP Version Display

Displays version information of all installed, power measurement-relevant software packages.

NRP-Z Uncertainty Calculator

Determines the expanded measurement uncertainty. The tool comes with a manual (PDF) that is also available in the "Start" menu.

S-Parameter Update Multi

Helps loading an S-parameter table into the power sensor.

For further details, see the user manual.

Terminal

Low-level communication program for sending commands to the power sensor.

5.2 Browser-based user interface



Requires a power sensor with networking capabilities, a LAN power sensor.

With the integrated, browser-based graphical user interface of the LAN power sensor, you can easily configure the most common settings and measure in the provided measurement modes.

There is no installation required. The web user interface can be used with all devices and operating systems, including tablets and smart phones that are connected to the same network.

Required equipment

- NRP LAN power sensor
- LAN cables
- PoE Ethernet switch or a non-PoE Ethernet switch and a PoE injector
- Device with a supported web browser installed:

- Mozilla Firefox 33 or later
- Google Chrome 36 or later
- Microsoft Internet Explorer 10 or later
- Safari 5.1 or later

Setup

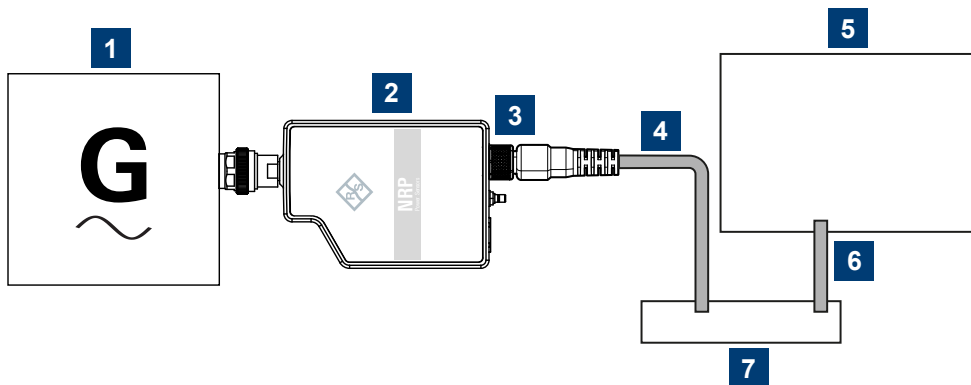

Figure 5-1: Setup with the web user interface

- 1 = Signal source
- 2 = LAN power sensor
- 3 = RJ-45 Ethernet connector
- 4, 6 = RJ-45 Ethernet cable
- 5 = Computer with a supported web browser installed
- 7 = Ethernet switch supporting PoE power delivery

1. **NOTICE!** Incorrectly connecting or disconnecting the power sensor can damage the power sensor or lead to erroneous results. Ensure that you connect or disconnect the power sensor as described in [Chapter 3.4, "Connecting to a DUT"](#), on page 14.

Connect the power sensor to the signal source.

2. Connect the cables as shown in [Figure 5-1](#).
For a detailed description, refer to [Chapter 3.7.4, "Using a LAN connection"](#), on page 23.

Starting a measurement

1. Open a supported web browser.
2. Enter the instrument name or the IP address of the sensor you want to connect to.

Example: `http://nrp33sn-123456`

For details on how to find out the IP address or hostname, refer to [Chapter 3.7.4.4, "Assigning the IP address"](#), on page 28 and [Chapter 3.7.4.3, "Using hostnames"](#), on page 27.

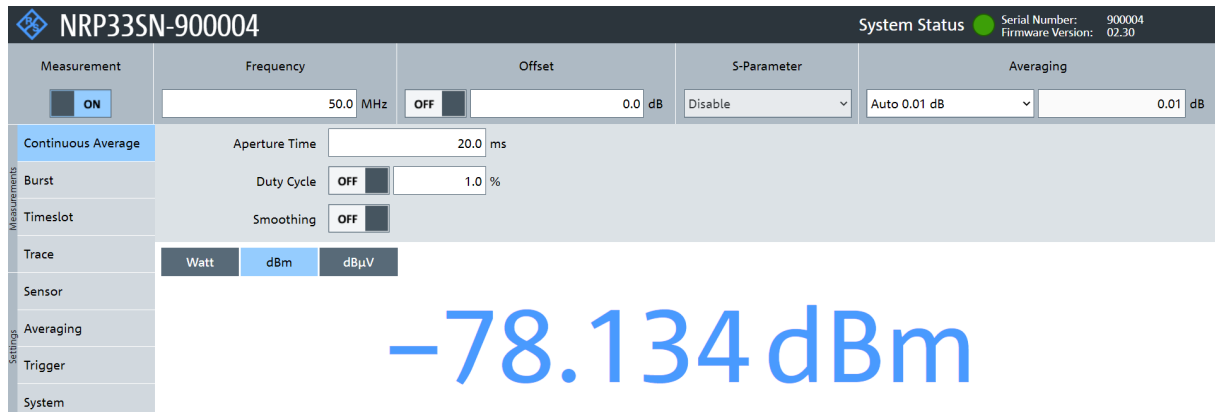

The main dialog of the web user interface opens.

3. Select the "Continuous Average" tab and perform any necessary changes.
4. Press "Measurement > ON" to start the measurement.

For a detailed description of the web user interface, refer to the corresponding chapter in the user manual.

5.3 Remote control

You can remote control the NRP power sensor easily. The change to remote control occurs "on the fly" and has no influence on the manual operation.

Further information:

- See the user manual for details.
- [Chapter 6, "Remote control interfaces and protocols"](#), on page 48
- [Chapter 3.7.1, "Computer"](#), on page 17

5.4 R&S NRPV

The R&S NRPV enables you to measure power in all available measurement modes. Also, you can use up to four power sensors simultaneously.

The R&S NRPV software is a separate standalone installation package. The installation package is provided on the Rohde & Schwarz website at:

- www.rohde-schwarz.com/software/nrp-a-an
- www.rohde-schwarz.com/software/nrp_s_sn
- www.rohde-schwarz.com/software/nrp-t-tn

Required equipment

- NRP power sensor
- R&S NRP-ZKU cable or R&S NRP-ZKC cable or an R&S NRP-Z5 sensor hub and an R&S NRP-ZK6 cable to connect the power sensor to the computer
- Windows computer with installed:
 - R&S NRP Toolkit version 4.23 or higher
 - R&S NRPV version 3.2 or higher (refer to the operating manual of the R&S NRPV for a description of the installation process)

Setup

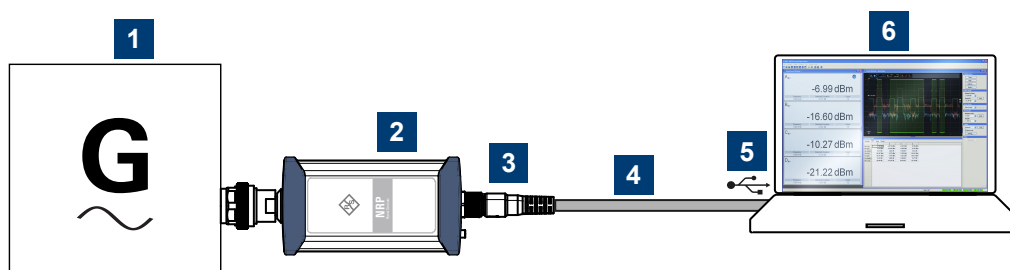

Figure 5-2: Setup with an R&S NRPV

- 1 = Signal source
- 2 = NRP power sensor
- 3 = Host interface connector
- 4 = R&S NRP-ZKU cable or R&S NRP-ZKC cable
- 5 = USB connector
- 6 = Computer with installed R&S NRPV

1. **NOTICE!** Incorrectly connecting or disconnecting the power sensor can damage the power sensor or lead to erroneous results. Ensure that you connect or disconnect the power sensor as described in [Chapter 3.4, "Connecting to a DUT"](#), on page 14.

Connect the power sensor to the signal source.

2. Connect the power sensor to the computer as shown in [Figure 5-2](#).
For a detailed description, refer to [Chapter 3.7.1.1, "USB connection"](#), on page 17.

Starting a measurement

For a detailed description of how to measure in this setup, refer to the operating manual of the R&S NRPV.

1. Start the R&S NRPV.
2. Execute zeroing.
Note: Turn off all measurement signals before zeroing. An active measurement signal during zeroing causes an error.
3. Switch on the test signal of the signal source.
4. Start a measurement.

5.5 R&S Power Viewer

The R&S Power Viewer is software that simplifies many measurement tasks.

The R&S Power Viewer is a separate standalone installation package. The installation package is provided on the Rohde & Schwarz website at:

- www.rohde-schwarz.com/software/nrp-a-an
- www.rohde-schwarz.com/software/nrp_s_sn
- www.rohde-schwarz.com/software/nrp-t-tn

Required equipment

- NRP power sensor
- R&S NRP-ZKU cable or R&S NRP-ZKC cable or an R&S NRP-Z5 sensor hub and an R&S NRP-ZK6 cable to connect the power sensor to the computer
- Computer with installed:
 - R&S NRP Toolkit version 4.23 or higher
 - R&S Power Viewer version 9.2 or higher (refer to the operating manual of the R&S Power Viewer for a description of the installation process)

- i** If you want to use an android device like a tablet or a smartphone, use the R&S Power Viewer Mobile. For details, see [Chapter 5.6, "R&S Power Viewer Mobile"](#), on page 45.

Setup

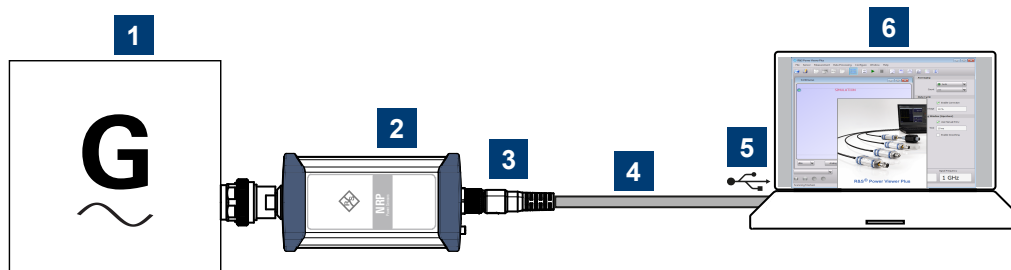

Figure 5-3: Setup with the R&S Power Viewer

- 1 = Signal source
- 2 = NRP power sensor
- 3 = Host interface connector
- 4 = R&S NRP-ZKU cable or R&S NRP-ZKC cable
- 5 = USB connector
- 6 = Computer with installed R&S Power Viewer

1. **NOTICE!** Incorrectly connecting or disconnecting the power sensor can damage the power sensor or lead to erroneous results. Ensure that you connect or disconnect the power sensor as described in [Chapter 3.4, "Connecting to a DUT"](#), on page 14.

Connect the power sensor to the signal source.

2. Connect the cables as shown in [Figure 5-3](#).
For a detailed description, refer to [Chapter 3.7.1.1, "USB connection"](#), on page 17.

Starting a measurement

For a detailed description, refer to the operating manual of the R&S Power Viewer. The manual is installed automatically during the installation of the R&S Power Viewer.

1. Start the R&S Power Viewer.
2. Execute zeroing.

Note: Turn off all measurement power signals before zeroing. An active measurement signal during zeroing causes an error.

3. Switch on the test signal of the signal source.
4. Select a measurement.
5. Start the measurement.

5.6 R&S Power Viewer Mobile

The R&S Power Viewer Mobile extends the functionality of the R&S Power Viewer to Android-based devices, such as a smartphone and tablets.

 For connecting the power sensor to USB-C type mobile phones (Android), use an R&S NRP-ZKC cable. It enables the R&S Power Viewer Mobile to take power measurements via the USB-C connection.

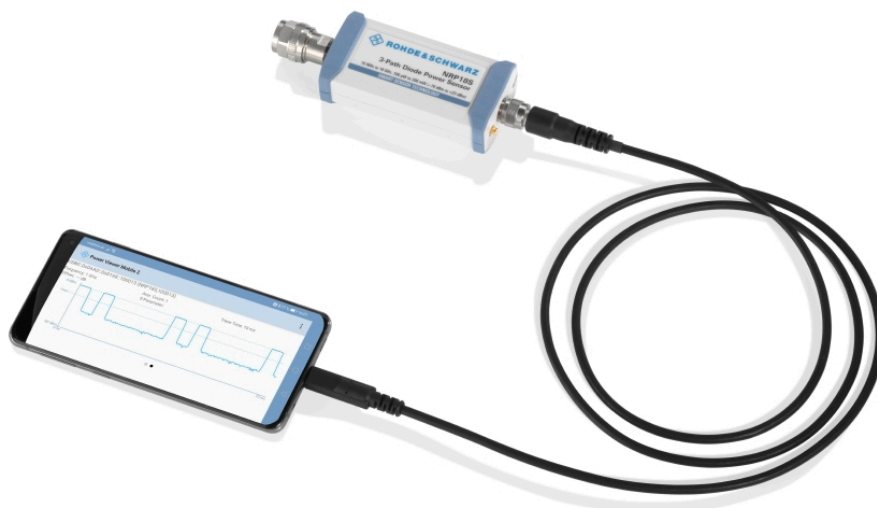

You can download the R&S Power Viewer Mobile free of charge from the Google Play Store.

The 1MA215 "Using R&S®NRP Series Power Sensors with Android™ Handheld Devices" application note gives a detailed description on installation and features of the R&S Power Viewer Mobile. The application note is provided on the documentation CD-ROM and on the Rohde & Schwarz website. Search for "1MA215".

5.7 R&S NRX

In a measurement, the R&S NRX uses all power sensor-dependent measurement functions and displays the results. Thus, you can configure both the measurement and the power sensor.

Required equipment

- NRP power sensor
- R&S NRP-ZK8 cable to connect the power sensor to the R&S NRX
- R&S NRX

Setup

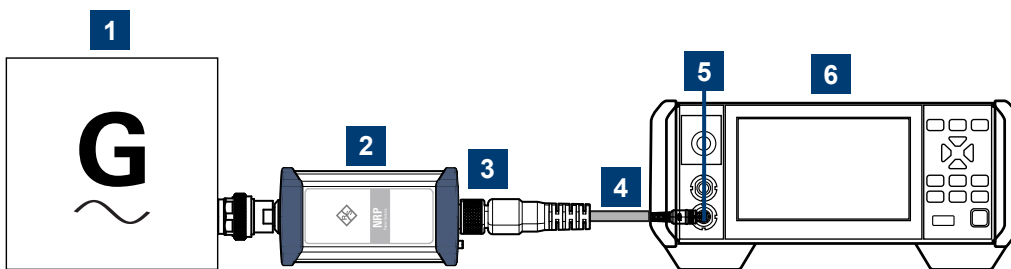

Figure 5-4: Setup with an R&S NRX base unit

- 1 = Signal source
- 2 = NRP power sensor
- 3 = Host interface connector
- 4 = R&S NRP-ZK8 cable
- 5 = Sensor input connector of the R&S NRX
- 6 = R&S NRX base unit

1. **NOTICE!** Incorrectly connecting or disconnecting the power sensor can damage the power sensor or lead to erroneous results. Ensure that you connect or disconnect the power sensor as described in [Chapter 3.4, "Connecting to a DUT"](#), on page 14.

Connect the power sensor to the signal source.

2. Connect the cables as shown in [Figure 5-4](#).

If the power sensor is a LAN sensor, you can set up a LAN connection instead of using the sensor input connector of the R&S NRX. See [Chapter 3.7.4, "Using a LAN connection"](#), on page 23.

Starting a measurement

For a detailed description of how to measure in this setup, refer to the user manual of the R&S NRX.

1. Preset the R&S NRX and the connected R&S power sensors.
 - a) Press the [Preset] key.
 - b) Tap "Preset".
All parameters are set to their defaults.
2. **Note:** Turn off all measurement signals before zeroing. An active measurement signal during zeroing causes an error.
 - a) Switch off the power of the signal source.
 - b) Press the [Zero] key of the R&S NRX.
 - c) Tap "Zero All Sensors".
3. Configure the measurement.
 - a) In the "Measurement Settings" dialog, select the "Measurement Type", for example "Continuous Average".
 - b) Tap "Quick Setup" > "Auto Set".
4. Switch on the signal source.
The measurement starts, and the result is displayed in dBm.
5. If necessary, perform further settings.

6 Remote control interfaces and protocols

For remote control, communication between the NRP power sensor power sensors and the controlling host is established based on various interfaces and protocols.

Depending on the power sensor type, the power sensors support different interfaces for remote control.

- NRP USB power sensors are always accessed using USB.
- NRP LAN power sensors can be accessed using USB or Ethernet.

[Table 6-1](#) describes the protocols that are supported for each interface.

Table 6-1: Remote control interfaces and protocols

Interface	Supported by	Protocols, VISA*) address string and Library
USB	All power sensors	<ul style="list-style-type: none"> • USBTMC USB::<vendor id="">::<product ID>:: <serial number>[::INSTR] VISA</vendor> • NRP legacy protocol
Ethernet	NRP LAN power sensors	<ul style="list-style-type: none"> • VXI-11 TCPIP::host address[:: LAN device name][::INSTR] VISA • HiSLIP High-Speed LAN Instrument Protocol (IVI-6.1) TCPIP::host address::hislip0[::INSTR] VISA • Socket communication (LAN Ethernet) TCPIP::host address[::LAN device name]: :<port>::SOCKET

*) VISA is a standardized software interface library providing input and output functions to communicate with instruments. A VISA installation on the controller is a prerequisite for remote control over USBTMC and LAN (when using VXI-11 or HiSLIP protocol) interfaces.

6.1 USB interface

For remote control using USB connection, the computer and the power sensors must be connected via the USB interface. A USB connection requires the VISA library to be installed. VISA detects and configures the R&S power sensors auto-

matically when the USB connection is established. Apart from the USBTMC driver (which comes with the installation of the R&S NRP Toolkit), you do not have to install a separate driver.

USB Test & Measurement Class Specification (USBTMC) is a protocol that is built on top of USB for communication with USB devices. It defines class code information of the power sensor that identifies its functionality to load the respective device driver. Using VISA library, it supports service request, triggers and other operations that are commonly found in GPIB devices.

Besides USBTMC, the NRP legacy protocol is available to ensure the compatibility of the NRP power sensors with the R&S NRP-Z power sensors. The usage of this protocol is not recommended for new applications.

The resource string represents an addressing scheme that is used to establish a communication session with the power sensor. It is based on the power sensor address and some power sensor- and vendor-specific information.

USB Resource String

The syntax of the used USB resource string is:

```
USB::::<product ID>::[::INSTR]
```

where:

- <vendor ID> is the vendor ID for Rohde & Schwarz (0x0AAD)
- <product ID> is the product ID for the Rohde & Schwarz power sensor
- <serial number> is the individual serial number on the name plate at the rear side of the power sensor

Table 6-2: R&S NRPxxA(N) USB product IDs

NRP power sensor	USB product ID
R&S NRP6A	0x0178
R&S NRP6AN	0x0179
R&S NRP18A	0x014E
R&S NRP18AN	0x014F

Table 6-3: R&S NRPxxP USB product IDs

NRP power sensor	USB product ID
R&S NRP18P	0x0143
R&S NRP40P	0x017C
R&S NRP50P	0x017E

Table 6-4: R&S NRPxxS(N) USB product IDs

NRP power sensor	USB product ID
R&S NRP8S	0x00E2
R&S NRP8SN	0x0137
R&S NRP18S	0x0138
R&S NRP18SN	0x0139
R&S NRP33S	0x0145
R&S NRP33SN	0x0146
R&S NRP33SN-V	0x0168
R&S NRP40S	0x015F
R&S NRP40SN	0x0160
R&S NRP50S	0x0161
R&S NRP50SN	0x0162
R&S NRP67S	0x024A
R&S NRP67SN	0x024B
R&S NRP67SN-V	0x026A
R&S NRP90S, model 02	0x024C
R&S NRP90S, model 03	
R&S NRP90SN	0x026B

Table 6-5: R&S NRP18S-xx USB product IDs

NRP power sensor	USB product ID
R&S NRP18S-10	0x0148
R&S NRP18S-20	0x014A
R&S NRP18S-25	0x014C

Table 6-6: R&S NRPxxT(N) USB product IDs

NRP power sensor	USB product ID
R&S NRP18T	0x0150
R&S NRP18TN	0x0151
R&S NRP33T	0x0152
R&S NRP33TN	0x0153
R&S NRP40T	0x0154
R&S NRP40TN	0x0155
R&S NRP50T	0x0156
R&S NRP50TN	0x0157
R&S NRP67T	0x0158
R&S NRP67TN	0x0159
R&S NRP90T	0x026C
R&S NRP90TN	0x026D
R&S NRP110T	0x015A

Table 6-7: R&S NRPxxTWG(N) USB product IDs

NRP power sensor	USB product ID
R&S NRP75TWG	0x01D1
R&S NRP75TWGN	0x0294
R&S NRP90TWG	0x01D2
R&S NRP90TWGN	0x0295
R&S NRP110TWG	0x01D3
R&S NRP110TWGN	0x0296
R&S NRP170TWG	0x02AF
R&S NRP170TWGN	0x02B0

Example:

```
USB::0x0AAD::0x00E2::100001
```

0x0AAD is the vendor ID for Rohde & Schwarz.

0x00E2 is the product ID for the NRP power sensor power sensor.

100001 is the serial number of the particular power sensor.

6.2 Ethernet interface

The Ethernet interface of the NRP LAN power sensor allows you to integrate them in a local area network (LAN).

For remote control via a network, the computer and the power sensor must be connected via the Ethernet interface to a common network with TCP/IP network protocol. The TCP/IP network protocol and the associated network services are preconfigured on the power sensor. Software for device control and the VISA program library must be installed on the computer.

6.2.1 VISA resource strings

The VISA resource string is required to establish a communication session between the controller and the power sensor in a LAN. The resource string is a unique identifier, composed of the specific IP address of the power sensor and some network and VISA-specific keywords.

TCPIP::*<IP address or hostname>*[:*<LAN device name>*][:INSTR]

- *TCPIP* designates the network protocol used
- *<IP address or hostname>* is the IP address or host name of the device
- [*[:<LAN device name>*] defines the protocol and the instance number of a sub-instrument:
- [*[:INSTR]*] indicates the power sensor resource class (optional)

The IP address or hostname is used by the programs to identify and control the power sensor. While the hostname is determined by settings in the power sensor, the IP address is assigned by a DHCP server when the power sensor requests one. Alternatively the IP address is determined with a procedure called Zeroconf.

You can also assign a *LAN device name* which defines the protocol characteristics of the connection. See the description of the VISA resource string below for the corresponding interface protocols. The string of the *LAN device name* is emphasized in italics.

HiSLIP

TCPIP::*<IP address or hostname>*::*hislip0*[:INSTR]

- *hislip0* is the HiSLIP device name, designates that the interface protocol HiSLIP is used (mandatory)

hislip0 is composed of [::*HiSLIP* device name[,*HiSLIP* port]] and must be assigned.

VXI-11

TCPIP::*<IP address or hostname>*::*inst0*::INSTR]

- *inst0* is the LAN device name, indicating that the VXI-11 protocol is used (optional)

inst0 currently selects the VXI-11 protocol by default and can be omitted.

Socket communication

TCPIP::*<IP address or hostname>*::*port*::SOCKET

- *port* determines the used port number
- *SOCKET* indicates the raw network socket resource class

Socket communication requires the specification of the port (commonly referred to as port number) and of "SOCKET" to complete the VISA resource string with the associated protocol used.

The default port for socket communication is port 5025.

Example:

A power sensor has the IP address *10.111.11.20*; the valid resource string using VXI-11 protocol is:

TCPIP::*10.111.11.20*::INSTR

The DNS host name is *nrp18sn-100001*; the valid resource string is:

TCPIP::*nrp18sn-100001*::*hislip0* (HiSLIP)

TCPIP::*nrp18sn-100001*::*inst0* (VXI-11)

A raw socket connection can be established using:

TCPIP::*10.111.11.20*::*5025*::SOCKET

TCPIP::*nrp18sn-100001*::*5025*::SOCKET

7 Contacting customer support

Technical support – where and when you need it

For quick, expert help with any Rohde & Schwarz product, contact our customer support center. A team of highly qualified engineers provides support and works with you to find a solution to your query on any aspect of the operation, programming or applications of Rohde & Schwarz products.

Contact information

Contact our customer support center at www.rohde-schwarz.com/support, or follow this QR code:



Figure 7-1: QR code to the Rohde & Schwarz support page

Index

A

Android device	
R&S Power Viewer Mobile	45
Application cards	10
Application notes	10

B

Brochures	9
Browser-based user interface	39
Button	
LAN reset	35

C

CD-ROM	9
Checking	12
Computer	
Connection types	17
Simple USB connection	17
USB sensor hub	18
Connecting	
Base unit	21
RF	14
Supported R&S instrument	21
To a computer	17
USB host	16
Connector	
Host interface	34
LAN	34
Overview	30
RF	31
Trigger I/O	34
Controlling host	17
Computer using LAN	23
R&S NRX	23
Customer support	54

D

Disconnecting	
Host interface	16
RF	15
Documentation overview	8
Download	
R&S NRP Toolkit	36
DUT	
Connecting	14
Disconnecting	14

E

Electromagnetic interference (EMI)	14
Electrostatic discharge (ESD)	14
Ethernet interface	
Remote control	52

F

Firmware update	38
-----------------------	----

G

Getting started	8
-----------------------	---

H

HiSLIP	52
Hostname	27

I

Instrument security procedures	9
Intended use	5
Interface	
Overview	30
IP address	28

K

Key facts	10
-----------------	----

L

Labels	6
LAN connection	
Configuring	38
Hostname	27
IP address	28
Setup	23, 26
LAN reset button	35
LED	
Network status	35
Power status	35
Status	33
Low-level communication program	39

M

Mobile measurements	45
---------------------------	----

N

Network status LED	35
--------------------------	----

O

Open-source acknowledgment (OSA)	10
Operating concepts	36
App for Android devices	45
Browser-based user interface	39
R&S NRP Toolkit	36
R&S NRPV	41
R&S NRX	46
R&S Power Viewer	43
Remote control	41
Operating conditions	12

P

Power status LED	35
Power supply	15
Preparing for use	12

R

R&S NRP Toolkit	36
Communication program	39
Components for Windows-based systems	37
Firmware update	38
Installation under Windows	37
Network configuration	38
S-parameter update	39
System requirements	37
Uncertainty calculator	39
Version display	39
Versions	36
R&S NRP-Z5	18
R&S NRPV	41
R&S NRX	46
R&S Power Viewer	43
R&S Power Viewer Mobile	45
Regulatory information	5
Release notes	10
Remote control	
Ethernet interface	52
Interfaces	48
Protocols	48
USB interface	48
VISA resource strings	52
Resource string	
HiSLIP	52
Socket	53
VISA	52
VXI-11	53
RF connector	14, 31

S

S-parameter update	39
Safety information	5, 12
Safety instructions	5, 9
Security procedures	9
Serial number	7
Setup	
LAN connection	23
Socket	53
Specifications	9
Status LED	33

T

Target audience	5
Test setup	13
Trigger I/O connector	34

U

Uncertainty calculator	39
Unpacking	12
USB connection	17
USB interface	
Remote control	48
USB product ID	49
USB resource string	49
USB sensor hub	18
User manual	8

V

VISA	52
VXI-11	53

W

Warning message	7
White papers	10

Z

Zero configuration networking	26
-------------------------------------	----