

# R&S®FSW Real-Time Spectrum Application and MSRT Operating Mode User Manual

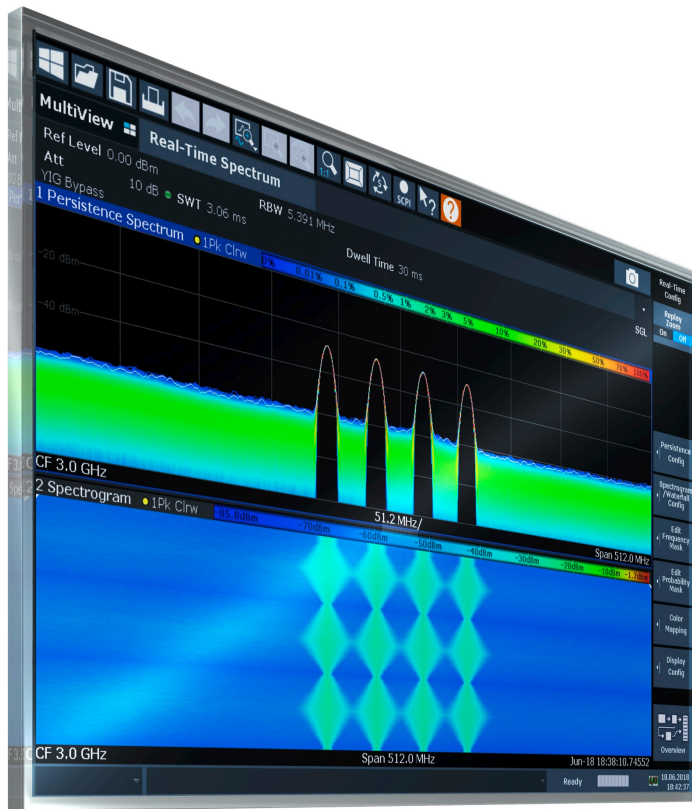

1175648402  
Version 26

**ROHDE & SCHWARZ**  
Make ideas real



This manual applies to the following FSW models with firmware version 6.00 and later:

- R&S®FSW8 (1331.5003K08 / 1312.8000K08)
- R&S®FSW13 (1331.5003K13 / 1312.8000K13)
- R&S®FSW26 (1331.5003K26 / 1312.8000K26)
- R&S®FSW43 (1331.5003K43 / 1312.8000K43)
- R&S®FSW50 (1331.5003K50 / 1312.8000K50)
- R&S®FSW67 (1331.5003K67 / 1312.8000K67)
- R&S®FSW85 (1331.5003K85 / 1312.8000K85)

The following firmware options are described:

- R&S®FSW-K161R (1338.2700.02)
- R&S®FSW-B512R (1321.6320.04)
- R&S®FSW-K512RE (1338.4731.02)
- R&S®FSW-U512R (1321.6320.06)
- R&S®FSW-B800R (1331.6400.16)
- R&S®FSW-K800RE (1338.7801.02)

© 2024 Rohde & Schwarz

Muehldorfstr. 15, 81671 Muenchen, Germany

Phone: +49 89 41 29 - 0

Email: [info@rohde-schwarz.com](mailto:info@rohde-schwarz.com)

Internet: [www.rohde-schwarz.com](http://www.rohde-schwarz.com)

Subject to change – data without tolerance limits is not binding.

R&S® is a registered trademark of Rohde & Schwarz GmbH & Co. KG.

All other trademarks are the properties of their respective owners.

1175.6484.02 | Version 26 | R&S®FSW Real-Time

Throughout this manual, products from Rohde & Schwarz are indicated without the ® symbol, e.g. R&S®FSW is indicated as R&S FSW. R&S®FSW Real-Time is indicated as R&S FSW Real-Time.

# Contents

<b>1</b>	<b>Documentation overview.....</b>	<b>7</b>
1.1	Getting started manual.....	7
1.2	User manuals and help.....	7
1.3	Service manual.....	7
1.4	Instrument security procedures.....	8
1.5	Printed safety instructions.....	8
1.6	Specifications and brochures.....	8
1.7	Release notes and open-source acknowledgment (OSA).....	8
1.8	Application notes, application cards, white papers, etc.....	9
1.9	Videos.....	9
<b>2</b>	<b>Welcome to the FSW real-time extension.....</b>	<b>10</b>
2.1	Starting the R&S FSW Real-Time Spectrum application.....	10
2.2	Starting the Multi-Standard Real-Time (MSRT) operating mode.....	11
2.3	Understanding the display information.....	12
<b>3</b>	<b>Typical applications.....</b>	<b>19</b>
<b>4</b>	<b>Applications and operating modes.....</b>	<b>20</b>
4.1	Available secondary applications.....	21
4.2	Selecting the MSRT operating mode and secondary applications.....	23
4.3	Multiple measurement channels and sequencer function.....	24
<b>5</b>	<b>Measurements and result displays.....</b>	<b>27</b>
5.1	Real-Time Spectrum measurement types.....	27
5.2	Real-Time Spectrum result displays.....	28
<b>6</b>	<b>Real-time basics.....</b>	<b>37</b>
6.1	Data acquisition and processing in real-time.....	37
6.2	Defining the resolution bandwidth.....	41
6.3	Sweep time and detector.....	41
6.4	Triggering real-time measurements.....	42
6.5	Working with Spectrogram / PVT Waterfall diagrams.....	49
6.6	Understanding persistence.....	61
6.7	Event-based actions.....	66

6.8	Digital output.....	67
6.9	Digital I/Q 40G streaming output.....	68
6.10	Multi-standard real-time analysis.....	68
<b>7</b>	<b>Configuring the R&amp;S FSW Real-Time Spectrum application.....</b>	<b>76</b>
7.1	Configuration overview.....	76
7.2	Input and output settings.....	78
7.3	Frequency and span settings.....	85
7.4	Amplitude settings.....	87
7.5	Scaling the y-axis.....	92
7.6	Trigger configuration.....	93
7.7	Bandwidth and sweep settings.....	104
7.8	Adjusting settings automatically.....	109
<b>8</b>	<b>Configuring and performing measurements in MSRT mode.....</b>	<b>112</b>
8.1	Configuring the MSRT primary.....	112
8.2	Trigger settings.....	112
8.3	Data acquisition.....	113
8.4	Performing a measurement in MSRT mode.....	113
<b>9</b>	<b>Analysis.....</b>	<b>116</b>
9.1	Display configuration.....	116
9.2	Persistence spectrum settings.....	116
9.3	Spectrogram and PVT waterfall settings.....	119
9.4	Color map settings.....	121
9.5	Trace settings.....	123
9.6	Trace / data export configuration.....	126
9.7	Trace math.....	128
9.8	Marker usage.....	130
9.9	Display and limit lines.....	142
9.10	Zoom functions.....	158
9.11	Analysis in MSRT secondary applications.....	159
<b>10</b>	<b>I/Q data export.....</b>	<b>161</b>
10.1	Export functions.....	161
10.2	How to export I/Q data.....	162

<b>11</b>	<b>How to perform Real-Time Spectrum measurements.....</b>	<b>165</b>
11.1	How to perform a basic Real-Time Spectrum measurement.....	165
11.2	How to obtain time domain results in real-time.....	166
11.3	How to analyze persistency in Real-Time Spectrum measurements.....	168
11.4	How to configure the color mapping.....	169
11.5	How to work with frequency mask triggers.....	171
11.6	How to output a trigger signal.....	174
11.7	How to output trigger signals continuously.....	174
11.8	How to perform measurements in MSRT mode.....	175
<b>12</b>	<b>Optimizing and troubleshooting the measurement.....</b>	<b>178</b>
<b>13</b>	<b>Remote commands to perform real-time measurements.....</b>	<b>179</b>
13.1	Introduction.....	180
13.2	Common suffixes.....	184
13.3	Activating the real-time spectrum application.....	185
13.4	Selecting the measurement type.....	189
13.5	Configuring real-time measurements.....	190
13.6	Capturing data and performing sweeps.....	262
13.7	Retrieving results.....	266
13.8	Analyzing results.....	280
13.9	Querying the status registers.....	335
13.10	Deprecated commands.....	339
13.11	Remote commands for MSRT operating mode.....	341
13.12	Programming examples: performing real-time measurements.....	344
	<b>Annex.....</b>	<b>353</b>
<b>A</b>	<b>Reference: ASCII file export format.....</b>	<b>353</b>
	<b>List of commands (Real-Time).....</b>	<b>358</b>
	<b>Index.....</b>	<b>366</b>



# 1 Documentation overview

This section provides an overview of the FSW user documentation. Unless specified otherwise, you find the documents at:

[www.rohde-schwarz.com/manual/FSW](http://www.rohde-schwarz.com/manual/FSW)

Further documents are available at:

[www.rohde-schwarz.com/product/FSW](http://www.rohde-schwarz.com/product/FSW)

## 1.1 Getting started manual

Introduces the FSW and describes how to set up and start working with the product. Includes basic operations, typical measurement examples, and general information, e.g. safety instructions, etc.

A printed version is delivered with the instrument. A PDF version is available for download on the Internet.

## 1.2 User manuals and help

Separate user manuals are provided for the base unit and the firmware applications:

- Base unit manual  
Contains the description of all instrument modes and functions. It also provides an introduction to remote control, a complete description of the remote control commands with programming examples, and information on maintenance, instrument interfaces and error messages. Includes the contents of the getting started manual.
- Firmware application manual  
Contains the description of the specific functions of a firmware application, including remote control commands. Basic information on operating the FSW is not included.

The contents of the user manuals are available as help in the FSW. The help offers quick, context-sensitive access to the complete information for the base unit and the firmware applications.

All user manuals are also available for download or for immediate display on the Internet.

## 1.3 Service manual

Describes the performance test for checking the rated specifications, module replacement and repair, firmware update, troubleshooting and fault elimination, and contains mechanical drawings and spare part lists.

The service manual is available for registered users on the global Rohde & Schwarz information system (GLORIS):

<https://gloris.rohde-schwarz.com>

## 1.4 Instrument security procedures

Deals with security issues when working with the FSW in secure areas. It is available for download on the internet.

## 1.5 Printed safety instructions

Provides safety information in many languages. The printed document is delivered with the product.

## 1.6 Specifications and brochures

The specifications document, also known as the data sheet, contains the technical specifications of the FSW. It also lists the firmware applications and their order numbers, and optional accessories.

The brochure provides an overview of the instrument and deals with the specific characteristics.

See [www.rohde-schwarz.com/brochure-datasheet/FSW](http://www.rohde-schwarz.com/brochure-datasheet/FSW)

## 1.7 Release notes and open-source acknowledgment (OSA)

The release notes list new features, improvements and known issues of the current firmware version, and describe the firmware installation.

The firmware makes use of several valuable open source software packages. An open-source acknowledgment document provides verbatim license texts of the used open source software.

See [www.rohde-schwarz.com/firmware/FSW](http://www.rohde-schwarz.com/firmware/FSW)



## 1.8 Application notes, application cards, white papers, etc.

These documents deal with special applications or background information on particular topics.

See [www.rohde-schwarz.com/application/FSW](http://www.rohde-schwarz.com/application/FSW)

## 1.9 Videos

Find various videos on Rohde & Schwarz products and test and measurement topics on YouTube: <https://www.youtube.com/@RohdeundSchwarz>

## 2 Welcome to the FSW real-time extension

The FSW real-time extension options provide both an application and an operating mode to display RF spectra in real-time and gapless, allowing for quick and simple error analysis and signal characterization.

While the R&S FSW Real-Time Spectrum application can perform basic real-time spectrum analysis on RF input data, the Multi-Standard Real-Time (MSRT) operating mode can capture data in real-time and then analyze this data in various secondary applications, similar to the Multi-Standard Radio Analysis (MSRA) operating mode.

The **"Multi-Standard Real-Time (MSRT)" operating mode** features:

- Real-time analysis of the same RF data in more than one secondary application
- Analysis of correlated effects captured without gaps
- Configuration of data acquisition settings only required once for all active secondary applications
- Overview of all results in one screen in addition to large display of individual results
- Common analysis line (time marker) across all secondary applications

This user manual contains a description of the functionality specific to the R&S FSW Real-Time Spectrum application and the MSRT operating mode, including remote control operation.

Functions not discussed in this manual are the same as in Signal and Spectrum Analyzer mode and are described in the FSW User Manual. The latest version is available for download at the product homepage (<http://www.rohde-schwarz.com/product/FSW.html>).

### Additional information

An application note discussing the implementation of real-time spectrum analysis using the FSW is available from the Rohde & Schwarz website:

[1EF77: Implementation of Real-Time Spectrum Analysis](#)

### Installation

You can find detailed installation instructions in the FSW Getting Started manual or in the Release Notes.

- [Starting the R&S FSW Real-Time Spectrum application](#)..... 10
- [Starting the Multi-Standard Real-Time \(MSRT\) operating mode](#)..... 11
- [Understanding the display information](#)..... 12

### 2.1 Starting the R&S FSW Real-Time Spectrum application

The R&S FSW Real-Time Spectrum application adds real-time measurement analysis to the FSW. It is only available if one of the real-time extension options are installed.

### To activate the R&S FSW Real-Time Spectrum application

1. Press [MODE] on the front panel of the FSW.

A dialog box opens that contains all operating modes and applications currently available on your FSW.

2. Select the "Real-Time Spectrum" item.



The FSW opens a new measurement channel for the R&S FSW Real-Time Spectrum application.

The measurement is started immediately with the default settings. It can be configured in the "Real-Time Spectrum" "Overview".

(See [Chapter 7.1, "Configuration overview"](#), on page 76)

## 2.2 Starting the Multi-Standard Real-Time (MSRT) operating mode

**Access:** [MODE] > "Multi-Standard Real-Time" tab.

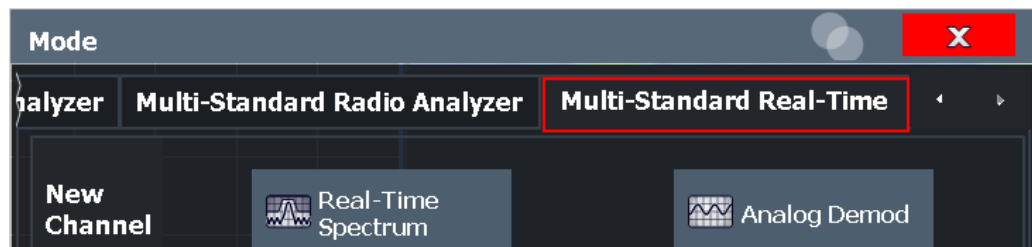

"Multi-Standard Real-Time (MSRT)" is a new operating mode on the FSW. It is only available if one of the real-time extension options are installed.

The FSW closes all active measurement channels in the current operating mode, then opens a new measurement channel for the MSRT operating mode. For details see [Chapter 4, "Applications and operating modes"](#), on page 20.

The Sequencer is automatically activated in continuous mode (see [Chapter 6.10.3, "Using the sequencer in MSRT mode"](#), on page 73), starting a real-time data acquisition with the default settings. It can be configured in the Real-Time Spectrum "Overview" (see [Chapter 7.1, "Configuration overview"](#), on page 76).

In addition to the "MSRT View" (the "MultiView" tab in real-time mode), an MSRT "Primary" tab is displayed.

#### Remote command:

```
INST:MODE RTMStandard
```

## 2.3 Understanding the display information

### 2.3.1 R&S FSW Real-Time Spectrum application

The following figure shows a measurement diagram in the R&S FSW Real-Time Spectrum application. All different information areas are labeled. They are explained in more detail in the following sections.

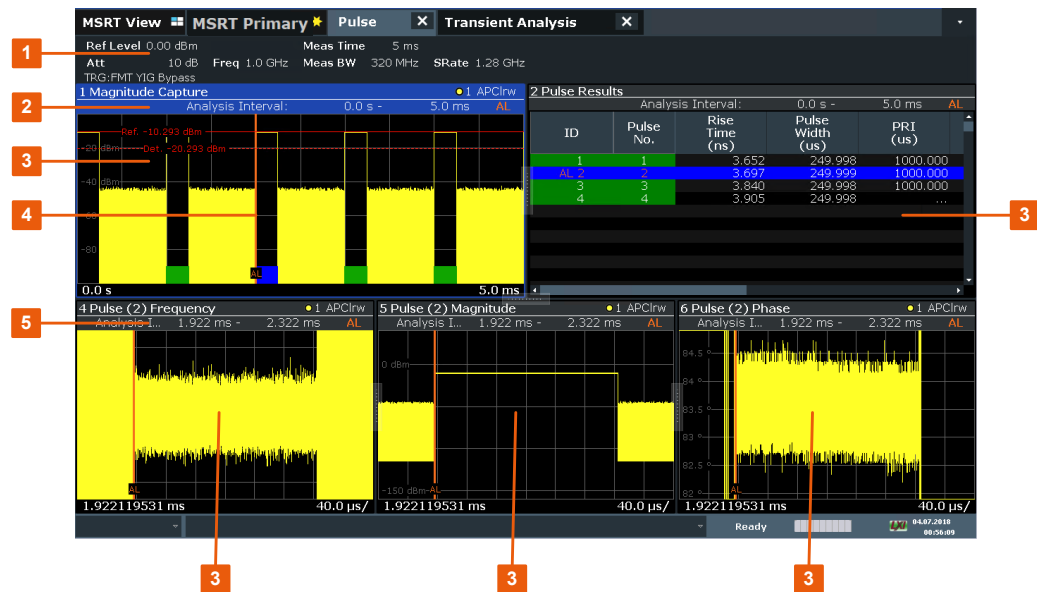

Figure 2-1: Screen elements in the Real-Time Spectrum channel

- 1 = Channel bar for firmware and measurement settings
- 2 = Window title bar with diagram-specific (trace) information
- 3 = Spectrum display
- 4+7 = Diagram footer with diagram-specific information, depending on evaluation
- 5 = "Spectrogram" color map legend
- 6 = "Spectrogram" display
- 8 = Instrument status bar with error messages, progress bar and date/time display

#### Channel bar information

In the R&S FSW Real-Time Spectrum application, the FSW shows the following settings:

Table 2-1: Information displayed in the channel bar in the R&S FSW Real-Time Spectrum application

"Ref Level"	Reference level
"Att" / "m.+el.Att"	Mechanical RF attenuation / Mechanical and electronic RF attenuation
"Offset"	Reference level offset
"SWT"	Data acquisition time for single spectrogram line in frequency domain
"PVT SWT"	Data acquisition time for single PVT waterfall line in time domain

"RBW"	Resolution bandwidth
"Dwell Time"	Measurement time for "Run Single" or "Continuous Sequencer" mode if no trigger is used.
"TRG"	Trigger source
"PreTrigger"/ "Post-Trigger"	Data acquisition time before / after the trigger event
"Meas"	Measurement mode: High Resolution or Multi Domain (only for FSW)
"SGL"	The measurement is set to single sweep mode.

In addition, the channel bar also displays information on instrument settings that affect the measurement results even though this is not immediately apparent from the display of the measured values. This information is displayed only when applicable for the current measurement. For details see the FSW Getting Started manual.

### Window title bar information

For each diagram, the header provides the following information:



- 1 = Window number
- 2 = Window type
- 3 = Trace color
- 4 = Trace number
- 5 = Trace detector
- 6 = Trace mode
- 7 = Color map legend

### Diagram footer information

The diagram footer (beneath the diagram) contains the following information, depending on the evaluation.

#### Spectrum displays:

- Center frequency (CF)
- Displayed frequency span per division
- Displayed frequency span

#### Spectrograms:

- Center frequency (CF)
- Displayed frequency span
- Timestamp or index of current frame

#### Time domain displays:

- Center frequency (CF)
- Displayed time span per division

### Status bar information

Global instrument settings, the instrument status and any irregularities are indicated in the status bar beneath the diagram. Furthermore, the progress of the current operation is displayed in the status bar.

### 2.3.2 MSRT operating mode

The following figure shows a screen display in MSRT operating mode. All different information areas are labeled. They are explained in more detail in the following sections.



- The blue background of the screen behind the measurement channel tabs indicates that you are in MSRT operating mode.
- The icon on the tab label indicates that the displayed trace (e.g. in a R&S FSW Real-Time Spectrum application) no longer matches the currently captured data. This may be the case, for example, if a data acquisition was performed in another application. As soon as the result display is refreshed, the icon disappears.
- The icon indicates that an error or warning is available for that measurement channel. This is particularly useful if the MSRT View tab is displayed.
- An orange "IQ" indicates that the results displayed in the MSRT secondary application(s) no longer match the data captured by the MSRT primary. The "IQ" disappears after the results in the secondary application(s) are refreshed.

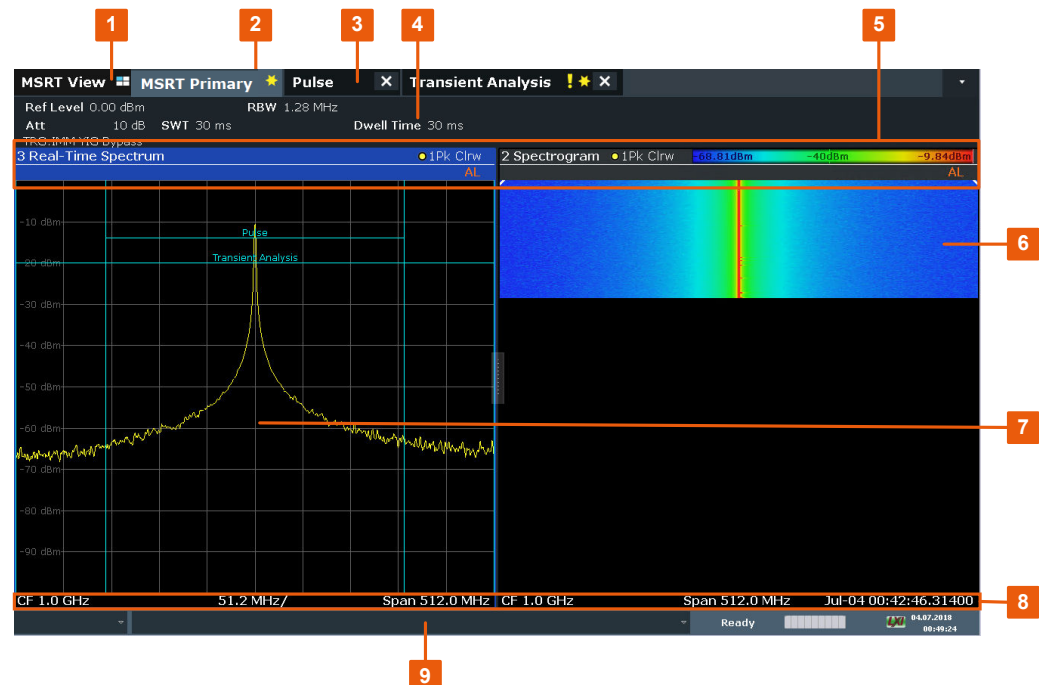

Figure 2-2: Screen elements in the MSRT operating mode

- 1 = MSRT View (overview of all active channels in MSRT mode)
- 2 = MSRT Primary (data acquisition channel with global configuration settings)
- 3 = Measurement channel tabs for individual MSRT secondary applications
- 4 = Channel bar for firmware and measurement settings of current channel
- 5 = Window title bar with diagram-specific (trace) information and analysis interval (secondary applications)
- 7 = "Spectrogram" display
- 6 = "Real-Time Spectrum" display
- 8 = Diagram footer with diagram-specific information, depending on evaluation
- 9 = Instrument status bar with error messages, progress bar and date/time display

### Window title bar information

For each diagram, the header provides the following information:



**Figure 2-3: Window title bar information in MSRT mode**

- 1 = Window number
- 2 = Window type
- 3 = Trace color
- 4 = Trace number
- 5 = Detector
- 6 = Trace mode
- 7 = Color legend
- 8 = Analysis line indication

#### 2.3.2.1 MSRT view

The MSRT View is an overview of all active channels in MSRT mode, similar to the MultiView tab in Signal and Spectrum Analyzer mode. At the top of the screen the MSRT primary is displayed, i.e. the application that captures data. Beneath the MSRT primary, all active secondary applications are displayed in individual windows. Each secondary application has its own channel bar with the current settings as well as a button in order to switch to that secondary application tab directly.

The MSRT View displays the following basic elements:

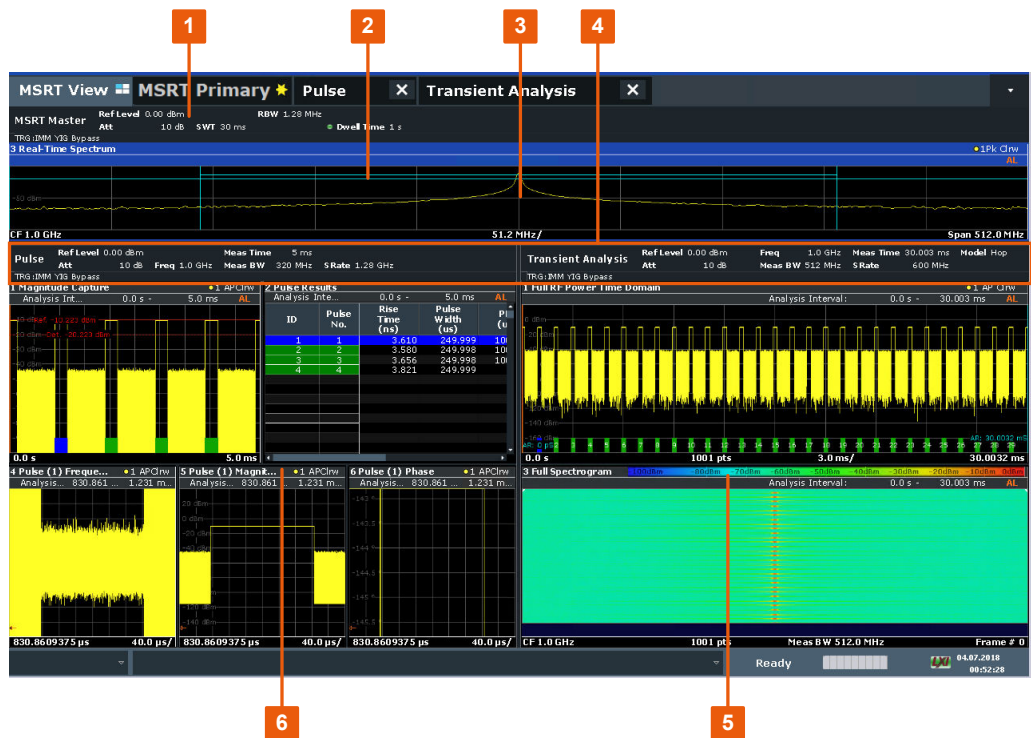

Figure 2-4: Screen elements in the MSRT View

- 1 = Channel information bar for the MSRT primary
- 2 = Data coverage for each active secondary application
- 3 = Spectrum display for MSRT primary
- 4 = Channel information bar for secondary application with button to switch to secondary application tab
- 5+6 = Result displays for secondary applications

### 2.3.2.2 MSRT primary

The MSRT primary is the only channel that captures I/Q data. It also controls global configuration settings for all secondary applications. The MSRT primary channel itself is implemented as a R&S FSW Real-Time Spectrum application. The MSRT primary measurement channel cannot be deleted or replaced.

The following figure shows the screen elements specific to the MSRT Primary channel.



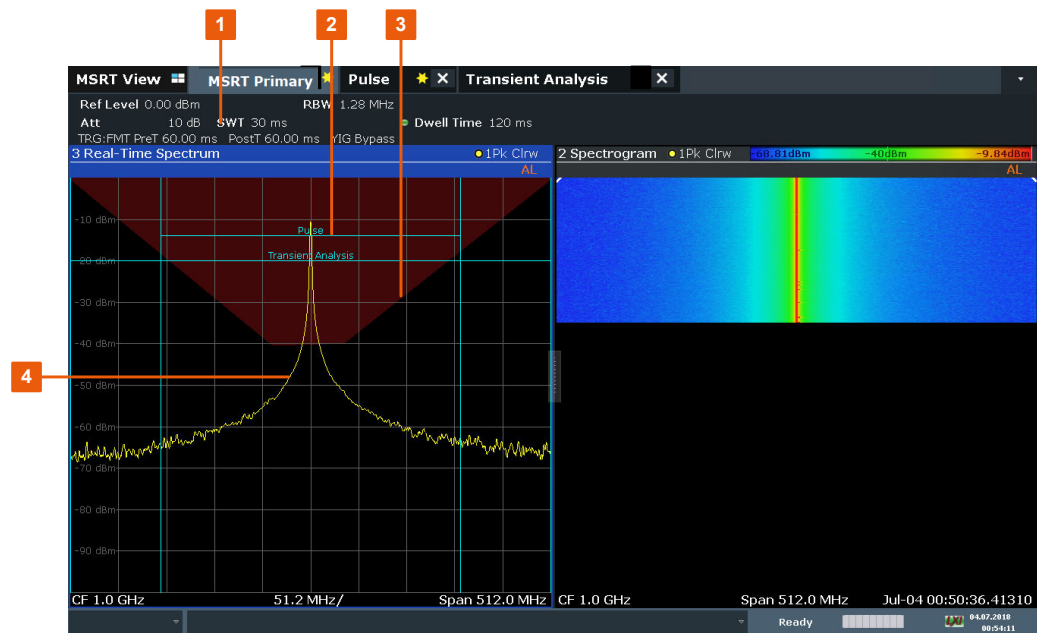

Figure 2-5: Screen elements in the MSRT Primary channel

- 1 = Channel information bar for the MSRT primary
- 2 = Data coverage for each active secondary application
- 3 = Frequency mask (trigger)
- 4 = "Real-Time Spectrum" display for MSRT primary

### Data coverage for each active secondary application

Each secondary application obtains an extract of the data captured by the MSRT primary (see also [Chapter 6.10, "Multi-standard real-time analysis"](#), on page 68). Thus, it is of interest to know which secondary application is analyzing which part of the captured data, or more precisely, which data channel. The MSRT primary display indicates the data covered by each secondary application by vertical blue lines labeled with the secondary application name.

#### 2.3.2.3 MSRT secondary applications

The data captured by the MSRT primary measurement (or only parts of it) can be evaluated by various secondary applications. The measurement channel for each secondary application evaluates a specific extract from the capture buffer, and displays the settings and results for that secondary application data. For example, in [Figure 2-6](#), the primary data is evaluated in the Pulse measurement secondary application and in the Transient Analysis secondary application.

The following figure shows the screen elements specific to the MSRT secondary application tabs.



Figure 2-6: Screen elements in MSRT secondary application channels

- 1 = Channel information bar for secondary applications (here: Pulse measurement)
- 2+5 = Analysis interval for current evaluation
- 3 = Result displays for analysis intervals
- 4 = Analysis line

The display for the individual MSRT secondary applications is identical to the display in Signal and Spectrum Analyzer mode except for the following differences:

- The analysis interval indicates which part of the capture buffer is being evaluated and displayed in each window.
- The acquisition time indicated in the channel bar ("Meas Time") indicates the *analyzed* measurement time, not the captured time.
- Any bandwidth or sample rate values refer to the secondary application data, not to the actual data acquisition from the input signal.
- The analysis line for time-based displays is only available in MSRT mode. It represents a common time marker in all secondary applications whose analysis interval includes that time (see "Analysis line" on page 71).

For details on the individual secondary application displays see the corresponding User Manuals for those applications.

### 3 Typical applications

A common challenge when developing RF applications are sporadic and transient interferences. In order to keep the time for development short, it is essential that such interferences are detected quickly and that the exact cause is determined. Possible causes may be interference from digital circuits or short-term effects from frequency hopping techniques in sending devices. Thus, a seamless data acquisition and a frequency mask trigger are required.

A further application for Real-Time Spectrum measurement is various standards working in the same frequency range, for example Bluetooth and WLAN. Frequent collisions reduce the data rates. To develop effective algorithms that elude collisions, the spectrum must be analyzed seamlessly.

Precise analysis of frequency-variant senders (hoppers) is not only indispensable for wireless data transfer, but also for radar applications or satellite communication. Administrative or regulatory authorities also depend on seamless spectrum analysis to supervise the frequency bands.

## 4 Applications and operating modes

The FSW provides several applications for different analysis tasks and different types of signals, e.g. vector signal analysis, I/Q analysis or basic spectrum analysis. When you activate an application, a new measurement channel is created which determines the measurement settings for that application. The same application can be activated with different measurement settings by creating several channels for the same application. Each channel is displayed in a separate tab on the screen.



The maximum number of measurement channels may be limited by the available memory on the instrument.

### Measurements

Depending on the task, the application can provide different measurement functions. The measurement function determines which settings, functions and evaluation methods are available in the FSW. Only one measurement can be performed at the same time within the same application instance. You select the measurement for an application via the [MEAS] key.

In the Spectrum application, for example, the FSW provides a variety of different measurement functions, including:

- Frequency sweep or zero span measurement
- **Basic measurements** - measure the spectrum of your signal or watch your signal in time domain
- **Power measurements** - calculate the powers involved in modulated carrier signals
- **Emission measurements** - detect unwanted signal emission
- **Statistic measurements** - evaluate the spectral distribution of the signal
- **Further measurements** - provide characteristic values of the signal
- **EMI measurements** - detect electromagnetic interference in the signal

The individual functions are described in detail in the FSW User Manual.

### Independent vs. correlating measurements

With the **conventional FSW Signal and Spectrum Analyzer** you can perform several different measurements almost simultaneously. However, the individual measurements are independent of each other - **each application captures and evaluates its own set of data**, regardless of what the other applications do.

In some cases it may be useful to **analyze the exact same input data using different applications**.

### Multi-Standard Real-Time mode

In **Multi-Standard Real-Time (MSRT) mode**, data acquisition is performed once as a real-time measurement by a primary application, and the captured data is then evaluated by any number of secondary applications. Data acquisition and general configura-

tion settings are controlled globally, while the evaluation and display settings can be configured individually for each secondary application.

Apart from providing gapless results, one of the big advantages of the real-time measurement is the availability of the frequency mask trigger. Using the Multi-Standard Real-Time mode, this trigger can be made available to various other application types as well. For example, a Real-Time measurement triggered with a frequency mask can be performed by the MSRT primary, and the results can be evaluated in the VSA secondary application to detect the cause of a frequency exception.

### Multi-Standard Radio Analyzer mode

A third operating mode is available, **Multi-Standard Radio Analyzer mode**, in which data acquisition is performed once as a common I/Q measurement by a primary application, and the captured data is then evaluated by any number of secondary applications for different radio standards. Using the Multi-Standard Radio Analyzer, unwanted correlations between different signal components using different transmission standards can be detected. Thus, for example, an irregularity in a GSM burst can be examined closer in the FSW 3G FDD BTS (W-CDMA) secondary application to reveal dependencies like a change in the EVM value.

### Distinct operating modes

Although the applications themselves are identical in all operating modes, the handling of the data between applications is not. Thus, the operating mode determines which applications are available and active. Whenever you change the operating mode, the currently active measurement channels are closed. The default operating mode is Signal and Spectrum Analyzer mode; however, the presetting can be changed.

### Remote command:

`INST:MODE RTMS`, see `INSTrument:MODE` on page 341

### Switching between applications

When you switch to a new application, a set of parameters is passed on from the current application to the new one:

- Center frequency and frequency offset
- Reference level and reference level offset
- Attenuation

After initial setup, the parameters for the measurement channel are stored upon exiting and restored upon re-entering the channel. Thus, you can switch between applications (tabs) quickly and easily.

## 4.1 Available secondary applications

Not all options available for the FSW are supported as secondary applications in the real-time mode. The supported secondary applications are listed here. Note that some

of the applications are provided with the base unit, while others are available only if the corresponding firmware options are installed.

I/Q Analyzer.....	22
AM/FM/PM Modulation Analysis.....	22
Pulse Measurements.....	22
Real-Time Spectrum.....	22
Transient Analysis.....	22
Vector Signal Analysis (VSA).....	23

### I/Q Analyzer

The I/Q Analyzer secondary application provides measurement and display functions for I/Q signals. Evaluation of the captured I/Q data in the frequency and time domain is also possible.

For details see the R&S FSW I/Q Analyzer user manual.

Remote command:

INST:SEL IQ, see [INSTrument\[:SElect\]](#) on page 188

### AM/FM/PM Modulation Analysis

The AM/FM/PM Modulation Analysis secondary application requires an instrument equipped with the corresponding optional software (FSW-K7). This secondary application provides measurement functions for demodulating AM, FM, or PM signals.

For details see the R&S FSW AM/FM/PM Modulation Analysis user manual.

Remote command:

INST:SEL ADEM, see [INSTrument\[:SElect\]](#) on page 188

### Pulse Measurements

The Pulse secondary application requires an instrument equipped with the Pulse Measurements option (R&S FSW-K6). This secondary application provides measurement functions for pulsed signals.

For details see the R&S FSW Pulse Measurements user manual.

Remote command:

INST:SEL PULSE, see [INSTrument\[:SElect\]](#) on page 188

### Real-Time Spectrum

The "Real-Time Spectrum" secondary application allows you to perform basic real-time spectrum analysis on RF input data.

For details refer to [Chapter 5, "Measurements and result displays"](#), on page 27.

Remote command:

INST:SEL RTIM, see [INSTrument\[:SElect\]](#) on page 188

### Transient Analysis

The Transient Analysis secondary application requires an instrument equipped with the Transient Analysis option (R&S FSW-K60). This secondary application provides measurements and evaluations for Transient Analysis.

For details see the R&S FSW Transient Analysis user manual.

Remote command:

INST:SEL TA, see [INSTrument\[:SElect\]](#) on page 188

### Vector Signal Analysis (VSA)

The VSA secondary application requires an instrument equipped with the Vector Signal Analysis option (R&S FSW-K70). This secondary application provides measurements and evaluations for single-carrier digitally modulated signals.

For details see the R&S FSW VSA user manual.

Remote command:

INST:SEL DDEM, see [INSTrument\[:SElect\]](#) on page 188

## 4.2 Selecting the MSRT operating mode and secondary applications

**Access:** [MODE]

The default operating mode is Signal and Spectrum Analyzer mode, however, the pre-setting can be changed.

(See the "Instrument Setup" chapter in the FSW user manual).

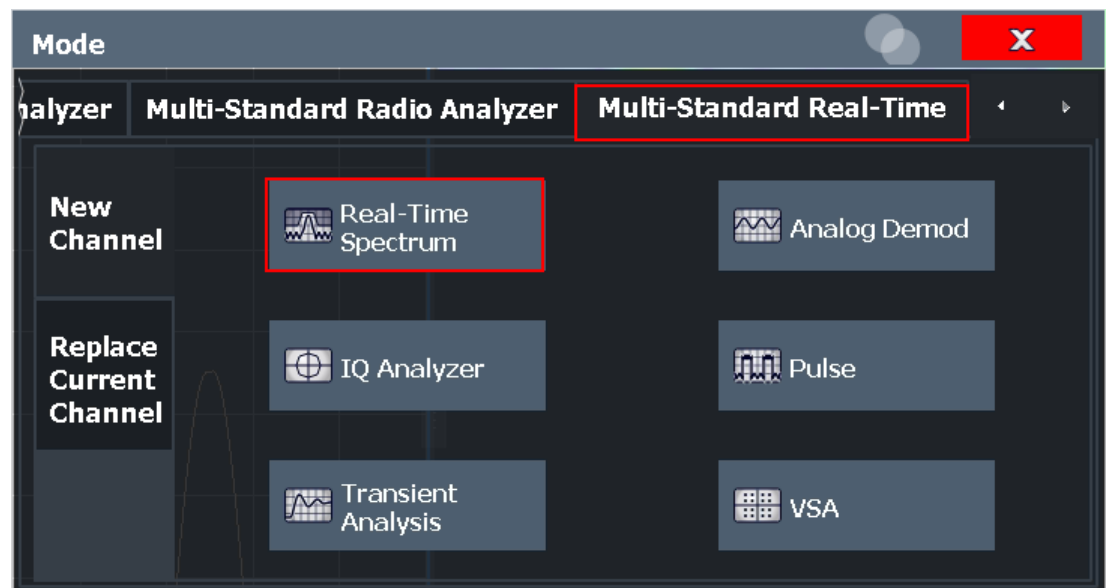

Switching the operating mode.....	23
Selecting a real-time application.....	24
└ New Channel.....	24
└ Replace Current Channel.....	24
Closing a secondary application.....	24

### Switching the operating mode

To switch the operating mode, select the corresponding tab (see [Chapter 2.2, "Starting the Multi-Standard Real-Time \(MSRT\) operating mode"](#), on page 11).

Remote command:

`INSTRument:MODE` on page 341

#### Selecting a real-time application

To start a new secondary application or replace an existing secondary application, select the corresponding button in the correct tab.

Remote command:

`INSTRument[:SElect]` on page 188

#### New Channel ← Selecting a real-time application

The secondary application selected on this tab is started in a new channel, i.e. a new tab in the display.

Remote command:

`INSTRument:CREate[:NEW]` on page 185

`INSTRument[:SElect]` on page 188

#### Replace Current Channel ← Selecting a real-time application

The secondary application selected on this tab is started in the currently displayed channel, replacing the current secondary application.

Remote command:

`INSTRument:CREate:REPLace` on page 186

#### Closing a secondary application

To close a secondary application, simply close the corresponding tab by selecting the "x" next to the channel name.

Remote command:

`INSTRument:DELeTe` on page 186

## 4.3 Multiple measurement channels and sequencer function

When you activate an application, a new measurement channel is created which determines the measurement settings for that application. The same application can be activated with different measurement settings by creating several channels (tabs) for the same application.

The number of channels that can be configured at the same time depends on the available memory on the instrument.

Only one measurement can be performed at any time, namely the one in the currently active channel. However, in order to perform the configured measurements consecutively, a Sequencer function is provided.

If activated, the measurements configured in the currently active channels are performed one after the other in the order of the tabs. The currently active measurement is indicated by a  symbol in the tab label. The result displays of the individual channels



are updated in the tabs (as well as the "MultiView") as the measurements are performed. Sequential operation itself is independent of the currently *displayed* tab.

For details on the Sequencer function see the FSW user manual.



### Using the Sequencer in MSRT mode

For information on using the Sequencer in MSRT mode see [Chapter 6.10.3, "Using the sequencer in MSRT mode"](#), on page 73.

### Specifics of using the Sequencer in Real-Time Spectrum measurements

When using the R&S FSW Real-Time Spectrum application with the Sequencer in continuous mode, I/Q data is analyzed on each iteration through the Sequencer. The duration of I/Q data acquisition is defined by the "Dwell Time" setting (see ["Dwell Time"](#) on page 106).

If a trigger is configured, the behavior of the Sequencer depends on the trigger settings.

**Table 4-1: Sequencer behavior for a Real-Time Spectrum measurement**

Sequencer mode	Trigger setting	Measurement behavior
Single sequence	No trigger (Free run)	R&S FSW Real-Time Spectrum application performs a single measurement which analyzes I/Q data. The amount of data is defined by the "Dwell Time" setting (see <a href="#">"Dwell Time"</a> on page 106).
	Trigger + "Auto Rearm"	After trigger, R&S FSW Real-Time Spectrum application performs single sweep, trigger is rearmed; subsequent applications perform single sweep
	Trigger + "Stop on trigger"	After trigger, R&S FSW Real-Time Spectrum application performs single sweep, trigger is <i>not</i> rearmed; subsequent applications perform single sweep
Continuous sequence	No trigger (Free run)	R&S FSW Real-Time Spectrum application performs a single measurement which analyzes I/Q data. The amount of data is defined by the "Dwell Time" setting (see <a href="#">"Dwell Time"</a> on page 106). Then the subsequent application performs analysis.
	Trigger + "Auto Rearm"	After trigger, R&S FSW Real-Time Spectrum application performs single sweep, trigger is rearmed; subsequent applications perform sweeps as configured; sequence is repeated with next trigger
	Trigger + "Stop on trigger"	After trigger, R&S FSW Real-Time Spectrum application sweeps until trigger is received; trigger is <i>not</i> rearmed; subsequent applications perform sweeps as configured; R&S FSW Real-Time Spectrum application does not perform any more sweeps due to unarmed trigger

## Multiple measurement channels and sequencer function

Sequencer mode	Trigger setting	Measurement behavior
Channel defined sequence	No trigger (Free run)	Initial sequence as for single sequence mode.  The amount of data is defined by the "Dwell Time" setting (see "Dwell Time" on page 106). Then the subsequent application performs analysis.
	Trigger + "Auto Rearm"	Initial sequence as for single sequence mode.  After trigger, R&S FSW Real-Time Spectrum application performs single sweep, trigger is rearmed; subsequent applications perform sweeps as configured; sequence is repeated with next trigger
	Trigger + "Stop on trigger"	Initial sequence as for single sequence mode.  Subsequent applications perform sweeps as configured; R&S FSW Real-Time Spectrum application does not perform any more sweeps due to unarmed trigger

For details on Real-Time trigger settings see [Chapter 7.6, "Trigger configuration"](#), on page 93.

## 5 Measurements and result displays

In order to accommodate for different requirements, different measurement types and result displays are provided for Real-Time Spectrum measurements.

### 5.1 Real-Time Spectrum measurement types

The R&S FSW Real-Time Spectrum application provides different measurement types to allow for Real-Time Spectrum measurements either optimized for high resolution or providing additional evaluation in the time domain.

- [High resolution Real-Time Spectrum measurement](#)..... 27
- [Multi domain Real-Time Spectrum measurement](#).....27

#### 5.1.1 High resolution Real-Time Spectrum measurement

High Resolution Real-Time Spectrum measurements are performed with frequency spans of up to 160 MHz, allowing for very precise results in the frequency domain.

Additional span/RBW couplings are available for precise frequency results.

##### Result displays

For High Resolution measurements, the following result displays are available:

- [Real-Time Spectrum](#)
- [Spectrogram](#)
- [Persistence Spectrum](#)
- [Marker Table](#)

##### SCPI command:

`CONF:REAL:MEAS HRES`, see [CONFigure:REALtime:MEASurement](#) on page 189

#### 5.1.2 Multi domain Real-Time Spectrum measurement

Multi Domain Real-Time Spectrum measurements allow for results both in the frequency and time domains.

When using the FSW-K161R option, Multi Domain measurements are performed with a restricted bandwidth of 100 MHz.

When using the FSW-B512R/-B800R, the maximum bandwidth is used for all measurements, both in the frequency and time domain.

**Result displays**

For Multi Domain measurements, the following result displays are available:

- [Real-Time Spectrum](#)
- [Spectrogram](#)
- [Persistence Spectrum](#)
- [Power vs. Time](#)
- [Power vs Time Waterfall](#)
- [Marker Table](#)

**SCPI command:**

CONF:REAL:MEAS MDOM, see [CONFigure:REALtime:MEASurement](#) on page 189

## 5.2 Real-Time Spectrum result displays

The FSW Real-Time Spectrum measurements not only process data in real-time, but also offer several result displays that help you analyze the data as it is displayed. The human eye has a limited capability of detecting changes – therefore the R&S FSW Real-Time Spectrum application result displays visualize the time axis, i.e. the changes of a signal over time. Display modes with information on past and present spectra at the same time allow for a quick analysis of changes for human eyes.

For Real-Time Spectrum measurements, up to 6 result displays can be displayed simultaneously in separate windows.

<a href="#">Real-Time Spectrum</a> .....	28
<a href="#">Spectrogram</a> .....	29
<a href="#">3-D Spectrogram</a> .....	30
<a href="#">Persistence Spectrum</a> .....	31
<a href="#">Power vs. Time</a> .....	33
<a href="#">Power vs Time Waterfall</a> .....	34
<a href="#">3-D Power vs Time Waterfall</a> .....	35
<a href="#">Marker Table</a> .....	36

**Real-Time Spectrum**

The "Real-Time Spectrum" diagram displays the measured power levels for the specified frequency span around the selected center frequency.

For multi-domain measurements using FSW-K161R, the span is restricted to 100 MHz.

The displayed data corresponds to one particular frame in the spectrogram. During a running measurement, the most recently captured frame is always displayed. During analysis, which frame is displayed depends on the selected frame in the spectrogram configuration (see ["Selecting a frame to display"](#) on page 108) or the marker position in the spectrogram (see ["Frame"](#) on page 132). The displayed frame is indicated by small white arrows on the left and right border of the "Spectrogram"/"PVT waterfall".

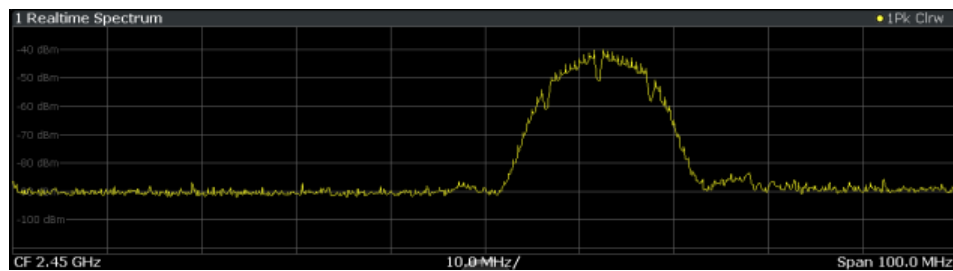

Figure 5-1: Real-Time Spectrum result display

Thus, the "Real-Time Spectrum" is useful to analyze the input signal measured at a specific time in more detail.

Remote command:

LAY:ADD? '1',RIGH, 'XFfrequency', see [LAYout:ADD\[:WINDow\]?](#)

on page 255

Results:

TRAC<n>:DATA? TRACEx, see [TRACe<n>\[:DATA\]](#) on page 269

[TRACe<n>\[:DATA\]:X?](#) on page 270

[MMEMory:STORE<n>:TRACe](#) on page 274

### Spectrogram

The spectrogram is a way of displaying multiple consecutive spectrums over time. The power level, which is usually displayed over frequency, is displayed over frequency and time. Graphically, time and frequency represent the vertical and horizontal axes of the diagram. The color of each point of the diagram represents the power level for the corresponding frequency and time.

At the beginning of a measurement, the diagram is empty. As the measurement advances, the graph is filled line by line. Lines in the spectrogram are called frames, as each frame represents one spectrum.

As the graph fills from top to bottom, the latest spectrum is always the topmost line, whereas older frames move towards the bottom.

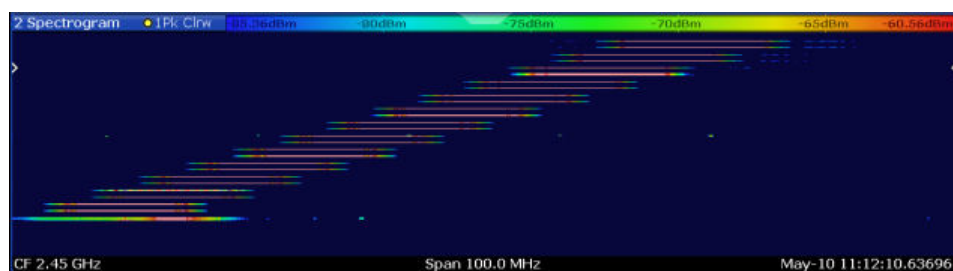

Figure 5-2: Frequency hopper exhibiting a transition with significant RF level from lowest to intermediate frequency

The currently selected frame is indicated by small white arrows on the left and right border of the spectrogram.

The spectrogram is a powerful tool to analyze time-variant spectrums. Typical applications are the transient oscillation of a VCO and the analysis of frequency hopping signals. In [Figure 5-2](#) a frequency hopper is shown. It is clearly visible that the signal is not completely off during the first hop (lowest frequency to middle frequency), whereas no significant RF level can be observed during the second hop.

Real-Time spectrograms are highly configurable. In particular, the number of frames and the colors used to display the power levels can be defined by the user.

Spectrograms are particularly useful in combination with a spectrum display. In this case, the spectrogram provides an overview of events over time, whereas the spectrum provides details for a specific frame.

For more information on working with spectrograms see [Chapter 6.5, "Working with Spectrogram / PVT Waterfall diagrams"](#), on page 49.

Remote command:

LAY:ADD? '1',RIGH,'XFfrequency:SGRam', see [LAYout:ADD\[:WINDow\]?](#) on page 255

Results:

TRAC<n>:DATA? SPEC, see [TRACe<n>\[:DATA\]](#) on page 269

[TRACe<n>\[:DATA\]:X?](#) on page 270

[MMEMory:STORe<n>:SPECTrogram](#) on page 273

### 3-D Spectrogram

A common spectrogram shows the frequency on the x-axis, while the y-axis shows the time (in frames). The power level is indicated by different colors of the 2-dimensional points.

In the new 3-dimensional spectrogram, the power is indicated by a value in a third dimension, the z-axis. The color mapping is maintained for the point in the 3-dimensional result display.

This new display provides an even better overview of how the strength of the signal varies over time for different frequencies.

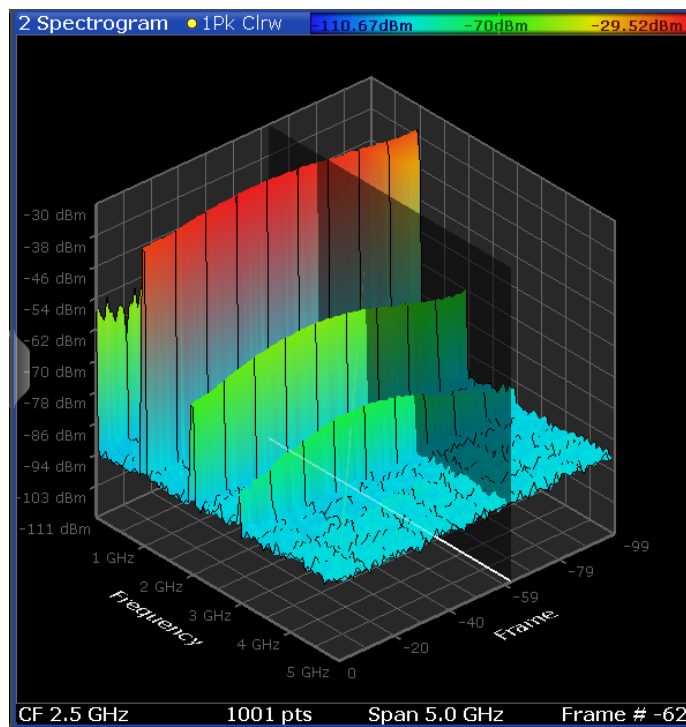

**Figure 5-3: Three-dimensional spectrogram**

Depending on which aspect of the spectrogram is currently of interest, you can rotate the display to have a closer look at the frequency, the time, or the power dimension. Simply drag your finger or the mouse pointer over the spectrogram in the direction you want to rotate it. You can rotate the display left or right, up and down.

For more information on working with 3-dimensional spectrograms, see [Chapter 6.5.5, "Three-dimensional Spectrogram / PVT Waterfall"](#), on page 59.

Remote command:

LAY:ADD? '1',RIGH,'XFRequency:SGRam:3D', see [LAYout:ADD\[:WINDow\]?](#) on page 255

Results:

TRAC<n>:DATA? SPEC, see [TRACe<n>\[:DATA\]](#) on page 269

[TRACe<n>\[:DATA\]:X?](#) on page 270

[MMEMory:STORe<n>:SPECTrogram](#) on page 273

### Persistence Spectrum

In a persistence spectrum, the probability of appearance for each frequency/level pair is displayed.

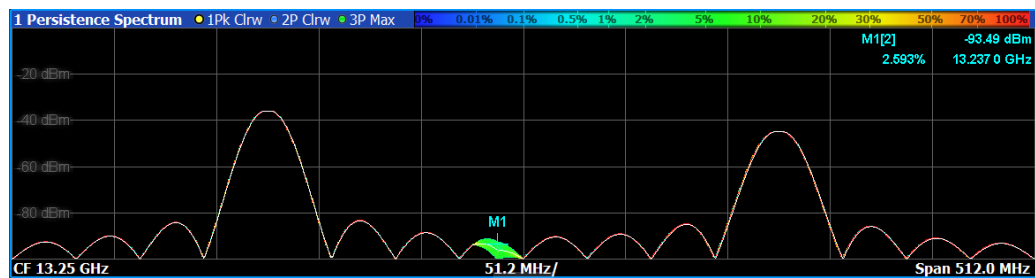

Figure 5-4: Persistence Spectrum result display

The "Persistence Spectrum" result displays 3 traces:

- Trace 1 is a standard trace in clear/write mode with a peak detector, which corresponds to the current "Real-Time Spectrum" trace. This trace is displayed for reference and can be disabled using the common trace settings. (See [Chapter 9.5, "Trace settings"](#), on page 123)
- Trace 2 shows the persistence spectrum in clear/write mode
- Trace 3 shows the persistence spectrum in Max Hold mode. This trace indicates the maximum probabilities ever measured during the entire measurement for each point in the diagram. The intensity of the Max Hold display is configurable so that it can be distinguished from the current trace, but it is not time-dependant (indefinite persistence). (See ["Configuring the Max Hold Function"](#) on page 118).

The persistence spectrum result is also referred to as a spectrum histogram. Both terms indicate the main features of this result display: persistence and histogram information. Persistence helps you view even very short events that the human eye could not capture otherwise. Moreover, it also allows for comparison between two events that are separated in time, but which share a time frame called *persistence granularity*. This time frame specifies the amount of time it takes for a singular event to fade completely.

Histogram information is basically a counter that sums up the appearance of a certain frequency/level pair within a certain amount of time. Instead of displaying the total of a counter, the "Persistence Spectrum" displays the counter result normalized to the maximum achievable count, which yields a probability of appearance for each frequency/level pair.

The "Persistence Spectrum" is made up of a horizontal frequency axis and a vertical level axis just as a normal spectrum display. The color of each dot in the "Persistence Spectrum" contains the histogram information, i.e. the probability information.

A typical application for the "Persistence Spectrum" is the analysis of signals that vary over time. It is an especially powerful tool to provide an overview of a signal, before it can be analyzed in detail.

Using a "Persistence Spectrum", fast frequency hops can be distinguished clearly from amplitude drops, whereas conventional analyzers may mislead the user. As opposed to the spectrogram display, the "Persistence Spectrum" offers a higher level resolution, as it does not employ color coding for the power.

**Tip:** In order to analyze the duration of an event found in the "Persistence Spectrum", use the [Power vs. Time](#) display.



Another application for the "Persistence Spectrum" is the separation of superimposed signals if they can be distinguished in terms of probability distribution of frequency/level pairs.

Figure 5-5 shows a "Persistence Spectrum" of a noise-like signal resulting from a motor with brushes. A weak GSM signal is clearly visible in the center of the span. A standard spectrum analyzer cannot resolve the two different signals, as it does not display probabilities for each signal point.

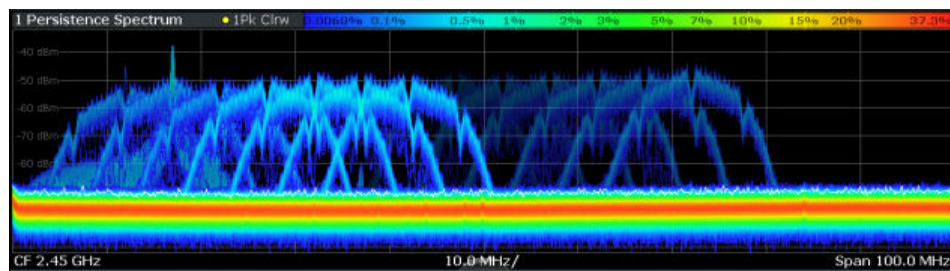

Figure 5-5: Wideband noise-like signal covering a GSM signal

### Markers in the Persistence Spectrum

Markers can be assigned to any of the three traces in the "Persistence Spectrum" display. Markers on the persistence traces are 2-dimensional markers defined by a frequency and level value, similar to fixed reference markers (see "Defining a Fixed Reference" on page 135). The marker result indicates the probability of appearance for the frequency/level pair.

Dedicated fixed reference markers are not supported in "Persistence Spectrum" displays. Use a normal marker and a delta marker instead.

For more information about markers, see [Chapter 9.8, "Marker usage"](#), on page 130.

For more information on how the histogram and persistence are evaluated see [Chapter 6.6, "Understanding persistence"](#), on page 61.

Remote command:

LAY:ADD? '1',RIGH,'XFrequency:PSpectrum', see [LAYout:ADD\[:WINDow\]?](#) on page 255

Results:

TRAC<n>:DATA? TRACEx, TRAC<n>:DATA? PSP, TRAC<n>:DATA? HMAX, see [TRACe<n>\[:DATA\]](#) on page 269

[TRACe<n>\[:DATA\]:X?](#) on page 270

[MMEMory:STORe<n>:PSpectrum](#) on page 272

### Power vs. Time

The Power vs. Time result display shows the power levels of a signal over a particular time period as a power vs. time diagram. The horizontal axis represents the (current sweep) time. The vertical axis shows the power levels. The sweep time for the PVT diagram is configurable, independently of the sweep time in the frequency domain.

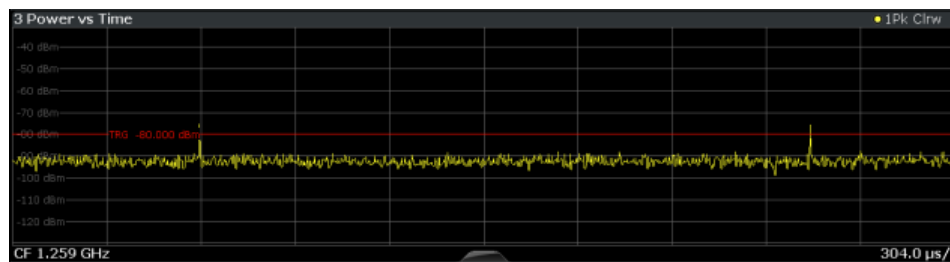

Figure 5-6: Power vs. Time result display

This result display is particularly useful in combination with a [Power vs Time Waterfall](#) display. Thus, you can determine irregular events in the waterfall, and analyze a specific frame in detail in the Power vs. Time display.

During a running measurement, the most recently captured frame is always displayed in the PVT diagram. During analysis, which frame is displayed depends on the selected frame in the waterfall configuration (see ["Selecting a frame to display"](#) on page 108) or on the marker position in the waterfall (see ["Frame"](#) on page 132). A separate frame number can be selected for measurements in the time domain, so that the displayed frame number may differ from the "Real-Time Spectrum" display.

The Power vs. Time result display is also useful in combination with a [Persistence Spectrum](#) display. Thus, you can determine time information for events which are detected in the persistence spectrum, for example pulses.

Remote command:

LAY:ADD? '1', RIGH, 'XTIME', see [LAYout:ADD\[:WINDow\]?](#) on page 255

Results:

TRAC<n>:DATA? TRACEx, see [TRACe<n>\[:DATA\]](#) on page 269

[TRACe<n>\[:DATA\]:X?](#) on page 270

[MMEMory:STORe<n>:TRACe](#) on page 274

### Power vs Time Waterfall

Similar to a spectrogram in the frequency domain, a waterfall diagram displays the measured power levels of the input signal over time for repeated measurements, thus showing the history of the measurement results.

PVT waterfalls are highly configurable. In particular, the number of frames and the colors used to display the power levels can be defined by the user. A separate sweep time is available for measurements in the time domain, so that the number of displayed "frames" may differ from the spectrogram display.

As the name "waterfall" implies, this diagram is filled from top to bottom; thus, the latest frame is always the topmost line, whereas older frames move towards the bottom.

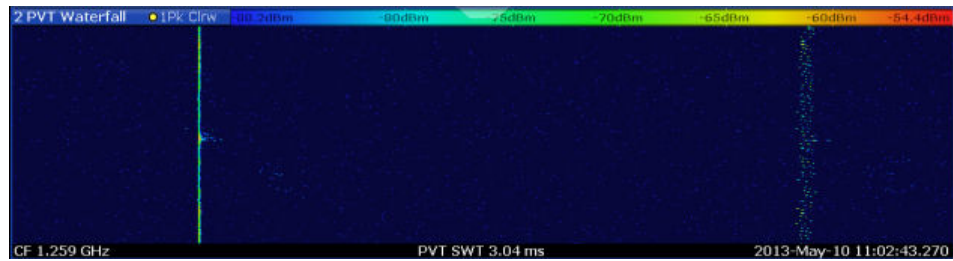

Figure 5-7: Power vs. Time Waterfall result display

To analyze a specific frame in the PVT waterfall in detail, use the [Power vs. Time](#) diagram.

Remote command:

LAY:ADD? '1',RIGH, 'XTIME:SGRam', see [LAYout:ADD\[:WINDOW\]?](#) on page 255

Results:

TRAC<n>:DATA? TRACE1; TRAC<n>:DATA? SPEC, see [TRACe<n>\[:DATA\]](#) on page 269

[TRACe<n>\[:DATA\]:X?](#) on page 270

### 3-D Power vs Time Waterfall

In the 3-dimensional PVT waterfall, the power is indicated by a value in a third dimension, the z-axis. The color mapping is maintained for the point in the 3-dimensional result display.

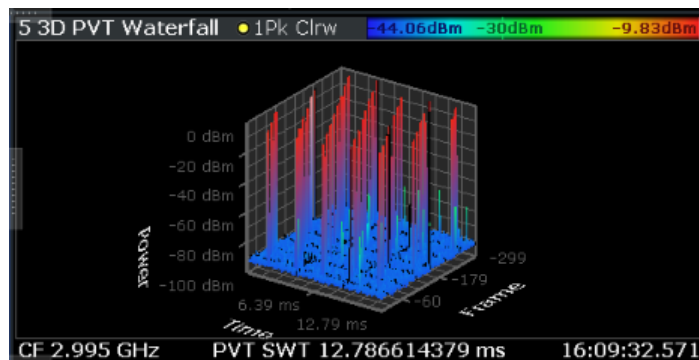

Figure 5-8: Three-dimensional PVT waterfall

Depending on which aspect of the PVT waterfall is currently of interest, you can rotate the display to have a closer look at the frame, the time, or the power dimension. Simply drag your finger or the mouse pointer over the PVT waterfall in the direction you want to rotate it. You can rotate the display left or right, up and down.

For more information on working with 3-dimensional PVT waterfall, see [Chapter 6.5.5, "Three-dimensional Spectrogram / PVT Waterfall"](#), on page 59.

Remote command:

LAY:ADD? '1',RIGH, 'XTIME:SGRam:3D', see [LAYout:ADD\[:WINDOW\]?](#) on page 255

Results:

TRAC<n>:DATA? TRACE1; TRAC<n>:DATA? SPEC, see [TRACe<n>\[:DATA\]](#)

on page 269

[TRACe<n>\[:DATA\]:X?](#) on page 270

### Marker Table

Displays a table with the current marker values for the active markers.

This table is displayed automatically if configured accordingly.

1 Marker Table							
Wnd	Type	Ref	Trc	X-Value	Y-Value	Function	Function Result
2	M1		1	2.1725 ms	-6.80 dBm		
2	D2	M1	1	13.859 ms	-0.00 dB		
2	D3	M1	1	4.6259 ms	-0.00 dB		
2	D4	M1	1	9.2331 ms	-0.00 dB		

**Tip:** To navigate within long marker tables, simply scroll through the entries with your finger on the touchscreen.

Remote command:

LAY:ADD? '1', RIGH, MTAB, see [LAYout:ADD\[:WINDow\]?](#) on page 255

Results:

[CALCulate<n>:MARKer<m>:X](#) on page 288

[CALCulate<n>:MARKer<m>:Y?](#) on page 289

## 6 Real-time basics

Some background knowledge on basic terms and principles used in Real-Time Spectrum measurements is provided here for a better understanding of the required configuration settings. For example, the mechanisms behind data capturing without blind times and triggering on frequency masks are described here.

- [Data acquisition and processing in real-time](#)..... 37
- [Defining the resolution bandwidth](#).....41
- [Sweep time and detector](#)..... 41
- [Triggering real-time measurements](#)..... 42
- [Working with Spectrogram / PVT Waterfall diagrams](#)..... 49
- [Understanding persistence](#)..... 61
- [Event-based actions](#).....66
- [Digital output](#)..... 67
- [Digital I/Q 40G streaming output](#).....68
- [Multi-standard real-time analysis](#)..... 68

### 6.1 Data acquisition and processing in real-time

This chapter shows the way the R&S FSW Real-Time Spectrum application acquires and processes the data compared to a conventional spectrum analyzer.



For more background information, see the Rohde & Schwarz White Paper "Implementation of "Real-Time Spectrum" Analysis" available at: <http://www.rohde-schwarz.com/appnote/1ef77>.

A conventional spectrum analyzer typically loses information after it has captured the signal ('blind time'). The blind time is because the LO has to return to the start frequency after a sweep of the selected frequency range (LO flyback). Blind time therefore occurs after the data capture and signal processing and before the next data capture can begin.

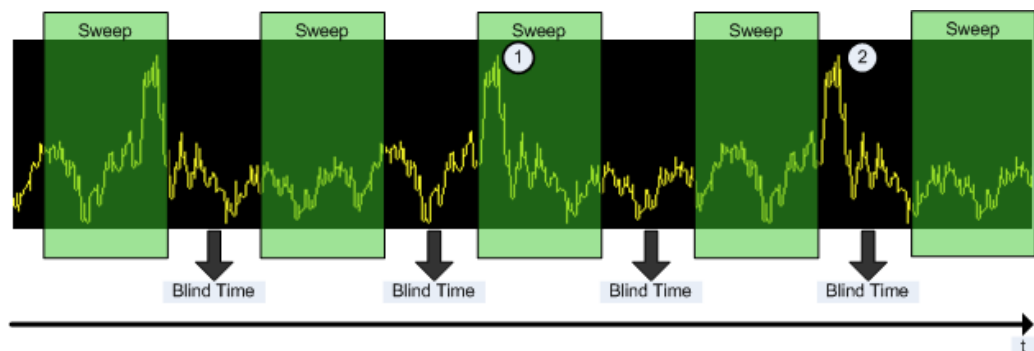

**Figure 6-1: Conventional spectrum analyzer measurement principle**

1 = Signals are captured by the sweep.

2 = Signal is missed by the sweep because of LO flyback (blind time; extended for clarity).

A real-time spectrum analyzer does not lose any information for the following reasons:

- There is no LO flyback because the LO is set to a fixed frequency in the real-time spectrum analyzer.
- It performs overlapping Fast Fourier transformations (FFT) instead of sweeping the spectrum or performing one FFT after another.
- The FSW captures data and performs FFTs at the same time instead of sequentially.

To get the results, the FSW simultaneously performs several processing stages:

- Acquiring the data
- Processing the data
- Displaying the data

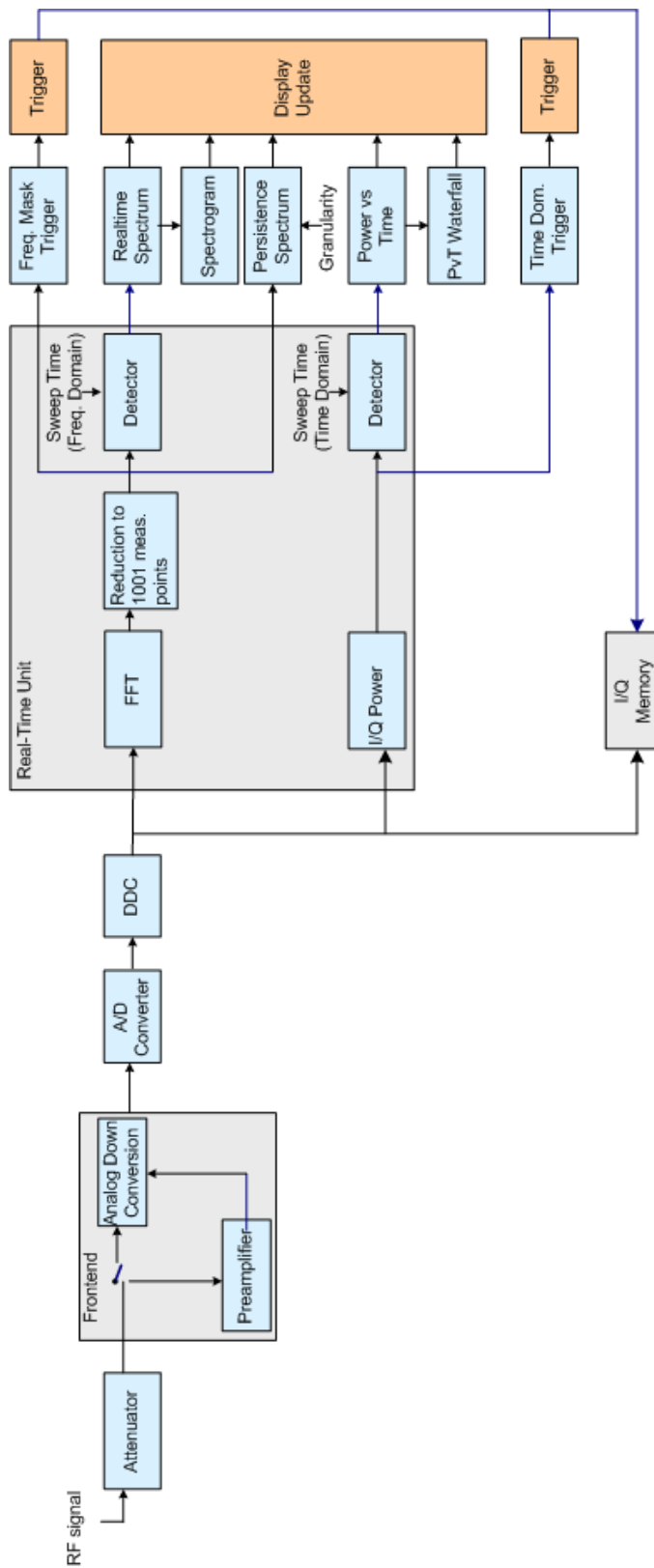

Figure 6-2: Block diagram of the FSW

### Acquiring the data

The data acquisition process is the same as in a conventional spectrum analyzer. First, the FSW attenuates the signal that you have applied to the RF input to get a signal level that the FSW can handle. If you have a weak signal, the FSW pre-amplifies the signal and then down-converts the RF signal to an intermediary frequency (IF), usually in several stages.

After the down-conversion, the FSW samples the signal into a digital data stream that is the basis for the Fast Fourier transformation (FFT). The sample rate the FSW uses for sampling is variable, but depends on the span you have set.

At the same time, the A/D data is down-converted and captured in the I/Q memory.



The memory extension option FSW-B106 is not available for real-time measurements.

### Processing the data

The FSW then splits the data stream stored in the I/Q memory into data blocks whose length is between 1024 and 32768 samples each to prepare it for the FFT.

Then the FSW performs the FFT on all data blocks it has acquired. The FFT processing rate of the FSW is variable with a maximum of approximately 1 million FFTs per second; for details see the Real-Time option's specifications document.

The distinctive feature of a real-time analyzer is that it uses a particular amount of data more than once to get the measurement results. It takes the first data block of 1024 samples, for example, and performs the FFT on it. The second and all subsequent data blocks, however, do not start at the next sample (for the second block, the 1025th), but at an earlier one. In fact, all data, except the first few samples, is processed more than once and overlapped to get the results.

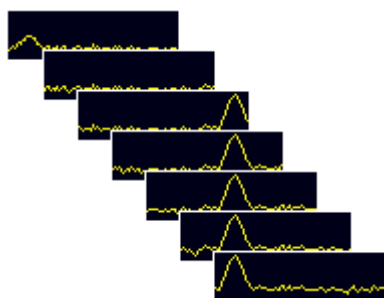

*Figure 6-3: Overlapping FFTs*

After the FFT is done and the spectra have been calculated, the result is a stream of spectra without information loss.



## 6.2 Defining the resolution bandwidth

The resolution bandwidth affects how the spectrum is measured and displayed. It determines the frequency resolution of the measured spectrum. A small resolution bandwidth has several advantages. The smaller the resolution bandwidth, the better you can observe signals whose frequencies are close together and the less noise is displayed. However, a small resolution bandwidth also increases the time required to ensure that *all* possible signal distortions are detected and the level is measured accurately. This requirement is also referred to as *100% probability of intercept (POI)*.

The resolution bandwidth parameters can be defined in the bandwidth configuration, see [Chapter 7.7, "Bandwidth and sweep settings"](#), on page 104.

## 6.3 Sweep time and detector

The [Sweep Time](#) parameter determines the amount of time used to sample data for one spectrum. One spectrum is defined by all FFTs calculated and combined from the sampled data in one sweep time period. In conventional spectrum analysis, the sweep time parameter describes the amount of time needed to sweep over the selected frequency span. As the effect is the same, i.e. it takes the sweep time to complete one spectrum, the real-time parameter is also called sweep time.



### Sweep Time vs. Dwell Time

The *sweep time* determines the amount of time used to sample data for one spectrum. The *dwell time* determines the amount of time to capture I/Q data for *multiple* spectra. This value is user-definable. It only affects measurements in single sweep mode or for Sequencer measurements in continuous mode. It is not considered for triggered measurements.

For details, see ["Sweep Time"](#) on page 106 and ["Dwell Time"](#) on page 106.

Combining several FFTs into one spectrum during the selected sweep time offers several possibilities of weighting the FFT results: determining the maximum level is an obvious one. Other possibilities of combining several FFTs are selecting the minimum for each frequency point, determining the average result, or selecting an arbitrary FFT result to represent the entire sweep time. The FFTs are combined by detectors.

A detector is available for each of the mentioned methods:

- "Positive Peak"
- "Negative Peak"
- "Average"
- "Sample"

"Positive Peak" is the default selection to make sure that even the shortest events can be analyzed.

Thus, the detector and sweep time parameters describe the data reduction from multiple FFTs to a single spectrum. A detector is not required for the "Persistence Spectro-

gram" display, which evaluates the individual FFTs (see [Chapter 6.6, "Understanding persistence"](#), on page 61).

## 6.4 Triggering real-time measurements

Real-time measurements pose some specific challenges to triggering, which require special trigger functions and options.

- [Triggering on specific frequency events \(frequency mask trigger\)](#).....42
- [Using pretrigger and posttrigger settings](#)..... 46
- [Trigger modes](#)..... 47

### 6.4.1 Triggering on specific frequency events (frequency mask trigger)

One way to analyze rare events in a given frequency range is to capture real-time data over a very long time. This method requires large amounts of fast memory. As a consequence, post-processing the bulk of stored data to find the event can be extremely time consuming.

Another way is to trigger on the event in the frequency spectrum and to acquire exactly the data of interest. This method reduces the necessary memory size dramatically, and in addition keeps the time to spot the event of interest in the acquired memory low. The question is: how can the analyzer trigger on events which show up in a certain frequency range only now and then?

#### Detecting rare events

The answer is the *Frequency Mask Trigger*. Speaking graphically, the frequency mask trigger is a mask in the frequency domain, which is checked with every calculated FFT. Thus, a 100% probability of intercept with full level accuracy even on short pulses is possible.

The minimum detectable pulse length is specified in the specifications document.

#### Mask definition

The frequency mask is configured by a list of individual trace points, defined as frequency (position) / level (value) pairs, which are connected to form a mask area. The individual mask points can also be defined simply by dragging the points to the required position on the touchscreen. The frequency mask can consist of up to 1001 points and can have an arbitrary shape.

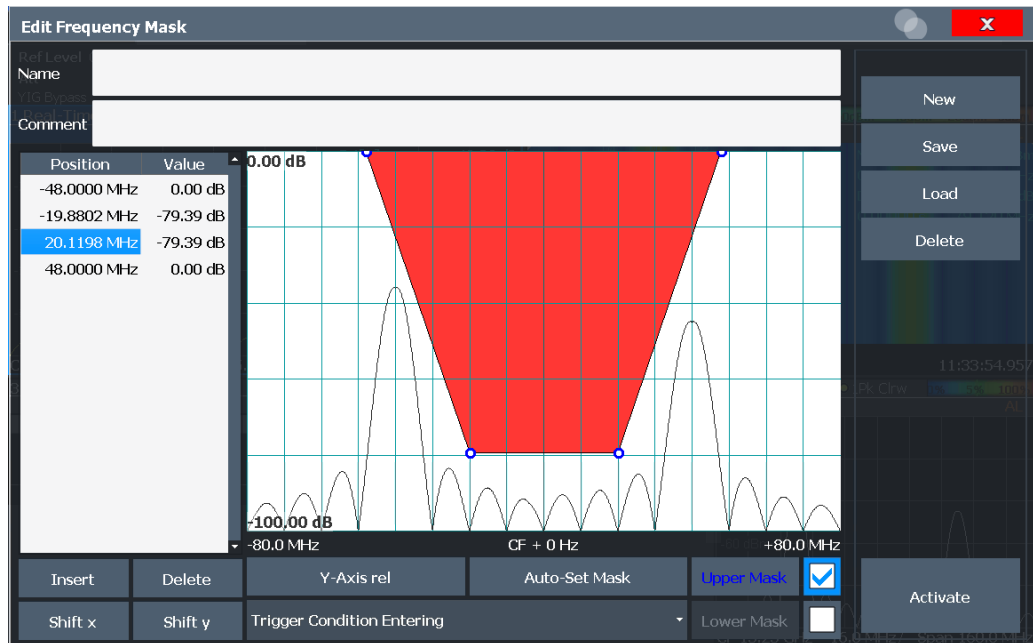

Figure 6-4: Frequency mask defined manually

Alternatively, a mask can be defined automatically according to the currently measured data. In this case, the mask is configured to follow the measurement trace with a specific distance to the power levels.

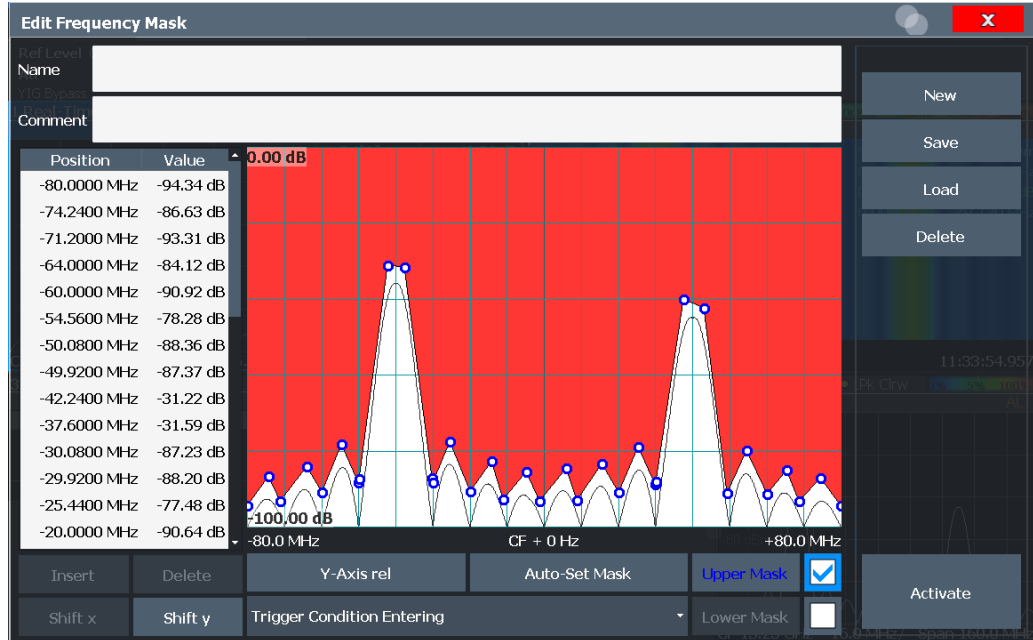

Figure 6-5: Frequency mask defined automatically according to measured data

### Upper and lower masks

By default, the configured mask is an upper mask, i.e. the mask is the area *above* the configured mask points. In addition or alternatively, a mask can be defined as a lower mask. In this case, the mask is the area *below* the configured mask points. Lower masks are useful, for example, to determine if the measured signal leaves a defined "corridor" of allowed values.

The lower limit mask is configured in the same manner as the upper limit mask. However, it cannot be configured automatically according to the currently measured values.

### Trigger conditions

The frequency mask can be evaluated in different ways to control data acquisition, depending on whether the mask area represents the relevant or irrelevant value range.

**"Entering"**: mask area represents the relevant value range

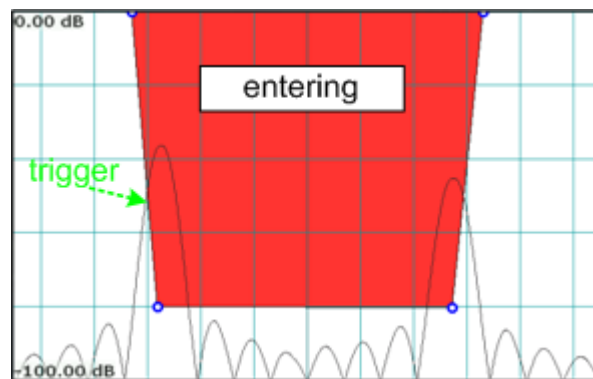

Figure 6-6: Trigger condition "entering": Data acquisition starts when the signal enters the mask area and continues until the measurement is stopped or completed.

**"Leaving"**: mask area represents the irrelevant value range

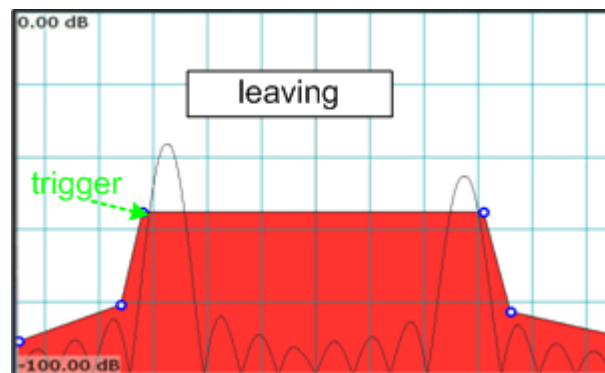

Figure 6-7: Trigger condition "leaving": Data acquisition starts when the signal leaves the mask area and continues until the measurement is stopped or completed.



The selected trigger condition applies to any active limits; that means the calculated FFTs are compared to the upper or lower, or both the upper and lower limits, if activated.

### Availability

The frequency mask trigger can be selected as a trigger source for all measurements in the R&S FSW Real-Time Spectrum application. As it is evaluated in parallel to the selected result displays, there is no influence on the real-time capabilities of the FSW.

A detailed description of how to define a frequency mask trigger is provided in [Chapter 11.5, "How to work with frequency mask triggers"](#), on page 171.

### Storing and loading frequency masks

As frequency masks can have a very complex structure, they can be stored for later use with other signals. The masks are stored in a file with the extension `.FMT` in the `C:\Program Files (x86)\Rohde-Schwarz\FSW\<version>\freqmask` directory. By default, the mask name is used as the file name.

### Trigger output

The frequency mask trigger is a trigger source which exceeds the capabilities of standard spectrum analyzers. To allow other instruments in a test system to make use of it, FSW provides a special connector ("Trigger Out 2 / 3"). This trigger pulse can be provided to a system setup as an external trigger source.

For details, see [Chapter 11.6, "How to output a trigger signal"](#), on page 174.

To output trigger pulses continuously, a special trigger mode is provided. See ["Mark only mode"](#) on page 49 and [Chapter 11.7, "How to output trigger signals continuously"](#), on page 174.

#### 6.4.1.1 Technical process

Basically the frequency mask trigger is an extended limit line check: the frequency mask is compared to every FFT spectrum calculated by the real-time hardware.

The FSW performs this mask check up to 600,000 times per second according to the FFT update rate. To ensure a real-time trigger, i.e. a given reaction time, the frequency mask trigger is evaluated by the real-time hardware.

[Element-wise comparison of frequency mask with current FFT result](#) shows the element-wise comparison of a real-time FFT with a frequency mask. The FFT-result is subtracted from the frequency mask value. If one result is negative, the FSW triggers.

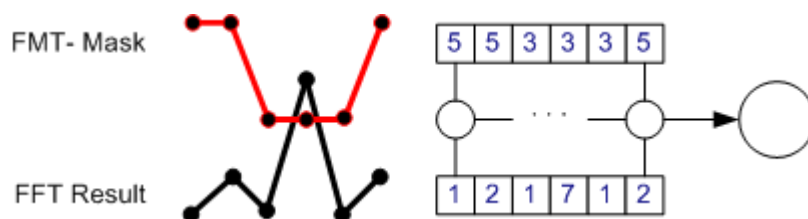

Figure 6-8: Element-wise comparison of frequency mask with current FFT result

Extended limit check means that the frequency mask trigger can link a complex condition to the limit line violation, such as entering or leaving the mask.

As already mentioned, the frequency mask can contain up to 1001 points, but can also be as short as 2 points. Shorter frequency mask trigger definitions are extended to 1001 points by interpolation within the firmware. The frequency mask trigger therefore always compares 1001 FFT points to 1001 frequency mask definition points. If the mask is violated at a single point, the frequency mask triggers.

To get a reliable frequency mask trigger with very short events, it is preferable to set the mask limit levels lower than the expected spectral power levels.

## 6.4.2 Using pretrigger and posttrigger settings

As described in [Chapter 6.3, "Sweep time and detector"](#), on page 41, the amount of time required to sample data for one spectrum (or one frame/line in a spectrogram) corresponds to the defined sweep time. If a trigger is used for the measurement, the displayed spectrum starts with the trigger event. However, you can define a pretrigger and posttrigger period in which data is also captured, in addition to the actual sweep time. (As the posttrigger time starts with the trigger event, it only has an effect if it is longer than the sweep time.) Pretrigger data allows you to analyze the data shortly before the actual trigger event or after the regular sweep period.

The data from this "extended" sweep time (pretrigger+posttrigger) is displayed in the real-time Spectrogram / PVT Waterfall.

By default, the frame displayed in the Real-Time Spectrum / PVT results is the frame that begins with the trigger event. If a pretrigger time is defined, one or more additional frames are available in the spectrogram/waterfall beneath the frame currently displayed in the Real-Time Spectrum / PVT diagram window, respectively. If a posttrigger time is defined, one or more additional frames are available in the Spectrogram / PVT Waterfall above the frame currently displayed in the Real-Time Spectrum / PVT diagram window, respectively.

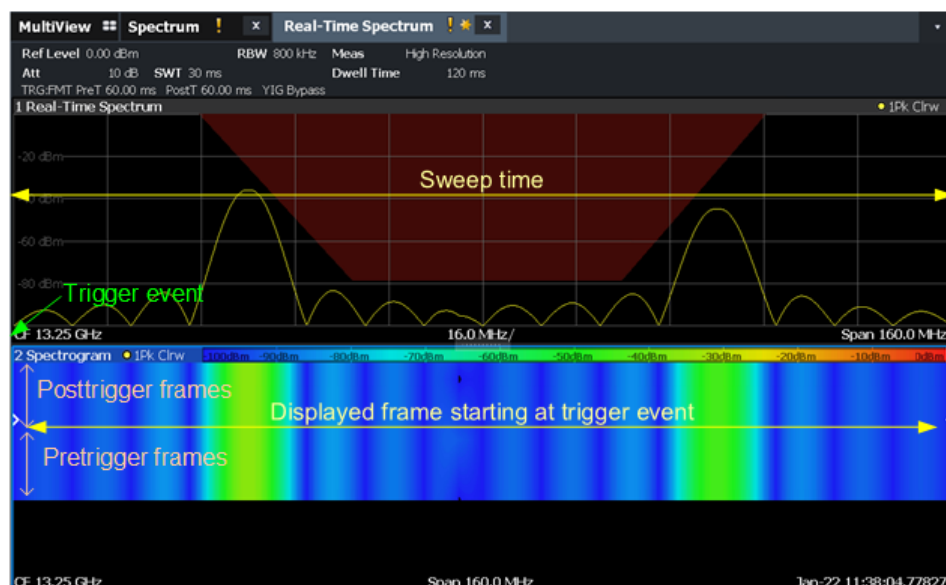

Figure 6-9: Pretrigger, currently displayed, and posttrigger frames

### 6.4.3 Trigger modes

By default, a trigger event causes the FSW to start a measurement and to re-arm the trigger ("Auto Rearm") immediately. In Run continuous mode, measurements are continuously triggered and results can become obsolete with the next measurement.

However, possibly you are interested in the results after the first trigger event only. For this case, a "Stop on Trigger" option is provided. If active, the trigger is not re-armed after the first trigger event has occurred; thus, data acquisition stops after one measurement. The results for that measurement remain on the display, including the pre-trigger and posttrigger periods.

#### Auto Rearm

When a triggered measurement starts in "Auto Rearm" mode, data is acquired. Once a trigger occurs, data acquisition continues for the posttrigger period. Then postprocessing takes place, in which the traces are calculated and displayed. Only then, the next measurement starts and data acquisition continues. The data from the pretrigger and posttrigger periods is processed to display the frequency and time domain results. In the spectrogram, the blind time due to postprocessing is indicated by black lines. Multiple frames are displayed for the measurement.

For the "PVT Waterfall" diagram, a single frame is displayed for the measurement, starting at (trigger time - trigger offset), and with a length specified by the PVT sweep time. For the next measurement, another frame is displayed, again starting at (trigger time - trigger offset). Thus, in the "PVT waterfall", all trigger events are neatly aligned one beneath the other.

For example, for a time domain trigger, the rising edges all start at the same time. The measurement ends after the specified sweep time is over ("Run single"), or when you stop the continuous measurement. [Figure 6-10](#) shows the time domain results ("Power vs. Time" and "PVT Waterfall") for a triggered measurement in "Auto Rearm" trigger mode with trigger offset ( $\Delta T$ ) = -5 ms. All trigger events in the "PVT Waterfall" are neatly aligned.

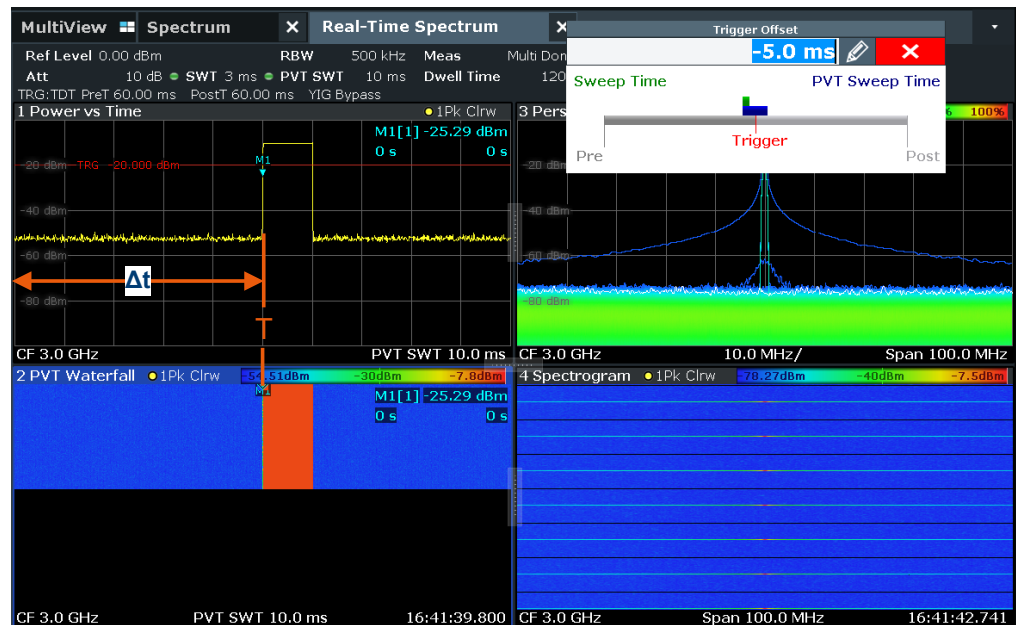

Figure 6-10: Triggered measurement in Auto Rearm trigger mode with a negative trigger offset

### Stop on trigger

When a triggered measurement starts in "Stop on trigger" mode, data is acquired. If a trigger occurs during the pretrigger period, it is ignored. After the pretrigger period, once a trigger occurs, data acquisition continues for the posttrigger period. Then the measurement stops, both for "Run single" and continuous measurement mode. The acquired data is displayed in the frequency and time domain results without further postprocessing. The trigger event can appear anywhere in the PVT frame, depending on the time it occurred within the measurement. If you perform several successive measurements, the triggers in the "PVT waterfall" are not neatly aligned, as they occur at different times within the individual measurements and are not postprocessed.

Figure 6-11 shows the time domain results for multiple triggered measurements in "Stop on trigger" mode with trigger offset = 0. The pulses start at different times, since the location of the trigger event within the Power vs. Time measurement is not known when the measurement starts.





Figure 6-11: Triggered measurements in Stop on trigger mode

### Mark only mode

For FSW-B512R/-B800R only, a third trigger mode is available: "Mark only". In this case, a free-run measurement is performed. The trigger event is merely indicated in the measurement results, but does not change the behavior of the measurement.

If "Mark only" trigger mode is active, a trigger pulse can be provided to a system setup as an external trigger source. In this case, each time a trigger event occurs, a high-level signal is output to the "Trigger 2" or "Trigger 3" output connector for 100  $\mu$ s. Using this trigger mode, all detected trigger events are output; there is no blind time.

For details, see [Chapter 11.7, "How to output trigger signals continuously"](#), on page 174.

## 6.5 Working with Spectrogram / PVT Waterfall diagrams

In Real-Time measurements, data is captured seamlessly over a specified time. The most recently measured power levels vs. frequency can then be displayed in the "Real-Time Spectrum". In these displays, the results from previous measurements are not included.

However, since the R&S FSW Real-Time Spectrum application stores the history of the measured data in its memory, the spectrogram display provides a record of the measured spectrum without gaps. You can then analyze the data in detail later by recalling one of the spectra in the spectrogram history.

The "PVT waterfall" is basically the same as a spectrogram, but in the time domain. In this diagram, a history of the power vs. time levels measured over time is displayed. A particular PVT diagram can then be selected and displayed for detailed analysis.

### 6.5.1 Time frames

The time information in the Spectrogram / PVT Waterfall is displayed vertically, along the y-axis. Each line (or trace) of the y-axis represents the data during one sweep time interval and is called a **time frame** or simply "frame". For spectrograms, as with standard spectrum traces, several measured values are combined in one sweep point using the selected detector (see [Chapter 6.3, "Sweep time and detector"](#), on page 41).

Frames are sorted in chronological order, beginning with the most recently recorded frame at the top of the diagram (frame number 0). With the next sweep, the previous frame is moved further down in the diagram, until the maximum number of captured frames is reached. The display is updated continuously during the measurement, and the measured trace data is stored. Spectrogram / PVT Waterfall displays are continued even after single sweep measurements unless they are cleared manually.



#### Clearing the Spectrogram / PVT Waterfall

To clear the history buffer and start a new Spectrogram / PVT Waterfall, you must clear it explicitly (see [Chapter 9.3, "Spectrogram and PVT waterfall settings"](#), on page 119).

The maximum number of stored frames is defined by the *history depth*, which is user-configurable (see ["History Depth"](#) on page 120).

#### Displaying individual frames

In [Chapter 6.3, "Sweep time and detector"](#), on page 41, the term "frame" was introduced as *one spectrum containing all FFTs calculated and combined from the sampled data in one sweep time period*. Thus, one frame/line in the spectrogram corresponds to one spectrum in the "Real-Time Spectrum" view.

Similarly, one frame/line in the "PVT Waterfall" corresponds to one power vs. time diagram for the PVT sweep time period.

The Spectrogram / PVT Waterfall diagram includes all stored frames since it was last cleared. Arrows on the left and right border of the Spectrogram / PVT Waterfall indicate the currently selected frame.

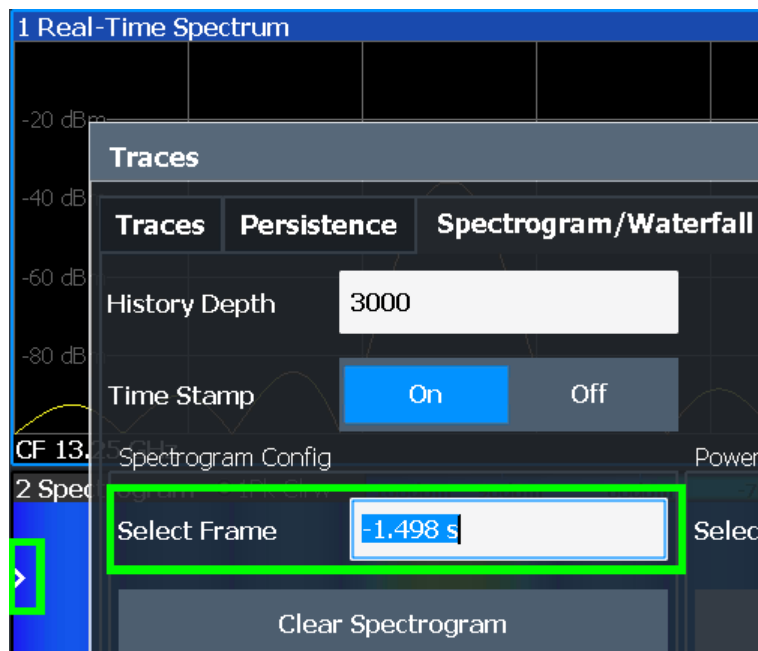

Figure 6-12: Display of a selected frame in the spectrogram

The Real-Time Spectrum / PVT diagram always displays the Real-Time Spectrum / PVT for the currently selected frame. The current frame number (or alternatively a time stamp, if activated) is indicated in the diagram footer of the Spectrogram / PVT Waterfall. The most recent frame, displayed at the top of the diagram, is frame number 0. Older frames further down in the diagram are indicated by a negative index, e.g. "-10". You can display the Real-Time Spectrum / PVT diagram of a previous frame by selecting a different frame number.



Separate frame numbers can be selected for the Real-Time Spectrum / PVT diagrams. The displayed frame can also change if a marker is set to a different frame in the Spectrogram / PVT Waterfall result display (see [Chapter 6.5.2, "Markers in the spectrogram"](#), on page 53).



#### Displaying pretrigger and posttrigger results

By default, the frame displayed in the Real-Time Spectrum / PVT results is the frame that begins with the trigger event. To display *pretrigger* results, if available, select a frame in the Spectrogram / PVT Waterfall *beneath* the currently selected frame. To display *posttrigger* results (after the sweep time), if available, select a frame in the Spectrogram / PVT Waterfall *above* the currently selected frame.



### Scrolling through frames of a spectrogram

The Real-Time Spectrum / PVT diagram always displays a single frame of the Spectrogram / PVT Waterfall, namely the currently selected frame. To scroll through the frames of the Spectrogram / PVT Waterfall as they were recorded, use the rotary knob or arrow keys to change the selected frame continuously. The index or time stamp is increased or decreased in steps of one frame.

### Time stamps vs. frame index

By default, the time information of the selected frame is provided as a time stamp in the footer of the Spectrogram / PVT Waterfall. The time stamp shows the time and date that the selected frame was recorded. The length of one frame corresponds to the sweep time. To select a specific frame, you have to enter the (negative) time in seconds, relative to the frame that was recorded last. The largest (absolute) time available is the sweep time multiplied with the number of sweeps performed since the diagram was last cleared.

Alternatively to time stamps, the time information can be provided as an index. The index is also relative to the frame that was recorded last, which has the index number 0. The lowest index is a negative number that corresponds to the history depth. To select a specific frame, you have to enter the (negative) index number of the frame you want to analyze.

### Frame count vs. sweep count

The maximum number of stored frames depends on the ["History Depth"](#) on page 120.

For standard spectrum sweeps, the sweep count defines how many sweeps are analyzed to create a single trace. Thus, for a trace in "Average" mode, for example, a sweep count of 10 means that 10 sweeps are averaged to create a single trace, or frame.

The frame count, on the other hand, determines how many frames are plotted during a single sweep measurement (as opposed to a continuous sweep). For a frame count of 2, for example, 2 frames are plotted during each single sweep. For continuous sweep mode, the frame count is irrelevant; one frame is plotted per sweep until the measurement is stopped.

If you combine the two settings, 20 sweeps are performed for each single sweep measurement. The first 10 are averaged to create the first frame, the next 10 are averaged to create the second frame.

As you can see, increasing the sweep count increases the accuracy of the individual traces, while increasing the frame count increases the number of traces in the diagram.

Especially for "Average" or "Min hold" and "Max hold" trace modes, the number of sweeps that are analyzed to create a single trace affects the accuracy of the results. Thus, you can also define whether the results from frames in previous traces are considered in the analysis for each new trace ("Continue frame").

## 6.5.2 Markers in the spectrogram

Markers and delta markers are shaped like diamonds in the spectrogram. They are only displayed in the spectrogram if the marker position is inside the visible area of the spectrogram. If more than two markers are active, the marker values are displayed in a separate marker table.

In the spectrum result display, the markers and their frequency and level values (1) are displayed as usual. Also, the frame number is displayed to indicate the position of the marker in time (2).

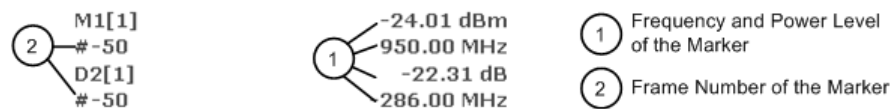

In the spectrogram result display, you can activate up to 16 markers or delta markers at the same time. Each marker can be assigned to a different frame. Therefore, in addition to the frequency you also define the frame number when activating a new marker. The frame to which a marker is assigned automatically becomes the currently selected frame. If no frame number is specified, the marker is positioned on the currently selected frame. (The selected frame is indicated by small white arrows on the left and right border of the diagram.)

All markers are visible that are positioned on a visible frame. Special search functions are provided for spectrogram markers (see [Chapter 9.8.3, "Marker search settings"](#), on page 136) to include the frame information as search criteria.

In the spectrum result display, only the markers positioned on the currently selected frame are visible. Thus, in "Continuous Sweep" mode, only markers positioned on frame 0 are visible. To view markers that are positioned on a frame other than frame 0 in the spectrum result display, you must stop the measurement and select the corresponding frame.

## 6.5.3 Color maps

Spectrogram / PVT Waterfall displays assign power levels to different colors to visualize them. The legend above the Spectrogram / PVT Waterfall display describes the power levels the colors represent. Similarly, "Persistence Spectrum" displays assign colors to the relative numbers of occurrence (percentage) of specific power levels.

The color display is highly configurable to adapt the spectrograms to your needs. You can define:

- Which colors to use (Color scheme)
- Which value range to apply the color scheme to
- How the colors are distributed within the value range, i.e. where the focus of the visualization lies (shape of the color curve)

The individual colors are assigned to the power levels automatically by the FSW.

### The Color Scheme

- **Hot**



Uses a color range from blue to red. Blue colors indicate low levels, red colors indicate high ones.

- **Cold**



Uses a color range from red to blue. Red colors indicate low levels, blue colors indicate high ones.

The "Cold" color scheme is the inverse "Hot" color scheme.

- **Radar**



Uses a color range from black over green to light turquoise with shades of green in between. Dark colors indicate low levels, light colors indicate high ones.

- **Grayscale**



Shows the results in shades of gray. Dark gray indicates low levels, light gray indicates high ones.

### The value range of the color map

If the measured values only cover a small area in the spectrogram, you can optimize the displayed value range. Then it becomes easier to distinguish between values that are close together. Display only parts of interest.

### The shape and focus of the color curve

The color-mapping function assigns a specified color to a specified power level in the spectrogram display. By default, colors on the color map are distributed evenly. However, to visualize a certain area of the value range in greater detail than the rest, you can set the focus of the color mapping to that area. Changing the focus is performed by changing the shape of the color curve.

The color curve is a tool to shift the focus of the color distribution on the color map. By default, the color curve is linear. If you shift the curve to the left or right, the distribution becomes non-linear. The slope of the color curve increases or decreases. One end of the color palette then covers a large range of results, while the other end distributes several colors over a relatively small result range.

You can use this feature to put the focus on a particular region in the diagram and to be able to detect small variations of the signal.

**Example:**

In the color map based on the linear color curve, the range from -100 dBm to -60 dBm is covered by blue and a few shades of green only. The range from -60 dBm to -20 dBm is covered by red, yellow and a few shades of green.

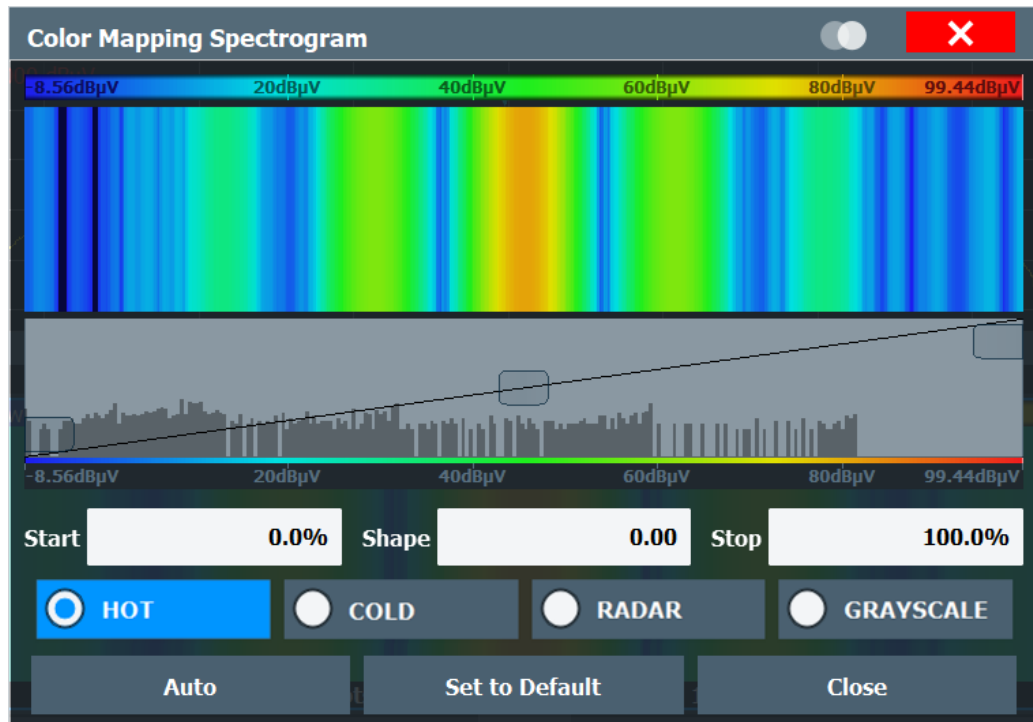

Figure 6-13: Spectrogram with (default) linear color curve shape = 0

The sample spectrogram is dominated by blue and green colors. After shifting the color curve to the left (negative value), more colors cover the range from -100 dBm to -60 dBm (blue, green and yellow). This range occurs more often in the example. The range from -60 dBm to -20 dBm, on the other hand, is dominated by various shades of red only.

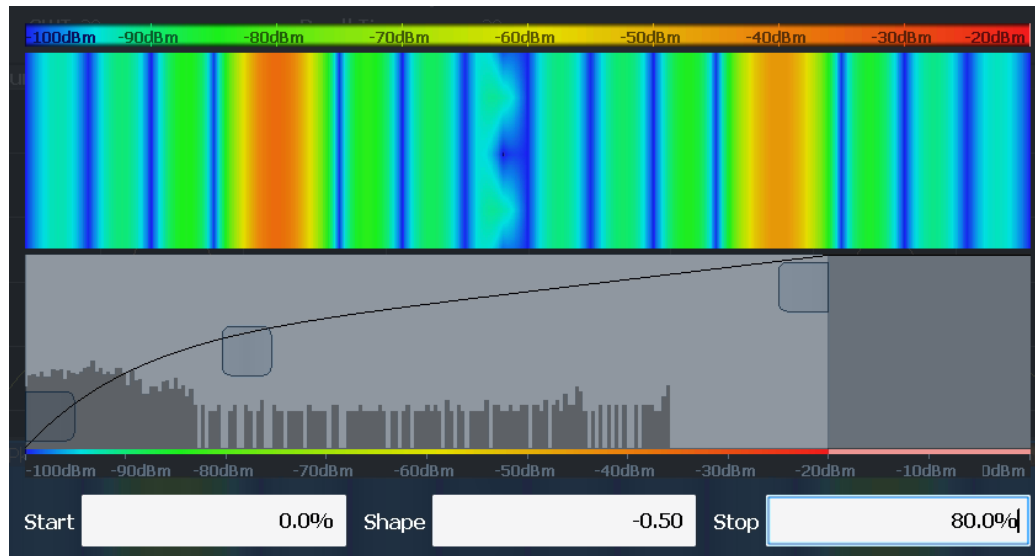

Figure 6-14: Spectrogram with non-linear color curve (shape = -0.5)

#### 6.5.4 Zooming into the spectrogram

For further and more detailed analysis of the data you have captured, a zoom function is provided for real-time spectrogram diagrams.



The graphical zoom provided for other measurements on the FSW is **not available** for Real-Time Spectrum measurements.

Instead, a more powerful data zoom is provided, which allows for zooming with increased frequency resolution.

For Real-Time Spectrum measurements, the zoom is available only for the spectrogram result display, but it has effects on other result displays (see "[Effects on other result displays](#)" on page 58). The zoom is only available if a spectrogram is active and selected (blue border).

The zoom is activated using the Single Zoom (🔍) icon in the toolbar. You define the zoom area by drawing a rectangle on the touchscreen. When you draw the zoom area, its boundaries are shown as a dashed line. The FSW stops the Real-Time Spectrum measurement and recalculates the displays for the area you have selected. The definition of the color map remains the same.

When a zoom is activated in the spectrogram, the sweep time and/or resolution bandwidth and span are temporarily reduced. The selected data that was measured previously and stored in the FSW memory is reprocessed and re-evaluated. Reprocessing improves the resolution of the data (while the graphical zoom available in other applications merely interpolates the data).



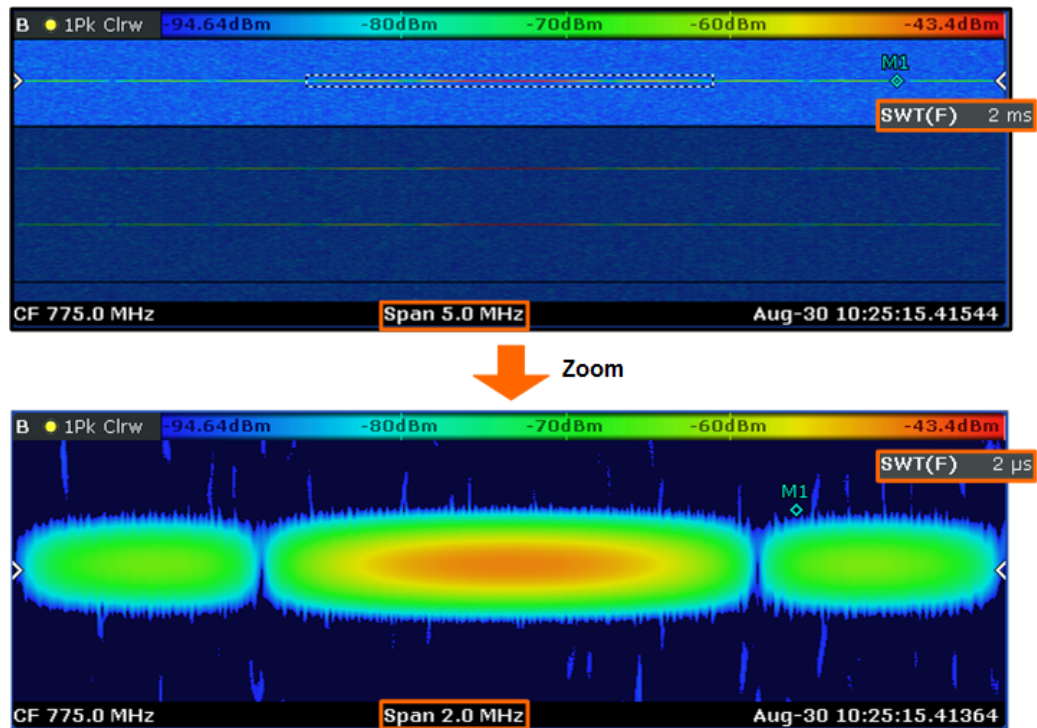

Figure 6-15: Zoomed spectrogram display with increased frequency and time resolution (due to reduced sweep time and span)

Because the zoom is based on I/Q data that has already been captured, the zoom also allows for faster sweep times (and thus spans) than are possible during live measurements.

Inside the zoom area, you can select frames as usual. The "Replay zoom" function allows you to switch between the zoomed display and the original display quickly for comparison (see "Replay Zoom" on page 159).

### Zoom restrictions

Principally, the zoom is available for all measurement situations, whether you measure continuously or in single sweep mode. However, possible zoom areas are restricted by the size of the I/Q data memory. If it is not possible to zoom into a part of the spectrogram area, the FSW colors that area in a darker color when you activate the zoom function.

The zoom factor is restricted to 10% of the original span of the frequency axis.



In addition, the zoom is also restricted by the originally defined bandwidth or span. Zooming into areas that are outside this bandwidth is not possible.

Note also that zoom availability depends on the trigger mode. You can only zoom while the measurement is running in "Free Run" mode. For all other trigger modes, you have to wait until the measurement is paused.

#### Effects on other result displays

Zooming also has an effect on the real-time spectrum and the power vs. time result displays. All other result displays are unaffected.

- The FSW updates the frequency range of the real-time spectrum according to the zoomed (new) spectrogram span. The range has an effect on the start, stop and center frequency as well as the span.  
The "Real-Time Spectrum" updates the shown spectrum to the currently selected spectrogram frame.
- The FSW updates the time range of the power vs. time result display according to the new height (sweep time) of the spectrogram.  
Note that it is not possible to change the sweep time or the trigger offset for the power vs. time diagram while the zoom is active.

Updates in the result displays only take effect if they are active when the spectrogram data is being recalculated.

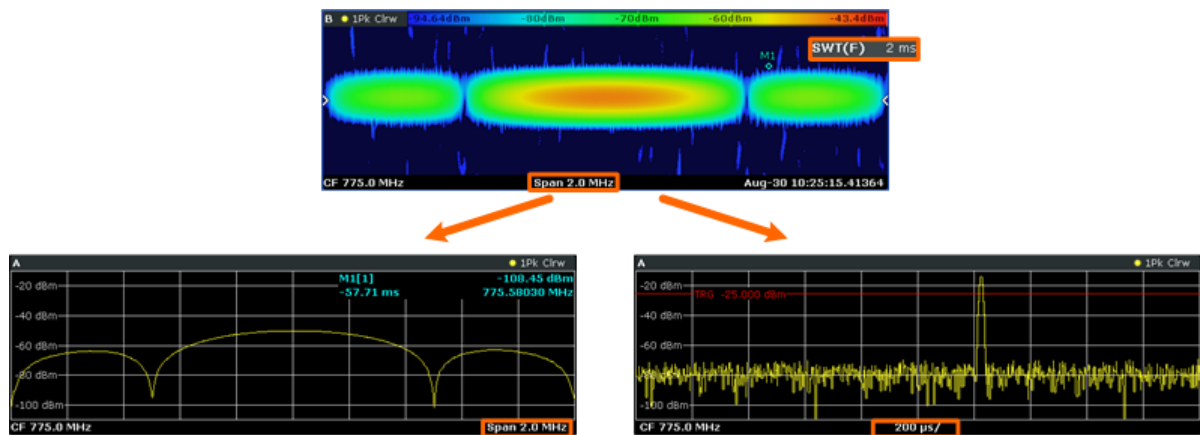

Figure 6-16: Effects of the Spectrogram zoom function on the Real-Time Spectrum / PVT displays

### 6.5.5 Three-dimensional Spectrogram / PVT Waterfall

A common spectrogram shows the frequency on the x-axis, while the y-axis shows the time (in frames). The power level is indicated by different colors of the two-dimensional points.

In the new three-dimensional spectrogram, the power is indicated by a value in a third dimension, the z-axis. The color mapping is maintained for the point in the three-dimensional result display.

This new display provides an even better overview of how the strength of the signal varies over time for different frequencies.

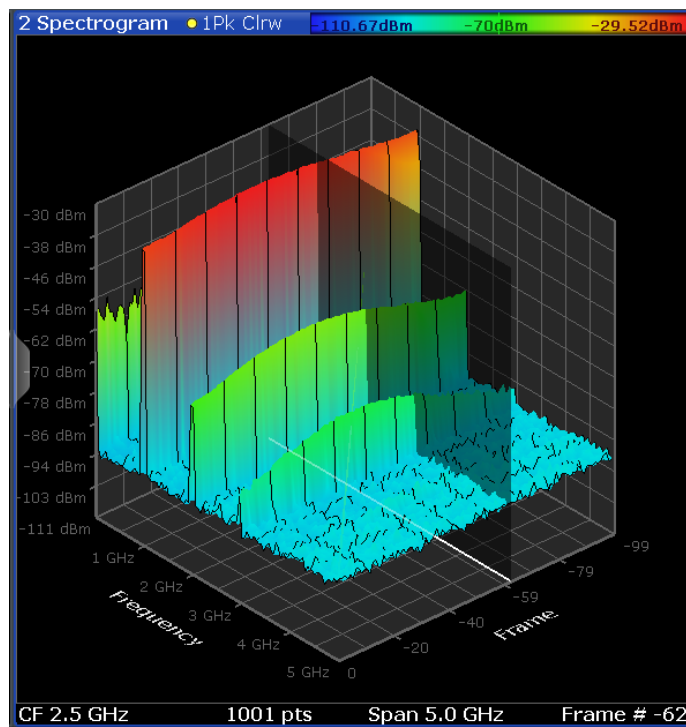

**Figure 6-17: Three-dimensional spectrogram**

Similarly, a three-dimensional power vs time waterfall diagram is available.

The number of frames displayed on the time (y-)axis is user-definable, whereas for two-dimensional Spectrogram / PVT Waterfall, the number of frames is determined automatically according to the size of the window. All other Spectrogram / PVT Waterfall settings are identical for 3D and 2D Spectrogram / PVT Waterfall.

When the measurement is stopped or completed, the currently selected frame is indicated by a gray vertical plane. (As opposed to the small white arrows at the borders of the 2D display.) The spectrum diagram always displays the spectrum for the currently selected frame.

By default, the most recently recorded frame (frame 0) is selected, and added at the front of the diagram.

### Rotating the Spectrogram / PVT Waterfall in three dimensions

Depending on which aspect of the Spectrogram / PVT Waterfall is currently of interest, you can rotate the display to have a closer look at the frequency, the time, or the power dimension. Simply drag your finger or the mouse pointer over the spectrogram in the direction you want to rotate it. You can rotate the display left or right, up and down. Note, however, that the degree of rotation is restricted in the upward direction to avoid confusing views. If you rotate the spectrogram such that you see the frequency-frame-plane directly from above, the display is identical to the two-dimensional spectrogram.

**Table 6-1: Effect of rotating the spectrogram in three dimensions**

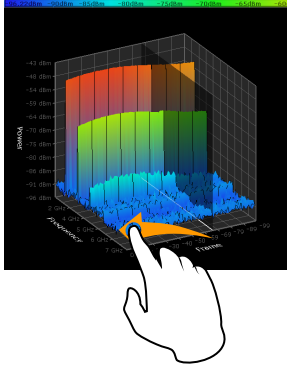
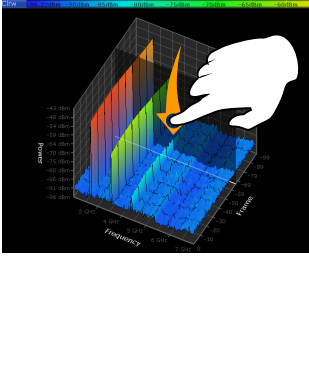
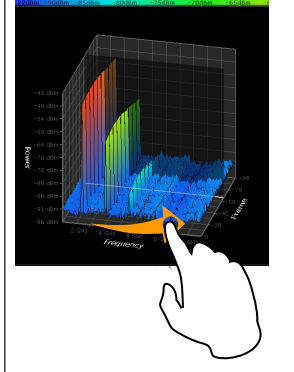
		
Rotation to the left > focus on frame	Rotation down > focus on frequency and frame	Rotation to the right > focus on frequency

### Markers in three-dimensional Spectrogram / PVT Waterfall

In three-dimensional Spectrogram / PVT Waterfall, the markers are indicated by the common arrows used in the spectrum display, for example. New markers are automatically placed on the current frame. You can move the markers to any position in all dimensions of the diagram. When you select a marker on the screen, three-dimensional cross-hairs indicate the position on all axes.

Sometimes, a marker can be hidden by other frames. If necessary, rotate the Spectrogram / PVT Waterfall or select a different frame as the current frame.

## 6.6 Understanding persistence

Persistence describes the duration that past histogram traces remain visible in the display before fading away.

### Historical term

The term persistence has its origins in cathode ray tube devices (CRTs). It describes the time period one point on the display stays illuminated after it has been lit by the cathode ray. The higher the persistence, the longer you could observe the illuminated point on the display.

### Moving density

In the "Persistence Spectrum" result display, the persistence results from the moving 'density' (like a moving average) over a certain number of traces. The number of traces that are considered to calculate the density depends on the user-definable persistence duration. The longer the persistence, the more traces are part of the calculation and the deeper the history of displayed information gets. A spectral event that has occurred a single time is visible for up to 8 seconds. As densities get smaller at coordinates with signal parts that are not constantly there, the trace color changes. The rate of the color change is high with a low persistence and low with a high persistence.

**Detecting changes over time**

Note that a signal with constant frequency and level characteristics does not show the effects of persistence on the trace. As soon as the power or frequency of a signal change slightly, however, the effect of persistence becomes visible through color changes or changes in the shape of the trace.

You can remove persistence by setting its duration to 0 seconds.

**Persistence Granularity**

The amount of data that the FSW uses to draw a single frame in the persistence spectrum is variable. By default, the data that was captured in 100 ms is used to calculate a frame. The time period in which data is captured and the mentioned density is calculated is referred to as the *persistence granularity*. The higher the granulation, i.e. the longer the data capturing time, the more data is included in each calculation.

A single histogram frame is calculated during the persistence granularity time. An initially empty matrix with 600 by 1001 elements, representing 600 discrete power levels and 1001 discrete frequency steps, is provided at the beginning of each histogram frame. After each newly calculated FFT, the matrix is updated according to the occurrence of each frequency/level pair. Every time the persistence granularity interval is completed, the matrix is reset to zero for each element and a new histogram frame is started.

**Example: Calculating an individual persistence frame**

Figure 6-18 demonstrates this process with a 6 by 8 elements matrix and a ratio of 2 for FFT time to granularity. Thus, two FFTs are calculated for each frame. Both FFTs contain the same signal and varying noise neighboring the signal. The FFTs are converted into a matrix of frequency/level pairs. The two matrices are summed up into the result matrix. The result matrix determines the color of the result trace in the histogram. In this example, red corresponds to a high count or probability, whereas the noise band is displayed in blue for a lower probability.

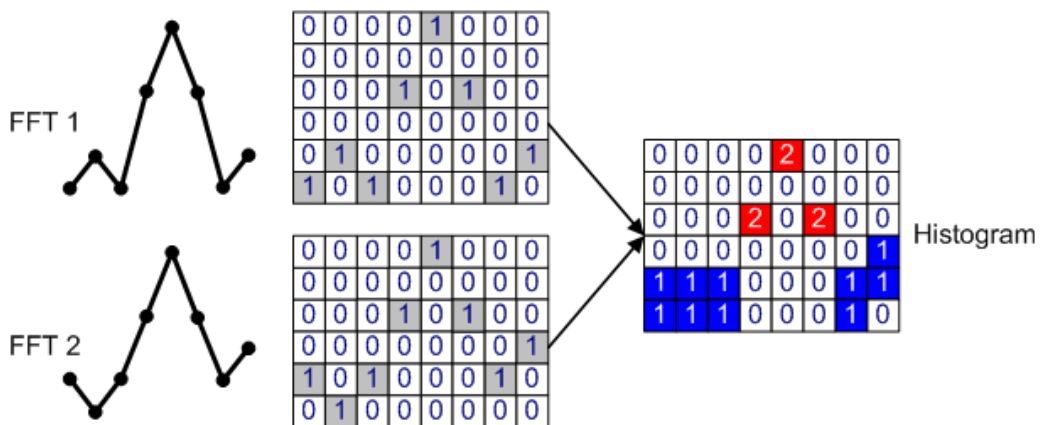

Figure 6-18: Schematic illustration of histogram calculation (dot style)



### "Persistence Spectrum" and detectors

The "Persistence Spectrum" display calculates persistence and histogram information directly from the FFT results. There is no need to use detectors for data reduction as in the spectrogram, since the histogram algorithm already reduces data to a rate that can easily be displayed. For persistence spectrum results, the detector setting affects only the "Max hold" values that can be plotted on top of the persistence spectrum (see [Chapter 6.6.1, "Analyzing maximum density - Max hold function"](#), on page 65).

### Matrix style

The individual traces in the persistence spectrum can be displayed using vectors or dots.

The FFT matrices in [Figure 6-18](#) contain only a single value per frequency column. This value is the level value returned by the FFT. The example shows a matrix in dot style, i.e. the matrices are filled with dots only. Note that the resulting diagram can contain "holes" where signal levels for neighboring probabilities differ strongly.

In contrast, for vector style matrices, each element in the matrix with the value "1" is analyzed. If the neighboring frequency also has the value 1, regardless at which power level, the two frequency points are connected by additional (interpolated) value 1 elements. Thus, possible "holes" in the diagram are filled by interpolated values, resulting in a continuous trace. Interpolation is useful to detect discrete values with a high probability, which can otherwise be overlooked. On the other hand, noise can be assigned a higher probability due to the interpolation values, increasing the displayed noise level (visible as more blue fields in the resulting histogram matrix in [Figure 6-20](#)).

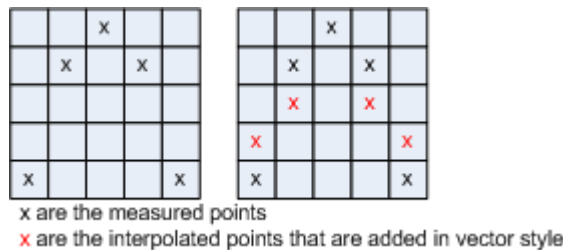

**Figure 6-19: Dotted-style matrix vs. vector-style matrix**

**Example: Histogram for vector-style matrix**

Figure 6-20 shows the vector-style representation for exactly the same example that was used in Figure 6-18 for dot style. To derive the vector-style matrices from the dot-style matrices, additional "1" elements are inserted to connect the "1" in column 4 to the neighboring "1" in columns 3 and 5.

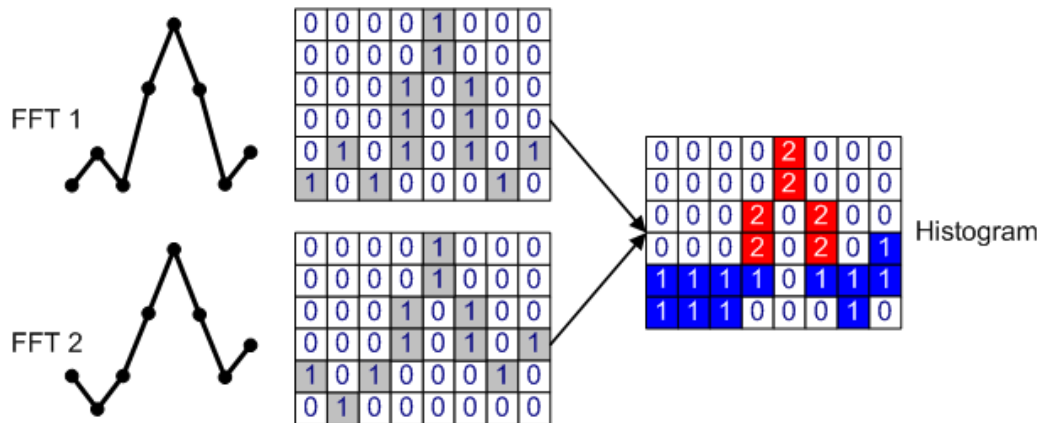

Figure 6-20: Histogram calculation using vector style

The additional "1" elements result in increased probability levels when changing from dot to vector mode. The increase is especially visible in areas with noise-like signals, that is, large level fluctuations.

**Color mapping for different matrix styles**

Color mapping for the persistence spectrum is identical to color mapping for the spectrogram or waterfall diagrams. The truncating function is especially useful to display only spectral components of a certain probability (see below).

Usually, you must adjust the color-mapping value range after changing the persistence style from vector to dot or vice versa, as the resulting probabilities can vary significantly as explained above.

For details on color mapping, see [Chapter 6.5.3, "Color maps"](#), on page 53.

**Truncating the persistence spectrum**

By default, results outside the defined value range of the color map are displayed in the colors for the minimum or maximum values in the range.



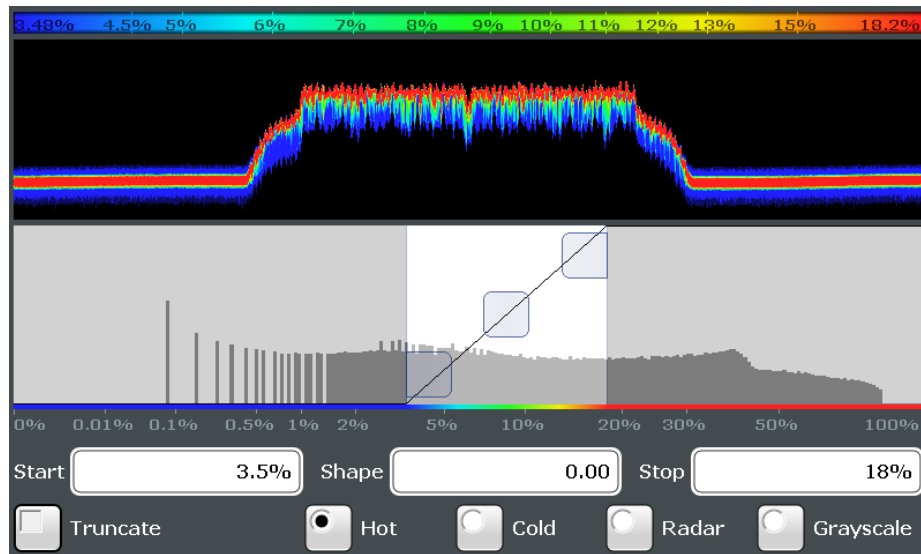

Figure 6-21: Default persistence spectrum coloring without truncating

Usually you restrict the value range displayed by the color map because only specific values are of interest. In that case, you can hide (or *truncate*) the results of the persistence spectrum outside the value range of the color map. Restricting the value range makes the display of the remaining - relevant - results clearer (see Figure 6-22), and allows you to eliminate the effects of noise, for example.

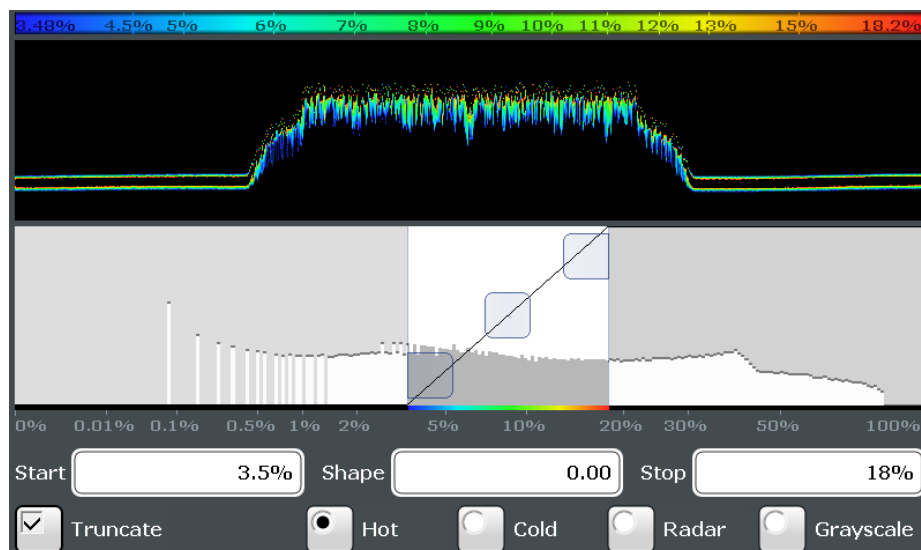

Figure 6-22: Persistence spectrum with truncated coloring

### 6.6.1 Analyzing maximum density - Max hold function

During analysis of a time-variant signal, level variations are usually of great interest; in particular, the ratio between the current signal and the maximum measured signal. The

currently measured Real-Time spectrum is displayed as a standard trace in clear/write mode with a peak detector in the "Persistence Spectrum" diagram.

An optional "Max hold" function indicates the maximum probabilities ever measured during the entire measurement for each point in the diagram. It allows for a worst-case estimation of signal-to-noise-ratios (SNR), when talking about noise or interferers. For useful signals, it allows for an estimation of amplitude variation. The "Persistence Spectrum" display can display the "Max hold" values on top of the persistence spectrum diagram. As mentioned above, the persistence colors fade out by reducing their intensity over time. The "Max hold" values, on the other hand, are assigned a time-independent intensity value to allow you to distinguish the "Max hold" values and the current persistence spectrum.

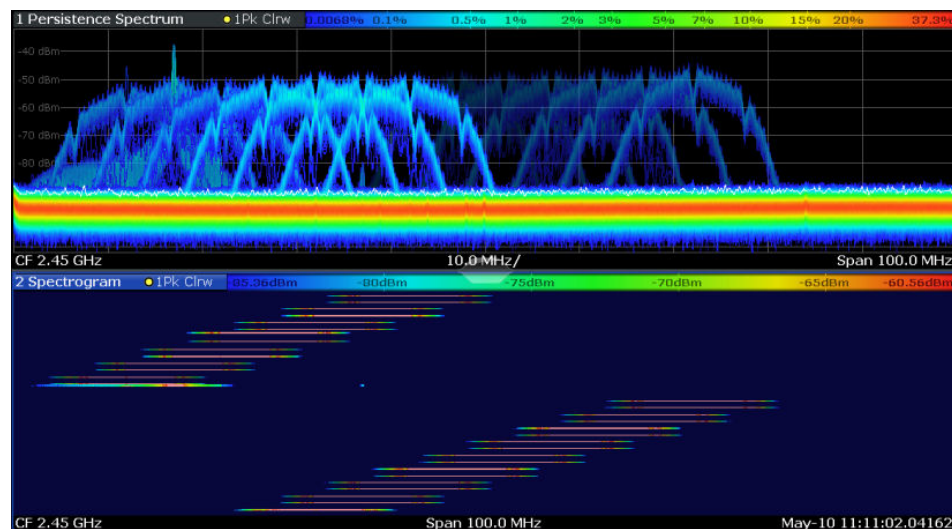

Figure 6-23: Persistence Spectrum with Max hold trace and Spectrogram display

### Changing the color intensity

By default, the "Max hold" values are displayed. You can disable the function explicitly, or hide the values by reducing the color intensity to its minimum. The maximum intensity corresponds to one of the current "Persistence Spectrum" displays. Stored "Max hold" values are cleared automatically after each new setting, and can be reset manually by the user.

For details on all settings concerning the "Max Hold" function and the "Persistence Spectrum" display in general, see [Chapter 9.2, "Persistence spectrum settings"](#), on page 116.

## 6.7 Event-based actions

The R&S FSW Real-Time Spectrum application supports event-based actions, as described in the FSW User Manual.

In particular, the following events are supported in real-time measurements:

- Marker condition (in frames active at the end of the sweep only)

- Limit line condition (at the end of a sweep)

The following actions are supported in real-time measurements:

- Store screenshot
- Stop continuous sweep
- Deactivate rule
- Auto level
- Start program/script

### Event-checking in real-time measurements

Due to the specific behavior of real-time data acquisition and processing (see [Chapter 6.1, "Data acquisition and processing in real-time"](#), on page 37), event-checking differs in some respects to other applications. The behavior depends on the current sweep mode and trigger mode. In particular, events are only checked at the end of a sweep. They are not checked if you abort the sweep.

**Table 6-2: Event-checking behavior for a Real-Time Spectrum measurement**

Sweep mode	Trigger setting	Time of event-checking
Single sweep	No trigger (Free run)	Completion of each single sweep Completion of <a href="#">Replay Zoom</a>
	Trigger + "Auto Rearm"	Completion of single sweep
	Trigger + "Stop on trigger"	Completion of single sweep
Continuous sweep	No trigger (Free run)	Never
	Trigger + "Auto Rearm"	Completion of processing a trigger
	Trigger + "Stop on trigger"	Completion of each individual sweep

## 6.8 Digital output

If the optional "Digital Baseband" interface (FSW-B17) is available, the R&S FSW Real-Time Spectrum application can provide the captured I/Q data to the Digital Baseband Output Interface of the FSW.



The only data source that can be provided to the LVDS digital baseband output is RF input.

If the Real-Time option -B512R/-B800R is used, digital output is only available for a span up to 160 MHz.

It is recommended that you use the R&S®SMU-Z6 (1415.0201.02) cable to connect other devices to the "Digital Baseband" interface of the FSW.

### Sample rate

The **sample rate** at the digital output depends on the current measurement span in the R&S FSW Real-Time Spectrum application (sample rate = 1.25 \* span). A maximum sample rate of 200 MHz is allowed for digital output.

The current sample rate is displayed in the Digital I/Q "Output" dialog box (read-only) when the digital output is enabled (see "[Output Settings Information](#)" on page 83).

For digital output, the full-scale level corresponds to the defined reference level (the reference level offset and transducer are not considered).

## 6.9 Digital I/Q 40G streaming output

The R&S FSW Real-Time Spectrum application also supports the digital I/Q 40G streaming output options (FSW-B517/-B1017). These options provide raw, unprocessed I/Q data to the QSFP+ connector on the rear panel of the FSW. Any supported device (see specifications document) can be connected to the FSW to process the I/Q data further.

Details on 40G streaming are provided in the FSW I/Q Analyzer and I/Q Input User Manual.

However, in continuous sweep mode, streaming behaves slightly differently in the R&S FSW Real-Time Spectrum application than in other applications. In this case, the streaming behavior depends on the Real-Time [Trigger mode \(Auto Rearm/ Stop on Trigger/ Mark only\)](#). I/Q data is streamed continuously only for untriggered measurements ("Free run") or for triggered measurements in "Mark only" mode. Otherwise, no continuous I/Q data stream is provided.

## 6.10 Multi-standard real-time analysis

### Application data

The **Multi-Standard Real-Time (MSRT) mode** combines the advantages of the Multi-Standard Radio Analysis (MSRA) mode with its correlated measurements and the gapless results and frequency mask triggering provided by Real-Time Spectrum measurements. In the MSRT operating mode, data acquisition is performed once as a Real-Time Spectrum measurement by a primary application, and the captured data is then evaluated by any number of secondary applications.

In MSRT mode, the secondary applications receive data for analysis from the capture buffer, if necessary resampled. The secondary applications can define their own center frequency, sample rate and record length for their **secondary application data**, which is an **extract of the capture buffer data**. The secondary applications cannot request more sample points than the captured data contains, or samples from a frequency outside the range of the capture buffer, for example.

The MSRT primary determines how long data is captured; as with all Real-Time Spectrum measurements, a pretrigger time and posttrigger time are defined, during which data is captured. For free-run measurements, the defined dwell time determines the amount of I/Q data to capture. This data is then available for all MSRT secondary applications.

Obviously, it is of interest to know which secondary application, or more precisely: which data channel is analyzing which part of the captured data and how each data channel is correlated (in time) to others. The MSRT primary display indicates the data covered by each secondary application by vertical blue lines labeled with the secondary application name.

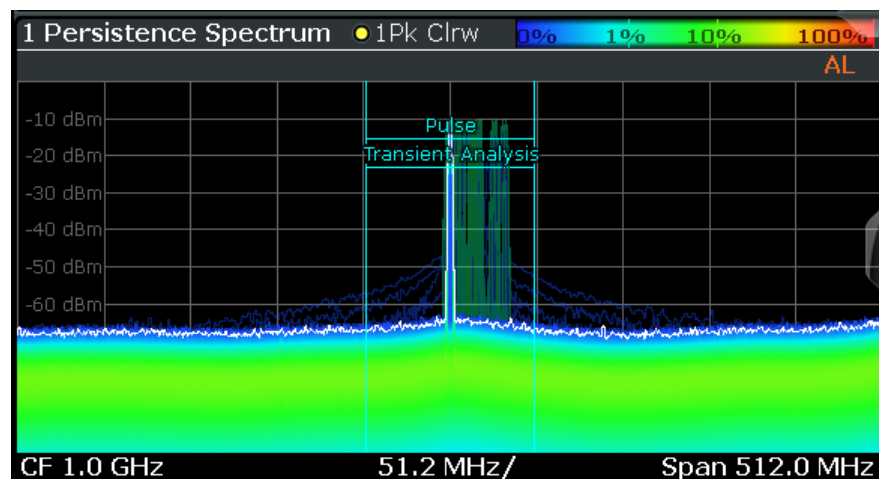

Figure 6-24: MSRT primary indicating covered bandwidth for 2 secondary applications

### Analysis interval

Each secondary application receives an extract of the data from the capture buffer. However, the individual evaluation methods of the secondary application need not analyze the complete data range. Some secondary applications allow you to select a specific part of the data for analysis, e.g. an individual pulse. Other secondary applications allow you to use an offline trigger that defines an additional offset to the capture buffer. The data range that is actually analyzed is referred to as the **analysis interval**.

The analysis interval is indicated in the window title bar for each evaluation, and can be queried via remote control (see [Chapter 13.11.2, "Analyzing real-time measurements in MSRT mode"](#), on page 342).



For secondary applications that do not allow you to restrict the evaluation range (e.g. I/Q Analyzer, Analog Demodulation), the analysis interval is identical to the secondary application data extract.

### Trigger offset vs. capture offset

The beginning of the capture buffer is defined by the trigger event and the trigger offset. The trigger source is defined by the MSRT primary, which means that all channels use the same trigger. However, each secondary application can require a different trigger offset or a different number of pretrigger samples. Instead of a trigger offset, the

secondary applications define a **capture offset**. The capture offset is defined as an **offset to the trigger event**, or for untriggered measurements, as an offset to the beginning of the capture buffer.

Thus, the beginning of the secondary application data extract is calculated as:

[time of trigger event] + [capture offset]

Note that in MSRT mode the trigger offset value can be negative (thus starting before the trigger event), as well as the capture offset. A negative capture offset means the secondary application data starts in the pretrigger time. The capture offset in the MSRT secondary applications must be configured such that the resulting data range lies within the MSRT primary's pretrigger+posttrigger time.

(This definition differs to the MSRA mode, where the capture offset is always defined as an offset to the beginning of the capture buffer, and therefore is always positive.)

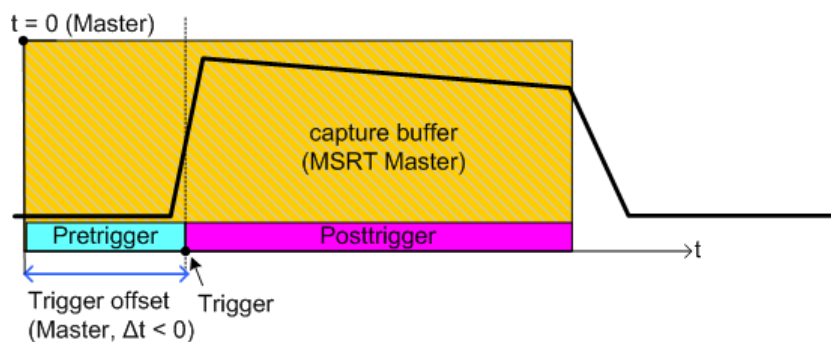

Figure 6-25: Trigger offset and capture buffer for MSRT primary

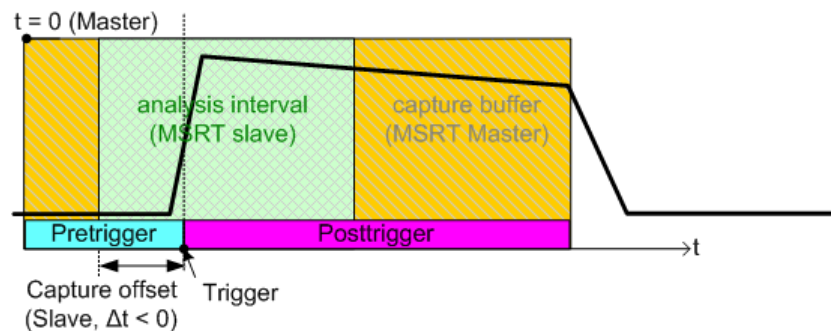

Figure 6-26: Capture offset (negative) and capture buffer for MSRT secondary

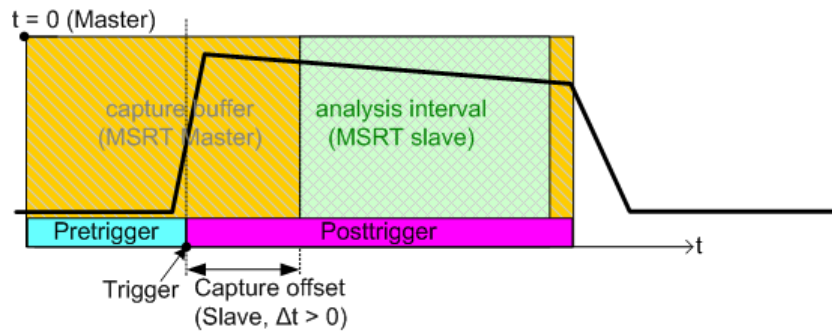

Figure 6-27: Capture offset (positive) and capture buffer for MSRT secondary

### Analysis line

In MSRT mode, an analysis line is provided as a common time marker for all MSRT secondary applications. It can be positioned in any MSRT secondary application or the MSRT primary and is then adjusted in all other secondary applications. Thus, you can easily analyze the results at a specific time in the measurement in all secondary applications and determine correlations.

If the analysis interval of the secondary application contains the marked point in time, the line is indicated in all time-based result displays, such as time, symbol, or bit diagrams. By default, the analysis line is displayed. However, you can hide it from view manually (see "Show Line" on page 160). In all result displays, the "AL" label in the window title bar indicates whether the analysis line lies within the analysis interval or not:

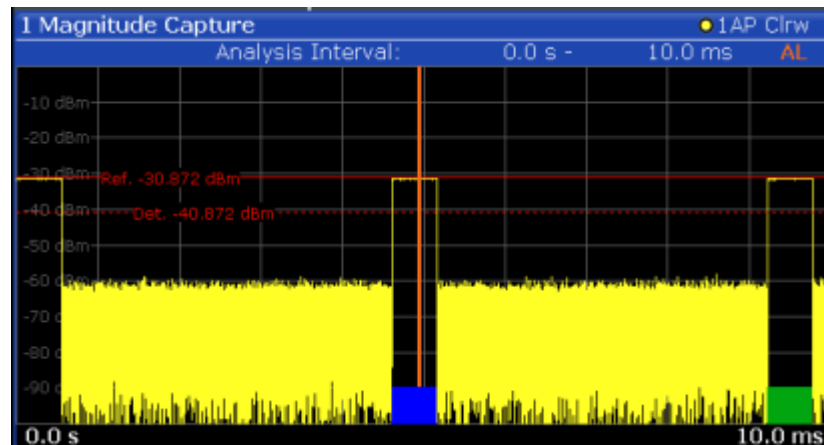

Figure 6-28: Analysis line in MSRT secondary application

- **orange "AL"**: the line lies within the interval
- **white "AL"**: the line lies within the interval, but is not displayed (hidden)
- **no "AL"**: the line lies outside the interval

• <a href="#">Configuration</a> .....	72
• <a href="#">Data acquisition</a> .....	72
• <a href="#">Using the sequencer in MSRT mode</a> .....	73
• <a href="#">Restrictions for secondary applications</a> .....	75

## 6.10.1 Configuration

### Primary parameters

In MSRT mode, only the MSRT primary performs a data acquisition. Thus, all parameters that determine how the data is captured from the RF input can only be configured in the MSRT primary tab. In all secondary application tabs, these settings are deactivated (or have a different meaning).

Typical primary parameters include:

- Span and dwell time
- Trigger settings (pretrigger, posttrigger)
- Center frequency
- Reference level
- External reference
- Impedance, preamplification, attenuation

### Channel-specific parameters

Each secondary application, however, can define all parameters concerning analysis individually.

Typical channel-specific parameters include:

- Center frequency, span and number of trace points for the secondary application data extract
- Capture offset for secondary capture buffer
- Evaluation methods
- Range and scaling
- Trace mode
- Marker positions

### Conflicting parameters

Primary and secondary-channel-specific parameters can be configured independently of one another, in any order that is convenient to you. However, there are dependencies between the parameters, as the secondary applications can only evaluate data that has been captured by the MSRT primary previously. Thus, configuring parameters is not restricted, but you are informed about the violation of possible restrictions by error messages in the status bar of the secondary applications where necessary.

## 6.10.2 Data acquisition

As mentioned before, only the MSRT primary performs a data acquisition. Thus, the MSRT primary defines the center frequency, span and dwell time (or post- and pretrigger times) of the captured I/Q data. It also defines the trigger event, thus all secondary applications have the same trigger. However, an offset from the trigger can be defined



by the individual secondary applications (see ["Trigger offset vs. capture offset"](#) on page 69).

With options R&S FSW-B800R and R&S FSW-B1200/-B2001+R&S FSW-K800RE, the MSRT primary application is restricted to a sample rate of 1000 MHz.

### Performing sweeps

When you switch to MSRT mode, the Sequencer is automatically activated in continuous mode (see [Chapter 6.10.3, "Using the sequencer in MSRT mode"](#), on page 73).

Alternatively, you can perform measurements manually. You can start a single or continuous sweep from any secondary application, which updates the data in the capture buffer and the results in the current secondary application. The results in the other secondary applications, however, remain unchanged. You must refresh them manually, either individually or all at once, using the **"Refresh"** function (see [Refresh \(MSRT only\)](#)/ ["Refresh All"](#) on page 114).

Note that in **continuous sweep mode**, sweeping is aborted when you switch to a different secondary application. You can then continue sweeping from there to evaluate the same data in different secondary applications without overwriting the data in the primary's capture buffer.

In **single sweep mode**, only one measurement is performed (for the duration of the [Dwell Time](#)); a sweep count is not available - neither for the MSRT primary, nor for the secondary applications. However, depending on the secondary application, a statistics count can be available for statistics based on a single data acquisition. Trace averaging is performed as usual if sweep count = 0, the current trace is averaged with the previously stored averaged trace.

### Data availability

The secondary applications can only receive data that is available in the primary's capture buffer. As soon as data has been stored to the capture buffer successfully, a status bit (#9) in the `STAT:OPER` register is set (see [Chapter 13.9, "Querying the status registers"](#), on page 335). If the required secondary application data is not available, an error message is displayed. Details on restrictions are described in [Chapter 6.10.4, "Restrictions for secondary applications"](#), on page 75.

## 6.10.3 Using the sequencer in MSRT mode

When you switch to MSRT mode, the Sequencer is automatically activated in continuous mode. In continuous mode, I/Q data is captured by the MSRT primary and analyzed by each secondary application on each iteration through the Sequencer.

For free-run measurements, the amount of I/Q data captured by the primary is defined by the [Dwell Time](#) setting. Evaluation in the other secondary applications starts after the data acquisition by the primary is completed.

It is also possible to use triggers in MSRT mode. If a trigger is configured, the behavior of the Sequencer depends on the trigger settings. For triggered measurements, the amount of I/Q data captured by the primary equals the pretrigger + posttrigger times.

For details on real-time trigger settings, see [Chapter 7.6, "Trigger configuration"](#), on page 93.

**Table 6-3: Sequencer modes and trigger settings in MSRT operating mode**

Sequencer mode	Trigger setting	Measurement behavior
Single sequence	No trigger (Free run)	Primary performs a single measurement, then secondary applications perform single evaluation; as a secondary, the R&S FSW Real-Time Spectrum application updates the result displays according to the data defined by the <a href="#">Dwell Time</a>
	Trigger + "Auto Rearm"	After trigger, primary performs single sweep, then secondary applications perform single evaluation; trigger is rearmed
	Trigger + "Stop on trigger"	After trigger, primary performs single sweep; then secondary applications perform single evaluation; trigger is <i>not</i> rearmed
Continuous sequence	No trigger (Free run)	Primary performs a single measurement, then secondary applications perform single evaluation; as a secondary, the R&S FSW Real-Time Spectrum application updates the result displays according to the data defined by the <a href="#">Dwell Time</a> . Then primary performs next measurement and the sequence is repeated.
	Trigger + "Auto Rearm"	After trigger, primary performs single sweep; then secondary applications perform single evaluation; trigger is rearmed; sequence is repeated with next trigger
	Trigger + "Stop on trigger"	Primary performs continuous sweep until trigger occurs; then secondary applications perform single evaluation; trigger is <i>not</i> rearmed



### Deactivated Sequencer

If the Sequencer is deactivated, note the following behavior in the MSRT mode:

- If continuous sweep is active (default) and you switch to a different secondary application, continuous sweep is aborted. Abortion is necessary to evaluate the same data in different secondary applications without overwriting the data in the capture buffer. Continuous sweep can be started again as usual.
- Only the secondary application that is currently displayed when a measurement is performed is updated automatically. A "Refresh" function is available to update the display in one or all other secondary applications (see [Chapter 8.4, "Performing a measurement in MSRT mode"](#), on page 113).

For details on the Sequencer function, see the FSW User Manual.

#### 6.10.4 Restrictions for secondary applications

For the greater part, the MSRT secondary applications are identical to Signal and Spectrum operating mode; however, the correlation between secondary applications and the MSRT primary requires some restrictions. Principally, you are not restricted in setting parameters. If any contradictions occur between the configured capture settings and the analysis settings, error messages are displayed in the status bar of the secondary application. Also, an icon (ⓘ) is displayed next to the channel label. It does not matter in which order you configure the settings - you are not prevented from doing so.

In particular, the following restrictions apply to secondary applications in MSRT mode:

- **Data acquisition:** parameters related to data acquisition can only be configured by the MSRT primary
- **Secondary application data:** only data contained in the primary's capture buffer can be analyzed by the secondary application; this implies the following restrictions:
  - **Center frequency:** must lie within the captured data bandwidth
  - **Measurement time/ dwell time:** must be smaller than or equal to the primary's capture buffer (dwell time/ pretrigger+posttrigger time)
  - **Capture offset:** must be smaller than dwell time or pretrigger and posttrigger time of the MSRT primary
  - **Trace averaging:** only for sweep count = 0
- **AUTO SET functions:** in secondary applications, only the frequency can be adjusted automatically; all other adjustment functions require a new data acquisition



General restrictions concerning sample rates and maximum usable I/Q bandwidths for I/Q data also apply in MSRT mode; see the FSW I/Q Analyzer User Manual for details.

## 7 Configuring the R&S FSW Real-Time Spectrum application

**Access:** [MODE] > "Real-Time Spectrum"

Real-Time Spectrum measurements on standard RF input require a special application on the FSW.

When you activate a measurement channel for the R&S FSW Real-Time Spectrum application, a Real-Time Spectrum measurement for the input signal is started automatically with the default configuration. The "Real-Time Config" menu is displayed and provides access to the most important configuration functions.

- [Configuration overview](#).....76
- [Input and output settings](#).....78
- [Frequency and span settings](#).....85
- [Amplitude settings](#).....87
- [Scaling the y-axis](#).....92
- [Trigger configuration](#).....93
- [Bandwidth and sweep settings](#).....104
- [Adjusting settings automatically](#).....109

### 7.1 Configuration overview



**Access:** all menus

Throughout the measurement channel configuration, an overview of the most important currently defined settings is provided in the "Overview" dialog box.

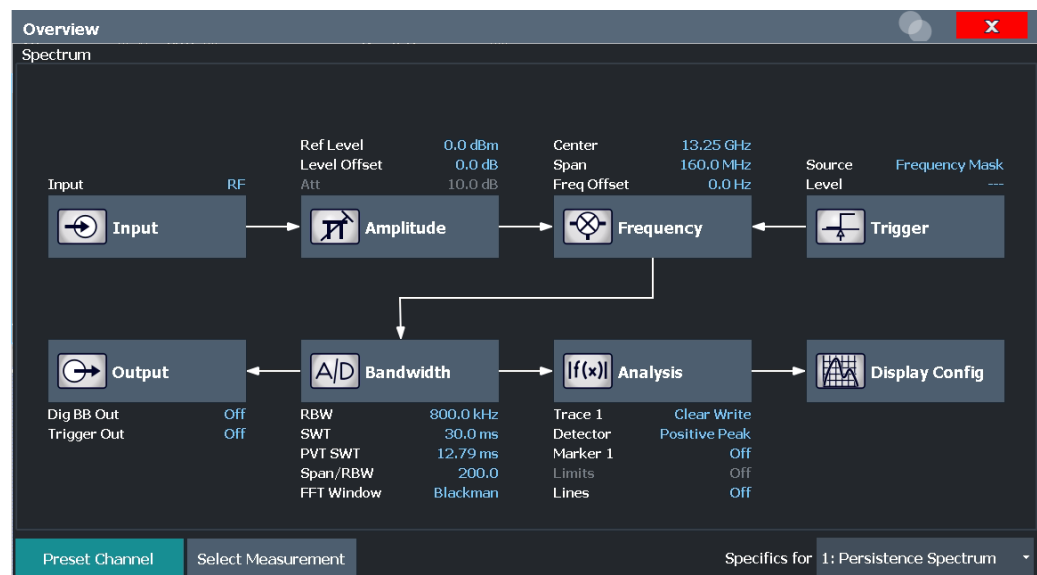

In addition to the main measurement settings, the "Overview" provides quick access to the main settings dialog boxes. The individual configuration steps are displayed in the

order of the data flow. Thus, you can easily configure an entire measurement channel from input over processing to output and analysis by stepping through the dialog boxes as indicated in the "Overview".



### Multiple access paths to functionality

The easiest way to configure a measurement channel is via the "Overview" dialog box. In this documentation, only the most convenient method of accessing the dialog boxes is indicated - usually via the "Overview" dialog box.

In particular, the "Overview" dialog box provides quick access to the following configuration dialog boxes (listed in the recommended order of processing):

1. "Select Measurement"  
See ["Select Measurement"](#) on page 78
2. Input  
See [Chapter 7.2.1, "Radio frequency input"](#), on page 78
3. Amplitude  
See [Chapter 7.4, "Amplitude settings"](#), on page 87
4. Frequency  
See [Chapter 7.3, "Frequency and span settings"](#), on page 85
5. (Optionally:) Trigger  
See [Chapter 7.6, "Trigger configuration"](#), on page 93
6. Bandwidth  
See [Chapter 7.7, "Bandwidth and sweep settings"](#), on page 104
7. (Optionally:) Outputs  
See [Chapter 7.2.2, "Output settings"](#), on page 81
8. Analysis  
See [Chapter 9, "Analysis"](#), on page 116
9. Display Configuration  
See [Chapter 9.1, "Display configuration"](#), on page 116

### To configure settings

- ▶ Select any button in the "Overview" to open the corresponding dialog box. Select a setting in the channel bar (at the top of the measurement channel tab) to change a specific setting.

For step-by-step instructions on configuring Real-Time Spectrum measurements, see [Chapter 11, "How to perform Real-Time Spectrum measurements"](#), on page 165.

### Preset Channel

Select "Preset Channel" in the lower left-hand corner of the "Overview" to restore all measurement settings *in the current channel* to their default values.

**Note:** Do not confuse "Preset Channel" with the [Preset] key, which restores the entire instrument to its default values and thus closes *all channels* on the FSW (except for the default channel)!

Remote command:

`SYSTem:PRESet:CHANnel[:EXEC]` on page 188

### Select Measurement

Selects a different measurement type to be performed.

See [Chapter 5.1, "Real-Time Spectrum measurement types"](#), on page 27.

Remote command:

`CONFigure:REALtime:MEASurement` on page 189

### Specific Settings for

The channel can contain several windows for different results. Thus, the settings indicated in the "Overview" and configured in the dialog boxes vary depending on the selected window.

Select an active window from the "Specific Settings for" selection list that is displayed in the "Overview" and in all window-specific configuration dialog boxes.

The "Overview" and dialog boxes are updated to indicate the settings for the selected window.

## 7.2 Input and output settings

- [Radio frequency input](#)..... 78
- [Output settings](#)..... 81
- [Digital I/Q output settings](#)..... 82
- [Digital I/Q 40G output settings](#)..... 84

### 7.2.1 Radio frequency input

**Access:** "Overview" > "Input/Frontend" > "Input Source" > "Radio Frequency"

Input Source		
Radio Frequency	<input checked="" type="checkbox"/> On	<input type="checkbox"/> Off
Input Coupling	<input checked="" type="radio"/> AC	<input type="radio"/> DC
Impedance	<input checked="" type="radio"/> 50Ω	<input type="radio"/> 75Ω
Direct Path	<input checked="" type="radio"/> Auto	<input type="radio"/> Off
High Pass Filter 1 to 3 GHz	<input type="radio"/> On	<input checked="" type="radio"/> Off
YIG-Preselector	<input type="radio"/> On	<input checked="" type="radio"/> Off



**RF Input Protection**

The RF input connector of the FSW must be protected against signal levels that exceed the ranges specified in the specifications document. Therefore, the FSW is equipped with an overload protection mechanism for DC and signal frequencies up to 30 MHz. This mechanism becomes active as soon as the power at the input mixer exceeds the specified limit. It ensures that the connection between RF input and input mixer is cut off.

When the overload protection is activated, an error message is displayed in the status bar ("INPUT OVLD"), and a message box informs you that the RF input was disconnected. Furthermore, a status bit (bit 3) in the `STAT:QUES:POW` status register is set. In this case, you must decrease the level at the RF input connector and then close the message box. Then measurement is possible again. Reactivating the RF input is also possible via the remote command `INPut:ATTenuation:PROTection:RESet`.



**Further input sources**

The R&S FSW Real-Time Spectrum application application can also process input from the following optional sources:

- External mixer
- Active modular probes

For details, see the FSW User Manual.

[Radio Frequency State](#)..... 79

[Input Coupling](#)..... 80

[Impedance](#)..... 80

[Direct Path](#)..... 80

[High Pass Filter 1 to 3 GHz](#)..... 80

[YIG-Preselector](#)..... 81

[Input Connector](#)..... 81

**Radio Frequency State**

Activates input from the "RF Input" connector.

For FSW85 models with two input connectors, you must define which input source is used for each measurement channel.

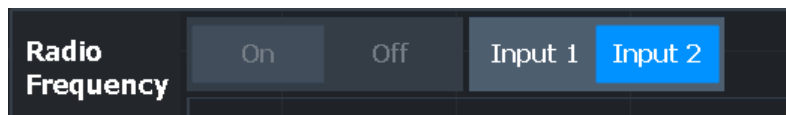

"Input 1"            1.00 mm RF input connector for frequencies up to 85 GHz (90 GHz with option R&S FSW-B90G)

"Input 2"            1.85 mm RF input connector for frequencies up to 67 GHz

Remote command:

`INPut:SElect` on page 193

`INPut:TYPE` on page 193

### Input Coupling

The RF input of the FSW can be coupled by alternating current (AC) or direct current (DC).

AC coupling blocks any DC voltage from the input signal. AC coupling is activated by default to prevent damage to the instrument. Very low frequencies in the input signal can be distorted.

However, some specifications require DC coupling. In this case, you must protect the instrument from damaging DC input voltages manually. For details, refer to the specifications document.

Remote command:

[INPut:COUPling](#) on page 191

### Impedance

For some measurements, the reference impedance for the measured levels of the FSW can be set to 50  $\Omega$  or 75  $\Omega$ .

Select 75  $\Omega$  if the 50  $\Omega$  input impedance is transformed to a higher impedance using a 75  $\Omega$  adapter of the RAZ type. (That corresponds to 25 $\Omega$  in series to the input impedance of the instrument.) The correction value in this case is 1.76 dB = 10 log (75 $\Omega$ /50 $\Omega$ ).

Remote command:

[INPut:IMPedance](#) on page 192

### Direct Path

Enables or disables the use of the direct path for small frequencies.

In spectrum analyzers, passive analog mixers are used for the first conversion of the input signal. In such mixers, the LO signal is coupled into the IF path due to its limited isolation. The coupled LO signal becomes visible at the RF frequency 0 Hz. This effect is referred to as LO feedthrough.

To avoid the LO feedthrough the spectrum analyzer provides an alternative signal path to the A/D converter, referred to as the *direct path*. By default, the direct path is selected automatically for RF frequencies close to zero. However, this behavior can be disabled. If "Direct Path" is set to "Off", the spectrum analyzer always uses the analog mixer path.

"Auto" (Default) The direct path is used automatically for frequencies close to zero.

"Off" The analog mixer path is always used.

Remote command:

[INPut:DPATh](#) on page 191

### High Pass Filter 1 to 3 GHz

Activates an additional internal highpass filter for RF input signals from 1 GHz to 3 GHz. This filter is used to remove the harmonics of the analyzer to measure the harmonics for a DUT, for example.

This function requires an additional hardware option.



**Note:** For RF input signals outside the specified range, the high-pass filter has no effect. For signals with a frequency of approximately 4 GHz upwards, the harmonics are suppressed sufficiently by the YIG-preselector, if available.)

Remote command:

`INPut:FILTer:HPASs[:STATe]` on page 192

### YIG-Preselector

Enables or disables the YIG-preselector.

This setting requires an additional option on the FSW.

**Note:** Note that the YIG-preselector is active only on frequencies greater than 8 GHz. Therefore, switching the YIG-preselector on or off has no effect if the frequency is below that value.

To use the optional 90 GHz frequency extension (R&S FSW-B90G), the YIG-preselector must be disabled.

The YIG-"Preselector" is off by default.

Remote command:

`INPut:FILTer:YIG[:STATe]` on page 192

### Input Connector

Determines which connector the input data for the measurement is taken from.

"RF"	(Default:) The "RF Input" connector
"RF Probe"	The "RF Input" connector with an adapter for a modular probe This setting is only available if a probe is connected to the "RF Input" connector.
"Baseband Input I"	The optional "Baseband Input I" connector This setting is only available if the optional "Analog Baseband" interface is installed and active for input. It is not available for the FSW67. For FSW85 models with two input connectors, this setting is only available for "Input 1".

Remote command:

`INPut:CONNector` on page 191

## 7.2.2 Output settings

**Access:** [Input/Output] > "Output"

The FSW can provide output to special connectors for other devices.

For details on connectors, refer to the FSW Getting Started manual, "Front / Rear Panel View" chapters.



How to provide trigger signals as output is described in detail in the FSW User Manual.

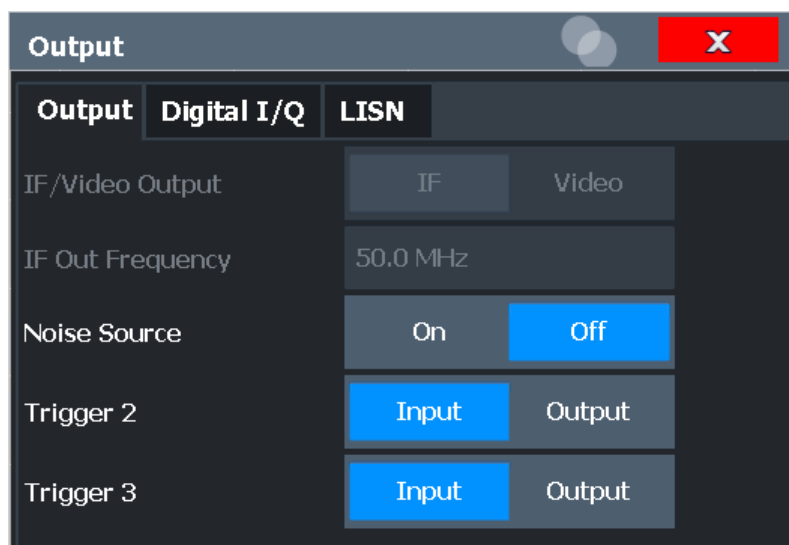

Noise Source Control..... 82

### Noise Source Control

Enables or disables the 28 V voltage supply for an external noise source connected to the "Noise source control / Power sensor") connector. By switching the supply voltage for an external noise source on or off in the firmware, you can enable or disable the device as required.

External noise sources are useful when you are measuring power levels that fall below the noise floor of the FSW itself, for example when measuring the noise level of an amplifier.

In this case, you can first connect an external noise source (whose noise power level is known in advance) to the FSW and measure the total noise power. From this value, you can determine the noise power of the FSW. Then when you measure the power level of the actual DUT, you can deduct the known noise level from the total power to obtain the power level of the DUT.

Remote command:

[DIAGnostic:SERvice:NSource](#) on page 210

### 7.2.3 Digital I/Q output settings

**Access:** "Overview" > "Output" > "Digital I/Q" tab

The optional "Digital Baseband" interface allows you to output I/Q data from any FSW application that processes I/Q data to an external device.

These settings are only available if the "Digital Baseband" interface option is installed on the FSW.

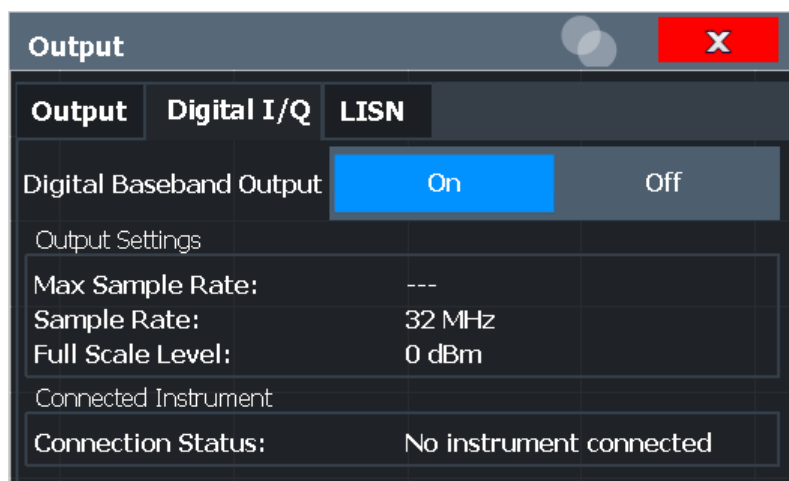

Digital Baseband Output.....	83
Output Settings Information.....	83
Connected Instrument.....	83

### Digital Baseband Output

Enables or disables a digital output stream to the optional "Digital Baseband" interface, if available.

**Note:** If digital baseband output is active, the sample rate is restricted to 200 MHz (max. 160 MHz bandwidth).

The only data source that can be used for digital baseband output is RF input.

Remote command:

`OUTPut:DIQ[:STATe]` on page 194

### Output Settings Information

Displays information on the settings for output via the optional "Digital Baseband" interface.

The following information is displayed:

- Maximum sample rate that can be used to transfer data via the "Digital Baseband" interface (i.e. the maximum input sample rate that can be processed by the connected instrument)
- Sample rate currently used to transfer data via the "Digital Baseband" interface
- Level and unit that corresponds to an I/Q sample with the magnitude "1"

Remote command:

`OUTPut<up>:DIQ:CDEvice?` on page 194

### Connected Instrument

Displays information on the instrument connected to the optional "Digital Baseband" interface, if available.

If an instrument is connected, the following information is displayed:

- Name and serial number of the instrument connected to the "Digital Baseband" interface
- Used port

Remote command:

`OUTPut<up>:DIQ:CDEvice?` on page 194

## 7.2.4 Digital I/Q 40G output settings

**Access:** "Overview" > "Output" > "Digital I/Q 40G" tab

The optional Digital I/Q 40G Streaming Output interface (FSW-B517/-B1017) allows you to output I/Q data to an external device at very high sample rates.

These settings are only available if one of the Digital I/Q 40G Streaming Output options is installed on the FSW.

For details see the FSW I/Q Analyzer and I/Q Input User Manual.

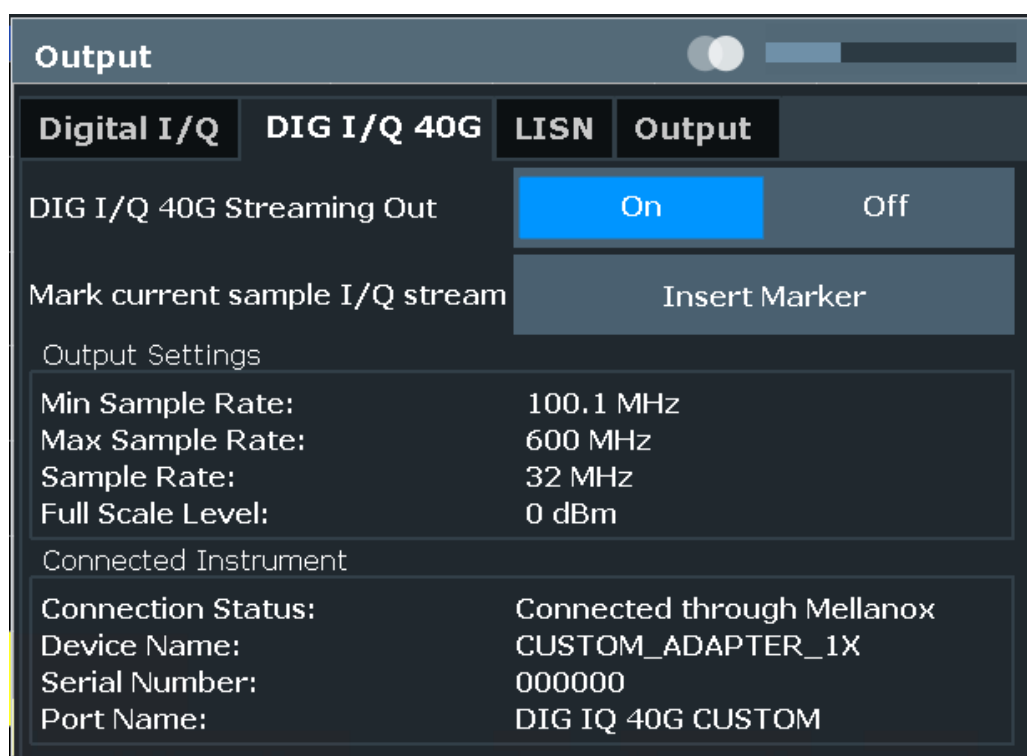

Digital I/Q 40G Streaming Out.....	84
Insert Marker.....	85
Output Settings Information.....	85
Connected Instrument.....	85

### Digital I/Q 40G Streaming Out

Enables or disables a digital output stream to the optional Digital I/Q 40G Streaming Output connector, if available.

Remote command:

`OUTPut:IQHS[:STATe]` on page 196

**Insert Marker**

Inserts marker information to the data stream during a running I/Q data output recording. Useful to mark a specific event during the measurement that you detect in the result window, for example. Then you can search for the marker information in the output data to analyze the effects at that time.

Tip: The "I/Q 40G Recording" window also provides an "Insert Marker" button that remains visible throughout the measurement, without having to open a dialog box. Thus, you can insert a marker at any time during the measurement.

Remote command:

[OUTPut: IQHS:MARKer](#) on page 196

**Output Settings Information**

Displays information on the settings for output via the Digital I/Q 40G Streaming Output option (FSW-B517/-B1017).

The following information is displayed:

- Minimum sample rate that can be used to transfer data via the Digital I/Q 40G Streaming Output interface
- Maximum sample rate that can be used to transfer data via the Digital I/Q 40G Streaming Output interface (i.e. the maximum input sample rate that can be processed by the connected instrument)
- Sample rate currently used to transfer data via the Digital I/Q 40G Streaming Output interface
- Level and unit that corresponds to an I/Q sample with the magnitude "1" (Full scale level)

Remote command:

[OUTPut: IQHS:SRATe?](#) on page 196

**Connected Instrument**

Displays information on the instrument connected to the Digital I/Q 40G Streaming Output connector, if available.

If an instrument is connected, the following information is displayed:

- Name and serial number of the instrument connected to the QSFP+ connector
- Used port

Remote command:

[OUTPut: IQHS:CDEvice?](#) on page 195

## 7.3 Frequency and span settings

**Access:** "Overview" > "Frequency"

**Frequency**

Frequency/Span

Center: 13.25 GHz Full Span

Span: 160.0 MHz

Start: 13.17 GHz Last Span

Stop: 13.33 GHz

Center Frequency Stepsize

Stepsize: 0.1 \* Span X-Factor: 10.0 %

Frequency Offset

Value: 0.0 Hz

Center Frequency.....	86
Span.....	86
Start / Stop.....	86
Last Span.....	86
Center Frequency Stepsize.....	87
Frequency Offset.....	87

### Center Frequency

Defines the center frequency of the signal in Hertz.

Remote command:

[SENSe:] FREQuency:CENTer on page 219

### Span

Defines the frequency span. The center frequency is kept constant. The allowed range depends on the installed real-time option and is specified in the specifications document.

Remote command:

[SENSe:] FREQuency:SPAN on page 221

### Start / Stop

Defines the start and stop frequencies.

Remote command:

[SENSe:] FREQuency:START on page 222

[SENSe:] FREQuency:STOP on page 222

### Last Span

Sets the span to the previous value. With this function you can switch between an overview measurement and a detailed measurement quickly.

Remote command:

[SENSe:] FREQuency: SPAN on page 221

### Center Frequency Stepsize

Defines the step size by which the center frequency is increased or decreased using the arrow keys.

When you use the rotary knob the center frequency changes in steps of only 1/10 of the span.

The step size can be coupled to another value or it can be manually set to a fixed value.

"X * Span"	Sets the step size for the center frequency to a defined factor of the span. The "X-Factor" defines the percentage of the span. Values between 1 % and 100 % in steps of 1 % are allowed. The default setting is 10 %.
"= Center"	Sets the step size to the value of the center frequency. The used value is indicated in the "Value" field.
"= Marker"	This setting is only available if a marker is active. Sets the step size to the value of the current marker and removes the coupling of the step size to span. The used value is indicated in the "Value" field.
"Manual"	Defines a fixed step size for the center frequency. Enter the step size in the "Value" field.

Remote command:

[SENSe:] FREQuency: CENTer: STEP on page 220

### Frequency Offset

Shifts the displayed frequency range along the x-axis by the defined offset.

This parameter has no effect on the instrument's hardware, on the captured data, or on data processing. It is simply a manipulation of the final results in which absolute frequency values are displayed. Thus, the x-axis of a spectrum display is shifted by a constant offset if it shows absolute frequencies. However, if it shows frequencies relative to the signal's center frequency, it is not shifted.

A frequency offset can be used to correct the display of a signal that is slightly distorted by the measurement setup, for example.

The allowed values range from -1 THz to 1 THz. The default setting is 0 Hz.

**Note:** In MSRT mode, this function is only available for the MSRT primary.

Remote command:

[SENSe:] FREQuency: OFFSet on page 221

## 7.4 Amplitude settings

**Access:** "Overview" > "Input/Frontend" > "Amplitude"

Amplitude settings determine how the FSW must process or display the expected input power levels.

Configuring amplitude settings allows you to:

- Adapt the instrument hardware to the expected maximum signal level by setting the **Reference Level** to this maximum
- Consider an external attenuator or preamplifier (using the "Offset").
- Optimize the SNR of the measurement for low signal levels by configuring the **Reference Level** as high as possible without introducing compression, clipping or overload. Use early amplification by the preamplifier and a low attenuation.
- Optimize the SNR for high signal levels and ensure that the instrument hardware is not damaged, using high attenuation and AC coupling (for DC input voltage).
- Adapt the reference impedance for power results when measuring in a 75-Ohm system by connecting an external matching pad to the RF input.

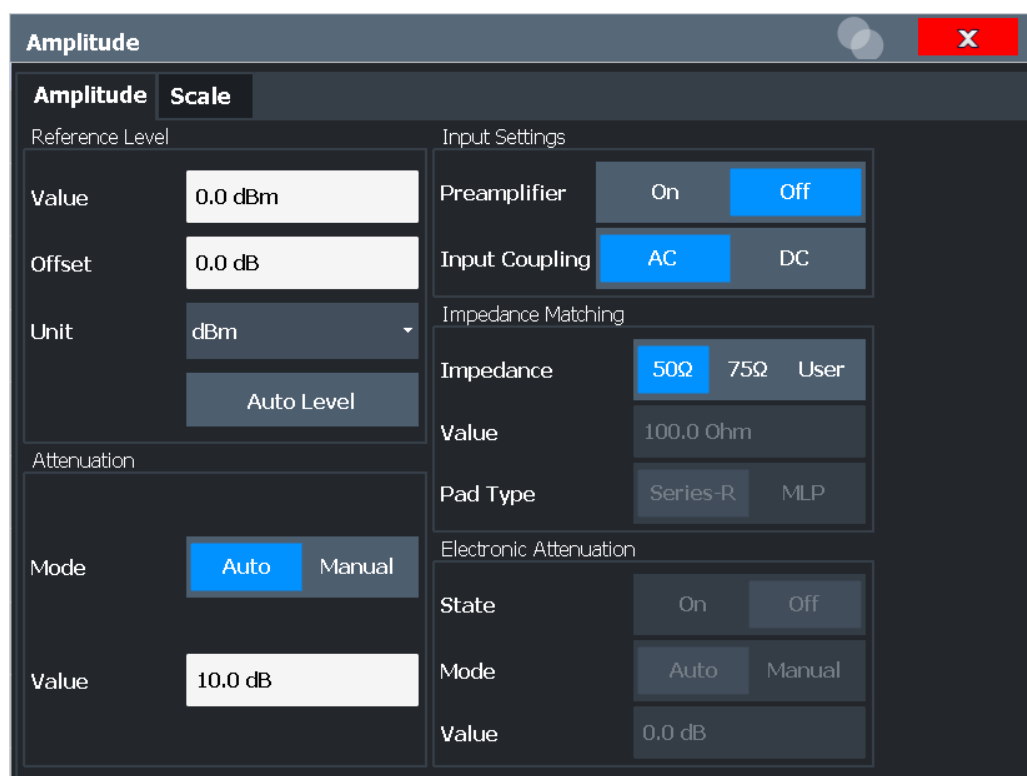

Reference Level.....	89
L Shifting the Display (Offset).....	89
L Unit.....	89
L Setting the Reference Level Automatically (Auto Level).....	90
Attenuation Mode / Value.....	90
Using Electronic Attenuation.....	90
Input Settings.....	91
L Preamplifier.....	91
L Ext. PA Correction.....	91



### Reference Level

The reference level can also be used to scale power diagrams; the reference level is then used for the calculation of the maximum on the y-axis.

Since the hardware of the FSW is adapted according to this value, it is recommended that you set the reference level close above the expected maximum signal level. Thus you ensure an optimal measurement (no compression, good signal-to-noise ratio).

Note that for input from the External Mixer (R&S FSW-B21) the maximum reference level also depends on the conversion loss; see the FSW base unit user manual for details.

Remote command:

```
DISPlay[:WINDow<n>][:SUBWindow<w>]:TRACe<t>:Y[:SCALe]:RLEVel
```

on page 212

### Shifting the Display (Offset) ← Reference Level

Defines an arithmetic level offset. This offset is added to the measured level. In some result displays, the scaling of the y-axis is changed accordingly.

Define an offset if the signal is attenuated or amplified before it is fed into the FSW so the application shows correct power results. All displayed power level results are shifted by this value.

The setting range is  $\pm 200$  dB in 0.01 dB steps.

Note, however, that the *internal* reference level (used to adjust the hardware settings to the expected signal) ignores any "Reference Level Offset". Thus, it is important to keep in mind the actual power level the FSW must handle. Do not rely on the displayed reference level (internal reference level = displayed reference level - offset).

Remote command:

```
DISPlay[:WINDow<n>][:SUBWindow<w>]:TRACe<t>:Y[:SCALe]:RLEVel:OFFSet
```

on page 212

### Unit ← Reference Level

The FSW measures the signal voltage at the RF input.

In the default state, the level is displayed at a power level of 1 mW (= dBm). Via the known input impedance (50  $\Omega$  or 75  $\Omega$ , see "[Impedance](#)" on page 80), conversion to other units is possible.

The following units are available and directly convertible:

- dBm
- dBmV
- dB $\mu$ V
- dB $\mu$ A
- dBpW
- Volt
- Ampere
- Watt

Remote command:

```
INPut:IMPedance on page 192  
CALCulate<n>:UNIT:POWer on page 211
```

**Setting the Reference Level Automatically (Auto Level) ← Reference Level**

To determine the required reference level, a level measurement is performed on the FSW.

If necessary, you can optimize the reference level further. Decrease the attenuation level manually to the lowest possible value before an overload occurs, then decrease the reference level in the same way.

Remote command:

[\[SENSe:\]ADJust:LEVel](#) on page 253

**Attenuation Mode / Value**

Defines the attenuation applied to the RF input of the FSW.

The RF attenuation can be set automatically as a function of the selected reference level (Auto mode). Automatic attenuation ensures that no overload occurs at the RF Input connector for the current reference level. It is the default setting.

By default and when no (optional) [electronic attenuation](#) is available, mechanical attenuation is applied.

In "Manual" mode, you can set the RF attenuation in 1 dB steps (down to 0 dB). Other entries are rounded to the next integer value. The range is specified in the specifications document. If the defined reference level cannot be set for the defined RF attenuation, the reference level is adjusted accordingly and the warning "limit reached" is displayed.

**NOTICE!** Risk of hardware damage due to high power levels. When decreasing the attenuation manually, ensure that the power level does not exceed the maximum level allowed at the RF input, as an overload can lead to hardware damage.

Remote command:

[INPut:ATTenuation](#) on page 213

[INPut:ATTenuation:AUTO](#) on page 213

**Using Electronic Attenuation**

If the (optional) Electronic Attenuation hardware is installed on the FSW, you can also activate an electronic attenuator.

In "Auto" mode, the settings are defined automatically; in "Manual" mode, you can define the mechanical and electronic attenuation separately.

**Note:** Electronic attenuation is not available for stop frequencies (or center frequencies in zero span) above 15 GHz.

In "Auto" mode, RF attenuation is provided by the electronic attenuator as much as possible to reduce the amount of mechanical switching required. Mechanical attenuation can provide a better signal-to-noise ratio, however.

When you switch off electronic attenuation, the RF attenuation is automatically set to the same mode (auto/manual) as the electronic attenuation was set to. Thus, the RF attenuation can be set to automatic mode, and the full attenuation is provided by the mechanical attenuator, if possible.

The electronic attenuation can be varied in 1 dB steps. If the electronic attenuation is on, the mechanical attenuation can be varied in 5 dB steps. Other entries are rounded to the next lower integer value.

For the FSW85, the mechanical attenuation can be varied only in 10 dB steps.

If the defined reference level cannot be set for the given attenuation, the reference level is adjusted accordingly and the warning "limit reached" is displayed in the status bar.

Remote command:

`INPut:EATT:STATe` on page 215

`INPut:EATT:AUTO` on page 214

`INPut:EATT` on page 214

### Input Settings

Some input settings affect the measured amplitude of the signal, as well.

The parameters "Input Coupling" and "Impedance" are identical to those in the "Input" settings.

### Preamplifier ← Input Settings

If the (optional) internal preamplifier hardware is installed on the FSW, a preamplifier can be activated for the RF input signal.

You can use a preamplifier to analyze signals from DUTs with low output power.

**Note:** If an optional external preamplifier is activated, the internal preamplifier is automatically disabled, and vice versa.

For all FSW models except for FSW85, the following settings are available:

"Off"	Deactivates the preamplifier.
"15 dB"	The RF input signal is amplified by about 15 dB.
"30 dB"	The RF input signal is amplified by about 30 dB.

For FSW85 models, the input signal is amplified by 30 dB if the preamplifier is activated.

Remote command:

`INPut:GAIN:STATe` on page 216

`INPut:GAIN[:VALue]` on page 216

### Ext. PA Correction ← Input Settings

This function is only available if an external preamplifier is connected to the FSW, and only for frequencies above 1 GHz. For details on connection, see the preamplifier's documentation.

Using an external preamplifier, you can measure signals from devices under test with low output power, using measurement devices which feature a low sensitivity and do not have a built-in RF preamplifier.

When you connect the external preamplifier, the FSW reads out the touchdown (.S2P) file from the EEPROM of the preamplifier. This file contains the s-parameters of the preamplifier. As soon as you connect the preamplifier to the FSW, the preamplifier is permanently on and ready to use. However, you must enable data correction based on the stored data explicitly on the FSW using this setting.

When enabled, the FSW automatically compensates the magnitude and phase characteristics of the external preamplifier in the measurement results. Any internal preamplifier, if available, is disabled.

For FSW85 models with two RF inputs, you can enable correction from the external preamplifier for each input individually, but not for both at the same time.

When disabled, no compensation is performed even if an external preamplifier remains connected.

Remote command:

`INPut:EGain[:STATe]` on page 215

## 7.5 Scaling the y-axis

The individual scaling settings that affect the vertical axis are described here.

**Access:** "Overview" > "Amplitude" > "Scale" tab

**Or:** [AMPT] > "Scale Config"

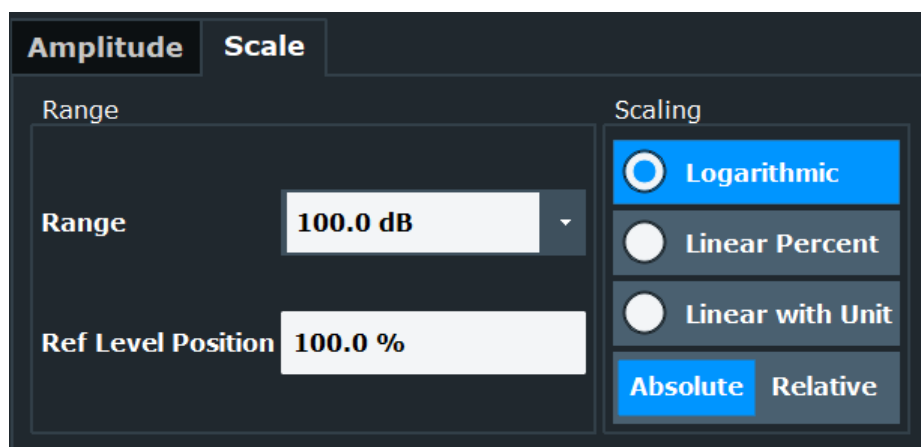

Range.....	92
Ref Level Position.....	92
Auto Scale Once.....	93
Scaling.....	93

### Range

Defines the displayed y-axis range in dB.

The default value is 100 dB.

Remote command:

`DISPlay[:WINDow<n>][:SUBWindow<w>]:TRACe<t>:Y[:SCALE]` on page 217

### Ref Level Position

Defines the reference level position, i.e. the position of the maximum AD converter value on the level axis in %.

0 % corresponds to the lower and 100 % to the upper limit of the diagram.

Values from -120 % to +280 % are available.

Larger values are useful for small scales, such as a power range of 10 dB or 20 dB, and low signal levels, for example 60 dB below the reference level. In this case, large reference level position values allow you to see the trace again.

Remote command:

`DISPlay[:WINDow<n>][:SUBWindow<w>]:TRACe<t>:Y[:SCALe]:RPOSition`  
on page 218

### Auto Scale Once

Automatically determines the optimal range and reference level position to be displayed for the current measurement settings.

The display is only set once; it is not adapted further if the measurement settings are changed again.

Remote command:

`DISPlay[:WINDow<n>][:SUBWindow<w>]:TRACe<t>:Y[:SCALe]:AUTO ONCE`  
on page 217

### Scaling

Defines the scaling method for the y-axis.

"Logarithmic"	Logarithmic scaling (only available for logarithmic units - dB..., and A, V, Watt)
"Linear with Unit"	Linear scaling in the unit of the measured signal
"Linear Percent"	Linear scaling in percentages from 0 to 100
"Absolute"	The labeling of the level lines refers to the absolute value of the reference level (not available for "Linear Percent")
"Relative"	The scaling is in dB, relative to the reference level (only available for logarithmic units - dB...). The upper line of the grid (reference level) is always at 0 dB.

Remote command:

`DISPlay[:WINDow<n>][:SUBWindow<w>]:TRACe<t>:Y:SPACing` on page 219  
`DISPlay[:WINDow<n>][:SUBWindow<w>]:TRACe<t>:Y[:SCALe]:MODE`  
on page 217

## 7.6 Trigger configuration

- [Trigger source settings](#).....93
- [Frequency mask trigger configuration](#).....97
- [Trigger input/output](#)..... 102

### 7.6.1 Trigger source settings

**Access:** "Overview" > "Trigger"

Trigger settings determine when the input signal is measured.

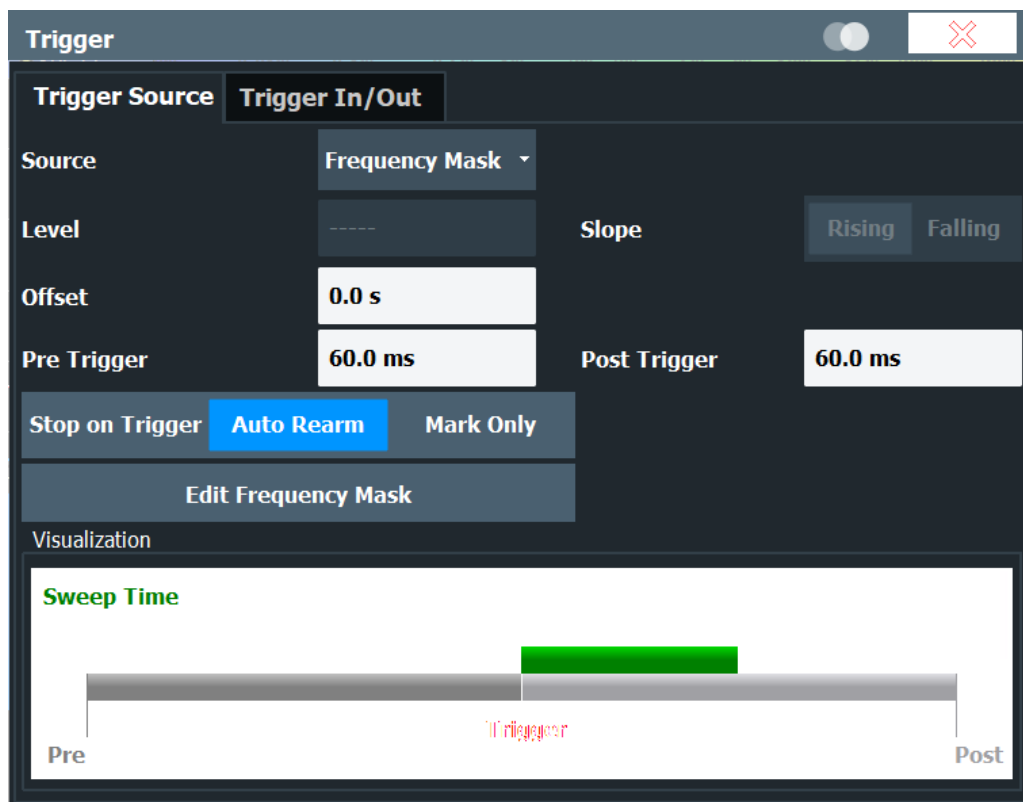

Trigger Source.....94

- L Free Run.....94
- L External Trigger 1/2/3.....95
- L Frequency Mask.....95
- L Time Domain.....95

Trigger Level.....95

Trigger Offset.....96

Slope.....96

Trigger Holdoff.....96

Pretrigger capture time.....96

Posttrigger capture time.....96

Trigger mode (Auto Rearm/ Stop on Trigger/ Mark only).....96

Edit Frequency Mask.....97

**Trigger Source**

Defines the trigger source. If a trigger source other than "Free Run" is set, "TRG" is displayed in the channel bar and the trigger source is indicated.

Remote command:

TRIGger [ : SEquence ] : SOURce on page 229

**Free Run ← Trigger Source**

No trigger source is considered. Data acquisition is started manually or automatically and continues until stopped explicitly.

Remote command:

TRIG:SOUR IMM, see [TRIGger\[:SEquence\]:SOURce](#) on page 229

### External Trigger 1/2/3 ← Trigger Source

Data acquisition starts when the TTL signal fed into the specified input connector meets or exceeds the specified trigger level.

(See ["Trigger Level"](#) on page 95).

**Note:** "External Trigger 1" automatically selects the trigger signal from the "TRIGGER 1 INPUT" connector on the front panel.

For details, see the "Instrument Tour" chapter in the FSW Getting Started manual.

"External Trigger 1"

Trigger signal from the "TRIGGER 1 INPUT" connector.

"External Trigger 2"

Trigger signal from the "TRIGGER 2 INPUT / OUTPUT" connector.

For FSW85 models, "Trigger 2" is not available due to the second RF input connector on the front panel.

"External Trigger 3"

Trigger signal from the "TRIGGER 3 INPUT / OUTPUT" connector on the rear panel.

Remote command:

TRIG:SOUR EXT, TRIG:SOUR EXT2

TRIG:SOUR EXT3

See [TRIGger\[:SEquence\]:SOURce](#) on page 229

### Frequency Mask ← Trigger Source

Triggers when the measured signal violates the (selected) user-defined frequency mask.

For details see [Chapter 6.4.1, "Triggering on specific frequency events \(frequency mask trigger\)"](#), on page 42.

Remote command:

TRIG:SOUR MASK, see [TRIGger\[:SEquence\]:SOURce](#) on page 229

### Time Domain ← Trigger Source

Triggers measurements if the signal exceeds a particular power level in the time domain.

Remote command:

TRIG:SEQ:SOUR TDTR, see [TRIGger\[:SEquence\]:SOURce](#) on page 229

[TRIGger\[:SEquence\]:TDTRigger:LEVel](#) on page 230

### Trigger Level

Defines the trigger level for the specified trigger source.

For details on supported trigger levels, see the instrument specifications document.

Remote command:

[TRIGger\[:SEquence\]:LEVel\[:EXternal<port>\]](#) on page 227

[TRIGger\[:SEquence\]:TDTRigger:LEVel](#) on page 230

**Trigger Offset**

Defines the time offset between the trigger event and the start of the measurement.

Offset > 0:	Start of the measurement is delayed
Offset < 0:	Measurement starts earlier (pretrigger)

Remote command:

[TRIGger\[:SEquence\]:HOLDoff\[:TIME\]](#) on page 227

**Slope**

For all trigger sources except frequency mask, you can define whether triggering occurs when the signal rises to the trigger level or falls down to it.

Remote command:

[TRIGger\[:SEquence\]:SLOPe](#) on page 229

**Trigger Holdoff**

Defines the minimum time (in seconds) that must pass between two trigger events. Trigger events that occur during the holdoff time are ignored.

This function is only available for "Mark only" trigger mode, see "[Trigger mode \(Auto Rearm/ Stop on Trigger/ Mark only\)](#)" on page 96.

Remote command:

[TRIGger\[:SEquence\]:IFPower:HOLDoff](#) on page 227

**Pretrigger capture time**

Defines a time period *before* the actual trigger event in which data is also captured, in addition to the posttrigger time.

In this case, one or more additional frames will be available in the spectrogram/waterfall *beneath* the frame displayed in the "Real-Time Spectrum" or PVT diagram window by default.

Remote command:

[TRIGger\[:SEquence\]:PRETrigger\[:TIME\]](#) on page 228

**Posttrigger capture time**

Defines a time period *after* the actual trigger event in which data is captured.

Posttrigger data after the sweep time are displayed as additional frames in the spectrogram/ PVT waterfall *above* the frame displayed in the "Real-Time Spectrum" or PVT diagram window by default.

Remote command:

[TRIGger\[:SEquence\]:POSTtrigger\[:TIME\]](#) on page 228

**Trigger mode (Auto Rearm/ Stop on Trigger/ Mark only)**

Determines the behavior of the R&S FSW Real-Time Spectrum application after a trigger event.



"Auto Rearm"	(Default:) A trigger event causes the FSW to start a measurement and to immediately rearm the trigger. In that case, measurements are continuously triggered and measurement results may become obsolete in a very short time. The pre- and posttrigger periods for each sweep time are displayed.
"Stop on Trigger"	The trigger is not rearmed after the first trigger event has occurred; thus, the measurement stops after one sweep. The measurement results for that sweep remain on the display, including the pretrigger and posttrigger periods. Note, however, that if the trigger event occurs before the defined pretrigger time has elapsed, the period between measurement start and the trigger event is shorter than the defined pretrigger time.
"Mark Only"	A free-run measurement is performed; the trigger event is merely indicated in the results, but does not change the behavior of the measurement. This setting is only available for FSW-B512R/-B800R.

Remote command:

[TRIGger:MODE](#) on page 226

#### **Edit Frequency Mask**

Opens the "Edit Frequency Mask" dialog box.

For details see [Chapter 7.6.2, "Frequency mask trigger configuration"](#), on page 97.

## **7.6.2 Frequency mask trigger configuration**

**Access:** [TRIG] > "Edit Frequency Mask"

The Frequency Mask Trigger (FMT) is a mask in the frequency domain, which is checked with every calculated FFT. When a specific condition concerning this mask occurs during the measurement of the input signal, data capturing is triggered.

When configuring a frequency mask, consider the effects an active transducer can have on the measurement results.

For details on transducers, see the FSW user manual.

For details see [Chapter 6.4.1, "Triggering on specific frequency events \(frequency mask trigger\)"](#), on page 42.

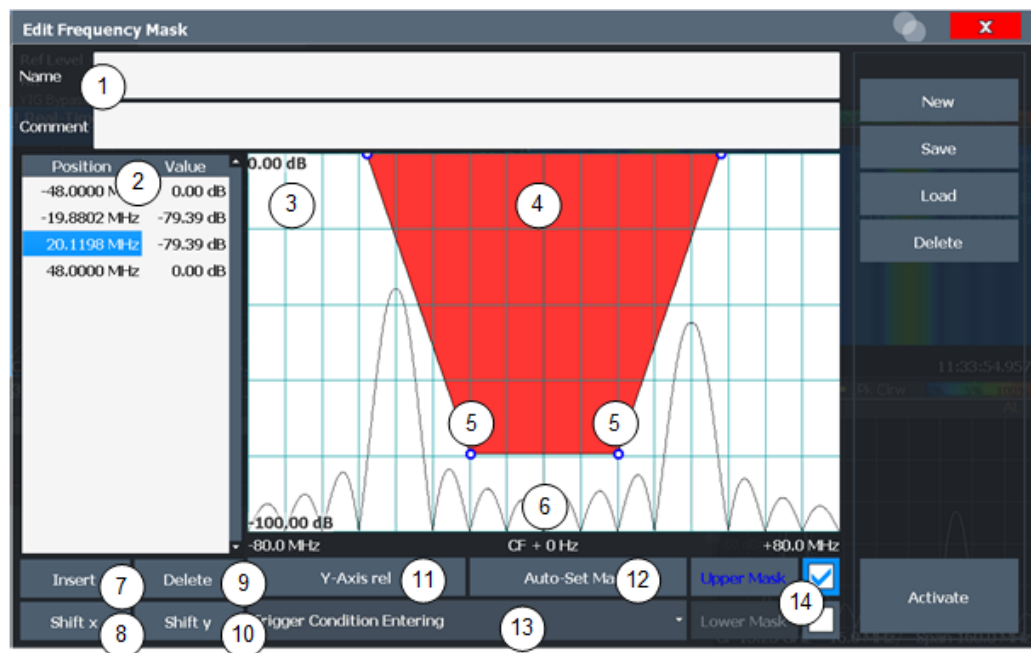

Figure 7-1: Edit Frequency Mask dialog box

- 1 = Name and description of the frequency mask
- 2 = Mask point table: list of position/value pairs defining mask coordinates
- 3 = Preview pane
- 4 = Frequency mask preview: the area the frequency mask currently covers is red
- 5 = Frequency mask mask points: define the shape of the frequency mask
- 6 = Preview of the current measurement trace; type and shape depend on currently selected measurement
- 7 = Insert: inserts a new mask point
- 8 = Shift X: shifts the complete frequency mask horizontally
- 9 = Delete: deletes an existing mask points
- 10 = Shift Y: shifts the complete frequency mask vertically
- 11 = Y-Axis Rel/Abs: switches between relative (dB) and absolute (dBm) amplitude values
- 12 = Auto Set Mask: creates a frequency mask automatically
- 13 = Trigger Condition selection: sets the trigger condition
- 14 = Upper Line/Lower Line: selects/deselects the upper and lower frequency mask lines



When you close the "Edit Frequency Mask" dialog box, the trigger source is not automatically set to "FMT". You must activate it manually (see "Activate" on page 99).

### 7.6.2.1 Frequency mask management

**Access:** [TRIG] > "Edit Frequency Mask"

As frequency masks can have a very complex structure, they can be stored for later use with other signals. The masks are stored in a file with the extension `.FMT` in the `C:\Program Files (x86)\Rohde-Schwarz\FSW\<version>\freqmask` directory. By default, the mask name is used as the file name; however, it can be edited.

#### **New**

Clears the current mask configuration to define a new frequency mask.

Remote command:

[CALCulate<n>:MASK:NAME](#) on page 234

### Save

Opens a file selection dialog box to save the current frequency mask configuration in a file.

By default, the mask name is used as the file name; however, it can be edited.

The mask is stored in a file with the extension `.FMT` in the

`C:\Program Files (x86)\Rohde-Schwarz\FSW\<version>\freqmask` directory.

Remote command:

Path selection:

[CALCulate<n>:MASK:CDIRectory](#) on page 231

Define mask name:

[CALCulate<n>:MASK:NAME](#) on page 234

### Load

Opens a file selection dialog box to restore a saved frequency mask.

The dialog box contains all frequency masks with the extension `.FMT` in the

`C:\Program Files (x86)\Rohde-Schwarz\FSW\<version>\freqmask` directory.

Select the required mask and confirm the selection with "Load".

Remote command:

Path selection:

[CALCulate<n>:MASK:CDIRectory](#) on page 231

Load mask:

[CALCulate<n>:MASK:NAME](#) on page 234

### Delete Mask

Opens a file selection dialog box to delete a previously saved frequency mask.

If confirmed, the file is deleted.

Remote command:

[CALCulate<n>:MASK:DELeTe](#) on page 232

### Activate

This function sets the trigger source to "Frequency Mask" and closes the dialog box. Thus, it activates the selected mask or masks. To deactivate the use of a frequency mask trigger, change the trigger source (for example to "Free Run", see ["Trigger Source"](#) on page 94).

Only selected masks are used for triggering. To deselect a mask, remove the checkmark that defines the mask as an upper or lower mask (see ["Selecting and deselecting upper and lower masks"](#) on page 101).

Remote command:

`TRIG:SOUR MASK`, see [TRIGger\[:SEQUence\]:SOURce](#) on page 229

### 7.6.2.2 Frequency mask definition

**Access:** [TRIG] > "Edit Frequency Mask"

The "Edit Frequency Mask" dialog box provides a basic structure of an upper frequency mask in the live preview window.

#### **Name**

Defines the name of the frequency mask. This name is used as the default file name for storage.

Remote command:

[CALCulate<n>:MASK:NAME](#) on page 234

#### **Comment**

An optional description of the frequency mask.

Remote command:

[CALCulate<n>:MASK:COMMeNT](#) on page 231

#### **Mask points**

Each mask is defined by a minimum of 2 and a maximum of 1001 mask points. Each mask point is defined by its position (x-axis) and value (y-value). Mask points must be defined in ascending order and have unique positions.

Remote command:

[CALCulate<n>:MASK:UPPer\[:DATA\]](#) on page 236

[CALCulate<n>:MASK:LOWer\[:DATA\]](#) on page 233

#### **Inserting points**

Inserts a mask point in the frequency mask above the selected one in the "Position/Value" list and the preview pane.

Remote command:

Redefine the list of data points:

[CALCulate<n>:MASK:UPPer\[:DATA\]](#) on page 236

[CALCulate<n>:MASK:LOWer\[:DATA\]](#) on page 233

#### **Deleting points**

Deletes the selected mask point in the "Position/Value" list and the preview pane.

Remote command:

Redefine the list of data points:

[CALCulate<n>:MASK:UPPer\[:DATA\]](#) on page 236

[CALCulate<n>:MASK:LOWer\[:DATA\]](#) on page 233

#### **Shifting the mask position horizontally (Shift x)**

Shifts the x-value (position) of each mask point horizontally by the defined shift width.

Remote command:

[CALCulate<n>:MASK:UPPer:SHIFt:X](#) on page 235

[CALCulate<n>:MASK:LOWer:SHIFt:X](#) on page 232

**Shifting the mask vertically (Shift y)**

Shifts the y-value of each mask point vertically by the defined shift height

Remote command:

[CALCulate<n>:MASK:UPPer:SHIFt:Y](#) on page 235

[CALCulate<n>:MASK:LOWer:SHIFt:Y](#) on page 232

**Changing the y-axis scaling (Y-Axis rel/abs)**

Switches between absolute scaling (in dBm) or relative scaling (in dB) for the mask (y-)values.

Remote command:

[CALCulate<n>:MASK:MODE](#) on page 234

**Defining a mask automatically (Auto-Set Mask)**

Defines a mask automatically according to the currently measured data. The mask is configured to follow the measurement trace with a specific distance to the power levels.

Remote command:

[CALCulate<n>:MASK:UPPer:AUTO](#) on page 235

**Setting the trigger condition**

Defines how the frequency mask is evaluated to control data acquisition.

For details see "[Trigger conditions](#)" on page 44.

"Entering"	Activates the trigger as soon as the signal enters the frequency mask. To arm the trigger, the signal initially has to be outside the frequency mask.
"Leaving"	Activates the trigger as soon as the signal leaves the frequency mask. To arm the trigger, the signal initially has to be inside the frequency mask.

Remote command:

[TRIGger\[:SEQUence\]:MASK:CONDition](#) on page 236

**Selecting and deselecting upper and lower masks**

Select the masks to be used for triggering. Deselecting a mask allows you to configure it in advance without having to use it immediately.

By default, the configured mask is defined to be an upper mask, i.e. the mask is the area *above* the configured mask points. In addition or alternatively, a lower mask can be configured. In a lower mask, the mask is the area *below* the configured mask points.

The lower mask is configured in the same manner as the upper mask. However, it cannot be configured automatically according to the currently measured values ("Auto-Set Mask").

Both upper and lower masks can be configured at the same time, in order to define a "corridor" of allowed values.

For details see "[Upper and lower masks](#)" on page 44

Note that selecting an upper or lower mask to be used for a measurement does not automatically activate them. You must also set the trigger source to "Frequency Mask" (see "Activate" on page 99).

Remote command:

CALCulate<n>:MASK:LOWer:STATe on page 233

CALCulate<n>:MASK:UPPer:STATe on page 236

### 7.6.3 Trigger input/output

**Access:** [TRIG] > "Trigger Config" > "Trigger In/Out" tab

Signals at one of the [TRIGGER INPUT/OUTPUT] connectors on the FSW can be configured for use as external triggers.

Trigger 2/3.....	102
L Output Type.....	103
L Level.....	103
L Pulse Length.....	103
L Send Trigger.....	103

#### Trigger 2/3

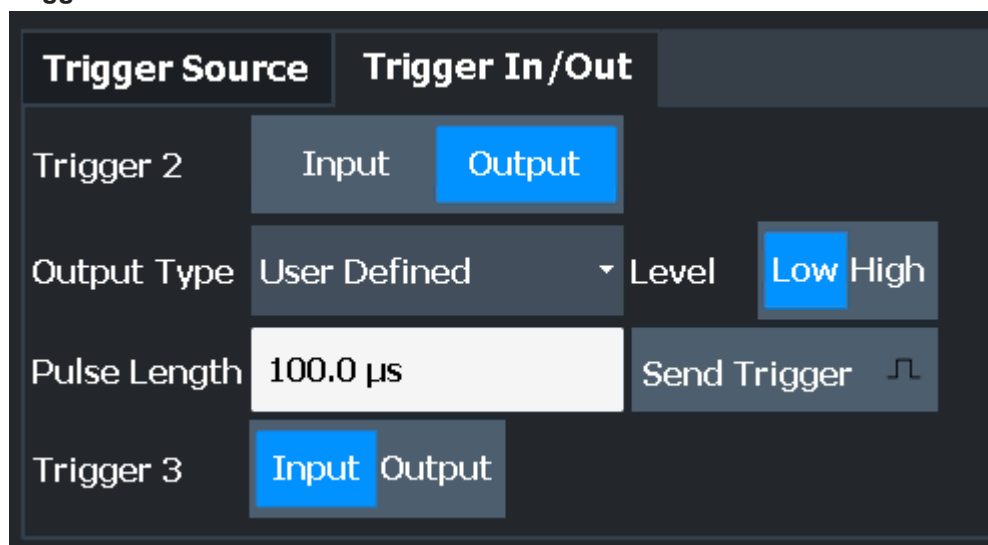

The trigger input and output functionality depends on how the variable "Trigger Input/Output" connectors are used.

**Note:** Providing trigger signals as output is described in detail in the FSW User Manual.

"Trigger 1"	"Trigger 1" is input only.
"Trigger 2"	Defines the usage of the variable "Trigger Input/Output" connector on the front panel (not available for FSW85 models with 2 RF input connectors)
"Trigger 3"	Defines the usage of the variable "Trigger 3 Input/Output" connector on the rear panel

- "Input" The signal at the connector is used as an external trigger source by the FSW. Trigger input parameters are available in the "Trigger" dialog box.
- "Output" The FSW sends a trigger signal to the output connector to be used by connected devices.  
Further trigger parameters are available for the connector.

Remote command:

[OUTPut:TRIGger<tp>:DIRection](#) on page 237

### Output Type ← Trigger 2/3

Type of signal to be sent to the output

- "Device Triggered" (Default) Sends a trigger when the FSW triggers.
- "Trigger Armed" Sends a (high level) trigger when the FSW is in "Ready for trigger" state.  
This state is indicated by a status bit in the `STATUS:OPERation` register (bit 5), as well as by a low-level signal at the "AUX" port (pin 9).
- "User Defined" Sends a trigger when you select "Send Trigger".  
In this case, further parameters are available for the output signal.

Remote command:

[OUTPut:TRIGger<tp>:OTYPe](#) on page 238

### Level ← Output Type ← Trigger 2/3

Defines whether a high (1) or low (0) constant signal is sent to the trigger output connector (for "Output Type": "User Defined").

The trigger pulse level is always opposite to the constant signal level defined here. For example, for "Level" = "High", a constant high signal is output to the connector until you select the [Send Trigger](#) function. Then, a low pulse is provided.

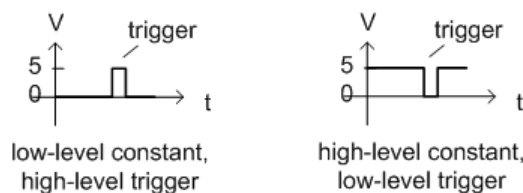

Remote command:

[OUTPut:TRIGger<tp>:LEVel](#) on page 237

### Pulse Length ← Output Type ← Trigger 2/3

Defines the duration of the pulse (pulse width) sent as a trigger to the output connector.

Remote command:

[OUTPut:TRIGger<tp>:PULSe:LENGth](#) on page 239

### Send Trigger ← Output Type ← Trigger 2/3

Sends a user-defined trigger to the output connector immediately.

Note that the trigger pulse level is always opposite to the constant signal level defined by the output [Level](#) setting. For example, for "Level" = "High", a constant high signal is output to the connector until you select the "Send Trigger" function. Then, a low pulse is sent.

Which pulse level is sent is indicated by a graphic on the button.

Remote command:

[OUTPut:TRIGger<tp>:PULSe:IMMediate](#) on page 238

## 7.7 Bandwidth and sweep settings

Access: "Overview" > "Bandwidth"

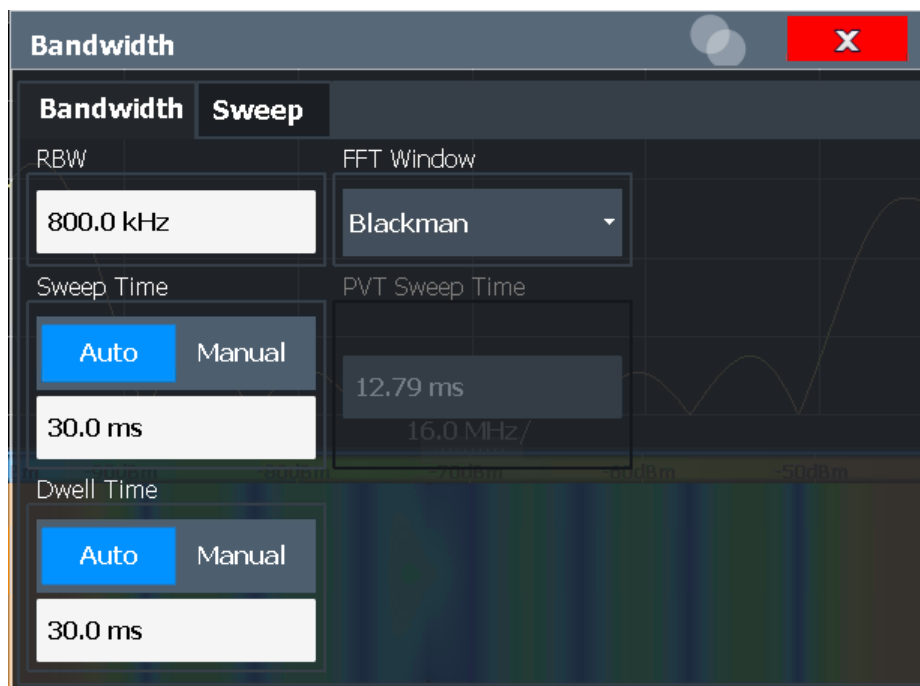

Figure 7-2: Bandwidth dialog box



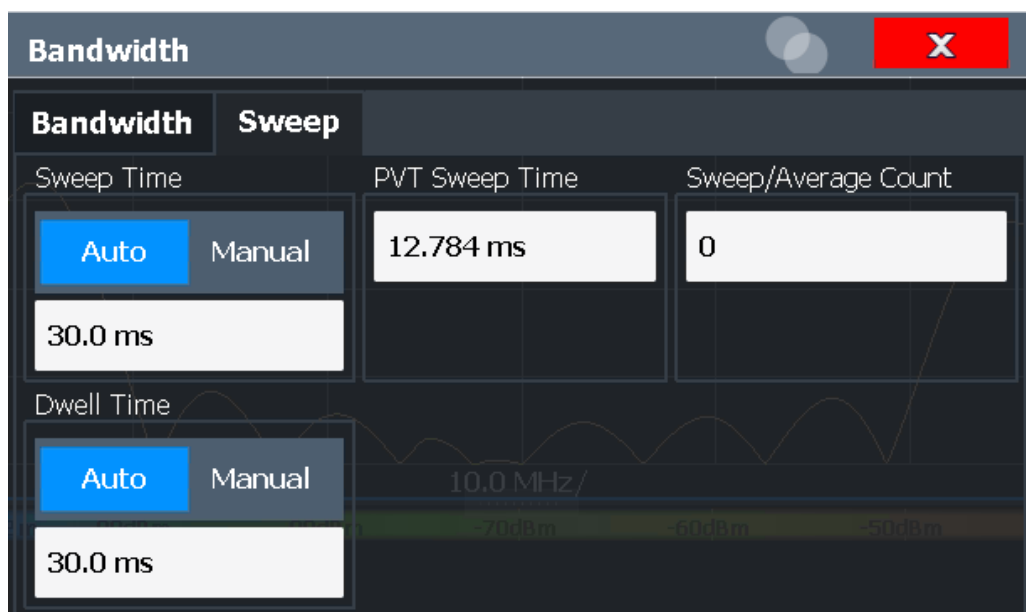

Figure 7-3: Sweep dialog box

RBW.....	105
FFT Window.....	105
Sweep Time.....	106
PVT Sweep Time.....	106
Dwell Time.....	106
Continuous Sweep / Run Cont.....	107
Single Sweep / Run Single.....	107
Selecting a frame to display.....	108
Sweep Count.....	108
Clear Spectrogram.....	109

### RBW

Defines the resolution bandwidth. The available resolution bandwidths are specified in the specifications document. Numeric input is always rounded to the nearest possible bandwidth according to the available Span/RBW coupling ratios.

Which coupling ratios are available depends on the selected [FFT Window](#).

The RBW can be defined independently of the selected span.

For more information see [Chapter 6.2, "Defining the resolution bandwidth"](#), on page 41.

Remote command:

`[SENSe:]BANDwidth[:RESolution]` on page 223

`[SENSe:]BANDwidth[:RESolution]:RATio` on page 223

### FFT Window

In the R&S FSW Real-Time Spectrum application you can select one of several FFT window types. The window type is coupled to the resolution bandwidth.

The following window types are available:

- Blackman

- Flattop
- Gaussian
- Rectangle
- Hanning
- Hamming
- Kaiser

Remote command:

[SENSe:] SWEEp:FFT:WINDow:TYPE on page 225

### Sweep Time

Determines the amount of time used to sample data for one spectrum. The sweep time can be defined automatically or manually.

The allowed sweep times depend on the device model; refer to the specifications document.

For more information see [Chapter 6.3, "Sweep time and detector"](#), on page 41.

"Auto"	The sweep time is coupled to the span and resolution bandwidth (RBW). If the span or resolution bandwidth is changed, the sweep time is automatically adjusted.
"Manual"	Define the sweep time manually. Allowed values depend on the coupling ratio of span to RBW. For details refer to the specifications document. Numeric input is always rounded to the nearest possible sweep time.

Remote command:

[SENSe:] SWEEp:TIME:AUTO on page 225

[SENSe:] SWEEp:TIME on page 225

### PVT Sweep Time

Determines the amount of time used to sample data for one power vs. time diagram. Note that the [Sweep Time](#) setting for results in the frequency domain and the PVT sweep time values are independent and may be different.

Remote command:

[SENSe:] SWEEp:TIME on page 225

### Dwell Time

Determines the amount of time used to sample a continuous stream of I/Q data. The stream is displayed as multiple rows in the spectrogram or waterfall diagrams (as opposed to the [Sweep Time](#), which defines the time to capture a *single* row in the diagrams). Dwell time is never applied for triggered measurements. It is only applied in single sweep mode or when the Sequencer is in continuous mode.

The dwell time can be defined automatically or manually.

For more information see [Chapter 6.3, "Sweep time and detector"](#), on page 41.

"Auto"	The dwell time is set to the maximum of: <ul style="list-style-type: none"><li>• <a href="#">"Sweep Time"</a> on page 106</li><li>• <a href="#">"PVT Sweep Time"</a> on page 106</li><li>• 30 ms</li></ul>
--------	--

"Manual" Define the dwell time manually. Values between 30 ms and 1 hour (3600 s) are allowed.

Remote command:

[SENSe:] SWEEp:DTIME:AUTO on page 224

[SENSe:] SWEEp:DTIME on page 224

### Continuous Sweep / Run Cont

After triggering, starts the measurement and repeats it continuously until stopped. This is the default setting.

While the measurement is running, "Continuous Sweep" and [RUN CONT] are highlighted. The running measurement can be aborted by selecting the highlighted softkey or key again. The results are not deleted until a new measurement is started.

**Note:** Sequencer. If the Sequencer is active, "Continuous Sweep" only controls the sweep mode for the currently selected channel. However, the sweep mode only takes effect the next time the Sequencer activates that channel, and only for a channel-defined sequence. In this case, a channel in continuous sweep mode is swept repeatedly.

If the Sequencer is active in MSRT mode, the "Continuous Sweep" function does not start data capturing. It merely affects trace averaging over multiple sequences. In this case, trace averaging is performed.

Furthermore, [RUN CONT] controls the Sequencer, not individual sweeps. [RUN CONT] starts the Sequencer in continuous mode.

For details on the Sequencer, see the FSW User Manual.

Remote command:

INITiate<n>:CONTinuous on page 263

### Single Sweep / Run Single

[RUN SINGLE] initiates a single measurement. If no trigger is used, data is captured for the defined **Dwell Time**, resulting in one or more spectrogram frames. Otherwise, the measurement starts after triggering and the measurement time is defined by the post- and pretrigger times. Can result in more than one frame.

While the measurement is running, "Single Sweep" and [RUN SINGLE] are highlighted. The running measurement can be aborted by selecting the highlighted softkey or key again.

**Note:** Sequencer. If the Sequencer is active, "Single Sweep" only controls the sweep mode for the currently selected channel. However, the sweep mode only takes effect the next time the Sequencer activates that channel, and only for a channel-defined sequence. In this case, the Sequencer sweeps a channel in single sweep mode only once.

If the Sequencer is active in MSRT mode, the "Single Sweep" function does not start data capturing. It merely affects trace averaging over multiple sequences. In this case, no trace averaging is performed.

Furthermore, [RUN SINGLE] controls the Sequencer, not individual sweeps. [RUN SINGLE] starts the Sequencer in single mode.

If the Sequencer is off, only the evaluation for the currently displayed channel is updated.

For details on the Sequencer, see the FSW User Manual.

Remote command:

`INITiate<n>[:IMMediate]` on page 264

### Selecting a frame to display

Selects a specific frame, loads the corresponding trace from the memory, and displays it in the "Real-Time Spectrum" or Power vs. Time window. Different frames can be displayed in the "Real-Time Spectrum" and Power vs. Time windows.

This function is only available in single sweep mode or if the sweep is stopped.

The most recent frame is number 0, all previous frames have a negative number.

Note that activating a marker or changing the position of the active marker automatically selects the frame that belongs to that marker.

The selected frame is indicated by small white arrows on the left and right border of the spectrogram/PVT waterfall.

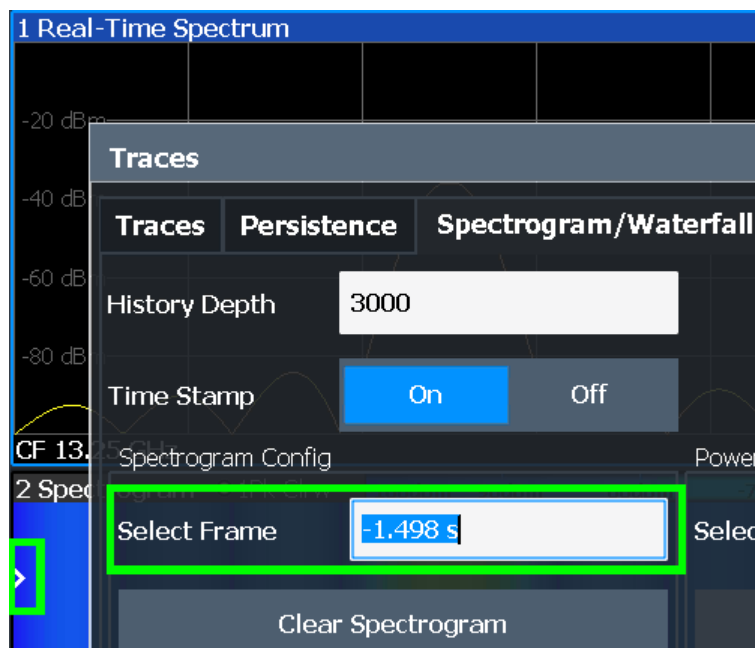

For more information see [Chapter 6.5.1, "Time frames"](#), on page 50.

Remote command:

`CALCulate<n>:SPECTrogram:FRAME:SElect` on page 240

### Sweep Count

Defines the number of measurements to be performed in the single sweep mode. Values from 0 to 200000 are allowed. If the values 0 or 1 are set, one measurement is performed. The sweep count is applied to all the traces in all "Real-Time Spectrum" and "Persistence Spectrum" diagrams.

If the trace configurations "Average", "Max Hold" or "Min Hold" are set, this value also determines the number of averaging or maximum search procedures.

In continuous sweep mode, if sweep count = 0 (default), averaging is performed over 10 sweeps. For sweep count = 1, no averaging, Max Hold or Min Hold operations are performed.

Remote command:

[SENSe:] SWEep:COUNT on page 223

### Clear Spectrogram

Resets the spectrogram result display and clears the history buffer.

This function is only available if a spectrogram is selected.

Remote command:

CALCulate<n>:SPECTrogram:CLEar[:IMMediate] on page 239

## 7.8 Adjusting settings automatically

**Access:** [AUTO SET]

Some settings can be adjusted by the FSW automatically according to the current measurement settings. In order to do so, a measurement is performed. The duration of this measurement can be defined automatically or manually.



### MSRT operating modes

In MSRT operating mode, settings related to data acquisition can only be adjusted automatically for the MSRT primary, not the applications.



### Adjusting settings automatically during triggered measurements

When you select an auto adjust function a measurement is performed to determine the optimal settings. If you select an auto adjust function for a triggered measurement, you are asked how the FSW should behave:

- (default:) The measurement for adjustment waits for the next trigger
- The measurement for adjustment is performed without waiting for a trigger.  
The trigger source is temporarily set to "Free Run". After the measurement is completed, the original trigger source is restored.

**Remote command:**

[SENSe:] ADJust:CONFigure:TRIGger on page 253

Adjusting all Determinable Settings Automatically (Auto All).....	109
Adjusting the Center Frequency Automatically (Auto Frequency).....	110
Setting the Reference Level Automatically (Auto Level).....	110
Resetting the Automatic Measurement Time (Meas Time Auto).....	110
Changing the Automatic Measurement Time (Meas Time Manual).....	110
Upper Level Hysteresis.....	110
Lower Level Hysteresis.....	111

### Adjusting all Determinable Settings Automatically (Auto All)

Activates all automatic adjustment functions for the current measurement settings, including:

- [Auto Frequency](#)

- **Auto Level**

**Note:** MSRT operating modes. In MSRT operating mode, this function is only available for the MSRT primary, not the secondary applications.

Remote command:

[SENSe:]ADJust:ALL on page 250

### **Adjusting the Center Frequency Automatically (Auto Frequency)**

The FSW adjusts the center frequency automatically.

The optimum center frequency is the frequency with the highest S/N ratio in the frequency span. As this function uses the signal counter, it is intended for use with sinusoidal signals.

Remote command:

[SENSe:]ADJust:FREquency on page 252

### **Setting the Reference Level Automatically (Auto Level)**

To determine the required reference level, a level measurement is performed on the FSW.

If necessary, you can optimize the reference level further. Decrease the attenuation level manually to the lowest possible value before an overload occurs, then decrease the reference level in the same way.

Remote command:

[SENSe:]ADJust:LEVel on page 253

### **Resetting the Automatic Measurement Time (Meas Time Auto)**

Resets the measurement duration for automatic settings to the default value.

Remote command:

[SENSe:]ADJust:CONFigure:LEVel:DURation:MODE on page 251

### **Changing the Automatic Measurement Time (Meas Time Manual)**

This function allows you to change the measurement duration for automatic setting adjustments. Enter the value in seconds.

**Note:** The maximum measurement duration depends on the currently selected measurement and the installed (optional) hardware. Thus, the measurement duration actually used to determine the automatic settings can be shorter than the value you define here.

Remote command:

[SENSe:]ADJust:CONFigure:LEVel:DURation:MODE on page 251

[SENSe:]ADJust:CONFigure:LEVel:DURation on page 251

### **Upper Level Hysteresis**

When the reference level is adjusted automatically using the **Auto Level** function, the internal attenuators and the preamplifier are also adjusted. To avoid frequent adaptation due to small changes in the input signal, you can define a hysteresis. This setting defines an upper threshold that the signal must exceed (compared to the last measurement) before the reference level is adapted automatically.

Remote command:

`[SENSe:]ADJust:CONFigure:HYSTeresis:UPPer` on page 252

#### **Lower Level Hysteresis**

When the reference level is adjusted automatically using the [Auto Level](#) function, the internal attenuators and the preamplifier are also adjusted. To avoid frequent adaptation due to small changes in the input signal, you can define a hysteresis. This setting defines a lower threshold that the signal must fall below (compared to the last measurement) before the reference level is adapted automatically.

Remote command:

`[SENSe:]ADJust:CONFigure:HYSTeresis:LOWer` on page 252

## 8 Configuring and performing measurements in MSRT mode

MSRT is a special operating mode on the FSW, which you activate using the [MODE] key on the front panel.

When you switch the operating mode of the FSW to MSRT mode the first time, the Sequencer is automatically activated in continuous mode (see [Chapter 8.4, "Performing a measurement in MSRT mode"](#), on page 113), starting a continuous "Real-Time Spectrum" sweep with the default settings. The "Real-Time Config" menu is displayed, providing access to the most important configuration functions.

- [Configuring the MSRT primary](#)..... 112
- [Trigger settings](#)..... 112
- [Data acquisition](#)..... 113
- [Performing a measurement in MSRT mode](#)..... 113

### 8.1 Configuring the MSRT primary

The MSRT primary is the only channel that captures data in MSRT mode. It also controls global configuration settings for all secondary applications. Thus, all settings that refer to data acquisition can only be configured in the MSRT Primary tab. These settings are deactivated in the configuration overviews and dialog boxes for all secondary application channels. All other settings, e.g. concerning the evaluated data range, the display configuration or analysis, can be configured individually for each secondary application and the primary.

In principle, the MSRT primary is configured just like as a "Real-Time Spectrum" application in Signal and Spectrum Analyzer mode (see [Chapter 7, "Configuring the R&S FSW Real-Time Spectrum application"](#), on page 76).



#### Restrictions

Note that although some restrictions apply to parameters that affect both the MSRT primary and secondary applications (see [Chapter 6.10.4, "Restrictions for secondary applications"](#), on page 75), it does not matter in which order you configure them. If any contradictions occur between the captured data and the data to be evaluated, error messages are displayed in the status bar of the secondary application and an icon (✖ or ⚠) is displayed next to the channel label. However, you will not be prevented from configuring contradictory settings.

### 8.2 Trigger settings

**Access:** "Overview" > "Trigger"



Trigger settings determine when the input signal is measured. These settings are only available for the MSRT primary.

See [Chapter 7.6, "Trigger configuration"](#), on page 93.

#### **Capture Offset**

This setting is only available for secondary applications in **MSRT operating mode**. It has a similar effect as the trigger offset in other measurements: it defines the time offset between the capture buffer start and the start of the extracted secondary application data.

In MSRT mode, the offset can be negative if a pretrigger time is defined.

For more information, see ["Trigger offset vs. capture offset"](#) on page 69.

Remote command:

MSRT mode:

`[SENSe:]RTMS:CAPTure:OFFSet` on page 344

## 8.3 Data acquisition

**Access:** "Overview" > "Bandwidth"

The data acquisition settings define which parts of the input signal are captured for further evaluation in the MSRT secondary applications.

See [Chapter 7.7, "Bandwidth and sweep settings"](#), on page 104.



Configuring data acquisition is only possible for the MSRT primary channel. In MSRT secondary application channels, these settings define the analysis interval (see ["Trigger offset vs. capture offset"](#) on page 69). Be sure to select the correct measurement channel before changing these settings.

**Remote command:**

To query the current analysis interval:

`CALCulate<n>:RTMS:WINDow<n>:IVAL` on page 343

## 8.4 Performing a measurement in MSRT mode

When you switch the operating mode of the FSW to MSRT mode the first time, the Sequencer is automatically activated in continuous mode (see [Chapter 8.4, "Performing a measurement in MSRT mode"](#), on page 113), starting a continuous "Real-Time Spectrum" sweep with the default settings.



The Sequencer behavior depends strongly on the trigger settings in MSRT mode (see [Chapter 6.10.3, "Using the sequencer in MSRT mode"](#), on page 73).

For details on the Sequencer function see the FSW User Manual.

### Manual measurement

To control the MSRT measurement manually, stop the Sequencer and switch between the primary and the secondary application tabs manually. Perform either a single sweep (using the [Single Sweep / Run Single](#) function), or a continuous sweep (using the [Continuous Sweep / Run Cont](#) function). The continuous sweep is stopped when you switch tabs.

If the Sequencer is deactivated, only the secondary application that is currently displayed when a measurement is performed is updated automatically. The other secondary applications must be updated manually using the "Refresh" functions (in the "Sequencer" menu or "Sweep" menu, see [Chapter 7.7, "Bandwidth and sweep settings"](#), on page 104).



The "Sequencer" menu is available from the toolbar.

### Sequencer State

Activates or deactivates the Sequencer. If activated, sequential operation according to the selected Sequencer mode is started immediately.

Remote command:

[SYSTem:SEQuencer](#) on page 266

[INITiate:SEQuencer:IMMediate](#) on page 264

[INITiate:SEQuencer:ABORT](#) on page 264

### Sequencer Mode

Defines how often which measurements are performed. The currently selected mode softkey is highlighted blue. During an active Sequencer process, the selected mode softkey is highlighted orange.

#### "Single Sequence"

Each measurement is performed once, until all measurements in all active channels have been performed.

#### "Continuous Sequence"

The measurements in each active channel are performed one after the other, repeatedly, in the same order, until sequential operation is stopped.

This is the default Sequencer mode.

In MSRT mode, the behavior of a continuous sequence depends on the trigger setting, see [Chapter 6.10.3, "Using the sequencer in MSRT mode"](#), on page 73.

Remote command:

[INITiate:SEQuencer:MODE](#) on page 265

### Refresh All

This function is only available if the Sequencer is deactivated, no sweep is currently running, and only in MSRT mode.

The data in the capture buffer is re-evaluated by all active secondary applications, for example after a new sweep was performed while the Sequencer was off.

**Note:** To update only the displays in the currently active secondary application, use the "Refresh" function in the "Sweep" menu for that secondary application (see "[Refresh \(MSRT only\)](#)" on page 115).

Remote command:

`INITiate:SEQuencer:REFresh[:ALL]` on page 265

#### **Refresh (MSRT only)**

This function is only available if the Sequencer is deactivated and only for **MSRT secondary applications**.

The data in the capture buffer is re-evaluated by the currently active secondary application only. The results for any other secondary applications remain unchanged.

This is useful, for example, after evaluation changes have been made or if a new sweep was performed from another secondary application. In this case, only that secondary application is updated automatically after data acquisition.

**Note:** To update all active secondary applications at once, use the "Refresh All" function in the "Sequencer" menu.

Remote command:

`INITiate<n>:REFresh` on page 343

## 9 Analysis

**Access:** "Overview" > "Analysis"

Specific result configuration for persistence and spectrogram or waterfall displays, as well as general result analysis settings concerning the trace, markers, windows etc. can be configured.



### Event-based actions

The R&S FSW Real-Time Spectrum application supports event-based actions, as described in the FSW User Manual.

See also [Chapter 6, "Real-time basics"](#), on page 37.

- [Display configuration](#)..... 116
- [Persistence spectrum settings](#)..... 116
- [Spectrogram and PVT waterfall settings](#)..... 119
- [Color map settings](#)..... 121
- [Trace settings](#)..... 123
- [Trace / data export configuration](#)..... 126
- [Trace math](#)..... 128
- [Marker usage](#)..... 130
- [Display and limit lines](#)..... 142
- [Zoom functions](#)..... 158
- [Analysis in MSRT secondary applications](#)..... 159

### 9.1 Display configuration



**Access:** [MEAS]

**Or:** "Overview" > "Display Config"

The captured signal can be displayed using various evaluation methods. All evaluation methods available for the "Real-Time Spectrum" application are displayed in the evaluation bar in SmartGrid mode.

Up to 6 evaluation methods can be displayed simultaneously in separate windows. The real-Time evaluation methods are described in [Chapter 5, "Measurements and result displays"](#), on page 27.



For details on working with the SmartGrid see the FSW Getting Started manual.

### 9.2 Persistence spectrum settings

**Access:** "Overview" > "Analysis" > "Persistence" tab

Or: [MEAS CONFIG] > "Persistence Config"

The persistence spectrum is highly configurable. You can change the colors with which the densities are visualized, the persistence of the data, and the style of the displayed results.

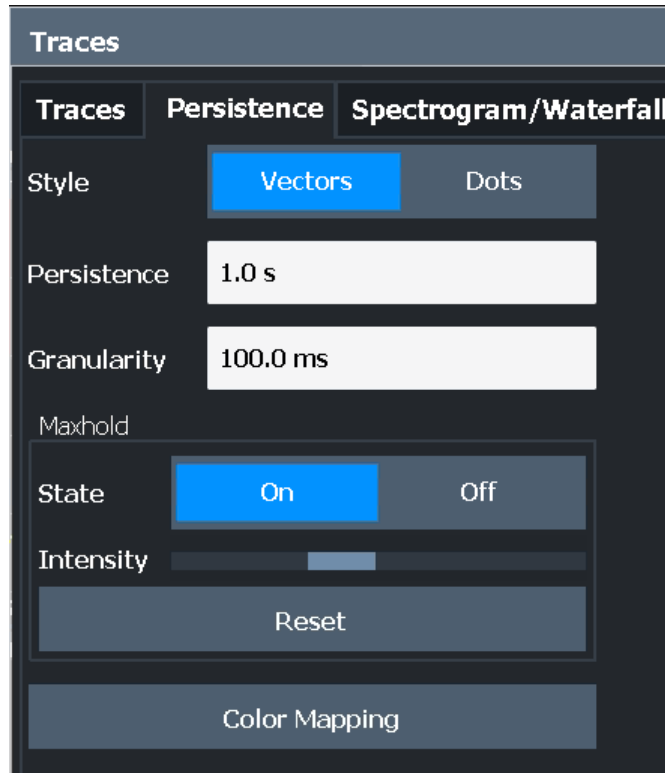

Diagram Style.....	117
Persistence.....	118
Granularity.....	118
Configuring the Max Hold Function.....	118
L Intensity.....	118
L Resetting the Max Hold Function.....	119
Color Mapping.....	119

### Diagram Style

The persistence spectrum can be displayed using vectors or dots.

For details see "[Matrix style](#)" on page 63.

- "Vectors"      Using vectors, the individual points - and thus the densities - are interpolated. The result is a persistence spectrum that contains no gaps between coordinates. Each point of the histogram is connected to the neighboring ones.
- "Dots"          Using dots, only those coordinates are displayed for which data has actually been measured. The result is a histogram made up out of individual points.

Remote command:

`DISPlay[:WINDow<n>][:SUBWindow<w>]:TRACe<t>:SYMBOL` on page 245

**Persistence**

Persistence defines the duration that shadows of past histogram traces remain visible in the display before fading away.

The number of traces that are considered when calculating the density depends on this persistence length.

For low persistence values, the density colors change quickly in the persistence spectrogram.

For high persistence values, the colors change slowly.

A value of 0 seconds deactivates persistence.

For details see [Chapter 6.6, "Understanding persistence"](#), on page 61.

Remote command:

`DISPlay[:WINDow<n>][:SUBWindow<w>]:TRACe<t>:PERSistence:DURation`  
on page 244

**Granularity**

Defines the amount of data that the FSW uses to draw a single frame in the persistence spectrum. By default, the moving density of the data that was captured in 100 ms is displayed for each frame.

For details see ["Persistence Granularity"](#) on page 62.

Remote command:

`DISPlay[:WINDow<n>][:SUBWindow<w>]:TRACe<t>:PERSistence:GRANularity`  
on page 244

**Configuring the Max Hold Function**

The Max Hold function remembers and shows the maximum densities that have been measured at each point in the diagram.

If activated, the maximum values from all past sweeps are indicated in the persistence spectrum, together with the measured values from the current sweep.

**Note:** Setting the [Intensity](#) to 0 has the same effect as deactivating the Max Hold function.

For details see [Chapter 6.6.1, "Analyzing maximum density - Max hold function"](#), on page 65.

Remote command:

`DISPlay[:WINDow<n>][:SUBWindow<w>]:TRACe<t>:MAXHold[:STATe]`  
on page 243

**Intensity ← Configuring the Max Hold Function**

The maximum values (that is, the Max Hold trace) are displayed in the defined intensity. The higher the intensity, the brighter the maximum values are displayed. With maximum intensity, the maximum values are displayed just as bright as the currently measured values.

**Note:** Setting the intensity to 0 has the same effect as deactivating the Max Hold function.

To change the intensity, move the slider to the left (weaker) or right (stronger).

Note that while the intensity of the Max Hold trace may differ to the currently measured trace, the color *mapping* is the same for both traces.

Remote command:

```
DISPlay[:WINDow<n>][:SUBWindow<w>]:TRACe<t>:MAXHold:INTensity
```

on page 243

### Resetting the Max Hold Function ← Configuring the Max Hold Function

The previous results of the Max Hold function are cleared and the function starts determining new maximum values.

Remote command:

```
DISPlay[:WINDow<n>][:SUBWindow<w>]:TRACe<t>:MAXHold:RESet
```

on page 242

### Color Mapping

Opens the "Color Map" dialog.

For details see [Chapter 9.4, "Color map settings"](#), on page 121.

## 9.3 Spectrogram and PVT waterfall settings

**Access:** "Overview" > "Analysis" > "Spectrogram/Waterfall" tab

**Or:** [MEAS CONFIG] > "Spectrogram/Waterfall Config"

The individual settings available for spectrogram and waterfall displays are described here. For settings on color mapping, see [Chapter 9.4, "Color map settings"](#), on page 121.

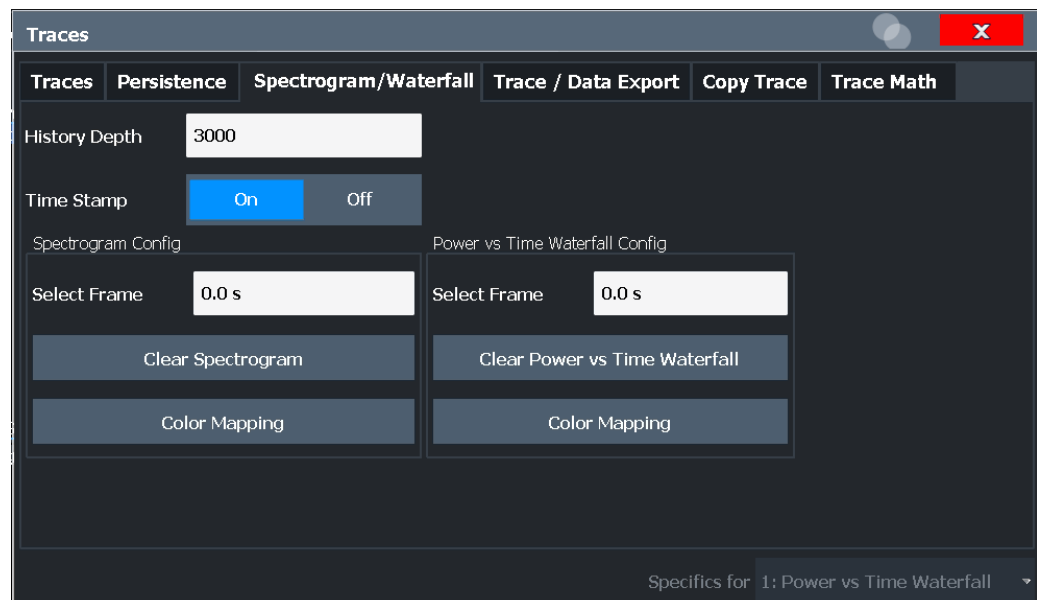

<a href="#">History Depth</a> .....	120
<a href="#">Time Stamp</a> .....	120
<a href="#">Selecting a frame to display</a> .....	120

Clear Spectrogram.....	121
Clear Power vs. Time Waterfall.....	121
Color Mapping.....	121

### History Depth

Sets the number of frames that the FSW stores in its memory. The maximum history depth is 100.000 frames.

If the memory is full, the FSW deletes the oldest frames stored in the memory and replaces them with the new data.

Remote command:

`CALCulate<n>:SPECTrogram:HDEPth` on page 240

### Time Stamp

Activates and deactivates the time stamp. If activated (default), the time stamp shows the system time while the measurement is running. In single sweep mode or if the sweep is stopped, the time stamp shows the time and date at the end of the sweep.

Individual frames are referred to by their time difference to the end of the sweep.

If deactivated, individual frames are referred to by their frame number in the spectrogram and waterfall diagrams.

For details see "[Time stamps vs. frame index](#)" on page 52.

Remote command:

`CALCulate<n>:SPECTrogram:TSTamp[:STATe]` on page 241

`CALCulate<n>:SPECTrogram:TSTamp:DATA?` on page 241

### Selecting a frame to display

Selects a specific frame, loads the corresponding trace from the memory, and displays it in the "Real-Time Spectrum" or Power vs. Time window. Different frames can be displayed in the "Real-Time Spectrum" and Power vs. Time windows.

This function is only available in single sweep mode or if the sweep is stopped.

The most recent frame is number 0, all previous frames have a negative number.

Note that activating a marker or changing the position of the active marker automatically selects the frame that belongs to that marker.

The selected frame is indicated by small white arrows on the left and right border of the spectrogram/PVT waterfall.



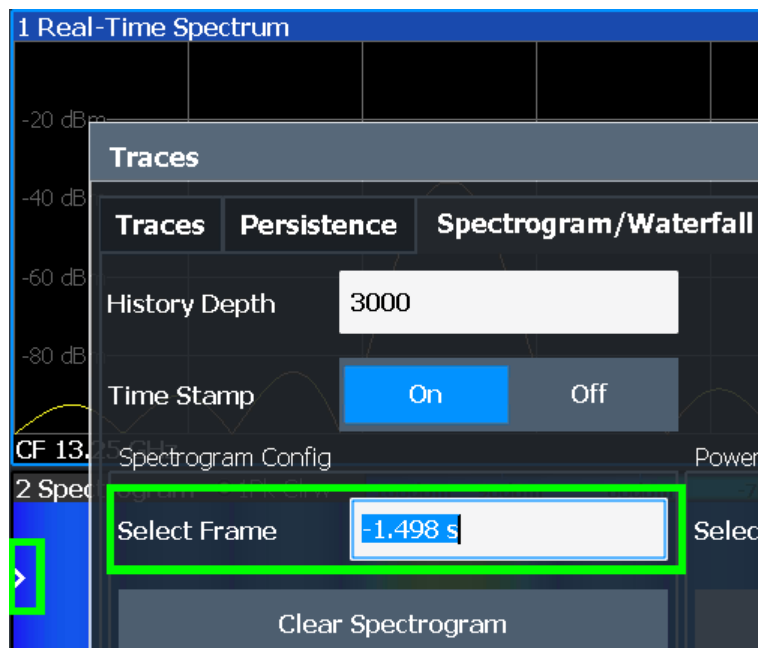

For more information see [Chapter 6.5.1, "Time frames"](#), on page 50.

Remote command:

[CALCulate<n>:SPECTrogram:FRAME:SElect](#) on page 240

#### Clear Spectrogram

Resets the spectrogram result display and clears the history buffer.

This function is only available if a spectrogram is selected.

Remote command:

[CALCulate<n>:SPECTrogram:CLEar\[:IMMEDIATE\]](#) on page 239

#### Clear Power vs. Time Waterfall

Resets the Power vs. Time Waterfall result display and clears the history buffer.

Remote command:

[CALCulate<n>:SPECTrogram:CLEar\[:IMMEDIATE\]](#) on page 239

#### Color Mapping

Opens the "Color Map" dialog.

For details see [Chapter 9.4, "Color map settings"](#), on page 121.

## 9.4 Color map settings

**Access:** [MEAS CONFIG] > "Color Mapping"

The settings for color maps are available for spectrograms, persistence spectra, and waterfall displays.

For more information on color maps see [Chapter 6.5.3, "Color maps"](#), on page 53.

For details on changing color map settings see [Chapter 11.4, "How to configure the color mapping"](#), on page 169.

In addition to the available color settings, the dialog box displays the current color map and provides a preview of the display with the current settings.

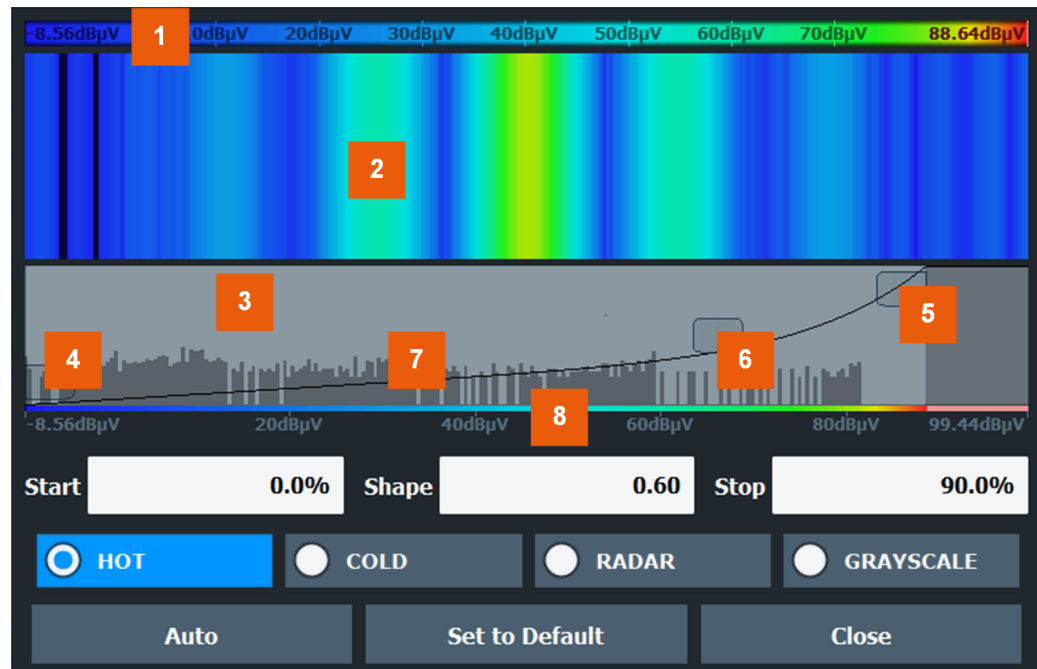

**Figure 9-1: Color Mapping dialog box**

- 1 = Color map: shows the current color distribution
- 2 = Preview pane: shows a preview of the diagram with any changes that you make to the color scheme
- 3 = Color curve pane: graphical representation of all settings available to customize the color scheme
- 4/5 = Color range start and stop sliders: define the range of the color map or amplitudes for the spectrogram
- 6 = Color curve slider: adjusts the focus of the color curve
- 7 = Histogram: shows the distribution of measured values
- 8 = Scale of the horizontal axis (value range)

### Start / Stop

Defines the lower and upper boundaries of the value range of the diagram.

Remote command:

`DISPlay[:WINDow<n>]:SPECTrogram:COLor:LOWer` on page 249

`DISPlay[:WINDow<n>]:SPECTrogram:COLor:UPPer` on page 250

`DISPlay[:WINDow<n>]:PSpectrum:COLor:LOWer` on page 246

`DISPlay[:WINDow<n>]:PSpectrum:COLor:UPPer` on page 247

### Shape

Defines the shape and focus of the color curve for the spectrogram result display.

- "-1 to <0" More colors are distributed among the lower values
- "0" Colors are distributed linearly among the values
- ">0 to 1" More colors are distributed among the higher values

Remote command:

[DISPlay\[:WINDow<n>\]:SPEctrogram:COLor:SHApe](#) on page 249

[DISPlay\[:WINDow<n>\]:PSpectrum:COLor:SHApe](#) on page 246

### Truncate

This command is available for "Persistence Spectrum" only.

By default, results that are smaller than the start value of the color map range are displayed in the color for the minimum value. Results that are larger than the stop value of the color map range are displayed in the color for the maximum value.

If the "Truncate" function is activated, the results of the persistence spectrum outside the value range of the color map are truncated, that is, not displayed.

Remote command:

[DISPlay\[:WINDow<n>\]:PSpectrum:COLor:TRUNcate](#) on page 247

### Hot/Cold/Radar/Grayscale

Sets the color scheme for the spectrogram.

Remote command:

[DISPlay\[:WINDow<n>\]:SPEctrogram:COLor\[:STYLE\]](#) on page 248

[DISPlay\[:WINDow<n>\]:PSpectrum:COLor\[:STYLE\]](#) on page 248

### Auto

Defines the color range automatically according to the existing measured values for optimized display.

### Set to Default

Sets the color map to the default settings.

Remote command:

[DISPlay\[:WINDow<n>\]:SPEctrogram:COLor:DEFault](#) on page 249

[DISPlay\[:WINDow<n>\]:PSpectrum:COLor:DEFault](#) on page 246

## 9.5 Trace settings

**Access:** "Overview" > "Analysis" > "Traces" tab

The trace settings determine how the measured data is analyzed and displayed in the window. Depending on the result display, between 1 and 4 traces may be displayed.



Trace data can also be exported to an ASCII file for further analysis. For details see [Chapter 9.6, "Trace / data export configuration"](#), on page 126.

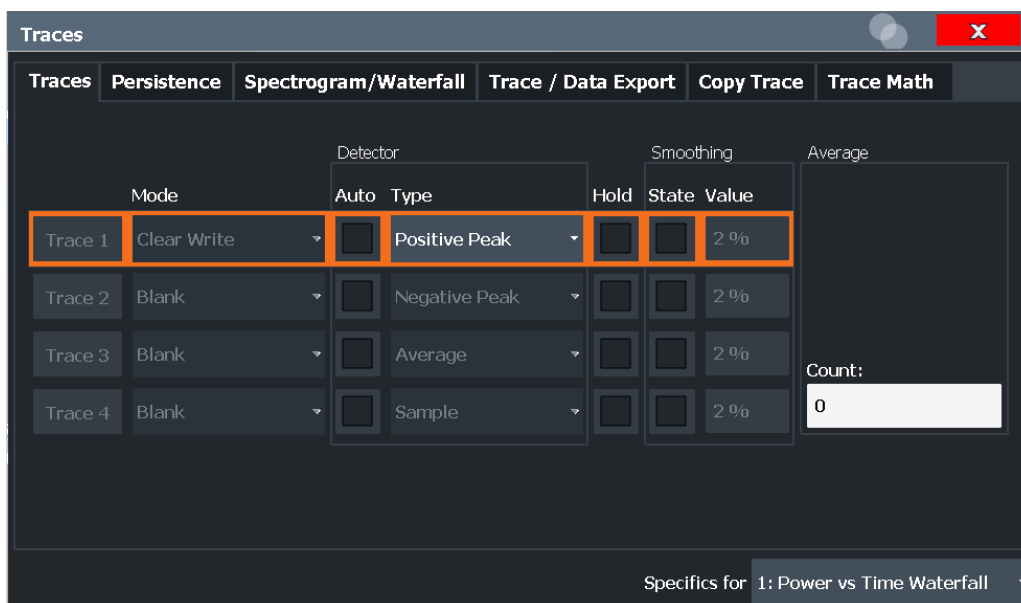

Trace 1/Trace 2/Trace 3/Trace 4..... 124

Mode..... 124

Detector..... 125

Hold..... 125

Smoothing..... 126

Average Count..... 126

Trace 1/ Trace 2/ Trace 3/ Trace 4 (Softkeys)..... 126

Copy Trace..... 126

**Trace 1/Trace 2/Trace 3/Trace 4**

Selects the corresponding trace for configuration. The currently selected trace is highlighted orange.

Remote command:

`DISPlay[:WINDow<n>][:SUBWindow<w>]:TRACe<t>[:STATe]` on page 282

Selected via numeric suffix of `TRACe<t>` commands

**Mode**

Defines the update mode for subsequent traces.

- "Clear Write" Overwrite mode: the trace is overwritten by each sweep. This is the default setting.
- "Max Hold" The maximum value is determined over several sweeps and displayed. The FSW saves the sweep result in the trace memory only if the new value is greater than the previous one.
- "Min Hold" The minimum value is determined over several sweeps and displayed. The FSW saves the sweep result in the trace memory only if the new value is greater than the previous one.
- "View" The current contents of the trace memory are frozen and displayed.
- "Blank" Removes the selected trace from the display.

Remote command:

`DISPlay[:WINDow<n>][:SUBWindow<w>]:TRACe<t>:MODE` on page 281

### Detector

Defines the trace detector to be used for trace analysis.

Detectors perform a data reduction from the swept values to the displayed trace points. The detector type determines which of the samples are displayed for each trace point.

**Note:** The detector activated for the specific trace is indicated in the corresponding trace information in the window title bar by an abbreviation.

The trace detector can analyze the measured data using various methods:

"Positive Peak"	Determines the largest of all positive peak values from the levels measured at the individual x-values which are displayed in one trace point
"Negative Peak"	Determines the smallest of all negative peak values from the levels measured at the individual x-values which are displayed in one trace point
"Average"	Calculates the linear average of all samples contained in a sweep point. To this effect, FSW uses the linear voltage after envelope detection. The sampled linear values are summed up and the sum is divided by the number of samples (= linear average value). Each sweep point thus corresponds to the average of the measured values summed up in the sweep point. The average detector supplies the average value of the signal irrespective of the waveform (CW carrier, modulated carrier, white noise or impulsive signal).
"Sample"	Selects the last measured value of the levels measured at the individual x-values which are displayed in one trace point; all other measured values for the x-axis range are ignored
"Persistence"	The "Persistence Spectrogram" display does not require a detector. It evaluates the individual FFTs (see <a href="#">Chapter 6.6, "Understanding persistence"</a> , on page 61). The "Persistence" detector is indicated only to distinguish the traces in the "Persistence Spectrogram".

Remote command:

`[SENSe:] [WINDow:] DETector<t>[:FUNction]` on page 284

### Hold

If activated, traces in "Min Hold", "Max Hold" and "Average" mode are not reset after specific parameter changes have been made.

Normally, the measurement is started again after parameter changes, before the measurement results are analyzed (e.g. using a marker). In all cases that require a new measurement after parameter changes, the trace is reset automatically to avoid false results (e.g. with span changes). For applications that require no reset after parameter changes, the automatic reset can be switched off.

The default setting is off.

Remote command:

`DISPlay[:WINDow<n>][:SUBWindow<w>]:TRACe<t>:MODE:HCONTinuous`  
on page 281

### Smoothing

If enabled, the trace is smoothed by the specified value (between 1 % and 50 %). The smoothing value is defined as a percentage of the display width. The larger the smoothing value, the greater the smoothing effect.

Remote command:

`DISPlay[:WINDow<n>][:SUBWindow<w>]:TRACe<t>:SMOothing[:STATe]`  
on page 283

`DISPlay[:WINDow<n>][:SUBWindow<w>]:TRACe<t>:SMOothing:APERture`  
on page 282

### Average Count

Determines the number of averaging or maximum search procedures If the trace modes "Average", "Max Hold" or "Min Hold" are set.

In continuous measurement mode, if sweep count = 0 (default), averaging is performed over 10 measurements. For sweep count =1, no averaging, Max Hold or Min Hold operations are performed.

Remote command:

`[SENSe:]AVERAge<n>:COUNT` on page 283

### Trace 1/ Trace 2/ Trace 3/ Trace 4 (Softkeys)

Displays the "Traces" settings and focuses the "Mode" list for the selected trace.

Remote command:

`DISPlay[:WINDow<n>][:SUBWindow<w>]:TRACe<t>[:STATe]` on page 282

### Copy Trace

**Access:** "Overview" > "Analysis" > "Traces" > "Copy Trace"

**Or:** [TRACE] > "Copy Trace"

Copies trace data to another trace.

The first group of buttons (labeled "Trace 1" to "Trace 4") selects the source trace. The second group of buttons (labeled "Copy to Trace 1" to "Copy to Trace 4") selects the destination.

Remote command:

`TRACe<n>:COPY` on page 284

## 9.6 Trace / data export configuration



**Access:** "Save" > "Export" > "Export Configuration"

**Or:** "Overview" > "Analysis" > "Trace Export"

**Or:** [TRACE] > "Trace Config" > "Trace / Data Export"



The standard data management functions (e.g. saving or loading instrument settings) that are available for all FSW applications are not described here.

See the FSW base unit user manual for a description of the standard functions.

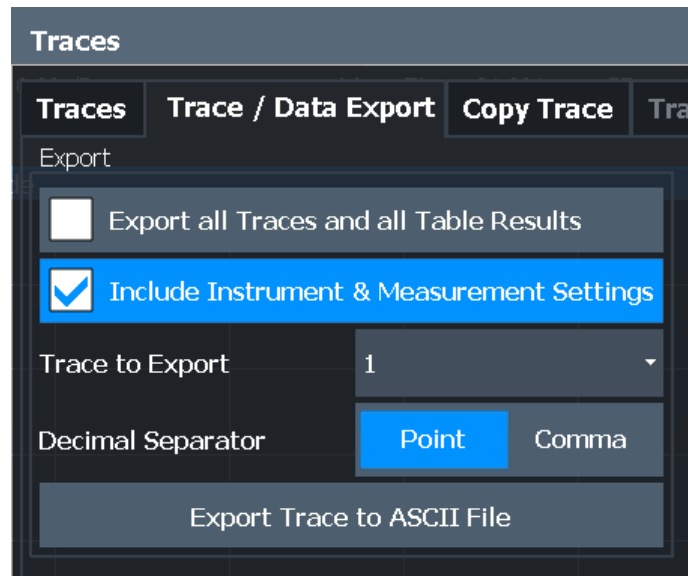

Export all Traces and all Table Results.....	127
Include Instrument & Measurement Settings.....	127
Trace to Export.....	127
Decimal Separator.....	128
Export Trace to ASCII File.....	128

#### Export all Traces and all Table Results

Selects all displayed traces and result tables (e.g. "Result Summary", marker table etc.) in the current application for export to an ASCII file.

Alternatively, you can select one specific trace only for export (see [Trace to Export](#)).

The results are output in the same order as they are displayed on the screen: window by window, trace by trace, and table row by table row.

Remote command:

`FORMat:DEXPort:TRACes` on page 275

#### Include Instrument & Measurement Settings

Includes additional instrument and measurement settings in the header of the export file for result data.

Remote command:

`FORMat:DEXPort:HEADer` on page 275

#### Trace to Export

Defines an individual trace to be exported to a file.

This setting is not available if [Export all Traces and all Table Results](#) is selected.

**Decimal Separator**

Defines the decimal separator for floating-point numerals for the data export/import files. Evaluation programs require different separators in different languages.

Remote command:

[FORMat:DEXPort:DSEParator](#) on page 274

**Export Trace to ASCII File**

Opens a file selection dialog box and saves the selected trace in ASCII format (.dat) to the specified file and directory.

The results are output in the same order as they are displayed on the screen: window by window, trace by trace, and table row by table row.

If the spectrogram display is selected when you perform this function, the entire histogram buffer with all frames is exported to a file. The data for a particular frame begins with information about the frame number and the time that frame was recorded. For large history buffers the export operation can take some time.

**Note:** Secure user mode.

In secure user mode, settings that are stored on the instrument are stored to volatile memory, which is restricted to 256 MB. Thus, a "memory limit reached" error can occur although the hard disk indicates that storage space is still available.

To store data permanently, select an external storage location such as a USB memory device.

For details, see "Protecting Data Using the Secure User Mode" in the "Data Management" section of the FSW base unit user manual.

Remote command:

[MMEMory:STORe<n>:TRACe](#) on page 274

## 9.7 Trace math

**Access:** [TRACE] > "Trace Math"

**Or:** "Overview" > "Analysis" > "Traces" > "Trace Math"

If you have several traces with different modes, for example an average trace and a maximum trace, it may be of interest to compare the results of both traces. In this example, you could analyze the maximum difference between the average and maximum values. To analyze the span of result values, you could subtract the minimum trace from the maximum trace. For such tasks, the results from several traces can be combined using mathematical functions.

Trace math functions are not available for "Persistence Spectrum" displays.



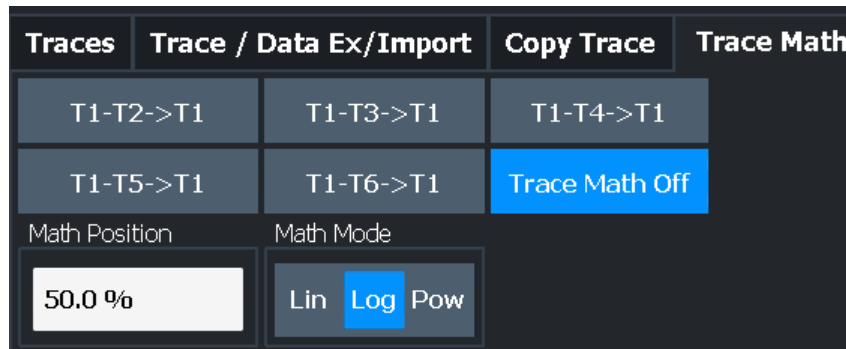

<a href="#">Trace Math Function</a> .....	129
<a href="#">Trace Math Off</a> .....	129
<a href="#">Trace Math Position</a> .....	129
<a href="#">Trace Math Mode</a> .....	129

### Trace Math Function

You can select one of several different math operations.

Each operation subtracts one trace from another as indicated on the corresponding button and writes the result to one of the traces. "T1 - T3 > T1", for example, subtracts trace 3 from trace 1 and writes the result to trace 1. You can apply one operation at a time.

The result refers to the zero point defined with the [Trace Math Position](#) setting. The following subtractions can be performed:

"T1-T2->T1"	Subtracts trace 2 from trace 1.
"T1-T3->T1"	Subtracts trace 3 from trace 1
"T1-T4->T1"	Subtracts trace 4 from trace 1

To switch off the trace math, use the [Trace Math Off](#) button.

Remote command:

[CALCulate<n>:MATH<t>\[:EXPRession\] \[:DEFine\]](#) on page 285

[CALCulate<n>:MATH<t>:STATe](#) on page 286

### Trace Math Off

Deactivates any previously selected trace math functions.

Remote command:

CALC:MATH:STAT OFF, see [CALCulate<n>:MATH<t>:STATe](#) on page 286

### Trace Math Position

Defines the zero point on the y-axis of the resulting trace in % of the diagram height. The range of values extends from -100 % to +200 %.

Remote command:

[CALCulate<n>:MATH<t>:POSition](#) on page 286

### Trace Math Mode

Defines the mode for the trace math calculations.

"Lin"	<p>Activates linear subtraction, which means that the power level values are converted into linear units prior to subtraction. After the subtraction, the data is converted back into its original unit.</p> <p>This setting takes effect if the grid is set to a linear scale. In this case, subtraction is done in two ways (depending on the set unit):</p> <ul style="list-style-type: none"> <li>• The unit is set to either W or dBm: the data is converted into W prior to subtraction, i.e. averaging is done in W.</li> <li>• The unit is set to either V, A, dBmV, dBμV, dBμA or dBpW: the data is converted into V prior to subtraction, i.e. subtraction is done in V.</li> </ul>
"Log"	<p>Activates logarithmic subtraction.</p> <p>This subtraction method only takes effect if the grid is set to a logarithmic scale, i.e. the unit of the data is dBm. In this case the values are subtracted in dBm. Otherwise (i.e. with linear scaling) the behavior is the same as with linear subtraction.</p>
"Power"	<p>Activates linear power subtraction.</p> <p>The power level values are converted into unit Watt prior to subtraction. After the subtraction, the data is converted back into its original unit.</p> <p>Unlike the linear mode, the subtraction is always done in W.</p>

Remote command:

[CALCulate<n>:MATH<t>:MODE](#) on page 285

## 9.8 Marker usage

**Access:** "Overview" > "Analysis" > "Marker" tab

- [Individual marker setup](#)..... 130
- [General marker settings](#)..... 134
- [Marker search settings](#)..... 136
- [Positioning functions](#)..... 139
- [Example: defining a delta marker in a persistence spectrum](#)..... 141

### 9.8.1 Individual marker setup

**Access:** "Overview" > "Analysis" > "Marker" tab > "Markers" tab

**Or:** [MKR] > "Marker Config"

Up to 17 markers or delta markers can be activated for each window simultaneously.

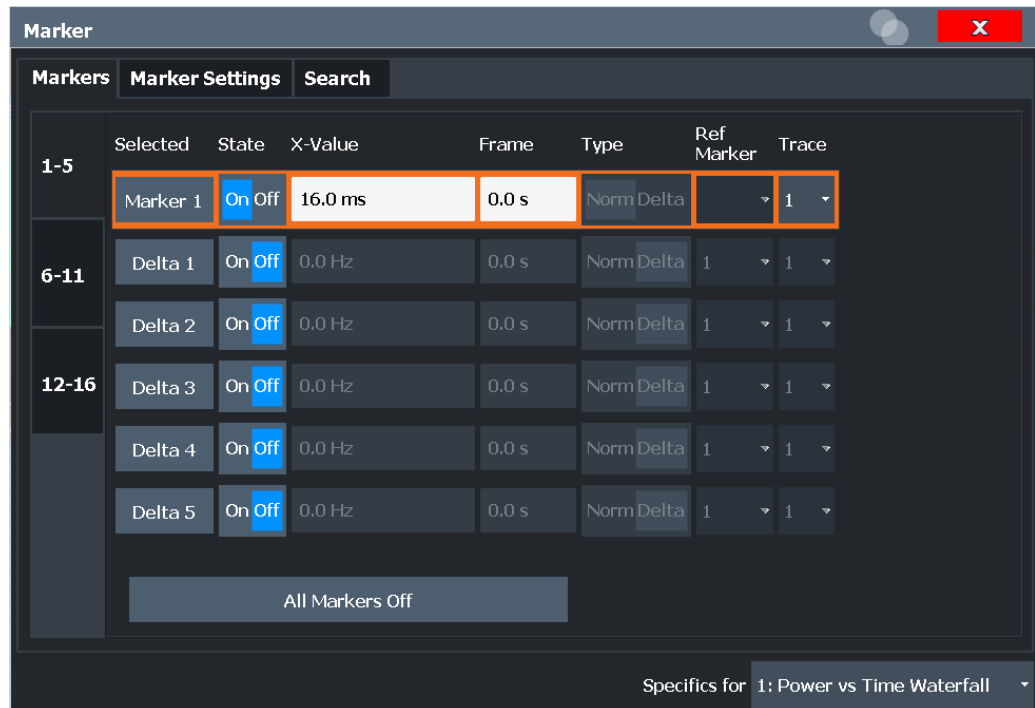

The markers are distributed among 3 tabs for a better overview. By default, the first marker is defined as a normal marker, whereas all others are defined as delta markers with reference to the first marker. All markers are assigned to trace 1, but only the first marker is active.

<a href="#">Selected Marker</a> .....	131
<a href="#">Marker State</a> .....	131
<a href="#">Marker Position X-value</a> .....	132
<a href="#">Marker Level (Y-value)</a> .....	132
<a href="#">Frame</a> .....	132
<a href="#">Marker Type</a> .....	132
<a href="#">Reference Marker</a> .....	132
<a href="#">Assigning the Marker to a Trace</a> .....	133
<a href="#">Select Marker</a> .....	133
<a href="#">All Markers Off</a> .....	133

### Selected Marker

Marker name. The marker which is currently selected for editing is highlighted orange.

Remote command:

Marker selected via suffix <m> in remote commands.

### Marker State

Activates or deactivates the marker in the diagram.

Remote command:

`CALCulate<n>:MARKer<m>[:STATe]` on page 287

`CALCulate<n>:DELTAmarker<m>[:STATe]` on page 291

**Marker Position X-value**

Defines the position (x-value) of the marker in the diagram. For normal markers, the absolute position is indicated. For delta markers, the position relative to the reference marker is provided.

Remote command:

[CALCulate<n>:MARKer<m>:X](#) on page 288

[CALCulate<n>:DELTAmarker<m>:X](#) on page 291

**Marker Level (Y-value)**

Defines the level (y-value) of the marker in the "Persistence Spectrum" diagram.

Remote command:

[CALCulate<n>:MARKer<m>:Y?](#) on page 289

[CALCulate<n>:DELTAmarker<m>:Y?](#) on page 292

**Frame**

"Spectrogram" frame number the marker is assigned to. The most recently swept frame is number 0, all previous frames have negative numbers.

The selected frame is indicated by small white arrows on the left and right border of the spectrogram/PVT waterfall.

Remote command:

[CALCulate<n>:MARKer<m>:SPECTrogram:FRAME](#) on page 306

**Marker Type**

Toggles the marker type.

The type for marker 1 is always "Normal", the type for delta marker 1 is always "Delta". These types cannot be changed.

**Note:** If normal marker 1 is the active marker, switching the "Mkr Type" activates an additional delta marker 1. For any other marker, switching the marker type does not activate an additional marker, it only switches the type of the selected marker.

"Normal"            A normal marker indicates the absolute value at the defined position in the diagram.

"Delta"             A delta marker defines the value of the marker relative to the specified reference marker (marker 1 by default).

Remote command:

[CALCulate<n>:MARKer<m>\[:STATe\]](#) on page 287

[CALCulate<n>:DELTAmarker<m>\[:STATe\]](#) on page 291

**Reference Marker**

Defines a marker as the reference marker which is used to determine relative analysis results (delta marker values).

If the reference marker is deactivated, the delta marker referring to it is also deactivated.

Remote command:

[CALCulate<n>:DELTAmarker<m>:MREference](#) on page 290

### Assigning the Marker to a Trace

The "Trace" setting assigns the selected marker to an active trace. The trace determines which value the marker shows at the marker position. If the marker was previously assigned to a different trace, the marker remains on the previous frequency or time, but indicates the value of the new trace.

**Note:** Markers in the persistence spectrum.

In the persistence spectrum result display, you can place each marker on one of the following traces:

- Trace 1: **Clear/write** positive peak (**Spectrum**) trace
- Trace 2: **Clear/write persistence** trace
- Trace 3: **Max Hold persistence** trace

Markers on the persistence traces are 2-dimensional markers defined by a frequency and level value. The marker result indicates the probability of appearance for the frequency/level pair. For details, see [Chapter 6.6, "Understanding persistence"](#), on page 61.

If a trace is turned off, the assigned markers and marker functions are also deactivated.

Remote command:

`CALCulate<n>:MARKer<m>:TRACe` on page 288

### Select Marker

The "Select Marker" function opens a dialog box to select and activate or deactivate one or more markers quickly.



Remote command:

`CALCulate<n>:MARKer<m>[:STATe]` on page 287

`CALCulate<n>:DELTAmarker<m>[:STATe]` on page 291

### All Markers Off

Deactivates all markers in one step.

Remote command:

[CALCulate<n>:MARKer<m>:AOFF](#) on page 287

## 9.8.2 General marker settings

**Access:** "Overview" > "Analysis" > "Marker" tab > "Marker Settings" tab

**Or:** [MKR] > "Marker Config" > "Marker Settings" tab

Some general marker settings allow you to influence the marker behavior for all markers.

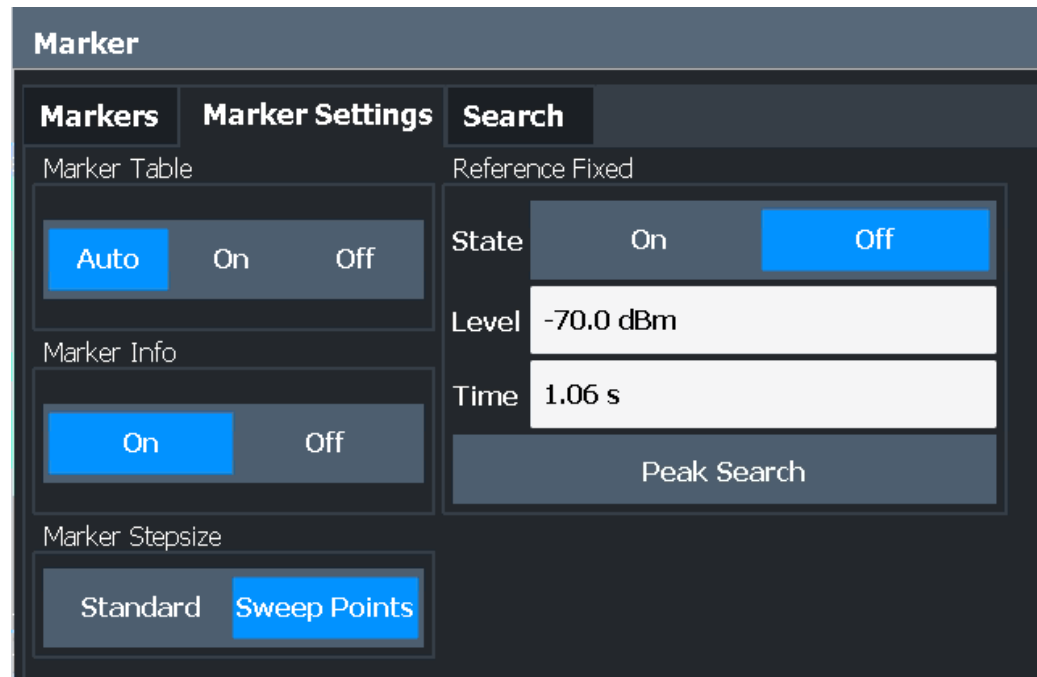

<a href="#">Marker Table Display</a> .....	134
<a href="#">Marker Info</a> .....	135
<a href="#">Marker Stepsize</a> .....	135
<a href="#">Defining a Fixed Reference</a> .....	135

### Marker Table Display

Defines how the marker information is displayed.

"On"	Displays the marker information in a table in a separate area beneath the diagram.
"Off"	No separate marker table is displayed. If <a href="#">Marker Info</a> is active, the marker information is displayed within the diagram area.
"Auto"	(Default) If more than two markers are active, the marker table is displayed automatically. If <a href="#">Marker Info</a> is active, the marker information for up to two markers is displayed in the diagram area.

Remote command:

`DISPlay[:WINDow<n>]:MTABLE` on page 295

### Marker Info

Turns the marker information displayed in the diagram on and off.

1AP Clrw	
M1[1]	81.13 dBµV 177.610 MHz
D2[1]	-22.18 dB -28.980 MHz

Remote command:

`DISPlay[:WINDow<n>]:MINFo[:STATe]` on page 295

### Marker Stepsize

Defines the size of the steps that the marker position is moved using the rotary knob.

"Standard"	The marker position is moved in steps of (Span/1000), which corresponds approximately to the number of pixels for the default display of 1001 measurement points. This setting is most suitable to move the marker over a larger distance.
"Sweep Points"	The marker position is moved from one sweep point to the next. This setting is required for a very precise positioning if more sweep points are collected than the number of pixels that can be displayed on the screen. It is the default mode.

Remote command:

`CALCulate<n>:MARKer<m>:X:SSIZE` on page 294

### Defining a Fixed Reference

Instead of using a reference marker whose position can vary depending on the measurement results, you can define a fixed reference marker for trace analysis.

Note that this function is not available in all result displays.

**Note:** Markers in the "Persistence Spectrum". In particular, fixed reference markers are not required and not supported in "Persistence Spectrum" displays. For details see ["Persistence Spectrum"](#) on page 31.

For "State" = "On", a vertical and a horizontal red display line are displayed, marked as "FXD". The normal marker 1 is activated and set to the peak value of the trace assigned to marker 1, and a delta marker to the next peak. The fixed reference marker is set to the position of marker 1 at the peak value. The delta marker refers to the fixed reference marker.

The "Level" and "Frequency" or "Time" settings define the position and value of the reference marker. To move the fixed reference, move the red display lines marked "FXD" in the diagram, or change the position settings in the "Marker Settings" tab of the "Marker" dialog box.

**Peak Search** sets the fixed reference marker to the current maximum value of the trace assigned to marker 1.

If activated, the fixed reference marker ("FXD") can also be selected as a [Reference Marker](#) instead of another marker.

Remote command:

`CALCulate<n>:DELTamarker<m>:FUNction:FIXed[:STATe]` on page 292

`CALCulate<n>:DELTamarker<m>:FUNction:FIXed:RPOint:Y` on page 294

`CALCulate<n>:DELTamarker<m>:FUNction:FIXed:RPOint:X` on page 293

`CALCulate<n>:DELTamarker<m>:FUNction:FIXed:RPOint:MAXimum[:PEAK]` on page 293

### 9.8.3 Marker search settings

**Access:** "Overview" > "Analysis" > "Marker" tab > "Search" tab

**Or:** [MKR ->] > "Search Config"

Spectrograms show not only the current sweep results, but also the sweep history. Thus, when searching for peaks, you must define the search settings within a single time frame (x-direction) and within several time frames (y-direction).

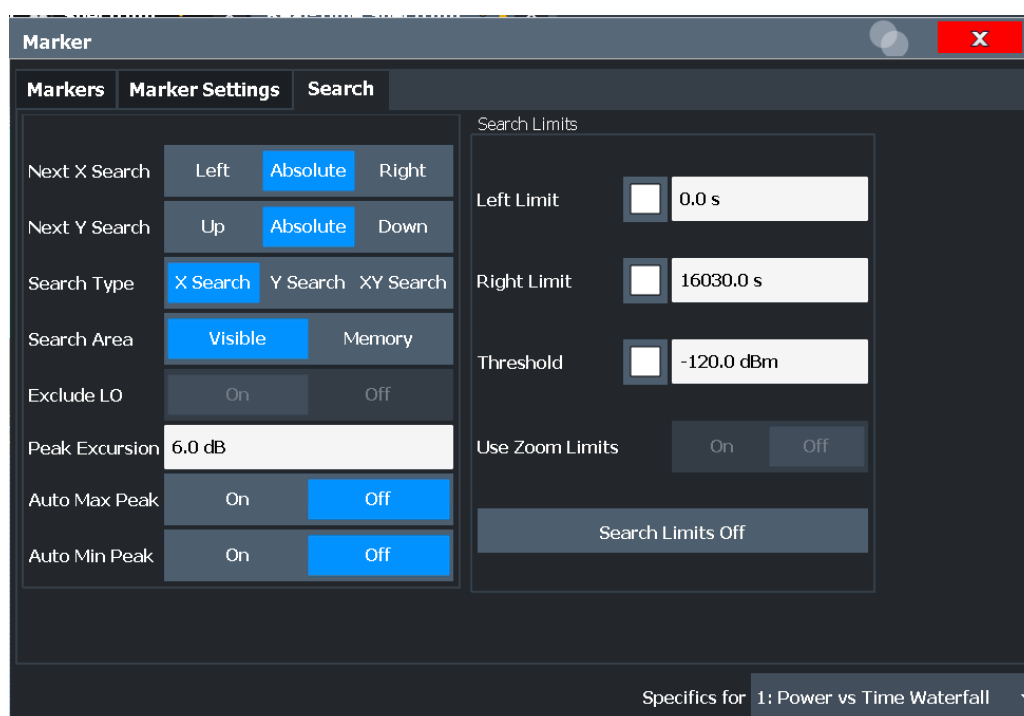

Search Mode for Next Peak in X Direction.....	137
Search Mode for Next Peak in Y Direction.....	137
Marker Search Type.....	138
Marker Search Area.....	138
Exclude LO.....	138
Peak Excursion.....	139
Auto Max Peak Search / Auto Min Peak Search.....	139



Search Limits.....	139
L Search Limits (Left / Right).....	139
L Search Threshold.....	139
L Search Limits Off.....	139

### Search Mode for Next Peak in X Direction

Selects the search mode for the next peak search within the currently selected frame.

"Left"	Determines the next maximum/minimum to the left of the current peak.
"Absolute"	Determines the next maximum/minimum to either side of the current peak.
"Right"	Determines the next maximum/minimum to the right of the current peak.

Remote command:

[CALCulate<n>:MARKer<m>:MAXimum:LEFT](#) on page 301  
[CALCulate<n>:MARKer<m>:MAXimum:NEXT](#) on page 301  
[CALCulate<n>:MARKer<m>:MAXimum:RIGHT](#) on page 301  
[CALCulate<n>:MARKer<m>:MINimum:LEFT](#) on page 302  
[CALCulate<n>:MARKer<m>:MINimum:NEXT](#) on page 302  
[CALCulate<n>:MARKer<m>:MINimum:RIGHT](#) on page 302

### Search Mode for Next Peak in Y Direction

Selects the search mode for the next peak search within all frames at the current marker position.

This setting is only available for spectrogram displays.

"Up"	Determines the next maximum/minimum above the current peak (in more recent frames).
"Absolute"	Determines the next maximum/minimum above or below the current peak (in all frames).
"Down"	Determines the next maximum/minimum below the current peak (in older frames).

Remote command:

[CALCulate<n>:MARKer<m>:SPECTrogram:Y:MAXimum:ABOVE](#) on page 307  
[CALCulate<n>:DELTamarker<m>:SPECTrogram:Y:MAXimum:ABOVE](#)  
on page 312  
[CALCulate<n>:MARKer<m>:SPECTrogram:Y:MAXimum:BELOW](#) on page 308  
[CALCulate<n>:DELTamarker<m>:SPECTrogram:Y:MAXimum:BELOW](#)  
on page 312  
[CALCulate<n>:MARKer<m>:SPECTrogram:Y:MAXimum:NEXT](#) on page 308  
[CALCulate<n>:DELTamarker<m>:SPECTrogram:Y:MAXimum:NEXT](#) on page 313  
[CALCulate<n>:MARKer<m>:SPECTrogram:Y:MINimum:ABOVE](#) on page 308  
[CALCulate<n>:DELTamarker<m>:SPECTrogram:Y:MINimum:ABOVE](#)  
on page 313  
[CALCulate<n>:MARKer<m>:SPECTrogram:Y:MINimum:BELOW](#) on page 309  
[CALCulate<n>:DELTamarker<m>:SPECTrogram:Y:MINimum:BELOW](#)  
on page 313

[CALCulate<n>:MARKer<m>:SPECTrogram:Y:MINimum:NEXT](#) on page 309

[CALCulate<n>:DELTamarker<m>:SPECTrogram:Y:MINimum:NEXT](#) on page 314

### Marker Search Type

Defines the type of search to be performed in the spectrogram.

"X-Search" Searches only within the currently selected frame.

"Y-Search" Searches within all frames but only at the current marker position.

"XY-Search" Searches in all frames at all positions.

Remote command:

[CALCulate<n>:MARKer<m>:SPECTrogram:XY:MAXimum\[:PEAK\]](#) on page 307

[CALCulate<n>:DELTamarker<m>:SPECTrogram:XY:MAXimum\[:PEAK\]](#)

on page 312

[CALCulate<n>:MARKer<m>:SPECTrogram:XY:MINimum\[:PEAK\]](#) on page 307

[CALCulate<n>:DELTamarker<m>:SPECTrogram:XY:MINimum\[:PEAK\]](#)

on page 312

[CALCulate<n>:MARKer<m>:SPECTrogram:Y:MAXimum\[:PEAK\]](#) on page 308

[CALCulate<n>:DELTamarker<m>:SPECTrogram:Y:MAXimum\[:PEAK\]](#)

on page 313

[CALCulate<n>:MARKer<m>:SPECTrogram:Y:MINimum\[:PEAK\]](#) on page 309

[CALCulate<n>:DELTamarker<m>:SPECTrogram:Y:MINimum\[:PEAK\]](#)

on page 314

[CALCulate<n>:MARKer<m>:MAXimum\[:PEAK\]](#) on page 301

[CALCulate<n>:DELTamarker<m>:MAXimum\[:PEAK\]](#) on page 303

[CALCulate<n>:MARKer<m>:MINimum\[:PEAK\]](#) on page 302

[CALCulate<n>:DELTamarker<m>:MINimum\[:PEAK\]](#) on page 304

### Marker Search Area

Defines which frames the search is performed in.

This setting is only available for spectrogram displays.

"Visible" Only the visible frames are searched.

"Memory" All frames stored in the memory are searched.

Remote command:

[CALCulate<n>:MARKer<m>:SPECTrogram:SARea](#) on page 306

[CALCulate<n>:DELTamarker<m>:SPECTrogram:SARea](#) on page 311

### Exclude LO

If activated, restricts the frequency range for the marker search functions.

"On" The minimum frequency included in the peak search range is  $\geq 5 \times$  resolution bandwidth (RBW).

Due to the interference by the first local oscillator to the first intermediate frequency at the input mixer, the LO is represented as a signal at 0 Hz. To avoid the peak marker jumping to the LO signal at 0 Hz, this frequency is excluded from the peak search.

"Off" No restriction to the search range. The frequency 0 Hz is included in the marker search functions.

Remote command:

[CALCulate<n>:MARKer<m>:LOEXclude](#) on page 296

#### Peak Excursion

Defines the minimum level value by which a signal must rise or fall so that it is identified as a maximum or a minimum by the search functions.

Remote command:

[CALCulate<n>:MARKer<m>:PEXCursion](#) on page 297

#### Auto Max Peak Search / Auto Min Peak Search

If activated, a maximum or minimum peak search is performed automatically for marker 1 after each measurement.

For spectrogram displays, define which frame the peak is to be searched in.

Remote command:

[CALCulate<n>:MARKer<m>:MAXimum:AUTO](#) on page 296

[CALCulate<n>:MARKer<m>:MINimum:AUTO](#) on page 296

#### Search Limits

The search results can be restricted by limiting the search area or adding search conditions.

#### Search Limits (Left / Right) ← Search Limits

If activated, limit lines are defined and displayed for the search. Only results within the limited search range are considered.

Remote command:

[CALCulate<n>:MARKer<m>:X:SLIMits\[:STATe\]](#) on page 297

[CALCulate<n>:MARKer<m>:X:SLIMits:LEFT](#) on page 298

[CALCulate<n>:MARKer<m>:X:SLIMits:RIGHT](#) on page 298

#### Search Threshold ← Search Limits

Defines an absolute threshold as an additional condition for the peak search. If enabled, only peaks that exceed the threshold are detected.

Remote command:

[CALCulate<n>:THReshold:STATe](#) on page 300

[CALCulate<n>:THReshold](#) on page 299

#### Search Limits Off ← Search Limits

Deactivates the search range limits.

Remote command:

[CALCulate<n>:MARKer<m>:X:SLIMits\[:STATe\]](#) on page 297

[CALCulate<n>:THReshold:STATe](#) on page 300

## 9.8.4 Positioning functions

**Access:** [MKR ->]

The following functions set the currently selected marker to the result of a peak search or set other characteristic values to the current marker value.

Peak Search.....	140
Search Next Peak.....	140
Search Minimum.....	140
Search Next Minimum.....	140
Center Frequency = Marker Frequency.....	141
Reference Level = Marker Level.....	141
Marker to Trigger.....	141

### Peak Search

Sets the selected marker/delta marker to the maximum of the trace. If no marker is active, marker 1 is activated.

Remote command:

[CALCulate<n>:MARKer<m>:MAXimum\[:PEAK\]](#) on page 301

[CALCulate<n>:DELTamarker<m>:MAXimum\[:PEAK\]](#) on page 303

### Search Next Peak

Sets the selected marker/delta marker to the next (lower) maximum of the assigned trace. If no marker is active, marker 1 is activated.

Remote command:

[CALCulate<n>:MARKer<m>:MAXimum:NEXT](#) on page 301

[CALCulate<n>:MARKer<m>:MAXimum:RIGHT](#) on page 301

[CALCulate<n>:MARKer<m>:MAXimum:LEFT](#) on page 301

[CALCulate<n>:DELTamarker<m>:MAXimum:NEXT](#) on page 303

[CALCulate<n>:DELTamarker<m>:MAXimum:RIGHT](#) on page 304

[CALCulate<n>:DELTamarker<m>:MAXimum:LEFT](#) on page 303

### Search Minimum

Sets the selected marker/delta marker to the minimum of the trace. If no marker is active, marker 1 is activated.

Remote command:

[CALCulate<n>:MARKer<m>:MINimum\[:PEAK\]](#) on page 302

[CALCulate<n>:DELTamarker<m>:MINimum\[:PEAK\]](#) on page 304

### Search Next Minimum

Sets the selected marker/delta marker to the next (higher) minimum of the selected trace. If no marker is active, marker 1 is activated.

Remote command:

[CALCulate<n>:MARKer<m>:MINimum:NEXT](#) on page 302

[CALCulate<n>:MARKer<m>:MINimum:LEFT](#) on page 302

[CALCulate<n>:MARKer<m>:MINimum:RIGHT](#) on page 302

[CALCulate<n>:DELTamarker<m>:MINimum:NEXT](#) on page 304

[CALCulate<n>:DELTamarker<m>:MINimum:LEFT](#) on page 304

[CALCulate<n>:DELTamarker<m>:MINimum:RIGHT](#) on page 305

**Center Frequency = Marker Frequency**

Sets the center frequency to the selected marker or delta marker frequency. A peak can thus be set as center frequency, for example to analyze it in detail with a smaller span.

This function is not available for zero span measurements.

Remote command:

`CALCulate<n>:MARKer<m>:FUNction:CENTer` on page 300

**Reference Level = Marker Level**

Sets the reference level to the selected marker level.

Remote command:

`CALCulate<n>:MARKer<m>:FUNction:REFerence` on page 211

**Marker to Trigger**

Sets the marker directly on the most recent trigger event.

This function is only available for spectrograms, and only if a trigger event already occurred.

Remote command:

`CALCulate<n>:MARKer<m>:SPECTrogram:Y:TRIGger` on page 310

**9.8.5 Example: defining a delta marker in a persistence spectrum**

The following example demonstrates how to define a delta marker in a persistence spectrum. We want to determine the difference in power levels between the spur and the upper noise level.

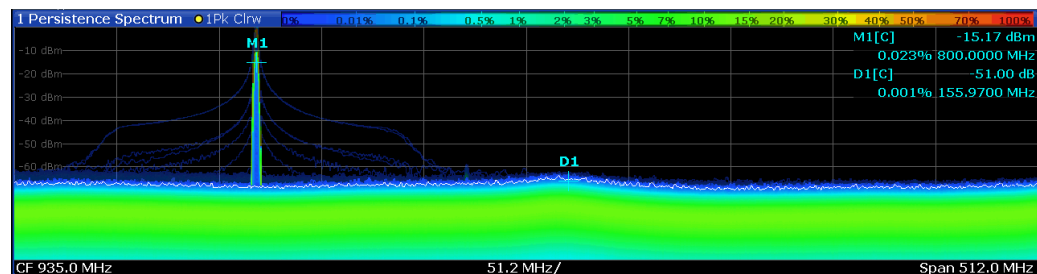

1. Tap the "Persistence Spectrum" window to set the focus in it.
2. Select the [MKR] key.
3. Select "Marker 1".  
A normal marker ("M1") is displayed in the diagram.
4. Drag the marker 1 to the peak of the spur.
5. Select "Marker 2".

A delta marker ("D2") is displayed in the diagram. The delta marker results indicate the difference in frequency, level, and probability of appearance to the normal marker 1.

6. Drag the delta marker to the upper noise level.

The deviation in the power level of the spur is indicated in the delta marker results. In this example, it is -51 dB.

## 9.9 Display and limit lines

Display and limit lines help you analyze a measurement trace.

**Access:** "Overview" > "Analysis" > "Lines"

For remote operation, see [Chapter 13.8.4, "Configuring display lines"](#), on page 314.

- [Display lines](#)..... 142
- [Limit lines](#)..... 144

### 9.9.1 Display lines

#### 9.9.1.1 Basics on display lines

Display lines help you analyze a trace – as do markers. The function of a display line is comparable to that of a ruler that can be shifted on the trace in order to mark absolute values. They are used exclusively to visually mark relevant frequencies or points in time (zero span), as well as constant level values. It is not possible to check automatically whether the points are below or above the marked level values - use limit lines for that task (see [Chapter 9.9.2.1, "Basics on limit lines"](#), on page 144).

Two different types of display lines are provided:

- Two horizontal lines: "Horizontal Line 1" and "Horizontal Line 2".  
These lines are continuous horizontal lines across the entire width of a diagram and can be shifted up and down.
- Four vertical lines: "Vertical Line 1" to "Vertical Line 4"  
These lines are continuous vertical lines across the entire height of the diagram and can be shifted left and right.

#### Lables

Each line is identified by one of the following abbreviations in the diagrams:

- H1: "Horizontal Line 1"
- H2: "Horizontal Line 2"
- V1: "Vertical Line 1"
- V2: "Vertical Line 2"
- V3: "Vertical Line 3"
- V4: "Vertical Line 4"

### 9.9.1.2 Display line settings

**Access:** "Overview" > "Analysis" > "Lines" > "Display Lines"

Four vertical and two horizontal lines can be defined in the display.

Line Config	
Limit Lines	Display Lines
Vertical Line 1	<input type="checkbox"/> 0.0 s
Vertical Line 2	<input type="checkbox"/> 0.0 s
Vertical Line 3	<input type="checkbox"/> 0.0 s
Vertical Line 4	<input type="checkbox"/> 0.0 s
Horizontal Line 1	<input type="checkbox"/> 0.0 dBm
Horizontal Line 2	<input type="checkbox"/> 0.0 dBm

<a href="#">Vertical Line &lt;x&gt;</a> .....	143
<a href="#">Horizontal Line 1/ Horizontal Line 2</a> .....	143

#### Vertical Line <x>

Activates a vertical display line in the diagram at the specified point of the x-axis, depending on the scale of the axis.

Remote command:

[CALCulate<n>:FLINE<dl>](#) on page 315

[CALCulate<n>:TLINE<dl>](#) on page 316

#### Horizontal Line 1/ Horizontal Line 2

Activates a horizontal display line (H1 or H2) in the diagram at the specified point of the y-axis.

Remote command:

[CALCulate<n>:DLINE<dl>](#) on page 315

[CALCulate<n>:DLINE<dl>](#) on page 315

### 9.9.1.3 Defining display lines

1. Display lines are configured in the "Lines Config" dialog box. To display this dialog box, press [Lines] and then "Lines Config".
2. Select the "Display Lines" tab.
3. To define a vertical line:

- a) Select "Vertical Line 1", 2, 3, or 4.
  - b) Enter the x-value at which the line is to be displayed.
4. To define a horizontal line:
- a) Select "Horizontal Line 1" or 2.
  - b) Enter the y-value at which the line is to be displayed.

## 9.9.2 Limit lines

Limit lines allow you to check automatically whether the measured points are below or above specified values.

- [Basics on limit lines](#)..... 144
- [Limit line settings and functions](#)..... 147
- [How to define limit lines](#)..... 153
- [Reference: limit line file format](#)..... 157

### 9.9.2.1 Basics on limit lines

Limit lines are used to define amplitude curves or spectral distribution boundaries in the result diagram which are not to be exceeded. They indicate, for example, the upper limits for interference radiation or spurious waves which are allowed from a device under test (DUT). When transmitting information in TDMA systems (e.g. GSM), the amplitude of the bursts in a time slot must adhere to a curve that falls within a specified tolerance band. The lower and upper limits may each be specified by a limit line. Then, the amplitude curve can be controlled either visually or automatically for any violations of the upper or lower limits (GO/NOGO test).

The FSW supports limit lines with a maximum of 200 data points. Eight of the limit lines stored in the instrument can be activated simultaneously. The number of limit lines stored in the instrument is only limited by the capacity of the storage device used.

Limit line data can also be exported to a file in ASCII (CSV) format for further evaluation in other applications. Limit lines stored in the specified ASCII (CSV) format can also be imported to the FSW for other measurements.

#### Compatibility

Limit lines are compatible with the current measurement settings, if the following applies:

- The x unit of the limit line has to be identical to the current setting.
- The y unit of the limit line has to be identical to the current setting with the exception of dB based units; all dB based units are compatible with each other.

#### Validity

Only limit lines that fulfill the following conditions can be activated:

- Each limit line must consist of a minimum of 2 and a maximum of 200 data points.



- The frequencies/times for each data point must be defined in ascending order; however, for any single frequency or time, two data points may be entered (to define a vertical segment of a limit line).
- Gaps in frequency or time are not allowed. If gaps are desired, two separate limit lines must be defined and then both enabled.
- The entered frequencies or times need not necessarily be selectable in FSW. A limit line may also exceed the specified frequency or time range. The minimum frequency for a data point is -200 GHz, the maximum frequency is 200 GHz. For the time range representation, negative times may also be entered. The allowed range is -1000 s to +1000 s.

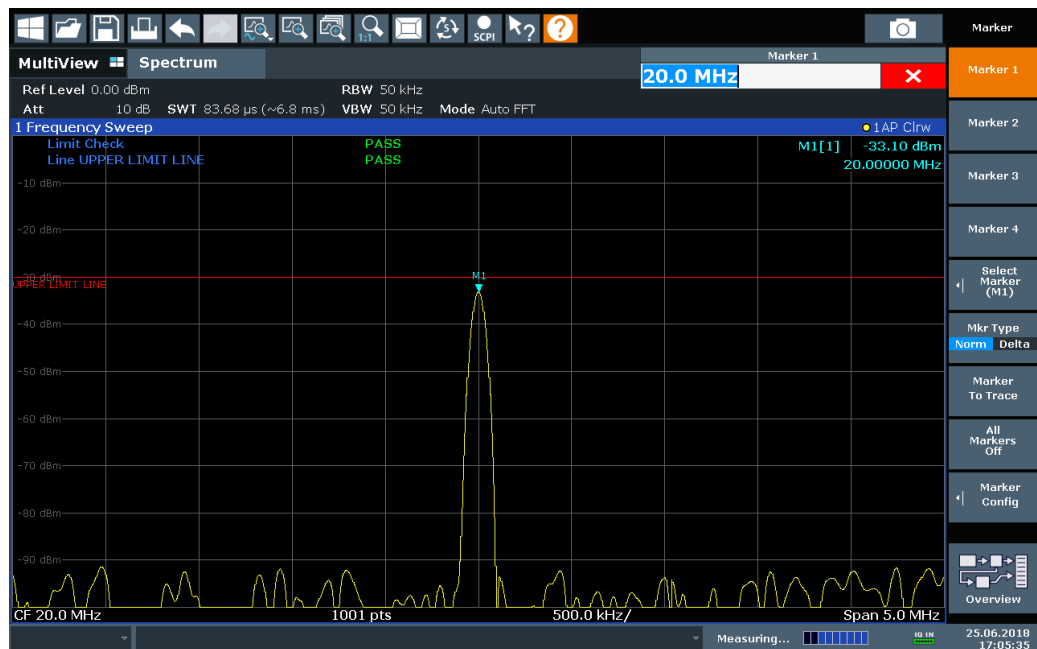
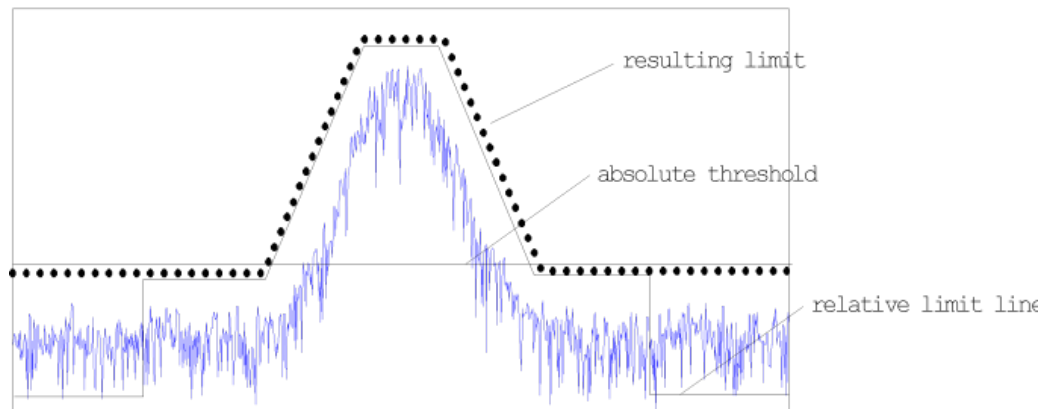

Figure 9-2: Example for an upper limit line

### Thresholds

If the y-axis for the limit line data points uses relative scaling, an additional absolute **threshold** can be defined for the limit check. In this case, both the threshold value and the relative limit line must be exceeded before a violation occurs.



### Offsets and Shifting

A configured limit line can easily be moved vertically or horizontally. Two different methods to do so are available:

- An **offset** moves the entire line in the diagram without editing the configured values or positions of the individual data points. This option is only available if relative scaling is used.  
Thus, a new limit line can be easily generated based upon an existing limit line which has been shifted horizontally or vertically.
- Defining a **shift** width for the values or position of the individual data points changes the line configuration, thus changing the position of the line in the diagram.

### Limit Check Results

A limit check is automatically performed as soon as any of the limit lines is activated ("Visibility" setting). Only the specified "Traces to be Checked" are compared with the active limit lines. The status of the limit check for each limit line is indicated in the diagram. If a violation occurs, the limit check status is set to "MARG" for a margin violation, or to "Fail" for a limit violation.

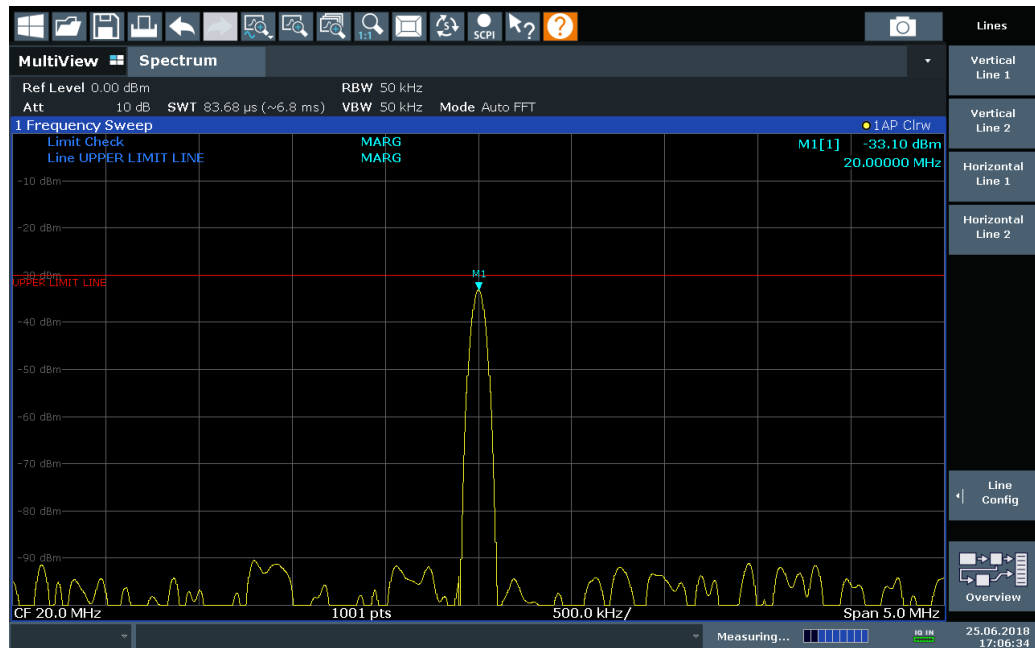

Figure 9-3: Margin violation for limit check

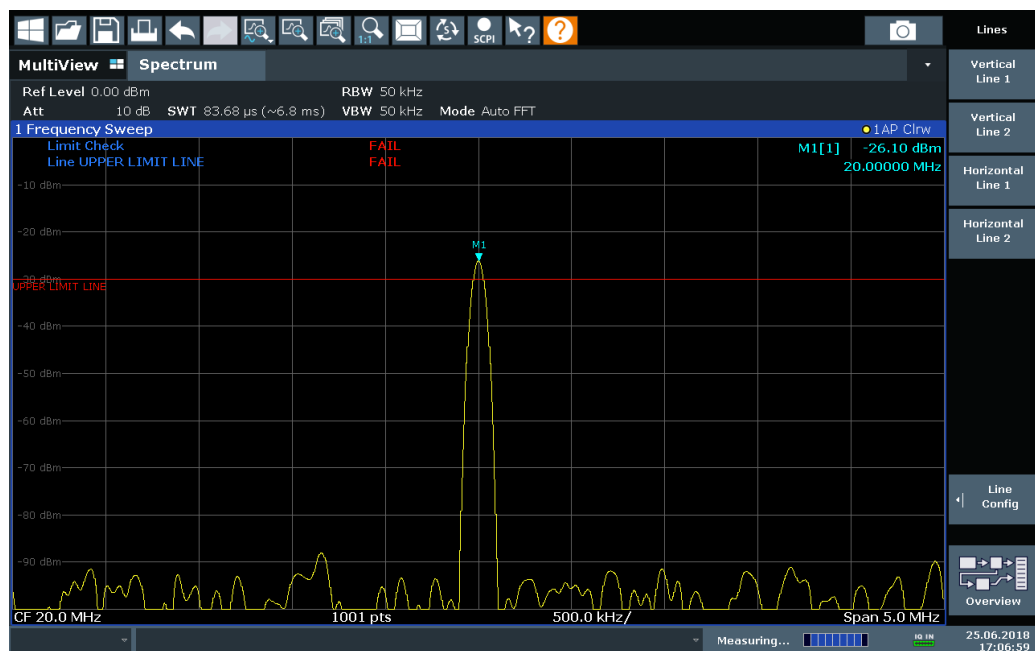

Figure 9-4: Limit violation for limit check

### 9.9.2.2 Limit line settings and functions

Access: "Overview" > "Analysis" > "Lines"

or: [LINES] > "Line Config"

Up to 8 limit lines can be displayed simultaneously in the FSW. Many more can be stored on the instrument.



**Stored limit line settings**

When storing and recalling limit line settings, consider the information provided in the Data Management chapter of the FSW User Manual.

- [Limit line management](#)..... 148
- [Limit line details](#)..... 150

**Limit line management**

**Access:** "Overview" > "Analysis" > "Lines" > "Limit Lines"

**or:** [LINES] > "Line Config" > "Limit Lines"

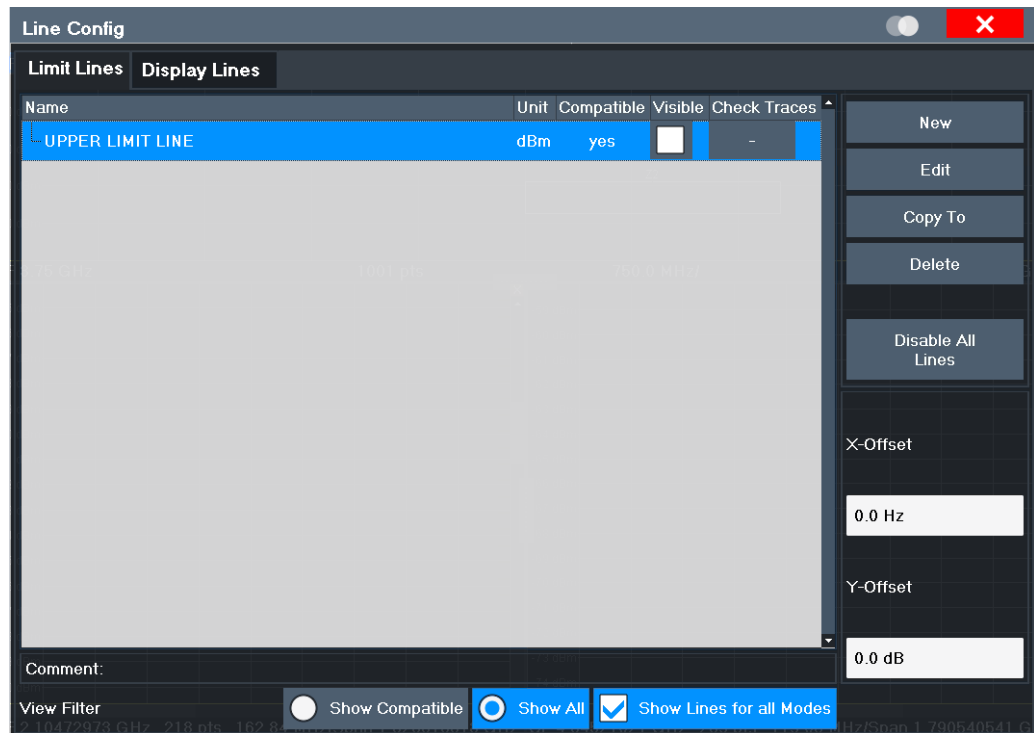

For the limit line overview, the FSW searches for all stored limit lines with the file extension .LIN in the limits subfolder of the main installation folder. The overview allows you to determine which limit lines are available and can be used for the current measurement.

For details on settings for individual lines see "[Limit line details](#)" on page 150.

[Name](#)..... 149

[Unit](#)..... 149

[Compatibility](#)..... 149

[Visibility](#)..... 149

[Traces to be Checked](#)..... 149

[Comment](#)..... 149

Included Lines in Overview (View Filter).....	149
↳ Show Lines for all Modes.....	150
X-Offset.....	150
Y-Offset.....	150
Create New Line.....	150
Edit Line.....	150
Copy Line.....	150
Delete Line.....	150
Disable All Lines.....	150

**Name**

The name of the stored limit line.

**Unit**

The unit in which the y-values of the data points of the limit line are defined.

**Compatibility**

Indicates whether the limit line definition is compatible with the current measurement settings.

**Visibility**

Displays or hides the limit line in the diagram. Up to 8 limit lines can be visible at the same time. Inactive limit lines can also be displayed in the diagram.

Remote command:

[CALCulate<n>:LIMit<li>:LOWer:STATe](#) on page 322

[CALCulate<n>:LIMit<li>:UPPer:STATe](#) on page 326

[CALCulate<n>:LIMit<li>:ACTive?](#) on page 327

**Traces to be Checked**

Defines which traces are automatically checked for conformance with the limit lines. As soon as a trace to be checked is defined, the assigned limit line is active. One limit line can be activated for several traces simultaneously. If any of the "Traces to be Checked" violate any of the active limit lines, a message is indicated in the diagram.

Remote command:

[CALCulate<n>:LIMit<li>:TRACe<t>:CHECK](#) on page 328

**Comment**

An optional description of the limit line.

**Included Lines in Overview (View Filter)**

Defines which of the stored lines are included in the overview.

"Show Compatible"	Only compatible lines Whether a line is compatible or not is indicated in the <a href="#">Compatibility</a> setting.
"Show All"	All stored limit lines with the file extension <code>.LIN</code> in the <code>limits</code> subfolder of the main installation folder. (if not restricted by "Show Lines for all Modes" setting).

**Show Lines for all Modes ← Included Lines in Overview (View Filter)**

If activated (default), limit lines from all applications are displayed. Otherwise, only lines that were created in the Spectrum application are displayed.

Note that limit lines from some applications may include additional properties that are lost when the limit lines are edited in the Spectrum application. In this case a warning is displayed when you try to store the limit line.

**X-Offset**

Shifts a limit line that has been specified for relative frequencies or times (x-axis) horizontally.

This setting does not have any effect on limit lines that are defined by absolute values for the x-axis.

Remote command:

[CALCulate<n>:LIMit<li>:CONTrol:OFFSet](#) on page 319

**Y-Offset**

Shifts a limit line that has relative values for the y-axis (levels or linear units such as volt) vertically.

This setting does not have any effect on limit lines that are defined by absolute values for the y-axis.

Remote command:

[CALCulate<n>:LIMit<li>:LOWer:OFFSet](#) on page 321

[CALCulate<n>:LIMit<li>:UPPer:OFFSet](#) on page 325

**Create New Line**

Creates a new limit line.

**Edit Line**

Edit an existing limit line configuration.

**Copy Line**

Copy the selected limit line configuration to create a new line.

Remote command:

[CALCulate<n>:LIMit<li>:COPY](#) on page 327

**Delete Line**

Delete the selected limit line configuration.

Remote command:

[CALCulate<n>:LIMit<li>:DELeTe](#) on page 328

**Disable All Lines**

Disable all limit lines in one step.

Remote command:

[CALCulate<n>:LIMit<li>:STATe](#) on page 328

**Limit line details**

**Access:** "Overview" > "Analysis" > "Lines" > "Limit Lines" > "New" / "Edit" / "Copy To"

or: [LINES] > "Line Config" > "Limit Lines" > "New" / "Edit" / "Copy To"

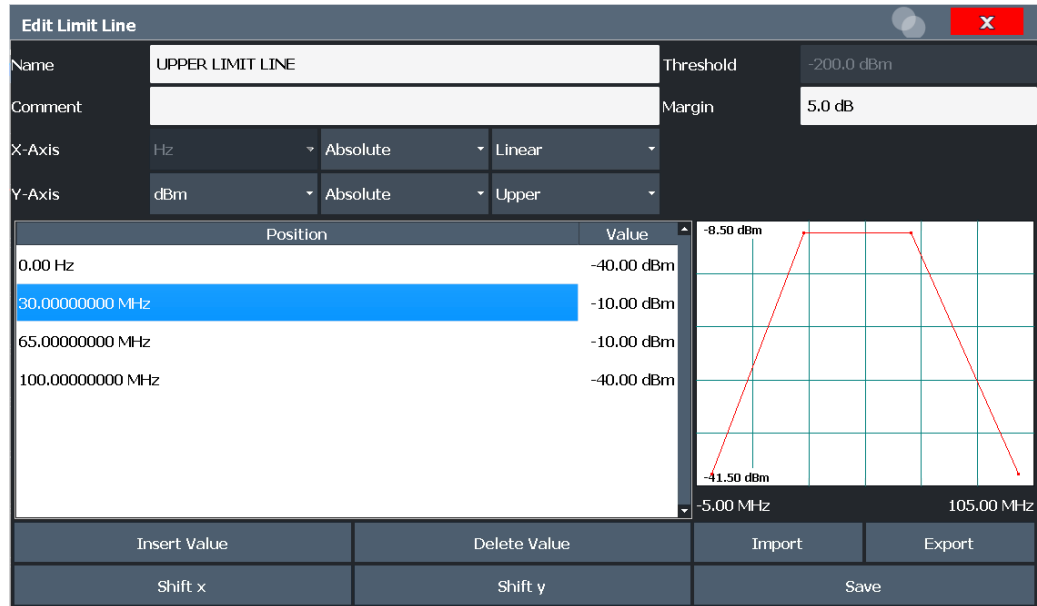

Name..... 151  
 Comment..... 151  
 Threshold..... 151  
 Margin..... 152  
 X-Axis..... 152  
 Y-Axis..... 152  
 Data Points..... 152  
 Insert Value..... 153  
 Delete Value..... 153  
 Shift x..... 153  
 Shift y..... 153  
 Save..... 153

**Name**

Defines the limit line name. All names must be compatible with Windows conventions for file names. The limit line data is stored under this name (with a .LIN extension).

Remote command:

CALCulate<n>:LIMit<li>:NAME on page 323

**Comment**

Defines an optional comment for the limit line.

Remote command:

CALCulate<n>:LIMit<li>:COMMENT on page 318

**Threshold**

Defines an absolute threshold value (only for relative scaling of the y-axis).

Remote command:

[CALCulate<n>:LIMit<li>:LOWer:THReshold](#) on page 323

[CALCulate<n>:LIMit<li>:UPPer:THReshold](#) on page 326

### Margin

Defines a margin for the limit line. The default setting is 0 dB (i.e. no margin).

Remote command:

[CALCulate<n>:LIMit<li>:LOWer:MARGin](#) on page 321

[CALCulate<n>:LIMit<li>:UPPer:MARGin](#) on page 324

### X-Axis

Describes the horizontal axis on which the data points of the limit line are defined.

Includes the following settings:

- Unit:
  - "Hz": for frequency domain
  - "s": for time domain
- Scaling mode: absolute or relative values  
For relative values, the frequencies are referred to the currently set center frequency. In the time domain, the left boundary of the diagram is used as the reference.
- Scaling: linear or logarithmic

Remote command:

[CALCulate<n>:LIMit<li>:CONTrol:MODE](#) on page 319

[CALCulate<n>:LIMit<li>:CONTrol:DOMain](#) on page 318

[CALCulate<n>:LIMit<li>:CONTrol:SPACing](#) on page 320

### Y-Axis

Describes the vertical axis on which the data points of the limit line are defined.

Includes the following settings:

- Level unit
- Scaling mode: absolute or relative (dB/%) values  
Relative limit values refer to the reference level.
- Limit type: upper or lower limit; values must stay above the lower limit and below the upper limit to pass the limit check

Remote command:

[CALCulate<n>:LIMit<li>:UNIT](#) on page 323

[CALCulate<n>:LIMit<li>:LOWer:MODE](#) on page 321

[CALCulate<n>:LIMit<li>:UPPer:MODE](#) on page 324

[CALCulate<n>:LIMit<li>:LOWer:SPACing](#) on page 322

[CALCulate<n>:LIMit<li>:UPPer:SPACing](#) on page 326

### Data Points

Each limit line is defined by a minimum of 2 and a maximum of 200 data points. Each data point is defined by its position (x-axis) and value (y-value). Data points must be defined in ascending order. The same position can have two different values.



Remote command:

[CALCulate<n>:LIMit<li>:CONTRol\[:DATA\]](#) on page 318

[CALCulate<n>:LIMit<li>:LOWer\[:DATA\]](#) on page 320

[CALCulate<n>:LIMit<li>:UPPer\[:DATA\]](#) on page 324

#### Insert Value

Inserts a data point in the limit line above the selected one in the "Edit Limit Line" dialog box.

#### Delete Value

Deletes the selected data point in the "Edit Limit Line" dialog box.

#### Shift x

Shifts the x-value of each data point horizontally by the defined shift width (as opposed to an additive offset defined for the entire limit line, see ["X-Offset"](#) on page 150).

Remote command:

[CALCulate<n>:LIMit<li>:CONTRol:SHIFt](#) on page 320

#### Shift y

Shifts the y-value of each data point vertically by the defined shift width (as opposed to an additive offset defined for the entire limit line, see ["Y-Offset"](#) on page 150).

Remote command:

[CALCulate<n>:LIMit<li>:LOWer:SHIFt](#) on page 322

[CALCulate<n>:LIMit<li>:UPPer:SHIFt](#) on page 325

#### Save

Saves the currently edited limit line under the name defined in the "Name" field.

### 9.9.2.3 How to define limit lines

**Access:** "Overview" > "Analysis" > "Lines" > "Limit Lines"

**or:** [LINES] > "Line Config" > "Limit Lines"

The following tasks are described here:

- ["How to find compatible limit lines"](#) on page 153
- ["How to activate and deactivate a limit check"](#) on page 154
- ["How to edit existing limit lines"](#) on page 154
- ["How to copy an existing limit line"](#) on page 154
- ["How to delete an existing limit line"](#) on page 154
- ["How to configure a new limit line"](#) on page 155
- ["How to move the limit line vertically or horizontally"](#) on page 156

#### How to find compatible limit lines

- ▶ In the "Line Config" dialog box, select the "View Filter" option: "Show Compatible".

All stored limit lines with the file extension `.LIN` in the `limits` subfolder of the main installation folder of the instrument that are compatible to the current measurement settings are displayed in the overview.

### How to activate and deactivate a limit check

A limit check is automatically performed as soon as any of the limit lines is activated.

1. To activate a limit check:  
Select the "Check Traces" setting for a limit line in the overview and select the trace numbers to be included in the limit check. One limit line can be assigned to several traces.

The specified traces to be checked are compared with the active limit lines. The status of the limit check is indicated in the diagram.

2. To deactivate a limit line, deactivate all "Traces to be Checked" for it.  
To deactivate all limit lines at once, select "Disable All Lines".

The limit checks for the deactivated limit lines are stopped and the results are removed from the display.

### How to edit existing limit lines

Existing limit line configurations can be edited.

1. In the "Line Config" dialog box, select the limit line.
2. Select "Edit".
3. Edit the line configuration as described in ["How to configure a new limit line"](#) on page 155.
4. Save the new configuration by selecting "Save".

If the limit line is active, the edited limit line is displayed in the diagram.

### How to copy an existing limit line

1. In the dialog box, select the limit line.
2. Select "Line Config" "Copy To".
3. Define a new name to create a new limit with the same configuration as the source line.
4. Edit the line configuration as described in ["How to configure a new limit line"](#) on page 155.
5. Save the new configuration by selecting "Save".

The new limit line is displayed in the overview and can be activated.

### How to delete an existing limit line

1. In the "Line Config" dialog box, select the limit line.

2. Select "Delete".
3. Confirm the message.

The limit line and the results of the limit check are deleted.

### How to configure a new limit line

1. In the "Line Config" dialog box, select "New".

The "Edit Limit Line" dialog box is displayed. The current line configuration is displayed in the preview area of the dialog box. The preview is updated after each change to the configuration.
2. Define a "Name" and, optionally, a "Comment" for the new limit line.
3. Define the x-axis configuration:
  - Time domain or frequency domain
  - Absolute or relative limits
  - Linear or logarithmic scaling
4. Define the y-axis configuration:
  - Level unit
  - Absolute or relative limits
  - Upper or lower limit line
5. Define the data points: minimum 2, maximum 200:
  - a) Select "Insert Value".
  - b) Define the x-value ("Position") and y-value ("Value") of the first data point.
  - c) Select "Insert Value" again and define the second data point.
  - d) Repeat this to insert all other data points.

To insert a data point before an existing one, select the data point and then "Insert Value".

To insert a new data point at the end of the list, move the focus to the line after the last entry and then select "Insert Value".

To delete a data point, select the entry and then "Delete Value".
6. Check the current line configuration in the preview area of the dialog box. If necessary, correct individual data points or add or delete some.

If necessary, shift the entire line vertically or horizontally by selecting "Shift x" or "Shift y" and defining the shift width.
7. Optionally, define a "Margin" at a fixed distance to the limit line.

The margin must be within the valid value range and is not displayed in the diagram or preview area.
8. Optionally, if the y-axis uses relative scaling, define an absolute "Threshold" as an additional criteria for a violation.
9. Save the new configuration by selecting "Save".

The new limit line is displayed in the overview and can be activated.

### How to move the limit line vertically or horizontally

A configured limit line can easily be moved vertically or horizontally. Thus, a new limit line can be easily generated based upon an existing limit line which has been shifted horizontally.

1. In the "Line Config" dialog box, select the limit line.
2. To shift the complete limit line parallel in the horizontal direction, select "X-Offset" and enter an offset value.  
To shift the complete limit line parallel in the vertical direction, select "Y-Offset" and enter an offset value.
3. To shift the individual data points of a limit line by a fixed value (all at once):
  - a) Select "Edit".
  - b) In the "Edit Limit Line" dialog box, select "Shift x" or "Shift y" and define the shift width.
  - c) Save the shifted data points by selecting "Save".

If activated, the limit line is shifted in the diagram.

### How to export a limit line

Limit line configurations can be stored to an ASCII file for evaluation in other programs or to be imported later for other measurements.

1. In the "Line Config" dialog box, select the limit line.
2. Select "New" or "Edit".
3. Define the limit line as described in ["How to configure a new limit line"](#) on page 155.
4. Select "Export" to save the configuration to a file.  
You are asked whether you would like to save the configuration internally on the FSW first.
5. Select a file name and location for the limit line.
6. Select the decimal separator to be used in the file.
7. Select "Save".

The limit line is stored to a file with the specified name and the extension `.CSV`.

For details on the file format see [Chapter 9.9.2.4, "Reference: limit line file format"](#), on page 157.

### How to import a limit line

Limit line configurations that are stored in an ASCII file and contain a minimum of required data can be imported to the FSW.

For details on the required file format see [Chapter 9.9.2.4, "Reference: limit line file format"](#), on page 157.

1. In the "Line Config" dialog box, select the limit line.

2. Select "New" or "Edit".
3. Select "Import" to load a limit line from a file.  
You are asked whether you would like to save the current configuration on the FSW first.
4. Select the file name of the limit line.
5. Select the decimal separator that was used in the file.
6. Select "Select".  
The limit line is loaded from the specified file and displayed in the "Edit Limit Line" dialog box.
7. Activate the limit line as described in ["How to activate and deactivate a limit check"](#) on page 154.

#### 9.9.2.4 Reference: limit line file format

Limit line data can be exported to a file in ASCII (CSV) format for further evaluation in other applications. Limit lines stored in the specified ASCII (CSV) format can also be imported to the FSW for other measurements (see ["How to import a limit line"](#) on page 156). This reference describes in detail the format of the export/import files for limit lines. Note that the **bold** data is **mandatory**, all other data is optional.

Different language versions of evaluation programs may require a different handling of the decimal point. Thus, you can define the decimal separator to be used (see ["Decimal Separator"](#) on page 128).

**Table 9-1: ASCII file format for limit line files**

File contents	Description
<b>Header data</b>	
<b>sep=;</b>	Separator for individual values (required by Microsoft Excel, for example)
<b>Type</b> ;RS_LimitLineDefinition;	Type of data
<b>FileFormatVersion</b> ;1.00;	File format version
Date;01.Oct 2006;	Date of data set storage
OptionID;SpectrumAnalyzer	Application the limit line was created for
<b>Name</b> ;RELFREQ1	Limit line name
Comment;Defines the upper limit line	Description of limit line
Mode;UPPER	Type of limit line (upper, lower)
ThresholdUnit;LEVEL_DBM	Unit of threshold value
ThresholdValue;-200	Threshold value
MarginValue;0	Margin value
XAxisScaling;LINEAR	Scaling of x-axis linear (LIN) or logarithmic (LOG)

File contents	Description
XAxisUnit;FREQ_HZ	Unit of x values
XAxisScaleMode;ABSOLUTE	Scaling of x-axis (absolute or relative)
YAxisUnit;LEVEL_DB	Unit of y values
YAxisScaleMode;ABSOLUTE	Scaling of y-axis (absolute or relative)
NoOfPoints;5	Number of points the line is defined by
<b>Data section for individual data points</b>	
-4500000000;-50	<b>x- and y-values of each data point defining the line</b>
-2000000000;-30	
-1000000000;0	
0;-30	
2500000000;-50	

## 9.10 Zoom functions

**Access:** The zoom functions are only available from the toolbar.

For details on the zoom functions see [Chapter 6.5.4, "Zooming into the spectrogram"](#), on page 56.

<a href="#">Single Zoom</a> .....	158
<a href="#">Restore Original Display</a> .....	159
<a href="#">Replay Zoom</a> .....	159

### Single Zoom



Define the zoom area by drawing a rectangle on the touchscreen. When you draw the zoom area, its boundaries are shown as a dashed line. The FSW stops the Real-Time measurement and recalculates the displays for the area you have selected. The definition of the color map remains the same.

**Note:** In Real-Time measurements, this function is only available for an active spectrogram.

The graphical zoom provided for other measurements on the FSW is **not available** for Real-Time measurements.

For details and restrictions see [Chapter 6.5.4, "Zooming into the spectrogram"](#), on page 56.

Remote command:

`DISPlay[:WINDow<n>][:SUBWindow<w>]:ZOOM[:STATe]` on page 334

`DISPlay[:WINDow<n>]:ZOOM:AREA` on page 333

### Restore Original Display



Restores the original display, that is, the originally calculated displays for the entire capture buffer, and closes all zoom windows.

**Note:** This function only restores graphically zoomed displays. Measurement zooms, for which measurement settings were adapted, are recalculated based on the adapted measurement settings. In this case, the zoomed display is maintained.

Remote command:

`DISPlay[:WINDow<n>][:SUBWindow<w>]:ZOOM[:STATe]` on page 334

### Replay Zoom

Switches between the zoomed displays and the original displays quickly for comparison.

If enabled, the zoomed displays are shown, that is, the recalculated displays for the selected zoom area.

If disabled, the original display is restored, that is, the originally calculated displays for the entire capture buffer.

This function is only available after a measurement has been performed.

For details see [Chapter 6.5.4, "Zooming into the spectrogram"](#), on page 56.

## 9.11 Analysis in MSRT secondary applications

The data that was captured by the MSRT primary can be analyzed in various different secondary applications.

The analysis settings and functions available in MSRT mode are those described for the individual secondary applications. The MSRT primary is in effect a "Real-Time Spectrum" application and has the same analysis functions and settings.

### Secondary application data extract and analysis interval

The settings required to configure the secondary application data extract or analysis intervals vary depending on the application type. See the corresponding application manuals for details.

In addition, a [Capture Offset](#) is available to define the secondary application data extract or analysis interval (see [Chapter 8.2, "Trigger settings"](#), on page 112).

### Analysis line settings

**AL** 10.0 ms

To hide or show and position the analysis line, a dialog box is available. To display the "Analysis Line" dialog box, tap the "AL" icon in the toolbar (only available in MSRT mode). The current position of the analysis line is indicated on the icon.

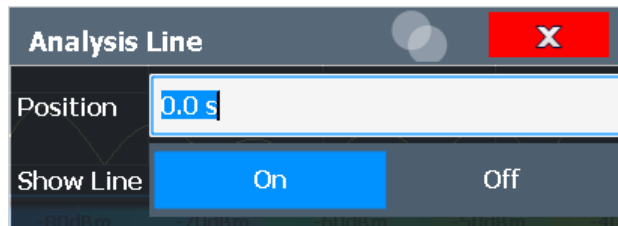

Position.....	160
Show Line.....	160

### Position

Defines the position of the analysis line in the time domain. The position must lie within the measurement time of the multistandard measurement.

Remote command:

[CALCulate<n>:RTMS:ALINE\[:VALue\]](#) on page 343

### Show Line

Hides or displays the analysis line in the time-based windows. By default, the line is displayed.

**Note:** The window title bar always shows whether the currently defined line position lies within the analysis interval of the active secondary application, even if the analysis line display is disabled.

Remote command:

[CALCulate<n>:RTMS:ALINE:SHOW](#) on page 342



## 10 I/Q data export

Baseband signals mostly occur as so-called complex baseband signals, i.e. a signal representation that consists of two channels; the in phase (I) and the quadrature (Q) channel. Such signals are referred to as I/Q signals. I/Q signals are useful because the specific RF or IF frequencies are not needed. The complete modulation information and even distortion that originates from the RF, IF or baseband domains can be analyzed in the I/Q baseband.

Exporting I/Q signals is useful for example to capture and save I/Q signals with a signal analyzer to analyze them with another FSW application or an external software tool (for example the R&S VSE software) later.



I/Q data cannot be imported in the R&S FSW Real-Time Spectrum application or in MSRT mode.

As opposed to storing trace data, which may be averaged or restricted to peak values, I/Q data is exported as it was captured, without further processing. The data is stored as complex values in 32-bit floating-point format.

Data from multiple channels (in MSRT mode) cannot be exported at the same time. The I/Q data is stored in a format with the file extension `.iq.tar`.

For a detailed description see the FSW I/Q Analyzer and I/Q Input User Manual.

- [Export functions](#)..... 161
- [How to export I/Q data](#)..... 162

### 10.1 Export functions

The export functions are available in the "Save/Recall" menu which is displayed when you select the  "Save" icon in the toolbar.

Some functions for particular data types are (also) available via softkeys or dialog boxes in the corresponding menus, e.g. trace data.



For a description of the other functions in the "Save/Recall" menu see the FSW User Manual.

<a href="#">Trace Export Configuration</a> .....	161
<a href="#">I/Q Export</a> .....	162
L <a href="#">File Type</a> .....	162
L <a href="#">File Explorer</a> .....	162

#### Trace Export Configuration

Opens the "Traces" dialog box to configure the trace and data export settings.

See [Chapter 9.6, "Trace / data export configuration"](#), on page 126.

**I/Q Export**

Opens a file selection dialog box to define an export file name to which the I/Q data is stored. This function is only available in single sweep mode.

For details, see the description in the FSW I/Q Analyzer User Manual ("Importing and Exporting I/Q Data").

**Note:** Storing large amounts of I/Q data (several Gigabytes) can exceed the available (internal) storage space on the FSW. In this case, it can be necessary to use an external storage medium.

**Note:** Secure user mode.

In secure user mode, settings that are stored on the instrument are stored to volatile memory, which is restricted to 256 MB. Thus, a "memory limit reached" error can occur although the hard disk indicates that storage space is still available.

To store data permanently, select an external storage location such as a USB memory device.

For details, see "Protecting Data Using the Secure User Mode" in the "Data Management" section of the FSW base unit user manual.

Remote command:

[MMEMory:STORe<n>:IQ:STATe](#) on page 279

[MMEMory:STORe<n>:IQ:COMMeNt](#) on page 279

**File Type ← I/Q Export**

The I/Q data file can be in stored in one of the following supported formats:

- .iq.tar
- .iqw
- .csv
- .mat
- .aid

For details on formats, see the FSW I/Q Analyzer and I/Q Input user manual.

**File Explorer ← I/Q Export**

Opens the Microsoft Windows File Explorer.

Remote command:

not supported

## 10.2 How to export I/Q data

**Capturing and exporting I/Q data**

1. Configure the data acquisition.
2. Press the [RUN SINGLE] key to perform a single sweep measurement.
3. Select the  "Save" icon in the toolbar.
4. Select "Export > I/Q Export".
5. In the file selection dialog box, select a storage location and enter a file name.

6. Select "Save".

The captured data is stored to a file with the extension `.iq.tar`.

The length of the captured data is equal to the defined "[Sweep Time](#)" on page 106 or "[PVT Sweep Time](#)" on page 106, whichever is larger.

#### **Previewing the I/Q data in a web browser**

The `iq-tar` file format allows you to preview the I/Q data in a web browser.

1. Use an archive tool (e.g. WinZip® or PowerArchiver®) to unpack the `iq-tar` file into a folder.
2. Locate the folder using Windows Explorer.
3. Open your web browser.

4. Drag the I/Q parameter XML file, e.g. `example.xml`, into your web browser.

**xzy.xml (of .iq.tar file)**

Description	
Saved by	FSV IQ Analyzer
Comment	Here is a comment
Date & Time	2011-03-03 14:33:05
Sample rate	6.5 MHz
Number of samples	65000
Duration of signal	10 ms
Data format	complex, float32
Data filename	xzy.complex.1ch.float32
Scaling factor	1 V

**Channel 1**

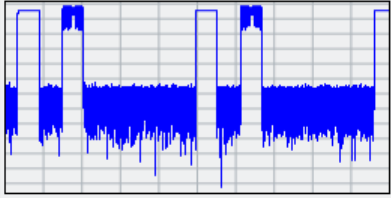
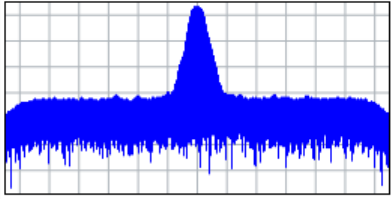
Comment	Channel 1 of 1
Power vs time y-axis: 10 dB /div x-axis: 1 ms /div	
Spectrum y-axis: 20 dB /div x-axis: 500 kHz /div	

E-mail: [info@rohde-schwarz.com](mailto:info@rohde-schwarz.com)  
Internet: <http://www.rohde-schwarz.com>  
Fileformat version: 1

# 11 How to perform Real-Time Spectrum measurements

- [How to perform a basic Real-Time Spectrum measurement](#)..... 165
- [How to obtain time domain results in real-time](#)..... 166
- [How to analyze persistency in Real-Time Spectrum measurements](#)..... 168
- [How to configure the color mapping](#)..... 169
- [How to work with frequency mask triggers](#)..... 171
- [How to output a trigger signal](#)..... 174
- [How to output trigger signals continuously](#)..... 174
- [How to perform measurements in MSRT mode](#)..... 175

## 11.1 How to perform a basic Real-Time Spectrum measurement

The following step-by-step instructions demonstrate how to perform a basic Real-Time Spectrum measurement with the R&S FSW Real-Time Spectrum application.

1. Press [MODE] on the front panel and select the "Real-Time Spectrum" application.
2. Press [RUN CONT] to stop the default continuous measurement.
3. Select "Overview" to display the "Overview" for a Real-Time Spectrum measurement.
4. Select "Amplitude" to define the required reference level and configure the attenuation, if necessary.
5. Select "Frequency" to define the center frequency of the measurement.
6. Optionally, select "Trigger" to use an external trigger or to configure a frequency mask trigger for the measurement. For details on using a frequency mask trigger see [Chapter 11.5, "How to work with frequency mask triggers"](#), on page 171. To capture and analyze I/Q data for a specific time around a trigger event, define a pretrigger and posttrigger time in the "Trigger" settings.
7. Select "Bandwidth" to configure the FFT parameters.
  - "RBW": Define the resolution bandwidth in Hz
  - "FFT Window": Select the window function depending on the required characteristics
  - "Sweep Time": Define how long data is to be captured for one line in the spectrogram
  - "Dwell Time": configure how long data is captured in a single sweep or a single measurement in continuous Sequencer mode. This determines how many lines in the spectrogram are measured.

8. Select "Analysis" and then the "Spectrogram/Waterfall" tab to configure the spectrogram.
  - "History Depth": number of lines (frames) to be stored in the spectrogram (possibly for several consecutive measurements).
  - Optionally, deactivate the "Time Stamp" option to refer to the individual lines (frames) using an index number instead of the time they were captured.
  - Optionally, select "Color Mapping" to change the colors with which the power levels are represented in the spectrogram. For details see [Chapter 11.4, "How to configure the color mapping"](#), on page 169.
  - Select "Clear Spectrogram" to start a new spectrogram display.
9. Press [RUN SINGLE] to start a sweep with the defined settings.

When the sweep is finished, the "Spectrogram" displays all captured lines captured during the dwell time, and the "Real-Time Spectrum" displays the spectrum that starts with the trigger event (or the most recently captured spectrum for free-run measurements).
10. Scroll through the individual frames of the "Spectrogram":
  - a) Tap the "Spectrogram" window.
  - b) Press [Sweep].
  - c) Select "Select Frame" and change the index number (negative numbers from 0 downwards).

The "Real-Time Spectrum" displays the stored spectrum for the selected frame.
11. Optionally, export the trace data of the spectrogram to a file.
  - a) Select "Analysis" in the "Overview".
  - b) In the "Traces" tab of the "Analysis" dialog box, switch to the "Trace Export" tab.
  - c) From the "Specifics for" list, select the spectrogram display.
  - d) Select "Export Trace to ASCII File".
  - e) Define a file name and storage location and select "OK".

## 11.2 How to obtain time domain results in real-time

The following step-by-step instructions demonstrate how to perform a Real-Time Spectrum measurement and obtain results in the time domain with the R&S FSW Real-Time Spectrum application.

1. Press [MODE] on the front panel and select the "Real-Time Spectrum" application.
2. Press [RUN CONT] to stop the default continuous measurement.
3. Select "Overview" to display the "Overview" for a Real-Time Spectrum measurement.
4. Select "Select Measurement" and select the "Multi Domain" measurement, which provides time domain results in addition to spectrum results.

When using the FSW-B512R/-B800R options, the Multi Domain measurement is performed by default. In this case, the "Select Measurement" function is not required or available.

5. Select "Amplitude" to define the required reference level and configure the attenuation, if necessary.
6. Optionally, select "Trigger" to use an external trigger, a time domain trigger, or a frequency mask trigger for the measurement. For details on using a frequency mask trigger see [Chapter 11.5, "How to work with frequency mask triggers"](#), on page 171.

To capture and analyze I/Q data for a specific time around a trigger event, define a pretrigger and posttrigger time in the "Trigger" settings.

If a trigger is used, enable the "Stop on Trigger" option to perform a single measurement.

7. Select "Bandwidth" to configure the FFT parameters.
  - "RBW": Define the resolution bandwidth in Hz
  - "FFT window": Select the window function depending on the required characteristics
  - "PVT Sweep time": Define how long data is to be captured for one Power vs. Time display
8. Select "Analysis" and then the "Spectrogram/Waterfall" tab to configure the waterfall diagram.
  - History depth: number of frames to be stored in the waterfall (possibly for several consecutive measurements).
  - Optionally, deactivate the time stamp option to refer to the individual frames using an index number instead of the time they were captured.
  - Optionally, select "Color Mapping" (in the "Power vs. Time Waterfall Config" area) to change the colors with which the power levels are represented in the waterfall. For details see [Chapter 11.4, "How to configure the color mapping"](#), on page 169.
  - Select "Clear Power vs. Time Waterfall" to start a new waterfall diagram.
9. Press [RUN SINGLE] to start a sweep with the defined settings.

When the sweep is finished, the "PVT Waterfall" diagram displays the captured frames, and the "PVT" diagram displays the results that start with the trigger event (or the most recently measured values for free-run measurements).
10. Scroll through the individual frames of the waterfall:
  - a) Tap the "PVT Waterfall" window.
  - b) Press [Sweep].
  - c) Select "Select Frame" and change the index number (negative numbers from 0 downwards).

The "PVT" window displays the stored diagram for the selected frame.
11. Optionally, export the trace data of the PVT diagram or PVT waterfall to a file.

- a) Select "Analysis" in the "Overview".
- b) In the "Traces" tab of the "Analysis" dialog box, switch to the "Trace Export" tab.
- c) From the "Specifics for" list, select the "PVT" or "PVT Waterfall" window
- d) Select "Export Trace to ASCII File".
- e) Define a file name and storage location and select "OK".

### 11.3 How to analyze persistency in Real-Time Spectrum measurements

The following step-by-step instructions demonstrate how to analyze persistency in the R&S FSW Real-Time Spectrum application.

1. Configure the R&S FSW Real-Time Spectrum application to perform a Real-Time Spectrum measurement as described in [Chapter 11.1, "How to perform a basic Real-Time Spectrum measurement"](#), on page 165.
2. Select "Display Config" and add a "Persistence Spectrum" window to the display.
3. Press [ESC] to exit the display configuration.
4. Select "Persistence Config" to configure the persistency.
  - "Persistence": Define how long each measured value is considered in the density calculation.
  - "Granularity": Define the time frame used to calculate a single frame in the "Persistence Spectrum".
  - Optionally, select "Dots" style to display only true values without interpolated data.
  - Optionally, select "Color Mapping" to change the colors with which the density is represented in the "Persistence Spectrum". For details see [Chapter 11.4, "How to configure the color mapping"](#), on page 169.
  - Optionally, deactivate or change the intensity of the "Max Hold" trace that shows only the maximum density for all frequencies. Select "Reset" to start a new "Max Hold" trace.
5. Press [RUN SINGLE] to start a sweep with the defined persistency settings.

When the sweep is finished, the "Persistence Spectrum" displays the density of all measured values, and the "Real-Time Spectrum" displays the spectrum that starts with the trigger event (or the most recently captured spectrum for free-run measurements).

Now you can analyze the colors in the "Persistence Spectrum", which indicate the probability of a particular level in the spectrum.



## 11.4 How to configure the color mapping

The color display is highly configurable to adapt the spectrogram to your needs.



Color mapping is very similar for "Spectrogram" and "Persistence Spectrum" result displays. The following description describes the "Spectrogram" color mapping, but applies to "Persistence Spectrum" displays, as well. The only difference is that the colors represent power values (in dBm) for Spectrograms, while they represent the percentage of specific level occurrence over the entire measurement duration in the "Persistence Spectrum".

The settings for color mapping are defined in the "Color Mapping" dialog box. To display this dialog box, do one of the following:

- Select the color map in the window title bar of the "Spectrogram" result display.
- Select "Color Mapping" in the "Real-Time Config" menu.

### To select a color scheme

You can select which colors are assigned to the measured values.

- ▶ In the "Color Mapping" dialog box, select the option for the color scheme to be used.

### Editing the value range of the color map

The distribution of the measured values is displayed as a histogram in the "Color Mapping" dialog box. To cover the entire measurement value range, make sure the first and last bar of the histogram are included.

To ignore noise in a spectrogram, for example, exclude the lower power levels from the histogram.



The value range of the color map must cover at least 10% of the value range on the horizontal axis of the diagram, that means, the difference between the start and stop values must be at least 10%.

The value range of the color map can be set numerically or graphically.

### To set the value range graphically using the color range sliders

1. Select and drag the bottom color curve slider (indicated by a gray box at the left of the color curve pane) to the lowest value you want to include in the color mapping.

2. Select and drag the top color curve slider (indicated by a gray box at the right of the color curve pane) to the highest value you want to include in the color mapping.

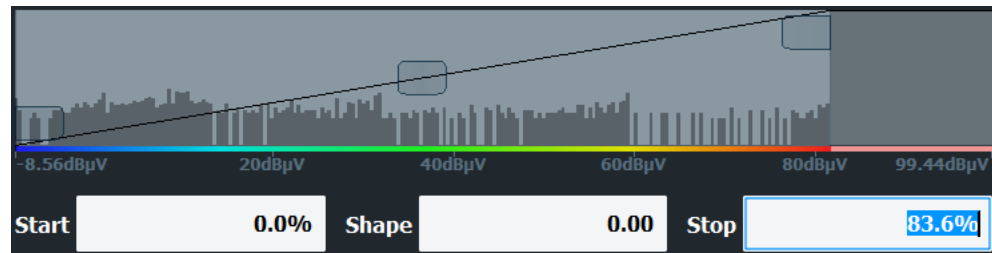

### To set the value range of the color map numerically

1. In the "Start" field, enter the percentage from the left border of the histogram that marks the beginning of the value range.
2. In the "Stop" field, enter the percentage from the right border of the histogram that marks the end of the value range.

#### Example:

The color map starts at -110 dBm and ends at -10 dBm (that is: a range of 100 dB). In order to suppress the noise, you only want the color map to start at -90 dBm. Thus, you enter *10%* in the "Start" field. The FSW shifts the start point 10% to the right, to -90 dBm.



#### Adjusting the reference level and level range

Since the color map is configured using percentages of the total value range, changing the reference level and level range of the measurement (and thus the power value range) also affects the color mapping in the spectrogram.



#### Truncating persistence spectrum results

By default, results that are smaller than the start value of the color map range are displayed in the color for the minimum value. Results that are larger than the stop value of the color map range are displayed in the color for the maximum value.

In order to hide results outside the value range of the color map, use the "Truncate" function (see ["Truncate"](#) on page 123).

#### Editing the shape of the color curve

The color curve is a tool to shift the focus of the color distribution on the color map. By default, the color curve is linear, i.e. the colors on the color map are distributed evenly. If you shift the curve to the left or right, the distribution becomes non-linear. The slope of the color curve increases or decreases. One end of the color palette then covers a large number of results, while the other end distributes several colors over a relatively small result range.

The color curve shape can be set numerically or graphically.

### To set the color curve shape graphically using the slider

- ▶ Select and drag the color curve shape slider (indicated by a gray box in the middle of the color curve) to the left or right. The area beneath the slider is focused, i.e. more colors are distributed there.

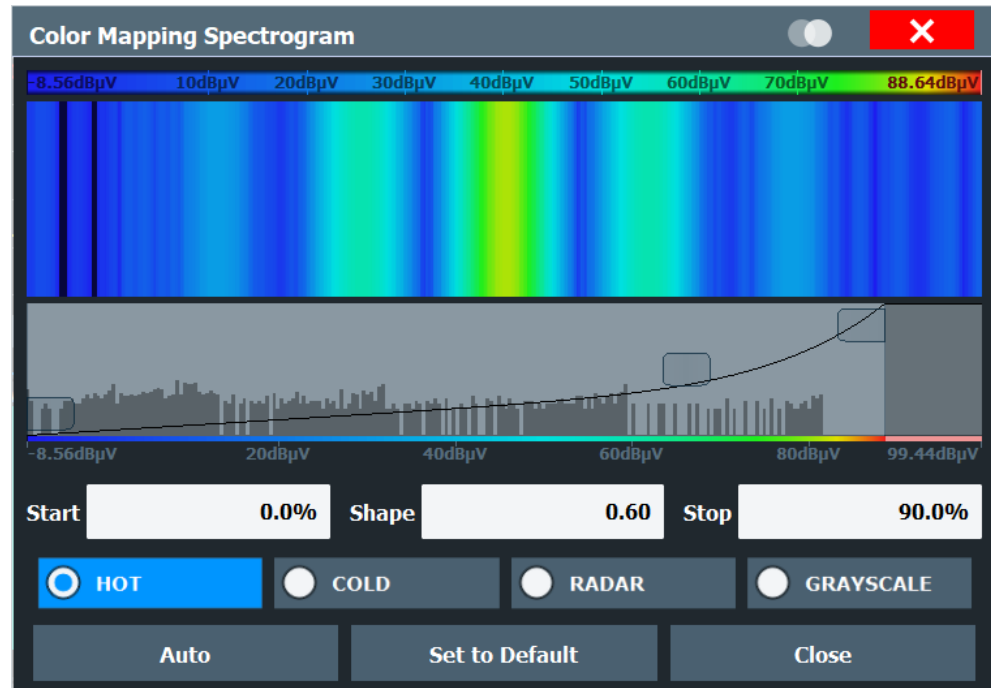

### To set the color curve shape numerically

- ▶ In the "Shape" field, enter a value to change the shape of the curve:
  - A negative value (-1 to <0) focuses the lower values
  - 0 defines a linear distribution
  - A positive value (>0 to 1) focuses the higher values

## 11.5 How to work with frequency mask triggers

The Frequency Mask Trigger (FMT) is a mask in the frequency domain, which is checked with every calculated FFT. When a specific condition concerning this mask occurs during the measurement of the input signal, I/Q data capturing is triggered.

For details see [Chapter 6.4.1, "Triggering on specific frequency events \(frequency mask trigger\)"](#), on page 42

### 11.5.1 How to create a new frequency mask

The frequency mask is configured by a set of individual trace points which are connected to form a mask area. The frequency mask may have any shape, defined by up to 1001 points.

There are several ways to create a new mask:

- Automatically, according to the currently measured values
- Graphically, by adding and moving mask points on the touchscreen
- Numerically, by defining the x- and y-values of the mask points

You can combine the methods. For example, first you sketch the mask quickly on the touchscreen, and then modify the point coordinates with precise values. Or you create an upper mask automatically and then add a lower mask manually.

#### To create a mask automatically

1. Press [MEAS CONFIG], then select the "Edit Frequency Mask".  
A default (upper) mask is displayed in the preview area of the "Edit Frequency Mask" dialog box.
2. Select "Auto-Set Mask".  
A mask in close proximity to the currently measured data is created.
3. If necessary, modify the mask or add a lower mask as described in ["To create a mask manually"](#) on page 172.
4. Activate the mask by selecting "Activate".  
The trigger source is set to "Frequency Mask" and the "Edit Frequency Mask" dialog box is closed.

#### To create a mask manually

1. Press [MEAS CONFIG], then select "Edit Frequency Mask".  
A default (upper) mask with 4 points is displayed in the preview area of the "Edit Frequency Mask" dialog box.
2. If the mask you want to create is very different to the default mask, select "Delete Mask".
3. To define an upper mask, select the "Upper Mask" option.  
To define a lower mask, select the "Lower Mask" option.
4. For each mask, tap the corner points of the mask in the preview area and drag them to the required destination, or enter the position and value of each mask point in the list of coordinates to the left of the preview area.
5. If necessary, insert additional mask points to design a more complex shape:
  - a) Tap an existing mask point in the preview area or in the list of coordinates before which you want to insert a new point.

- b) Select "Insert".  
An additional point is inserted in the mask in the preview area and in the list of coordinates.
  - c) Drag the new point to the required destination, or define its coordinates.
6. To shift the entire mask (upper and lower) vertically or horizontally, for example to consider a frequency or reference level offset in the input signal, select "Shift x" or "Shift y".
7. Repeat these steps until the required mask shape is displayed.  
For upper masks, the display region above the defined mask points is defined as the frequency mask and filled with red color. For lower masks, the display region below the mask points is defined as the frequency mask and also filled in red.
8. Define how the frequency mask is to be evaluated, depending on whether the mask area represents the relevant or irrelevant value range. See "[Trigger conditions](#)" on page 44 for detailed descriptions of the possible conditions.
9. Optionally, store the frequency mask configuration for later use:
  - a) Provide a name and, optionally, a comment for the mask.
  - b) Select "Save Mask".
  - c) In the file selection dialog box, select the storage location for the file (default: `C:\Program Files (x86)\Rohde-Schwarz\FSW\<version>\freqmask`).  
By default, the mask name is used as the file name; however, it can be edited.
  - d) Select "Save".

The mask is stored in a file with the extension `.FMT` in the selected directory.
10. Activate the mask by selecting "Activate".  
The trigger source is set to "Frequency Mask" and the "Edit Frequency Mask" dialog box is closed.

### 11.5.2 How to use a frequency mask trigger

You can activate the use of a frequency mask trigger directly after creating the mask (see [Chapter 11.5.1, "How to create a new frequency mask"](#), on page 172). To use a frequency mask trigger that has already been configured, follow these steps.

1. Press [TRIG], then select "Frequency Mask" to use a mask as the trigger source.
2. Press [MEAS CONFIG], then select "Edit Frequency Mask".
3. Define which frequency mask is to be used as a trigger source:
  - a) Select "Load Mask" to select a stored frequency mask.
  - b) In the file selection dialog box, select the storage location of the file (default: `C:\Program Files (x86)\Rohde-Schwarz\FSW\<version>\freqmask`) with the extension `.FMT`.

- c) If necessary, modify the mask as described in ["To create a mask manually"](#) on page 172.
4. Make sure the checkbox next to "Upper Mask" or "Lower Mask" is selected for use in the measurement.

The next Real-Time Spectrum measurement will be triggered when the specified event concerning the frequency mask occurs.

## 11.6 How to output a trigger signal

Using the variable Trigger 2/3 connector of the FSW, the internal trigger signal can be output for use by other connected devices.

For details on the connectors see the FSW "Getting Started" manual.

### To output a trigger to a connected device

1. Select [Trigger] > "Trigger Config".
2. Switch to the "Trigger In/Out" tab of "Trigger and Gate".
3. Set the trigger to be used to "Output".  
(Note: Trigger 2 is output to the front panel connector, Trigger 3 is output to the rear panel connector. For FSW85 models with two RF input connectors, Trigger 2 is not available.)
4. Define whether the trigger signal is to be output automatically ("Output Type" = "Device triggered" or "Trigger Armed") or whether you want to start output manually ("Output Type" = "User-defined").
5. For manual output: Specify the constant signal level and the length of the trigger pulse to be output. Note that the level of the trigger pulse is opposite to the constant output "Level" setting (compare the graphic on "Send Trigger").
6. Connect a device that will receive the trigger signal to the configured Trigger 2/3 connector.
7. Start a measurement and wait for an internal trigger, or select "Send Trigger".

The configured trigger is output to the connector.

## 11.7 How to output trigger signals continuously

Using the variable Trigger 2/3 connector of the FSW and the "Mark only" trigger mode, an internal trigger signal can be output continuously for use by other connected devices. See also [Chapter 6.4.3, "Trigger modes"](#), on page 47.

For details on the connectors see the FSW "Getting Started" manual.

**To output a trigger to a connected device continuously**

1. Select [Trigger] > "Trigger Config".
2. Select the trigger source, for example a frequency mask trigger.
3. Configure the trigger or frequency mask as required.
4. Select the "Mark only" trigger mode.
5. Switch to the "Trigger In/Out" tab.
6. Set the trigger to be used to "Output".  
(Note: Trigger 2 is output to the front panel connector, Trigger 3 is output to the rear panel connector. For FSW85 models with two RF input connectors, Trigger 2 is not available.)
7. Set the trigger signal to be output automatically ("Output Type" = "Device triggered").
8. Connect a device that will receive the trigger signal to the configured Trigger 2/3 connector.
9. Start a measurement.  
Each trigger is output to the connector.

## 11.8 How to perform measurements in MSRT mode

The following step-by-step instructions demonstrate how to perform a measurement in MSRT mode.

**How to capture data in MSRT mode**

1. Press [MODE] on the front panel and select the "Multi-Standard Real-Time" operating mode.  
Confirm the message.
2. Select "Overview" to display the "Overview" for a Real-Time Spectrum measurement.
3. Select "Amplitude" to define the required reference level and configure the attenuation, if necessary.
4. Select "Frequency" to define the frequency range to be measured (maximum 160 MHz).  
Configure at least one of the following parameter combinations:
  - Center frequency and span
  - Start and stop frequency

5. Select "Trigger" to use an external trigger or to configure a frequency mask trigger for the measurement. For details on using a frequency mask trigger see [Chapter 11.5, "How to work with frequency mask triggers"](#), on page 171.  
Define a pretrigger and posttrigger time in the "Trigger" settings.  
Enable the "Stop on Trigger" option to perform a single measurement.
6. Select "Bandwidth" to configure the FFT parameters.
  - "RBW": Define the resolution bandwidth in Hz
  - "FFT window": Select the window function depending on the required characteristics
  - "Sweep time": Define how long data is to be captured for one line in the spectrogram
  - "Dwell time": configure how long data is captured in a single sweep or a single measurement in continuous Sequencer mode. This determines how many sweep time intervals are captured for the spectrogram.
7. If necessary, select "Display Config" and add other result displays.  
Arrange them to suit your preferences.
8. Press [ESC] to exit the display configuration.  
  
After the trigger event occurs, a single measurement is performed and you can analyze the captured I/Q data in various MSRT secondary applications at the same time.

#### How to analyze the captured data in MSRT secondary applications

1. Press [MODE] on the front panel and select an MSRT secondary application.
2. Select "Overview" to display the "Overview" for the MSRT secondary application.
3. Define the secondary application data extract, that is: the range of the capture buffer you want to analyze in this secondary application. The exact settings depend on the type of application; usually, they are the same settings used to define data acquisition in the application in Signal and Spectrum Analyzer mode. Additionally, a [Capture Offset](#) is available (see also "[Application data](#)" on page 68).
4. Select "Frequency" and define the center frequency for the analysis interval.
5. Select "Display Config" and add other displays to analyze the data in the configured interval.  
Arrange them to suit your preferences.
6. Press [ESC] to exit the display configuration.  
  
Repeat these steps for any other secondary applications.

#### How to perform analysis of the correlated data

1. Perform a single data acquisition measurement as described in "[How to capture data in MSRT mode](#)" on page 175.



2. Activate measurement channels for the MSRT secondary applications you require as described in "[How to analyze the captured data in MSRT secondary applications](#)" on page 176.
3. Select the MSRT View to get an overview of the captured data and all configured secondary applications.  
Define the individual data ranges that you want to analyze in the different secondary applications. The exact settings depend on the type of application; usually, they are the same settings used to define data acquisition in the application in Signal and Spectrum Analyzer mode. Additionally, a [Capture Offset](#) is available (see also "[Application data](#)" on page 68).  
The analysis line indicates a common time in all time-based result displays for easy comparison.

## 12 Optimizing and troubleshooting the measurement

If the results do not meet your expectations, try the following methods to optimize the measurement or solve problems:

[No results are displayed in MSRT applications](#)..... 178

### **No results are displayed in MSRT applications**

When you switch to MSRT mode, the Sequencer is automatically activated in **Continuous Sequence mode**. Since the default trigger mode is **"Free Run"** and **"Auto Rearm"**, the MSRT primary continuously performs a Real-Time measurement until it is stopped. During this time, the Sequencer never passes the data on to other MSRT applications and no evaluation is performed in those result displays.

Thus, it is important that you configure a trigger for the MSRT primary, or stop the Sequencer and switch between the primary and the application tabs manually. In this case, the continuous measurement is stopped when you switch tabs. However, you will have to update the subsequent application displays manually, using the "Refresh" functions (see ["Refresh \(MSRT only\)"](#) on page 115/["Refresh All"](#) on page 114).

For details see [Chapter 8, "Configuring and performing measurements in MSRT mode"](#), on page 112.

## 13 Remote commands to perform real-time measurements

The following commands are specific to performing measurements in the "Real-Time Spectrum" application in a remote environment.

It is assumed that the FSW has already been set up for remote control in a network as described in the FSW User Manual.



Note that basic tasks that are also performed in the base unit in the same way are not described here. For a description of such tasks, see the FSW User Manual.

In particular, this includes:

- Managing Settings and Results, i.e. storing and loading settings and result data
- Basic instrument configuration, e.g. checking the system configuration, customizing the screen layout, or configuring networks and remote operation
- Using the common status registers



### SCPI Recorder - automating tasks with remote command scripts

The R&S FSW Real-Time Spectrum application also supports the SCPI Recorder functionality.

Using the SCPI Recorder functions, you can create a SCPI script directly on the instrument and then export the script for use on the controller. You can also edit or write a script manually, using a suitable editor on the controller. For manual creation, the instrument supports you by showing the corresponding command syntax for the current setting value.

For details see the "Network and Remote Operation" chapter in the FSW User Manual.

The following tasks specific to Real-Time measurements are described here:

• <a href="#">Introduction</a> .....	180
• <a href="#">Common suffixes</a> .....	184
• <a href="#">Activating the real-time spectrum application</a> .....	185
• <a href="#">Selecting the measurement type</a> .....	189
• <a href="#">Configuring real-time measurements</a> .....	190
• <a href="#">Capturing data and performing sweeps</a> .....	262
• <a href="#">Retrieving results</a> .....	266
• <a href="#">Analyzing results</a> .....	280
• <a href="#">Querying the status registers</a> .....	335
• <a href="#">Deprecated commands</a> .....	339
• <a href="#">Remote commands for MSRT operating mode</a> .....	341
• <a href="#">Programming examples: performing real-time measurements</a> .....	344

## 13.1 Introduction

Commands are program messages that a controller (e.g. a PC) sends to the instrument or software. They operate its functions ('setting commands' or 'events') and request information ('query commands'). Some commands can only be used in one way, others work in two ways (setting and query). If not indicated otherwise, the commands can be used for settings and queries.

The syntax of a SCPI command consists of a header and, usually, one or more parameters. To use a command as a query, you have to append a question mark after the last header element, even if the command contains a parameter.

A header contains one or more keywords, separated by a colon. Header and parameters are separated by a "white space" (ASCII code 0 to 9, 11 to 32 decimal, e.g. blank). If there is more than one parameter for a command, they are separated by a comma from one another.

Only the most important characteristics that you need to know when working with SCPI commands are described here. For a more complete description, refer to the user manual of the FSW.



### Remote command examples

Note that some remote command examples mentioned in this general introduction are possibly not supported by this particular application.

### 13.1.1 Conventions used in descriptions

The following conventions are used in the remote command descriptions:

- **Command usage**  
If not specified otherwise, commands can be used both for setting and for querying parameters.  
If a command can be used for setting or querying only, or if it initiates an event, the usage is stated explicitly.
- **Parameter usage**  
If not specified otherwise, a parameter can be used to set a value, and it is the result of a query.  
Parameters required only for setting are indicated as **Setting parameters**.  
Parameters required only to refine a query are indicated as **Query parameters**.  
Parameters that are only returned as the result of a query are indicated as **Return values**.
- **Conformity**  
Commands that are taken from the SCPI standard are indicated as **SCPI confirmed**. All commands used by the FSW follow the SCPI syntax rules.
- **Asynchronous commands**  
A command which does not automatically finish executing before the next command starts executing (overlapping command) is indicated as an **Asynchronous command**.
- **Reset values (\*RST)**

Default parameter values that are used directly after resetting the instrument (\*RST command) are indicated as \*RST values, if available.

- **Default unit**  
The default unit is used for numeric values if no other unit is provided with the parameter.
- **Manual operation**  
If the result of a remote command can also be achieved in manual operation, a link to the description is inserted.

### 13.1.2 Long and short form

The keywords have a long and a short form. You can use either the long or the short form, but no other abbreviations of the keywords.

The short form is emphasized in uppercase letters. Note however, that this emphasis only serves the purpose to distinguish the short from the long form in the manual. For the instrument, the case does not matter.

**Example:**

`SENSe:FREQUency:CENTer` is the same as `SENS:FREQ:CENT`.

### 13.1.3 Numeric suffixes

Some keywords have a numeric suffix if the command can be applied to multiple instances of an object. In that case, the suffix selects a particular instance (e.g. a measurement window).

Numeric suffixes are indicated by angular brackets (<n>) next to the keyword.

If you do not quote a suffix for keywords that support one, a 1 is assumed.

**Example:**

`DISPlay[:WINDow<1...4>]:ZOOM:STATe` enables the zoom in a particular measurement window, selected by the suffix at `WINDow`.

`DISPlay:WINDow4:ZOOM:STATe ON` refers to window 4.

### 13.1.4 Optional keywords

Some keywords are optional and are only part of the syntax because of SCPI compliance. You can include them in the header or not.



If an optional keyword has a numeric suffix and you need to use the suffix, you have to include the optional keyword. Otherwise, the suffix of the missing keyword is assumed to be the value 1.

Optional keywords are emphasized with square brackets.

**Example:**

Without a numeric suffix in the optional keyword:

```
[SENSe:]FREQuency:CENTer is the same as FREQuency:CENTer
```

With a numeric suffix in the optional keyword:

```
DISPlay[:WINDow<1...4>]:ZOOM:STATe
```

DISPlay:ZOOM:STATe ON enables the zoom in window 1 (no suffix).

DISPlay:WINDow4:ZOOM:STATe ON enables the zoom in window 4.

### 13.1.5 Alternative keywords

A vertical stroke indicates alternatives for a specific keyword. You can use both keywords to the same effect.

**Example:**

```
[SENSe:]BANDwidth|BWIDth[:RESolution]
```

In the short form without optional keywords, BAND 1MHZ would have the same effect as BWID 1MHZ.

### 13.1.6 SCPI parameters

Many commands feature one or more parameters.

If a command supports more than one parameter, they are separated by a comma.

**Example:**

```
LAYout:ADD:WINDow Spectrum,LEFT,MTABLE
```

Parameters can have different forms of values.

- [Numeric values](#)..... 182
- [Boolean](#)..... 183
- [Character data](#)..... 184
- [Character strings](#)..... 184
- [Block data](#)..... 184

#### 13.1.6.1 Numeric values

Numeric values can be entered in any form, i.e. with sign, decimal point or exponent. For physical quantities, you can also add the unit. If the unit is missing, the command uses the basic unit.

**Example:**

With unit: SENSe:FREQuency:CENTer 1GHZ

Without unit: SENSe:FREQuency:CENTer 1E9 would also set a frequency of 1 GHz.

Values exceeding the resolution of the instrument are rounded up or down.

If the number you have entered is not supported (e.g. for discrete steps), the command returns an error.

Instead of a number, you can also set numeric values with a text parameter in special cases.

- **MIN/MAX**  
Defines the minimum or maximum numeric value that is supported.
- **DEF**  
Defines the default value.
- **UP/DOWN**  
Increases or decreases the numeric value by one step. The step size depends on the setting. Sometimes, you can customize the step size with a corresponding command.

### Querying numeric values

When you query numeric values, the system returns a number. For physical quantities, it applies the basic unit (e.g. Hz for frequencies). The number of digits after the decimal point depends on the type of numeric value.

#### Example:

Setting: `SENSe:FREQuency:CENTer 1GHZ`

Query: `SENSe:FREQuency:CENTer?` would return `1E9`

Sometimes, numeric values are returned as text.

- **INF/NINF**  
Infinity or negative infinity. Represents the numeric values `9.9E37` or `-9.9E37`.
- **NAN**  
Not a number. Represents the numeric value `9.91E37`. NAN is returned if errors occur.

### 13.1.6.2 Boolean

Boolean parameters represent two states. The "on" state (logically true) is represented by "ON" or the numeric value 1. The "off" state (logically untrue) is represented by "OFF" or the numeric value 0.

### Querying Boolean parameters

When you query Boolean parameters, the system returns either the value 1 ("ON") or the value 0 ("OFF").

#### Example:

Setting: `DISPlay:WINDow:ZOOM:STATe ON`

Query: `DISPlay:WINDow:ZOOM:STATe?` would return `1`

### 13.1.6.3 Character data

Character data follows the syntactic rules of keywords. You can enter text using a short or a long form. For more information, see [Chapter 13.1.2, "Long and short form"](#), on page 181.

#### Querying text parameters

When you query text parameters, the system returns its short form.

#### Example:

Setting: `SENSe:BANDwidth:RESolution:TYPE NORMal`

Query: `SENSe:BANDwidth:RESolution:TYPE?` would return `NORM`

### 13.1.6.4 Character strings

Strings are alphanumeric characters. They have to be in straight quotation marks. You can use a single quotation mark ( ' ) or a double quotation mark ( " ).

#### Example:

`INSTRument:DELeTe 'Spectrum'`

### 13.1.6.5 Block data

Block data is a format which is suitable for the transmission of large amounts of data.

The ASCII character # introduces the data block. The next number indicates how many of the following digits describe the length of the data block. The data bytes follow. During the transmission of these data bytes, all end or other control signs are ignored until all bytes are transmitted. #0 specifies a data block of indefinite length. The use of the indefinite format requires an `NL^END` message to terminate the data block. This format is useful when the length of the transmission is not known or if speed or other considerations prevent segmentation of the data into blocks of definite length.

## 13.2 Common suffixes

In the R&S FSW Real-Time Spectrum application, the following common suffixes are used in remote commands:

*Table 13-1: Common suffixes used in remote commands in the R&S FSW Real-Time Spectrum application*

Suffix	Value range	Description
<m>	1 to 16	Marker
<n>	1 to 6	Window (in the currently selected channel)



Suffix	Value range	Description
<t>	1 to 4	Trace
<li>	1 to 8	Limit line

### 13.3 Activating the real-time spectrum application

Real-Time measurements require a special application. A measurement is started immediately with the default settings.

<a href="#">INSTrument:CREate:DUPLicate</a> .....	185
<a href="#">INSTrument:CREate[:NEW]</a> .....	185
<a href="#">INSTrument:CREate:REPLace</a> .....	186
<a href="#">INSTrument:DELeTe</a> .....	186
<a href="#">INSTrument:LIST?</a> .....	187
<a href="#">INSTrument:REName</a> .....	187
<a href="#">INSTrument[:SELeCt]</a> .....	188
<a href="#">SYSTem:PRESet:COMPAtible</a> .....	188
<a href="#">SYSTem:PRESet:CHANnel[:EXEC]</a> .....	188

---

#### INSTrument:CREate:DUPLicate

Duplicates the currently selected channel, i.e. creates a new channel of the same type and with the identical measurement settings. The name of the new channel is the same as the copied channel, extended by a consecutive number (e.g. "IQAnalyzer" -> "IQAnalyzer 2").

The channel to be duplicated must be selected first using the `INST:SEL` command.

Is not available if the MSRT primary channel is selected.

**Example:**

```
INST:SEL 'IQAnalyzer'
```

```
INST:CRE:DUPL
```

Duplicates the channel named 'IQAnalyzer' and creates a new channel named 'IQAnalyzer2'.

**Usage:** Event

---

#### INSTrument:CREate[:NEW] <ChannelType>, <ChannelName>

Adds a measurement channel. You can configure up to 10 measurement channels at the same time (depending on available memory).

##### Parameters:

- <ChannelType> Channel type of the new channel.  
For a list of available channel types, see [INSTrument:LIST?](#) on page 187.
- <ChannelName> String containing the name of the channel.  
Note that you cannot assign an existing channel name to a new channel. If you do, an error occurs.

**Example:** `INST:CRE SAN, 'Spectrum 2'`  
Adds a spectrum display named "Spectrum 2".

**Manual operation:** See ["New Channel"](#) on page 24

**INSTrument:CREate:REPLace** <ChannelName1>, <ChannelType>,  
<ChannelName2>

Replaces a channel with another one.

**Setting parameters:**

<ChannelName1> String containing the name of the channel you want to replace.

<ChannelType> Channel type of the new channel.  
For a list of available channel types, see [INSTrument:LIST?](#) on page 187.

<ChannelName2> String containing the name of the new channel.  
**Note:** If the specified name for a new channel already exists, the default name, extended by a sequential number, is used for the new channel (see [INSTrument:LIST?](#) on page 187).  
Channel names can have a maximum of 31 characters, and must be compatible with the Windows conventions for file names. In particular, they must not contain special characters such as ":", "\*", "?".

**Example:** `INST:CRE:REPL 'IQAnalyzer2', IQ, 'IQAnalyzer'`  
Replaces the channel named "IQAnalyzer2" by a new channel of type "IQ Analyzer" named "IQAnalyzer".

**Usage:** Setting only

**Manual operation:** See ["Replace Current Channel"](#) on page 24

**INSTrument:DELeTe** <ChannelName>

Deletes a channel.

If you delete the last channel, the default "Spectrum" channel is activated.

**Setting parameters:**

<ChannelName> String containing the name of the channel you want to delete.  
A channel must exist to delete it.

**Example:** `INST:DEL 'IQAnalyzer4'`  
Deletes the channel with the name 'IQAnalyzer4'.

**Usage:** Setting only

**Manual operation:** See ["Closing a secondary application"](#) on page 24

**INSTrument:LIST?**

Queries all active channels. The query is useful to obtain the names of the existing channels, which are required to replace or delete the channels.

**Return values:**

<ChannelType>, For each channel, the command returns the channel type and  
<ChannelName> channel name (see tables below).

Tip: to change the channel name, use the `INSTrument:REName` command.

**Example:**

`INST:LIST?`

Result for 3 channels:

```
'ADEM', 'Analog Demod', 'IQ', 'IQ Analyzer', 'IQ', 'IQ Analyzer2'
```

**Usage:**

Query only

**Table 13-2: Available channel types and default channel names in MSRT mode**

Secondary application	<ChannelType> Parameter	Default Channel Name*)
AM/FM/PM Modulation Analysis (FSW-K7)	ADEM	Analog Demod
I/Q Analyzer	IQ	IQ Analyzer
Pulse (FSW-K6)	PULSE	Pulse
"Real-Time Spectrum"	RTIM	"Real-Time Spectrum"
Transient Analysis (FSW-K60)	TA	Transient Analysis
VSA (FSW-K70)	DDEM	VSA

Note: the default channel name is also listed in the table. If the specified name for a new channel already exists, the default name, extended by a sequential number, is used for the new channel.

**INSTrument:REName** <ChannelName1>, <ChannelName2>

Renames a channel.

**Setting parameters:**

<ChannelName1> String containing the name of the channel you want to rename.

<ChannelName2> String containing the new channel name.

Note that you cannot assign an existing channel name to a new channel. If you do, an error occurs.

Channel names can have a maximum of 31 characters, and must be compatible with the Windows conventions for file names. In particular, they must not contain special characters such as ":", "\*", "?".

**Example:**

```
INST:REN 'IQAnalyzer2', 'IQAnalyzer3'
```

Renames the channel with the name 'IQAnalyzer2' to 'IQAnalyzer3'.

**Usage:** Setting only

---

**INSTRument[:SElect] <ChannelType>**

Selects the application (channel type) for the current channel.

See also [INSTRument:CREate\[:NEW\]](#) on page 185.

For a list of available channel types see [INSTRument:LIST?](#) on page 187.

**Parameters:**

<ChannelType>      **RTIM**  
 "Real-Time Spectrum" application  
 (not MSRT operating mode! See [INSTRument:MODE](#)  
 on page 341)

**Example:** See [Chapter 13.12.2, "Example 2: performing a basic real-time measurement"](#), on page 345.

**Manual operation:** See ["I/Q Analyzer"](#) on page 22  
 See ["AM/FM/PM Modulation Analysis"](#) on page 22  
 See ["Pulse Measurements"](#) on page 22  
 See ["Real-Time Spectrum"](#) on page 22  
 See ["Transient Analysis"](#) on page 22  
 See ["Vector Signal Analysis \(VSA\)"](#) on page 23  
 See ["Selecting a real-time application"](#) on page 24  
 See ["New Channel"](#) on page 24

---

**SYSTem:PRESet:COMPAtible <OpMode>**

Defines the operating mode that is activated when you switch on the FSW or press [PRESET].

**Parameters:**

<OpMode>      **SANalyzer**  
 (Default:)  
 Defines Signal and Spectrum Analyzer operating mode as the  
 presetting.

**MSRA**  
 Defines Multi-Standard Radio Analysis (MSRA) as the preset  
 default operating mode.

**RTMS**  
 Defines Multi-Standard Real-Time (MSRT) as the preset default  
 operating mode.

---

**SYSTem:PRESet:CHANnel[:EXEC]**

Restores the default instrument settings in the current channel.

Use [INST:SEL](#) to select the channel.

<b>Example:</b>	<pre>INST:SEL 'Spectrum2'</pre> Selects the channel for "Spectrum2". <pre>SYST:PRES:CHAN:EXEC</pre> Restores the factory default settings to the "Spectrum2" channel.
<b>Usage:</b>	Event
<b>Manual operation:</b>	See " <a href="#">Preset Channel</a> " on page 77

## 13.4 Selecting the measurement type

The R&S FSW Real-Time Spectrum application provides different measurement types to allow for Real-Time Spectrum measurements either optimized for high resolution or providing additional evaluation in the time domain.

[CONFigure:REALtime:MEASurement](#)..... 189

---

### CONFigure:REALtime:MEASurement <MeasType>

In order to accommodate for different requirements, different measurement types are provided for Real-Time Spectrum measurements.

These measurements are only available for FSW-K161R.

For FSW-B512R/-B800R, the R&S FSW Real-Time Spectrum application always performs a [Chapter 5.1.2, "Multi domain Real-Time Spectrum measurement"](#), on page 27. In this case, this command is not available.

#### Parameters:

<MeasType>

#### HRESolution

High Resolution Real-Time measurements are performed with frequency spans of up to 160 MHz, allowing for very precise results in the frequency domain.

Additional Span/RBW couplings are available for precise frequency results.

Time domain evaluation is not available.

#### MDOmain

Multi Domain Real-Time measurements allow for results both in the frequency and time domains, however with spans up to 100 MHz only.

\*RST: HRESolution

**Example:** See [Chapter 13.12.4, "Example 4: obtaining time domain results in real-time"](#), on page 351.

**Manual operation:** See "[Select Measurement](#)" on page 78

## 13.5 Configuring real-time measurements

• Configuring input/output settings.....	190
• Configuring the vertical axis (amplitude, scaling).....	211
• Defining the frequency and span.....	219
• Configuring bandwidth and sweep settings.....	222
• Triggering.....	226
• Configuring spectrograms and PVT waterfalls.....	239
• Configuring the persistence spectrum.....	242
• Configuring color maps.....	246
• Adjusting settings automatically.....	250
• Configuring the result display.....	253

### 13.5.1 Configuring input/output settings

The following commands are required to define input and output settings. Any settings related to data acquisition or data output are only available for the "Real-Time Spectrum" Application or the MSRT primary.

• RF input.....	190
• Configuring digital I/Q output.....	193
• Digital I/Q 40G streaming output commands.....	195
• Using external mixers.....	196
• Configuring the outputs.....	210

#### 13.5.1.1 RF input

INPut:ATTenuation:PROTection:RESet.....	190
INPut:CONNector.....	191
INPut:COUPLing.....	191
INPut:DPATH.....	191
INPut:FILTer:HPASs[:STATe].....	192
INPut:FILTer:YIG[:STATe].....	192
INPut:IMPedance.....	192
INPut:SELect.....	193
INPut:TYPE.....	193

---

#### INPut:ATTenuation:PROTection:RESet

Resets the attenuator and reconnects the RF input with the input mixer for the FSW after an overload condition occurred and the protection mechanism intervened. The error status bit (bit 3 in the `STAT:QUES:POW` status register) and the `INPUT OVLD` message in the status bar are cleared.

The command works only if the overload condition has been eliminated first.

**Example:** `INP:ATT:PROT:RES`

---

**INPut:CONNector** <ConnType>

Determines which connector the input for the measurement is taken from.

**Parameters:**

&lt;ConnType&gt;

**RF**

RF input connector

**AIQI**

Analog Baseband I connector

This setting is only available if the "Analog Baseband" interface (FSW-B71) is installed and active for input. It is not available for the FSW67 or FSW85.

For more information on the "Analog Baseband" interface (FSW-B71), see the FSW I/Q Analyzer and I/Q Input User Manual.

**RFProbe**

Active RF probe

\*RST: RF

**Example:**

INP:CONN RF

Selects input from the RF input connector.

**Manual operation:** See "[Input Connector](#)" on page 81

---

**INPut:COUPling** <CouplingType>

Selects the coupling type of the RF input.

**Parameters:**

&lt;CouplingType&gt;

AC | DC

**AC**

AC coupling

**DC**

DC coupling

\*RST: AC

**Example:**

INP:COUP DC

**Manual operation:** See "[Input Coupling](#)" on page 80

---

**INPut:DPATH** <DirectPath>

Enables or disables the use of the direct path for frequencies close to 0 Hz.

**Parameters:**

&lt;DirectPath&gt;

AUTO | OFF

**AUTO | 1**

(Default) the direct path is used automatically for frequencies close to 0 Hz.

**OFF | 0**

The analog mixer path is always used.

**Example:** `INP:DPAT OFF`

**Manual operation:** See "[Direct Path](#)" on page 80

#### **INPut:FILTer:HPASs[:STATe] <State>**

Activates an additional internal high-pass filter for RF input signals from 1 GHz to 3 GHz. This filter is used to remove the harmonics of the FSW to measure the harmonics for a DUT, for example.

Requires an additional high-pass filter hardware option.

(Note: for RF input signals outside the specified range, the high-pass filter has no effect. For signals with a frequency of approximately 4 GHz upwards, the harmonics are suppressed sufficiently by the YIG-preselector, if available.)

#### **Parameters:**

<State>            ON | OFF | 0 | 1  
**OFF | 0**  
 Switches the function off  
**ON | 1**  
 Switches the function on  
 \*RST:            0

**Example:** `INP:FILT:HPAS ON`  
 Turns on the filter.

**Manual operation:** See "[High Pass Filter 1 to 3 GHz](#)" on page 80

#### **INPut:FILTer:YIG[:STATe] <State>**

Enables or disables the YIG filter.

#### **Parameters:**

<State>            ON | OFF | 0 | 1

**Example:** `INP:FILT:YIG OFF`  
 Deactivates the YIG-preselector.

**Manual operation:** See "[YIG-Preselector](#)" on page 81

#### **INPut:IMPedance <Impedance>**

Selects the nominal input impedance of the RF input. In some applications, only 50 Ω are supported.

#### **Parameters:**

<Impedance>        50 | 75  
 \*RST:            50 Ω  
 Default unit: OHM

**Example:** `INP:IMP 75`



**Manual operation:** See ["Impedance"](#) on page 80  
See ["Unit"](#) on page 89

---

### INPut:SElect <Source>

Selects the signal source for measurements, i.e. it defines which connector is used to input data to the FSW.

For FSW85 models with two RF input connectors, you must select the input connector to configure first using [INPut:TYPE](#).

#### Parameters:

<Source>                    **RF**  
Radio Frequency ("RF INPUT" connector)  
\*RST:                    RF

#### Example:

```
INP:TYPE INP1
For FSW85 models with two RF input connectors: selects the
1.00 mm RF input connector for configuration.
INP:SEL RF
```

**Manual operation:** See ["Radio Frequency State"](#) on page 79

---

### INPut:TYPE <Input>

The command selects the input path.

#### Parameters:

<Input>                    **INPUT1**  
Selects RF input 1.  
1 mm [RF Input] connector  
**INPUT2**  
Selects RF input 2.  
For FSW85 models with two RF input connectors:  
1.85 mm [RF2 Input] connector  
For all other models: not available  
\*RST:                    INPUT1

#### Example:

```
//Select input path
INP:TYPE INPUT1
```

**Manual operation:** See ["Radio Frequency State"](#) on page 79

### 13.5.1.2 Configuring digital I/Q output

[OUTPut:DIQ\[:STATE\]](#)..... 194  
[OUTPut<up>:DIQ:CDEvice?](#)..... 194

**OUTPut:DIQ:STATe] <State>**

Turns continuous output of I/Q data to the optional "Digital Baseband" interface on and off.

Using the digital input and digital output simultaneously is not possible.

If digital baseband output is active, the sample rate is restricted to 100 MHz (200 MHz if enhanced mode is possible; max. 160 MHz bandwidth).

**Parameters:**

<State>                    ON | OFF | 0 | 1  
**OFF | 0**  
 Switches the function off  
**ON | 1**  
 Switches the function on

**Example:**                OUTP:DIQ ON

**Manual operation:**    See "[Digital Baseband Output](#)" on page 83

**OUTPut<up>:DIQ:CDEvice?**

Queries the current configuration and the status of the digital I/Q data output to the optional "Digital Baseband" interface.

**Suffix:**

<up>

**Return values:**

<ConnState>              Defines whether a device is connected or not.  
**0**  
 No device is connected.  
**1**  
 A device is connected.

<DeviceName>            Device ID of the connected device

<SerialNumber>          Serial number of the connected device

<PortName>                Port name used by the connected device

<SampleRate>             Current data transfer rate of the connected device in Hz

<MaxTransferRate>        Maximum data transfer rate of the connected device in Hz

<ConnProtState>         State of the connection protocol which is used to identify the connected device.  
**Not Started**  
**Has to be Started**  
**Started**  
**Passed**  
**Failed**

	<b>Done</b>
<PRBSTestState>	State of the PRBS test.
	<b>Not Started</b>
	<b>Has to be Started</b>
	<b>Started</b>
	<b>Passed</b>
	<b>Failed</b>
	<b>Done</b>
<NotUsed>	to be ignored
<Placeholder>	for future use; currently "0"
<b>Example:</b>	<pre>OUTP:DIQ:CDEV? Result: 1,SMW200A,101190,CODER 1 IN, 0,200000000,Passed,Done,0,0</pre>
<b>Usage:</b>	Query only
<b>Manual operation:</b>	See <a href="#">"Output Settings Information"</a> on page 83 See <a href="#">"Connected Instrument"</a> on page 83

### 13.5.1.3 Digital I/Q 40G streaming output commands

The following commands are only available if the Digital I/Q 40G Streaming Output option (FSW-B517/-B1017) is installed.

<a href="#">OUTPut:IQHS:CDEvice?</a> .....	195
<a href="#">OUTPut:IQHS:MARKer</a> .....	196
<a href="#">OUTPut:IQHS:SRATe?</a> .....	196
<a href="#">OUTPut:IQHS[:STATe]</a> .....	196

---

#### OUTPut:IQHS:CDEvice?

Returns a comma-separated list of information on the instrument connected to the QSFP+ connector, if available.

**Example:**

```
OUTP:IQHS:CDEV?
Result:
1,IQW,1525.7551k05,900987,DIG IQ 40G A,tcpip::
computername::hislip0,1.9,1.1,1,1
```

**Usage:** Query only

**Manual operation:** See ["Connected Instrument"](#) on page 85

**OUTPut:IQHS:MARKer**

Inserts marker information to the data stream during a running I/Q data output recording. Useful to mark a specific event during the measurement that you detect in the result window, for example. Then you can search for the marker information in the output data to analyze the effects at that time.

**Usage:** Event

**Manual operation:** See ["Insert Marker"](#) on page 85

**OUTPut:IQHS:SRATe?**

Returns the currently used sample rate to transfer data via the Digital I/Q 40G Streaming Output interface.

**Usage:** Query only

**Manual operation:** See ["Output Settings Information"](#) on page 85

**OUTPut:IQHS[:STATe] <State>**

Enables or disables a digital output stream to the optional QSFP+ connector, if available.

**Parameters:**

<State> ON | OFF | 0 | 1  
**OFF | 0**  
 Switches the function off  
**ON | 1**  
 Switches the function on  
 \*RST: 0

**Manual operation:** See ["Digital I/Q 40G Streaming Out"](#) on page 84

**13.5.1.4 Using external mixers**

The commands required to work with external mixers in a remote environment are described here. Note that these commands require the FSW to have an external mixer option installed and an external mixer to be connected to the FSW.

In MSRT mode, external mixers are not supported.

- [Basic settings](#)..... 196
- [Mixer settings](#)..... 198
- [Conversion loss table settings](#)..... 204
- [Programming example: working with an external mixer](#).....208

**Basic settings**

The basic settings concern general usage of an external mixer.

[SENSe:]MIXer<x>[:STATe].....	197
[SENSe:]MIXer<x>:BIAS:HIGH.....	197
[SENSe:]MIXer<x>:BIAS[:LOW].....	197
[SENSe:]MIXer<x>:LOPower.....	198

---

### [SENSe:]MIXer<x>[:STATe] <State>

Activates or deactivates the use of a connected external mixer as input for the measurement. This command is only available if the optional External Mixer is installed and an external mixer is connected.

**Suffix:**

<x>                    1..n  
                         irrelevant

**Parameters:**

<State>                ON | OFF | 1 | 0  
                         \*RST:        0

**Example:**            MIX ON

---

### [SENSe:]MIXer<x>:BIAS:HIGH <BiasSetting>

Defines the bias current for the high (last) range.

Is only available if the external mixer is active (see [SENSe:]MIXer<x>[:STATe] on page 197).

**Suffix:**

<x>                    1..n  
                         irrelevant

**Parameters:**

<BiasSetting>        \*RST:        0.0 A  
                         Default unit: A

---

### [SENSe:]MIXer<x>:BIAS[:LOW] <BiasSetting>

Defines the bias current for the low (first) range.

Is only available if the external mixer is active (see [SENSe:]MIXer<x>[:STATe] on page 197).

**Suffix:**

<x>                    1..n  
                         irrelevant

**Parameters:**

<BiasSetting>        \*RST:        0.0 A  
                         Default unit: A

**[SENSe:]MIXer<x>:LOPower <Level>**

Specifies the LO level of the external mixer's LO port.

**Suffix:**

<x>                    1..n  
                         irrelevant

**Parameters:**

<Level>                Range:        13.0 dBm to 17.0 dBm  
                         Increment: 0.1 dB  
                         \*RST:        15.5 dBm  
                         Default unit: DBM

**Example:**            MIX:LOP 16.0dBm

**Mixer settings**

The following commands are required to configure the band and specific mixer settings.

[SENSe:]MIXer<x>:FREQUENCY:HANdOver.....	198
[SENSe:]MIXer<x>:FREQUENCY:STARt.....	199
[SENSe:]MIXer<x>:FREQUENCY:STOP.....	199
[SENSe:]MIXer<x>:HARMonic:BAND:PRESet.....	199
[SENSe:]MIXer<x>:HARMonic:BAND.....	199
[SENSe:]MIXer<x>:HARMonic:HIGH:STATe.....	200
[SENSe:]MIXer<x>:HARMonic:HIGH[:VALue].....	200
[SENSe:]MIXer<x>:HARMonic:TYPE.....	201
[SENSe:]MIXer<x>:HARMonic[:LOW].....	201
[SENSe:]MIXer<x>:IF?.....	201
[SENSe:]MIXer<x>:LOSS:HIGH.....	202
[SENSe:]MIXer<x>:LOSS:TABLE:HIGH.....	202
[SENSe:]MIXer<x>:LOSS:TABLE[:LOW].....	202
[SENSe:]MIXer<x>:LOSS[:LOW].....	203
[SENSe:]MIXer<x>:PORTs.....	203
[SENSe:]MIXer<x>:RFOVerrange[:STATe].....	203

**[SENSe:]MIXer<x>:FREQUENCY:HANdOver <Frequency>**

Defines the frequency at which the mixer switches from one range to the next (if two different ranges are selected). The handover frequency for each band can be selected freely within the overlapping frequency range.

Is only available if the external mixer is active (see [SENSe:]MIXer<x>[:STATe] on page 197).

**Suffix:**

<x>                    1..n  
                         irrelevant

**Parameters:**

<Frequency>            Default unit: HZ

**Example:**           MIX ON  
 Activates the external mixer.  
 MIX:FREQ:HAND 78.0299GHz  
 Sets the handover frequency to 78.0299 GHz.

#### [SENSe:]MIXer<x>:FREQuency:STARt

Sets or queries the frequency at which the external mixer band starts.

**Suffix:**

<x>                   1..n  
 irrelevant

**Example:**           MIX:FREQ:STAR?  
 Queries the start frequency of the band.

#### [SENSe:]MIXer<x>:FREQuency:STOP

Sets or queries the frequency at which the external mixer band stops.

**Suffix:**

<x>                   1..n  
 irrelevant

**Example:**           MIX:FREQ:STOP?  
 Queries the stop frequency of the band.

#### [SENSe:]MIXer<x>:HARMonic:BAND:PRESet

Restores the preset frequency ranges for the selected standard waveguide band.

**Note:** Changes to the band and mixer settings are maintained even after using the [PRESET] function. Use this command to restore the predefined band ranges.

**Suffix:**

<x>                   1..n  
 irrelevant

**Example:**           MIX:HARM:BAND:PRES  
 Presets the selected waveguide band.

#### [SENSe:]MIXer<x>:HARMonic:BAND <Band>

Selects the external mixer band. The query returns the currently selected band.

Is only available if the external mixer is active (see [SENSe:]MIXer<x>[:STATe] on page 197).

**Suffix:**

<x>                   1..n  
 irrelevant

**Parameters:**

&lt;Band&gt;

KA | Q | U | V | E | W | F | D | G | Y | J | USER

Standard waveguide band or user-defined band.

**Table 13-3: Frequency ranges for pre-defined bands**

Band	Frequency start [GHz]	Frequency stop [GHz]
KA (A) *)	26.5	40.0
Q	33.0	50.0
U	40.0	60.0
V	50.0	75.0
E	60.0	90.0
W	75.0	110.0
F	90.0	140.0
D	110.0	170.0
G	140.0	220.0
J	220.0	325.0
Y	325.0	500.0
USER	32.18 (default)	68.22 (default)

\*) The band formerly referred to as "A" is now named "KA".

**[SENSe:]MIXer<x>:HARMonic:HIGH:STATe <State>**

Specifies whether a second (high) harmonic is to be used to cover the band's frequency range.

**Suffix:**

&lt;x&gt; 1..n

**Parameters:**

&lt;State&gt; ON | OFF

\*RST: ON

**Example:**

MIX:HARM:HIGH:STAT ON

**[SENSe:]MIXer<x>:HARMonic:HIGH[:VALue] <HarmOrder>**

Specifies the harmonic order to be used for the high (second) range.

**Suffix:**<x> 1..n  
irrelevant



**Parameters:**

<HarmOrder>            Range:        2 to 128 (USER band); for other bands: see band definition

**Example:**

```
MIX:HARM:HIGH:STAT ON
MIX:HARM:HIGH 3
```

**[SENSe:]MIXer<x>:HARMonic:TYPE <OddEven>**

Specifies whether the harmonic order to be used should be odd, even, or both.

Which harmonics are supported depends on the mixer type.

**Suffix:**

<x>                        1..n  
                             irrelevant

**Parameters:**

<OddEven>                ODD | EVEN | EODD  
                             **ODD | EVEN | EODD**  
                             \*RST:        EVEN

**Example:**

```
MIX:HARM:TYPE ODD
```

**[SENSe:]MIXer<x>:HARMonic[:LOW] <HarmOrder>**

Specifies the harmonic order to be used for the low (first) range.

**Suffix:**

<x>                        1..n  
                             irrelevant

**Parameters:**

<HarmOrder>            Range:        2 to 128 (USER band); for other bands: see band definition  
                             \*RST:        2 (for band F)

**Example:**

```
MIX:HARM 3
```

**[SENSe:]MIXer<x>:IF?**

Queries the intermediate frequency currently used by the external mixer.

**Suffix:**

<x>                        1..n  
                             irrelevant

**Example:**

```
MIX:IF?
```

**Example:**

See "[Programming example: working with an external mixer](#)" on page 208.

**Usage:**

Query only

---

**[SENSe:]MIXer<x>:LOSS:HIGH <Average>**

Defines the average conversion loss to be used for the entire high (second) range.

**Suffix:**

<x>                    1..n  
                         irrelevant

**Parameters:**

<Average>            Range:        0 to 100  
                         \*RST:        24.0 dB  
                         Default unit: dB

**Example:**            MIX:LOSS:HIGH 20dB

---

**[SENSe:]MIXer<x>:LOSS:TABLE:HIGH <FileName>**

Defines the conversion loss table to be used for the high (second) range.

**Suffix:**

<x>                    1..n  
                         irrelevant

**Parameters:**

<FileName>            String containing the path and name of the file, or the serial number of the external mixer whose file is required. The FSW automatically selects the correct cvl file for the current IF. As an alternative, you can also select a user-defined conversion loss table (.acl file).

**Example:**            MIX:LOSS:TABL:HIGH '101567'  
                         MIX:LOSS:TABL:HIGH?  
                         //Result for installed B5000, bw<= 4.4 GHz: 101567\_B5000\_2G8.B5G:  
                         //'101567\_MAG\_6\_B5000\_2G8.B5G'  
                         //Result for installed B5000, bw> 4.4 GHz: 101567\_B5000\_2G8.B5G:  
                         //'101567\_MAG\_6\_B5000\_3G5.B5G'  
                         //Result for installed B2001 and bw> 80 MHz:  
                         //'101567\_MAG\_6\_B1200\_B2001.B2G'  
                         //Result for installed B2001 and bw<= 80 MHz:  
                         //'101567\_MAG\_6.ACL'

---

**[SENSe:]MIXer<x>:LOSS:TABLE[:LOW] <FileName>**

Defines the file name of the conversion loss table to be used for the low (first) range.

**Suffix:**

<x>                    1..n  
                         irrelevant

**Parameters:**

<FileName> String containing the path and name of the file, or the serial number of the external mixer whose file is required. The FSW automatically selects the correct cvl file for the current IF. As an alternative, you can also select a user-defined conversion loss table (.acl file).

**Example:**

```
MIX:LOSS:TABL '101567'
MIX:LOSS:TABL?
//Result:
'101567_MAG_6_B5000_3G5.B5G'
```

**[SENSe:]MIXer<x>:LOSS[:LOW] <Average>**

Defines the average conversion loss to be used for the entire low (first) range.

**Suffix:**

<x> 1..n  
irrelevant

**Parameters:**

<Average> Range: 0 to 100  
\*RST: 24.0 dB  
Default unit: dB

**Example:**

```
MIX:LOSS 20dB
```

**[SENSe:]MIXer<x>:PORTs <PortType>**

Selects the mixer type.

**Suffix:**

<x> 1..n  
irrelevant

**Parameters:**

<PortType> **2 | 3**  
**2**  
Two-port mixer.  
**3**  
Three-port mixer.  
\*RST: 2

**Example:**

```
MIX:PORT 3
```

**[SENSe:]MIXer<x>:RFOVerrange[:STATe] <State>**

If enabled, the band limits are extended beyond "RF Start" and "RF Stop" due to the capabilities of the used harmonics.

**Suffix:**

<x> 1..n  
irrelevant

**Parameters:**

<State> ON | OFF | 1 | 0  
\*RST: 0

**Conversion loss table settings**

The following settings are required to configure and manage conversion loss tables.

[SENSe:]CORRection:CVL:BAND.....	204
[SENSe:]CORRection:CVL:BIAS.....	204
[SENSe:]CORRection:CVL:CAalog?.....	205
[SENSe:]CORRection:CVL:CLEar.....	205
[SENSe:]CORRection:CVL:COMMeNt.....	205
[SENSe:]CORRection:CVL:DATA.....	206
[SENSe:]CORRection:CVL:HARMonic.....	206
[SENSe:]CORRection:CVL:MIXer.....	206
[SENSe:]CORRection:CVL:PORTs.....	207
[SENSe:]CORRection:CVL:SElect.....	207
[SENSe:]CORRection:CVL:SNUMber.....	207

**[SENSe:]CORRection:CVL:BAND <Band>**

Defines the waveguide band for which the conversion loss table is to be used. This setting is checked against the current mixer setting before the table can be assigned to the range.

Before this command can be performed, the conversion loss table must be selected (see [SENSe:]CORRection:CVL:SElect on page 207).

Is only available with option B21 (External Mixer) installed.

**Parameters:**

<Band> K | KA | Q | U | V | E | W | F | D | G | Y | J | USER  
Standard waveguide band or user-defined band.  
For a definition of the frequency range for the pre-defined bands, see [Table 13-3](#).  
\*RST: F (90 GHz - 140 GHz)

**Example:**

```
CORR:CVL:SEL 'LOSS_TAB_4'
Selects the conversion loss table.
CORR:CVL:BAND KA
Sets the band to KA (26.5 GHz - 40 GHz).
```

**[SENSe:]CORRection:CVL:BIAS <BiasSetting>**

Defines the bias setting to be used with the conversion loss table.

Before this command can be performed, the conversion loss table must be selected (see [\[SENSe:\]CORRection:CVL:SElect](#) on page 207).

Is only available with option B21 (External Mixer) installed.

**Parameters:**

<BiasSetting>            \*RST:        0.0 A  
                              Default unit: A

**Example:**

```
CORR:CVL:SEL 'LOSS_TAB_4'  
Selects the conversion loss table.  
CORR:CVL:BIAS 3A
```

---

**[SENSe:]CORRection:CVL:CATalog?**

Queries all available conversion loss tables saved in the C:\R\_S\INSTR\USER\cv1\ directory on the instrument.

Is only available with option B21 (External Mixer) installed.

**Return values:**

<Files>                    'string'  
                              Comma-separated list of strings containing the file names.

**Example:**                CORR:CVL:CAT?

**Usage:**                    Query only

---

**[SENSe:]CORRection:CVL:CLEar**

Deletes the selected conversion loss table. Before this command can be performed, the conversion loss table must be selected (see [\[SENSe:\]CORRection:CVL:SElect](#) on page 207).

Is only available with option B21 (External Mixer) installed.

**Example:**                CORR:CVL:SEL 'LOSS\_TAB\_4'  
                              Selects the conversion loss table.  
CORR:CVL:CLE

---

**[SENSe:]CORRection:CVL:COMment <Text>**

Defines a comment for the conversion loss table. Before this command can be performed, the conversion loss table must be selected (see [\[SENSe:\]CORRection:CVL:SElect](#) on page 207).

Is only available with option B21 (External Mixer) installed.

**Parameters:**

<Text>

**Example:**

```
CORR:CVL:SEL 'LOSS_TAB_4'
Selects the conversion loss table.
CORR:CVL:COMM 'Conversion loss table for
FS_Z60'
```

---

#### [SENSe:]CORRection:CVL:DATA {<Freq>, <Level>}...

Defines the reference values of the selected conversion loss tables. The values are entered as a set of frequency/level pairs. You can define a maximum of 500 frequency/level pairs. Before this command can be performed, you must select the conversion loss table (see [SENSe:]CORRection:CVL:SELEct on page 207).

Is only available with option B21 (External Mixer) installed.

#### Parameters:

<Freq>                    The frequencies have to be sent in ascending order.  
                               Default unit: HZ

<Level>                    Default unit: DB

**Example:**

```
CORR:CVL:SEL 'LOSS_TAB_4'
Selects the conversion loss table.
CORR:CVL:DATA 1MHZ, -30DB, 2MHZ, -40DB
```

---

#### [SENSe:]CORRection:CVL:HARMonic <HarmOrder>

Defines the harmonic order for which the conversion loss table is to be used. This setting is checked against the current mixer setting before the table can be assigned to the range.

Before this command can be performed, the conversion loss table must be selected (see [SENSe:]CORRection:CVL:SELEct on page 207).

Is only available with option B21 (External Mixer) installed.

#### Parameters:

<HarmOrder>              Range:        2 to 65

**Example:**

```
CORR:CVL:SEL 'LOSS_TAB_4'
Selects the conversion loss table.
CORR:CVL:HARM 3
```

---

#### [SENSe:]CORRection:CVL:MIXer <Type>

Defines the mixer name in the conversion loss table. This setting is checked against the current mixer setting before the table can be assigned to the range.

Before this command can be performed, the conversion loss table must be selected (see [SENSe:]CORRection:CVL:SELEct on page 207).

Is only available with option B21 (External Mixer) installed.

**Parameters:**

<Type> string  
Name of mixer with a maximum of 16 characters

**Example:**

```
CORR:CVL:SEL 'LOSS_TAB_4'
Selects the conversion loss table.
CORR:CVL:MIX 'FS_Z60'
```

**[SENSe:]CORRection:CVL:PORTs <PortType>**

Defines the mixer type in the conversion loss table. This setting is checked against the current mixer setting before the table can be assigned to the range.

Before this command can be performed, the conversion loss table must be selected (see [\[SENSe:\]CORRection:CVL:SElect](#) on page 207).

Is only available with option B21 (External Mixer) installed.

**Parameters:**

<PortType> 2 | 3  
\*RST: 2

**Example:**

```
CORR:CVL:SEL 'LOSS_TAB_4'
Selects the conversion loss table.
CORR:CVL:PORT 3
```

**[SENSe:]CORRection:CVL:SElect <FileName>**

Selects the conversion loss table with the specified file name. If <file\_name> is not available, a new conversion loss table is created.

Is only available with option B21 (External Mixer) installed.

**Parameters:**

<FileName> String containing the path and name of the file.

**Example:**

```
CORR:CVL:SEL 'LOSS_TAB_4'
```

**[SENSe:]CORRection:CVL:SNUMber <SerialNo>**

Defines the serial number of the mixer for which the conversion loss table is to be used. This setting is checked against the current mixer setting before the table can be assigned to the range.

Before this command can be performed, the conversion loss table must be selected (see [\[SENSe:\]CORRection:CVL:SElect](#) on page 207).

Is only available with option B21 (External Mixer) installed.

**Parameters:**

<SerialNo> Serial number with a maximum of 16 characters

**Example:**           CORR:CVL:SEL 'LOSS\_TAB\_4'  
                           Selects the conversion loss table.  
                           CORR:CVL:MIX '123.4567'

### Programming example: working with an external mixer

This example demonstrates how to work with an external mixer in a remote environment. It is performed in the Spectrum application in the default layout configuration. Note that without a real input signal and connected mixer, this measurement will not return useful results.

```
//-----Preparing the instrument -----
//Reset the instrument
*RST
//Activate the use of the connected external mixer.
SENS:MIX ON
//----- Configuring basic mixer behavior -----
//Set the LO level of the mixer's LO port to 15 dBm.
SENS:MIX:LOP 15dBm
//Set the bias current to -1 mA .
SENS:MIX:BIAS:LOW -1mA
//----- Configuring the mixer and band settings -----
//Use band "V" to full possible range extent for assigned harmonic (6).
SENS:MIX:HARM:BAND V
SENS:MIX:RFOV ON
//Query the possible range
SENS:MIX:FREQ:STAR?
//Result: 4748000000 (47.48 GHz)
SENS:MIX:FREQ:STOP?
//Result: 13802000000 (138.02 GHz)
//Use a 3-port mixer type
SENS:MIX:PORT 3
//Split the frequency range into two ranges;
//range 1 covers 47.48 GHz GHz to 80 GHz; harmonic 6, average conv. loss of 20 dB
//range 2 covers 80 GHz to 138.02 GHz; harmonic 8, average conv.loss of 30 dB
SENS:MIX:HARM:TYPE EVEN
SENS:MIX:HARM:HIGH:STAT ON
SENS:MIX:FREQ:HAND 80GHz
SENS:MIX:HARM:LOW 6
SENS:MIX:LOSS:LOW 20dB
SENS:MIX:HARM:HIGH 8
SENS:MIX:LOSS:HIGH 30dB
//----- Activating automatic signal identification functions -----
//Activate both automatic signal identification functions.
SENS:MIX:SIGN ALL
//Use auto ID threshold of 8 dB.
SENS:MIX:THR 8dB

//-----Performing the Measurement-----
//Select single sweep mode.
```



```

INIT:CONT OFF
//Initiate a basic frequency sweep and wait until the sweep has finished.
INIT;*WAI
//-----Retrieving Results-----
//Return the trace data for the input signal without distortions
//(default screen configuration)
TRAC:DATA? TRACE3

```

### Configuring a conversion loss table for a user-defined band

```

//-----Preparing the instrument -----
//Reset the instrument
*RST
//Activate the use of the connected external mixer.
SENS:MIX ON
//-----Configuring a new conversion loss table -----
//Define cvl table for range 1 of band as described in previous example
// (extended V band)
SENS:CORR:CVL:SEL 'UserTable'
SENS:CORR:CVL:COMM 'User-defined conversion loss table for USER band'
SENS:CORR:CVL:BAND USER
SENS:CORR:CVL:HARM 6
SENS:CORR:CVL:BIAS -1mA
SENS:CORR:CVL:MIX 'FS_Z60'
SENS:CORR:CVL:SNUM '123.4567'
SENS:CORR:CVL:PORT 3
//Conversion loss is linear from 55 GHz to 75 GHz
SENS:CORR:CVL:DATA 55GHZ,-20DB,75GHZ,-30DB
//----- Configuring the mixer and band settings -----
//Use user-defined band and assign new cvl table.
SENS:MIX:HARM:BAND USER
//Define band by two ranges;
//range 1 covers 47.48 GHz to 80 GHz; harmonic 6, cvl table 'UserTable'
//range 2 covers 80 GHz to 138.02 GHz; harmonic 8, average conv.loss of 30 dB
SENS:MIX:HARM:TYPE EVEN
SENS:MIX:HARM:HIGH:STAT ON
SENS:MIX:FREQ:HAND 80GHz
SENS:MIX:HARM:LOW 6
SENS:MIX:LOSS:TABL:LOW 'UserTable'
SENS:MIX:HARM:HIGH 8

SENS:MIX:LOSS:HIGH 30dB
//Query the possible range
SENS:MIX:FREQ:STAR?
//Result: 47480000000 (47.48 GHz)
SENS:MIX:FREQ:STOP?
//Result: 138020000000 (138.02 GHz)

//-----Performing the Measurement-----

```

```
//Select single sweep mode.
INIT:CONT OFF
//Initiate a basic frequency sweep and wait until the sweep has finished.
INIT;*WAI
//-----Retrieving Results-----
//Return the trace data (default screen configuration)
TRAC:DATA? TRACel
```

### 13.5.1.5 Configuring the outputs

The following commands are required to provide output from the FSW.



Configuring trigger input/output is described in [Chapter 13.5.5.3, "Configuring the trigger output"](#), on page 237.

[DIAGnostic:SERvice:NSOource](#).....210  
[SYSTem:SPEaker:VOLume](#)..... 210

---

#### **DIAGnostic:SERvice:NSOource** <State>

Turns the 28 V supply of the BNC connector labeled [noise source control] on the FSW on and off.

#### **Parameters:**

<State>            ON | OFF | 0 | 1  
**OFF | 0**  
 Switches the function off  
**ON | 1**  
 Switches the function on

**Example:**            DIAG:SERV:NSO ON

**Manual operation:**    See "[Noise Source Control](#)" on page 82

---

#### **SYSTem:SPEaker:VOLume** <Volume>

Defines the volume of the built-in loudspeaker for demodulated signals. This setting is maintained for all applications.

The command is available in the time domain in Spectrum mode and in Analog Modulation Analysis mode.

#### **Parameters:**

<Volume>            Percentage of the maximum possible volume.  
 Range:            0 to 1  
 \*RST:            0.5

**Example:**            SYST:SPE:VOL 0  
 Switches the loudspeaker to mute.

## 13.5.2 Configuring the vertical axis (amplitude, scaling)

The following commands are required to configure the amplitude and vertical axis settings in a remote environment.

- [Amplitude settings](#).....211
- [Configuring the attenuation](#).....213
- [Configuring a preamplifier](#).....215
- [Scaling the Y-axis](#).....217

### 13.5.2.1 Amplitude settings

**Useful commands for amplitude configuration described elsewhere:**

- [\[SENSe:\]ADJust:LEVel](#) on page 253

**Remote commands exclusive to amplitude configuration:**

<a href="#">CALCulate&lt;n&gt;:MARKer&lt;m&gt;:FUNction:REFerence</a> .....	211
<a href="#">UNIT&lt;n&gt;:POWer</a> .....	211
<a href="#">CALCulate&lt;n&gt;:UNIT:POWer</a> .....	211
<a href="#">DISPlay[:WINDow&lt;n&gt;][:SUBWindow&lt;w&gt;]:TRACe&lt;t&gt;:Y[:SCALe]:RLEVel</a> .....	212
<a href="#">DISPlay[:WINDow&lt;n&gt;][:SUBWindow&lt;w&gt;]:TRACe&lt;t&gt;:Y[:SCALe]:RLEVel:OFFSet</a> .....	212

---

#### **CALCulate<n>:MARKer<m>:FUNction:REFerence**

Matches the reference level to the power level of a marker.

If you use the command in combination with a delta marker, that delta marker is turned into a normal marker.

**Suffix:**

<n>                      [Window](#)

<m>                      [Marker](#)

**Example:**

`CALC:MARK2:FUNC:REF`

Sets the reference level to the level of marker 2.

**Manual operation:** See "[Reference Level = Marker Level](#)" on page 141

---

#### **UNIT<n>:POWer <Unit>**

#### **CALCulate<n>:UNIT:POWer <Unit>**

Selects the unit of the y-axis.

The unit applies to all power-based measurement windows with absolute values.

**Suffix:**

<n>                      irrelevant

**Parameters:**

<Unit> DBM | V | A | W | DBPW | WATT | DBUV | DBMV | VOLT |  
 DBUA | AMPere | DBM\_mhz | DBM\_hz | DBUa\_mhz |  
 DBUV\_mhz | DBmV\_mhz | DBpW\_mhz  
 (Units based on 1 MHz require installed R&S FSW-K54 (EMI  
 measurements) option.)  
 \*RST: dBm

**Example:**

CALC:UNIT:POW DBM  
 Sets the power unit to dBm.

**Manual operation:** See "Unit" on page 89

**DISPlay[:WINDow<n>][:SUBWindow<w>]:TRACe<t>:Y[:SCALe]:RLEVel**  
 <ReferenceLevel>

Defines the reference level (for all traces in all windows).

With a reference level offset ≠ 0, the value range of the reference level is modified by the offset.

**Suffix:**

<n> irrelevant  
 <w> subwindow  
 Not supported by all applications  
 <t> irrelevant

**Parameters:**

<ReferenceLevel> The unit is variable.  
 Range: see specifications document  
 \*RST: 0 dBm  
 Default unit: DBM

**Example:**

DISP:TRAC:Y:RLEV -60dBm

**Manual operation:** See "Reference Level" on page 89

**DISPlay[:WINDow<n>][:SUBWindow<w>]:TRACe<t>:Y[:SCALe]:RLEVel:OFFSet**  
 <Offset>

Defines a reference level offset (for all traces in all windows).

**Suffix:**

<n> irrelevant  
 <w> subwindow  
 Not supported by all applications  
 <t> irrelevant

**Parameters:**

<Offset>                   Range:       -200 dB to 200 dB  
                               \*RST:        0dB  
                               Default unit: DB

**Example:**                DISP:TRAC:Y:RLEV:OFFS -10dB

**Manual operation:**    See "[Shifting the Display \(Offset\)](#)" on page 89

**13.5.2.2 Configuring the attenuation**

INPut:ATTenuation.....	213
INPut:ATTenuation:AUTO.....	213
INPut:ATTenuation:AUTO:MODE.....	214
INPut:EATT.....	214
INPut:EATT:AUTO.....	214
INPut:EATT:STATE.....	215

**INPut:ATTenuation** <Attenuation>

Defines the total attenuation for RF input.

If you set the attenuation manually, it is no longer coupled to the reference level, but the reference level is coupled to the attenuation. Thus, if the current reference level is not compatible with an attenuation that has been set manually, the command also adjusts the reference level.

**Parameters:**

<Attenuation>            Range:        see specifications document  
                               Increment:   5 dB (with optional electr. attenuator: 1 dB)  
                               \*RST:        10 dB (AUTO is set to ON)  
                               Default unit: DB

**Example:**                INP:ATT 30dB  
 Defines a 30 dB attenuation and decouples the attenuation from the reference level.

**Manual operation:**    See "[Attenuation Mode / Value](#)" on page 90

**INPut:ATTenuation:AUTO** <State>

Couples or decouples the attenuation to the reference level. Thus, when the reference level is changed, the FSW determines the signal level for optimal internal data processing and sets the required attenuation accordingly.

**Parameters:**

<State>                   ON | OFF | 0 | 1  
                               \*RST:        1

**Example:**                INP:ATT:AUTO ON  
 Couples the attenuation to the reference level.

**Manual operation:**    See "[Attenuation Mode / Value](#)" on page 90

**INPut:ATTenuation:AUTO:MODE** <OptMode>

Selects the priority for signal processing *after* the RF attenuation has been applied.

**Parameters:**

<OptMode> LNOise | LDISTortion

**LNOise**

Optimized for high sensitivity and low noise levels

**LDISTortion**

Optimized for low distortion by avoiding intermodulation

\*RST: LDISTortion (WLAN application: LNOise)

**Example:**

INP:ATT:AUTO:MODE LNO

**INPut:EATT** <Attenuation>

Defines an electronic attenuation manually. Automatic mode must be switched off (INP:EATT:AUTO OFF, see [INPut:EATT:AUTO](#) on page 214).

If the current reference level is not compatible with an attenuation that has been set manually, the command also adjusts the reference level.

**Parameters:**

<Attenuation> attenuation in dB

Range: see specifications document

Increment: 1 dB

\*RST: 0 dB (OFF)

Default unit: DB

**Example:**

INP:EATT:AUTO OFF

INP:EATT 10 dB

**Manual operation:** See ["Using Electronic Attenuation"](#) on page 90

**INPut:EATT:AUTO** <State>

Turns automatic selection of the electronic attenuation on and off.

If on, electronic attenuation reduces the mechanical attenuation whenever possible.

**Parameters:**

<State> ON | OFF | 0 | 1

**OFF | 0**

Switches the function off

**ON | 1**

Switches the function on

\*RST: 1

**Example:**

INP:EATT:AUTO OFF

**Manual operation:** See ["Using Electronic Attenuation"](#) on page 90

**INPut:EATT:STATe** <State>

Turns the electronic attenuator on and off.

**Parameters:**

<State>                    ON | OFF | 0 | 1  
                               **OFF | 0**  
                               Switches the function off  
                               **ON | 1**  
                               Switches the function on  
                               \*RST:        0

**Example:**                INP:EATT:STAT ON  
 Switches the electronic attenuator into the signal path.

**Manual operation:**    See "[Using Electronic Attenuation](#)" on page 90

**13.5.2.3 Configuring a preamplifier**

<a href="#">INPut:EGAIN[:STATe]</a> .....	215
<a href="#">INPut:GAIN:STATe</a> .....	216
<a href="#">INPut:GAIN[:VALue]</a> .....	216

**INPut:EGAIN[:STATe]** <State>

Before this command can be used, the external preamplifier must be connected to the FSW. See the preamplifier's documentation for details.

When activated, the FSW automatically compensates the magnitude and phase characteristics of the external preamplifier in the measurement results.

Note that when an optional external preamplifier is activated, the internal preamplifier is automatically disabled, and vice versa.

For FSW85 models with two RF inputs, you must enable correction from the external preamplifier for each input individually. Correction cannot be enabled for both inputs at the same time.

When deactivated, no compensation is performed even if an external preamplifier remains connected.

**Parameters:**

<State>                    ON | OFF | 0 | 1  
                               **OFF | 0**  
                               No data correction is performed based on the external preamplifier  
                               **ON | 1**  
                               Performs data corrections based on the external preamplifier  
                               \*RST:        0

**Example:**                INP:EGA ON

**Manual operation:**    See "[Ext. PA Correction](#)" on page 91

**INPut:GAIN:STATe** <State>

Turns the internal preamplifier on and off. It requires the optional preamplifier hardware.

Note that if an optional external preamplifier is activated, the internal preamplifier is automatically disabled, and vice versa.

If option R&S FSW-B22 is installed, the preamplifier is only active below 7 GHz.

If option R&S FSW-B24 is installed, the preamplifier is active for all frequencies.

**Parameters:**

<State>                    ON | OFF | 0 | 1  
                               **OFF | 0**  
                               Switches the function off  
                               **ON | 1**  
                               Switches the function on  
                               \*RST:        0

**Example:**

```
INP:GAIN:STAT ON
INP:GAIN:VAL 15
Switches on 15 dB preamplification.
```

**Manual operation:** See "[Preamplifier](#)" on page 91

**INPut:GAIN[:VALue]** <Gain>

Selects the "gain" if the preamplifier is activated (INP:GAIN:STAT ON, see [INPut:GAIN:STATe](#) on page 216).

The command requires the additional preamplifier hardware option.

**Parameters:**

<Gain>                    For all FSW models except for FSW85, the following settings are available:  
                               15 dB and 30 dB  
                               All other values are rounded to the nearest of these two.  
                               For FSW85 models:  
                               FSW43 or higher:  
                               30 dB  
                               Default unit: DB

**Example:**

```
INP:GAIN:STAT ON
INP:GAIN:VAL 30
Switches on 30 dB preamplification.
```

**Manual operation:** See "[Preamplifier](#)" on page 91



### 13.5.2.4 Scaling the Y-axis

DISPlay[:WINDow<n>][:SUBWindow<w>]:TRACe<t>:Y[:SCALe].....	217
DISPlay[:WINDow<n>][:SUBWindow<w>]:TRACe<t>:Y[:SCALe]:AUTO ONCE.....	217
DISPlay[:WINDow<n>][:SUBWindow<w>]:TRACe<t>:Y[:SCALe]:MODE.....	217
DISPlay[:WINDow<n>][:SUBWindow<w>]:TRACe<t>:Y[:SCALe]:PDIVision.....	218
DISPlay[:WINDow<n>][:SUBWindow<w>]:TRACe<t>:Y[:SCALe]:RPOStion.....	218
DISPlay[:WINDow<n>][:SUBWindow<w>]:TRACe<t>:Y:SPACing.....	219

---

#### DISPlay[:WINDow<n>][:SUBWindow<w>]:TRACe<t>:Y[:SCALe] <Range>

Defines the display range of the y-axis (for all traces).

**Suffix:**

<n>	Window
<w>	subwindow Not supported by all applications
<t>	irrelevant

**Parameters:**

<Range>	Range: 1 dB to 200 dB
	*RST: 100 dB
	Default unit: HZ

**Example:** DISP:TRAC:Y 110dB

**Manual operation:** See "Range" on page 92

---

#### DISPlay[:WINDow<n>][:SUBWindow<w>]:TRACe<t>:Y[:SCALe]:AUTO ONCE

Automatic scaling of the y-axis is performed once, then switched off again (for all traces).

**Suffix:**

<n>	Window
<t>	irrelevant

**Manual operation:** See "Auto Scale Once" on page 93

---

#### DISPlay[:WINDow<n>][:SUBWindow<w>]:TRACe<t>:Y[:SCALe]:MODE <Mode>

Selects the type of scaling of the y-axis (for all traces).

When the display update during remote control is off, this command has no immediate effect.

**Suffix:**

<n>	Window
<w>	subwindow

<t> irrelevant

**Parameters:**

<Mode>           **ABSolute**  
absolute scaling of the y-axis

**RELative**  
relative scaling of the y-axis

\*RST:           ABSolute

**Example:**           DISP:TRAC:Y:MODE REL

**Manual operation:** See "Scaling" on page 93

**DISPlay[:WINDow<n>][:SUBWindow<w>]:TRACe<t>:Y[:SCALe]:PDIVision**  
<Value>

This remote command determines the grid spacing on the Y-axis for all diagrams, where possible.

In spectrum displays, for example, this command is not available.

**Suffix:**

<n>                   Window

<w>                   subwindow  
Not supported by all applications

<t>                   irrelevant

**Parameters:**

<Value>           numeric value WITHOUT UNIT (unit according to the result display)  
Defines the range per division (total range = 10\*<Value>)

\*RST:           depends on the result display  
Default unit: DBM

**Example:**           DISP:TRAC:Y:PDIV 10  
Sets the grid spacing to 10 units (e.g. dB) per division

**DISPlay[:WINDow<n>][:SUBWindow<w>]:TRACe<t>:Y[:SCALe]:RPOSition**  
<Position>

Defines the vertical position of the reference level on the display grid (for all traces).

The FSW adjusts the scaling of the y-axis accordingly.

**Suffix:**

<n>                   Window

<w>                   subwindow  
Not supported by all applications

<t>                   irrelevant

**Example:**           DISP:TRAC:Y:RPOS 50PCT

**Manual operation:** See ["Ref Level Position"](#) on page 92

---

**DISPlay[:WINDow<n>][:SUBWindow<w>]:TRACe<t>:Y:SPACing <ScalingType>**

Selects the scaling of the y-axis (for all traces, <t> is irrelevant).

**Suffix:**

<n>                    [Window](#)  
 <w>                    subwindow  
 <t>                    [Trace](#)

**Parameters:**

<ScalingType>        **LOGarithmic**  
                           Logarithmic scaling.  
                           **LINear**  
                           Linear scaling in %.  
                           **LDB**  
                           Linear scaling in the specified unit.  
                           **PERCent**  
                           Linear scaling in %.  
                           \*RST:        LOGarithmic

**Example:**            DISP:TRAC:Y:SPAC LIN  
 Selects linear scaling in %.

**Manual operation:** See ["Scaling"](#) on page 93

### 13.5.3 Defining the frequency and span

The commands required to configure the frequency and span settings in a remote environment are described here. The tasks for manual operation are described in [Chapter 7.3, "Frequency and span settings"](#), on page 85 .

[SENSe:]FREQUency:CENTer.....	219
[SENSe:]FREQUency:CENTer:STEP.....	220
[SENSe:]FREQUency:CENTer:STEP:AUTO.....	220
[SENSe:]FREQUency:CENTer:STEP:LINK.....	220
[SENSe:]FREQUency:CENTer:STEP:LINK:FACTor.....	221
[SENSe:]FREQUency:OFFSet.....	221
[SENSe:]FREQUency:SPAN.....	221
[SENSe:]FREQUency:STARt.....	222
[SENSe:]FREQUency:STOP.....	222

---

**[SENSe:]FREQUency:CENTer <Frequency>**

Defines the center frequency.

**Parameters:**

<Frequency> For the allowed range and  $f_{\max}$ , refer to the specifications document.

\*RST:  $f_{\max}/2$

Default unit: Hz

**Example:**

```
FREQ:CENT 100 MHz
FREQ:CENT:STEP 10 MHz
FREQ:CENT UP
```

Sets the center frequency to 110 MHz.

**Manual operation:** See "[Center Frequency](#)" on page 86

**[SENSe:]FREQuency:CENTer:STEP <StepSize>**

Defines the center frequency step size.

**Parameters:**

<StepSize> For  $f_{\max}$ , refer to the specifications document.

Range: 1 to  $f_{\max}$

\*RST: 0.1 x span

Default unit: Hz

**Example:**

//Set the center frequency to 110 MHz.

```
FREQ:CENT 100 MHz
FREQ:CENT:STEP 10 MHz
FREQ:CENT UP
```

**Manual operation:** See "[Center Frequency Stepsize](#)" on page 87

**[SENSe:]FREQuency:CENTer:STEP:AUTO <State>**

Couples or decouples the center frequency step size to the span.

In time domain (zero span) measurements, the center frequency is coupled to the RBW.

**Parameters:**

<State> ON | OFF | 0 | 1

\*RST: 1

**Example:**

```
FREQ:CENT:STEP:AUTO ON
```

Activates the coupling of the step size to the span.

**[SENSe:]FREQuency:CENTer:STEP:LINK <CouplingType>**

Couples and decouples the center frequency step size to the span or the resolution bandwidth.

**Parameters:**

<CouplingType> SPAN | RBW | OFF

**SPAN**

Couples the step size to the span. Available for measurements in the frequency domain.

**OFF**

Decouples the step size.

\*RST: SPAN

**Example:** //Couple step size to span  
FREQ:CENT:STEP:LINK SPAN

**[SENSe:]FREQuency:CENTer:STEP:LINK:FACTor <Factor>****Parameters:**

<Factor> 1 to 100 PCT  
\*RST: 10  
Default unit: PCT

**Example:** //Couple frequency step size to span and define a step size factor  
FREQ:CENT:STEP:LINK SPAN  
FREQ:CENT:STEP:LINK:FACT 20PCT

**[SENSe:]FREQuency:OFFSet <Offset>**

Defines a frequency offset.

If this value is not 0 Hz, the application assumes that the input signal was frequency shifted outside the application. All results of type "frequency" will be corrected for this shift numerically by the application.

**Note:** In MSRT mode, the setting command is only available for the MSRT primary application. For MSRT secondary applications, only the query command is available.

**Parameters:**

<Offset> Range: -1 THz to 1 THz  
\*RST: 0 Hz  
Default unit: HZ

**Example:** FREQ:OFFS 1GHZ

**Manual operation:** See "[Frequency Offset](#)" on page 87

**[SENSe:]FREQuency:SPAN <Span>**

Defines the frequency span.

**Parameters:**

<Span> Range: 1 kHz to depends on installed option, see specifications document  
\*RST: fmax

**Manual operation:** See "Span" on page 86  
See "Last Span" on page 86

---

#### [SENSe:]FREQUency:STARt <Frequency>

Defines the start frequency for a Real-Time measurement. If you set a start frequency that would exceed the maximum span, the FSW adjusts the stop frequency to stay within the maximum span.

**Parameters:**

<Frequency> 0 to (fmax - min span)  
\*RST: 0  
Default unit: HZ

**Example:** `FREQ:STAR 20MHz`

**Manual operation:** See "Start / Stop" on page 86

---

#### [SENSe:]FREQUency:STOP <Frequency>

Defines the stop frequency for a Real-Time measurement. If you set a start frequency that would exceed the maximum span, the FSW adjusts the start frequency to stay within the maximum span.

**Parameters:**

<Frequency> min span to fmax  
\*RST: fmax  
Default unit: HZ

**Example:** `FREQ:STOP 2000 MHz`

**Manual operation:** See "Start / Stop" on page 86

### 13.5.4 Configuring bandwidth and sweep settings

The commands required to configure the bandwidth, sweep and filter settings in a remote environment are described here. The tasks for manual operation are described in [Chapter 7.7, "Bandwidth and sweep settings"](#), on page 104.

Useful commands for configuring sweeps described elsewhere:

- [\[SENSe:\]AVERage<n>:COUNT](#) on page 283

**Remote commands exclusive to configuring bandwidth and sweeps:**

<a href="#">[SENSe:]BANDwidth[:RESolution]</a> .....	223
<a href="#">[SENSe:]BANDwidth[:RESolution]:RATio</a> .....	223
<a href="#">[SENSe:]SWEep:COUNT</a> .....	223
<a href="#">[SENSe:]SWEep:DTIME</a> .....	224
<a href="#">[SENSe:]SWEep:DTIME:AUTO</a> .....	224

[SENSe:]SWEep:FFT:WINDow:TYPE.....	225
[SENSe:]SWEep:TIME.....	225
[SENSe:]SWEep:TIME:AUTO.....	225

---

### [SENSe:]BANDwidth[:RESolution] <Bandwidth>

Defines the resolution bandwidth and decouples the resolution bandwidth from the span.

In the Real-Time application, the resolution bandwidth is always coupled to the span.

The 6 MHz Gaussian filter is provided for special measurements, such as 5G NR spurious emissions measurements. It is only available if you enter the value manually, not using the `BAND:RES MAX` command. It is not supported by all applications.

#### Parameters:

<Bandwidth> refer to specifications document  
Default unit: Hz

#### Example:

`BAND 1 MHz`  
Sets the resolution bandwidth to 1 MHz

**Manual operation:** See "[RBW](#)" on page 105

---

### [SENSe:]BANDwidth[:RESolution]:RATio <Ratio>

Defines the ratio between the resolution bandwidth (Hz) and the span (Hz).

Note that the ratio defined with this remote command (RBW/span) is reciprocal to that of the coupling ratio (span/RBW).

Changing this ratio also affects the FFT length, which in turn affects the time resolution of the FFT. Furthermore, the ratio also affects the RBW value according to:

$$RBW = Span / Coupling\ ratio$$

#### Parameters:

<Ratio> Range: 0.0001 to 1

#### Example:

`BAND:RAT 0.1`

#### Example:

[Chapter 13.12.3, "Example 3: analyzing persistency"](#),  
on page 348

**Manual operation:** See "[RBW](#)" on page 105

---

### [SENSe:]SWEep:COUNT <SweepCount>

Defines the number of measurements that the application uses to average traces.

In continuous measurement mode, the application calculates the moving average over the average count.

In single measurement mode, the application stops the measurement and calculates the average after the average count has been reached.

**Example:**

```
SWE:COUN 64
Sets the number of measurements to 64.
INIT:CONT OFF
Switches to single measurement mode.
INIT;*WAI
Starts a measurement and waits for its end.
```

**Manual operation:** See ["Sweep Count"](#) on page 108

#### [SENSe:]SWEep:DTIME <Time>

Determines the amount of time used to sample a continuous stream of I/Q data. The stream is displayed as multiple rows in the spectrogram or waterfall diagrams (as opposed to the *sweep time*, which defines the time to capture a *single* row in the diagrams). Dwell time is never applied for triggered measurements. It is only applied in single sweep mode or when the Sequencer is in continuous mode.

The query returns the amount of time used to sample I/Q data in the current measurement.

Tip: the dwell time can also be defined automatically, see [\[SENSe:\]SWEep:DTIME:AUTO](#) on page 224.

For more information see [Chapter 6.3, "Sweep time and detector"](#), on page 41.

#### Parameters:

<Time>                    numeric value  
 Range:                30 ms to 3600 s  
 \*RST:                30 ms  
 Default unit: s

**Example:**

```
SENS:SWE:DTIM:AUTO OFF
SENS:SWE:DTIM 1s
```

**Manual operation:** See ["Dwell Time"](#) on page 106

#### [SENSe:]SWEep:DTIME:AUTO <State>

Determines whether the dwell time is defined automatically or manually.

For more information see [Chapter 6.3, "Sweep time and detector"](#), on page 41.

#### Parameters:

<State>                    ON | OFF | 0 | 1  
**OFF | 0**  
 Switches the function off  
**ON | 1**  
 Switches the function on

**Example:**

```
SENS:SWE:DTIM:AUTO OFF
SENS:SWE:DTIM 1s
```

**Manual operation:** See ["Dwell Time"](#) on page 106



---

**[SENSe:]SWEep:FFT:WINDow:TYPE <FFTWindow>**

Selects the type of FFT window that you want to use in Real-Time mode.

**Parameters:**

<FFTWindow>      **BLACkharris**  
                          **FLATtop**  
                          **GAUSSian**  
                          **HAMMING**  
                          **HANNing**  
                          **KAISerbessel**  
                          **RECTangular**  
 \*RST:            BLACkharris

**Example:**            `SWE:FFT:WIND:TYPE HANN`  
 Selects the Hanning FFT window.

**Example:**            See [Chapter 13.12.3, "Example 3: analyzing persistency"](#), on page 348.

**Example:**            See [Chapter 13.12.4, "Example 4: obtaining time domain results in real-time"](#), on page 351.

**Manual operation:**    See ["FFT Window"](#) on page 105

---

**[SENSe:]SWEep:TIME <Time>**

Determines the amount of time used to sample data for one spectrum or one PVT diagram.

For more information see [Chapter 6.3, "Sweep time and detector"](#), on page 41.

**Parameters:**

<Time>                refer to specifications document  
 Default unit: S

**Example:**            Window 1: "Real-Time Spectrum"  
 Window 2: PVT diagram  
`SWE:TIME 0.3s`  
`SENS2:SWE:TIME 0.128s`

**Example:**            See [Chapter 13.12.4, "Example 4: obtaining time domain results in real-time"](#), on page 351.

**Manual operation:**    See ["Sweep Time"](#) on page 106  
 See ["PVT Sweep Time"](#) on page 106

---

**[SENSe:]SWEep:TIME:AUTO <State>**

Activates and deactivates automatic sweep time definition.

**Parameters:**

<State> ON | OFF | 0 | 1  
 \*RST: 1

**Example:**

SWE:TIME:AUTO ON  
 Activates automatic sweep time.

**Manual operation:** See "[Sweep Time](#)" on page 106

### 13.5.5 Triggering

The following remote commands are required to configure a triggered measurement in a remote environment. In MSRT mode, these commands are only available for the MSRT primary channel. More details are described for manual operation in [Chapter 7.6, "Trigger configuration"](#), on page 93.



\*OPC should be used after requesting data. This will hold off any subsequent changes to the selected trigger source, until after the sweep is completed and the data is returned.

- [Configuring the triggering conditions](#).....226
- [Configuring a frequency mask trigger](#).....231
- [Configuring the trigger output](#).....237

#### 13.5.5.1 Configuring the triggering conditions

TRIGger:MODE.....	226
TRIGger[:SEQuence]:HOLDoff[:TIME].....	227
TRIGger[:SEQuence]:IFPower:HOLDoff.....	227
TRIGger[:SEQuence]:LEVel[:EXTernal<port>].....	227
TRIGger[:SEQuence]:POSTtrigger[:TIME].....	228
TRIGger[:SEQuence]:PRETrigger[:TIME].....	228
TRIGger[:SEQuence]:SLOPe.....	229
TRIGger[:SEQuence]:SOURce.....	229
TRIGger[:SEQuence]:TDTRigger:LEVel.....	230

---

#### TRIGger:MODE <Mode>

Turns continuous triggering on and off.

**Parameters:**

<Mode>                   **CONTInuous**  
 Continuous measurement

**STOP**  
 Measurement stops after the trigger event is done

**MARK**

A free-run measurement is performed; the trigger event is merely indicated in the results, but does not change the behavior of the measurement.

This setting is only available for FSW-B512R/-B800R.

\*RST: CONTInuous

**Example:** See [Chapter 13.12.2, "Example 2: performing a basic real-time measurement"](#), on page 345.

**Example:** See [Chapter 13.12.3, "Example 3: analyzing persistency"](#), on page 348.

**Example:** See [Chapter 13.12.4, "Example 4: obtaining time domain results in real-time"](#), on page 351.

**Manual operation:** See ["Trigger mode \(Auto Rearm/ Stop on Trigger/ Mark only\)"](#) on page 96

**TRIGger[:SEQuence]:HOLDoff[:TIME] <Offset>**

Defines the time offset between the trigger event and the start of the measurement.

**Parameters:**

<Offset>                    \*RST:        0 s  
                                   Default unit: S

**Example:**                    TRIG:HOLD 500us

**Manual operation:** See ["Trigger Offset"](#) on page 96

**TRIGger[:SEQuence]:IFPower:HOLDoff <Period>**

Defines the holding time before the next trigger event.

Note that this command can be used for **any trigger source**, not just IF Power (despite the legacy keyword).

**Parameters:**

<Period>                    Range:        0 s to 10 s  
                                   \*RST:        0 s  
                                   Default unit: S

**Example:**                    TRIG:SOUR EXT  
                                   Sets an external trigger source.  
                                   TRIG:IFP:HOLD 200 ns  
                                   Sets the holding time to 200 ns.

**Manual operation:** See ["Trigger Holdoff"](#) on page 96

**TRIGger[:SEQuence]:LEVel[:EXTernal<port>] <TriggerLevel>**

Defines the level the external signal must exceed to cause a trigger event.

**Suffix:**

<port>                      Selects the trigger port.  
 1 = trigger port 1 (TRIGGER INPUT connector on front panel)  
 2 = trigger port 2 (TRIGGER INPUT/OUTPUT connector on front panel)  
 (Not available for FSW85 models with two RF input connectors.)  
 3 = trigger port 3 (TRIGGER3 INPUT/OUTPUT connector on rear panel)

**Parameters:**

<TriggerLevel>            Range:        0.5 V to 3.5 V  
                                  \*RST:        1.4 V  
                                  Default unit: V

**Example:**                      TRIG:LEV 2V

**Manual operation:**    See ["Trigger Level"](#) on page 95

**TRIGger[:SEquence]:POSTtrigger[:TIME] <Time>**

Defines the length of the posttrigger.

**Parameters:**

<Time>                      Length of the posttrigger in seconds.  
 Note that the pre- and posttrigger combined may not be longer than 1 second.  
 Range:        0 s to 1 s  
 \*RST:        60 ms  
 Default unit: S

**Example:**                      TRIG:POST 0.5s  
 Selects a posttrigger time of 0.5 seconds.

**Example:**                      See [Chapter 13.12.2, "Example 2: performing a basic real-time measurement"](#), on page 345.

**Example:**                      See [Chapter 13.12.3, "Example 3: analyzing persistency"](#), on page 348.

**Example:**                      See [Chapter 13.12.4, "Example 4: obtaining time domain results in real-time"](#), on page 351.

**Manual operation:**    See ["Posttrigger capture time"](#) on page 96

**TRIGger[:SEquence]:PRETrigger[:TIME] <Time>**

Defines the length of the pretrigger.

**Parameters:**

<Time> Length of the pretrigger in seconds.  
 Note that the pre- and posttrigger combined may not be longer than 1 second.  
 Range: 0 s to 1 s  
 \*RST: 60 ms  
 Default unit: S

**Example:**

TRIG:PRE 0.5s  
 Selects a pretrigger time of 0.5 seconds.

**Example:**

See [Chapter 13.12.2, "Example 2: performing a basic real-time measurement"](#), on page 345.

**Example:**

See [Chapter 13.12.3, "Example 3: analyzing persistency"](#), on page 348.

**Example:**

See [Chapter 13.12.4, "Example 4: obtaining time domain results in real-time"](#), on page 351.

**Manual operation:** See ["Pretrigger capture time"](#) on page 96

**TRIGger[:SEQuence]:SLOPe <Type>**

For all trigger sources except frequency mask, you can define whether triggering occurs when the signal rises to the trigger level or falls down to it.

**Parameters:**

<Type> POSitive | NEGative  
**POSitive**  
 Triggers when the signal rises to the trigger level (rising edge).  
**NEGative**  
 Triggers when the signal drops to the trigger level (falling edge).  
 \*RST: POSitive

**Example:**

TRIG:SLOP NEG

**Manual operation:** See ["Slope"](#) on page 96

**TRIGger[:SEQuence]:SOURce <Source>**

Selects the trigger source.

**Note on external triggers:**

If a measurement is configured to wait for an external trigger signal in a remote control program, remote control is blocked until the trigger is received and the program can continue. Make sure that this situation is avoided in your remote control programs.

**Parameters:**

<Source> **IMMediate**  
 Free Run

**EXTernal**

Trigger signal from the "Trigger Input" connector.

**EXT2**

Trigger signal from the "Trigger Input/Output" connector.

For FSW85 models, Trigger 2 is not available due to the second RF input connector on the front panel. The trigger signal is taken from the "Trigger Input/Output" connector on the rear panel.

Note: Connector must be configured for "Input".

**EXT3**

Trigger signal from the "TRIGGER 3 INPUT/ OUTPUT" connector.

Note: Connector must be configured for "Input".

**MASK**

Triggers when the measured signal violates the user-defined frequency mask.

For details see [Chapter 6.4.1, "Triggering on specific frequency events \(frequency mask trigger\)"](#), on page 42.

**TDTR**

Triggers when the measured signal exceeds the defined power level in the **time domain**.

\*RST: IMMEDIATE

- Example:** TRIG:SOUR EXT  
Selects the external trigger input as source of the trigger signal
- Example:** See [Chapter 13.12.2, "Example 2: performing a basic real-time measurement"](#), on page 345 and [Chapter 13.12.4, "Example 4: obtaining time domain results in real-time"](#), on page 351.
- Manual operation:** See ["Trigger Source"](#) on page 94  
See ["Free Run"](#) on page 94  
See ["External Trigger 1/2/3"](#) on page 95  
See ["Frequency Mask"](#) on page 95  
See ["Time Domain"](#) on page 95  
See ["Activate"](#) on page 99

**TRIGger[:SEquence]:TDTRigger:LEVel <TriggerLevel>**

Sets the trigger level for the time domain trigger.

**Parameters:**

<TriggerLevel> Default unit: dBm

**Example:** TRIG:TDTR:LEV 0  
Sets a trigger level of 0 dBm.

**Example:** See [Chapter 13.12.4, "Example 4: obtaining time domain results in real-time"](#), on page 351.

**Manual operation:** See ["Time Domain"](#) on page 95  
See ["Trigger Level"](#) on page 95

### 13.5.5.2 Configuring a frequency mask trigger

The Frequency Mask Trigger (FMT) is a mask in the frequency domain, which is checked with every calculated FFT. When a specific condition concerning this mask occurs during the measurement of the input signal, data capturing is triggered.

For details see [Chapter 6.4.1, "Triggering on specific frequency events \(frequency mask trigger\)"](#), on page 42.

CALCulate<n>:MASK:CDIRectory.....	231
CALCulate<n>:MASK:COMMeNt.....	231
CALCulate<n>:MASK:DELeTe.....	232
CALCulate<n>:MASK:LOWer:SHIFt:X.....	232
CALCulate<n>:MASK:LOWer:SHIFt:Y.....	232
CALCulate<n>:MASK:LOWer:STATe.....	233
CALCulate<n>:MASK:LOWer[:DATA].....	233
CALCulate<n>:MASK:MODE.....	234
CALCulate<n>:MASK:NAME.....	234
CALCulate<n>:MASK:SPAN.....	234
CALCulate<n>:MASK:UPPer:AUTO.....	235
CALCulate<n>:MASK:UPPer:SHIFt:X.....	235
CALCulate<n>:MASK:UPPer:SHIFt:Y.....	235
CALCulate<n>:MASK:UPPer:STATe.....	236
CALCulate<n>:MASK:UPPer[:DATA].....	236
TRIGger[:SEQueNce]:MASK:CONDition.....	236

---

#### CALCulate<n>:MASK:CDIRectory <Subdirectory>

Selects the directory the FSW stores frequency masks in.

##### Suffix:

<n> [Window](#)

##### Parameters:

<Subdirectory> String containing the path to the directory. The directory has to be a subdirectory of the default directory. Thus the path is always relative to the default directory (C:\R\_S\INSTR\freqmask).  
An empty string selects the default directory.

**Example:** See [Chapter 13.12.1, "Example 1: creating a frequency mask trigger"](#), on page 344.

**Example:** See [Chapter 13.12.2, "Example 2: performing a basic real-time measurement"](#), on page 345.

**Manual operation:** See "Save" on page 99  
See "Load" on page 99

---

#### CALCulate<n>:MASK:COMMeNt <Comment>

Defines a comment for the frequency mask that you have selected with [CALCulate<n>:MASK:NAME](#) on page 234.

**Suffix:**  
<n> [Window](#)

**Parameters:**  
<Comment> String containing the comment for the frequency mask.

**Example:** See [Chapter 13.12.1, "Example 1: creating a frequency mask trigger"](#), on page 344.

**Manual operation:** See ["Comment"](#) on page 100

---

#### CALCulate<n>:MASK:DELeTe

**Suffix:**  
<n> 1..n

**Manual operation:** See ["Delete Mask"](#) on page 99

---

#### CALCulate<n>:MASK:LOWer:SHIFt:X <Frequency>

Shifts the lower frequency mask horizontally by a specified distance. Positive values move the mask to the right, negative values shift the mask to the left.

Before making any changes to a frequency mask, you have to select one by name with [CALCulate<n>:MASK:NAME](#) on page 234.

**Suffix:**  
<n> [Window](#)

**Parameters:**  
<Frequency> Defines the distance of the shift.  
Default unit: Hz

**Manual operation:** See ["Shifting the mask position horizontally \(Shift x\)"](#) on page 100

---

#### CALCulate<n>:MASK:LOWer:SHIFt:Y <Level>

Shifts the lower frequency mask vertically by a specified distance. Positive values move the mask upwards, negative values shift the mask downwards.

Before making any changes to a frequency mask, you have to select one by name with [CALCulate<n>:MASK:NAME](#) on page 234.

**Suffix:**  
<n> [Window](#)

**Parameters:**  
<Level> Defines the distance of the shift. The shift is relative to the current position.  
Default unit: dB

**Example:** See [Chapter 13.12.1, "Example 1: creating a frequency mask trigger"](#), on page 344.



**Manual operation:** See ["Shifting the mask vertically \(Shift y\)"](#) on page 101

---

### CALCulate<n>:MASK:LOWer:STATe <State>

Turns the lower frequency mask on and off.

Before making any changes to a frequency mask, you have to select one by name with [CALCulate<n>:MASK:NAME](#) on page 234.

**Suffix:**

<n> [Window](#)

**Parameters:**

<State> ON | OFF | 0 | 1  
**OFF | 0**  
 Switches the function off  
**ON | 1**  
 Switches the function on

**Example:** See [Chapter 13.12.1, "Example 1: creating a frequency mask trigger"](#), on page 344.

**Manual operation:** See ["Selecting and deselecting upper and lower masks"](#) on page 101

---

### CALCulate<n>:MASK:LOWer[:DATA] <Frequency>,<Level>,...

Defines the shape of the lower frequency mask.

Before making any changes to a frequency mask, you have to select one by name with [CALCulate<n>:MASK:NAME](#) on page 234.

The unit of the power levels depends on [CALCulate<n>:MASK:MODE](#) on page 234.

For R&S FSW-K70, this command is query only.

[N] pairs of numerical values. [N] is the number of data points the mask consists of.

Each data point is defined by the frequency and the level. All values are separated by commas.

Note that the data points have to be inside the current span.

**Suffix:**

<n> [Window](#)

**Parameters:**

<Frequency> Frequency of the data point  
 Default unit: Hz  
 <Level> Level of the data point  
 Default unit: DBM

**Example:** See [Chapter 13.12.1, "Example 1: creating a frequency mask trigger"](#), on page 344.

**Manual operation:** See ["Mask points"](#) on page 100  
 See ["Inserting points"](#) on page 100  
 See ["Deleting points"](#) on page 100

#### CALCulate<n>:MASK:MODE <Mode>

Defines the scaling of the level axis for frequency masks.

**Suffix:**

<n> [Window](#)

**Parameters:**

<Mode>           **ABSolute**  
 absolute scaling of the level axis.  
**RELative**  
 relative scaling of the level axis.  
 \*RST:           RELative

**Example:** See [Chapter 13.12.1, "Example 1: creating a frequency mask trigger"](#), on page 344.

**Manual operation:** See ["Changing the y-axis scaling \(Y-Axis rel/abs\)"](#) on page 101

#### CALCulate<n>:MASK:NAME <Name>

**Suffix:**

<n>               1..n  
[Window](#)

**Parameters:**

<Name>           String containing the name of the mask.  
 Note that an empty string does not select a frequency mask.

**Example:** See [Chapter 13.12.1, "Example 1: creating a frequency mask trigger"](#), on page 344.

**Manual operation:** See ["New"](#) on page 98  
 See ["Save"](#) on page 99  
 See ["Load"](#) on page 99  
 See ["Name"](#) on page 100

#### CALCulate<n>:MASK:SPAN <Span>

Defines the frequency span of the frequency mask.

**Suffix:**

<n>               [Window](#)

**Parameters:**

<Span>           Range:       1 kHz to fmax  
 \*RST:           fmax  
 Default unit: HZ

**Example:**            `CALC:MASK:SPAN 10 MHz`  
 Defines a span of 10 MHz.

**Example:**            See [Chapter 13.12.1, "Example 1: creating a frequency mask trigger"](#), on page 344.

#### **CALCulate<n>:MASK:UPPer:AUTO**

**Suffix:**  
 <n>                    1..n

**Manual operation:** See ["Defining a mask automatically \(Auto-Set Mask\)"](#) on page 101

#### **CALCulate<n>:MASK:UPPer:SHIFt:X <Frequency>**

Shifts the lower frequency mask horizontally by a specified distance. Positive values move the mask to the right, negative values shift the mask to the left.

You have to select a mask before you can use this command with `CALCulate<n>:MASK:NAME` on page 234.

**Suffix:**  
 <n>                    [Window](#)

**Parameters:**  
 <Frequency>        Defines the distance of the shift.  
 Default unit: HZ

**Manual operation:** See ["Shifting the mask position horizontally \(Shift x\)"](#) on page 100

#### **CALCulate<n>:MASK:UPPer:SHIFt:Y <Level>**

Shifts the upper frequency mask vertically by a specified distance. Positive values move the mask upwards, negative values shift the mask downwards.

You have to select a mask before you can use this command with `CALCulate<n>:MASK:NAME` on page 234.

**Suffix:**  
 <n>                    [Window](#)

**Parameters:**  
 <Level>              Defines the distance of the shift. The shift is relative to the current position.  
 Default unit: dB

**Manual operation:** See ["Shifting the mask vertically \(Shift y\)"](#) on page 101

**CALCulate<n>:MASK:UPPer:STATe** <State>

Turns the upper frequency mask on and off.

Before making any changes to a frequency mask, you have to select one by name with [CALCulate<n>:MASK:NAME](#) on page 234.

**Suffix:**

<n> [Window](#)

**Parameters:**

<State> ON | OFF | 0 | 1  
**OFF | 0**  
 Switches the function off  
**ON | 1**  
 Switches the function on

**Manual operation:** See ["Selecting and deselecting upper and lower masks"](#) on page 101

**CALCulate<n>:MASK:UPPer[:DATA]** {<Frequency>,<Level>}

Activates and defines the shape of the upper frequency mask trigger mask.

You have to select a mask before you can use this command with [CALCulate<n>:MASK:NAME](#) on page 234.

[N] pairs of numerical values. [N] is the number of data points the mask consists of.

Each data point is defined by the frequency and the level. All values are separated by commas.

**Suffix:**

<n> [Window](#)

**Parameters:**

<Frequency> Frequency of the data point within the current span.  
 Default unit: Hz

<Level> Level of the data point. The unit of the power levels depends on [CALCulate<n>:MASK:MODE](#) on page 234.  
 Default unit: DBM

**Example:** See [Chapter 13.12.1, "Example 1: creating a frequency mask trigger"](#), on page 344.

**Manual operation:** See ["Mask points"](#) on page 100  
 See ["Inserting points"](#) on page 100  
 See ["Deleting points"](#) on page 100

**TRIGger[:SEquence]:MASK:CONDition** <Condition>

Sets the condition that activates the frequency mask trigger.

For details see [Chapter 6.4.1, "Triggering on specific frequency events \(frequency mask trigger\)"](#), on page 42.

**Parameters:**

<Condition>           **ENTer**  
Triggers on entering the frequency mask.

**LEAVing**  
Triggers on leaving the frequency mask.

\*RST:           ENTer

**Example:**           See [Chapter 13.12.2, "Example 2: performing a basic real-time measurement"](#), on page 345.

**Example:**           See [Chapter 13.12.3, "Example 3: analyzing persistency"](#), on page 348.

**Manual operation:** See ["Setting the trigger condition"](#) on page 101

### 13.5.5.3 Configuring the trigger output

The following commands are required to send the trigger signal to one of the variable "TRIGGER INPUT/OUTPUT" connectors on the FSW.

<a href="#">OUTPut:TRIGger&lt;tp&gt;:DIRection</a> .....	237
<a href="#">OUTPut:TRIGger&lt;tp&gt;:LEVel</a> .....	237
<a href="#">OUTPut:TRIGger&lt;tp&gt;:OTYPe</a> .....	238
<a href="#">OUTPut:TRIGger&lt;tp&gt;:PULSe:IMMediate</a> .....	238
<a href="#">OUTPut:TRIGger&lt;tp&gt;:PULSe:LENGth</a> .....	239

---

#### **OUTPut:TRIGger<tp>:DIRection** <Direction>

Selects the trigger direction for trigger ports that serve as an input as well as an output.

**Suffix:**

<tp>                   Selects the used trigger port.  
2 = trigger port 2 (front)  
(Not available for FSW85 models with two RF input connectors.)  
3 = trigger port 3 (rear panel)

**Parameters:**

<Direction>           INPut | OUTPut

**INPut**  
Port works as an input.

**OUTPut**  
Port works as an output.

\*RST:           INPut

**Manual operation:** See ["Trigger 2/3"](#) on page 102

---

#### **OUTPut:TRIGger<tp>:LEVel** <Level>

Defines the level of the (TTL compatible) signal generated at the trigger output.

Works only if you have selected a user-defined output with `OUTPut:TRIGger<tp>:OTYPe`.

**Suffix:**

<tp> 1..n  
 Selects the trigger port to which the output is sent.  
 2 = trigger port 2 (front)  
 (Not available for FSW85 models with two RF input connectors.)  
 3 = trigger port 3 (rear)

**Parameters:**

<Level> **HIGH**  
 5 V  
**LOW**  
 0 V  
 \*RST: LOW

**Example:** `OUTP:TRIG2:LEV HIGH`

**Manual operation:** See "[Level](#)" on page 103

**OUTPut:TRIGger<tp>:OTYPe <OutputType>**

Selects the type of signal generated at the trigger output.

**Suffix:**

<tp> 1..n  
 Selects the trigger port to which the output is sent.  
 2 = trigger port 2 (front)  
 (Not available for FSW85 models with two RF input connectors.)  
 3 = trigger port 3 (rear)

**Parameters:**

<OutputType> **DEVIce**  
 Sends a trigger signal when the FSW has triggered internally.  
**TARMed**  
 Sends a trigger signal when the trigger is armed and ready for an external trigger event.  
**UDEFI ned**  
 Sends a user-defined trigger signal. For more information, see [OUTPut:TRIGger<tp>:LEVel](#).  
 \*RST: DEVIce

**Manual operation:** See "[Output Type](#)" on page 103

**OUTPut:TRIGger<tp>:PULSe:IMMediate**

Generates a pulse at the trigger output.

**Suffix:**

<tp> 1..n  
 Selects the trigger port to which the output is sent.  
 2 = trigger port 2 (front)  
 (Not available for FSW85 models with two RF input connectors.)  
 3 = trigger port 3 (rear)

**Manual operation:** See ["Send Trigger"](#) on page 103

**OUTPut:TRIGger<tp>:PULSe:LENGth <Length>**

Defines the length of the pulse generated at the trigger output.

**Suffix:**

<tp> Selects the trigger port to which the output is sent.  
 2 = trigger port 2 (front)  
 (Not available for FSW85 models with two RF input connectors.)  
 3 = trigger port 3 (rear)

**Parameters:**

<Length> Pulse length in seconds.  
 Default unit: S

**Example:** `OUTP:TRIG2:PULS:LENG 0.02`

**Manual operation:** See ["Pulse Length"](#) on page 103

### 13.5.6 Configuring spectrograms and PVT waterfalls

The remote commands required for the individual settings available for spectrogram and waterfall displays are described here. For color mapping commands, see [Chapter 13.5.8, "Configuring color maps"](#), on page 246.

Note that these commands are applicable for both spectrograms and PVT waterfalls. The suffix <n> for CALCulate determines the window and thus which display the command is applied to.

<a href="#">CALCulate&lt;n&gt;:SGRam:CLEar[:IMMediate]</a> .....	239
<a href="#">CALCulate&lt;n&gt;:SPECTrogram:CLEar[:IMMediate]</a> .....	239
<a href="#">CALCulate&lt;n&gt;:SGRam:FRAMe:SElect</a> .....	240
<a href="#">CALCulate&lt;n&gt;:SPECTrogram:FRAMe:SElect</a> .....	240
<a href="#">CALCulate&lt;n&gt;:SGRam:HDEPth</a> .....	240
<a href="#">CALCulate&lt;n&gt;:SPECTrogram:HDEPth</a> .....	240
<a href="#">CALCulate&lt;n&gt;:SGRam:TSTamp:DATA</a> .....	241
<a href="#">CALCulate&lt;n&gt;:SPECTrogram:TSTamp:DATA?</a> .....	241
<a href="#">CALCulate&lt;n&gt;:SGRam:TSTamp[:STATe]</a> .....	241
<a href="#">CALCulate&lt;n&gt;:SPECTrogram:TSTamp[:STATe]</a> .....	241

**CALCulate<n>:SGRam:CLEar[:IMMediate]****CALCulate<n>:SPECTrogram:CLEar[:IMMediate]**

Resets the spectrogram and clears the history buffer.

**Suffix:**<n> [Window](#)**Example:**

```
//Reset the result display and clear the memory
CALC:SGR:CLE
```

**Manual operation:**

See ["Clear Spectrogram"](#) on page 109  
 See ["Clear Power vs. Time Waterfall"](#) on page 121

**CALCulate<n>:SGRam:FRAMe:SElect <Frame>****CALCulate<n>:SPECtrogram:FRAMe:SElect <Frame> | <Time>**

Selects a specific frame for further analysis.

The command is available if no measurement is running or after a single sweep has ended.

**Suffix:**<n> [Window](#)**Parameters:**

<Frame> Selects a frame directly by the frame number. Valid if the time stamp is off.  
 The range depends on the history depth.  
 Default unit: S

<Time> Selects a frame via its time stamp. Valid if the time stamp is on.  
 The number is the distance to frame 0 in seconds. The range depends on the history depth.

**Example:**

```
INIT:CONT OFF
Stop the continuous sweep.
CALC:SGR:FRAM:SEL -25
Selects frame number -25.
```

**Example:**

See [Chapter 13.12.4, "Example 4: obtaining time domain results in real-time"](#), on page 351.

**Manual operation:**

See ["Selecting a frame to display"](#) on page 108

**CALCulate<n>:SGRam:HDEPth <History>****CALCulate<n>:SPECtrogram:HDEPth <History>**

Defines the number of frames to be stored in the FSW memory.

**Suffix:**<n> [Window](#)**Parameters:**

<History> The maximum number of frames depends on the number of sweep points.  
 Range: 781 to 20000  
 Increment: 1  
 \*RST: 3000



**Example:** //Set the history depth to 1500  
CALC:SGR:SPEC 1500

**Manual operation:** See ["History Depth"](#) on page 120

**CALCulate<n>:SGRam:TSTamp:DATA <Frames>**  
**CALCulate<n>:SPECTrogram:TSTamp:DATA? <Frames>**

Queries the starting time of the frames.

The return values consist of four values for each frame. If the "Spectrogram" is empty, the command returns '0,0,0,0'. The times are given as delta values, which simplifies evaluating relative results; however, you can also calculate the absolute date and time as displayed on the screen.

The frame results themselves are returned with TRAC:DATA? SGR

**Suffix:**

<n> [Window](#)

**Query parameters:**

<Frames>

**CURRENT**

Returns the starting time of the current frame.

**ALL**

Returns the starting time for all frames. The results are sorted in descending order, beginning with the current frame.

**Return values:**

<Seconds>

Number of seconds that have passed since 01.01.1970 until the frame start

<Nanoseconds>

Number of nanoseconds that have passed *in addition to the* <Seconds> since 01.01.1970 until the frame start.

<Reserved>

The third value is reserved for future uses.

<Reserved>

The fourth value is reserved for future uses.

**Example:**

CALC:SGR:TST:DATA? ALL

Returns the starting times of all frames sorted in a descending order.

**Usage:**

Query only

**Manual operation:** See ["Time Stamp"](#) on page 120

**CALCulate<n>:SGRam:TSTamp[:STATe] <State>**  
**CALCulate<n>:SPECTrogram:TSTamp[:STATe] <State>**

Activates and deactivates the time stamp.

If the time stamp is active, some commands do not address frames as numbers, but as (relative) time values:

- [CALCulate<n>:DELTaMarker<m>:SPECTrogram:FRAMe](#) on page 311
- [CALCulate<n>:MARKer<m>:SPECTrogram:FRAMe](#) on page 306

- `CALCulate<n>:SPECTrogram:FRAME:SElect` on page 240

**Suffix:**

<n> 1..n  
Window

**Parameters:**

<State> ON | OFF | 0 | 1  
**OFF | 0**  
Switches the function off  
**ON | 1**  
Switches the function on

**Example:** //Activates the time stamp  
CALC:SGR:TST ON

**Manual operation:** See "Time Stamp" on page 120

### 13.5.7 Configuring the persistence spectrum

You can customize the persistence spectrum in several ways. You can change the colors with which the densities are visualized, you can change the persistence of the data and change the style of the displayed results.

**Compatibility with R&S FSVR**

For compatibility with the R&S FSVR, the following commands required to configure the persistence spectrum also accept the optional `SUBWindow` keyword (`DISPlay:WINDow[:SUBWindow] . . .`). However, this keyword is ignored and has no effect on remote control.

<code>DISPlay:WINDow&lt;n&gt;[:SUBWindow&lt;w&gt;]:TRACe&lt;t&gt;:MAXHold:RESet</code> .....	242
<code>DISPlay:WINDow&lt;n&gt;[:SUBWindow&lt;w&gt;]:TRACe&lt;t&gt;:MAXHold:INTensity</code> .....	243
<code>DISPlay:WINDow&lt;n&gt;[:SUBWindow&lt;w&gt;]:TRACe&lt;t&gt;:MAXHold[:STATe]</code> .....	243
<code>DISPlay:WINDow&lt;n&gt;[:SUBWindow&lt;w&gt;]:TRACe&lt;t&gt;:PERSistence:DURation</code> .....	244
<code>DISPlay:WINDow&lt;n&gt;[:SUBWindow&lt;w&gt;]:TRACe&lt;t&gt;:PERSistence:GRANularity</code> .....	244
<code>DISPlay:WINDow&lt;n&gt;[:SUBWindow&lt;w&gt;]:TRACe&lt;t&gt;:PERSistence[:STATe]</code> .....	245
<code>DISPlay:WINDow&lt;n&gt;[:SUBWindow&lt;w&gt;]:TRACe&lt;t&gt;:SYMBOL</code> .....	245

---

**DISPlay:WINDow<n>[:SUBWindow<w>]:TRACe<t>:MAXHold:RESet**
**Suffix:**

<n> 1..n  
<w> 1..n  
<t> 1..n

**Manual operation:** See "Resetting the Max Hold Function" on page 119

---

**DISPlay[:WINDow<n>][:SUBWindow<w>]:TRACe<t>:MAXHold:INTensity**  
 <Intensity>

Defines the color intensity of the maxhold persistence spectrum.

Note: Setting the intensity to 0 has the same effect as deactivating the Maxhold function (see [DISPlay\[:WINDow<n>\]\[:SUBWindow<w>\]:TRACe<t>:MAXHold\[:STATe\]](#) on page 243).

**Suffix:**

<n>                    [Window](#)  
 <w>                    subwindow  
 <t>                    [Trace](#)

**Parameters:**

<Intensity>                Sets the color intensity of the maxhold trace.  
 Range:                0 to 254  
 Increment:            1  
 \*RST:                100

**Example:**                `DISP:WIND:TRAC:MAXH:INT 120`  
 Sets the color intensity of the maxhold trace to 120.

**Example:**                See [Chapter 13.12.3, "Example 3: analyzing persistency"](#), on page 348.

**Manual operation:**    See ["Intensity"](#) on page 118

---

**DISPlay[:WINDow<n>][:SUBWindow<w>]:TRACe<t>:MAXHold[:STATe] <State>**

Switches the maxhold trace in the persistence spectrum on and off.

Note: Setting the intensity to 0 has the same effect as deactivating the Maxhold function (see [DISPlay\[:WINDow<n>\]\[:SUBWindow<w>\]:TRACe<t>:MAXHold:INTensity](#) on page 243).

**Suffix:**

<n>                    [Window](#)  
 <w>                    subwindow  
 <t>                    [Trace](#)

**Parameters:**

<State>                ON | OFF | 0 | 1  
**OFF | 0**  
 Switches the function off  
**ON | 1**  
 Switches the function on

**Example:**                See [Chapter 13.12.3, "Example 3: analyzing persistency"](#), on page 348.

**Manual operation:**    See ["Configuring the Max Hold Function"](#) on page 118

---

**DISPlay[:WINDow<n>][:SUBWindow<w>]:TRACe<t>:PERSistence:DURation**  
 <Persistence>

Sets the duration of the persistence.

Setting the persistence to 0 turns it off and thus has the same effect as the command `DISP:WIND:TRAC:PERS OFF` (see `DISPlay[:WINDow<n>][:SUBWindow<w>]:TRACe<t>:PERSistence[:STATe]` on page 245).

**Suffix:**

<n> [Window](#)

<w> subwindow

<t> [Trace](#)

**Parameters:**

<Persistence> Persistence in seconds.  
 Range: 0 to 8  
 Increment: 0.001  
 \*RST: 1 seconds  
 Default unit: seconds

**Example:** `DISP:WIND:TRAC:PERS:DUR 4.3`  
 Sets the persistence to 4.3 seconds.

**Example:** See [Chapter 13.12.3, "Example 3: analyzing persistency"](#), on page 348.

**Manual operation:** See ["Persistence"](#) on page 118

---

**DISPlay[:WINDow<n>][:SUBWindow<w>]:TRACe<t>:PERSistence:GRANularity**  
 <Granularity>

Defines the duration that data is captured to build one persistence spectrum.

**Suffix:**

<n> [Window](#)

<w> subwindow

<t> [Trace](#)

**Parameters:**

<Granularity> duration in seconds  
 \*RST: 0.1s  
 Default unit: S

**Example:** See [Chapter 13.12.3, "Example 3: analyzing persistency"](#), on page 348.

**Manual operation:** See ["Granularity"](#) on page 118

---

**DISPlay[:WINDow<n>][:SUBWindow<w>]:TRACe<t>:PERSistence[:STATe]**  
<State>

Switches persistence in the persistence spectrum on and off.

Note: Setting the persistence to 0 turns it off and thus has the same effect as this command (see [DISPlay\[:WINDow<n>\]\[:SUBWindow<w>\]:TRACe<t>:PERSistence:DURation](#) on page 244).

**Suffix:**

<n> [Window](#)

<w> subwindow

<t> [Trace](#)

**Parameters:**

<State> ON | OFF | 0 | 1

**OFF | 0**

Switches the function off

**ON | 1**

Switches the function on

---

**DISPlay[:WINDow<n>][:SUBWindow<w>]:TRACe<t>:SYMBol <Style>**

Sets the display style of the persistence spectrum.

**Suffix:**

<n> [Window](#)

<w> subwindow

<t> [Trace](#)

**Parameters:**

<Style> **DOTS**

Displays the data as dots. The result is a persistence spectrum made up out of dots.

**VECTor**

Interpolates the measurement points. The result is an uninterrupted persistence spectrum.

\*RST: **VECTor**

**Example:**

DISP:WIND:TRAC:SYMB DOTS

Displays the persistence spectrum as dots.

**Example:**

See [Chapter 13.12.3, "Example 3: analyzing persistency"](#), on page 348.

**Manual operation:**

See "[Diagram Style](#)" on page 117

### 13.5.8 Configuring color maps

The color display used in spectrograms, persistence spectra, and PVT waterfall diagrams is highly configurable to adapt the display to your needs.

For details see [Chapter 6.5.3, "Color maps"](#), on page 53.

|  |     |
|--|-----|
| DISPlay[:WINDow<n>]:PSPectrum:COLor:DEFault.....   | 246 |
| DISPlay[:WINDow<n>]:PSPectrum:COLor:LOWer.....     | 246 |
| DISPlay[:WINDow<n>]:PSPectrum:COLor:SHAPE.....     | 246 |
| DISPlay[:WINDow<n>]:PSPectrum:COLor:TRUNcate.....  | 247 |
| DISPlay[:WINDow<n>]:PSPectrum:COLor:UPPer.....     | 247 |
| DISPlay[:WINDow<n>]:PSPectrum:COLor[:STYLe].....   | 248 |
| CALCulate<n>:SPECTrogram:COLor.....                | 248 |
| DISPlay[:WINDow<n>]:SPECTrogram:COLor[:STYLe]..... | 248 |
| DISPlay[:WINDow<n>]:SPECTrogram:COLor:DEFault..... | 249 |
| DISPlay[:WINDow<n>]:SPECTrogram:COLor:LOWer.....   | 249 |
| DISPlay[:WINDow<n>]:SPECTrogram:COLor:SHAPE.....   | 249 |
| DISPlay[:WINDow<n>]:SPECTrogram:COLor:UPPer.....   | 250 |

---

#### DISPlay[:WINDow<n>]:PSPectrum:COLor:DEFault

##### Suffix:

<n> 1..n

**Manual operation:** See ["Set to Default"](#) on page 123

---

#### DISPlay[:WINDow<n>]:PSPectrum:COLor:LOWer <Percentage>

Sets the lower percentage boundary of the persistence spectrum.

##### Suffix:

<n> [Window](#)

##### Parameters:

<Percentage> Statistical frequency percentage.  
 Range: 0 to 65,6  
 \*RST: 0  
 Default unit: %

**Example:** DISP:WIND:HIST:COL:LOW 10  
 Sets the start of the color map to 10%.

**Example:** See [Chapter 13.12.3, "Example 3: analyzing persistency"](#), on page 348.

**Manual operation:** See ["Start / Stop"](#) on page 122

---

#### DISPlay[:WINDow<n>]:PSPectrum:COLor:SHAPE <Shape>

Defines the shape and focus of the color curve for the persistence spectrum result display.

|                          |  |
|--------------------------|--|
| <b>Suffix:</b>           |  |
| <n>                      | <a href="#">Window</a>   |
| <b>Parameters:</b>       |  |
| <Shape>                  | Shape of the color curve.  |
|                          | Range: -1 to 1   |
|                          | *RST: 0  |
| <b>Example:</b>          | See <a href="#">Chapter 13.12.3, "Example 3: analyzing persistency"</a> , on page 348. |
| <b>Manual operation:</b> | See <a href="#">"Shape"</a> on page 122  |

#### DISPlay[:WINDow<n>]:PSPectrum:COLor:TRUNcate <State>

Reduces the range of the color map of the persistence spectrum if there are no hits at the start or end of the value range.

|                          |  |
|--------------------------|--|
| <b>Suffix:</b>           |  |
| <n>                      | <a href="#">Window</a>   |
| <b>Parameters:</b>       |  |
| <State>                  | ON   OFF   0   1   |
|                          | <b>OFF   0</b>   |
|                          | Switches the function off  |
|                          | <b>ON   1</b>  |
|                          | Switches the function on   |
| <b>Example:</b>          | DISP:WIND:PSP:COL:TRUN ON<br>Activates truncation of the color map.                    |
| <b>Example:</b>          | See <a href="#">Chapter 13.12.3, "Example 3: analyzing persistency"</a> , on page 348. |
| <b>Manual operation:</b> | See <a href="#">"Truncate"</a> on page 123   |

#### DISPlay[:WINDow<n>]:PSPectrum:COLor:UPPer <Percentage>

Sets the upper percentage boundary of the persistence spectrum.

|                    |  |
|--------------------|--|
| <b>Suffix:</b>     |  |
| <n>                | <a href="#">Window</a>   |
| <b>Parameters:</b> |  |
| <Percentage>       | Statistical frequency percentage.  |
|                    | Range: 0.01 to 100   |
|                    | *RST: 100  |
|                    | Default unit: %  |
| <b>Example:</b>    | DISP:WIND:HIST:COL:UPP 95<br>Sets the upper boundary of the color map to 95%.          |
| <b>Example:</b>    | See <a href="#">Chapter 13.12.3, "Example 3: analyzing persistency"</a> , on page 348. |

**Manual operation:** See ["Start / Stop"](#) on page 122

---

**DISPlay[:WINDow<n>]:PSPectrum:COLor[:STYLE] <ColorScheme>**

Sets the color scheme for the persistence spectrum.

**Suffix:**

<n> [Window](#)

**Parameters:**

<ColorScheme> **HOT**  
**COLD**  
**RADar**  
**GRAYscale**  
 \*RST: HOT

**Example:**

DISP:WIND:HIST:COL GRAY

Changes the color scheme of the persistence spectrum to black and white.

**Example:**

See [Chapter 13.12.3, "Example 3: analyzing persistency"](#), on page 348.

**Manual operation:** See ["Hot/Cold/Radar/Grayscale"](#) on page 123

---

**CALCulate<n>:SPECtrogram:COLor <ColorScheme>**

**DISPlay[:WINDow<n>]:SPECtrogram:COLor[:STYLE] <ColorScheme>**

Selects the color scheme.

**Suffix:**

<n> window; spectrograms and PVT waterfall displays can be selected

**Parameters:**

<ColorScheme> **HOT**  
 Uses a color range from blue to red. Blue colors indicate low levels, red colors indicate high ones.  
**COLD**  
 Uses a color range from red to blue. Red colors indicate low levels, blue colors indicate high ones.  
**RADar**  
 Uses a color range from black over green to light turquoise with shades of green in between.  
**GRAYscale**  
 Shows the results in shades of gray.  
 \*RST: HOT

**Example:**

DISP:WIND:SPEC:COL GRAY

Changes the color scheme of the spectrogram to black and white.



**Example:** See [Chapter 13.12.2, "Example 2: performing a basic real-time measurement"](#), on page 345.

**Example:** See [Chapter 13.12.4, "Example 4: obtaining time domain results in real-time"](#), on page 351

**Manual operation:** See ["Hot/Cold/Radar/Grayscale"](#) on page 123

#### **DISPlay[:WINDow<n>]:SPECtrogram:COLor:DEFault**

Restores the original color map.

**Suffix:**

<n> [Window](#)

**Manual operation:** See ["Set to Default"](#) on page 123

#### **DISPlay[:WINDow<n>]:SPECtrogram:COLor:LOWer <Percentage>**

Defines the starting point of the color map.

**Suffix:**

<n> [Window](#)

**Parameters:**

<Percentage> Statistical frequency percentage.  
 Range: 0 to 66  
 \*RST: 0  
 Default unit: %

**Example:** DISP:WIND:SGR:COL:LOW 10  
 Sets the start of the color map to 10%.

**Example:** See [Chapter 13.12.2, "Example 2: performing a basic real-time measurement"](#), on page 345.

**Example:** See [Chapter 13.12.4, "Example 4: obtaining time domain results in real-time"](#), on page 351

**Manual operation:** See ["Start / Stop"](#) on page 122

#### **DISPlay[:WINDow<n>]:SPECtrogram:COLor:SHAPE <Shape>**

Defines the shape and focus of the color curve for the spectrogram result display.

**Suffix:**

<n> [Window](#)

**Parameters:**

<Shape> Shape of the color curve.  
 Range: -1 to 1  
 \*RST: 0

- Example:** See [Chapter 13.12.2, "Example 2: performing a basic real-time measurement"](#), on page 345.
- Example:** See [Chapter 13.12.4, "Example 4: obtaining time domain results in real-time"](#), on page 351
- Manual operation:** See ["Shape"](#) on page 122

#### **DISPlay[:WINDow<n>]:SPECtrogram:COLor:UPPer <Percentage>**

Defines the end point of the color map.

##### **Suffix:**

<n> [Window](#)

##### **Parameters:**

<Percentage> Statistical frequency percentage.

Range: 0 to 66

\*RST: 0

Default unit: %

**Example:** DISP:WIND:SGR:COL:UPP 95  
Sets the start of the color map to 95%.

**Example:** See [Chapter 13.12.2, "Example 2: performing a basic real-time measurement"](#), on page 345.

**Example:** See [Chapter 13.12.4, "Example 4: obtaining time domain results in real-time"](#), on page 351

**Manual operation:** See ["Start / Stop"](#) on page 122

### 13.5.9 Adjusting settings automatically

The following remote commands are required to adjust settings automatically in a remote environment. In MSRT mode, these commands are only available for the MSRT primary channel. The functions for manual operation are described in [Chapter 7.8, "Adjusting settings automatically"](#), on page 109.

|   |     |
|---|-----|
| [SENSe:]ADJust:ALL.....                           | 250 |
| [SENSe:]ADJust:CONFigure:LEVel:DURation.....      | 251 |
| [SENSe:]ADJust:CONFigure:LEVel:DURation:MODE..... | 251 |
| [SENSe:]ADJust:FREQuency.....                     | 252 |
| [SENSe:]ADJust:CONFigure:HYSTeresis:LOWer.....    | 252 |
| [SENSe:]ADJust:CONFigure:HYSTeresis:UPPer.....    | 252 |
| [SENSe:]ADJust:CONFigure:TRIGger.....             | 253 |
| [SENSe:]ADJust:LEVel.....                         | 253 |

#### **[SENSe:]ADJust:ALL**

Initiates a measurement to determine and set the ideal settings for the current task automatically (only once for the current measurement).

This includes:

- Center frequency
- Reference level

**Example:** ADJ:ALL

**Manual operation:** See ["Adjusting all Determinable Settings Automatically \(Auto All\)"](#) on page 109

#### [SENSe:]ADJust:CONFigure:LEVel:DURation <Duration>

To determine the ideal reference level, the FSW performs a measurement on the current input data. This command defines the length of the measurement if [SENSe:]ADJust:CONFigure:LEVel:DURation:MODE is set to MANual.

##### Parameters:

<Duration>                      Numeric value in seconds  
 Range:                      0.001 to 16000.0  
 \*RST:                      0.001  
 Default unit: s

**Example:** ADJ:CONF:DUR:MODE MAN  
 Selects manual definition of the measurement length.  
 ADJ:CONF:LEV:DUR 5ms  
 Length of the measurement is 5 ms.

**Manual operation:** See ["Changing the Automatic Measurement Time \(Meas Time Manual\)"](#) on page 110

#### [SENSe:]ADJust:CONFigure:LEVel:DURation:MODE <Mode>

To determine the ideal reference level, the FSW performs a measurement on the current input data. This command selects the way the FSW determines the length of the measurement .

##### Parameters:

<Mode>                      **AUTO**  
 The FSW determines the measurement length automatically according to the current input data.  
                                  **MANual**  
 The FSW uses the measurement length defined by [SENSe:]ADJust:CONFigure:LEVel:DURation on page 251.  
 \*RST:                      AUTO

**Manual operation:** See ["Resetting the Automatic Measurement Time \(Meas Time Auto\)"](#) on page 110  
 See ["Changing the Automatic Measurement Time \(Meas Time Manual\)"](#) on page 110

**[SENSe:]ADJ:FREquency**

Sets the center frequency to the frequency with the highest signal level in the current frequency range.

**Example:** ADJ:FREQ

**Manual operation:** See "[Adjusting the Center Frequency Automatically \(Auto Frequency\)](#)" on page 110

**[SENSe:]ADJ:CONF:HYSTerisis:LOWer <Threshold>**

When the reference level is adjusted automatically using the [SENSe:]ADJ:LEVEL on page 253 command, the internal attenuators and the preamplifier are also adjusted. To avoid frequent adaptation due to small changes in the input signal, you can define a hysteresis. This setting defines a lower threshold the signal must fall below (compared to the last measurement) before the reference level is adapted automatically.

**Parameters:**

<Threshold> Range: 0 dB to 200 dB  
\*RST: +1 dB  
Default unit: dB

**Example:** SENS:ADJ:CONF:HYST:LOW 2  
For an input signal level of currently 20 dBm, the reference level is only adjusted when the signal level falls below 18 dBm.

**Manual operation:** See "[Lower Level Hysteresis](#)" on page 111

**[SENSe:]ADJ:CONF:HYSTerisis:UPPer <Threshold>**

When the reference level is adjusted automatically using the [SENSe:]ADJ:LEVEL on page 253 command, the internal attenuators and the preamplifier are also adjusted. To avoid frequent adaptation due to small changes in the input signal, you can define a hysteresis. This setting defines an upper threshold the signal must exceed (compared to the last measurement) before the reference level is adapted automatically.

**Parameters:**

<Threshold> Range: 0 dB to 200 dB  
\*RST: +1 dB  
Default unit: dB

**Example:** SENS:ADJ:CONF:HYST:UPP 2

**Example:** For an input signal level of currently 20 dBm, the reference level is only adjusted when the signal level rises above 22 dBm.

**Manual operation:** See "[Upper Level Hysteresis](#)" on page 110

**[SENSe:]ADJJust:CONFigure:TRIGger <State>**

Defines the behavior of a triggered measurement when adjusting a setting automatically (using `SENS:ADJ:LEV ON`, for example).

See "[Adjusting settings automatically during triggered measurements](#)" on page 109

**Parameters:**

<State>                    ON | OFF | 0 | 1

**ON | 1**  
(default:) The measurement for adjustment waits for the next trigger.

**OFF | 0**  
The measurement for adjustment is performed without waiting for a trigger (corresponds to "Continue" in manual operation).

\*RST:                    0

**Example:**

```
//Use default ref level at 0.00 dBm.
//Define an RF power trigger at -20 dBm
:TRIG:SEQ:SOUR RFP
:TRIG:SEQ:LEV:RFP -20
//Perform adjustment measurement without waiting for trigger
SENS:ADJ:CONF:TRIG OFF
//Perform auto level adjustment
:SENS:ADJ:LEV;*WAI
```

**[SENSe:]ADJJust:LEVel**

Initiates a single (internal) measurement that evaluates and sets the ideal reference level for the current input data and measurement settings. Thus, the settings of the RF attenuation and the reference level are optimized for the signal level. The FSW is not overloaded and the dynamic range is not limited by an S/N ratio that is too small.

**Example:**                    ADJ:LEV

**Manual operation:**    See "[Setting the Reference Level Automatically \(Auto Level\)](#)" on page 90

### 13.5.10 Configuring the result display

The following remote commands are required to configure the screen display in a remote environment. The tasks for manual operation are described in [Chapter 5.2, "Real-Time Spectrum result displays"](#), on page 28.

- [General window commands](#).....254
- [Working with windows in the display](#).....254

### 13.5.10.1 General window commands

The following commands are required to configure general window layout, independent of the application.

|  |     |
|--|-----|
| <a href="#">DISPlay:FORMat</a> .....                 | 254 |
| <a href="#">DISPlay[:WINDow&lt;n&gt;]:SIZE</a> ..... | 254 |

---

#### **DISPlay:FORMat** <Format>

Determines which tab is displayed.

##### Parameters:

<Format>

##### **SPLit**

Displays the MultiView tab with an overview of all active channels

##### **SINGle**

Displays the measurement channel that was previously focused.

\*RST: SING

##### Example:

DISP:FORM SPL

---

#### **DISPlay[:WINDow<n>]:SIZE** <Size>

Maximizes the size of the selected result display window *temporarily*. To change the size of several windows on the screen permanently, use the `LAY:SPL` command (see [LAYout:SPLitter](#) on page 258).

##### Suffix:

<n>

Window

##### Parameters:

<Size>

##### **LARGE**

Maximizes the selected window to full screen. Other windows are still active in the background.

##### **SMALI**

Reduces the size of the selected window to its original size. If more than one measurement window was displayed originally, these are visible again.

\*RST: SMALI

##### Example:

DISP:WIND2:SIZE LARG

### 13.5.10.2 Working with windows in the display

The following commands are required to change the evaluation type and rearrange the screen layout for a channel as you do using the SmartGrid in manual operation. Since the available evaluation types depend on the selected application, some parameters for the following commands also depend on the selected channel.

Note that the suffix <n> always refers to the window *in the currently selected channel*.

|                            |     |
|----------------------------|-----|
| LAYout:ADD[:WINDow]?       | 255 |
| LAYout:CATalog[:WINDow]?   | 256 |
| LAYout:IDENtify[:WINDow]?  | 257 |
| LAYout:MOVE[:WINDow]       | 257 |
| LAYout:REMove[:WINDow]     | 258 |
| LAYout:REPLace[:WINDow]    | 258 |
| LAYout:SPLitter            | 258 |
| LAYout:WINDow<n>:ADD?      | 260 |
| LAYout:WINDow<n>:IDENtify? | 260 |
| LAYout:WINDow<n>:REMove    | 261 |
| LAYout:WINDow<n>:REPLace   | 261 |

---

### LAYout:ADD[:WINDow]? <WindowName>, <Direction>, <WindowType>

Adds a window to the display in the active channel.

Is always used as a query so that you immediately obtain the name of the new window as a result.

To replace an existing window, use the `LAYout:REPLace[:WINDow]` command.

#### Query parameters:

|              |   |
|--------------|---|
| <WindowName> | String containing the name of the existing window the new window is inserted next to.<br>By default, the name of a window is the same as its index. To determine the name and index of all active windows, use the <code>LAYout:CATalog[:WINDow]?</code> query. |
| <Direction>  | LEFT   RIGHT   ABOVE   BELOW<br>Direction the new window is added relative to the existing window.  |
| <WindowType> | text value<br>Type of result display (evaluation method) you want to add. See the table below for available parameter values.   |

#### Return values:

|                 |   |
|-----------------|---|
| <NewWindowName> | When adding a new window, the command returns its name (by default the same as its number) as a result. |
|-----------------|---|

#### Example:

```
LAY:ADD? '1', LEFT, MTAB
```

Result:

```
'2'
```

Adds a new window named '2' with a marker table to the left of window 1.

#### Usage:

Query only

**Manual operation:** See ["Real-Time Spectrum"](#) on page 28  
 See ["Spectrogram"](#) on page 29  
 See ["3-D Spectrogram"](#) on page 30  
 See ["Persistence Spectrum"](#) on page 31  
 See ["Power vs. Time"](#) on page 33  
 See ["Power vs Time Waterfall"](#) on page 34  
 See ["3-D Power vs Time Waterfall"](#) on page 35  
 See ["Marker Table"](#) on page 36

For a detailed example, see [Chapter 13.12.3, "Example 3: analyzing persistency"](#), on page 348 and [Chapter 13.12.4, "Example 4: obtaining time domain results in real-time"](#), on page 351.

**Table 13-4:** <WindowType> parameter values for Real-Time measurements

| Parameter value  | Window type   |
|--|---|
| 'XFRequency:RFPower[:SPEctrum]'<br>'XFRequency[:SPEctrum]' | "Real-Time Spectrum"  |
| 'XFRequency:RFPower:SGRam'<br>'XFRequency:SGRam'           | "Spectrogram"   |
| 'XFRequency:RFPower:SGRam:3D'<br>'XFRequency:SGRam:3D'     |   |
| 'XFRequency:RFPower:PSpectrum'<br>'XFRequency:PSpectrum'   | "Persistence Spectrum"  |
| 'XTIME:RFPower[:TDOMain]'<br>'XTIME[:TDOMain]'             | "Power vs. Time"  |
| 'XTIME:RFPower:SGRam'<br>'XTIME:SGRam'                     | "PVT Waterfall"   |
| 'XTIME:RFPower:SGRam:3D'<br>'XTIME:SGRam:3D'               | "3-D PVT Waterfall"   |
| MTABLE   | "Marker table"  |
| RECORDing  | "I/Q 40G Recording" window providing "Insert Marker" function |

### LAYout:CATalog[:WINDow]?

Queries the name and index of all active windows in the active channel from top left to bottom right. The result is a comma-separated list of values for each window, with the syntax:

<WindowName\_1>,<WindowIndex\_1>..<WindowName\_n>,<WindowIndex\_n>

#### Return values:

<WindowName> string  
 Name of the window.  
 In the default state, the name of the window is its index.



|                 |  |
|-----------------|--|
| <WindowIndex>   | <b>numeric value</b><br>Index of the window.   |
| <b>Example:</b> | LAY:CAT?<br>Result:<br>'2',2,'1',1<br>Two windows are displayed, named '2' (at the top or left), and '1' (at the bottom or right). |
| <b>Usage:</b>   | Query only   |

**LAYout:IDENTify[:WINDow]? <WindowName>**

Queries the **index** of a particular display window in the active channel.

**Note:** to query the **name** of a particular window, use the `LAYout:WINDow<n>:IDENTify?` query.

**Query parameters:**

<WindowName> String containing the name of a window.

**Return values:**

<WindowIndex> Index number of the window.

**Example:** LAY:IDEN:WIND? '2'  
Queries the index of the result display named '2'.  
Response:  
2

**Usage:** Query only

**LAYout:MOVE[:WINDow] <WindowName>, <WindowName>, <Direction>****Setting parameters:**

<WindowName> String containing the name of an existing window that is to be moved.  
By default, the name of a window is the same as its index. To determine the name and index of all active windows in the active channel, use the `LAYout:CATalog[:WINDow]?` query.

<WindowName> String containing the name of an existing window the selected window is placed next to or replaces.  
By default, the name of a window is the same as its index. To determine the name and index of all active windows in the active channel, use the `LAYout:CATalog[:WINDow]?` query.

<Direction> LEFT | RIGHT | ABOVE | BELOW | REPLACE  
Destination the selected window is moved to, relative to the reference window.

**Example:** LAY:MOVE '4','1',LEFT  
Moves the window named '4' to the left of window 1.

**Example:** `LAY:MOVE '1','3',REPL`  
 Replaces the window named '3' by window 1. Window 3 is deleted.

**Usage:** Setting only

#### **LAYout:REMOve[:WINDow] <WindowName>**

Removes a window from the display in the active channel.

#### **Setting parameters:**

<WindowName> String containing the name of the window. In the default state, the name of the window is its index.

**Example:** `LAY:REM '2'`  
 Removes the result display in the window named '2'.

**Usage:** Setting only

#### **LAYout:REPLace[:WINDow] <WindowName>,<WindowType>**

Replaces the window type (for example from "Diagram" to "Result Summary") of an already existing window in the active channel while keeping its position, index and window name.

To add a new window, use the `LAYout:ADD[:WINDow]?` command.

#### **Setting parameters:**

<WindowName> String containing the name of the existing window.  
 By default, the name of a window is the same as its index. To determine the name and index of all active windows in the active channel, use the `LAYout:CATalog[:WINDow]?` query.

<WindowType> Type of result display you want to use in the existing window.  
 See `LAYout:ADD[:WINDow]?` on page 255 for a list of available window types.

**Example:** `LAY:REPL:WIND '1',MTAB`  
 Replaces the result display in window 1 with a marker table.

**Usage:** Setting only

#### **LAYout:SPLitter <Index1>, <Index2>, <Position>**

Changes the position of a splitter and thus controls the size of the windows on each side of the splitter.

Compared to the `DISPlay[:WINDow<n>]:SIZE` on page 254 command, the `LAYout:SPLitter` changes the size of all windows to either side of the splitter permanently, it does not just maximize a single window temporarily.

Note that windows must have a certain minimum size. If the position you define conflicts with the minimum size of any of the affected windows, the command does not work, but does not return an error.

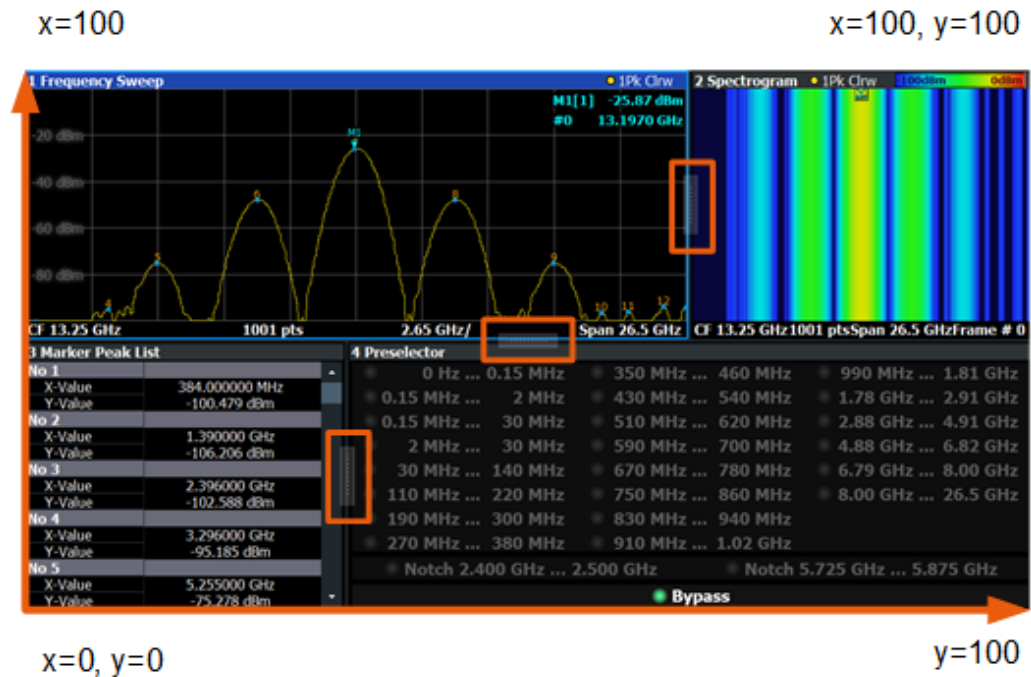

Figure 13-1: SmartGrid coordinates for remote control of the splitters

#### Setting parameters:

- <Index1> The index of one window the splitter controls.
- <Index2> The index of a window on the other side of the splitter.
- <Position> New vertical or horizontal position of the splitter as a fraction of the screen area (without channel and status bar and softkey menu).  
The point of origin ( $x = 0$ ,  $y = 0$ ) is in the lower left corner of the screen. The end point ( $x = 100$ ,  $y = 100$ ) is in the upper right corner of the screen. (See Figure 13-1.)  
The direction in which the splitter is moved depends on the screen layout. If the windows are positioned horizontally, the splitter also moves horizontally. If the windows are positioned vertically, the splitter also moves vertically.

Range: 0 to 100

#### Example:

LAY:SPL 1,3,50

Moves the splitter between window 1 ("Frequency Sweep") and 3 ("Marker Table") to the center (50%) of the screen, i.e. in the figure above, to the left.

**Example:** `LAY:SPL 1,4,70`  
 Moves the splitter between window 1 ('Frequency Sweep') and 3 ('Marker Peak List') towards the top (70%) of the screen. The following commands have the exact same effect, as any combination of windows above and below the splitter moves the splitter vertically.  
`LAY:SPL 3,2,70`  
`LAY:SPL 4,1,70`  
`LAY:SPL 2,1,70`

**Usage:** Setting only

### **LAYout:WINDow<n>:ADD? <Direction>,<WindowType>**

Adds a measurement window to the display. Note that with this command, the suffix <n> determines the existing window next to which the new window is added. Unlike [LAYout:ADD\[:WINDow\]?](#), for which the existing window is defined by a parameter.

To replace an existing window, use the [LAYout:WINDow<n>:REPLace](#) command.

Is always used as a query so that you immediately obtain the name of the new window as a result.

#### **Suffix:**

<n> [Window](#)

#### **Query parameters:**

<Direction> LEFT | RIGHT | ABOVE | BELOW

<WindowType> Type of measurement window you want to add.  
 See [LAYout:ADD\[:WINDow\]?](#) on page 255 for a list of available window types.

#### **Return values:**

<NewWindowName> When adding a new window, the command returns its name (by default the same as its number) as a result.

**Example:** `LAY:WIND1:ADD? LEFT,MTAB`  
**Result:**  
`'2'`  
 Adds a new window named '2' with a marker table to the left of window 1.

**Usage:** Query only

### **LAYout:WINDow<n>:IDENTify?**

Queries the **name** of a particular display window (indicated by the <n> suffix) in the active channel.

**Note:** to query the **index** of a particular window, use the [LAYout:IDENTify\[:WINDow\]?](#) command.

|                       |   |
|-----------------------|---|
| <b>Suffix:</b>        |   |
| <n>                   | Window  |
| <b>Return values:</b> |   |
| <WindowName>          | String containing the name of a window.<br>In the default state, the name of the window is its index. |
| <b>Example:</b>       | LAY:WIND2:IDEN?<br>Queries the name of the result display in window 2.<br>Response:<br>'2'            |
| <b>Usage:</b>         | Query only  |

---

#### LAYout:WINDow<n>:REMove

Removes the window specified by the suffix <n> from the display in the active channel.  
The result of this command is identical to the [LAYout:REMove\[:WINDow\]](#) command.

|                 |  |
|-----------------|--|
| <b>Suffix:</b>  |  |
| <n>             | Window   |
| <b>Example:</b> | LAY:WIND2:REM<br>Removes the result display in window 2. |
| <b>Usage:</b>   | Event  |

---

#### LAYout:WINDow<n>:REPLace <WindowType>

Changes the window type of an existing window (specified by the suffix <n>) in the active channel.

The effect of this command is identical to the [LAYout:REPLace\[:WINDow\]](#) command.

To add a new window, use the [LAYout:WINDow<n>:ADD?](#) command.

|                            |  |
|----------------------------|--|
| <b>Suffix:</b>             |  |
| <n>                        | Window   |
| <b>Setting parameters:</b> |  |
| <WindowType>               | Type of measurement window you want to replace another one with.<br>See <a href="#">LAYout:ADD[:WINDow]?</a> on page 255 for a list of available window types. |
| <b>Example:</b>            | LAY:WIND2:REPL MTAB<br>Replaces the result display in window 2 with a marker table.  |
| <b>Usage:</b>              | Setting only   |

## 13.6 Capturing data and performing sweeps

When you activate a "Real-Time Spectrum" measurement channel, a measurement is started immediately with the default settings. However, you can start and stop new measurements at any time.



### Capturing data in MSRT mode

The only true measurement in MSRT mode in which data from the input signal is captured and stored is performed by the MSRT primary. This data acquisition is performed as in the "Real-Time Spectrum" application.

As soon as data has been stored to the capture buffer successfully, a status bit (#9) in the `STAT:OPER` register is set (see [Chapter 13.9.1, "STATUS:OPERation register"](#), on page 335). Once the bit has been set, the device under test can already be reconfigured while the FSW performs analysis on the captured data. For measurements that require long measurement times and comprehensive analysis tasks, using the "capture finished" information can reduce the overall measurement time significantly.

See also:

- [INITiate<n>:REFresh](#) on page 343

|  |     |
|--|-----|
| <a href="#">ABORT</a> .....                            | 262 |
| <a href="#">INITiate&lt;n&gt;:CONMeas</a> .....        | 263 |
| <a href="#">INITiate&lt;n&gt;:CONTinuous</a> .....     | 263 |
| <a href="#">INITiate&lt;n&gt;:[IMMediate]</a> .....    | 264 |
| <a href="#">INITiate:SEQuencer:ABORT</a> .....         | 264 |
| <a href="#">INITiate:SEQuencer:IMMediate</a> .....     | 264 |
| <a href="#">INITiate:SEQuencer:MODE</a> .....          | 265 |
| <a href="#">INITiate:SEQuencer:REFResh[:ALL]</a> ..... | 265 |
| <a href="#">SYSTem:SEQuencer</a> .....                 | 266 |

---

### ABORT

Aborts the measurement in the current channel and resets the trigger system.

To prevent overlapping execution of the subsequent command before the measurement has been aborted successfully, use the `*OPC?` or `*WAI` command after `ABOR` and before the next command.

For details on overlapping execution see [Remote control via SCPI](#).

To abort a sequence of measurements by the Sequencer, use the `INITiate:SEQuencer:ABORT` command.

#### Note on blocked remote control programs:

If a sequential command cannot be completed, for example because a triggered sweep never receives a trigger, the remote control program will never finish and the remote channel to the FSW is blocked for further commands. In this case, you must interrupt processing on the remote channel first in order to abort the measurement.

To do so, send a "Device Clear" command from the control instrument to the FSW on a parallel channel to clear all currently active remote channels. Depending on the used interface and protocol, send the following commands:

- **Visa:** `viClear()`
- **GPIB:** `ibclr()`
- **RSIB:** `RSDLLibclr()`

Now you can send the `ABORt` command on the remote channel performing the measurement.

**Example:** `ABOR; :INIT:IMM`  
Aborts the current measurement and immediately starts a new one.

**Example:** `ABOR; *WAI`  
`INIT:IMM`  
Aborts the current measurement and starts a new one once abortion has been completed.

**Usage:** Event

### **INITiate<n>:CONMeas**

Restarts a (single) measurement that has been stopped (using `ABORt`) or finished in single measurement mode.

The measurement is restarted at the beginning, not where the previous measurement was stopped.

As opposed to `INITiate<n>[:IMMediate]`, this command does not reset traces in maxhold, minhold or average mode. Therefore it can be used to continue measurements using maxhold or averaging functions.

**Suffix:**  
<n> irrelevant

**Usage:** Asynchronous command

### **INITiate<n>:CONTinuous <State>**

Controls the measurement mode for an individual channel.

Note that in single measurement mode, you can synchronize to the end of the measurement with `*OPC`, `*OPC?` or `*WAI`. In continuous measurement mode, synchronization to the end of the measurement is not possible. Thus, it is not recommended that you use continuous measurement mode in remote control, as results like trace data or markers are only valid after a single measurement end synchronization.

For details on synchronization see [Remote control via SCPI](#).

If the measurement mode is changed for a channel while the Sequencer is active (see `INITiate:SEQuencer:IMMediate` on page 264), the mode is only considered the next time the measurement in that channel is activated by the Sequencer.

**Suffix:**

<n> irrelevant

**Parameters:**

<State> ON | OFF | 0 | 1  
**ON | 1**  
 Continuous measurement  
**OFF | 0**  
 Single measurement  
 \*RST: 1 (some applications can differ)

**Example:**

INIT:CONT OFF  
 Switches the measurement mode to single measurement.  
 INIT:CONT ON  
 Switches the measurement mode to continuous measurement.

**Manual operation:** See "[Continuous Sweep / Run Cont](#)" on page 107

**INITiate<n>[:IMMEDIATE]**

Starts a (single) new measurement.

You can synchronize to the end of the measurement with \*OPC, \*OPC? or \*WAI.

For details on synchronization see [Remote control via SCPI](#).

**Suffix:**

<n> irrelevant

**Usage:**

Asynchronous command

**Manual operation:** See "[Single Sweep / Run Single](#)" on page 107

**INITiate:SEQuencer:ABORt**

Stops the currently active sequence of measurements.

You can start a new sequence any time using [INITiate:SEQuencer:IMMEDIATE](#) on page 264.

**Usage:**

Event

**Manual operation:** See "[Sequencer State](#)" on page 114

**INITiate:SEQuencer:IMMEDIATE**

Starts a new sequence of measurements by the Sequencer.

Its effect is similar to the [INITiate<n>\[:IMMEDIATE\]](#) command used for a single measurement.

Before this command can be executed, the Sequencer must be activated (see [SYSTem:SEQuencer](#) on page 266).



**Example:**

```

SYST:SEQ ON
Activates the Sequencer.
INIT:SEQ:MODE SING
Sets single sequence mode so each active measurement is performed once.
INIT:SEQ:IMM
Starts the sequential measurements.

```

**Manual operation:** See "[Sequencer State](#)" on page 114

#### INITiate:SEQuencer:MODE <Mode>

Defines the capture mode for the entire measurement sequence and all measurement groups and channels it contains.

**Note:** To synchronize to the end of a measurement sequence using \*OPC, \*OPC? or \*WAI, use SINGle Sequencer mode.

#### Parameters:

<Mode>

##### **SINGle**

Each measurement group is started one after the other in the order of definition. All measurement channels in a group are started simultaneously and performed once. After *all* measurements are completed, the next group is started. After the last group, the measurement sequence is finished.

##### **CONTInuous**

Each measurement group is started one after the other in the order of definition. All measurement channels in a group are started simultaneously and performed once. After *all* measurements are completed, the next group is started. After the last group, the measurement sequence restarts with the first one and continues until it is stopped explicitly.

\*RST: CONTInuous

**Manual operation:** See "[Sequencer Mode](#)" on page 114

#### INITiate:SEQuencer:REFResh[:ALL]

Is only available if the Sequencer is deactivated (`SYSTEM:SEQuencer` `SYST:SEQ:OFF`) and only in MSRT mode.

The data in the capture buffer is re-evaluated by all active MSRT secondary applications.

**Example:**

```

SYST:SEQ:OFF
Deactivates the scheduler
INIT:CONT OFF
Switches to single sweep mode.
INIT;*WAI
Starts a new data measurement and waits for the end of the
sweep.
INIT:SEQ:REFR
Refreshes the display for all channels.

```

**Manual operation:** See "[Refresh All](#)" on page 114

---

### SYSTem:SEQuencer <State>

Turns the Sequencer on and off. The Sequencer must be active before any other Sequencer commands (INIT:SEQ . . .) are executed, otherwise an error occurs.

#### Parameters:

<State>                    ON | OFF | 0 | 1

**ON | 1**  
The Sequencer is activated and a sequential measurement is started immediately.

**OFF | 0**  
The Sequencer is deactivated. Any running sequential measurements are stopped. Further Sequencer commands (INIT:SEQ . . .) are not available.

\*RST:                    0

**Example:**

```

SYST:SEQ ON
Activates the Sequencer.
INIT:SEQ:MODE SING
Sets single Sequencer mode so each active measurement is
performed once.
INIT:SEQ:IMM
Starts the sequential measurements.
SYST:SEQ OFF

```

**Manual operation:** See "[Sequencer State](#)" on page 114

## 13.7 Retrieving results

The following commands are required to retrieve the results in a remote environment.

- [Retrieving marker results](#)..... 267
- [Retrieving trace results](#)..... 268
- [Measurement results for TRACe<n>\[:DATA\]?](#)..... 271
- [Exporting trace results](#)..... 272
- [Retrieving trace I/Q data](#)..... 275
- [Exporting \(raw\) I/Q data](#)..... 278

### 13.7.1 Retrieving marker results

Useful commands for retrieving results described elsewhere:

- [CALCulate<n>:DELTaMarker<m>:X](#) on page 291
- [CALCulate<n>:DELTaMarker<m>:Y?](#) on page 292
- [CALCulate<n>:MARKer<m>:X](#) on page 288
- [CALCulate<n>:MARKer<m>:Y?](#) on page 289

**Remote commands exclusive to retrieving marker results:**

|   |     |
|---|-----|
| <a href="#">CALCulate&lt;n&gt;:DELTaMarker&lt;m&gt;:X:RELative?</a> ..... | 267 |
| <a href="#">CALCulate&lt;n&gt;:DELTaMarker&lt;m&gt;:Z</a> .....           | 267 |
| <a href="#">CALCulate&lt;n&gt;:MARKer&lt;m&gt;:Z?</a> .....               | 267 |

---

#### **CALCulate<n>:DELTaMarker<m>:X:RELative?**

Queries the relative position of a delta marker on the x-axis.

If necessary, the command activates the delta marker first.

**Suffix:**

<n>                      [Window](#)

<m>                      [Marker](#)

**Return values:**

<Position>              Position of the delta marker in relation to the reference marker.

**Example:**

`CALC:DELT3:X:REL?`

Outputs the frequency of delta marker 3 relative to marker 1 or relative to the reference position.

**Usage:**

Query only

---

#### **CALCulate<n>:DELTaMarker<m>:Z**

**Suffix:**

<n>                      1..n

<m>                      1..n

---

#### **CALCulate<n>:MARKer<m>:Z?**

Queries the z-axis value of the indicated marker in the persistence spectrum result display.

You can select whether to query the results of the persistence trace or the maxhold trace with [CALCulate<n>:DELTaMarker<m>:TRACe](#) on page 291.

**Suffix:**

<n>                      [Window](#)

<m>                      [Marker](#)

**Return values:**

<Result> The return value is the percentage of hits on the marker position.

**Usage:**

Query only

### 13.7.2 Retrieving trace results

The following remote commands are required to retrieve the trace results in a remote environment.

Useful commands for retrieving results described elsewhere:

- `CALCulate<n>:SPECTrogram:FRAME:SELEct` on page 240
- `CALCulate<n>:SPECTrogram:TSTamp:DATA?` on page 241

**Remote commands exclusive to retrieving trace results:**

|  |     |
|--|-----|
| <code>FORMat[:DATA]</code> .....                 | 268 |
| <code>TRACe&lt;n&gt;[:DATA]</code> .....         | 269 |
| <code>TRACe&lt;n&gt;[:DATA]:MEMory?</code> ..... | 270 |
| <code>TRACe&lt;n&gt;[:DATA]:X?</code> .....      | 270 |

---

**FORMat[:DATA] <Format>[, <BitLength>]**

Selects the data format that is used for transmission of trace data from the FSW to the controlling computer.

Note that the command has no effect for data that you send to the FSW. The FSW automatically recognizes the data it receives, regardless of the format.

**Parameters:**

<Format>

**AScii**

AScii format, separated by commas.

This format is almost always suitable, regardless of the actual data format. However, the data is not as compact as other formats can be.

**REAL**

Floating-point numbers (according to IEEE 754) in the "definite length block format".

In the Spectrum application, the format setting `REAL` is used for the binary transmission of trace data.

<BitLength>

Length in bits for floating-point results

**16**

16-bit floating-point numbers.

Compared to `REAL, 32` format, half as many numbers are returned.

**32**

32-bit floating-point numbers

For I/Q data, 8 bytes per sample are returned for this format setting.

**64**

64-bit floating-point numbers

Compared to `REAL, 32` format, twice as many numbers are returned.

**Example:** `FORM REAL, 32`

**TRACe<n>[:DATA]**

Queries current trace data and measurement results.

The data format depends on `FORMat [:DATA]` on page 268.

For details, see [Chapter 13.7.3, "Measurement results for TRACe<n>\[:DATA\]?"](#), on page 271.

**Suffix:**

<n> [Window](#)

**Query parameters:**

<ResultType> Selects the type of result to be returned.

**TRACE1 | ... | TRACE4**

Returns the trace data for the corresponding trace.

The trace data consists of a list of measured power levels. The number of power levels in the list depends on the currently selected number of sweep points. The unit depends on the measurement and on the configured unit.

For the auto peak detector, the command returns positive peak values only. (To retrieve negative peak values, define a second trace with a negative peak detector.)

**SPECTrogram | SGRam**

Returns the results of the spectrogram result display.

For every frame in the spectrogram, the command returns the measured power levels, one for each sweep point. The number of frames depends on the size of the history depth. The power level depends on the configured unit. For spectrogram trace results, only `REAL, 32` format is supported

**PSpectrum**

Returns the result of the Clear/Write (trace 2) "Persistence Spectrum" result display.

For every sweep point in the "Persistence Spectrum", the command returns the probability values that have been determined.

**HMAXhold**

Returns the result of the Max Hold (trace 3) "Persistence Spectrum" result display.

For every sweep point in the "Persistence Spectrum", the command returns the probability values that have been determined.

**Example:** `TRAC? TRACE3`  
Queries the data of trace 3.

**Manual operation:** See ["Real-Time Spectrum"](#) on page 28  
 See ["Spectrogram"](#) on page 29  
 See ["3-D Spectrogram"](#) on page 30  
 See ["Persistence Spectrum"](#) on page 31  
 See ["Power vs. Time"](#) on page 33  
 See ["Power vs Time Waterfall"](#) on page 34  
 See ["3-D Power vs Time Waterfall"](#) on page 35

### TRACe<n>[:DATA]:MEMory? <Trace>,<OffsSwPoint>,<NoOfSwPoints>

Queries the previously captured trace data for the specified trace from the memory. As an offset and number of sweep points to be retrieved can be specified, the trace data can be retrieved in smaller portions, making the command faster than the TRAC:DATA? command. This is useful if only specific parts of the trace data are of interest.

If no parameters are specified with the command, the entire trace data is retrieved; in this case, the command returns the same results as TRAC:DATA? TRACE1.

For details on the returned values see the TRAC:DATA? <TRACE...> command.

#### Suffix:

<n> [Window](#)

#### Query parameters:

<Trace> TRACE1 | TRACE2 | TRACE3 | TRACE4

<OffsSwPoint> The offset in sweep points related to the start of the measurement at which data retrieval is to start.

<NoOfSwPoints> Number of sweep points to be retrieved from the trace.

#### Return values:

<SweepPointValues>

#### Example:

TRAC:DATA:MEM? TRACE1,25,100

Retrieves 100 sweep points from trace 1, starting at sweep point 25.

#### Usage:

Query only

### TRACe<n>[:DATA]:X? <TraceNumber>

Queries the horizontal trace data for each sweep point in the specified window, for example the frequency in frequency domain or the time in time domain measurements.

#### Suffix:

<n> [Window](#)

#### Query parameters:

<TraceNumber> Trace number.

TRACE1 | TRACE2 | TRACE3 | TRACE4

#### Return values:

<X-Values>

|                          |   |
|--------------------------|---|
| <b>Example:</b>          | TRAC3:X? TRACE1<br>Returns the x-values for trace 1 in window 3.  |
| <b>Usage:</b>            | Query only  |
| <b>Manual operation:</b> | See "Real-Time Spectrum" on page 28<br>See "Spectrogram" on page 29<br>See "3-D Spectrogram" on page 30<br>See "Persistence Spectrum" on page 31<br>See "Power vs. Time" on page 33<br>See "Power vs Time Waterfall" on page 34<br>See "3-D Power vs Time Waterfall" on page 35 |

### 13.7.3 Measurement results for TRACe<n>[:DATA]?

The result type selected by `LAYout:ADD[:WINDOW]?` and the data format defined by `FORMat[:DATA]` also affect the results of the trace data query (see `TRACe<n>[:DATA]` on page 269). Details on the returned trace data depending on the result type and data format are provided here.

| TRACe<n>[:DATA]? parameter | Result type   | Result Format   |
|----------------------------|---|---|
| TRACE1   ...   TRACE4      | "Persistence Spectrum" (TRACE1 only)<br>"Real-Time Spectrum"<br>"Spectrogram" (TRACE1 only)<br>"Power vs Time"<br>PVT Waterfall (TRACE1 only) | Depends on <code>FORMat[:DATA]</code> . By default, comma-separated floats in ASCII format. In Real-Time, traces are always 1001 points.<br><br>For Waterfall displays, TRACE1 returns the newest frame.<br><br>For the Persistence display, TRACE1 returns its TRACE1, which is also TRACE1 of the "Real-Time Spectrum".   |
| SPECTrogram/SGRam          | "Spectrogram"<br>PVT Waterfall  | Depends on <code>FORMat[:DATA]</code> . By default, comma-separated floats in ASCII format. REAL16 and 64 not supported.<br><br>Comma-separated list, formatted as 1001 x <frame_count>. No delimiter between frames. Frames are returned from newest frame (top of the spectrogram) to oldest (bottom of the spectrogram). |

| TRACe<n>[:DATA]? parameter | Result type            | Result Format   |
|----------------------------|------------------------|---|
| PSpectrum                  | "Persistence Spectrum" | Returns the data of the Clear/Write histogram, Trace 2.<br>Depends on <a href="#">FORMat [:DATA]</a> . By default, 1001x600 comma-separated floats in ASCII format. REAL16 and 64 not supported.<br><br>Data is returned in Row-Major order, from top to bottom (i.e. the first 1001 values returned are the top row of the display, from left to right; the last 1001 values returned are the bottom row of the display). Each value is the probability for a specific pixel, as a percentage in range [0.0, 100.0]. |
| HMAXhold                   | "Persistence Spectrum" | Returns the data of the Max Hold histogram, Trace 3.<br>Depends on <a href="#">FORMat [:DATA]</a> . By default, 1001x600 comma-separated floats in ASCII format. REAL16 and 64 not supported.<br><br>Data is returned in Row-Major order, from top to bottom (i.e. the first 1001 values returned are the top row of the display, from left to right; the last 1001 values returned are the bottom row of the display). Each value is the probability for a specific pixel, as a percentage in range [0.0, 100.0].    |

### 13.7.4 Exporting trace results

Trace results can be exported to a file.

For more commands concerning data and results storage see the FSW User Manual.

|  |     |
|--|-----|
| <a href="#">MMEMory:STORe&lt;n&gt;:PSPepectrum</a> ..... | 272 |
| <a href="#">MMEMory:STORe&lt;n&gt;:SPeCtrogram</a> ..... | 273 |
| <a href="#">MMEMory:STORe&lt;n&gt;:TRACe</a> .....       | 274 |
| <a href="#">FORMat:DEXPort:DSEParator</a> .....          | 274 |
| <a href="#">FORMat:DEXPort:HEADer</a> .....              | 275 |
| <a href="#">FORMat:DEXPort:TRACes</a> .....              | 275 |

---

#### **MMEMory:STORe<n>:PSPepectrum <FileName>**

Exports persistence spectrum data to an ASCII file.

The file contains the most recently determined percentage value for each pixel in the persistence spectrum, that is, for 1001 frequency and 600 power values, followed by the 1001\*600 maxhold percentages.

For details see [Table A-2](#).

Note that, due to the large amount of data involved, the process of exporting the data can take a while.

#### **Secure User Mode**

In secure user mode, settings that are stored on the instrument are stored to volatile memory, which is restricted to 256 MB. Thus, a "memory limit reached" error can occur although the hard disk indicates that storage space is still available.



To store data permanently, select an external storage location such as a USB memory device.

For details, see "Protecting Data Using the Secure User Mode" in the "Data Management" section of the FSW base unit user manual.

**Suffix:**

<n> [Window](#)

**Parameters:**

<FileName> String containing the path and name of the target file.

**Example:**

MMEM:STOR:PSP 'C:\PersistentSpectrum'

Copies the persistent spectrum data to a file.

**Example:**

See [Chapter 13.12.3, "Example 3: analyzing persistency"](#), on page 348.

**Manual operation:** See "[Persistence Spectrum](#)" on page 31

**MMEMory:STORe<n>:SPEctrogram <FileName>**

Exports spectrogram data to an ASCII file.

The file contains the data for every frame in the history buffer. The data corresponding to a particular frame begins with information about the frame number and the time that frame was recorded.

Note that, depending on the size of the history buffer, the process of exporting the data can take a while.

**Secure User Mode**

In secure user mode, settings that are stored on the instrument are stored to volatile memory, which is restricted to 256 MB. Thus, a "memory limit reached" error can occur although the hard disk indicates that storage space is still available.

To store data permanently, select an external storage location such as a USB memory device.

For details, see "Protecting Data Using the Secure User Mode" in the "Data Management" section of the FSW base unit user manual.

**Suffix:**

<n> [Window](#)

**Parameters:**

<FileName> String containing the path and name of the target file.

**Example:**

MMEM:STOR:SGR 'Spectrogram'

Copies the spectrogram data to a file.

**Example:**

See [Chapter 13.12.2, "Example 2: performing a basic real-time measurement"](#), on page 345.

**Example:**

See [Chapter 13.12.4, "Example 4: obtaining time domain results in real-time"](#), on page 351

**Manual operation:** See ["Spectrogram"](#) on page 29  
See ["3-D Spectrogram"](#) on page 30

---

### MMEMory:STORe<n>:TRACe <Trace>, <FileName>

Exports trace data from the specified window to an ASCII file.

#### Secure User Mode

In secure user mode, settings that are stored on the instrument are stored to volatile memory, which is restricted to 256 MB. Thus, a "memory limit reached" error can occur although the hard disk indicates that storage space is still available.

To store data permanently, select an external storage location such as a USB memory device.

For details, see "Protecting Data Using the Secure User Mode" in the "Data Management" section of the FSW base unit user manual.

#### Suffix:

<n> [Window](#)

#### Parameters:

<Trace> Number of the trace to be stored

<FileName> String containing the path and name of the target file.

#### Example:

```
MMEM:STOR1:TRAC 1, 'C:\TEST.ASC'
```

Stores trace 1 from window 1 in the file TEST.ASC.

#### Example:

See [Chapter 13.12.4, "Example 4: obtaining time domain results in real-time"](#), on page 351

#### Manual operation:

See ["Real-Time Spectrum"](#) on page 28

See ["Power vs. Time"](#) on page 33

See ["Export Trace to ASCII File"](#) on page 128

---

### FORMat:DEXPort:DSEParator <Separator>

Selects the decimal separator for data exported in ASCII format.

#### Parameters:

<Separator> POINT | COMMa

#### COMMa

Uses a comma as decimal separator, e.g. 4,05.

#### POINT

Uses a point as decimal separator, e.g. 4.05.

\*RST: \*RST has no effect on the decimal separator.  
Default is POINT.

#### Example:

```
FORM:DEXP:DSEP POIN
```

Sets the decimal point as separator.

#### Manual operation:

See ["Decimal Separator"](#) on page 128

**FORMat:DEXPort:HEADer** <State>

If enabled, additional instrument and measurement settings are included in the header of the export file for result data. If disabled, only the pure result data from the selected traces and tables is exported.

**Parameters:**

<State> ON | OFF | 0 | 1  
\*RST: 1

**Manual operation:** See ["Include Instrument & Measurement Settings"](#) on page 127

**FORMat:DEXPort:TRACes** <Selection>

Selects the data to be included in a data export file (see [MMEMory:STORe<n>:TRACe](#) on page 274).

**Parameters:**

<Selection> SINGle | ALL

**SINGle**

Only a single trace is selected for export, namely the one specified by the [MMEMory:STORe<n>:TRACe](#) command.

**ALL**

Selects all active traces and result tables (e.g. "Result Summary", marker peak list etc.) in the current application for export to an ASCII file.

The <trace> parameter for the [MMEMory:STORe<n>:TRACe](#) command is ignored.

\*RST: SINGle

**Manual operation:** See ["Export all Traces and all Table Results"](#) on page 127

### 13.7.5 Retrieving trace I/Q data

As opposed to retrieving only the y-values of a trace, the I/Q data of an evaluated trace can also be retrieved.

|   |     |
|---|-----|
| <a href="#">[SENSe:]IQ:FFT:LENGth</a> ..... | 275 |
| <a href="#">TRACe:IQ:BWIDth</a> .....       | 276 |
| <a href="#">TRACe:IQ:DATA:FORMat</a> .....  | 276 |
| <a href="#">TRACe:IQ:DATA:MEMory?</a> ..... | 276 |
| <a href="#">TRACe:IQ:RLENGth</a> .....      | 277 |
| <a href="#">TRACe:IQ:SRATe</a> .....        | 278 |
| <a href="#">TRACe:IQ:TPISample?</a> .....   | 278 |

**[SENSe:]IQ:FFT:LENGth** <NoOfBins>

Defines the number of frequency points determined by each FFT calculation. The more points are used, the higher the resolution in the spectrum becomes, but the longer the calculation takes.

**Parameters:**

<NoOfBins> integer value  
 Range: 3 to 524288  
 \*RST: 4096

**Example:** IQ:FFT:LENG 2048

**TRACe:IQ:BWIDth**

Defines or queries the bandwidth of the resampling filter.

The bandwidth of the resampling filter depends on the sample rate.

**Parameters:**

<Bandwidth> Default unit: HZ

**TRACe:IQ:DATA:FORMat <Format>**

Selects the order of the I/Q data.

**Parameters:**

<Format> COMPAtible | IQBLock | IQPair

**COMPAtible**

I and Q values are separated and collected in blocks: A block (512k) of I values is followed by a block (512k) of Q values, followed by a block of I values, followed by a block of Q values etc. (I,I,I,I,Q,Q,Q,Q,I,I,I,I,Q,Q,Q,Q...)

**IQBLock**

First all I-values are listed, then the Q-values (I,I,I,I,I,...Q,Q,Q,Q,Q,Q)

**IQPair**

One pair of I/Q values after the other is listed (I,Q,I,Q,I,Q...).

\*RST: IQBL

**TRACe:IQ:DATA:MEMory? [<OffsetSamples>,<NoOfSamples>]**

Queries the I/Q data currently stored in the capture buffer of the FSW.

By default, the command returns all I/Q data in the memory. You can, however, narrow down the amount of data that the command returns using the optional parameters.

If no parameters are specified with the command, the entire trace data is retrieved.

The command returns a comma-separated list of the measured values in floating point format (comma-separated values = CSV). The number of values returned is 2 \* the number of complex samples.

The total number of complex samples is displayed in the channel bar in manual operation and can be calculated as:

<SampleRate> \* <CaptureTime>

**Query parameters:**

<OffsetSamples> Selects an offset at which the output of data should start in relation to the first data. If omitted, all captured samples are output, starting with the first sample.

Range: 0 to <# of samples> – 1, with <# of samples> being the maximum number of captured values

\*RST: 0

<NoOfSamples> Number of samples you want to query, beginning at the offset you have defined. If omitted, all captured samples (starting at offset) are output.

Range: 1 to <# of samples> - <offset samples> with <# of samples> maximum number of captured values

\*RST: <# of samples>

**Return values:**

<IQData> Measured value pair (I,Q) for each sample that has been recorded.

By default, the first half of the list contains the I values, the second half the Q values. The order can be configured using

[TRACe:IQ:DATA:FORMat](#).

The data format of the individual values depends on [FORMat \[ : DATA\]](#) on page 268.

Default unit: V

**Example:**

```
// Perform a single I/Q capture.
INIT; *WAI
// Determine output format (binary float32)
FORMat REAL, 32
// Read 1024 I/Q samples starting at sample 2048.
TRAC: IQ: DATA: MEM? 2048, 1024
```

**Usage:**

Query only

**TRACe:IQ:RLENgth** <NoOfSamples>

Sets the record length for the acquired I/Q data.

Increasing the record length also increases the measurement time.

**Note:** Alternatively, you can define the measurement time using the [SENS: SWE: TIME](#) command.

**Parameters:**

<NoOfSamples> Number of samples to record.

\*RST: 1001

**Example:**

```
TRAC: IQ: RLEN 256
```

**TRACe:IQ:SRATe** <SampleRate>

Queries the final user sample rate for the acquired I/Q data.

**Parameters:**

<SampleRate> The valid sample rates depend on the used span.  
Default unit: HZ

**Example:** TRAC : IQ : SRAT ?

**TRACe:IQ:TPISample?**

Queries the time offset from the sample start to the trigger event (trigger point in sample = TPIS). Since the FSW usually samples with a much higher sample rate than the specific application actually requires, the trigger point determined internally is much more precise than the one determined from the (downsampled) data in the application. Thus, the TPIS indicates the offset from the sample start to the actual trigger event.

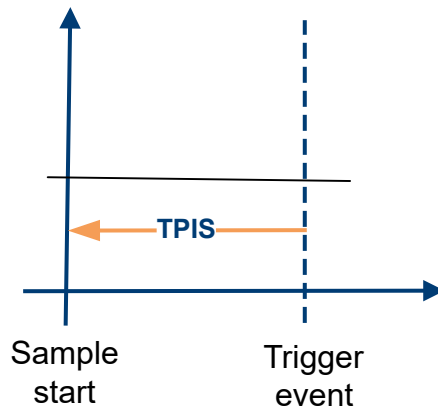

This value can only be determined in triggered measurements using external or IFPower triggers, otherwise the value is 0.

Is not available if the "Digital Baseband" interface (FSW-B17) is active.

**Return values:**

<TPIS> numeric value  
Default unit: s

**Example:**

TRAC : IQ : TPIS ?  
Result for a sample rate of 1 MHz: between 0 and 1/1 MHz, i.e. between 0 and 1  $\mu$ s (the duration of 1 sample).

**Usage:** Query only

### 13.7.6 Exporting (raw) I/Q data

For information on exporting I/Q data see [Chapter 10, "I/Q data export"](#), on page 161.

|                                  |     |
|----------------------------------|-----|
| MMEMory:STORe<n>:IQ:COMMeNt..... | 279 |
| MMEMory:STORe<n>:IQ:FORMat.....  | 279 |
| MMEMory:STORe<n>:IQ:STATe.....   | 279 |

---

**MMEMory:STORe<n>:IQ:COMMeNt <Comment>**

Adds a comment to a file that contains I/Q data.

**Suffix:**

<n> irrelevant

**Parameters:**

<Comment> String containing the comment.

**Example:**

```
MMEM:STOR:IQ:COMM 'Device test 1b'
Creates a description for the export file.
MMEM:STOR:IQ:STAT 1, 'C:
\R_S\Instr\user\data.iq.tar'
Stores I/Q data and the comment to the specified file.
```

**Manual operation:** See "[I/Q Export](#)" on page 162

---

**MMEMory:STORe<n>:IQ:FORMat <Format>,<DataFormat>**

Sets or queries the format of the I/Q data to be stored.

**Suffix:**

<n> irrelevant

**Parameters:**

<Format> **FLOat32**  
32-bit floating point format.

**INT32**  
32-bit integer format.

\*RST: FLOat32

<DataFormat> **COMPLex**  
Exports complex data.

**REAL**  
Exports real data.

\*RST: COMPLex

**Example:** MMEM:STOR:IQ:FORM INT32,REAL

---

**MMEMory:STORe<n>:IQ:STATe <1>, <FileName>**

Writes the captured I/Q data to a file.

By default, the contents of the file are in 32-bit floating point format.

**Suffix:**

<n> 1..n

**Parameters:**

&lt;1&gt;

<FileName> String containing the path and name of the target file.  
The file type is determined by the file extension. If no file extension is provided, the file type is assumed to be `.iq.tar`.  
For `.mat` files, Matlab® v4 is assumed.

**Example:**

```
MMEM:STOR:IQ:STAT 1, 'C:
\R_S\Instr\user\data.iq.tar'
```

Stores the captured I/Q data to the specified file.

**Usage:**

Asynchronous command

**Manual operation:** See "[I/Q Export](#)" on page 162

## 13.8 Analyzing results

The following remote commands are required to configure general result analysis settings concerning the trace, markers, lines etc. in a remote environment.

More details are described for manual operation in [Chapter 9, "Analysis"](#), on page 116.

- [Configuring traces](#).....280
- [Using trace mathematics](#).....285
- [Working with markers remotely](#).....287
- [Configuring display lines](#).....314
- [Defining limit checks](#).....317
- [Zooming into the display](#).....333

### 13.8.1 Configuring traces

#### Useful commands for trace configuration described elsewhere

- `DISPlay[:WINDow<n>][:SUBWindow<w>]:TRACe<t>:Y:SPACing`  
on page 219
- `DISPlay[:WINDow<n>][:SUBWindow<w>]:TRACe<t>:Y[:SCALe]`  
on page 217
- [Chapter 13.7.4, "Exporting trace results"](#), on page 272

#### Remote commands exclusive to trace configuration

|   |     |
|---|-----|
| <code>DISPlay[:WINDow&lt;n&gt;][:SUBWindow&lt;w&gt;]:TRACe&lt;t&gt;:MODE</code> .....               | 281 |
| <code>DISPlay[:WINDow&lt;n&gt;][:SUBWindow&lt;w&gt;]:TRACe&lt;t&gt;:MODE:HCONTinuous</code> .....   | 281 |
| <code>DISPlay[:WINDow&lt;n&gt;][:SUBWindow&lt;w&gt;]:TRACe&lt;t&gt;[:STATe]</code> .....            | 282 |
| <code>DISPlay[:WINDow&lt;n&gt;][:SUBWindow&lt;w&gt;]:TRACe&lt;t&gt;:SMOothing:APERture</code> ..... | 282 |
| <code>DISPlay[:WINDow&lt;n&gt;][:SUBWindow&lt;w&gt;]:TRACe&lt;t&gt;:SMOothing[:STATe]</code> .....  | 283 |
| <code>[SENSe:]AVERAge&lt;n&gt;:COUNT</code> .....   | 283 |



|  |     |
|--|-----|
| [SENSe:]AVERAge<n>[:STATe<t>].....           | 284 |
| [SENSe:][WINDow:]DETEctor<t>[:FUNCTion]..... | 284 |
| TRACe<n>:COPY.....                           | 284 |

---

**DISPlay[:WINDow<n>][:SUBWindow<w>]:TRACe<t>:MODE <Mode>**

Selects the trace mode. If necessary, the selected trace is also activated.

For max hold, min hold or average trace mode, you can set the number of single measurements with [SENSe:]SWEep:COUNT. Note that synchronization to the end of the measurement is possible only in single sweep mode.

**Suffix:**

|     |  |
|-----|--|
| <n> | Window   |
| <w> | subwindow<br>Not supported by all applications |
| <t> | Trace  |

**Parameters:**

|        |   |
|--------|---|
| <Mode> | <b>WRITE</b><br>(default:) Overwrite mode: the trace is overwritten by each sweep.  |
|        | <b>MAXHold</b><br>The maximum value is determined over several sweeps and displayed. The FSW saves the sweep result in the trace memory only if the new value is greater than the previous one.     |
|        | <b>MINHold</b><br>The minimum value is determined from several measurements and displayed. The FSW saves the sweep result in the trace memory only if the new value is lower than the previous one. |
|        | <b>BLANK</b><br>Hides the selected trace.<br>*RST: Trace 1: WRITE, Trace 2-6: BLANK   |

**Example:**

```
INIT:CONT OFF
Switching to single sweep mode.
SWE:COUN 16
Sets the number of measurements to 16.
DISP:TRAC3:MODE WRIT
Selects clear/write mode for trace 3.
INIT;*WAI
Starts the measurement and waits for the end of the measurement.
```

**Manual operation:** See "Mode" on page 124

---

**DISPlay[:WINDow<n>][:SUBWindow<w>]:TRACe<t>:MODE:HCONTinuous  
<State>**

Turns an automatic reset of a trace on and off after a parameter has changed.

The reset works for trace modes min hold, max hold and average.

Note that the command has no effect if critical parameters like the span have been changed to avoid invalid measurement results

**Suffix:**

<n>                    [Window](#)  
 <w>                    subwindow  
 <t>                    [Trace](#)

**Parameters:**

<State>                ON | OFF | 0 | 1  
                           **OFF | 0**  
                           Switches the function off  
                           **ON | 1**  
                           Switches the function on

**Example:**            DISP:WIND:TRAC3:MODE:HCON ON  
 Switches off the reset function.

**Manual operation:** See "[Hold](#)" on page 125

**DISPlay[:WINDow<n>][:SUBWindow<w>]:TRACe<t>[:STATE] <State>**

Turns a trace on and off.

The measurement continues in the background.

**Suffix:**

<n>                    [Window](#)  
 <w>                    subwindow  
                           Not supported by all applications  
 <t>                    [Trace](#)

**Parameters:**

<State>                ON | OFF | 0 | 1  
                           **OFF | 0**  
                           Switches the function off  
                           **ON | 1**  
                           Switches the function on

**Example:**            DISP:TRAC3 ON

**Manual operation:** See "[Trace 1/Trace 2/Trace 3/Trace 4](#)" on page 124  
 See "[Trace 1/ Trace 2/ Trace 3/ Trace 4 \(Softkeys\)](#)" on page 126

**DISPlay[:WINDow<n>][:SUBWindow<w>]:TRACe<t>:SMOothing:APERture  
 <Aperture>**

Defines the degree (aperture) of the trace smoothing, if `DISPlay[:WINDow<n>][:SUBWindow<w>]:TRACe<t>:SMOothing[:STATE]TRUE`.

**Suffix:**

<n> [Window](#)

<w> subwindow

<t> [Trace](#)

**Parameters:**

<Aperture> Range: 1 to 50  
\*RST: 2  
Default unit: PCT

**Example:**

DISP3:TRAC2:SMO:APER 5  
Defines an aperture of 5% for trace 2 in window 3

**Manual operation:** See "[Smoothing](#)" on page 126

**DISPlay[:WINDow<n>][:SUBWindow<w>]:TRACe<t>:SMOothing[:STATe] <State>**

Turns trace smoothing for a particular trace on and off.

If enabled, the trace is smoothed by the value specified using [DISPlay\[:WINDow<n>\]\[:SUBWindow<w>\]:TRACe<t>:SMOothing:APERture](#) on page 282.

**Suffix:**

<n> [Window](#)

<w> subwindow

<t> [Trace](#)

**Parameters:**

<State> ON | OFF | 0 | 1  
**OFF | 0**  
Switches the function off  
**ON | 1**  
Switches the function on

**Example:**

DISP3:TRAC2:SMO ON  
Turns on trace smoothing for trace 2 in window 3

**Manual operation:** See "[Smoothing](#)" on page 126

**[SENSe:]AVERage<n>:COUNT <AverageCount>**

Defines the number of measurements that the application uses to average traces.

In case of continuous sweep mode, the application calculates the moving average over the average count.

In case of single sweep mode, the application stops the measurement and calculates the average after the average count has been reached.

**Suffix:**

<n> irrelevant

**Manual operation:** See ["Average Count"](#) on page 126

---

**[SENSe:]AVERAge<n>[:STATe<t>] <State>**

Turns averaging for a particular trace in a particular window on and off.

**Suffix:**

<n> [Window](#)

<t> [Trace](#)

**Parameters:**

<State> ON | OFF | 1 | 0

---

**[SENSe:][WINDow:]DETEctor<t>[:FUNctIon] <Detector>**

Defines the trace detector to be used for trace analysis.

For details see [Chapter 6.3, "Sweep time and detector"](#), on page 41.

**Parameters:**

<Detector>      **NEGative**  
 Negative peak

**POSitive**  
 Positive peak

**SAMPlE**  
 First value detected per trace point

**AVERAge**  
 Average

\*RST:            POS

**Example:**            DET POS  
 Sets the detector to "positive peak".

**Manual operation:** See ["Detector"](#) on page 125

---

**TRACe<n>:COpy <TraceNumber>, <TraceNumber>**

Copies data from one trace to another.

**Suffix:**

<n> [Window](#)

**Parameters:**

<TraceNumber>    **TRACE1 | TRACE2 | TRACE3 | TRACE4**  
 The first parameter is the destination trace, the second parameter is the source.  
 (Note the 'e' in the parameter is required!)

**Example:**            TRAC:COpy TRACE1, TRACE2  
 Copies the data from trace 2 to trace 1.

**Manual operation:** See ["Copy Trace"](#) on page 126

## 13.8.2 Using trace mathematics

The following commands control trace mathematics.

|   |     |
|---|-----|
| CALCulate<n>:MATH<t>[:EXPRession][:DEFine]..... | 285 |
| CALCulate<n>:MATH<t>:MODE.....                  | 285 |
| CALCulate<n>:MATH<t>:POSition.....              | 286 |
| CALCulate<n>:MATH<t>:STATe.....                 | 286 |

---

### CALCulate<n>:MATH<t>[:EXPRession][:DEFine] <Expression>

Selects the mathematical expression for trace mathematics.

Before you can use the command, you have to turn trace mathematics on.

#### Suffix:

|     |                        |
|-----|------------------------|
| <n> | <a href="#">Window</a> |
| <t> | irrelevant             |

#### Parameters:

|              |   |
|--------------|---|
| <Expression> | <b>(TRACE1-TRACE2)</b><br>Subtracts trace 2 from trace 1. |
|              | <b>(TRACE1-TRACE3)</b><br>Subtracts trace 3 from trace 1. |
|              | <b>(TRACE1-TRACE4)</b><br>Subtracts trace 4 from trace 1. |

#### Example:

```
CALC:MATH:STAT ON
Turns trace mathematics on.
CALC:MATH:EXPR:DEF (TRACE1-TRACE3)
Subtracts trace 3 from trace 1.
```

**Manual operation:** See "[Trace Math Function](#)" on page 129

---

### CALCulate<n>:MATH<t>:MODE <Mode>

Selects the way the FSW calculates trace mathematics.

#### Suffix:

|     |                        |
|-----|------------------------|
| <n> | <a href="#">Window</a> |
| <t> | irrelevant             |

#### Parameters:

<Mode> For more information on the way each mode works see [Trace Math Mode](#).

#### **LINear**

Linear calculation.

#### **LOGarithmic**

Logarithmic calculation.

#### **POWer**

Linear power calculation.

\*RST: LOGarithmic

**Example:** CALC:MATH:MODE LIN  
Selects linear calculation.

**Manual operation:** See ["Trace Math Mode"](#) on page 129

### CALCulate<n>:MATH<t>:POSition <Position>

Defines the position of the trace resulting from the mathematical operation.

**Suffix:**

<n> [Window](#)

<t> irrelevant

**Parameters:**

<Position> Vertical position of the trace in % of the height of the diagram area.

100 PCT corresponds to the upper diagram border.

Range: -100 to 200

\*RST: 50

Default unit: PCT

**Example:** CALC:MATH:POS 100  
Moves the trace to the top of the diagram area.

**Manual operation:** See ["Trace Math Position"](#) on page 129

### CALCulate<n>:MATH<t>:STATe <State>

Turns the trace mathematics on and off.

**Suffix:**

<n> [Window](#)

<t> irrelevant

**Parameters:**

<State> ON | OFF | 0 | 1

**OFF | 0**

Switches the function off

**ON | 1**

Switches the function on

**Example:** CALC:MATH:STAT ON  
Turns on trace mathematics.

**Manual operation:** See ["Trace Math Function"](#) on page 129  
See ["Trace Math Off"](#) on page 129

### 13.8.3 Working with markers remotely

In the "Real-Time Spectrum" application, up to 16 markers or delta markers can be activated for each window simultaneously.

For more details see [Chapter 6.5.2, "Markers in the spectrogram"](#), on page 53.

- [Setting up individual markers](#).....287
- [General marker settings](#).....292
- [Configuring and performing a marker search](#).....295
- [Positioning the marker](#)..... 300
- [Marker search \(spectrograms\)](#)..... 305

#### 13.8.3.1 Setting up individual markers

The following commands define the position of markers in the diagram.

|  |     |
|--|-----|
| <a href="#">CALCulate&lt;n&gt;:MARKer&lt;m&gt;:AOFF</a> .....            | 287 |
| <a href="#">CALCulate&lt;n&gt;:MARKer&lt;m&gt;[:STATE]</a> .....         | 287 |
| <a href="#">CALCulate&lt;n&gt;:MARKer&lt;m&gt;:TRACe</a> .....           | 288 |
| <a href="#">CALCulate&lt;n&gt;:MARKer&lt;m&gt;:X</a> .....               | 288 |
| <a href="#">CALCulate&lt;n&gt;:MARKer&lt;m&gt;:Y</a> .....               | 289 |
| <a href="#">CALCulate&lt;n&gt;:MARKer&lt;m&gt;:Y?</a> .....              | 289 |
| <a href="#">CALCulate&lt;n&gt;:DELTaMarker&lt;m&gt;:AOFF</a> .....       | 289 |
| <a href="#">CALCulate&lt;n&gt;:DELTaMarker&lt;m&gt;:LINK</a> .....       | 289 |
| <a href="#">CALCulate&lt;n&gt;:DELTaMarker&lt;m&gt;:MODE</a> .....       | 290 |
| <a href="#">CALCulate&lt;n&gt;:DELTaMarker&lt;m&gt;:MREFerence</a> ..... | 290 |
| <a href="#">CALCulate&lt;n&gt;:DELTaMarker&lt;m&gt;[:STATE]</a> .....    | 291 |
| <a href="#">CALCulate&lt;n&gt;:DELTaMarker&lt;m&gt;:TRACe</a> .....      | 291 |
| <a href="#">CALCulate&lt;n&gt;:DELTaMarker&lt;m&gt;:X</a> .....          | 291 |
| <a href="#">CALCulate&lt;n&gt;:DELTaMarker&lt;m&gt;:Y</a> .....          | 292 |
| <a href="#">CALCulate&lt;n&gt;:DELTaMarker&lt;m&gt;:Y?</a> .....         | 292 |

---

#### **CALCulate<n>:MARKer<m>:AOFF**

Turns off all markers.

##### **Suffix:**

<n>                      [Window](#)

<m>                      [Marker](#)

##### **Example:**

CALC:MARK:AOFF

Switches off all markers.

**Manual operation:** See ["All Markers Off"](#) on page 133

---

#### **CALCulate<n>:MARKer<m>[:STATE] <State>**

Turns markers on and off. If the corresponding marker number is currently active as a delta marker, it is turned into a normal marker.

**Suffix:**<n> [Window](#)<m> [Marker](#)**Parameters:**

&lt;State&gt; ON | OFF | 0 | 1

**OFF | 0**

Switches the function off

**ON | 1**

Switches the function on

**Example:**

CALC:MARK3 ON

Switches on marker 3.

**Manual operation:**See "[Marker State](#)" on page 131See "[Marker Type](#)" on page 132See "[Select Marker](#)" on page 133**CALCulate<n>:MARKer<m>:TRACe <Trace>**

Selects the trace the marker is positioned on.

Note that the corresponding trace must have a trace mode other than "Blank".

If necessary, the command activates the marker first.

**Suffix:**<n> [Window](#)<m> [Marker](#)**Parameters:**<Trace> **1 to 4**

Trace number the marker is assigned to.

**MAXHold**Marker is assigned to maxhold trace of persistent spectrum  
(only available in Persistent Spectrum window)**WRITe**Marker is assigned to clear/write trace of persistent spectrum  
(only available in Persistent Spectrum window)**Example:**

//Assign marker to trace 1

CALC:MARK3:TRAC 2

**Manual operation:**See "[Assigning the Marker to a Trace](#)" on page 133**CALCulate<n>:MARKer<m>:X <Position>**

Moves a marker to a specific coordinate on the x-axis.

If necessary, the command activates the marker.



If the marker has been used as a delta marker, the command turns it into a normal marker.

**Suffix:**

<n> [Window](#)

<m> [Marker](#)

**Parameters:**

<Position> Numeric value that defines the marker position on the x-axis.  
The unit depends on the result display.

Range: The range depends on the current x-axis range.  
Default unit: Hz

**Example:**

CALC:MARK2:X 1.7MHz

Positions marker 2 to frequency 1.7 MHz.

**Manual operation:**

See "[Marker Table](#)" on page 36

See "[Marker Position X-value](#)" on page 132

**CALCulate<n>:MARKer<m>:Y <Position>**

**CALCulate<n>:MARKer<m>:Y?**

Queries the result at the position of the specified marker.

**Suffix:**

<n> 1..n

<m> 1..n

**Return values:**

<Result> Default unit: DBM

**Usage:**

Query only

**Manual operation:**

See "[Marker Table](#)" on page 36

See "[Marker Level \(Y-value\)](#)" on page 132

**CALCulate<n>:DELTamarker<m>:AOFF**

Turns off *all* delta markers.

**Suffix:**

<n> [Window](#)

<m> irrelevant

**Example:**

CALC:DELT:AOFF

Turns off all delta markers.

**CALCulate<n>:DELTamarker<m>:LINK <State>**

Links delta marker <m> to marker 1.

If you change the horizontal position (x-value) of marker 1, delta marker <m> changes its horizontal position to the same value.

**Suffix:**

<n> [Window](#)

<m> [Marker](#)

**Parameters:**

<State> ON | OFF | 0 | 1

**OFF | 0**

Switches the function off

**ON | 1**

Switches the function on

**Example:**

CALC:DELT2:LINK ON

**CALCulate<n>:DELTamarker<m>:MODE <Mode>**

Defines whether the position of a delta marker is provided as an absolute value or relative to a reference marker. Note that this setting applies to *all* windows.

Note that when the position of a delta marker is *queried*, the result is always an absolute value (see [CALCulate<n>:DELTamarker<m>:X](#) on page 291)!

**Suffix:**

<n> irrelevant

<m> irrelevant

**Parameters:**

<Mode>

**ABSolute**

Delta marker position in absolute terms.

**RELative**

Delta marker position in relation to a reference marker.

\*RST: RELative

**Example:**

CALC:DELT:MODE ABS

Absolute delta marker position.

**CALCulate<n>:DELTamarker<m>:MREFerence <Reference>**

Selects a reference marker for a delta marker other than marker 1.

**Suffix:**

<n> [Window](#)

<m> [Marker](#)

**Parameters:**

<Reference>

**Example:** `CALC:DELT3:MREF 2`  
Specifies that the values of delta marker 3 are relative to marker 2.

**Manual operation:** See ["Reference Marker"](#) on page 132

### **CALCulate<n>:DELTamarker<m>[:STATe] <State>**

Turns delta markers on and off.

If necessary, the command activates the delta marker first.

No suffix at DELTmarker turns on delta marker 1.

**Suffix:**

<n> [Window](#)

<m> [Marker](#)

**Parameters:**

<State> ON | OFF | 0 | 1

**OFF | 0**

Switches the function off

**ON | 1**

Switches the function on

**Example:** `CALC:DELT2 ON`  
Turns on delta marker 2.

**Manual operation:** See ["Marker State"](#) on page 131  
See ["Marker Type"](#) on page 132  
See ["Select Marker"](#) on page 133

### **CALCulate<n>:DELTamarker<m>:TRACe <Trace>**

Selects the trace a delta marker is positioned on.

Note that the corresponding trace must have a trace mode other than "Blank".

If necessary, the command activates the marker first.

**Suffix:**

<n> [Window](#)

<m> [Marker](#)

**Parameters:**

<Trace> Trace number the marker is assigned to.

**Example:** `CALC:DELT2:TRAC 2`  
Positions delta marker 2 on trace 2.

### **CALCulate<n>:DELTamarker<m>:X <Position>**

Moves a delta marker to a particular coordinate on the x-axis.

If necessary, the command activates the delta marker and positions a reference marker to the peak power.

**Suffix:**

<n> [Window](#)

<m> [Marker](#)

**Example:**

CALC:DELT:X?

Outputs the absolute x-value of delta marker 1.

**Manual operation:** See "[Marker Position X-value](#)" on page 132

**CALCulate<n>:DELTaMarker<m>:Y <Position>**

**CALCulate<n>:DELTaMarker<m>:Y?**

Queries the result at the position of the specified delta marker.

**Suffix:**

<n> 1..n

<m> 1..n

**Return values:**

<Result> Result at the position of the delta marker.  
The unit is variable and depends on the one you have currently set.  
Default unit: DBM

**Usage:** Query only

**Manual operation:** See "[Marker Level \(Y-value\)](#)" on page 132

### 13.8.3.2 General marker settings

The following commands control general marker functionality.

|  |     |
|--|-----|
| CALCulate<n>:DELTaMarker<m>:FUNCTION:FIXed[:STATE]               | 292 |
| CALCulate<n>:DELTaMarker<m>:FUNCTION:FIXed:RPOint:MAXimum[:PEAK] | 293 |
| CALCulate<n>:DELTaMarker<m>:FUNCTION:FIXed:RPOint:X              | 293 |
| CALCulate<n>:DELTaMarker<m>:FUNCTION:FIXed:RPOint:Y              | 294 |
| CALCulate<n>:MARKer<m>:X:SSize                                   | 294 |
| DISPlay[:WINDow<n>]:MINFo[:STATE]                                | 295 |
| DISPlay[:WINDow<n>]:MTABLE                                       | 295 |

**CALCulate<n>:DELTaMarker<m>:FUNCTION:FIXed[:STATE] <State>**

Activates or deactivates a marker that defines a fixed reference point for relative marker analysis.

If necessary, the command activates a marker and positions it on the peak power.

Subsequently, you can change the coordinates of the fixed reference independent of the marker. The fixed reference is independent of the trace and is applied to all active delta markers.

**Suffix:**<n> [Window](#)<m> [Marker](#)**Parameters:**

&lt;State&gt; ON | OFF | 0 | 1

**OFF | 0**

Switches the function off

**ON | 1**

Switches the function on

**Example:**

CALC:DELT:FUNC:FIX ON

Switches on the measurement with fixed reference value for all delta markers.

CALC:DELT:FUNC:FIX:RPO:X 128 MHZ

Sets the frequency reference to 128 MHz.

CALC:DELT:FUNC:FIX:RPO:Y 30 DBM

Sets the reference level to +30 dBm.

**Manual operation:** See ["Defining a Fixed Reference"](#) on page 135**CALCulate<n>:DELTaMarker<m>:FUNctioN:FIXed:RPOint:MAXimum[:PEAK]**

Moves the fixed reference marker to the peak power.

**Suffix:**<n> [Window](#)<m> [Marker](#)**Example:**

CALC:DELT:FUNC:FIX:RPO:MAX

Sets the reference point level for delta markers to the peak of the selected trace.

**Manual operation:** See ["Defining a Fixed Reference"](#) on page 135**CALCulate<n>:DELTaMarker<m>:FUNctioN:FIXed:RPOint:X <RefPoint>**

Defines the horizontal position of the fixed delta marker reference point. The coordinates of the reference may be anywhere in the diagram.

**Suffix:**<n> [Window](#)<m> [Marker](#)**Parameters:**

&lt;RefPoint&gt; Numeric value that defines the horizontal position of the reference.

For frequency domain measurements, it is a frequency in Hz.

For time domain measurements, it is a point in time in s.

\*RST: Fixed Reference: OFF

Default unit: HZ

**Example:** `CALC:DELTA:FUNC:FIX:RPO:X 128 MHz`  
Sets the frequency reference to 128 MHz.

**Manual operation:** See ["Defining a Fixed Reference"](#) on page 135

**CALCulate<n>:DELTAmarker<m>:FUNCTION:FIXed:RPOint:Y <RefPointLevel>**

Defines the vertical position of the fixed delta marker reference point. The coordinates of the reference may be anywhere in the diagram.

**Suffix:**

<n> [Window](#)

<m> [Marker](#)

**Parameters:**

<RefPoint> Numeric value that defines the vertical position of the reference. The unit and value range is variable.

\*RST: Fixed Reference: OFF

Default unit: DBM

**Example:** `CALC:DELTA:FUNC:FIX:RPO:Y -10dBm`  
Sets the reference point level for delta markers to -10 dBm.

**Manual operation:** See ["Defining a Fixed Reference"](#) on page 135

**CALCulate<n>:MARKer<m>:X:SSIZE <StepSize>**

Selects the marker step size mode for *all* markers in *all* windows.

The step size defines the distance the marker moves when you move it with the rotary knob.

It therefore takes effect in manual operation only.

**Suffix:**

<n> irrelevant

<m> irrelevant

**Parameters:**

<StepSize> **STANdard**  
the marker moves from one pixel to the next

**POINTs**  
the marker moves from one sweep point to the next

\*RST: POINTs

**Example:** `CALC:MARK:X:SSIZ STAN`  
Sets the marker step size to one pixel.

**Manual operation:** See ["Marker Stepsize"](#) on page 135

**DISPlay[:WINDow<n>]:MINFo[:STATe] <State>**

Turns the marker information in all diagrams on and off.

**Suffix:**

<n> irrelevant

**Parameters:**

<State> **ON | 1**  
Displays the marker information in the diagrams.  
**OFF | 0**  
Hides the marker information in the diagrams.  
\*RST: 1

**Example:** DISP:MINF OFF  
Hides the marker information.

**Manual operation:** See "[Marker Info](#)" on page 135

**DISPlay[:WINDow<n>]:MTABle <DisplayMode>**

Turns the marker table on and off.

**Suffix:**

<n> irrelevant

**Parameters:**

<DisplayMode> **ON | 1**  
Turns on the marker table.  
**OFF | 0**  
Turns off the marker table.  
\*RST: AUTO

**Example:** DISP:MTAB ON  
Activates the marker table.

**Manual operation:** See "[Marker Table Display](#)" on page 134

**13.8.3.3 Configuring and performing a marker search**

The following commands control the marker search.

|  |     |
|--|-----|
| CALCulate<n>:MARKer<m>:LOEXclude.....              | 296 |
| CALCulate<n>:MARKer<m>:MAXimum:AUTO.....           | 296 |
| CALCulate<n>:MARKer<m>:MINimum:AUTO.....           | 296 |
| CALCulate<n>:MARKer<m>:PEXCursion.....             | 297 |
| CALCulate<n>:MARKer<m>:X:SLIMits[:STATe].....      | 297 |
| CALCulate<n>:MARKer<m>:X:SLIMits:LEFT.....         | 298 |
| CALCulate<n>:MARKer<m>:X:SLIMits:RIGHT.....        | 298 |
| CALCulate<n>:MARKer<m>:X:SLIMits:ZOOM[:STATe]..... | 299 |
| CALCulate<n>:THReshold.....                        | 299 |
| CALCulate<n>:THReshold:STATe.....                  | 300 |

**CALCulate<n>:MARKer<m>:LOEXclude <State>**

Turns the suppression of the local oscillator during automatic marker positioning on and off (for *all* markers in *all* windows).

**Suffix:**

<n> irrelevant

<m> irrelevant

**Parameters:**

<State> ON | OFF | 0 | 1

\*RST: 1

**Example:** CALC:MARK:LOEX ON

**Manual operation:** See "[Exclude LO](#)" on page 138

**CALCulate<n>:MARKer<m>:MAXimum:AUTO <State>**

Turns an automatic marker peak search for a trace maximum on and off (using marker 1). The FSW performs the peak search after each sweep.

**Suffix:**

<n> [Window](#)

<m> irrelevant

**Parameters:**

<State> ON | OFF | 0 | 1

**OFF | 0**

Switches the function off

**ON | 1**

Switches the function on

**Example:** CALC:MARK:MAX:AUTO ON

Activates the automatic peak search function for marker 1 at the end of each particular sweep.

**Manual operation:** See "[Auto Max Peak Search / Auto Min Peak Search](#)" on page 139

**CALCulate<n>:MARKer<m>:MINimum:AUTO <State>**

Turns an automatic marker peak search for a trace minimum on and off (using marker 1). The FSW performs the peak search after each sweep.

**Suffix:**

<n> [Window](#)

<m> irrelevant

**Parameters:**

<State> ON | OFF | 0 | 1



**OFF | 0**

Switches the function off

**ON | 1**

Switches the function on

**Example:**

CALC:MARK:MIN:AUTO ON

Activates the automatic minimum value search function for marker 1 at the end of each particular sweep.

**Manual operation:**See ["Auto Max Peak Search / Auto Min Peak Search"](#) on page 139**CALCulate<n>:MARKer<m>:PEXCursion <Excursion>**Defines the peak excursion (for *all* markers in *all* windows).

The peak excursion sets the requirements for a peak to be detected during a peak search.

The unit depends on the measurement.

**Suffix:**

&lt;n&gt; irrelevant

&lt;m&gt; irrelevant

**Parameters:**

&lt;Excursion&gt;

The excursion is the distance to a trace maximum that must be attained before a new maximum is recognized, or the distance to a trace minimum that must be attained before a new minimum is recognized

\*RST: 6.0 dB

**Manual operation:**See ["Peak Excursion"](#) on page 139**CALCulate<n>:MARKer<m>:X:SLIMits[:STATe] <State>**Turns marker search limits on and off for *all* markers in *all* windows.

If you perform a measurement in the time domain, this command limits the range of the trace to be analyzed.

**Suffix:**

&lt;n&gt; irrelevant

&lt;m&gt; irrelevant

**Parameters:**

&lt;State&gt;

ON | OFF | 0 | 1

**OFF | 0**

Switches the function off

**ON | 1**

Switches the function on

**Example:** `CALC:MARK:X:SLIM ON`  
Switches on search limitation.

**Manual operation:** See ["Search Limits \(Left / Right\)"](#) on page 139  
See ["Search Limits Off"](#) on page 139

#### **CALCulate<n>:MARKer<m>:X:SLIMits:LEFT <SearchLimit>**

Defines the left limit of the marker search range for *all* markers in *all* windows.

If you perform a measurement in the time domain, this command limits the range of the trace to be analyzed.

**Suffix:**

<n> irrelevant

<m> irrelevant

**Parameters:**

<SearchLimit> The value range depends on the frequency range or measurement time.

The unit is Hz for frequency domain measurements and s for time domain measurements.

\*RST: left diagram border

Default unit: HZ

**Example:** `CALC:MARK:X:SLIM ON`  
Switches the search limit function on.  
`CALC:MARK:X:SLIM:LEFT 10MHz`  
Sets the left limit of the search range to 10 MHz.

**Manual operation:** See ["Search Limits \(Left / Right\)"](#) on page 139

#### **CALCulate<n>:MARKer<m>:X:SLIMits:RIGHT <SearchLimit>**

Defines the right limit of the marker search range for *all* markers in *all* windows.

If you perform a measurement in the time domain, this command limits the range of the trace to be analyzed.

**Suffix:**

<n> irrelevant

<m> irrelevant

**Parameters:**

<Limit> The value range depends on the frequency range or measurement time.

The unit is Hz for frequency domain measurements and s for time domain measurements.

\*RST: right diagram border

Default unit: HZ

**Example:**            `CALC:MARK:X:SLIM ON`  
 Switches the search limit function on.  
`CALC:MARK:X:SLIM:RIGH 20MHz`  
 Sets the right limit of the search range to 20 MHz.

**Manual operation:** See "[Search Limits \(Left / Right\)](#)" on page 139

### **CALCulate<n>:MARKer<m>:X:SLIMits:ZOOM[:STATe] <State>**

Adjusts the marker search range to the zoom area for *all* markers in *all* windows.

**Suffix:**

<n>                    irrelevant

<m>                    irrelevant

**Parameters:**

<State>              ON | OFF | 0 | 1

**OFF | 0**

Switches the function off

**ON | 1**

Switches the function on

**Example:**            `CALC:MARK:X:SLIM:ZOOM ON`  
 Switches the search limit function on.  
`CALC:MARK:X:SLIM:RIGH 20MHz`  
 Sets the right limit of the search range to 20 MHz.

### **CALCulate<n>:THReshold <Level>**

Defines a threshold level for the marker peak search (for *all* markers in *all* windows).

Note that you must enable the use of the threshold using [CALCulate<n>:THReshold:STATe](#) on page 300.

**Suffix:**

<n>                    irrelevant

**Parameters:**

<Level>              Numeric value. The value range and unit are variable.

\*RST:                -120 dBm

Default unit: DBM

**Example:**            `CALC:THR:STAT ON`

**Example:**            `CALC:THR -82DBM`

Enables the search threshold and sets the threshold value to -82 dBm.

**Manual operation:** See "[Search Threshold](#)" on page 139

**CALCulate<n>:THReshold:STATe <State>**

Turns a threshold for the marker peak search on and off (for *all* markers in *all* windows).

**Suffix:**

<n> irrelevant

**Parameters:**

<State> ON | OFF | 0 | 1  
**OFF | 0**  
 Switches the function off  
**ON | 1**  
 Switches the function on

**Example:**

CALC:THR:STAT ON  
 Switches on the threshold line.

**Manual operation:** See ["Search Threshold"](#) on page 139  
 See ["Search Limits Off"](#) on page 139

**13.8.3.4 Positioning the marker**

The following remote commands are required to position the marker on a trace.

- [Positioning markers](#).....300
- [Positioning delta markers](#).....303

**Positioning markers**

The following commands position markers on the trace.

|  |     |
|--|-----|
| <a href="#">CALCulate&lt;n&gt;:MARKer&lt;m&gt;:FUNCTion:CENTer</a> ..... | 300 |
| <a href="#">CALCulate&lt;n&gt;:MARKer&lt;m&gt;:MAXimum:LEFT</a> .....    | 301 |
| <a href="#">CALCulate&lt;n&gt;:MARKer&lt;m&gt;:MAXimum:NEXT</a> .....    | 301 |
| <a href="#">CALCulate&lt;n&gt;:MARKer&lt;m&gt;:MAXimum[:PEAK]</a> .....  | 301 |
| <a href="#">CALCulate&lt;n&gt;:MARKer&lt;m&gt;:MAXimum:RIGHT</a> .....   | 301 |
| <a href="#">CALCulate&lt;n&gt;:MARKer&lt;m&gt;:MINimum:LEFT</a> .....    | 302 |
| <a href="#">CALCulate&lt;n&gt;:MARKer&lt;m&gt;:MINimum:NEXT</a> .....    | 302 |
| <a href="#">CALCulate&lt;n&gt;:MARKer&lt;m&gt;:MINimum[:PEAK]</a> .....  | 302 |
| <a href="#">CALCulate&lt;n&gt;:MARKer&lt;m&gt;:MINimum:RIGHT</a> .....   | 302 |

**CALCulate<n>:MARKer<m>:FUNCTion:CENTer**

Matches the center frequency to the frequency of a marker.

If you use the command in combination with a delta marker, that delta marker is turned into a normal marker.

**Suffix:**

<n> [Window](#)

<m> [Marker](#)

**Example:**                    `CALC:MARK2:FUNC:CENT`  
Sets the center frequency to the frequency of marker 2.

**Manual operation:**    See "[Center Frequency = Marker Frequency](#)" on page 141

#### **CALCulate<n>:MARKer<m>:MAXimum:LEFT**

Moves a marker to the next positive peak.

The search includes only measurement values to the left of the current marker position.

**Suffix:**

<n>                            [Window](#)

<m>                            [Marker](#)

**Manual operation:**    See "[Search Mode for Next Peak in X Direction](#)" on page 137  
See "[Search Next Peak](#)" on page 140

#### **CALCulate<n>:MARKer<m>:MAXimum:NEXT**

Moves a marker to the next positive peak.

**Suffix:**

<n>                            [Window](#)

<m>                            [Marker](#)

**Manual operation:**    See "[Search Mode for Next Peak in X Direction](#)" on page 137  
See "[Search Next Peak](#)" on page 140

#### **CALCulate<n>:MARKer<m>:MAXimum[:PEAK]**

Moves a marker to the highest level.

If the marker is not yet active, the command first activates the marker.

**Suffix:**

<n>                            [Window](#)

<m>                            [Marker](#)

**Manual operation:**    See "[Marker Search Type](#)" on page 138  
See "[Peak Search](#)" on page 140

#### **CALCulate<n>:MARKer<m>:MAXimum:RIGHT**

Moves a marker to the next positive peak.

The search includes only measurement values to the right of the current marker position.

**Suffix:**

<n>                            [Window](#)

<m> [Marker](#)

**Manual operation:** See ["Search Mode for Next Peak in X Direction"](#) on page 137  
See ["Search Next Peak"](#) on page 140

#### **CALCulate<n>:MARKer<m>:MINimum:LEFT**

Moves a marker to the next minimum peak value.

The search includes only measurement values to the right of the current marker position.

**Suffix:**

<n> [Window](#)

<m> [Marker](#)

**Manual operation:** See ["Search Mode for Next Peak in X Direction"](#) on page 137  
See ["Search Next Minimum"](#) on page 140

#### **CALCulate<n>:MARKer<m>:MINimum:NEXT**

Moves a marker to the next minimum peak value.

**Suffix:**

<n> [Window](#)

<m> [Marker](#)

**Manual operation:** See ["Search Mode for Next Peak in X Direction"](#) on page 137  
See ["Search Next Minimum"](#) on page 140

#### **CALCulate<n>:MARKer<m>:MINimum[:PEAK]**

Moves a marker to the minimum level.

If the marker is not yet active, the command first activates the marker.

**Suffix:**

<n> [Window](#)

<m> [Marker](#)

**Manual operation:** See ["Marker Search Type"](#) on page 138  
See ["Search Minimum"](#) on page 140

#### **CALCulate<n>:MARKer<m>:MINimum:RIGHT**

Moves a marker to the next minimum peak value.

The search includes only measurement values to the right of the current marker position.

**Suffix:**

<n> [Window](#)

<m>                    Marker

**Manual operation:** See "Search Mode for Next Peak in X Direction" on page 137  
See "Search Next Minimum" on page 140

### Positioning delta markers

The following commands position delta markers on the trace.

|   |     |
|---|-----|
| CALCulate<n>:DELTaMarker<m>:MAXimum:LEFT.....   | 303 |
| CALCulate<n>:DELTaMarker<m>:MAXimum:NEXT.....   | 303 |
| CALCulate<n>:DELTaMarker<m>:MAXimum[:PEAK]..... | 303 |
| CALCulate<n>:DELTaMarker<m>:MAXimum:RIGHT.....  | 304 |
| CALCulate<n>:DELTaMarker<m>:MINimum:LEFT.....   | 304 |
| CALCulate<n>:DELTaMarker<m>:MINimum:NEXT.....   | 304 |
| CALCulate<n>:DELTaMarker<m>:MINimum[:PEAK]..... | 304 |
| CALCulate<n>:DELTaMarker<m>:MINimum:RIGHT.....  | 305 |

---

#### CALCulate<n>:DELTaMarker<m>:MAXimum:LEFT

Moves a delta marker to the next positive peak value.

The search includes only measurement values to the left of the current marker position.

**Suffix:**

<n>                    Window

<m>                    Marker

**Manual operation:** See "Search Next Peak" on page 140

---

#### CALCulate<n>:DELTaMarker<m>:MAXimum:NEXT

Moves a marker to the next positive peak value.

**Suffix:**

<n>                    1..n  
Window

<m>                    1..n  
Marker

**Manual operation:** See "Search Next Peak" on page 140

---

#### CALCulate<n>:DELTaMarker<m>:MAXimum[:PEAK]

Moves a delta marker to the highest level.

If the marker is not yet active, the command first activates the marker.

**Suffix:**

<n>                    Window

<m>                    Marker

**Manual operation:** See ["Marker Search Type"](#) on page 138  
See ["Peak Search"](#) on page 140

---

**CALCulate<n>:DELTamarker<m>:MAXimum:RIGHT**

Moves a delta marker to the next positive peak value on the trace.

The search includes only measurement values to the right of the current marker position.

**Suffix:**

<n> [Window](#)

<m> [Marker](#)

**Manual operation:** See ["Search Next Peak"](#) on page 140

---

**CALCulate<n>:DELTamarker<m>:MINimum:LEFT**

Moves a delta marker to the next minimum peak value.

The search includes only measurement values to the right of the current marker position.

**Suffix:**

<n> [Window](#)

<m> [Marker](#)

**Manual operation:** See ["Search Next Minimum"](#) on page 140

---

**CALCulate<n>:DELTamarker<m>:MINimum:NEXT**

Moves a marker to the next minimum peak value.

**Suffix:**

<n> [Window](#)

<m> [Marker](#)

**Manual operation:** See ["Search Next Minimum"](#) on page 140

---

**CALCulate<n>:DELTamarker<m>:MINimum[:PEAK]**

Moves a delta marker to the minimum level.

If the marker is not yet active, the command first activates the marker.

**Suffix:**

<n> [Window](#)

<m> [Marker](#)

**Manual operation:** See ["Marker Search Type"](#) on page 138  
See ["Search Minimum"](#) on page 140



**CALCulate<n>:DELTaMarker<m>:MINimum:RIGHT**

Moves a delta marker to the next minimum peak value.

The search includes only measurement values to the right of the current marker position.

**Suffix:**

<n> [Window](#)

<m> [Marker](#)

**Manual operation:** See ["Search Next Minimum"](#) on page 140

**13.8.3.5 Marker search (spectrograms)**

The following commands automatically define the marker and delta marker position in the spectrogram.



The usage of these markers is demonstrated in [Chapter 13.12.2, "Example 2: performing a basic real-time measurement"](#), on page 345.

**Using markers**

The following commands control spectrogram markers.

**Useful commands for spectrogram markers described elsewhere**

The following commands define the horizontal position of the markers.

- [CALCulate<n>:MARKer<m>:MAXimum:LEFT](#) on page 301
- [CALCulate<n>:MARKer<m>:MAXimum:NEXT](#) on page 301
- [CALCulate<n>:MARKer<m>:MAXimum\[:PEAK\]](#) on page 301
- [CALCulate<n>:MARKer<m>:MAXimum:RIGHT](#) on page 301
- [CALCulate<n>:MARKer<m>:MINimum:LEFT](#) on page 302
- [CALCulate<n>:MARKer<m>:MINimum:NEXT](#) on page 302
- [CALCulate<n>:MARKer<m>:MINimum\[:PEAK\]](#) on page 302
- [CALCulate<n>:MARKer<m>:MINimum:RIGHT](#) on page 302

**Remote commands exclusive to spectrogram markers**

|  |     |
|--|-----|
| <a href="#">CALCulate&lt;n&gt;:MARKer&lt;m&gt;:SGRam:FRAME</a> .....                   | 306 |
| <a href="#">CALCulate&lt;n&gt;:MARKer&lt;m&gt;:SPEctrogram:FRAME</a> .....             | 306 |
| <a href="#">CALCulate&lt;n&gt;:MARKer&lt;m&gt;:SGRam:SARea</a> .....                   | 306 |
| <a href="#">CALCulate&lt;n&gt;:MARKer&lt;m&gt;:SPEctrogram:SARea</a> .....             | 306 |
| <a href="#">CALCulate&lt;n&gt;:MARKer&lt;m&gt;:SGRam:XY:MAXimum[:PEAK]</a> .....       | 307 |
| <a href="#">CALCulate&lt;n&gt;:MARKer&lt;m&gt;:SPEctrogram:XY:MAXimum[:PEAK]</a> ..... | 307 |
| <a href="#">CALCulate&lt;n&gt;:MARKer&lt;m&gt;:SGRam:XY:MINimum[:PEAK]</a> .....       | 307 |
| <a href="#">CALCulate&lt;n&gt;:MARKer&lt;m&gt;:SPEctrogram:XY:MINimum[:PEAK]</a> ..... | 307 |
| <a href="#">CALCulate&lt;n&gt;:MARKer&lt;m&gt;:SGRam:Y:MAXimum:ABOVE</a> .....         | 307 |

|  |     |
|--|-----|
| CALCulate<n>:MARKer<m>:SPEctrogram:Y:MAXimum:ABOVE.....  | 307 |
| CALCulate<n>:MARKer<m>:SGRam:Y:MAXimum:BELOW.....        | 308 |
| CALCulate<n>:MARKer<m>:SPEctrogram:Y:MAXimum:BELOW.....  | 308 |
| CALCulate<n>:MARKer<m>:SGRam:Y:MAXimum:NEXT.....         | 308 |
| CALCulate<n>:MARKer<m>:SPEctrogram:Y:MAXimum:NEXT.....   | 308 |
| CALCulate<n>:MARKer<m>:SGRam:Y:MAXimum[:PEAK].....       | 308 |
| CALCulate<n>:MARKer<m>:SPEctrogram:Y:MAXimum[:PEAK]..... | 308 |
| CALCulate<n>:MARKer<m>:SGRam:Y:MINimum:ABOVE.....        | 308 |
| CALCulate<n>:MARKer<m>:SPEctrogram:Y:MINimum:ABOVE.....  | 308 |
| CALCulate<n>:MARKer<m>:SGRam:Y:MINimum:BELOW.....        | 309 |
| CALCulate<n>:MARKer<m>:SPEctrogram:Y:MINimum:BELOW.....  | 309 |
| CALCulate<n>:MARKer<m>:SGRam:Y:MINimum:NEXT.....         | 309 |
| CALCulate<n>:MARKer<m>:SPEctrogram:Y:MINimum:NEXT.....   | 309 |
| CALCulate<n>:MARKer<m>:SGRam:Y:MINimum[:PEAK].....       | 309 |
| CALCulate<n>:MARKer<m>:SPEctrogram:Y:MINimum[:PEAK]..... | 309 |
| CALCulate<n>:MARKer<m>:SGRam:Y:TRIGger.....              | 310 |
| CALCulate<n>:MARKer<m>:SPEctrogram:Y:TRIGger.....        | 310 |

---

**CALCulate<n>:MARKer<m>:SGRam:FRAME <Frame>**

**CALCulate<n>:MARKer<m>:SPEctrogram:FRAME <Frame> | <Time>**

Positions a marker on a particular frame.

**Suffix:**

<n> [Window](#)

<m> [Marker](#)

**Parameters:**

<Frame> Selects a frame directly by the frame number. Valid if the time stamp is off.  
The range depends on the history depth.  
Default unit: S

<Time> Selects a frame via its time stamp. Valid if the time stamp is on.  
The number is the (negative) distance to frame 0 in seconds.  
The range depends on the history depth.

**Example:**

`CALC:MARK:SGR:FRAM -20`

Sets the marker on the 20th frame before the present.

`CALC:MARK2:SGR:FRAM -2s`

Sets second marker on the frame 2 seconds ago.

**Manual operation:** See "[Frame](#)" on page 132

---

**CALCulate<n>:MARKer<m>:SGRam:SARea <SearchArea>**

**CALCulate<n>:MARKer<m>:SPEctrogram:SARea <SearchArea>**

Defines the marker search area for all spectrogram markers in the channel.

**Suffix:**

<n> irrelevant

<m> irrelevant

**Parameters:**

<SearchArea>

**VISible**

Performs a search within the visible frames.

Note that the command does not work if the spectrogram is not visible for any reason (e.g. if the display update is off).

**MEMory**

Performs a search within all frames in the memory.

\*RST: VISible

**Manual operation:** See "[Marker Search Area](#)" on page 138

**CALCulate<n>:MARKer<m>:SGRam:XY:MAXimum[:PEAK]**

**CALCulate<n>:MARKer<m>:SPECTrogram:XY:MAXimum[:PEAK]**

Moves a marker to the highest level of the spectrogram.

**Suffix:**

<n> [Window](#)

<m> [Marker](#)

**Manual operation:** See "[Marker Search Type](#)" on page 138

**CALCulate<n>:MARKer<m>:SGRam:XY:MINimum[:PEAK]**

**CALCulate<n>:MARKer<m>:SPECTrogram:XY:MINimum[:PEAK]**

Moves a marker to the minimum level of the spectrogram.

**Suffix:**

<n> [Window](#)

<m> [Marker](#)

**Manual operation:** See "[Marker Search Type](#)" on page 138

**CALCulate<n>:MARKer<m>:SGRam:Y:MAXimum:ABOVE**

**CALCulate<n>:MARKer<m>:SPECTrogram:Y:MAXimum:ABOVE**

Moves a marker vertically to the next lower peak level for the current frequency.

The search includes only frames above the current marker position. It does not change the horizontal position of the marker.

**Suffix:**

<n> [Window](#)

<m> [Marker](#)

**Manual operation:** See "[Search Mode for Next Peak in Y Direction](#)" on page 137

---

**CALCulate<n>:MARKer<m>:SGRam:Y:MAXimum:BELOW**  
**CALCulate<n>:MARKer<m>:SPECTrogram:Y:MAXimum:BELOW**

Moves a marker vertically to the next lower peak level for the current frequency.

The search includes only frames below the current marker position. It does not change the horizontal position of the marker.

**Suffix:**

<n> [Window](#)

<m> [Marker](#)

**Manual operation:** See "[Search Mode for Next Peak in Y Direction](#)" on page 137

---

**CALCulate<n>:MARKer<m>:SGRam:Y:MAXimum:NEXT**  
**CALCulate<n>:MARKer<m>:SPECTrogram:Y:MAXimum:NEXT**

Moves a marker vertically to the next lower peak level for the current frequency.

The search includes all frames. It does not change the horizontal position of the marker.

**Suffix:**

<n> [Window](#)

<m> [Marker](#)

**Manual operation:** See "[Search Mode for Next Peak in Y Direction](#)" on page 137

---

**CALCulate<n>:MARKer<m>:SGRam:Y:MAXimum[:PEAK]**  
**CALCulate<n>:MARKer<m>:SPECTrogram:Y:MAXimum[:PEAK]**

Moves a marker vertically to the highest level for the current frequency.

The search includes all frames. It does not change the horizontal position of the marker.

If the marker hasn't been active yet, the command looks for the peak level in the whole spectrogram.

**Suffix:**

<n> [Window](#)

<m> [Marker](#)

**Manual operation:** See "[Marker Search Type](#)" on page 138

---

**CALCulate<n>:MARKer<m>:SGRam:Y:MINimum:ABOVE**  
**CALCulate<n>:MARKer<m>:SPECTrogram:Y:MINimum:ABOVE**

Moves a marker vertically to the next higher minimum level for the current frequency.

The search includes only frames above the current marker position. It does not change the horizontal position of the marker.

**Suffix:**<n> [Window](#)<m> [Marker](#)**Manual operation:** See "[Search Mode for Next Peak in Y Direction](#)" on page 137**CALCulate<n>:MARKer<m>:SGRam:Y:MINimum:BELOW****CALCulate<n>:MARKer<m>:SPECTrogram:Y:MINimum:BELOW**

Moves a marker vertically to the next higher minimum level for the current frequency.

The search includes only frames below the current marker position. It does not change the horizontal position of the marker.

**Suffix:**<n> [Window](#)<m> [Marker](#)**Manual operation:** See "[Search Mode for Next Peak in Y Direction](#)" on page 137**CALCulate<n>:MARKer<m>:SGRam:Y:MINimum:NEXT****CALCulate<n>:MARKer<m>:SPECTrogram:Y:MINimum:NEXT**

Moves a marker vertically to the next higher minimum level for the current frequency.

The search includes all frames. It does not change the horizontal position of the marker.

**Suffix:**<n> [Window](#)<m> [Marker](#)**Manual operation:** See "[Search Mode for Next Peak in Y Direction](#)" on page 137**CALCulate<n>:MARKer<m>:SGRam:Y:MINimum[:PEAK]****CALCulate<n>:MARKer<m>:SPECTrogram:Y:MINimum[:PEAK]**

Moves a marker vertically to the minimum level for the current frequency.

The search includes all frames. It does not change the horizontal position of the marker.

If the marker hasn't been active yet, the command first looks for the peak level for all frequencies and moves the marker vertically to the minimum level.

**Suffix:**<n> [Window](#)<m> [Marker](#)**Manual operation:** See "[Marker Search Type](#)" on page 138

**CALCulate<n>:MARKer<m>:SGRam:Y:TRIGger****CALCulate<n>:MARKer<m>:SPECTrogram:Y:TRIGger**

Positions a marker in the spectrogram on the most recent trigger event.

**Suffix:**

<n> [Window](#)

<m> [Marker](#)

**Manual operation:** See "[Marker to Trigger](#)" on page 141

**Using delta markers**

The following commands control spectrogram delta markers.

**Useful commands for spectrogram markers described elsewhere**

The following commands define the horizontal position of the delta markers.

- [CALCulate<n>:DELTamarker<m>:MAXimum:LEFT](#) on page 303
- [CALCulate<n>:DELTamarker<m>:MAXimum:NEXT](#) on page 303
- [CALCulate<n>:DELTamarker<m>:MAXimum\[:PEAK\]](#) on page 303
- [CALCulate<n>:DELTamarker<m>:MAXimum:RIGHT](#) on page 304
- [CALCulate<n>:DELTamarker<m>:MINimum:LEFT](#) on page 304
- [CALCulate<n>:DELTamarker<m>:MINimum:NEXT](#) on page 304
- [CALCulate<n>:DELTamarker<m>:MINimum\[:PEAK\]](#) on page 304
- [CALCulate<n>:DELTamarker<m>:MINimum:RIGHT](#) on page 305

**Remote commands exclusive to spectrogram markers**

|   |     |
|---|-----|
| <a href="#">CALCulate&lt;n&gt;:DELTamarker&lt;m&gt;:SGRam:FRAME</a> .....                   | 311 |
| <a href="#">CALCulate&lt;n&gt;:DELTamarker&lt;m&gt;:SPECTrogram:FRAME</a> .....             | 311 |
| <a href="#">CALCulate&lt;n&gt;:DELTamarker&lt;m&gt;:SGRam:SARea</a> .....                   | 311 |
| <a href="#">CALCulate&lt;n&gt;:DELTamarker&lt;m&gt;:SPECTrogram:SARea</a> .....             | 311 |
| <a href="#">CALCulate&lt;n&gt;:DELTamarker&lt;m&gt;:SGRam:XY:MAXimum[:PEAK]</a> .....       | 312 |
| <a href="#">CALCulate&lt;n&gt;:DELTamarker&lt;m&gt;:SPECTrogram:XY:MAXimum[:PEAK]</a> ..... | 312 |
| <a href="#">CALCulate&lt;n&gt;:DELTamarker&lt;m&gt;:SGRam:XY:MINimum[:PEAK]</a> .....       | 312 |
| <a href="#">CALCulate&lt;n&gt;:DELTamarker&lt;m&gt;:SPECTrogram:XY:MINimum[:PEAK]</a> ..... | 312 |
| <a href="#">CALCulate&lt;n&gt;:DELTamarker&lt;m&gt;:SGRam:Y:MAXimum:ABOVe</a> .....         | 312 |
| <a href="#">CALCulate&lt;n&gt;:DELTamarker&lt;m&gt;:SPECTrogram:Y:MAXimum:ABOVe</a> .....   | 312 |
| <a href="#">CALCulate&lt;n&gt;:DELTamarker&lt;m&gt;:SGRam:Y:MAXimum:BELow</a> .....         | 312 |
| <a href="#">CALCulate&lt;n&gt;:DELTamarker&lt;m&gt;:SPECTrogram:Y:MAXimum:BELow</a> .....   | 312 |
| <a href="#">CALCulate&lt;n&gt;:DELTamarker&lt;m&gt;:SGRam:Y:MAXimum:NEXT</a> .....          | 313 |
| <a href="#">CALCulate&lt;n&gt;:DELTamarker&lt;m&gt;:SPECTrogram:Y:MAXimum:NEXT</a> .....    | 313 |
| <a href="#">CALCulate&lt;n&gt;:DELTamarker&lt;m&gt;:SGRam:Y:MAXimum[:PEAK]</a> .....        | 313 |
| <a href="#">CALCulate&lt;n&gt;:DELTamarker&lt;m&gt;:SPECTrogram:Y:MAXimum[:PEAK]</a> .....  | 313 |
| <a href="#">CALCulate&lt;n&gt;:DELTamarker&lt;m&gt;:SGRam:Y:MINimum:ABOVe</a> .....         | 313 |
| <a href="#">CALCulate&lt;n&gt;:DELTamarker&lt;m&gt;:SPECTrogram:Y:MINimum:ABOVe</a> .....   | 313 |
| <a href="#">CALCulate&lt;n&gt;:DELTamarker&lt;m&gt;:SGRam:Y:MINimum:BELow</a> .....         | 313 |
| <a href="#">CALCulate&lt;n&gt;:DELTamarker&lt;m&gt;:SPECTrogram:Y:MINimum:BELow</a> .....   | 313 |

|   |     |
|---|-----|
| CALCulate<n>:DELTamarker<m>:SGRam:Y:MINimum:NEXT.....         | 314 |
| CALCulate<n>:DELTamarker<m>:SPECTrogram:Y:MINimum:NEXT.....   | 314 |
| CALCulate<n>:DELTamarker<m>:SGRam:Y:MINimum[:PEAK].....       | 314 |
| CALCulate<n>:DELTamarker<m>:SPECTrogram:Y:MINimum[:PEAK]..... | 314 |

---

**CALCulate<n>:DELTamarker<m>:SGRam:FRAME <Frame>**
**CALCulate<n>:DELTamarker<m>:SPECTrogram:FRAME <Frame>**

Positions a delta marker on a particular frame. The frame is relative to the position of marker 1.

The command is available for the spectrogram.

**Suffix:**

<n>                      [Window](#)

<m>                      [Marker](#)

**Parameters:**

<Frame>                      Selects a frame either by its frame number or time stamp. The frame number is available if the time stamp is off. The range depends on the history depth. The time stamp is available if the time stamp is on. The number is the distance to frame 0 in seconds. The range depends on the history depth. Default unit: S

**Example:**

```
CALC:DELT4:SGR:FRAM -20
```

Sets fourth deltamarker 20 frames below marker 1.

```
CALC:DELT4:SGR:FRAM 2 s
```

Sets fourth deltamarker 2 seconds above the position of marker 1.

---

**CALCulate<n>:DELTamarker<m>:SGRam:SAREa <SearchArea>**
**CALCulate<n>:DELTamarker<m>:SPECTrogram:SAREa <SearchArea>**

Defines the marker search area for *all* spectrogram markers in the channel.

**Suffix:**

<n>                      irrelevant

<m>                      irrelevant

**Parameters:**

<SearchArea>

**VISible**

Performs a search within the visible frames.

Note that the command does not work if the spectrogram is not visible for any reason (e.g. if the display update is off).

**MEMory**

Performs a search within all frames in the memory.

\*RST:                  VISible

**Manual operation:** See "[Marker Search Area](#)" on page 138

---

**CALCulate<n>:DELTamarker<m>:SGRam:XY:MAXimum[:PEAK]**  
**CALCulate<n>:DELTamarker<m>:SPECTrogram:XY:MAXimum[:PEAK]**

Moves a marker to the highest level of the spectrogram over all frequencies.

**Suffix:**

<n> [Window](#)

<m> [Marker](#)

**Manual operation:** See "[Marker Search Type](#)" on page 138

---

**CALCulate<n>:DELTamarker<m>:SGRam:XY:MINimum[:PEAK]**  
**CALCulate<n>:DELTamarker<m>:SPECTrogram:XY:MINimum[:PEAK]**

Moves a delta marker to the minimum level of the spectrogram over all frequencies.

**Suffix:**

<n> [Window](#)

<m> [Marker](#)

**Manual operation:** See "[Marker Search Type](#)" on page 138

---

**CALCulate<n>:DELTamarker<m>:SGRam:Y:MAXimum:ABOVE**  
**CALCulate<n>:DELTamarker<m>:SPECTrogram:Y:MAXimum:ABOVE**

Moves a marker vertically to the next higher level for the current frequency.

The search includes only frames above the current marker position. It does not change the horizontal position of the marker.

**Suffix:**

<n> [Window](#)

<m> [Marker](#)

**Manual operation:** See "[Search Mode for Next Peak in Y Direction](#)" on page 137

---

**CALCulate<n>:DELTamarker<m>:SGRam:Y:MAXimum:BELOW**  
**CALCulate<n>:DELTamarker<m>:SPECTrogram:Y:MAXimum:BELOW**

Moves a marker vertically to the next higher level for the current frequency.

The search includes only frames below the current marker position. It does not change the horizontal position of the marker.

**Suffix:**

<n> [Window](#)

<m> [Marker](#)

**Manual operation:** See "[Search Mode for Next Peak in Y Direction](#)" on page 137



---

**CALCulate<n>:DELTaMarker<m>:SGRam:Y:MAXimum:NEXT****CALCulate<n>:DELTaMarker<m>:SPECTrogram:Y:MAXimum:NEXT**

Moves a delta marker vertically to the next higher level for the current frequency.

The search includes all frames. It does not change the horizontal position of the marker.

**Suffix:**

<n> [Window](#)

<m> [Marker](#)

**Manual operation:** See "[Search Mode for Next Peak in Y Direction](#)" on page 137

---

**CALCulate<n>:DELTaMarker<m>:SGRam:Y:MAXimum[:PEAK]****CALCulate<n>:DELTaMarker<m>:SPECTrogram:Y:MAXimum[:PEAK]**

Moves a delta marker vertically to the highest level for the current frequency.

The search includes all frames. It does not change the horizontal position of the marker.

If the marker hasn't been active yet, the command looks for the peak level in the whole spectrogram.

**Suffix:**

<n> [Window](#)

<m> [Marker](#)

**Manual operation:** See "[Marker Search Type](#)" on page 138

---

**CALCulate<n>:DELTaMarker<m>:SGRam:Y:MINimum:ABOVE****CALCulate<n>:DELTaMarker<m>:SPECTrogram:Y:MINimum:ABOVE**

Moves a delta marker vertically to the next minimum level for the current frequency.

The search includes only frames above the current marker position. It does not change the horizontal position of the marker.

**Suffix:**

<n> [Window](#)

<m> [Marker](#)

**Manual operation:** See "[Search Mode for Next Peak in Y Direction](#)" on page 137

---

**CALCulate<n>:DELTaMarker<m>:SGRam:Y:MINimum:BELOW****CALCulate<n>:DELTaMarker<m>:SPECTrogram:Y:MINimum:BELOW**

Moves a delta marker vertically to the next minimum level for the current frequency.

The search includes only frames below the current marker position. It does not change the horizontal position of the marker.

**Suffix:**<n> [Window](#)<m> [Marker](#)**Manual operation:** See ["Search Mode for Next Peak in Y Direction"](#) on page 137**CALCulate<n>:DELTamarker<m>:SGRam:Y:MINimum:NEXT****CALCulate<n>:DELTamarker<m>:SPECTrogram:Y:MINimum:NEXT**

Moves a delta marker vertically to the next minimum level for the current frequency.

The search includes all frames. It does not change the horizontal position of the marker.

**Suffix:**<n> [Window](#)<m> [Marker](#)**Manual operation:** See ["Search Mode for Next Peak in Y Direction"](#) on page 137**CALCulate<n>:DELTamarker<m>:SGRam:Y:MINimum[:PEAK]****CALCulate<n>:DELTamarker<m>:SPECTrogram:Y:MINimum[:PEAK]**

Moves a delta marker vertically to the minimum level for the current frequency.

The search includes all frames. It does not change the horizontal position of the marker.

If the marker hasn't been active yet, the command first looks for the peak level in the whole spectrogram and moves the marker vertically to the minimum level.

**Suffix:**<n> [Window](#)<m> [Marker](#)**Manual operation:** See ["Marker Search Type"](#) on page 138

## 13.8.4 Configuring display lines

The commands required to configure display lines in a remote environment are described here.

|  |     |
|--|-----|
| <a href="#">CALCulate&lt;n&gt;:DLINe&lt;dl&gt;</a> .....       | 315 |
| <a href="#">CALCulate&lt;n&gt;:DLINe&lt;dl&gt;:STATe</a> ..... | 315 |
| <a href="#">CALCulate&lt;n&gt;:FLINe&lt;dl&gt;</a> .....       | 315 |
| <a href="#">CALCulate&lt;n&gt;:FLINe&lt;dl&gt;:STATe</a> ..... | 316 |
| <a href="#">CALCulate&lt;n&gt;:TLINe&lt;dl&gt;</a> .....       | 316 |
| <a href="#">CALCulate&lt;n&gt;:TLINe&lt;dl&gt;:STATe</a> ..... | 317 |

---

**CALCulate<n>:DLINe<dl>** <Position>

Defines the (horizontal) position of a display line.

**Suffix:**

<n> [Window](#)

<dl> 1 | 2

**Parameters:**

<Position> The value range is variable.  
You can use any unit you want, the FSW then converts the unit to the currently selected unit. If you omit a unit, the FSW uses the currently selected unit.

\*RST: (state is OFF)

Default unit: DBM

**Example:**

CALC:DLIN2 -20dBm

Positions the second display line at -20 dBm.

**Manual operation:** See "[Horizontal Line 1/ Horizontal Line 2](#)" on page 143

---

**CALCulate<n>:DLINe<dl>:STATe** <State>

Turns a display line on and off

**Suffix:**

<n> [Window](#)

<dl> 1 | 2

**Parameters:**

<State> ON | OFF | 0 | 1

**OFF | 0**

Switches the function off

**ON | 1**

Switches the function on

**Example:**

CALC:DLIN2:STAT ON

Turns on display line 2.

---

**CALCulate<n>:FLINe<dl>** <Frequency>

Defines the position of a frequency line.

**Suffix:**

<n> [Window](#)

<dl> 1 to 4  
frequency line

**Parameters:**

&lt;Frequency&gt;

Note that you can not set a frequency line to a position that is outside the current span.

Range: 0 Hz to Fmax

\*RST: (STATe to OFF)

Default unit: HZ

**Example:**

CALC:FLIN2 120MHz

Sets frequency line 2 to a frequency of 120 MHz.

**Manual operation:** See "[Vertical Line <x>](#)" on page 143**CALCulate<n>:FLINe<dl>:STATe <State>**

Turns a frequency line on and off

**Suffix:**<n> [Window](#)<dl> 1 to 4  
frequency line**Parameters:**

&lt;State&gt; ON | OFF | 0 | 1

**OFF | 0**

Switches the function off

**ON | 1**

Switches the function on

**Example:**

CALC:FLIN2:STAT ON

Turns frequency line 2 on.

**CALCulate<n>:TLINe<dl> <Time>**

Defines the position of a time line.

**Suffix:**<n> [Window](#)<dl> 1 to 4  
time line**Parameters:**

&lt;Time&gt;

Note that you can not set a time line to a position that is higher than the current sweep time.

Range: 0 s to 1600 s

\*RST: (STATe to OFF)

Default unit: S

**Example:**

CALC:TLIN 10ms

Sets the first time line to 10 ms.

**Manual operation:** See "[Vertical Line <x>](#)" on page 143

**CALCulate<n>:TLINe<dl>:STATe <State>**

Turns a time line on and off

**Suffix:**

<n> [Window](#)  
 <dl> 1 to 4  
 time line

**Parameters:**

<State> ON | OFF | 0 | 1  
**OFF | 0**  
 Switches the function off  
**ON | 1**  
 Switches the function on

**Example:**

CALC:TLIN:STAT ON  
 Turns the first time line on.

### 13.8.5 Defining limit checks

Note that in remote control, upper and lower limit lines are configured using separate commands. Thus, you must decide in advance which you want to configure. The x-values for both upper and lower limit lines are defined as a common control line. This control line is the reference for the y-values for both upper and lower limit lines.

- [Configuring limit lines](#)..... 317
- [Managing limit lines](#)..... 327
- [Checking the results of a limit check](#)..... 330
- [Programming example: using limit lines](#)..... 330

#### 13.8.5.1 Configuring limit lines

|   |     |
|---|-----|
| CALCulate<n>:LIMit<li>:COMMeNt.....         | 318 |
| CALCulate<n>:LIMit<li>:CONTRol[:DATA].....  | 318 |
| CALCulate<n>:LIMit<li>:CONTRol:DOMain.....  | 318 |
| CALCulate<n>:LIMit<li>:CONTRol:MODE.....    | 319 |
| CALCulate<n>:LIMit<li>:CONTRol:OFFSet.....  | 319 |
| CALCulate<n>:LIMit<li>:CONTRol:SHIFt.....   | 320 |
| CALCulate<n>:LIMit<li>:CONTRol:SPACing..... | 320 |
| CALCulate<n>:LIMit<li>:LOWer[:DATA].....    | 320 |
| CALCulate<n>:LIMit<li>:LOWer:MARGin.....    | 321 |
| CALCulate<n>:LIMit<li>:LOWer:MODE.....      | 321 |
| CALCulate<n>:LIMit<li>:LOWer:OFFSet.....    | 321 |
| CALCulate<n>:LIMit<li>:LOWer:SHIFt.....     | 322 |
| CALCulate<n>:LIMit<li>:LOWer:SPACing.....   | 322 |
| CALCulate<n>:LIMit<li>:LOWer:STATe.....     | 322 |
| CALCulate<n>:LIMit<li>:LOWer:THReshold..... | 323 |
| CALCulate<n>:LIMit<li>:NAME.....            | 323 |

|   |     |
|---|-----|
| CALCulate<n>:LIMit<li>:UNIT.....            | 323 |
| CALCulate<n>:LIMit<li>:UPPer[:DATA].....    | 324 |
| CALCulate<n>:LIMit<li>:UPPer:MARGin.....    | 324 |
| CALCulate<n>:LIMit<li>:UPPer:MODE.....      | 324 |
| CALCulate<n>:LIMit<li>:UPPer:OFFSet.....    | 325 |
| CALCulate<n>:LIMit<li>:UPPer:SHIFt.....     | 325 |
| CALCulate<n>:LIMit<li>:UPPer:SPACing.....   | 326 |
| CALCulate<n>:LIMit<li>:UPPer:STATe.....     | 326 |
| CALCulate<n>:LIMit<li>:UPPer:THReshold..... | 326 |

---

### CALCulate<n>:LIMit<li>:COMMeNt <Comment>

Defines a comment for a limit line.

#### Suffix:

|      |            |
|------|------------|
| <n>  | irrelevant |
| <li> | Limit line |

#### Parameters:

<Comment> String containing the description of the limit line.

**Manual operation:** See "Comment" on page 151

---

### CALCulate<n>:LIMit<li>:CONTRol[:DATA] <LimitLinePoints>...

Defines the horizontal definition points of a limit line.

#### Suffix:

|      |            |
|------|------------|
| <n>  | irrelevant |
| <li> | Limit line |

#### Parameters:

<LimitLinePoints> Variable number of x-axis values.  
 Note that the number of horizontal values has to be the same as the number of vertical values set with `CALCulate<n>:LIMit<li>:LOWer[:DATA]` or `CALCulate<n>:LIMit<li>:UPPer[:DATA]`. If not, the FSW either adds missing values or ignores surplus values.

\*RST: -  
 Default unit: HZ

**Manual operation:** See "Data Points" on page 152

---

### CALCulate<n>:LIMit<li>:CONTRol:DOMain <SpanSetting>

Selects the domain of the limit line.

#### Suffix:

|     |            |
|-----|------------|
| <n> | irrelevant |
|-----|------------|

<li> [Limit line](#)

**Parameters:**

<SpanSetting> FREQUENCY | TIME

**FREQUENCY**

For limit lines that apply to a range of frequencies.

**TIME**

For limit lines that apply to a period of time.

\*RST: FREQUENCY

**Example:**

CALC:LIM:CONT:DOM FREQ

Select a limit line in the frequency domain.

**Manual operation:** See "[X-Axis](#)" on page 152

**CALCulate<n>:LIMit<li>:CONTrol:MODE <Mode>**

Selects the horizontal limit line scaling.

**Suffix:**

<n> irrelevant

<li> [Limit line](#)

**Parameters:**

<Mode>

**ABSolute**

Limit line is defined by absolute physical values (Hz or s).

**RELative**

Limit line is defined by relative values related to the center frequency (frequency domain) or the left diagram border (time domain).

\*RST: ABSolute

**Manual operation:** See "[X-Axis](#)" on page 152

**CALCulate<n>:LIMit<li>:CONTrol:OFFSet <Offset>**

Defines an offset for a complete limit line.

Compared to shifting the limit line, an offset does not actually change the limit line definition points.

**Suffix:**

<n> irrelevant

<li> [Limit line](#)

**Parameters:**

<Offset>

Numeric value.

The unit depends on the scale of the x-axis.

\*RST: 0

Default unit: HZ

**Manual operation:** See "X-Offset" on page 150

---

**CALCulate<n>:LIMit<li>:CONTrol:SHIFt <Distance>**

Moves a complete limit line horizontally.

Compared to defining an offset, this command actually changes the limit line definition points by the value you define.

**Suffix:**

<n> irrelevant

<li> [Limit line](#)

**Parameters:**

<Distance> Numeric value.  
The unit depends on the scale of the x-axis.  
Default unit: HZ

**Manual operation:** See "Shift x" on page 153

---

**CALCulate<n>:LIMit<li>:CONTrol:SPACing <InterpolMode>**

Selects linear or logarithmic interpolation for the calculation of limit lines from one horizontal point to the next.

**Suffix:**

<n> [Window](#)

<li> [Limit line](#)

**Parameters:**

<InterpolMode> LINear | LOGarithmic  
\*RST: LIN

**Example:** CALC:LIM:CONT:SPAC LIN

**Manual operation:** See "X-Axis" on page 152

---

**CALCulate<n>:LIMit<li>:LOWer[:DATA] <LimitLinePoints>...**

Defines the vertical definition points of a lower limit line.

**Suffix:**

<n> irrelevant

<li> [Limit line](#)



**Parameters:**

<LimitLinePoints> Variable number of level values.  
 Note that the number of vertical values has to be the same as the number of horizontal values set with `CALCulate<n>:LIMit<li>:CONTRol[:DATA]`. If not, the FSW either adds missing values or ignores surplus values.  
 \*RST: Limit line state is OFF  
 Default unit: DBM

**Manual operation:** See "[Data Points](#)" on page 152

**CALCulate<n>:LIMit<li>:LOWer:MARGin <Margin>**

Defines an area around a lower limit line where limit check violations are still tolerated.

**Suffix:**

<n> irrelevant  
 <li> [Limit line](#)

**Parameters:**

<Margin> **numeric value**  
 \*RST: 0  
 Default unit: dB

**Manual operation:** See "[Margin](#)" on page 152

**CALCulate<n>:LIMit<li>:LOWer:MODE <Mode>**

Selects the vertical limit line scaling.

**Suffix:**

<n> [Window](#)  
 <li> [Limit line](#)

**Parameters:**

<Mode> **ABSolute**  
 Limit line is defined by absolute physical values.  
 The unit is variable.  
**RELative**  
 Limit line is defined by relative values related to the reference level (dB).  
 \*RST: ABSolute

**Manual operation:** See "[Y-Axis](#)" on page 152

**CALCulate<n>:LIMit<li>:LOWer:OFFSet <Offset>**

Defines an offset for a complete lower limit line.

Compared to shifting the limit line, an offset does not actually change the limit line definition points.

**Suffix:**

<n> [Window](#)

<li> [Limit line](#)

**Parameters:**

<Offset> Numeric value.

\*RST: 0

Default unit: dB

**Manual operation:** See "[Y-Offset](#)" on page 150

**CALCulate<n>:LIMit<li>:LOWer:SHIFt <Distance>**

Moves a complete lower limit line vertically.

Compared to defining an offset, this command actually changes the limit line definition points by the value you define.

**Suffix:**

<n> [Window](#)

<li> [Limit line](#)

**Parameters:**

<Distance> Defines the distance that the limit line moves.

Default unit: DB

**Manual operation:** See "[Shift y](#)" on page 153

**CALCulate<n>:LIMit<li>:LOWer:SPACing <InterpolType>**

Selects linear or logarithmic interpolation for the calculation of a lower limit line from one horizontal point to the next.

**Suffix:**

<n> [Window](#)

<li> [Limit line](#)

**Parameters:**

<InterpolType> LINear | LOGarithmic

\*RST: LIN

**Manual operation:** See "[Y-Axis](#)" on page 152

**CALCulate<n>:LIMit<li>:LOWer:STATe <State>**

Turns a lower limit line on and off.

Before you can use the command, you have to select a limit line with [CALCulate<n>:LIMit<li>:NAME](#) on page 323.

**Suffix:**

<n> irrelevant

<li> [Limit line](#)

**Parameters:**

<State> ON | OFF | 0 | 1

**OFF | 0**

Switches the function off

**ON | 1**

Switches the function on

**Manual operation:** See "[Visibility](#)" on page 149

**CALCulate<n>:LIMit<li>:LOWer:THReshold <Threshold>**

Defines a threshold for relative limit lines.

The FSW uses the threshold for the limit check, if the limit line violates the threshold.

**Suffix:**

<n> irrelevant

<li> [Limit line](#)

**Parameters:**

<Threshold> Numeric value.

The unit depends on [CALCulate<n>:LIMit<li>:UNIT](#) on page 323.

\*RST: -200 dBm

Default unit: DBM

**Manual operation:** See "[Threshold](#)" on page 151

**CALCulate<n>:LIMit<li>:NAME <Name>**

Selects a limit line that already exists or defines a name for a new limit line.

**Suffix:**

<n> [Window](#)

<li> [Limit line](#)

**Parameters:**

<Name> String containing the limit line name.

\*RST: REM1 to REM8 for lines 1 to 8

**Manual operation:** See "[Name](#)" on page 151

**CALCulate<n>:LIMit<li>:UNIT <Unit>**

Defines the unit of a limit line.

**Suffix:**

<n> irrelevant

<li> [Limit line](#)

**Parameters:**

<Unit> If you select a dB-based unit for the limit line, the command automatically turns the limit line into a relative limit line.

\*RST: DBM

**Manual operation:** See "[Y-Axis](#)" on page 152

**CALCulate<n>:LIMit<li>:UPPer[:DATA] <LimitLinePoints>...**

Defines the vertical definition points of an upper limit line.

**Suffix:**

<n> irrelevant

<li> [Limit line](#)

**Parameters:**

<LimitLinePoints> Variable number of level values.

Note that the number of vertical values has to be the same as the number of horizontal values set with [CALCulate<n>:LIMit<li>:CONTRol\[:DATA\]](#). If not, the FSW either adds missing values or ignores surplus values.

\*RST: Limit line state is OFF

Default unit: DBM

**Manual operation:** See "[Data Points](#)" on page 152

**CALCulate<n>:LIMit<li>:UPPer:MARGIN <Margin>**

Defines an area around an upper limit line where limit check violations are still tolerated.

**Suffix:**

<n> irrelevant

<li> [Limit line](#)

**Parameters:**

<Margin> **numeric value**

\*RST: 0

Default unit: dB

**Manual operation:** See "[Margin](#)" on page 152

**CALCulate<n>:LIMit<li>:UPPer:MODE <Mode>**

Selects the vertical limit line scaling.

**Suffix:**<n> [Window](#)<li> [Limit line](#)**Parameters:**

&lt;Mode&gt;

**ABSolute**

Limit line is defined by absolute physical values.  
The unit is variable.

**RELative**

Limit line is defined by relative values related to the reference level (dB).

\*RST: ABSolute

**Manual operation:** See "[Y-Axis](#)" on page 152**CALCulate<n>:LIMit<li>:UPPer:OFFSet <Offset>**

Defines an offset for a complete upper limit line.

Compared to shifting the limit line, an offset does not actually change the limit line definition points.

**Suffix:**

&lt;n&gt; irrelevant

<li> [Limit line](#)**Parameters:**

&lt;Offset&gt;

Numeric value.

\*RST: 0

Default unit: dB

**Manual operation:** See "[Y-Offset](#)" on page 150**CALCulate<n>:LIMit<li>:UPPer:SHIFt <Distance>**

Moves a complete upper limit line vertically.

Compared to defining an offset, this command actually changes the limit line definition points by the value you define.

**Suffix:**

&lt;n&gt; irrelevant

<li> [Limit line](#)**Parameters:**

&lt;Distance&gt;

Defines the distance that the limit line moves.

**Manual operation:** See "[Shift y](#)" on page 153

**CALCulate<n>:LIMit<li>:UPPer:SPACing** <InterpolType>

Selects linear or logarithmic interpolation for the calculation of an upper limit line from one horizontal point to the next.

**Suffix:**

<n> [Window](#)

<li> [Limit line](#)

**Parameters:**

<InterpolType> LINear | LOGarithmic

\*RST: LIN

**Manual operation:** See "[Y-Axis](#)" on page 152

**CALCulate<n>:LIMit<li>:UPPer:STATe** <State>

Turns an upper limit line on and off.

Before you can use the command, you have to select a limit line with [CALCulate<n>:LIMit<li>:NAME](#) on page 323.

**Suffix:**

<n> irrelevant

<li> [Limit line](#)

**Parameters:**

<State> ON | OFF | 0 | 1

**OFF | 0**

Switches the function off

**ON | 1**

Switches the function on

**Manual operation:** See "[Visibility](#)" on page 149

**CALCulate<n>:LIMit<li>:UPPer:THReshold** <Limit>

Defines an absolute limit for limit lines with a relative scale.

The FSW uses the threshold for the limit check, if the limit line violates the threshold.

**Suffix:**

<n> irrelevant

<li> [Limit line](#)

**Parameters:**

<Limit> Numeric value.

The unit depends on [CALCulate<n>:LIMit<li>:UNIT](#) on page 323.

\*RST: -200

Default unit: dBm

**Manual operation:** See ["Threshold"](#) on page 151

### 13.8.5.2 Managing limit lines

Useful commands for managing limit lines described in the FSW User Manual:

- `MMEM:SEL[:ITEM]:LIN:ALL`
- `MMEM:STOR:TYPE`
- `MMEM:LOAD:TYPE`

#### Remote commands exclusive to managing limit lines:

|  |     |
|--|-----|
| <code>CALCulate&lt;n&gt;:LIMit&lt;li&gt;:ACTive?</code> .....              | 327 |
| <code>CALCulate&lt;n&gt;:LIMit&lt;li&gt;:COPY</code> .....                 | 327 |
| <code>CALCulate&lt;n&gt;:LIMit&lt;li&gt;:DELete</code> .....               | 328 |
| <code>CALCulate&lt;n&gt;:LIMit&lt;li&gt;:STATe</code> .....                | 328 |
| <code>CALCulate&lt;n&gt;:LIMit&lt;li&gt;:TRACe&lt;t&gt;:CHECK</code> ..... | 328 |
| <code>MMEMory:LOAD&lt;n&gt;:LIMit</code> .....                             | 329 |
| <code>MMEMory:STORe&lt;n&gt;:LIMit</code> .....                            | 329 |

---

#### `CALCulate<n>:LIMit<li>:ACTive?`

Queries the names of *all* active limit lines.

##### Suffix:

|                         |            |
|-------------------------|------------|
| <code>&lt;n&gt;</code>  | irrelevant |
| <code>&lt;li&gt;</code> | irrelevant |

##### Return values:

|                                 |  |
|---------------------------------|--|
| <code>&lt;LimitLines&gt;</code> | String containing the names of all active limit lines in alphabetical order. |
|---------------------------------|--|

##### Example:

`CALC:LIM:ACT?`  
Queries the names of all active limit lines.

##### Usage:

Query only

**Manual operation:** See ["Visibility"](#) on page 149

---

#### `CALCulate<n>:LIMit<li>:COPY <Line>`

Copies a limit line.

##### Suffix:

|                         |            |
|-------------------------|------------|
| <code>&lt;n&gt;</code>  | Window     |
| <code>&lt;li&gt;</code> | Limit line |

##### Parameters:

|                           |  |
|---------------------------|--|
| <code>&lt;Line&gt;</code> | <b>1 to 8</b><br>number of the new limit line                        |
|                           | <b>&lt;name&gt;</b><br>String containing the name of the limit line. |

**Example:**            `CALC:LIM1:COPY 2`  
                          Copies limit line 1 to line 2.  
                          `CALC:LIM1:COPY 'FM2'`  
                          Copies limit line 1 to a new line named FM2.

**Manual operation:** See ["Copy Line"](#) on page 150

### **CALCulate<n>:LIMit<li>:DELete**

Deletes a limit line.

**Suffix:**

<n>                    [Window](#)

<li>                   [Limit line](#)

**Manual operation:** See ["Delete Line"](#) on page 150

### **CALCulate<n>:LIMit<li>:STATe <State>**

Turns the limit check for a specific limit line on and off.

To query the limit check result, use `CALCulate<n>:LIMit<li>:FAIL?`.

Note that a new command exists to activate the limit check and define the trace to be checked in one step (see `CALCulate<n>:LIMit<li>:TRACe<t>:CHECK` on page 328).

**Suffix:**

<n>                    irrelevant

<li>                   [Limit line](#)

**Parameters:**

<State>              `ON | OFF | 0 | 1`

**OFF | 0**

Switches the function off

**ON | 1**

Switches the function on

**Example:**            `CALC:LIM:STAT ON`  
                          Switches on the limit check for limit line 1.

**Manual operation:** See ["Disable All Lines"](#) on page 150

### **CALCulate<n>:LIMit<li>:TRACe<t>:CHECK <State>**

Turns the limit check for a specific trace on and off.

To query the limit check result, use `CALCulate<n>:LIMit<li>:FAIL?`.



Note that this command replaces the two commands from previous signal and spectrum analyzers (which are still supported, however):

- `CALC:LIM:TRAC`; see the description of commands for compatibility in the FSW User Manual
- `CALCulate<n>:LIMit<li>:STATe` on page 328

**Suffix:**

|      |            |
|------|------------|
| <n>  | Window     |
| <li> | Limit line |
| <t>  | Trace      |

**Parameters:**

|         |                           |
|---------|---------------------------|
| <State> | ON   OFF   0   1          |
|         | <b>OFF   0</b>            |
|         | Switches the function off |
|         | <b>ON   1</b>             |
|         | Switches the function on  |

**Example:**

```
CALC:LIM3:TRAC2:CHEC ON
```

Switches on the limit check for limit line 3 on trace 2.

**Manual operation:** See "[Traces to be Checked](#)" on page 149

**MMEMemory:LOAD<n>:LIMit <FileName>**

Loads the limit line from the selected file in .CSV format.

**Suffix:**

|     |            |
|-----|------------|
| <n> | irrelevant |
|-----|------------|

**Parameters:**

|            |   |
|------------|---|
| <FileName> | String containing the path and name of the CSV import file. |
|------------|---|

**Example:**

```
MMEM:LOAD:LIM 'C:\TEST.CSV'
```

**MMEMemory:STORe<n>:LIMit <FileName>, <LimitLineName>**

Exports limit line data to an ASCII (CSV) file.

**Suffix:**

|     |            |
|-----|------------|
| <n> | irrelevant |
|-----|------------|

**Parameters:**

|                 |   |
|-----------------|---|
| <FileName>      | String containing the path and name of the target file. |
| <LimitLineName> | Name of the limit line to be exported.                  |

**Example:**

```
MMEM:STOR:LIM 'C:\TEST', 'UpperLimitLine'
```

Stores the limit line named "UpperLimitLine" in the file TEST.CSV.

### 13.8.5.3 Checking the results of a limit check

|  |     |
|--|-----|
| <a href="#">CALCulate&lt;n&gt;:LIMit&lt;li&gt;:CLEar[:IMMEDIATE]</a> ..... | 330 |
| <a href="#">CALCulate&lt;n&gt;:LIMit&lt;li&gt;:FAIL?</a> .....             | 330 |

---

#### **CALCulate<n>:LIMit<li>:CLEar[:IMMEDIATE]**

Deletes the result of the current limit check.

The command works on *all* limit lines in *all* measurement windows at the same time.

#### **Suffix:**

<n>                      [Window](#)

<li>                      irrelevant

#### **Example:**

`CALC:LIM:CLE`

Deletes the result of the limit check.

---

#### **CALCulate<n>:LIMit<li>:FAIL?**

Queries the result of a limit check in the specified window.

To get a valid result, you have to perform a complete measurement with synchronization to the end of the measurement before reading out the result. This is only possible for single measurement mode.

See also [INITiate<n>:CONTinuous](#) on page 263.

#### **Suffix:**

<n>                      [Window](#)

<li>                      [Limit line](#)

#### **Return values:**

|          |          |
|----------|----------|
| <Result> | <b>0</b> |
|          | PASS     |
|          | <b>1</b> |
|          | FAIL     |

#### **Example:**

`INIT;*WAI`

Starts a new sweep and waits for its end.

`CALC2:LIM3:FAIL?`

Queries the result of the check for limit line 3 in window 2.

#### **Usage:**

Query only

### 13.8.5.4 Programming example: using limit lines

The following examples demonstrate how to work with limit lines in a remote environment.

- [Example: configuring limit lines](#).....331
- [Example: performing a limit check](#).....332

### Example: configuring limit lines

This example demonstrates how to configure 2 limit lines - an upper and a lower limit - for a measurement in a remote environment.

```
//----- Configuring the limit lines -----
CALC:LIM1:NAME 'FM1'
//Names limit line 1 'FM1'.

CALC:LIM1:CONT:MODE ABS
//Selects absolute scaling for the horizontal axis.
CALC:LIM1:CONT 1 MHz,50MHz,100 MHz,150MHz,200MHz
//Defines 5 horizontal definition points for limit line 1.
CALC:LIM1:UPP:MODE ABS
//Selects an absolute vertical scale for limit line 1.
CALC:LIM1:UNIT DBM
//Selects the unit dBm for limit line 1.
CALC:LIM1:UPP -10,-5,0,-5,-10
//Defines 5 definition points for limit line 1.

CALC:LIM1:UPP:MARG 5dB
//Defines an area of 5 dB around limit line 1 where limit check violations
//are still tolerated.

CALC:LIM1:UPP:SHIF -10DB
//Shifts the limit line 1 by -10 dB.
CALC:LIM1:UPP:OFFS -3dB
//Defines an additional -3 dB offset for limit line 1.

CALC:LIM3:NAME 'FM3'
//Names limit line 3 'FM3'.

CALC:LIM3:LOW:MODE REL
//Selects a relative vertical scale for limit line 3.
CALC:LIM3:UNIT DB

CALC:LIM3:CONT 1 MHz,50MHz,100 MHz,150MHz,200MHz
//Defines 5 horizontal definition points for limit line 3.
CALC:LIM3:LOW -90,-60,-40,-60,-90
//Defines 5 definition points relative to the reference level for limit line 3.

CALC:LIM3:LOW:SHIF 2
//Shifts the limit line 3 by 2dB.
CALC:LIM3:LOW:OFFS 3
//Defines an additional 3 dB offset for limit line 3.

CALC:LIM3:LOW:THR -200DBM
//Defines a power threshold of -200dBm that must be exceeded for limit to be checked

CALC:LIM3:LOW:MARG 5dB
//Defines an area of 5dB around limit line 3 where limit check violations
```

```
//are still tolerated.

//----- Storing the limit lines -----
MMEM:SEL:CHAN:LIN:ALL ON
MMEM:STOR:TYPE CHAN
MMEM:STOR:STAT 1,'LimitLines_FM1_FM3'
```

### Example: performing a limit check

This example demonstrates how to perform a limit check during a basic frequency sweep measurement in a remote environment. The limit lines configured in ["Example: configuring limit lines"](#) on page 331 are assumed to exist and be active.

```
//-----Preparing the instrument -----
*RST
//Resets the instrument
INIT:CONT OFF
//Selects single sweep mode.

//-----Configuring the measurement -----
FREQ:CENT 100MHz
//Defines the center frequency
FREQ:SPAN 200MHz
//Sets the span to 100 MHz on either side of the center frequency.
SENS:SWE:COUN 10
//Defines 10 sweeps to be performed in each measurement.
DISP:TRAC1:Y:RLEV 0dBm
//Sets the reference level to 0 dBm.
TRIG:SOUR IFP
TRIG:LEV:IFP -10dBm
//Defines triggering when the second intermediate frequency rises to a level
//of -10 dBm.

//-----Configuring the Trace-----
DISP:TRAC2 ON
DISP:TRAC2:MODE AVER
DISP:TRAC3 ON
DISP:TRAC3:MODE MAXH
//Configures 3 traces: 1 (default): clear/write; 2: average; 3: max hold

//----- Configuring the limit check -----
MMEM:LOAD:TYPE REPL
MMEM:LOAD:STAT 1,'LimitLines_FM1_FM3'
//Loads the limit lines stored in 'LimitLines_FM1_FM3'
CALC:LIM1:NAME 'FM1'
CALC:LIM1:UPP:STAT ON
//Activates upper limit FM1 as line 1.
CALC:LIM3:NAME 'FM3'
CALC:LIM3:LOW:STAT ON
//Activates lower limit line FM3 as line 3.
CALC:LIM:ACT?
```

```

//Queries the names of all active limit lines
//Result: 'FM1,FM3'
CALC:LIM1:TRAC3:CHEC ON
//Activates the upper limit to be checked against trace3 (maxhold trace)
CALC:LIM3:TRAC2:CHEC ON
//Activates the upper limit to be checked against trace2 (average trace)
CALC:LIM:CLE
//Clears the previous limit check results

//----- Performing the measurement-----
INIT;*WAI
//Initiates a new measurement and waits until the last sweep has finished.

//----- Retrieving limit check results-----

CALC:LIM1:FAIL?
//Queries the result of the upper limit line check
CALC:LIM3:FAIL?
//Queries the result of the lower limit line check

```

### 13.8.6 Zooming into the display

**DISPlay[:WINDow<n>]:ZOOM:AREA <x1>,<y1>,<x2>,<y2>**

This command defines the zoom area for the spectrogram (see [Chapter 6.5.4, "Zooming into the spectrogram"](#), on page 56).

To define a zoom area, you first have to turn the zoom on (see [DISPlay\[:WINDow<n>\]\[:SUBWindow<w>\]:ZOOM\[:STATe\]](#) on page 334).

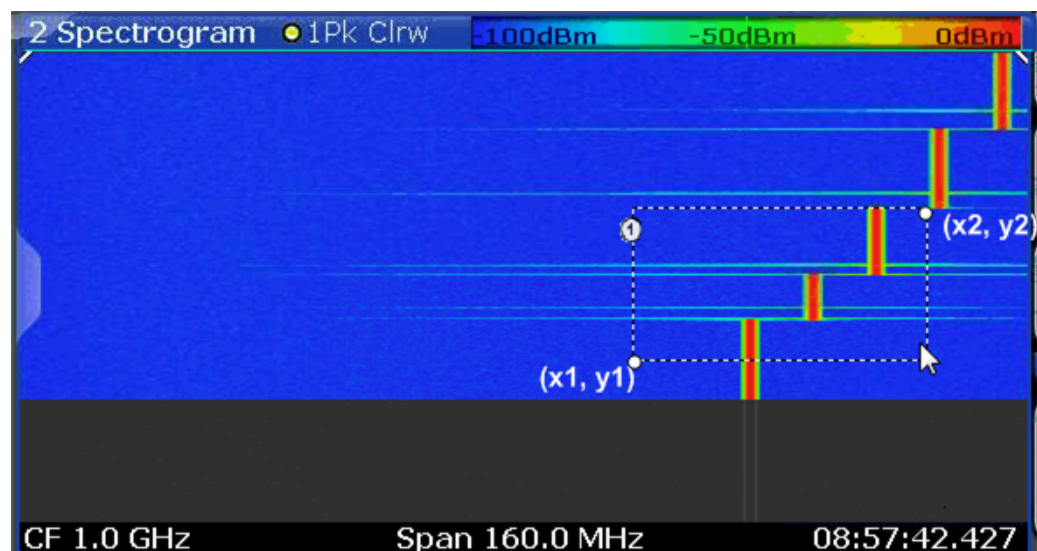

1 = zoom area (e.g. x1 = 1020 MHz, y1 = -80 ms, x2 = 1060 MHz, y2 = -40 ms)

(x1,y1) = zoom area start

(x2,y2) = zoom area end

**Suffix:**<n> [Window](#)**Parameters:**

&lt;x1&gt; Starting frequency for the zoom area. Left side of zoom area.

Range: CF - Span/2 to CF + Span/2

Default unit: Hz

&lt;y1&gt; Oldest time for zoom area. Bottom side of zoom area.

Range: starting time of spectrogram to 0

Default unit: s

&lt;x2&gt; Ending frequency for the zoom area. Right side of zoom area.

Range: CF - Span/2 to CF + Span/2

Default unit: Hz

&lt;y2&gt; Most recent time for zoom area. Top side of zoom area.

Range: starting time of spectrogram to 0

Default unit: s

**Example:**DISPlay:WINDow2:ZOOM:AREA 1020 MHz, -0.08 s,  
1060 MHz, -0.040 s;**Manual operation:** See "[Single Zoom](#)" on page 158**DISPlay[:WINDow<n>][:SUBWindow<w>]:ZOOM[:STATe] <State>**

Turns the zoom on and off.

**Suffix:**<n> [Window](#)<w> subwindow  
Not supported by all applications**Parameters:**

&lt;State&gt; ON | OFF | 0 | 1

**OFF | 0**

Switches the function off

**ON | 1**

Switches the function on

**Example:**DISP:ZOOM ON  
Activates the zoom mode.**Manual operation:** See "[Single Zoom](#)" on page 158  
See "[Restore Original Display](#)" on page 159

## 13.9 Querying the status registers

The "Real-Time Spectrum" application uses the standard status registers of the FSW, as well as the `STATUS:QUESTIONABLE:TIME` register.

The MSRT operating mode uses an additional bit in the `STATUS:OPERATION` register.

This register and the commands required to query its contents are described here.

For details on the common FSW status registers refer to the description of remote control basics in the FSW User Manual.



\*RST does not influence the status registers.

- [STATUS:OPERATION register](#)..... 335
- [STATUS:QUESTIONABLE:TIME register](#)..... 336
- [Commands to query the STATUS:OPERATION register](#)..... 336
- [Commands to query the STATUS:QUESTIONABLE:TIME register](#)..... 338

### 13.9.1 STATUS:OPERATION register

The `STATUS:OPERATION` register contains information on current activities of the FSW. It also contains information on activities that have been executed since the last read out.

You can read out the register with `STATUS:OPERATION:CONDITION?` on page 336 or `STATUS:OPERATION[:EVENT]?` on page 337.

**Table 13-5: Meaning of the bits used in the STATUS:OPERATION register**

| Bit No. | Meaning   |
|---------|---|
| 0       | <code>CALibrating</code><br>This bit is set as long as the instrument is performing a self-alignment.   |
| 1-2     | Not used  |
| 3       | <code>SWEEPing</code><br>Sweep is being performed in base unit (applications are not considered); identical to bit 4<br>In applications, this bit is not used.        |
| 4       | <code>MEASuring</code><br>Measurement is being performed in base unit (applications are not considered); identical to bit 3<br>In applications, this bit is not used. |
| 5       | <code>Waiting for TRigger</code><br>Instrument is ready to trigger and waiting for trigger signal.  |
| 6-7     | Not used  |
| 8       | <code>HardCOpy in progress</code><br>This bit is set while the instrument is printing a hardcopy.   |

| Bit No. | Meaning   |
|---------|---|
| 9       | For data acquisition in MSRT mode only:<br>Multi-Standard capture finish<br><br>This bit is set if a data acquisition measurement was completed successfully in MSRT operating mode and data is available for evaluation.<br><br>For details on the MSRT operating mode see the FSW "Real-Time Spectrum" Application and MSRT Operating Mode User Manual. |
| 11-14   | Not used  |
| 15      | This bit is always 0.   |

### 13.9.2 STATUS:QUESTIONABLE:TIME register

The `STATUS:QUESTIONABLE:TIME` register contains information about possible time errors that may occur during operation of the FSW. A separate time register exists for each active channel.

You can read out the register with `STATUS:QUESTIONABLE:TIME:CONDITION?` or `STATUS:QUESTIONABLE:TIME[:EVENT]?`

**Table 13-6: Meaning of the bits used in the STATUS:QUESTIONABLE:TIME register**

| Bit No. | Meaning   |
|---------|---|
| 0       | Real-Time Data Loss<br><br>This bit is set if the FSW loses data during the measurement and measurements are no longer possible in Real-Time. |
| 1 to 14 | Unused  |
| 15      | This bit is always 0.   |

### 13.9.3 Commands to query the STATUS:OPERATION register

The following commands are required to query the contents of the `STATUS:OPERATION` register.

|   |     |
|---|-----|
| <code>STATUS:OPERATION:CONDITION?</code> .....  | 336 |
| <code>STATUS:OPERATION:ENABLE</code> .....      | 337 |
| <code>STATUS:OPERATION:NTRANSITION</code> ..... | 337 |
| <code>STATUS:OPERATION:PTRANSITION</code> ..... | 337 |
| <code>STATUS:OPERATION[:EVENT]?</code> .....    | 337 |

---

#### **STATUS:OPERATION:CONDITION? <ChannelName>**

This command reads out the `CONDITION` section of the status register.

The command does not delete the contents of the `EVENT` section.



**Query parameters:**

<ChannelName> String containing the name of the channel.  
The parameter is optional. If you omit it, the command works for the currently active channel.

**Usage:** Query only

**STATus:OPERation:ENABLE** <SumBit>,<ChannelName>**Parameters:**

<SumBit>

**Query parameters:**

<ChannelName> String containing the name of the channel.  
The parameter is optional. If you omit it, the command works for the currently active channel.

**STATus:OPERation:NTRansition** <SumBit>,<ChannelName>**Parameters:**

<SumBit>

**Query parameters:**

<ChannelName> String containing the name of the channel.  
The parameter is optional. If you omit it, the command works for the currently active channel.

**STATus:OPERation:PTRansition** <SumBit>,<ChannelName>**Parameters:**

<SumBit>

**Query parameters:**

<ChannelName> String containing the name of the channel.  
The parameter is optional. If you omit it, the command works for the currently active channel.

**STATus:OPERation[:EVENT]?** <ChannelName>

Queries the contents of the EVENT section of the status register.

A query deletes the contents of the EVENT section.

**Query parameters:**

<ChannelName> String containing the name of the channel.  
The parameter is optional. If you omit it, the command works for the currently active channel.

**Return values:**

<RegisterContents> Range: 0 to 32767

**Usage:** Query only

### 13.9.4 Commands to query the STATus:QUEStionable:TIME register

The following commands are required to query the contents of the STATus:QUEStionable:TIME register.

|                                      |     |
|--------------------------------------|-----|
| STATus:QUEStionable:TIME:CONDition?  | 338 |
| STATus:QUEStionable:TIME:ENABle      | 338 |
| STATus:QUEStionable:TIME:NTRansition | 338 |
| STATus:QUEStionable:TIME:PTRansition | 339 |
| STATus:QUEStionable:TIME[:EVENT]?    | 339 |

---

#### STATus:QUEStionable:TIME:CONDition? [<ChannelName>]

These commands read out the CONDition section of the status register.

The commands do not delete the contents of the CONDition section.

##### Suffix:

<n> [Window](#)

##### Query parameters:

<ChannelName> String containing the name of the channel.  
The parameter is optional. If you omit it, the command works for the currently active channel.

**Usage:** Query only

---

#### STATus:QUEStionable:TIME:ENABle <SumBit>[, <ChannelName>]

These commands control the ENABle part of a register.

The ENABle part allows true conditions in the EVENT part of the status register to be reported in the summary bit. If a bit is 1 in the enable register and its associated event bit transitions to true, a positive transition will occur in the summary bit reported to the next higher level.

##### Suffix:

<n> [Window](#)

##### Parameters:

<SumBit> Range: 0 to 65535

<ChannelName> String containing the name of the channel.  
The parameter is optional. If you omit it, the command works for the currently active channel.

---

#### STATus:QUEStionable:TIME:NTRansition <SumBit>[, <ChannelName>]

These commands control the Negative TRansition part of a register.

Setting a bit causes a 1 to 0 transition in the corresponding bit of the associated register. The transition also writes a 1 into the associated bit of the corresponding EVENT register.

**Suffix:**<n> [Window](#)**Parameters:**

&lt;SumBit&gt; Range: 0 to 65535

<ChannelName> String containing the name of the channel.  
The parameter is optional. If you omit it, the command works for the currently active channel.**STATus:QUEStionable:TIME:PTRansition** <SumBit>[, <ChannelName>]

These commands control the Positive TRansition part of a register.

Setting a bit causes a 0 to 1 transition in the corresponding bit of the associated register. The transition also writes a 1 into the associated bit of the corresponding EVENT register.

**Suffix:**<n> [Window](#)**Parameters:**

&lt;SumBit&gt; Range: 0 to 65535

<ChannelName> String containing the name of the channel.  
The parameter is optional. If you omit it, the command works for the currently active channel.**STATus:QUEStionable:TIME[:EVENT]?** [<ChannelName>]

These commands read out the EVENT section of the status register.

At the same time, the commands delete the contents of the EVENT section.

**Suffix:**<n> [Window](#)**Query parameters:**<ChannelName> String containing the name of the channel.  
The parameter is optional. If you omit it, the command works for the currently active channel.**Usage:** Query only

## 13.10 Deprecated commands

Note that these commands are maintained for compatibility with the R&S FSVR only. Use the specified commands for new remote control programs.



### DISPlay:WINDow[:SUBWindow] commands

For compatibility with the R&S FSVR, the commands required to configure the persistence spectrum (see [Chapter 13.5.7, "Configuring the persistence spectrum"](#), on page 242) also accept the optional SUBWindow keyword (DISPlay:WINDow[:SUBWindow] . . .). However, this keyword is ignored and has no effect on remote control.

[CALCulate<n>:FEED](#)..... 340

---

### CALCulate<n>:FEED <ResultDisplay>

This command selects the result display in Real-Time mode.

Note that this command is maintained for compatibility reasons only. Use the LAYout commands for new remote control programs (see [Chapter 13.5.10.2, "Working with windows in the display"](#), on page 254).

#### Suffix:

<n>                      Window

#### Parameters:

|                 |  |
|-----------------|--|
| <ResultDisplay> | 'XFRequency:RFPower:SPEctrum'                    |
|                 | 'XFRequency[:SPEctrum]'                          |
|                 | Selects the Real-Time spectrum result display.   |
|                 | 'XFRequency:RFPower:SGRam'                       |
|                 | 'XFRequency:SGRam'                               |
|                 | Selects the spectrogram result display.          |
|                 | 'XFRequency:RFPower:PSPEctrum'                   |
|                 | 'XFRequency:PSPEctrum'                           |
|                 | Selects the persistence spectrum result display. |
|                 | 'XTIME:RFPower[:TDOMain]'                        |
|                 | 'XTIME[:TDOMain]'                                |
|                 | Selects the power vs. time result display.       |
|                 | 'XTIME:RFPower:SGRam'                            |
|                 | 'XTIME:SGRam'                                    |
|                 | Selects the power vs. time waterfall diagram.    |
|                 | *RST:            SPEctrum                        |

#### Example:

```
CALC:FEED 'XFR:PSP'
```

Starts the persistence spectrum result display.

## 13.11 Remote commands for MSRT operating mode

The following commands are required to perform measurements in the Multi-Standard Real-Time (MSRT) operating mode. For details see [Chapter 4, "Applications and operating modes"](#), on page 20.

- [Activating real-time measurements in MSRT mode](#).....341
- [Analyzing real-time measurements in MSRT mode](#).....342

### 13.11.1 Activating real-time measurements in MSRT mode

Real-Time measurements requires a special operating mode on the FSW. A measurement is started immediately with the default settings.



The special MSRT primary measurement channel is of the channel type "RTIM" and is referred to by the channel name "MSRT primary". This channel cannot be replaced, deleted, or renamed.

[INSTrument:MODE](#)..... 341

---

#### **INSTrument:MODE** <OpMode>

The operating mode of the FSW determines which applications are available and active. Whenever you change the operating mode, the currently active channels are closed. The default operating mode is Signal and Spectrum Analyzer mode, however, the presetting can be changed.

(See the "Instrument Setup" chapter in the FSW User Manual).

For details on operating modes and applications see [Chapter 4, "Applications and operating modes"](#), on page 20.

#### **Parameters:**

<OpMode>

#### **SANalyzer**

Signal and Spectrum Analyzer mode

#### **MSRanalyzer**

Multi-Standard Radio Analysis (MSRA) mode

#### **RTMStandard**

Multi-Standard Real-Time (MSRT) mode

Only available if one of the real-time options is installed.

\*RST: SAN

#### **Example:**

```
INST:MODE RTMS
```

Switches to Multi-Standard Real-Time (MSRT) mode.

#### **Manual operation:**

See "[Switching the operating mode](#)" on page 23

### 13.11.2 Analyzing real-time measurements in MSRT mode

The data that was captured by the MSRT primary can be analyzed in various different secondary applications.

The analysis settings and functions available in MSRT mode are those described for the individual secondary applications. The MSRT primary is in effect a "Real-Time Spectrum" application and has the same analysis functions and settings.

#### Configuring an Analysis Interval and Line

In MSRT operating mode, only the MSRT primary actually captures data; the MSRT secondary applications define an extract of the captured data for analysis, referred to as the **analysis interval**. The **analysis line** is a common time marker for all MSRT secondary applications.

In addition, a capture offset can be defined, i.e. an offset from the start of the captured data to the start of the analysis interval for the "Real-Time Spectrum" measurement.

#### Remote commands exclusive to MSRT secondary applications

The following commands are only available for MSRT secondary application channels:

|                                       |     |
|---------------------------------------|-----|
| CALCulate<n>:RTMS:ALINe:SHOW.....     | 342 |
| CALCulate<n>:RTMS:ALINe[:VALue].....  | 343 |
| CALCulate<n>:RTMS:WINDow<n>:IVAL..... | 343 |
| INITiate<n>:REFresh.....              | 343 |
| [SENSe:]RTMS:CAPTure:OFFSet.....      | 344 |

---

#### CALCulate<n>:RTMS:ALINe:SHOW

Defines whether or not the analysis line is displayed in all time-based windows in all MSRT secondary applications and the MSRT primary.

**Note:** even if the analysis line display is off, the indication whether or not the currently defined line position lies within the analysis interval of the active secondary application remains in the window title bars.

#### Suffix:

<n>                      irrelevant

#### Parameters:

<State>                ON | OFF | 0 | 1  
**OFF | 0**  
 Switches the function off  
**ON | 1**  
 Switches the function on

**Manual operation:** See "Show Line" on page 160

---

**CALCulate<n>:RTMS:ALINe[:VALue]** <Position>

Defines the position of the analysis line for all time-based windows in all MSRT secondary applications and the MSRT primary.

**Suffix:**

<n> irrelevant

**Parameters:**

<Position> Position of the analysis line in seconds. The position must lie within the measurement time (pretrigger + posttrigger) of the MSRT measurement.

Default unit: s

**Manual operation:** See "[Position](#)" on page 160

---

**CALCulate<n>:RTMS:WINDow<n>:IVAL**

Returns the current analysis interval for applications in MSRT operating mode.

**Suffix:**

<n> irrelevant

<n> 1..n  
[Window](#)

**Return values:**

<IntStart> Analysis start = Capture offset time  
Default unit: s

<IntStop> Analysis end = capture offset + capture time  
Default unit: s

---

**INITiate<n>:REFresh**

Updates the current measurement results to reflect the current measurement settings.

No new I/Q data is captured. Thus, measurement settings apply to the I/Q data currently in the capture buffer.

The command applies exclusively to I/Q measurements. It requires I/Q data.

**Suffix:**

<n> irrelevant

**Example:**

INIT:REFR

Updates the IQ measurement results.

**Usage:**

Asynchronous command

**Manual operation:** See "[Refresh \(MSRT only\)](#)" on page 115

**[SENSe:]RTMS:CAPTure:OFFSet <Offset>**

This setting is only available for secondary applications in MSRT mode, not for the MSRT primary. It has a similar effect as the trigger offset in other measurements.

**Parameters:**

<Offset>

This parameter defines the time offset between the capture buffer start and the start of the extracted secondary application data. The offset must be a positive value, as the secondary application can only analyze data that is contained in the capture buffer.

Range: - [pretrigger time] to min (posttrigger time; sweep time)

\*RST: 0

Default unit: S

**Manual operation:** See "[Capture Offset](#)" on page 113

## 13.12 Programming examples: performing real-time measurements

The following programming examples demonstrate how to perform Real-Time measurements in a remote environment.



Some commands in the following examples may not be necessary as they reflect the default settings; however, they are included to demonstrate the command usage.

- [Example 1: creating a frequency mask trigger](#).....344
- [Example 2: performing a basic real-time measurement](#).....345
- [Example 3: analyzing persistency](#).....348
- [Example 4: obtaining time domain results in real-time](#).....351

### 13.12.1 Example 1: creating a frequency mask trigger

In this example we will create a frequency mask trigger with an upper and lower mask. This trigger mask can be used in [Example 2: performing a basic real-time measurement](#).

```
//----- Configuring a frequency mask trigger -----
//Store trigger mask as 'C:\R_S\INSTR\freqmask\myFMTS\NewFreqMaskTrigger'
//Note the 'myFMTS' subdirectory must be created under 'C:\R_S\INSTR\freqmask'
//beforehand.
CALC:MASK:CDIR 'myFMTS'
CALC:MASK:NAME 'NewFreqMaskTrigger'
CALC:MASK:COMM 'Upper and lower frequency mask'

//----- Defining an upper frequency mask automatically -----
```



## Programming examples: performing real-time measurements

```

//Use relative scaling for the level axis
CALC:MASK:MODE REL
//Define a span of 20 MHz
CALC:MASK:SPAN 20000000
//Configure automatic upper mask according to measured spectrum
CALC:MASK:UPP:AUTO
//Query the mask points for the upper mask
CALC:MASK:UPP:DATA?
//Result: comma-separated list of value pairs (Frequency, level);
//one for each data point
//Example:
//-9.990009990E+006,-9.600020599E+001,-9.230769231E+006,-8.738758087E+001,
//-8.831168831E+006,-9.565835571E+001,-7.972027972E+006,-8.494093323E+001,
//...
//+8.171828172E+006,-8.577051544E+001,+8.631368631E+006,-9.534964752E+001,
//+9.530469530E+006,-8.848562622E+001,+9.990009990E+006,-9.600020599E+001

//----- Configuring the lower frequency mask manually -----
//Configure lower mask 20 dB lower than upper mask;
//Use upper mask as basis, then shift all values by 20 dB
CALC:MASK:LOW:STAT ON
CALC:MASK:LOW:DATA -9.990009990E+006,-9.600020599E+001,-9.230769231E+006,-8.738758087E+001,
-8.831168831E+006,-9.565835571E+001,-7.972027972E+006,-8.494093323E+001,
-7.492507493E+006,-9.450020599E+001,-6.793206793E+006,-7.878201294E+001,
-6.693306693E+006,-7.925418091E+001,-6.213786214E+006,-9.578102112E+001,
-5.414585415E+006,-3.991313553E+001,-4.995004995E+006,-3.050031662E+001,
-4.575424575E+006,-3.975288010E+001,-3.776223776E+006,-9.574020386E+001,
-3.296703297E+006,-7.856089020E+001,-2.777222777E+006,-8.525804901E+001,
-2.497502498E+006,-9.450020599E+001,-1.878121878E+006,-8.315855408E+001,
-1.258741259E+006,-9.424127960E+001,-1.238761239E+006,-9.424189758E+001,
-1.058941058E+006,-8.987026215E+001,-4.995004995E+005,-9.452841949E+001,
-3.308057785E-006,-9.450020599E+001,+5.394605395E+005,-8.521303558E+001,
+1.238761239E+006,-9.425141144E+001,+1.258741259E+006,-9.425095367E+001,
+1.858141858E+006,-8.382637787E+001,+2.497502497E+006,-9.450020599E+001,
+2.817182817E+006,-8.492385864E+001,+3.356643357E+006,-8.088692474E+001,
+3.756243756E+006,-9.698367310E+001,+4.535464535E+006,-4.851605225E+001,
+4.995004995E+006,-3.950028992E+001,+5.454545455E+006,-4.873092270E+001,
+6.213786214E+006,-9.597808838E+001,+6.273726274E+006,-9.304232788E+001,
+6.773226773E+006,-8.045437622E+001,+7.492507493E+006,-9.450020599E+001,
+8.171828172E+006,-8.577051544E+001,+8.631368631E+006,-9.534964752E+001,
+9.530469530E+006,-8.848562622E+001,+9.990009990E+006,-9.600020599E+001
CALC:MASK:LOW:SHIFT:Y -20

```

### 13.12.2 Example 2: performing a basic real-time measurement

The first measurement example performs a basic Real-Time measurement in the frequency domain with the default display configuration (Real-Time spectrum and spectrogram). It uses a frequency mask trigger stored as

C:\R\_S\INSTR\freqmask\myFMTS\NewFreqMaskTrigger, as described in [Example 1: creating a frequency mask trigger](#).



To perform a basic Real-Time measurement without a frequency mask trigger, simply remove the section Using a Frequency Mask Trigger in the following example.

```
//-----Preparing the instrument -----
//Reset the instrument
*RST

//----- Activating a Real-Time measurement channel -----
//Activate a Real-Time measurement channel named "Real-Time"
INST:CRE:NEW RTIM, 'Real-Time'

//Stop the current measurement
INIT:CONT OFF

//----- Configuring the Measurement -----
//Define the center frequency
FREQ:CENT 100MHz
//Set the span to 10 MHz on either side of the center frequency.
FREQ:SPAN 20MHz

//Set the reference level to 0 dBm
DISP:TRAC:Y:SCAL:RLEV 0

//Couple the RBW to the span, with RBW/span = 0.000625
BAND:RAT 0.000625
//Use a Gaussian FFT window function
SWE:FFT:WIND:TYPE GAUS
//Collect data for 20 ms for each spectrum
SWE:TIME 0.02

//----- Using a Frequency Mask Trigger -----
//Configure the use of an existing frequency mask (from Example 4) as a trigger
TRIG:SOUR MASK
//Select the mask to use
CALC:MASK:CDIR 'myFMTS'
CALC:MASK:NAME 'NewFreqMaskTrigger'
//Trigger on entering the frequency mask
TRIG:MASK:COND ENT

//Define a pretrigger period of 10 ms, posttrigger = 0.5 s
TRIG:PRET 0.001
TRIG:POST 0.5
//Use rearming trigger mode to perform continuous measurements
TRIG:MODE CONT

//----- Configuring the result displays -----
```

## Programming examples: performing real-time measurements

```

//Clear the initial spectrogram results
CALC2:SPEC:CLE
//Store up to 1000 spectrogram frames
CALC2:SPEC:HDEP 1000

//----- Configuring spectrogram color mapping -----
//Use grayscale coloring
DISP:WIND2:SPEC:COL GRAY
//Configure a value range from 0.5% to 95%
DISP:WIND2:SPEC:COL:LOW 0.5
DISP:WIND2:SPEC:COL:UPP 95
//Change the shape of the color mapping function to distribute more colors among
//high values
DISP:WIND2:SPEC:COL:SHAP 0.35

//----- Performing the Measurement -----
//Initiate a new measurement
INIT:CONT ON
INIT:IMM
//Wait until some measurements have been performed.
INIT:CONT OFF

//----- Retrieving Results -----
//Query the spectrogram results for the Real-Time measurement
CALC2:SPEC:TST:DATA? ALL
//Result: 4 values for each of the measured frames indicating the time passed
//since 01.01.1970 till the start of the frame, e.g.:
//1370524679,49559852,0,0,1370524679,18552034,0,0,
//1370524678,987161993,0,0,1370524678,971568114,0,0,
//...
//1370524670,79975615,0,0,1370524670,48813821,0,0
//First frame: 01.01.1970 + 1370524670 seconds
//Most recent frame: 01.01.1970 + 1370524679 seconds
//Measurement duration: 1370524679 s - 1370524670 s = 9 s

//Return the 1001 measured power levels for each of the measured frames
TRAC2:DATA? SPEC

//Store the spectrogram to a file
MMEM:STOR2:SPEC 'C:\temp\spectrogram'

//Query spectrum results for the most recent spectrum
CALC2:SPEC:FRAM:SEL 0
TRAC1:DATA:X? TRACE1
TRAC1:DATA? TRACE1

//Query spectrum results for the previous spectrum
CALC2:SPEC:TST OFF
//Use frame index instead of time stamp
CALC2:SPEC:FRAM:SEL -1

```

```

TRAC1:DATA:X? TRACE1
TRAC1:DATA? TRACE1
//Store these spectrum results to a file
MMEM:STOR1:TRAC 1,'C:\temp\FirstSpectrum'

//----- Analyzing the results using markers -----
//Set marker1 on the peak power in the most recent spectrum and query
//its position
CALC2:SPEC:FRAM:SEL 0
CALC2:MARK1 ON
CALC2:MARK1:X?
CALC2:MARK1:Y?

//Set marker2 on the peak power in frame -1 and query its position
CALC2:MARK2 ON
CALC2:MARK2:SGR:FRAM -1s
CALC2:MARK2:X?
CALC2:MARK2:Y?

//Set marker3 on peak power level in the entire spectrogram in memory and
//query its position
CALC2:MARK3 ON
CALC2:MARK:SPEC:SAR MEM
CALC2:MARK3:SPEC:XY:MAX
CALC2:MARK3:X?
CALC2:MARK3:Y?

//Move marker 3 to the next lower peak level for the same frequency
CALC2:MARK3:SPEC:Y:MAX:NEXT
CALC2:MARK3:X?
CALC2:MARK3:Y?

//Set marker4 on the most recent trigger event in the spectrogram and query
//its position
CALC2:MARK4 ON
CALC2:MARK4:SPEC:Y:TRIG
CALC2:MARK4:X?
CALC2:MARK4:Y?

```

### 13.12.3 Example 3: analyzing persistency

This measurement example performs a basic Real-Time measurement in the frequency domain with an additional persistence spectrum window. It uses a frequency mask trigger stored as

C:\R\_S\INSTR\freqmask\myFMTS\NewFreqMaskTrigger, as described in [Example 1: creating a frequency mask trigger](#).



To perform a basic Real-Time measurement without a frequency mask trigger, simply remove the section Using a Frequency Mask Trigger in the following example.

```
//-----Preparing the instrument -----
//Reset the instrument
*RST

//----- Activating a Real-Time measurement channel -----
//Activate a Real-Time measurement channel named "Real-Time"
INST:CRE:NEW RTIM, 'Real-Time'

//Stop the current measurement
INIT:CONT OFF

//----- Configuring the Measurement -----
//Define the center frequency
FREQ:CENT 100MHz
//Set the span to 10 MHz on either side of the center frequency.
FREQ:SPAN 20MHz

//Set the reference level to 0 dBm
DISP:TRAC:Y:SCAL:RLEV 0

//Couple the RBW to the span, with RBW/span = 0.000625
BAND:RAT 0.000625
//Use a Gaussian FFT window function
SWE:FFT:WIND:TYPE GAUS
//Collect data for 20 ms for each spectrum
SWE:TIME 0.02

//----- Using a Frequency Mask Trigger -----
//Configure the use of an existing frequency mask (from Example 4) as a trigger
TRIG:SOUR MASK
//Select the mask to use
CALC:MASK:CDIR 'myFMTS'
CALC:MASK:NAME 'NewFreqMaskTrigger'
//Trigger on entering the frequency mask
TRIG:MASK:COND ENT

//Define a pretrigger period of 10 ms, posttrigger = 0.5 s
TRIG:PRET 0.001
TRIG:POST 0.5
//Use rearming trigger mode to perform continuous measurements
TRIG:MODE CONT

//----- Configuring the result displays -----
//Add a persistence spectrum result display
LAY:ADD? '1',RIGH, 'XFrequency:PSpectrum'
//Result: '3'
```

## Programming examples: performing real-time measurements

```
//Clear the initial spectrogram results
CALC2:SPEC:CLE

//Configure vector-style trace for an uninterrupted (interpolated)
//persistence spectrum
DISP:WIND:TRAC:SYMB VECT

//Define a persistence duration of 1.2 s
DISP:WIND:TRAC:PERS:DUR 1.2
//Use the data captured in 120 ms for a single frame (persistence granularity)
DISP:WIND:TRAC:PERS:GRAN 0.12

//Activate the maxhold trace in the persistence spectrum display
DISP:WIND:TRAC:MAXH ON
//Define an intensity of 125 for the maxhold trace
DISP:WIND:TRAC:MAXH:INT 125
//Clear the maxhold trace
DISP:WIND:TRAC:MAXH:RES

//----- Configuring persistence color mapping -----
//Use greyscale coloring
DISP:WIND:PSP:COL GRAY
//Configure a value range from 0.5% to 95%
DISP:WIND:PSP:COL:LOW 0.5
DISP:WIND:PSP:COL:UPP 95
//Reduce the range of the color map if no hits are found at the value range edges
DISP:WIND:PSP:COL:TRUN ON
//Change the shape of the color mapping function to distribute more colors among
//high values
DISP:WIND:PSP:COL:SHAP 0.35

//----- Performing the Measurement -----
//Initiate a new measurement and wait until some measurements have been performed.
INIT:CONT ON
INIT:IMM
INIT:CONT OFF

//----- Retrieving Results -----
//Query the persistence spectrum results
TRAC3:DATA? PSP
//Result: 1001*600 percentages, one for each pixel in the histogram

//Return the 1001 measured power levels for the most recent spectrum
TRAC3:DATA? TRACE1

//Return the 1001*600 maximum probabilities for the maxhold trace
TRAC3:DATA? HMAX

//Store the persistence spectrum to a file
```

```
MMEM:STOR3:PSP 'C:\temp\persistence'
```

### 13.12.4 Example 4: obtaining time domain results in real-time

This example demonstrates how to obtain results in the time domain in a Real-Time measurement. It uses a trigger based on power levels measured in the time domain.

```
//-----Preparing the instrument -----
//Reset the instrument
*RST

//----- Activating a Real-Time measurement channel -----

//Activate a Real-Time measurement channel named "Real-Time"
INST:CRE:NEW RTIM,'Real-Time'

//Stop the current measurement
INIT:CONT OFF

//----- Configuring the measurement -----
//Define the center frequency
FREQ:CENT 100MHz
//Set the span to the maximum
FREQ:SPAN:FULL

//Set the reference level to 0 dBm
DISP:TRAC:Y:SCAL:RLEV 0

//Use a rectangular FFT window function
SWE:FFT:WIND:TYPE RECT
//Use a coupling ratio RBW/span = 0.00125
BAND:RAT 0.00125
//Query the resulting RBW (125 kHz)
BAND?
//Result: 125000
//Collect data for 20 ms for each spectrum
SWE:TIME 0.02
//Collect data for 15 ms for each PVT diagram
SENS3:SWE:TIME 0.015

//Configure a power level trigger at -50dBm
TRIG:SOUR TDTR
TRIG:TDTR:LEV -50
//Define a pretrigger period of 10 ms, posttrigger = 0.5 s
TRIG:PRET 0.001
TRIG:POST 0.5
//Use stop on trigger mode to perform only one measurement
TRIG:MODE STOP
```

## Programming examples: performing real-time measurements

```
//----- Configuring the result displays -----  
//Clear the initial spectrogram and PVT waterfall results  
CALC2:SPEC:CLE  
CALC4:SPEC:CLE  
//Store up to 1000 spectrogram or PVT frames  
CALC2:SPEC:HDEP 1000  
//Use index instead of time stamps to identify individual frames  
CALC2:SPEC:TST OFF  
  
//----- Configuring waterfall color mapping -----  
//Use grayscale coloring  
DISP:WIND4:SPEC:COL GRAY  
//Configure a value range from 0.5% to 95%  
DISP:WIND4:SPEC:COL:LOW 0.5  
DISP:WIND4:SPEC:COL:UPP 95  
//Change the shape of the color mapping function to distribute more colors among  
//high values  
DISP:WIND4:SPEC:COL:SHAP 0.35  
  
//----- Performing the Measurement -----  
//Initiate a new measurement and wait until a measurement has been performed  
INIT;*WAI  
  
//----- Retrieving Results -----  
//Return the 1001 measured power levels for each PVT diagram  
TRAC4:DATA? SPEC  
  
//Store the PVT waterfall diagram to a file  
MMEM:STOR4:SPEC 'C:\temp\PVTWaterfall'  
  
//Query time and power values for the most recent PVT  
CALC2:SPEC:FRAM:SEL 0  
TRAC3:DATA:X? TRACE1  
TRAC3:DATA? TRACE1  
//Store these PVT results to a file  
MMEM:STOR3:TRAC 1, 'C:\temp\PVT'  
  
//Query time and power values for the previous PVT  
CALC2:SPEC:FRAM:SEL -1  
TRAC3:DATA:X? TRACE1  
TRAC3:DATA? TRACE1
```



# Annex

## A Reference: ASCII file export format

Trace data (for example Real-Time spectrum, persistence spectrum, or spectrogram) can be exported to a file in ASCII format for further evaluation in other applications.

The file consists of the header containing important measurement parameters and a data section containing the trace data.

Generally, the format of this ASCII file can be processed by spreadsheet calculation programs, e.g. MS-Excel. Different language versions of evaluation programs may require a different handling of the decimal point. Thus you can define the decimal separator to be used (decimal point or comma, see "[Decimal Separator](#)" on page 128).

The data of the file header consist of three columns, each separated by a semicolon: parameter name; numeric value; basic unit. The data section contains the measured data in two columns, which are also separated by a semicolon.

The file contents vary depending on the result type.

**Table A-1: ASCII file format for Spectrum trace export**

| File contents                    | Description              |
|----------------------------------|--------------------------|
| <b>Header data</b>               |                          |
| Type;FSW;                        | Instrument model         |
| Version;1.80;                    | Firmware version         |
| Date;20.Jul 2013;                | Date of data set storage |
| Mode;Real-Time;                  | Channel type             |
| Preamplifier;OFF;                | Preamplifier state       |
| Transducer;OFF;                  | Transducer state         |
| Center Freq;1000000000.000000;Hz | Center frequency         |
| Freq Offset;0.000000;Hz          | Frequency offset         |
| Start;920000000.000000;Hz        | Start frequency          |
| Stop;1080000000.000000;Hz        | Stop frequency           |
| Span;160000000.000000;Hz         | Measured span            |
| Ref Level;0.000000;dBm           | Reference level          |
| Level Offset;0.000000;dB         | Reference level offset   |
| Rf Att;10.000000;dB              | Input attenuation        |
| EI Att;0.000000;dB               | Electronic attenuation   |
| RBW;800000.000000;Hz             | Resolution bandwidth     |
| SWT;0.030000;s                   | Sweep time               |

| File contents   | Description                                 |
|---|---|
| Sweep Count;0;  | Number of sweeps                            |
| Window;1;"Real-Time Spectrum"   | Window containing the exported results      |
| Ref Position;100.000000; %  | Reference level position in percent         |
| Level Range;100.000000;dB   | Power level (y-axis) range                  |
| x-Axis;LIN;   | x-axis scaling mode (linear, log.)          |
| y-Axis;LOG;   | y-axis scaling mode (linear, log.)          |
| x-Unit;Hz;  | x-axis unit                                 |
| y-Unit;dBm;   | y-axis unit                                 |
| <b>Data section</b>   |   |
| Trace;1;  | Trace number                                |
| Trace Mode;CLR/WRITE;   | Trace mode                                  |
| Detector;MAXPEAK;   | Detector used for trace                     |
| Values; 1001;   | Number of measured frequencies              |
| 1317000000;-100.50020599365234;<br>13170160000;-100.16989898681641;<br>...;...; | Measured values: <frequency>, <power level> |

Table A-2: ASCII file format for persistence spectrum trace export

| File contents                    | Description              |
|----------------------------------|--------------------------|
| <b>Header data</b>               |                          |
| Type;FSW;                        | Instrument model         |
| Version;1.80;                    | Firmware version         |
| Date;20.Jul 2013;                | Date of data set storage |
| Mode;Real-Time;                  | Channel type             |
| Preamplifier;OFF;                | Preamplifier state       |
| Transducer;OFF;                  | Transducer state         |
| Center Freq;1000000000.000000;Hz | Center frequency         |
| Freq Offset;0.000000;Hz          | Frequency offset         |
| Start;920000000.000000;Hz        | Start frequency          |
| Stop;1080000000.000000;Hz        | Stop frequency           |
| Span;160000000.000000;Hz         | Measured span            |
| Ref Level;0.000000;dBm           | Reference level          |
| Level Offset;0.000000;dB         | Reference level offset   |
| Rf Att;10.000000;dB              | Input attenuation        |

| File contents  | Description  |
|--|--|
| EI Att;0.000000;dB   | Electronic attenuation   |
| RBW;800000.000000;Hz   | Resolution bandwidth   |
| SWT;0.030000;s   | Sweep time   |
| Sweep Count;0;   | Number of sweeps   |
| Trace Mode;CLR/WRITE;MAXHOLD;  | Display mode of traces: 1. CLR/WRITE; 2.MAXHOLD  |
| Detector;PERSISTENCE;  | Detector used for trace (none for persistence)   |
| <b>Data section</b>  |  |
| Values; 1001;600;  | Number of measurement points for x-axis (frequency) and y-axis (power)   |
| 920000000;920160000;920320000;920480000;<br>...<br>1079520000;1079680000;1079840000;1080000000 | 1001 frequency values used for histogram   |
| -37.5;-37.583472454090149;<br>...<br>-87.416527545909844;-87.5                                 | 600 power levels used for histogram  |
| CLR/WRITE  | Introduction for persistence spectrum data   |
| 0;0;0;<br>...<br>0.60534548759460449;0.37962344288825989                                       | 1000*600 most recently calculated percentage values in histogram from top left to bottom right, that is, starting with the lowest frequency and highest power value and ending with the highest frequency and lowest power level<br> |
| MAXHOLD  | Introduction for MAXHOLD data  |
| 0;0;0;<br>...<br>0.90801829099655151;0.56943517923355103                                       | 1000*600 maximum percentage values for MAXHOLD trace from top left to bottom right, that is, starting with the lowest frequency and highest power value and ending with the highest frequency and lowest power level   |

Table A-3: ASCII file format for spectrogram trace export

| File contents      | Description              |
|--------------------|--------------------------|
| <b>Header data</b> |                          |
| Type;FSW;          | Instrument model         |
| Version;1.80;      | Firmware version         |
| Date;20.Jul 2013;  | Date of data set storage |

| File contents                            | Description                            |
|--|--|
| Mode;Real-Time;                          | Channel type                           |
| Preamplifier;OFF;                        | Preamplifier state                     |
| Transducer;OFF;                          | Transducer state                       |
| Center Freq;1000000000.000000;Hz         | Center frequency                       |
| Freq Offset;0.000000;Hz                  | Frequency offset                       |
| Start;920000000.000000;Hz                | Start frequency                        |
| Stop;1080000000.000000;Hz                | Stop frequency                         |
| Span;160000000.000000;Hz                 | Measured span                          |
| Ref Level;0.000000;dBm                   | Reference level                        |
| Level Offset;0.000000;dB                 | Reference level offset                 |
| Rf Att;10.000000;dB                      | Input attenuation                      |
| EI Att;0.000000;dB                       | Electronic attenuation                 |
| RBW;800000.000000;Hz                     | Resolution bandwidth                   |
| SWT;0.030000;s                           | Sweep time                             |
| Sweep Count;0;                           | Number of sweeps                       |
| Window;1;"Real-Time Spectrum"            | Window containing the exported results |
| Ref Position;100.000000; %               | Reference level position in percent    |
| Level Range;100.000000;dB                | Power level (y-axis) range             |
| x-Axis;LIN;                              | x-axis scaling mode (linear, log.)     |
| y-Axis;LOG;                              | y-axis scaling mode (linear, log.)     |
| x-Unit;Hz;                               | x-axis unit                            |
| y-Unit;dBm;                              | y-axis unit                            |
| <b>Data section</b>                      |  |
| Trace;1;                                 | Trace number                           |
| Trace Mode;CLR/WRITE;                    | Trace mode                             |
| Detector;MAXPEAK;                        | Detector used for trace                |
| Values; 1001;                            | Number of measured frequencies         |
| Frames;130;                              | Number of exported frames              |
| <b>Data section for individual frame</b> |  |
| Frame;0;                                 | Most recent frame number               |
| Timestamp;29.Jul 13;08:51:19.355         | Timestamp of this frame                |

| File contents   | Description  |
|---|--|
| 10000;-10.3;-15.7<br>10130;-11.5;-16.9<br>10360;-12.0;-17.4<br>...;...; | Measured values:<br><frequency>; <power value1>; <power value2>;<br><power value 2> only for AUTOPEAK detector; contains the minimum of the two measured values for each measurement point |
| <b>Data section for individual frame</b>                                |  |
| Frame;-1;   | Previous frame   |
| Timestamp;29.Jul 13;08:51:19.278  | Timestamp of this frame  |
| ...   |  |

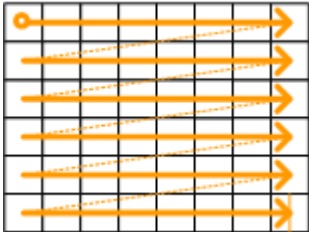
## List of commands (Real-Time)

|   |     |
|---|-----|
| [SENSe:]WINDow:DETEctor<t>[:FUNction].....        | 284 |
| [SENSe:]ADJust:ALL.....                           | 250 |
| [SENSe:]ADJust:CONFigure:HYSTeresis:LOWer.....    | 252 |
| [SENSe:]ADJust:CONFigure:HYSTeresis:UPPer.....    | 252 |
| [SENSe:]ADJust:CONFigure:LEVel:DURation.....      | 251 |
| [SENSe:]ADJust:CONFigure:LEVel:DURation:MODE..... | 251 |
| [SENSe:]ADJust:CONFigure:TRIGger.....             | 253 |
| [SENSe:]ADJust:FREQuency.....                     | 252 |
| [SENSe:]ADJust:LEVel.....                         | 253 |
| [SENSe:]AVERage<n>:COUNT.....                     | 283 |
| [SENSe:]AVERage<n>[:STATe<t>].....                | 284 |
| [SENSe:]BANDwidth[:RESolution].....               | 223 |
| [SENSe:]BANDwidth[:RESolution]:RATio.....         | 223 |
| [SENSe:]CORRection:CVL:BAND.....                  | 204 |
| [SENSe:]CORRection:CVL:BIAS.....                  | 204 |
| [SENSe:]CORRection:CVL:CATalog?.....              | 205 |
| [SENSe:]CORRection:CVL:CLEar.....                 | 205 |
| [SENSe:]CORRection:CVL:COMMeNt.....               | 205 |
| [SENSe:]CORRection:CVL:DATA.....                  | 206 |
| [SENSe:]CORRection:CVL:HARMonic.....              | 206 |
| [SENSe:]CORRection:CVL:MIXer.....                 | 206 |
| [SENSe:]CORRection:CVL:PORTs.....                 | 207 |
| [SENSe:]CORRection:CVL:SElect.....                | 207 |
| [SENSe:]CORRection:CVL:SNUMber.....               | 207 |
| [SENSe:]FREQuency:CENTer.....                     | 219 |
| [SENSe:]FREQuency:CENTer:STEP.....                | 220 |
| [SENSe:]FREQuency:CENTer:STEP:AUTO.....           | 220 |
| [SENSe:]FREQuency:CENTer:STEP:LINK.....           | 220 |
| [SENSe:]FREQuency:CENTer:STEP:LINK:FACTor.....    | 221 |
| [SENSe:]FREQuency:OFFSet.....                     | 221 |
| [SENSe:]FREQuency:SPAN.....                       | 221 |
| [SENSe:]FREQuency:STARt.....                      | 222 |
| [SENSe:]FREQuency:STOP.....                       | 222 |
| [SENSe:]IQ:FFT:LENGth.....                        | 275 |
| [SENSe:]MIXer<x>:BIAS:HIGH.....                   | 197 |
| [SENSe:]MIXer<x>:BIAS[:LOW].....                  | 197 |
| [SENSe:]MIXer<x>:FREQuency:HANDover.....          | 198 |
| [SENSe:]MIXer<x>:FREQuency:STARt.....             | 199 |
| [SENSe:]MIXer<x>:FREQuency:STOP.....              | 199 |
| [SENSe:]MIXer<x>:HARMonic:BAND.....               | 199 |
| [SENSe:]MIXer<x>:HARMonic:BAND:PRESet.....        | 199 |
| [SENSe:]MIXer<x>:HARMonic:HIGH:STATe.....         | 200 |
| [SENSe:]MIXer<x>:HARMonic:HIGH[:VALue].....       | 200 |
| [SENSe:]MIXer<x>:HARMonic:TYPE.....               | 201 |
| [SENSe:]MIXer<x>:HARMonic[:LOW].....              | 201 |
| [SENSe:]MIXer<x>:IF?.....                         | 201 |
| [SENSe:]MIXer<x>:LOPower.....                     | 198 |

|   |     |
|---|-----|
| [SENSe:]MIXer<x>:LOSS:HIGH.....                                       | 202 |
| [SENSe:]MIXer<x>:LOSS:TABLE:HIGH.....                                 | 202 |
| [SENSe:]MIXer<x>:LOSS:TABLE[:LOW].....                                | 202 |
| [SENSe:]MIXer<x>:LOSS[:LOW].....                                      | 203 |
| [SENSe:]MIXer<x>:PORTs.....   | 203 |
| [SENSe:]MIXer<x>:RFOVerrange[:STATe].....                             | 203 |
| [SENSe:]MIXer<x>[:STATe].....   | 197 |
| [SENSe:]RTMS:CAPTure:OFFSet.....                                      | 344 |
| [SENSe:]SWEep:COUNT.....  | 223 |
| [SENSe:]SWEep:DTIME.....  | 224 |
| [SENSe:]SWEep:DTIME:AUTO.....   | 224 |
| [SENSe:]SWEep:FFT:WINDow:TYPE.....                                    | 225 |
| [SENSe:]SWEep:TIME.....   | 225 |
| [SENSe:]SWEep:TIME:AUTO.....  | 225 |
| ABORt.....  | 262 |
| CALCulate<n>:DELTAmarker<m>:AOFF.....                                 | 289 |
| CALCulate<n>:DELTAmarker<m>:FUNCTion:FIXed:RPOint:MAXimum[:PEAK]..... | 293 |
| CALCulate<n>:DELTAmarker<m>:FUNCTion:FIXed:RPOint:X.....              | 293 |
| CALCulate<n>:DELTAmarker<m>:FUNCTion:FIXed:RPOint:Y.....              | 294 |
| CALCulate<n>:DELTAmarker<m>:FUNCTion:FIXed[:STATe].....               | 292 |
| CALCulate<n>:DELTAmarker<m>:LINK.....                                 | 289 |
| CALCulate<n>:DELTAmarker<m>:MAXimum:LEFT.....                         | 303 |
| CALCulate<n>:DELTAmarker<m>:MAXimum:NEXT.....                         | 303 |
| CALCulate<n>:DELTAmarker<m>:MAXimum:RIGHT.....                        | 304 |
| CALCulate<n>:DELTAmarker<m>:MAXimum[:PEAK].....                       | 303 |
| CALCulate<n>:DELTAmarker<m>:MINimum:LEFT.....                         | 304 |
| CALCulate<n>:DELTAmarker<m>:MINimum:NEXT.....                         | 304 |
| CALCulate<n>:DELTAmarker<m>:MINimum:RIGHT.....                        | 305 |
| CALCulate<n>:DELTAmarker<m>:MINimum[:PEAK].....                       | 304 |
| CALCulate<n>:DELTAmarker<m>:MODE.....                                 | 290 |
| CALCulate<n>:DELTAmarker<m>:MREFerence.....                           | 290 |
| CALCulate<n>:DELTAmarker<m>:SGRam:FRAME.....                          | 311 |
| CALCulate<n>:DELTAmarker<m>:SGRam:SARea.....                          | 311 |
| CALCulate<n>:DELTAmarker<m>:SGRam:XY:MAXimum[:PEAK].....              | 312 |
| CALCulate<n>:DELTAmarker<m>:SGRam:XY:MINimum[:PEAK].....              | 312 |
| CALCulate<n>:DELTAmarker<m>:SGRam:Y:MAXimum:ABOVe.....                | 312 |
| CALCulate<n>:DELTAmarker<m>:SGRam:Y:MAXimum:BELow.....                | 312 |
| CALCulate<n>:DELTAmarker<m>:SGRam:Y:MAXimum:NEXT.....                 | 313 |
| CALCulate<n>:DELTAmarker<m>:SGRam:Y:MAXimum[:PEAK].....               | 313 |
| CALCulate<n>:DELTAmarker<m>:SGRam:Y:MINimum:ABOVe.....                | 313 |
| CALCulate<n>:DELTAmarker<m>:SGRam:Y:MINimum:BELow.....                | 313 |
| CALCulate<n>:DELTAmarker<m>:SGRam:Y:MINimum:NEXT.....                 | 314 |
| CALCulate<n>:DELTAmarker<m>:SGRam:Y:MINimum[:PEAK].....               | 314 |
| CALCulate<n>:DELTAmarker<m>:SPECTrogram:FRAME.....                    | 311 |
| CALCulate<n>:DELTAmarker<m>:SPECTrogram:SARea.....                    | 311 |
| CALCulate<n>:DELTAmarker<m>:SPECTrogram:XY:MAXimum[:PEAK].....        | 312 |
| CALCulate<n>:DELTAmarker<m>:SPECTrogram:XY:MINimum[:PEAK].....        | 312 |
| CALCulate<n>:DELTAmarker<m>:SPECTrogram:Y:MAXimum:ABOVe.....          | 312 |
| CALCulate<n>:DELTAmarker<m>:SPECTrogram:Y:MAXimum:BELow.....          | 312 |
| CALCulate<n>:DELTAmarker<m>:SPECTrogram:Y:MAXimum:NEXT.....           | 313 |

|  |     |
|--|-----|
| CALCulate<n>:DELTamarker<m>:SPECtrogram:Y:MAXimum[:PEAK] | 313 |
| CALCulate<n>:DELTamarker<m>:SPECtrogram:Y:MINimum:ABOVE  | 313 |
| CALCulate<n>:DELTamarker<m>:SPECtrogram:Y:MINimum:BELOW  | 313 |
| CALCulate<n>:DELTamarker<m>:SPECtrogram:Y:MINimum:NEXT   | 314 |
| CALCulate<n>:DELTamarker<m>:SPECtrogram:Y:MINimum[:PEAK] | 314 |
| CALCulate<n>:DELTamarker<m>:TRACe                        | 291 |
| CALCulate<n>:DELTamarker<m>:X                            | 291 |
| CALCulate<n>:DELTamarker<m>:X:RELative?                  | 267 |
| CALCulate<n>:DELTamarker<m>:Y                            | 292 |
| CALCulate<n>:DELTamarker<m>:Y?                           | 292 |
| CALCulate<n>:DELTamarker<m>:Z                            | 267 |
| CALCulate<n>:DELTamarker<m>[:STATe]                      | 291 |
| CALCulate<n>:DLINe<dl>                                   | 315 |
| CALCulate<n>:DLINe<dl>:STATe                             | 315 |
| CALCulate<n>:FEED  | 340 |
| CALCulate<n>:FLINe<dl>                                   | 315 |
| CALCulate<n>:FLINe<dl>:STATe                             | 316 |
| CALCulate<n>:LIMit<li>:ACTive?                           | 327 |
| CALCulate<n>:LIMit<li>:CLEar[:IMMediate]                 | 330 |
| CALCulate<n>:LIMit<li>:COMMeNt                           | 318 |
| CALCulate<n>:LIMit<li>:CONTRol:DOMain                    | 318 |
| CALCulate<n>:LIMit<li>:CONTRol:MODE                      | 319 |
| CALCulate<n>:LIMit<li>:CONTRol:OFFSet                    | 319 |
| CALCulate<n>:LIMit<li>:CONTRol:SHIFt                     | 320 |
| CALCulate<n>:LIMit<li>:CONTRol:SPACing                   | 320 |
| CALCulate<n>:LIMit<li>:CONTRol[:DATA]                    | 318 |
| CALCulate<n>:LIMit<li>:COPIE                             | 327 |
| CALCulate<n>:LIMit<li>:DELeTe                            | 328 |
| CALCulate<n>:LIMit<li>:FAIL?                             | 330 |
| CALCulate<n>:LIMit<li>:LOWer:MARGIn                      | 321 |
| CALCulate<n>:LIMit<li>:LOWer:MODE                        | 321 |
| CALCulate<n>:LIMit<li>:LOWer:OFFSet                      | 321 |
| CALCulate<n>:LIMit<li>:LOWer:SHIFt                       | 322 |
| CALCulate<n>:LIMit<li>:LOWer:SPACing                     | 322 |
| CALCulate<n>:LIMit<li>:LOWer:STATe                       | 322 |
| CALCulate<n>:LIMit<li>:LOWer:THReshold                   | 323 |
| CALCulate<n>:LIMit<li>:LOWer[:DATA]                      | 320 |
| CALCulate<n>:LIMit<li>:NAME                              | 323 |
| CALCulate<n>:LIMit<li>:STATe                             | 328 |
| CALCulate<n>:LIMit<li>:TRACe<t>:CHECK                    | 328 |
| CALCulate<n>:LIMit<li>:UNIT                              | 323 |
| CALCulate<n>:LIMit<li>:UPPer:MARGIn                      | 324 |
| CALCulate<n>:LIMit<li>:UPPer:MODE                        | 324 |
| CALCulate<n>:LIMit<li>:UPPer:OFFSet                      | 325 |
| CALCulate<n>:LIMit<li>:UPPer:SHIFt                       | 325 |
| CALCulate<n>:LIMit<li>:UPPer:SPACing                     | 326 |
| CALCulate<n>:LIMit<li>:UPPer:STATe                       | 326 |
| CALCulate<n>:LIMit<li>:UPPer:THReshold                   | 326 |
| CALCulate<n>:LIMit<li>:UPPer[:DATA]                      | 324 |
| CALCulate<n>:MARKer<m>:AOFF                              | 287 |



|   |     |
|---|-----|
| CALCulate<n>:MARKer<m>:FUNction:CENTer.....               | 300 |
| CALCulate<n>:MARKer<m>:FUNction:REFerence.....            | 211 |
| CALCulate<n>:MARKer<m>:LOEXclude.....                     | 296 |
| CALCulate<n>:MARKer<m>:MAXimum:AUTO.....                  | 296 |
| CALCulate<n>:MARKer<m>:MAXimum:LEFT.....                  | 301 |
| CALCulate<n>:MARKer<m>:MAXimum:NEXT.....                  | 301 |
| CALCulate<n>:MARKer<m>:MAXimum:RIGHT.....                 | 301 |
| CALCulate<n>:MARKer<m>:MAXimum[:PEAK].....                | 301 |
| CALCulate<n>:MARKer<m>:MINimum:AUTO.....                  | 296 |
| CALCulate<n>:MARKer<m>:MINimum:LEFT.....                  | 302 |
| CALCulate<n>:MARKer<m>:MINimum:NEXT.....                  | 302 |
| CALCulate<n>:MARKer<m>:MINimum:RIGHT.....                 | 302 |
| CALCulate<n>:MARKer<m>:MINimum[:PEAK].....                | 302 |
| CALCulate<n>:MARKer<m>:PEXCursion.....                    | 297 |
| CALCulate<n>:MARKer<m>:SGRam:FRAMe.....                   | 306 |
| CALCulate<n>:MARKer<m>:SGRam:SARea.....                   | 306 |
| CALCulate<n>:MARKer<m>:SGRam:XY:MAXimum[:PEAK].....       | 307 |
| CALCulate<n>:MARKer<m>:SGRam:XY:MINimum[:PEAK].....       | 307 |
| CALCulate<n>:MARKer<m>:SGRam:Y:MAXimum:ABOVe.....         | 307 |
| CALCulate<n>:MARKer<m>:SGRam:Y:MAXimum:BELOW.....         | 308 |
| CALCulate<n>:MARKer<m>:SGRam:Y:MAXimum:NEXT.....          | 308 |
| CALCulate<n>:MARKer<m>:SGRam:Y:MAXimum[:PEAK].....        | 308 |
| CALCulate<n>:MARKer<m>:SGRam:Y:MINimum:ABOVe.....         | 308 |
| CALCulate<n>:MARKer<m>:SGRam:Y:MINimum:BELOW.....         | 309 |
| CALCulate<n>:MARKer<m>:SGRam:Y:MINimum:NEXT.....          | 309 |
| CALCulate<n>:MARKer<m>:SGRam:Y:MINimum[:PEAK].....        | 309 |
| CALCulate<n>:MARKer<m>:SGRam:Y:TRIGger.....               | 310 |
| CALCulate<n>:MARKer<m>:SPECTrogram:FRAMe.....             | 306 |
| CALCulate<n>:MARKer<m>:SPECTrogram:SARea.....             | 306 |
| CALCulate<n>:MARKer<m>:SPECTrogram:XY:MAXimum[:PEAK]..... | 307 |
| CALCulate<n>:MARKer<m>:SPECTrogram:XY:MINimum[:PEAK]..... | 307 |
| CALCulate<n>:MARKer<m>:SPECTrogram:Y:MAXimum:ABOVe.....   | 307 |
| CALCulate<n>:MARKer<m>:SPECTrogram:Y:MAXimum:BELOW.....   | 308 |
| CALCulate<n>:MARKer<m>:SPECTrogram:Y:MAXimum:NEXT.....    | 308 |
| CALCulate<n>:MARKer<m>:SPECTrogram:Y:MAXimum[:PEAK].....  | 308 |
| CALCulate<n>:MARKer<m>:SPECTrogram:Y:MINimum:ABOVe.....   | 308 |
| CALCulate<n>:MARKer<m>:SPECTrogram:Y:MINimum:BELOW.....   | 309 |
| CALCulate<n>:MARKer<m>:SPECTrogram:Y:MINimum:NEXT.....    | 309 |
| CALCulate<n>:MARKer<m>:SPECTrogram:Y:MINimum[:PEAK].....  | 309 |
| CALCulate<n>:MARKer<m>:SPECTrogram:Y:TRIGger.....         | 310 |
| CALCulate<n>:MARKer<m>:TRACe.....                         | 288 |
| CALCulate<n>:MARKer<m>:X.....                             | 288 |
| CALCulate<n>:MARKer<m>:X:SLIMits:LEFT.....                | 298 |
| CALCulate<n>:MARKer<m>:X:SLIMits:RIGHT.....               | 298 |
| CALCulate<n>:MARKer<m>:X:SLIMits:ZOOM[:STATe].....        | 299 |
| CALCulate<n>:MARKer<m>:X:SLIMits[:STATe].....             | 297 |
| CALCulate<n>:MARKer<m>:X:SSIZe.....                       | 294 |
| CALCulate<n>:MARKer<m>:Y.....                             | 289 |
| CALCulate<n>:MARKer<m>:Y?.....                            | 289 |
| CALCulate<n>:MARKer<m>:Z?.....                            | 267 |

|   |     |
|---|-----|
| CALCulate<n>:MARKer<m>[:STATe].....               | 287 |
| CALCulate<n>:MASK:CDIRectory.....                 | 231 |
| CALCulate<n>:MASK:COMMeNt.....                    | 231 |
| CALCulate<n>:MASK:DELeTe.....                     | 232 |
| CALCulate<n>:MASK:LOWer:SHIFt:X.....              | 232 |
| CALCulate<n>:MASK:LOWer:SHIFt:Y.....              | 232 |
| CALCulate<n>:MASK:LOWer:STATe.....                | 233 |
| CALCulate<n>:MASK:LOWer[:DATA].....               | 233 |
| CALCulate<n>:MASK:MODE.....                       | 234 |
| CALCulate<n>:MASK:NAME.....                       | 234 |
| CALCulate<n>:MASK:SPAN.....                       | 234 |
| CALCulate<n>:MASK:UPPer:AUTO.....                 | 235 |
| CALCulate<n>:MASK:UPPer:SHIFt:X.....              | 235 |
| CALCulate<n>:MASK:UPPer:SHIFt:Y.....              | 235 |
| CALCulate<n>:MASK:UPPer:STATe.....                | 236 |
| CALCulate<n>:MASK:UPPer[:DATA].....               | 236 |
| CALCulate<n>:MATH<t>:MODE.....                    | 285 |
| CALCulate<n>:MATH<t>:POSItion.....                | 286 |
| CALCulate<n>:MATH<t>:STATe.....                   | 286 |
| CALCulate<n>:MATH<t>[:EXPRession][:DEFine].....   | 285 |
| CALCulate<n>:RTMS:ALINe:SHOW.....                 | 342 |
| CALCulate<n>:RTMS:ALINe:VALue].....               | 343 |
| CALCulate<n>:RTMS:WINDow<n>:IVAL.....             | 343 |
| CALCulate<n>:SGRam:CLear[:IMMediate].....         | 239 |
| CALCulate<n>:SGRam:FRAMe:SELeCt.....              | 240 |
| CALCulate<n>:SGRam:HDEPth.....                    | 240 |
| CALCulate<n>:SGRam:TSTamp:DATA.....               | 241 |
| CALCulate<n>:SGRam:TSTamp[:STATe].....            | 241 |
| CALCulate<n>:SPECTrogram:CLear[:IMMediate].....   | 239 |
| CALCulate<n>:SPECTrogram:COLor.....               | 248 |
| CALCulate<n>:SPECTrogram:FRAMe:SELeCt.....        | 240 |
| CALCulate<n>:SPECTrogram:HDEPth.....              | 240 |
| CALCulate<n>:SPECTrogram:TSTamp:DATA?.....        | 241 |
| CALCulate<n>:SPECTrogram:TSTamp[:STATe].....      | 241 |
| CALCulate<n>:THReshold.....                       | 299 |
| CALCulate<n>:THReshold:STATe.....                 | 300 |
| CALCulate<n>:TLINe<dl>.....                       | 316 |
| CALCulate<n>:TLINe<dl>:STATe.....                 | 317 |
| CALCulate<n>:UNIT:POWer.....                      | 211 |
| CONFigure:REALtime:MEASurement.....               | 189 |
| DIAGnostic:SERVice:NSource.....                   | 210 |
| DISPlay:FORMat.....                               | 254 |
| DISPlay[:WINDow<n>]:MINFo[:STATe].....            | 295 |
| DISPlay[:WINDow<n>]:MTABLE.....                   | 295 |
| DISPlay[:WINDow<n>]:PSPectrum:COLor:DEFault.....  | 246 |
| DISPlay[:WINDow<n>]:PSPectrum:COLor:LOWer.....    | 246 |
| DISPlay[:WINDow<n>]:PSPectrum:COLor:SHAPE.....    | 246 |
| DISPlay[:WINDow<n>]:PSPectrum:COLor:TRUNcate..... | 247 |
| DISPlay[:WINDow<n>]:PSPectrum:COLor:UPPer.....    | 247 |
| DISPlay[:WINDow<n>]:PSPectrum:COLor[:STYLE].....  | 248 |

|  |     |
|--|-----|
| DISPlay[:WINDow<n>]:SIZE.....  | 254 |
| DISPlay[:WINDow<n>]:SPECTrogram:COLor:DEFault.....                       | 249 |
| DISPlay[:WINDow<n>]:SPECTrogram:COLor:LOWer.....                         | 249 |
| DISPlay[:WINDow<n>]:SPECTrogram:COLor:SHAPE.....                         | 249 |
| DISPlay[:WINDow<n>]:SPECTrogram:COLor:UPPer.....                         | 250 |
| DISPlay[:WINDow<n>]:SPECTrogram:COLor[:STYLe].....                       | 248 |
| DISPlay[:WINDow<n>]:ZOOM:AREA.....                                       | 333 |
| DISPlay[:WINDow<n>][:SUBWindow<w>]:TRACe<t>:MAXHold:INTensity.....       | 243 |
| DISPlay[:WINDow<n>][:SUBWindow<w>]:TRACe<t>:MAXHold:RESet.....           | 242 |
| DISPlay[:WINDow<n>][:SUBWindow<w>]:TRACe<t>:MAXHold[:STATe].....         | 243 |
| DISPlay[:WINDow<n>][:SUBWindow<w>]:TRACe<t>:MODE.....                    | 281 |
| DISPlay[:WINDow<n>][:SUBWindow<w>]:TRACe<t>:MODE:HCONTinuous.....        | 281 |
| DISPlay[:WINDow<n>][:SUBWindow<w>]:TRACe<t>:PERSistence:DURation.....    | 244 |
| DISPlay[:WINDow<n>][:SUBWindow<w>]:TRACe<t>:PERSistence:GRANularity..... | 244 |
| DISPlay[:WINDow<n>][:SUBWindow<w>]:TRACe<t>:PERSistence[:STATe].....     | 245 |
| DISPlay[:WINDow<n>][:SUBWindow<w>]:TRACe<t>:SMOothing:APERture.....      | 282 |
| DISPlay[:WINDow<n>][:SUBWindow<w>]:TRACe<t>:SMOothing[:STATe].....       | 283 |
| DISPlay[:WINDow<n>][:SUBWindow<w>]:TRACe<t>:SYMBOL.....                  | 245 |
| DISPlay[:WINDow<n>][:SUBWindow<w>]:TRACe<t>:Y:SPACing.....               | 219 |
| DISPlay[:WINDow<n>][:SUBWindow<w>]:TRACe<t>:Y[:SCALE].....               | 217 |
| DISPlay[:WINDow<n>][:SUBWindow<w>]:TRACe<t>:Y[:SCALE]:AUTO ONCE.....     | 217 |
| DISPlay[:WINDow<n>][:SUBWindow<w>]:TRACe<t>:Y[:SCALE]:MODE.....          | 217 |
| DISPlay[:WINDow<n>][:SUBWindow<w>]:TRACe<t>:Y[:SCALE]:PDIVision.....     | 218 |
| DISPlay[:WINDow<n>][:SUBWindow<w>]:TRACe<t>:Y[:SCALE]:RLEVel.....        | 212 |
| DISPlay[:WINDow<n>][:SUBWindow<w>]:TRACe<t>:Y[:SCALE]:RLEVel:OFFSet..... | 212 |
| DISPlay[:WINDow<n>][:SUBWindow<w>]:TRACe<t>:Y[:SCALE]:RPOSition.....     | 218 |
| DISPlay[:WINDow<n>][:SUBWindow<w>]:TRACe<t>[:STATe].....                 | 282 |
| DISPlay[:WINDow<n>][:SUBWindow<w>]:ZOOM[:STATe].....                     | 334 |
| FORMat:DEXPort:DSEParator.....   | 274 |
| FORMat:DEXPort:HEADer.....   | 275 |
| FORMat:DEXPort:TRACes.....   | 275 |
| FORMat[:DATA].....   | 268 |
| INITiate:SEQuencer:ABORT.....  | 264 |
| INITiate:SEQuencer:IMMEDIATE.....  | 264 |
| INITiate:SEQuencer:MODE.....   | 265 |
| INITiate:SEQuencer:REFResh[:ALL].....                                    | 265 |
| INITiate<n>:CONMeas.....   | 263 |
| INITiate<n>:CONTinuous.....  | 263 |
| INITiate<n>:REFResh.....   | 343 |
| INITiate<n>[:IMMEDIATE].....   | 264 |
| INPut:ATTenuation.....   | 213 |
| INPut:ATTenuation:AUTO.....  | 213 |
| INPut:ATTenuation:AUTO:MODE.....   | 214 |
| INPut:ATTenuation:PROTection:RESet.....                                  | 190 |
| INPut:CONNector.....   | 191 |
| INPut:COUPling.....  | 191 |
| INPut:DPATH.....   | 191 |
| INPut:EATT.....  | 214 |
| INPut:EATT:AUTO.....   | 214 |
| INPut:EATT:STATe.....  | 215 |

|   |     |
|---|-----|
| INPut:EGain[:STATe].....                | 215 |
| INPut:FiLTer:HPASs[:STATe].....         | 192 |
| INPut:FiLTer:YIG[:STATe].....           | 192 |
| INPut:GAIN:STATe.....                   | 216 |
| INPut:GAIN[:VALue].....                 | 216 |
| INPut:IMPedance.....                    | 192 |
| INPut:SElect.....                       | 193 |
| INPut:TYPE.....                         | 193 |
| INSTRument:CREate:DUPLicate.....        | 185 |
| INSTRument:CREate:REPLace.....          | 186 |
| INSTRument:CREate[:NEW].....            | 185 |
| INSTRument:DElete.....                  | 186 |
| INSTRument:LIST?.....                   | 187 |
| INSTRument:MODE.....                    | 341 |
| INSTRument:REName.....                  | 187 |
| INSTRument[:SElect].....                | 188 |
| LAYout:ADD[:WINDow]?.....               | 255 |
| LAYout:CATalog[:WINDow]?.....           | 256 |
| LAYout:IDENtify[:WINDow]?.....          | 257 |
| LAYout:MOVE[:WINDow].....               | 257 |
| LAYout:REMOve[:WINDow].....             | 258 |
| LAYout:REPLace[:WINDow].....            | 258 |
| LAYout:SPLitter.....                    | 258 |
| LAYout:WINDow<n>:ADD?.....              | 260 |
| LAYout:WINDow<n>:IDENtify?.....         | 260 |
| LAYout:WINDow<n>:REMOve.....            | 261 |
| LAYout:WINDow<n>:REPLace.....           | 261 |
| MMEMory:LOAD<n>:LIMit.....              | 329 |
| MMEMory:STORe<n>:IQ:COMMeNt.....        | 279 |
| MMEMory:STORe<n>:IQ:FORMat.....         | 279 |
| MMEMory:STORe<n>:IQ:STATe.....          | 279 |
| MMEMory:STORe<n>:LIMit.....             | 329 |
| MMEMory:STORe<n>:PSPeCtrum.....         | 272 |
| MMEMory:STORe<n>:SPeCtrogram.....       | 273 |
| MMEMory:STORe<n>:TRACe.....             | 274 |
| OUTPut:DIQ[:STATe].....                 | 194 |
| OUTPut:IQHS:CDEvice?.....               | 195 |
| OUTPut:IQHS:MARKer.....                 | 196 |
| OUTPut:IQHS:SRATe?.....                 | 196 |
| OUTPut:IQHS[:STATe].....                | 196 |
| OUTPut:TRIGger<tp>:DIReCtion.....       | 237 |
| OUTPut:TRIGger<tp>:LEVel.....           | 237 |
| OUTPut:TRIGger<tp>:OTYPe.....           | 238 |
| OUTPut:TRIGger<tp>:PULSe:IMMeDiate..... | 238 |
| OUTPut:TRIGger<tp>:PULSe:LENGth.....    | 239 |
| OUTPut<up>:DIQ:CDEvice?.....            | 194 |
| STATus:OPERation:CONDition?.....        | 336 |
| STATus:OPERation:ENABle.....            | 337 |
| STATus:OPERation:NTRansiion.....        | 337 |
| STATus:OPERation:PTRansiion.....        | 337 |

|  |     |
|--|-----|
| STATus:OPERation[:EVENT]?.....                 | 337 |
| STATus:QUEStionable:TIME:CONDition?.....       | 338 |
| STATus:QUEStionable:TIME:ENABle.....           | 338 |
| STATus:QUEStionable:TIME:NTRansition.....      | 338 |
| STATus:QUEStionable:TIME:PTRansition.....      | 339 |
| STATus:QUEStionable:TIME[:EVENT]?.....         | 339 |
| SYSTem:PRESet:CHANnel[:EXEC].....              | 188 |
| SYSTem:PRESet:COMPAtible.....                  | 188 |
| SYSTem:SEQuencer.....                          | 266 |
| SYSTem:SPEaker:VOLume.....                     | 210 |
| TRACe:IQ:BWIDth.....                           | 276 |
| TRACe:IQ:DATA:FORMat.....                      | 276 |
| TRACe:IQ:DATA:MEMory?.....                     | 276 |
| TRACe:IQ:RENGth.....                           | 277 |
| TRACe:IQ:SRATe.....                            | 278 |
| TRACe:IQ:TPISAmple?.....                       | 278 |
| TRACe<n>:COPY.....                             | 284 |
| TRACe<n>[:DATA].....                           | 269 |
| TRACe<n>[:DATA]:MEMory?.....                   | 270 |
| TRACe<n>[:DATA]:X?.....                        | 270 |
| TRIGger:MODE.....                              | 226 |
| TRIGger[:SEQuence]:HOLDoff[:TIME].....         | 227 |
| TRIGger[:SEQuence]:IFPower:HOLDoff.....        | 227 |
| TRIGger[:SEQuence]:LEVel[:EXTernal<port>]..... | 227 |
| TRIGger[:SEQuence]:MASK:CONDition.....         | 236 |
| TRIGger[:SEQuence]:POSTtrigger[:TIME].....     | 228 |
| TRIGger[:SEQuence]:PRETrigger[:TIME].....      | 228 |
| TRIGger[:SEQuence]:SLOPe.....                  | 229 |
| TRIGger[:SEQuence]:SOURce.....                 | 229 |
| TRIGger[:SEQuence]:TDTRigger:LEVel.....        | 230 |
| UNIT<n>:POWER.....                             | 211 |

# Index

## Symbols

|                         |     |
|-------------------------|-----|
| *OPC .....              | 226 |
| 3-D PVT waterfall       |     |
| Evaluation method ..... | 35  |
| 3-D Spectrogram         |     |
| Evaluation method ..... | 30  |

## A

|                                       |          |
|---------------------------------------|----------|
| Aborting                              |          |
| Sweep .....                           | 107      |
| AC/DC coupling .....                  | 80       |
| Activating                            |          |
| MSRT (remote) .....                   | 341      |
| Amplitude                             |          |
| Configuration .....                   | 87       |
| Scaling .....                         | 93       |
| Settings .....                        | 87       |
| Analog Demodulation                   |          |
| Real-Time secondary application ..... | 22       |
| Analysis                              |          |
| Remote control .....                  | 280      |
| Settings .....                        | 116      |
| Analysis interval .....               | 69       |
| Configuration .....                   | 159      |
| Configuration (MSRT, remote) .....    | 342      |
| I/Q Analyzer .....                    | 113, 159 |
| Start .....                           | 69       |
| Analysis line .....                   | 71       |
| Configuration .....                   | 159      |
| Configuration (MSRT, remote) .....    | 342      |
| Application cards .....               | 9        |
| Application data .....                | 68       |
| Application notes .....               | 9        |
| Applications                          |          |
| Real-Time Spectrum .....              | 22       |
| see MSRT secondary applications ..... | 20       |
| ASCII trace export .....              | 353      |
| Attenuation                           |          |
| Auto .....                            | 90       |
| Electronic .....                      | 90       |
| Manual .....                          | 90       |
| Option .....                          | 90       |
| Protective (remote) .....             | 190      |
| Audio demodulation                    |          |
| Volume (remote control) .....         | 210      |
| Auto adjustment                       |          |
| Triggered measurement .....           | 253      |
| Auto all .....                        | 109      |
| Auto frequency .....                  | 110      |
| Auto level                            |          |
| Hysteresis .....                      | 110, 111 |
| Reference level .....                 | 90, 110  |
| Softkey .....                         | 90, 110  |
| Auto scaling .....                    | 93       |
| Auto settings                         |          |
| Meastime Auto .....                   | 110      |
| Meastime Manual .....                 | 110      |
| Remote .....                          | 250      |
| Auto-Set Mask                         |          |
| Frequency masks .....                 | 101      |
| Average count .....                   | 108, 126 |

## B

|                               |     |
|-------------------------------|-----|
| Band                          |     |
| External Mixer (remote) ..... | 199 |
| Bandwidth                     |     |
| Configuration (remote) .....  | 222 |
| Configuration (Softkey) ..... | 104 |
| Resolution .....              | 105 |
| Settings .....                | 113 |
| Bias                          |     |
| External Mixer (remote) ..... | 197 |
| Brochures .....               | 8   |

## C

|                                   |                   |
|-----------------------------------|-------------------|
| Capture buffer .....              | 68                |
| Capture finished                  |                   |
| Status bit .....                  | 335               |
| Capture offset .....              | 69                |
| MSRT secondary applications ..... | 113               |
| Remote .....                      | 344               |
| Softkey .....                     | 113               |
| Capture time                      |                   |
| see also Measurement time .....   | 224, 225          |
| Center = Mkr Freq .....           | 141               |
| Center frequency .....            | 86                |
| Automatic configuration .....     | 110               |
| Setting to marker .....           | 141               |
| Softkey .....                     | 86                |
| Step size .....                   | 87                |
| Channel                           |                   |
| Creating (remote) .....           | 186, 341          |
| Deleting (remote) .....           | 186               |
| Duplicating (remote) .....        | 185               |
| Querying (remote) .....           | 187               |
| Renaming (remote) .....           | 187               |
| Replacing (remote) .....          | 186               |
| Selecting (remote) .....          | 341               |
| Channels                          |                   |
| New .....                         | 24                |
| Operating modes .....             | 20                |
| Replacing .....                   | 24                |
| Closing                           |                   |
| Channels (remote) .....           | 186               |
| Windows (remote) .....            | 261               |
| Color curve                       |                   |
| Shape .....                       | 54, 122           |
| Spectrograms .....                | 54, 170           |
| Color mapping                     |                   |
| Color curve .....                 | 122               |
| Color range .....                 | 122, 123          |
| Color scheme .....                | 123               |
| Persistence spectrum .....        | 53, 121, 169      |
| Settings .....                    | 121               |
| Settings (remote) .....           | 246               |
| Softkey .....                     | 119, 121          |
| Spectrograms .....                | 53, 119, 121, 169 |
| Step by step .....                | 169               |
| Value range .....                 | 54                |
| Waterfall .....                   | 53, 121, 169      |
| Color scheme                      |                   |
| Spectrogram .....                 | 54, 123           |

- Comment
  - Limit lines ..... 151
- Compatibility
  - Commands ..... 339
  - Limit lines ..... 144, 149
  - R&S FSVR ..... 242, 339
- Configuration
  - MSRT mode ..... 112
- Continuous Sequencer
  - Softkey ..... 114
- Continuous sweep
  - Softkey ..... 107
- Conventions
  - SCPI commands ..... 180
- Conversion loss
  - External Mixer (remote) ..... 202, 203
- Conversion loss tables
  - Available (remote) ..... 205
  - Band (remote) ..... 204
  - Bias (remote) ..... 204
  - Deleting (remote) ..... 205
  - External Mixer (remote) ..... 202
  - Harmonic order (remote) ..... 206
  - Mixer type (remote) ..... 207
  - Selecting (remote) ..... 207
- Copying
  - Channel (remote) ..... 185
  - Traces ..... 126
- Coupling ratio
  - Real-Time ..... 41
  - Span/RBW (remote) ..... 223
- D**
- Data acquisition
  - Analysis interval ..... 113
  - Basics ..... 72
  - Performing (remote) ..... 262
  - Procedure ..... 175
  - Softkey ..... 113
  - Status bit ..... 335
- Data format
  - Remote ..... 275
- Data sheets ..... 8
- Decimal separator
  - Trace export ..... 128
- Deleting
  - Frequency mask values ..... 100
  - Limit line values ..... 153
- Delta markers ..... 132
  - Defining ..... 132
- Detectors
  - FFT ..... 41
  - Remote control ..... 284
  - Trace ..... 125
- Diagram footer information ..... 13
- Diagram style
  - Persistence spectrum ..... 117
- Digital Baseband
  - Output settings ..... 85
- Digital Baseband interface ..... 83
  - Connected instrument ..... 83
  - Output ..... 67
  - Output connection status (remote) ..... 194
  - Output settings ..... 82, 83
- Digital I/Q
  - Connection information ..... 83, 85
  - Output settings ..... 82
  - Output settings information ..... 83, 85
- Digital I/Q 40G
  - Output settings ..... 84
- Digital I/Q 40G Streaming Out ..... 84
  - Connected instrument ..... 85
- Digital output
  - Digital Baseband interface ..... 67
  - Enabling ..... 83, 84
- Direct path
  - Input configuration ..... 80
- Display configuration ..... 116
- Display elements
  - MSRT ..... 14
  - Real-Time Spectrum application ..... 12
- Display lines ..... 142
  - Defining ..... 143
  - Settings ..... 143
- Duplicating
  - Channel (remote) ..... 185
- Dwell time
  - vs. sweep time ..... 41
- E**
- Edit Frequency Mask
  - Softkey ..... 97
- Electronic input attenuation ..... 90
- Entering
  - Trigger condition ..... 101
- Errors
  - IF OVLD ..... 89
- Evaluation methods
  - Remote ..... 255
- Exclude LO ..... 138
  - Remote ..... 296
- Export format
  - Traces ..... 353
- Exporting
  - Data ..... 161
  - I/Q data ..... 161, 162
  - Measurement settings ..... 127
  - Traces ..... 126, 128, 161
  - Traces (remote) ..... 272
- External Mixer
  - Activating (remote) ..... 197
  - Band ..... 199
  - Programming example ..... 208
  - RF overrange ..... 203
  - Type ..... 203
- External trigger ..... 95
  - Level (remote) ..... 227
- F**
- FFT
  - Parameters ..... 41
  - Sweep time ..... 41
  - Window functions ..... 105
- File format
  - Trace export ..... 353
- Filters
  - High-pass (RF input) ..... 80
  - YIG (remote) ..... 192

- Fixed reference
  - Defining ..... 135
- Format
  - Data (remote) ..... 275
- Frame count
  - Spectrograms ..... 52
- Frames
  - Index ..... 52, 120
  - Spectrogram marker ..... 132
  - Time stamps ..... 52, 120
- Free Run
  - Trigger ..... 94
- Frequency
  - Configuration (Softkey) ..... 85
  - Offset ..... 87
  - Span ..... 86
  - Start ..... 86
  - Stop ..... 86
- Frequency mask trigger
  - Availability ..... 45
  - Basics ..... 42
  - Conditions ..... 44
  - Output ..... 45
  - Selecting ..... 95
  - Settings ..... 97
  - Settings (remote) ..... 231
  - Step by step ..... 171
  - Technical process ..... 45
- Frequency masks
  - Activating ..... 99
  - Comment ..... 100
  - Creating ..... 98, 172
  - Defining automatically ..... 101
  - Deleting ..... 99
  - Deleting values ..... 100
  - Editing ..... 97
  - Inserting values ..... 100
  - Loading ..... 99
  - Management ..... 98
  - Name ..... 100
  - Points ..... 100
  - Saving ..... 99
  - Scaling ..... 101
  - Settings ..... 100
  - Shifting horizontally ..... 100
  - Shifting vertically ..... 101
  - Trigger condition ..... 101
  - Upper/lower ..... 44, 101
  - Using ..... 173
- Frontend settings
  - Remote ..... 190
- G**
- Getting started ..... 7
- Granularity
  - Persistence spectrum ..... 118
- Group delay
  - Smoothing ..... 126
- H**
- Handover frequency
  - External Mixer (remote) ..... 198
- Hardware settings
  - Displayed ..... 12
- Harmonics
  - External Mixer (remote) ..... 201
- High Resolution Real-Time Spectrum measurement
  - Result displays ..... 27
- High-pass filter
  - RF input ..... 80
- History
  - PVT ..... 49
  - PVT waterfall ..... 120
  - Spectrograms ..... 120
  - Spectrum ..... 49
- History Depth
  - Softkey ..... 120
- Hold
  - Trace setting ..... 125
- Horizontal Line 1/2
  - Softkeys ..... 143
- Hysteresis
  - Lower (Auto level) ..... 111
  - Upper (Auto level) ..... 110
- I**
- I/Q Analyzer
  - Analysis interval ..... 159
  - MSRT primary ..... 342
  - Real-Time secondary application ..... 22
- I/Q data
  - Analyzing ..... 176
  - Availability ..... 73
  - Capturing ..... 175
  - Exporting ..... 161, 162
  - Trigger point in sample (TPIS) ..... 278
- Impedance
  - Setting ..... 80
- Index
  - Frames ..... 52
- Input
  - Coupling ..... 80
  - Overload (remote) ..... 190
  - RF ..... 79
  - Settings ..... 91
  - Source, Radio frequency (RF) ..... 78
- Input settings
  - Remote ..... 190
- Inserting
  - Frequency mask values ..... 100
  - Limit line values ..... 153
- Inside
  - Trigger condition ..... 101
- Installation ..... 10
- Instrument security procedures ..... 8
- Intensity
  - Max Hold function ..... 118
- K**
- Keys
  - MKR ..... 130
  - MKR -> ..... 139
  - MKR FUNCT (not used) ..... 76
  - Peak Search ..... 140
  - RUN CONT ..... 107
  - RUN SINGLE ..... 107



- L**
- Last span
    - Softkey ..... 86
  - Leaving
    - Trigger condition ..... 101
  - Limit check
    - Activating/Deactivating ..... 154
    - Remote control ..... 317
    - Results ..... 146
  - Limit lines ..... 144, 147
    - Activating/Deactivating ..... 149
    - Comment ..... 151
    - Compatibility ..... 144, 149
    - Compatible ..... 153
    - Copying ..... 150, 154
    - Creating ..... 150, 155
    - Data points ..... 152
    - Deactivating ..... 150
    - Defining ..... 153
    - Deleting ..... 150, 154
    - Deleting values ..... 153
    - Details ..... 150
    - Editing ..... 150, 154
    - Inserting values ..... 153
    - Managing ..... 148
    - Margin ..... 152
    - Name ..... 151
    - Offsets ..... 146
    - Peak search ..... 139
    - Remote control ..... 317
    - Saving ..... 153
    - Selecting ..... 150
    - Shifting ..... 146, 153, 156
    - Threshold ..... 145, 151
    - Traces ..... 149
    - View filter ..... 149
    - Violation ..... 146
    - Visibility ..... 149
    - X-axis ..... 152
    - X-Offset ..... 150
    - Y-axis ..... 152
    - Y-Offset ..... 150
  - Lines
    - Configuration ..... 147
    - Display ..... 142, 143
    - Horizontal ..... 143
    - Limit, see Limit lines ..... 147
    - Vertical ..... 143
  - LO feedthrough ..... 80
  - Lower Level Hysteresis ..... 111
  - Lower mask
    - Activating/Deactivating ..... 99
    - Frequency masks ..... 101
- M**
- Margins
    - Limit lines ..... 152
    - Violation ..... 146
  - Marker search area
    - Remote control ..... 295
  - Marker table
    - Evaluation method ..... 36
  - Marker to Trace ..... 133
  - Markers
    - Assigned trace ..... 133
    - Basic settings ..... 130
    - Configuration (remote control) ..... 287
    - Configuration (softkey) ..... 130, 134
    - Deactivating ..... 133
    - Delta markers ..... 132
    - Fixed reference (remote control) ..... 292
    - Minimum ..... 140
    - Minimum (remote control) ..... 295, 300
    - Next minimum ..... 140
    - Next minimum (remote control) ..... 295, 300
    - Next peak ..... 140
    - Next peak (remote control) ..... 295, 300
    - Peak ..... 140
    - Peak (remote control) ..... 295, 300
    - Position ..... 132
    - Positioning ..... 139
    - Positioning (remote control) ..... 287
    - Remote control ..... 287
    - Retrieving results (remote) ..... 267
    - Search (remote control) ..... 295
    - Search area (softkey) ..... 138
    - Search type (softkey) ..... 138
    - Setting center frequency ..... 141
    - Setting reference level ..... 141
    - Setting up (remote control) ..... 287
    - Spectrograms ..... 53
    - Spectrograms (remote control) ..... 305
    - State ..... 131
    - Step size ..... 135
    - Step size (remote control) ..... 292
    - Table ..... 134
    - Table (evaluation method) ..... 36
    - Table (remote control) ..... 292
    - Type ..... 132
    - X-value ..... 132
    - Y-value ..... 132
  - Mask points
    - Deleting ..... 100
    - Frequency mask ..... 100
    - Inserting ..... 100
  - Max hold function
    - Persistence spectrum ..... 65
  - Max Hold function
    - Configuring ..... 118
    - Intensity ..... 118
    - Persistence spectrum ..... 118
    - Resetting ..... 119
  - Maximizing
    - Windows (remote) ..... 254
  - Measurement channel
    - Activating ..... 185
    - Creating (remote) ..... 188
    - Selecting (remote) ..... 188
  - Measurement time
    - Auto settings ..... 110
    - Remote ..... 224, 225
  - Measurement types
    - High Resolution real-time ..... 27
    - Multi Domain real-time ..... 27
    - Real-Time ..... 27
    - Selecting (remote) ..... 189
  - Measurements
    - Activating (remote) ..... 341
    - Analyzing ..... 342

- Correlating ..... 20
- Selecting ..... 78
- Minimum ..... 140
- Marker positioning ..... 140
- Next ..... 140
- MKR
- Key ..... 130
- MKR ->
- Key ..... 139
- Modes
- see Operating mode ..... 20
- Moving density ..... 61
- Maximum ..... 65
- MSRT primary
- Configuring ..... 112
- Data acquisition ..... 113
- Data acquisition (basics) ..... 73
- Display elements ..... 16
- Selecting (remote) ..... 341
- Tab ..... 16
- Trigger settings ..... 112
- MSRT secondary applications ..... 20
- Capture offset ..... 113
- Capture offset (remote) ..... 344
- Display elements ..... 17
- MSRT View ..... 176
- Display elements ..... 15
- Tab ..... 15
- Multi-standard
- Analysis ..... 176
- Multi-Standard Real-Time (MSRT) operating mode ..... 10
- Multidomain measurement
- Result displays ..... 27
- Multiple
- Measurement channels ..... 24
- N**
- Name
- Limit lines ..... 151
- Next Minimum ..... 140
- Marker positioning ..... 140
- Next Mode X
- Softkey ..... 137
- Next Mode Y
- Softkey ..... 137
- Next Peak ..... 140
- Marker positioning ..... 140
- Noise
- Source ..... 82
- O**
- Offset
- Analysis interval ..... 113
- Frequency ..... 87
- Limit lines ..... 146
- Reference level ..... 89
- Operating mode ..... 20
- Changing ..... 21
- MSRT (remote) ..... 341
- Selecting ..... 23
- Starting ..... 11
- Options
- Electronic attenuation ..... 90
- High-pass filter ..... 80
- Preamplifier ..... 91
- Output
- Configuration ..... 81
- Configuration (remote) ..... 210
- Digital Baseband interface ..... 67
- Digital Baseband interface settings ..... 82, 83
- Digital Baseband interface status ..... 194
- Digital Baseband settings ..... 85
- Digital I/Q (remote) ..... 194
- Digital I/Q 40G settings ..... 84
- Noise source ..... 82
- Settings ..... 81
- Settings (remote) ..... 190
- Trigger ..... 102
- Outside
- Trigger condition ..... 101
- Overload
- RF input (remote) ..... 190
- Overview
- Configuration ..... 76
- P**
- Parameters
- Conflicting ..... 72
- Passing between applications ..... 21
- Real-Time primary ..... 72
- Real-Time secondary applications ..... 72
- Peak excursion ..... 139
- Peak list
- Peak excursion ..... 139
- Peak search
- Area (spectrograms) ..... 138
- Automatic ..... 139
- Deactivating limits ..... 139
- Key ..... 140
- Limits ..... 139
- Mode ..... 137
- Mode (spectrograms) ..... 136, 137
- Reference marker ..... 135
- Threshold ..... 139
- Type (spectrograms) ..... 138
- Peaks
- Marker positioning ..... 140
- Next ..... 140
- Softkey ..... 140
- Performing
- Real-Time measurement ..... 165
- Persistence
- Basics ..... 61
- Duration ..... 118
- Granularity ..... 62
- Histogram ..... 62
- Persistence spectrum
- Color mapping ..... 53, 121, 169
- Detector ..... 63
- Diagram style ..... 117
- Evaluation method ..... 31
- Granularity ..... 118
- Max Hold function ..... 118
- Max hold intensity ..... 65
- Max hold reset ..... 65
- Max hold trace ..... 65
- Persistence duration ..... 118
- Settings ..... 116
- Settings (remote) ..... 242
- Spectrogram ..... 54
- Vector style ..... 63

- Persistency
  - Real-Time analysis ..... 168
- Ports
  - External Mixer (remote) ..... 203
- Position
  - Frequency mask points ..... 100
  - Limit line values ..... 152
- Posttrigger
  - Results, displaying ..... 46
  - Time ..... 96
- Power vs. time
  - see PVT ..... 33
- Preamplifier
  - Setting ..... 91
  - Softkey ..... 91
- Preset
  - Bands (External Mixer, remote) ..... 199
- Presetting
  - Channels ..... 77
- Pretrigger
  - Results, displaying ..... 46
  - Time ..... 96
- Probability of intercept (POI) ..... 41, 42
- Programming examples
  - External Mixer ..... 208
  - Statistics ..... 331, 332, 344
- Protection
  - RF input (remote) ..... 190
- Pulse
  - Real-Time secondary applications ..... 22
- PVT
  - Displayed frame ..... 108, 120
  - Evaluation method ..... 33
  - History ..... 49
  - Real-Time measurement ..... 166
  - Sweep time ..... 106
- PVT waterfall
  - Clearing ..... 121
  - Evaluation method ..... 34
  - History depth ..... 120
  - Selecting frames ..... 108, 120
  - Settings ..... 119
  - Settings (remote) ..... 239
  - Time stamps ..... 120
- R**
- Range ..... 92
  - Scaling ..... 93
- RBW
  - Real-Time ..... 41
- Ready for trigger
  - Status register ..... 335
- Real-Time
  - Persistence ..... 61
- Real-time measurements
  - Result displays ..... 28
  - Types ..... 27
- Real-Time measurements
  - Channel, activating ..... 185
  - Configuration ..... 76
  - Configuring (remote) ..... 190
  - Remote control ..... 179
  - Step by step ..... 165
- Real-Time primary
  - Capturing data ..... 175
  - Parameters ..... 72
- Real-Time secondary applications
  - Analog Demodulation ..... 22
  - Analyzing I/Q data ..... 176
  - Available ..... 21
  - I/Q Analyzer ..... 22
  - Parameters ..... 72
  - Pulse ..... 22
  - Restrictions ..... 75
  - Selecting ..... 23
  - Transient Analysis ..... 22
  - Vector Signal Analysis (VSA) ..... 23
- Real-Time spectrum
  - Application ..... 22
- Real-Time Spectrum
  - Application ..... 10
  - Application, activating ..... 185
  - Displayed frame ..... 108, 120
  - Evaluation method ..... 28
- Ref Lvl = Mkr Lvl ..... 141
- Reference
  - Fixed ..... 135
  - Marker ..... 135
- Reference level ..... 89
  - Auto level ..... 90, 110
  - Offset ..... 89
  - Position ..... 92
  - Setting to marker ..... 141
  - Unit ..... 89
  - Value ..... 89
- Reference marker ..... 132
- Refreshing ..... 114
  - All secondary applications (softkey) ..... 114
  - MSRA secondary applications ..... 115
  - MSRT secondary applications ..... 115
  - Result display ..... 73
  - Softkey ..... 115
- Release notes ..... 8
- Remote commands
  - Basics on syntax ..... 180
  - Boolean values ..... 183
  - Capitalization ..... 181
  - Character data ..... 184
  - Data blocks ..... 184
  - Numeric values ..... 182
  - Optional keywords ..... 181
  - Parameters ..... 182
  - Strings ..... 184
  - Suffixes ..... 181
- Resetting
  - RF input protection ..... 190
- Resolution bandwidth
  - Auto (Softkey) ..... 105
  - Manual (Softkey) ..... 105
- Restoring
  - Channel settings ..... 77
- Restrictions
  - Real-Time secondary applications ..... 75
- Result displays
  - 3-D PVT waterfall ..... 35
  - 3-D Spectrogram ..... 30
  - Configuration ..... 116
  - Marker table ..... 36
  - Persistence spectrum ..... 31
  - Power vs. Time ..... 33
  - PVT waterfall ..... 34
  - Real-Time Spectrum ..... 28
  - Spectrogram ..... 29

|                                      |          |
|--------------------------------------|----------|
| Results                              |          |
| Analyzing .....                      | 116      |
| ASCII export format .....            | 353      |
| Data format (remote) .....           | 275      |
| Exporting .....                      | 127      |
| Markers (remote) .....               | 267      |
| Retrieving (remote) .....            | 266      |
| Time domain (Real-Time) .....        | 166      |
| Traces (remote) .....                | 268      |
| Traces, exporting (remote) .....     | 272      |
| Updating the display .....           | 115      |
| RF attenuation                       |          |
| Auto .....                           | 90       |
| Manual .....                         | 90       |
| RF input .....                       | 78       |
| Overload protection (remote) .....   | 190      |
| Remote .....                         | 190      |
| RF overrange                         |          |
| External Mixer .....                 | 203      |
| RUN CONT                             |          |
| Key .....                            | 107      |
| RUN SINGLE                           |          |
| Key .....                            | 107      |
| <b>S</b>                             |          |
| Safety instructions .....            | 8        |
| Sample rate                          |          |
| Digital output .....                 | 68       |
| Remote .....                         | 278      |
| Saving                               |          |
| Limit lines .....                    | 153      |
| Scaling                              |          |
| Amplitude range, automatically ..... | 93       |
| Configuration .....                  | 92       |
| Frequency masks .....                | 101      |
| Y-axis .....                         | 93       |
| Y-axis (remote control) .....        | 219      |
| Scrolling                            |          |
| Spectrogram .....                    | 52       |
| Search limits                        |          |
| Deactivating .....                   | 139      |
| Search Limits                        |          |
| Activating .....                     | 139      |
| Search Mode                          |          |
| Spectrogram markers .....            | 136      |
| Searching                            |          |
| Configuration (softkey) .....        | 136      |
| secondary application data           |          |
| Coverage .....                       | 16       |
| Secondary application data           |          |
| Availability .....                   | 73       |
| Coverage .....                       | 17       |
| Restrictions .....                   | 75       |
| Results .....                        | 17       |
| Settings .....                       | 72       |
| Start .....                          | 69       |
| Security procedures .....            | 8        |
| Select Frame                         |          |
| Softkey .....                        | 108, 120 |
| Select Marker .....                  | 133      |
| Select measurement                   |          |
| Remote .....                         | 189      |
| Types .....                          | 27       |
| Sequencer .....                      | 24       |
| Activating (remote) .....            | 264      |
| Continuous sweep .....               | 25, 74   |
| Mode .....                           | 114      |
| MSRT mode .....                      | 11, 73   |
| Real-Time mode .....                 | 113      |
| Remote .....                         | 263      |
| Result display .....                 | 25, 74   |
| Softkey .....                        | 114      |
| State .....                          | 114      |
| Sequences                            |          |
| Aborting (remote) .....              | 264      |
| Mode (remote) .....                  | 265      |
| Service manual .....                 | 7        |
| Shift x                              |          |
| Frequency masks .....                | 100      |
| Limit lines .....                    | 153      |
| Shift y                              |          |
| Frequency masks .....                | 101      |
| Limit lines .....                    | 153      |
| Shifting                             |          |
| Limit lines .....                    | 146      |
| Signal capturing                     |          |
| Duration (remote) .....              | 224, 225 |
| Single Sequencer                     |          |
| Softkey .....                        | 114      |
| Single sweep                         |          |
| Softkey .....                        | 107      |
| Single zoom .....                    | 158      |
| Slope                                |          |
| Trigger .....                        | 96, 229  |
| Smoothing                            |          |
| Traces (group delay) .....           | 126      |
| Softkeys                             |          |
| Activate .....                       | 99       |
| Amplitude Config .....               | 87       |
| Auto All .....                       | 109      |
| Auto Freq .....                      | 110      |
| Auto Level .....                     | 90, 110  |
| Bandwidth Config .....               | 104      |
| Capture Offset .....                 | 113      |
| Center .....                         | 86       |
| Center = Mkr Freq .....              | 141      |
| Clear Spectrogram .....              | 109, 121 |
| Color Mapping .....                  | 119, 121 |
| Continuous Sequencer .....           | 114      |
| Continuous Sweep .....               | 107      |
| Continuous trigger .....             | 47       |
| Data Acquisition .....               | 113      |
| Delete mask .....                    | 99       |
| Edit Frequency Mask .....            | 97       |
| Export config .....                  | 161      |
| External .....                       | 95       |
| Free Run .....                       | 94       |
| Frequency Config .....               | 85       |
| Frequency mask .....                 | 95       |
| History Depth .....                  | 120      |
| Horizontal Line 1/2 .....            | 143      |
| I/Q Export .....                     | 162      |
| Last Span .....                      | 86       |
| Line Config .....                    | 147      |
| Load (mask) .....                    | 99       |
| Lower Level Hysteresis .....         | 111      |
| Marker Config .....                  | 130, 134 |
| Marker Search Area .....             | 138      |
| Marker Search Type .....             | 138      |
| Marker to Trace .....                | 133      |
| Meastime Auto .....                  | 110      |
| Meastime Manual .....                | 110      |
| Min .....                            | 140      |

|                                |                   |
|--------------------------------|-------------------|
| New (mask) .....               | 98                |
| New mask .....                 | 100               |
| Next Min .....                 | 140               |
| Next Mode X .....              | 137               |
| Next Mode Y .....              | 137               |
| Next Peak .....                | 140               |
| Norm/Delta .....               | 132               |
| Outputs Config .....           | 81                |
| Peak .....                     | 140               |
| Posttrigger .....              | 46                |
| Preamp .....                   | 91                |
| Pretrigger .....               | 46                |
| Ref Level .....                | 89                |
| Ref Level Offset .....         | 89                |
| Ref Lvl = Mkr Lvl .....        | 141               |
| Refresh .....                  | 115               |
| Refresh All .....              | 114               |
| Res BW Auto .....              | 105               |
| Res BW Auto (remote) .....     | 223               |
| Res BW Manual .....            | 105               |
| RF Atten Auto .....            | 90                |
| RF Atten Manual .....          | 90                |
| Save (mask) .....              | 99                |
| Scale Config .....             | 92                |
| Search Config .....            | 136               |
| Select Frame .....             | 108, 120          |
| Select Marker .....            | 133               |
| Sequencer .....                | 114               |
| Single Sequencer .....         | 114               |
| Single Sweep .....             | 107               |
| Span Manual .....              | 86                |
| Start .....                    | 86                |
| Stop .....                     | 86                |
| Stop on trigger .....          | 47                |
| Sweep Config .....             | 104               |
| Sweep count .....              | 108               |
| Sweeptime Auto .....           | 106               |
| Sweeptime Manual .....         | 106               |
| Time Stamp .....               | 120               |
| Trace 1/2/3/4 .....            | 126               |
| Trace Config .....             | 123, 128          |
| Trigger Config .....           | 93, 112           |
| Trigger Offset .....           | 96                |
| Upper Level Hysteresis .....   | 110               |
| Vertical Line 1/2 .....        | 143               |
| Span .....                     | 86                |
| FFT calculation .....          | 85                |
| FFT calculation (Remote) ..... | 219               |
| Manual .....                   | 86                |
| Real-Time .....                | 41                |
| Speaker .....                  |                   |
| Remote control .....           | 210               |
| Specifications .....           | 8                 |
| Specifics for .....            |                   |
| Configuration .....            | 78                |
| Spectrogram .....              |                   |
| Evaluation method .....        | 29                |
| Scrolling .....                | 52                |
| Spectrograms .....             |                   |
| Basics .....                   | 49                |
| Clear .....                    | 49                |
| Clearing .....                 | 109, 121          |
| Color curve .....              | 54, 122, 170      |
| Color mapping .....            | 53, 119, 121, 169 |
| Color scheme .....             | 54, 123           |
| Continue frame .....           | 52                |
| Frame count .....              | 52                |
| History .....                  | 49                |
| History depth .....            | 120               |
| Markers .....                  | 53                |
| Markers (remote control) ..... | 305               |
| Selecting frames .....         | 108, 120          |
| Settings .....                 | 119               |
| Settings (remote) .....        | 239               |
| Sweep count .....              | 52                |
| Time frames .....              | 50                |
| Time stamp .....               | 49                |
| Time stamps .....              | 120               |
| Value range .....              | 54, 169           |
| Zoom .....                     | 56                |
| Spectrum .....                 |                   |
| History .....                  | 49                |
| Standards .....                |                   |
| Multiple, analyzing .....      | 19                |
| Start frequency .....          |                   |
| Softkey .....                  | 86                |
| Statistics .....               |                   |
| Programming example .....      | 331, 332, 344     |
| Status .....                   |                   |
| Capture finished .....         | 335               |
| Status registers .....         |                   |
| Querying .....                 | 338               |
| Querying (remote) .....        | 335               |
| STAT:QUES:POW .....            | 190               |
| STATus:OPERation .....         | 73, 335           |
| STATus:QUESTionable:TIME ..... | 336               |
| Step size .....                |                   |
| Markers .....                  | 135               |
| Markers (remote control) ..... | 292               |
| Stop frequency .....           |                   |
| Softkey .....                  | 86                |
| Suffixes .....                 |                   |
| Common .....                   | 184               |
| Remote commands .....          | 181               |
| Sweep .....                    |                   |
| Aborting .....                 | 107               |
| Configuration (remote) .....   | 222               |
| Configuration (Softkey) .....  | 104               |
| Count .....                    | 108               |
| Count (spectrograms) .....     | 52                |
| MSRT .....                     | 73                |
| Performing (remote) .....      | 262               |
| Time (remote) .....            | 224, 225          |
| Sweep status .....             |                   |
| Status register .....          | 335               |
| Sweep time .....               |                   |
| Auto (Softkey) .....           | 106               |
| FFT .....                      | 41                |
| Manual (Softkey) .....         | 106               |
| PVT .....                      | 106               |
| Spectrum .....                 | 106               |
| <b>T</b> .....                 |                   |
| Tabs .....                     |                   |
| Channels .....                 | 20                |
| MSRT primary .....             | 16                |
| MSRT View .....                | 15                |
| Threshold .....                |                   |
| Limit lines .....              | 145, 151          |
| Peak search .....              | 139               |
| Time domain .....              |                   |
| Trigger source .....           | 95                |

- Time frames
    - Selecting ..... 50, 108, 120
    - Spectrograms ..... 50
    - Waterfalls ..... 50
  - Time stamps
    - Frames ..... 52
    - PVT waterfall ..... 120
    - Softkey (Spectrogram) ..... 120
    - Spectrograms ..... 120
  - TPIS
    - I/Q data ..... 278
  - Trace math
    - Functions ..... 129
    - Settings ..... 128
  - Traces
    - Configuration (Softkey) ..... 123, 128
    - Configuring (remote control) ..... 280
    - Copying ..... 126
    - Copying (remote control) ..... 284
    - Detector ..... 125
    - Detector (remote control) ..... 284
    - Export format ..... 128
    - Exporting ..... 126, 127, 128
    - Exporting results (remote) ..... 272
    - Hold ..... 125
    - Mode ..... 124
    - Mode (remote) ..... 281
    - Retrieving results (remote) ..... 268
    - Selecting ..... 124
    - Settings (remote control) ..... 280
  - Traces to be Checked
    - Limit lines ..... 149
  - Transient Analysis
    - Real-Time secondary applications ..... 22
  - Trigger
    - Configuration (softkey) ..... 93, 112
    - External (remote) ..... 229
    - Holdoff ..... 96
    - Input ..... 102
    - Mode ..... 96
    - Offset ..... 69, 96
    - Output ..... 102
    - Posttrigger ..... 46
    - Pretrigger ..... 46
    - Real-Time measurements ..... 42
    - Rearming ..... 47, 96
    - Remote control ..... 226
    - Slope ..... 96, 229
    - Status register ..... 335
    - Stop measurement ..... 96
    - Stop on trigger ..... 47
  - Trigger condition
    - Frequency masks ..... 101
  - Trigger level ..... 95
    - External trigger (remote) ..... 227
  - Trigger source ..... 94
    - Configuration ..... 93
    - External ..... 95
    - Free Run ..... 94
    - Frequency mask ..... 95
    - Time domain ..... 95
  - Troubleshooting
    - Input overload ..... 190
  - Truncate
    - Persistence Spectrum ..... 123
- U**
- Units
    - Reference level ..... 89
  - Updating
    - Result display ..... 115
  - Upper Level Hysteresis ..... 110
  - Upper mask
    - Activating/Deactivating ..... 99
    - Frequency masks ..... 101
- V**
- Vector style
    - Persistence spectrum ..... 63
    - Sample histograms ..... 64
  - Vertical Line 1/2
    - Softkeys ..... 143
  - Videos ..... 9
  - View filter
    - Limit lines ..... 149
  - Visible
    - Limit lines ..... 149
  - Volume
    - Remote control ..... 210
  - VSA (Vector Signal Analysis)
    - Real-Time secondary application ..... 23
- W**
- Waiting for trigger
    - Status register ..... 335
  - Waterfall
    - Basics ..... 49
    - Color mapping ..... 53, 121, 169
    - see PVT waterfall ..... 34
    - Time frames ..... 50
  - White papers ..... 9
  - Window title bar information ..... 13, 15
  - Windows
    - Adding (remote) ..... 255
    - Closing (remote) ..... 261
    - Configuring ..... 78
    - Layout (remote) ..... 258
    - Maximizing (remote) ..... 254
    - Querying (remote) ..... 256, 257
    - Replacing (remote) ..... 258
    - Splitting (remote) ..... 254
    - Types (remote) ..... 255
- X**
- X-axis
    - Limit lines ..... 152
  - X-Offset
    - Limit lines ..... 150
  - X-value
    - Marker ..... 132
- Y**
- Y-axis
    - Limit lines ..... 152
    - Scaling ..... 93
    - Settings ..... 92
  - Y-Offset
    - Limit lines ..... 150

|  |     |
|--|-----|
| Y-value                                |     |
| Marker .....                           | 132 |
| YIG-preselector                        |     |
| Activating/Deactivating .....          | 81  |
| Activating/Deactivating (remote) ..... | 192 |

## Z

|                                  |     |
|----------------------------------|-----|
| Zooming .....                    | 56  |
| Activating (remote) .....        | 334 |
| Area (remote) .....              | 333 |
| Functions .....                  | 158 |
| Remote .....                     | 333 |
| Restoring original display ..... | 159 |
| Single mode .....                | 158 |
| Switching displays .....         | 159 |