

R&S® Pulse Sequencer (DFS)

DFS Signal Generation Software

User Manual



1177532702
Version 20

ROHDE & SCHWARZ
Make ideas real



This document describes the following software options:

- R&S®SMW-K350
1413.9160.02
- R&S®SMBV-K350
1419.2767.02
- R&S®SMBVB-K350
1423.8443.02
- R&S®SMM-K350
1441.1224.02
- R&S®SMU-K350
1408.8830.02
- R&S®SMJ-K350
1409.3702.02
- R&S®SGT-K350
1419.8107.02

This manual describes software version V2.7 and later of the R&S®Pulse Sequencer (DFS).

© 2023 Rohde & Schwarz

Muehldorfstr. 15, 81671 Muenchen, Germany

Phone: +49 89 41 29 - 0

Email: info@rohde-schwarz.com

Internet: www.rohde-schwarz.com

Subject to change – data without tolerance limits is not binding.

R&S® is a registered trademark of Rohde & Schwarz GmbH & Co. KG.

All other trademarks are the properties of their respective owners.

1177.5327.02 | Version 20 | R&S®Pulse Sequencer (DFS)

Throughout this manual, products from Rohde & Schwarz are indicated without the ® symbol , e.g. R&S®SMW200A is indicated as R&S SMW.

Contents

1	Welcome to the R&S Pulse Sequencer (DFS)	5
1.1	R&S Pulse Sequencer (DFS) key features	5
1.2	Accessing the R&S Pulse Sequencer (DFS)	6
1.3	Documentation overview	6
1.3.1	User manuals and help	6
1.3.2	Release notes and open-source acknowledgment (OSA)	6
1.3.3	Data sheets and brochures	7
1.3.4	Application notes, application cards, white papers, etc.	7
1.4	Scope of this user manual	7
1.5	Notes on screenshots	7
2	Getting started	9
2.1	Required options	9
2.2	Installing the software	10
2.3	Starting the R&S Pulse Sequencer (DFS) for the first time	12
2.4	Understanding the displayed information	13
2.5	Loading a DFS project file	17
2.6	Getting information and help	18
3	About the R&S Pulse Sequencer (DFS)	21
3.1	Normative reference	24
4	Generating test files and conducting the trials	25
4.1	How to connect the signal generator	26
4.2	How to create test reports	29
4.3	How to create the waveforms and conduct the trial	31
	Annex	43
A	Overview of the test requirements and provided test patterns	43
A.1	ETSI 301 893, ETSI 302 502, ETSI 303 258	43
A.1.1	Waveform requirements 301893	43
A.1.2	Waveform requirements 302502	44
A.1.3	Waveform requirements 303258	45
A.2	FCC	46

A.2.1	FCC 06-96.....	46
A.2.2	FCC KDB 905462 D02.....	49
A.2.3	FCC 13-22.....	49
A.3	MIC.....	50
A.3.1	Japan radar parameters for W53 band, former MIC specification.....	50
A.3.2	Japan radar parameters for W53 band, MIC specification 07/2019.....	51
A.3.3	Japan radar parameters for W56 band.....	51
A.4	Korea.....	52
A.5	YD/T.....	53
B	References.....	55
	Glossary: Terms and abbreviations.....	57
	Glossary: DFS standards and references.....	59
	Index.....	61

1 Welcome to the R&S Pulse Sequencer (DFS)

Worldwide, the two frequency bands 5.25 GHz to 5.35 GHz and 5.47 GHz to 5.725 GHz are used by various radar systems. In addition, they are allocated to unlicensed WLAN devices. A requirement arising from this frequency band reuse is a method called Dynamic Frequency Selection (DFS).

A system that requires DFS must be capable to avoid interfering with radar systems. This is achieved by various methods:

- Verify that the channel is free of any radar signals before using it.
- Continuous monitoring for radar signals once a channel is in use. The channel needs to be vacated if a radar signal is detected.
- Blacklisting channels where a radar signal was detected.
- Using channels equally (Uniform Loading).
- Transmit only the required amount of power (Transmit Power Control).

Most radar systems in these bands are used by the military and their actual signatures are confidential. The representative test patterns therefore contain random variations. The specifications require that WLAN devices not only detect a specific pattern but also respond to a wider variety of signals.

Different standards documents exist worldwide that define requirements and test patterns. An overview is provided in Appendix, "DFS Standards and References".

Installation

You can find detailed installation instructions in the delivery of the option or in [Chapter 2.2, "Installing the software"](#), on page 10.

1.1 R&S Pulse Sequencer (DFS) key features

The R&S Pulse Sequencer (DFS) software is a standalone, PC-based application that generates Dynamic Frequency Selection (DFS) pulse patterns according to [FCC](#), [ETSI](#), and [MIC](#) standards. This software is available for free download on the R&S website.

Waveforms can be played by the following instruments:

- R&S SMW
- R&S SMBV
- R&S SMBV100B
- R&S SMM
- R&S SMU
- R&S SMJ
- R&S SGT

The processing of the generated waveforms requires software option R&S SMW/SMBV/SMU/SMJ/SGT-K350 installed on the instrument.

Key features:

- Supported Standards for Europe, the US, Japan, Korea and China
- Generation of all required waveforms and automatic transfer to the signal generator
- Automatic report generation.
Reports contain all parameters used for the waveform calculation
- Two report formats: Excel spreadsheets and ASCII text format

1.2 Accessing the R&S Pulse Sequencer (DFS)

To open the application

- ▶ On your PC, select "Start > All Programs > R&S Pulse Sequencer DFS".

The software opens and displays the "Repository Manager" or the last used "Workspace".

1.3 Documentation overview

This section provides an overview of the R&S Pulse Sequencer (DFS) user documentation. Unless specified otherwise, you find the documents on the software option page at:

www.rohde-schwarz.com/product/SMWK350 > "Downloads"> "Manuals"

1.3.1 User manuals and help

Introduces the R&S Pulse Sequencer (DFS) and describes how to start working with the software. For description of the graphical user interface, basic operations, and the remote control commands, see the R&S®Pulse Sequencer user manual.

The contents of the user manuals are available as help in the R&S Pulse Sequencer (DFS). The help offers quick, context-sensitive access to the complete information.

All user manuals are also available for download or for immediate display on the Internet.

1.3.2 Release notes and open-source acknowledgment (OSA)

The release notes list new features, improvements and known issues of the current firmware version, and describe the firmware installation.

The open-source acknowledgment document provides verbatim license texts of the used open-source software.

See www.rohde-schwarz.com/product/SMWK350 > "Downloads" > "Software"

1.3.3 Data sheets and brochures

The data sheet contains the technical specifications of the R&S Pulse Sequencer (DFS). It also lists the options and their order numbers and optional accessories.

The brochure provides an overview of the instrument and deals with the specific characteristics.

See <https://www.rohde-schwarz.com/brochure-datasheet/smwk350/>

1.3.4 Application notes, application cards, white papers, etc.

These documents deal with special applications or background information on particular topics.

1.4 Scope of this user manual

The R&S Pulse Sequencer (DFS) is the DFS variant of the R&S®Pulse Sequencer software that is specially developed for DFS testing.

This user manual describes the functionality that the R&S Pulse Sequencer (DFS) software provides.

Functions that are the same as in the R&S®Pulse Sequencer software are not described here; they are described in its user manual.

Functions of the vector signal generators are also not described here; they are described in the user manual of the corresponding base unit. You find the latest version on the product page, for example at www.rohde-schwarz.com/product/SMW200A.

1.5 Notes on screenshots

When describing the functions of the product, we use sample screenshots. These screenshots are meant to illustrate as many as possible of the provided functions and possible interdependencies between parameters. The shown values may not represent realistic usage scenarios.

The screenshots usually show a fully equipped product, that is: with all options installed. Thus, some functions shown in the screenshots may not be available in your particular product configuration.

2 Getting started

This section describes the basic steps to be taken when starting up the R&S Pulse Sequencer (DFS) for the first time.

- [Required options](#)..... 9
- [Installing the software](#)..... 10
- [Starting the R&S Pulse Sequencer \(DFS\) for the first time](#)..... 12
- [Understanding the displayed information](#)..... 13
- [Loading a DFS project file](#)..... 17
- [Getting information and help](#)..... 18

2.1 Required options

The R&S Pulse Sequencer (DFS) software is a stand-alone, PC-based application that creates waveform files. This software is available for free download on the R&S web-site. Waveforms generated with the software can be played by a subset of instruments, that must fulfill the minimum requirements listed below.

The following vector signal generators support the [FCC 06-96](#) Type 6 simulated frequency hopping.

R&S SMW200A

R&S SMW200A base unit equipped with:

- Option baseband generator (R&S SMW-B10)
- Option frequency (R&S SMW-B1006)
- Option baseband main module, one I/Q path to RF (R&S SMW-B13)
- Option DFS (R&S SMW-K350)

R&S SMBV100B

R&S SMBV100B base unit equipped with:

- Option frequency (R&S SMBV-B103/KB106)
- Option DFS (R&S SMBVB-K350)

R&S SMM100A

R&S SMM base unit equipped with:

- Option wideband baseband generator R&S SMM-B9
- Option frequency (e.g. R&S SMM-B1006)
- Option DFS (R&S SMM-K350)

R&S SGT100A

R&S SGT100A base unit equipped with:

- Option frequency (R&S SGT-KB106)

- Option baseband generator (R&S SGT-K510)
- Option memory extension for ARB (R&S SGT-K51x)
- Option DFS (R&S SGT-K350)

R&S SMJ100A and R&S SMU200A

R&S SMJ100A or R&S SMU200A base unit equipped with:

- Option baseband generator (R&S SMJ/SMU-B9)
- Option baseband main module (R&S SMJ/SMU-B13)
- Option frequency (R&S SMJ/SMU-B106)
- Option DFS (R&S SMJ/SMU-K350)

R&S SMBV100A

R&S SMBV100A base unit equipped with:

- Option baseband generator (R&S SMBV-B51)
- Option frequency (R&S SMBV-B1xx)
- Option DFS (R&S SMBV-K350)

2.2 Installing the software

Software updates and the release notes describing the improvements and modifications are available for download at the product page <https://www.rohde-schwarz.com/software/pulse-sequencer/>.

Software and hardware requirements

Minimum requirements:

- **Software**
 - Microsoft®Windows 10, 64-Bit operating system (x64-based or x86-based processor)
 - Microsoft Excel (recommended)
- **Hardware**

Table 2-1: Hardware requirements

	Minimum requirements	Recommended hardware
AMD or Intel CPU	Dual Core, 2 GHz	Intel 8 Core i7 10700, AMD Ryzen series
RAM	≥ 2 GB	64 GB
Video	NVIDIA Quadro 128 MB or ATI Radeon	NVIDIA Quadro 128 MB or ATI Radeon
Video resolution	≥ 1280 x 1024 pixels	≥ 1920 x 1200 pixels
Network	LAN 1 GB/s	LAN 1 GB/s

To install the software

Download the R&S Pulse Sequencer (DFS) software from the Rohde & Schwarz website.

The R&S Pulse Sequencer (DFS) software consists of the file
PS-DFS-Install <major>.<minor>.<build>.<release>.msi.

1. Start the PS-DFS-Install <major>.<minor>.<build>.<release>.msi file.

The filename follows the naming conventions:

- <major>.<minor> is the software version
- <build> is the build number.
This is the day elapsed since 1 January 2000
- <release> indicates the release on the build date.
This is 1/10 of the number of seconds elapsed since midnight.
- x64 indicates that this is a 64-bit installation file.
You can run the software version with the extension x64 only on a 64-bit operating system, see "[Software and hardware requirements](#)" on page 10.

2. Depending on your user rights, select one of the following:

- a) Installation for all users (default)
 - Requires administrator rights
 - Is a per-machine installation
 - Project data and program data are common to all users
 - Users keep their individual settings
- b) Installation for current user only
 - Does not require administrator rights
 - Is a per-user installation
 - Installation in %HomePath%

3. Choose the setup type.

4. Follow the installation instructions.

The installer performs the following actions:

- If enabled, installs the R&S VISA software on the PC
- Installs the R&S Pulse Sequencer (DFS) software including an uninstall tool
- Creates a shortcut on the desktop
- Creates the folder structure listed in [Table 2-2](#).

Table 2-2: Default file location (software installation for all users)

File type	File location
Program data	%PROGRAMFILES (X86) %\Rohde-Schwarz\ Pulse Sequencer DFS (Path)
Project data (Repository data- base) SDK files	%PUBLIC%\Public\Documents\Rohde-Schwarz\ Pulse Sequencer DFS (DataPath)
Report files, startup log file, calcu- lated data, volatile data	%HOMEPATH% (HomePath OR ReportPath)
User settings (Workspace, etc.)	%HOMEPATH%\AppData\Roaming\Rohde-Schwarz\ Pulse Sequencer DFS

2.3 Starting the R&S Pulse Sequencer (DFS) for the first time

- ▶ On your PC, select "Start > R&S Pulse Sequencer (DFS) > R&S Pulse Sequencer (DFS)"

The R&S Pulse Sequencer (DFS) workspace opens. When you start the software for the first time, the "Repository Manager" dialog opens.

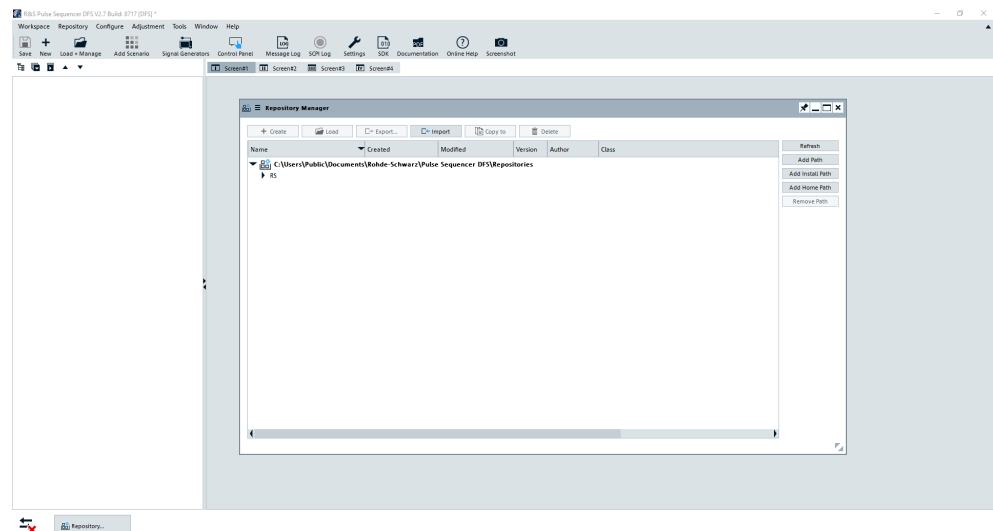

Follow the steps described in [Chapter 2.5, "Loading a DFS project file"](#), on page 17.

See also [Chapter A, "Overview of the test requirements and provided test patterns"](#), on page 43.

2.4 Understanding the displayed information

The following figure shows an example test scenario during software operation. The different information areas are labeled. They are explained in more detail in the following sections.

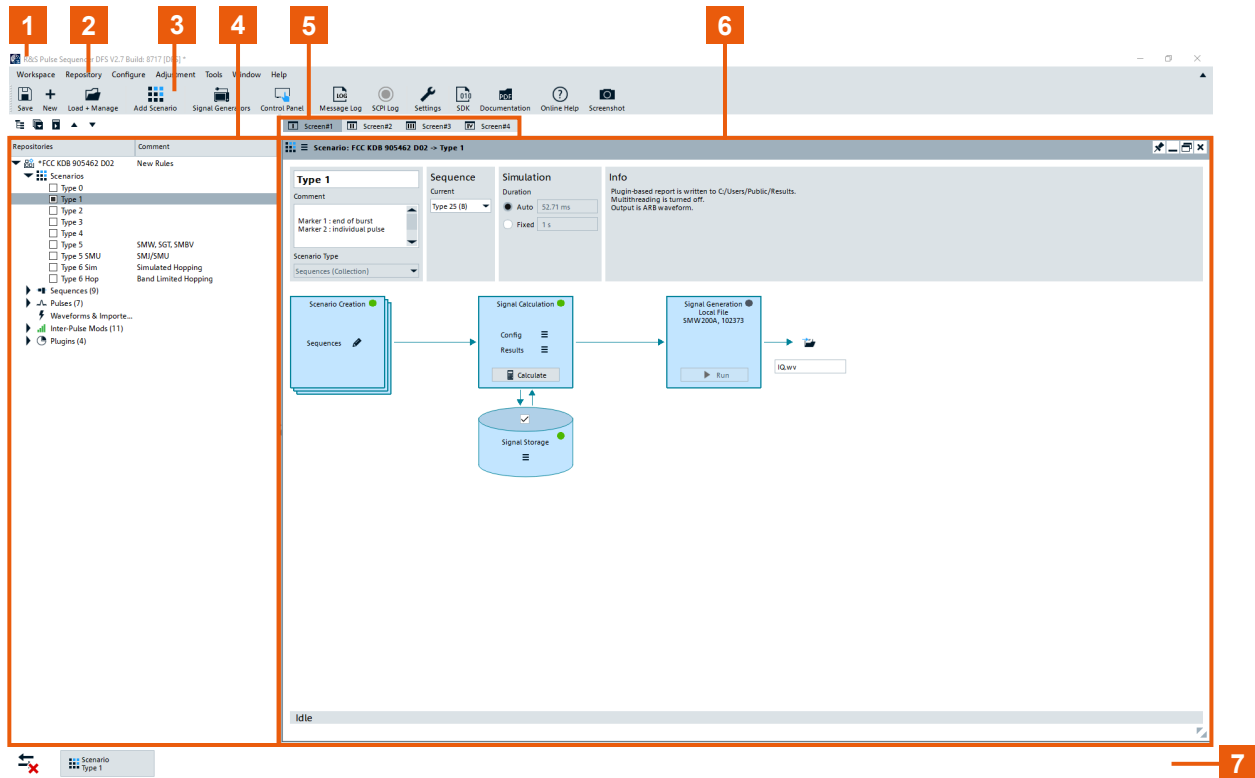

Figure 2-1: R&S Pulse Sequencer (DFS) default workspace: understanding the displayed information

- 1 = Title bar
- 2 = Menu bar with standard functions, e.g. save/open file etc.
- 3 = Toolbar
- 4 = Project tree (repository tree)
- 5 = Screens for individual scenarios
- 6 = Work area
- 4+6 = Workspace
- 7 = Taskbar with indication of enabled remote control incl. details like IP address (if enabled), information on the required highest security level (if enabled) and access to active dialogs

The user interface of the R&S Pulse Sequencer (DFS) offers an intuitive operating concept. Operation is similar to any operating system. All menus and dialogs use known elements, e.g., selection lists, checkboxes, and entry fields.

Menu bar

Table 2-3: Content of the menu bar

Workspace	Repository	Configure	Adjustment	Tools		Window	Help
<ul style="list-style-type: none"> • Clear • Open • Save • Save As • Exit 	<ul style="list-style-type: none"> • New • Load or Manage • Save • Import • Export • Edit 	<ul style="list-style-type: none"> • Signal Generators • Remote Control • Colors • Settings 	<ul style="list-style-type: none"> • Configure • Manage Data • Run level Adjustment 	<ul style="list-style-type: none"> • Script • Control Panel • Console 		<ul style="list-style-type: none"> • Message Log • SCPI Log • MinSize All Windows • Cascade • Close All • Screen 1 .. 4 	<ul style="list-style-type: none"> • Online Help • Documentation • SDK • Find connector • Debug Information • About

Toolbars

The R&S Pulse Sequencer (DFS) offers two toolbars.

Standard functions can be performed via the icons in the main toolbar at the top of the screen. Click the arrow on the right-hand side of the menu bar to expand and collapse the toolbar.



Figure 2-2: Standard functions in the main toolbar

- 1 = Save as: Stores current workspace configuration
- 2 = Repository: Creates a repository/Opens "Manage Repository" dialog for loading, discarding or exporting repositories
- 3 = Project tree: Creates a scenario
- 4 = Generator: Opens the "Signal Generators" dialog/Opens the signal generator "control panel"
- 5 = Logs: Opens the "Message Log" window/"SCPI Log" window
- 6 = Opens the "Program Settings" dialog
- 7 = Help: Opens the "SDK" folder/Opens the help documentation folder containing help documents/Displays context-sensitive help topic for currently selected element
- 8 = Hardcopy: Copies current dialog to the clipboard

Functions relating to the "Project Tree" can be performed via the icons in the toolbar below the main toolbar.



Figure 2-3: Functions in the Project Tree toolbar

- 1 = Switches between tree view and table mode, see "[Repository tree](#)" on page 15.
- 2 = Expand/collapse all nodes in the "Project Tree"
- 3 = Moves the elements within a node up/down in the "Project Tree"

Virtual screens

Using the R&S Pulse Sequencer (DFS) you can handle several scenarios with even comprehensive settings at the same time. You can arrange the dialogs across multiple screens logically, so that you can easily switch between them. You can, for example, assign the subset of antenna dialogs to one screen and the pulse and modulation dialogs to another.

Repository tree

The repository tree shows the content of all currently loaded repositories. Repository elements are indicated with the assigned icons, their names, and the first comment line.

You can also switch the tree view to table mode. Table mode displays the number of items in the repository element in brackets. If you select a repository element, the "Item Overview" dialog opens and displays all items of the selected repository element.

Repositories	Comment
<ul style="list-style-type: none"> <ul style="list-style-type: none"> > Scenarios > Sequences > Pulses ⚡ Waveforms & Importe... > Inter-Pulse Mods > Plugins 	
<ul style="list-style-type: none"> <ul style="list-style-type: none"> <input type="checkbox"/> Type 0 <input checked="" type="checkbox"/> Type 1 <input type="checkbox"/> Type 2 <input type="checkbox"/> Type 3 <input type="checkbox"/> Type 4 <input type="checkbox"/> Type 5 <input type="checkbox"/> Type 5 SMU <input type="checkbox"/> Type 6 Sim <input type="checkbox"/> Type 6 Hop 	New Rules
<ul style="list-style-type: none"> <ul style="list-style-type: none"> > Sequences > Pulses ⚡ Waveforms & Importe... > Inter-Pulse Mods > Plugins 	SMW, SGT, SMBV SMJ/SMU Simulated Hopping Band Limited Hopping

1 = Name

2 = First comment line

Name and comment

Each repository element is identified with its unique name and optional description entered in the comment field. The description can contain several lines; new line is added by pressing [Shift+Enter].

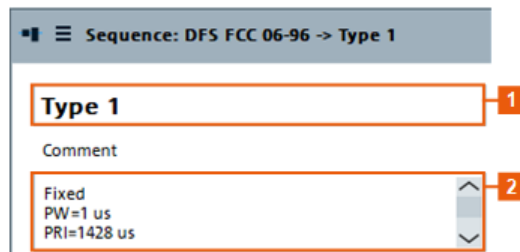

- 1 = A unique name to indicate the element in the repository
 2 = Description; the first line is displayed in the repository tree

Context-sensitive menus

All user interface controls provide a context-sensitive menu. Context-sensitive menus are accessed with a right mouse click the control.

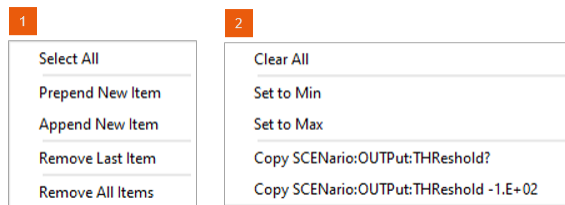

- 1 = Context menu of an icon
 2 = Context menu of a parameter

Tooltips

Tooltips indicate the possible value range of a parameter or list overview information on current settings.

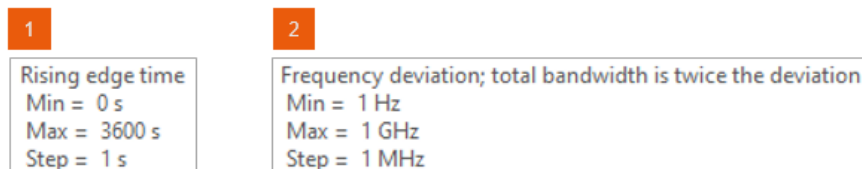

- 1 = Tooltip of a setting parameter, indicating the allowed value range
 2 = Tooltip with detailed information on a setting

Dialog names

The name of a dialog indicates its content or the functionality this dialog covers. The used naming convention helps you to recognize which database element you are configuring, to which scenario it belongs and what its current name is.

Undocking dialogs

If your workspace contains several simultaneously opened dialogs, you can undock dialogs and distribute them also outside the workspace, for example place them on a second monitor.



1 = Undocks the dialog

Keyboard shortcuts

Keyboard shortcuts are available for the most common functions in the software.

2.5 Loading a DFS project file

We assume that you have started the R&S Pulse Sequencer (DFS), as described in [Chapter 2.3, "Starting the R&S Pulse Sequencer \(DFS\) for the first time"](#), on page 12.

1. In the R&S Pulse Sequencer (DFS), the "Repository Manager" dialog is open.

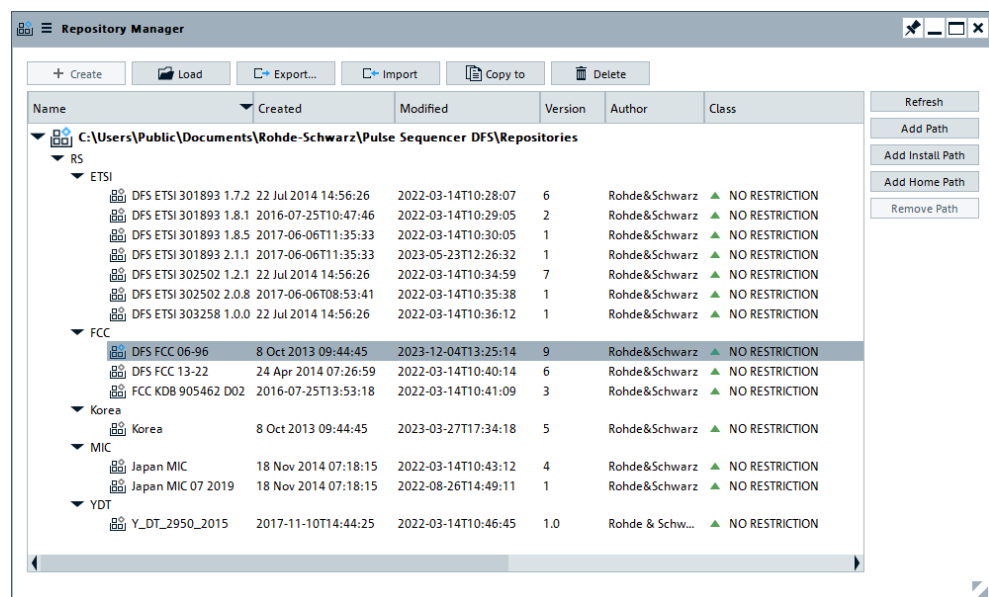

Figure 2-4: R&S Pulse Sequencer (DFS) Repository Manager

2. In the "Repository Manager", select the required standard, e.g. "FCC > DFS FCC 06-96".

Repository files contain all signal definitions and report templates, as required for the selected standard.

See also [Chapter 3.1, "Normative reference"](#), on page 24.

3. Select "Load".

The project tree opens and lists the project content.

Your workspace contains the selected predefined FCC test patterns.

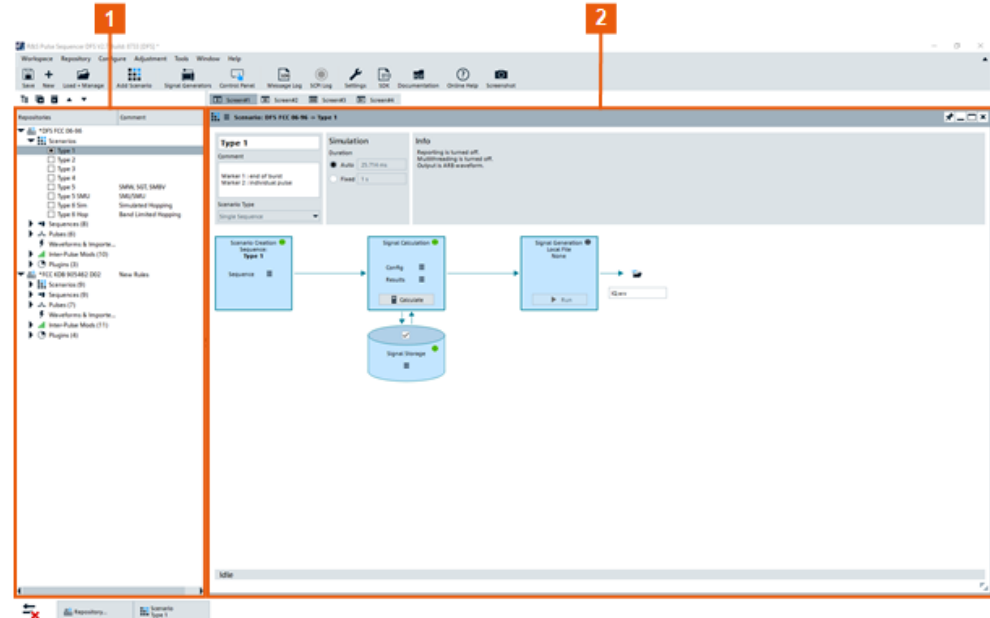

Figure 2-5: R&S Pulse Sequencer (DFS) workspace: Understanding the displayed information

1 = Project tree displaying the loaded DFS FCC test patterns

2 = Scenario dialog displaying a loaded test pattern (DFS FCC 06-96 Type 1)

See:

- [Chapter 4, "Generating test files and conducting the trials"](#), on page 25
- [Chapter A, "Overview of the test requirements and provided test patterns"](#), on page 43

2.6 Getting information and help

If any questions or problems concerning the R&S Pulse Sequencer (DFS) arise, an extensive online help system is provided in the software and can be consulted at any time.

The integrated help system provides the description of all functions. The help system is context-sensitive and provides information specifically for the current operation or setting to be performed. In addition, general topics provide an overview on complete tasks or function groups and background information.



Functions that are the same as in the R&S®Pulse Sequencer are not described in this manual.

You find information on them in the online help system and in the R&S®Pulse Sequencer user manual.

Calling up Help

- ▶ To display the "Help" dialog for the currently focused screen element, e.g. a setting in an opened dialog, select the "Help" icon on the toolbar or press F1.

The "Help" dialog is displayed. A topic containing information about the focused element is displayed. If no context-specific help topic is available, a more general topic or the "Contents" tab is displayed.

The "Help" toolbar provides buttons with standard navigation functions. The "Help" window contains several tabs:

- "View" - shows the selected help topic
- "Contents" - contains a table of help contents
- "Index" - contains index entries to search for help topics
The index is sorted alphabetically. You can browse the list, or search for entries in the list
- "Bookmarks" - contains custom bookmarks
- "Search" - provides text search

To close the Help window

- ▶ Select the "Close" icon in the upper right corner of the help window.

3 About the R&S Pulse Sequencer (DFS)

The R&S Pulse Sequencer (DFS) comes as a stand-alone PC-based software with pre-configured project files for various DFS standards.

Test setup

A typical setup includes a PC with installed software and a connected signal generator. An example of a simplified test setup is shown on [Figure 3-1](#).

You find the detailed requirements for the various standards in the related standard documents. See also [Chapter 3.1, "Normative reference"](#), on page 24.

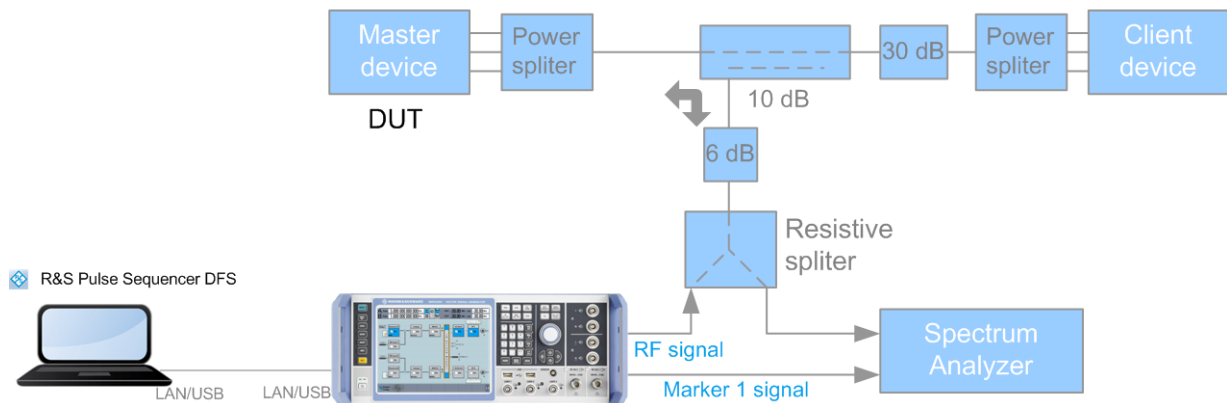

Figure 3-1: Simplified test setup for conducted DFS tests (Example with R&S SMW)

The setup uses a master device as DUT and a client device for the setup of the data link. The test signal is attenuated by an additional 30 dB in the RF path to the client device. This ensures that only the master device responds to the test signal.

The R&S Pulse Sequencer (DFS) calculates the test patterns and transfers them to the signal generator. The signal generator injects the DFS test signal into the communication between the master and the client device. The spectrum analyzer is operated in zero span mode on the channel center frequency. It monitors the traffic between the two devices and the injected radar pulses. Both, the signal generator and the spectrum analyzer can be remote controlled by a PC software for test automation.

Consider to trigger the spectrum analyzer sweep when a new radar test signal is injected. A suitable trigger source is one of the markers signals contained in the generated DFS test patterns.

If the signal levels are high enough an alternative method for the measurement of the RF test signals or the data traffic is the use of the R&S®NRP-Z81 Power Sensor. The [Figure 3-2](#) shows a measurement of the FCC Type 1 pulse train generated by a signal generator. Marker 1 is used as external trigger for the power sensor. This signal marks the end of the entire burst.

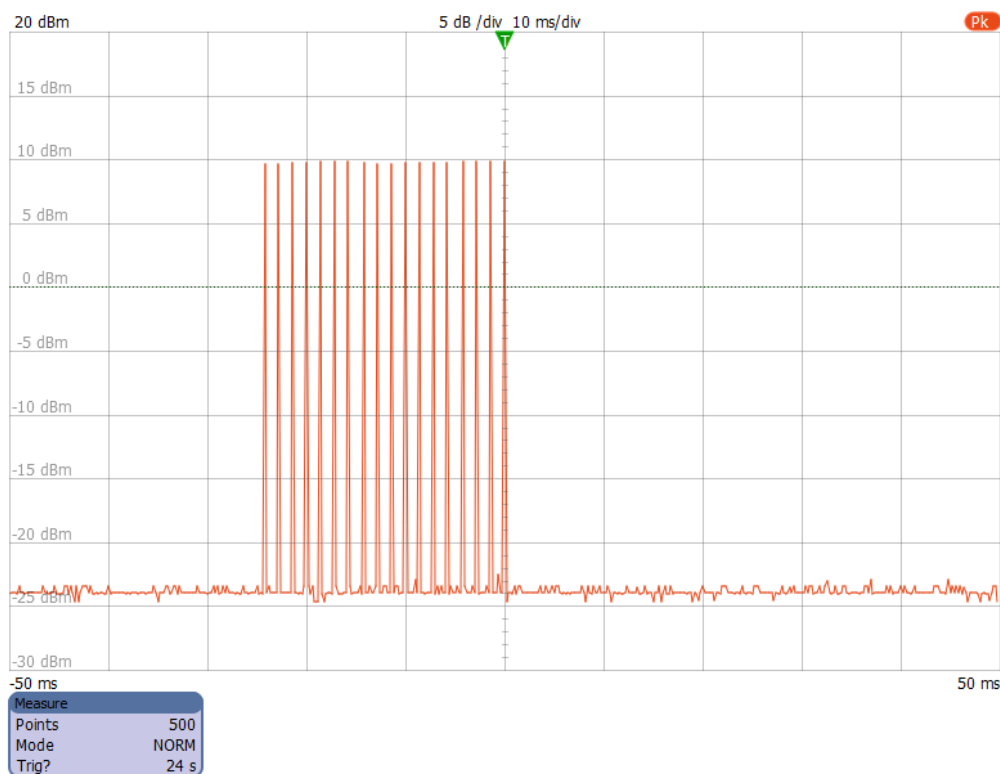

Figure 3-2: Power Sensor measurement result (FCC 06-96 Type 1 pulse train)

A signal created and processed in this way is suitable for performing test in accordance with the standards, listed in Appendix, "DFS Standards and References".

See also [Chapter 4, "Generating test files and conducting the trials"](#), on page 25.

Report generation

The R&S Pulse Sequencer (DFS) provides a built-in report generation function. During waveform generation, this report function documents all used parameters and stores them into a file. The storage location is configurable.

Report files can be stored as:

- **Microsoft Excel spread sheets** (default)

FCC 06-96				
Tester:				
Test Lab:				
Date:				
Device:				
Serial:				
Firmware:				
Manufacturer:				
Test:				
RADAR TYPE 2				Rohde & Schwarz K350 Pulse Sequencer DFS
Trial #	Number of Pulses per Burst	Pulse Width (µsec)	PRI (µs)	Detection (yes/no)
1	26	2,9	175	
2	28	3	162	
3	28	1,5	174	
4	23	1,8	162	
5	27	5	194	
6	24	4	185	
7	25	2	217	

Figure 3-3: Example of a report file ("Type > Plugin")

This reporting function is tailored for the DFS testing. It uses a Microsoft Excel plug-in, that is included in the repository. During waveform generation, the R&S Pulse Sequencer (DFS) sends all relevant parameters to the plugin and populates the spread sheet.

See also [Chapter 4.2, "How to create test reports"](#), on page 29.

- **ASCII text files**

The reporting uses a predefined but editable template. Generated is an ASCII text file where data is formatted in columns, including header description.

```
FCC 06-96 Type 2

Date:          26.11.2014 15:54:18
Repository:    DFS FCC 06-96
Scenario:      Type 2

Trial | Pulse | PW | PRI | Level
      |      |   |    |     |
      |      |   |    |     |
-----|-----|-----|-----|-----
1 | 1 | 3.7 | 215 | -30
1 | 2 | 3.7 | 215 | -30
1 | 3 | 3.7 | 215 | -30
1 | 4 | 3.7 | 215 | -30
1 | 5 | 3.7 | 215 | -30
1 | 6 | 3.7 | 215 | -30
1 | 7 | 3.7 | 215 | -30
1 | 8 | 3.7 | 215 | -30
1 | 9 | 3.7 | 215 | -30
```

Figure 3-4: Example of a *.txt report file ("Type > Template")

You can print the report files and use them to mark the test status, e.g. passed or failed. See also [Chapter 4.2, "How to create test reports"](#), on page 29.

The provided templates can be modified. For detailed description of the file formats, the template and the plugin, see the R&S Pulse Sequencer user manual.

Status information on whether report logging is enabled or not is displayed in the "Scenario" dialog, see [Figure 4-1](#).

Embedded marker signals

The generated waveforms contain two predefined marker signals:

- **Marker 1**
A short marker that marks the end of the last pulse, i.e. the end of the waveform. The rising edge of this signal marks the measurements start point, e.g. in Channel Move Time measurements.
- **Marker 2**
Marks the individual pulses
This signal can be used to trigger a spectrum analyzer, e.g. for pulse train verification measurements in zero span mode.

An overview information on the marker signals is displayed in the "Comment" field of each test scenario, see [Figure 4-1](#).

Marker signals are output at the corresponding BNC connectors of the Rohde&Schwarz signal generator. In the R&S SMW for example, these signals are routed per default to the [USER 1/2] and to the [T/M 2/3] connectors. You can use these signals to synchronize or to trigger connected spectrum analyzers or power sensors. For examples, see [Figure 3-1](#) and [Figure 3-2](#).

3.1 Normative reference

The DFS testing is subject of the standards listed in Appendix, "DFS Standards and References".

The software provides the required test patterns for the following standards:

- ETSI, see [Chapter A.1, "ETSI 301 893, ETSI 302 502, ETSI 303 258"](#), on page 43
- FCC 06-96, see [Chapter A.2.1, "FCC 06-96"](#), on page 46
- FCC KDB 905462 D02, see [Chapter A.2.2, "FCC KDB 905462 D02"](#), on page 49
- FCC 13-22, see [Chapter A.2.3, "FCC 13–22"](#), on page 49
- MIC, see [Chapter A.3, "MIC"](#), on page 50

4 Generating test files and conducting the trials

DFS signals created with the R&S Pulse Sequencer (DFS) can be processed by:

- R&S SMW
- R&S SMBV
- R&S SMBV100B
- R&S SMJ
- R&S SMM
- R&S SMU
- R&S SGT

The R&S Pulse Sequencer (DFS) creates DFS test signals according to the specification listed in [Chapter 3.1, "Normative reference"](#), on page 24.

For detailed description of the requirements and the test signals, see [Chapter A, "Overview of the test requirements and provided test patterns"](#), on page 43.

How to perform DFS tests with R&S Pulse Sequencer (DFS) and Rohde & Schwarz vector signal generator

The following outlines the main steps to be performed with the R&S Pulse Sequencer (DFS) and the signal generator.

For description on the exact test setup, refer to the corresponding standard documentation.

We assume that the vector signal generator is equipped with the options listed in [Chapter 2.1, "Required options"](#), on page 9.

1. Install the R&S Pulse Sequencer (DFS) on a PC as described in [Chapter 2.2, "Installing the software"](#), on page 10.
2. Connect the vector signal generator and the PC with the installed R&S Pulse Sequencer (DFS) software to a LAN.
See [Figure 3-1](#).
3. Route the marker 1 signal from the vector signal generator to the trigger input of the spectrum analyzer or the power sensor.
Marker signals are output at one of the BNC connectors of the vector signal generator. For more information, refer to the user manual of the corresponding instrument.
4. Ensure that Microsoft Excel is installed on the PC.
Otherwise use template-based reporting.
5. Start the R&S Pulse Sequencer (DFS) software. Load the DFS repository of the standard to be tested.
See [Chapter 2.5, "Loading a DFS project file"](#), on page 17.

6. In the R&S Pulse Sequencer (DFS), set up the connection between the software and the vector signal generator.
See [Chapter 4.1, "How to connect the signal generator"](#), on page 26.
7. Create test reports.
See [Chapter 4.2, "How to create test reports"](#), on page 29.
8. Conduct the trial.
See [Chapter 4.3, "How to create the waveforms and conduct the trial"](#), on page 31.

The R&S Pulse Sequencer (DFS) creates all required files and transfers them to the vector signal generator.

4.1 How to connect the signal generator

This section shows how to:

- ["To select a physical generator"](#) on page 26
- ["To add a connected physical signal generator to the list of available instruments"](#) on page 28

To select a physical generator

This section assumes that you have loaded a DFS repository as described in [Chapter 2.5, "Loading a DFS project file"](#), on page 17.

1. In the project tree, select the required "Scenario".
In the context of this software, the term scenario describes all trials of a waveform. For example, to perform DFS tests according to FCC type 5, select "DFS FCC 06-96 > Scenario > Type 5".

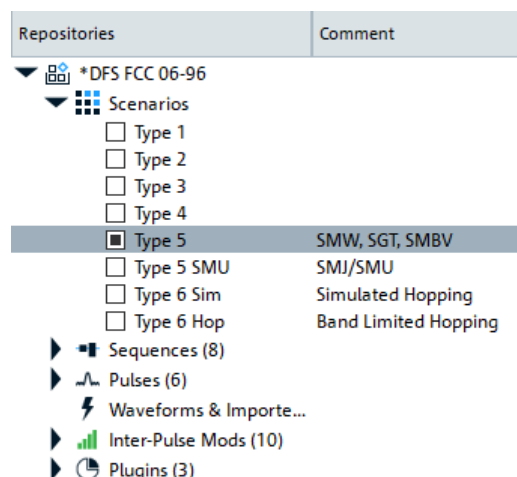

The "Scenario" dialog opens and displays information on the sequence, generated waveform, marker signals, etc.

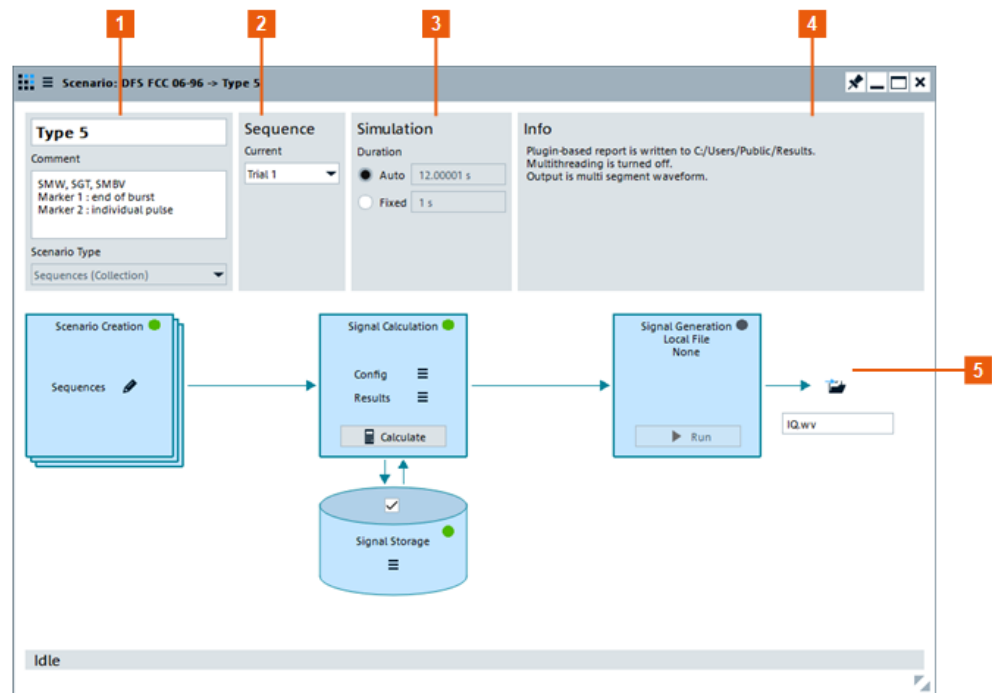
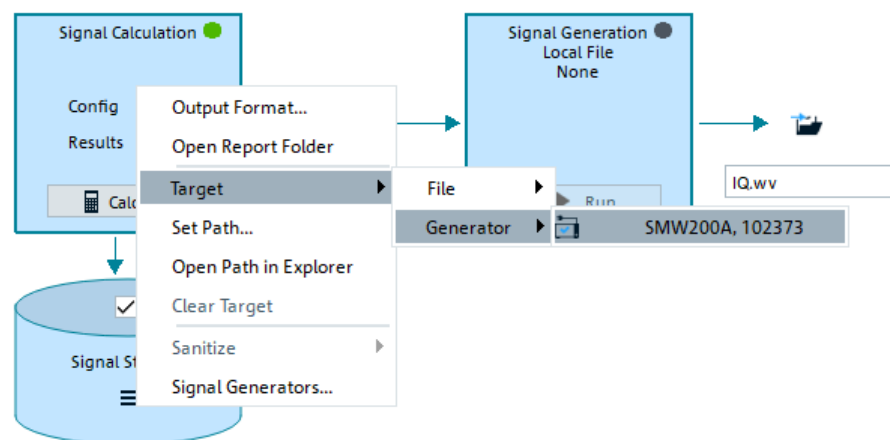

Figure 4-1: Scenario dialog: Understanding the displayed information

- 1 = Scenario name, additional information on generated markers and whether the same or variable trials are used
- 2 = If the test requires several trials, the entire set of sequences is automatically generated; "Current" indicates the name of the currently selected trail
- 3 = Simulation duration settings
- 4 = Information on the storage location, the generated waveform (single or multi-segment), and display of status messages
- 5 = Selected generator or output file, together with status indication

See also "Embedded marker signals" on page 24.

2. In the "Signal Calculation" block, open the context menu under "Config".
3. Select the target generator, for example "Config > Target > Generator > SMWA200A".



The selected generator is displayed in the "Signal Generation" block.

Note: If no physical generators are available, see ["To add a connected physical signal generator to the list of available instruments"](#) on page 28.

To add a connected physical signal generator to the list of available instruments

1. In the menu bar, select "Configure > Signal Generators".

The "Signal Generators" dialog opens.

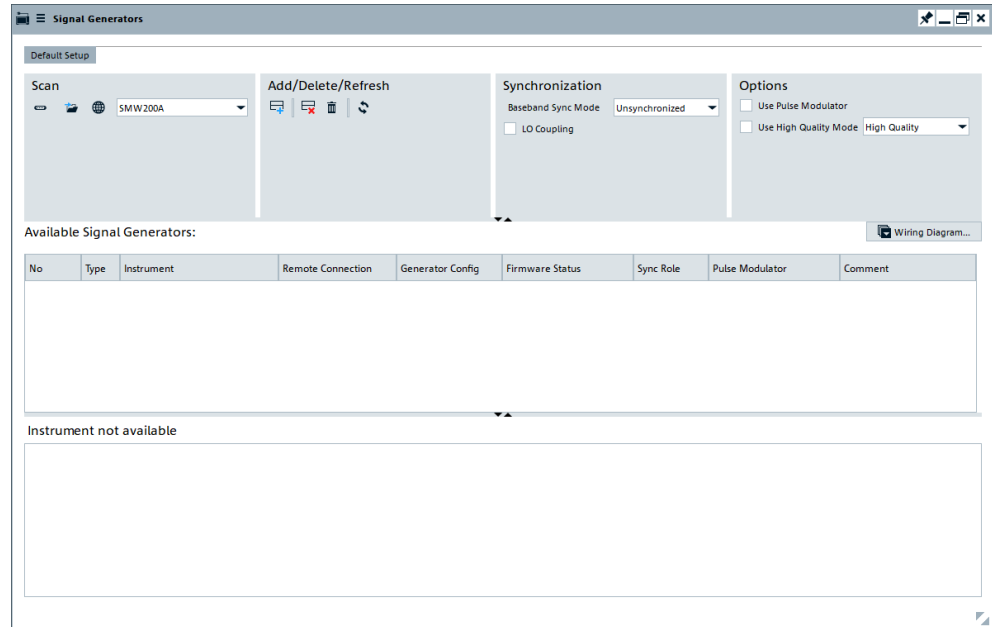

2. If the "Available Signal Generators" list is empty, perform one of the following:

- a) **Scan for available instruments.**

Select one of the "Scan" options by clicking the appropriate icon (GPIB, USB or LAN).

To scan for a particular type of generator, select it in the drop-down list (e.g. SMW200A).

- b) **Add a particular instrument.**

Select the "Add" icon.

Enter the IP address, the computer name, or the complete VISA resource string of the connected instrument.

Select "OK".

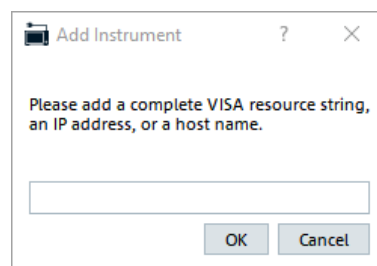

The new instrument is added to the list.

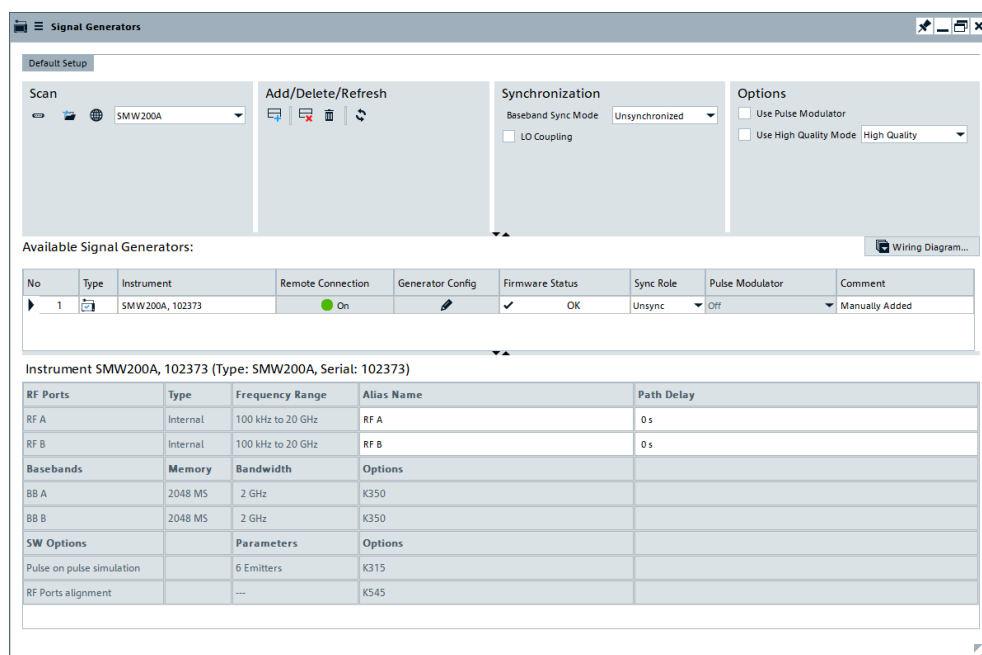

This generator also appears in the list of generators available via the "Signal Generators" block in the "Scenarios" dialog.

4.2 How to create test reports

An introduction to the reporting function is provided in ["Report generation"](#) on page 22.

This section shows how to:

- ["To enable report file generation"](#) on page 29
- ["To set the storage location for the generated report files"](#) on page 30
- ["To change the report type"](#) on page 30

To enable report file generation

In R&S Pulse Sequencer (DFS), the reporting function is enabled per default.

The "Scenario" dialog provides information on the report logging status. The related information is displayed to the right of the "Comment" field.

Sequences (Collection)

Plugin-based report is written to C:_My_Report_Files.
Data output is in MSW or waveform format.

To enable or disable the report file generation, proceed as following:

1. In the "Scenario" dialog, select "Waveform Generation > Config".
2. In the "Signal Calculation Settings" dialog, select "Reporting > Reporting Enable > On".

To set the storage location for the generated report files

Per default, report files are stored in the user home directory of the current user, that is the %HOMEPATH% directory.

1. Open the "Scenario" dialog to retrieve information on the current storage location. Information is displayed to the right of the "Comment" field.
2. Select "Signal Calculation > Config > Config".
3. In the "Signal Calculation Settings" dialog, select "Reporting".
The parameter "Target Path" indicates the current storage location.

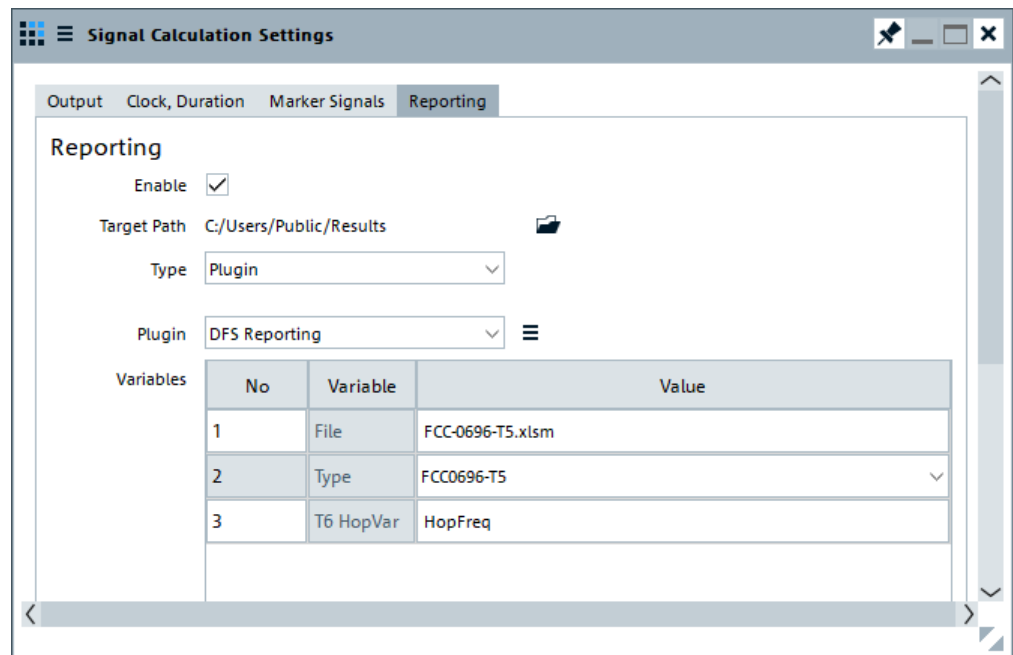

4. To change this location, select the "Set target path" icon, navigate to the directory, and confirm with "Select Folder".

To change the report type

You can also store the test reports in text form or as HTML pages (e.g. if Microsoft Excel is not installed on your PC).

To change the type of the generated reports, proceed as following:

1. In the "Scenario" dialog, select "Signal Calculation > Config > Config > Report".
2. Select "Type > Template".
3. Select "Edit" to display the current template.

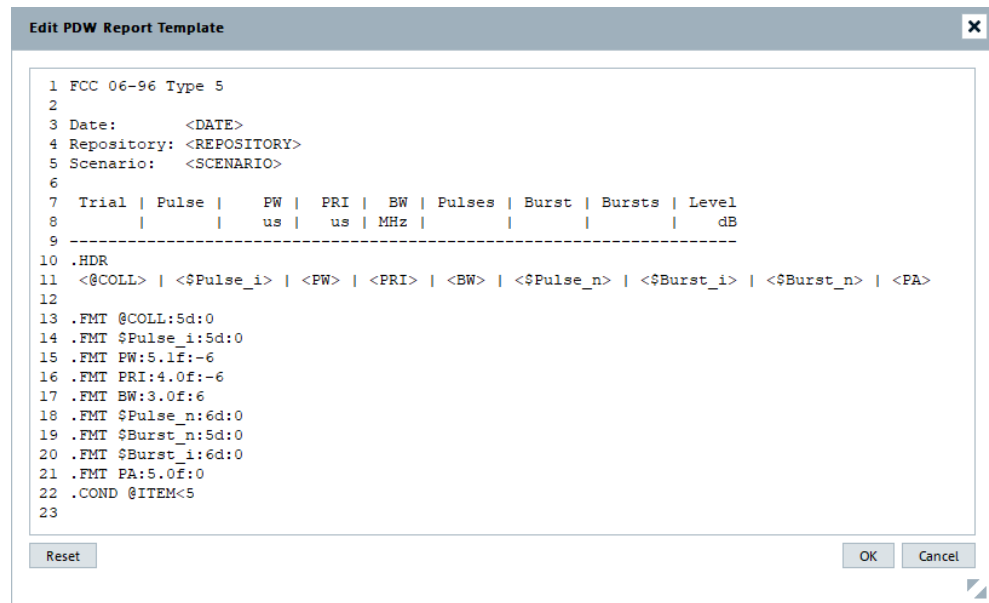

```

1 FCC 06-96 Type 5
2
3 Date: <DATE>
4 Repository: <REPOSITORY>
5 Scenario: <SCENARIO>
6
7 Trial | Pulse | PW | PRI | BW | Pulses | Burst | Bursts | Level
8 | | us | us | MHz | | | | dB
9 -----
10 .HDR
11 <@COLL> | <${Pulse_i}> | <PW> | <PRI> | <BW> | <${Pulse_n}> | <${Burst_i}> | <${Burst_n}> | <PA>
12
13 .FMT @COLL:5d:0
14 .FMT ${Pulse_i}:5d:0
15 .FMT PW:5.1f:-6
16 .FMT PRI:4.0f:-6
17 .FMT BW:3.0f:6
18 .FMT ${Pulse_n}:6d:0
19 .FMT ${Burst_n}:5d:0
20 .FMT ${Burst_i}:6d:0
21 .FMT PA:5.0f:0
22 .COND @ITEM<5
23

```

Reset OK Cancel

For detailed description of the file formats, the template and the plugin, see the R&S Pulse Sequencer user manual.

4.3 How to create the waveforms and conduct the trial

Once you have completed the configuration described in [Chapter 4.1, "How to connect the signal generator"](#), on page 26, you can start waveform generation.

We assume that the reporting function uses the predefined report plug-in.

This section shows how to:

- ["To generate the waveforms"](#) on page 31
- ["To view the created reports"](#) on page 33
- ["To store the generated waveforms in the repository"](#) on page 33
- ["To verify the configuration of the connected signal generator"](#) on page 34
- ["To play the generated signal"](#) on page 36
- ["To set the DUT's frequency and bandwidth for FCC 06-96 type 6 tests with simulated hopping"](#) on page 36
- ["To set the DUT's frequency and bandwidth for FCC KDB 905462 D02 type 5 tests"](#) on page 40

To generate the waveforms

We recommend that you **create all waveforms before starting the manual tests**. Waveform generation is only required once for all trials.

1. In the "Scenario" dialog, observe the displayed "Comment".
Some scenarios require more configurations, like, for example, the [FCC 06-96 type 6](#) or [FCC KDB 905462 D02 type 5](#) tests.

2. Configure the test-related settings first.

See also:

- "To set the DUT's frequency and bandwidth for FCC 06-96 type 6 tests with simulated hopping" on page 36
- "To set the DUT's frequency and bandwidth for FCC KDB 905462 D02 type 5 tests" on page 40

3. In the "Scenario" dialog, select "Calculate".

The waveform calculation starts. Depending on the PC performance, waveform calculation can take several minutes. Progress information, the size of the waveform and a busy status indicator is displayed.

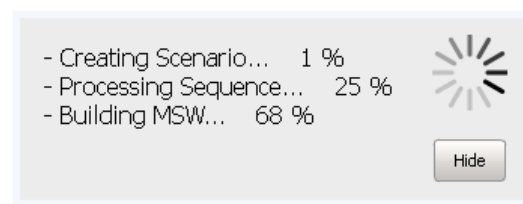

Note: Do not interrupt this process. Do not execute other actions while the calculation is in progress.

With the waveform generation start, the software performs automatically the following:

- Invokes Microsoft Excel and opens a spreadsheet for reporting

TYPE 5 PARAMETER SHEET							Rohde & Schwarz Pulse Sequencer
Trial Number : 3							
Bursts in Trial: 11							
Burst	Number of Pulses	Pulse Width (µsec)	Chirp Width (MHz)	Pulse 1-to-2 Spacing (µsec)	Pulse 2-to-3 Spacing (µsec)	Start Location Within Interval (msec)	
1	11	51,5	8				
2	11	98,5	17	1275	1117		
3	11	58,8	10	1582			
4	11	55,1	13				
5	11	85,6	5	1179	1629		
6	11	59,4	7	1676			
7	11	90,9	15	1137			
8	11	60,1	5	1426			
9	11	85,4	13	1082	1366		
10	11	99,8	9				
11	11	88	5	1576			

Figure 4-2: Example of a spreadsheet

- Creates the individual waveforms and transfers them to the vector signal generator
- Stores the populated reports and closes Microsoft Excel

The green status indicator in the "Signal Calculation" block indicates that the waveform generation has completed successfully.

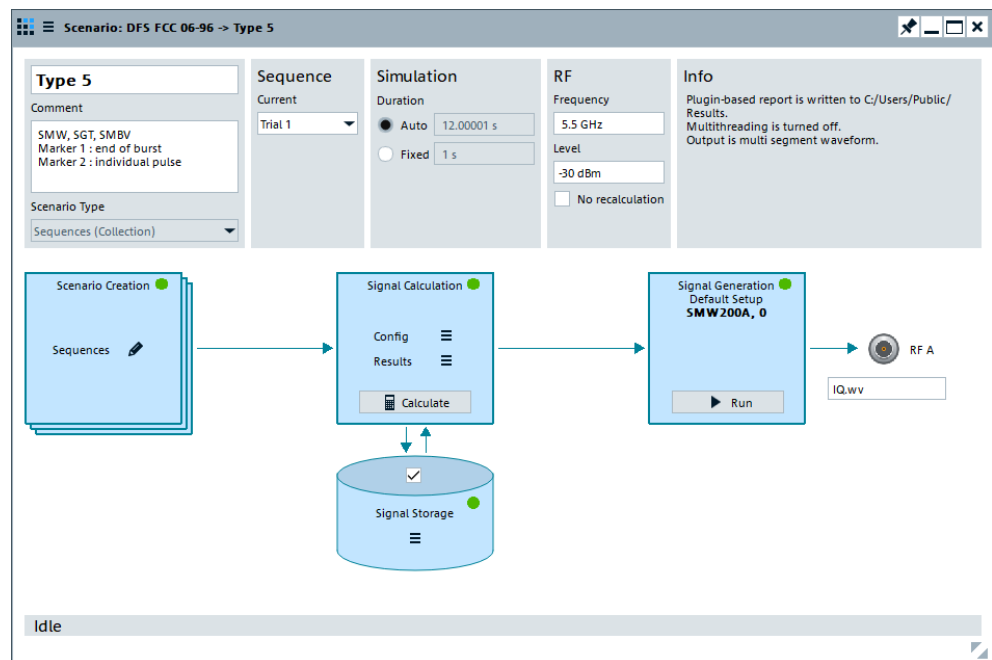

If the default "Single Shot" play mode is used, the vector signal generator plays the waveform once.

The RF frequency and level in the vector signal generator are set with the respective parameters in the "Scenario > RF" settings in the dialog.

To view the created reports

Once the waveform is created, you can view the created report files.

- In the "Scenario" dialog, select "Signal Calculation > Config > Open Report Folder".

To play the generated waveforms

Once the waveform is created, you can play the created waveform files.

1. In the "Scenario" dialog, select "Signal Calculation > Results > View".
2. Select a trial from the list.

The "Signal Preview" dialog opens.

To store the generated waveforms in the repository

According to the DFS standards, each new waveform calculation uses new random values.

To continue testing later or to repeat measurements with the *same* random parameters, generated waveforms can be stored in the repository.

1. In the "Scenario" dialog, select "Storage > On".
2. Select "Signal Calculation > Results > Save calculated results".

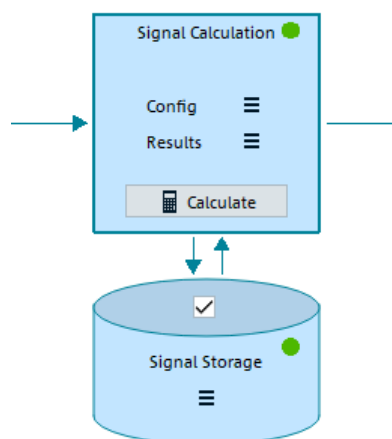

The green indicator in the "Storage" block confirms that the calculated waveforms are stored in the repository. The dotted line also indicates that waveform data is retrieved from the repository.

3. To load previously stored waveforms, select "Signal Generation > Results > Load calculated results".
4. To trigger a waveform calculation for the same "Scenario" but with *new* random values, perform the reverse operation:
 - a) Select "Storage > Clear"
 - b) Select "Storage > Off"
 - c) Select "Start".

To verify the configuration of the connected signal generator

All required waveforms are stored in the user directory on the instrument's hard disk.

The following example uses R&S SMW.

1. In the R&S Pulse Sequencer (DFS), select "Signal Generation > Run".
 The software controls the signal generator. The RF frequency and the pulse top power level are set automatically.
 The selected trial is loaded into the ARB. The ARB and the RF output are activated.
2. On the instrument's display, observe the block diagram.

How to create the waveforms and conduct the trial

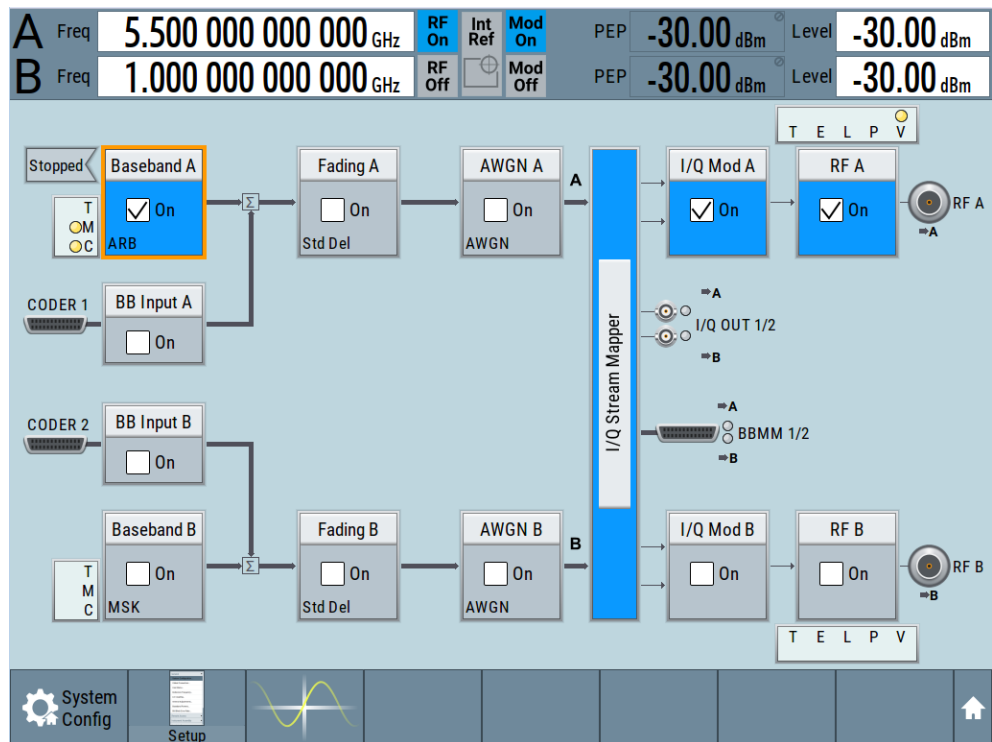

The displayed "RF Frequency" and "PEP" values confirms the settings performed in the R&S Pulse Sequencer (DFS).

3. Select "Baseband > ARB".

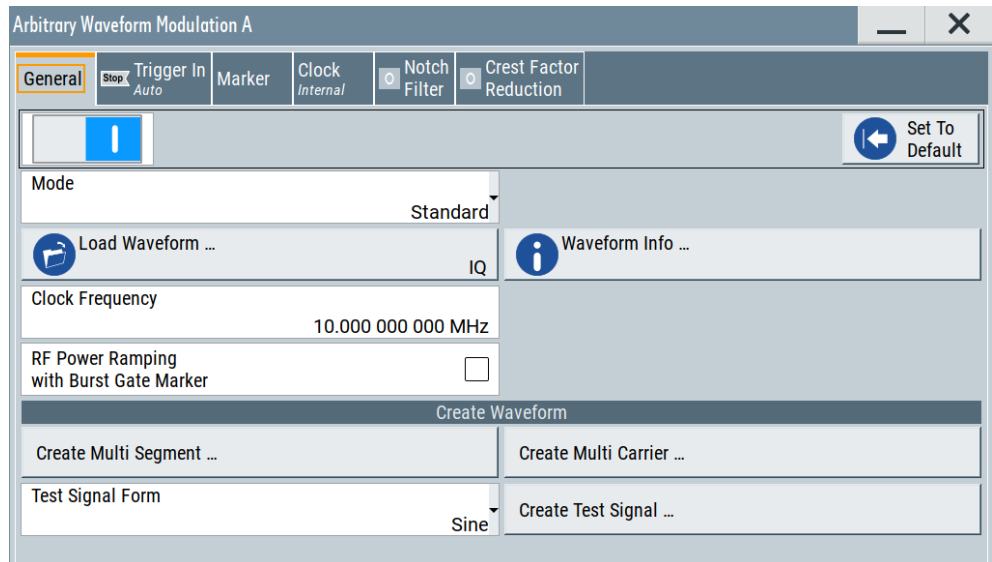

The waveform "IQ" is loaded.

To play the generated signal

The signal generator is configured in "Trigger Mode > Armed Auto". To play the waveform, execute the trigger manually:

- ▶ In the signal generator, select "Baseband > ARB > Trigger > Execute Trigger".

The instrument generates the selected waveform once. The required test signal is output at [RF A] connector.

The "Marker 1" and "Marker 2" signals, at the [T/M 2] and [T/M 3] connectors.

To load and process further trials from the same DFS type

All required waveform had been created and transferred to the instrument. With the following steps, you select the trial to be loaded in the ARB:

1. In the R&S Pulse Sequencer (DFS), open the "Scenario" dialog. Select the next trial, for example "Sequence > Current > Trial 2"

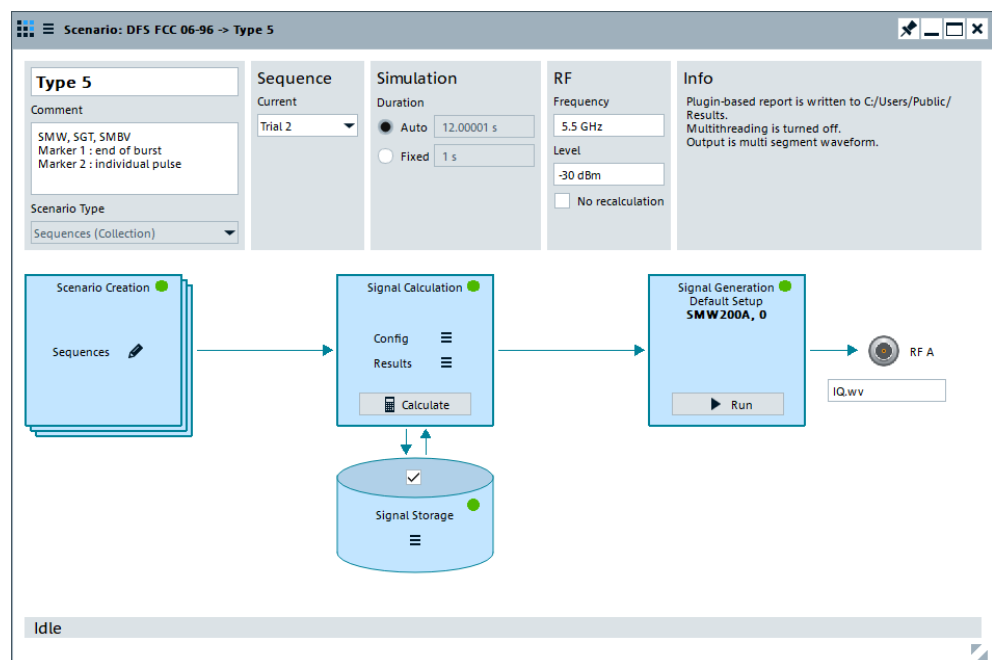

2. Select "Run".

The waveform of trial 2 is activated in the ARB.

If "Single Shot" play mode is used, signal generation starts automatically. The waveform is played once.

To set the DUT's frequency and bandwidth for FCC 06-96 type 6 tests with simulated hopping

FCC 06-96 type 6 tests use simulated hopping. A short introduction to the principle is provided in [Chapter A.2.1.3, "Radar type 6"](#), on page 47.

To calculate the waveform, the R&S Pulse Sequencer (DFS) software uses the following parameters: the DUT's bandwidth, the center frequency, and the description of the frequency hopping.

To configure the required parameters, proceed as following:

1. In the "Scenario" dialog, select set the parameter "Frequency" to the operating frequency of the DUT.
2. Observe the displayed "Comment".

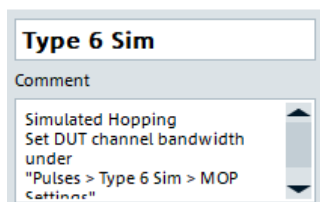

To perform [FCC 06-96](#) type 6 tests with simulated hopping, adjust the DUT's bandwidth.

The default bandwidth is 20 MHz. To change this value:

3. In the "Repository tree", select "DFS FCC 06-96 > Pulses > Pulse 6 Sim".

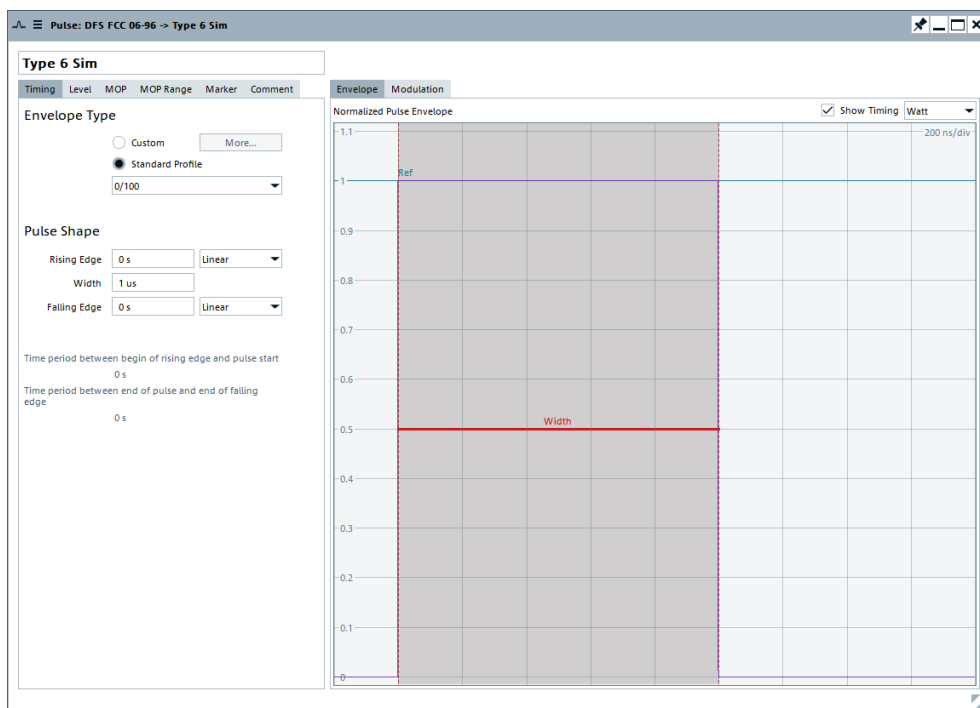

4. In the "Pulse" dialog, select "MOP"

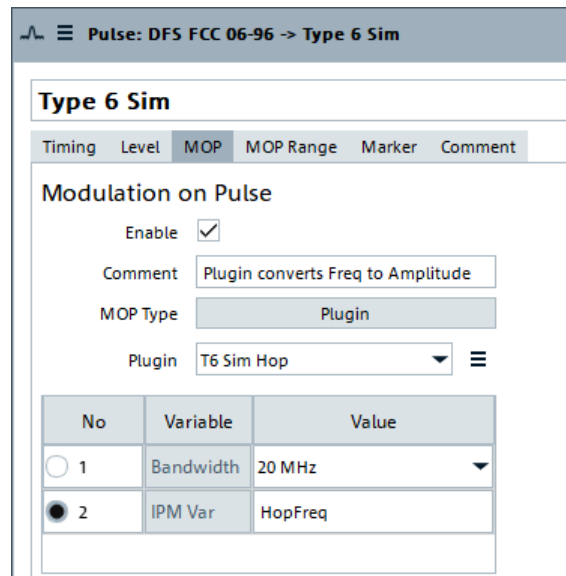

- In the "Bandwidth" field, select the DUT bandwidth according to the particular test requirements, e.g. 20 MHz.

Generated are only pulses whose frequency f_{hop} fall within this "Bandwidth". Frequencies that fall outside the "Bandwidth" are suppressed.

See also [Figure A-1](#).

Note: Do not change the value of the variable "IPM Var".

The value "HopFreq" is internally used for the calculation of the frequency hops.

- The frequency hopping is described with a predefined **IPM** profile. To see the IPM profile, select "Repository Tree > IPM > Type 6, Hopping".

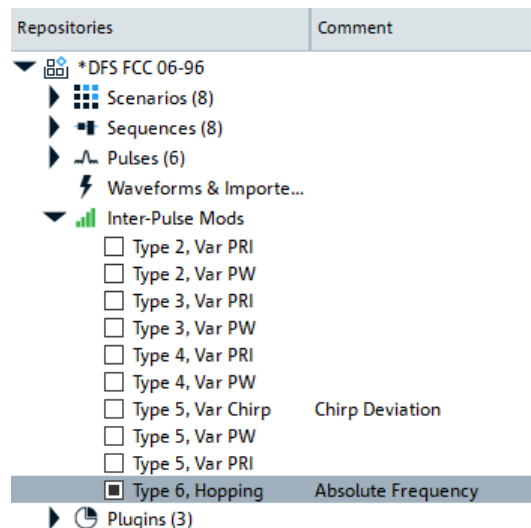

The "IPM" dialog opens and displays information on the configured IPM profile.

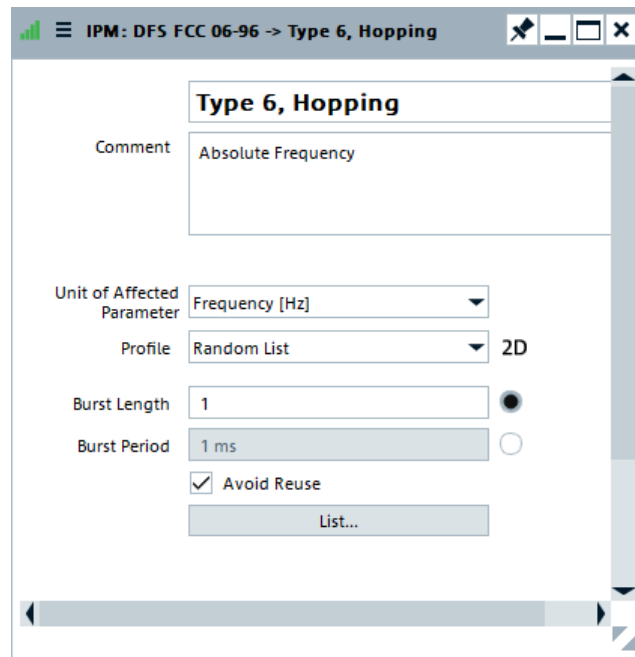

The "Type 6, Hopping" is implemented as a "Random List" profile. The frequency is selected on a random manner without frequency reuse.

7. To retrieve information on the used frequency range, select "List".

No	Value
<input type="checkbox"/> 1	5.25 G
<input type="checkbox"/> 2	5.251 G
<input type="checkbox"/> 3	5.252 G
<input type="checkbox"/> 4	5.253 G
<input type="checkbox"/> 5	5.254 G
<input type="checkbox"/> 6	5.255 G
<input type="checkbox"/> 7	5.256 G
<input type="checkbox"/> 8	5.257 G

Figure 4-3: IPM profile for DFS FCC 06-96 type 6 tests with simulated hopping (extract)

The list contains 475 frequencies in the frequency range between 5.25 GHz to 5.724 GHz. The extract on [Figure 4-3](#) shows the first few values.

For more information on the provided settings, see the R&S Pulse Sequencer user manual.

8. Close the dialogs.

9. Conduct the trial.
See ["To generate the waveforms"](#) on page 31.
10. Open the generated report file `FCC-0696-T6Sim.xls`.

The file contains 1 overview sheet and 30 individual sheets, one for each trial.

TYPE 6 PARAMETER SHEET				
Trial Number : 15				
Bursts in Trial: 100				
Burst	Carrier (GHz)	Hop (GHz)	DUT BW (MHz)	Within RX
1	5,5	5,459	20	
2	5,5	5,28	20	
3	5,5	5,606	20	
4	5,5	5,714	20	
5	5,5	5,576	20	
6	5,5	5,278	20	
7	5,5	5,483	20	
8	5,5	5,374	20	
9	5,5	5,499	20	*
10	5,5	5,567	20	
11	5,5	5,491	20	*

Figure 4-4: DFS FCC 06-96 type 6 trial 15 spreadsheet (extract)

* = indicates frequencies that fall within the bandwidth of the DUT

Each spreadsheet lists the randomly selected 100 frequencies and indicates the frequency hops that fall within the bandwidth of the DUT.

See also [Figure A-1](#).

To set the DUT's frequency and bandwidth for FCC KDB 905462 D02 type 5 tests

To perform the [FCC KDB 905462 D02](#) type 5 tests, you have to specify the center frequency (F_c) and the bandwidth of your DUT.

Configure the required parameters as following:

1. In the "Scenario" dialog, set the "Target > File".
2. Enable report generation, as described in [Chapter 4.2, "How to create test reports"](#), on page 29.
3. In the "Scenario" dialog, select "Controls > Prepare".
Wait until the waveforms and the report are generated.
4. In the "Scenario" dialog, select "Signal Generation > Config > Open Report Folder".
5. Open the generated report file `FCC905462D02v02-T5.xls`.
The file contains 1 overview sheet and 30 individual sheets, one for each trial.
6. Observe the information on the "Overview" tab.

How to create the waveforms and conduct the trial

FCC 905462 D02 New Rules v02				
Tester: Test Lab: Date: Device: Serial: Firmware: Manufacturer: Test:		Fc:	5500	1
		Fobl:	5491	2
		Fobh:	5509	
TYPE 5				
Trial #	Detection (yes/no)	Chirp Width (MHz)	Subset	Fc
1		5	1	5500
2		5	1	5500
3		8	1	5500
4		12	1	5500
5		20	1	5500
6		8	1	5500
7		8	1	5500
8		13	1	5500
9		5	1	5500
10		8	1	5500
11		5	2	5493
12		5	2	5493
13		16	2	5497.4
14		9	2	5494.6
15		11	2	5495.4
16		12	2	5495.8
17		8	2	5494.2
18		18	2	5498.2
19		20	2	5499
20		13	2	5496.2
21		11	3	5504.6
22		11	3	5504.6
23		9	3	5505.4
24		20	3	5501
25		14	3	5503.4
26		20	3	5501
27		15	3	5503
28		10	3	5505
29		19	3	5501.4
30		14	3	5503.4

- 1 = F_c : Center frequency of the DUT
- 2 = DUT's bandwidth, set as F_{OBL} (occupied bandwidth low edge) and F_{OBH} (occupied bandwidth high edge)
- 3 = $F_{c,\#}$: center frequency per trial, calculated automatically from the DUT's center frequency and its bandwidth

The tab shows a table with summary information on the 30 trials. The indicated F_c , F_{OBL} and F_{OBH} values are the default values.

7. Set the F_c , F_{OBL} and F_{OBH} values to fit the center frequency and bandwidth of **your DUT**.

The $F_{c,\#}$ values per trial are calculated automatically.

8. In the "Scenario" dialog, select "Traget > Config > Generator".
9. Depending on the used instrument, select a suitable profile. Proceed as described in [Chapter 4.1, "How to connect the signal generator"](#), on page 26.
10. In the "Scenario" dialog, select "Sequence > Trial 1".
11. Set the parameter "RF > Frequency" to the center frequency $F_{c,1}$ as shown in the report.
12. Set "RF > Supress Recalculation > On".
This setting prevents that the waveform is recalculated each time you change the RF frequency.
13. Conduct the trial.
See ["To generate the waveforms"](#) on page 31.
14. Repeat steps [step 11](#) and [step 13](#)
15. Open the generated report file `FCC905462D02v02-T5.xls`.

Annex

A Overview of the test requirements and provided test patterns

The software supports waveform generation according to different version of the same specification. If not other stated, all versions of the same specification use the same waveform requirements.

A.1 ETSI 301 893, ETSI 302 502, ETSI 303 258

This section describes the generation of the **DFS** related radar test signals according to the **ETSI** specifications.

- [Waveform requirements 301893](#).....43
- [Waveform requirements 302502](#).....44
- [Waveform requirements 303258](#).....45

A.1.1 Waveform requirements 301893

The waveform requirements are listed in [Table A-1](#).

Table A-1: Waveform requirements 301893 (Annex D, DFS)

Radar test signal	Pulse width [us]	PRF [us]	Pulses per burst	Additional requirements
1	0.5 to 5	200 to 1000	10, 18	See Table A-2 .
2	0.5 to 15	200 to 1600	15, 18	
3	0.5 to 15	2300 to 4000	25	
4	20 to 30	2000 to 4000	20	
5	0.5 to 2	300 to 400	10, 18	
6	0.5 to 2	400 to 1200	15, 18	

Table A-2: Additional requirements

Radar test signal	Pulse descriptions
1	Constant PRF
2	Constant PRF
3	Constant PRF
4	Constant PRF Modulated radar test signal. Chirp with a ± 2.5 MHz frequency deviation.

Radar test signal	Pulse descriptions
5	Staggered PRF (2 or 3 different PRF values and a single pulse type). PRF values differ by 20 PPS to 50 PPS. Note: R&S Pulse Sequencer (DFS) provides two off-channel CAC scenarios to support wideband and narrowband signal generators.
6	Staggered PRF (2 or 3 different PRF values and a single pulse type) PRF values differ by 80 PPS to 400 PPS



For off-channel CAC testing, the test signal contains groups of pulses.

For all other tests, single pulses are used.

Refer to diagrams D1 to D4 in the [ETSI](#) specification (see [ETSI 301893](#)).

Starting from V2.1.1 of [ETSI 301893](#), the generation of two communication signals is required.

In this implementation, the signals are generated as follows:

- OFDM test signal with "Pulse Width = 40 us", continuously generated
- LTE test signal with "Pulse Width = 20000 us", continuously generated

For all test signals, a total of 20 randomly generated test patterns are required.

A.1.2 Waveform requirements 302502

The waveform requirements described in this section apply to the following ETSI standards:

- ETSI EN 302 502 V2.0.8
- ETSI EN 302 502 V2.1.1

The waveform requirements are listed in [Table A-3](#).

Table A-3: Waveform requirements 302502 (Annex D, DFS, Table D.3.1)

Radar test signal	Pulse width [us]	PRF [us]	Pulses per burst	Requirements
1	1	750	15	Variable PRF and pulse width
2	1, 2, 5	200, 300, 500, 800, 1000	10	
3	10, 15	200, 300, 500, 800, 1000	15	
4	1, 2, 5, 10, 15	1200, 1500, 1600	15	
5	1, 2, 5, 10, 15	2300, 3000, 3500, 4000	25	
6	20, 30	2000, 3000, 4000	20	

The radar test signal 6 requires a linear chirp modulation from -2.5 MHz to +2.5 MHz within the pulse. For the test signals 2 to 6, a total of 20 randomly generated test patterns are required.

This standard adds two more waveforms that simulate frequency hopping radar systems, see [Table A-4](#).

Table A-4: Waveform requirements 302502 (Annex D, DFS, Table D.3.2)

Radar test signal	Pulse width [us]	PRF [us]	Pulses per burst	Burst length [ms]	MOP
1	1	3000	9	3	-
2	20	4500	9	2	Chirp

Both signals use bursts that contain 9 pulses with fixed pulse width and fixed PRF. The second signal also uses a linear FM chirp from -2.5 MHz to +2.5 MHz. In contrast to the other waveforms the spacing between the bursts is increased from trial to trial by a fixed step size, see [Table A-5](#).

Table A-5: Waveform requirements 302502 (burst spacing)

Radar test signal	Trials	Min spacing [ms]	Max spacing [ms]	Step size [ms]
1	29	1.25	37.5	1.25
2	29	5	150	5

A.1.3 Waveform requirements 303258

The waveform requirements are listed in [Table A-6](#).

Table A-6: Waveform requirements 303258 (Annex D)

Radar test signal	Pulse width [us]	PRF [PPS]	Pulses per burst	Requirements
1	0.5 to 5	200 to 1000	10	Constant PRF for each test pattern
2	0.5 to 15	200 to 1600	15	
3	0.5 to 15	200 to 4000	25	
4	20 to 30	2000 to 4000	20	

The radar test signal 4 also requires a linear chirp modulation from -2.5 MHz to +2.5 MHz within the pulse.

For all test signals a total of 20 randomly generated test patterns are required.

A.2 FCC

- [FCC 06-96](#).....46
- [FCC KDB 905462 D02](#).....49
- [FCC 13–22](#).....49

A.2.1 FCC 06-96

This section describes the generation of the [DFS](#) related radar test signals according to the [FCC 06-96](#) specification.

The R&S Pulse Sequencer (DFS) provides a repository with all test signals defined in the standard. The repository contains all relevant pulse definitions and creates waveforms of all the required trials. The provided test patterns are in line with the requirements listed in [Table A-7](#).

Table A-7: FCC 06-96: Overview of the related chapters

Chapter	Test Patterns/Trials	Description	Related section
Chapter 6.1	Radar Type 1 to 4	Short Pulse Radar Waveforms	Chapter A.2.1.1, "Radar type 1 to 4" , on page 46
Chapter 6.2	Radar Type 5	Long Pulse Radar Test Waveform	Chapter A.2.1.2, "Radar type 5" , on page 47
Chapter 6.3	Radar Type 6	Frequency Hopping Radar Test Waveform	Chapter A.2.1.3, "Radar type 6" , on page 47

You can use the built-in reporting function to generate and store report files. If enabled, the reporting plug-in populates Microsoft Excel spreadsheets, formatted according to the requirements and populated with the parameters used during the waveform generation. You can use these spreadsheets during testing or for filing test results.

A.2.1.1 Radar type 1 to 4

The parameters for the waveforms of type 1 to 4 are listed in [Table A-8](#).

Table A-8: Radar types 1 to 4: Parameters overview

Radar type	Pulse width (0.1 us steps)	PRI [us] (1 us steps)	Number of Pulses	Requirements	Comment
1	1	1428	18	1 waveform	Fixed (static) PRI
2	1 to 5	150 to 230	23 to 29	min 30 unique waveforms per type	Variable PRI, pulse width, and number of pulses
3	6 to 10	200 to 500	16 to 18		
4	11 to 20	200 to 500	12 to 16		

A.2.1.2 Radar type 5

Radar type 5 is a waveform that uses FM chirped bursts. Several pulse parameters vary randomly. The overall duration of the waveform is 12 seconds. The time is divided equally, depending on the number of used bursts. Each burst starts at a random moment within its time interval. The following parameters are selected randomly per burst and applied to all pulses belonging to same burst.

- Number of pulses
- FM chirp deviation

The same applies for the PRI, with the exception that bursts containing three pulses also vary the PRI within the burst. In this case, the intra-pulse spacing is different between pulse one and two as well as between pulse two and three.

The parameters for the waveform of type 5 are listed in [Table A-9](#).

Table A-9: Radar type 5: Parameters overview

Radar type	Pulse width (0.1 us steps)	PRI [us] (1 us steps)	Pulses per burst	Bursts	Chirp deviation [MHz]	Requirements	Comment
5	50 to 100	1000 to 2000	1 to 3	8 to 20	5 to 20	30 unique waveforms	Variable PRI, pulse width, and number of pulses/bursts

The R&S Pulse Sequencer (DFS) automatically creates the required waveforms of all 30 trials.

A.2.1.3 Radar type 6

Radar type 6 is a waveform that consists of 9 consecutive pulses on one frequency. This burst is referred to as the pulses per hop.

A total of 100 frequencies are selected from a range 5.25 GHz to 5.724 GHz. The frequency changes every 3 ms and each burst of 9 pulses uses a unique frequency. It must be ensured that at least one of the random frequencies falls into the receiver bandwidth of the DUT.

The parameters for the waveform of type 6 are listed in [Table A-10](#).

Table A-10: Radar type 6: Parameters overview

Radar type	Pulse width [us]	PRI [us]	Waveform duration [ms]	Pulses per hop	Hop rate [Hz]
6	1	333	300	9	333

Simulated frequency hopping

The FCC 06-96 Radar type 6 waveform uses a static pattern but requires frequency hops across a wide frequency range. A real frequency hopping is a demanding implementation, that would, for example, require a vector signal generator with large bandwidth or a fast hopping synthesizer. As an alternative, the standard proposes a method called simulated hopping. DUTs are devices that receive RF signals in a limited RF band. Therefore, it is allowed to simulate only the subset of random frequency hops, that would fall within the DUT's bandwidth.

The principle of the simulated hopping is illustrated on Figure A-1.

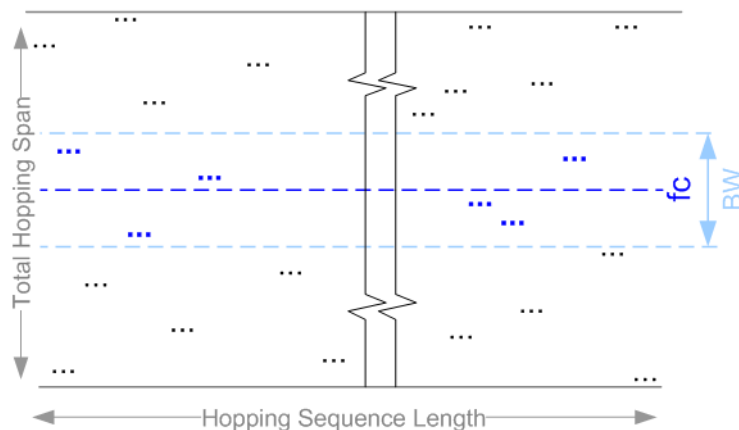

Figure A-1: Principle of simulated hopping (according to FCC 06-96)

fc = center frequency
 BW = DUT's bandwidth
 black dots = hops that are outside the DUT's bandwidth
 blue dots = hops that are within the DUT's bandwidth

If simulated hopping is used, generated are only pulses with frequency f_{hop} that fulfill the equation:

$$(f_c - BW/2) < f_{hop} < (f_c + BW/2)$$

For the example on Figure A-1, generated are the six blue hops that are within the DUT's bandwidth.

In the R&S Pulse Sequencer (DFS), the DUT's receiver bandwidth and center frequency are configurable parameters. The frequency hopping is described with the pre-defined IPM profile "Type 6, Hopping".

During waveform generation, the software selects random frequencies, lists all frequencies in the reporting file and then selects and marks those frequencies that are within the selected DUT bandwidth.

See also "To set the DUT's frequency and bandwidth for FCC 06-96 type 6 tests with simulated hopping" on page 36.

A.2.2 FCC KDB 905462 D02

This section describes the generation of the **DFS** related radar test signals according to the **FCC KDB 905462 D02** specification. This specification is also known as "New rules", whereas the specification **FCC 06-96** is referred as the "Old rules". The compliance procedure is specified for all master devices operating in the U-NII bands (U-NII-1 band, U-NII-2 band and the U-NII-3 band).

The **FCC KDB 905462 D02** specification modifies and extends the **FCC 06-96** rules. For description of the test patterns, refer to the **FCC 06-96** description and the overview information in [Table A-7](#).

Table A-11: FCC KDB 905462 D02: Overview of the related chapters

Chapter	Test Patterns/Trials	Description	Related section	Modification
Chapter 6.1	Radar Type 0 to 4	Short Pulse Radar Waveforms	Chapter A.2.1.1, "Radar type 1 to 4" , on page 46	New Radar Type 0 (identical to the FCC 06-96 Radar Type 1) Modified Radar Type 1 (the rules of FCC 13-22 Radar Type 1 apply)
Chapter 6.2	Radar Type 5	Long Pulse Radar Test Waveform	Chapter A.2.1.2, "Radar type 5" , on page 47	Modified frequency selection procedure The FM chirp deviation is selected randomly for the whole transmission interval. It does not vary per burst as in the FCC 06-96 rules.
Chapter 6.3	Radar Type 6	Frequency Hopping Radar Test Waveform	Chapter A.2.1.3, "Radar type 6" , on page 47	-

The R&S Pulse Sequencer (DFS) provides a repository with all test signals defined in the standard. The provided test patterns are in line with the requirements.

You can use the built-in reporting function to generate and store report files. If enabled, the reporting plug-in populates Microsoft Excel spreadsheets, formatted according to the requirements and populated with the parameters used during the waveform generation. You can use these spreadsheets during testing or for filing test results.

A.2.3 FCC 13–22

This section describes the generation of the **DFS** related radar test signals according to the **FCC 13-22** specification.

Table A-12: FCC 13–22: Overview of the related chapters

Chapter	Test Patterns/Trials	Description	Related section
Chapter 6.1	Radar type 0 to 4	Short Pulse Radar Waveforms	Table A-13

The parameters for the waveforms of Type 0 to 4 are listed in [Table A-13](#).

Table A-13: Radar types 0 to 4: Parameters overview

Radar type	Pulse width (0.1 us steps)	PRI [us] (1 us steps)	Number of Pulses	Requirements	Comment
0	1	1428	18	1 waveform	Fixed (static) PRI
1	1	518 to 3066	18 to 102 ^{*)}	Test A and Test B ^{**)}	Variable PRI, pulse width, and number of pulses
2	1 to 5	150 to 230	23 to 29	min 30 unique waveforms per type;	
3	6 to 10	200 to 500	16 to 18		
4	11 to 20	200 to 500	12 to 16	If more than 30 waveforms are used, then each additional waveform must also be unique	

^{*)} Roundup $\{(1/360)*[19*10^6/PRI[us]]\}$.

^{**)}

- Test A: waveforms with 15 unique randomly selected PRI values
- Test B: waveforms with 15 unique randomly selected PRI values, excluding PRI values selected in Test A
- If more than 30 waveforms are used, then each additional waveform must be generated with Test B.
The test must be unique and not repeated from the previous waveforms in Test A and Test B

A.3 MIC

The MIC standard specifies DFS parameters for testing on two bands:

- The 5.3 GHz band, see:
 - [Chapter A.3.1, "Japan radar parameters for W53 band, former MIC specification"](#), on page 50
 - [Chapter A.3.2, "Japan radar parameters for W53 band, MIC specification 07/2019"](#), on page 51
- The 5.6 GHz band, see [Chapter A.3.3, "Japan radar parameters for W56 band"](#), on page 51

A.3.1 Japan radar parameters for W53 band, former MIC specification

The waveform requirements for the types 1 and 2 are listed in [Table A-14](#).

Table A-14: Radar types 1 and 2: Parameters overview

Radar type	Pulse width [us]	Pulse repetition frequency [Hz]	Number of Pulses	Requirements	Comment
1	1	700	18	1 waveform	Fixed (static) PRI
2	2.5	260	18	Non-modulated pulses	

A.3.2 Japan radar parameters for W53 band, MIC specification 07/2019

The waveform requirements for the types 1 to 8 are listed in [Table A-14](#).

Table A-15: Radar types 1 to 8: Parameters overview

Radar type	Pulse width ^{*)} [us]	Pulse repetition frequency ^{*)} [Hz]	Number of Pulses
1	0.5 to 5	200 to 1000	10
2	0.5 to 15	200 to 1600	15
3	0.5 to 5	200 to 1000	min to max ^{**)}
4	0.5 to 15	200 to 1600	min to max ^{**)}
5	0.5 to 1.5	1114 to 1118	30
6	0.5 to 1.5	928 to 932	25
7	0.5 to 1.5	886 to 890	24
8	0.5 to 1.5	738 to 742	20

Where:

- ^{*)} value selected randomly within the specified range.
Pulses within the same burst are calculated with the same random value. Hence, the pulse width and pulse repetition frequencies are constant within a burst.
- ^{**)}
 - min = min [(Pulse Repetition Frequency * 0.026), 30]
 - max = max [(Pulse Repetition Frequency * 0.026), 22]

A.3.3 Japan radar parameters for W56 band

The requirements for DFS testing on the 5.6 GHz band are divided into:

- Short pulse radar types, see [Table A-16](#)
- Long pulse radar type, see [Table A-17](#)
- Frequency hopping radar type, see [Table A-18](#).

Table A-16: Radar types 1 to 6: Parameters overview

Radar type	Pulse width [us]	Pulse repetition frequency [Hz]	Number of Pulses	Comment
1	0.5	720	18	Fixed (static) PRI
2	1	700	18	
3	2	250	18	
4	1 to 5	4347 to 6667	23 to 29	Variable PRI, pulse width, and number of pulses
5	6 to 10	2000 to 5000	16 to 18	
6	11 to 20	2000 to 5000	12 to 16	

The Long Pulse Radar Type 1 requirements are identical with the requirements of [FCC 06-96 Radar type 5](#).

Table A-17: Radar type 1: Parameters overview

Radar type	Pulse width (0.1 us steps)	PRI [us] (1 us steps)	Pulses per burst	Bursts	Chirp deviation [MHz]	Requirements	Comment
1	50 to 100	1000 to 2000	1 to 3	8 to 20	5 to 20	30 unique waveforms	Variable PRI, pulse width, and number of pulses/bursts

The Hopping Radar Type 1 requirements are identical with the requirements of [FCC 06-96 Radar type 6](#). Simulated frequency hopping is used.

Table A-18: Hopping Radar Type 1: Parameters overview

Radar type	Pulse width [us]	PRI [us]	Waveform duration [ms]	Pulses per hop	Hop rate [Hz]
1	1	333	300	9	333

A.4 Korea

The waveform requirements are listed in [Table A-19](#).

Table A-19: Waveform requirements

Radar test signal	Pulse width [us]	PRF [PPS]	Pulses per burst	Requirements
1	1	700	18	Fixed PRF and pulse width
2	1	1800	10	
3	2	330	70	

A.5 YD/T

The YD/T is the related DFS specification in China. The test requirements are similar to the requirements specified by ETSI 301893, see [Chapter A.1.1, "Waveform requirements 301893"](#), on page 43.

Other as in ETSI 301893, the YD/T specifies fixed number of pulses per burst, see [Table A-20](#).

Table A-20: Waveform requirements YD/T

Radar test signal	Pulse width [us]	PRF [PPS]	Pulses per burst	Requirements
1	0.5 to 5	200 to 1000	12	Fixed PRF
2	0.5 to 15	200 to 1600	16	
3	0.5 to 15	2300 to 4000	24	
4	20 to 30	2000 to 4000	20	
5	0.5 to 2	300 to 400	12	Variable PRF
6	0.5 to 2	400 to 1200	16	

B References

- R&S SMW200A Vector Signal Generator user manual, the latest version is available for download at www.rohde-schwarz.com/product/SMW200A.
- R&S SMBV100A Vector Signal Generator operating manual, the latest version is available for download at www.rohde-schwarz.com/product/SMBV100A.
- R&S SMU200A Vector Signal Generator operating manual, the latest version is available for download at www.rohde-schwarz.com/product/SMU200A.
- R&S SMJ100A Vector Signal Generator operating manual, the latest version is available for download at www.rohde-schwarz.com/product/SMJ100A.
- R&S SGT100A SGMA Vector RF Source operating manual, the latest version is available for download at www.rohde-schwarz.com/product/SGT100A.

Glossary: Terms and abbreviations

A

AS/NZS: Australia and New Zealand standards

D

DFS: Dynamic Frequency Selection

DUT: Device under test

F

FCC: U.S. Federal Communication Commission

G

GUI: Graphical User Interface

I

Inter-Pulse Modulation: [IPM](#)

Intra-Pulse Modulation: [MOP](#)

IPM: Inter-Pulse Modulation

M

MIC: Japan standard

MOP: Modulation on Pulse

MSW: Multi-segment waveforms

P

PDW: Pulse Descriptor Word
Format of the reported data

PEP: Peak Envelope Power
[DFS](#) testing requires to control the pulse power rather than an average signal power; for DFS testing, the PEP is equal to the average level.

Plugin: A loadable Microsoft Windows DDL module that describes custom modulation schemes or envelope shapes.

PRF: Pulse repetition frequency

PRI: Pulse repetition interval

Defines the overall time of a pulse cycle.

PRT: Pulse repetition time

Pulse sequence: [Pulse train](#)

Pulse train: A sequence of repetitive pulses

Pulse-to-Pulse Modulation: [IPM](#)

PW: Pulse width

R

RSS: Industry Canada, Radio Standards Specifications

S

Stagger PRI: Pulse train composed of two or more pulse subtrains that use the same PRI

Glossary: DFS standards and references

A

AS/NZS 4268:2008: Australia and New Zealand standards
Radio equipment and systems – Short range devices – Limits and methods of measurement

E

ETSI: The European Telecommunications Standards Institute
<http://www.etsi.org>

ETSI EN 301 893: [en_301893v010701p.pdf](#)

ETSI EN 302 502: Broadband Radio Access Networks (BRAN);
5.8 GHz fixed broadband data transmitting systems;
Harmonized EN covering the essential requirements of article 3.2 of the R&TTE Directive

F

FCC: U.S. Federal Communication Commission
<http://www.fcc.gov>
FCC search page for approved devices: <https://fjallfoss.fcc.gov/oetcf/eas/reports/GenericSearch.cfm>

FCC 06-96: U.S. Federal Communication Commission Part 15, Subpart E
[FCC-06-96A1.pdf](#)
APPENDIX "COMPLIANCE MEASUREMENT PROCEDURES FOR UNLICENSED NATIONAL INFORMATION INFRASTRUCTURE DEVICES OPERATING THE 5250–5350 MHz AND 5470–5725 MHz BANDS INCORPORATING DYNAMIC FREQUENCY SELECTION".

FCC 13-22: U.S. Federal Communication Commission
[FCC-13-22A1.pdf](#)
APPENDIX B "Changes to Compliance Measurement Procedures For Unlicensed-National Information Infrastructure Devices Operating in The 5250–5350 MHz and 5470–5725 MHz Bands Incorporating Dynamic Frequency Selection".

FCC KDB 905462 D02: U.S. Federal Communication Commission Part 15, Subpart E
KDB 905462 D02 UNII DFS Compliance Procedure "**New Rules**"
[905462-D02-V02.pdf](#)
APPENDIX "COMPLIANCE MEASUREMENT PROCEDURES FOR UNLICENSED-NATIONAL INFORMATION INFRASTRUCTURE DEVICES OPERATING THE 5250–5350 MHz AND 5470–5725 MHz BANDS INCORPORATING DYNAMIC FREQUENCY SELECTION".

M

MIC: Japan standard

Available in two versions: MIC and MIC 07 2019

N

NTIA: National Telecommunications And Information Administration

DFS information

<http://ntiacsd.ntia.doc.gov/dfs/> ·

R

RSS 210: Issue 7, June 2007

Industry Canada, Radio Standards Specifications

Low-power License-exempt Radiocommunication Devices (All Frequency Bands) Category I Equipment

This document refers under section A9.4 (b) to the DFS test procedures published by the U.S. Federal Communication Commission (FCC).

Y

YD/T: China standard

Index

A

Application cards	7
Application notes	7

B

Brochures	7
-----------------	---

D

Data sheets	7
DFS test	
General workflow	25
How to perform	25

F

FCC	
Trial 1	46
Trial 2	46
Trial 3	46
Trial 4	46
Trial 5	47
Trial 6	47
FCC 06-96 trial 6	
Simulated hopping	48
Frequency hopping	
Simulated	48

H

Hardware	
CPU, requirements	10
Requirements	10
Virtual memory	10
Help	6

I

Installation	5
Installing	
Hardware	10
Software	10
Uninstalling old version	10
InstallPath	
see path	12

M

Marker	
Power sensor, triggering	22
Spectrum analyzer, triggering	21

O

Open-source acknowledgment (OSA)	6
--	---

R

Release notes	6
RepositoryPath	
see DataPath	12

RF signal measurement

Power sensor	22
Spectrum analyzer	21

S

Software	
Requirements	10

T

Triggering	
Power sensor	22
Spectrum analyzer	21

U

User manual	6
-------------------	---

W

White papers	7
--------------------	---