

R&S®FSWP

Phase Noise Analyzer

User Manual



1177563302
Version 15

ROHDE & SCHWARZ
Make ideas real



This manual describes the following R&S®FSWP models with firmware version 3.01 or higher:

- R&S®FSWP8 (1322.8003K08)
- R&S®FSWP8 (1322.8003K09)
- R&S®FSWP26 (1322.8003K26)
- R&S®FSWP26 (1322.8003K27)
- R&S®FSWP50 (1322.8003K50)
- R&S®FSWP50 (1322.8003K51)

In addition, the following options are described:

- R&S FSWP-B21 (1325.3848.02)
- R&S FSWP-B24 (1325.3725.08)
- R&S FSWP-B24 (1325.3725.26)
- R&S FSWP-B24 (1325.3725.50)
- R&S FSWP-B60 (1322.9800.08)
- R&S FSWP-B60 (1322.9800.26)
- R&S FSWP-B60 (1322.9800.50)
- R&S FSWP-B64 (1322.9900.26)
- R&S FSWP-B64 (1322.9900.50)
- R&S FSWP-K4 (1325.5034.02)
- R&S FSWP-K33 (1325.5040.02)

© 2023 Rohde & Schwarz

Muehldorfstr. 15, 81671 Muenchen, Germany

Phone: +49 89 41 29 - 0

Email: info@rohde-schwarz.com

Internet: www.rohde-schwarz.com

Subject to change – data without tolerance limits is not binding.

R&S® is a registered trademark of Rohde & Schwarz GmbH & Co. KG.

Trade names are trademarks of the owners.

1177.5633.02 | Version 15 | R&S®FSWP

Throughout this manual, products from Rohde & Schwarz are indicated without the ® symbol , e.g. R&S®FSWP is indicated as R&S FSWP.

Contents

1	Safety and regulatory information.....	19
1.1	Safety instructions.....	19
1.2	Warning messages in the documentation.....	22
1.3	Korea certification class A.....	22
2	Documentation overview.....	23
2.1	Getting started manual.....	23
2.2	User manuals and help.....	23
2.3	Service manual.....	23
2.4	Instrument security procedures.....	24
2.5	Printed safety instructions.....	24
2.6	Data sheets and brochures.....	24
2.7	Release notes and open source acknowledgment (OSA).....	24
2.8	Application notes, application cards, white papers, etc.....	24
3	Preparing for use.....	25
3.1	Lifting and carrying.....	25
3.2	Unpacking and checking.....	25
3.3	Choosing the operating site.....	25
3.4	Setting up the R&S FSWP.....	26
3.4.1	Placing the product on a bench top.....	26
3.4.2	Mounting the R&S FSWP in a rack.....	27
3.5	Connecting the AC power.....	27
3.6	Switching the instrument on and off.....	28
3.7	Connecting to LAN.....	29
3.8	Connecting a keyboard.....	30
3.9	Connecting an external monitor.....	31
3.10	Windows operating system.....	32
3.11	Logging on.....	34
3.12	Checking the supplied options.....	35
3.13	Performing a self-alignment.....	36
3.14	Considerations for test setup.....	36

4	Instrument tour.....	38
4.1	The front panel.....	38
4.1.1	Display (touchscreen).....	39
4.1.2	Power key.....	40
4.1.3	System control keys.....	40
4.1.4	The function keys.....	41
4.1.5	The Keypad.....	42
4.1.6	Navigation Control.....	43
4.1.7	RF Input (50 Ω).....	44
4.1.8	Signal Source Output.....	45
4.1.9	USB ports.....	45
4.1.10	Power sensors.....	45
4.1.11	Probe Power Connector (3 Pins).....	46
4.1.12	Noise source control.....	46
4.1.13	Trigger input and output.....	46
4.1.14	Baseband input.....	46
4.1.15	External Mixer (Optional).....	47
4.1.16	DC Power Supply.....	47
4.1.17	LO AUX input (optional).....	47
4.2	The rear panel.....	48
4.2.1	Removable hard disk.....	49
4.2.2	AC power supply connection and main power switch.....	49
4.2.3	Display port and DVI.....	49
4.2.4	LAN.....	50
4.2.5	USB ports.....	50
4.2.6	IF / video / demod output.....	50
4.2.7	IF Wide Out.....	50
4.2.8	Sync trigger input and output.....	51
4.2.9	AUX Port.....	51
4.2.10	GPIB Interface.....	51
4.2.11	External Generator Control (Optional).....	51
4.2.12	OCXO (optional).....	52
4.2.13	REF INPUT / REF OUTPUT.....	52

4.2.14	Labels on R&S FSWP.....	53
4.2.15	Device ID.....	53
5	Trying out the instrument.....	54
5.1	Initial setup.....	55
5.2	Measurements.....	56
5.2.1	Measurement selection.....	57
5.2.2	The phase noise measurement.....	57
5.2.3	The additive noise measurement.....	60
5.2.4	The baseband noise measurement.....	63
5.2.5	The pulsed phase noise measurement.....	65
5.2.6	The pulsed additive noise measurement.....	65
5.2.7	Adding another measurement channel.....	67
5.3	Result evaluation.....	67
5.3.1	Trace smoothing.....	68
5.3.2	Integration ranges.....	70
5.3.3	The Cross-Correlation gain indicator.....	72
5.3.4	Miscellaneous evaluation tools.....	73
5.4	Measurement configuration.....	74
5.4.1	Frequency configuration.....	74
5.4.2	The half decade configuration table.....	75
5.4.3	Pulsed measurement configuration.....	76
5.4.4	Signal generation.....	77
5.4.5	DUT power supply.....	79
6	Operating the instrument.....	81
6.1	Understanding the display information.....	81
6.1.1	Channel bar.....	82
6.1.2	Window title bar.....	84
6.1.3	Marker information.....	85
6.1.4	Spot noise information.....	86
6.1.5	Measurement progress information.....	86
6.1.6	Frequency information in diagram footer.....	87
6.1.7	Instrument and status information.....	87
6.1.8	Error information.....	88

6.2	Accessing functions.....	89
6.2.1	Toolbar.....	90
6.2.2	Softkeys.....	91
6.2.3	Context menus.....	92
6.2.4	On-screen keyboard.....	92
6.3	Changing the focus.....	93
6.4	Entering data.....	93
6.4.1	Entering numeric parameters.....	94
6.4.2	Entering alphanumeric parameters.....	94
6.5	Touchscreen gestures.....	96
6.6	Displaying results.....	99
6.6.1	Activating and deactivating channels.....	99
6.6.2	Laying out the result display with the smartgrid.....	100
6.6.2.1	Background information: the smartgrid principle.....	101
6.6.2.2	How to activate smartgrid mode.....	102
6.6.2.3	How to add a new result window.....	103
6.6.2.4	How to close a result window.....	103
6.6.2.5	How to arrange the result windows.....	104
6.6.3	Changing the size of windows.....	104
6.6.4	Switching between a split and maximized window display.....	105
6.6.5	Changing the display.....	105
6.7	Remote control.....	106
6.7.1	Remote desktop connection.....	106
6.7.2	Connecting a PC via the GPIB interface.....	106
7	Applications.....	107
7.1	R&S multiview.....	107
7.2	Available Applications.....	108
7.3	Starting an application.....	110
7.4	Running a sequence of measurements.....	112
7.4.1	The sequencer concept.....	112
7.4.2	Sequencer settings.....	114
7.4.3	How to set up the sequencer.....	115
8	Measurements and result displays.....	117

8.1	Basics on phase noise measurements.....	117
8.1.1	Residual effects.....	117
8.2	Performing measurements.....	118
8.3	Selecting measurements.....	120
8.4	Result displays.....	122
9	Common measurement settings.....	133
9.1	Configuration overview.....	133
9.2	Input source.....	135
9.2.1	RF input.....	135
9.2.2	Baseband input.....	137
9.2.3	External mixers.....	138
9.2.3.1	Basics on external mixers.....	139
	Frequency ranges.....	139
	Bias current.....	140
	Conversion loss tables.....	141
9.2.3.2	Mixer settings.....	143
9.2.3.3	Basic settings.....	147
9.2.3.4	Conversion loss table.....	149
	Managing conversion loss tables.....	149
	Editing conversion loss tables.....	150
9.3	Level characteristics.....	154
9.3.1	Signal attenuation.....	154
9.3.2	Amplitude characteristics.....	155
9.3.3	Diagram scale.....	157
9.4	Frequency.....	158
9.5	Noise measurement configuration.....	163
9.5.1	Triggered measurements (phase noise CW).....	163
9.5.2	Measurement range.....	163
9.5.3	Noise configuration.....	164
9.5.4	Integrated measurement configuration.....	170
9.5.5	Spot noise information.....	173
9.5.6	Spur display.....	174
9.5.7	Frequency stability configuration.....	177

9.6	Output.....	177
9.6.1	DC source configuration.....	178
9.6.2	Signal source configuration.....	181
9.6.3	Miscellaneous output.....	185
9.6.3.1	Output for noise sources.....	185
9.6.3.2	Output configuration.....	186
9.7	Pulsed phase noise and pulsed additive noise configuration.....	186
9.8	VCO characterization configuration.....	190
9.8.1	Sweep configuration.....	191
9.8.2	Trace configuration.....	193
9.9	Spot noise vs tune configuration.....	194
9.9.1	Trace configuration.....	194
9.10	PN transient analysis configuration.....	195
9.10.1	Frequency configuration.....	196
9.10.2	Trigger configuration.....	198
9.10.3	Data acquisition.....	200
9.10.4	Amplitude configuration.....	201
9.10.5	Diagram scale.....	202
9.10.6	Settling time.....	204
9.10.7	Frequency deviation.....	205
9.10.8	Trace configuration.....	205
9.10.9	Marker configuration.....	206
9.10.10	Limit lines.....	207
10	Common analysis and display functions.....	208
10.1	Result display configuration.....	208
10.1.1	Basic result displays.....	208
10.1.2	Laying out the result display with the smartgrid.....	208
10.1.2.1	Background information: the smartgrid principle.....	209
10.1.2.2	How to activate smartgrid mode.....	210
10.1.2.3	How to add a new result window.....	211
10.1.2.4	How to close a result window.....	211
10.1.2.5	How to arrange the result windows.....	212
10.2	Zoomed displays.....	212

10.2.1	Single zoom versus multiple zoom.....	213
10.2.2	Zoom functions.....	214
10.2.3	How to zoom into a diagram.....	216
10.3	Trace configuration.....	219
10.3.1	Basics on traces.....	219
10.3.1.1	Analyzing several traces - trace mode.....	219
10.3.1.2	Trace averaging.....	220
	Sweep count.....	220
	Trace smoothing.....	221
10.3.1.3	Spurs and spur removal.....	221
10.3.2	Trace configuration.....	222
10.3.3	Trace export and import.....	226
10.3.4	Copying traces.....	231
10.3.5	Trace math.....	231
10.3.6	Trace labels.....	232
10.3.7	How to configure traces.....	233
10.3.7.1	How to export trace data and numerical results.....	233
10.3.8	References.....	234
10.3.8.1	Reference: ASCII file export format.....	234
10.4	Markers.....	241
10.4.1	Basics on markers and marker functions.....	241
10.4.1.1	Activating markers.....	242
10.4.1.2	Marker results.....	243
10.4.2	Marker settings.....	244
10.4.2.1	Individual marker setup.....	244
10.4.2.2	General marker settings.....	247
10.4.3	Marker search settings and positioning functions.....	248
10.4.3.1	Marker search settings.....	248
10.4.3.2	Positioning functions.....	250
10.5	Limit lines.....	251
10.5.1	Basics on limit lines.....	251
10.5.2	Limit line settings and functions.....	254
10.5.2.1	Limit line management.....	255

10.5.2.2	Limit line details.....	256
10.5.3	How to define limit lines.....	258
11	Data management.....	262
11.1	Restoring the default instrument configuration (preset).....	262
11.2	Protecting data using the secure user mode.....	263
11.3	Storing and recalling instrument settings and measurement data.....	265
11.3.1	Quick save/quick recall.....	267
11.3.1.1	Quick save / quick recall settings.....	267
11.3.2	Configurable storage and recall.....	270
11.3.2.1	Stored data types.....	270
11.3.2.2	Storage location and filename.....	270
11.3.2.3	Save and recall dialog boxes.....	271
11.3.2.4	Startup recall settings.....	273
11.3.3	How to save and load instrument settings.....	275
11.4	Import/export functions.....	277
11.5	Creating screenshots of current measurement results and settings.....	279
11.5.1	Print and screenshot settings.....	279
11.5.1.1	Print content settings.....	279
11.5.1.2	Print preview functions.....	282
11.5.1.3	Printer settings.....	284
11.5.1.4	Page setup.....	287
11.5.1.5	Print color settings.....	289
11.5.2	How to store or print screenshots of the display.....	290
11.5.3	Example for storing multiple measurement results to a PDF file.....	293
12	General instrument setup.....	296
12.1	Alignment.....	296
12.1.1	Basics on alignment.....	296
12.1.2	Alignment settings.....	298
12.1.3	How to perform a self-test.....	302
12.1.4	How to align the instrument.....	303
12.1.5	How to align the touchscreen.....	303
12.2	Display settings.....	303
12.2.1	Display settings.....	303

12.2.1.1	General display settings.....	304
12.2.1.2	Displayed items.....	305
12.2.1.3	Display theme and colors.....	309
12.2.1.4	External monitor settings.....	313
12.2.2	How to configure the colors for display and printing.....	314
12.2.3	How to work with the soft front panels.....	315
12.2.4	Reference: Keyboard shortcuts for the mini front panel.....	315
12.3	Reference frequency settings.....	317
12.4	System configuration settings.....	321
12.4.1	Hardware information.....	321
12.4.2	Information on versions and options.....	321
12.4.3	System messages.....	323
12.4.4	Firmware updates.....	324
12.4.5	General configuration settings.....	325
12.4.6	AC power loss behavior.....	327
12.5	Service functions.....	328
12.5.1	R&S support information.....	328
12.5.2	Self-test settings and results.....	330
12.5.3	Calibration signal display.....	331
12.5.4	Service functions.....	332
12.5.5	Hardware diagnostics.....	334
13	Network operation and remote control.....	336
13.1	Remote control interfaces and protocols.....	336
13.1.1	LAN interface.....	337
13.1.1.1	LAN web browser interface.....	339
13.1.2	GPIB interface (IEC 625/IEEE 418 bus interface).....	340
13.1.3	USB interface.....	341
13.2	Status reporting system.....	341
13.2.1	Hierarchy of status registers.....	342
13.2.2	Contents of the status registers.....	342
13.2.2.1	Status byte (STB) and service request enable register (SRE).....	343
13.2.2.2	IST flag and parallel poll enable register (PPE).....	344
13.2.2.3	Event status register (ESR) and event status enable register (ESE).....	344

13.2.2.4	STATus:OPERation register.....	345
13.2.2.5	STATus:QUEStionable register.....	346
13.2.2.6	STATus:QUEStionable:ACPLimit register.....	347
13.2.2.7	STATus:QUEStionable:EXTended register.....	348
13.2.2.8	STATus:QUEStionable:EXTended:INFO register.....	348
13.2.2.9	STATus:QUEStionable:FREQuency register.....	349
13.2.2.10	STATus:QUEStionable:LIMit register.....	350
13.2.2.11	STATus:QUEStionable:LMARgin register.....	350
13.2.2.12	STATus:QUEStionable:POWer register.....	351
13.2.2.13	STATus:QUEStionable:POWer:DCPNoise.....	352
13.2.2.14	STATus:QUEStionable:PNOise.....	352
13.2.2.15	STATus:QUEStionable:TEMPerature register.....	353
13.2.2.16	STATus:QUEStionable:TIME register.....	353
13.2.3	Reset values of the status reporting system.....	354
13.3	GPIB languages.....	354
13.4	The IECWIN tool.....	356
13.5	Automating tasks with remote command scripts.....	357
13.5.1	The context-sensitive SCPI command menu.....	358
13.5.2	The SCPI recorder.....	360
13.5.2.1	Recording.....	360
13.5.2.2	Managing recordings.....	363
13.5.2.3	Recording settings.....	365
13.5.3	How to determine the required SCPI command.....	366
13.5.4	How to create and export SCPI scripts.....	366
13.6	Network and remote control settings.....	369
13.6.1	General network settings.....	370
13.6.2	GPIB settings.....	372
13.6.3	Compatibility settings.....	375
13.6.4	LAN settings.....	376
13.6.5	HUMS settings.....	378
13.6.5.1	Basic settings.....	379
13.6.5.2	Protocol settings.....	380
13.6.5.3	Device tags.....	383

13.6.6	Remote errors.....	384
13.6.7	Returning to manual mode ("local").....	386
13.7	How to set up a network and remote control.....	387
13.7.1	How to configure a network.....	387
13.7.1.1	How to connect the instrument to the network.....	387
13.7.1.2	How to assign the IP address.....	388
13.7.1.3	How to change the instrument name.....	390
13.7.1.4	How to configure the LAN using the web browser interface.....	391
	LAN configuration.....	392
13.7.1.5	How to change the GPIB instrument address.....	393
13.7.2	How to operate the instrument without a network.....	393
13.7.3	How to log on to the network.....	394
13.7.3.1	How to create users.....	394
13.7.3.2	How to change the user password.....	395
13.7.3.3	How to configure the automatic login mechanism.....	395
13.7.4	How to share directories (only with Microsoft networks).....	396
13.7.5	How to control the R&S FSWP via the web browser interface.....	397
13.7.6	How to deactivate the web browser interface.....	398
13.7.7	How to set up remote desktop.....	399
13.7.7.1	How to configure the R&S FSWP for remote operation via remote desktop.....	400
13.7.7.2	How to configure the controller.....	401
13.7.7.3	How to start and close the remote desktop.....	403
13.7.7.4	How to shut down the R&S FSWP via remote operation.....	405
13.7.8	How to start a remote control session from a PC.....	405
13.7.9	How to return to manual operation.....	406
14	Remote control.....	407
14.1	Conventions used in SCPI command descriptions.....	407
14.2	Common suffixes.....	408
14.3	Common commands.....	408
14.4	Selecting the operating mode and application.....	413
14.4.1	Selecting mode and applications.....	413
14.4.2	Performing a sequence of measurements.....	417
14.4.3	Programming example: performing a sequence of measurements.....	419

14.5	Measurements and result displays.....	421
14.5.1	Measurement selection.....	421
14.5.2	Performing measurements.....	423
14.5.3	Querying results.....	426
14.5.4	Programming examples.....	436
14.6	Common measurement settings.....	437
14.6.1	Remote commands to configure the input source.....	437
14.6.1.1	RF input.....	437
14.6.1.2	Baseband input.....	439
14.6.1.3	External mixer.....	440
	Mixer settings.....	440
	Basic settings.....	446
	Conversion loss table.....	447
14.6.2	Output.....	451
14.6.2.1	DC power.....	452
14.6.2.2	Signal source.....	461
14.6.2.3	Miscellaneous output.....	465
14.6.3	Remote commands to configure user ports.....	465
14.6.4	Remote commands to configure level characteristics.....	467
14.6.5	Remote commands to configure the frequency.....	473
14.6.6	Phase noise measurement configuration.....	478
14.6.6.1	Noise configuration.....	478
14.6.6.2	Residual calculation configuration.....	486
14.6.6.3	Spot noise configuration.....	489
14.6.6.4	Spur display.....	493
14.6.7	Pulsed Phase Noise Configuration.....	498
14.6.8	VCO characterization configuration.....	501
14.6.8.1	Sweep configuration.....	501
14.6.9	Spot noise vs tune configuration.....	504
14.6.9.1	Sweep configuration.....	504
14.6.9.2	Trace configuration.....	506
14.6.10	Transient analysis.....	508
14.6.10.1	Frequency configuration.....	508

14.6.10.2	Amplitude configuration.....	511
14.6.10.3	Data acquisition.....	511
14.6.10.4	Trigger configuration.....	512
14.6.10.5	Y-Axis scale.....	515
14.6.10.6	Settling time.....	519
14.6.10.7	Frequency deviation.....	522
14.6.10.8	Trace configuration.....	524
14.6.10.9	Marker configuration.....	524
14.6.10.10	Limit lines.....	524
14.7	Common analysis and display functions.....	524
14.7.1	Display configuration.....	524
14.7.2	Zoom.....	533
14.7.3	Trace configuration.....	537
14.7.3.1	Trace characteristics.....	537
14.7.3.2	Trace copy.....	543
14.7.3.3	Trace export and import.....	544
14.7.3.4	Trace mathematics.....	547
14.7.3.5	Formats for returned values: ASCII format and binary format.....	549
14.7.4	Marker.....	549
14.7.4.1	Individual marker setup.....	549
14.7.4.2	General marker settings.....	555
14.7.4.3	Marker search.....	556
14.7.4.4	Positioning markers.....	557
14.7.4.5	Retrieving marker positions.....	561
14.7.5	Limit lines.....	563
14.7.5.1	Managing limit lines.....	563
14.7.5.2	Designing limit lines.....	567
14.7.5.3	Reading out the results of a limit check.....	573
14.7.5.4	Programming Example: Using Limit Lines.....	574
14.7.6	Examples: configuring the result display.....	575
14.7.6.1	Example 1: adding and arranging windows.....	575
14.7.6.2	Example 2: replacing and removing windows.....	576
14.8	Managing settings and results.....	577

14.8.1	Managing files.....	578
14.8.2	Selecting items to store.....	583
14.8.3	Saving and loading instrument settings.....	586
14.8.4	Storing and printing screenshots.....	590
14.8.5	Saving measurement results.....	601
14.8.6	Examples: managing data.....	601
14.8.6.1	Storing data.....	602
14.8.6.2	Loading data.....	602
14.8.6.3	Storing instrument settings.....	603
14.8.6.4	Loading instrument settings.....	603
14.8.6.5	Printing to a file.....	603
14.8.6.6	Printing on a printer.....	604
14.9	Configuring the R&S FSWP.....	604
14.9.1	Basic instrument setup.....	604
14.9.2	Configuring the reference frequency.....	606
14.9.3	Calibrating the R&S FSWP and checking temperature.....	611
14.9.4	Customizing the screen layout.....	617
14.9.4.1	Configuring screen elements.....	617
14.9.4.2	Selecting colors and schemes.....	620
14.9.4.3	CMAP suffix assignment.....	622
14.9.5	Configuring network and remote control.....	623
14.9.6	Configuring HUMS.....	629
14.9.7	Checking the system configuration.....	635
14.9.8	Using service functions.....	641
14.9.9	Reference: Command Set of 5052 Emulation.....	644
14.9.10	Reference: command set of emulated PSA models.....	646
14.10	Recording SCPI Commands Automatically.....	650
14.11	Using the status register.....	654
14.11.1	General status register commands.....	655
14.11.2	Reading out the CONDition part.....	655
14.11.3	Reading out the EVENt part.....	656
14.11.4	Controlling the ENABle part.....	657
14.11.5	Controlling the negative transition part.....	657

14.11.6	Controlling the positive transition part.....	658
14.12	Programming examples.....	659
14.12.1	Service request.....	659
14.12.1.1	Initiate service request.....	659
14.12.1.2	Waiting for the arrival of a service request.....	661
14.12.1.3	Waiting without blocking the keyboard and mouse.....	662
14.12.1.4	Service request routine.....	663
14.12.1.5	Reading out the output buffer.....	664
14.12.1.6	Reading error messages.....	664
14.12.1.7	Evaluation of SCPI status registers.....	665
14.12.1.8	Evaluation of event status register.....	666
15	Troubleshooting.....	668
15.1	Collecting information for support.....	668
15.2	Contacting customer support.....	670
16	Transporting.....	671
17	Maintenance, storage, transport and disposal.....	672
17.1	Cleaning.....	672
17.2	Storage.....	672
17.3	Transporting.....	672
17.4	Disposal.....	673
	List of commands.....	674
	Index.....	687

1 Safety and regulatory information

The product documentation helps you use the product safely and efficiently. Follow the instructions provided here and in the following chapters.

Intended use

The product is intended for the development, production and verification of electronic components and devices in industrial, administrative, and laboratory environments. Use the product only for its designated purpose. Observe the operating conditions and performance limits stated in the data sheet.

Target audience

Where do I find safety information?

Safety information is part of the product documentation. It warns you of potential dangers and gives instructions on how to prevent personal injury or damage caused by dangerous situations. Safety information is provided as follows:

- In [Chapter 1.1, "Safety instructions"](#), on page 19. The same information is provided in many languages as printed "Safety Instructions". The printed "Safety Instructions" are delivered with the product.
- Throughout the documentation, safety instructions are provided when you need to take care during setup or operation.

1.1 Safety instructions

Products from the Rohde & Schwarz group of companies are manufactured according to the highest technical standards. To use the products safely, follow the instructions provided here and in the product documentation. Keep the product documentation nearby and offer it to other users.

Use the product only for its intended use and within its performance limits. Intended use and limits are described in the product documentation such as the data sheet, manuals and the printed "Safety Instructions". If you are unsure about the appropriate use, contact Rohde & Schwarz customer service.

Using the product requires specialists or specially trained personnel. These users also need sound knowledge of at least one of the languages in which the user interfaces and the product documentation are available.

Reconfigure or adjust the product only as described in the product documentation or the data sheet. Any other modifications can affect safety and are not permitted.

Never open the casing of the product. Only service personnel authorized by Rohde & Schwarz are allowed to repair the product. If any part of the product is damaged or broken, stop using the product. Contact Rohde & Schwarz customer service at <https://www.rohde-schwarz.com/support>.

Lifting and carrying the product

The product is heavy. Do not move or carry the product by yourself. A single person can only carry a maximum of 18 kg safely depending on age, gender and physical condition. Look up the maximum weight in the data sheet. Use the product handles to move or carry the product. Do not lift by the accessories mounted on the product. Accessories are not designed to carry the weight of the product.

To move the product safely, you can use lifting or transporting equipment such as lift trucks and forklifts. Follow the instructions provided by the equipment manufacturer.

Choosing the operating site

Only use the product indoors. The product casing is not waterproof. Water that enters can electrically connect the casing with live parts, which can lead to electric shock, serious personal injury or death if you touch the casing. If Rohde & Schwarz provides accessories designed for your product, e.g. a carrying bag, you can use the product outdoors.

Unless otherwise specified, you can operate the product up to an altitude of 2000 m above sea level. The product is suitable for pollution degree 2 environments where nonconductive contamination can occur. For more information on environmental conditions such as ambient temperature and humidity, see the data sheet.

Setting up the product

Always place the product on a stable, flat and level surface with the bottom of the product facing down. If the product is designed for different positions, secure the product so that it cannot fall over.

If the product has foldable feet, always fold the feet completely in or out to ensure stability. The feet can collapse if they are not folded out completely or if the product is moved without lifting it. The foldable feet are designed to carry the weight of the product, but not an extra load.

If stacking is possible, keep in mind that a stack of products can fall over and cause injury.

If you mount products in a rack, ensure that the rack has sufficient load capacity and stability. Observe the specifications of the rack manufacturer. Always install the products from the bottom shelf to the top shelf so that the rack stands securely. Secure the product so that it cannot fall off the rack.

Connecting to power

The product is an overvoltage category II product. Connect the product to a fixed installation used to supply energy-consuming equipment such as household appliances and similar loads. Keep in mind that electrically powered products have risks, such as electric shock, fire, personal injury or even death. Replace parts that are relevant to safety only by original parts, e.g. power cables or fuses.

Take the following measures for your safety:





- Before switching on the product, ensure that the voltage and frequency indicated on the product match the available power source. If the power adapter does not adjust automatically, set the correct value and check the rating of the fuse.
- Only use the power cable delivered with the product. It complies with country-specific safety requirements. Only insert the plug into an outlet with protective conductor terminal.
- Only use intact cables and route them carefully so that they cannot be damaged. Check the power cables regularly to ensure that they are undamaged. Also ensure that nobody can trip over loose cables.
- If you connect the product to an external power supply, use the one delivered with the product or recommended in the product documentation. The external power supply must conform to the country-specific regulations.
- Only connect the product to a power source with a fuse protection of maximum 20 A.
- Ensure that you can disconnect the product from the power source at any time. Pull the power plug to disconnect the product. The power plug must be easily accessible. If the product is integrated into a system that does not meet these requirements, provide an easily accessible circuit breaker at the system level.

Cleaning the product

Use a dry, lint-free cloth to clean the product. When cleaning, keep in mind that the casing is not waterproof. Do not use liquid cleaning agents.

Meaning of safety labels

Safety labels on the product warn against potential hazards.

	<p>Potential hazard</p> <p>Read the product documentation to avoid personal injury or product damage.</p>
	<p>Heavy product</p> <p>Be careful when lifting, moving or carrying the product. Carrying the product requires a sufficient number of persons or transport equipment.</p>
	<p>Electrical hazard</p> <p>Indicates live parts. Risk of electric shock, fire, personal injury or even death.</p>
	<p>Hot surface</p> <p>Do not touch. Risk of skin burns. Risk of fire.</p>
	<p>Protective conductor terminal</p> <p>Connect this terminal to a grounded external conductor or to protective ground. This connection protects you against electric shock if an electric problem occurs.</p>

1.2 Warning messages in the documentation

A warning message points out a risk or danger that you need to be aware of. The signal word indicates the severity of the safety hazard and how likely it will occur if you do not follow the safety precautions.

WARNING

Potentially hazardous situation. Could result in death or serious injury if not avoided.

CAUTION

Potentially hazardous situation. Could result in minor or moderate injury if not avoided.

NOTICE

Potential risks of damage. Could result in damage to the supported product or to other property.

1.3 Korea certification class A



이 기기는 업무용(A급) 전자파 적합기기로서 판매자 또는 사용자는 이 점을 주의하시기 바라며, 가정외의 지역에서 사용하는 것을 목적으로 합니다.

2 Documentation overview

This section provides an overview of the R&S FSWP user documentation. Unless specified otherwise, you find the documents at:

www.rohde-schwarz.com/manual/FSWP

2.1 Getting started manual

Introduces the R&S FSWP and describes how to set up and start working with the product. Includes basic operations, typical measurement examples, and general information, e.g. safety instructions, etc.

A printed version is delivered with the instrument. A PDF version is available for download on the Internet.

2.2 User manuals and help

The user manual contains the description of all instrument modes and functions. It also provides an introduction to remote control, a complete description of the remote control commands with programming examples, and information on maintenance, instrument interfaces and error messages. Includes the contents of the getting started manual.

The contents of the user manual are available as help in the R&S FSWP. The help offers quick, context-sensitive access to the complete information for the instrument and its firmware.

The user manual is also available for download or for immediate display on the Internet.

2.3 Service manual

Describes the performance test for checking the rated specifications, module replacement and repair, firmware update, troubleshooting and fault elimination, and contains mechanical drawings and spare part lists.

The service manual is available for registered users on the global Rohde & Schwarz information system (GLORIS):

<https://gloris.rohde-schwarz.com>

Application notes, application cards, white papers, etc.

2.4 Instrument security procedures

Deals with security issues when working with the R&S FSWP in secure areas. It is available for download on the internet.

2.5 Printed safety instructions

Provides safety information in many languages. The printed document is delivered with the product.

2.6 Data sheets and brochures

The data sheet contains the technical specifications of the R&S FSWP. It also lists the firmware applications and their order numbers, and optional accessories.

The brochure provides an overview of the instrument and deals with the specific characteristics.

See www.rohde-schwarz.com/brochure-datasheet/FSWP

2.7 Release notes and open source acknowledgment (OSA)

The release notes list new features, improvements and known issues of the current firmware version, and describe the firmware installation.

The software makes use of several valuable open source software packages. An open source acknowledgment document provides verbatim license texts of the used open source software.

See www.rohde-schwarz.com/firmware/FSWP

2.8 Application notes, application cards, white papers, etc.

These documents deal with special applications or background information on particular topics.

See www.rohde-schwarz.com/application/FSWP

3 Preparing for use

Here, you can find basic information about setting up the product for the first time.

3.1 Lifting and carrying

The carrying handles are designed to lift or carry the instrument. Do not apply excessive external force to the handles.

See "[Lifting and carrying the product](#)" on page 20.

3.2 Unpacking and checking

1. Unpack the R&S FSWP carefully.
2. Retain the original packing material. Use it when transporting or shipping the R&S FSWP later.
3. Using the delivery notes, check the equipment for completeness.
4. Check the equipment for damage.

If the delivery is incomplete or equipment is damaged, contact Rohde & Schwarz.

3.3 Choosing the operating site

Specific operating conditions ensure proper operation and avoid damage to the product and connected devices. For information on environmental conditions such as ambient temperature and humidity, see the data sheet.

For safety information, see "[Choosing the operating site](#)" on page 20.

Electromagnetic compatibility classes

The electromagnetic compatibility (EMC) class indicates where you can operate the product. The EMC class of the product is given in the data sheet.

- Class B equipment is suitable for use in:
 - Residential environments
 - Environments that are directly connected to a low-voltage supply network that supplies residential buildings
- Class A equipment is intended for use in industrial environments. It can cause radio disturbances in residential environments due to possible conducted and radiated disturbances. It is therefore not suitable for class B environments.

If class A equipment causes radio disturbances, take appropriate measures to eliminate them.

3.4 Setting up the R&S FSWP

The R&S FSWP is designed for use on a bench top or in a rack.

See also:

- "Setting up the product" on page 20
- "Intended use" on page 19

3.4.1 Placing the product on a bench top

To place the product on a bench top

1. Place the product on a stable, flat and level surface. Ensure that the surface can support the weight of the product. For information on the weight, see the data sheet.
2. **WARNING!** A stack of products can fall over and cause injury. Never stack more than two products. Otherwise, mount them in a rack.

Stack as follows:

- All products must have the same dimensions (width and length).
- Do not exceed a total load of 50 kg placed on the product at the bottom of the stack.

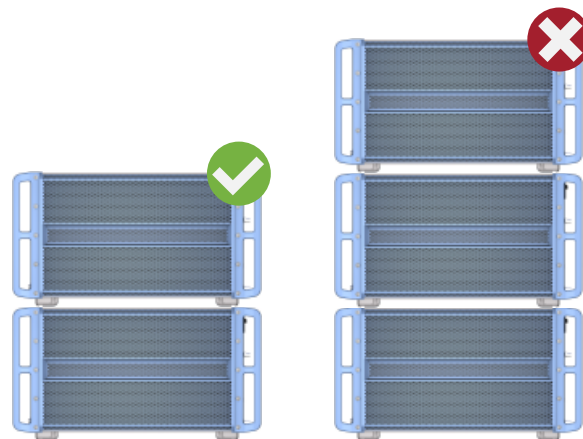

Left = Stacked correctly

Right = Stacked incorrectly, too many products

3. **NOTICE!** Overheating can damage the product.

Prevent overheating as follows:

- Keep a minimum distance of 10 cm between the fan openings of the product and any object in the vicinity to provide sufficient airflow and ventilation.
- Do not place the product next to heat-generating equipment such as radiators or other products.

3.4.2 Mounting the R&S FSWP in a rack

To prepare the rack

1. Observe the requirements and instructions in "[Setting up the product](#)" on page 20.
2. **NOTICE!** Insufficient airflow can cause overheating and damage the product. Design and implement an efficient ventilation concept for the rack.

To mount the R&S FSWP in a rack

1. Use an adapter kit to prepare the R&S FSWP for rack mounting.
 - a) Order the rack adapter kit designed for the R&S FSWP. For the order number, see the data sheet.
 - b) Mount the adapter kit. Follow the assembly instructions provided with the adapter kit.
2. Lift the R&S FSWP to shelf height.
3. Grab the handles and push the R&S FSWP onto the shelf until the rack brackets fit closely to the rack.
4. Tighten all screws in the rack brackets with a tightening torque of 1.2 Nm to secure the R&S FSWP in the rack.

To unmount the R&S FSWP from a rack

1. Loosen the screws at the rack brackets.
2. Remove the R&S FSWP from the rack.
3. If placing the R&S FSWP on a bench top again, unmount the adapter kit from the R&S FSWP. Follow the instructions provided with the adapter kit.

3.5 Connecting the AC power

In the standard version, the R&S FSWP is equipped with an AC power supply connector.

The R&S FSWP can be used with different AC power voltages and adapts itself automatically to it. Refer to the data sheet for the requirements of voltage and frequency.

For safety information, see "[Connecting to power](#)" on page 20.

To connect the AC power

1. Plug the AC power cable into the AC power connector on the rear panel of the instrument. Only use the AC power cable delivered with the R&S FSWP.
2. Plug the AC power cable into a power outlet with ground contact.
The required ratings are listed next to the AC power connector and in the data sheet.

For details on the connector, refer to [Chapter 4.2.2, "AC power supply connection and main power switch"](#), on page 49.

3.6 Switching the instrument on and off

Table 3-1: Overview of power states

Status	LED on Power key	Position of main power switch
Off	● gray	[0]
Standby	● orange	[I]
Ready	● green	[I]

To switch on the R&S FSWP

Prerequisites:

The R&S FSWP is off but connected to power.

No RF input is connected to the instrument.

1. Set the switch on the power supply to position [I].
See [Chapter 4.2.2, "AC power supply connection and main power switch"](#), on page 49.

The LED of the Power key is orange.

See [Chapter 4.1.2, "Power key"](#), on page 40.

Note: If the R&S FSWP was disconnected from power before it was switched off regularly, it automatically switches back on when the power is reconnected.

Using a LAN-controlled power switch, you can take advantage of this behavior to switch the device on and off remotely.

2. Press the Power key.
See [Table 3-1](#).

The LED changes to green.

The R&S FSWP boots.

After booting, the instrument is ready for operation.

**Warm-up time for OCXO**

When the instrument is switched on, the OCXO requires an extended warm-up time (see data sheet).

To shut down the product

Prerequisites:

The product is in the ready state.

Any RF input is disconnected from the instrument.

- ▶ Press the [Power] key.

The operating system shuts down. The LED changes to orange.



If the instrument temperature exceeds the limit specified in the data sheet, the R&S FSWP automatically shuts down to protect the instrument from damage.

To disconnect from power

The R&S FSWP is in the standby state.

1. **NOTICE!** Risk of data loss. If you disconnect the product from power when it is in the ready state, you can lose settings and data. Shut it down first.

Set the switch on the power supply to position [0].

See [Chapter 4.2.2, "AC power supply connection and main power switch"](#), on page 49.

The LED of the standby key is switched off.

2. Disconnect the R&S FSWP from the power source.

3.7 Connecting to LAN

You can connect the instrument to a LAN for remote operation via a PC.

Provided the network administrator has assigned you the appropriate rights and adapted the Windows firewall configuration, you can use the interface, for example:

- To transfer data between a controlling device and the test device, e.g. to run a remote control program
- To access or control the measurement from a remote computer using the "Remote Desktop" application (or a similar tool)
- To connect external network devices (e.g. printers)
- To transfer data from a remote computer and back, e.g. using network folders

Network environment

Before connecting the product to a local area network (LAN), consider the following:

- Install the latest firmware to reduce security risks.

- For internet or remote access, use secured connections, if applicable.
- Ensure that the network settings comply with the security policies of your company. Contact your local system administrator or IT department before connecting your product to your company LAN.
- When connected to the LAN, the product may potentially be accessed from the internet, which may be a security risk. For example, attackers might misuse or damage the product. For more information about IT security and how to operate the product in a secure LAN environment, see the Rohde & Schwarz white paper [1EF96: Malware Protection Windows 10](#).

► **NOTICE!** Risk of network failure.

Consult your network administrator before performing the following tasks:

- Connecting the instrument to the network
- Configuring the network
- Changing IP addresses
- Exchanging hardware

Errors can affect the entire network.

Connect the R&S FSWP to the LAN via the LAN interface on the rear panel of the instrument.

Windows automatically detects the network connection and activates the required drivers.

By default, the R&S FSWP is configured to use DHCP and no static IP address is configured.



The default instrument name is <Type><variant>-<serial_number>, for example, FSWP26-123456. For information on determining the serial number, see [Chapter 4.2.15, "Device ID"](#), on page 53.

For more information on LAN configuration, see [Chapter 13.6.4, "LAN settings"](#), on page 376.

3.8 Connecting a keyboard

The keyboard is detected automatically when it is connected. The default input language is English – US.

However, you can also connect foreign language keyboards; currently the following languages are supported for the R&S FSWP:

- German
- Swiss
- French
- Russian

To configure the keyboard language

1. To access the Windows operating system, press the Windows key on the external keyboard.
2. Select "Start > Settings > Time & language > Region & language > Add a language" .

3.9 Connecting an external monitor

You can connect an external monitor (or projector) to the "DVI" or "Display port" connector on the rear panel of the R&S FSWP (see also [Chapter 4.2.3, "Display port and DVI"](#), on page 49).

**Screen resolution and format**

The touchscreen of the R&S FSWP is calibrated for a 16:10 format. If you connect a monitor or projector using a different format (e.g. 4:3), the calibration is not correct and the screen does not react to your touch actions properly.

The touchscreen has a screen resolution of 1280x800 pixels. Usually, the display of the external monitor is a duplicate of the instrument's monitor.

If you configure the external monitor to be used as the *only* display in the Windows configuration dialog box ("Show only on 2"), the maximum screen resolution of the monitor is used. In this case, you can maximize the R&S FSWP application window and see even more details. You cannot change the monitor's screen resolution via the standard Windows configuration dialog box.

However, you can restore the default instrument resolution (1280x800) on the monitor using the instrument function "Setup" > "Display" > "Configure Monitor" > "Screen Resolution: Restore to default".

The R&S FSWP supports a minimum resolution of 1280x768 pixels.

1. Connect the external monitor to the R&S FSWP.
2. Press [Setup].
3. Press "Display".
4. Select the "Configure Monitor" tab in the "Display" dialog box.
The standard Windows "Screen Resolution" dialog box is displayed.

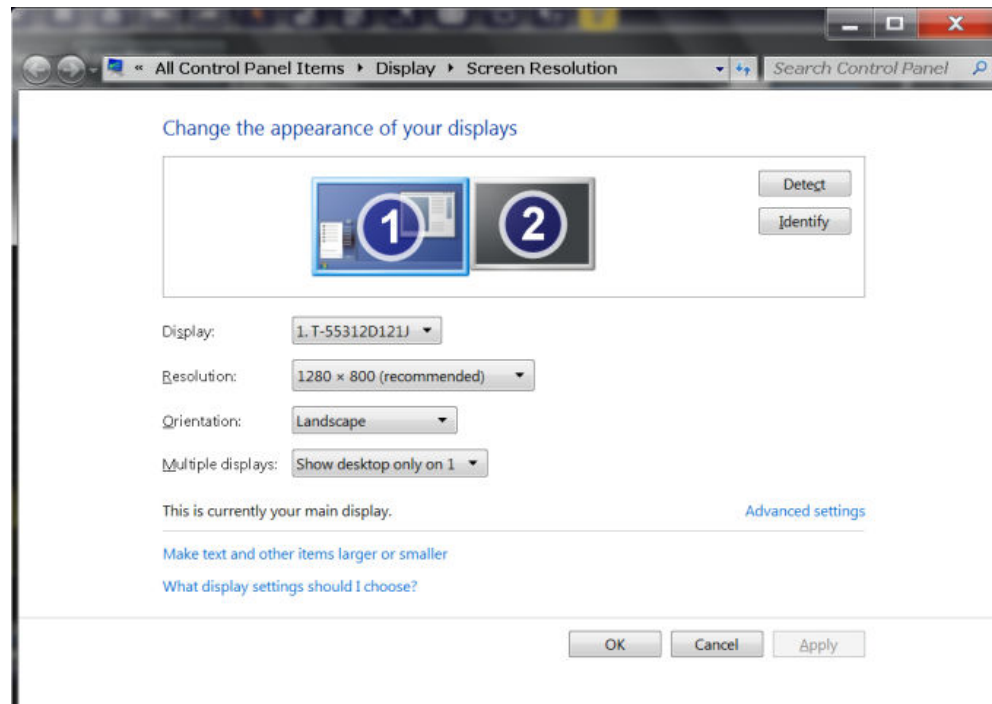

5. Select the instrument for display:
 - "Display 1": internal monitor only
 - "Display 2": external monitor only
 - "Duplicate": both internal and external monitor
6. Tap "Apply" to try out the settings before they are accepted permanently, then you can easily return to the previous settings, if necessary.
7. Select "OK" if the settings are suitable.

3.10 Windows operating system

The instrument contains the Microsoft Windows operating system which has been configured according to the instrument's features and needs. Changes in the system setup are only required when peripherals like a keyboard or a printer are installed or if the network configuration does not comply with the default settings. After the R&S FSWP is started, the operating system boots and the instrument firmware is started automatically.

Tested software

The drivers and programs used on the instrument under Microsoft Windows are adapted to the instrument. Only install update software released by Rohde & Schwarz to modify existing instrument software.

You can install additional software on the instrument; however, additional software can impair instrument function. Thus, run only programs that Rohde & Schwarz has tested for compatibility with the instrument software.

The following program packages have been tested:

- Symantec Endpoint Security – virus-protection software
- FileShredder - for reliable deletion of files on the hard disk

Service packs and updates

Microsoft regularly creates security updates and other patches to protect Windows-based operating systems. They are released through the Microsoft Update website and associated update server. Update instruments using Windows regularly, especially instruments that connect to a network.

Firewall settings

A firewall protects an instrument by preventing unauthorized users from gaining access to it through a network. Rohde & Schwarz highly recommends using the firewall on your instrument. Rohde & Schwarz instruments are shipped with the Windows firewall enabled. All ports and connections for remote control are enabled.

Note that changing firewall settings requires administrator rights.

Virus protection

Take appropriate steps to protect your instruments from infection. Use strong firewall settings and scan any removable storage device used with a Rohde & Schwarz instrument regularly. It is also recommended that you install anti-virus software on the instrument. Rohde & Schwarz does NOT recommend running anti-virus software in the background ("on-access" mode) on Windows-based instruments, due to potentially degrading instrument performance. However, Rohde & Schwarz does recommend running it during non-critical hours.

For details and recommendations, see the following Rohde & Schwarz white paper:

- [1EF96: Malware Protection Windows 10](#)

To access the "Start" menu

The Windows "Start" menu provides access to the Microsoft Windows functionality and installed programs.



- ▶ Select the "Windows" icon in the toolbar, or press the "Windows" key or the [CTRL + ESC] key combination on the (external) keyboard.

The "Start" menu and the Windows taskbar are displayed.



The Windows taskbar also provides quick access to commonly used programs, for example Paint or WordPad. IECWIN, the auxiliary remote control tool provided free of charge and installed by Rohde & Schwarz, is also available from the taskbar or "Start" menu.

For details on the IECWIN tool, see [Chapter 13.4, "The IECWIN tool"](#), on page 356.

All necessary system settings can be defined in the "Start > Settings" menu.

For required settings, refer to the Microsoft Windows documentation and to the hardware description.

3.11 Logging on

Microsoft Windows requires that users identify themselves by entering a user name and password in a login window. By default, the R&S FSWP provides two user accounts:

- **"Instrument"**: a standard user account with limited access
- **"Admin"** or **"Administrator"** (depends on firmware image): an administrator account with unrestricted access to the computer/domain

Some administrative tasks require administrator rights (e.g. adapting the auto-login function or configuring a LAN network). Refer to the description of the basic instrument Setup ([Setup] menu) to find out which functions are affected.

Passwords

For all default user accounts, the initial password is *894129*. Note that this password is very weak, and we strongly recommend that you change the password for both users after initial login. An administrator can change the password in Microsoft Windows for any user at any time via "Start > Settings > Account > SignIn Options > Password > Change".

Auto-login

When shipped, the instrument automatically logs on the default "Instrument" user to Microsoft Windows using the default password. This function is active until an administrator explicitly deactivates it or changes the password.



Changing the password and use of auto-login function

Note that when you change the default password, the default auto-login function no longer works!

In this case, you must enter the new password manually to log on.

Adapting the auto-login function to a new password

If you change the password that is used during auto-login, this function no longer works. Adapt the settings for the auto-login function first.



Changing the password for auto-login requires administrator rights.



1. Select the "Windows" icon in the toolbar to access the operating system of the R&S FSWP (see also ["To access the "Start" menu"](#) on page 33).

2. Open the `C:\R_S\INSTR\USER\AUTOLOGIN.REG` file in any text editor (e.g. Notepad).
3. In the line `"DefaultPassword"="894129"`, replace the default password (894129) by the new password for automatic login.
4. Save the changes to the file.
5. In the Windows "Start" menu, select "Run".
The "Run" dialog box is displayed.
6. Enter the command `C:\R_S\INSTR\USER\AUTOLOGIN.REG`.
7. Press [ENTER] to confirm.
The auto-login function is reactivated with the changed password. It is applied the next time you switch on the instrument.

Switching users when using the auto-login function

Which user account is used is defined during login. If auto-login is active, the login window is not displayed. However, you can switch the user account to be used even when the auto-login function is active.



1. Select the "Windows" icon in the toolbar to access the operating system of the R&S FSWP (see also ["To access the "Start" menu"](#) on page 33).
2. Press [CTRL] + [ALT] + [DEL], then select "Sign out".
The "Login" dialog box is displayed, in which you can enter the different user account name and password.

For information on deactivating and reactivating the auto-login function, see ["Deactivating the auto-login function"](#) on page 396.

3.12 Checking the supplied options

The instrument can be equipped with both hardware and firmware options. To check whether the installed options correspond to the options indicated on the delivery note, proceed as follows.

1. Press [SETUP].
2. Press "System Config".
3. Switch to the "Versions + Options" tab in the "System Configuration" dialog box.
A list with hardware and firmware information is displayed.
4. Check the availability of the hardware options as indicated in the delivery note.

3.13 Performing a self-alignment

When temperature changes occur in the environment of the R&S FSWP, or after updating the firmware, you have to perform a self-alignment to align the data to a reference source.

During self-alignment, do not connect a signal to the RF input connector. Running a self-alignment with a signal connected to the RF input can lead to false measurement results.

Performing a self-alignment

Before performing this alignment, make sure that the instrument has reached its operating temperature (for details, refer to the data sheet).

A message in the status bar ("Instrument warming up...") indicates that the operating temperature has not yet been reached.

Depending on the installation settings, an automatic self-alignment is performed after installation. A dialog box is displayed indicating how much warm-up time is still required before self-alignment can be performed.

1. Press [Setup].
2. Press "Alignment".
3. Select "Start Self Alignment" in the "Alignment" dialog box.

Once the system correction values have been calculated successfully, a message is displayed.



To display the alignment results again later

- Press [SETUP].
- Press "Alignment".

3.14 Considerations for test setup

Cable selection and electromagnetic interference (EMI)

Electromagnetic interference (EMI) can affect the measurement results.

To suppress electromagnetic radiation during operation:

- Use high-quality shielded cables, for example, double-shielded RF and LAN cables.
- Always terminate open cable ends.
- Ensure that connected external devices comply with EMC regulations.

Signal input and output levels

Information on signal levels is provided in the data sheet and on the instrument, next to the connector. Keep the signal levels within the specified ranges to avoid damage to the R&S FSWP and connected devices.

4 Instrument tour

On the instrument tour, you can learn about the different control elements and connectors on the front and back panel of the R&S FSWP.

- [The front panel](#).....38
- [The rear panel](#).....48

4.1 The front panel

This chapter describes the front panel, including all function keys and connectors.

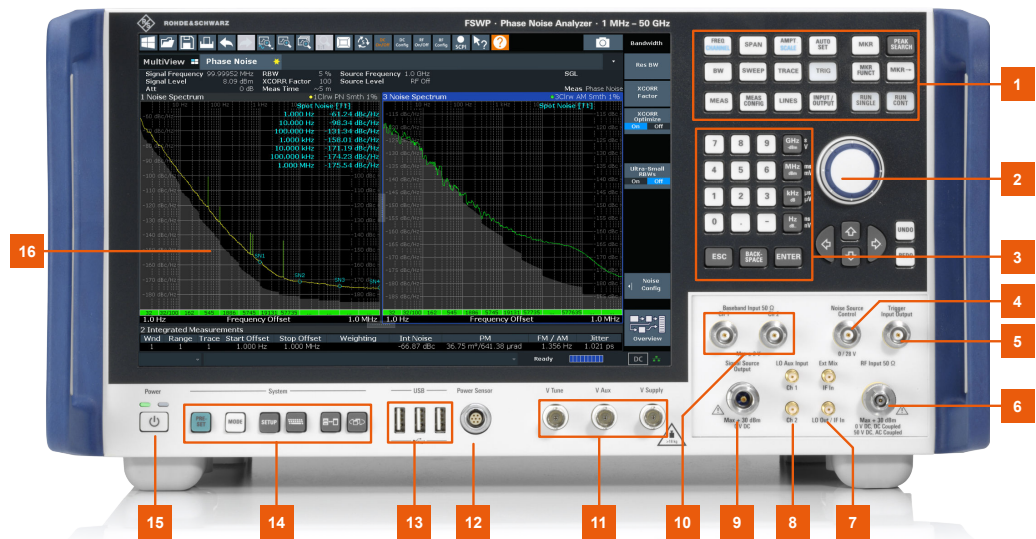

Figure 4-1: Front panel of the R&S FSWP

- 1 = Function keys
- 2 = Navigation control
- 3 = Keypad
- 4 = Noise source control
- 5 = Trigger in- and output
- 6 = RF input
- 7 = External mixer ports (optional)
- 8 = External LO input (optional)
- 9 = Signal source output (optional)
- 10 = Baseband connectors
- 11 = DC power connectors
- 12 = Power sensor connector
- 13 = USB 2.0 interfaces
- 14 = System control keys
- 15 = Power key
- 16 = Display (touchscreen)

• Display (touchscreen).....	39
• Power key.....	40
• System control keys.....	40
• The function keys.....	41
• The Keypad.....	42
• Navigation Control.....	43
• RF Input (50 Ω).....	44
• Signal Source Output.....	45
• USB ports.....	45
• Power sensors.....	45
• Probe Power Connector (3 Pins).....	46
• Noise source control.....	46
• Trigger input and output.....	46
• Baseband input.....	46
• External Mixer (Optional).....	47
• DC Power Supply.....	47
• LO AUX input (optional).....	47

4.1.1 Display (touchscreen)

The touchscreen on the front panel of the R&S FSWP displays the measurement results. Additionally, the screen display provides status and setting information and allows you to switch between various measurement tasks. The screen is touch-sensitive, offering an alternative means of user interaction for quick and easy handling of the instrument.

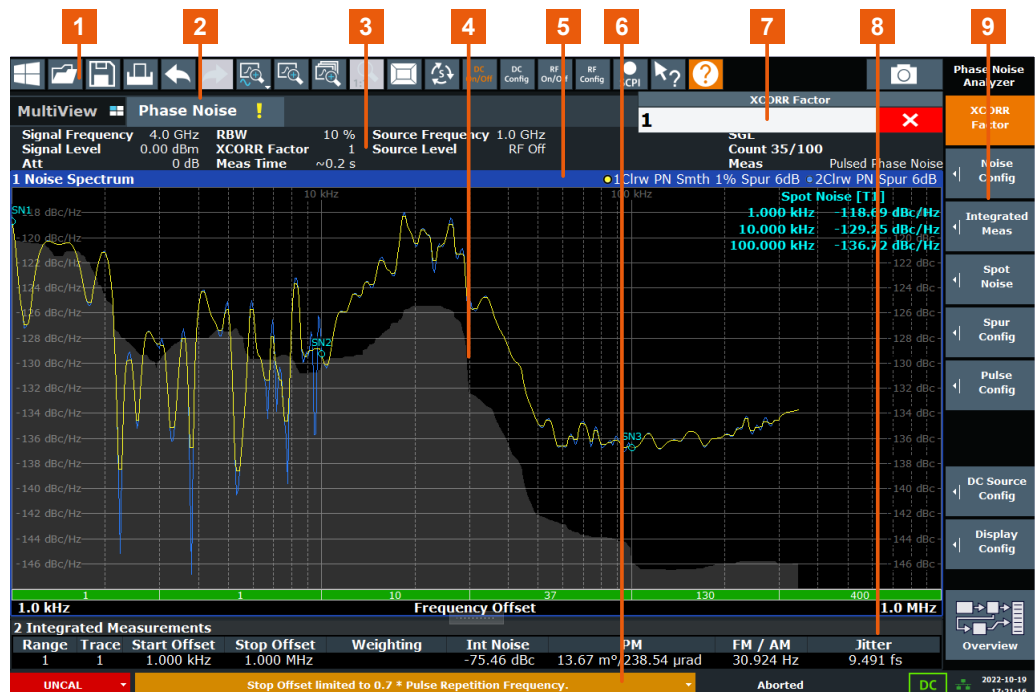

- 1 = Toolbar: contains general functionality of the firmware.
- 2 = Channel tab: contains measurement channel.
- 3 = Channel bar: shows measurement settings.
- 4 = Result display: contains measurement results.
- 5 = Window title bar: contains diagram-specific (trace) information.
- 6 = Status bar: contains system messages, progress bar and date and time.
- 7 = Input field.
- 8 = Diagram footer: contains diagram-specific information.
- 9 = Softkeys: provide access to measurement functions.

A touchscreen is a screen that is touch-sensitive, i.e. it reacts in a specified way when a particular element on the screen is tapped by a finger or a pointing device, for example. Any user interface elements that can be clicked on by a mouse pointer can also be tapped on the screen to trigger the same behavior, and vice versa.

Using the touchscreen, the following tasks (among others) can be performed by the tap of your finger:

- Changing a setting
- Changing the display
- Moving a marker
- Zooming into a diagram
- Selecting a new evaluation method
- Scrolling through a result list
- Saving or printing results and settings

To imitate a right-click by mouse using the touchscreen, for example to open a context-sensitive menu for a specific item, press the screen for about 1 second.

4.1.2 Power key



The power key is on the lower left corner of the front panel. It starts up and shuts down the instrument.

See also "[Connecting to power](#)" on page 20.

4.1.3 System control keys

System control keys provide access to the basic instrument configuration.





Refer to the User Manual for an extensive description of the system configuration functionality.



Resets the instrument to its default configuration.











Selects a particular measurement application or operating mode.

	Provides functionality to configure basic instrument characteristics, for example: <ul style="list-style-type: none"> • the LAN connection • the date and time • the display configuration • the reference frequency • firmware update and application installation • service functions • transducer configuration
	Provides access to the on-screen keyboard.
	Turns full screen mode on and off.
	Selects a window in split screen mode or browses through active windows in full screen mode.

4.1.4 The function keys

Function keys provide access to the most common measurement settings and functions.

Refer to the user manual for an extensive description of the measurement settings and functions.

	Provides functionality to define frequency parameters, for example: <ul style="list-style-type: none"> • the measurement range • the signal frequency
	Provides functionality to configure the measurement range.
	Provides functionality to configure amplitude or level characteristics, for example: <ul style="list-style-type: none"> • the attenuation • the input impedance • the scale of the level axis • the preamplifier
	Provides functionality to automatically define various parameters like the level or frequency.
	Provides functionality to define various filter bandwidths.
	Provides functionality to configure the measurement, for example: <ul style="list-style-type: none"> • the measurement mode (single or continuous measurements) • the number of measurements
	Provides functionality to configure data acquisition and analyze measured data, for example: <ul style="list-style-type: none"> • the trace mode • the displayed result
	n/a

MKR	Provides functionality to activate and position absolute and relative markers (markers and delta markers).
PEAK SEARCH	Performs a peak search for active markers. If no marker is active, marker 1 is activated and the peak search is performed for it.
MKR FUNCT	n/a
MKR →	Provides functionality to position and control markers, for example: <ul style="list-style-type: none"> • to configure the marker search • to configure the peak excursion
MEAS	Provides the measurement functions, for example: <ul style="list-style-type: none"> • the phase noise measurement • the AM noise measurement • the pulsed noise measurement • the spot noise vs tune measurement
MEAS CONFIG	Provides functionality to configure the measurement.
LINES	Provides functionality to control display and limit lines.
INPUT / OUTPUT	Provides functionality to configure inputs and outputs.
RUN SINGLE	Starts a measurement in single measurement mode.
RUN CONT	Starts a measurement in continuous measurement mode.

4.1.5 The Keypad

The alphanumeric keys allow you to enter alphanumeric characters where necessary (for example in dialog boxes or input fields). The keypad containing the alphanumeric keys also provides keys that select a particular unit.

0	Provide access to numbers and (special) characters.
...	
9	
.	Inserts a decimal point at the cursor position (".").
-	Changes the sign of a numeric value or inserts a dash character ("-") in case of alphanumeric input.

Hz dB..	Select a particular unit for a numeric value. The labels on and next to the key state the units it selects.
GHz dBm	Pressing one of the unit keys also completes the entry of a numeric value. Note that in case of level entries (dB, dBm etc.) or dimensionless values, all unit keys have the value "1" as multiplying factor and thus work like the [ENTER] key..
ESC	<p>Provides the following functions:</p> <p>In dialog boxes:</p> <ul style="list-style-type: none"> • Closes all kinds of dialog boxes if edit mode is not active. • Quits edit mode if it is active. • Selects the "Cancel" button when available. <p>In "Edit" dialog boxes:</p> <ul style="list-style-type: none"> • If data entry has been started, it retains the original value and closes the dialog box. • If data entry has not been started or has been completed, it closes the dialog box.
BACK-SPACE	Deletes the character to the left of the cursor (if an (alpha)numeric entry has been started already).
ENTER	<p>Provides the following functions:</p> <ul style="list-style-type: none"> • Completes the entry of input made with the alphanumeric keys (numeric or alphanumeric) and accepts the input. If you enter a numeric value that has a unit, the [ENTER] key works like the [HZ/DB] key. • Selects the default or focused element in dialog boxes.

4.1.6 Navigation Control

Navigation control consists of a rotary knob and cursor keys. These keys allow you to navigate within the display or within dialog boxes.

In addition to the rotary knob and the cursor keys, the navigation control also provides undo / redo functionality.

Rotary knob

The rotary knob allows you to do several things:

- It increases or decreases any kind of numeric value. In most cases, the rotary knob changes numeric values with a fixed step size.
Turning it to the right corresponds to an increase, turning it to the left to a decrease of a numeric value.
- It works like a cursor key in dialog boxes or lists (for example dropdown menus). In that case you can navigate to one of the items with the rotary knob. If the dialog box covers more than one screen page, it also scrolls through the dialog box.
Turning it to the right corresponds to a downward movement. Moving it to the left to an upward movement.
- It moves around markers and other graphical elements on the screen. In most cases, the step size is fix.
- Pressing the rotary knob has the same effect as pressing the [ENTER] key as it confirms an entry or selection.

Cursor keys

The cursor keys allow you to do several things:

- The up and down keys increase or decrease any kind of numeric value if an input field is active.
The cursor keys change numeric values with a fixed step size.
- The cursor keys navigate through dialog boxes or lists (for example dropdown menus).
- The left and right keys move the cursor in an input field in the corresponding direction.
- The up and down keys move markers around.
The step size is fix.
- The cursor keys allow you to navigate to a cell in a table.
- The cursor keys move a scroll bar (vertical or horizontal) in dialog boxes that have one.

Undo and redo functionality



Reverts the software to an older state by erasing the last change you have applied.

The undo function is useful, for example, if you are performing a measurement with several markers and a limit line and accidentally select a different measurement. In this case, a lot of settings would be lost. However, if you press [UNDO] immediately afterwards, the previous status is retrieved.



Reverses an undo action or repeats the most recently performed action.



The [UNDO] function is not available after a [PRESET] or "RECALL" operation. When these functions are used, the history of previous actions is deleted.

4.1.7 RF Input (50 Ω)

The RF Input allows you to connect a device under test (or DUT) to the R&S FSWP, usually via cable and an appropriate connector (for example a male N connector).

The supported frequency range depends on the R&S FSWP model you have. Refer to the datasheet for details.

The RF Input also serves as an attenuator in case you are measuring signal with high levels. The supported attenuation range depends on the R&S FSWP model you have. Refer to the datasheet for details..

NOTICE**Risk of instrument damage**

Do not overload the RF input. For maximum allowed values, see the data sheet.

When measuring unknown signals, always apply attenuation to protect the input mixer. Otherwise, the input mixer may be damaged or destroyed.

For AC coupling, a DC input voltage of 50 V must never be exceeded. For DC coupling, DC voltage must not be applied at the input. In both cases, noncompliance will destroy the input mixers.

4.1.8 Signal Source Output

The optional "Signal Source" output allows you to generate a signal that can be fed into the DUT or other external accessories like frequency dividers or amplifiers. You can connect the DUT or accessories with a cable that has a male N connector.

NOTICE**Risk of damage to the R&S FSWP**

The maximum supported reverse power is 30 dBm. Make sure that this value is not exceeded to avoid damage to the R&S FSWP.

The maximum DC output voltage is 0 V.

For details on configuring the signal source output and generating a signal, see the User Manual.

4.1.9 USB ports

The three USB ports on the front panel (type A) allow you to connect devices like keyboards, mice or memory sticks.



The R&S FSWP provides additional USB ports (including one type B port) on the rear panel.

All USB ports support standard 2.0.

4.1.10 Power sensors

The LEMOSA female connector is used to connect Rohde & Schwarz power sensors or smart noise sources to the R&S FSWP. For a detailed list of supported noise sources and power sensors, see the data sheet.

For details on configuring and using power sensors, see the R&S FSWP-B1 Signal and Spectrum Analyzer User Manual.

The identification and setup procedure after connecting a smart noise source may take up to 10 seconds.

4.1.11 Probe Power Connector (3 Pins)

The Probe Power connector allows you to supply external equipment with power (for example probes or transducers).

The three-pinned probe power connector supports supply voltages from +15 V to -12.6 V and ground. The maximum permissible current is 150 mA. This probe power connector is suitable, for example, for high-impedance probes.

4.1.12 Noise source control

The female BNC connector labeled "Noise Source" allows you to connect and control an external noise source, and supplies the required supply voltage.

You can use a noise source, for example, to measure the noise figure and gain of amplifiers and frequency converting devices.

Conventional noise sources require a voltage of +28 V in order to be switched on and 0 V to be switched off. The output supports a maximum load of 100 mA.

If you want to use a smart noise source, connect it to the [power sensor](#) connector.

4.1.13 Trigger input and output

The female BNC connector labeled "Trigger Input / Output" allows you to receive an external trigger signal or send a trigger signal to another device.

When you are using the connector as a trigger input, you can apply voltages in the range from 0.5 V to 3.5 V (the default value is 1.4 V). The typical input impedance is 10 k Ω .

When you are using the connector as a trigger output, the TTL compatible signal is transmitted (0 V / 5 V).

Note that you can find another connector for trigger input and output on the rear panel.

For more information about controlling and configuring trigger input and output, refer to the User Manual.

4.1.14 Baseband input

The two connectors labeled "Baseband Input 50 Ω " are two female BNC connectors that you can use to connect a DUT for Baseband Noise measurements.

When you perform measurements with two external mixers, the "Ch2" connector is the IF input for the second mixer. This function is available with the optional external mixer support.

NOTICE**Risk of instrument damage**

Do not overload the baseband input. An overload condition can damage or destroy the baseband inputs.

For maximum allowed values, see the data sheet.

4.1.15 External Mixer (Optional)

The two (optional) SMA connectors (LO OUT/IF IN and IF IN) allow you to connect external mixers.

External mixers increase the available frequency range. The way to connect an external mixer depends on the type of mixer and the test setup. For more information about connecting and controlling external mixers refer to the user manual.

If not in use, it is recommended to cover the SMA connectors with the provided protective caps.

4.1.16 DC Power Supply

The female BNC connectors labeled " V_{Tune} ", " V_{Aux} " and " V_{Supply} " allow you to supply external devices, for example a DUT or an external reference oscillator, with the required voltage.

The V_{Supply} connector provides supply voltage from 0 V to +16 V, for example to provide voltage for an oscillator. The supported maximum current is 2000 mA.

The V_{Tune} connector provides tuning voltage from -10 V to +28 V. The supported maximum current is 20 mA.

The V_{Aux} connector provides DC voltage from -10 V to +10 V. The supported maximum current is 100 mA.

For more information about configuring the DC Power supply, refer to the User Manual.

4.1.17 LO AUX input (optional)

The two optional connectors labeled "LO AUX Input - Ch1" and "LO AUX Input - Ch2" are two female SMA connectors that you can use to connect an external local oscillator (LO). The external LO requires two connectors ("Ch1" and "Ch2") to work properly.

The "LO AUX Input" connectors are part of the optional Signal Source.

NOTICE**Risk of instrument damage**

Do not overload the LO AUX input. An overload condition can damage or destroy the inputs.

For maximum allowed values, see the data sheet.

4.2 The rear panel

The rear panel contains various connectors for various purposes.

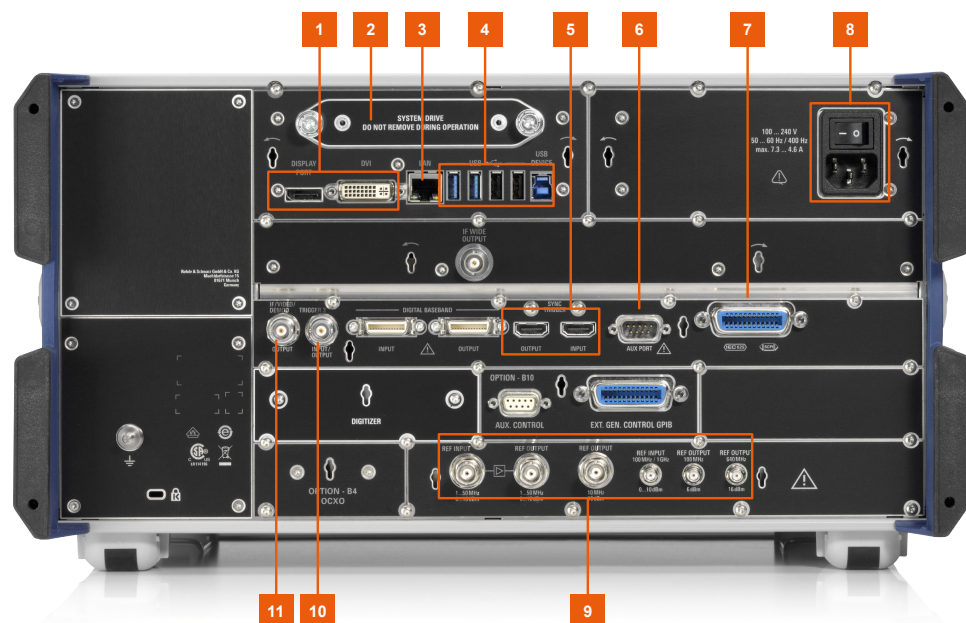

Figure 4-2: Rear panel of the R&S FSWP

- 1 = DisplayPort and DVI
- 2 = Removable hard disk
- 3 = LAN interface
- 4 = USB ports
- 5 = Sync trigger input and output
- 6 = AUX port
- 7 = GPIB interface
- 8 = AC power connector and power switch
- 9 = Ref input and output
- 10 = Trigger in- / output
- 11 = IF / Video / Demod output

For information about the trigger in- and output available on the rear panel, see [Chapter 4.1.13, "Trigger input and output"](#), on page 46.

The digital baseband in- and outputs shown in the image above are not supported by the R&S FSWP.

• Removable hard disk	49
• AC power supply connection and main power switch	49
• Display port and DVI	49
• LAN	50
• USB ports	50
• IF / video / demod output	50
• IF Wide Out	50
• Sync trigger input and output	51
• AUX Port	51
• GPIB Interface	51
• External Generator Control (Optional)	51
• OCXO (optional)	52
• REF INPUT / REF OUTPUT	52
• Labels on R&S FSWP	53
• Device ID	53

4.2.1 Removable hard disk

The removable hard disk is accessible from the rear of the instrument.

In addition to the operating system and the firmware, the R&S FSWP also stores measurement data on that disk. When you remove the hard disk, you can store it and the data on it somewhere secure.

4.2.2 AC power supply connection and main power switch

An AC power supply connector and main power switch are located in a unit on the rear panel of the instrument.

Main power switch function:

Position 1: The instrument can be started via the Power key on the front panel.

The (optional) OCXO reference frequency is warmed up.

Position O: The entire instrument is disconnected from the AC power supply.

For details, refer to "[Connecting to power](#)" on page 20 and [Chapter 3.5, "Connecting the AC power"](#), on page 27.

4.2.3 Display port and DVI

You can connect an external monitor or other display device to the R&S FSWP to provide an enlarged display. Two different types of connectors are provided for this purpose:

- Display Port
- DVI (digital visual interface)

For details, see [Chapter 3.9, "Connecting an external monitor"](#), on page 31.

4.2.4 LAN

The R&S FSWP is equipped with a 1 GBit Ethernet IEEE 802.3u network interface with Auto-MDI(X) functionality. The assignment of the RJ-45 connector supports twisted-pair category 5 UTP/STP cables in a star configuration (UTP stands for *unshielded twisted pair*, and STP for *shielded twisted pair*).

For details, see [Chapter 13, "Network operation and remote control"](#), on page 336.

4.2.5 USB ports

The four USB ports on the rear panel (type A) allow you to connect devices like keyboards, mice or memory sticks.

The male USB connector (type B) allows you to connect the R&S FSWP to a computer and establish a remote control connection, for example. (Note: the USB type B interface is not available for instruments with CPU board 1206.3874.00 or higher.)

All USB connectors support standard 2.0.

4.2.6 IF / video / demod output

The two female BNC connectors can be used for various outputs:

- Output of the intermediate frequency (IF)
- Output of the video signal

Details about configuring the output type and characteristics are part of the user manual.

Note that you can use this connector for applications available with the optional spectrum analyzer hardware and analog modulation analysis application.

4.2.7 IF Wide Out

You can extend the signal analysis bandwidth of the R&S FSWP by installing a hardware option. The bandwidth extension allows for a linear bandwidth up to 320 MHz.

You can activate and deactivate the bandwidth extension manually in the I/Q analyzer that is integral part of the optional spectrum analyzer (R&S FSWP-B1) or other optional applications that require the spectrum analyzer hardware.

Together with the bandwidth extension an additional IF output connector is provided (if wide output). As opposed to the default [IF / video / demod output](#) connector, the IF output frequency of the optional connector cannot be defined manually, but is determined automatically depending on the center frequency. For details on the used frequencies,

see the data sheet. The IF Wide Output connector is used automatically when the bandwidth extension is activated (i.e. for bandwidths > 80 MHz).

4.2.8 Sync trigger input and output

The "Sync Trigger Input / Output" connectors allow you to synchronize several devices (for example two R&S FSWPs) with respect to the trigger signal, but also the reference frequency. A 100 MHz signal can be output as a trigger or reference signal to another device, and an external trigger or reference signal can be received at the input connector by the R&S FSWP.

4.2.9 AUX Port

The 9 pole SUB-D male connector provides control signals for controlling external devices. The voltage levels are TTL compatible (max. 5 V).



Pin	Signal	Description
1	+5 V / max. 250 mA	Supply voltage for external circuits
2 to 7	I/O	Control lines for user ports (see User Manual)
8	GND	Ground
9	READY FOR TRIGGER	Signal indicating that the instrument is ready to receive a trigger signal (Low active = 0 V)

NOTICE

Short-circuit hazard

Always observe the designated pin assignment. A short-circuit can damage the port.

4.2.10 GPIB Interface

The GPIB interface is in compliance with IEEE488 and SCPI. A computer for remote control can be connected via this interface. To set up the connection, a shielded cable is recommended. For more details refer to "Setting Up Remote Control" in the User Manual.

4.2.11 External Generator Control (Optional)

The optional "External Generator Control" provides an additional GPIB interface and AUX port.

The GPIB connector can be used to connect an external generator to the R&S FSWP.

The AUX port is required for TTL synchronization, if supported by the generator (see [Chapter 4.2.9, "AUX Port"](#), on page 51).

For details on connecting an external generator see the "External Generator Control" section of the R&S FSWP User Manual.

4.2.12 OCXO (optional)

This optional OCXO generates a 10 MHz reference signal with a very precise frequency. If installed, and if no external signal is used, this signal is used as an internal reference. It can also be used to synchronize other connected devices via the REF OUTPUT 10 MHz connector.



Warm-up time for OCXO

When the instrument is switched on, the OCXO requires an extended warm-up time (see data sheet).

4.2.13 REF INPUT / REF OUTPUT

The REF INPUT connectors are used to provide an external reference signal to the R&S FSWP.

The REF OUTPUT connectors can be used to provide an external reference signal (or the optional OCXO reference signal) from the R&S FSWP to other devices that are connected to this instrument.

The REF OUTPUT connectors can be used to provide an external reference signal or the OCXO reference signal from the R&S FSWP to other devices that are connected to this instrument.

Various connectors are provided for different reference signals:

Connector	Reference signal	Usage
REF INPUT	1...20 MHz 0...10 dBm	To provide an external reference signal on the R&S FSWP.
REF OUTPUT	1...20 MHz 0...10 dBm	To provide the same external reference signal received by the REF INPUT 1...20 MHz connector to another device, when available.
REF OUTPUT	10 MHz 10 dBm	To provide the internal reference signal from the R&S FSWP to another device continuously. Also used to provide OCXO reference signal to another device.
REF INPUT	100 MHz 0...10 dBm	To provide an external reference signal on the R&S FSWP.
REF OUTPUT	100 MHz 6 dBm	To provide a 100 MHz reference signal from the R&S FSWP to another device.
REF OUTPUT	640 MHz 16 dBm	To provide a 640 MHz reference signal from the R&S FSWP to another device.



SYNC TRIGGER

The SYNC TRIGGER connector can also be used to synchronize the reference frequency on several devices.

4.2.14 Labels on R&S FSWP

Labels on the casing inform about:

- Personal safety, see "[Meaning of safety labels](#)" on page 21
- Product and environment safety, see [Table 4-1](#)
- Identification of the product, see [Chapter 4.2.15, "Device ID"](#), on page 53

Table 4-1: Labels regarding R&S FSWP and environment safety

	<p>Labeling in line with EN 50419 for disposal of electrical and electronic equipment after the product has come to the end of its service life.</p> <p>For more information, see "Disposing of electrical and electronic equipment" on page 673.</p>
--	---

4.2.15 Device ID

The unique device identifier is provided as a barcode sticker on the rear panel of the R&S FSWP.

It consists of the device order number and a serial number.



The serial number is used to define the **default instrument name**, which is:

<Type><variant>-<serial_number>

For example, FSWP26-123456.

The instrument name is required to establish a connection to the instrument in a LAN.

5 Trying out the instrument

Overview of tutorials

Initial setup:

- ["Preparing the R&S FSWP"](#) on page 55
- ["Selecting the phase noise application"](#) on page 55
- ["Performing a preset"](#) on page 56

Measurement selection

- ["Selecting a measurement"](#) on page 57

The phase noise measurement

- ["Measuring phase noise"](#) on page 58
- ["Measuring amplitude noise"](#) on page 58
- ["Measuring spurs"](#) on page 59
- ["Measuring spot noise"](#) on page 59
- ["Measuring integrated noise"](#) on page 59
- ["Test setup for measurements with two external mixers"](#) on page 60

The additive noise measurement

- ["How to measure additive noise"](#) on page 61

The baseband noise measurement

- ["How to measure baseband noise at the RF input"](#) on page 64
- ["How to measure baseband noise at the baseband input"](#) on page 64

The pulsed phase noise measurement

- ["How to measure the phase noise of a pulse"](#) on page 65

The pulsed additive noise measurement

- ["How to measure pulsed additive noise with an internally modulated pulse"](#) on page 66
- ["How to measure pulsed additive noise with an externally modulated pulse"](#) on page 66

Trace smoothing

- ["How to smooth the trace by averaging the measurement data"](#) on page 68
- ["How to smooth the trace by adjusting the number of XCORR operations"](#) on page 68
- ["How to smooth the trace graphically"](#) on page 69
- ["How to remove spurs from a trace"](#) on page 69

Integration ranges

- ["How to define integration ranges"](#) on page 70
- ["How to correct integrated measurements"](#) on page 71

The cross-correlation gain indicator

- ["How to control the cross-correlation gain indicator \(gray area\)"](#) on page 72

Miscellaneous evaluation tools

- ["Zooming into the results"](#) on page 73
- ["Labeling traces"](#) on page 73
- ["Exporting measurement data"](#) on page 73

Frequency configuration

- ["How to define the measurement range"](#) on page 74
- ["How to search for signals"](#) on page 74
- ["How to define the capture range for the signal search"](#) on page 75
- ["How to define a carrier frequency manually"](#) on page 75

The half decade configuration table

- ["How to work with the half decade configuration table"](#) on page 75

Pulsed measurement configuration

- ["How to configure a gate for measurements on pulses"](#) on page 76

Signal generation

- ["How to generate a CW signal"](#) on page 77
- ["How to generate a pulse"](#) on page 78
- ["How to use an external pulse modulator \(configuration\)"](#) on page 79

DUT power supply

- ["How to supply DUTs with current or voltage"](#) on page 79

• Initial setup	55
• Measurements	56
• Result evaluation	67
• Measurement configuration	74

5.1 Initial setup

Preparing the R&S FSWP

1. Connect the R&S FSWP to an electrical outlet as described in [Chapter 3.5, "Connecting the AC power"](#), on page 27.
2. Turn on the R&S FSWP as described in [Chapter 3.6, "Switching the instrument on and off"](#), on page 28.

Selecting the phase noise application

1. Select the [MODE] key.
2. Select the "Phase Noise" item in the "Mode" dialog box.

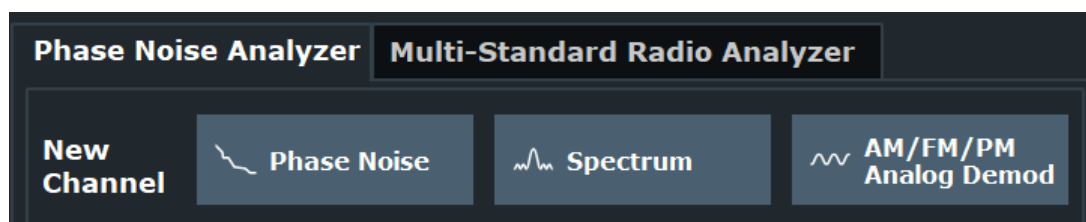

There's more than one way to skin a cat

In most cases, the firmware of the R&S FSWP provides several ways to change measurement parameters. For example, the measurement range can be defined via the [FREQ] key, the "MEAS CONFIG" key or the "Overview" dialog box.

All procedures in this chapter use the "Overview" dialog box as a starting point (when possible). You can reach this dialog via the "Overview" softkey displayed at the bottom of the softkey bar on the right side of the diagram area.

Performing a preset

Before configuring and starting a new measurement, it is always recommended to perform a preset and restore the default configuration of the instrument or the measurement application.

1. Select the [PRESET] key on the front panel to restore the default state of the R&S FSWP.
2. Enter the "Overview" dialog box and select the "Preset Channel" item to restore the default state of the selected measurement channel. All other measurement channels keep their custom configuration.

5.2 Measurements

Measuring the phase noise characteristics of a DUT requires a simple measurement setup consisting of the R&S FSWP and a DUT.

Some measurements require additional equipment.

- For additive noise measurements, the R&S FSWP must be equipped with the optional Signal Source hardware.
- For pulsed noise measurements, the R&S FSWP must be equipped with the optional Pulsed Phase Noise Measurement application.
- For pulsed additive noise measurements, the R&S FSWP must be equipped with the optional Pulsed Phase Noise Measurement application and the optional Signal Source hardware.

• Measurement selection	57
• The phase noise measurement	57
• The additive noise measurement	60
• The baseband noise measurement	63

- [The pulsed phase noise measurement](#)..... 65
- [The pulsed additive noise measurement](#)..... 65
- [Adding another measurement channel](#)..... 67

5.2.1 Measurement selection

Selecting a measurement

- ▶ Select the [MEAS] key.

The R&S FSWP opens a dialog box to select the measurement.

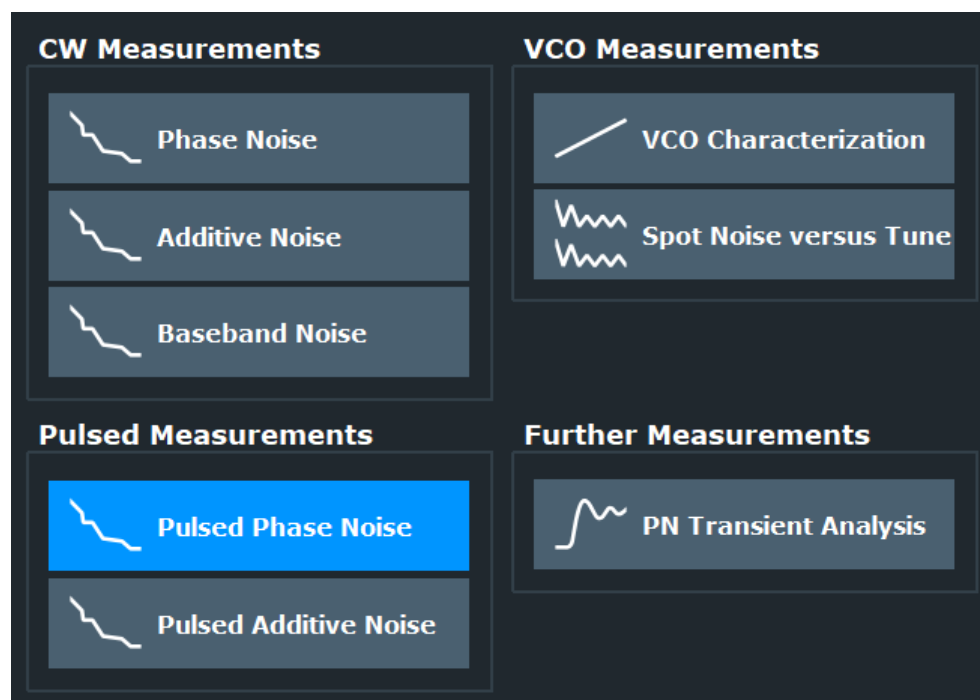

5.2.2 The phase noise measurement

Test setup

Connect the DUT via cable to the RF input of the R&S FSWP as shown in the illustration.

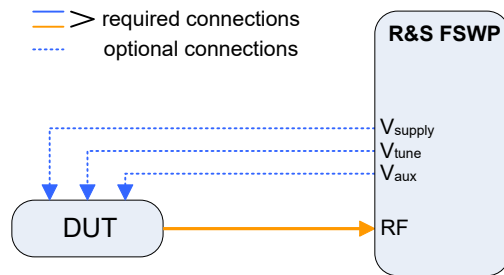

Figure 5-1: Typical test setup for basic noise measurements

Measuring phase noise

1. Perform a [PRESET].

The application automatically starts a continuous measurement.

First, it searches for a carrier signal (see [How to search for signals](#)). When one has been found, it measures the noise characteristics of the DUT in the default measurement (or frequency offset) range.

If no carrier could be found, a corresponding error message is displayed in the status bar below the diagram.

2. You can stop the measurement (to analyze the measurement data in detail) with the [RUN SGL] or [RUN CONT] key; [RUN SGL] performs one more measurement, then stops, [RUN CONT] stops immediately.
By default, two traces are displayed: the first trace shows the smoothed data without spurs, the second trace the raw data including spurs.

Measuring amplitude noise

The test setup is the same as shown above.

The default phase noise trace shows the phase noise characteristics of the DUT. In addition, you can also display the amplitude noise characteristics (or both together).

1. Enter the "Overview" dialog box and, from there, enter the "Analysis" dialog box.
2. Select the vertical "Trace" tab, and then the horizontal "Traces" tab.
3. For any trace, select "AM Noise" from the "Result" dropdown menu.

Traces	Traces		Export / Import	Copy Trace	Trace Math	Trace Label		Smoothing		Spurious		Trace Offset		Persistence	
	Mode	Result	State/Value	Thresh	Hide	State/Offset	State/Decay								
Markers	Trace 1	Clear Write	Phase Noise	<input checked="" type="checkbox"/>	1 %	6.0 dB	<input checked="" type="checkbox"/>	0.0 dB	<input type="checkbox"/>	0 s					
	Trace 2	Clear Write	Phase Noise	<input type="checkbox"/>	1 %	6.0 dB	<input type="checkbox"/>	0.0 dB	<input type="checkbox"/>	0 s					
Limit Lines	Trace 3	Blank	Phase Noise	<input type="checkbox"/>	1 %	6.0 dB	<input type="checkbox"/>	0.0 dB	<input type="checkbox"/>	0 s					
	Trace 4	Blank	Phase Noise	<input type="checkbox"/>	1 %	6.0 dB	<input type="checkbox"/>	0.0 dB	<input type="checkbox"/>	0 s					

4. Start a new measurement to determine the AM noise of the DUT.
(The "Phase + AM Noise" menu item displays the sum of phase and amplitude noise.)

Tip: If you'd like to view both results separately at the same time, open two phase noise diagrams, one that shows the phase noise, the other showing the AM noise and perform a measurement.

In addition to the graphical representation of the phase noise characteristics, the application also provides several tables that show specific phase noise characteristics.

Measuring spurs

In addition to the graphical display of spurs in the diagram (spikes on the trace), the application also features a result display that contains a list of all detected spurs.

- ▶ Open the SmartGrid (📊) and drag the "Spurious List" item from the evaluation bar into the display.

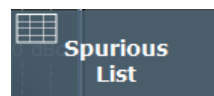

The spurious list contains all detected spurs (including their characteristics) on all traces and all windows.

More information:

- [Spurious list](#)
- [Spur removal](#)

Measuring spot noise

Spot noise is the phase noise or AM noise at a specific offset frequency (for example the phase noise at 500 kHz).

- ▶ Open the SmartGrid (📊) and drag the "Spot Noise" item from the evaluation bar into the display.



The table contains a list of spot noise values for selected frequency offsets (in the default state, these are the decade edges) on each active trace.

More information:

- [Spot noise table](#)

Tip: You can define custom spot noise frequencies in the "Spot Noise" tab of the "Noise Config" dialog box.

Measuring integrated noise

Integrated measurements show various noise characteristics, like the residual noise, integrated over a certain offset frequency range.

- ▶ Open the SmartGrid (📊) and drag the "Integrated Measurements" item from the evaluation bar into the display.

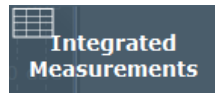

The table contains a list of integrated measurement results.

More information:

- [Integrated measurements](#)

Tip: You can define [custom integration ranges](#) in the "Integration Ranges" tab of the "Noise Config" dialog box.

Test setup for measurements with two external mixers

Connect the DUT to the mixers and the mixers to the R&S FSWP as shown in the illustration.

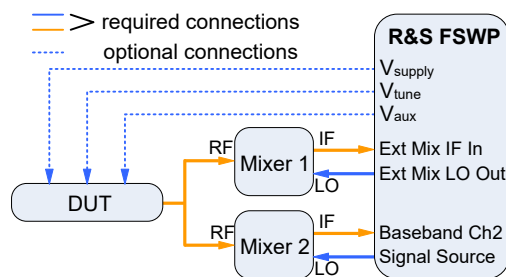

1. Perform a [PRESET].
2. Select the [MEAS] key and select the "Phase Noise" measurement.
3. Enter the "Overview" dialog box, and from there, enter the "Input" dialog box.
4. Configure both mixers in the "External Mixer" tab of the "Input Source" dialog box.

More information:

- [External mixer](#)

5. Start the measurement ([RUN SGL] or [RUN CONT]).

5.2.3 The additive noise measurement

Additive noise measurements require the signal source output that is available as an optional hardware component.

Test setup

Connect the DUT via cable to the RF input and the signal source output of the R&S FSWP as shown in the illustration.

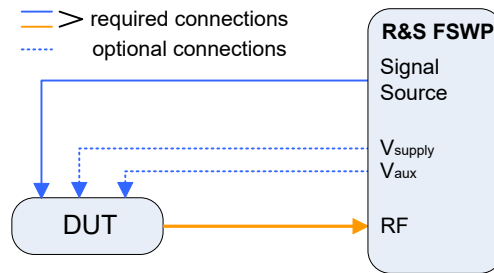

How to measure additive noise

1. Perform a [PRESET].
2. Select the "Additive Noise" measurement via the [MEAS] key.
3. Configure the signal source output as described in "How to generate a CW signal" on page 77.
4. Start the measurement ([RUN SGL] or [RUN CONT]).
 The application measures the additive noise on the output frequency of the signal source in the default measurement (or frequency offset) range.
5. You can stop the measurement (to analyze the measurement data in detail) with the [RUN SGL] or [RUN CONT] key; [RUN SGL] performs one more measurement, then stops, [RUN CONT] stops immediately.
 By default, two traces are displayed: the first trace shows the smoothed data without spurs, the second trace the raw data including spurs.

How to measure additive noise characteristics of amplifiers and dividers

Measuring the noise characteristics of amplifiers and dividers require a complex test setup. The test setup depends on the type of DUT you are testing and is explained here.

1. Measuring the additive noise of amplifiers with an external signal source

The test setup for this measurement looks like this:

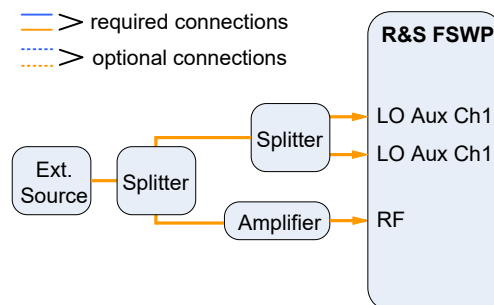

- a) Configure the external signal source to generate the required fixed frequency.
- b) Connect the first power splitter to the amplifier and the second power splitter.
- c) Connect the amplifier to the RF input of the R&S FSWP.

- d) Connect the second power splitter to both LO AUX input channels of the R&S FSWP.
The power at each LO AUX input must have a level between 5 dBm and 10 dBm.
Except for the second power splitter, do not add any additional hardware to this signal path.
- e) If required, you can add an attenuator between the first splitter and the amplifier to reduce the amplifier input level.
- f) Select "Overview" > "Select Measurement" > "Additive Noise"
- g) Select "Overview" > "Input" > "Input Source" > "Radio Frequency" > "Local Oscillator" > "External"
- h) Start the measurement ([RUN SINGLE] or [RUN CONT]).

2. Measuring the additive noise of a divider with an external signal source (without cross-correlation)

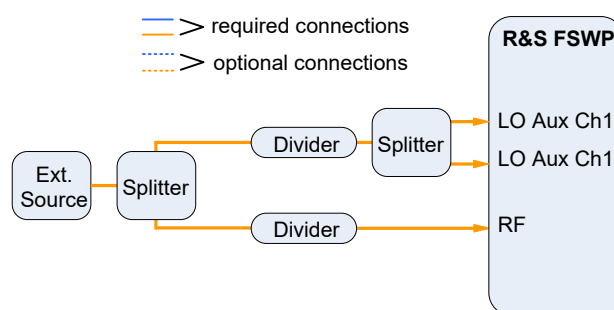

- a) Configure the external signal source to generate the required fixed frequency.
- b) Connect both frequency dividers to the first power splitter.
- c) Connect the first frequency divider to the RF input of the R&S FSWP.
- d) Connect the second power splitter to the other frequency divider and connect the resulting signal streams to both LO AUX input channels of the R&S FSWP.
Regarding the frequency divider, make sure that both dividers are the same model and have the same dividing factor.
Also make sure that the frequency fed into all inputs of the R&S FSWP is the same.
- e) Select "Overview" > "Select Measurement" > "Additive Noise"
- f) Select "Overview" > "Input" > "Input Source" > "Radio Frequency" > "Local Oscillator" > "External"
- g) Start the measurement ([RUN SINGLE] or [RUN CONT]).
The results in these measurements are 3 dB higher than they actually are. This is because the divider at the LO AUX inputs is not canceled out. To get the actual results, subtract 3 dB from the results, for example by shifting the trace by this amount ("Overview" > "Analysis" > "Traces" > "Traces" > "Trace Offset: 3 dB").

3. Measuring the additive noise of a divider with an external signal source (with cross-correlation)

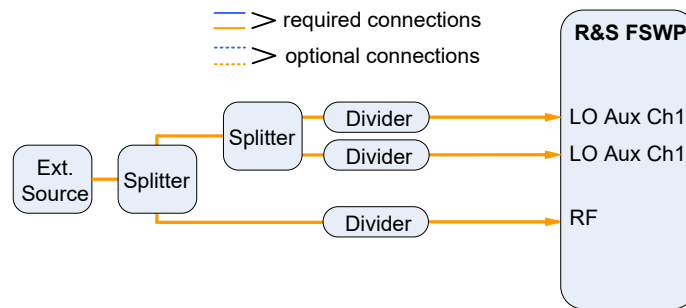

- Configure the external signal source to generate the required fixed frequency.
- Connect the first frequency dividers to the first power splitter.
- Connect the first frequency divider to the RF input of the R&S FSWP.
- Connect the second power splitter to the first power splitter.
- Connect the other two frequency dividers to the second power splitter and connect the resulting signal streams to both LO AUX input channels of the R&S FSWP.

Regarding the frequency divider, make sure that all three dividers are the same model and have the same dividing factor.

Also make sure that the frequency fed into all inputs of the R&S FSWP is the same.

- Select "Overview" > "Select Measurement" > "Additive Noise"
- Select "Overview" > "Input" > "Input Source" > "Radio Frequency" > "Local Oscillator" > "External"
- Start the measurement ([RUN SINGLE] or [RUN CONT]).

Compared to measurements on two dividers, this setup displays the correct additive noise of the first frequency divider. The results do not have to be corrected. The additive noise of the frequency dividers connected to the LO AUX inputs is canceled out because of the cross-correlation properties in the two channels of the LO AUX input.

5.2.4 The baseband noise measurement

Baseband Noise measurements measure the noise characteristics of a DUT over an absolute frequency span (not relative to carrier).

You can use either the RF input for these measurements, or the baseband inputs. The baseband inputs are DC coupled and extend the lower frequency range to 1 mHz (the lowest supported frequency on the RF input is 1 MHz). Using the baseband input, you can, for example, test the voltage supply of DC sources.

Test setup

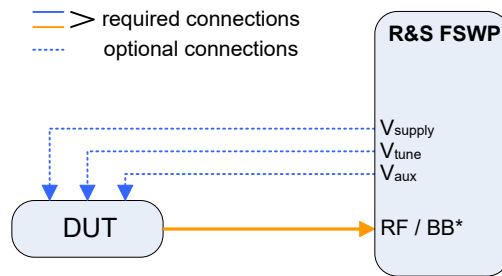

* = See text below for instructions on how to use the baseband input.

How to measure baseband noise at the RF input

For baseband noise measurements on the RF input, proceed as follows.

1. Connect the DUT to the RF input.
2. Perform a [PRESET].
The application automatically starts a continuous measurement and measures the noise characteristics of the DUT in the default frequency range.
3. Select the "Baseband Noise" measurement via the [MEAS] key.
4. You can stop the measurement (to analyze the measurement data in detail) with the [RUN SGL] or [RUN CONT] key; [RUN SGL] performs one more measurement, then stops, [RUN CONT] stops immediately.
By default, two traces are displayed: the first trace shows the smoothed data without spurs, the second trace the raw data including spurs.

Tip: Integrated measurement results. Note that the "PM", "FM" and "Jitter" results are always "0" for baseband noise measurements.

How to measure baseband noise at the baseband input

For baseband noise measurements on the baseband input, proceed as follows.

1. Connect the DUT to one of the baseband channels.
If you want to cross-correlate the measurement, connect the DUT to both baseband channels (add a splitter to the test setup, if the DUT has just one output).
2. Perform a [PRESET].
3. Select the "Baseband Noise" measurement via the [MEAS] key.
4. Enter the "Overview" dialog box, and from there, enter the "Input" dialog box.
5. Select the vertical "Baseband" tab.
6. Turn on the baseband input.
7. Select the "Input" channel you are using for the measurement ("CH1", "CH2" or "CH1xCH2").

The application automatically starts a continuous measurement and measures the noise characteristics of the DUT in the default frequency range.

5.2.5 The pulsed phase noise measurement

Noise measurements on pulses are available with the optional pulsed phase noise measurements firmware application.

Test setup

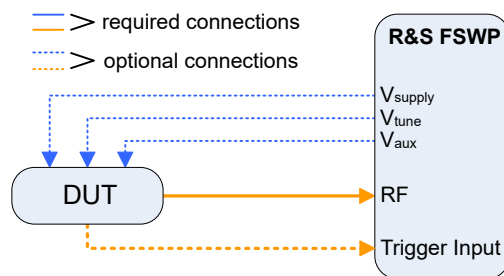

How to measure the phase noise of a pulse

1. Connect the DUT via cable to the RF input of the R&S FSWP as shown in the illustration.
2. Perform a [PRESET].
3. Select the [MEAS] key and select the "Pulsed Phase Noise" measurement.

The application tries to detect a pulse in the signal you have applied, using two automatic mechanisms:

- search for the pulse frequency
- detection of the pulse characteristics

If successful, it configures a gate based on the pulse characteristics and starts the noise measurement of the pulse.

The results are displayed the same way as in the other measurements (two traces in the diagram and results for the integrated measurements).

If no frequency or pulse could be found, a corresponding error message is displayed in the status bar below the diagram.

If required, you can also define the [frequency](#) and the [pulse characteristics](#) manually.

5.2.6 The pulsed additive noise measurement

Additive noise measurements on pulses require the optional pulsed phase noise measurements firmware application and the optional signal source output.

The test setup depends on whether you use internal or external modulation with a pulse modulator.

Test setup (internal pulse modulation)

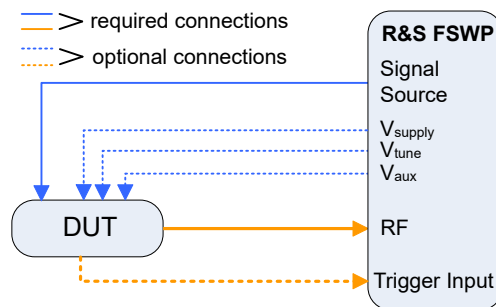

How to measure pulsed additive noise with an internally modulated pulse

1. Connect the signal source (supplies the pulse) to the DUT.
The pulse is modulated internally and output on the signal source.
2. Connect the DUT to the RF input.
3. Perform a [PRESET].
4. Select the [MEAS] key and select the "Pulsed Additive Noise" measurement.
5. Enter the "Overview" dialog box, and from there, enter the "Output" dialog box.
6. Select the "Signal Source" tab and turn on the "Pulse Modulator".
7. Configure the [pulse characteristics](#).
8. Start the measurement with [RUN SGL] or [RUN CONT].

Test setup (external pulse modulation)



For pulsed measurements using the LO AUX input, do not apply pulses with a frequency below 1024 MHz. Pulses below that frequency will abort the measurement.

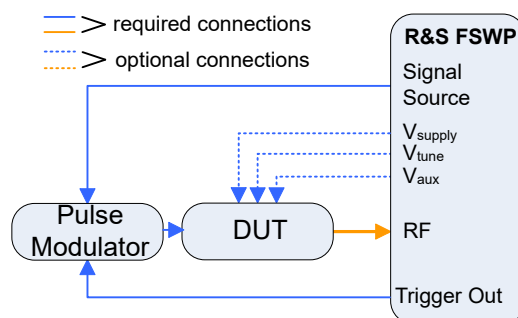

How to measure pulsed additive noise with an externally modulated pulse

1. Connect the signal source to the pulse modulator.
The signal source in that case provides a continuous wave signal which is modulated into a pulse by the pulse modulator.
2. Connect the trigger 1 output to the pulse modulator.

The signal provided on this output is a pulse and is required as a trigger signal for the external pulse modulator.

3. Connect the pulse modulator to the DUT.
4. Connect the DUT to the RF input.
5. Perform a [PRESET].
6. Select the [MEAS] key and select the "Pulsed Phase Noise" measurement.
7. Select the "Signal Source" tab and turn off the "Pulse Modulator".
8. Select the output at the [Trigger 1 Output](#)
9. Configure the [pulse characteristics](#).
10. Start the measurement with [RUN SGL] or [RUN CONT].

5.2.7 Adding another measurement channel

Measuring the noise characteristics in two different measurement channels allows you, for example, to capture and analyze two different data streams with different measurement configurations.

Adding another measurement channel

1. Select the [MODE] key.
2. Select the "Phase Noise" item in the "Mode" dialog box.

The firmware adds a second instance of the phase noise application which is independent of the first one.

5.3 Result evaluation

The phase noise application provides several tools to control the data displayed in the various result displays. Some tools have an effect on the graphical result displays, other on the numerical results and still others on both graphical and numerical (for example in case the numerical results are based on the graphical results).

- [Trace smoothing](#)..... 68
- [Integration ranges](#)..... 70
- [The Cross-Correlation gain indicator](#)..... 72
- [Miscellaneous evaluation tools](#)..... 73

5.3.1 Trace smoothing

How to smooth the trace by averaging the measurement data

When you average the trace, the application measures the data several times and builds an average over all measurements when it is done. Averaging measurement data yields a smoother trace.

Trace averaging is applied to all traces.

1. Enter the "Overview" dialog box, and from there, enter the "Noise Config" dialog box.
2. Define the number of measurements to be performed in the "Sweep / Average Count" input field, for example "10".



3. Start the measurement.
 - In case of a single measurement, the application performs x measurements over the frequency range you have defined. An average count of "10", for example, would result in 10 measurements.
 - In case of continuous measurements, the application performs a moving average over the average count.

How to smooth the trace by adjusting the number of XCORR operations

When you apply cross-correlation operations, the application is able to determine the phase noise characteristics at a certain frequency offset more precisely.

You can improve cross-correlation performance with the corresponding hardware option.

The number of cross-correlation operations applied in each half decade depends on a cross-correlation factor that you can define arbitrarily.

Cross-correlation operations are applied to all traces.

1. Enter the "Overview" dialog box, and from there, enter the "Noise Config" dialog box.
2. Define the cross-correlation factor as required in the "XCORR Factor" input field.



The application calculates the number of cross-correlations for each half decade based on this factor. You can see the resulting operations in the table of the "Noise Config" dialog box.

The number of operations calculated for each half decade targets a similar measurement time for all half decades, so that the measurement is done at roughly the same time in each half decade.

You can also see the resulting number of operations in the green bar at the bottom of the diagram area.

More information:

- [Cross-correlation](#)

How to smooth the trace graphically

When you apply trace smoothing, the existing data remains the same. The trace is smoothed by applying mathematical operations

Trace smoothing is applied to each trace individually.

1. Enter the "Overview" dialog box, and from there, enter the "Analysis" dialog box.
2. Select the vertical "Trace" tab, and then the horizontal "Traces" tab.
3. For any trace, turn on "Smoothing" and define the amount by which the trace should be smoothed (in %) in the corresponding input field.

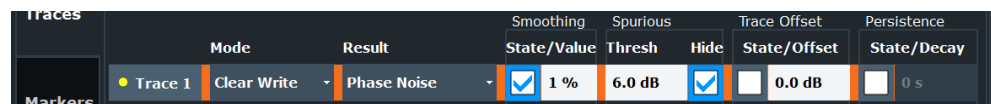

Trace smoothing is applied immediately after you have applied it to a trace.

More information:

- [Trace smoothing](#)

How to remove spurs from a trace

By default, the application already shows a trace without spurs (the yellow one). However, you can decide for each trace individually whether it shows spurs or not.

Spur removal is done after traces have been smoothed in any way.

1. Enter the "Overview" dialog box, and from there, enter the "Analysis" dialog box.
2. Select the vertical "Trace" tab, and then the horizontal "Traces" tab.
3. For any trace, remove or display spurs individually. You can also enter a threshold that defines a level from which a spur is recognized as a spur.

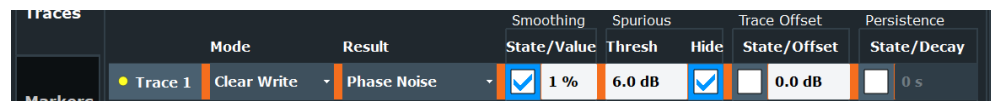

The application removes all signals that are above the threshold from the trace spur removal is applied to. Signals with levels below the threshold are not regarded as spurs and are still displayed.

More information:

- [Spur removal](#)

Note: Note that the threshold is always taken into account in the spur table, regardless of whether spur removal is on or off.

5.3.2 Integration ranges

How to define integration ranges

For the integrated measurements (residual AM, FM and PM and jitter), you can define custom integration ranges.

By default, the integration range corresponds to the measurement range defined by the frequency offsets. Custom integration ranges can have any range you desire.

Integration is done after traces have been smoothed in any way.

1. Enter the "Overview" dialog box and, from there, enter the "Noise Config" dialog box.
2. Select the "Integrated Measurements" tab.

Noise Config		Integrated Measurements		Spot Noise	Spurious	Frequency Stability
Ranges 1-5		Ranges 6-10		Weighting Filter		
Ranges						
	Show	Range		Range Start	Range Stop	Weighting Filter
Range 1	Trace 1	Meas	Manual	1.0 kHz	1.0 MHz	NONE
Range 2	None	Meas	Manual	20.0 kHz	400.0 kHz	NONE

3. Select the "Trace" whose data you would like to integrate from the "Show" drop-down menu.

Tip: If you select a trace that is currently not displayed in the diagram, no integrated measurement results will be displayed for the corresponding range.

4. Select "Manual" integration ranges.
5. Define the frequency ranges ("Range Start" and "Range Stop") over which you would like to integrate.

The application calculates the measurement results as defined. Results in the integrated measurements result table are adjusted accordingly (see ["Measuring integrated noise"](#) on page 59 for a description on how to view that table).

1 Integrated Measurements	
Range 1	
Trace	1
Start Offset	1.000 kHz
Stop Offset	1.000 MHz
Weighting	
Int Noise	-72.21 dBc
PM	19.86 m°/346.70 μrad
FM / AM	173.170 Hz
Jitter	13.795 fs

Figure 5-2: Custom integration range results (frequency range from 3 kHz to 500 kHz, applied to trace 2)

Note that the integration ranges are displayed graphically in the noise diagram.

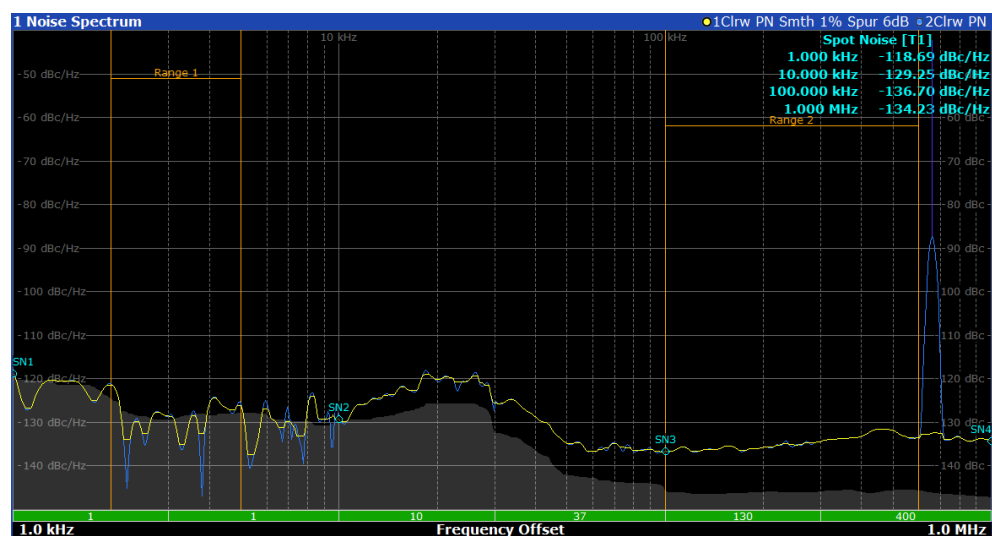

Figure 5-3: Custom integration ranges are represented in the diagram as colored lines

More information: [Residual effects](#)

How to correct integrated measurements

You can use so called weighting filters to compensate external effects that affect the phase noise in certain frequency ranges.

Weighting filters are applied before trace are smoothed and before integration is applied.

1. Enter the "Overview" dialog box, and from there, enter the "Noise Config" dialog box.
2. Select the "Integrated Measurements" tab.
3. Select a weighting filter from the corresponding dropdown menu.

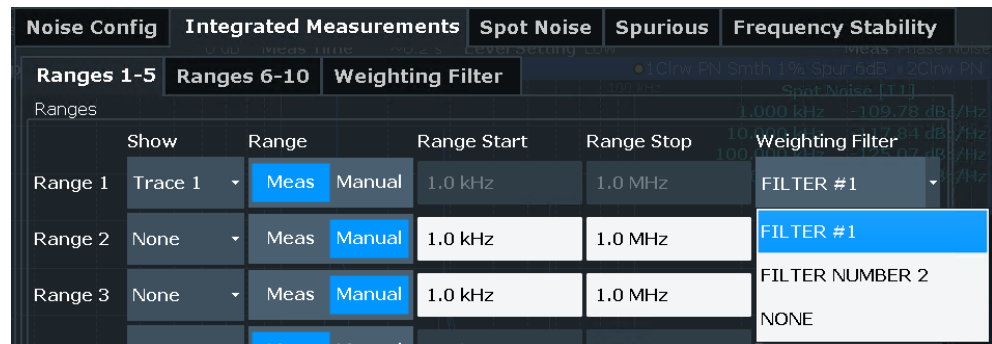

The dropdown menu contains all filters currently available on the hard disk of the R&S FSWP.

When you apply the weighting filter, the results are automatically corrected by the filter characteristics.

If you do not have a filter yet, or want to change filter characteristics for an existing filter, design one or change one.

More information:

- [Weighting filter design](#)
- [Weighting filter management](#)

5.3.3 The Cross-Correlation gain indicator

How to control the cross-correlation gain indicator (gray area)

The gray trace, or cross-correlation gain indicator, indicates the ideal position of the measurement trace for the current number of cross-correlation operations. Thus, the position of this area depends on the number of cross-correlations that are currently applied in each half decade.

This in turn indicates that measurement traces that are close to the gray area (even if only in places) can be improved by increasing the cross-correlation operations. On the other hand, when the measurement trace lies above the gray area throughout (about 10 dB), it is not possible to improve the results anymore.

More information: [XCORR gain indicator](#)

1. Enter the "Overview" dialog box, and from there, enter the "Noise Config" dialog box.
2. Select the "Noise Config" tab.
3. Change the "XCORR Factor", run a single measurement, and see how the position of the gray area changes.

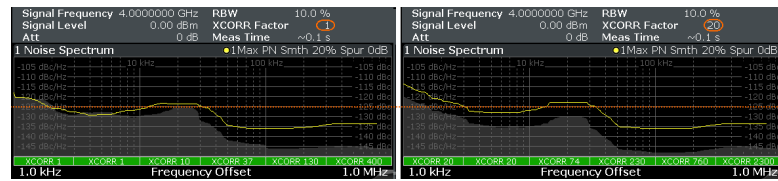



Figure 5-4: Increasing XCORR operations changes shape of gray area

- If required, you can turn this area on and off as required with the "XCORR Gain Indicator" feature.

5.3.4 Miscellaneous evaluation tools

Zooming into the results

The zoom tool is useful if you want to see parts of the results in more detail.

- Select the "Zoom" icon in the toolbar (.
- In the diagram, select the area you want to zoom in to (while doing this, the area is marked by a dotted line).
- You can return to the full display anytime with the "Unzoom" icon in the toolbar (.

Labeling traces

Labeling traces with a short keyword is a good way to distinguish traces and see immediately what the trace actually represents.

- Enter the "Overview" dialog box and, from there, enter the "Analysis" dialog box.
- Select the vertical "Traces" tab and the horizontal "Trace Label" tab.
- Turn on the trace label for a certain trace and define a string of text as a label.

The application adds a label to the trace. The color of the label is the same as the trace color.

Tip: You can move trace labels around via drag and drop.

Exporting measurement data

Exporting measurement data to a .dat file allows you to archive that data in external programs like a spreadsheet.

- Enter the "Overview" dialog box and, from there, enter the "Analysis" dialog box.
- Select the vertical "Traces" tab and the horizontal "Trace / Data Export" tab.
- Select the data types as required (trace data only or together with numerical results and / or measurement settings).
- Select the "Export to ASCII File" button and select the destination where you want to save that data.

- View the .dat file that has been created with your preferred program.

5.4 Measurement configuration

The Phase Noise application provides several tools that make the measurement process easier to handle or allow you to customize the measurement configuration according to your needs.

- [Frequency configuration](#).....74
- [The half decade configuration table](#).....75
- [Pulsed measurement configuration](#).....76
- [Signal generation](#).....77
- [DUT power supply](#).....79

5.4.1 Frequency configuration

How to define the measurement range

The measurement range defines the carrier frequency offset over which the phase noise measurement takes place.

- Enter the "Overview" dialog box, and from there, enter the "Noise Config" dialog box.
- Select the "Noise Config" tab.
- Define the measurement range with the "Start Offset" and "Stop Offset" properties.



The application adjusts the measurement range. You can see this change, for example, in the noise diagram result display.

Note: In case of baseband measurements, the measurement range is defined by an absolute start and stop frequency instead of offsets.

More information:

- [Measurement range](#)

How to search for signals

The application allows you to search for a carrier signal, instead of defining the carrier frequency manually.

- Enter the "Overview" dialog box, and from there, enter the "Frequency" dialog box.

2. Turn on the "Auto Search" feature (it is on by default).
3. Define the frequency range in which the search should take place ("Start" and "Stop"). By default the search is done in the maximum frequency range supported by the hardware.
4. Define a "Threshold" for the search. Signals below the threshold are ignored during the search.

When the application finds a signal with appropriate characteristics, it starts a phase noise measurement in the [measurement range](#) you have defined.

Note: Automatic signal search is only available in phase noise and pulsed phase noise measurements.

How to define the capture range for the signal search

The capture range represents the frequency bandwidth with which a signal is searched, and, if found, tracked.

A **normal capture range** is recommended for measurements on stable (or slowly drifting) DUTs. A **wide capture range** is recommended for DUTs whose frequency drifts over greater distances. In the latter case, a normal capture range would probably result in a scenario, where the signal drifts out of the capture range, and has to be searched again (which would slow down the measurement considerably).

1. Enter the "Overview" dialog box, and from there, enter the "Frequency" dialog box.
2. Select an appropriate "Capture Range" for your DUT.

Note: This feature is only available in phase noise and pulsed phase noise measurements.

How to define a carrier frequency manually

When you already know the frequency of the carrier signal, you can define it manually and reduce the measurement time.

1. Enter the "Overview" dialog box, and from there, enter the "Frequency" dialog box.
2. Turn off the "Auto Search" feature.
3. Define the "Signal Frequency".

The application performs the measurement on the defined frequency.

5.4.2 The half decade configuration table

How to work with the half decade configuration table

The half decade configuration table contains the measurement configuration for each half decade that is analyzed during a measurement.

You can either enter the values for the measurement bandwidth and number of cross-correlation operations directly. Or you can let the application calculate ideal values for each half decade.

1. Enter the "Overview" dialog box, and from there, enter the "Noise Config" dialog box.
2. Select automatic or manual configuration mode with the "Half Decade Config" feature.
3. In case of an **automatic configuration**, define an "RBW" factor and an "XCORR Factor".

From these values, the application calculates the best and least time-consuming absolute resolution bandwidth and cross-correlation operations for each half decade.

4. In case of a **manual configuration**, define the resolution bandwidth and number of cross-correlations for each half decade directly in the half decade configuration table as absolute values.
The relative "RBW" factor and "XCORR Factor" are ignored.

5.4.3 Pulsed measurement configuration

How to configure a gate for measurements on pulses

Noise measurements on pulses are available with the optional pulsed phase noise measurements firmware application.

By default, the application automatically detects the pulse characteristics and defines the gate characteristics based on the pulse. If required, you can also define these parameters manually.

1. Enter the pulsed phase noise measurement.
2. Select the [MEAS CONFIG] key and enter the "Pulse" dialog box with the "Pulse Config" softkey.
3. In the "Pulse" dialog box, select "Manual" pulse detection.
The input fields for the "Pulse Repetition Interval" and those for the "Gate Characteristics" become available. You can change them if required.
4. Configure the "Pulse Rep Interval" as required.
5. Configure the gate as required ("Gate Type", "Gate Level", "Gate Delay" and "Gate Length").
The shape of the gate is represented by various lines and bars in the "Preview" diagram that is part of the dialog box.

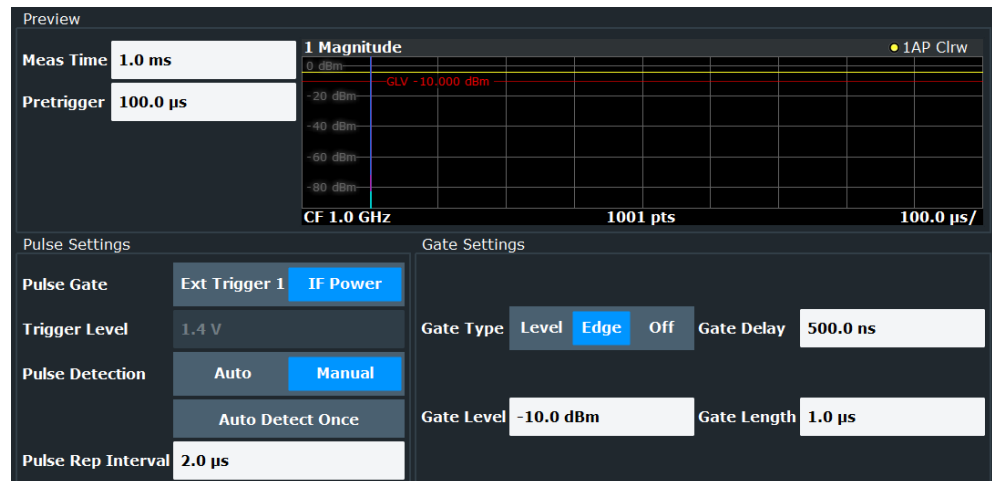

More information:

- [Pulsed phase noise](#)

Tip: You can turn off the gate, if one is not required for the measurement. To do so, select "Gate Type: Off".

5.4.4 Signal generation

How to generate a CW signal

Some measurement setups require you to feed a signal into the DUT. You can equip the R&S FSWP with an optional Signal Source that is able to generate such a signal.

Available only for additive noise measurements and with the optional signal source hardware component.

1. Enter the [Additive Noise](#) measurement.
2. Enter the "Overview" dialog box, and from there, enter the "Output" dialog box.
3. Select the "Signal Source" tab.
4. Define the frequency and level of the CW signal in the corresponding input fields.

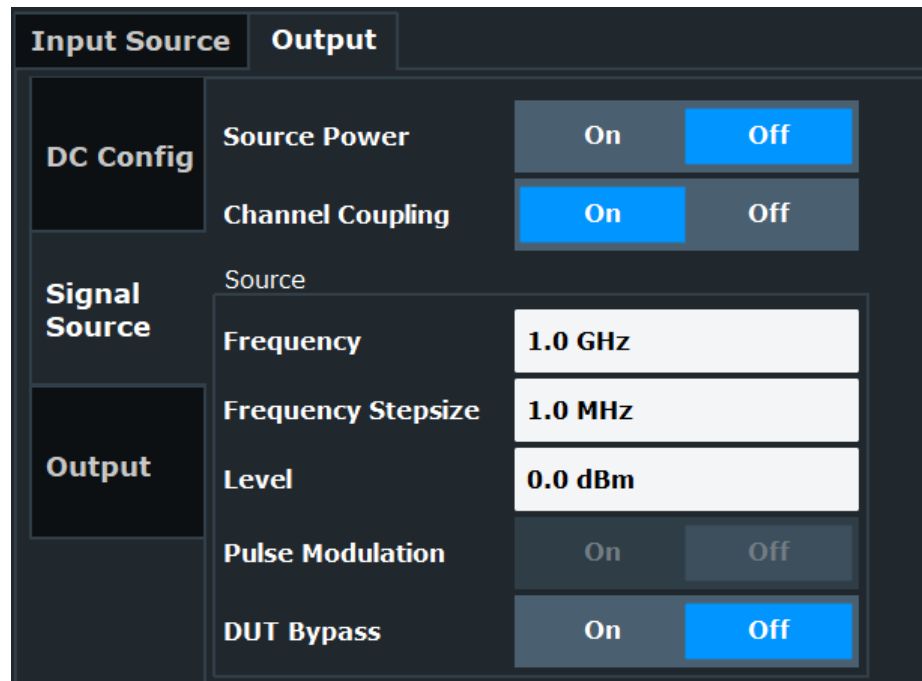

- Turn on the signal source with the "Source Power" feature.

Tip: You can turn the signal source on and off effectively with the "RF On/Off" button in the toolbar. The "RF Config" button provides access to a softkey menu that lets you change the signal source characteristics without entering a dialog box.

How to generate a pulse

Instead of a continuous wave signal, you can generate a pulse at the signal source output.

Available only for additive pulsed phase noise measurements and with the optional signal source hardware component.

- Enter the "Overview" dialog box, and from there, enter the "Output" dialog box.
- Select the "Signal Source" tab.
- Turn on the (internal) "Pulse Modulator".

When the "Pulse Modulator" is off, a CW signal is generated.

However, you can still generate a pulse with an external pulse modulator (a trigger signal is required for that, see ["How to use an external pulse modulator \(configuration\)"](#) on page 79).

- Define the required pulse "Width" and "Period".
- Turn on the signal source with the "Source Power" feature.

Tip: You can turn the signal source on and off easily with the "RF On/Off" button in the toolbar. The "RF Config" button provides access to a softkey menu that lets you change the signal source characteristics without entering a dialog box.

How to use an external pulse modulator (configuration)

Instead of generating a pulse internally, you can also use an external pulse modulator to generate a pulse required for testing of a DUT.

In this scenario, you can use a trigger signal (available at the trigger output) to control an external pulse modulator.

1. Enter the "Overview" dialog box, and from there, enter the "Output" dialog box.
2. Select the "Signal Source" tab.
3. Turn off the (internal) "Pulse Modulator".
When the (internal) "Pulse Modulator" is off, a CW signal is generated at the signal source.
4. Select the output type at the "Trigger 1 Output" (on the front panel) to generate a pulse at the trigger output.
 - "High" generates a high active pulse at the trigger 1 output.

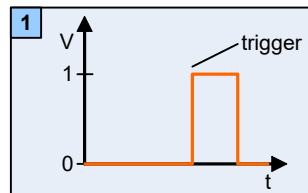

- "Low" generates a low active pulse at the trigger 1 output.

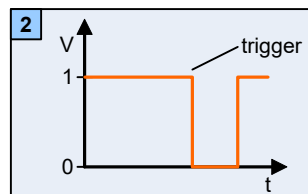

Note: In the phase noise application, the trigger connector on the front panel always serves as an output.

5. Define the required pulse "Width" and "Period".
6. Turn on the signal source with the "Source Power" feature.

Tip: You can turn the signal source on and off easily with the "RF On/Off" button in the toolbar. The "RF Config" button provides access to a softkey menu that lets you change the signal source characteristics without entering a dialog box.

5.4.5 DUT power supply

How to supply DUTs with current or voltage

Some measurement setups or DUTs require you to supply them with either voltage or current.

The R&S FSWP can provide both, when you set it up that way.

1. Enter the "Overview" dialog box and, from there, enter the "Output" dialog box.
2. Select the "DC Config" tab.

There you have the following options:

- Turn each of the three DC outputs on or off.
- Define the supplied voltage (or current in case of the V_{supply} output).
- Define limits for the outputs. When you define limits, the supplied voltage will not go below or above these.
- [DC power output](#)

3. Turn on the output of voltage or current with the "DC Power" feature.

Tip: You can turn the output on and off easily with the "DC On / Off" button in the toolbar. The "DC Config" button provides access to a softkey menu that lets you define the signal characteristics without entering a dialog box.

6 Operating the instrument

The following topics provide an overview on how to work with the R&S FSWP. They describe what kind of information is displayed in the diagram area, how to operate the R&S FSWP via the front panel keys and other interaction methods, and how to use the Online Help.

- [Understanding the display information](#).....81
- [Accessing functions](#)..... 89
- [Changing the focus](#)..... 93
- [Entering data](#).....93
- [Touchscreen gestures](#).....96
- [Displaying results](#).....99
- [Remote control](#)..... 106

6.1 Understanding the display information

The following figure shows a measurement diagram in the Phase Noise application. All different information areas are labeled. They are explained in more detail in the following sections.



- 1 = Toolbar: contains general functionality of the firmware.
- 2 = Channel tab: contains measurement channel.
- 3 = Channel bar: shows measurement settings.
- 4 = Result display: contains measurement results.
- 5 = Window title bar: contains diagram-specific (trace) information.
- 6 = Status bar: contains system messages, progress bar and date and time.

- 7 = Input field.
- 8 = Diagram footer: contains diagram-specific information.
- 9 = Softkeys: provide access to measurement functions.



Hiding elements in the display

You can hide some of the elements in the display, for example the status bar or channel bar, in order to enlarge the display area for the measurement results ("Setup > Display > Displayed Items").

For details see the R&S FSWP User Manual.

• Channel bar.....	82
• Window title bar.....	84
• Marker information.....	85
• Spot noise information.....	86
• Measurement progress information.....	86
• Frequency information in diagram footer.....	87
• Instrument and status information.....	87
• Error information.....	88

6.1.1 Channel bar

Using the R&S FSWP you can handle several different measurement tasks (channels) at the same time (although they can only be performed asynchronously). For each channel, a separate tab is displayed on the screen. In order to switch from one channel display to another, simply select the corresponding tab.

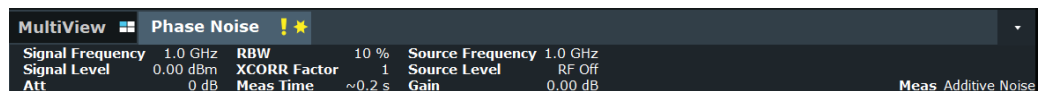

Alternatively, if many tabs are displayed, select the tab selection list icon at the right end of the channel bar and select the channel you want to switch to from the list.

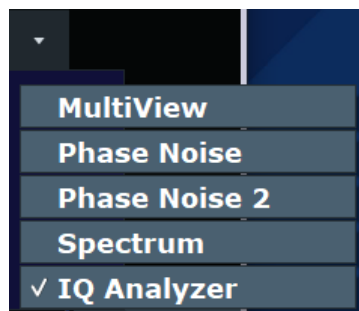

MultiView tab

An additional tab labelled "MultiView" provides an overview of all active channels at a glance. In the "MultiView" tab, each individual window contains its own channel bar with an additional button. Tap this button to switch to the corresponding channel display quickly.

MultiView		Phase Noise		!		★	
Phase Noise	Signal Frequency	4.0 GHz	RBW	10 %	Source Frequency	1.0 GHz	SGL
	Signal Level	0.00 dBm	XCORR Factor	1	Source Level	RF Off	Count 0/100
	Att	0 dB	Meas Time	~0.2 s			Meas Pulsed Phase Noise

Icons in the channel bar

The star icon (★) on the tab label indicates that the displayed trace no longer matches the current instrument settings. This may be the case, for example, if a trace is frozen and the instrument settings are changed. As soon as a new measurement is performed, the icon disappears.

The exclamation mark ("!" or !) icon indicates that an error or warning is available for that measurement channel. This is particularly useful if the MultiView tab is displayed.

The gear icon indicates the currently active channel during an automatic measurement sequence (**Sequencer** functionality).

Beneath the channel name, information on channel-specific settings for the measurement are displayed in the **channel bar**. Channel information varies depending on the active application.

In addition to the channel-specific settings, the channel bar above the diagram also displays information on instrument settings that affect the measurement results even though this is not immediately apparent from the display of the measured values. This information is displayed only when applicable for the current measurement.

The following table contains all labels that might be displayed in the Spectrum and Receiver applications.

Table 6-1: Channel settings displayed in the channel bar

Label	Information
Signal Frequency	Current carrier frequency of the applied signal.
Signal Level	Currently level measured on the carrier frequency.
Att	Current RF attenuation.
RBW	Current Resolution bandwidth (RBW). The RBW is a function of the start offset frequency of each half decade included in the measurement.
XCORR Factor	Current cross-correlation factor. The cross-correlation factor defines the number of cross-correlations are done in each half decade included in the measurement.
Meas Time (estimated)	Current estimated measurement time. The measurement time depends, among other things, on the offset frequency, the resolution bandwidth or the number of averages / cross-correlations that you have defined.
Source Frequency	Current frequency of the signal source output. Displayed if the optional signal source is installed.
Source Level	Current level of the signal source output. Displayed if the optional signal source is installed.
SGL	Current number of measurements performed in a single sweep. Only displayed if you are in single sweep measurement mode.

Label	Information
Count	The current signal count for measurement tasks that involve a specific number of subsequent sweeps.
Meas	Currently selected measurement (Phase Noise, Additive Phase Noise etc.).
Input ExtMix	Currently selected waveguide band of an external mixer. Only displayed if an external mixer is selected as an input source.
Gain	Difference between DUT signal level and signal source level. Displayed in Additive Noise measurements.

Icons for individual settings

A bullet next to the setting indicates that user-defined settings are used, not automatic settings. A green bullet indicates this setting is valid and the measurement is correct. A red bullet indicates an invalid setting that does not provide useful results.

6.1.2 Window title bar

Each channel in the R&S FSWP display may contain several windows. Each window can display either a graph or a table as a result of the channel measurement. Which type of result evaluation is displayed in which window is defined in the display configuration (see [Chapter 6.6, "Displaying results"](#), on page 99). The window's title bar indicates which type of evaluation is displayed.

Trace Information in Window Title Bar

Information on the displayed traces is indicated in the window title bar.

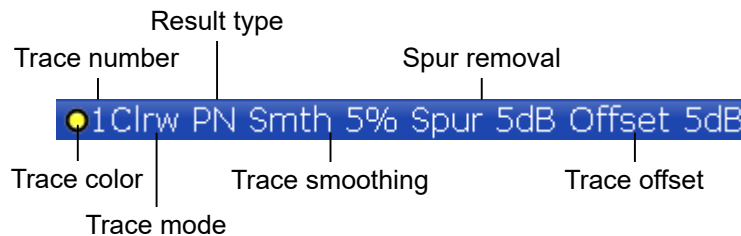

Trace color	Color of trace display in diagram
Trace number	Number of the trace (1 to 6)
Trace Mode	Abbreviation of the trace mode: <ul style="list-style-type: none"> • Clrw Clear Write trace • Max Max Hold trace • Min Min Hold trace • Avg Average trace • View Frozen trace • WrH Write Hold trace

Result type	Type of result the trace represents. <ul style="list-style-type: none"> • PN • AM • PN + AM
Trace smoothing	Trace smoothing characteristics. Only displayed if trace smoothing has been turned on for a trace.
Spur removal	Spur removal characteristics. Only displayed if spur removal has been turned on for a trace.
Trace offset	Trace offset characteristics. Only displayed if an offset has been defined for a trace.

6.1.3 Marker information

Marker information is provided either in the diagram grid or in separate marker tables, depending on the configuration.

Marker information in diagram grid

Within the diagram, the x-axis and y-axis positions of the last 2 markers or delta markers that were set are displayed, if available, as well as their index. The value in the square brackets after the index indicates the trace to which the marker is assigned. (Example: M2[1] defines marker 2 on trace 1.) For more than 2 markers, a separate marker table is displayed beneath the diagram by default.

Marker information in marker table

In addition to the marker information displayed within the diagram grid, separate marker tables may be added to the display. These tables provide the following information for all active markers:

Table 6-2: Regular marker table

Label	Information
Wnd	Window type the marker is positioned in. (Only if there is more than one window containing a phase noise diagram.)
Type	Marker type: N (normal), D (delta), T (temporary, internal)
Ref	Reference (for delta markers)
Trc	Trace to which the marker is assigned
X-value	x-value of the marker
Y-value	y-value of the marker

6.1.4 Spot noise information

Spot noise information in diagram grid

The diagram contains information about all spot noise positions [T<x>]. Spot noise information is made up out of the position of the spot noise measurement on the x-axis and the y-axis. The value in the square brackets after the index indicates the trace to which the spot noise calculation is assigned (Example: [T1] indicates trace 1). Note that you can also display spot noise information in a separate table.

Spot noise information in spot noise table

The R&S FSWP also provides a numerical result table for the spot noise measurement. The spot noise table has to be added deliberately. Note that the spot noise table only contains information when the calculation of spot noise has been turned on.

Table 6-3: Spot noise information result table

Label	Information
Wnd	Measurement window that the spot noise has been calculated for. (Only if there is more than one window containing a phase noise diagram.)
Offset	Offset frequency or spot noise position on the x-axis of the Phase Noise diagram.
Noise [T<x>]	Measured noise on the spot noise position for each active trace.

6.1.5 Measurement progress information

The Phase Noise result display shows the progress of the measurement in a series of green bars at the bottom of the diagram area. For each half decade in the measurement, the R&S FSWP adds a bar that spans the frequency range of the corresponding half decade.

The bar has several features.

- Measurement times less than 1 s
The numbers within the green bar indicate the number of cross-correlation operations applied to the corresponding half decade.
- Measurement times greater than 1 s
The numbers within the green bar show the progress of the cross-correlation operations in the half decade the application currently works on.
The first number is the current, the second number the total count of cross-correlations for that half decade. The bars of half decades in which a measurement is still running has a lighter tone of green than bars of half decades in which the measurement has already finished (see image below).
- A double-click on the bar opens the "Noise Config" dialog box to define the cross-correlation factor for that half decade.
- A right-click on the bar opens a context menu.

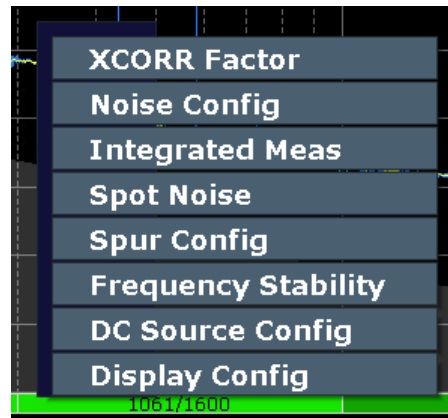

The context menu provides easy access to various parameters to set up the measurement.

6.1.6 Frequency information in diagram footer

Graphical result displays contain information in the diagram footer. The information (beneath the diagram) depends on the result display.

The contents depend on the application and the result display.

Label	Information
Start offset	Start offset frequency
Stop offset	Stop offset frequency

6.1.7 Instrument and status information

Global instrument settings and functions, the instrument status and any irregularities are indicated in the status bar beneath the diagram.



In the MultiView tab the status bar always displays the information for the currently selected measurement.

The following information is displayed:

Instrument status



The state of the DC Power features.

- white label = DC Power has been turned off
- green label = DC Power has been turned on and is within the defined limits
- red label = DC Power has been turned on and violates the defined limits



The R&S FSWP is configured for operation with an external reference.

Progress

The status of the current operation is displayed in the status bar. This includes the remaining measurement time for measurements that last longer than 1 second.

Display of the remaining measurement time is supported by the following measurements:

- (Additive) phase noise
- Pulsed (additive) phase noise
- Baseband noise

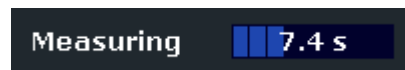

In the MultiView tab, the progress bar indicates the status of the currently selected measurement, not the measurement currently being performed by a Sequencer, for example.

Date and time

The date and time settings of the instrument are displayed in the status bar.

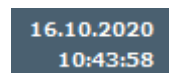

Error messages and warnings

If errors or irregularities are detected, a keyword and an error message, if available, are displayed in the status bar.

6.1.8 Error information

If errors or irregularities are detected, a keyword and an error message, if available, are displayed in the status bar.



Depending on the type of message, the status message is indicated in varying colors.

Table 6-4: Status bar information - color coding

Color	Type	Description
red	Error	An error occurred at the start or during a measurement, e.g. due to missing data or wrong settings, so that the measurement cannot be started or completed correctly.
orange	Warning	An irregular situation occurred during measurement, e.g. the settings no longer match the displayed results, or the connection to an external device was interrupted temporarily.
gray	Information	Information on the status of individual processing steps.

Color	Type	Description
no color	No errors	No message displayed - normal operation.
green	Measurement successful	Some applications visualize that the measurement was successful by showing a message.



If any error information is available for a measurement channel, an exclamation mark is displayed next to the channel name (❗). This is particularly useful when the MultiView tab is displayed, as the status bar in the MultiView tab always displays the information for the currently selected measurement only.

Furthermore, a status bit is set in the `STATUS:QUESTIONABLE:EXTENDED:INFO` register for the application concerned (see [Chapter 13.2.2.8, "STATUS:QUESTIONABLE:EXTENDED:INFO register"](#), on page 348). Messages of a specific type can be queried using the `SYST:ERR:EXT?` command, see [SYSTEM:ERROR:EXTENDED?](#) on page 637.

Table 6-5: Keywords in the status bar

Message	Meaning
IF OVLD	Overload of the IF signal path in the A/D converter or in the digital IF. Increase attenuation or remove the signal from the RF input.
LOUNL	Error in the instrument's frequency processing hardware was detected.
NO REF	Instrument was set to an external reference but no signal was detected on the reference input.
OVEN	The optional OCXO reference frequency has not yet reached its operating temperature. The message usually disappears a few minutes after power has been switched on.
RF OVLD	Overload of the input mixer or of the analog IF path. Reduce the input level.
UNCAL	One of the following conditions applies: <ul style="list-style-type: none"> • Correction data has been switched off. • No correction values are available, for example after a firmware update. • Record the correction data by performing a self alignment
WRONG_FW	The firmware version is out-of-date and does not support the currently installed hardware. Until the firmware version is updated, this error message is displayed and self-alignment fails. (For details refer to the R&S FSWP User Manual).

6.2 Accessing functions

All tasks necessary to operate the instrument can be performed using the user interface. Apart from instrument specific keys, all other keys that correspond to an external keyboard (for example arrow keys, [Enter] key) operate conform to Microsoft.

For most tasks, there are at least 2 alternative methods to perform them:

- Using the touchscreen

- Using other elements provided by the front panel, for example the keypad, rotary knob, or arrow and position keys.

The measurement and instrument functions and settings can be accessed by selecting one of the following elements:

- System and function keys on the front panel of the instrument
- Softkeys on the touchscreen
- Context menus for specific elements on the touchscreen
- Icons on the tool bar in the touchscreen
- Displayed setting on the touchscreen
- [Toolbar](#)..... 90
- [Softkeys](#)..... 91
- [Context menus](#)..... 92
- [On-screen keyboard](#)..... 92

6.2.1 Toolbar

The icons in the toolbar provide access to general functions.



You can hide the toolbar display, for example when using remote control, in order to enlarge the display area for the measurement results ("Setup > Display > Displayed Items"). See the R&S FSWP User Manual for details.



Windows: opens the Windows "Start" menu and task bar.



Open: opens a file from the instrument or an external device ("Save/Recall" menu).



Store: stores data on the instrument or an external device ("Save/Recall" menu).









Print: defines print settings ("Print" menu).



Undo: reverts last operation



Redo: repeats previously reverted operation

	Select: the cursor can be used to select (and move) elements in the display (markers, lines etc.).
	Zoom mode: displays a dotted rectangle in the diagram that can be expanded to define the zoom area.
	Multiple zoom mode: multiple zoom areas can be defined for the same diagram.
	Zoom off: displays the diagram in its original size.
	SmartGrid: activates "SmartGrid" mode to configure the screen layout.
	Sequencer: opens the "Sequencer" menu to perform consecutive measurements.
	DC Power: turns the DC power output on and off.
	DC Configuration: provides quick access to configure the main parameters for DC power supply.
	Signal Source: turns the optional signal source output on and off. (Available when the optional signal source output is installed.)
	RF Config: provides quick access to configure the main parameters of the signal source. (Available when the optional signal source output is installed.)
	Help (+ Select): allows you to select an element for which context-specific help is displayed.
	Help: displays context-sensitive help topic for currently selected element.
	Print immediately: prints the current display (screenshot) as configured.
In "SmartGrid" mode only:	
	Close: Exit "SmartGrid" mode.

6.2.2 Softkeys

Softkeys are virtual keys provided by the software. Thus, more functions can be provided than those that can be accessed directly via the function keys on the instrument.

Softkeys are dynamic: depending on the selected function key, a different list of softkeys is displayed on the right side of the screen.

A list of softkeys for a certain function key is also called a menu. Softkeys can either perform a specific function or open a dialog box.

Recognizing the softkey status by color

Color	Meaning
orange	associated dialog box is open
blue	associated function is active; for toggle keys: currently active state
gray	instrument function is temporarily not available due to a specific setting or missing option



You can hide the softkey display, e.g. when using remote control, in order to enlarge the display area for the measurement results ("Setup > Display > Displayed Items"). See the User Manual for details.

6.2.3 Context menus

Several items in the diagram area have context menus (for example markers, traces or the channel bar). If you right-click on one of these items (or tap it for about 1 second), a menu is displayed which contains the same functions as the corresponding softkey. This is useful, for example, when the softkey display is hidden.

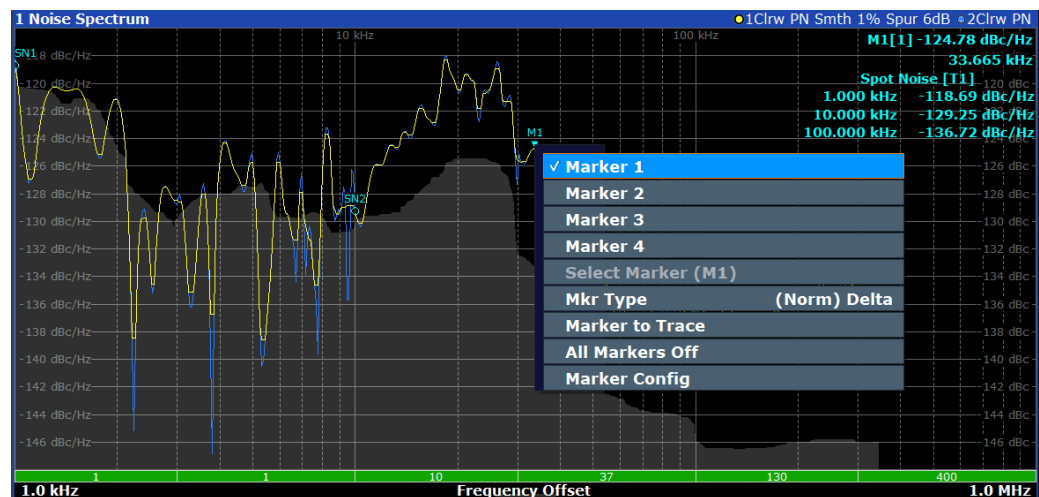

6.2.4 On-screen keyboard

The on-screen keyboard is an additional means of interacting with the instrument without having to connect an external keyboard.

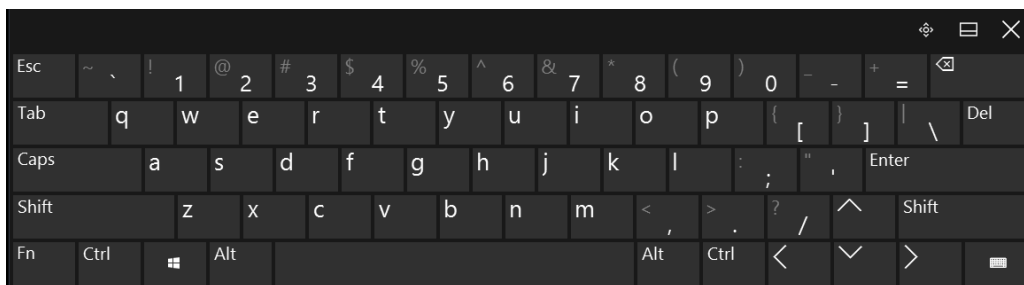

The on-screen keyboard display can be switched on and off as desired using the "On-Screen Keyboard" function key beneath the screen.



When you press this key, the display switches between the following options:

- Keyboard displayed at the top of the screen
- Keyboard displayed at the bottom of the screen
- No keyboard displayed



You can use the TAB key on the on-screen keyboard to move the focus from one field to another in dialog boxes.

6.3 Changing the focus

Any selected function is always performed on the currently focused element in the display, e.g. a dialog field, diagram, or table row. Which element is focused is indicated by a blue frame (diagram, window, table) or is otherwise highlighted (softkey, marker etc.). Moving the focus is most easily done by tapping on the element on the touchscreen. Alternatively, use the "Tab" key on the on-screen keyboard or the rotary knob to move the focus from one element to the next on the display.

6.4 Entering data

You can enter data in dialog boxes using any of the following methods:

- Using the touchscreen, via the on-screen keyboard
- Using other elements provided by the front panel, e.g. the keypad, rotary knob, or navigation keys
The rotary knob acts like the [ENTER] key when it is pressed.
- Using a connected external keyboard



Transparent dialog boxes

You can change the transparency of the dialog boxes to see the results in the windows behind the dialog box. Thus, you can see the effects that the changes you make to the settings have on the results immediately.

To change the transparency, select the transparency icon at the top of the dialog box. A slider is displayed. To hide the slider, select the transparency icon again.



(The title bar of the dialog box is always slightly transparent and is not affected by the slider.)



Particularities in Windows dialog boxes

In some cases, e.g. if you want to install a printer, original Windows dialog boxes are used. In these dialog boxes, the rotary knob and function keys do not work. Use the touchscreen instead.

6.4.1 Entering numeric parameters

If a field requires numeric input, the keypad provides only numbers.

1. Enter the parameter value using the keypad, or change the currently used parameter value by using the rotary knob (small steps) or the [UP] or [DOWN] keys (large steps).
2. After entering the numeric value via keypad, press the corresponding unit key. The unit is added to the entry.
3. If the parameter does not require a unit, confirm the entered value by pressing [ENTER] or any of the unit keys. The editing line is highlighted to confirm the entry.

6.4.2 Entering alphanumeric parameters

If a field requires alphanumeric input, you can use the on-screen keyboard to enter numbers and (special) characters (see [Chapter 6.2.4, "On-screen keyboard"](#), on page 92).

Alternatively, you can use the keypad. Every alphanumeric key represents several characters and one number. The decimal point key (.) represents special characters, and the sign key (-) toggles between capital and small letters. For the assignment, refer to [Table 6-6](#).



You can change the default behavior of the keypad for text input. This is useful if you frequently enter numeric values in text fields, for example to define file names consisting of numbers.

For details, see "[Number block behavior](#)" on page 327.

To enter numbers and (special) characters via the keypad

1. Press the key once to enter the first possible value.
2. All characters available via this key are displayed.
3. To choose another value provided by this key, press the key again, until your desired value is displayed.
4. With every key stroke, the next possible value of this key is displayed. If all possible values have been displayed, the series starts with the first value again. For information on the series, refer to [Table 6-6](#).
5. To change from capital to small letters and vice versa, press the sign key (-).
6. When you have chosen the desired value, wait for 2 seconds (to use the same key again), or start the next entry by pressing another key.

To enter a blank

- ▶ Press the "Space" bar, or press "0" and wait 2 seconds.

To correct an entry

1. Using the arrow keys, move the cursor to the right of the entry you want to delete.
2. Press [BACKSPACE].
The entry to the left of the cursor is deleted.
3. Enter your correction.

To complete the entry

- ▶ Press [ENTER] or the rotary knob.

To abort the entry

- ▶ Press [ESC].
The dialog box is closed without changing the settings.

Table 6-6: Keys for alphanumeric parameters

Key name (upper inscription)	Series of (special) characters and number provided
7	7 μ Ω ° € ¥ \$ ¢
8	A B C 8 Ä Æ Å Ç

Key name (upper inscription)	Series of (special) characters and number provided
9	D E F 9 É
4	G H I 4
5	J K L 5
6	M N O 6 Ń Ö
1	P Q R S 1
2	T U V 2 Ü
3	W X Y Z 3
0	<blank> 0 – @ + / \ < > = % &
.	. * : _ , ; " ' ? () #
–	<toggles between capital and small letters>

6.5 Touchscreen gestures

A touchscreen allows you to interact with the software using various finger gestures on the screen. The basic gestures supported by the software and most applications are described here. Further actions using the same gestures may be possible.



Tapping

Touch the screen quickly, usually on a specific element.

You can tap most elements on the screen; in particular, any elements you can also click on with a mouse pointer.

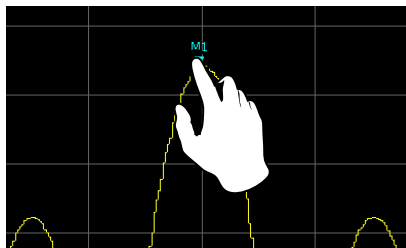
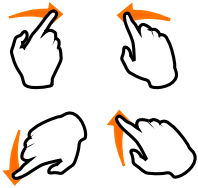

Figure 6-1: Tapping

Double-tapping

Tap the screen twice, in quick succession.

Double-tap a diagram or the window title bar to maximize a window in the display, or to restore the original size.



Dragging

Move your finger from one position to another on the display, keeping your finger on the display the whole time.

By dragging your finger over a table or diagram you can pan the displayed area of the table or diagram to show results that were previously out of view.

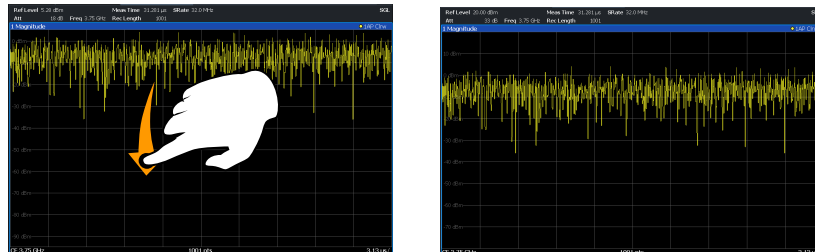
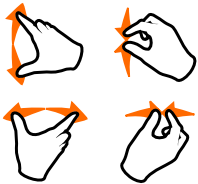

Figure 6-2: Dragging



Pinching and spreading two fingers

Move two fingers together on the display (pinch) or move two fingers apart on the display (spread).

When you pinch two fingers in the display, you decrease the size of the currently displayed area, showing the surrounding areas previously out of view.

When you spread two fingers in the display, you increase the size of the currently displayed area, showing more details.

You can pinch or spread your fingers vertically, horizontally, or diagonally. The direction in which you move your fingers determines which dimension of the display is changed.

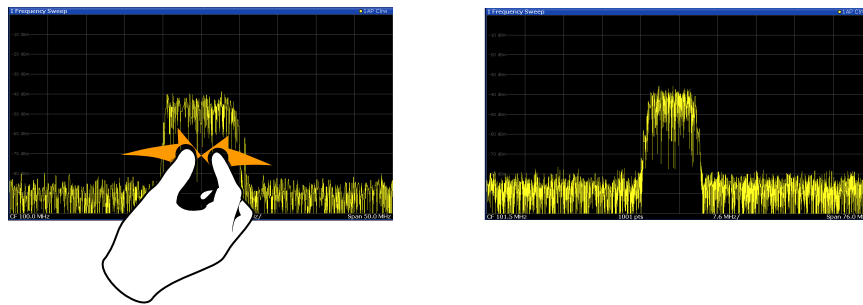

Figure 6-3: Pinching

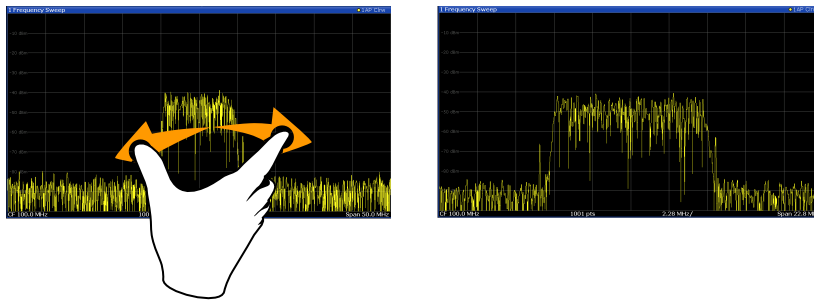

Figure 6-4: Spreading



Touch gestures in diagrams change measurement settings

When you change the display using touch gestures, the corresponding measurement settings are adapted. This is different to selecting an area on the screen in zoom mode, where merely the resolution of the displayed trace points is changed temporarily (graphical zoom).

Mouse vs. touch actions

Any user interface elements that react to actions by a mouse pointer also react to finger gestures on the screen, and vice versa. The following touch actions correspond to mouse actions:

Table 6-7: Correlation of mouse and touch actions

Mouse operation	Touch operation
Click	Tap
Double-click	Double-tap
Click and hold	Touch and hold
Right-click	Touch, hold for 1 second and release
Drag-&-drop (= click and hold, then drag and release)	Touch, then drag and release
Mouse wheel to scroll up or down	Swipe
Dragging scrollbars to scroll up or down, left or right	Swipe
In (graphical) Zoom mode only: dragging the borders of the displayed rectangle to change its size	Touch, then drag and release

Example:

You can scroll through a long table in conventional mouse operation by clicking in the table's scrollbar repeatedly. In touch operation, you would scroll through the table by dragging the table up and down with your finger.

6.6 Displaying results

The R&S FSWP provides several instrument applications for different analysis tasks and different types of signals, for example the Phase Noise application, the optional Spectrum application or the optional I/Q Analyzer. For each application, a new measurement channel is created and displayed in a separate tab on the screen.

The results of a measurement channel can be evaluated in many different ways, both graphically and numerically. For each evaluation method the results are displayed in a separate window in the tab.

The R&S FSWP allows you to configure the display to suit your specific requirements and optimize analysis.

6.6.1 Activating and deactivating channels

When you activate an application, a new measurement channel is created which determines the measurement settings for that application. The same application can be activated with different measurement settings by creating several channels for the same application. Whenever you switch channels, the corresponding measurement settings are restored. Each channel is displayed in a separate tab on the screen.

An additional tab ("MultiView") provides an overview of all currently active channels at once.

Only one measurement can be performed at any time, namely the one in the currently active channel. However, in order to perform the configured measurements consecutively, a Sequencer function is provided.

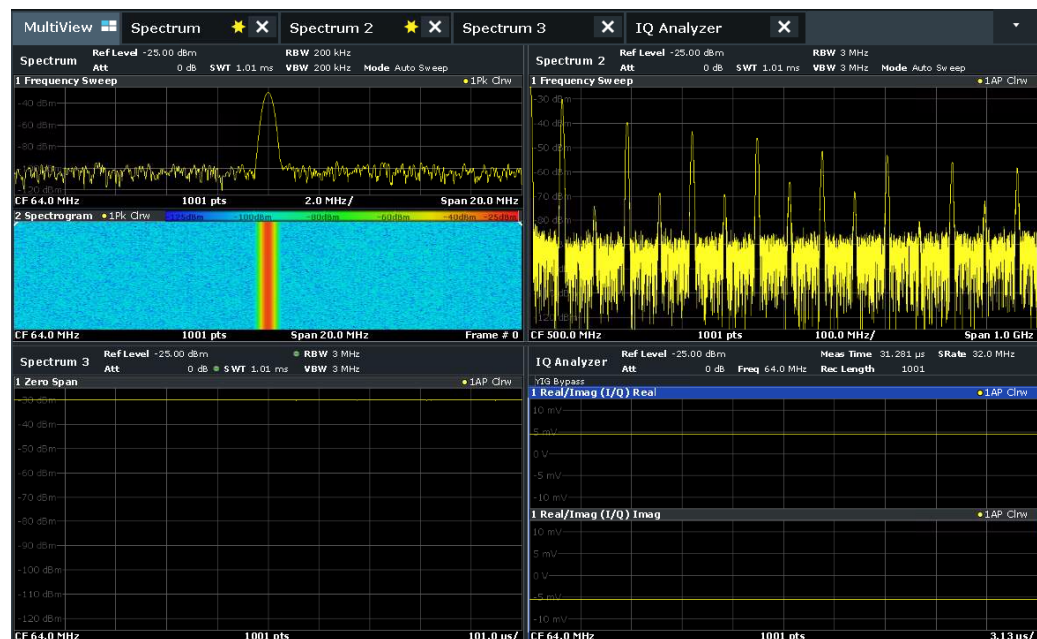

To start a new channel

1. Select [Mode].
2. In the "Mode" dialog box, select the required application on the "New Channel" tab. A new tab is displayed for the new channel.

Remote command:

[INSTRument:CREate\[:NEW\]](#) on page 414/ [INSTRument:CREate:DUPLicate](#) on page 413

To change the application in an active channel

1. Select the tab of the channel you want to change.
2. Select [Mode].
3. In the "Mode" dialog box, select the new application to be displayed on the "Replace Current Channel" tab. The selected application is displayed in the current channel.

Remote command:

[INSTRument:CREate:REPLace](#) on page 414

To close a measurement channel

Select the "Close" icon on the tab of the measurement channel.

The tab is closed, any running measurements are aborted, and all results for that channel are deleted.

Remote command:

[INSTRument:DELeTe](#) on page 415

6.6.2 Laying out the result display with the smartgrid

Measurement results can be evaluated in many different ways, for example graphically, as summary tables, statistical evaluations etc. Each type of evaluation is displayed in a separate window in the channel tab. Up to 16 individual windows can be displayed per channel (i.e. per tab). To arrange the diagrams and tables on the screen, the Rohde & Schwarz SmartGrid function helps you find the target position simply and quickly.

Principally, the layout of the windows on the screen is based on an underlying grid, the SmartGrid. However, the SmartGrid is dynamic and flexible, allowing for many different layout possibilities. The SmartGrid functionality provides the following basic features:

- Windows can be arranged in columns or in rows, or in a combination of both.

- Windows can be arranged in up to four rows and four columns.
 - Windows are moved simply by dragging them to a new position on the screen, possibly changing the layout of the other windows, as well.
 - All evaluation methods available for the currently selected measurement are displayed as icons in the evaluation bar. If the evaluation bar contains more icons than can be displayed at once on the screen, it can be scrolled vertically. The same evaluation method can be displayed in multiple windows simultaneously.
 - New windows are added by dragging an evaluation icon from the evaluation bar to the screen. The position of each new window depends on where you drop the evaluation icon in relation to the existing windows.
 - All display configuration actions are only possible in SmartGrid mode. When SmartGrid mode is activated, the evaluation bar replaces the current softkey menu display. When the SmartGrid mode is deactivated again, the previous softkey menu display is restored.
- [Background information: the smartgrid principle](#)..... 101
 - [How to activate smartgrid mode](#)..... 102
 - [How to add a new result window](#)..... 103
 - [How to close a result window](#)..... 103
 - [How to arrange the result windows](#)..... 104

6.6.2.1 Background information: the smartgrid principle

SmartGrid display

During any positioning action, the underlying SmartGrid is displayed. Different colors and frames indicate the possible new positions. The position in the SmartGrid where you drop the window determines its position on the screen.

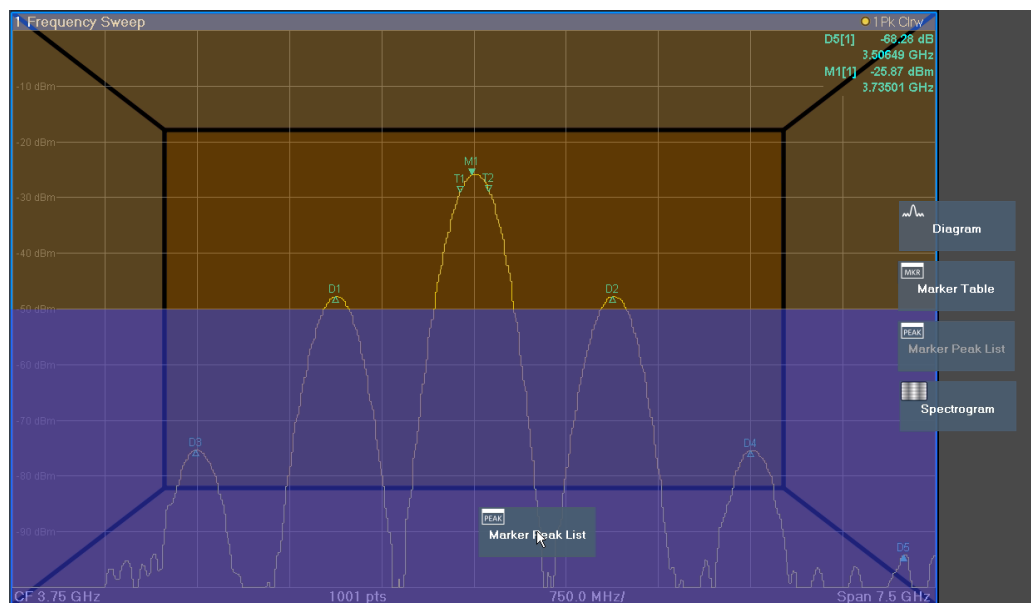

Figure 6-5: Moving a window in SmartGrid mode

The brown area indicates the possible "drop area" for the window, i.e. the area in which the window can be placed. A blue area indicates the (approximate) layout of the window as it would be if the icon were dropped at the current position. The frames indicate the possible destinations of the new window with respect to the existing windows: above/below, right/left or replacement (as illustrated in [Figure 6-6](#)). If an existing window would be replaced, the drop area is highlighted in a darker color shade.

Positioning the window

The screen can be divided into up to four rows. Each row can be split into up to four columns, where each row can have a different number of columns. However, rows always span the entire width of the screen and may not be interrupted by a column. A single row is available as the drop area for the window in the SmartGrid. The row can be split into columns, or a new row can be inserted above or below the existing row (if the maximum of 4 has not yet been reached).

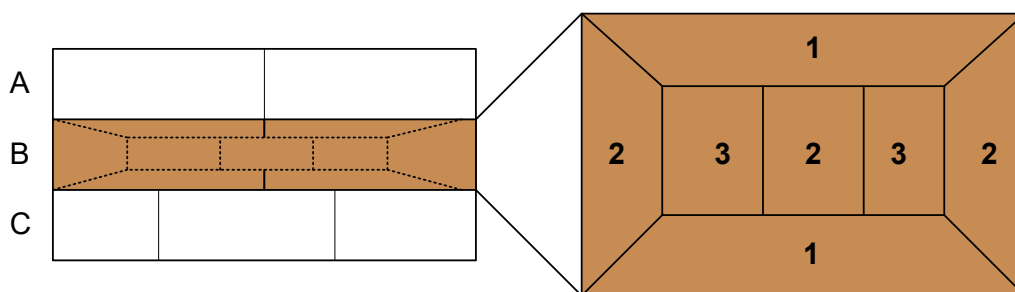

Figure 6-6: SmartGrid window positions

- 1 = Insert row above or below the existing row
- 2 = Create a new column in the existing row
- 3 = Replace a window in the existing row

SmartGrid functions

Once the evaluation icon has been dropped, icons in each window provide delete and move functions.



The "Move" icon allows you to move the position of the window, possibly changing the size and position of the other displayed windows.



The "Delete" icon allows you to close the window, enlarging the display of the remaining windows.

6.6.2.2 How to activate smartgrid mode

All display configuration actions are only possible in SmartGrid mode. In SmartGrid mode the evaluation bar replaces the current softkey menu display. When the SmartGrid mode is deactivated again, the previous softkey menu display is restored.

- ▶ To activate SmartGrid mode, do one of the following:



Select the "SmartGrid" icon from the toolbar.

- Select "Display Config" in the configuration "Overview".
- Select "Display Config" from the [Meas Config] menu.

The SmartGrid functions and the evaluation bar are displayed.



To close the SmartGrid mode and restore the previous softkey menu, select the "Close" icon, or press any key.

6.6.2.3 How to add a new result window

Each type of evaluation is displayed in a separate window. Up to 16 individual windows can be displayed per channel (i.e. per tab).

1. Activate SmartGrid mode.

All evaluation methods available for the currently selected measurement are displayed as icons in the evaluation bar.

2. Select the icon for the required evaluation method from the evaluation bar. If the evaluation bar contains more icons than can be displayed at once on the screen, it can be scrolled vertically. Touch the evaluation bar between the icons and move it up or down until the required icon appears.
3. Drag the required icon from the evaluation bar to the SmartGrid, which is displayed in the diagram area, and drop it at the required position. (See [Chapter 6.6.2.5, "How to arrange the result windows"](#), on page 104 for more information on positioning the window).

Remote command:

[LAYout:ADD\[:WINDow\]? on page 526](#) / [LAYout:WINDow<n>:ADD? on page 531](#)

6.6.2.4 How to close a result window

- ▶ To close a window, activate SmartGrid mode and select the "Delete" icon for the window.



Remote command:

[LAYout:REMOve\[:WINDow\] on page 529](#) / [LAYout:WINDow<n>:REMOve on page 532](#)

6.6.2.5 How to arrange the result windows

1. Select an icon from the evaluation bar or the "Move" icon for an existing evaluation window.



2. Drag the evaluation over the SmartGrid.
A blue area shows where the window will be placed.
3. Move the window until a suitable area is indicated in blue.
4. Drop the window in the target area.
The windows are rearranged to the selected layout, and "Delete" and "Move" icons are displayed in each window.
5. To close a window, select the corresponding "Delete" icon.



Remote command:

[LAYout:REPLace\[:WINDow\]](#) on page 529 / [LAYout:WINDow<n>:REPLace](#)
on page 532

[LAYout:MOVE\[:WINDow\]](#) on page 529

6.6.3 Changing the size of windows

Each channel tab may contain several windows to evaluate the measurement results using different methods. A "splitter" allows you to change the size of neighboring windows.

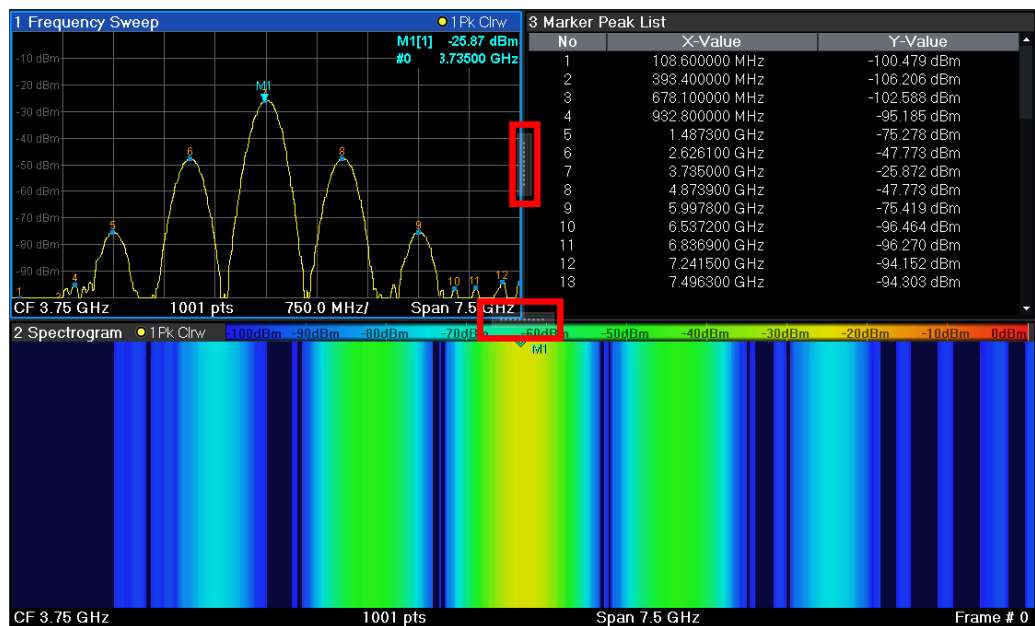

The splitters are not available in SmartGrid mode.

- To change the size of two neighboring windows, drag the splitter between the windows in either direction.

6.6.4 Switching between a split and maximized window display

To get an overview of the results, displaying several windows at the same time may be helpful. However, the individual windows may become rather small. In this case it is useful to maximize an individual window to the entire screen temporarily in order to analyze the results in more detail.



To switch between a split and a maximized display without having to close and re-open windows, press [SPLIT/MAXIMIZE] on the front panel. In maximized display, the currently focused window is maximized. In split display, all active windows are displayed.

Alternatively, double-tap the title bar of a window to maximize it.

6.6.5 Changing the display

The display can be optimized for your individual needs. The following display functions are available and are described in detail in [Chapter 12.2, "Display settings"](#), on page 303 and [Chapter 10.1, "Result display configuration"](#), on page 208.

- Displaying a simulation of the entire front panel of the instrument on the screen ("Front Panel")

- Displaying the main function hardkeys in a separate window on the screen ("Mini Front Panel")
- Hiding or showing various screen elements
- Selecting a display theme and colors
- Changing the display update rate
- Activating or deactivating the touch-sensitivity of the screen
- Zooming into the diagram

6.7 Remote control

In addition to working with the R&S FSWP interactively, located directly at the instrument, it is also possible to operate and control it from a remote PC. Various methods for remote control are supported:

- Connecting the instrument to a (LAN) network
(See the R&S FSWP user manual.)
- Using the Windows Remote Desktop application in a LAN network
- Connecting a PC via the GPIB interface

How to configure the remote control interfaces is described in the User Manual.



The R&S FSWP is delivered with *IECWIN* installed, the auxiliary remote control tool provided free of charge by Rohde & Schwarz.

For details on the IECWIN tool, see the "Network and Remote Control" chapter of the R&S FSWP User Manual.

6.7.1 Remote desktop connection

Remote Desktop is a Windows application which can be used to access and control the instrument from a remote computer through a LAN connection. While the instrument is in operation, the instrument screen contents are displayed on the remote computer. Remote Desktop provides access to all of the applications, files, and network resources of the instrument. Thus, remote operation of the instrument is possible.

The Remote Desktop Client is part of the installed Windows operating system. For other versions of Windows, Microsoft offers the Remote Desktop Client as an add-on.

6.7.2 Connecting a PC via the GPIB interface

You can connect a PC to the R&S FSWP via the GPIB interface to send remote commands to control and operate the instrument. You can configure the GPIB address and the ID response string. The GPIB language is set as SCPI by default but can be changed to emulate other instruments.

A GPIB interface is integrated on the rear panel of the instrument.

7 Applications

The R&S FSWP is a dedicated Phase Noise Analyzer whose main feature is the phase noise measurement application.

When equipped accordingly (with optional hardware or software), it is able to provide several additional applications for different analysis tasks (for example the spectrum application).

When you activate an application, the R&S FSWP creates a new measurement channel which in turn determines the measurement settings for that application. You can use the same application with different measurement settings by creating several channels for the same application. Each channel is represented by a separate tab on the screen.

Note that the number of channels can be limited by the available memory of the R&S FSWP.

- [R&S multiview](#)..... 107
- [Available Applications](#)..... 108
- [Starting an application](#)..... 110
- [Running a sequence of measurements](#)..... 112

7.1 R&S multiview

Each application is displayed in a separate tab. An additional tab ("MultiView") provides an overview of all currently active channels at a glance. In the "MultiView" tab, each individual window contains its own channel bar with an additional button. Select this button to switch to the corresponding channel display quickly.



Remote command:

`DISPlay:FORMat` on page 525

7.2 Available Applications

Depending on its outfit, the R&S FSWP provides one or more applications for specific measurement tasks.

Phase Noise.....	108
Spectrum Monitor.....	108
Spectrum.....	109
Analog Modulation Analysis.....	109
I/Q Analyzer.....	109
Noise Figure.....	109
Pulse Measurements.....	110
Spurious Measurements.....	110
Transient Analysis.....	110
Vector Signal Analysis (VSA).....	110

Phase Noise

The phase noise application provides measurement functions to measure the phase noise characteristics of a DUT.

This application is used in the initial configuration.

For details, refer to [Chapter 8, "Measurements and result displays"](#), on page 117.

Remote command:

`INST:SEL PNO`, see `INSTrument[:SELect]` on page 416

Spectrum Monitor

The spectrum monitor application provides measurement functions for basic I/Q data analysis.

It runs on the phase noise analyzer hardware and is available for free with firmware version 1.60.

Compared to the full I/Q analyzer, which runs on the optional spectrum analyzer hardware, it has the following characteristics and limitations.

- When you open a spectrum monitor, the frequency, level and input parameters are initially adopted from the phase noise application (you can change them in the spectrum monitor, of course). Those settings are the same as in the full I/Q analyzer.
- Maximum analysis bandwidth of 20 MHz and sample rate of 25 MHz (and no support of bandwidth extensions).
- Advanced data acquisition settings are unavailable.
- I/Q data import and export are the same as in the full I/Q analyzer.
- Spectrograms, general marker functionality, marker functions and limit lines are the same as in the full I/Q analyzer.
- Only external triggers are supported.
- Only evaluation of the frequency spectrum is supported.

- Trace mathematics are not available.

All other functionality is the same as that of the I/Q analyzer.

For details, refer to the user manual of the I/Q analyzer.

Remote command:

INST:SEL SMONitor, see [INSTrument\[:SElect\]](#) on page 416

Spectrum

The spectrum application is an optional application that is available with R&S FSWP-B1.

In the spectrum application, the provided functions correspond to those of a conventional spectrum analyzer. The analyzer measures the frequency spectrum of the RF input signal over the selected frequency range with the selected resolution and sweep time, or, for a fixed frequency, displays the waveform of the video signal.

For details, refer to the user manual of the spectrum analyzer measurement application.

Remote command:

INST:SEL SAN, see [INSTrument\[:SElect\]](#) on page 416

Analog Modulation Analysis

The analog modulation analysis application requires an instrument equipped with the spectrum analyzer hardware (R&S FSWP-B1) and the analog modulation analysis option (R&S FSWP-K7).

The analog modulation analysis application provides measurement functions for demodulating AM, FM, or PM signals.

For details, refer to the user manual of the analog modulation analysis application.

Remote command:

INST:SEL ADEM, see [INSTrument\[:SElect\]](#) on page 416

I/Q Analyzer

The I/Q analyzer application requires an instrument equipped with the spectrum analyzer hardware component (R&S FSWP-B1).

The I/Q analyzer application provides measurement and display functions for I/Q data.

For details, refer to the user manual of the I/Q analyzer.

Remote command:

INST:SEL IQ, see [INSTrument\[:SElect\]](#) on page 416

Noise Figure

The noise figure application requires an instrument equipped with the spectrum analyzer hardware (R&S FSWP-B1) and the noise figure Measurements option (R&S FSWP-K30).

For details, refer to the user manual of the noise figure measurement application.

Remote command:

INST:SEL NOISE, see [INSTrument\[:SElect\]](#) on page 416

Pulse Measurements

The pulse application requires an instrument equipped with the spectrum analyzer hardware (R&S FSWP-B1) and the pulse measurements option (R&S FSWP-K6(S)). This application provides measurement functions for pulsed signals.

For details, refer to the user manual of the pulse measurement application.

Remote command:

INST:SEL PULSE, see [INSTrument\[:SElect\]](#) on page 416

Spurious Measurements

The Spurious Measurements application requires an instrument equipped with the Spurious Measurements option, R&S FSWP-K50. This application provides measurements and evaluations for spurious signal effects.

For details, refer to the user manual of the spurious measurements application.

Remote command:

INST:SEL SPUR, see [INSTrument\[:SElect\]](#) on page 416

Transient Analysis

The Transient Analysis application requires an instrument equipped with the Transient Analysis option, R&S FSWP-K60. This application provides measurements and evaluations for Transient Analysis.

For details, refer to the user manual of the transient analysis measurement application.

Remote command:

INST:SEL TA, see [INSTrument\[:SElect\]](#) on page 416

Vector Signal Analysis (VSA)

The VSA application requires an instrument equipped with the spectrum analyzer hardware (R&S FSWP-B1) and the vector signal analysis option (R&S FSWP-K70). This application provides measurement and evaluations for vector signal analysis.

For details, refer to the VSA user manual.

Remote command:

INST:SEL DDEM, see [INSTrument\[:SElect\]](#) on page 416

7.3 Starting an application

The default application that is running when you start the R&S FSWP is the phase noise application.

Access to application selection

► [MODE]

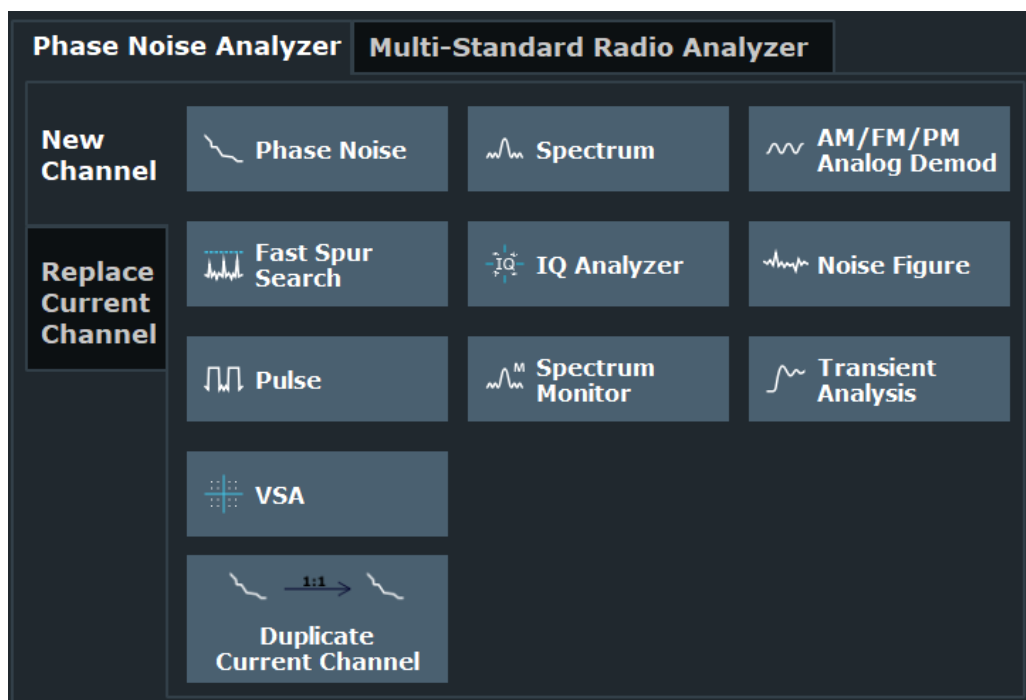

To select an application, select the corresponding button.



To deactivate a channel, simply close the corresponding tab.

The remote commands required to perform these tasks are described in [Chapter 14.4, "Selecting the operating mode and application"](#), on page 413.



The measurement channels are labeled with their default name. If that name already exists, a sequential number is added.

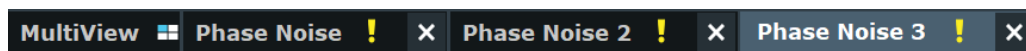

In remote control, the name of the measurement channel can be changed. For details and an overview of default names, see [INSTrument:LIST?](#).

New Channel	111
Replace Current Channel	112
Duplicate Current Channel	112

New Channel

The applications selected on this tab are started in a new measurement channel, i.e. a new tab in the display.

Remote command:

[INSTrument:CREate \[:NEW\]](#) on page 414

[INSTrument\[:SELEct\]](#) on page 416

Replace Current Channel

The applications selected on this tab are started in the currently displayed measurement channel, replacing the current application.

Remote command:

[INSTrument:CREate:REPLace](#) on page 414

Duplicate Current Channel

The currently active channel can be duplicated, i.e. a new channel of the same type and with the identical measurement settings is started. The name of the new channel is the same as the copied channel, extended by a consecutive number (e.g. "Spectrum" - > "Spectrum 2").

Remote command:

[INSTrument:CREate:DUPLicate](#) on page 413

7.4 Running a sequence of measurements

Only one measurement can be performed at any time, namely the one in the currently active channel. However, in order to perform the configured measurements consecutively, a Sequencer function is provided.

- [The sequencer concept](#)..... 112
- [Sequencer settings](#)..... 114
- [How to set up the sequencer](#)..... 115

7.4.1 The sequencer concept

The instrument can only activate one specific channel at any time. Thus, only one measurement can be performed at any time, namely the one in the currently active channel. However, in order to perform the configured measurements consecutively, a Sequencer function is provided, which changes the channel of the instrument as required. If activated, the measurements configured in the currently defined "Channel"s are performed one after the other in the order of the tabs.

For each individual measurement, the sweep count is considered. Thus, each measurement may consist of several sweeps. The currently active measurement is indicated by a  symbol in the tab label.

The result displays of the individual channels are updated in the tabs as the measurements are performed. Sequential operation itself is independent of the currently *displayed* tab.

Sequencer modes

Three different Sequencer modes are available:

- **Single Sequence**
Similar to single sweep mode; each measurement is performed once, until all measurements in all defined "Channel"s have been performed.

Running a sequence of measurements

- Continuous Sequence**
 Similar to continuous sweep mode; the measurements in each defined "Channel" are performed one after the other, repeatedly, in the same order, until sequential operation is stopped. This is the default Sequencer mode.
- Channel-defined Sequence**
 First, a single sequence is performed. Then, only "Channel"s in continuous sweep mode are repeated continuously.

Example: Sequencer procedure

Assume the following active channel definition:



Tab name	Application	Sweep mode	Sweep count
Spectrum	Spectrum	Cont. Sweep	5
Spectrum 2	Spectrum	Single Sweep	6

Tab name	Application	Sweep mode	Sweep count
Spectrum 3	Spectrum	Cont. Sweep	2
IQ Analyzer	IQ Analyzer	Single Sweep	7

For **Single Sequence**, the following sweeps will be performed:

5x Spectrum, 6x Spectrum 2, 2 x Spectrum 3, 7x IQ Analyzer

For **Continuous Sequence**, the following sweeps will be performed:

5x Spectrum, 6x Spectrum 2, 2 x Spectrum 3, 7x IQ Analyzer,

5x Spectrum, 6x Spectrum 2, 2 x Spectrum 3, 7x IQ Analyzer,

...

For **Channel-defined Sequence**, the following sweeps will be performed:

5x Spectrum, 6x Spectrum 2, 2 x Spectrum 3, 7x IQ Analyzer,

5x Spectrum, 2 x Spectrum 3,

5x Spectrum, 2 x Spectrum 3,

...

Run Single/Run Cont and Single Sweep/Sweep Continuous keys

While the Sequencer is active, the [Run Single] and [Run Cont] keys control the Sequencer, not individual sweeps. [Run Single] starts the Sequencer in single mode, while [Run Cont] starts the Sequencer in continuous mode.

The "Single Sweep" and "Continuous Sweep" *softkeys* control the sweep mode for the currently selected channel only; the sweep mode only has an effect the next time the Sequencer activates that channel, and only for a channel-defined sequence. In this case, a channel in single sweep mode is swept only once by the Sequencer. A channel in continuous sweep mode is swept repeatedly.

7.4.2 Sequencer settings



The "Sequencer" menu is available from the toolbar.

Sequencer State.....	114
Sequencer Mode.....	115

Sequencer State

Activates or deactivates the Sequencer. If activated, sequential operation according to the selected Sequencer mode is started immediately.

Remote command:

`SYSTEM:SEQuencer` on page 418

`INITiate:SEQuencer:IMMediate` on page 417

`INITiate:SEQuencer:ABORT` on page 417

Sequencer Mode

Defines how often which measurements are performed. The currently selected mode softkey is highlighted blue. During an active Sequencer process, the selected mode softkey is highlighted orange.

"Single Sequence"

Each measurement is performed once, until all measurements in all active channels have been performed.

"Continuous Sequence"

The measurements in each active channel are performed one after the other, repeatedly, in the same order, until sequential operation is stopped.

This is the default Sequencer mode.

"Channel Defined Sequence"

First, a single sequence is performed. Then, only channels in continuous sweep mode are repeated.

Remote command:

`INITiate:SEQuencer:MODE` on page 418

7.4.3 How to set up the sequencer

In order to perform the configured measurements consecutively, a Sequencer function is provided.

1. Configure a channel for each measurement configuration as required, including the sweep mode.
2. In the toolbar, select the "Sequencer" icon.



The "Sequencer" menu is displayed.

3. Toggle the "Sequencer" softkey to "On".
A continuous sequence is started immediately.
4. To change the Sequencer mode and start a new sequence immediately, select the corresponding mode softkey, or press the [Run Single] or [Run Cont] key.

The measurements configured in the currently active channels are performed one after the other in the order of the tabs until the Sequencer is stopped.

The result displays in the individual channels are updated as the measurements are performed.

To stop the sequencer

- To stop the Sequencer temporarily, press the highlighted [Run Single] or [Run Cont] key (not for a channel-defined sequence). To continue the Sequencer, press the key again.

To stop the Sequencer permanently, select the "Sequencer" icon in the toolbar and toggle the "Sequencer" softkey to "Off".

8 Measurements and result displays

The noise performance of a DUT is usually described by various effects and signal characteristics that can be measured by the R&S FSWP.

The R&S FSWP provides several measurements, each of which analyzes different noise characteristics for different types of signal.

All measurements support several result displays, each of which shows different aspects of the noise characteristics of the measured signal.

- [Basics on phase noise measurements](#)..... 117
- [Performing measurements](#)..... 118
- [Selecting measurements](#)..... 120
- [Result displays](#)..... 122

8.1 Basics on phase noise measurements

- [Residual effects](#)..... 117

8.1.1 Residual effects

Residual noise effects are modulation products that originate directly from the phase noise. It is possible to deduct them mathematically from the phase noise of a DUT.

The application calculates three residual noise effects. All calculations are based on an integration of the phase noise over a particular offset frequency range.

Residual PM

The residual phase modulation is the contribution of the phase noise to the output of a PM demodulator. It is evaluated over the frequency range you have defined.

$$\text{Residual PM} = \sqrt{2 \cdot \int_{f_{start}}^{f_{stop}} L(f_m) df_m} \text{ [rad]}$$

with $L(f) =$ single sideband phase noise [dBc/Hz]

Residual FM

The residual frequency modulation is the contribution of the phase noise to the output of an FM demodulator. It is evaluated over the frequency range you have defined.

$$\text{Residual FM} = \sqrt{2 \cdot \int_{f_{\text{start}}}^{f_{\text{stop}}} f_m^2 L(f_m) df_m} \text{ [Hz]}$$

with $L(f_m)$ = single sideband phase noise [dBc/Hz]

f_m = frequency [Hz]

Jitter

The jitter is the RMS temporal fluctuation of a carrier with the given phase noise evaluated over a given frequency range of interest.

$$\text{Jitter[s]} = \frac{\text{ResidualPM [rad]}}{2\pi \cdot f_0}$$

with f_0 = Carrier frequency

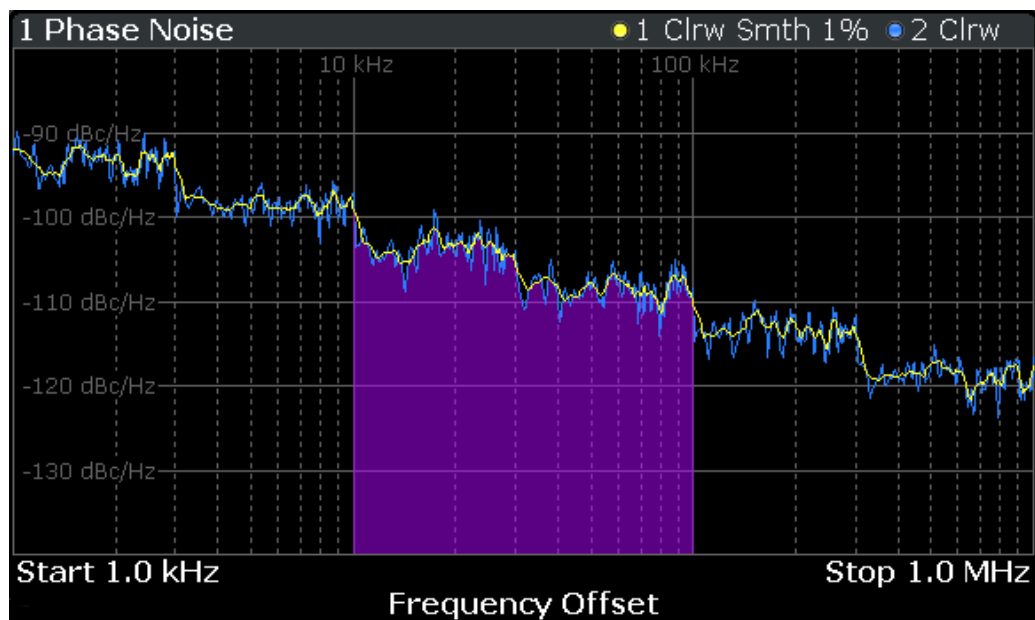

Figure 8-1: Residual noise based on an integration between 10 kHz and 100 kHz offset

8.2 Performing measurements

To start single measurements

1. Configure the measurement range you would like to measure ("Frequency" dialog box, see [Chapter 9.4, "Frequency"](#), on page 158).
2. Configure the number of measurements you would like to perform in a single measurement ("Sweep Config" dialog box, see ["Sweep/Average Count"](#) on page 169).

3. Define how the results are evaluated for display ("Trace" dialog box, see [Chapter 10.3, "Trace configuration"](#), on page 219).
4. To start the measurement, select one of the following:
 - [RUN SINGLE] key
 - "Single Sweep" softkey in the "Sweep" menu

The defined number of sweeps are performed, then the measurement is stopped. While the measurement is running, the [RUN SINGLE] key is highlighted. To abort the measurement, press the [RUN SINGLE] key again. The key is no longer highlighted. The results are not deleted until a new measurement is started.
5. To repeat the same number of measurements without deleting the last trace, select the "Continue Single Sweep" softkey in the "Sweep" menu.

To start continuous measurements

1. If you want to average the trace or search for a maximum over more (or less) than 10 measurements, configure the "Average/Sweep Count" ("Sweep Config" dialog box, see ["Sweep/Average Count"](#) on page 169).
2. To start the measurement, select one of the following:
 - [RUN CONT] key
 - "Continuous Sweep" softkey in the "Sweep" menu

After each sweep is completed, a new one is started automatically. While the measurement is running, the [RUN CONT] key is highlighted. To stop the measurement, press the [RUN CONT] key again. The key is no longer highlighted. The results are not deleted until a new measurement is started.

Single Sweep / Run Single	119
Continuous Sweep / Run Cont	120
Continue Single Sweep	120

Single Sweep / Run Single

Initiates a single measurement. The measurement is finished after all frequencies in the frequency list have been measured. If necessary, the application automatically determines the reference level before starting the actual measurement.

While the measurement is running, the "Single Sweep" softkey and the [RUN SINGLE] key are highlighted. The running measurement can be aborted by selecting the highlighted softkey or key again.

Note: Sequencer. If the Sequencer is active, "Single Sweep" only controls the sweep mode for the currently selected channel. However, the sweep mode only takes effect the next time the Sequencer activates that channel, and only for a channel-defined sequence. In this case, the Sequencer sweeps a channel in single sweep mode only once.

Furthermore, [RUN SINGLE] controls the Sequencer, not individual sweeps. [RUN SINGLE] starts the Sequencer in single mode.

If the Sequencer is off, only the evaluation for the currently displayed channel is updated.

For details on the Sequencer, see [Chapter 7.4.1, "The sequencer concept"](#), on page 112.

Remote command:

`INITiate<n>[:IMMediate]` on page 426

Continuous Sweep / Run Cont

Initiates a measurement and repeats it continuously until stopped. If necessary, the application automatically determines the reference level before starting the actual measurement.

While the measurement is running, the "Continuous Sweep" softkey and the [RUN CONT] key are highlighted. The running measurement can be aborted by selecting the highlighted softkey or key again. The results are not deleted until a new measurement is started.

Note: Sequencer. If the Sequencer is active, "Continuous Sweep" only controls the sweep mode for the currently selected channel. However, the sweep mode only takes effect the next time the Sequencer activates that channel, and only for a channel-defined sequence. In this case, a channel in continuous sweep mode is swept repeatedly.

Furthermore, [RUN CONT] controls the Sequencer, not individual sweeps. [RUN CONT] starts the Sequencer in continuous mode.

For details on the Sequencer, see [Chapter 7.4.1, "The sequencer concept"](#), on page 112.

Remote command:

`INITiate<n>:CONTInuous` on page 425

Continue Single Sweep

Repeats the number of measurements defined by the "Sweep Count", without deleting the trace of the last measurement.

While the measurement is running, the "Continue Single Sweep" softkey and the [RUN SINGLE] key are highlighted. The running measurement can be aborted by selecting the highlighted softkey or key again.

Remote command:

`INITiate<n>:CONMeas` on page 424

8.3 Selecting measurements

Access: [MEAS]

The R&S FSWP provides several noise measurements, each determining different noise aspects of different types of signal.

Phase noise Measurement	121
Additive noise measurements (optional)	121
Baseband noise measurement	121
VCO characterization	121
Spot noise vs tune	121

PN Transient analysis.....	122
Pulsed phase noise measurements (optional).....	122
Pulsed additive noise measurements (optional).....	122

Phase noise Measurement

Provides tools to measure the noise characteristics of a continuous wave signal.

This measurement measures the combined noise characteristics of the components in the test setup.

Remote command:

[CONFigure:PNOise:MEASurement](#) on page 421

Additive noise measurements (optional)

Provides tools to measure the additive noise characteristics of a continuous wave signal.

The optional signal source that is necessary for this measurement allows you to measure the noise characteristics of individual components in the test setup.

Remote command:

[CONFigure:PNOise:MEASurement](#) on page 421

Baseband noise measurement

Provides tools to measure the noise characteristics of a DUT in absolute terms (not relative to a carrier).

The measurement is designed to check the voltage supply of DC sources or to determine the noise characteristics of amplifiers. Baseband measurements are possible between 0 Hz and 30 MHz (absolute).

Remote command:

[CONFigure:PNOise:MEASurement](#) on page 421

VCO characterization

Provides tools to measure various characteristics of DUTs whose characteristics change depending on the applied voltage or current. Examples would be voltage controlled oscillators (VCOs) or YIG oscillators.

The measurement is designed to evaluate DUT characteristics as a function of the tuning voltage (also known as sweep voltage).

Remote command:

[CONFigure:VCO:MEASurement\[:STATe\]](#) on page 423

Spot noise vs tune

Provides tools to measure the spot noise characteristic of DUTs whose spot noise characteristic changes depending on the applied voltage or current. Examples would be voltage controlled oscillators (VCOs) or YIG oscillators.

The measurement is designed to evaluate DUT spot noise characteristic as a function of the tuning voltage (also known as sweep voltage).

Remote command:

[CONFigure:SNtune:MEASurement\[:STATe\]](#) on page 422

PN Transient analysis

Provides tools to analyze the transient response of a DUT.

The measurement is designed to monitor the frequency and phase variations of a signal over time and to find out how long it takes until the signal is in a stable state.

Remote command:

[CONFigure:TRANsient:MEASurement\[:STATe\]](#) on page 422

Pulsed phase noise measurements (optional)

Provides tools to measure the noise characteristics of pulses.

The optional pulsed phase noise measurement application measures the combined noise characteristics of the components in the test setup.

Remote command:

[CONFigure:PNOise:MEASurement](#) on page 421

Pulsed additive noise measurements (optional)

Provides tools to measure the additive noise characteristics of pulses.

The optional pulsed phase noise measurement application in combination with the optional signal source allows you to measure the noise characteristics of individual components in the test setup.

Remote command:

[CONFigure:PNOise:MEASurement](#) on page 421

8.4 Result displays

Result displays show different aspects of the measurement results in numerical or graphical form.

Depending on the measurement, one or more result displays are supported.

Phase noise, additive noise, baseband noise, pulsed phase noise and pulsed additive noise measurements:

- ["Noise Diagram"](#) on page 123
- ["Integrated Measurements"](#) on page 124
- ["Spurious List"](#) on page 125
- ["Spot Noise"](#) on page 126
- ["Marker Table"](#) on page 131
- ["Allan Variance / Allan Deviation"](#) on page 127
(Phase noise measurement only.)

VCO characterization measurements:

- ["Frequency \(VCO Characterization\)"](#) on page 128
- ["Sensitivity"](#) on page 128
- ["Power"](#) on page 128
- ["Current / Voltage"](#) on page 129
- ["Power vs. Frequency"](#) on page 129

- "Harmonic Power" on page 129
- "Marker Table" on page 131

Spot noise vs tune measurements:

- "Spot Noise vs Tune PN" on page 130
- "Spot Noise vs Tune AM" on page 130
- "Marker Table" on page 131

Transient analysis

- "Frequency (Transient Analysis)" on page 130
- "Frequency Deviation" on page 131
- "Phase" on page 131
- "Marker Table" on page 131

Noise Diagram.....	123
Integrated Measurements.....	124
Spurious List.....	125
Spot Noise.....	126
Allan Variance / Allan Deviation.....	127
Frequency (VCO Characterization).....	128
Sensitivity.....	128
Power.....	128
Current / Voltage.....	129
Power vs. Frequency.....	129
Harmonic Power.....	129
Spot Noise vs Tune PN.....	130
Spot Noise vs Tune AM.....	130
Frequency (Transient Analysis).....	130
Frequency Deviation.....	131
Phase.....	131
Marker Table.....	131

Noise Diagram

The "Noise Diagram" result display shows the power level of the noise over a variable frequency offset from the carrier frequency.

The unit of both axes in the diagram is fix. The x-axis always shows the offset frequencies in relation to the carrier frequency on a logarithmic scale in Hz. It always has a logarithmic scale to make sure of an equal representation of offsets near and far away from the carrier. The range of offsets that the x-axis shows is variable and depends on the [measurement range](#) you have defined and the scope of the x-axis that you have set.

The y-axis always shows the noise power level contained in a 1 Hz bandwidth in relation to the level of the carrier.

The unit of the y-axis depends on which version of the "Noise Spectrum" diagram you have selected.

- "Noise Spectrum": Default display showing the single sideband phase noise with linear y-axis in dBc/Hz.

- "Noise Spectrum L(f)": Same as the "Noise Spectrum" without AM noise calculation.
- "Noise Spectrum S Φ (f)": Display showing the spectral density of phase fluctuations with linear y-axis in dB/Hz.
- "Noise Spectrum Sv(f)": Display showing the spectral density of frequency fluctuations with logarithmic y-axis in Hz/sqrt(Hz).
- "Noise Spectrum Sy(f)": Display showing the spectral density of fractional frequency fluctuations with logarithmic y-axis in 1/sqrt(Hz).
The R&S FSWP adjusts numerical results like integrated measurements and spot noise accordingly. AM noise calculation is only supported by the "Noise Spectrum" result display.

Additionally, there are two more "Noise Spectrum" result displays with preconfigured traces for specific measurements available.

- "PN Noise Spectrum": Preconfigured for PN Noise measurements.
- "AM Noise Spectrum": Preconfigured for AM Noise measurements.

The scale of the y-axis is variable. Usually it is best to use the automatic scaling that the application provides, because it makes sure that the whole trace is always visible. You can, however, also customize the range, the minimum and the maximum values on the y-axis by changing the y-axis scale.

The measurement results are displayed as traces in the diagram area. Up to six active traces at any time are possible. Each of those can have a different setup and thus show different aspects of the measurement results.

In the default state, the application shows two traces. A yellow one and a blue one. Both result from the same measurement data, but have been evaluated differently. On the first trace, smoothing has been applied, the second one shows the raw data.

The diagram also contains a gray area in its default state. This trace represents the [cross-correlation gain indicator](#).

Remote command:

[TRACe<n> \[:DATA\] ?](#) on page 432

[TRACe<n> \[:DATA\] :X?](#) on page 435

[TRACe<n> \[:DATA\] :X:POINts?](#) on page 435

[TRACe<n> \[:DATA\] :Y?](#) on page 435

[TRACe<n> \[:DATA\] :Y:POINts?](#) on page 436

Integrated Measurements

The "Integrated Measurements" result display summarizes the [residual effects](#) results in a table.

The table consists of up to four rows with each row representing a different integration interval. Each row basically contains the same information, which depends on the [residual effects configuration](#).

Result	Description
Wnd	Shows the number of the measurement window the integration is done in (usually "1", unless you have several noise diagrams open at the same time).
Range	Shows the index of the integration range (1 to 4).

Result	Description
Trace	Shows the number of the trace the integration is applied to.
Start / Stop Offset	Shows the start and stop offset of the integration interval.
Weighting	Shows the name of the weighting filter, if you have applied one.
Int Noise	Shows the integrated noise. The integral is calculated over the frequency range defined by the "Start" and "Stop" values.
PM*	Shows the residual PM result in degrees and rad. (Only available for Phase Noise traces.)
FM / AM*	Shows the residual FM results in Hz or the residual AM results in %, depending on the trace configuration . (Only available for Phase Noise traces.)
Jitter*	Shows the jitter in seconds. (Only available for Phase Noise traces.)

* For baseband noise measurements, these values are always 0.

Remote command:

Int. PHN: `FETCh<n>[:RANGe<ri>]:PNOise<t>:IPN?` on page 429

FM: `FETCh<n>[:RANGe<ri>]:PNOise<t>:RFM?` on page 430

AM: `FETCh<n>[:RANGe<ri>]:PNOise<t>:RAM?` on page 429

PM: `FETCh<n>[:RANGe<ri>]:PNOise<t>:RPM?` on page 431

Jitter: `FETCh<n>[:RANGe<ri>]:PNOise<t>:RMS?` on page 430

Spurious List

[Spurs](#) are peak levels at one or more offset frequencies and are caused mostly by interfering signals. The "Spurious List" result display shows the location of all detected spurs in a table.

Note that only signals above a certain [threshold](#) are regarded as spurs. This threshold is also considered in the spurious list if spur removal has been turned off for a trace.

The order of the spurs in the table depends on the [sort order](#).

The table consists of a variable number of rows. For each detected spur, the table shows several results.

Wnd	Shows the number of the measurement window the spur is in (usually "1", unless you have several noise diagrams open at the same time).
Trace	Shows the trace that the spur is on.
Spur	Shows the spur number. Spurs are sorted by their frequency, beginning with the spur with the lowest frequency.
Offset*	Shows the position (offset frequency) of the spur.

Power**	Shows the power level of the spur in dBc.
Jitter**	Shows the jitter value of the spur in s. In addition to the jitter for each spur, the result display also shows the discrete jitter and the random jitter at the end of the table. <ul style="list-style-type: none"> • The discrete jitter is the RMS average of all individual spur jitter values. • The random jitter is the jitter contribution of the phase noise without spurs.

* For baseband noise measurements, the result is the absolute frequency that the spur is located at.

** For baseband noise measurements, the [unit is variable](#).

*** For baseband noise measurements, the jitter is always 0.

Remote command:

[FETCh<n>:PNOise<t>:SPURs?](#) on page 427

[FETCh<n>:PNOise<t>:SPURs:COUnT?](#) on page 427

[FETCh<n>:PNOise<t>:SPURs:JITTer?](#) on page 428

[FETCh<n>:PNOise<t>:SPURs:DISCReTe?](#) on page 428

[FETCh<n>:PNOise<t>:SPURs:RANDOm?](#) on page 429

Spot Noise

The "Spot Noise" result display shows the noise at a certain frequency offset (or spot) that is part of the measurement range. It is thus like a fixed marker.

The unit of spot noise results is dBc/Hz ([variable unit](#) for baseband noise measurements). The application shows the results in a table.

The table consists of a variable number of 10_x frequencies (depending on the measurement range), and a maximum of six user frequencies, with each row containing the spot noise information for a particular frequency offset.

The spot noise information is made up out of several values.

Offset Frequency*	Shows the offset frequency the spot noise is evaluated for. You can add any offset that is part of the measurement range. The number in brackets (T<x>) indicates the trace the result refers to.
Noise[T<x>]	Shows the noise for the corresponding offset frequency. The number in brackets (T<x>) indicates the trace the result refers to.

* For baseband noise measurements, the result is the absolute frequency of the spot.

Remote command:

Querying spot noise results on 10_x offset frequencies:

[CALCulate<n>:SNOise<ri>\[:TRACe<t>\]:DECades:X?](#) on page 491

[CALCulate<n>:SNOise<ri>\[:TRACe<t>\]:DECades:Y?](#) on page 491

Querying custom spot noise results:

[CALCulate<n>:SNOise<ri>\[:TRACe<t>\]:Y?](#) on page 492

Allan Variance / Allan Deviation

The "Allan Variance" and "Allan Deviation" result displays are tools to determine the frequency stability of a DUT over a long period of time (days or even months).

Frequency stability is a measure of how well a DUT is able to produce its specified frequency over time without deviating from that frequency. Because of the noise characteristics of oscillators, standard variance or deviation are not really applicable. Instead the Allan variance and deviation are the tools of choice for these statistical evaluations. Like the standard deviation, the Allan variance and deviation show how much the frequency of the DUT deviates from its specified (= average) value. Also like the standard variance and deviation, the deviation is the square root of the variance.

The R&S FSWP calculates the Allan variance from the phase noise spectrum using the following relationship:

$$\sigma_y^2(\tau) = 2 \int_0^{f_h} S_y(f) \frac{\sin^4(\pi\tau f)}{(\pi\tau f)^2} df$$

f_h = integration bandwidth

S_y = spectral density of fractional frequency fluctuations

τ = observation time

f = offset frequency

Overall, low values, both variance and deviation, correspond to a stable DUT, high values to an unstable DUT.

When you measure the stability of an oscillator, the resulting curve has a characteristic shape. The shape is the same for variance and deviation.

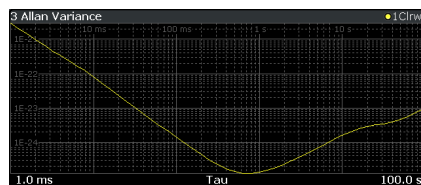

The point of interest in the diagram is the minimum of the curve. First, the deviation is high, because of noise. During the progression of the observation, the noise averages out until the minimum is reached. The minimum thus corresponds to the point in time when the deviation from the specified frequency is at its lowest. After that, the stability deteriorates due to temperature effects and aging.

From the slope of the curve, you can also identify the type of noise that is in effect (white noise, flicker phase, white frequency, flicker frequency, random walk).

For a comprehensive discussion of the Allan variance, refer to application note [1EF69: Time Domain Oscillator Stability Measurement - Allan Variance](#).

The logarithmic x-axis corresponds to the observation time ("Tau"). Note that Tau is not the measurement time, but the evaluated time - the measurement lasts longer than Tau. Because the R&S FSWP calculates the Allan variance based on the measurement range of the phase noise measurement (offset frequency), the observation time corresponds to the measurement range and vice versa.

The start time also defines the measurement bandwidth or integration bandwidth (f_h in the equation above):

$$BW_{Meas} = \frac{1}{\tau_{Start}}$$

The measurement bandwidth is displayed in the diagram area.

The y-axis shows the variance or deviation. It also has a logarithmic scale.

Remote command:

Trace data: `TRACe<n>[:DATA]?` on page 432

Measurement bandwidth: `[SENSe:]BWIDth:MEASurement?` on page 432

Frequency (VCO Characterization)

The "Frequency" result display shows the frequency characteristics of the DUT as a function of the tuning voltage or current.

The x-axis shows the tuning characteristics of the DC source.

- For V_{supply} the tuning voltage in Volt or current in Ampere, depending on the [output type](#).
- For V_{tune} and V_{aux} the tuning voltage in Volt.

The tuning voltages (alternatively: current) applied during the measurement depends on the [tuning range](#) you have defined.

The y-axis shows the frequency on which the VCO operates at a given tuning voltage or current in Hz.

Remote command:

`TRACe<n>[:DATA]?` on page 432

Sensitivity

The "Sensitivity" result display shows the slope of the DUT characteristics, expressed as the frequency change between measurement points.

The x-axis shows the tuning characteristics of the DC source.

- For V_{supply} the tuning voltage in Volt or current in Ampere, depending on the [output type](#).
- For V_{tune} and V_{aux} the tuning voltage in Volt.

The tuning voltages (alternatively: current) applied during the measurement depends on the [tuning range](#) you have defined.

The y-axis shows the sensitivity of the VCO at a given tuning voltage or current in Hz/V.

Remote command:

`TRACe<n>[:DATA]?` on page 432

Power

The "Power" result display shows the output power characteristics of the DUT as a function of the tuning voltage or current.

The x-axis shows the tuning characteristics of the DC source.

- For V_{supply} the tuning voltage in Volt or current in Ampere, depending on the [output type](#).
- For V_{tune} and V_{aux} the tuning voltage in Volt.

The tuning voltages (alternatively: current) applied during the measurement depends on the [tuning range](#) you have defined.

The y-axis shows the output power of the VCO at a given tuning voltage or current in Hz.

Remote command:

[TRACe<n>\[:DATA\]?](#) on page 432

Current / Voltage

The "Current / Voltage" result display shows the voltage or current that the DUT is supplied with by the [selected fix source](#) and displays the result for each measurement point. Each measurement point corresponds to a specific tuning voltage (or current) that was applied to the DUT.

The x-axis shows the tuning characteristics of the DC source.

- For V_{supply} the tuning voltage in Volt or current in Ampere, depending on the [output type](#).
- For V_{tune} and V_{aux} the tuning voltage in Volt.

The tuning voltages (alternatively: current) applied during the measurement depends on the [tuning range](#) you have defined.

The y-axis shows the current or voltage of the selected fix DC source. When V_{Supply} is configured to supply current and selected as the "Fix Source", the diagram shows the voltage in Volt. In all other cases, it shows the current in mA.

Remote command:

[TRACe<n>\[:DATA\]?](#) on page 432

Power vs. Frequency

The "Power vs. Frequency" result display shows the frequency characteristics of the DUT as a function of the tuning voltage or current.

The x-axis shows the frequency on which the VCO operates at a given tuning voltage or current in Hz.

The y-axis shows the output power of the VCO at a given tuning voltage or current in Hz.

Remote command:

[TRACe<n>\[:DATA\]?](#) on page 432

Harmonic Power

The "Harmonic Power" result display explicitly shows the power of the fundamental wave and the power of the harmonics of a DUT measured for each measurement point.

The x-axis shows the tuning characteristics of the DC source.

- For V_{supply} the tuning voltage in Volt or current in Ampere, depending on the [output type](#).
- For V_{tune} and V_{aux} the tuning voltage in Volt.

The tuning voltages (alternatively: current) applied during the measurement depends on the [tuning range](#) you have defined.

The y-axis shows the output power of the DUT at a given tuning voltage or current in dBm.

Remote command:

[TRACe<n>\[:DATA\]? on page 432](#)

Spot Noise vs Tune PN

The "Spot Noise vs Tune PN" result display shows the phase noise at specific frequency offsets measured on each measurement point. Each measurement point corresponds to a specific tuning voltage (or current) that was applied to the DUT.

The x-axis shows the tuning characteristics of the DC source.

- For V_{supply} the tuning voltage in Volt or current in Ampere, depending on the [output type](#).
- For V_{tune} and V_{aux} the tuning voltage in Volt.

The tuning voltages (alternatively: current) applied during the measurement depends on the [tuning range](#) you have defined.

The y-axis shows the phase noise measured at a given tuning voltage or current in dBc/Hz.

You can configure the traces to show the phase noise for specific frequency offsets relative to the carrier.

Remote command:

[TRACe<n>\[:DATA\]? on page 432](#)

Spot Noise vs Tune AM

The "Spot Noise vs Tune AM" result display shows the AM noise at specific frequency offsets measured on each measurement point. Each measurement point corresponds to a specific tuning voltage (or current) that was applied to the DUT.

The x-axis shows the tuning characteristics of the DC source.

- For V_{supply} the tuning voltage in Volt or current in Ampere, depending on the [output type](#).
- For V_{tune} and V_{aux} the tuning voltage in Volt.

The tuning voltages (alternatively: current) applied during the measurement depends on the [tuning range](#) you have defined.

The y-axis shows the AM noise measured at a given tuning voltage or current in dBc/Hz.

You can configure the traces to show the AM noise for specific frequency offsets relative to the carrier.

Remote command:

[TRACe<n>\[:DATA\]? on page 432](#)

Frequency (Transient Analysis)

The "Frequency" result display shows the frequency characteristics of the transient response of the DUT over time.

The x-axis shows the time period over which the signal has been measured. The scale depends on the measurement time.

The y-axis shows the frequency, either in absolute or relative terms. For a relative scale, the offset frequencies displayed on the y-axis refer to the center frequency. In both cases, the grid line in the middle of the diagram represents the center frequency.

Remote command:

Trace data: `TRACe<n>[:DATA]?` on page 432

Y-axis scale: [Chapter 14.6.10.1, "Frequency configuration"](#), on page 508

Frequency Deviation

The "Frequency Deviation" result display shows the frequency deviation of the transient response of the DUT from an ideal linear behavior over time.

The x-axis shows the time period over which the signal has been measured. The scale depends on the defined start and stop time.

The y-axis shows the deviation of the signal from the reference line within the time-frame between start and stop time. The scale of the y-axis depends on your configuration.

The frequency deviation calculation settings are described in [Chapter 9.10.7, "Frequency deviation"](#), on page 205.

Remote command:

Trace data: `TRACe<n>[:DATA]?` on page 432

Phase

The "Phase" result display shows the phase characteristics of the transient response of the DUT over time.

The x-axis shows the time period over which the signal has been measured. The scale depends on the measurement time.

The y-axis shows the phase. The scale of the y-axis depends on your configuration.

Remote command:

Trace data: `TRACe<n>[:DATA]?` on page 432

Y-axis scale: [Chapter 14.6.10.5, "Y-Axis scale"](#), on page 515

Marker Table

Displays a table with the current marker values for the active markers.

This table is displayed automatically if configured accordingly.

Type	Shows the marker type and number ("M" for a normal marker, "D" for a delta marker).						
Ref	Shows the reference marker that a delta marker refers to.						
Trace	Shows the trace that the marker is positioned on.						
X- / Y-Value	Shows the marker coordinates (usually frequency and level).						

1 Marker Table							
Wnd	Type	Ref	Trc	X-Value	Y-Value	Function	Function Result
2	M1		1	2.1725 ms	-6.80 dBm		
2	D2	M1	1	13.859 ms	-0.00 dB		
2	D3	M1	1	4.6259 ms	-0.00 dB		
2	D4	M1	1	9.2331 ms	-0.00 dB		

Tip: To navigate within long marker tables, simply scroll through the entries with your finger on the touchscreen.

Remote command:

LAY:ADD? '1',RIGH, MTAB, see [LAYout:ADD\[:WINDow\]?](#) on page 526

Results:

[CALCulate<n>:MARKer<m>:X](#) on page 554

9 Common measurement settings

Basic measurement settings that are common to many measurement tasks, regardless of the application or operating mode, are described here. If you are using an application other than the Phase Noise application, be sure to check the documentation for that application. The settings can deviate from the common settings described here.

- [Configuration overview](#)..... 133
- [Input source](#)..... 135
- [Level characteristics](#)..... 154
- [Frequency](#)..... 158
- [Noise measurement configuration](#)..... 163
- [Output](#)..... 177
- [Pulsed phase noise and pulsed additive noise configuration](#)..... 186
- [VCO characterization configuration](#)..... 190
- [Spot noise vs tune configuration](#)..... 194
- [PN transient analysis configuration](#)..... 195

9.1 Configuration overview



Access: "Overview"

Throughout the measurement channel configuration, an overview of the most important currently defined settings is provided in the "Overview". The "Overview" is displayed when you select the "Overview" icon, which is available at the bottom of all softkey menus.

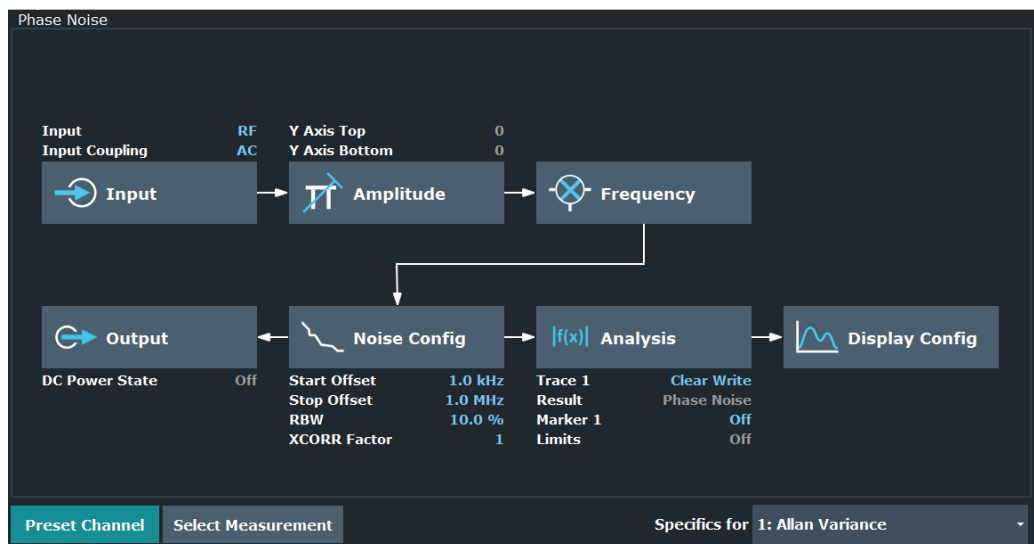

In addition to the main measurement settings, the "Overview" provides quick access to the main settings dialog boxes. The individual configuration steps are displayed in the order of the data flow. Thus, you can easily configure an entire measurement channel from input over processing to output and analysis by stepping through the dialog boxes as indicated in the "Overview".

In particular, the "Overview" provides quick access to the following configuration dialog boxes (listed in the recommended order of processing):

1. Input
See [Chapter 9.2, "Input source"](#), on page 135.
2. Amplitude / Scaling
See [Chapter 9.3, "Level characteristics"](#), on page 154.
3. Frequency
See [Chapter 9.4, "Frequency"](#), on page 158.
4. Noise
See [Chapter 9.5, "Noise measurement configuration"](#), on page 163.
5. Output
See [Chapter 9.6, "Output"](#), on page 177.
6. Analysis
See [Chapter 10, "Common analysis and display functions"](#), on page 208.
7. Display Configuration
See [Chapter 8, "Measurements and result displays"](#), on page 117.

In addition, the dialog box provides the "Select Measurement" button that serves as a shortcut to select the measurement type.

Selecting the noise measurement type	134
Preset Channel	135
Specific Settings for	135

Selecting the noise measurement type

The R&S FSWP provides different [types of measurements](#) to measure the noise characteristics of a DUT.

- Phase Noise
Phase noise and AM noise measurements for continuous wave signals.
- Additive Noise
Phase noise and AM noise measurements for continuous wave signals including a signal source.
Available with the optional Signal Source hardware.
- Baseband Noise
Noise measurement in absolute terms over a selected frequency range.
- VCO Characterization
Measurements to determine the characteristics of a voltage controlled oscillator (VCO).
- Spot Noise vs Tune
Phase noise and AM noise measurements for a voltage controlled oscillator (VCO).
- Pulsed Phase Noise
Phase noise and AM noise measurements for pulse signals.
Available with the optional Pulsed Phase Noise measurement application.
- Pulsed Additive Noise

Phase noise and AM noise measurements for pulse signals including a signal source.

Available with the optional Pulsed Phase Noise measurement application.

Remote command:

[CONFigure:PNOise:MEASurement](#) on page 421

Preset Channel

Select "Preset Channel" in the lower left-hand corner of the "Overview" to restore all measurement settings *in the current channel* to their default values.

Note: Do not confuse the "Preset Channel" button with the [Preset] key, which restores the entire instrument to its default values and thus closes *all channels* on the R&S FSWP (except for the default channel)!

See "Preset Mode" on page 326

Remote command:

[SYSTem:PRESet:CHANnel\[:EXEC\]](#) on page 590

Specific Settings for

The channel can contain several windows for different results. Thus, the settings indicated in the "Overview" and configured in the dialog boxes vary depending on the selected window.

Select an active window from the "Specific Settings for" selection list that is displayed in the "Overview" and in all window-specific configuration dialog boxes.

The "Overview" and dialog boxes are updated to indicate the settings for the selected window.

9.2 Input source

The phase noise application supports input from several signal sources.

For more information about the available connectors, refer to the getting started manual.

- [RF input](#).....135
- [Baseband input](#)..... 137
- [External mixers](#)..... 138

9.2.1 RF input

Access (RF input settings): "Overview" > "Input" > "Input Source" > "Radio Frequency" > "Config"

Access (schematic test setups): "Overview" > "Input" > "Input Source" > "Radio Frequency" > "Test Setup"

The RF Input is the default input source.

A typical test setup for measurements over the RF input depends on the selected measurement and the equipment used in the test setup. A schematic representation of such a setup is provided in the dialog box.

- The DUT directly sends a signal to the RF input of the R&S FSWP.
- If necessary, the R&S FSWP can supply the DUT with power over the DC ports.

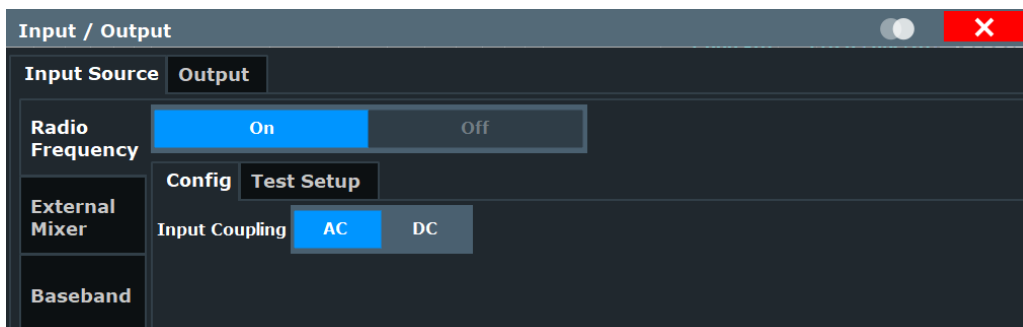

For more information about configuring the DC ports used in the setup, see [Chapter 9.6.1, "DC source configuration"](#), on page 178.

The remote commands required to configure the frequency are described in [Chapter 14.6.1.1, "RF input"](#), on page 437.

Radio Frequency State	136
Input Coupling	136
Local Oscillator	136

Radio Frequency State

Activates input from the "RF Input" connector.

Remote command:

`INPut<ip>:SElect` on page 438

Input Coupling

The RF input of the R&S FSWP can be coupled by alternating current (AC) or direct current (DC).

AC coupling blocks any DC voltage from the input signal. AC coupling is activated by default to prevent damage to the instrument. Very low frequencies in the input signal can be distorted.

However, some specifications require DC coupling. In this case, you must protect the instrument from damaging DC input voltages manually. For details, refer to the data sheet.

Remote command:

`INPut<ip>:COUpling` on page 437

Local Oscillator

Selects the type of the local oscillator you are using for the measurement.

- Internal
Uses the local oscillator of the R&S FSWP.
- External

Uses an external local oscillator, connected to the "LO AUX Input" (Ch1 and Ch2) of the R&S FSWP.

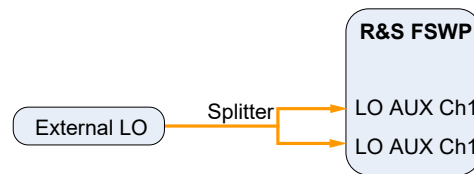

For an external LO, specify whether the signal at the input has a low or high "Level". A low level corresponds to signals with a level of approximately 0 dBm. A high level corresponds to signals with a level between about +5 dBm and +10 dBm.

The exact definitions of low and high depend on the signal frequency and are specified in the data sheet.

Note that for low phase noise boards with material number 1331.6439.xx, the low / high setting is not available.

You can check the material number of the low phase noise board in the hardware information dialog box (column "order #", see [Chapter 12.4.1, "Hardware information"](#), on page 321).

Available for additive noise measurements.

Remote command:

`INPut<ip>:LOSCillator:SOURce` on page 438

`INPut<ip>:LOSCillator:SOURce:EXTernal:LEVel` on page 438

9.2.2 Baseband input

Access (baseband input settings): "Overview" > "Input" > "Input Source" > "Baseband" > "Config"

Access (schematic test setups): "Overview" > "Input" > "Input Source" > "Baseband" > "Test Setup"

Baseband measurements

In addition to the RF input, baseband noise measurements also support measurements on the two channels of the baseband input.

You can either perform measurements on a single channel (select either "CH1" or "CH2" for that) or perform measurements on both channels simultaneously ("CH1 x CH2"). In the latter case, the I/Q data is cross-correlated before the results are displayed, which allows you to determine the noise characteristics of your DUT very accurately.

Remote command:

Input selection: `INPut<ip>:SElect` on page 438

Channel selection: `INPut<ip>:CONNector` on page 439

The baseband input is always DC coupled, which allows you to measure the noise characteristics of a DUT near 0 Hz (DC) in the context of baseband noise measurements.

Note that you have to turn on the baseband input deliberately before you can use it. When the baseband input is active, the RF input is automatically turned off.

A typical test setup for measurements over the RF input depends on the selected measurement and the equipment used in the test setup. A schematic representation of such a setup is provided in the dialog box.

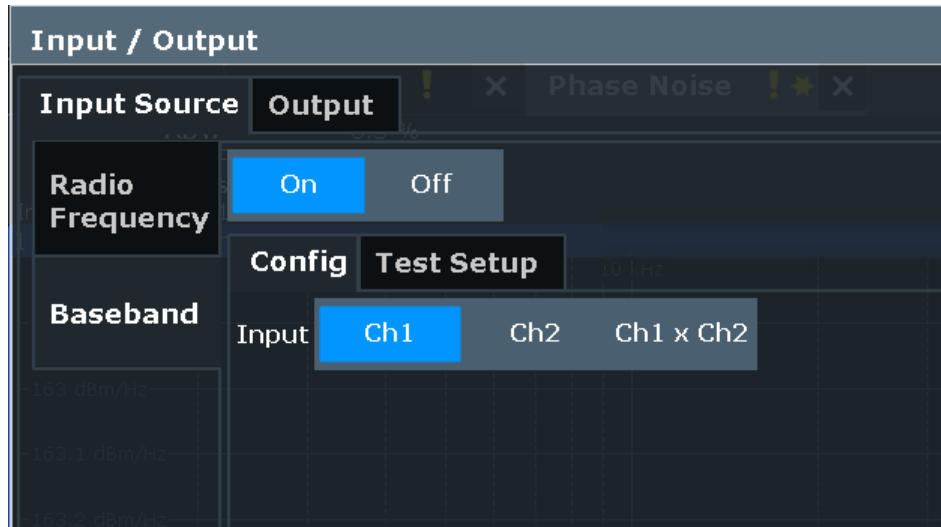

See [Chapter 5.2.4, "The baseband noise measurement"](#), on page 63 for more information on how to set up and perform baseband noise measurements.

Additive noise measurements (CW and pulsed)

If you are using an I/Q mixer in the test setup of an additive noise measurement, you can use the baseband inputs to analyze I and Q data streams.

Note that you have to turn on the baseband input deliberately before you can use it. When the baseband input is active, the RF input is automatically turned off.

Remote command:

Input selection: `INPut<ip>:SElect` on page 438

See [Chapter 5.2.3, "The additive noise measurement"](#), on page 60 for more information on how to set up and perform additive noise measurements using the baseband input.

9.2.3 External mixers

Access (mixer settings): "Overview" > "Input" > "Input Source" > "External Mixer" > "Mixer Settings"

Access (basic settings): "Overview" > "Input" > "Input Source" > "External Mixer" > "Basic Settings"

Access (conversion loss table): "Overview" > "Input" > "Input Source" > "External Mixer" > "Conversion Loss Table"

Access (schematic test setups): "Overview" > "Input" > "Input Source" > "External Mixer" > "Test Setup"

The optional support for external mixers allows you to connect up to two external three-port mixers to the R&S FSWP. An external mixer allows you to perform measurements on frequencies that are out of the frequency range supported by the R&S FSWP.



Note on using three-port mixers

When using three-port mixers, the LO signal output from the R&S FSWP and the IF input from the mixer are transmitted on separate connectors.

The nominal LO level is 15.5 dBm.

External mixers are supported by several measurements in the phase noise application.

- Phase noise measurement
- Pulsed phase noise measurement

You can connect up to two external mixers and configure them individually (where necessary).

A typical test setup for measurements over the RF input depends on the selected measurement and the equipment used in the test setup. A schematic representation of such a setup is provided in the dialog box.

- [Basics on external mixers](#)..... 139
- [Mixer settings](#)..... 143
- [Basic settings](#)..... 147
- [Conversion loss table](#)..... 149

9.2.3.1 Basics on external mixers

Some background knowledge on basic terms and principles used with external mixers is provided here for a better understanding of the required configuration settings.

- [Frequency ranges](#)..... 139
- [Bias current](#)..... 140
- [Conversion loss tables](#)..... 141

Frequency ranges

In a common spectrum analyzer, rather than providing one large (and thus inaccurate) filter, or providing several filters to cover the required frequency range of the input signal (at a high cost), a single, very accurate filter is used. Therefore, the input signal must be converted to the frequencies covered by the single accurate filter. This is done by a mixer, which converts and multiplies the frequency of the input signal with the help of the local oscillator (LO). The result is a higher and lower intermediate frequency (IF). The local oscillator can be tuned within the supported frequency range of the input signal.

In order to extend the supported frequency range of the input signal, an external mixer can be used. In this case, the LO frequency is output to the external mixer, where it is mixed with the RF input from the original input signal. In addition, the *harmonics* of the LO are mixed with the input signal, and converted to new intermediate frequencies. Thus, a wider range of frequencies can be obtained. The IF from the external mixer is then returned to the spectrum analyzer.

The frequency of the input signal can be expressed as a function of the LO frequency and the selected harmonic of the first LO as follows:

$$f_{in} = n * f_{LO} + f_{IF}$$

Where:

f_{in} : Frequency of input signal

n : Order of harmonic used for conversion

f_{LO} : Frequency of first LO: 7.65 GHz to 16.00 GHz

f_{IF} : Intermediate frequency (variable; defined internally depending on RBW and span)

Thus, depending on the required frequency band, the appropriate order of harmonic must be selected. For commonly required frequency ranges, predefined bands with the appropriate harmonic order setting are provided. By default, the lowest harmonic order is selected that allows conversion of input signals in the whole band.

For the "USER" band, the order of harmonic is defined by the user. The order of harmonic can be between 2 and 61, the lowest usable frequency being 16.88 GHz.

The frequency ranges for pre-defined bands are described in [Table 14-3](#).



Changes to the band and mixer settings are maintained even after using the [PRESET] function. A "Preset band" function allows you to restore the original band settings.

Extending predefined ranges

In some cases, the harmonics defined for a specific band allow for an even larger frequency range than the band requires. By default, the pre-defined range is used. However, you can take advantage of the extended frequency range by overriding the defined start and stop frequencies by the maximum possible values ("RF Overrange" option).

Additional ranges

If due to the LO frequency the conversion of the input signal is not possible using one harmonic, the band must be split. An adjacent, partially overlapping frequency range can be defined using different harmonics. In this case, the sweep begins using the harmonic defined for the first range, and at a specified frequency in the overlapping range ("handover frequency"), switches to the harmonic for the second range.

Bias current

Single-diode mixers generally require a DC voltage which is applied via the LO line. This DC voltage is to be tuned to the minimum conversion loss versus frequency. Such

a DC voltage can be set via the "BIAS" function using the D/A converter of the R&S FSWP. The value to be entered is not the voltage but the short-circuit current. The current is defined in the "Bias Settings" or set to the value of the conversion loss table.

See "[Bias Value](#)" on page 148 and "[Bias](#)" on page 152.

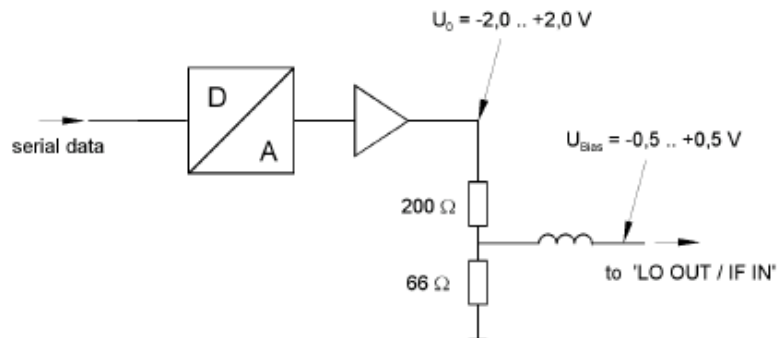

Figure 9-1: Bias circuit of the R&S FSWP

The voltage U_0 at the output of the operational amplifier can be set in the range -2.0 V to $+2.0\text{ V}$. An open-circuit voltage U_{bias} of -0.5 V to $+0.5\text{ V}$ is obtained accordingly at the output of the voltage divider. A short-circuit current of $I_{\text{short}} = U_0 / 200\ \Omega = 10\text{ mA}$ to $+10\text{ mA}$ is obtained for a short circuit at the output of the voltage divider. In order to use biasing it is not important to know the exact current flowing through the diode since the conversion loss must be set to a minimum with the frequency. Therefore, it makes no difference whether the setting is performed by an open-circuit voltage or by a short-circuit current. A DC return path is ensured via the $66\ \Omega$ resistor, which is an advantage in some mixers.

Conversion loss tables

Conversion loss tables consist of value pairs that describe the correction values for conversion loss at certain frequencies. Correction values for frequencies between the reference values are obtained by interpolation. Linear interpolation is performed if the table contains only two values. If it contains more than two reference values, spline interpolation is carried out. Outside the frequency range covered by the table the conversion loss is assumed to be the same as that for the first and last reference value (see [Figure 9-2](#)).

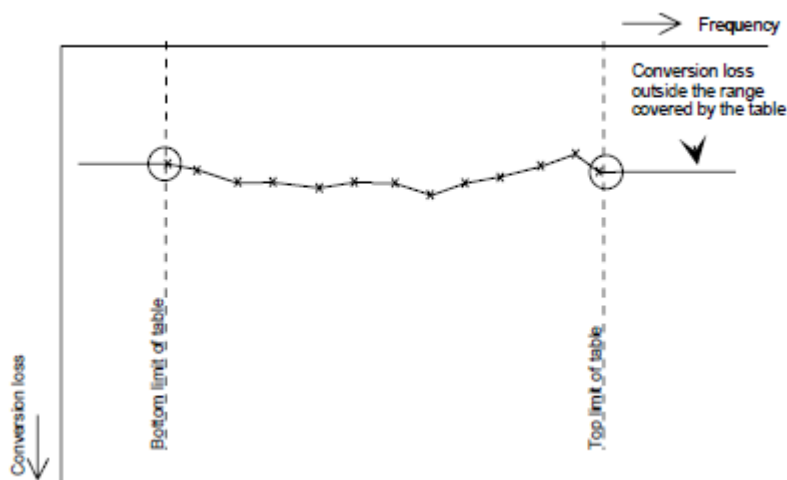

Figure 9-2: Conversion loss outside the band's frequency range

Predefined conversion loss tables are often provided with the external mixer and can be imported to the R&S FSWP.

Alternatively, you can define your own conversion loss tables. Conversion loss tables are configured and managed in the "Conversion loss Table Settings" tab of the "External Mixer Configuration" dialog box.

See ["Managing conversion loss tables"](#) on page 149 for more information about conversion loss tables.

Importing CVL tables

The conversion loss table to be used for a particular measurement range is also defined in the "External Mixer Configuration" dialog box.

The frequency range that the cvl table must cover depends on the used IF, which varies depending on the instrument and installed bandwidth extension options. Thus, external mixers from Rohde & Schwarz provide multiple conversion loss table files. When you select a storage path containing cvl files, or a particular cvl file from a Rohde & Schwarz mixer for import, all available files are copied to the `C:\R_S\INSTR\USER\cvl\` directory on the R&S FSWP. Provided `.acl` files are renamed according to the following syntax:

```
<serial_number>_<harmonic_order>_<IF>.acl,
```

e.g. 12345_2_1330M.acl

To select a conversion loss table for use in a measurement, you merely have to select the serial number for the external mixer in use. The R&S FSWP automatically selects the correct cvl file for the current IF. As an alternative, you can also select a user-defined conversion loss table (`.acl` file).



Before copying any files to the `C:\R_S\INSTR\USER\cv1\` directory, the R&S FSWP firmware moves any existing user-defined cvl tables to a `backup` subdirectory. To use a user-defined cvl table later, select the file in the `C:\R_S\INSTR\USER\cv1\backup` directory.

A validation check is then performed on the selected table to ensure that it complies with the settings. In particular, the following is checked:

- The assigned band name
- The harmonic order
- The mixer type
- The table must contain at least one frequency that lies within the frequency range for the band

Reference level

The maximum possible reference level depends on the maximum used conversion loss value. Thus, the reference level can be adjusted for each range according to the used conversion loss table or average conversion loss value. If a conversion loss value is used which exceeds the maximum reference level, the reference level is adjusted to the maximum value permitted by the firmware.

9.2.3.2 Mixer settings

Access: "Overview" > "Input" > "Input Source" > "External Mixer" > "Mixer Settings"

With the R&S FSWP, you can control either one or two three-port mixers.

Most settings are applied globally for both mixers (like the frequency band settings). Settings that you can configure for each mixer separately are labeled accordingly in the description below.

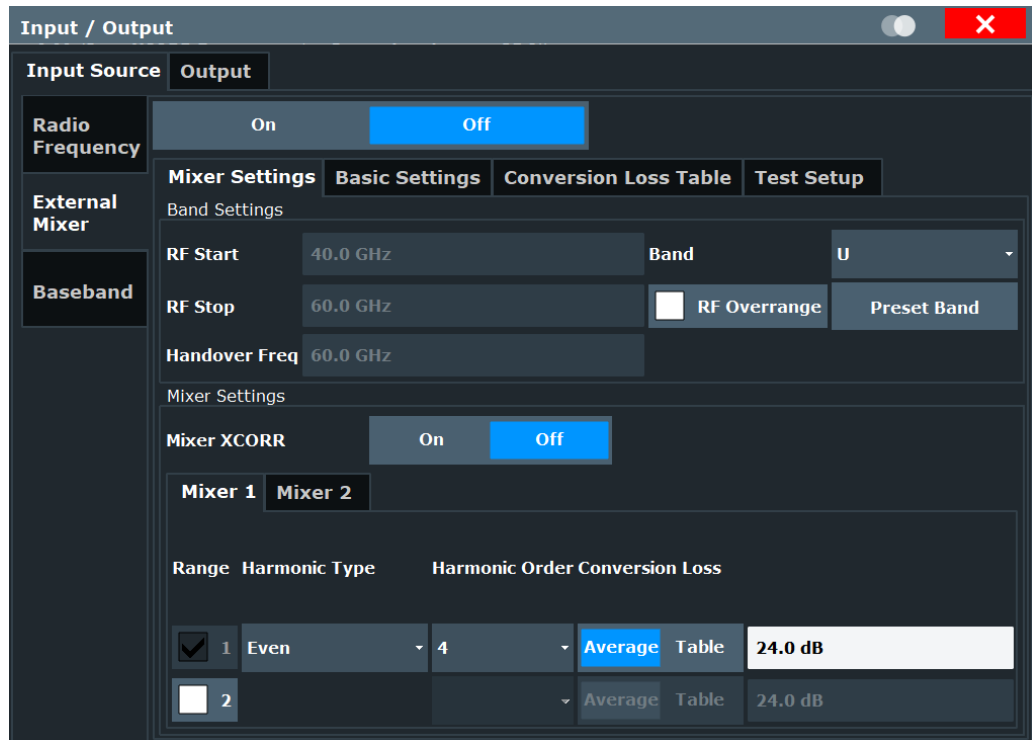

External Mixer (State).....	144
RF Start / RF Stop.....	144
Handover Freq.....	145
Band.....	145
RF Overrange.....	145
Preset Band.....	145
Mixer XCORR.....	146
Range 1/Range 2.....	146
Harmonic Type.....	146
Harmonic Order.....	146
Conversion Loss.....	146

External Mixer (State)

Activates or deactivates the external mixer for input. If activated, "ExtMix" is indicated in the channel bar of the application, together with the used band (see "Band" on page 145).

Remote command:

[SENSe:]MIXer<x>[:STATe] on page 447

RF Start / RF Stop

Displays the start and stop frequency of the selected band (read-only).

The frequency range for the user-defined band is defined via the harmonics configuration (see "Range 1/Range 2" on page 146).

For details on available frequency ranges, see [table 14-3 on page 441](#).

Remote command:

[SENSe:]MIXer<x>:FREQuency:START on page 440

[SENSe:]MIXer<x>:FREQuency:STOP on page 441

Handover Freq

If due to the LO frequency the conversion of the input signal is not possible using one harmonic, the band must be split. An adjacent, partially overlapping frequency range can be defined using different harmonics. In this case, the sweep begins using the harmonic defined for the first range. At the specified "handover frequency" in the overlapping range, it switches to the harmonic for the second range.

The handover frequency can be selected freely within the overlapping frequency range.

Remote command:

[SENSe:]MIXer<x>:FREQuency:HANDOver on page 440

Band

Defines the waveguide frequency band or user-defined frequency band to be used by the mixer.

The start and stop frequencies of the selected band are displayed in the "RF Start" and "RF Stop" fields.

For a definition of the frequency range for the pre-defined bands, see [table 14-3 on page 441](#).

The mixer settings for the user-defined band can be selected freely. The frequency range for the user-defined band is defined via the harmonics configuration (see "[Range 1/Range 2](#)" on page 146).

Remote command:

[SENSe:]MIXer<x>:HARMonic:BAND on page 441

RF Overage

Sometimes, the harmonics defined for a specific band allow for an even larger frequency range than the band requires. By default, the pre-defined range is used. However, you can take advantage of the extended frequency range by overriding the defined "RF Start" and "RF Stop" frequencies by the maximum values.

If "RF Overage" is enabled, the frequency range is not restricted by the band limits ("RF Start" and "RF Stop"). In this case, the full frequency range that can be reached using the selected harmonics is used.

Remote command:

[SENSe:]MIXer<x>:RFOVerrange[:STATe] on page 445

Preset Band

Restores the presettings for the selected band.

Note: changes to the band and mixer settings are maintained even after using the [PRESET] function. This function allows you to restore the original band settings.

Remote command:

[SENSe:]MIXer<x>:HARMonic:BAND:PRESet on page 442

Mixer XCORR

Turns the simultaneous use of two external mixers on and off.

Using two external mixers allows you to perform measurements with external cross-correlation. Through cross-correlation operations, the noise of the DUT is kept constant while the noise of the signal path (including the external mixers) is reduced.

Remote command:

[\[SENSe:\]MIXer<x>:XCORr](#) on page 445

Range 1/Range 2

Enables the use of one or two frequency ranges, where the second range is based on another harmonic frequency of the mixer to cover the band's frequency range.

For each range, you can define which harmonic to use and how the conversion loss is handled.

If you are using two mixers, this property is always the same for both mixers.

Remote command:

[\[SENSe:\]MIXer<x>:HARMonic:HIGH:STATe](#) on page 442

Harmonic Type

Defines if only even, only odd, or even and odd harmonics can be used for conversion. Depending on this selection, the order of harmonic to be used for conversion changes (see ["Harmonic Order"](#) on page 146). Which harmonics are supported depends on the mixer type.

If you are using two mixers, the harmonic type is always the same for both mixers.

Remote command:

[\[SENSe:\]MIXer<x>:HARMonic:TYPE](#) on page 443

Harmonic Order

Defines which order of the harmonic of the LO frequencies is used to cover the frequency range.

By default, the lowest order of the specified harmonic type is selected that allows conversion of input signals in the whole band. If due to the LO frequency the conversion is not possible using one harmonic, the band is split.

For the "USER" band, the order of harmonic is defined by the user. The order of harmonic can be between 2 and 61, the lowest usable frequency being 16.88 GHz.

If you are using two mixers, the harmonic type is always the same for both mixers.

Remote command:

[\[SENSe:\]MIXer<x>:HARMonic\[:LOW\]](#) on page 443

[\[SENSe:\]MIXer<x>:HARMonic:HIGH\[:VALue\]](#) on page 442

Conversion Loss

Defines how the conversion loss is handled. The following methods are available:

If you are using two mixers, you can define the source of the conversion loss data for each mixer separately.

"Average" Defines the average conversion loss for the entire frequency range in dB.

"Table" Defines the conversion loss via the table selected from the list. Pre-defined conversion loss tables are often provided with the external mixer and can be imported to the R&S FSWP. Alternatively, you can define your own conversion loss tables. Imported tables are checked for compatibility with the current settings before being assigned. Conversion loss tables are configured and managed in the [Conversion Loss Table](#) tab.
For details on importing tables, see ["Import Table"](#) on page 150.

Remote command:

Average for range 1:

[\[SENSe:\]MIXer<x>:LOSS\[:LOW\]](#) on page 444

Table for range 1:

[\[SENSe:\]MIXer<x>:LOSS:TABLE\[:LOW\]](#) on page 444

Average for range 2:

[\[SENSe:\]MIXer<x>:LOSS:HIGh](#) on page 443

Table for range 2:

[\[SENSe:\]MIXer<x>:LOSS:TABLE:HIGh](#) on page 444

9.2.3.3 Basic settings

Access: "Overview" > "Input" > "Input Source" > "External Mixer" > "Basic Settings"

With the R&S FSWP, you can control either one or two three-port mixers.

Most settings are applied globally for both mixers (like the frequency band settings).

Settings that you can configure for each mixer separately are labeled accordingly in the description below.

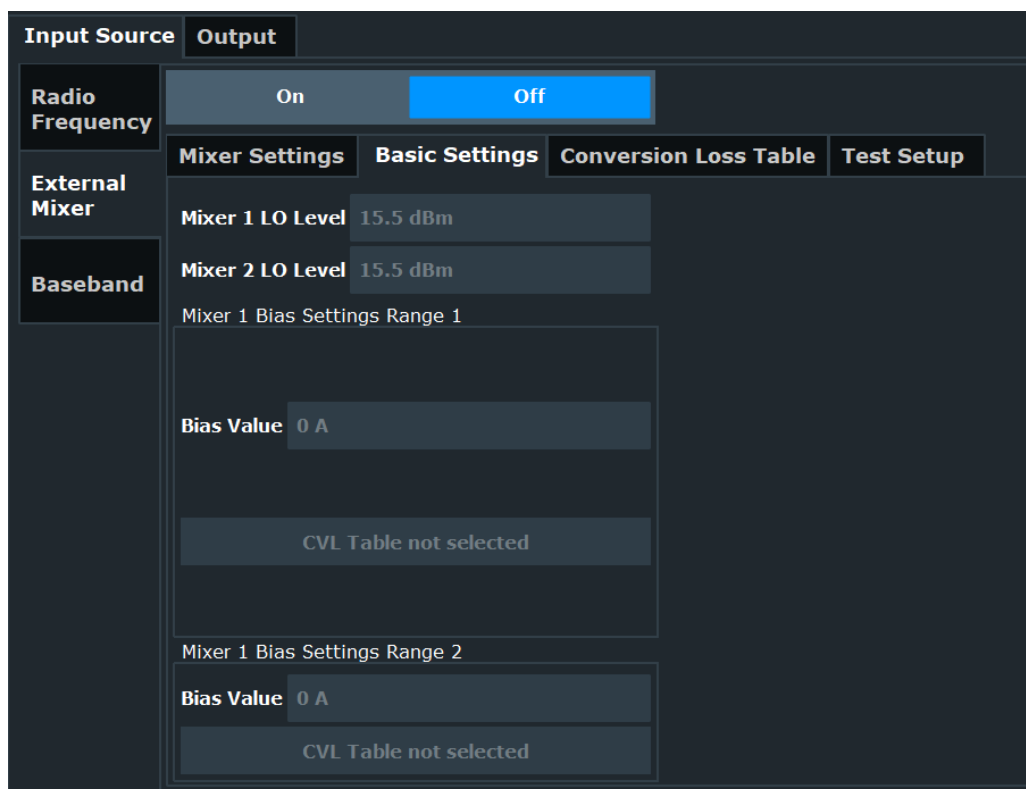

LO Level.....	148
Bias Value.....	148
↳ Write to CVL table.....	149

LO Level

Defines the LO level of the external mixer's LO port. Possible values are from 13.0 dBm to 17.0 dBm in 0.1 dB steps. Default value is 15.5 dB.

If you are using two mixers, you can define the LO level for each mixer separately.

Remote command:

[SENSe:]MIXer<x>:LOPower on page 447

Bias Value

Define the bias current for each range, which is required to set the mixer to its optimum operating point. It corresponds to the short-circuit current. The bias current can range from -10 mA to 10 mA. The actual bias current is lower because of the forward voltage of the mixer diode(s).

Tip: The trace in the currently active result display (if applicable) is adapted to the settings immediately so you can check the results.

To store the bias setting in the currently selected conversion loss table, select [Write to CVL table](#).

The "Bias Value" is available for mixer 1 only.

Remote command:

[SENSe:]MIXer<x>:BIAS[:LOW] on page 446

[SENSe:]MIXer<x>:BIAS:HIGH on page 446

Write to CVL table ← Bias Value

Stores the bias setting in the currently selected "Conversion Loss Table" for the range (see "Managing conversion loss tables" on page 149). If no conversion loss table is selected yet, this function is not available ("CVL Table not selected").

Remote command:

[SENSe:]CORRection:CVL:BIAS on page 448

9.2.3.4 Conversion loss table**Managing conversion loss tables**

Access: "Overview" > "Input" > "Input Source" > "External Mixer" > "Conversion Loss Table"

Conversion loss tables consist of value pairs that describe the correction values for conversion loss at certain frequencies. The correction values for frequencies between the reference points are obtained via interpolation.

The currently selected table for each range is displayed at the top of the dialog box. All conversion loss tables found in the instrument's C:\R_S\INSTR\USER\cvl\ directory are listed in the "Modify Tables" list.

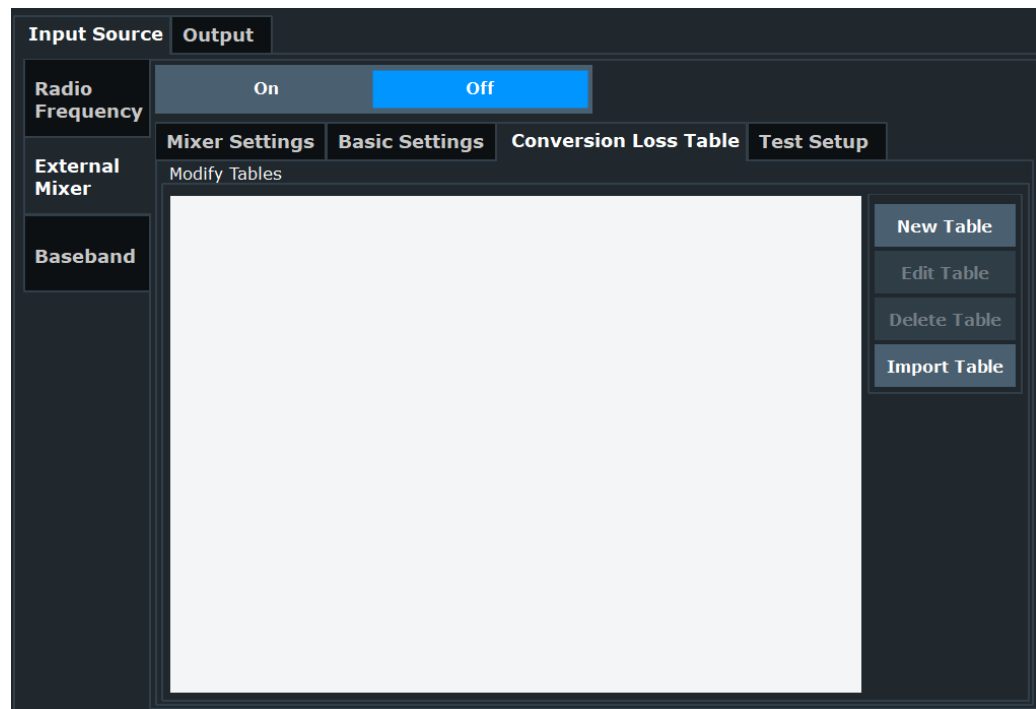

New Table	150
Edit Table	150
Delete Table	150
Import Table	150

New Table

Opens the "Edit conversion loss table" dialog box to configure a new conversion loss table.

For details on table configuration, see ["Editing conversion loss tables"](#) on page 150.

Remote command:

`[SENSe:]CORRection:CVL:SElect` on page 451

Edit Table

Opens the "Edit conversion loss table" dialog box to edit the selected conversion loss table.

For details on table configuration, see ["Editing conversion loss tables"](#) on page 150.

Remote command:

`[SENSe:]CORRection:CVL:SElect` on page 451

Delete Table

Deletes the currently selected conversion loss table after you confirm the action.

Remote command:

`[SENSe:]CORRection:CVL:CLEar` on page 449

Import Table

Imports one or more stored conversion loss tables from any directory and copies them to the instrument's `C:\R_S\INSTR\USER\cv1\` directory. They can then be assigned for use for a specific frequency range (see ["Conversion Loss"](#) on page 146).

Note:

Before copying any files to the `C:\R_S\INSTR\USER\cv1\` directory, the R&S FSWP firmware moves any existing user-defined cvl tables to a `backup` subdirectory. To use a user-defined cvl table later, select the file in the `C:\R_S\INSTR\USER\cv1\backup` directory.

Remote command:

```
MMEM: COPY '<conversionlosstable>',C:\R_S\INSTR\USER\cv1\
```

Editing conversion loss tables

Access: "Overview" > "Input" > "Input Source" > "External Mixer" > "Conversion Loss Table" > "New Table" / "Edit Table"

Conversion loss tables can be newly defined and edited.

A preview pane displays the current configuration of the conversion loss function as described by the position/value entries.

Table	
File Name	NONE
Comment	
Band Settings	
Band	<div style="display: flex; align-items: center;"> <div style="border: 1px solid black; width: 150px; height: 20px; margin-right: 5px;"></div> <div style="font-size: 10px;">▼</div> <div style="margin-left: 10px;">Mixer Name</div> <div style="border: 1px solid black; width: 150px; height: 20px; margin-left: 5px;"></div> </div>
Harmonic Order	<div style="display: flex; align-items: center;"> <div style="border: 1px solid black; width: 100px; height: 20px; text-align: center; margin-right: 5px;">2</div> <div style="margin-left: 10px;">Mixer S/N</div> <div style="border: 1px solid black; width: 100px; height: 20px; margin-left: 5px;"></div> </div>
Bias	<div style="display: flex; align-items: center;"> <div style="border: 1px solid black; width: 100px; height: 20px; text-align: center; margin-right: 5px;">0 A</div> <div style="margin-left: 10px;">Mixer Type</div> <div style="border: 1px solid black; width: 100px; height: 20px; text-align: center; margin-left: 5px;">2-Port ▼</div> </div>
Position	Value
<div style="display: flex; justify-content: space-between; width: 100%;"> 0.01 dB 10.00 mHz </div> <div style="display: flex; justify-content: space-between; width: 100%; margin-top: 10px;"> -0.01 dB -10.00 mHz </div>	
Insert Value	Delete Value
Shift x	Shift y
Save	

File Name..... 151

Comment..... 152

Band..... 152

Harmonic Order..... 152

Bias..... 152

Mixer Name..... 152

Mixer S/N..... 152

Mixer Type..... 153

Position/Value..... 153

Insert Value..... 153

Delete Value..... 153

Shift x..... 153

Shift y..... 153

Save..... 153

File Name

Defines the name under which the table is stored in the C:\R_S\INSTR\USER\cv1\ directory on the instrument. The name of the table is identical to the name of the file (without extension) in which the table is stored. This setting is mandatory. The .ACL extension is automatically appended during storage.

Remote command:

[SENSe:]CORRection:CVL:SElect on page 451

Comment

An optional comment that describes the conversion loss table. The comment is user-definable.

Remote command:

[\[SENSe:\]CORRection:CVL:COMMeNt](#) on page 449

Band

The waveguide or user-defined band to which the table applies. This setting is checked against the current mixer setting before the table can be assigned to the range.

For a definition of the frequency range for the pre-defined bands, see [table 14-3 on page 441](#).

Remote command:

[\[SENSe:\]CORRection:CVL:BAND](#) on page 448

Harmonic Order

The harmonic order of the range to which the table applies. This setting is checked against the current mixer setting before the table can be assigned to the range.

Remote command:

[\[SENSe:\]CORRection:CVL:HARMONic](#) on page 450

Bias

The bias current which is required to set the mixer to its optimum operating point. It corresponds to the short-circuit current. The bias current can range from -10 mA to 10 mA. The actual bias current is lower because of the forward voltage of the mixer diode(s).

Tip: You can also define the bias interactively while a preview of the trace with the changed setting is displayed, see "[Bias Value](#)" on page 148.

Remote command:

[\[SENSe:\]CORRection:CVL:BIAS](#) on page 448

Mixer Name

Specifies the name of the external mixer to which the table applies. This setting is checked against the current mixer setting before the table can be assigned to the range.

Remote command:

[\[SENSe:\]CORRection:CVL:MIXer](#) on page 450

Mixer S/N

Specifies the serial number of the external mixer to which the table applies.

The specified number is checked against the currently connected mixer number before the table can be assigned to the range.

Remote command:

[\[SENSe:\]CORRection:CVL:SNUMber](#) on page 451

Mixer Type

Specifies whether the external mixer to which the table applies is a two-port or three-port type. This setting is checked against the current mixer setting before the table can be assigned to the range.

Remote command:

[\[SENSe:\]CORRection:CVL:PORTs](#) on page 450

Position/Value

Each position/value pair defines the conversion loss value in dB for a specific frequency. Enter the reference values in order of increasing frequencies. You can define a maximum of 500 reference values. To enter a new value pair, select an empty space in the "Position"/"Value" table, or select [Insert Value](#).

Correction values for frequencies between the reference values are interpolated. Linear interpolation is performed if the table contains only two values. If it contains more than two reference values, spline interpolation is carried out. Outside the frequency range covered by the table, the conversion loss is assumed to be the same as for the first and last reference value.

The current configuration of the conversion loss function as described by the position/value entries is displayed in the preview pane to the right of the table.

Remote command:

[\[SENSe:\]CORRection:CVL:DATA](#) on page 449

Insert Value

Inserts a new position/value entry in the table.

If the table is empty, a new entry at 0 Hz is inserted.

If entries already exist, a new entry is inserted above the selected entry. The position of the new entry is selected such that it divides the span to the previous entry in half.

Delete Value

Deletes the currently selected position/value entry.

Shift x

Shifts all positions in the table by a specific value. The value can be entered in the edit dialog box. The conversion loss function in the preview pane is shifted along the x-axis.

Shift y

Shifts all conversion loss values by a specific value. The value can be entered in the edit dialog box. The conversion loss function in the preview pane is shifted along the y-axis.

Save

The conversion loss table is stored under the specified file name in the `C:\R_S\INSTR\USER\cv1\` directory of the instrument.

9.3 Level characteristics

Measurement results usually consist of the measured signal levels (amplitudes) displayed on the vertical y-axis for the determined frequency spectrum (horizontal, x-axis). The settings for the vertical axis, regarding amplitude and scaling, are described here.

- [Signal attenuation](#)..... 154
- [Amplitude characteristics](#)..... 155
- [Diagram scale](#)..... 157

9.3.1 Signal attenuation

Signal attenuation reduces the level of the signal that you feed into the R&S FSWP. Reducing the level is necessary to protect the input mixer from signals with high levels, because high levels can cause an overload of the input mixer. An input mixer overload in turn can lead to incorrect measurement results or even damage or destroy the input mixer.

The level at the input mixer is determined by the set RF attenuation according to the formula:

$$\text{level}_{\text{mixer}} = \text{level}_{\text{input}} - \text{RF attenuation}$$

The maximum level that the input mixer can handle is 0 dBm. Levels above this value cause an overload. The R&S FSWP indicates an overload situation by the "RF OVLD" label in the status bar.

The R&S FSWP features a mechanical attenuator. The mechanical attenuator is located directly after the RF input of the R&S FSWP. Its step size is 5 dB.

Effects of the attenuator

Attenuation has a direct effect on the sensitivity of the analyzer - attenuation must be compensated for by reamplifying the signal levels after the mixer. Thus, high attenuation values cause the inherent noise (or noise floor) to rise, which in turn decreases the sensitivity of the analyzer. The highest sensitivity is obtained at an RF attenuation of 0 dB. Each additional 10 dB of attenuation reduces the sensitivity by 10 dB, i.e. the displayed noise is increased by 10 dB. To measure a signal with an improved signal-to-noise ratio, decrease the RF attenuation.

Another (positive) effect is that high attenuation also helps to avoid intermodulation.



For ideal sinusoidal signals, the displayed signal level is independent of the RF attenuation.

In the default state, the R&S FSWP automatically determines the attenuation according to the signal level that is currently applied. Automatic determination of the attenuation is a good way to find a compromise between a low noise floor, high intermodulation levels, and protecting the instrument from high input levels.

However, you can also define the attenuation manually, if necessary.

9.3.2 Amplitude characteristics

Access: "Overview" > "Amplitude / Scaling" > "Amplitude"

Amplitude settings allow you to adapt the R&S FSWP for the signal that is fed into its input (for example the RF input).

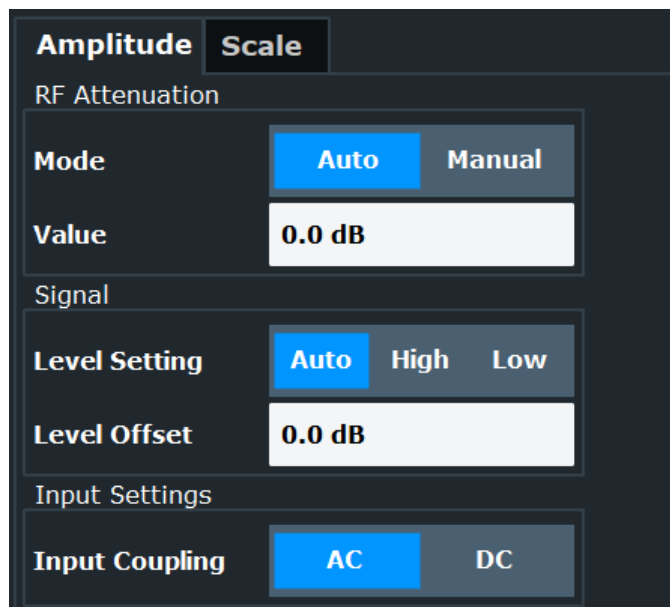

Functionality to configure amplitude characteristics described elsewhere:

- ["Input Coupling"](#) on page 136
- [Level Setting](#)

The remote commands required to configure the amplitude are described in [Chapter 14.6.4, "Remote commands to configure level characteristics"](#), on page 467.

Attenuating the signal	155
Shifting the level	156
Searching for the signal level	156

Attenuating the signal

You can either determine the [attenuation](#) automatically or manually. Signal attenuation is possible in 5 dB steps. The range is specified in the data sheet.

When you select "Auto" mode, the R&S FSWP determines the attenuation based on the level of the signal that is applied. Automatic determination of the attenuation makes sure that the ideal attenuation is always selected.

In "Manual" mode, the "Value" field becomes available and you can define an attenuation as required.

Not available for baseband noise measurements.

NOTICE! Risk of hardware damage due to high power levels.

When you decrease the attenuation manually, make sure that the signal level does not exceed the maximum level allowed at the RF input. Otherwise, an overload of the input mixer can cause hardware damage.

Remote command:

Mode: `INPut<ip>:ATTenuation:AUTO` on page 471

Attenuation: `INPut<ip>:ATTenuation` on page 471

Shifting the level

You can define an arithmetic level offset that is added to the measured level.

Defining a level offset is useful, for example, if you attenuate or amplify the signal before it is fed into the R&S FSWP. The R&S FSWP is then able to display the correct power results.

To determine the required offset, consider the external attenuation or gain applied to the input signal. For attenuation, define a positive offset so the R&S FSWP increases the displayed power values. If an external gain is applied, define a negative offset so the R&S FSWP decreases the displayed power values.

Not available for baseband noise measurements and VCO measurements.

Not available for baseband noise measurements.

Remote command:

`[SENSe:]POWer:RLEVel:OFFSet` on page 472

Searching for the signal level

The R&S FSWP automatically measures the level of the signal you have applied and keeps track of the measured signal levels.

The currently measured signal level is displayed in the channel bar.

MultiView				Phase Noise	
Signal Frequency	4.0 GHz	RBW	10 %		
Signal Level	0.00 dBm	XCORR Factor	1		
Att	0 dB	Meas Time	~0.2 s		Meas: Phase Noise

Note that you should attenuate the signal if its level is too high, especially if you have no idea about the signal strength you are measuring. For more information, see ["Attenuating the signal"](#) on page 155.

The measurement starts only if the signal level is within the level threshold that you have defined via the "Auto Search" feature.

If the signal level is outside the threshold that you have defined, it is ignored.



Figure 9-3: Basic principle of the signal search feature

Signal search is not available for baseband noise measurements.

Remote command:

Signal level: `[SENSe:]POWer:RLEVel?` on page 472

Threshold: `[SENSe:]ADJust:CONFigure:LEVel:THReshold` on page 472

9.3.3 Diagram scale

Access: "Overview" > "Amplitude / Scaling" > "Scale"

The scale settings define the scale of the y-axis in graphical result displays.

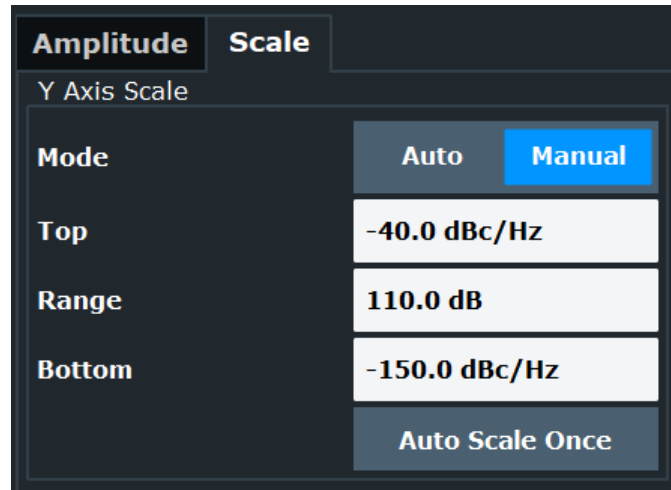

The remote commands required to configure the amplitude are described in [Chapter 14.6.4, "Remote commands to configure level characteristics"](#), on page 467.

Scaling the x-axis	157
Scaling the y-axis	157
Selecting the unit of the y-axis	158

Scaling the x-axis

You can scale the x-axis of the "Power vs Frequency" result display in a VCO characterization measurement.

Scaling the axis automatically has the advantage that the application automatically selects the ideal scale for the current measurement results. When you select the "Auto" scale mode, the R&S FSWP adjusts the scale of the axis during the measurement.

When you select the "Manual" scale mode, you can select any scale that suits your needs by entering specific "Start", "Stop" and "Span" values.

In addition, you can perform a single automatic scale adjustment with the "Auto Scale Once" feature. When you do so, the R&S FSWP selects the ideal scale for the current measurement results, but will not update the scale for the next measurement.

Scaling the y-axis

You can scale the y-axis of graphical result displays automatically or manually.

Scaling the axis automatically has the advantage that the application automatically selects the ideal scale for the current measurement results. When you select the "Auto" scale mode, the R&S FSWP adjusts the scale of the axis during the measurement.

When you select the "Manual" scale mode, you can select any scale that suits your needs. You can scale the axis by the following logic:

- Define a "Top" and "Bottom" value. The "Range" is adjusted accordingly.
- Define a "Top" value and a "Range". The "Bottom" value is adjusted accordingly.
- Define a "Range" and a "Bottom" value. The "Top" value is adjusted accordingly.
- When you change the "Top" or "Bottom" values only, the "Range" is adjusted.
- When you change the "Range" only, the "Bottom" value is adjusted.

In addition, you can perform a single automatic scale adjustment with the "Auto Scale Once" feature. When you do so, the R&S FSWP selects the ideal scale for the current measurement results, but will not update the scale for the next measurement.

Remote command:

Mode: `DISPlay[:WINDow<n>]:TRACe<t>:Y[:SCALe]:AUTO` on page 469

Top: `DISPlay[:WINDow<n>]:TRACe<t>:Y[:SCALe]:RLEVel` on page 469

Bottom: `DISPlay[:WINDow<n>]:TRACe<t>:Y[:SCALe]:RLEVel:LOWer`
on page 470

Range: `DISPlay[:WINDow<n>]:TRACe<t>:Y[:SCALe]` on page 468

Selecting the unit of the y-axis

Baseband noise measurements allow you to select one of several units in which the results are displayed.

You can select the desired unit from the "Y Axis Unit" dropdown menu.

Not available for all other measurements in the phase noise measurement application. The units used by other measurements depend on the selected diagram and cannot be changed manually.

Remote command:

`DISPlay[:WINDow<n>]:TRACe<t>:Y:UNIT` on page 470

9.4 Frequency

Access (carrier frequency): "Overview" > "Frequency"

Access (measurement range): "Overview" > "Noise Config" > "Noise Config"

Frequency settings allow you to control the characteristics of the measurement frequency.

Auto Search	
Signal Frequency	4.0 GHz
Level Setting	Auto High Low
Auto Search	On Off
Signal Count	On Off
Auto Search	
Start	1.0 MHz
Stop	26.501 GHz
Threshold	-20.0 dBm
Capture Range	Normal Wide 40 MHz
Low Pass	
State	On Off
Cutoff Frequency	1.0 MHz

The auto search features are available for phase noise and pulsed phase noise measurements.

The remote commands required to configure the frequency are described in [Chapter 14.6.5, "Remote commands to configure the frequency"](#), on page 473.

Defining the signal frequency	159
Searching for a signal	160
Capture Range	161
Defining the measurement range	161
Measuring low frequency and low level signals	162
L Low signal frequencies	162
L Low signal levels	162
L Multicarrier signals	163

Defining the signal frequency

The "Signal Frequency" is the frequency the signal is transmitted with.

You can define it manually in the corresponding input field or let the R&S FSWP search for the signal frequency in an [automatic frequency search](#) (turn on the "Auto Search" in that case).

For pulsed measurements (phase noise and additive noise), the minimum supported carrier frequency is 30 MHz.

Not available for baseband noise measurements.

Remote command:

[SENSe:]FREQuency:CENTer on page 475

Searching for a signal

The R&S FSWP automatically scans the frequency spectrum for any signals before a phase noise measurement begins. If it can find a signal on any frequency, it starts a measurement on that frequency.

The current signal frequency is displayed in the channel bar.

MultiView		Phase Noise	
Signal Frequency	4.0 GHz	RBW	10 %
Signal Level	0.00 dBm	XCORR Factor	1
Att	0 dB	Meas Time	~0.2 s

Meas: Phase Noise

In case you already know the signal frequency, you can also turn off the "Auto Search" and [define it manually](#). When you turn off automatic search, the R&S FSWP still verifies if a signal is present at the frequency you have defined and, if necessary, adjusts the frequency if the signal is a few Hz off. If you want to skip the signal verification and measure exactly the frequency you have entered manually, turn off the "Signal Count" feature. In that case, the R&S FSWP tunes to the frequency you have entered and measures its phase noise characteristics, even if no signal is present. Turning off the frequency counter can improve measurement speed, however.

The measurement starts only if a signal is present within the frequency search limits that you have defined via the "Auto Search" feature. The search range is defined by a minimum and maximum value. The maximum frequency range that you can scan depends on the hardware you are using. Note that a signal must also be within a certain [level range](#) for it to be detected.

No measurement will be initiated if no signal can be found in the frequency search range you have defined.

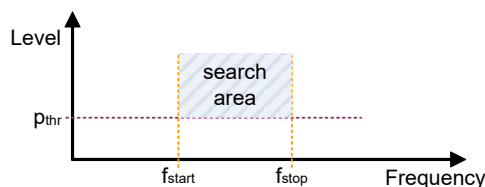

Figure 9-4: Basic principle of the signal search feature

During a frequency scan, the R&S FSWP steps through the frequency search range you have defined in a predefined step size (one step usually covers the full I/Q bandwidth).

Signal search is only available for phase noise and pulsed phase noise measurements.

Remote command:

Signal frequency: [SENSe:]FREQuency:CENTer on page 475

Mode: [SENSe:]ADJust:CONFigure:FREQuency:AUTOsearch[:STATe] on page 473

Signal count: [SENSe:]ADJust:CONFigure:FREQuency:COUNT on page 473

Lower search limit: [\[SENSe:\]ADJust:CONFigure:FREQuency:LIMit:LOW](#)
on page 474

Upper search limit: [\[SENSe:\]ADJust:CONFigure:FREQuency:LIMit:HIGH](#)
on page 474

Capture Range

The "Capture Range" defines the bandwidth with which the R&S FSWP searches for a signal or tracks drifting signals.

Use a "Normal" capture range for stable or slowly drifting DUTs. For fast drifting DUTs, use a "Wide" capture range.

Use a "40 MHz" capture range to measure carriers swept from -40 MHz to +40 MHz relative to the center frequency. Additional spurs and restrictions of the measurement accuracy are possible for CW signals, or carriers swept in other frequency ranges. For specifics of the measurement accuracy, refer to the data sheet.

The capture range is available for the phase noise measurement.

Remote command:

[\[SENSe:\]SWEep:CAPTure:RANGe](#) on page 478

Defining the measurement range

Noise measurements determine the noise of a DUT over a certain measurement range. The measurement range is defined by the two offset frequencies that you define ("Start Offset" and "Stop Offset").

The frequency offsets themselves are relative to the carrier frequency of the DUT: a frequency offset of 1 MHz, for example, measures the noise characteristics up to a distance of 1 MHz from the carrier. The maximum offset that you can define depends on the hardware you are using.

Note: For pulsed phase noise measurements (phase noise and additive), the maximum offset is limited to 30 MHz.

For baseband noise measurements, the frequency range is defined by absolute start and stop frequencies instead of relative offset frequencies. The center frequency represents the carrier frequency. The measurement range or span depends on the input you are using: For the RF input, it depends on the hardware you are using. For the baseband input, measurements up to 40 MHz are supported.

The measurement range thus defines the scale of the x-axis in the "Phase Noise" diagram.

The measurement range again is divided into several (logarithmic) decades, or, for configuration purposes, into [half decades](#).

Note: For [frequency stability measurements](#), the start and stop frequency offsets of the phase noise measurement are the reciprocal values of the start and stop values of the observation time ("Tau Start" and "Tau Stop").

Tau Start and Tau Stop thus define the scale of the x-axis in the "Allan Variance" and "Allan Deviation" diagrams.

Remote command:

Start offset: [\[SENSe:\]FREQuency:START](#) on page 476

Stop offset: [\[SENSe:\]FREQuency:STOP](#) on page 476

Start Tau: [SENSe:] TIME:START on page 485

Stop Tau: [SENSe:] TIME:STOP on page 485

Measuring low frequency and low level signals

The R&S FSWP provides functionality to measure the phase noise of signals with a low frequency and / or a low signal level.

- Low frequencies can be measured by applying the low pass filter.
- Low signal levels can be measured by selecting the appropriate level setting.
- Very low signal levels can be measured by selecting the appropriate level setting and applying the low pass filter.

Low signal frequencies ← Measuring low frequency and low level signals

The R&S FSWP provides a low pass filter that suppresses the DC offset of the I/Q mixer to measure signal frequencies below 1 MHz. Applying the filter results in a better sensitivity.

When you are measuring such signals, turn on the filter ("State"), and define its "Cutoff Frequency". The cutoff frequency should be the same as the signal frequency. For example, the cutoff frequency to measure a signal frequency of 100 Hz should also be 100 Hz.

Measuring low frequencies and levels is available for phase noise measurements on continuous wave signals.

Note that using the filter has several effects.

- The [automatic search](#) for a signal is not supported. Define the signal frequency manually instead.
- A [signal count](#) is not possible.
- The [stop offset](#) is limited to 20 % of the carrier signal frequency.

For measurements on frequencies below 10 MHz, you must use [DC coupling](#) (independent of the low pass filter).

Remote command:

Filter state: [SENSe:] FILTER:LPASs[:STATE] on page 475

Cutoff frequency: [SENSe:] FILTER:LPASs:FREQuency:MANual on page 474

Low signal levels ← Measuring low frequency and low level signals

The R&S FSWP supports different modes to measure signals with different levels.

- "Auto"; The R&S FSWP automatically selects the level setting that is best suited for the current measurement.
- "High": The R&S FSWP works like a traditional phase noise tester with zero IF.
- "Low": The R&S FSWP uses an IF of 15 MHz. Therefore, the DC offset of the I/Q mixers does not limit the sensitivity. It is recommended to use this level setting for signal levels below -10 dBm.

For very low signal levels (below approximately -40 dBm), the broadband noise in the demodulator becomes an issue and disables the measurement. To measure such signals, apply the [low pass filter](#), because it reduces the noise bandwidth. The nominal improvement of the sensitivity is 10 dB for 10 MHz, 20 dB for 1 MHz cutoff frequency.

Note that using the filter has several effects.

- The [automatic search](#) for a signal is not supported. Define the signal frequency manually instead.
- A [signal count](#) is not possible.
- The [stop offset](#) is limited to 20 % of the carrier signal frequency.

Remote command:

Filter state: `[SENSe:]FILTeR:LPASs[:STATe]` on page 475

Cutoff frequency: `[SENSe:]FILTeR:LPASs:FREQuency:MANual` on page 474

Level setting: `[SENSe:]POWeR:RLEVel:MODE` on page 477

Query current setting: `[SENSe:]POWeR:RLEVel:MODE:USED?` on page 477

Multicarrier signals ← Measuring low frequency and low level signals

You can also use the low pass filter when you want to measure the phase noise of a single carrier in a multicarrier signal. In that case, the cutoff frequency of the filter should be the same as the carrier spacing.

9.5 Noise measurement configuration

Noise measurements are performed based on several specific measurement parameters.

- [Triggered measurements \(phase noise CW\)](#)..... 163
- [Measurement range](#)..... 163
- [Noise configuration](#)..... 164
- [Integrated measurement configuration](#)..... 170
- [Spot noise information](#)..... 173
- [Spur display](#)..... 174
- [Frequency stability configuration](#)..... 177

9.5.1 Triggered measurements (phase noise CW)

The start of the noise measurements can be defined via the "Trigger" hardkey. If "Free Run" is selected, no trigger source is considered. You can start the measurement manually any time and stop it as required. If "External Trigger 1" is selected, a measurement starts when a TTL signal is fed into the [specified input connector](#).

9.5.2 Measurement range

Noise measurements determine the noise characteristics of a DUT over a particular measurement range. This **measurement range** is defined by two offset frequencies. The **frequency offsets** themselves are relative to the nominal frequency of the DUT.

The measurement range again is divided into several (logarithmic) decades, or, for configuration purposes, into **half decades**.

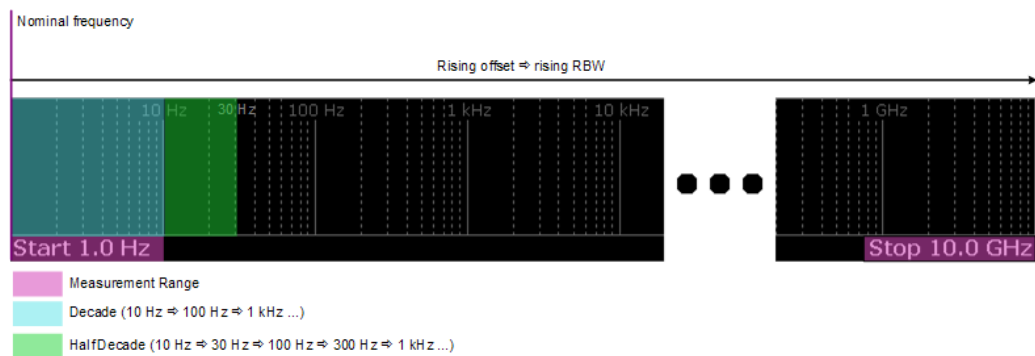

Figure 9-5: Measurement range and half decades

This breakdown into several half decades is made to speed up measurements. See "[Working with the half decade configuration table](#)" on page 169 for more information about the measurement configuration in each half decade.

The main issue in this context is the **resolution bandwidth (RBW)** and its effect on the measurement time. In general, it is best to use a resolution bandwidth as small as possible for the most accurate measurement results. However, accuracy comes at the price of measurement speed.

To avoid long measurement times, the application provides only a certain range of RBWs that are available for each half decade.

9.5.3 Noise configuration

Access: "Overview" > "Noise Config" > "Noise Config"

The measurement range parameters define the way the phase noise of a DUT is measured.

The screenshot shows the 'Noise Config' interface with two main sections: 'Measurement Configuration' and 'Half Decade Configuration'.

Measurement Configuration:

- Start Offset: 1.0 kHz
- Stop Offset: 1.0 MHz
- Half Decade Config: Auto (selected), Manual
- RBW: 10.0 %
- Ultra-Small RBWs: On, Off (selected)
- XCORR Factor: 1
- XCORR Optimization: On (selected), Off
- XCORR Optimization Threshold: 15.0 dB
- XCORR Gain Indicator: On (selected), Off
- Capture Range: Normal (selected), Wide, 40 MHz
- Sweep/Avg Count: 0
- Sweep Forward: On, Off (selected)

Half Decade Configuration Table:

Start Offset	Stop Offset	RBW	XCORR
1.0 kHz	3.0 kHz	300.0 Hz	1
3.0 kHz	10.0 kHz	300.0 Hz	1
10.0 kHz	30.0 kHz	1.0 kHz	10
30.0 kHz	100.0 kHz	3.0 kHz	37
100.0 kHz	300.0 kHz	10.0 kHz	130
300.0 kHz	1.0 MHz	30.0 kHz	400

The remote commands required to configure the measurement range are described in [Chapter 14.6.6.1, "Noise configuration"](#), on page 478.

Functions to configure the measurement range described elsewhere:

- [Start Offset](#)
- [Stop Offset](#)
- [Capture Range](#)

[Estimating the measurement time](#)..... 165

[Defining the resolution bandwidth](#)..... 166

[Ultra-Small RBWs](#)..... 166

[Defining cross-correlation parameters](#)..... 167

[Cross-correlation gain indicator](#)..... 168

[Capture Range](#)..... 168

[Sweep/Average Count](#)..... 169

[Selecting the sweep direction](#)..... 169

[Working with the half decade configuration table](#)..... 169

Estimating the measurement time

Based on the parameters you have defined for the noise measurement, the application estimates the total measurement time required to measure the noise characteristics over all half decades. It is displayed in the channel bar ("Meas Time" label).

The remaining measurement time of the current measurement is indicated in the progress bar in the status bar (for measurements that last longer than 1 second).

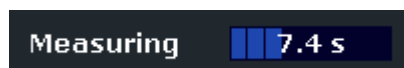

Display of the remaining measurement time is supported by the following measurements:

- Phase noise
- Pulsed (additive) phase noise
- Baseband noise

The measurement time is function of the [resolution bandwidth](#), [cross-correlation factor](#) and the [number of averages](#) defined for the measurement.

For [resolution bandwidths](#) below 0.1%, the estimated measurement time is not available.

Remote command:

[\[SENSe:\]SWEep:TIME](#) on page 483

Defining the resolution bandwidth

The resolution bandwidth (RBW) is the filter bandwidth applied during the noise measurement. Noise measurements apply a different resolution bandwidth to each half decade that is measured: small bandwidths for small frequency offsets and higher bandwidths for larger frequency offsets (to speed up the measurement on larger frequency offsets).

You can define a custom resolution bandwidth for each half decade, or let the application select an appropriate resolution bandwidth, depending on the "Half Decade Config" mode.

For an **automatic selection**, the resolution bandwidth that is applied to each half decade is a function of the frequency offset. By default, the resolution bandwidth is 10 % of the start offset of the half decade. If the start offset is, for example 10 kHz, the resulting resolution bandwidth is 1 kHz.

If necessary, you can change the resolution bandwidth factor. A selected set of percentages in the range from 0.1 % to 30 % is supported.

A resolution bandwidth factor below 0.1% is available with the [Ultra-Small RBWs](#).

For a **manual selection**, you can enter the required resolution bandwidth as an absolute value in the corresponding cells of the [half decade table](#).

Remote command:

Configuration mode: [\[SENSe:\]SWEep:MODE](#) on page 483

RBW factor: [\[SENSe:\]LIST:BWIDth\[:RESolution\]:RATio](#) on page 479

RBW: [\[SENSe:\]LIST:RANGe<ri>:BWIDth\[:RESolution\]](#) on page 479

Ultra-Small RBWs

Provides functionality to enable ultra-small resolution bandwidths (RBW) for the current measurement.

It can only be used in [phase noise](#) and [additive noise](#) measurements.

The minimum RBW can be set to 0.0003% (instead of 0.1%) if this function is enabled. Also, only one measurement channel can be used due to memory limitation.

Be aware that if the function is enabled, and the function is enabled in an instrument saveset, recall of the saveset fails. If the function is enabled in a saveset used for startup recall, every second preset acts as if startup recall had been disabled.

If this function is enabled and RBWs below 0.1% are used, the estimated [measurement time](#) is not available.

Remote command:

[\[SENSe:\]LIST:BWIDth\[:RESolution\]:USMall](#) on page 481

Defining cross-correlation parameters

Cross-correlation is a method to calculate the noise characteristics by routing it through two different signal paths. The signal has correlated noise characteristics in both channels while the oscillators have uncorrelated noise characteristics. Through cross-correlation operations, the noise of the DUT is kept constant while the noise of the signal path is reduced.

You can define a custom number of cross-correlation operations for each half decade, or let the application select an appropriate number, depending on the "Half Decade Config" mode.

For an **automatic selection**, the number of cross-correlation operations that are performed depends on the half decade that is measured. Small offsets (which usually have a higher noise level) require fewer operations to get accurate results, while large offsets (whose noise levels can be very low) require more operations for accurate results.

The base number of the first decade is a fixed value. The number of operations for the other half decades is determined in such a way, that all operations are finished at roughly the same time.

For a **manual selection**, you can enter the required number of cross-correlation operations as an absolute value in the corresponding cells of the [half decade table](#).

Example:

The operations in the first half decade need 1 s to finish. The number of operations done in the other half decades is calculated with respect to this 1 s timeframe. For example, if the application can perform 10 cross-correlation operations in 1 s in another half decade, it will do so, but no more than that number.

You can control the number of cross-correlations for the first half decade with the cross-correlation factor ("XCORR Factor"). By multiplying this value with the base number of operations for the first half decade, the application calculates the time it takes to perform these operations in the first half decade and then adjusts the number of operations for all other half decades.

When you turn on the "XCORR Optimization" feature, cross-correlation operations are only performed as long as the measurement results still improve. When this is not the case, the R&S FSWP stops calculating results, even when the selected number of operations has not yet been reached. This is thus a good tool to speed up the measurement.

The point at which measurement results cannot be improved anymore is defined by the "XCORR Optimization Threshold". The threshold is the distance between the [gain indicator](#) and the actual trace. When the distance between those two traces exceeds the threshold in any given half decade, the R&S FSWP stops measuring in this half decade and resumes with the next one.

Example:

The number of operations in a half decade is 30. When optimization is on, and the results do not improve any more after 20 operations, the application stops measurements in that half decade.

You can also finish the measurement of a specific half decade manually with the "Finish Segment" softkey available in the "Sweep" menu. The R&S FSWP resumes the measurement of the next half decade in that case.

For offsets greater than 30 MHz, each half decade is divided into smaller segments. For these offsets, the "Finish Segment" feature does not resume with the next half decade, but with the next offset segment.

Remote command:

Configuration mode: `[SENSe:]SWEep:MODE` on page 483

XCORR factor: `[SENSe:]SWEep:XFACTOR` on page 484

XCORR number: `[SENSe:]LIST:RANGE<ri>:XCOUNT` on page 481

Optimization: `[SENSe:]SWEep:XOPTimize[:STATe]` on page 484

Optimization threshold: `[SENSe:]SWEep:XOPTimize:THReshold` on page 484

Finish segment: `[SENSe:]SWEep:FSEGment` on page 482

Cross-correlation gain indicator

The [phase noise diagram](#) contains a gray area in its default state. This area represents the cross-correlation gain indicator.

It shows the rejection of uncorrelated noise dependent on the number of correlation averages. If the measurement trace itself lies on the cross-correlation gain indicator, further correlation will reduce the phase noise value. If some distance between the cross-correlation gain indicator and the measurement result is obtained, further correlation will not reduce the phase noise value any more, but only smooth the trace. When you turn on the "Optimize XCORR" feature, the measurement stops automatically when the gap between the cross-correlation gain indicator and the measurement trace exceeds 10 dB.

You can turn the display of the gray area on and off as required.

You can also query the data of the cross-correlation gain indicator.

Remote command:

Turn indicator on or off: `DISPlay: XGINdicator[:STATe]` on page 479

Query indicator: `TRACe<n>[:DATA]? XGINdicator`

Capture Range

The "Capture Range" defines the bandwidth with which the R&S FSWP searches for a signal or tracks drifting signals.

Use a "Normal" capture range for stable or slowly drifting DUTs. For fast drifting DUTs, use a "Wide" capture range.

Use a "40 MHz" capture range to measure carriers swept from -40 MHz to +40 MHz relative to the center frequency. Additional spurs and restrictions of the measurement accuracy are possible for CW signals, or carriers swept in other frequency ranges. For specifics of the measurement accuracy, refer to the data sheet.

The capture range is available for the phase noise measurement.

Remote command:

[SENSe:] SWEEp:CAPTure:RANGe on page 478

Sweep/Average Count

Defines the number of measurements to be performed in the single sweep mode. Values from 0 to 200000 are allowed. If the values 0 or 1 are set, one measurement is performed.

The sweep count is applied to all the traces in all diagrams.

For "Average" trace mode, the "Sweep Count" also determines the number of individual measurements used to average the trace.

In continuous sweep mode, a "Sweep Count" = 0 (default) calculates a moving average over 10 measurements. A "Sweep Count" = 1 calculates no averages.

Remote command:

[SENSe:] SWEEp:COUNT on page 482

Selecting the sweep direction

The sweep direction selects the order in which the R&S FSWP measures the half decades.

For the reverse sweep ("Sweep Forward" = "Off"), the measurement sequence is:

- Analysis of half decades > 30 MHz
- Analysis of half decades between 30 MHz and 1 MHz
- Analysis of half decades < 1 MHz

For the forward sweep ("Sweep Forward" = "On"), the measurement sequence is:

- Analysis of half decades < 1 MHz
- Analysis of half decades between 30 MHz and 1 MHz
- Analysis of half decades > 30 MHz

Otherwise, the measurements are the same and yield the same results, regardless of the sweep direction you select. The difference is that results near the carrier are available faster when you select the forward sweep.

Remote command:

[SENSe:] SWEEp:FORWard on page 482

Working with the half decade configuration table

The half decade configuration table shows the measurement characteristics for each half decade that is part of the measurement.

The features of the table depend on the "Half Decade Config" mode:

- For the **automatic mode**, the table is read only, the values in the table depend on the settings you have made for the noise measurements ([RBW Factor](#) and [XCORR Factor](#)).
The size (number of rows) depends on the number of half decades that you have defined.
Automatic half decade configuration is designed to yield the optimal measurement times for each half decade.
- For the **manual mode**, you can define custom values for the [resolution bandwidth](#) (RBW) and the number of [cross-correlation operations](#).

The table contains the following values.

- **Start Offset**

Start frequency offset of the half decade.

Depends on the [frequency offsets](#) you have defined.

- **Stop Offset**

Stop frequency offset of the half decade.

Depends on the [frequency offsets](#) you have defined.

- **RBW**

Resolution bandwidth applied to the corresponding half decade during the measurement.

Depends on the [resolution bandwidth factor](#) you have defined.

Custom RBWs become available when you are using manual configuration mode.

- **XCORR**

Shows the number of cross-correlation operations applied in the corresponding half decade.

Depends on the [XCORR factor](#) you have defined.

Custom cross-correlation operations become available when you are using manual configuration mode.

Remote command:

Configuration mode: `[SENSe:]SWEep:MODE` on page 483

Start offset: `[SENSe:]LIST:RANGe<ri>:FREQuency:STARt?` on page 480

Stop offset: `[SENSe:]LIST:RANGe<ri>:FREQuency:STOP?` on page 480

RBW: `[SENSe:]LIST:RANGe<ri>:BWIDth[:RESolution]` on page 479

XCORR: `[SENSe:]LIST:RANGe<ri>:XCOut` on page 481

9.5.4 Integrated measurement configuration

Access: "Overview" > "Noise Config" > "Integrated Measurements"

You can control the integration ranges and data source (traces) that the calculations for integrated measurement results are based on.

For integrated measurements, the raw measurement data are used instead of the data smoothed by the [trace smoothing](#) functionality.

Noise Config	Integrated Measurements	Spot Noise	Spurious	Frequency Stability	
Ranges 1-5		Ranges 6-10		Weighting Filter	
Ranges					
	Show	Range	Range Start	Range Stop	Weighting Filter
Range 1	Trace 1 ▾	Meas Manual	1.0 kHz	1.0 MHz	NONE ▾
Range 2	None ▾	Meas Manual	1.0 kHz	1.0 MHz	NONE ▾
Range 3	None ▾	Meas Manual	1.0 kHz	1.0 MHz	NONE ▾
Range 4	None ▾	Meas Manual	1.0 kHz	1.0 MHz	NONE ▾
Range 5	None ▾	Meas Manual	1.0 kHz	1.0 MHz	NONE ▾

The remote commands required to configure residual calculations are described in [Chapter 14.6.6.2, "Residual calculation configuration"](#), on page 486.

Selecting the trace for residual calculations.....	171
Defining the integration range.....	171
Working with weighting filters.....	171
L Applying weighting filters.....	171
L Managing weighting filters.....	172
L Designing weighting filters.....	172

Selecting the trace for residual calculations

Residual calculations are only performed when you select an (active) trace that serves as the data source (when the selected trace is inactive, residual effects are not calculated).

You can select any trace as the data source ("Trace 1" to "Trace 6" in the dropdown menu), and define the [frequency range](#) over which the integration is performed.

When you select "None" from the dropdown menu, residuals effects are not calculated.

Remote command:

`CALCulate<n>[:RANGe<ri>]:EVALuation:TRACe` on page 487

Defining the integration range

You can define up to 10 integration ranges on different [traces](#).

By default, the R&S FSWP integrates over the entire frequency range defined for the measurement (Range = "Meas"). You can, however, also define custom integration ranges (Range = "Manual").

In that case, the input fields next to the "Range" control become available to define a customized integration range. The application shows orange lines ("Range <x>") in the graphical result display to indicate custom ranges.

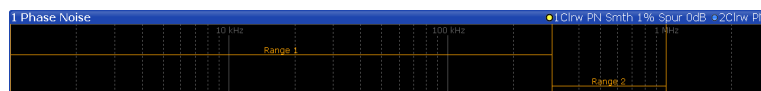

Remote command:

State: `CALCulate<n>[:RANGe<ri>]:EVALuation[:STATe]` on page 487

Start: `CALCulate<n>[:RANGe<ri>]:EVALuation:STARt` on page 486

Stop: `CALCulate<n>[:RANGe<ri>]:EVALuation:STOP` on page 486

Working with weighting filters

The weighting filter feature provides functionality to correct integrated measurements and thus compensate for external effects that affect the results in certain frequency ranges. A weighting filter is a useful feature if you already know that this is the case and would like to compensate for these effects.

Note that the weighting filter only has an effect on the integrated measurement results and has no effect in the noise diagram or other numerical results.

Applying weighting filters ← Working with weighting filters

When you apply a weighting filter, the R&S FSWP takes the correction values defined in the weighting filter into account for the calculation of integrated measurements.

The "Weighting Filter" dropdown menu contains all weighting filters that are available on the internal hard disk of the R&S FSWP.

Remote command:

[CALCulate<n>\[:RANGe<j>\]:EVALuation:WEIGhting](#) on page 488

Managing weighting filters ← Working with weighting filters

The table in the "Residual Calculations" dialog box shows all currently available weighting filter.

From this dialog box, you have the following options.

- Edit a weighting filter that already exists (→ "Edit").
- Create a new weighting filter (→ "New").
- Create a new weighting filter based on an existing one (→ "Copy").
If necessary, you can delete the selected filter at any time (→ "Delete").

Each of the options opens a dialog box that contains the functionality to characterize a weighting filter.

Remote command:

Select a filter: [\[SENSe:\]CORRection:WEIGhting:SELEct](#) on page 489

Delete: [\[SENSe:\]CORRection:WEIGhting:DELEte](#) on page 488

Designing weighting filters ← Working with weighting filters

The R&S FSWP provides the following tools to design a weighting filter.

- "Name" / "Comment"
Defines a name and / or comment of the weighting filter. The name defines the label by which the filter appears in the "Weighting Filter" dropdown menu.
- "Position" and "Value"
Define the data points of the weighting filter (including a graphical preview). They define by which amount (dB) residual effects are corrected for specific frequencies. For example, you could say that at a frequency of 100 MHz, the residual effects are corrected by 5 dB.
- "Insert Value"
Inserts a weighting filter data point. Alternatively, you can click in the table itself to add a new data point.
- "Delete Value"
Deletes the currently selected data point. The currently selected data point is highlighted blue.
- "Shift X" / "Shift Y"
Shifts all data points of the weighting filter horizontally or vertically by a certain amount.
- "Save"
Saves and stores the weighting filter on the internal hard disk of the R&S FSWP.

A weighting filter consists of up to 625 data points. Each data point is a pair of values: the first value describes the frequency, the second value describes the level (correction value) for that frequency.

Frequencies must be entered in ascending order and must not overlap.

When you save the filter, the R&S FSWP uses the name of the weighting filter as the file name. If a weighting filter of the same name already exists, the R&S FSWP asks before it overwrites the existing file.

Remote command:

Name: `[SENSe:]CORRection:WEIGHting:NAME` on page 489

Comment: `[SENSe:]CORRection:WEIGHting:COMMeNt` on page 488

Data: `[SENSe:]CORRection:WEIGHting:DATA` on page 488

9.5.5 Spot noise information

Access: "Overview" > "Noise Config" > "Spot Noise"

Spot noise is the phase noise measured at a certain offset frequency. The information about spot noise is provided in the noise diagram (optionally) and in a separate spot noise information table.

The R&S FSWP provides several features to control the spot noise information.

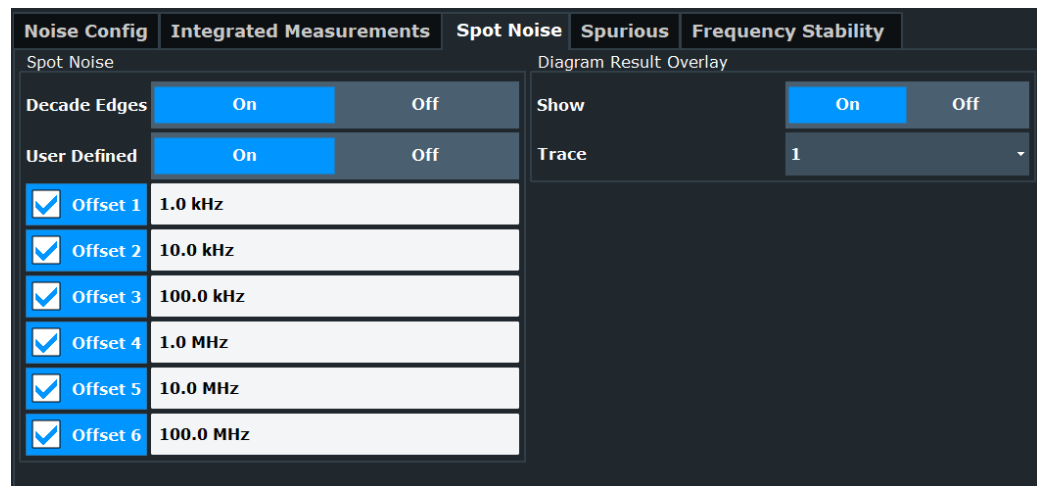

The remote commands required to configure spot noise measurements are described in [Chapter 14.6.6.3, "Spot noise configuration"](#), on page 489.

Displaying spot noise information	173
Selecting the spot noise positions	174

Displaying spot noise information

By default, when you perform a measurement, the R&S FSWP displays the spot noise information in the diagram area.

You can turn off the displayed spot noise information any time, for example if you want a better view of the measurement results.

You can also select the trace the displayed spot noise information refers to from the "Trace" dropdown menu.

Remote command:

`DISPlay:SNINfo[:STATe]` on page 493

`DISPlay:SNINfo:TRACe` on page 493

Selecting the spot noise positions

The R&S FSWP provides several methods to define the positions where the spot noise is measured.

By default, it calculates the spot noise on all "Decade Edges" (10^x offset frequencies) in the measurement range. Therefore, the number of spot noise results depends on the measurement range.

If you want to evaluate the spot noise on positions other than the decade edges, you can add "User Defined" spot noise positions. When you turn on that feature, changes that you make to the "Offset" input fields are considered in the current measurement (by default, user defined spot noise positions are the decade edges).

You can define any offset frequency that is part of the measurement range as a new spot noise position. To exclude an offset frequency, uncheck the checkbox of the current offset.

The results for the user defined spot noise positions are displayed in the spot noise table in addition to the decade edge spot noise results.

When you turn off the "Decade Edges" spot noise positions, the spot noise table contains only the user defined spot noise positions.

Remote command:

See [Chapter 14.6.6.3, "Spot noise configuration"](#), on page 489.

9.5.6 Spur display

Access: "Overview" > "Noise Config" > "Spurious"

Spurs are (usually undesired) peak levels that can occur in the measured frequency range. They are represented by unusually tall spikes on the trace.

Noise Config	Integrated Measurements	Spot Noise	Spurious	Frequency Stability
Specifics for Diagram		Spurious Filter		
Trace 1	Detection Threshold 6.0 dB	Hide <input checked="" type="checkbox"/>	Mode Off	Suppress Show
Trace 2	6.0 dB	<input type="checkbox"/>	Include Harmonics <input type="checkbox"/>	
Trace 3	6.0 dB	<input type="checkbox"/>	Range 1.0 * RBW	
Trace 4	6.0 dB	<input type="checkbox"/>	Name NONE	
Trace 5	6.0 dB	<input type="checkbox"/>	Offset	
Trace 6	6.0 dB	<input type="checkbox"/>		
Specifics for	1: PN Noise Spectrum			
Spurious List				
Sort Order	Power	Offset		
Weighting Filter	NONE			
Spurious Color	Trace	Shifted		
		Insert	Delete	Clear
		Save	Load	

The remote commands required to configure the spur display are described in [Chapter 14.6.6.4, "Spur display"](#), on page 493.

Hiding spurs

Hiding spurs is a method to remove displayed peak levels visually.

You can apply spur removal to all active traces individually (spurious removal "Hide In Diagram"), and define a threshold (in dB) that defines when a peak level is recognized as a spur (spurious removal "Detection Threshold").

Note: In the spot noise vs tune measurement, spur removal properties apply to all traces.

Remote command:

State: `DISPlay[:WINDow<n>]:TRACe<t>:SPURs:SUPPpress` on page 494

Value: `DISPlay[:WINDow<n>]:TRACe<t>:SPURs:THReshold` on page 494

State (SN vs Tune): `[SENSe:]SPURs:SUPPpress` on page 507

Value (SN vs Tune): `[SENSe:]SPURs:THReshold` on page 507

Sorting spurs

The sort order of the spurs in the [spurious list](#) result display depends on the "Sort Order" you select.

"Power" Sorts the spurs according to their power (highest to lowest power).

"Offset" Sorts the spurs according to their offset from the carrier (lowest to highest offset).

Remote command:

`[SENSe:]SPURs:SORT` on page 495

Applying a spurious weighting filter

The spurious weighting filter feature provides functionality to apply a weighting filter to spurious analysis. For more information on how to apply, manage and design weighting filters, see ["Working with weighting filters"](#) on page 171.

Remote command:

[\[SENSe:\] SPURs:WEIGhting](#) on page 495

Defining the spurious color

The spurious color feature provides functionality to enable an automatic shift of the color of the displayed spurious lines. The color setting is not changed by a preset of the instrument.

Remote command:

[\[SENSe:\] SPURs:COLor](#) on page 497

Filtering spurs

Filtering spurs is a method to show or hide items of the spurious list.

Mode	<ul style="list-style-type: none"> • "Off": No spurious filter is applied. • "Suppress": The spurs in the spurious filter are removed from the spurious list, the diagram and dependent calculations. • "Show": Only the spurs in the spurious filter are displayed in the spurious list, the diagram and dependent calculations.
Include Harmonics	In addition to the spurs in the defined spurious filter list, also their harmonics are displayed or removed in the spurious list.
Range	Defines the filter range as a multiple of the resolution bandwidth.
Name	Displays the name of the currently selected spurious filter.
Spurious Filter Management	<p>The spurious filter configuration table provides several management tools:</p> <ul style="list-style-type: none"> • "Insert": Adds a new offset frequency to the spurious filter. • "Delete": Removes an existing offset frequency from the spurious filter. • "Clear": Clears the spurious filter. • "Save": Saves the spurious filter configuration. With this function, the name of the spurious filter can be defined. • "Load": Loads an existing spurious filter configuration.

Remote command:

[\[SENSe:\] SPURs:FILTer:MODE](#) on page 495

[\[SENSe:\] SPURs:FILTer:HARMonics](#) on page 496

[\[SENSe:\] SPURs:FILTer:RANGe](#) on page 496

[\[SENSe:\] SPURs:FILTer:NAME?](#) on page 496

[\[SENSe:\] SPURs:FILTer:OFFSet](#) on page 496

[\[SENSe:\] SPURs:FILTer:CLEar](#) on page 497

[\[SENSe:\] SPURs:FILTer:SAVE](#) on page 497

[\[SENSe:\] SPURs:FILTer:LOAD](#) on page 497

9.5.7 Frequency stability configuration

Access: "Overview" > "Noise Config" > "Frequency Stability"

The results of the frequency stability measurements ([Allan variance and deviation](#)) are derived from the phase noise measurement. Thus, the frequency stability measurements and the phase noise measurement use the same configuration.

The "Frequency Stability" dialog contains the most important settings for the frequency stability measurements. However, everything that you change in the [phase noise configuration](#) is also applied to the frequency stability measurements, and vice versa.

- "Tau Start" and "Tau Stop"
Tau start and stop define the observation time Tau for the frequency stability measurement. They are coupled to the [measurement range](#). Tau start is the reciprocal value of the stop frequency offset. Tau stop is the reciprocal value of the start frequency offset.
For example, a measurement range from 1 mHz to 1 MHz would result in an observation time from 1 μ s to 1000 s and vice versa.
- "RBW" and "XCORR"
Note that if you define the [RBW](#) and number of [cross-correlation](#) operations manually, the values of the half decade configuration table are also applied to the frequency stability measurements.
- "Meas BW"
The measurement bandwidth (or integration bandwidth) is the reciprocal value of "Tau Start".

Noise Config	Integrated Measurements	Spot Noise	Spurious	Frequency Stability
Frequency Stability				
Tau Start	1.0 μ s			
Tau Stop	1.0 ms			
Meas BW	1.0 MHz			
RBW	10.0 %			
XCORR Factor	1			

The remote commands required to configure frequency stability measurements are described in [Chapter 14.6.6.1, "Noise configuration"](#), on page 478.

9.6 Output

The phase noise application is able to provide different kinds of output for various purposes.

For more information about the available connectors, refer to the getting started manual.

- [DC source configuration](#).....178
- [Signal source configuration](#).....181
- [Miscellaneous output](#).....185

9.6.1 DC source configuration

Access (all DC port settings): "Overview" > "Output" > "Output" > "DC Config"

Access (most relevant DC port settings):  (in the toolbar)

Access (DC port state): "Overview" >  (in the toolbar)

The "DC Power" settings allow you to configure the DC power supply sources available on the front panel for different purposes.

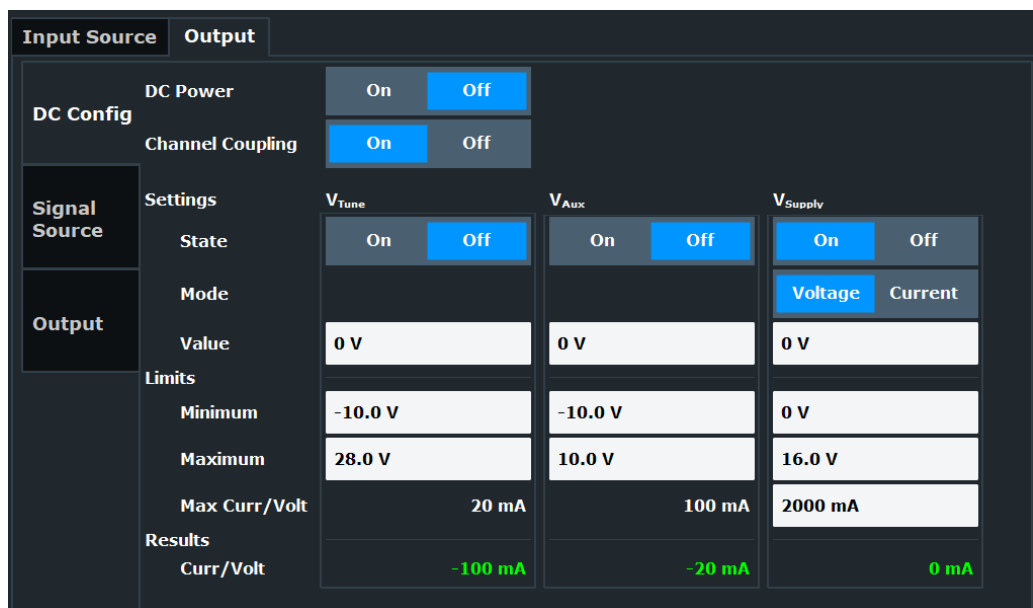

Proper configuration of the DC ports

Setting DC voltages and currents properly is an important step during the configuration in order not to damage the device under test (DUT) by applying too much voltage or current!

Therefore it is recommended to connect the device under test (DUT) to the instrument after the DC settings have been made and verified.

The remote commands required to configure the DC power output are described in [Chapter 14.6.2, "Output"](#), on page 451.

- [Turning the DC output on and off](#).....179
- [Coupling the output configuration across measurement channels](#).....179
- [Configuring the DC power output](#).....179
 - ↳ [Turning the output on and off](#).....179

L Selecting the output type (Vsupply only)	180
L Defining the output level	180
L Reading the actual output levels	181

Turning the DC output on and off

DC output power is only supplied when you turn on the DC power output in general with the "DC Power" feature.

You have to turn on at least one of the individual voltage supplies V_{supply} , V_{tune} or V_{aux} (→ [Output State](#)) before you can turn on DC output in general.

When you turn off DC power supply in general, no power is supplied, even when the individual outputs have been turned on.

Remote command:

`SOURce:VOLTagE[:STATe]` on page 460

Coupling the output configuration across measurement channels

You can couple the configuration of the DC power output and the (optional) signal source output across all active measurement channels.

When you turn on coupling, all active measurement channels apply the same configuration.

When you turn off coupling, you can define a different configuration for each measurement channel.

Remote command:

DC power: `SOURce:VOLTagE:CHANnel:COUPling` on page 455

Signal source: `SOURce:GENerator:CHANnel:COUPling` on page 461

Configuring the DC power output

The R&S FSWP features three outputs that allow you to supply external devices like the DUT or external measurement equipment with DC power.

The outputs are labeled " V_{supply} " (supply voltage), " V_{tune} " (tuning voltage) and " V_{aux} " (auxiliary voltage). Each of the outputs has different characteristics regarding the supported voltage range and maximum output current, and is thus designed for different purposes.

Note: If you change one of the DC power output parameters during a measurement, the measurement is aborted and restarted.

For more information about the output connectors, refer to the getting started.

Basically, you can define the same parameters for all three outputs.

- ["Turning the output on and off"](#) on page 179
- ["Selecting the output type \(Vsupply only\)"](#) on page 180
- ["Defining the output level"](#) on page 180
- ["Reading the actual output levels"](#) on page 181

Turning the output on and off ← Configuring the DC power output

Apart from the general [DC power output state](#), you can turn each individual output on and off. Output is generated only, when the required DC output is actually turned on.

By default, all outputs are turned off. When you want to use one of the outputs, turn it on.

Note that you have to turn on at least one of the outputs to be able to [turn on the output in general](#).

Remote command:

V_{supply} : `SOURce:VOLTage:POWer<i>:LEVel[:STATe]` on page 459

V_{tune} : `SOURce:VOLTage:CONTRol<i>:LEVel[:STATe]` on page 457

V_{aux} : `SOURce:VOLTage:AUX:LEVel[:STATe]` on page 455

Selecting the output type (V_{supply} only) ← Configuring the DC power output

The supply voltage output (V_{supply}) supports variable voltages and variable current. For this output, you can select whether you want to control the output in terms of current or voltage.

When you select "Voltage", you can define the output in terms of the voltage that is supplied. The supplied current is adjusted accordingly (up to the maximum current you have allowed).

When you select "Current", you can define the output in terms of the current that is supplied. The supplied voltage is adjusted accordingly (up to the maximum voltage you have allowed).

The other outputs are already limited regarding the output current; only the voltage is variable for these outputs.

Note: When you switch between "Voltage" and "Current", DC output is turned off as a precaution. You have to [turn it on](#) again deliberately.

Remote command:

`SOURce:VOLTage:POWer<i>:LEVel:MODE` on page 458

Defining the output level ← Configuring the DC power output

For all three outputs, you can control the voltage that should be output to supply the DUT or other devices. The supported voltage range is different for each output (see data sheet for details).

In addition to the hardware limits regarding the range of output values, you can also define soft limits. These soft limits limit the output to a range that suits your needs. They thus help you to avoid accidentally defining an output level that is too high for the DUT you are testing.

Note that when you change the output voltage while a measurement is running, this measurement is aborted and restarted.

Controlling the supply current for the V_{supply} output

For the supply voltage output (V_{supply}), you can select whether you want to control the output in terms of current or voltage (→ [Output Type](#)).

If you select output type "Voltage", you can define the output level and limits in terms of voltage (the current is adjusted, if necessary).

If you select output type "Current", you can define the output level and limits in terms of current (the voltage is adjusted, if necessary). In that case, the range defining the soft limits are also defined in terms of current.

In addition, you can define the maximum output current (or voltage) that is supplied in the "Max Curr / Volt" field.

For the other two outputs (V_{tune} and V_{aux}), the maximum current that can be drawn by the DUT is fixed to the value supported by the hardware. The "Max Curr / Volt" information is read-only information for these two outputs.

Remote command:

Level V_{supply} : `SOURce:VOLTage:POWer<i>:LEVel:AMPLitude` on page 457

Level V_{tune} : `SOURce:VOLTage:CONTRol<i>:LEVel:AMPLitude` on page 456

Level V_{aux} : `SOURce:VOLTage:AUX:LEVel:AMPLitude` on page 454

Limits V_{supply} : `SOURce:VOLTage:POWer<i>:LEVel:LIMit:LOW` on page 458 /

`SOURce:VOLTage:POWer<i>:LEVel:LIMit:HIGH` on page 458

Limits V_{tune} : `SOURce:VOLTage:CONTRol<i>:LEVel:LIMit:LOW` on page 456 /

`SOURce:VOLTage:CONTRol<i>:LEVel:LIMit:HIGH` on page 456

Limits V_{aux} : `SOURce:VOLTage:AUX:LEVel:LIMit:LOW` on page 454 / `SOURce:`

`VOLTage:AUX:LEVel:LIMit:HIGH` on page 454

Max. V: `SOURce:VOLTage:POWer<i>:LIMit:HIGH` on page 459

Max. A: `SOURce:CURREnt:POWer<i>:LIMit:HIGH` on page 453

Reading the actual output levels ← Configuring the DC power output

The actual output levels (voltage and current) for each output source is displayed in the "Results" part of the dialog box.

When the output levels are as you have defined them, the font of these result values is green. If the voltage or current that is output differs from the values that you have defined, the font turns red.

This may be the case, for example. If the DUT draws too much current, and the voltage required for that current would exceed the limits you have defined.

Remote command:

Voltage: `SOURce:VOLTage:SEQuence:RESult?` on page 460

Current: `SOURce:CURREnt:SEQuence:RESult?` on page 453

Power: `SOURce:POWer:SEQuence:RESult?` on page 454

9.6.2 Signal source configuration

Access (all settings): "Overview" > "Output" > "Output" > "Signal Source"

Access (most relevant signal source settings):  (in the toolbar)

Access (state of the signal source):  (in the toolbar)

The "Signal Source" settings allow you to configure the internal signal source output.

You can use the signal source to feed a signal into the DUT. The signal is either a sine wave or a pulse. Its frequency and level of that signal are variable.

Pulsed output signals are only supported if the "pulsed phase noise" option R&S FSWP-K4 is installed.

In the pulse measurement application, the output signal is always a pulse.

The output is available when you have installed the optional hardware component.

NOTICE**Risk of damage to the instrument or DUT**

Make sure that the DUT can handle the signal power that you output via the signal source. Power levels that are too high might damage the DUT.

Make also sure that the reflected power does not exceed 30 dBm. Power levels higher than that might damage or destroy the signal source output.

**Restrictions and availability of the signal source**

The signal source is available for (additive) phase noise, pulsed (additive) noise and transient measurements.

If you are using the signal source for normal phase noise and pulsed phase noise measurements, cross-correlation is no longer possible. The R&S FSWP shows a message that cross-correlation has been turned off if you turn on the signal source in these measurements. In addition, you can only use one external mixer (instead of two) if you are using the signal source.

Input Source	Output
DC Config	Source Power <input type="checkbox"/> On <input checked="" type="checkbox"/> Off
	Channel Coupling <input checked="" type="checkbox"/> On <input type="checkbox"/> Off
Signal Source	Source
Output	Frequency <input type="text" value="1.0 GHz"/>
	Frequency Stepsize <input type="text" value="1.0 MHz"/>
	Level <input type="text" value="0.0 dBm"/>
	Pulse Modulation <input type="checkbox"/> On <input checked="" type="checkbox"/> Off
	DUT Bypass <input type="checkbox"/> On <input checked="" type="checkbox"/> Off
	Pulse
	Period <input type="text" value="2.0 μs"/>
Width <input type="text" value="1.0 μs"/>	
Trigger 1 Output <input checked="" type="checkbox"/> Off <input type="checkbox"/> Low <input type="checkbox"/> High	

The remote commands required to configure the signal source output are described in [Chapter 14.6.2.2, "Signal source"](#), on page 461.

Functions to configure the signal source output described elsewhere:

- ["Coupling the output configuration across measurement channels"](#) on page 179

Signal source state	183
Signal source frequency	183
Signal source level	183
Pulse modulation state	183
Bypassing the DUT	184
Pulse characteristics	184

Signal source state

A signal from the signal source is supplied only if you turn it on with "Source Power".

Otherwise, the signal source output remains inactive.

Remote command:

`SOURce:GENerator[:STATe]` on page 464

Signal source frequency

Select the "Frequency" of the signal generated at the signal source output and the "Frequency Step size".

The frequency step size defines the step size with which the signal frequency is changed.

Remote command:

Frequency: `SOURce:GENerator:FREQuency` on page 462

Step size: `SOURce:GENerator:FREQuency:STEP` on page 462

Signal source level

Selects the "Level" of the output signal.

When you define the signal level, make sure that your DUT can handle the power that you have defined. Otherwise, the DUT can be damaged.

For low phase noise boards with material number 1331.6439.xx, you can define an output level in 0.1 dB steps. For boards with a different material number, the step size is 1 dB.

You can check the material number of the low phase noise board in the hardware information dialog box (column "order #", see [Chapter 12.4.1, "Hardware information"](#), on page 321).

Remote command:

`SOURce:GENerator:LEVel` on page 462

Pulse modulation state

Turns the internal "Pulse Modulation" on and off.

When "Pulse Modulation" is on, the R&S FSWP generates a pulse with the defined [pulse characteristics](#) on the signal source output.

When "Pulse Modulation" is off, the R&S FSWP generates a continuous wave signal on the signal source output (a pulse can still be output on the trigger 1 output, however, for example to control an external pulse modulator).

Remote command:

Pulse modulation: [SOURce:GENerator:MODulation](#) on page 463

Bypassing the DUT

The "DUT Bypass" feature measures the noise of the R&S FSWP.

This can come in handy when measuring the additive noise, and you would like to draw a trace that shows the contribution of the R&S FSWP to the overall noise characteristics.

The feature works for additive noise and pulsed additive noise measurements. It is also available in the optional applications, Spectrum application, the I/Q Analyzer etc.

Remote command:

[SOURce:GENerator:DUTBypass](#) on page 461

Pulse characteristics

The signal source hardware allows you to generate a pulse when you perform pulsed measurements.

The pulse with the defined characteristics is generated internally when you turn on the [Pulse Modulation](#) feature.

- "Period"
The pulse period defines the distance between two consecutive pulses (off time of the pulse).
- "Width"
The pulse width defines the length of the pulse (on time of the pulse).
Note: Pulse period and width apply to the pulse that is output at the signal source as well as the pulse that is output at the trigger 1 output.
- "Trigger 1 Output"
Selects the pulse type sent to the trigger output.
You can use the signal on the trigger 1 output to control an external pulse modulator, for example.
 - "Off": Provides no signal at the trigger output.
 - "High": Provides a (high active) pulse with the defined width and period at the trigger output.

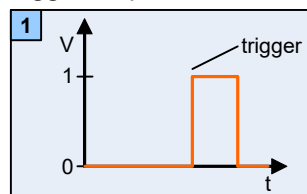

- "Low": Provides a (low active) pulse with the defined width and period at the trigger output.

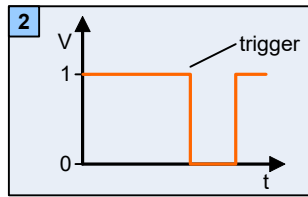

Note that the pulse at the trigger output is generated even when the "Pulse Modulation" feature is turned off.

Remote command:

Period: `SOURce:GENerator:PULSe:PERiod` on page 463

Width: `SOURce:GENerator:PULSe:WIDTh` on page 464

Trigger Output: `SOURce:GENerator:PULSe:TRIGger:OUTPut` on page 463

9.6.3 Miscellaneous output

Access: "Overview" > "Output" > "Output"

The "General Output" dialog box contains settings that allow you to configure various outputs available on the R&S FSWP.

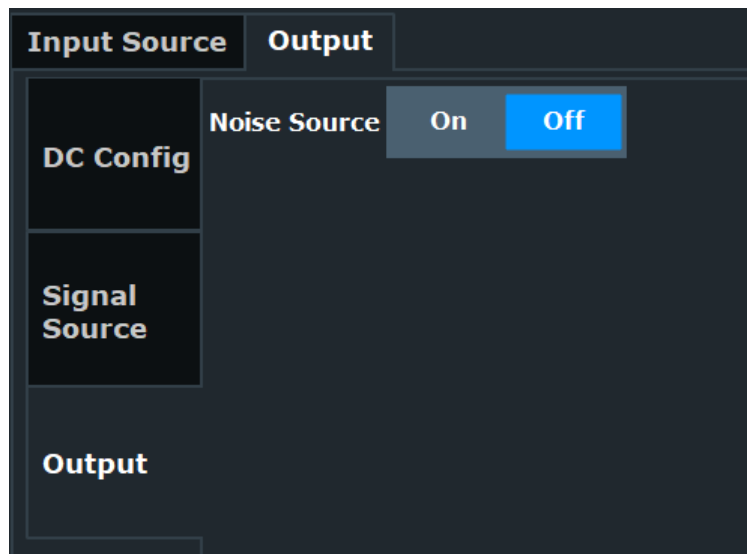

The remote commands required to configure miscellaneous output are described in [Chapter 14.6.2.3, "Miscellaneous output"](#), on page 465.

- [Output for noise sources](#)..... 185
- [Output configuration](#)..... 186

9.6.3.1 Output for noise sources

The R&S FSWP provides a connector ([NOISE SOURCE CONTROL]) with a voltage supply for an external noise source. By switching the supply voltage for an external noise source on or off in the firmware, you can activate or deactivate the device as required.

External noise sources are useful when you are measuring power levels that fall below the noise floor of the R&S FSWP itself, for example when measuring the noise level of an amplifier.

In this case, you can first connect an external noise source (whose noise power level is known in advance) to the R&S FSWP and measure the total noise power. From this value you can determine the noise power of the R&S FSWP. Then when you measure the power level of the actual DUT, you can deduct the known noise level from the total power to obtain the power level of the DUT.

The noise source is controlled in the "Output" settings, see ["Noise Source Control"](#) on page 186

9.6.3.2 Output configuration

[Noise Source Control](#)..... 186

Noise Source Control

Enables or disables the 28 V voltage supply for an external noise source connected to the "Noise source control / Power sensor") connector. By switching the supply voltage for an external noise source on or off in the firmware, you can enable or disable the device as required.

External noise sources are useful when you are measuring power levels that fall below the noise floor of the R&S FSWP itself, for example when measuring the noise level of an amplifier.

In this case, you can first connect an external noise source (whose noise power level is known in advance) to the R&S FSWP and measure the total noise power. From this value, you can determine the noise power of the R&S FSWP. Then when you measure the power level of the actual DUT, you can deduct the known noise level from the total power to obtain the power level of the DUT.

Remote command:

[DIAGnostic:SERvice:NSOurce](#) on page 465

9.7 Pulsed phase noise and pulsed additive noise configuration

Access (measurement): "Overview" > "Select Measurement" > "Pulsed Phase Noise"

Access (measurement): "Overview" > "Select Measurement" > "Pulsed Additive Noise"

Access (settings): "Overview" > "Pulse"

When you equip the R&S FSWP with the optional pulsed phase noise measurement application, the R&S FSWP provides functionality to measure the phase noise and additive noise of pulsed signals.

This measurement mode only measures the noise during the time the pulse is transmitted, like a gated measurement does in a spectrum analyzer. The measurement only

Pulsed phase noise and pulsed additive noise configuration

works when the application knows the pulse characteristics, so it can open up a gate during which it records and analyzes the signal data. The time when the gate opens is either controlled by an internal IF power trigger or an external pulse gate.

If necessary, the application is able to [detect a pulse](#) in the frequency spectrum. When a pulse has been found, it can also [detect pulse characteristics](#) automatically.

Of course, you can omit the signal search and automatic pulse characterisation and instead define these parameters manually.

The screenshot shows the configuration interface for pulsed phase noise and additive noise. It is divided into several sections:

- Preview:** Shows a magnitude plot with a peak at -10.000 dBm. Parameters include Meas Time (1.0 ms), Pretrigger (100.0 µs), CF (1.0 GHz), 1001 pts, and 100.0 µs/.
- Pulse Settings:**
 - Pulse Gate: Ext Trigger 1, IF Power
 - Trigger Level: 1.4 V
 - Pulse Detection: Auto, Manual
 - Auto Detect Once
 - Pulse Rep Interval: 2.0 µs
- Gate Settings:**
 - Gate Type: Level, Edge, Off
 - Gate Delay: 500.0 ns
 - Gate Level: -10.0 dBm
 - Gate Length: 1.0 µs

The remote commands required to configure pulses are described in [Chapter 14.6.7, "Pulsed Phase Noise Configuration"](#), on page 498.

Defining preview diagram characteristics	187
Selecting the source for pulse gating	187
Selecting the pulse detection mode	188
Defining the pulse repetition interval	188
Defining the gate characteristics	188
L Selecting the gate type	189
L Defining the shape of the gate	189

Defining preview diagram characteristics

The application provides some feature that scale the "Preview" diagram shown in the dialog box.

The "Measurement Time" defines scale of the x-axis.

The "Pretrigger" defines an offset from the origin of the x-axis.

Both parameters have no effect on the actual measurement of the noise characteristics of the pulse.

Remote command:
not supported

Selecting the source for pulse gating

You can select the source for pulse gating.

Pulsed phase noise and pulsed additive noise configuration

When you select the "IF Power" source, the pulse gate is controlled by an internal IF power pulse gate. The R&S FSWP opens the gate when the signal meets or exceeds a certain IF power level. This is the default source.

When you select "Ext Trigger 1", the pulse gate is controlled by an external pulse gate. This requires an external source connected to the trigger 1 connector on the front panel of the R&S FSWP. The trigger level is adjustable and the pulse gate opens when the trigger signal meets or exceeds that level.

When you are using an external pulse gate, the following restrictions apply.

- Using an external pulse gate is only possible with a phase noise digitizer board revision 4.0 or higher.
You can check the version that you have in the [hardware info](#) dialog box.
- Defining a [gate level](#) is not possible.
- The [pulse modulation](#) in the signal source settings is always turned off.
- The [trigger 1 output](#) must be turned off.

Remote command:

[\[SENSe:\] SWEep:PULSe:GATE](#) on page 500

Selecting the pulse detection mode

The easiest way to set up pulsed phase noise measurements is to let the application detect the pulse characteristics and configure the measurement accordingly. This is especially useful when you are measuring an unknown pulse.

After the pulse has been found, the application configures the following parameters:

- [Pulse repetition interval](#)
- [Gate level](#)
- [Gate delay](#)
- [Gate length](#) (for Gate Type = Edge)

You can also start the detection of the pulse characteristics deliberately with the "Auto Detect Once" feature.

When you already know the pulse characteristics, you can also configure the measurement manually by selecting "Manual" mode and entering the values as required.

Remote command:

[\[SENSe:\] SWEep:PULSe:DETection](#) on page 499

Defining the pulse repetition interval

The "Pulse Repetition Interval" defines the time between two consecutive pulse edges of the same polarity in seconds (requires at least two measured pulses). It thus defines the (statistical) frequency with which a pulse is transmitted.

In the default state, when [automatic pulse detection](#) is on, the application automatically determines the pulse repetition interval. If necessary, and you already know that value, you can also enter it directly in the corresponding input field.

In the preview diagram, the pulse repetition interval is indicated by a turquoise bar.

Remote command:

[\[SENSe:\] SWEep:PULSe:PRI](#) on page 500

Defining the gate characteristics

Gate characteristics define the type and shape of the gate.

Data is only acquired when the gate is active during the ON time of a pulse. Data transmitted during the OFF time of the pulse is ignored and thus not considered in the noise analysis. This method makes sure that the broadband noise that is present between pulses does not affect the noise results.

Selecting the gate type ← Defining the gate characteristics

The phase noise application supports several "Gate Types".

- **Level**
The gate opens and starts the measurement when the signal exceeds a certain [level](#), and stops when the level drops below that value.
- **Edge**
The gate opens and starts the measurement when the signal exceeds a certain [level](#), and stops after a certain time defined by the [gate length](#).
- **Off**
No gate is used during the measurement, and the data during the OFF time of the pulse is also recorded and analyzed.
You can turn off the gate, for example, when you expect only low noise with little effect on the measurement results during the OFF time of the pulse.
Note that a lowpass filter that filters fundamentals and makes sure that only the pulse is analyzed is still active when you turn off the gate.
The gate mode is always "Off" in case [pulse modulation](#) is on.

Note that even when automatic pulse detection is on, you still can select the gate type, if necessary.

Remote command:

Gate type: `[SENSe:]SWEep:EGATe:TYPE` on page 499

Defining the shape of the gate ← Defining the gate characteristics

The shape of the gate is defined by several parameters that is visualized in the "Preview" diagram.

In the default state, when [automatic pulse detection](#) is on, the gate characteristics are determined based on the pulse characteristics. In that case, changes here not necessary.

The "Gate Level" defines the signal level that opens the gate. As long as the signal level is below the gate level, no data is recorded. When the signal level rises above the gate level, the measurement starts. For the "Gate Type: Level", the gate level also defines the moment when the gate closes, and data acquisition stops.

In the preview diagram, the gate level is indicated by a red horizontal line. A label also indicates the currently defined gate level.

The "Gate Delay", defines a time offset between the moment the level rises above the gate level (= the beginning of the pulse) and the actual start of the measurement. When you define a gate delay, the first few measurement points after the gate opens are not considered in the measurement results.

In the preview diagram, the gate delay is indicated by a blue bar. The actual starting point of data acquisition is indicated by a red vertical line in the preview diagram.

The "Gate Length" defines the time period that the gate is open. It is closed when the time define by the gate length has elapsed. The gate length is only available for "Gate Type: Edge".

In the preview diagram, the gate length is indicated by a magenta colored bar. The end of the gate in that case is indicated by second red vertical line.

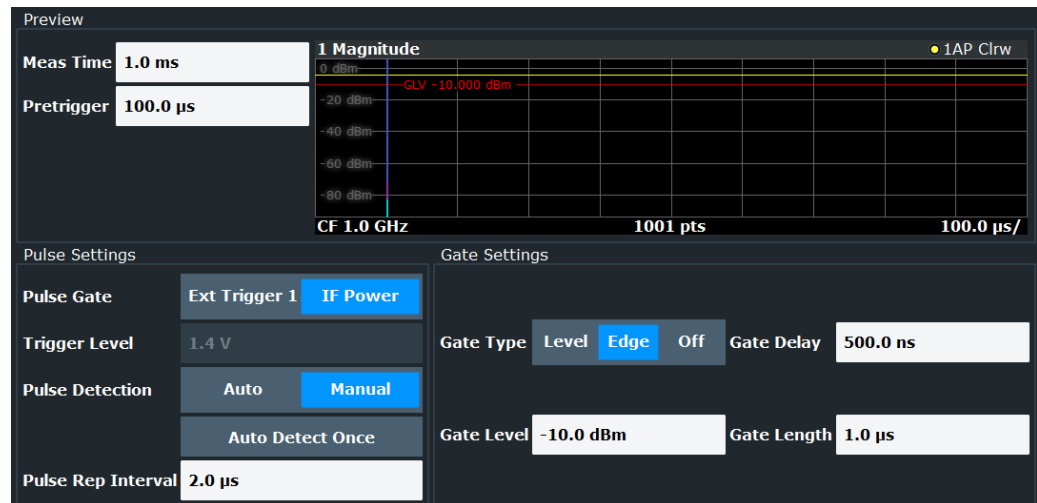

Remote command:

Level: `[SENSe:]SWEep:EGATE:LEVel` on page 499

Delay: `[SENSe:]SWEep:EGATE:HOLDoFF` on page 498

Length: `[SENSe:]SWEep:EGATE:LENGth` on page 498

9.8 VCO characterization configuration

Access (measurement): "Overview" > "Select Measurement" > "VCO Characterization"

The VCO characterization measurement determines the characteristics of a DUT when you apply different input voltages or current (the tuning range or sweep range). The DUT can be, for example, a voltage controlled oscillator (VCO) or a YIG oscillator whose characteristics are a function of the applied current. The measurement provides results for characteristics like the oscillation frequency at a certain input voltage, the output power or the sensitivity of the DUT.

VCO measurements basically provide the following measurement types.

- Normal VCO measurements
In a typical VCO measurement, the "Sweep Source" is connected to the tune port of the DUT. The "Fix Source" is connected to the supply port of the DUT.
- Pushing measurements
Pushing measurements are possible when you connect the "Sweep Source" to the supply port of the DUT and the "Fix Source" to the tune port of the DUT. A pushing measurement typically measures the influence of a swept supply source on the DUT characteristics.

You can use all available DC sources as a sweep source (tuning source) or fix source (V_{supply} , V_{tune} and V_{aux}).

Most of the functionality for VCO characterization is the same as in the phase noise measurement, differences and additional functionality is described in this section of the documentation.

Refer to the following topics for more information about equivalent functionality.

- Input configuration: [Chapter 9.2, "Input source"](#), on page 135
- Amplitude configuration and diagram scale: [Chapter 9.3, "Level characteristics"](#), on page 154
- DC source configuration: [Chapter 9.6.1, "DC source configuration"](#), on page 178
- Measurement configuration: [Chapter 8.2, "Performing measurements"](#), on page 118
- Limit line configuration: [Chapter 10.5, "Limit lines"](#), on page 251
- Marker configuration: [Chapter 10.4, "Markers"](#), on page 241

Notable differences are the measurement configuration itself and the trace configuration, as described in this topic.

- [Sweep configuration](#).....191
- [Trace configuration](#)..... 193

9.8.1 Sweep configuration

Access: "Overview" > "Sweep Config"

The "Sweep Config" dialog box contains two main features: DC source configuration and the sweep configuration (which corresponds to the tuning configuration).

DC Power (Global)	On	Off		
Sweep Source	VTune	VAux	VSupply	
Fix Source	VTune	VAux	VSupply	
DC Source VTune		Sweep VTune		
State	On	Off	Start	0 V
Mode	Voltage	Current	Stop	3.0 mV
Value	0 V		Meas Points	4
Minimum	-10.0 V		Initial Settling Time	0 s
Maximum	28.0 V		Settling Time / Meas Point	1.0 ms
			Frequency Resolution	1.0 kHz

DC source configuration

The functionality to configure the DC sources is basically the same as in the "DC Config" dialog box. The main difference is that the dialog box does not show all available DC sources. Instead, you have to select the DC source you would like to use.

- "Sweep Source"
Selects the DC source that tunes the DUT. Voltage or current change supplied by the sweep source on each measurement point.
Remote command:
VCO characterization: [CONFigure:VCO:SWEep:SOURce](#) on page 503
Spot noise vs tune: [CONFigure:SN Tune:SWEep:SOURce](#) on page 505
- "Fix Source"
Selects the DC source that is considered in the [Current / Voltage](#) result display. Current or voltage supplied by the fix source remains on a fix value during the measurement.
Remote command:
[CONFigure:VCO:FIX:SOURce](#) on page 501

For the other features, refer to the following topics.

- ["Turning the DC output on and off"](#) on page 179
- ["Turning the output on and off"](#) on page 179
- ["Selecting the output type \(Vsupply only\)"](#) on page 180
- ["Defining the output level"](#) on page 180

Sweep settings

The sweep settings define the tuning properties. They control the output of the selected DC source over the course of a measurement: which voltage or current is applied for each measurement, the sweep range and the measurement time for each measurement point.

You can define sweep settings for each DC source individually.

Defining the sweep range	192
Defining the settling time	193
Selecting the frequency resolution	193

Defining the sweep range

The R&S FSWP characterizes a DUT by applying a series of (tuning) voltages or currents to the DUT. Each voltage or current is a measurement point. The number of measurements performed during a VCO characterization therefore depends on the number of measurement points.

You can define the first and last tuning value applied to the DUT with the "Start" and "Stop" values. Within this sweep range, the voltages or currents applied to the DUT depend on the number of "Meas Points". The measurement points not only define the number of measurements, but also the distance between voltages or currents.

Example:

The start and stop values are 0 V and 5 V respectively. The number of measurement points is 10.

This means that a measurement is performed on every 0.5 V of voltage:

0 V, 0.5 V, 1 V, 1.5 V, etc.

Remote command:

Start (VCO Characteristics): [CONFigure:VCO:SWEep:START](#) on page 503

Stop (VCO Characteristics): [CONFigure:VCO:SWEep:STOP](#) on page 503

Points (VCO Characteristics): [CONFigure:VCO:SWEep:POINTs](#) on page 502

Start (Spot Noise vs Tune): [CONFigure:SN Tune:SWEep:START](#) on page 505

Stop (Spot Noise vs Tune): [CONFigure:SN Tune:SWEep:STOP](#) on page 505

Points (Spot Noise vs Tune): [CONFigure:SN Tune:SWEep:POINTs](#) on page 504

Defining the settling time

When you apply a different tuning voltage (or current) to the DUT, it usually needs some time before its characteristics become stable. This time period is the settling time.

- The "Settling Time / Meas Point" property defines for how long you allow the DUT to settle, before the characteristics for each applied voltage or current are measured.
- The "Initial Settling Time" property defines for how long you allow the DUT to settle, before the characteristics of the first applied voltage or current of the tuning range are measured.

Remote command:

Settling time (VCO Characterization): [CONFigure:VCO:SWEep:DElay\[:POINT\]](#) on page 502

Settling time (Spot Noise vs Tune): [CONFigure:SN Tune:SWEep:DElay\[:POINT\]](#) on page 504

Initial settling time (VCO characterization): [CONFigure:VCO:SWEep:DElay:INITial](#) on page 501

Initial settling time (Spot Noise vs Tune): [CONFigure:SN Tune:SWEep:DElay:INITial](#) on page 504

Selecting the frequency resolution

The "Frequency Resolution" defines the accuracy with which the frequency of the DUT is measured on each measurement point.

Note that only discrete values for the frequency resolution are supported. If you enter a frequency resolution that is not supported, the next available frequency resolution is selected. For example, if you enter 200 Hz, which is not supported, the R&S FSWP selects 1 kHz instead.

Remote command:

[CONFigure:VCO:SWEep:FCounter:RESolution](#) on page 502

9.8.2 Trace configuration

In the VCO characterization measurement, you can select the [Trace Mode](#) for each trace.

Traces in the Harmonic Power result display

In the [Harmonic Power](#) result display, each trace represents the power of one harmonic.

9.9 Spot noise vs tune configuration

Access (measurement): "Overview" > "Select Measurement" > "Spot Noise vs Tune"

The spot noise vs tune measurement determines the spot noise characteristics of a DUT when you apply different input voltages or current (the tuning range or sweep range). The DUT can be, for example, a voltage controlled oscillator (VCO) or a YIG oscillator whose characteristic are a function of the applied current. The measurement provides results for phase noise and AM noise characteristics at a certain input voltage or current.

You can use all available DC sources as a sweep source (tuning source) or fix source (V_{supply} , V_{tune} and V_{aux}).

Most of the functionality for spot noise vs tune measurements is the same as in the phase noise measurement. Differences and additional functionality are described in this section of the documentation.

Refer to the following topics for more information about equivalent functionality.

- Input configuration: [Chapter 9.2, "Input source"](#), on page 135
- Amplitude configuration and diagram scale: [Chapter 9.3, "Level characteristics"](#), on page 154
- Frequency configuration: [Chapter 9.4, "Frequency"](#), on page 158
- Noise configuration: [Chapter 9.5.3, "Noise configuration"](#), on page 164
- Spot noise configuration: [Chapter 9.5.5, "Spot noise information"](#), on page 173
- Sweep configuration: [Chapter 9.8.1, "Sweep configuration"](#), on page 191
Note: The "Fix Source" and "Frequency Resolution" settings are not available in the spot noise vs tune measurement.
- DC source configuration: [Chapter 9.6.1, "DC source configuration"](#), on page 178
- Measurement configuration: [Chapter 8.2, "Performing measurements"](#), on page 118
- Limit line configuration: [Chapter 10.5, "Limit lines"](#), on page 251
- Marker configuration: [Chapter 10.4, "Markers"](#), on page 241

The one notable difference is the trace configuration, as described in this topic.

- [Trace configuration](#)..... 194

9.9.1 Trace configuration

Access: "Overview" > "Analysis" > "Traces" > "Traces"

Trace configuration is similar to that of other measurements with the following distinctive features.

- You can select the [Trace Mode](#) for each trace.
- Each trace shows the noise characteristics at a certain spot noise offset over the tuning range. You can customize the offset frequencies that a trace shows in the "Spot Noise Offset" input fields.

By default, for example, trace 1 shows the noise measured for each tuning voltage on a 1 kHz frequency offset.

Trace 2 shows the noise measured at each tuning voltage on a 10 kHz offset.
etc.

If you change the spot noise offsets for a trace, you can restore the default values easily with the "Set Decade Offsets" feature.

Remote command:

See [Chapter 14.6.6.3, "Spot noise configuration"](#), on page 489.

- [Trace smoothing](#) and [spur removal](#) have the same effect as in other measurement, but can only be set globally for all traces instead of for each trace separately.

Remote command:

See [Chapter 14.6.9.2, "Trace configuration"](#), on page 506.

For all other trace functionality, refer to the following topics.

- [Chapter 10.3.3, "Trace export and import"](#), on page 226
- [Chapter 10.3.4, "Copying traces"](#), on page 231
- [Chapter 10.3.6, "Trace labels"](#), on page 232
- Trace mathematics are unavailable for spot noise vs tune measurements.

9.10 PN transient analysis configuration

Access (measurement): "Overview" > "Select Measurement" > "PN Transient Analysis"

Access (settings): "Overview"

The PN transient analysis measurement determines the frequency and phase characteristics of a signal over time. It is thus an appropriate measurement to analyze the transient response of a DUT and see how long it takes until the DUT reaches a stable state.

Parts of the functionality for transient analysis are the same as in the phase noise measurement, differences and additional functionality is described in this section of the documentation.

Refer to the following topics for more information about equivalent functionality.

- Input configuration: [Chapter 9.2, "Input source"](#), on page 135
- DC source configuration: [Chapter 9.6.1, "DC source configuration"](#), on page 178
- Measurement configuration: [Chapter 8.2, "Performing measurements"](#), on page 118
- Limit line configuration: [Chapter 10.5, "Limit lines"](#), on page 251
- Marker configuration: [Chapter 10.4, "Markers"](#), on page 241

- [Frequency configuration](#)..... 196
- [Trigger configuration](#)..... 198
- [Data acquisition](#)..... 200
- [Amplitude configuration](#)..... 201
- [Diagram scale](#)..... 202

• Settling time.....	204
• Frequency deviation.....	205
• Trace configuration.....	205
• Marker configuration.....	206
• Limit lines.....	207

9.10.1 Frequency configuration

Access: "Overview" > "Frequency"

The frequency settings define the frequency characteristics of the signal and the amount of frequency information that is displayed.

Frequency

Frequency Range

Mode Wide Narrow

Range 256 MHz .. 8 GHz

Frequency/Span

Center 4.128 GHz

Span 7.744 GHz

Start 256.0 MHz

Stop 8.0 GHz

Center Frequency Stepsize

Stepsize 0.1 * Span

X-Factor 10 %

The remote commands required to configure the frequency are described in [Chapter 14.6.10.1, "Frequency configuration"](#), on page 508.

Selecting the measurement mode.....	196
Defining the frequency range of the measurement.....	197
Defining a frequency step size.....	197

Selecting the measurement mode

Transient analysis has two measurement modes, wideband and narrowband mode. The measurement mode selects the signal path that is used to measure the signal.

- Wideband mode ("Wide")
 - Select the wideband mode for measurements with a span > 40 MHz.

Wideband mode only works in the frequency range between 256 MHz and 8 GHz. Thus, the maximum span is 7.774 GHz. Supported center frequencies are in the range between 276 MHz and 7.980 GHz.

- **Narrowband mode ("Narrow")**
Select the narrowband mode for measurements with a span < 40 MHz. Narrowband mode works over the complete frequency range supported by your R&S FSWP.

If you select a span > 40 MHz in the specified frequency range, the R&S FSWP automatically selects the wideband mode.

If you select a span < 40 MHz, the R&S FSWP automatically selects the narrowband mode. The R&S FSWP also selects the narrowband mode automatically if you define a frequency that is outside of the frequency range supported by the wideband mode and reduces the span (for example a center frequency of 100 MHz reduces the span to 40 MHz).

Remote command:

[CONFigure:TRANsient:MODE](#) on page 509

Defining the frequency range of the measurement

The frequency parameters define the scale of the y-axis of the [frequency result display](#).

- The bottom of the diagram corresponds to the "Start Frequency".
- The top of the diagram corresponds to the "Stop Frequency".
- The middle of the diagram corresponds to the "Center Frequency".
The center frequency is the frequency of the signal you are measuring.
- The complete range of the y-axis corresponds to the selected span.

Note that changing any one of the frequency parameters can change the [measurement mode](#) you have selected.

Remote command:

Center frequency: [\[SENSe:\]FREQuency:CENTer](#) on page 475

Start frequency: [\[SENSe:\]FREQuency:START](#) on page 476

Stop frequency: [\[SENSe:\]FREQuency:STOP](#) on page 476

Span: [\[SENSe:\]FREQuency:SPAN](#) on page 511

Defining a frequency step size

Defines the step size by which the center frequency is increased or decreased when you press the arrow keys.

The "Stepsize" is a function of the span.

- "0.1 * Span": Changes the center frequency by 10 % of the current span.
- "X * Span": Changes the center frequency by custom percentage of the current span. If you select this, you can define the percentage in the "X-Factor" input field.
- "Manual": Changes the center frequency by a custom value. If you select this, you can define the step size in Hz in the "Value" field.

Remote command:

Stepsize: [\[SENSe:\]FREQuency:CENTer:STEP:LINK](#) on page 510

Factor: [\[SENSe:\]FREQuency:CENTer:STEP:LINK:FACTor](#) on page 510

Manual: [\[SENSe:\]FREQuency:CENTer:STEP](#) on page 509

9.10.2 Trigger configuration

Access: "Overview" > "Trigger"

Transient measurement support trigger functionality that allows you to control when a measurement begins.

Trigger Source		Trigger In/Out	
Source	Frequency		
Frequency	4.128 GHz	Drop-Out Time	0 s
Offset	0 s	Slope	Rising Falling
Hysteresis	100.0 kHz	Holdoff	0 s

The remote commands required to configure trigger are described in [Chapter 14.6.10.4, "Trigger configuration"](#), on page 512.

Selecting the trigger source.....	198
Defining the trigger level and frequency.....	199
Trigger Offset.....	199
Defining a trigger hysteresis.....	199
Trigger Holdoff.....	199
Defining a trigger slope.....	199
Defining a trigger drop-out time.....	200

Selecting the trigger source

The "Trigger Source" selects the type of event whose condition must be met to start data acquisition.

The R&S FSWP supports the following trigger sources.

- "Free Run"
No trigger source is considered. You can start the measurement manually any time and stop it as required.
- "Ext <x>"
A measurement starts when the TTL signal fed into the specified input connector meets or exceeds the specified trigger level.
"Ext Trigger 1" and "Ext Trigger 2" select the trigger connector to which you have connected the TTL signal. Note that the trigger connector must be configured as a trigger input.
- "Frequency"
A measurement starts when measured signal exceeds or falls below a specified frequency.
The frequency trigger available for transient measurements is an online trigger. An online trigger responds to a trigger event as soon as this event occurs while it is capturing data (a live trigger, so to speak). An offline trigger, on the other hand, first captures data, and looks if it can find a trigger event in that data.
- "I/Q Power"

A measurement starts when the R&S FSWP detects a rise or fall of the signal level within the demodulation bandwidth (span).

This trigger source is only available for [narrow](#) measurement mode.

Remote command:

[TRIGger \[:SEquence\] :SOURce](#) on page 515

Defining the trigger level and frequency

Trigger source other than the free run source initiate measurements on a certain condition.

For an external trigger, the condition is a "Level" value. The measurement starts when the trigger signal meets or exceeds that level.

For a frequency trigger, the condition is a "Frequency" value. The measurement starts when the input signal meets or exceeds that frequency.

Remote command:

Trigger level: [TRIGger \[:SEquence\] :LEVel \[:EXTErnal<1|2>\]](#) on page 514

Trigger frequency: [TRIGger \[:SEquence\] :FREQuency](#) on page 513

Trigger Offset

Defines the time offset between the trigger event and the start of the measurement.

Offset > 0:	Start of the measurement is delayed
Offset < 0:	Measurement starts earlier (pretrigger)

Remote command:

[TRIGger \[:SEquence\] :HOLDoff \[:TIME\]](#) on page 514

Defining a trigger hysteresis

The trigger "Hysteresis" is the distance in Hz to the [trigger frequency](#) that the trigger source must exceed before a trigger event occurs. Setting a hysteresis avoids unwanted trigger events caused by frequency oscillation around the trigger frequency.

The trigger hysteresis is available for the frequency trigger.

Remote command:

[TRIGger \[:SEquence\] :FREQuency:HYSTEResis](#) on page 513

Trigger Holdoff

Defines the minimum time (in seconds) that must pass between two trigger events.

Trigger events that occur during the holdoff time are ignored.

Remote command:

[TRIGger \[:SEquence\] :IFPower:HOLDoff](#) on page 514

Defining a trigger slope

The trigger slope defines whether triggering occurs when the signal level or frequency rises to the trigger level or frequency or falls down to it.

Remote command:

[TRIGger \[:SEquence\] :SLOPe](#) on page 515

Defining a trigger drop-out time

The drop-out time is the minimum time period that must have passed between two consecutive trigger events without initiating another measurement after the first trigger event has occurred and initiated a measurement.

For the frequency trigger, the drop-out time avoids the triggering of another measurement just because the frequency of the DUT is not yet stable.

Example:

The trigger event is a certain frequency on falling slope.

The first trigger event that initiates the measurement occurs. After some time, the trigger frequency again falls below the trigger frequency - this happens several times, until the DUT is stable.

Without a drop-out time, the R&S FSWP would start a measurement each time the frequency falls below the trigger frequency. With a drop-out time, however, only the first trigger event initiates a measurement. The other trigger events after the first are ignored, because the undesired events are within the drop-out time.

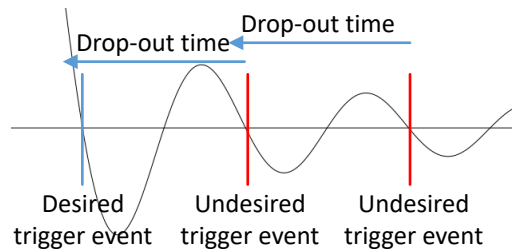

For the external trigger, the drop-out time defines a minimum duration that the input signal must stay below the trigger level before triggering again. The dropout time helps you stabilize triggering when the analyzer is triggering on undesired events.

Remote command:

`TRIGger [:SEquence] :DTIME` on page 513

9.10.3 Data acquisition

Access: "Overview" > "Data Acquisition"

The data acquisition settings configure the signal capture. The measurement time defines the scale of the x-axis.

Meas Time	<input type="text" value="1.0 ms"/>
VBW Mode	<input checked="" type="radio"/> Auto <input type="radio"/> Manual
VBW	<input type="text" value="100.0 kHz"/>
Sweep Count	<input type="text" value="0"/>

The remote commands required to configure the data acquisition are described in [Chapter 14.6.10.3, "Data acquisition"](#), on page 511.

Functions in the "Data Acquisition" dialog box described elsewhere:

- Sweep count: ["Sweep/Average Count"](#) on page 169
- Continuous sweep: ["Continuous Sweep / Run Cont"](#) on page 120
- Single sweep: ["Single Sweep / Run Single"](#) on page 119
- Continue single sweep: ["Continue Single Sweep"](#) on page 120

Defining the measurement time	201
Defining the video bandwidth	201

Defining the measurement time

The measurement time defines for how long the R&S FSWP measures the transient response.

The R&S FSWP always matches the scale of the x-axis of the result displays to the measurement time.

Remote command:

[\[SENSe:\]SWEep:TIME](#) on page 483

Defining the video bandwidth

The video filter is a lowpass filter that removes the higher frequency parts of the voltage from the signal (for example harmonics). This process makes the trace smoother and makes it easier to read out results.

You can set the bandwidth of this filter, the video bandwidth or VBW, automatically or manually ("VBW Mode").

In automatic VBW mode, the R&S FSWP automatically selects an appropriate video bandwidth for the signal you measure.

In manual VBW mode, you can define the video bandwidth you like in the "VBW" field.

Remote command:

Mode: [\[SENSe:\]BWIDth:VIDeo:AUTO](#) on page 512

VBW: [\[SENSe:\]BWIDth:VIDeo](#) on page 512

9.10.4 Amplitude configuration

Access: "Overview" > "Amplitude / Scaling" > "Amplitude"

The amplitude settings configure the characteristics of the input signal.

The screenshot shows the 'Amplitude' dialog box with the following settings:

- Reference Level:** Value: 0.0 dBm
- RF Attenuation:** Mode: Auto, Value: 0.0 dB
- Input Settings:** Input Coupling: AC

The remote commands required to configure the amplitude are described in [Chapter 14.6.10.2, "Amplitude configuration"](#), on page 511.

Functions in the "Amplitude" dialog box described elsewhere:

- RF attenuation: "[Attenuating the signal](#)" on page 155
- Input coupling: "[Input Coupling](#)" on page 136

[Defining a reference level](#)..... 202

Defining a reference level

The reference level is the expected level of the signal you are measuring.

Because the hardware of the R&S FSWP is adapted according to this value, it is recommended that you set the reference level close above the expected maximum signal level.

The reference level is a value between 0 dB, and 30 dBm and is always coupled to the [attenuation](#). When you turn on auto attenuation, the R&S FSWP selects an attenuation that results in a nominal signal level of (about) 0 dBm to protect the input mixer.

Remote command:

`INPut<ip>:RLEVel` on page 511

9.10.5 Diagram scale

Access: "Overview" > "Amplitude / Scaling" > "Scale"

Depending on the result display you have selected (frequency or phase), you can adjust the scale of the y-axis as required.

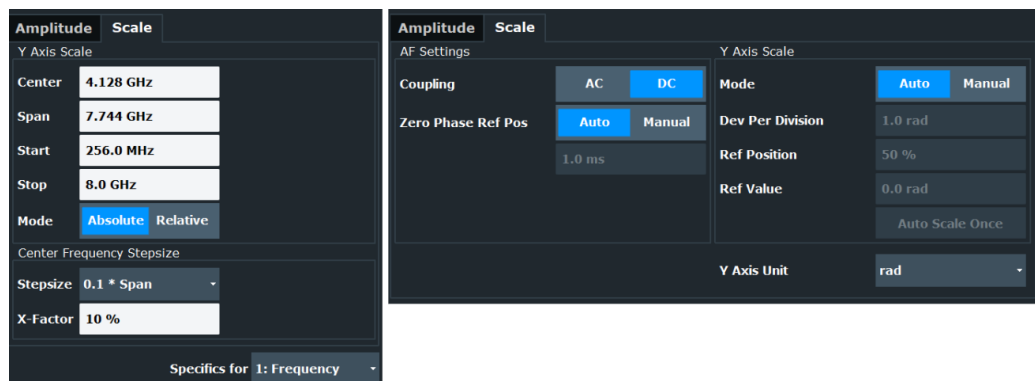

The remote commands required to configure the diagram axes are described in [Chapter 14.6.10.5, "Y-Axis scale"](#), on page 515.

Scaling the y-axis of the frequency diagram	203
Scaling the y-axis of the phase diagram	203
Selecting the AF coupling mode	204
Positioning the zero-phase	204

Scaling the y-axis of the frequency diagram

The y-axis of the [frequency result display](#) always corresponds to the [frequency parameters](#) you have defined for the measurement.

The settings of the "Scale" dialog box are linked to the settings in the "Frequency" dialog box. If you change them in one place, they are automatically adjusted in the other.

In addition, you can select how the frequency is displayed on the y-axis.

- "Absolute": Frequencies are displayed as absolute frequencies.
- "Relative": Frequencies are displayed as relative frequencies that refer to the center frequency (offset to the center frequency).

In both cases, the center frequency is displayed in the middle of the y-axis.

Remote command:

Display mode: `DISPlay[:WINDow<n>]:TRACe<t>:Y[:SCALE]:MODE` on page 517

Scaling the y-axis of the phase diagram

The [phase result display](#) supports various scaling possibilities for the y-axis, on which the phase is displayed.

The default "Y Axis Unit" for phase results is rad, but you can also select the unit degree, if you like.

By default, the R&S FSWP automatically scales the y-axis based on the measured signal.

When you select manual scaling "Mode", you can define the "Dev Per Division", the "Ref Position" and the "Ref Value" as required. In manual scaling mode, you can deliberately initiate a single automatic scaling with the "Auto Scale Once" feature.

The "Dev Per Division" defines the amount of phase deviation covered by each division of the diagram (the value multiplied by 10 is the complete value range of the y-axis). Note that the value defined per division refers to the default display of 10 divisions on the y-axis. If there are fewer divisions (for example because the window is reduced in height), the range per division is adjusted accordingly.

The "Ref Position" determines the position of the reference value for the phase deviation on the y-axis of the diagram. The position is a percentage of the diagram height with 100 % corresponding to the upper diagram border. The default setting is 50 % (diagram center).

The "Ref Value" determines the phase deviation displayed at the reference position.

Remote command:

Mode: `DISPlay[:WINDow<n>]:TRACe<t>:Y[:SCALe]:AUTO` on page 469

Deviation / division: `DISPlay[:WINDow<n>]:TRACe<t>:Y[:SCALe]:PDIVision` on page 518

Reference position: `DISPlay[:WINDow<n>]:TRACe<t>:Y[:SCALe]:RPOSition` on page 518

Reference value: `DISPlay[:WINDow<n>]:TRACe<t>:Y[:SCALe]:RVALue` on page 519

Auto scale once: `DISPlay[:WINDow<n>]:TRACe<t>:Y[:SCALe]:AUTO` on page 469

Unit: `DISPlay[:WINDow<n>]:TRACe<t>:Y[:SCALe]:UNIT` on page 519

Selecting the AF coupling mode

The "AF Coupling" property controls the automatic correction of the phase and frequency offset of the input signal.

- "DC": The phase runs according to the existing frequency offset. In addition, the DC signal contains a phase offset of $\pm\pi$.
- "AC": The frequency offset and phase offset are automatically corrected, i.e. the trace is always symmetric with respect to the zero line.

Remote command:

AF coupling: `CONFigure:TRANsient[:WINDow<n>]:AF:COUPLing` on page 516

Positioning the zero-phase

The R&S FSWP normalizes the last trace point in the phase diagram (right diagram border) to zero rad or degree.

You can also define a different position of the zero phase when you select manual "Zero Phase Ref Pos" mode. For manual zero-phase positioning, define any point on the x-axis (time value) as the zero-phase position, and the R&S FSWP adjusts the trace of the phase display accordingly.

Manual selection of the zero-phase position is available for DC AF coupling mode.

Remote command:

Mode: `CONFigure:TRANsient[:WINDow<n>]:AF:COUPLing:RPOint:MODE` on page 516

Position: `CONFigure:TRANsient[:WINDow<n>]:AF:COUPLing:RPOint[:X]` on page 517

9.10.6 Settling time

Access: "Overview" > "Frequency Config"

> "Settling Time"

The settling time calculation shows the time until the frequency of the DUT has reached a defined target corridor. The corridor is defined by the lower and the upper frequency limit, diagram and trace can be selected. The calculated settling time is displayed in the channel bar.

Frequency	Trigger	Data Acquisition	Amplitude	Scale	Settling Time	Frequency Deviation
Calculation						
State	<input checked="" type="radio"/> On <input type="radio"/> Off					
Upper Frequency Limit	8.0 GHz					
Lower Frequency Limit	256.0 MHz					
Diagram	1: Frequency					
Trace	Trace1					

The remote commands required to configure the settling time calculation are described in [Chapter 14.6.10.6, "Settling time"](#), on page 519.

9.10.7 Frequency deviation

Access: "Overview" > "Frequency Config"

> "Frequency Deviation"

The "Frequency Deviation" result display shows the frequency deviation of the transient response of the DUT from an ideal linear behavior over time. The time frame is defined by the start and stop time.

Frequency	Trigger	Data Acquisition	Amplitude	Scale	Settling Time	Frequency Deviation
Calculation						
State	<input type="radio"/> On <input checked="" type="radio"/> Off					
Start	0 s					
Stop	1.0 ms					
Diagram	1: Frequency					
Trace	Trace1					

The frequency deviation result display is described in ["Frequency Deviation"](#) on page 131.

The remote commands required to configure the frequency deviation calculation are described in [Chapter 14.6.10.7, "Frequency deviation"](#), on page 522.

9.10.8 Trace configuration

Access: "Overview" > "Analysis" > "Traces"

You can display several traces in the transient analysis. Most trace functionality is the same as in the phase noise application. Trace settings specific to the transient analysis are described below, for more information about trace settings also available in other measurements, refer to the following topics.

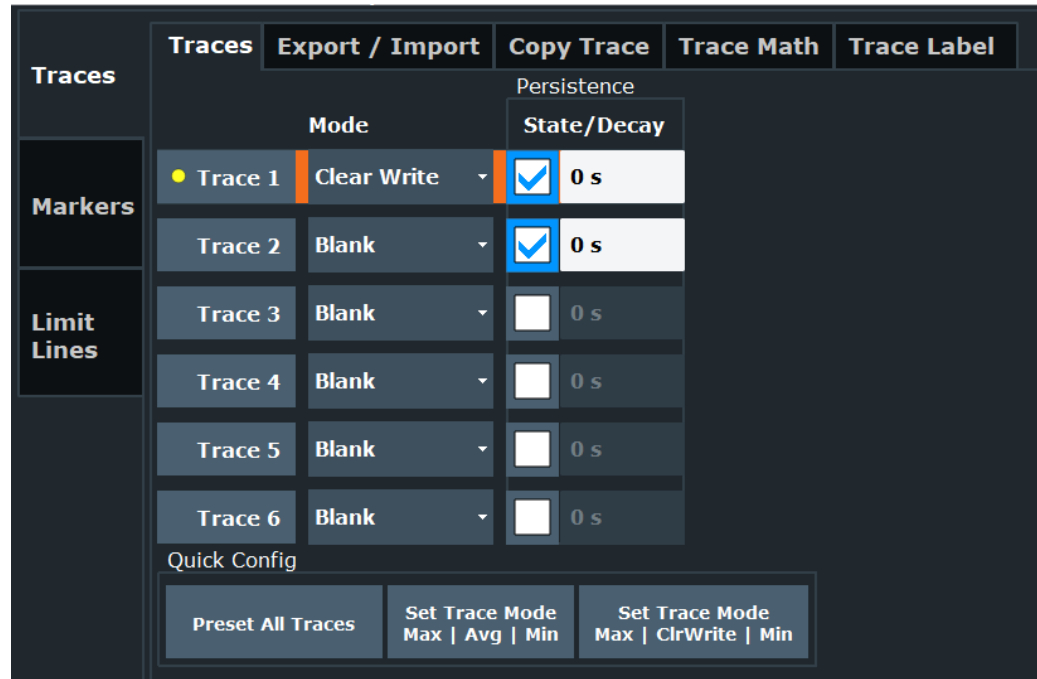

The remote commands required to configure traces are described in [Chapter 14.6.10.8, "Trace configuration"](#), on page 524.

Settings in the "Traces" dialog box described elsewhere:

- Select trace: ["Trace 1/Trace 2/Trace 3/Trace 4/Trace 5/Trace 6"](#) on page 223
- Trace mode: ["Trace Mode"](#) on page 224
- Trace export: [Chapter 10.3.3, "Trace export and import"](#), on page 226
- Trace copy: [Chapter 10.3.4, "Copying traces"](#), on page 231
- Trace mathematics: [Chapter 10.3.5, "Trace math"](#), on page 231
Note that trace mathematics are only available in the [frequency](#) diagram.
- Trace labels: [Chapter 10.3.6, "Trace labels"](#), on page 232
- Persistence: ["Displaying persistence"](#) on page 225

The remote commands required to configure traces are described in [Chapter 14.6.10.8, "Trace configuration"](#), on page 524.

9.10.9 Marker configuration

Access: "Overview" > "Analysis" > "Markers"

Marker functionality is the same as in other phase noise measurements. For more information, see [Chapter 10.4, "Markers"](#), on page 241.

9.10.10 Limit lines

Access: "Overview" > "Analysis" > "Limit Lines"

You can use limit lines in the diagrams of the transient analysis. The basic principle of limit lines is the same as in other phase noise measurement only with a different scale (time on the x-axis and frequency or phase on the y-axis). Relative limits in the frequency diagram always refer to current center frequency you have defined for the transient measurement. Relative limits in the phase diagram always refer to the [reference value](#).

For more information about configuring and using limit lines, see [Chapter 10.5, "Limit lines"](#), on page 251.

10 Common analysis and display functions

General methods and basic settings to display and analyze measurements, regardless of the operating mode, are described here. If you are using an application other than the phase noise application, be sure to check the documentation for that application. The settings can deviate from the common settings described here.

- [Result display configuration](#)..... 208
- [Zoomed displays](#)..... 212
- [Trace configuration](#)..... 219
- [Markers](#)..... 241
- [Limit lines](#)..... 251

10.1 Result display configuration

Measurement results can be evaluated in many different ways, for example graphically, as summary tables, statistical evaluations. Thus, the result display is highly configurable to suit your specific requirements and optimize analysis. Here you can find out how to optimize the display for your measurement results.

- [Basic result displays](#).....208
- [Laying out the result display with the smartgrid](#)..... 208

10.1.1 Basic result displays

Measurement results can be displayed and evaluated using various different methods, also at the same time. Depending on the currently selected measurement, in particular when using optional firmware applications, not all evaluation methods are available.

The result displays described here are available for most measurements in the phase noise application.

Find a list of supported result displays in [Chapter 8, "Measurements and result displays"](#), on page 117.

10.1.2 Laying out the result display with the smartgrid

Measurement results can be evaluated in many different ways, for example graphically, as summary tables, statistical evaluations etc. Each type of evaluation is displayed in a separate window in the channel tab. Up to 16 individual windows can be displayed per channel (i.e. per tab). To arrange the diagrams and tables on the screen, the Rohde & Schwarz SmartGrid function helps you find the target position simply and quickly.

Principally, the layout of the windows on the screen is based on an underlying grid, the SmartGrid. However, the SmartGrid is dynamic and flexible, allowing for many different layout possibilities. The SmartGrid functionality provides the following basic features:

- Windows can be arranged in columns or in rows, or in a combination of both.

- Windows can be arranged in up to four rows and four columns.
 - Windows are moved simply by dragging them to a new position on the screen, possibly changing the layout of the other windows, as well.
 - All evaluation methods available for the currently selected measurement are displayed as icons in the evaluation bar. If the evaluation bar contains more icons than can be displayed at once on the screen, it can be scrolled vertically. The same evaluation method can be displayed in multiple windows simultaneously.
 - New windows are added by dragging an evaluation icon from the evaluation bar to the screen. The position of each new window depends on where you drop the evaluation icon in relation to the existing windows.
 - All display configuration actions are only possible in SmartGrid mode. When SmartGrid mode is activated, the evaluation bar replaces the current softkey menu display. When the SmartGrid mode is deactivated again, the previous softkey menu display is restored.
- [Background information: the smartgrid principle](#).....209
 - [How to activate smartgrid mode](#).....210
 - [How to add a new result window](#).....211
 - [How to close a result window](#).....211
 - [How to arrange the result windows](#).....212

10.1.2.1 Background information: the smartgrid principle

SmartGrid display

During any positioning action, the underlying SmartGrid is displayed. Different colors and frames indicate the possible new positions. The position in the SmartGrid where you drop the window determines its position on the screen.

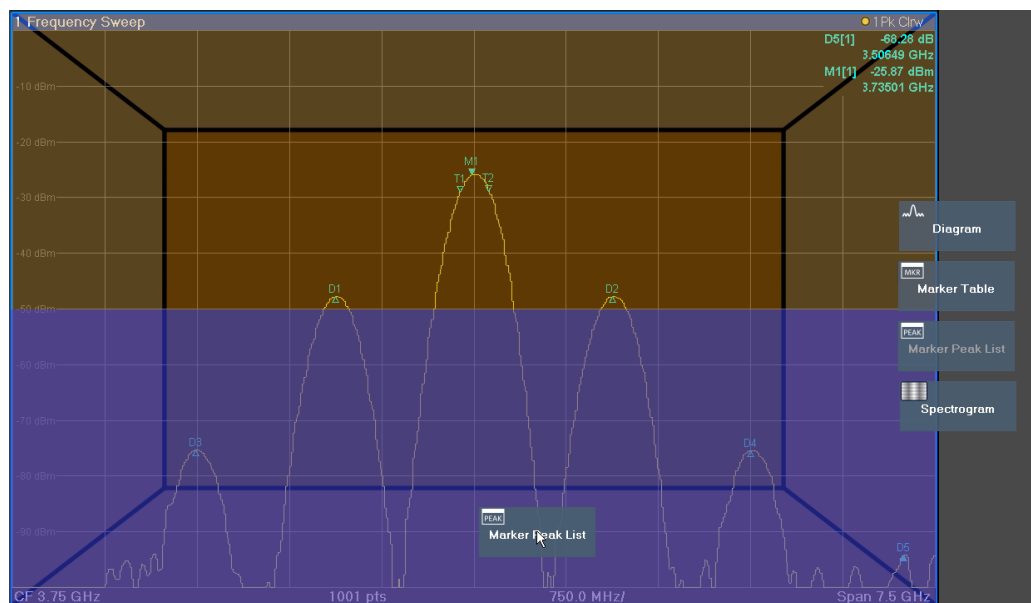

Figure 10-1: Moving a window in SmartGrid mode

The brown area indicates the possible "drop area" for the window, i.e. the area in which the window can be placed. A blue area indicates the (approximate) layout of the window as it would be if the icon were dropped at the current position. The frames indicate the possible destinations of the new window with respect to the existing windows: above/below, right/left or replacement (as illustrated in Figure 6-6). If an existing window would be replaced, the drop area is highlighted in a darker color shade.

Positioning the window

The screen can be divided into up to four rows. Each row can be split into up to four columns, where each row can have a different number of columns. However, rows always span the entire width of the screen and may not be interrupted by a column. A single row is available as the drop area for the window in the SmartGrid. The row can be split into columns, or a new row can be inserted above or below the existing row (if the maximum of 4 has not yet been reached).

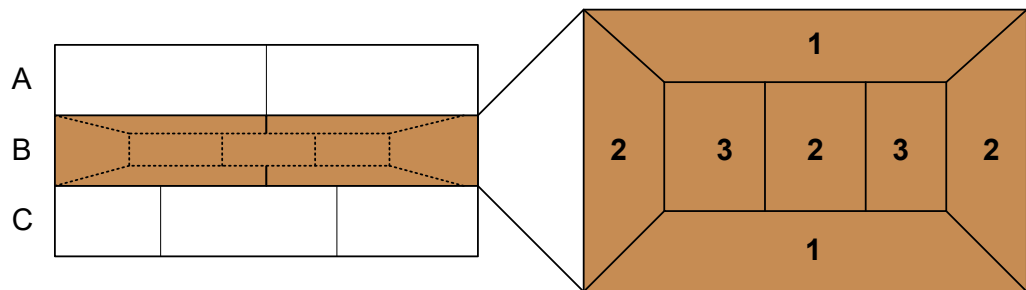
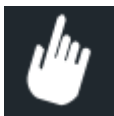

Figure 10-2: SmartGrid window positions

- 1 = Insert row above or below the existing row
- 2 = Create a new column in the existing row
- 3 = Replace a window in the existing row

SmartGrid functions

Once the evaluation icon has been dropped, icons in each window provide delete and move functions.



The "Move" icon allows you to move the position of the window, possibly changing the size and position of the other displayed windows.



The "Delete" icon allows you to close the window, enlarging the display of the remaining windows.

10.1.2.2 How to activate smartgrid mode

All display configuration actions are only possible in SmartGrid mode. In SmartGrid mode the evaluation bar replaces the current softkey menu display. When the SmartGrid mode is deactivated again, the previous softkey menu display is restored.

- To activate SmartGrid mode, do one of the following:



Select the "SmartGrid" icon from the toolbar.

- Select "Display Config" in the configuration "Overview".
- Select "Display Config" from the [Meas Config] menu.

The SmartGrid functions and the evaluation bar are displayed.



To close the SmartGrid mode and restore the previous softkey menu, select the "Close" icon, or press any key.

10.1.2.3 How to add a new result window

Each type of evaluation is displayed in a separate window. Up to 16 individual windows can be displayed per channel (i.e. per tab).

1. Activate SmartGrid mode.

All evaluation methods available for the currently selected measurement are displayed as icons in the evaluation bar.

2. Select the icon for the required evaluation method from the evaluation bar.

If the evaluation bar contains more icons than can be displayed at once on the screen, it can be scrolled vertically. Touch the evaluation bar between the icons and move it up or down until the required icon appears.

3. Drag the required icon from the evaluation bar to the SmartGrid, which is displayed in the diagram area, and drop it at the required position. (See [Chapter 6.6.2.5, "How to arrange the result windows"](#), on page 104 for more information on positioning the window).

Remote command:

[LAYout:ADD\[:WINDow\]?](#) on page 526 / [LAYout:WINDow<n>:ADD?](#) on page 531

10.1.2.4 How to close a result window

- ▶ To close a window, activate SmartGrid mode and select the "Delete" icon for the window.



Remote command:

[LAYout:REMOve\[:WINDow\]](#) on page 529 / [LAYout:WINDow<n>:REMOve](#) on page 532

10.1.2.5 How to arrange the result windows

1. Select an icon from the evaluation bar or the "Move" icon for an existing evaluation window.



2. Drag the evaluation over the SmartGrid. A blue area shows where the window will be placed.
3. Move the window until a suitable area is indicated in blue.
4. Drop the window in the target area. The windows are rearranged to the selected layout, and "Delete" and "Move" icons are displayed in each window.
5. To close a window, select the corresponding "Delete" icon.



Remote command:

[LAYout:REPLace\[:WINDow\]](#) on page 529 / [LAYout:WINDow<n>:REPLace](#) on page 532

[LAYout:MOVE\[:WINDow\]](#) on page 529

10.2 Zoomed displays

You can zoom into the diagram to visualize the measurement results in greater detail. Using the touchscreen or a mouse pointer you can easily define the area to be enlarged.

Graphical Zoom Versus Measurement Zoom

Graphical zooming is merely a visual tool, it does not change any measurement settings, such as the number of sweep points, the frequency range, or the reference level. Graphical zooming only changes the resolution of the displayed trace points temporarily. You must explicitly activate the graphical zoom function (see [Chapter 10.2.2, "Zoom functions"](#), on page 214).

When you change the display using touch gestures, however, the corresponding measurement settings are adapted. For example, dragging horizontally in a spectrum display changes the center frequency. Dragging vertically in a spectrum display changes the reference level (for absolute scaling). These changes are permanent for the measurement. This behavior is also referred to as *measurement zoom*, and is active by

default in the new R&S FSWP. However, you can also activate it manually for a display that has already been zoomed graphically. In this case, the temporary changes to the display are replaced by permanent changes to the measurement settings with the same effect.

Example:

Assume you have a spectrum display from a spurious emission measurement. You graphically zoom into the area around a detected spur. If you now activate a measurement zoom, the reference level, the center frequency, the frequency span, and the scaling settings are adapted so that the results of the measurement now indicate only the formerly zoomed area around the detected spur.

- [Single zoom versus multiple zoom](#).....213
- [Zoom functions](#).....214
- [How to zoom into a diagram](#)..... 216

10.2.1 Single zoom versus multiple zoom

Two different (graphical) zoom modes are available: single zoom and multiple zoom. A single zoom replaces the current diagram by a new diagram which displays an enlarged extract of the trace. This function can be used repetitively until the required details are visible. In multiple zoom mode, you can enlarge up to four different areas of the trace simultaneously. An overview window indicates the zoom areas in the original trace, while the zoomed trace areas are displayed in individual windows. The zoom areas can be moved and resized any time. The zoom area that corresponds to the individual zoom display is indicated in the lower right corner, between the scrollbars.

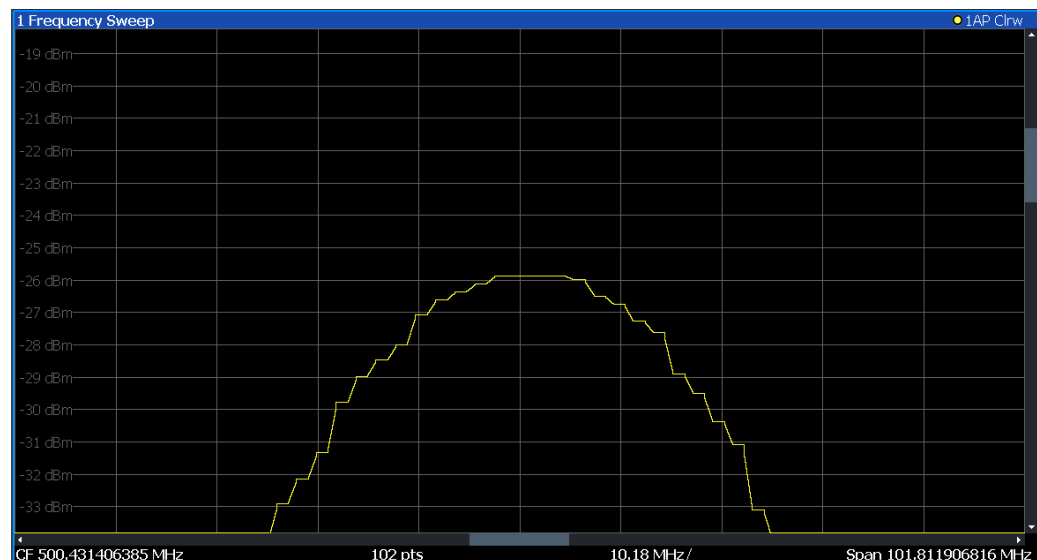

Figure 10-3: Single zoom

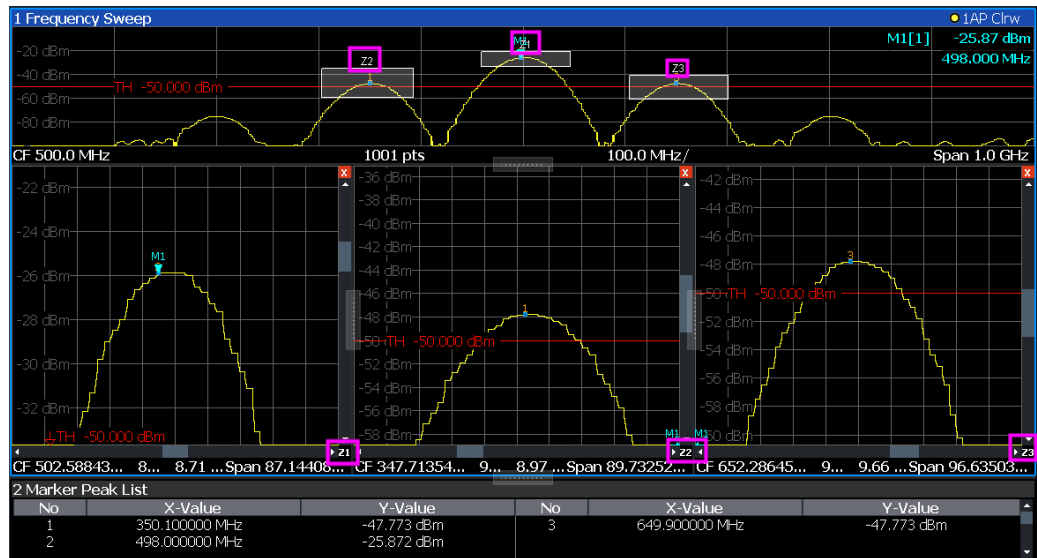

Figure 10-4: Multiple zoom

10.2.2 Zoom functions

Access: "Zoom" icons in toolbar

- Single Zoom..... 214
- Multi-Zoom..... 214
- Measurement Zoom..... 215
 - L Level Lock..... 215
 - L X-Lock..... 215
 - L Y-Lock..... 216
 - L Adapt Measurement to Zoom (selected diagram)..... 216
- Restore Original Display..... 216

Single Zoom



A single zoom replaces the current diagram by a new diagram which displays an enlarged extract of the trace. This function can be used repetitively until the required details are visible.

Remote command:

`DISPlay[:WINDow<n>][:SUBWindow<w>]:ZOOM[:STATE]` on page 536

`DISPlay[:WINDow<n>][:SUBWindow<w>]:ZOOM:AREA` on page 533

Multi-Zoom



In multiple zoom mode, you can enlarge several different areas of the trace simultaneously. An overview window indicates the zoom areas in the original trace, while the zoomed trace areas are displayed in individual windows. The zoom area that corresponds to the individual zoom display is indicated in the lower right corner, between the scrollbars.

Remote command:

`DISPlay[:WINDow<n>][:SUBWindow<w>]:ZOOM:MULTiple<zn>[:STATe]`
on page 536

`DISPlay[:WINDow<n>][:SUBWindow<w>]:ZOOM:MULTiple<zn>:AREA`
on page 535

Measurement Zoom

As opposed to the graphical zoom, which is merely a visual tool, the measurement zoom adapts the measurement settings such that the data you are interested in is displayed in the required detail. In measurement zoom mode, you can change the display using touch gestures. This is the default operating mode of the R&S FSWP.

For details on touch gestures see "Operating Basics" in the R&S FSWP Getting Started manual.

Note: The measurement settings are adapted to practical values based on a suitable grid for the current settings, rather than to unwieldy values that reflect precisely the pixel you happen to tap.

If the measurement zoom leads to undesirable results, you can easily return to the original measurement settings using the "UNDO" function.

When you select the "Measurement Zoom" icon, then tap in a diagram, a dotted rectangle is displayed which you can drag to define the zoom area. This allows you to define the zoom area more precisely than by spreading two fingers in the display.

The measurement zoom function provides further options in a context-sensitive menu, which is displayed when you tap the icon for about a second (or right-click it). These options concern the behavior of the firmware for subsequent touch gestures on the screen. Note that these settings remain unchanged after a channel preset.

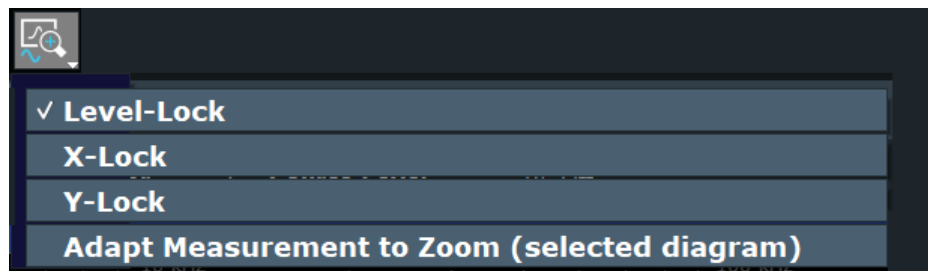

Level Lock ← Measurement Zoom

If activated (default), the reference level (and thus the attenuation) is locked, that is: remains unchanged during touch gestures on the screen.

X-Lock ← Measurement Zoom

If activated, the x-axis of the diagram is not changed during subsequent touch gestures.

Y-Lock ← Measurement Zoom

If activated, the y-axis of the diagram is not changed during subsequent touch gestures.

Adapt Measurement to Zoom (selected diagram) ← Measurement Zoom

If you already performed a graphical zoom using the "Single Zoom" on page 214 or "Multi-Zoom" on page 214 functions, this function automatically adapts the measurement settings to maintain the currently zoomed display.

Restore Original Display

Restores the original display, that is, the originally calculated displays for the entire capture buffer, and closes all zoom windows.

Note: This function only restores graphically zoomed displays. Measurement zooms, for which measurement settings were adapted, are recalculated based on the adapted measurement settings. In this case, the zoomed display is maintained.

Remote command:

`DISPlay[:WINDow<n>][:SUBWindow<w>]:ZOOM[:STATe]` on page 536

10.2.3 How to zoom into a diagram

The remote commands required to zoom into a display are described in [Chapter 14.7.2, "Zoom"](#), on page 533.

The following tasks are described here:

- "To zoom into the diagram at one position" on page 216
- "To return to original display" on page 217
- "To zoom into multiple positions in the diagram" on page 217
- "To maintain a zoomed display permanently" on page 218

To zoom into the diagram at one position

1. 

Click on the "Single Zoom" icon in the toolbar.

Zoom mode is activated.

2. Tap and drag your finger in the diagram to select the area to be enlarged. The selected area is indicated by a dotted rectangle.

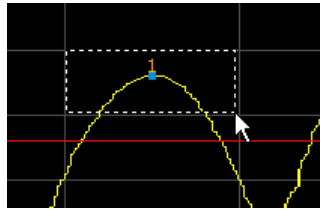

When you leave the touchscreen, the diagram is replaced by the zoomed trace area.

3. Repeat these steps, if necessary, to enlarge the diagram further.



Scrolling in the zoomed display

You can scroll the diagram area to display the entire diagram using the scrollbars at the right and at the bottom of the diagram.

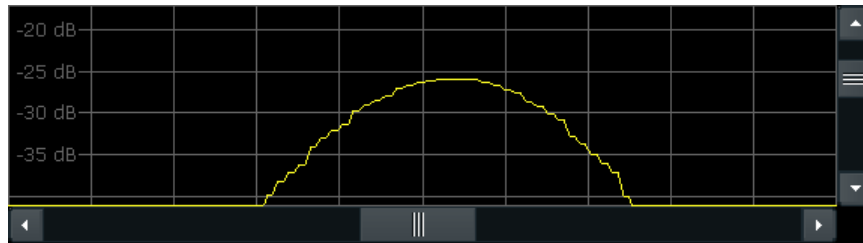

To return to original display



Click on the "Zoom Off" icon in the toolbar.

The original trace display is restored. Zoom mode remains active, however.

To zoom into multiple positions in the diagram



Click on the "Multi-Zoom" icon in the toolbar.

Multiple zoom mode is activated.

2. Select the first area in the diagram to be enlarged as described in ["To zoom into the diagram at one position"](#) on page 216. The selected area is indicated by a dotted rectangle.

When you have completed your selection, the original trace is shown in an overview diagram with the selected area indicated by a dotted rectangle. The zoomed trace area is displayed in a separate window (see [Figure 10-4](#)).



Click on the "Multi-Zoom" icon in the toolbar again.

- In the overview diagram, select the next area to be enlarged.

The second zoom area is indicated in the overview diagram, and a second zoom window is displayed.

- Repeat these steps, if necessary, to zoom into further trace areas (up to four).

To move or change zoom areas

In multiple zoom mode, you can change the size or position of the individual zoom areas easily at any time.

- ▶ To resize a zoom area, tap directly **on** the corresponding frame in the overview window and drag the line to change the size of the frame.
To move a zoom area, tap **inside** the corresponding frame in the overview window and drag the frame to the new position.

The contents of the zoom windows are adapted accordingly.

To maintain a zoomed display permanently

Graphical zooming only changes the resolution of the displayed trace points temporarily. In order to change the display permanently, you must change the corresponding measurement settings.

(Note: Performing a measurement zoom automatically adapts the measurement settings to reflect a graphically zoomed display, see ["To perform a measurement zoom"](#) on page 218).

- Perform a graphical zoom as described in the previous procedures.



- Select the "Measurement Zoom" icon from the toolbar.

- Select "Adapt Measurement to Zoom (selected diagram)".

The measurement settings are adapted as required to obtain the zoomed result display.

To perform a measurement zoom

Performing a measurement zoom automatically adapts the measurement settings to reflect a graphically zoomed display.



- Select the "Measurement Zoom" icon from the toolbar.
- Do one of the following to define the zoom area:
 - Stretch two fingers in the diagram to enlarge the area between them.

- Tap and drag one finger in the diagram to select the area to be enlarged. The selected area is indicated by a dotted rectangle.

The measurement settings are adapted as required to obtain the zoomed result display.

10.3 Trace configuration

- [Basics on traces](#).....219
- [Trace configuration](#)..... 222
- [Trace export and import](#)..... 226
- [Copying traces](#)..... 231
- [Trace math](#)..... 231
- [Trace labels](#).....232
- [How to configure traces](#)..... 233
- [References](#).....234

10.3.1 Basics on traces

- [Analyzing several traces - trace mode](#).....219
- [Trace averaging](#)..... 220
- [Spurs and spur removal](#).....221

10.3.1.1 Analyzing several traces - trace mode

If several measurements are performed one after the other, or continuous measurements are performed, the trace mode determines how the data for subsequent traces is processed. After each measurement, the trace mode determines whether:

- The data is frozen ("View")
- The data is hidden ("Blank")
- The data is replaced by new values ("Clear Write")
- The data is replaced selectively ("Max Hold", "Min Hold", "Average")



Each time you change the trace mode, the selected trace memory is cleared.

The R&S FSWP supports the following trace modes:

Table 10-1: Overview of available trace modes

Trace Mode	Description
Blank	Hides the selected trace.
Clear Write	Overwrite mode: the trace is overwritten by each measurement. This is the default setting. All available detectors can be selected.

Trace Mode	Description
Max Hold	The maximum value is determined over several measurements and displayed. The R&S FSWP saves the measurement result in the trace memory only if the new value is greater than the previous one.
Min Hold	The minimum value is determined from several measurements and displayed. The R&S FSWP saves the measurement result in the trace memory only if the new value is lower than the previous one.
Average	The average is formed over several measurements and displayed. The Sweep/Average Count determines the number of averaging procedures.
View	The current contents of the trace memory are frozen and displayed.
Write Hold	The trace is overwritten when new data is available, but only after all cross-correlation operations defined for a half decade are done.



If a trace is frozen ("View" mode), you can change the measurement settings, apart from scaling settings, without impact on the displayed trace. The fact that the displayed trace no longer matches the current measurement settings is indicated by a yellow asterisk * on the tab label.

If you change any parameters that affect the scaling of the diagram axes, the R&S FSWP automatically adapts the trace data to the changed display range. Thus, you can zoom into the diagram after the measurement to show details of the trace.

10.3.1.2 Trace averaging

The application provides several methods of trace averaging that you can use separately or in any combination.

The order in which averaging is performed is as follows.

1. Cross-correlation
The application performs a certain number of cross-correlation operations in each half decade.
2. Sweep count.
The application measures the complete measurement range a particular number of times.
It again includes the cross-correlation operations as defined.
After the measurement over the sweep count is finished, the application displays the averaged results.
3. Trace smoothing.
Calculates the moving average for the current trace.

Sweep count

The sweep count defines the number of sweeps that the application performs during a complete measurements.

A sweep in this context is the measurement over the complete measurement range once. A complete measurement, however, can consist of more than one sweep. In that case, the application measures until the number of sweeps that have been defined are done. The measurement configuration stays the same all the time.

In combination with the average trace mode and cross-correlation operations, the sweep count averages the trace even more.

Trace smoothing

(Software-based) **smoothing** is a way to remove anomalies visually in the trace that can distort the results. The smoothing process is based on a moving average over the complete measurement range. The number of samples included in the averaging process (the *aperture size*) is variable and is a percentage of all samples that the trace consists of.

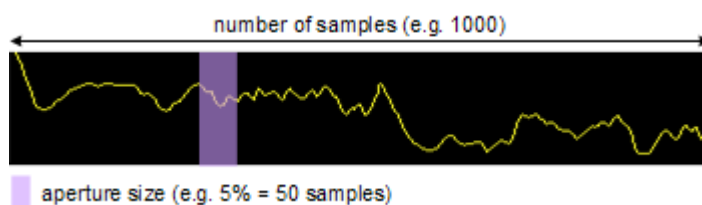

Figure 10-5: Sample size included in trace smoothing

The application smooths the trace continuously. Smoothing is just an enhancement of the trace display, not of the data itself. It is always applied before trace averaging, max hold, min hold or write hold. For the smoothing process, a median filter is applied on the logarithmic data.

You can turn trace smoothing on and off for all traces individually and compare, for example, the raw and the smooth trace.

The **median** trace smoothing uses a median filter which takes the median value over a sliding window. The window size can be set in the trace menu in percent of the total evaluation range. A median filter suppresses outliers while smoothing the underlying noise curve.

10.3.1.3 Spurs and spur removal

Most phase noise results contain unwanted spurs. Spurs are peak levels at one or more offset frequencies and are caused mostly by interfering signals. For some applications, you might want to identify the location of spurs. For other applications, spurs do not matter in evaluating the results and you might want to remove them from the trace to get a "smooth" phase noise trace.

Spur display

Usually, spurs are visible on the trace as a peak. In addition, the R&S FSWP draws a straight, vertical line to represent the position of a spur visually. The length of these lines indicates the level of the spur in dBc and refers to the scale on the right side of the phase noise diagram.

The lines indicating a spur are not part of the trace data. When you export the trace, for example, the spur data is not exported.

Spur data is evaluated in the [Spurious List](#).

Spur suppression

The application allows you to (visually) remove spurs from the trace. Spur removal is based on an algorithm that detects and completely removes the spurs from the trace and fills the gaps with data that has been determined mathematically.

The spur removal functionality separates the actual spur power from the underlying phase noise and displays the latter in a two-stage process. The first stage of spur detection is based on a sliding median during the signal processing.

Spur threshold

During the second stage, the application uses statistical methods to remove a spur. A spur is detected, if the level of the signal is above a certain threshold. The spur threshold is relative to an imaginary median trace that the application calculates.

If parts of the signal are identified as spurs, the application removes all signal parts above that level and substitutes them with the median trace.

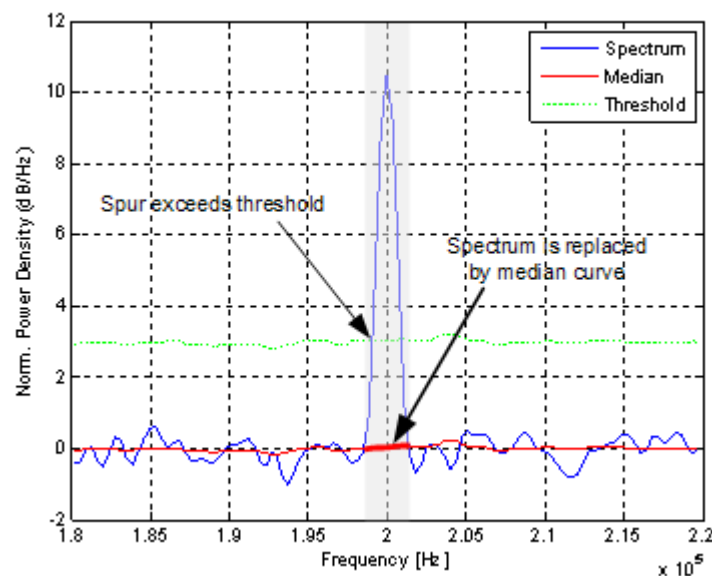
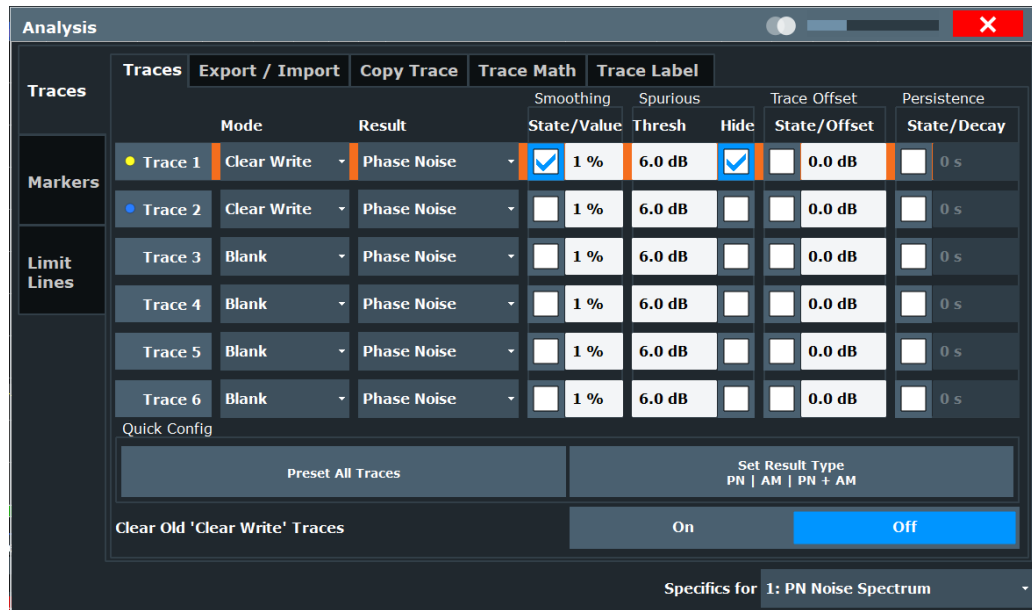

Figure 10-6: Spur detection and removal principle

10.3.2 Trace configuration

Access: "Overview" > "Analysis" > "Traces" > "Traces"

Traces are the graphical representation of the measurement results. Depending on the trace configuration, they carry different information or evaluate the results differently.



Restoring default traces

The application allows you to easily restore the default trace configuration (Trace 1 and 2 with their respective default characteristics) with the "Preset all Traces" button.

Displaying all result types

Similarly, you can easily display all available result type (PM, AM and overall noise) with the "Set Result Type" button. When you do so, the application displays three traces in the diagram: One for the phase noise, one for the AM noise and the third showing the sum of the phase noise and AM noise (PN + AM).

Functions in the "Traces" dialog box described elsewhere:

- "Hiding spurs" on page 175

The remote commands required to configure traces are described in [Chapter 14.7.3.1, "Trace characteristics"](#), on page 537.

Clear Old 'Clear Write' Traces

When enabled, all "Clear Write" traces from the last measurement are cleared at the start of a new sweep. This feature does not impact other trace modes such as "View" or "Min/Max Hold".

If the option is disabled, the trace data remains until it is overwritten by new measurement results.

Remote command:

`DISPlay[:WINDow]:TRACe:CLEAr:AUTO` on page 540

Trace 1/Trace 2/Trace 3/Trace 4/Trace 5/Trace 6

Selects the corresponding trace for configuration. The currently selected trace is highlighted.

Remote command:

Selected via numeric suffix of:TRACe<1 . . . 6> commands

DISPlay[:WINDow<n>] [:SUBWindow<w>]:TRACe<t>[:STATe] on page 541

Trace Mode

Defines the update mode for subsequent traces.

For details, see [Chapter 10.3.1.1, "Analyzing several traces - trace mode"](#), on page 219.

"Clear/ Write"	Overwrite mode (default): the trace is overwritten by each measurement. All available detectors can be selected.
"Max Hold"	The maximum value is determined over several measurements and displayed. The R&S FSWP saves the measurement result in the trace memory only if the new value is greater than the previous one. Not supported by "Spot Noise vs Tune" measurements.
"Min Hold"	The minimum value is determined from several measurements and displayed. The R&S FSWP saves the measurement result in the trace memory only if the new value is lower than the previous one. Not supported by "Spot Noise vs Tune" measurements.
"Average"	The average is formed over several measurements.
"View"	The current contents of the trace memory are frozen and displayed. Note: If a trace is frozen, you can change the measurement settings, apart from scaling settings, without impact on the displayed trace. The fact that the displayed trace no longer matches the current measurement settings is indicated by a yellow asterisk * on the tab label. If you change any parameters that affect the scaling of the diagram axes, the R&S FSWP automatically adapts the trace data to the changed display range. Thus, you can zoom into the diagram after the measurement to show details of the trace.
"Blank"	Removes the selected trace from the display.
"Write Hold"	The trace is overwritten when new data is available, but only after all cross-correlation operations defined for a half decade are done.
"Write Hold"	The trace is overwritten when new data is available, but only after all cross-correlation operations defined for a half decade are done. (Or when the trace cannot be improved further when "XCORR Optimization" is on). Example: 100 cross-correlation operations are defined for a half decade. The trace is updated when all 100 cross-correlations are done, not after each individual cross-correlation operation.

Remote command:

DISPlay[:WINDow<n>] [:SUBWindow<w>]:TRACe<t>:MODE on page 537

Selecting the displayed result

The R&S FSWP supports several noise characteristics that you can assign to a trace and thus display in the diagram.

- "Phase Noise"

- Shows the measured phase noise characteristics.
- "AM Noise"
 - Shows the measured amplitude noise characteristics.
- "Phase + AM Noise"
 - Shows the sum of the phase noise and AM noise characteristics.

The "AM Noise" and "Phase + AM Noise" traces are only available for the "Noise Spectrum" diagram, and not in its variations ("Noise Spectrum L(f)", "Noise Spectrum S Φ (f)", "Noise Spectrum Sv(f)", "Noise Spectrum Sy(f)").

Remote command:

`DISPlay[:WINDow<n>]:TRACe<t>:RESult[:TYPE]` on page 540

Smoothing traces

The R&S FSWP allows you to [smooth traces](#) and thus remove unwanted anomalies.

You can apply smoothing to all active traces individually (Smoothing "State"), and define the magnitude of trace smoothing in percent (Smoothing "Value").

The range is from 1% to 20%.

Note: In the spot noise vs tune measurement, trace smoothing properties apply to all traces.

Remote command:

State: `DISPlay[:WINDow<n>]:TRACe<t>:SMOothing[:STATe]` on page 543

Value: `DISPlay[:WINDow<n>]:TRACe<t>:SMOothing:APERture` on page 542

State (SN vs Tune): `[SENSe:]SMOothing[:STATe]` on page 507

Value (SN vs Tune): `[SENSe:]SMOothing:APERture` on page 506

Shifting the trace

Shifting the trace can be useful to subtract external noise sources from the results. The trace offset is a visual device that shifts the trace by certain level.

You can apply an offset to all active traces individually (Offset "State"), and define an offset in dB by which the trace should be shifted.

Remote command:

State: `DISPlay[:WINDow<n>]:TRACe<t>:Y[:SCALE]:RLEVel:OFFSet:STATe` on page 542

Offset: `DISPlay[:WINDow<n>]:TRACe<t>:Y[:SCALE]:RLEVel:OFFSet` on page 541

Displaying persistence

The term persistence has its origins in cathode ray tube devices (CRTs). It describes the time period one point on the display stays illuminated after it has been lit by the cathode ray. The higher the persistence, the longer you could observe the illuminated point on the display.

In the phase noise application, the persistence defines for how long a trace remains visible before it fades away. An event that has occurred a single time is visible for up to 8 seconds. As the statistical frequency of an event gets smaller at coordinates with signal parts that are not constantly there, the trace fades away.

A signal with constant frequency or phase characteristics does not show the effects of persistence on the trace. When the frequency or phase of a signal change slightly, however, the effect of persistence becomes visible through color changes or changes in the shape of the trace.

You can turn on persistence for all traces in the display ("State"). The "Decay" property defines the time that shadows of past traces remain visible in the display before fading away. With a decay of 0 s, all past traces remain visible.

When you change a measurement setting, the R&S FSWP resets the persistence effect.

Persistence is supported by phase noise measurements (CW and pulsed) and the transient measurement.

Remote command:

`DISPlay[:WINDow<n>]:TRACe<t>:PERSistence[:STATe]` on page 539

`DISPlay[:WINDow<n>]:TRACe<t>:PERSistence:DECay` on page 539

10.3.3 Trace export and import

Access: "Overview" > "Analysis" > "Traces" > "Trace / Data Export"

The R&S FSWP provides various evaluation methods for the results of a measurement. However, if you want to evaluate the data with external applications, you can export the measurement data to a standard format file (ASCII or XML).

The following data types can be exported (depending on the application):

- Trace data
- Table results, for example result summaries, marker peak lists.

You can also import existing trace data from a file, for example to compare your latest measurement results with results that you have saved some time ago.



Availability of trace import

The trace import is available for the following measurements.

- Phase noise
- Pulsed phase noise
- Additive noise
- Pulsed additive noise
- Baseband noise



I/Q data can only be imported and exported in applications that process I/Q data, such as the I/Q analyzer or optional applications.

See the corresponding user manuals for those applications for details.



The standard data management functions (e.g. saving or loading instrument settings) that are available for all R&S FSWP applications are not described here.

See [Chapter 11, "Data management"](#), on page 262 for a description of the standard functions.

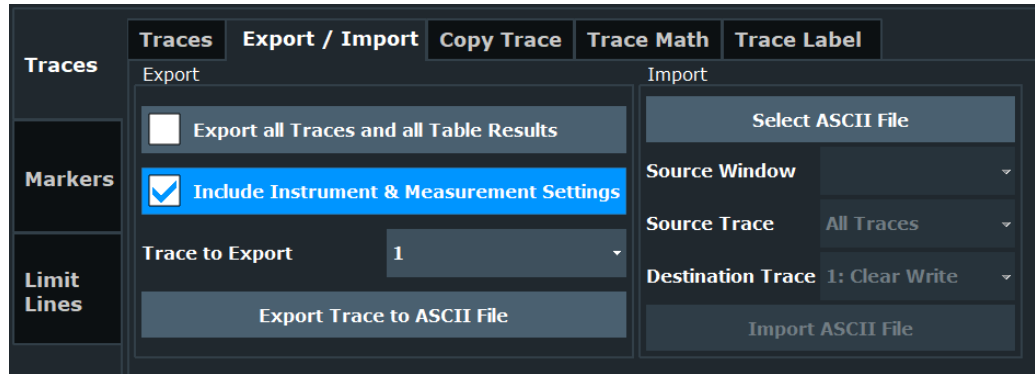

The remote commands required to import and export traces are described in [Chapter 14.7.3.3, "Trace export and import"](#), on page 544.

Export all Traces and all Table Results	227
Include Instrument & Measurement Settings	227
Trace to Export	228
Export Trace to ASCII File	228
L File Type	229
L Decimal Separator	229
L Column Separator	229
L File Explorer	229
Select ASCII File	229
Source Window / Source Trace	230
Destination Trace	230
Import	230

Export all Traces and all Table Results

Selects all displayed traces and result tables (e.g. "Result Summary", marker table etc.) in the current application for export to an ASCII file.

Alternatively, you can select one specific trace only for export (see [Trace to Export](#)).

The results are output in the same order as they are displayed on the screen: window by window, trace by trace, and table row by table row.

Remote command:

`FORMat:DEXPort:TRACes` on page 546

Include Instrument & Measurement Settings

Includes additional instrument and measurement settings in the header of the export file for result data.

Remote command:

`FORMat:DEXPort:HEADer` on page 546

Trace to Export

Defines an individual trace to be exported to a file.

This setting is not available if [Export all Traces and all Table Results](#) is selected.

Export Trace to ASCII File

Saves the selected trace or all traces in the currently active result display to the specified file and directory in the selected ASCII format.

"File Explorer": Instead of using the file manager of the R&S FSWP firmware, you can also use the Microsoft Windows File Explorer to manage files.

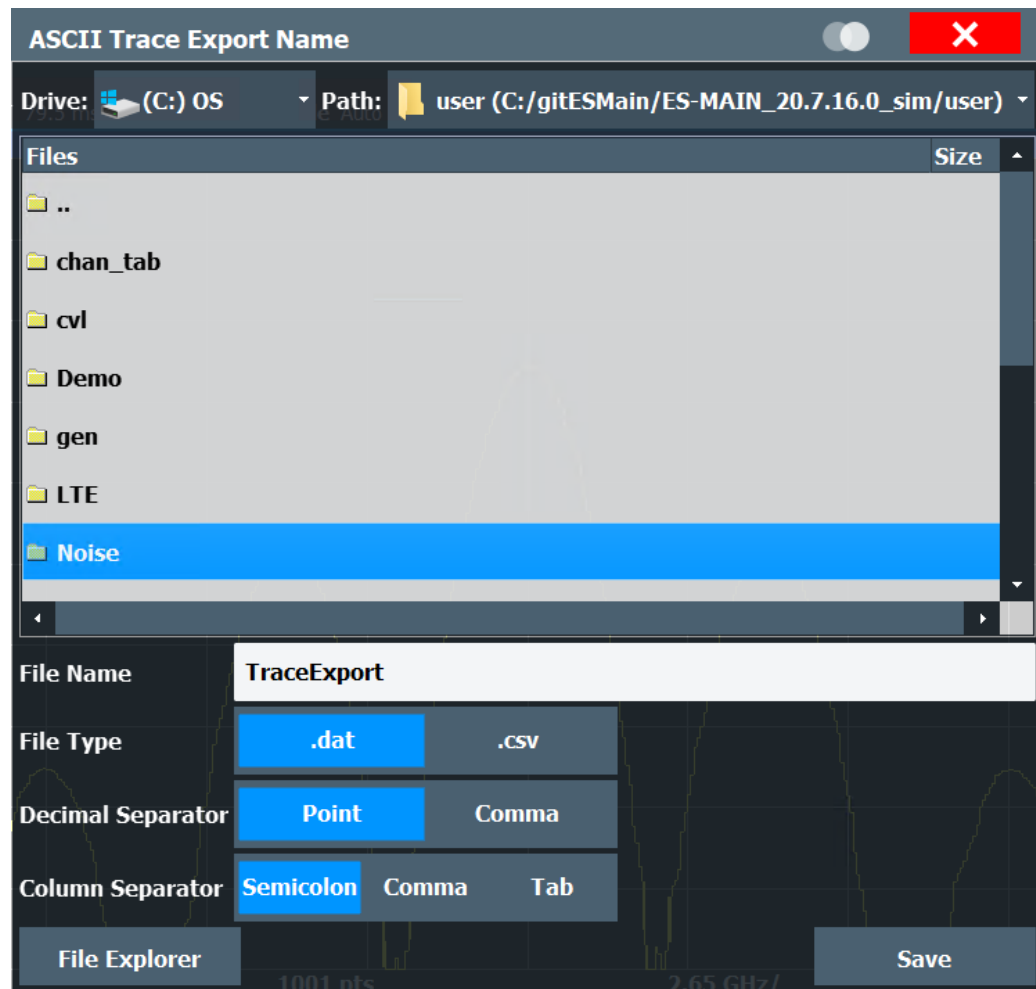

For details on the file format, see [Chapter 10.3.8.1, "Reference: ASCII file export format"](#), on page 234.

Note: Secure user mode.

In secure user mode, settings that are stored on the instrument are stored to volatile memory, which is restricted to 256 MB. Thus, a "memory limit reached" error can occur although the hard disk indicates that storage space is still available.

To store data permanently, select an external storage location such as a USB memory device.

For details, see [Chapter 11.2, "Protecting data using the secure user mode"](#), on page 263.

Remote command:

`MMEMoRY:STORe<n>:TRACe` on page 601

File Type ← Export Trace to ASCII File

Determines the format of the ASCII file to be imported or exported.

Depending on the external program in which the data file was created or is evaluated, a comma-separated list (CSV) or a plain data format (DAT) file is required.

Remote command:

`FORMat:DEXPort:FORMat` on page 545

Decimal Separator ← Export Trace to ASCII File

Defines the decimal separator for floating-point numerals for the data export/import files. Evaluation programs require different separators in different languages.

Remote command:

`FORMat:DEXPort:DSEParator` on page 545

Column Separator ← Export Trace to ASCII File

Selects the character that separates columns in the exported ASCII file. The character can be either a semicolon, a comma or a tabulator (tab).

Example for semicolon:

```
Type;FSWP26;Version;1.00;Date;01.Jan 3000;
```

Example for comma:

```
Type,FSWP26,  
Version,1.00,  
Date,01.Jan 3000,
```

Example for tabulator (tab after the last column is not visible):

```
Type      FSWP26  
Version   1.00  
Date      01.Jan 3000
```

The selected column separator setting remains the same, even after a preset.

Remote command:

`FORMat:DEXPort:CSEParator` on page 545

File Explorer ← Export Trace to ASCII File

Opens the Microsoft Windows File Explorer.

Remote command:

not supported

Select ASCII File

The "Select ASCII File" button opens a dialog box to select results that you want to import.

You can select files with the extensions `.csv` or `.dat`.

Remote command:

[MMEMory:LOAD<n>:TRACe](#) on page 546

Source Window / Source Trace

Files that contain result data can contain the results of several measurements and result displays. The "Source Window" and "Source Trace" dropdown menus select the data that you would like to import.

The source data must be compatible to a currently active window.

Example:

If you want to import trace 1 of a previously exported noise diagram:

- Select the phase noise measurement and open a noise diagram from the Smart-Grid.
Importing phase noise trace data into a transient measurement diagram is not possible.
- Select "Noise Diagram" from the "Source Window" dropdown menu.
- Select "1" from the "Source Trace" dropdown menu.
If you select "All Traces", the R&S FSWP imports all traces of the selected result type.

Remote command:

[MMEMory:LOAD<n>:TRACe](#) on page 546

Destination Trace

The "Destination Trace" dropdown menu becomes available when you select to import a [single trace](#) only.

In that case, you can select the trace number you want to write the trace data to.

If you select a trace that already exists, the trace import overwrites the currently displayed trace. Imported traces always get the trace mode "View".

Example:

You have selected trace "1" as the trace you want to import from the "Source Trace" dropdown menu.

If you select "1: Clear Write" ("Clear Write" indicates the trace is currently displayed) from the "Destination Trace" dropdown menu, the import overwrites the trace. The trace mode for trace 1 is replaced by trace mode "View".

If you select "5: Blank" ("Blank" indicates that the trace is currently not displayed) from the "Destination Trace" dropdown menu, the imports adds a new trace to the diagram (with trace mode "View". All other traces remain in the diagram.

Remote command:

[MMEMory:LOAD<n>:TRACe](#) on page 546

Import

The "Import" button imports the selected trace(s).

The R&S FSWP does not import numeric results associated with the imported trace (spot noise, values from the spurious list etc.)

Remote command:

`MMEMoRy:LOAD<n>:TRACe` on page 546

10.3.4 Copying traces

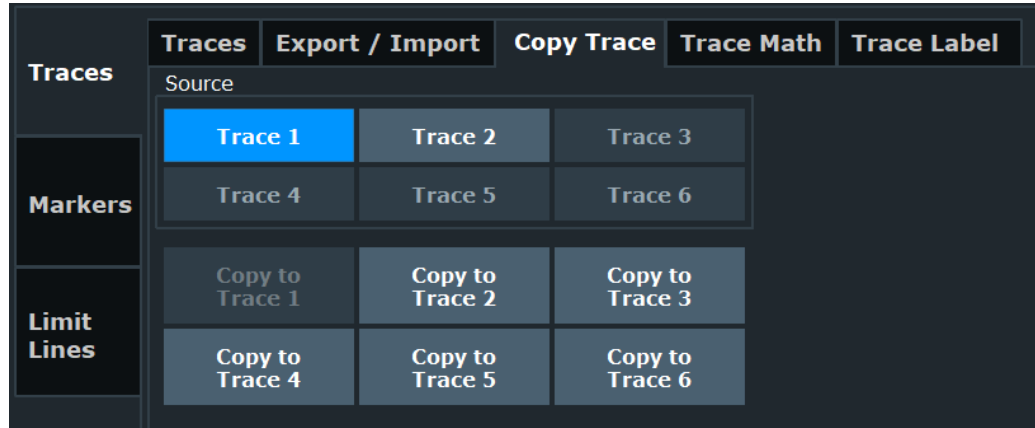

The remote commands required to copy traces are described in [Chapter 14.7.3.2, "Trace copy"](#), on page 543.

[Copy Trace](#).....231

Copy Trace

Access: "Overview" > "Analysis" > "Traces" > "Copy Trace"

Or: [TRACE] > "Copy Trace"

Copies trace data to another trace.

Remote command:

`TRACe<n>:COPY` on page 543

10.3.5 Trace math

Access: [TRACE] > "Trace Math"

Or: "Overview" > "Analysis" > "Traces" > "Trace Math"

If you have several traces with different modes, for example an average trace and a maximum trace, it may be of interest to compare the results of both traces. In this example, you could analyze the maximum difference between the average and maximum values. To analyze the span of result values, you could subtract the minimum trace from the maximum trace. For such tasks, the results from several traces can be combined using mathematical functions.

The remote commands required to configure trace mathematics are described in [Chapter 14.7.3.4, "Trace mathematics"](#), on page 547.

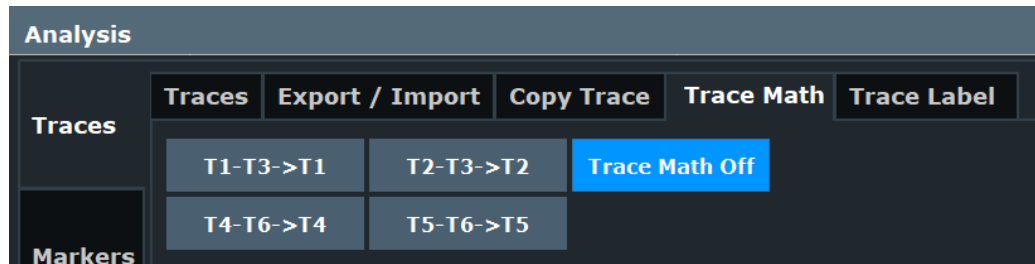

Trace Math Function.....	232
Trace Math Off.....	232

Trace Math Function

You can select one of several different math operations.

Each operation subtracts one trace from another as indicated on the corresponding button and writes the result to one of the traces. "T1 - T3 > T1", for example, subtracts trace 3 from trace 1 and writes the result to trace 1. You can apply one operation at a time.

"T1-T3->T1"	Subtracts trace 3 from trace 1
T2-T3->T2	Subtracts trace 3 from trace 2
T4-T6->T4	Subtracts trace 6 from trace 4
T5-T6->T5	Subtracts trace 6 from trace 5

To switch off the trace math, use the [Trace Math Off](#) button.

Remote command:

`CALCulate<n>:MATH<t>[:EXPRession] [:DEFine]` on page 548

`CALCulate<n>:MATH<t>:STATe` on page 548

Trace Math Off

Deactivates any previously selected trace math functions.

Remote command:

`CALC:MATH:STAT OFF`, see `CALCulate<n>:MATH<t>:STATe` on page 548

10.3.6 Trace labels

Access: "Overview" > "Analysis" > "Traces" > "Trace Label"

Trace labels are a way to assign a descriptive label to traces instead of the general "Trace <x>" label (default). The labels you use are arbitrary and are displayed in the diagram area. The font color corresponds to the color of the respective trace (for example yellow trace: yellow font).



Figure 10-7: Example: the yellow and blue traces have a label.

You can define trace labels in the "Trace Label" tab of the "Trace" dialog box.

Traces	Export / Import	Copy Trace	Trace Math	Trace Label
	State Text			
Trace 1	<input type="checkbox"/>	Trace 1		
Trace 2	<input type="checkbox"/>	Trace 2		
Trace 3	<input type="checkbox"/>	Trace 3		
Trace 4	<input type="checkbox"/>	Trace 4		
Trace 5	<input type="checkbox"/>	Trace 5		
Trace 6	<input type="checkbox"/>	Trace 6		

How to assign trace labels

Trace labels can be configured via the "Trace Labels" dialog box.

1. Turn on the trace label for a specific trace and assign a label in the corresponding input field.
Note that a trace must be active. Otherwise assigning a label is not possible.
2. Move the trace label to any position on the display by dragging it to the new position.

Remote command:

State: `DISPlay[:WINDow<n>]:TRACe<t>:LABel[:STATe]` on page 538

Label: `DISPlay[:WINDow<n>]:TRACe<t>:LABel:TEXT` on page 539

10.3.7 How to configure traces

- [How to export trace data and numerical results](#).....233

10.3.7.1 How to export trace data and numerical results

The measured trace data and numerical measurement results in tables can be exported to an ASCII file. For each measurement point, the measured trace position and value are output. The file is stored with a `.DAT` extension. For details on the storage format, see [Chapter 10.3.8.1, "Reference: ASCII file export format"](#), on page 234.

To export trace data and table results

Trace data can be exported from the "Trace" menu.

1. Press the [Trace] key, then select the "Trace Config" softkey and switch to the "Trace / Data Export" tab.

2. Select "Export all Traces and all Table Results" to export all available measurement result data for the current application. Alternatively, select a specific "Trace to Export".
3. Optionally, select the "Include Instrument & Measurement Settings" option to insert additional information in the export file header.
4. If necessary, change the decimal separator used in the ASCII export file.
5. Select the "Export Trace to ASCII File" button.
6. In the file selection dialog box, select the storage location and file name for the export file.
7. Select "Save" to close the dialog box.
8. Export the data to the file.

10.3.8 References

- [Reference: ASCII file export format](#)..... 234

10.3.8.1 Reference: ASCII file export format

Trace data can be exported to a file in ASCII format for further evaluation in other applications. This reference describes in detail the format of the export files for result data.

(For details see [Chapter 10.3.7.1, "How to export trace data and numerical results"](#), on page 233).

The file consists of the header information (general configuration of the measurement) and the measurement results. Optionally, the header can be excluded from the file.

The file of the Phase Noise application contains several sections, each section containing related data as shown in the tables below. Each section can contain header information and / or result information (header information is represented by a blue font in the tables below).

The data of the file header consist of three columns, each separated by a semicolon: parameter name; numeric value; basic unit. The data section starts with the keyword "Trace <n>" (<n> = number of stored trace). The measured data follows in one or several columns (depending on the measurement), which are also separated by a semicolon.

The results are output in the same order as they are displayed on the screen: window by window, trace by trace, and table row by table row.

Generally, the format of this ASCII file can be processed by spreadsheet calculation programs, e.g. MS Excel. Different language versions of evaluation programs can require a different handling of the decimal point. Thus, you can define the decimal separator to use (decimal point or comma).

Blue font: header data only written to file if header data is exported, too.	
Black font: result data is always exported to the file	
General measurement configuration	
Type; R&S FSWP;	Instrument model
Version;1.00;	Firmware version
Date;01. Jan 3000;	Date of data set storage
Tune Source;Vtune;	DC power source (Vsupply, Vtune, Vaux or None)
VSupply;ON;	State of the supply voltage source (on or off)
Mode;Voltage;	Type of output on the supply voltage source (voltage or current)
Voltage Set;5.000;V;	Output characteristics of the supply voltage
Voltage Min;4.750;V;	
Voltage Max;5.250;V;	
Voltage Meas;0.000;V;	
Current Max;0.050000;A;	
Current Meas;0.000000;A;	
VTune;OFF;	State of the tuning voltage source (on or off)
Voltage Set;5.000;V;	Output characteristics of the tuning voltage
Voltage Min;4.750;V;	
Voltage Max;5.250;V;	
Voltage Meas;0.000;V;	
Current Max;0.050000;A;	
Current Meas;0.000000;A;	
VAux;OFF;	State of the auxiliary voltage source (on or off)
Voltage Set;5.000;V;	Output characteristics of the auxiliary voltage
Voltage Min;4.750;V;	
Voltage Max;5.250;V;	
Voltage Meas;0.000;V;	
Current Max;0.050000;A;	
Current Meas;0.000000;A;	
Mode;Phase Noise;	Application
Measurement;Phase Noise;	Measurement type
Input;RF;	Input source
RF Att;0.000000;dB;	RF attenuation
Coupling;AC;	Input coupling type
RBW;x;%;	Resolution bandwidth factor
XCORR Factor;x;	Cross-correlation factor
XCORR Optimize;ON;	State of cross-correlation optimization
Estimated Meas Time;x;s;	Estimated measurement time
Sweep Count;0;	Current sweep count
Signal frequency;190920481.7452;Hz;	Carrier frequency
Signal level;-43.160000;dBm;	Carrier signal level
Start;1000.000000;Hz;	Start offset frequency
Stop;3000.000000;Hz;	Stop offset frequency

Figure 10-8: Example

Half decade configuration (amount of data depends on number of half decades in measurement)	
SubSweep;1;	Number of half decade
Start;1000.000000;Hz;	Start offset frequency of half decade
Stop;3000.000000;Hz;	Stop offset frequency of half decade
RBW;30.000000;Hz;	Resolution bandwidth applied in half decade
XCORR Count;10;	Number of cross-correlation operations in half decade
(...)	

Integrated measurement configuration (amount of data depends on number of integration ranges)	
Integrated Measurements Range;1;	Number of integration range
Start;1000.000000;Hz;	Start offset frequency of integration range
Stop;300000.000000;Hz;	Stop offset frequency of integration range
Weighting;ON;FilterName;	State and name of weighting filter
(...)	

Spot noise measurement configuration (amount of data depends on number of spot noise positions)	
SpotNoiseDecadeEdges;ON;	State of spot noise evaluation on decade edges
SpotNoiseUserDefined;ON;	State of user defined spot noise evaluation
SpotNoiseUserDefinedOffset;1;	User defined spot noise information
State;ON;	State of user defined spot noise information
Offset;500000.000000;Hz;	Position of user defined spot noise
(...)	

Noise Spectrum measurement results (amount of data depends on the number of phase measurement windows and the number of traces in each window)	
Window;1;Noise Spectrum;	Number and type of window
Trace;1;	Trace number
Trace Mode;CLR/WRITE;	Trace mode
Trace Result;PN;	Result type (phase noise or amplitude noise etc.)
Smoothing;ON;	State of trace smoothing
Smoothing value;10;%;	Trace smoothing aperture
Spurious Removal;OFF;	State of spur removal
Spurious Removal Threshold;x;dB;	Spur removal threshold
Trace Offset;ON;	State of trace offset
Trace Offset;x;dB;	Value of trace offset
Trace Label;ON;	State of trace label
Trace Label;LabelDesignation;	Trace label
X-Unit;Hz;	Unit of the x-axis
Y-Unit;dBc/Hz;	Unit of the y-axis
Values;601;	Number of measurement points
<x-value>;<y-value>;	Results (one level for every measurement point)
(...)	
Trace;2;	
(...)	
Window;2;PhaseNoise;	
(...)	

Integrated measurement results (amount of data depends on the number of integration ranges)	
Window;3;Integrated Measurements;	Number and type of window
Window;Range;Trace;	Window and trace number a integration range applies to
Start Offset;Unit;	Start offset of the integration range
Stop Offset;Unit;	Stop offset of the integration range
Weighting;	Name of the weighting filter, if present
Int Noise;Unit;	Value for integrated noise
PM;Unit;	Value for the Residual PM
FM;Unit;	Value for the Residual FM
Jitter;Unit;	Value for the jitter
Window;3;Range2;Trace;	
(...)	

Spot noise measurement results (amount of data depends on the number of spot noise markers)	
Window;4;Spot Noise;	Number and type of window
Window;Trace;	Window and trace number the spot noise marker is positioned in
X-Value;Unit;	Position of the spot noise marker
Y-Value;Unit;	Spot noise
(...)	

Spur measurement results (amount of data depends on the number of spurs)	
Window;5;Spurious;	Number and type of window
Window;Trace;	Window and trace number the spurious is found in
Spur;	Number of the spurious
Offset Frequency;Unit;	Offset frequency of the spur
Power;Unit;	Level of the spur
Jitter;Unit;	Jitter of the spur
(...)	
Window;Trace;	Window and trace number the spurious is found in
Discrete Jitter;Unit;	Discrete jitter result
Random Jitter;Unit;	Random jitter result

Marker results (amount of data depends on the number of active markers)	
Window;6;Marker Table;	Number and type of window
Window;	Window the marker is in
Type;	Marker type
Reference;	Reference marker
Trace;	Number of the trace the marker is on
X-Value;Unit;	Position of the marker on the x-axis, incl. unit
Y-Value;Unit;	Position of the marker on the y-axis, incl. unit
(...)	

Blue font: header data only written to file if header data is exported, too.	
Black font: result data is always exported to the file	
VCO Characterization + Spot Noise vs Tune: General measurement configuration	
Type; R&S FSWP;	Instrument model
Version;1.00;	Firmware version
Date;01. Jan 3000;	Date of data set storage
VSupply;ON;	State of the supply voltage source (on or off)
Mode;Voltage;	Type of output on the supply voltage source (voltage or current)
Voltage Set;5.000;V;	Output characteristics of the supply voltage
Voltage Min;4.750;V;	
Voltage Max;5.250;V;	
Voltage Meas;0.000;V;	
Current Max;0.050000;A;	
Current Meas;0.000000;A;	
VTune;OFF;	State of the tuning voltage source (on or off)
Voltage Set;5.000;V;	Output characteristics of the tuning voltage
Voltage Min;4.750;V;	
Voltage Max;5.250;V;	
Voltage Meas;0.000;V;	
Current Max;0.050000;A;	
Current Meas;0.000000;A;	
VAux;OFF;	State of the auxiliary voltage source (on or off)
Voltage Set;5.000;V;	Output characteristics of the auxiliary voltage
Voltage Min;4.750;V;	
Voltage Max;5.250;V;	
Voltage Meas;0.000;V;	
Current Max;0.050000;A;	
Current Meas;0.000000;A;	
Mode;Phase Noise;	Application
Measurement;VCO Characterization;	Measurement type
Input;RF;	Input source
RF Att;0.000000;dB;	RF attenuation
Coupling;AC;	Input coupling type
Sweep Count;0;	Sweep count
Sweep Source;Vtune;	Sweep source (Vsupply,Vtune or Vaux)
Fix Source;Vsupply;	Fix source (Vsupply,Vtune or Vaux)
Sweep Start;0.000000;V;	Tuning range start value
Sweep Stop;5.000000;V;	Tuning range stop value
Meas Points;10;	Measurement points within the tuning range
Settling Time;0.001000;s;	Settling time for each measurement point
Initial Settling Time;0.001000;s;	Settling time before the measurement begins
Frequency Counter Resolution;1.000000000;Hz;	Start offset frequency

VCO Characterization + SN vs Tune: Results (amount of data depends on evaluated result displays)	
Window;1;Frequency;	Number and type of window (Frequency, Sensitivity etc.)
Trace;1;	Trace number
Trace Mode;CLR/WRITE;	Trace mode
Trace Label;ON;	State of trace label
Trace Label;LabelDesignation;	Trace label
X-Unit;V;	Unit of the x-axis
Y-Unit;Hz;	Unit of the y-axis
Values;601;	Number of measurement points
<x-value>;<y-value>;	Results (one value for every measurement point)
(...)	
Trace;2;	
(...)	
Window;2;Power;	
(...)	

Blue font: header data only written to file if header data is exported, too.

Black font: result data is always exported to the file

Transient analysis: General measurement configuration

Measurement;Transient Analysis;	Measurement type
Input;RF;	Input source
Mode;NARROW;	Transient analysis mode
Center Freq;1325000000.000000;Hz;	Center frequency
Start;0.000000;Hz;	Start frequency
Stop;26500000000.000000;Hz;	Stop frequency
Span;26500000000.000000;Hz;	Frequency span
Ref Level;0.000000;dBm;	Reference level
Rf Att;10.000000;dB;	RF attenuation
Coupling;AC;	Input coupling
VBW;3000000.000000;Hz;	Video bandwidth
Meas Time;0.079500;s;	Measurement time
Sweep Count;0;	Sweep count

Transient analysis: results (amount of data depends on evaluated result displays)	
Window;1;Frequency vs Time;	Number and type of window (Frequency, phase etc.)
Scale Mode;ABSOLUTE;	Scaling mode of the y-axis (frequency results only)
AF Coupling;AC;	AF coupling mode (phase results only)
Trace;1;	Trace number
Trace Mode;CLR/WRITE;	Trace mode
Trace Label;ON;	State of trace label
Trace Label;LabelDesignation;	Trace label
X-Unit;s;	Unit of the x-axis
Y-Unit;Hz;	Unit of the y-axis
Values;601;	Number of measurement points
<x-value>;<y-value>;	Results (one value for every measurement point)
(...)	
Trace;2;	
(...)	

10.4 Markers

Markers help you analyze your measurement results by determining particular values in the diagram. Thus you can extract numeric values from a graphical display.

- [Basics on markers and marker functions](#)..... 241
- [Marker settings](#).....244
- [Marker search settings and positioning functions](#)..... 248

10.4.1 Basics on markers and marker functions

Some background knowledge on marker settings and functions is provided here for a better understanding of the required configuration settings.

Markers are used to mark points on traces, to read out measurement results and to select a display section quickly. R&S FSWP provides 16 markers per display window. In the Phase Noise application, markers across measurement windows are independent from each other - thus you can move a marker in one window without moving it in another window.

- The easiest way to work with markers is using the touchscreen. Simply drag the marker and drop it at the required position. When a marker label is selected, a vertical line is displayed which indicates the marker's current x-value.

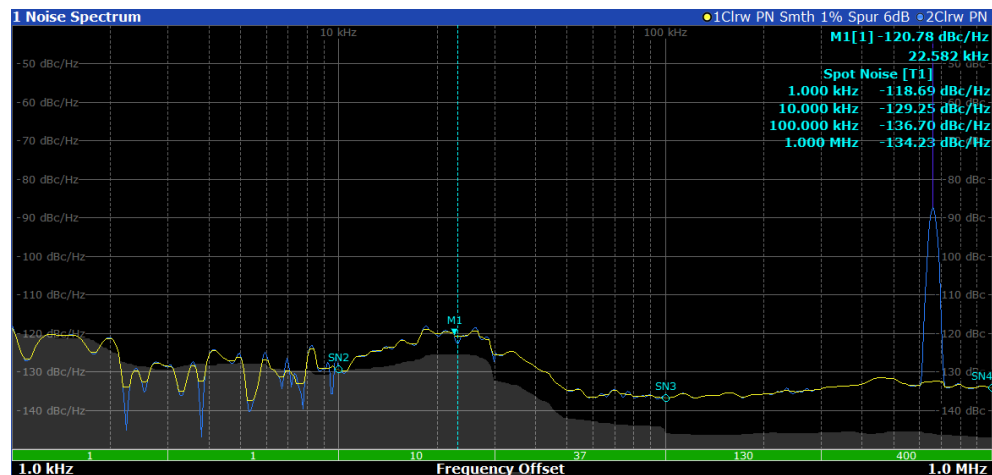

- Alternatively, change the position of the selected marker using the rotary knob. By default, the marker is moved from one pixel to the next.
- You can also set an active marker to a new position by defining its position on the x-axis numerically. When you select the softkey for a marker, an edit dialog box is displayed.
- The most commonly required marker settings and functions are also available as softkeys or via the context menu. Tap the marker on the touchscreen and hold your finger for about 2 seconds until the context menu is opened, then select the required entry.
- Softkeys for active markers (displayed on the screen) are highlighted blue. The softkey for the currently selected marker (for which functions are performed) is highlighted orange.
- To set individual markers quickly, use the softkeys in the "Marker" menu.
- To set up several markers at once, use the "Marker" dialog box.
- To position the selected marker to a special value, use the softkeys in the "Marker To" menu.

Marker types

All markers can be used either as normal markers or delta markers. A normal marker indicates the absolute signal value at the defined position in the diagram. A delta marker indicates the value of the marker relative to the specified reference marker (by default marker 1).

- [Activating markers](#).....242
- [Marker results](#)..... 243

10.4.1.1 Activating markers

Only active markers are displayed in the diagram and in the marker table.

Active markers are indicated by a highlighted softkey.

By default, marker 1 is active and positioned on the maximum value (peak) of trace 1 as a normal marker. If several traces are displayed, the marker is set to the maximum

value of the trace which has the lowest number and is not frozen (View mode). The next marker to be activated is set to the frequency of the next lower level (next peak) as a delta marker; its value is indicated as an offset to marker 1.

A marker can only be activated when at least one trace in the corresponding window is visible. If a trace is switched off, the corresponding markers and marker functions are also deactivated. If the trace is switched on again, the markers along with coupled functions are restored to their original positions, provided the markers have not been used on another trace.

10.4.1.2 Marker results

Normal markers point to a trace point on the x-axis and display the associated numeric value for that trace point. Delta markers indicate an offset between the level at the delta marker position and the level at the position of the assigned reference marker, in dB.

The results can be displayed directly within the diagram area or in a separate table. By default, the first two active markers are displayed in the diagram area. If more markers are activated, the results are displayed in a marker table.

Marker information in diagram area

By default, the results of the last two markers or delta markers that were activated are displayed in the diagram area.

D2[1]	-21.90 dB
	-3.9180 GHz
M1[1]	-25.87 dBm
	13.1970 GHz

The following information is displayed there:

- The marker type (M for normal, D for delta, or special function name)
- The marker number
- The assigned trace number in square brackets []
- The marker value on the y-axis, or the result of the marker function
- The marker position on the x-axis

Marker information in marker table

In addition to the marker information displayed within the diagram area, a separate marker table may be displayed beneath the diagram. This table provides the following information for all active markers:

Table 10-2: Contents of the marker table in the Phase Noise application

Window	Window the marker is in (only if you have opened more than one Phase Noise diagram)
Type	Marker type: N (normal), D (delta), T (temporary, internal) and number
Ref	Reference marker for delta markers

Trc	Trace to which the marker is assigned
X-value	X-value of the marker
Y-value	Y-value of the marker

10.4.2 Marker settings

For more information about marker search, see [Chapter 10.4.3, "Marker search settings and positioning functions"](#), on page 248

- [Individual marker setup](#)..... 244
- [General marker settings](#)..... 247

10.4.2.1 Individual marker setup

Access: "Overview" > "Analysis" > "Markers" > "Markers"

Up to 17 markers or delta markers can be activated for each window simultaneously. Initial marker setup is performed using the "Marker" dialog box.

The markers are distributed among 3 tabs for a better overview. By default, the first marker is defined as a normal marker, whereas all others are defined as delta markers with reference to the first marker. All markers are assigned to trace 1, but only the first marker is active.

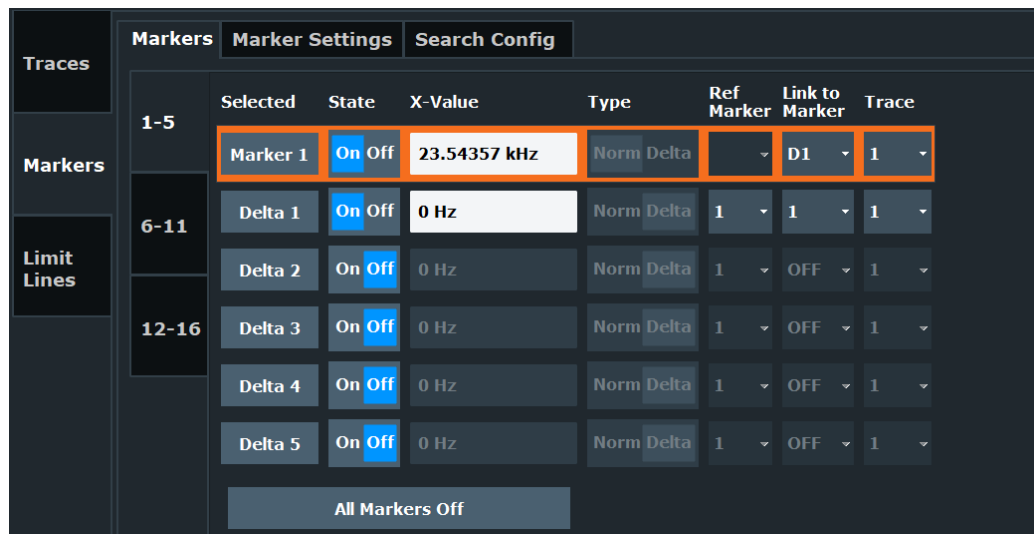

The remote commands required to define these settings are described in [Chapter 14.7.4, "Marker"](#), on page 549.

- [Selected Marker](#)..... 245
- [Marker State](#)..... 245
- [Marker Position X-value](#)..... 245
- [Marker Type](#)..... 245
- [Reference Marker](#)..... 245
- [Linking to Another Marker](#)..... 246

Assigning the Marker to a Trace.....	246
Select Marker.....	246
All Markers Off.....	247

Selected Marker

Marker name. The marker which is currently selected for editing is highlighted orange.

Remote command:

Marker selected via suffix <m> in remote commands.

Marker State

Activates or deactivates the marker in the diagram.

Remote command:

[CALCulate<n>:MARKer<m>\[:STATe\]](#) on page 554

[CALCulate<n>:DELTAmarker<m>\[:STATe\]](#) on page 552

Marker Position X-value

Defines the position (x-value) of the marker in the diagram. For normal markers, the absolute position is indicated. For delta markers, the position relative to the reference marker is provided.

Remote command:

[CALCulate<n>:MARKer<m>:X](#) on page 554

[CALCulate<n>:DELTAmarker<m>:X](#) on page 552

Marker Type

Toggles the marker type.

The type for marker 1 is always "Normal", the type for delta marker 1 is always "Delta". These types cannot be changed.

Note: If normal marker 1 is the active marker, switching the "Mkr Type" activates an additional delta marker 1. For any other marker, switching the marker type does not activate an additional marker, it only switches the type of the selected marker.

"Normal" A normal marker indicates the absolute value at the defined position in the diagram.

"Delta" A delta marker defines the value of the marker relative to the specified reference marker (marker 1 by default).

Remote command:

[CALCulate<n>:MARKer<m>\[:STATe\]](#) on page 554

[CALCulate<n>:DELTAmarker<m>\[:STATe\]](#) on page 552

Reference Marker

Defines a marker as the reference marker which is used to determine relative analysis results (delta marker values).

If the reference marker is deactivated, the delta marker referring to it is also deactivated.

Remote command:

[CALCulate<n>:DELTAmarker<m>:MREFerence](#) on page 551

Linking to Another Marker

Links the current marker to the marker selected from the list of active markers. If the x-axis value of the initial marker is changed, the linked marker follows to the same position on the x-axis. Linking is off by default.

Using this function you can set two markers on different traces to measure the difference (e.g. between a max hold trace and a min hold trace or between a measurement and a reference trace).

Remote command:

[CALCulate<n>:MARKer<ms>:LINK:TO:MARKer<md>](#) on page 553

[CALCulate<n>:DELTAmarker<ms>:LINK:TO:MARKer<md>](#) on page 550

[CALCulate<n>:DELTAmarker<m>:LINK](#) on page 550

Assigning the Marker to a Trace

The "Trace" setting assigns the selected marker to an active trace. The trace determines which value the marker shows at the marker position. If the marker was previously assigned to a different trace, the marker remains on the previous frequency or time, but indicates the value of the new trace.

If a trace is turned off, the assigned markers and marker functions are also deactivated.

Remote command:

[CALCulate<n>:MARKer<m>:TRACe](#) on page 554

Select Marker

The "Select Marker" function opens a dialog box to select and activate or deactivate one or more markers quickly.



Remote command:

[CALCulate<n>:MARKer<m>\[:STATe\]](#) on page 554

[CALCulate<n>:DELTAmarker<m>\[:STATe\]](#) on page 552

All Markers Off

Deactivates all markers in one step.

Remote command:

[CALCulate<n>:MARKer<m>:AOFF](#) on page 553

10.4.2.2 General marker settings

Access: "Overview" > "Analysis" > "Markers" > "Settings"

Some general marker settings allow you to influence the marker behavior for all markers.

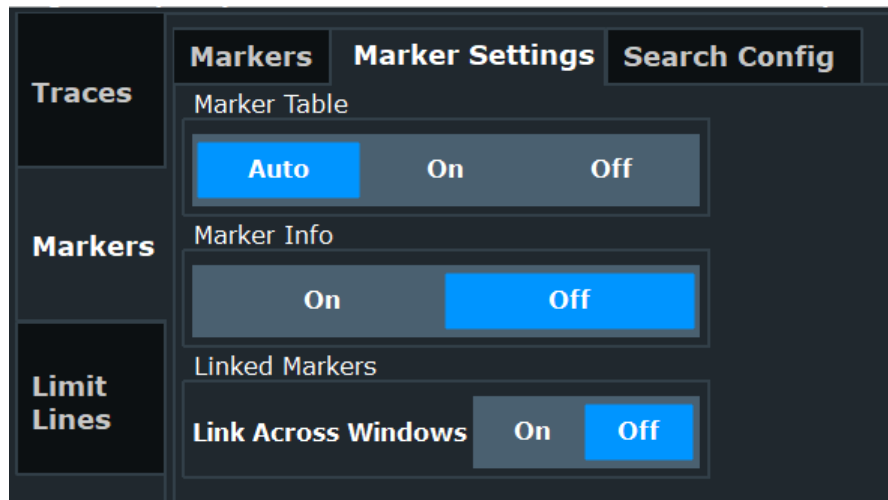

The remote commands required to define these settings are described in [Chapter 14.7.4, "Marker"](#), on page 549.

[Marker Table Display](#).....247

[Linked Markers](#).....247

Marker Table Display

Defines how the marker information is displayed.

"On" Displays the marker information in a table in a separate area beneath the diagram.

"Off" No separate marker table is displayed.

Remote command:

[DISPlay\[:WINDow<n>\]:MTABLE](#) on page 555

Linked Markers

If enabled, the markers in all diagrams with the same x-axis are linked, i.e. when you move a marker in one window, the markers in all other windows are moved to the same x-value.

Remote command:

[CALCulate<n>:MARKer<m>:LINK](#) on page 555

10.4.3 Marker search settings and positioning functions

Several functions are available to set the marker to a specific position quickly and easily, or to use the current marker position to define another characteristic value. In order to determine the required marker position, searches can be performed. The search results can be influenced by special settings.

Most marker positioning functions and the search settings are available in the [MKR →] menu.

Search settings are also available via the [Marker] key or in the vertical "Marker Config" tab of the "Analysis" dialog box (horizontal "Search Settings" tab).

- [Marker search settings](#).....248
- [Positioning functions](#).....250

10.4.3.1 Marker search settings

Access: "Overview" > "Analysis" > "Markers" > "Search"

Markers are commonly used to determine peak values, i.e. maximum or minimum values, in the measured signal. Configuration settings allow you to influence the peak search results.

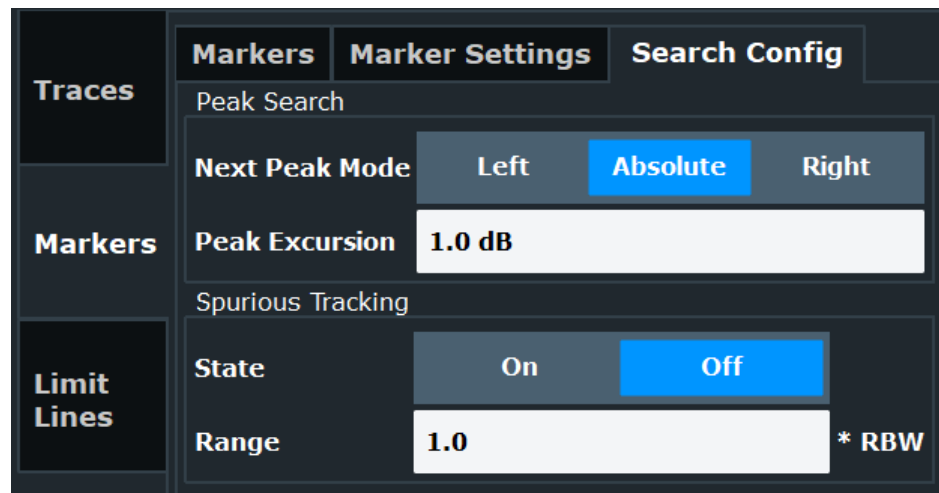

The remote commands required to define marker search are described in [Chapter 14.7.4.3, "Marker search"](#), on page 556.

Search Mode for Next Peak	248
Peak Excursion	249
Spurious Tracking	249

Search Mode for Next Peak

Selects the search mode for the next peak search.

"Left" Determines the next maximum/minimum to the left of the current peak.

"Absolute"	Determines the next maximum/minimum to either side of the current peak.
"Right"	Determines the next maximum/minimum to the right of the current peak.

Remote command:

Find a list of remote commands in [Chapter 14.7.4.4, "Positioning markers"](#), on page 557.

Peak Excursion

Defines the minimum level value by which a signal must rise or fall so that it is identified as a maximum or a minimum by the search functions.

Entries from 0 dB to 60 dB are allowed; the resolution is 0.1 dB. The default setting for the peak excursion is 1 dB.

For transient measurements, the peak excursion is either a value in Hz (frequency diagram) or rad / deg (phase diagram). The value range is from 0 Hz to 10 MHz (default: 50 kHz) and 0 rad to 10 rad (default: 0.5 rad) respectively.

Remote command:

`CALCulate<n>:MARKer<m>:PEXCursion` on page 556

Spurious Tracking

Spurs can be unstable regarding their frequency characteristics. In such cases, markers would not remain on the spur, but on the frequency you have set them on initially.

You can avoid this situation using spurious tracking. Spur tracking makes sure that the marker remains on the spur, even if the spur changes its frequency. When you turn on spur tracking, you can define a frequency range within which the R&S FSWP tracks the spur and adjusts the marker position automatically.

The tracking "Range" defines an area around the marker position and is a function of the [resolution bandwidth](#) (RBW) used in the half decade the marker is in. Note that the tracking range is dynamic and always relative to the latest marker position, not the initial marker position.

Example:

You are measuring with an RBW of 10 kHz and place the marker on a spur.

The tracking range is defined as $1 * \text{RBW} = 10 \text{ kHz}$.

If the spur changes its position by up to $\pm 10 \text{ kHz}$, the R&S FSWP changes the marker position along with the spur.

Note that the [spurious list](#) contains the tracked spurs and always shows the latest position of the spur.

Remote command:

State: `CALCulate<n>:MARKer<m>:FUNCTION:SPTRacking[:STATE]`
on page 557

Range: `CALCulate<n>:MARKer<m>:FUNCTION:SPTRacking:RANGE` on page 556

10.4.3.2 Positioning functions

Access: [MKR →]

The following functions set the currently selected marker to the result of a peak search or set other characteristic values to the current marker value.

The remote commands required to position markers are described in [Chapter 14.7.4.4, "Positioning markers"](#), on page 557.

Peak Search.....	250
Search Next Peak.....	250
Search Minimum.....	250
Search Next Minimum.....	250

Peak Search

Sets the selected marker/delta marker to the maximum of the trace. If no marker is active, marker 1 is activated.

Remote command:

`CALCulate<n>:MARKer<m>:MAXimum[:PEAK]` on page 560

`CALCulate<n>:DELTamarker<m>:MAXimum[:PEAK]` on page 558

Search Next Peak

Sets the selected marker/delta marker to the next (lower) maximum of the assigned trace. If no marker is active, marker 1 is activated.

Remote command:

`CALCulate<n>:MARKer<m>:MAXimum:NEXT` on page 560

`CALCulate<n>:MARKer<m>:MAXimum:RIGHT` on page 560

`CALCulate<n>:MARKer<m>:MAXimum:LEFT` on page 559

`CALCulate<n>:DELTamarker<m>:MAXimum:NEXT` on page 558

`CALCulate<n>:DELTamarker<m>:MAXimum:RIGHT` on page 558

`CALCulate<n>:DELTamarker<m>:MAXimum:LEFT` on page 558

Search Minimum

Sets the selected marker/delta marker to the minimum of the trace. If no marker is active, marker 1 is activated.

Remote command:

`CALCulate<n>:MARKer<m>:MINimum[:PEAK]` on page 561

`CALCulate<n>:DELTamarker<m>:MINimum[:PEAK]` on page 559

Search Next Minimum

Sets the selected marker/delta marker to the next (higher) minimum of the selected trace. If no marker is active, marker 1 is activated.

Remote command:

`CALCulate<n>:MARKer<m>:MINimum:NEXT` on page 561

`CALCulate<n>:MARKer<m>:MINimum:LEFT` on page 560

`CALCulate<n>:MARKer<m>:MINimum:RIGHT` on page 561

`CALCulate<n>:DELTamarker<m>:MINimum:NEXT` on page 559

[CALCulate<n>:DELTamarker<m>:MINimum:LEFT](#) on page 559

[CALCulate<n>:DELTamarker<m>:MINimum:RIGHT](#) on page 559

10.5 Limit lines

Limit lines help you analyze a measurement trace.

- [Basics on limit lines](#).....251
- [Limit line settings and functions](#).....254
- [How to define limit lines](#).....258

10.5.1 Basics on limit lines

Limit lines are used to define amplitude curves or spectral distribution boundaries in the result diagram which are not to be exceeded. They indicate, for example, the upper limits for interference radiation or spurious waves which are allowed from a device under test (DUT). When transmitting information in TDMA systems (e.g. GSM), the amplitude of the bursts in a time slot must adhere to a curve that falls within a specified tolerance band. The lower and upper limits may each be specified by a limit line. Then, the amplitude curve can be controlled either visually or automatically for any violations of the upper or lower limits (GO/NOGO test).

The R&S FSWP supports limit lines with a maximum of 200 data points. Eight of the limit lines stored in the instrument can be activated simultaneously. The number of limit lines stored in the instrument is only limited by the capacity of the storage device used.

Limit line data can also be exported to a file in ASCII (CSV) format for further evaluation in other applications. Limit lines stored in the specified ASCII (CSV) format can also be imported to the R&S FSWP for other measurements.

Compatibility

Limit lines are compatible with the current measurement settings, if the following applies:

- The x unit of the limit line has to be identical to the current setting.
- The y unit of the limit line has to be identical to the current setting.

Validity

Only limit lines that fulfill the following conditions can be activated:

- Each limit line must consist of a minimum of 2 and a maximum of 200 data points.
- The frequencies/times for each data point must be defined in ascending order; however, for any single frequency or time, two data points may be entered (to define a vertical segment of a limit line).
- Gaps in frequency or time are not allowed. If gaps are desired, two separate limit lines must be defined and then both enabled.

- The entered frequencies or times need not necessarily be selectable in R&S FSWP. A limit line may also exceed the specified frequency or time range. The minimum frequency for a data point is -200 GHz, the maximum frequency is 200 GHz. For the time range representation, negative times may also be entered. The allowed range is -1000 s to +1000 s.

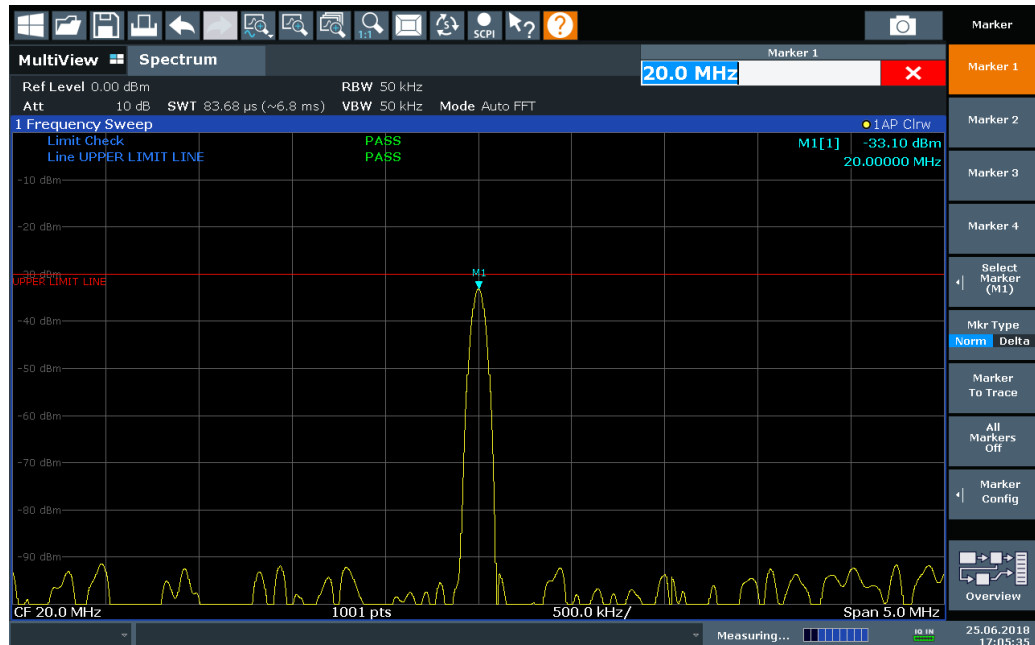
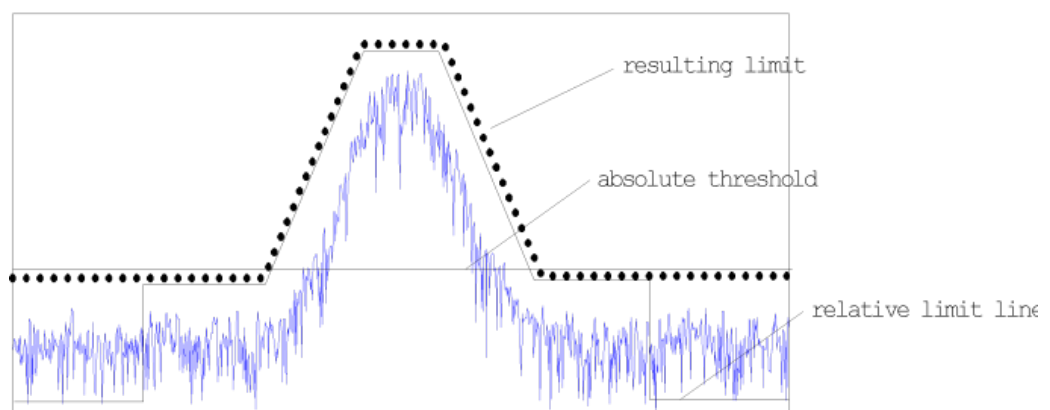

Figure 10-9: Example for an upper limit line

Thresholds

If the y-axis for the limit line data points uses relative scaling, an additional absolute **threshold** can be defined for the limit check. In this case, both the threshold value and the relative limit line must be exceeded before a violation occurs.



Offsets and Shifting

A configured limit line can easily be moved vertically or horizontally. Two different methods to do so are available:

- An **offset** moves the entire line in the diagram without editing the configured values or positions of the individual data points. This option is only available if relative scaling is used.
Thus, a new limit line can be easily generated based upon an existing limit line which has been shifted horizontally or vertically.
- Defining a **shift** width for the values or position of the individual data points changes the line configuration, thus changing the position of the line in the diagram.

Limit Check Results

A limit check is automatically performed as soon as any of the limit lines is activated ("Visibility" setting). Only the specified "Traces to be Checked" are compared with the active limit lines. The status of the limit check for each limit line is indicated in the diagram. If a violation occurs, the limit check status is set to "MARG" for a margin violation, or to "Fail" for a limit violation.



Figure 10-10: Margin violation for limit check

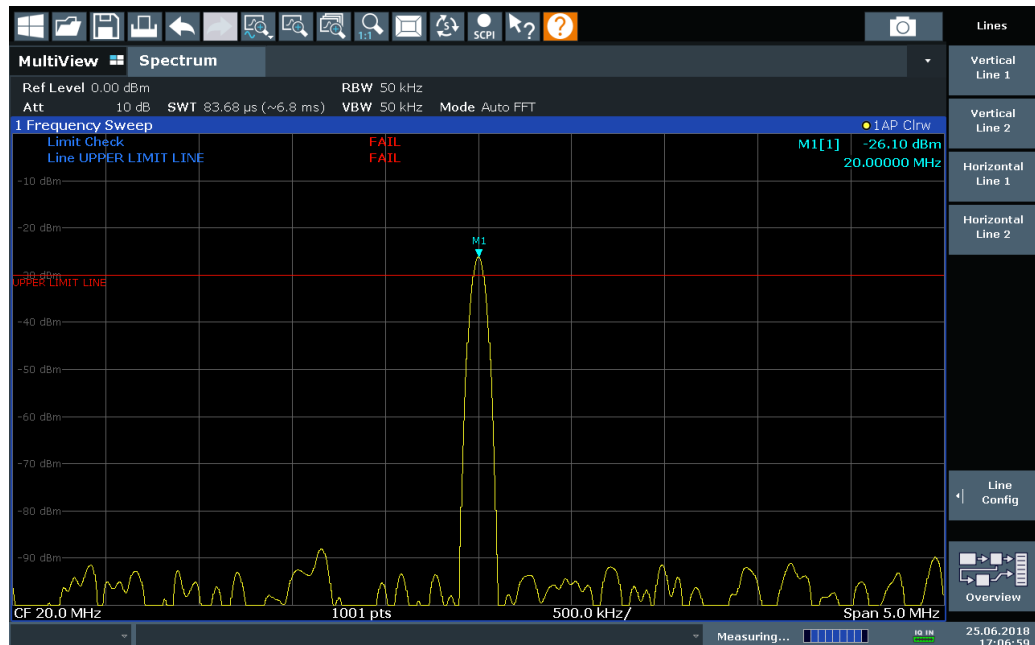

Figure 10-11: Limit violation for limit check



Storing and Recalling Limit Lines

Limit lines can be stored with the configuration settings so they can be recalled for other measurements at a later time (see [Chapter 11.3, "Storing and recalling instrument settings and measurement data"](#), on page 265). Note, however, that any changes made to the limit lines *after* storing the configuration file cannot be restored and will be overwritten by the stored values when the configuration file is recalled. Always remember to store the settings again after changing the limit line values.

After recalling measurement settings, the limit line values applied to the measurement may be different to those displayed in the "Limit Lines" dialog box; see ["Saving and recalling transducer and limit line settings"](#) on page 266.

10.5.2 Limit line settings and functions

Access: "Overview" > "Analysis" > "Lines"

or: [LINES] > "Line Config"

Up to 8 limit lines can be displayed simultaneously in the R&S FSWP. Many more can be stored on the instrument.



Stored limit line settings

When storing and recalling limit line settings, consider the information provided in ["Saving and recalling transducer and limit line settings"](#) on page 266.

- [Limit line management](#).....255
- [Limit line details](#).....256

10.5.2.1 Limit line management

Access: "Overview" > "Analysis" > "Lines" > "Limit Lines"

or: [LINES] > "Line Config" > "Limit Lines"

For the limit line overview, the R&S FSWP searches for all stored limit lines with the file extension `.LIN` in the `limits` subfolder of the main installation folder. The overview allows you to determine which limit lines are available and can be used for the current measurement.

For details on settings for individual lines see [Chapter 10.5.2.2, "Limit line details"](#), on page 256.

For more basic information on limit lines see [Chapter 10.5.1, "Basics on limit lines"](#), on page 251.

Name	255
Unit	255
Compatibility	255
Visibility	255
Traces to be Checked	256
Comment	256
Included Lines in Overview (View Filter)	256
Create New Line	256
Edit Line	256
Copy Line	256
Delete Line	256
Disable All Lines	256

Name

The name of the stored limit line.

Unit

The unit in which the y-values of the data points of the limit line are defined.

Compatibility

Indicates whether the limit line definition is compatible with the current measurement settings.

For more information on which conditions a limit line must fulfill to be compatible, see ["Compatibility"](#) on page 251.

Visibility

Displays or hides the limit line in the diagram. Up to 8 limit lines can be visible at the same time. Inactive limit lines can also be displayed in the diagram.

Remote command:

`CALCulate<n>:LIMit:LOWer:STATe` on page 565

`CALCulate<n>:LIMit:UPPer:STATe` on page 567

`CALCulate<n>:LIMit:ACTive?` on page 563

Traces to be Checked

Defines which traces are automatically checked for conformance with the limit lines. As soon as a trace to be checked is defined, the assigned limit line is active. One limit line can be activated for several traces simultaneously. If any of the "Traces to be Checked" violate any of the active limit lines, a message is indicated in the diagram.

Remote command:

[CALCulate<n>:LIMit:TRACe<t>:CHECK](#) on page 566

Comment

An optional description of the limit line.

Included Lines in Overview (View Filter)

Defines which of the stored lines are included in the overview.

- | | |
|-------------------|--|
| "Show Compatible" | Only compatible lines
Whether a line is compatible or not is indicated in the Compatibility setting. |
| "Show All" | All stored limit lines with the file extension <code>.LIN</code> in the <code>limits</code> subfolder of the main installation folder.
(if not restricted by "Show Lines for all Modes" setting). |

Create New Line

Creates a new limit line.

Edit Line

Edit an existing limit line configuration.

Copy Line

Copy the selected limit line configuration to create a new line.

Remote command:

[CALCulate<n>:LIMit:COPY](#) on page 564

Delete Line

Delete the selected limit line configuration.

Remote command:

[CALCulate<n>:LIMit:DELEte](#) on page 564

Disable All Lines

Disable all limit lines in one step.

Remote command:

[CALCulate<n>:LIMit:STATe](#) on page 565

10.5.2.2 Limit line details

Access: "Overview" > "Analysis" > "Lines" > "Limit Lines" > "New" / "Edit" / "Copy To"
or: [LINES] > "Line Config" > "Limit Lines" > "New" / "Edit" / "Copy To"

Name.....	257
Comment.....	257
X-Axis.....	257
Y-Axis.....	257
Data Points.....	258
Insert Value.....	258
Delete Value.....	258
Shift x.....	258
Shift y.....	258
Save.....	258

Name

Defines the limit line name. All names must be compatible with Windows conventions for file names. The limit line data is stored under this name (with a `.LIN` extension).

Remote command:

`CALCulate<n>:LIMit:NAME` on page 571

Comment

Defines an optional comment for the limit line.

Remote command:

`CALCulate<n>:LIMit:COMMENT` on page 567

X-Axis

Describes the horizontal axis on which the data points of the limit line are defined.

Includes the following settings:

- Unit:
 - "Hz": for frequency domain
 - "s": for time domain
 - V: for VCO Characterization or Spot Noise vs Tune
 - mA: for VCO Characterization or Spot Noise vs Tune
- Scaling mode: absolute or relative values
Not supported
- Scaling: linear or logarithmic

Remote command:

`CALCulate<n>:LIMit:CONTrol:MODE` on page 568

`CALCulate<n>:LIMit:CONTrol:DOMain` on page 568

`CALCulate<n>:LIMit:CONTrol:SPACing` on page 569

Y-Axis

Describes the vertical axis on which the data points of the limit line are defined.

Includes the following settings:

- Level unit
- Scaling mode: absolute or relative (dB/%) values
Relative limit values refer to the center frequency (frequency diagram) or the reference value (phase diagram).
- Limit type: upper or lower limit; values must stay above the lower limit and below the upper limit to pass the limit check

Available for transient measurements.

Remote command:

[CALCulate<n>:LIMit:UNIT](#) on page 571

[CALCulate<n>:LIMit:LOWer:MODE](#) on page 570

[CALCulate<n>:LIMit:UPPer:MODE](#) on page 572

[CALCulate<n>:LIMit:LOWer:MODE](#) on page 570

[CALCulate<n>:LIMit:UPPer:MODE](#) on page 572

[CALCulate<n>:LIMit:LOWer:SPACing](#) on page 571

[CALCulate<n>:LIMit:UPPer:SPACing](#) on page 573

Data Points

Each limit line is defined by a minimum of 2 and a maximum of 200 data points. Each data point is defined by its position (x-axis) and value (y-value). Data points must be defined in ascending order. The same position can have two different values.

Remote command:

[CALCulate<n>:LIMit:CONTRol\[:DATA\]](#) on page 568

[CALCulate<n>:LIMit:LOWer\[:DATA\]](#) on page 570

[CALCulate<n>:LIMit:UPPer\[:DATA\]](#) on page 572

Insert Value

Inserts a data point in the limit line above the selected one in the "Edit Limit Line" dialog box.

Delete Value

Deletes the selected data point in the "Edit Limit Line" dialog box.

Shift x

Shifts the x-value of each data point horizontally by the defined shift width.

Remote command:

[CALCulate<n>:LIMit:CONTRol:SHIFt](#) on page 569

Shift y

Shifts the y-value of each data point vertically by the defined shift width.

Remote command:

[CALCulate<n>:LIMit:LOWer:SHIFt](#) on page 570

[CALCulate<n>:LIMit:UPPer:SHIFt](#) on page 572

Save

Saves the currently edited limit line under the name defined in the "Name" field.

10.5.3 How to define limit lines

Access: "Overview" > "Analysis" > "Lines" > "Limit Lines"

or: [LINES] > "Line Config" > "Limit Lines"

The following tasks are described here:

- ["How to find compatible limit lines"](#) on page 259

- ["How to activate and deactivate a limit check"](#) on page 259
- ["How to edit existing limit lines"](#) on page 259
- ["How to copy an existing limit line"](#) on page 259
- ["How to delete an existing limit line"](#) on page 260
- ["How to configure a new limit line"](#) on page 260
- ["How to move the limit line vertically or horizontally"](#) on page 261

How to find compatible limit lines

- ▶ In the "Line Config" dialog box, select the "View Filter" option: "Show Compatible". All stored limit lines with the file extension `.LIN` in the `limits` subfolder of the main installation folder of the instrument that are compatible to the current measurement settings are displayed in the overview.

How to activate and deactivate a limit check

A limit check is automatically performed as soon as any of the limit lines is activated.

1. To activate a limit check:
Select the "Check Traces" setting for a limit line in the overview and select the trace numbers to be included in the limit check. One limit line can be assigned to several traces.
The specified traces to be checked are compared with the active limit lines. The status of the limit check is indicated in the diagram.
2. To deactivate a limit line, deactivate all "Traces to be Checked" for it.
To deactivate all limit lines at once, select "Disable All Lines".
The limit checks for the deactivated limit lines are stopped and the results are removed from the display.

How to edit existing limit lines

Existing limit line configurations can be edited.

1. In the "Line Config" dialog box, select the limit line.
2. Select "Edit".
3. Edit the line configuration as described in ["How to configure a new limit line"](#) on page 260.
4. Save the new configuration by selecting "Save".
If the limit line is active, the edited limit line is displayed in the diagram.

How to copy an existing limit line

1. In the dialog box, select the limit line.
2. Select "Line Config" "Copy To".

3. Define a new name to create a new limit with the same configuration as the source line.
4. Edit the line configuration as described in ["How to configure a new limit line"](#) on page 260.
5. Save the new configuration by selecting "Save".

The new limit line is displayed in the overview and can be activated.

How to delete an existing limit line

1. In the "Line Config" dialog box, select the limit line.
2. Select "Delete".
3. Confirm the message.

The limit line and the results of the limit check are deleted.

How to configure a new limit line

1. In the "Line Config" dialog box, select "New".
The "Edit Limit Line" dialog box is displayed. The current line configuration is displayed in the preview area of the dialog box. The preview is updated after each change to the configuration.
2. Define a "Name" and, optionally, a "Comment" for the new limit line.
3. Define the x-axis configuration:
 - Time domain or frequency domain
 - Absolute or relative limits
 - Linear or logarithmic scaling
4. Define the y-axis configuration:
 - Level unit
 - Absolute or relative limits
 - Upper or lower limit line
5. Define the data points: minimum 2, maximum 200:
 - a) Select "Insert Value".
 - b) Define the x-value ("Position") and y-value ("Value") of the first data point.
 - c) Select "Insert Value" again and define the second data point.
 - d) Repeat this to insert all other data points.
 - To insert a data point before an existing one, select the data point and then "Insert Value".
 - To insert a new data point at the end of the list, move the focus to the line after the last entry and then select "Insert Value".
 - To delete a data point, select the entry and then "Delete Value".
6. Check the current line configuration in the preview area of the dialog box. If necessary, correct individual data points or add or delete some.

If necessary, shift the entire line vertically or horizontally by selecting "Shift x" or "Shift y" and defining the shift width.

7. Optionally, define a "Margin" at a fixed distance to the limit line. The margin must be within the valid value range and is not displayed in the diagram or preview area.
8. Optionally, if the y-axis uses relative scaling, define an absolute "Threshold" as an additional criteria for a violation.
9. Save the new configuration by selecting "Save".

The new limit line is displayed in the overview and can be activated.

How to move the limit line vertically or horizontally

A configured limit line can easily be moved vertically or horizontally. Thus, a new limit line can be easily generated based upon an existing limit line which has been shifted horizontally.

1. In the "Line Config" dialog box, select the limit line.
2. To shift the complete limit line parallel in the horizontal direction, select "X-Offset" and enter an offset value.
To shift the complete limit line parallel in the vertical direction, select "Y-Offset" and enter an offset value.
3. To shift the individual data points of a limit line by a fixed value (all at once):
 - a) Select "Edit".
 - b) In the "Edit Limit Line" dialog box, select "Shift x" or "Shift y" and define the shift width.
 - c) Save the shifted data points by selecting "Save".

If activated, the limit line is shifted in the diagram.

11 Data management

The R&S FSWP allows you to store and load instrument settings, as well as import and export measurement data for analysis later. Finally, you can store or print the measurement results displayed on the screen.

General storage and import/export functions are available via the toolbar. Some special storage functions are (also) available via softkeys or dialog boxes in the corresponding menus, for example trace data export.

- [Restoring the default instrument configuration \(preset\)](#)..... 262
- [Protecting data using the secure user mode](#).....263
- [Storing and recalling instrument settings and measurement data](#)..... 265
- [Import/export functions](#).....277
- [Creating screenshots of current measurement results and settings](#)..... 279

11.1 Restoring the default instrument configuration (preset)

When delivered, the R&S FSWP has a default configuration. You can restore this defined initial state at any time as a known starting point for measurements. This is often recommendable as a first step in troubleshooting when unusual measurement results arise.



Factory default configuration

The factory default configuration is selected such that the RF input is always protected against overload, provided that the applied signal levels are in the allowed range for the instrument.

Alternatively to the factory default settings, you can define user-specific recall settings to be restored after a preset or reboot, see "[To recall settings automatically after preset or reboot](#)" on page 277.

To restore the default instrument configuration for all channels at once

- ▶ Press [PRESET].



After you use the [PRESET] function, the history of previous actions is deleted, i.e. any actions performed previously cannot be undone or redone using the [UNDO/REDO] keys.

Remote command:

*RST or SYSTem:PRESet

To restore the default configuration for a single channel

The default measurement settings can also be reset for an individual channel only, rather than resetting the entire instrument.

- ▶ In the "Overview", select "Preset Channel".

The factory default settings are restored to the current channel. Note that a user-defined recall settings file is **NOT** restored.

Remote command:

`SYSTem:PRESet:CHANnel[:EXEC]` on page 590

11.2 Protecting data using the secure user mode

During normal operation, the R&S FSWP uses a solid-state drive to store its operating system, instrument firmware, instrument self-alignment data, and any user data created during operation.

Redirecting storage to volatile memory

Alternatively, to avoid storing any sensitive data on the R&S FSWP permanently, the *secure user mode* was introduced (option R&S FSWP-K33). In secure user mode, the instrument's solid-state drive is write-protected so that no information can be written to memory permanently. Data that the R&S FSWP normally stores on the solid-state drive is redirected to volatile memory instead, which remains available only until the instrument is switched off. This data includes:

- Windows operating system files
- Firmware shutdown files containing information on last instrument state
- Self-alignment data
- General instrument settings such as the IP address
- Measurement settings
- User data created during operation (see also [Table 11-1](#))
- Any data created by other applications installed on the R&S FSWP, for example, text editors (Notepad), the clipboard, or drawing tools.

Users can access data that is stored in volatile memory just as in normal operation. However, when the instrument's power is switched off, all data in this memory is cleared. Thus, in secure user mode, the instrument always starts in a defined, fixed state when switched on.

To store data such as measurement results permanently, it must be stored to an external storage device, such as a memory stick.



Limited storage space

The volatile memory used to store data in secure user mode is restricted to 256 MB. Thus, a "Memory full" error can occur although the hard disk indicates that storage space is still available.

Storing required data permanently

Any data that is to be available for subsequent sessions with the R&S FSWP must be stored on the instrument permanently, *before activating the secure user mode*. This includes predefined instrument settings, transducer factors and self-alignment data.



Self-alignment data

Note that self-alignment data becomes invalid with time and due to temperature changes. Therefore, to achieve optimal accuracy, it can be preferable to perform a new self-alignment at the start of each new session on the R&S FSWP.



Windows updates

In secure user mode, in rare cases, Windows updates trigger a reboot. We recommend using secure user mode on R&S FSWP-K33 only in private LAN without access to the internet or disconnected to LAN to avoid unwanted Windows updates. In preparation for Windows updates, disable secure user mode temporarily.

Restricted operation

Since permanent storage is not possible, the following functions are not available in secure user mode:

- Firmware update
- Activating a new option key

Furthermore, since the "SecureUser" used in secure user mode does not have administrator rights, **administrative tasks** such as LAN configuration and some general instrument settings are not available. Refer to the description of the basic instrument setup ([SETUP] menu) to find out which functions are affected.

Activating and deactivating secure user mode

Only a user with administrator rights can activate (and deactivate) the secure user mode. Once activated, a restart is required. The special user "SecureUser" is then logged on to the R&S FSWP automatically using the auto-login function. While the secure user mode is active, a message is displayed in the status bar at the bottom of the screen.



Secure passwords

By default, the initial password for both the administrator account and the "Secure-User" account is "894129". When the secure user mode is activated the first time after installation, you are prompted to change the passwords for all user accounts to improve system security. Although it is possible to continue without changing the passwords, it is strongly recommended that you do so.

You can change the password in Microsoft Windows for any user at any time via:
"Start > Settings > Account > SignIn Options > Password > Change"

To deactivate the secure user mode, the "SecureUser" must log off and a user with administrator rights must log on.



Switching users when using the auto-login function

In the "Start" menu, select the arrow next to "Shut down" and then "Log off".

The "Login" dialog box is displayed, in which you can enter the different user account name and password.

The secure user mode setting and auto-login is automatically deactivated when another user logs on. The "SecureUser" is no longer available.

For users with administrator rights, the secure user mode setting is available in the general system configuration settings (see "[SecureUser Mode](#)" on page 326).

Remote control

Initially after installation of the R&S FSWP-K33 option, secure user mode must be enabled manually once before remote control is possible.

(See `SYSTEM:SECurity[:STATe].`)

Manual activation is necessary to prompt for a change of passwords.

11.3 Storing and recalling instrument settings and measurement data



Access: "Save"/ "Open" icon in the toolbar



Possibly you would like to restore or repeat a measurement you performed under specific conditions on the instrument. Or you want to evaluate imported data in another application on the R&S FSWP and would like to restore the measurement settings applied during measurement. In these cases, you can store and recall instrument and measurement settings, and possibly other related measurement data.

Two different methods are available for managing instrument settings:

- Quick Save/Quick Recall - a defined set of instrument settings or channels are stored or recalled quickly in just one step

- Configurable Save/Recall - a user-defined set of instrument settings or channels are stored to a definable storage location



Restrictions when recalling measurement settings

When recalling a saved configuration file, the following restrictions apply:

- The R&S FSWP must support the frequency range defined in the configuration file.
- Configuration files created on a R&S FSWP with certain options in use do not work on an R&S FSWP without these options.
- Files created with newer firmware versions may not work with a previous version.
- Files created on an instrument other than the R&S FSWP do not work on the R&S FSWP.



Saving instrument settings in secure user mode

Be sure to store instrument settings that you require beyond the current session before [SecureUser Mode](#) is enabled; see [Chapter 11.2, "Protecting data using the secure user mode"](#), on page 263.

Settings that are saved via QuickSave in secure user mode are only available during the current session. As soon as the power is switched off on the R&S FSWP, the data is cleared.



Saving and recalling transducer and limit line settings

If a limit lines file was in use when the save set was stored (with the save item "Current Settings" only) the R&S FSWP assumes that these limit lines values should remain valid after every recall of that save set. Thus, even if the limit lines file is changed and the original save set file is recalled later, the *originally stored* limit lines values are recalled and applied to the measurement. In the "Edit" limit lines dialog box, however, the *changed* limit lines file values are displayed, as no updated limit lines file was loaded.

The same applies to limit line settings.

The same applies to integrated measurements' weighting filter.

Similarly, if you want to apply the changed limit values after recalling the save set, you must force the application to reload the limit file. To do so, simply open the "Edit Limit Line" dialog box (see [Chapter 10.5.2, "Limit line settings and functions"](#), on page 254) and toggle the "Y-Axis" unit. Due to that change, the limit line file is automatically reloaded, and the changed limit values are applied to the current measurement. Now a new save set with the updated limit values can be created.

- [Quick save/quick recall](#)..... 267
- [Configurable storage and recall](#)..... 270
- [How to save and load instrument settings](#)..... 275

11.3.1 Quick save/quick recall

The "Quick Save" and "Quick Recall" functions allow you to store instrument settings or channels very easily and quickly in one step. Up to ten different sets of settings can be stored to or recalled from "save sets". Each save set is identified by its storage date and type (instrument or specific "Channel") in the display. The save sets are stored in the C:\R_S\INSTR\QuickSave directory, in files named QuickSave1.dfl to QuickSave10.dfl. Only the current measurement settings are stored, not any additional data such as traces, limit line or transducer files (see [Chapter 11.3.2.1, "Stored data types"](#), on page 270).

Source calibration files for an optional external generator, if available, are included.



Saving instrument settings in secure user mode

Settings that are saved via Quick Save in secure user mode are stored to the SDRAM, and are only available during the current session. As soon as the power is switched off on the R&S FSWP, the data is cleared (see [Chapter 11.2, "Protecting data using the secure user mode"](#), on page 263).

During recall, save sets of type "Instrument" replace the settings of the entire instrument. All other save sets start a new channel with the stored settings.



If a channel with the same name as the "Channel" to be restored is already active, the name for the new channel is extended by a consecutive number:



11.3.1.1 Quick save / quick recall settings



Access: "Save"/ "Open" icon in the toolbar > "Quick Save" / "Quick Recall"



Both dialog boxes are very similar and closely related.

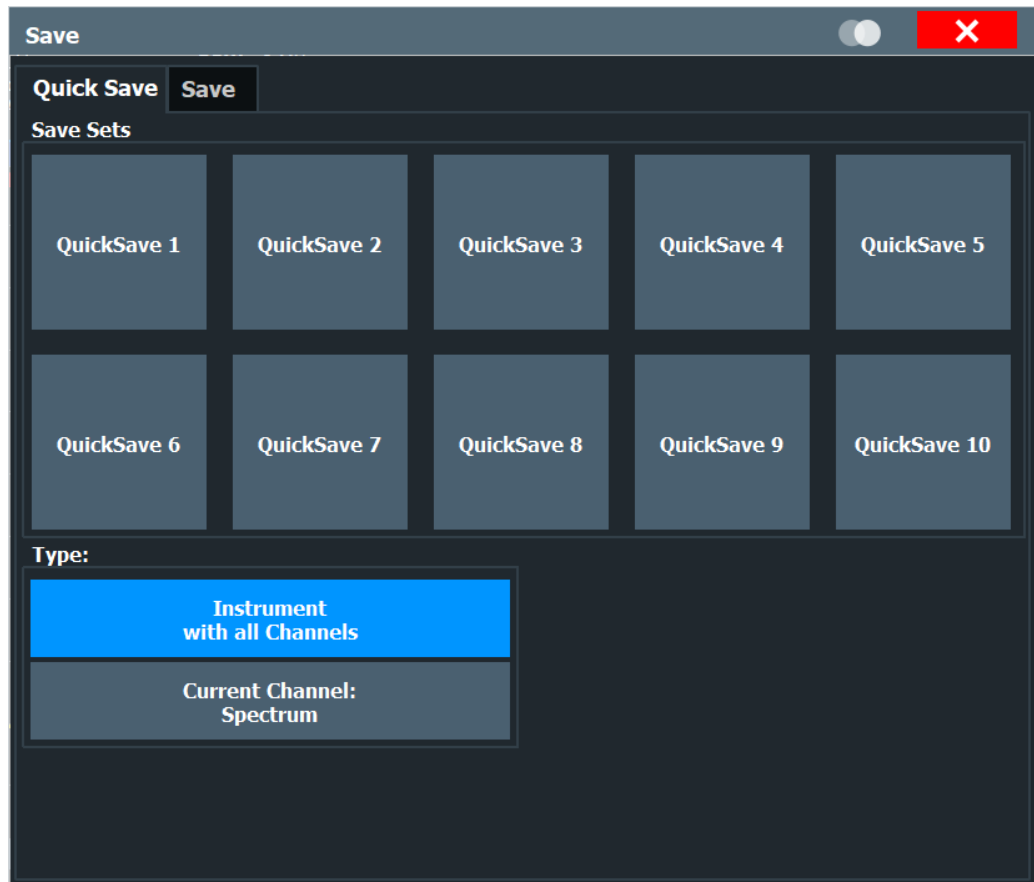

QuickSave 1 / ... / QuickSave 10.....	268
└ Rename.....	269
└ Write Protection.....	269
Storage Type (Save only).....	269
Recall.....	269

QuickSave 1 / ... / QuickSave 10

Selects one of the save sets to store the current settings in or to be recalled. At the time of storage, the "QuickSave 1 / ... / QuickSave 10" placeholder is replaced by a label indicating the storage date and time and the storage type.

Right-click on one of the QuickSave buttons to display a context menu with additional functions for the save set.

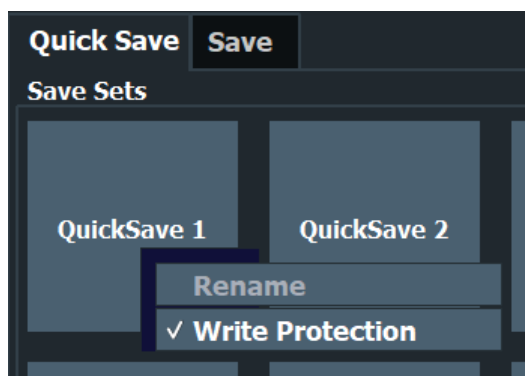

During recall, save sets of type "Instrument" replace the settings of the entire instrument. All other save sets start a new channel with the stored settings.

Note: Saving instrument settings in secure user mode.

Settings that are saved via Quick Save in secure user mode are only available during the current session. As soon as the power is switched off on the R&S FSWP, the data is cleared (see [Chapter 11.2, "Protecting data using the secure user mode"](#), on page 263).

Rename ← QuickSave 1 / ... / QuickSave 10

Displays an input field to rename the save set, if write protection is disabled.

Write Protection ← QuickSave 1 / ... / QuickSave 10

Enables or disables write protection for the save set. If enabled, the save set cannot be renamed or overwritten.

Storage Type (Save only)

Defines which type of settings are stored in the save set.

"Instrument with all Channels"	The instrument settings for all currently active "Channel"s are stored.
"Current Channel"	Only the instrument settings for the currently selected measurement "Channel"s are stored.

Recall

Restores the instrument settings as saved in the selected settings file. If the settings file contains settings for a specific "Channel" only, a new channel with the stored settings is activated, otherwise all "Channel"s and instrument settings are overwritten with the stored settings.

Note: After you use the "Recall" function, the history of previous actions is deleted, i.e. any actions performed previously cannot be undone or redone using the [UNDO/REDO] keys.

Remote command:

[MMEMory:LOAD:STATe](#) on page 587

11.3.2 Configurable storage and recall

The more sophisticated storage and recall functions allow you to define which settings are stored, and where the settings file is stored to. Any settings file can be selected for recall.

- [Stored data types](#).....270
- [Storage location and filename](#).....270
- [Save and recall dialog boxes](#).....271
- [Startup recall settings](#).....273

11.3.2.1 Stored data types

The following types of data can be stored to and loaded from files via the "Save" dialog box on the R&S FSWP:

Table 11-1: Items that can be stored to files

Item	Description
Current Settings	Current instrument and measurement settings.
All Transducers	All transducer factor <i>files</i> . (Note: Restoring a saveset overwrites transducer factor files on the hard disk that have the same name as those in the saveset. For more information, see "Saving and recalling transducer and limit line settings" on page 266.) (Not in the phase noise application.)
All Traces	All active traces.
All Limit Lines	All limit line <i>files</i> .
All Weighting Filters	All weighting filter <i>files</i> . (Only in the phase noise application.)
Spectrograms	Spectrogram trace data (only available if spectrogram display is currently active). (Only in applications that feature a spectrogram, for example the (optional) spectrum application.)

11.3.2.2 Storage location and filename

The data is stored on the internal flash disk or, if selected, on a memory stick or network drive. The operating system, firmware and stored instrument settings are located on drive C.



Saving instrument settings in secure user mode

In secure user mode all data is stored to the SDRAM, and is only available during the current session. As soon as the power is switched off on the R&S FSWP, the data is cleared (see [Chapter 11.2, "Protecting data using the secure user mode"](#), on page 263).

Other storage locations cannot be selected in this mode.

The storage location and filename are selected in a file selection dialog box which is displayed when you perform a storage function.

By default, the name of a settings file consists of a base name followed by an underscore and three numbers, e.g. `limit_lines_005`. In the example, the base name is `limit_lines`. The base name can contain characters, numbers and underscores. The file extension `df1` is added automatically. The default folder for settings files is `C:\R_S\INSTR\Save`.



File name restrictions

File names must be compatible with the Windows conventions for file names. In particular, they must not contain special characters such as ":", "*", "?".

11.3.2.3 Save and recall dialog boxes



Access: "Save"/ "Open" icon in the toolbar > "Save" / "Recall"



Both dialog boxes are very similar and closely related.

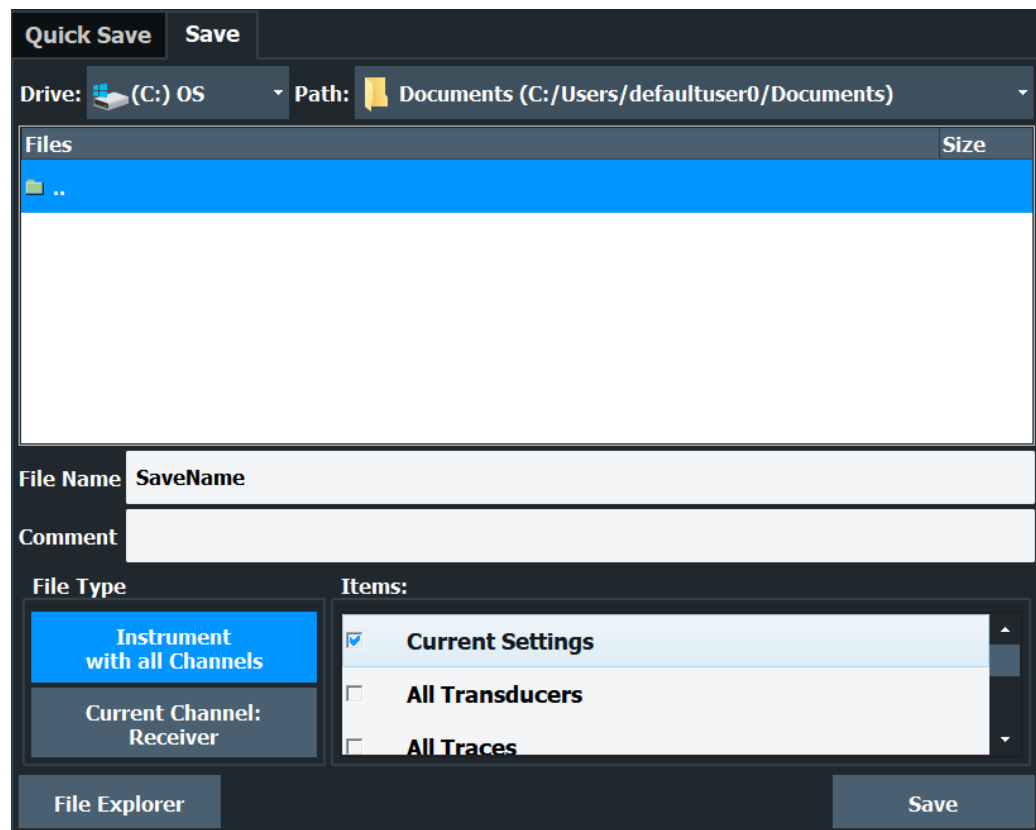

Selecting Storage Location - Drive/ Path/ Files.....	272
File Name.....	272
Comment.....	272
File Explorer.....	272
File Type.....	272

Items:.....	272
Save File.....	273
Recall in New Channel / Recall in Current Channel.....	273

Selecting Storage Location - Drive/ Path/ Files

Select the storage location of the file on the instrument or an external drive.

Note: Saving instrument settings in secure user mode.

In secure user mode, settings that are stored on the instrument are stored to volatile memory, which is restricted to 256 MB. Thus, a "memory limit reached" error can occur although the hard disk indicates that storage space is still available.

To store data permanently, select an external storage location such as a USB memory device.

For details, see [Chapter 11.2, "Protecting data using the secure user mode"](#), on page 263.

Remote command:

[MMEMoRY:CATalog](#) on page 578

File Name

Contains the name of the data file without the path or extension.

By default, the name of a user file consists of a base name followed by an underscore. Multiple files with the same base name are extended by three numbers, e.g.

limit_lines_005.

File names must be compatible with the Windows conventions for file names. In particular, they must not contain special characters such as ":", "*", "?".

For details on the filename and location, see [Chapter 11.3.2.2, "Storage location and filename"](#), on page 270.

Comment

An optional description for the data file. A maximum of 60 characters can be displayed.

Remote command:

[MMEMoRY:COMMeNt](#) on page 579

File Explorer

Opens the Microsoft Windows File Explorer.

Remote command:

not supported

File Type

Determines whether the global instrument settings with all "Channel"s are stored or recalled, or the current "Channel" settings only.

Items:

Defines which data and settings are stored or are recalled. Depending on the "File Type", either channels only, or global settings are available. Which items are available also depends on the installed options (see also [Chapter 11.3.2.1, "Stored data types"](#), on page 270).

Depending on the application, items may or may not be available. For example, saving spectrogram data is only possible in applications that feature a spectrogram.

Remote command:

`MMEMory:SELEct[:ITEM]:ALL` on page 584
`MMEMory:SELEct[:ITEM]:DEFault` on page 584
`MMEMory:SELEct[:ITEM]:NONE` on page 585
`MMEMory:SELEct[:ITEM]:HWSettings` on page 584
`MMEMory:SELEct[:ITEM]:LINes:ALL` on page 585
`MMEMory:SELEct[:ITEM]:SGRam` on page 585
`MMEMory:SELEct[:ITEM]:TRACe<1...3>[:ACTive]` on page 586
`MMEMory:SELEct[:ITEM]:TRANsducer:ALL` on page 586

Save File

Saves the settings file with the defined filename.

Note: Secure user mode. In secure user mode, settings that are stored on the instrument are stored to volatile memory, which is restricted to 256 MB. Thus, a "memory limit reached" error can occur although the hard disk indicates that storage space is still available.

For details, see [Chapter 11.2, "Protecting data using the secure user mode"](#), on page 263.

Remote command:

`MMEMory:STORe<1|2>:STATe` on page 588
`MMEMory:STORe<1|2>:STATe:NEXT` on page 589

Recall in New Channel / Recall in Current Channel

Restores the instrument settings as saved in the selected settings file. If the settings file contains settings for a specific "Channel" only, select "Recall in New Channel" to activate a new channel with the stored settings. Select "Recall in Current Channel" to replace the current "Channel" settings.

Note: After you use the "Recall" function, the history of previous actions is deleted, i.e. any actions performed previously cannot be undone or redone using the [UNDO/REDO] keys.

Remote command:

`MMEMory:LOAD:STATe` on page 587

11.3.2.4 Startup recall settings



Access: "Open" icon in the toolbar > "Startup Recall"

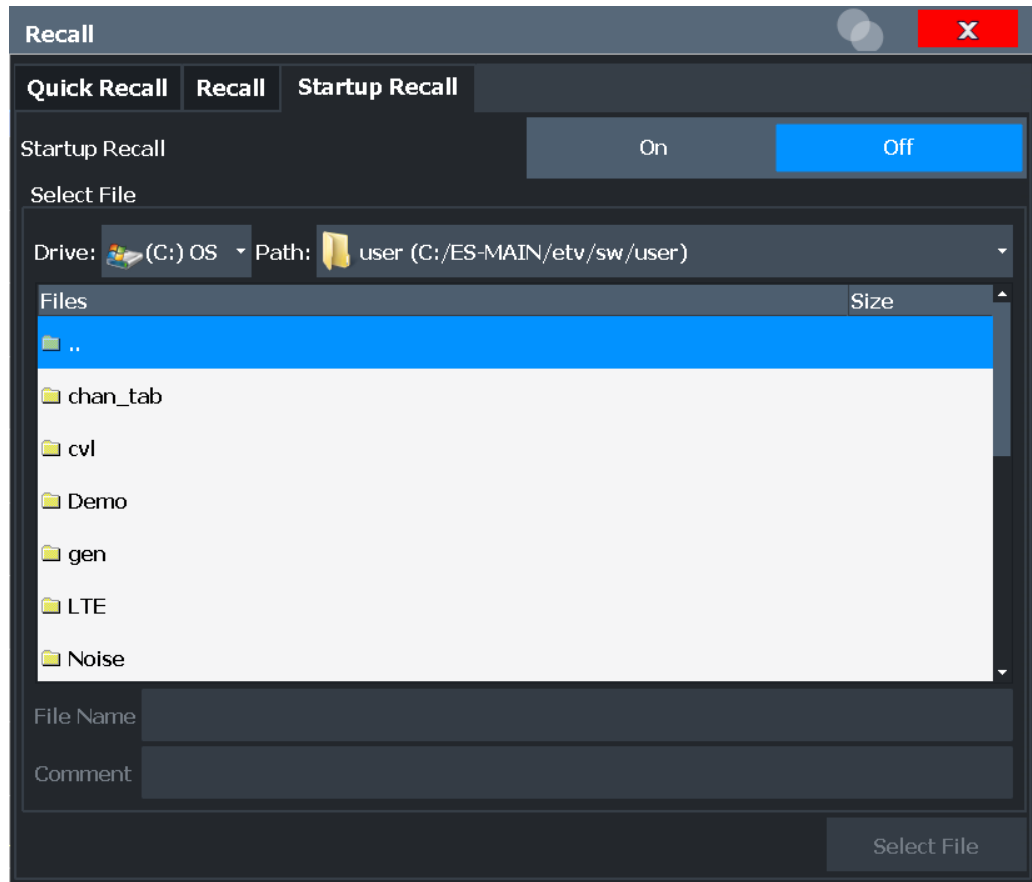

Startup Recall.....	274
Selecting Storage Location - Drive/ Path/ Files.....	274
File Name.....	275
Comment.....	275

Startup Recall

Activates or deactivates the startup recall function. If activated, the settings stored in the selected file are loaded each time the instrument is started or preset. If deactivated, the default settings are loaded.

Note that only *instrument* settings files can be selected for the startup recall function, not "Channel" files.

Remote command:

`MMEMoRY:LOAD:AUTO` on page 587

Selecting Storage Location - Drive/ Path/ Files

Select the storage location of the file on the instrument or an external drive.

Note: Saving instrument settings in secure user mode.

In secure user mode, settings that are stored on the instrument are stored to volatile memory, which is restricted to 256 MB. Thus, a "memory limit reached" error can occur although the hard disk indicates that storage space is still available.

To store data permanently, select an external storage location such as a USB memory device.

For details, see [Chapter 11.2, "Protecting data using the secure user mode"](#), on page 263.

Remote command:

[MMEMoRY:CATalog](#) on page 578

File Name

Contains the name of the data file without the path or extension.

By default, the name of a user file consists of a base name followed by an underscore. Multiple files with the same base name are extended by three numbers, e.g.

`limit_lines_005.`

File names must be compatible with the Windows conventions for file names. In particular, they must not contain special characters such as ":", "*", "?".

For details on the filename and location, see [Chapter 11.3.2.2, "Storage location and filename"](#), on page 270.

Comment

An optional description for the data file. A maximum of 60 characters can be displayed.

Remote command:

[MMEMoRY:COMMeNt](#) on page 579

11.3.3 How to save and load instrument settings

Instrument settings can be saved to a file and loaded again later, so that you can repeat the measurement with the same settings. Optionally, user-defined measurement settings can automatically be restored each time you start or preset the instrument.

To save and recall instrument settings using the Quick Save function



1. Select the "Save" icon from the toolbar.
2. Select whether the instrument settings for **all**"Channel"s are stored, or only those for the **current**"Channel".
3. Select one of the save sets in which the settings are stored ("QuickSaveX").

The selected settings are stored to the file

`C:\R_S\INSTR\QuickSave\QuickSaveX.dfl.`

Note: If you make any changes to the settings *after* storing the configuration file, remember to save the settings again. Otherwise those settings cannot be restored and will be overwritten by the stored values when the configuration file is recalled.



4. To restore the settings, select the "Open" icon from the toolbar.
5. Select the save set in which the settings were stored ("QuickSaveX").
The selected settings are restored to the instrument or channel.

To save configurable instrument settings



1. Select the "Save" icon from the toolbar.
2. In the "Save" dialog box, switch to the "Save" tab.
3. In the file selection dialog box, select a filename and storage location for the settings file.
4. Optionally, define a comment to describe the stored settings.
5. Select whether the instrument settings for **all**"Channel"s are stored, or only those for the **current**"Channel".
6. Select the items to be saved with the settings. Either the settings for the currently selected "Channel" only, or the settings for all "Channel"s can be stored. Various other items, such as lines or traces etc., can be stored as well (see [Chapter 11.3.2.1, "Stored data types"](#), on page 270).
7. Select "Save".

A file with the defined name and path and the extension `.df1` is created.



If you make any changes to the settings *after* storing the configuration file, remember to save the settings again. Otherwise those settings cannot be restored and will be overwritten by the stored values when the configuration file is recalled.

To recall configurable instrument settings



1. Select the "Open" icon from the toolbar.
2. In the "Recall" dialog box, switch to the "Recall" tab.
3. In the file selection dialog box, select the filename and storage location of the settings file.
Note: The "File Type" indicates whether the file contains instrument settings for **all**"Channel"s, or only those for the current "Channel".
4. If several items were saved, select which items are restored.
5. If a "Channel" was saved, select whether the settings will replace the settings in the current "Channel", or whether a new channel with the saved settings will be opened.
6. Select "Recall".

The settings and selected items from the saved measurement are restored and you can repeat the measurement with the same settings.

Note that any changes made to the settings *after* storing the configuration file will be overwritten by the stored values when the configuration file is recalled.

To recall settings automatically after preset or reboot

You can define the settings that are restored when you preset or reboot the instrument.

1. Configure the settings as required and save them as described in "[To save configurable instrument settings](#)" on page 276.
2. In the "Save/Recall" menu, select "Startup Recall".
3. From the file selection dialog box, select the recall settings to restore.
4. Select "Select File".
5. Set "Startup Recall" to "On".

Now when you press [PRESET] or reboot the instrument, the defined settings will be restored.

6. To restore the factory preset settings, set "Startup Recall" to "Off".

11.4 Import/export functions



Access: "Save"/ "Open" icon in the toolbar > "Import" / "Export"



The R&S FSWP provides various evaluation methods for the results of the performed measurements. However, you may want to evaluate the data with further, external applications. In this case, you can export the measurement data to a standard format file (ASCII or XML). Some of the data stored in these formats can also be re-imported to the R&S FSWP for further evaluation later, for example in other applications.

The following data types can be exported (depending on the application):

- Trace data
- Table results, such as result summaries, marker peak lists etc.
- I/Q data (in applications that process I/Q data)

The following data types can be imported (depending on the application):

- I/Q data (in applications that process I/Q data)



I/Q data can only be imported and exported in applications that process I/Q data, such as the I/Q analyzer or other optional applications.

See the corresponding user manuals for those applications for details.



These functions are only available if no measurement is running.

In particular, if [Continuous Sweep / Run Cont](#) is active, the import/export functions are not available.

Import	278
Export	278

L Export Configuration	278
L I/Q Export	278
L File Explorer	278



Import

Access: "Save/Recall" > Import



Provides functions to import data.

Currently, only I/Q data can be imported, and only by applications that process I/Q data.

See the R&S FSWP I/Q Analyzer user manual for more information.



Export

Access: "Save/Recall" > Export



Opens a submenu to configure data export.

For more information, see ["Export Trace to ASCII File"](#) on page 228.

Export Configuration ← Export

Opens the "Traces" dialog box to configure the trace and data export settings.

[Chapter 10.3.3, "Trace export and import"](#), on page 226

I/Q Export ← Export

Opens a file selection dialog box to define an export file name to which the I/Q data is stored. This function is only available in single sweep mode.

It is only available in applications that process I/Q data, such as the I/Q Analyzer or other optional applications.

For details, see the description in the R&S FSWP I/Q Analyzer User Manual ("Importing and Exporting I/Q Data").

Note: Storing large amounts of I/Q data (several Gigabytes) can exceed the available (internal) storage space on the R&S FSWP. In this case, it can be necessary to use an external storage medium.

Note: Secure user mode.

In secure user mode, settings that are stored on the instrument are stored to volatile memory, which is restricted to 256 MB. Thus, a "memory limit reached" error can occur although the hard disk indicates that storage space is still available.

To store data permanently, select an external storage location such as a USB memory device.

For details, see [Chapter 11.2, "Protecting data using the secure user mode"](#), on page 263.

File Explorer ← I/Q Export ← Export

Opens the Microsoft Windows File Explorer.

Remote command:

not supported

11.5 Creating screenshots of current measurement results and settings

To document the graphical results and the most important settings for the currently performed measurement, you can create a screenshot of the current display. Screenshots can either be printed or stored to a file.

- [Print and screenshot settings](#).....279
- [How to store or print screenshots of the display](#)..... 290
- [Example for storing multiple measurement results to a PDF file](#)..... 293

11.5.1 Print and screenshot settings



Access: "Print" icon in the toolbar

For step-by-step instructions, see [Chapter 11.5.2, "How to store or print screenshots of the display"](#), on page 290.

Remote commands for these settings are described in [Chapter 14.8.4, "Storing and printing screenshots"](#), on page 590.



To print a screenshot of the current display with the current settings immediately, without switching to the "Print" menu, use the "SnapShot" icon in the toolbar.

- [Print content settings](#).....279
- [Print preview functions](#).....282
- [Printer settings](#).....284
- [Page setup](#).....287
- [Print color settings](#).....289

11.5.1.1 Print content settings



Access: "Print" > "Print Config" > "Content" tab

The content settings determine which data is included in the printout.

Note that some content settings are independent of the selected printing device, others are printing device-specific.

Print Screenshot.....	280
Print Multiple Windows.....	281
Comment.....	281
Print Logo.....	281
Print Page Count.....	281
Select Device 1/2.....	281
Print Dialog.....	282
Print Date and Time.....	282

Print Screenshot

Selects all measurement results displayed on the screen for the current channel (or "MultiView"): diagrams, traces, markers, marker lists, limit lines, etc., including the channel bar and status bar, for printout on a single page. Displayed items belonging to the software user interface (e.g. softkeys) are not included. The position and size of the elements in the printout is identical to the display.

This setting is independent of the printing device.

Remote command:

[HCOPY:CONTent](#) on page 593

Print Multiple Windows

Includes only the selected windows in the printout. All currently active windows for the current channel (or "MultiView") are available for selection. How many windows are printed on a single page of the printout is user-definable (see "[Windows Per Page](#)" on page 289).

This option is only available when printing on a printer or to a PDF file (see "[Destination](#)" on page 286). If the [Destination](#) is currently set to an image file or the clipboard for the selected printing device, it is automatically changed to be a PDF file.

Remote command:

[HCOPY:CONTent](#) on page 593

[HCOPY:PAGE:WINDow:STATe](#) on page 599

[HCOPY:PAGE:WINDow:CHANnel:STATe](#) on page 598

Comment

Defines an optional comment to be included in the printout of the display. Maximum 120 characters are allowed. Up to 60 characters fit in one line. In the first line, a manual line-feed can be forced at any point by entering "@".

The comment is printed in the top left corner of each printout page. If a comment should not be printed, it must be deleted.

This setting is independent of the printing device.

Tip: The current date and time can be inserted automatically, see "[Print Date and Time](#)" on page 282.

Remote command:

[HCOPY:ITEM:WINDow:TEXT](#) on page 596

Print Logo

Activates/deactivates the printout of the Rohde & Schwarz company logo in the upper right corner.

This setting is independent of the printing device.

Remote command:

[DISPlay:LOGO](#) on page 591

Print Page Count

Includes the page number for printouts consisting of multiple windows ("[Print Multiple Windows](#)" on page 281).

This setting is independent of the printing device.

Remote command:

[HCOPY:PAGE:COUNt:STATe](#) on page 596

Select Device 1/2

Selects the printing device to be configured.

Creating screenshots of current measurement results and settings

Two different printout devices can be configured, for example one for printing and one for storage to a file. When you execute the "SnapShot" function, the selected printing device and its settings determine the behavior of the R&S FSWP.

Print Dialog

Includes any currently displayed dialog in the screenshot printout.

This setting is (printing) device-specific and only available if [Print Screenshot](#) is selected.

Print Date and Time

Includes or removes the current date and time at the bottom of the printout.

This setting is (printing) device-specific.

Remote command:

[HCOPY:TDSTamp:STATe](#) on page 600

11.5.1.2 Print preview functions

Access: "Print"

The "Print Preview" of the printout according to the current configuration is available in all "Print Settings" dialog tabs.

The preview display (not the functions) is device-specific (see ["Select Device 1/2"](#) on page 281).

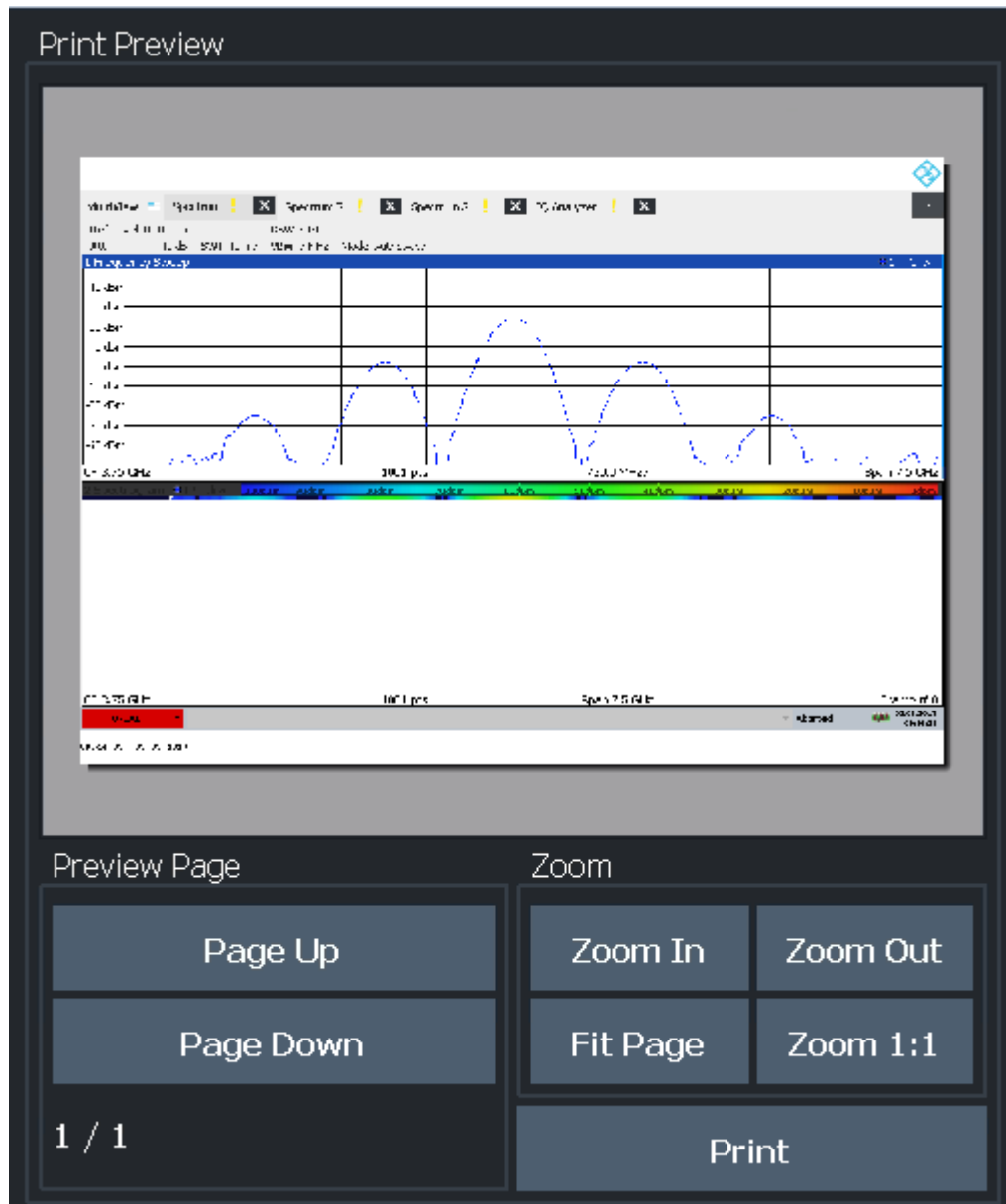

Zoom In / Zoom Out.....	283
Fit Page.....	284
Zoom 1:1.....	284
Page Up / Page Down.....	284
Print.....	284

Zoom In / Zoom Out

Zooms into (enlarges) or zooms out of (decreases) the preview display. Note that the zoom functions affect only the preview, not the printout itself.

Fit Page

Adapts the preview display zoom factor so that one complete page is visible as large as possible in the available display space. Note that the zoom functions affect only the preview, not the printout itself.

Zoom 1:1

Displays the printout in its original size, as it will be printed.

Page Up / Page Down

Depending on the selected contents (see [Chapter 11.5.1.1, "Print content settings"](#), on page 279), the printout can consist of multiple pages. Use these functions to scroll within the preview to see the individual pages.

Print

Starts to print or store the selected screen contents to a file (see [Chapter 11.5.1.1, "Print content settings"](#), on page 279).

Whether the output is sent to the printer or stored in a file or the clipboard depends on the selected printing device and the printing device settings (see [Chapter 11.5.1.3, "Printer settings"](#), on page 284).

If the output is stored to a file, a file selection dialog box is opened to select the file-name and location. The default path is C:\R_S\INSTR\USER.

Remote command:

[HCOPY\[:IMMEDIATE\]](#) on page 595

[HCOPY\[:IMMEDIATE\]:NEXT](#) on page 595

11.5.1.3 Printer settings

Access: "Print" > "Print Config" > "Printer" tab

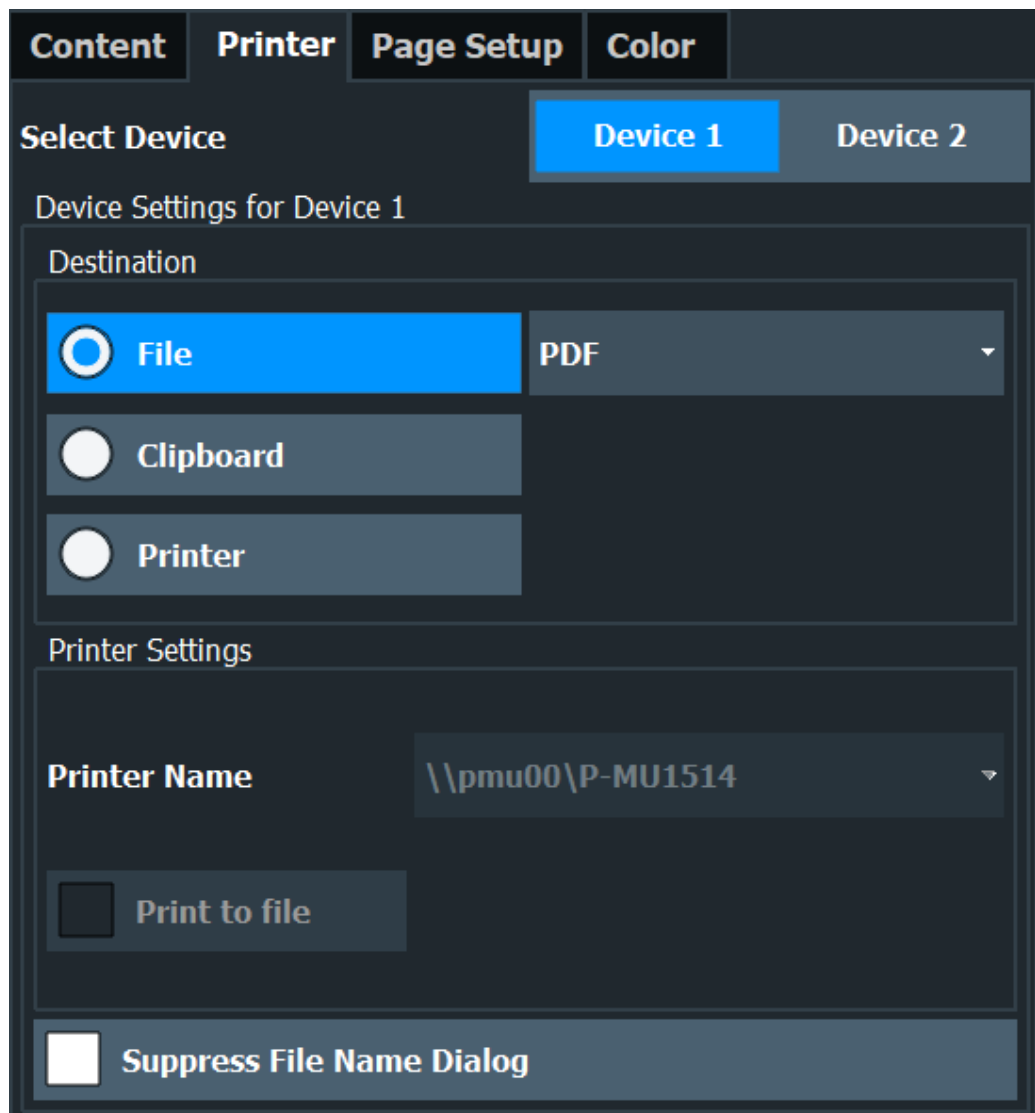

Content **Printer** **Page Setup** **Color**

Select Device **Device 1** Device 2

Device Settings for Device 1

Destination

File PDF

Clipboard

Printer

Printer Settings

Printer Name \\pmu00\P-MU1514

Print to file

Suppress File Name Dialog



Printer settings are (printing) device-specific. That means you can configure two different printing devices (for example, a printer and a file) and switch between configurations easily simply by selecting the appropriate device before printing.

Select Device 1/2.....	286
Destination.....	286
L Destination: File.....	286
L Destination: Clipboard.....	286
L Destination: Printer.....	286
Suppress File Name Dialog.....	286
Printer Name.....	286
Print to file.....	287
Install Printer.....	287

Select Device 1/2

Selects the printing device to be configured.

Two different printout devices can be configured, for example one for printing and one for storage to a file. When you execute the "SnapShot" function, the selected printing device and its settings determine the behavior of the R&S FSWP.

Destination

Defines the medium to which the printout is output.

Destination: File ← Destination

Stores the printout to a file in the selected format. The filename is queried at the time of storage, or a default name is used (see [Suppress File Name Dialog](#)).

Multiple windows can only be printed to a file in PDF format. If you select an image file format, the content setting is automatically set to [Print Screenshot](#). Page settings are not available for image files; however, you can configure the colors used for the screenshot (see [Chapter 11.5.1.5, "Print color settings"](#), on page 289).

Remote command:

To save as a file:

```
HCOPY:DESTination<di> 'MMEM'
```

To save as a file in the specified format:

```
HCOPY:DEVICE:LANGUage on page 595
```

Destination: Clipboard ← Destination

Copies the printout to the clipboard. Since only single pages can be copied, only screenshots can be copied to this destination, not multiple windows (see [Chapter 11.5.1.1, "Print content settings"](#), on page 279). Page settings are not available; however, you can configure the colors used for the screenshot (see [Chapter 11.5.1.5, "Print color settings"](#), on page 289).

If you select the clipboard as the printing destination, the content setting is automatically set to [Print Screenshot](#).

Remote command:

```
HCOP:DEST1 'SYSTEM:COMMunicate:CLIPboard'
```

Destination: Printer ← Destination

Sends the printout to the printer selected from the [Printer Name](#) list.

Remote command:

```
HCOP:DEST1 'SYSTEM:COMMunicate:PRINter'
```

Suppress File Name Dialog

If the [Destination](#) is a file, the file selection dialog box is not displayed. Instead, the default storage location and filename are used.

```
(C:\R_S\INSTR\USER\FSWP_ScreenShot_<date and time>).
```

Printer Name

Defines the printer to print to if a printer is selected as the [Destination](#).

Any printers detected in the network are listed for selection.

Tip: the printout can also be stored in a print file using the selected printer driver, see ["Print to file"](#) on page 287.

Remote command:

`SYSTem:COMMUnicate:PRINter:ENUMerate[:NEXT]` on page 600

`SYSTem:COMMUnicate:PRINter:ENUMerate:FIRSt` on page 600

`SYSTem:COMMUnicate:PRINter:SElect<di>` on page 600

Print to file

If a printer is selected as the [Destination](#), use this option to store the data in a `.prn` file using the selected printer driver.

Remote command:

To enable: `HCOP:DEST1 'MMEM'`

To disable: `HCOP:DEST1 'SYSTem:COMMUnicate:PRINter'`

Install Printer

This softkey opens the standard Windows dialog box to install a new printer. All printers that are already installed are displayed.

Only user accounts with administrator rights can install a printer.

For further information, refer to the Microsoft Windows documentation.

11.5.1.4 Page setup



Access: "Print" > "Print Config" > "Page Setup" tab

Content	Printer	Page Setup	Color
Select Device		Device 1	Device 2
Device Settings for Device 1			
Orientation	Portrait		
Windows Per Page	1		
Scaling	Maintain aspect ratio	Size to fit	
Margins			
Top	4.23 mm		
Bottom	4.23 mm		
Left	4.23 mm		
Right	4.23 mm		
Margin Unit	mm	in	



Page settings are (printing) device-specific. That means you can configure two different printing devices (for example, a printer and a file) and switch between configurations easily simply by selecting the appropriate device before printing.

Page settings are only available when printing on a printer or to a PDF file (see "[Destination](#)" on page 286).

Select Device 1/2	288
Orientation	288
Windows Per Page	289
Scaling	289
Margins	289

Select Device 1/2

Selects the printing device to be configured.

Two different printout devices can be configured, for example one for printing and one for storage to a file. When you execute the "SnapShot" function, the selected printing device and its settings determine the behavior of the R&S FSWP.

Orientation

Selects the page orientation of the printout: portrait or landscape.

Remote command:

[HCOPY:PAGE:ORIENTATION](#) on page 597

Windows Per Page

Defines how many windows are displayed on a single page of the printout. This setting is only available if [Print Multiple Windows](#) is active (see [Chapter 11.5.1.1, "Print content settings"](#), on page 279).

If more than one window is printed on one page, each window is printed in equal size.

Remote command:

[HCOPY:PAGE:WINDOW:COUNT](#) on page 598

Scaling

Determines the scaling of the windows in the printout if [Print Multiple Windows](#) is active (see [Chapter 11.5.1.1, "Print content settings"](#), on page 279).

If more than one window is printed on one page (see [Windows Per Page](#)), each window is printed in equal size.

"Maintain aspect ratio" Each window is printed as large as possible while maintaining the aspect ratio of the original display.

"Size to fit" Each window is scaled to fit the page size optimally, not regarding the aspect ratio of the original display.

Remote command:

[HCOPY:PAGE:WINDOW:SCALE](#) on page 599

Margins

Defines margins for the printout page on which no elements are printed. The margins are defined according to the selected unit.

Remote command:

[HCOPY:PAGE:MARGIN:BOTTOM](#) on page 596

[HCOPY:PAGE:MARGIN:LEFT](#) on page 596

[HCOPY:PAGE:MARGIN:RIGHT](#) on page 597

[HCOPY:PAGE:MARGIN:TOP](#) on page 597

[HCOPY:PAGE:MARGIN:UNIT](#) on page 597

11.5.1.5 Print color settings



Access: "Print" > "Print Config" > "Color" tab

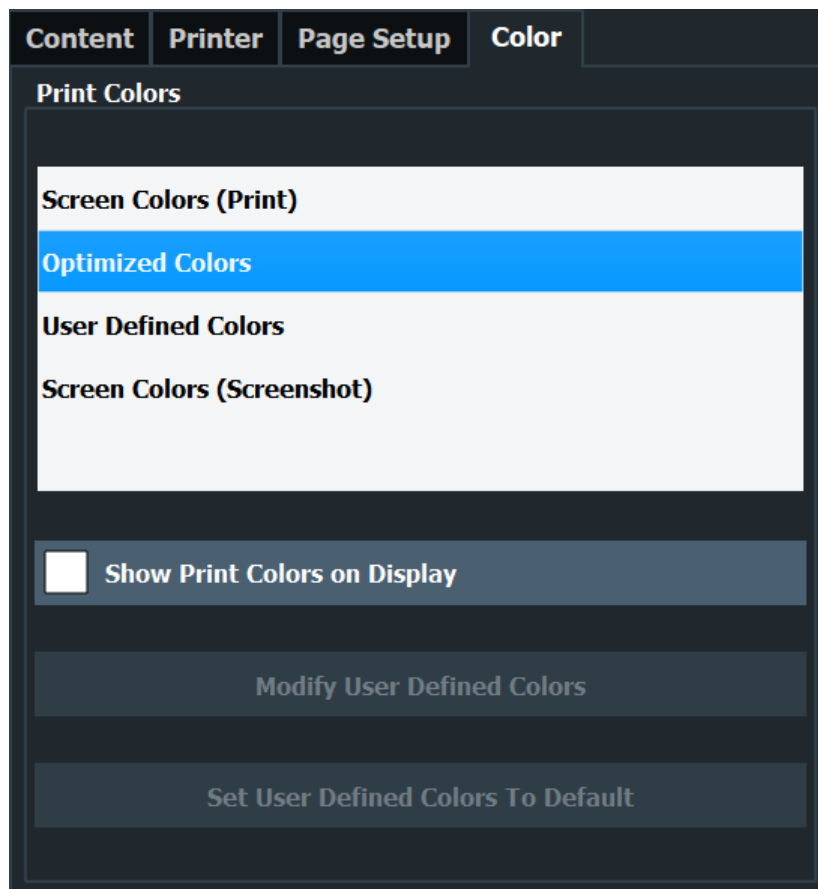

The settings provided here are identical to those in the "Print Colors" section of the "Display" > "Theme + Color" dialog box.

See ["Print Colors"](#) on page 310.

11.5.2 How to store or print screenshots of the display

The measurement results displayed on the screen can be printed or stored to a file very easily.

Two different scenarios can be configured in parallel, assigned to different printing devices. You can then perform one or the other simply by selecting the corresponding printing device and the "Print" function.



For a programming example, see [Chapter 14.8.6, "Examples: managing data"](#), on page 601.

To start printing or storing results to a file



- ▶ If the R&S FSWP has already been set up according to your current requirements, simply select the "Print immediate" on the toolbar.

The current measurement display is printed or stored to a file, as configured.

To print a screenshot

This configuration assumes a printer has already been installed. To install a new printer, use the [Install Printer](#) function (common Microsoft Windows procedure).



1. Select the "Printer" tool in the toolbar.
The "Print Settings" dialog box is displayed.
2. Select "Device 1" or "Device 2" to define which printing device you want to configure.
(Note: Some settings are independent of the printing-device.)
3. In the "Content" tab, define the elements of the screen and additional information to be included in the printout.
 - a) Select "Print Screenshot" to include all elements displayed on the screen in a single-page printout.
 - b) Optionally, add a comment to be printed at the top of the printout.
 - c) Optionally, activate the date and time or the logo so they are added to the printout.
 - d) Optionally, activate "Print Dialog" to include any dialog boxes currently displayed on the screen in the printout. This is useful, for example, to document the used settings for a particular result.
 - e) Check the "Print Preview" to make sure all relevant elements of the display are visible.
4. In the "Printer" tab, select "Printer" as the "Destination".
5. Select the "Printer Name" to print to from the list of installed printers.
6. In the "Page Setup" tab, configure the layout of the printout page.
 - a) Select the page orientation.
 - b) Define the page margins.
 - c) Check the "Print Preview" to make sure all relevant elements of the display are visible.
7. In the "Color" tab, define the colors to be used for the printout.
 - a) By default, "Optimized Colors" are used to improve the visibility of the colors. The background is always printed in white and the grid in black.
For a printout that reflects exactly what you see on the screen, select "Screen Colors (Screenshot)".
 - b) Check the "Print Preview" to find out if the setting is appropriate.
8. Select "Print" to execute the print function.
The screenshot is printed on the printer as configured.



9. To print another screenshot using the same configuration any other time, simply press the "SnapShot" icon on the toolbar.

If you use different printing scenarios alternately, perform the following steps to print another screenshot:

- a) Select the  "Printer" tool in the toolbar.
- b) Select "Device 1" or "Device 2" to select the configured printing device.
- c) Select "Print" to execute the print function.

To store a printout containing multiple windows



1. Select the "Printer" tool in the toolbar.
The "Print Settings" dialog box is displayed.
2. Select "Device 1" or "Device 2" to define which printing device you want to configure.
3. In the "Content" tab, define the elements of the screen and additional information to be included in the printout.
 - a) Select "Print Selected Windows" to include the selected windows in the printout, possibly on multiple pages.
 - b) Select the result displays in the currently selected channel to be included in the printout.
Tip: Select the "MultiView" before configuring the printout to include result displays from any active channel.
 - c) Optionally, add a comment to be printed at the top of each page of the printout.
 - d) Optionally, activate the date and time or the logo so they are added to the printout pages.
4. Check the "Print Preview" to make sure all required result displays are included.
 - a) Scroll through the individual pages of the printout using "Page Up" and "Page Down".
 - b) Use the zoom functions to make sure all relevant parts of the result display are visible.
5. In the "Printer" tab, select "File" as the "Destination".
6. Select the file format from the selection list.
7. By default, you define the filename individually for each print operation. To avoid having the "File Selection" dialog box being displayed for each print operation, select "Suppress File Name Dialog". In this case, the previously used or default storage location and filename are used.
(C:\R_S\INSTR\USER\FSWP_ScreenShot_<date and time>).
8. In the "Page Setup" tab, configure the layout of the printout page.
 - a) Select the page orientation.
 - b) Define the page margins.
 - c) Check the "Print Preview" to make sure all relevant elements of the display are visible.

9. In the "Color" tab, define the colors to be used for the printout.
 - a) By default, "Optimized Colors" are used to improve the visibility of the colors. The background is always printed in white and the grid in black. For a printout that reflects the colors you see on the screen, but with a white background, select "Screen Colors (Print)".
 - b) Check the "Print Preview" to find out if the setting is appropriate.
10. Select "Print" to execute the print function.
11. If you did not select the option to suppress the dialog, enter a filename in the file selection dialog box.

The selected data elements are stored to the file as configured.



12. To store another file using the same configuration any other time, simply select the "Print immediate" icon on the toolbar. If you use different printing scenarios alternately, perform the following steps to store another file:
 - a) Select the  "Printer" tool in the toolbar.
 - b) Select "Device 1" or "Device 2" to select the configured printing device.
 - c) Select "Print" to execute the print function.

11.5.3 Example for storing multiple measurement results to a PDF file

The following example describes the procedure to store results from measurements in the Spectrum application and the I/Q Analyzer to a single PDF file.

1. Configure and perform the measurements in the Spectrum application and I/Q Analyzer as required. Configure at least the following result displays:
 - Frequency Sweep, Spectrogram (Spectrum)
 - Magnitude, Spectrum (I/Q Analyzer)
2. Switch to the "MultiView" tab to display an overview of the result displays in all active channels.

Creating screenshots of current measurement results and settings

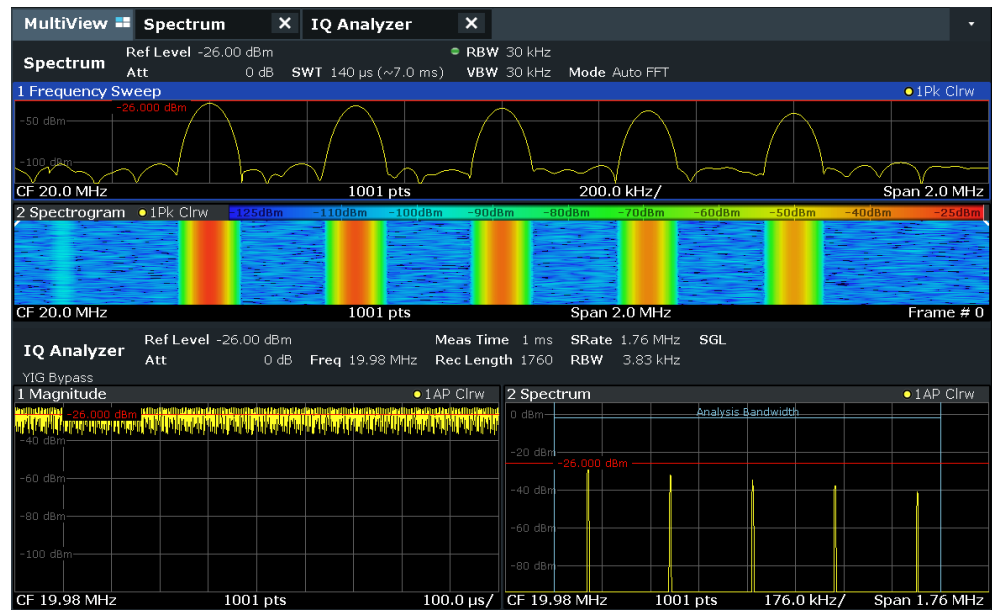

3. Select the "Printer" tool in the toolbar.
The "Print Settings" dialog box is displayed.
4. Select "Device 1" to configure the settings for this printing device.
5. In the "Content" tab, select "Print Selected Windows".
6. Select the result displays listed in [step 1](#).
7. Enter the comment *Measurement Test Report* to be inserted at the top of each page.
8. Select "Print Page Count" and "Print Date and Time".
9. In the "Content" tab, select "Print Selected Windows".
10. In the "Printer" tab, select "File" as the "Destination".
11. Select "PDF" from the file format selection list.
12. Select "Suppress File Name Dialog".
13. In the "Page Setup" tab, select "Landscape" as the "Orientation".
14. Select "Windows Per Page": 1 to print a single result display on each page.
15. Select the "Scaling" option "Size to fit" to maximize the result display on each page.
16. In the "Color" tab, select "Screen Colors (Print)" for a printout that reflects the colors you see on the screen, but with a white background.
17. Check the "Print Preview" to make sure all required result displays are included and all relevant data elements are visible.
 - a) Scroll through the individual pages of the printout using "Page Up" and "Page Down".

Creating screenshots of current measurement results and settings

- b) Use the zoom functions to make sure all relevant parts of the result display are visible.
18. Select "Print" to execute the print function.

The selected data elements are stored to the file as configured.

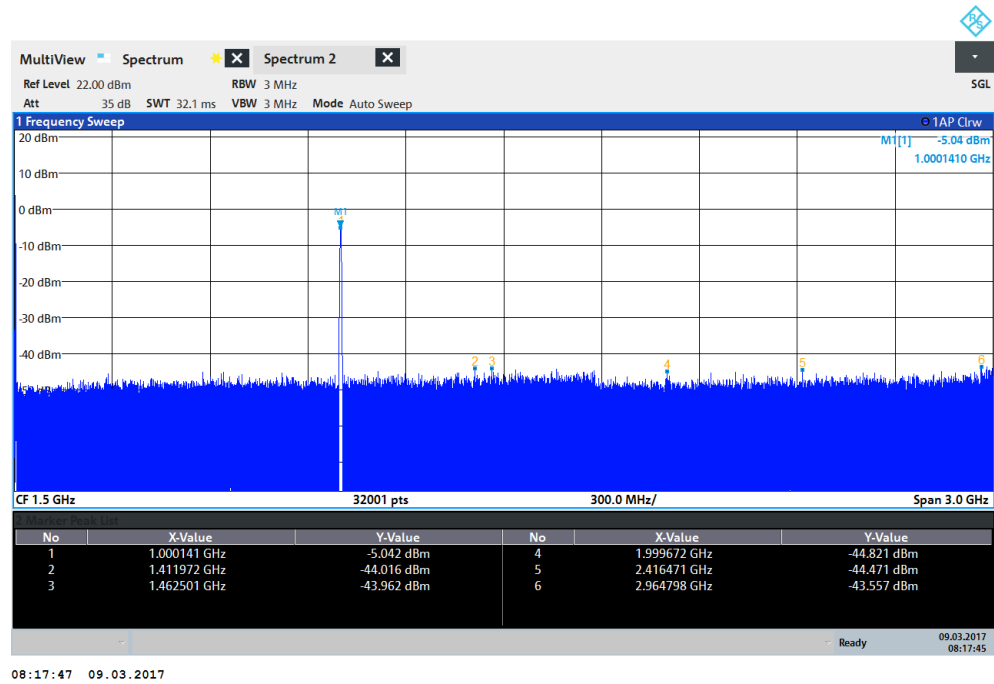

12 General instrument setup

Access: [SETUP]

Some basic instrument settings can be configured independently of the selected operating mode or application. Usually, you will configure most of these settings initially when you set up the instrument according to your personal preferences or requirements and then only adapt individual settings to special circumstances when necessary. Some special functions are provided for service and basic system configuration.



Network and remote settings, display settings

Settings for network and remote operation are described in [Chapter 13, "Network operation and remote control"](#), on page 336.

Display settings are described in [Chapter 12.2.1, "Display settings"](#), on page 303.

- [Alignment](#).....296
- [Display settings](#).....303
- [Reference frequency settings](#).....317
- [System configuration settings](#).....321
- [Service functions](#).....328

12.1 Alignment

12.1.1 Basics on alignment

When you put the instrument into operation for the first time or when strong temperature changes occur, align the data to a reference source (see ["Temperature check"](#) on page 297).

The firmware determines the correction data and characteristics required for the alignment. It compares the results at different settings with the known characteristics of the high-precision calibration signal source at 64 MHz.

Basic operation of the R&S FSWP can be affected before or after a self-alignment in the following ways:

- Depending on the installation settings, an automatic self-alignment is performed directly after installation, and a dialog is displayed indicating how much warm-up time is still required before self-alignment can be performed.
- During instrument start, the firmware checks whether the installed hardware is supported. If not, an error message is displayed ("Wrong Firmware Version") and you are asked to update the firmware. Until the firmware version is updated, self-alignment fails.

- By default, a reminder is shown in the status bar of the instrument 30 days after the last self-alignment took place. You can enable or disable the reminder, and change the timing for it.
Tip: To check for a self-alignment reminder message in the status history, use the `SYStem:ERRor:EXTended?` command and search for messages that start with `Self alignment older than`.
- If you start a self-alignment remotely and then select "Local" while the alignment is still running, the instrument only returns to the manual operation state after the alignment is completed.
- During self-alignment, do not connect a signal to the RF input connector. Running a self-alignment with a signal connected to the RF input can lead to false measurement results.

Alignment results

The alignment results are displayed and contain the following information:

- Date and time of last correction data record
- Overall results of correction data record
- List of performed alignment steps

The results are classified as follows:

PASSED	Calibration successful without any restrictions
CHECK	Deviation of correction value larger than expected, correction could however be performed
FAILED	Deviations of correction value too large, no correction was possible. The found correction data is not applicable.

The results are available until the next self-alignment process is started or the instrument is switched off.

Temperature check

During self-alignment, the instrument's frontend temperature is measured (if activated, only after the instrument has warmed up completely, see "[Await Warm-Up Operation before Self Alignment](#)" on page 301). This temperature is used as a reference for a continuous temperature check during operation. If the current temperature deviates from the stored self-alignment temperature by a certain degree, a warning is displayed in the status bar. The warning indicates the resulting deviation in the measured power levels. A status bit in the `STATUs:QUEStionable:TEMPerature` register indicates a possible deviation. The current temperature of the frontend can be queried using a remote command (see `SOURce<si>:TEMPerature:FRONtend` on page 616).

Touchscreen alignment

When the device is delivered, the touchscreen is initially calibrated. However, to ensure that the touchscreen responds to the finger contact correctly, a touchscreen alignment is required.

Alignment of the touchscreen is useful:

- At first use
- After an image update or after exchanging a hard disk
- If you notice that touching a specific point on the screen does not achieve the correct response
- If the position of the instrument has been changed and you cannot look straight on the screen
- If another person operates the instrument

12.1.2 Alignment settings

Access: [Setup] > "Alignment"

Both the instrument and the touchscreen can be aligned when necessary (see [Chapter 12.1.1, "Basics on alignment"](#), on page 296).



Automatic self-alignment

During installation of the R&S FSWP firmware, you can configure an automatic self-alignment to be performed directly after installation. In addition, you can activate a preceding warmup time before self-alignment, which is strongly recommended. If you do not activate this option, make sure the instrument has reached its operating temperature before installing the firmware. Furthermore, you can force the instrument to shut down after self-alignment. Note, however, that you cannot switch the instrument back on remotely afterwards.

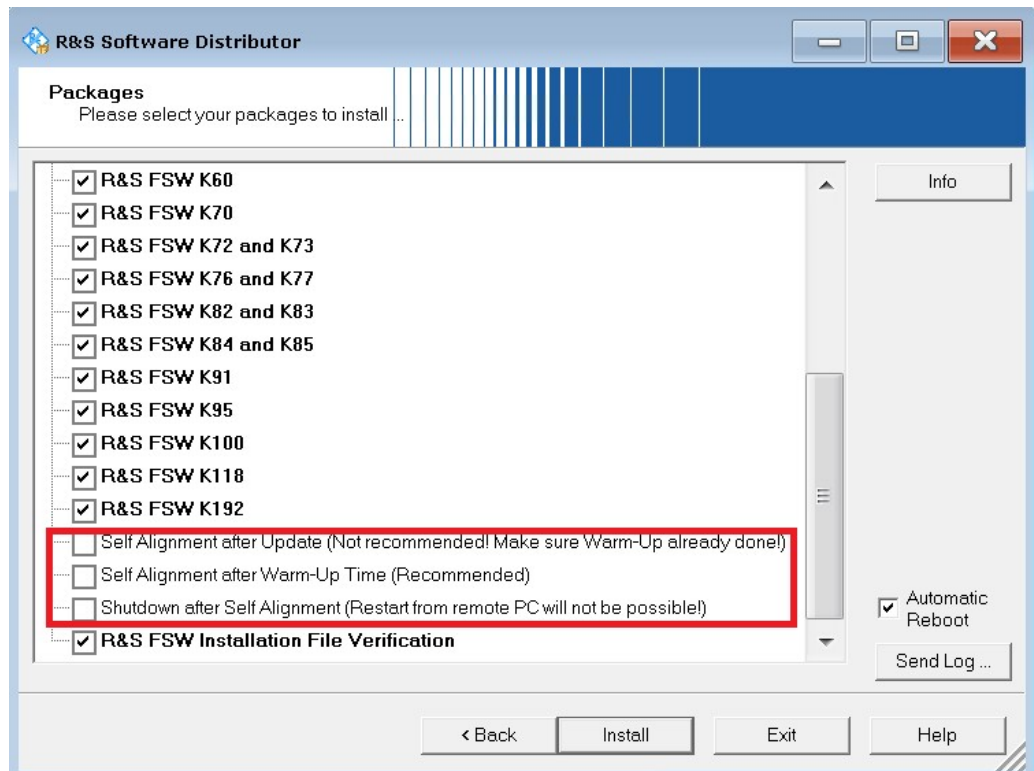

The additional settings for self-alignment can also be activated or deactivated during operation in the "Alignment" settings dialog (see [Await Warm-Up Operation before Self Alignment](#) and [Shut down Device after Self Alignment](#).)

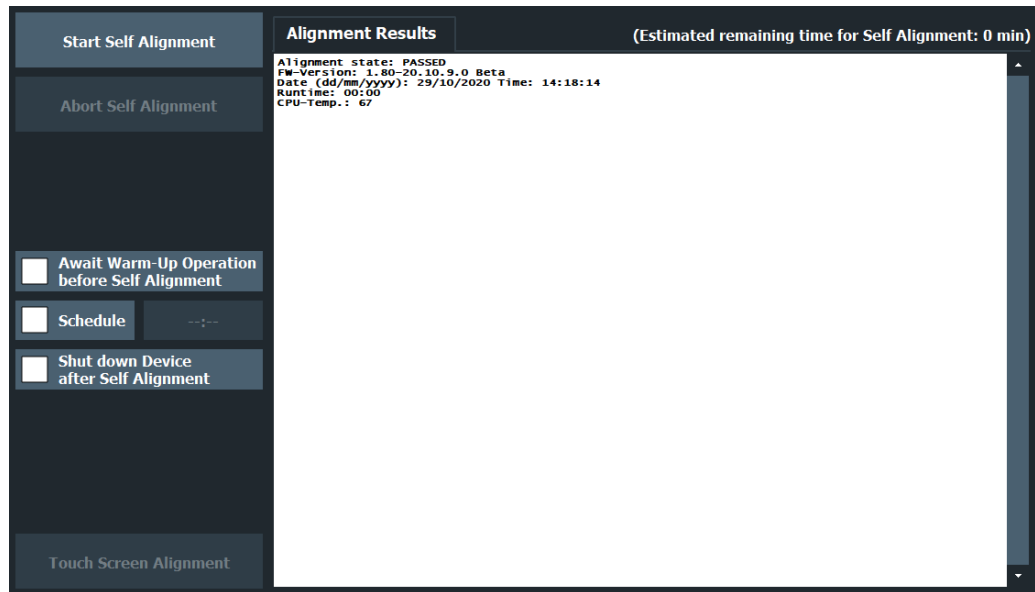

Self-alignment results in secure user mode

Be sure to store self-alignment results before [SecureUser Mode](#) is enabled; see [Chapter 11.2, "Protecting data using the secure user mode"](#), on page 263.

In secure user mode, the results are not stored permanently. Thus, if the currently stored self-alignment results are not suitable, you must perform a self-alignment each time you switch on the R&S FSWP.

Start Self Alignment	300
Abort Self Alignment	301
Await Warm-Up Operation before Self Alignment	301
Schedule	301
Shut down Device after Self Alignment	301
Reuse Old Alignment Data	301
Starting Touch Screen Alignment	302
Regular Reminder	302
Alignment Results	302

Start Self Alignment

Starts recording correction data for the instrument. If the correction data acquisition fails or if the correction values are deactivated, a corresponding message is displayed in the status field.

For details, see [Chapter 12.1.1, "Basics on alignment"](#), on page 296.

Note:

A running Sequencer operation is aborted when you start a self-alignment.

During self-alignment, do not connect a signal to the RF input connector. Running a self-alignment with a signal connected to the RF input can lead to false measurement results.

Remote command:

*CAL? on page 409, see also [CALibration\[:ALL\]?](#) on page 611

Abort Self Alignment

As long as the self-alignment data is being collected, the procedure can be canceled using "Abort Self Alignment".

Note: If you start a self-alignment remotely, then select "Local" while the alignment is still running, the instrument only returns to the manual operation state after the alignment is completed. In this case, you cannot abort a self-alignment manually.

Await Warm-Up Operation before Self Alignment

Displays a message indicating the remaining warmup time required before self-alignment is performed. After the warmup operation has completed, self-alignment is started automatically.

Remote command:

[CALibration:DUE:WARMup](#) on page 612

Schedule

If enabled, a self-alignment is performed regularly at specific days and time.

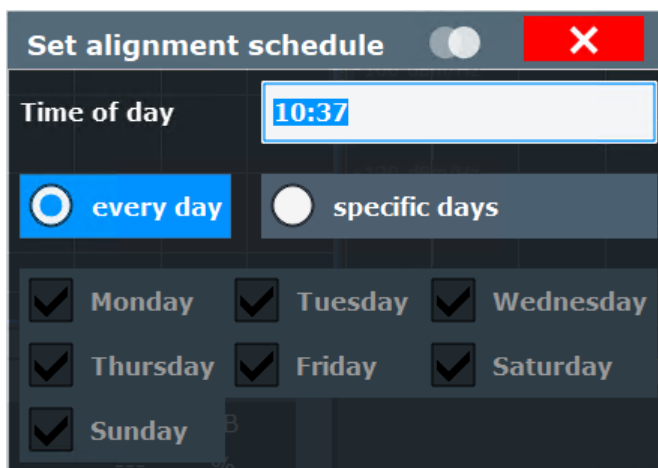

Remote command:

[CALibration:DUE:SCHedule](#) on page 612

[CALibration:DUE:DAYs](#) on page 613

[CALibration:DUE:TIME](#) on page 614

Shut down Device after Self Alignment

If activated, the R&S FSWP is automatically shut down after self-alignment is completed. Note that the instrument cannot be restarted via remote control.

Remote command:

[CALibration:DUE:SHUTdown](#) on page 614

Reuse Old Alignment Data

If data from a previous self-alignment is available on the instrument, it can be reused even though the instrument claims the instrument is uncalibrated. This is useful, for example, after activating a software option or updating the firmware to a beta version. After rebooting the instrument, you must re-activate this function if you still want to reuse the old alignment data.

Note, however, that **re-using old alignment data can lead to inaccurate measurement results, or even cause the R&S FSWP firmware to fail altogether**. For measurements using old alignment data, an [OLD CAL] message is indicated in the status bar (instead of [UNCAL], which indicates that a new self-alignment is actually required.)

To measure with the accuracy specified in the data sheet, always perform a self-alignment when the instrument calls for it.

Starting Touch Screen Alignment

Starts the touchscreen alignment.

Tap the 4 markers on the screen as you are asked to do. The touchscreen is aligned according to the executed pointing operations.

Regular Reminder

Schedules a regular reminder for self-alignment. By default, a reminder is shown in the status bar of the instrument 30 days after the last self-alignment took place.

Enable or disable the reminder as required.

If enabled, define the number of days after the last self-alignment that the reminder appears.

Alignment Results:

Information on whether the alignment was performed successfully and on the applied correction data is displayed. The results are available until the next self-alignment process is started or the instrument is switched off.

Remote command:

[CALibration:RESult?](#) on page 612

12.1.3 How to perform a self-test

You do not have to repeat the self-test every time you switch on the instrument. It is only necessary when instrument malfunction is suspected.



Operating temperature

Before performing this alignment, make sure that the instrument has reached its operating temperature (for details, refer to the data sheet).

1. Select [SETUP].
2. Select "Service".
3. Select "Selftest".

Once the instrument modules have been checked successfully, a message is displayed.

12.1.4 How to align the instrument



Operating temperature

Before performing this alignment, make sure that the instrument has reached its operating temperature (for details, refer to the data sheet).

To perform a self-alignment

Make sure no signal is connected to the RF input connector. Running a self-alignment with a signal connected to the RF input can lead to false measurement results.

1. Select [SETUP].
2. Select "Alignment".
3. Select "Start Self Alignment".
4. To abort the self-alignment process, select "Abort Self Alignment".

Once the system correction values have been calculated successfully, a message is displayed.

To display the alignment results again later

- ▶ Select [SETUP] > "Alignment".

12.1.5 How to align the touchscreen

To align the touchscreen

1. Press [Setup].
2. Select "Alignment".
3. Select "Touch Screen Alignment".
A blinking cross appears in the lower left corner of the screen.
4. Touch and hold the blinking cross until it stops blinking.
Repeat this action for the crosses in the other corners.

12.2 Display settings

12.2.1 Display settings

Access: [Setup] > "Display"

Some general display settings are available regardless of the current application or operating mode. For information on optimizing your display for measurement results, see [Chapter 10.1, "Result display configuration"](#), on page 208.

- [General display settings](#).....304
- [Displayed items](#).....305
- [Display theme and colors](#).....309
- [External monitor settings](#).....313

12.2.1.1 General display settings

Access: [Setup] > "Display" > "General"

This section includes general screen display behavior and date and time display.

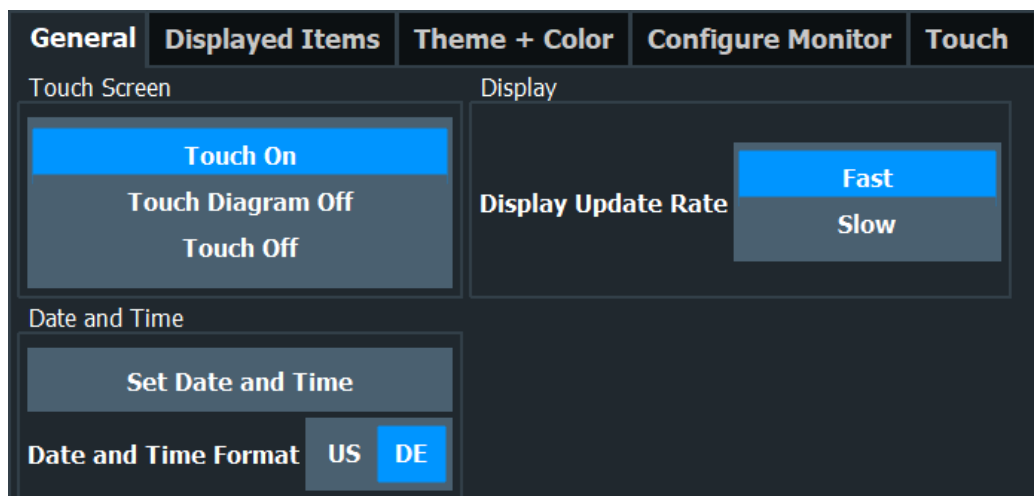

- [Deactivating and Activating the Touchscreen](#)..... 304
- [Display Update Rate](#)..... 305
- [Set Date and Time](#)..... 305
- [Date and Time Format](#)..... 305

Deactivating and Activating the Touchscreen

The touchscreen function can be deactivated, e.g. when the instrument is being used for demonstration purposes and tapping the screen must not provoke an action.

To reactivate the touchscreen, simply press [Setup] on the front panel. The "Display" dialog box is opened automatically and the "Touch Screen" option is set to "On".

"Touch On" Touchscreen function is active for the entire screen.

"Touch Off" Touchscreen is deactivated for the entire screen.

"Touch Diagram Off"
Touchscreen is deactivated for the diagram area of the screen, but active for the surrounding softkeys, toolbars and menus.

Remote command:

`DISPlay:TOUCHscreen[:STATe]` on page 618

Display Update Rate

By default, a fast update rate ensures the most recent measurement results on the display. However, when performance is poor due to slow data transfer (for example during remote control), it can be helpful to decrease the frequency with which the screen display is updated.

Set Date and Time

Sets the current date and time for the internal real-time clock on the instrument. This function uses the standard Windows "Date and Time Properties" dialog box. Setting the clock requires administrator rights.

Select "Set Date and Time" in the "Display" dialog box, or select the date and time display in the status bar to open the Windows dialog box.

Remote command:

[SYSTem:DATE](#) on page 605

[SYSTem:TIME](#) on page 605

Date and Time Format

Switches the time and date display on the screen between US, ISO and German (DE) format.

"DE" dd.mm.yyyy hh:mm:ss
24 hour format.

"US" mm/dd/yyyy hh:mm:ss
12 hour format.

"ISO" yyyy-mm-dd hh:mm:ss
24 hour format.

Remote command:

[DISPlay\[:WINDow<n>\]:TIME:FORMat](#) on page 619

12.2.1.2 Displayed items

Access: [Setup] > "Display" > "Displayed Items"

Several elements on the screen display can be hidden or shown as required, for example to enlarge the display area for the measurement results.

General	Displayed Items	Theme + Color	Configure Monitor	Touch
Toolbar	<input checked="" type="checkbox"/> On <input type="checkbox"/> Off		Status Bar	<input checked="" type="checkbox"/> On <input type="checkbox"/> Off
Softkey Bar	<input checked="" type="checkbox"/> On <input type="checkbox"/> Off		Channel Bar	<input checked="" type="checkbox"/> On <input type="checkbox"/> Off
Annotation	<input checked="" type="checkbox"/> On <input type="checkbox"/> Off		Date and Time	<input checked="" type="checkbox"/> On <input type="checkbox"/> Off
Front Panel	<input checked="" type="checkbox"/> On <input type="checkbox"/> Off		Mini Front Panel	<input type="checkbox"/> On <input checked="" type="checkbox"/> Off
Disconnect RF	<input checked="" type="checkbox"/> On <input type="checkbox"/> Off		Frequency Lock	<input checked="" type="checkbox"/> On <input type="checkbox"/> Off

Toolbar.....	306
Status Bar.....	306
Softkey Bar.....	306
Channel Bar.....	306
Diagram Footer (Annotation).....	306
Date and Time.....	307
Front Panel.....	307
Mini Front Panel.....	308

Toolbar

The toolbar provides access to frequently used functions via icons at the top of the screen. Some functions, such as zooming, finding help, printing screenshots or storing and loading files are not accessible at all without the toolbar.

Remote command:

`DISPlay:TBAR[:STATe]` on page 618

Status Bar

The status bar beneath the diagram indicates the global instrument settings, the instrument status and any irregularities during measurement or display.

Some of the information displayed in the status bar can be queried from the status registry via remote commands.

We recommend displaying the status bar at all times. If you hide the status bar, you can miss important error messages.

Remote command:

`DISPlay:SBAR[:STATe]` on page 618

Softkey Bar

Softkeys are virtual keys provided by the software. Thus, more functions can be provided than can be accessed directly via the function keys on the device.

The functions provided by the softkeys are often also available via dialog boxes. However, some functions are not accessible at all without the softkey bar.

Note: The softkey bar is hidden while the SmartGrid is displayed and restored automatically when the SmartGrid is closed.

Remote command:

`DISPlay:SKEYs[:STATe]` on page 618

Channel Bar

The channel bar provides information on firmware and measurement settings for a specific channel.

Remote command:

`DISPlay:ANNotation:CBAR` on page 617

Diagram Footer (Annotation)

The diagram footer beneath the diagram contains information on the x-axis of the diagram display, such as:

- The current center frequency and span settings
- The displayed span per division

- The number of sweep points

Remote command:

[DISPlay:ANNOtation:FREQuency](#) on page 617

Date and Time

The date and time display can be switched off independently of the status bar.

You can set the current date and time and configure the display format in the "General" tab of the "Display" dialog box.

Remote command:

[DISPlay\[:WINDow<n>\]:TIME](#) on page 619

Front Panel

The "Front Panel" display simulates the entire front panel of the device (except for the external connectors) on the screen. Thus, you can interact with the R&S FSWP without the keypad and keys on the front panel of the device. That is useful, for example, when working with an external monitor or operating via remote control from a computer.



To hide or show the front panel temporarily, press [F6] on the external keyboard (if available) or the remote computer.

For more information, see [Chapter 12.2.3, "How to work with the soft front panels"](#), on page 315.

Remote command:

[SYSTem:DISPlay:FPANel\[:STATe\]](#) on page 619

Mini Front Panel

If you require a front panel display but do not want to lose too much space for results in the display area, a mini front panel is available. The mini version displays only the main function keys in a separate window in the display area.



For more information, see [Chapter 12.2.3, "How to work with the soft front panels"](#), on page 315.

Note:

You can also show the mini front panel using the key combination [ALT + m] (be aware of the keyboard language defined in the operating system!). That is useful when you are working from a remote PC and the front panel function is not active.

Remote command:

`SYSTem:DISPlay:FPANel[:STATe]` on page 619

12.2.1.3 Display theme and colors

Access: [Setup] > "Display" > "Theme + Color"

You can configure the used colors and styles of display elements on the screen.

For step-by-step instructions see [Chapter 12.2.2, "How to configure the colors for display and printing"](#), on page 314.

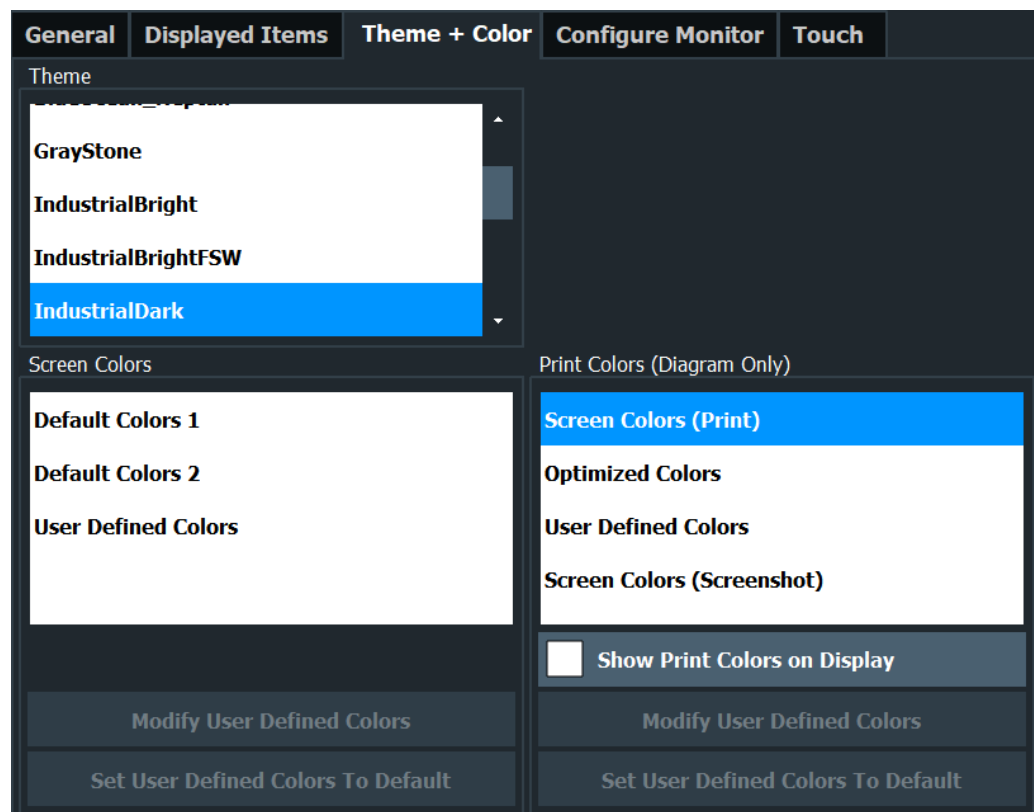

Theme.....	309
Screen Colors.....	310
Print Colors.....	310
Showing Print Colors on Display.....	310
Modifying User-Defined Color Assignments.....	310
L Selecting the Object.....	311
L Predefined Colors.....	311
L Preview.....	311
Defining User-specific Colors.....	312
Restoring the User Settings to Default Colors.....	312

Theme

The theme defines the colors and style used to display softkeys and other screen objects.

The default theme is "IndustrialDark".

Remote command:

`DISPlay:THEMe:SELEct` on page 622

Screen Colors

Two different color sets are provided by the instrument, a third user-defined set can be configured.

The default color schemes provide optimum visibility of all screen objects when regarding the screen from above or below. Default setting is "Default Colors 1".

If "User Defined Colors" is selected, a user-defined color set can be defined (see ["Defining User-specific Colors"](#) on page 312).

Remote command:

`DISPlay:CMAP<it>:DEFault<ci>` on page 620

Print Colors

Defines the color settings used for printout.

In addition to the predefined settings, a user-defined color set can be configured (see ["Defining User-specific Colors"](#) on page 312).

If "Show Print Colors on Display" is activated, the currently selected print colors are displayed as a preview for your selection.

Gui setting	Description	Remote command
"Optimized Colors"	Selects an optimized color setting for the printout to improve the visibility of the colors (default setting). Trace 1 is blue, trace 2 black, trace 3 green, and the markers are turquoise. The background is always printed in white and the grid in black.	HCOP:CMAP:DEF2
"Screen Colors (Print)"	Selects the current screen colors for the printout. The background is always printed in white and the grid in black.	HCOP:CMAP:DEF1
"Screen Colors (Screenshot)"	Selects the current screen colors without any changes for a screenshot.	HCOP:CMAP:DEF4
"User Defined Colors"	Selects the user-defined color setting.	HCOP:CMAP:DEF3

Remote command:

`HCOPy:CMAP<it>:DEFault<ci>` on page 591

Showing Print Colors on Display

Temporarily shows the currently selected print colors on the screen display. This function can be used as a preview for printing.

Modifying User-Defined Color Assignments

You can configure the colors used to display and print individual screen objects according to your specific requirements.

The colors are configured in the (identical) "Screen Color Setup"/"Printer Color Setup" dialog boxes.

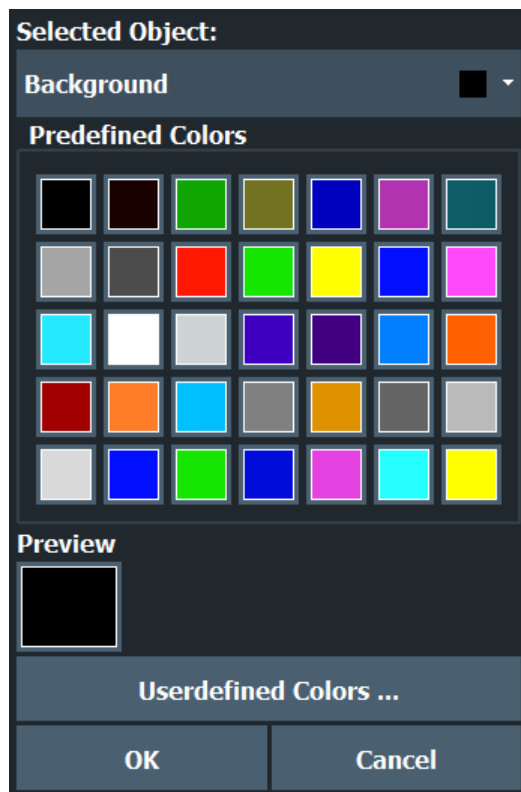

Selecting the Object ← Modifying User-Defined Color Assignments

Selects the object for which the color is to be defined. Colors can be defined for the following objects:

- Background
- Grid
- Individual traces
- Display lines
- Limit lines and check results
- Markers and marker information

Remote command:

Each object is assigned to a specific suffix of the CMAP commands, see [Chapter 14.9.4.3, "CMAP suffix assignment"](#), on page 622.

Predefined Colors ← Modifying User-Defined Color Assignments

Displays the available colors from the predefined color set that can be used for the selected object.

Remote command:

[HCOPY:CMAP<it>:PDEFined](#) on page 592

Preview ← Modifying User-Defined Color Assignments

Indicates the currently selected color that will be used for the selected object.

Defining User-specific Colors

In addition to the colors in the predefined color set you can configure a user-specific color to be used for the selected object.

When you select "Userdefined Colors...", the set of predefined colors is replaced by a color palette and color configuration settings.



The color palette allows you to select the color directly. The color settings allow you to define values for tint, saturation and brightness.

Remote command:

[HCOPY:CMAP<it>:HSL](#) on page 592

Restoring the User Settings to Default Colors

In addition to the predefined color settings, a user-defined setting can be configured. By default, the same settings as defined in "Default Colors 1" are used. They can then be modified according to user-specific requirements (see "[Modifying User-Defined Color Assignments](#)" on page 310).

The "Set to Default" function restores the original default settings for the user-defined color set. You can select which of the three default settings are restored.

Remote command:

[DISPlay:CMAP<it>:PDEFined](#) on page 621

12.2.1.4 External monitor settings

Access: [Setup] > "Display" > "Configure Monitor"

You can connect an external monitor (or projector) to the "DVI" or "display port" connector on the instrument's rear panel.



Screen resolution and format

The touchscreen of the R&S FSWP is calibrated for a 16:10 format. If you connect a monitor or projector using a different format (e.g. 4:3), the calibration is not correct and the screen does not react to your touch actions properly.

The touchscreen has a screen resolution of 1280x800 pixels. Usually, the display of the external monitor is a duplicate of the instrument's monitor.

If you configure the external monitor to be used as the *only* display in the Windows configuration dialog box ("Show only on 2"), the maximum screen resolution of the monitor is used. In this case, you can maximize the R&S FSWP application window and see even more details. You cannot change the monitor's screen resolution via the standard Windows configuration dialog box.

However, you can restore the default instrument resolution (1280x800) on the monitor using the instrument function "Setup" > "Display" > "Configure Monitor" > "Screen Resolution: Restore to default".

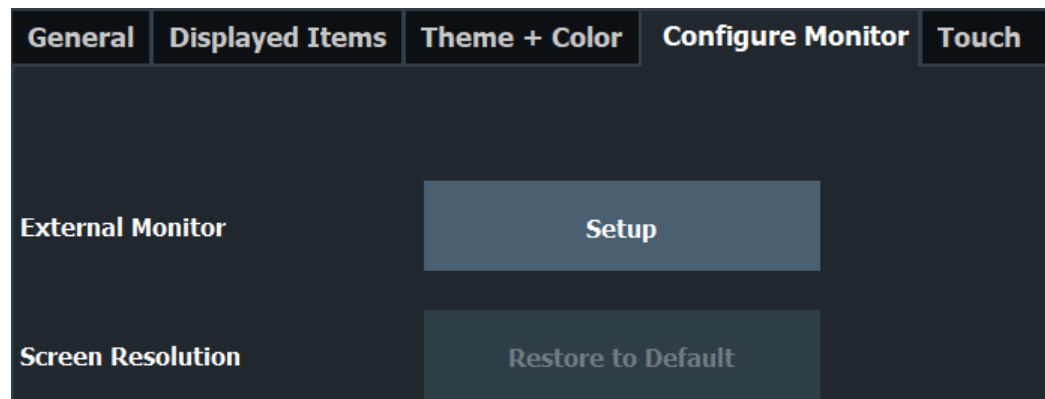

Setup	313
Screen Resolution: Restore to Default	313

Setup

Opens the standard Windows configuration dialog box to configure the used display devices.

Screen Resolution: Restore to Default

The default screen resolution (1280 x 800) is restored in the Windows configuration settings. This is useful, for instance, if the instrument was connected to a display device and was adapted to different requirements.

12.2.2 How to configure the colors for display and printing

You can configure the style and colors with which various screen objects are displayed or printed.

To select a color set

1. Press [Setup] and select "Display".
2. Select the "Theme + Color" tab.
3. In the "Screen Colors" area, do one of the following:
 - Select a predefined set of colors for screen display.
 - Select "User Defined Colors" to configure the color set yourself.
4. In the "Print Colors" area, do one of the following:
 - Select a predefined set of colors for printing screenshots.
 - Select "User Defined Colors" to configure the color set yourself.
5. Activate the "Show Print Colors on Display" option to see a preview of the print colors.

To configure a user-defined color set



1. In the "Theme + Color" tab of the "Display" dialog box, select "User Defined Colors" either for the screen or the print colors.
2. Select "Modify User Defined Colors".
The "Screen Color Setup" dialog box is opened.
3. From the "Selected Object:" list, select the object to which you want to assign a color.
4. Do one of the following:
 - Select a color from the "Predefined Colors".
 - Select "Userdefined Colors ..." to define a different color.
The "Preview" area indicates the currently selected color.
5. To assign a user-specific color to the selected object, do one of the following:
 - Select the color from the palette.
 - Enter values for the "Tint:", "Saturation:", and "Brightness:".
Note: In the continuous color spectrum ("Tint:"), 0 % represents red and 100 % represents blue.
 - Enter an "ARGB:" value in hexadecimal format.
6. Select the next object to which you want to assign a color from the "Selected Object:" list.
7. Repeat these steps until you have assigned a color to all objects you want to configure.

8. Select "OK" to close the dialog box.
The colors are applied to the assigned objects.

12.2.3 How to work with the soft front panels

Basic operation with the soft front panels is identical to normal operation, except for the following aspects:

- To activate a key, select the key on the touchscreen.
- To simulate the use of the rotary knob, use the additional keys displayed between the keypad and the arrow keys:

Icon	Function
	Turn left
	Enter
	Turn right

Mini front panel

The mini front panel provides only the keys on the touchscreen, to operate the R&S FSWP via an external monitor or remote desktop.

To display the soft front panel or mini front panel

1. Press [Setup] and select "Display".
2. Select the "Displayed Items" tab.
3. Select "Front Panel": "On" or "Mini Front Panel": "On".



To hide or show the front panel, press [F6] on the external keyboard (if available) or on the remote computer.

To hide or show the "Mini Front Panel", double-click the title of the softkey menu. As an alternative, press [ALT + m] (be aware of the keyboard language defined in the operating system!) on the external keyboard (if available) or on the remote computer.

To close the mini front panel



- ▶ Select the  "Close" icon at the top of the panel.

12.2.4 Reference: Keyboard shortcuts for the mini front panel

The mini front panel provides an alternative way to access the functionality of the hard-keys when you are operating the instrument remotely. You can access the keys either using a mouse or using keyboard shortcuts on the remote computer. The follow table provides an overview of the assigned keyboard shortcuts *for a German keyboard layout*. Be aware of the keyboard language defined in the operating system!



To hide or show the "Mini Front Panel", double-click the title of the softkey menu. As an alternative, press [ALT + m].

Hardkey on instrument	Keyboard shortcut
[Freq.]	[Alt+Shift+J]
[Span]	[Alt+Shift+K]
[Ampt./Scale]	[Alt+Shift+C]
[Auto Set]	[Alt+Shift+N]
[BW]	[Alt+Shift+L]
[Sweep]	[Alt+Shift+M]
[Trace]	[Alt+Shift+F]
[Trigger]	[Alt+Shift+S]
[Meas]	[Alt+Shift+A]
[Meas Config]	[Alt+Shift+W]
[Lines]	[Alt+Shift+B]
[Input/Output]	[Alt+Shift+I]
[Marker]	[Alt+Shift+G]
[Peak Search]	[Alt+Shift+R]
[Marker Function]	[Alt+Shift+Q]
[Marker ->]	[Alt+Shift+H]
[Undo]	[CTRL+Shift+U]
[Redo]	[CTRL+Shift+R]
[Run Single]	[Alt+Shift+D]
[Run Cont.]	[Alt+Shift+E]
[Setup]	[Alt+Shift+T]
[Print]	[Alt+CTRL+P]
[File]	[CTRL+S]
[Mode]	[Alt+Shift+P]
	[CTRL+M]
	[CTRL+N]
[GHz s -dBm V]	[CTRL+Shift+G]
[MHz ms dBm mV]	[CTRL+Shift+M]
[kHz μs dB μV]	[CTRL+Shift+K]

Hardkey on instrument	Keyboard shortcut
[Hz ns dB.. nV]	[CTRL+Shift+H]
[Preset]	[Alt+Shift+U]

12.3 Reference frequency settings

Access: [Setup] > "Reference"

Reference [X]

Reference Frequency Input

Internal Reference
 External Reference 10 MHz
 External Reference 1..50 MHz
 External Reference 100 MHz
 External Reference 1 GHz
 Sync Trigger

Tuning Range: +/- 0.5 ppm, +/- 6 ppm

Frequency: 10.0 MHz

Loop Bandwidth: 10 Hz

In case of missing External Reference

Show Error Flag Switch to Internal Reference

Reference Frequency Output

Output 100 MHz: On Off Output Sync Trigger: On Off

Output 640 MHz: On Off

Set To Default

Reference Frequency Input.....	318
L Behavior in case of missing external reference.....	318
L Tuning Range.....	319
L Frequency.....	319
L Loop Bandwidth.....	319

Reference Frequency Output.....	319
Set to Default.....	320
Advanced reference frequency configuration.....	320

Reference Frequency Input

The R&S FSWP can use the internal reference source or an external reference source as the frequency standard for all internal oscillators. A 10 MHz crystal oscillator is used as the internal reference source. In the external reference setting, all internal oscillators of the R&S FSWP are synchronized to the external reference frequency.

External references are connected to one of the REF INPUT or the SYNC TRIGGER connectors on the rear panel.

Note: The optional, and more precise OCXO signal can replace the internal reference source.

The default setting is the internal reference. When an external reference is used, EXT REF is displayed in the status bar.

The following reference inputs are available:

Table 12-1: Available Reference Frequency Input

Setting	Source Connector	Frequency	Tuning Range	Loop Bandwidth	Description
Internal	(OCXO)	10 MHz	-	1-100 Hz	Internal reference signal or optional OCXO
External Reference 10 MHz	REF INPUT 1..50 MHz	10 MHz	+/- 6 ppm	1-100 Hz	Fixed external 10 MHz reference frequency Good phase noise performance
External Reference 1..50MHz	REF INPUT 1..50 MHz	1..50 MHz in 1 Hz steps	+/- 0.5 ppm	0.1 Hz (fixed)	Variable external reference frequency in 1 Hz steps Good external phase noise suppression. Small tuning range.
			+/- 6 ppm	1-30 Hz	Variable external reference frequency in 1 Hz steps Wide tuning range.
External Reference 100 MHz	REF INPUT 100 MHz / 1 GHz	100 MHz	+/- 6 ppm	1-300 Hz	External reference Good phase noise performance
External Reference 1 GHz	REF INPUT 100 MHz / 1 GHz	1 GHz	+/- 6 ppm	1-300 Hz	External reference
Sync Trigger	SYNC TRIGGER INPUT	100 MHz	+/- 6 ppm	1-300 Hz	External reference

Remote command:

`[SENSe:]ROSCillator:SOURce` on page 609

`SOURce<si>:EXTernal<ext>:ROSCillator:EXTernal:FREQuency`
on page 608

Behavior in case of missing external reference ← Reference Frequency Input

If an external reference is selected but none is available, there are different ways the instrument can react.

"Show Error Flag" The error message "External reference missing" is displayed if no valid external reference signal is available. Additionally, the flag "NO REF" is displayed to indicate that no synchronization was performed *for the last measurement*.

"Switch to internal reference" The instrument automatically switches back to the internal reference if no external reference is available. Note that you must re-activate the external reference if it becomes available again at a later time.

Remote command:

[\[SENSe:\]ROSCillator:EXTernal:FALLback](#) on page 610

Tuning Range ← Reference Frequency Input

The tuning range is only available for the variable external reference frequency. It determines how far the frequency may deviate from the defined level in parts per million (10^{-6}).

" ± 0.5 ppm" With this smaller deviation a very narrow fixed loop bandwidth of 0.1 Hz is realized. With this setting the instrument can synchronize to an external reference signal with a very precise frequency. Due to the very narrow loop bandwidth, unwanted noise or spurious components on the external reference input signal are strongly attenuated. Furthermore, the loop requires about 30 seconds to reach a locked state. During this locking process, "NO REF" is displayed in the status bar.

" ± 6 ppm" The larger deviation allows the instrument to synchronize to less precise external reference input signals.

Remote command:

[\[SENSe:\]ROSCillator:TRANge](#) on page 610

Frequency ← Reference Frequency Input

Defines the external reference frequency to be used (for variable connectors only).

Loop Bandwidth ← Reference Frequency Input

Defines the speed of internal synchronization with the reference frequency. The setting requires a compromise between performance and increasing phase noise.

For a variable external reference frequency with a narrow tuning range (± 0.5 ppm), the loop bandwidth is fixed to 0.1 Hz and cannot be changed.

Remote command:

[\[SENSe:\]ROSCillator:LBWidth](#) on page 607

Reference Frequency Output

A reference frequency can be provided by the R&S FSWP to other devices that are connected to this instrument. If activated, the reference signal is output to the corresponding connector.

"Output 100 MHz"

Provides a 100 MHz reference signal to the REF OUTPUT 100 MHz connector.

"Output 640 MHz"

Provides a 640 MHz reference signal to the REF OUTPUT 640 MHz connector.

"Output Sync Trigger"

Provides a 100 MHz reference signal to the SYNC TRIGGER OUTPUT connector.

Remote command:

[SENSe:]ROSCillator:O640 on page 607

[SENSe:]ROSCillator:OSYNc on page 608

Set to Default

The values for the "Tuning Range", "Frequency" and "Loop Bandwidth" are stored for each source of "Reference Frequency Input".

When you switch the input source, the previously defined settings are restored. You can restore the default values for all input sources using the "Set to Default" function.

Advanced reference frequency configuration

The cross-correlation hardware options (R&S FSWP-B60 and -B61) provide a second internal reference frequency. This reference signal is phase locked to the reference frequency of the base instrument with a different loop bandwidth. If you have an R&S FSWP equipped with one of these options, you can synchronize the reference frequencies (internal and external).

The "Coupling" property turns coupling of the two references on and off.

If you select "Auto" coupling, the R&S FSWP uses the following logic.

- The R&S FSWP turns on coupling if you have selected the internal reference frequency of the base instrument.
- The R&S FSWP turns on the coupling if the tuning range for an external reference frequency is ± 0.5 ppm. We also recommend to manually couple the references in that case to avoid spurs.
If an external reference has better accuracy than 0.5 ppm, the R&S FSWP also turns on the coupling.
- The R&S FSWP turns off the coupling if the selected tuning range for an external reference frequency is ± 6 ppm. Because the OCXO of the R&S FSWP-B60 and -B61 can handle only ± 0.5 ppm, it is tuned with a DA converter.

You can also define the speed of the synchronization between the two references with the "Bandwidth" setting.

If you select "Auto", the R&S FSWP automatically selects an appropriate bandwidth.

- The default bandwidth is 20 mHz. To yield the best results in phase noise measurements, the coupling bandwidth should be as low as possible.
For measurements with a start offset > 1 Hz, we recommend that you select a coupling bandwidth of 1 Hz to speed up the settling time of the reference loop.
- When the signal source is on, the R&S FSWP selects a coupling bandwidth of 100 kHz. With this setting the phase noise of the signal source and the receiving path correlate, which leads to better results measuring additive phase noise on frequency translating DUTs.

Remote command:

State: [SENSe:]ROSCillator:COUpling:MODE on page 607

Bandwidth (mode): [SENSe:]ROSCillator:COUpling:BANDwidth:MODE on page 606

Bandwidth (value): [SENSe:]ROSCillator:COUpling:BANDwidth on page 606

12.4 System configuration settings

Access: [Setup] > "System Configuration"

- [Hardware information](#).....321
- [Information on versions and options](#)..... 321
- [System messages](#).....323
- [Firmware updates](#)..... 324
- [General configuration settings](#)..... 325
- [AC power loss behavior](#)..... 327

12.4.1 Hardware information

Access: [Setup] > "System Configuration" > "Hardware Info"

An overview of the installed hardware in your R&S FSWP is provided.

Every listed component is described by its serial number, part number, model information, hardware code, and hardware revision.

This information can be useful when problems occur with the instrument and you require support from Rohde & Schwarz.

Hardware Info	Versions + Options	System Messages	Firmware Update	Config			
COMPONENT			SERIAL #	ORDER #	MODEL	HWC	REV
CISPR 16-1-1 EDITION 4 READY							
FRONTEND BOARD							
DIGITAL MOTHERBOARD							
DETECTOR BOARD, REV.3							
MICROWAVE CONVERTER BASE BOARD							
MICROWAVE CONVERTER FRONTEND UNIT							
RF ATTENUATOR							
RF PREAMPLIFIER BOARD							
DETECTOR EXTENSION BOARD, REV. 2							
SYNTHESIZER BOARD							
REFERENCE BOARD							
OCXO							
FRONT PANEL BOARD							
PRESELECTOR 1							
PRESELECTOR 2 UNIT							
EXTERNAL GENERATOR CONTROL BOARD							
CPU BOARD - SIM							

Remote command:

[DIAGnostic:SERvice:HWInfo?](#) on page 636

12.4.2 Information on versions and options

Access: [Setup] > "System Configuration" > "Versions + Options"

Information on the firmware version and options installed on your instrument is provided. The unique Rohde & Schwarz device ID is also indicated here, as it is required for license and option administration.

You can also install new firmware options in this dialog box.

The table also contains:

- The open source acknowledgements (PDF file) for the firmware and other software packages used by the R&S FSWP



Installing options in secure user mode

Be sure to install any new options before [SecureUser Mode](#) is enabled; see [Chapter 11.2, "Protecting data using the secure user mode"](#), on page 263.

For restricted users in secure user mode, this function is not available!



Expired option licenses

If an option is about to expire, a message box is displayed to inform you. You can then use the "Install Option" function to enter a new license key.

If an option has already expired, a message box appears for you to confirm. In this case, all instrument functions are unavailable (including remote control) until the R&S FSWP is rebooted. You must then use the "Install Option" function to enter the new license key.

Hardware Info		Versions + Options	System Messages	Firmware Update	Config
State	Item	Option	Version	License	
	R&S Device ID		1328.4100K26-100005-ML		
	Instrument Firmware		1.80-20.10.9.0 Beta		
	BIOS		47.11- SIM		
	Image		0.0.0		
	Device Installation		0.0.0		
	PCIE-FPGA		8.05		
	SA-FPGA		10.12		
	RTSA-FPGA-B160RA		13.13		
	RTSA-FPGA-NRT		16.13		
	MB-FPGA		0.0.0.0		
	SYNTH-FPGA		0.0.0.0		
	REF-FPGA		0.0.0.0		
	MWC-FPGA		0.0.0.0		
	Data Sheet		01.00		
	Time Control Management				active
	Smart Card Service				installed

Install Option
Install Option by XML

Remote commands:

[SYSTem:FORMat:IDENT](#) on page 639

[DIAGnostic:SERVICE:BIOSinfo?](#) on page 636

[DIAGnostic:SERVICE:VERSinfo?](#) on page 636

Open Source Acknowledgment: Open

Displays a PDF file containing information on open source code used by the R&S FSWP firmware.

Install Option

Opens an edit dialog box to enter the license key for the option that you want to install.

Only user accounts with administrator rights are able to install options.

Install Option by XML

Opens a file selection dialog box to install an additional option to the R&S FSWP using an XML file. Enter or browse for the name of an XML file that contains the option key and select "Select".

Only user accounts with administrator rights are able to install options.

12.4.3 System messages

Access: [Setup] > "System Configuration" > "System Messages"

The system messages generated by the R&S FSWP are displayed.

The messages are displayed in the order of their occurrence; the most recent messages are placed at the top of the list. Messages that have occurred since you last visited the system messages tab are marked with an asterisk "*".

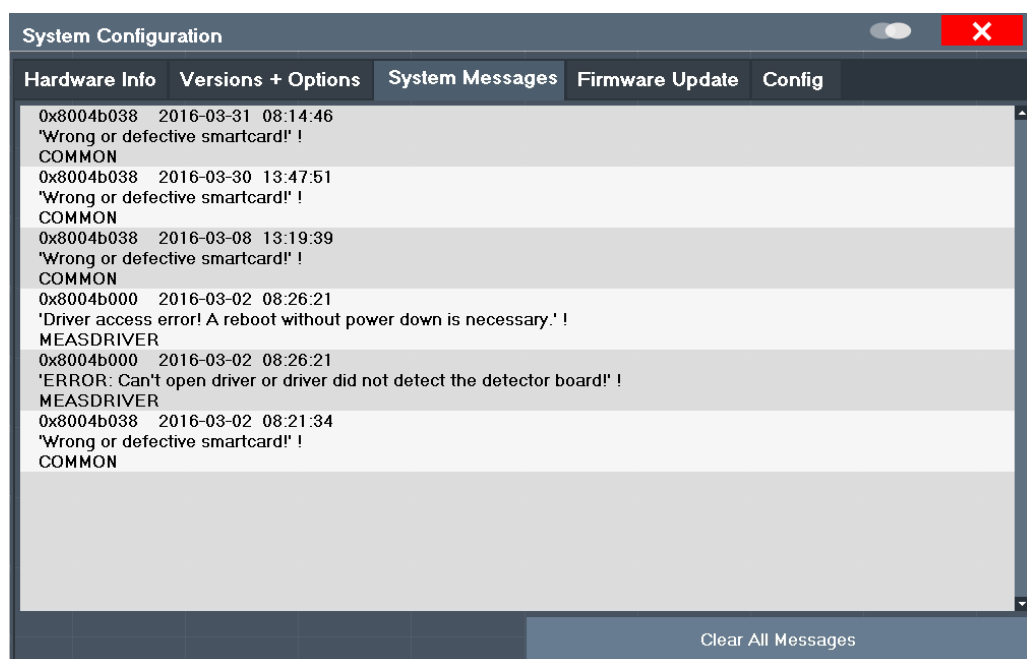

If the number of error messages exceeds the capacity of the error buffer, "Message Buffer Overflow" is displayed. To clear the message buffer, use "Clear All Messages".

The following information is available:

No	device-specific error code
Message	brief description of the message
Component	hardware messages: name of the affected module
	software messages: name of the affected software
Date/Time	date and time of the occurrence of the message

Remote command:

`SYSTem:ERRor:LIST?` on page 638

12.4.4 Firmware updates

Access: [Setup] > "System Configuration" > "Firmware Update"

During instrument start, the R&S FSWP checks the installed hardware against the current firmware version to ensure that the hardware is supported. If not, an error message is displayed ("Wrong Firmware Version") and you are asked to update the firmware. Until the firmware version is updated, self-alignment fails. To see which components are not supported, see the [System messages](#).

Possibly, you also have to update the firmware on your R&S FSWP to enable additional new features or if reasons for improvement come up. Ask your sales representative or check the Rohde & Schwarz website for availability of firmware updates. A firmware update package includes at least a setup file and release notes.



Before updating the firmware on your instrument, read the release notes delivered with the firmware version.



Installing options in secure user mode

Be sure to perform any firmware updates before [SecureUser Mode](#) is enabled; see [Chapter 11.2, "Protecting data using the secure user mode"](#), on page 263.

For restricted users in secure user mode, this function is not available.

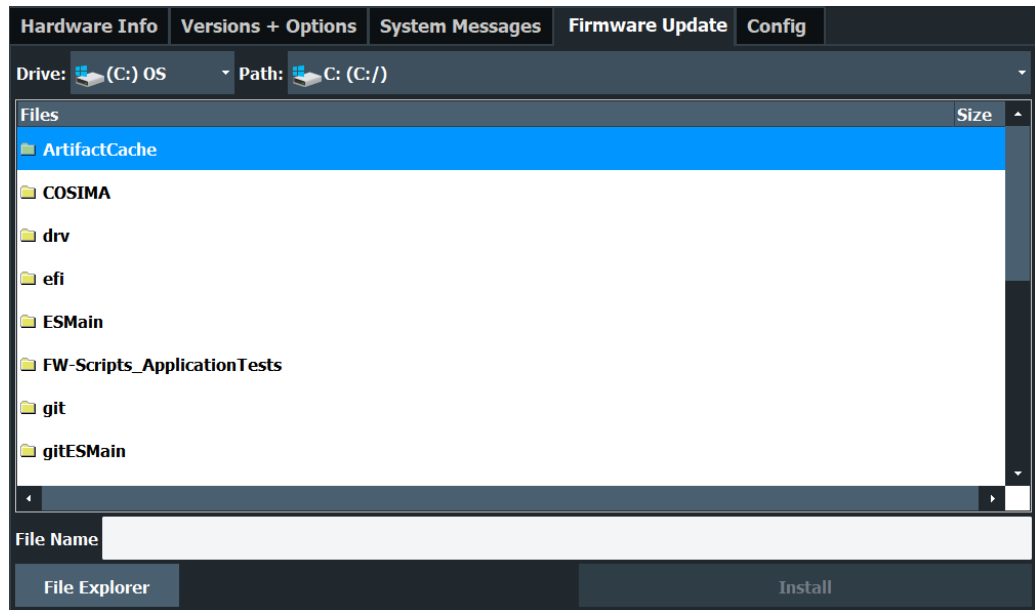

For detailed instructions on installing the firmware, see the product release notes.

Remote command:

`SYSTEM:FIRMWARE:UPDATE` on page 639

12.4.5 General configuration settings

Access: [Setup] > "System Configuration" > "Config"

General system settings, for example concerning the initial behaviour of the R&S FSWP after booting, can also be configured.

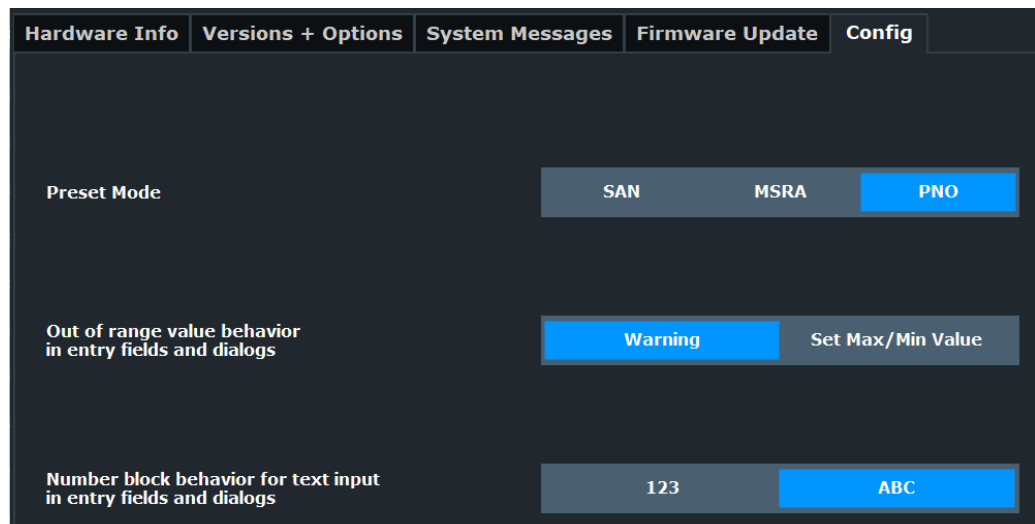

Preset Mode.....	326
Out-of-range value behavior.....	326
SecureUser Mode.....	326
└ Changing the password.....	327
Number block behavior.....	327

Preset Mode

The preset mode selects the application that is started after an instrument preset.

The presettings can be defined in the "Config" tab of the "System Configuration" dialog box.

For details on operating modes see [Chapter 7, "Applications"](#), on page 107.

"SAN"	Signal and Spectrum Analyzer mode (Only when the optional Spectrum application has been installed.)
"MSRA"	Multi-Standard Radio Analysis mode (Only when the optional Spectrum application has been installed.)
"PNO"	Phase Noise application

Remote command:

`SYSTem:PRESet:COMPAtible` on page 639

Out-of-range value behavior

By default, if you enter a value that is outside the valid range in an input field for a setting, a warning is displayed and the value is not accepted. Alternatively, entries below the minimum value can automatically be set to the minimum entry, and entries above the maximum value set to the maximum entry. This behavior avoids errors and facilitates setting correct values.

SecureUser Mode

If activated, the R&S FSWP requires a reboot and then automatically logs in using the "SecureUser" account.

Data that the R&S FSWP normally stores on the solid-state drive is redirected to volatile memory instead. Data that is stored in volatile memory can be accessed by the user during the current instrument session. However, when the instrument's power is removed, all data in volatile memory is erased.

The Secure User Mode can only be activated or deactivated by a user with administrator rights.

Note: Storing instrument settings permanently. Before you activate secure user mode, store any instrument settings that are required beyond the current session, such as predefined instrument settings, transducer files, or self-alignment data.

For details on the secure user mode, see [Chapter 11.2, "Protecting data using the secure user mode"](#), on page 263.

Remote command:

`SYSTem:SECurity[:STATe]` on page 640

Note: Initially after installation of the R&S FSWP-K33 option, secure user mode must be enabled manually once before remote control is possible.

Changing the password ← SecureUser Mode

When the secure user mode is activated the first time after installation, you are prompted to change the passwords for all user accounts to improve system security.



To save the new password, select "Save". The password dialog for the next user is displayed, until you have been prompted to change the password all user accounts.

If you cancel the dialog without changing the password, the password dialog for the next user is displayed, until you have been prompted to change the password for all user accounts. It is possible to continue in secure user mode without changing the passwords, and you will not be prompted to do so again. However, we strongly recommend that you do define a more secure password for all users.

By default, the password characters are not displayed to ensure confidentiality during input. To display the characters, select "Show password".

To display the onscreen keyboard, select "Keyboard".

Number block behavior

Defines the default behavior of the keypad on the front panel of the R&S FSWP for **text** input. Depending on the type of values you most frequently enter using the keypad, a different default is useful.

- | | |
|-------|--|
| "123" | Numeric values are entered when you press a key on the keypad. To enter alphanumeric values, use an external or the on-screen keyboard, or switch this setting. |
| "ABC" | (Default)
Every key on the keypad represents several characters and one number. If you press the key multiple times in quick succession, you toggle through the symbols assigned to the key. For the assignment, refer to Table 6-6 . |

12.4.6 AC power loss behavior

Access: BIOS

Using a specific configuration setting in the BIOS of the R&S FSWP, you can define how the instrument behaves after the AC power supply is interrupted. The setting applies regardless whether the interruption occurs due to an irregular power outage in the mains supply, by removing the power cable, or by switching the instrument power supply off.

The setting supports the following values:

- "Power Off": Instrument remains switched off.
- "Power On": Instrument automatically switches on as soon as power supply is restored.
- "Last State": (Default) Instrument restores the state that it was in before the outage occurred.

To change the instrument's power loss behavior

Prerequisite: the instrument is switched off and a keyboard is connected.

1. Switch on the power switch on the rear panel of the R&S FSWP.
2. Watch for the prompt on the display, then press [DEL] on the keyboard to enter the BIOS setup.
3. In the BIOS menu, select "Chipset" > "PCH-IO Configuration" > "Restore AC Power Loss".
4. Select the required setting as described above.
5. In the BIOS menu, select "Save & Exit" > "Save Changes and Exit".

12.5 Service functions

Access: [Setup] > "Service"

When unexpected problems arise with the R&S FSWP some service functions may help you solve them.

For more helpful information for support, see also [Chapter 15.1, "Collecting information for support"](#), on page 668

• R&S support information	328
• Self-test settings and results	330
• Calibration signal display	331
• Service functions	332
• Hardware diagnostics	334

12.5.1 R&S support information

Access: [Setup] > "Service" > "R&S Support"

In case of errors you can store useful information for troubleshooting and send it to your Rohde & Schwarz support center.

R&S Support	Selftest	Calibration Signal	Service Function	Hardware Diagnostics
Create R&S Support Information		Location: C:/user/		
<p>In case of problems, follow the customer support link, log in to GLORIS and navigate to the R&S Support Center area. Create a request, describe the problem and attach the Support Information file.</p>				
Save Device Footprint		Location: C:/devicedata/xml/		
<p>Contact Information Contact our customer support center at www.rohde-schwarz.com/support/, or follow this QR code:</p>				
				

Create R&S Support Information	329
Save Device Footprint	329
Last Service Date	329
Last Calibration Date	330
Next Calibration Due	330

Create R&S Support Information

Creates a *.zip file with important support information. The *.zip file contains the system configuration information ("Device Footprint"), the current eeprom data and a screenshot of the screen display.

This data is stored to the C:\R_S\INSTR\USER directory on the instrument.

The file name consists of the unique device ID and the current date and time of the file creation.

If you contact the Rohde & Schwarz support to get help for a certain problem, send these files to the support in order to identify and solve the problem faster.

Remote command:

[DIAGnostic:SERVice:SINFo?](#) on page 642

Save Device Footprint

Creates an *.xml file with information on installed hardware, software, image and FPGA versions. The *.xml file is stored under

C:\Program Files (x86)\Rohde-Schwarz\FSWP\\devicedata\xml\ on the instrument. It is also included in the service ZIP file (see "[Create R&S Support Information](#)" on page 329).

Last Service Date

Opens a calendar to define the date that the R&S FSWP was inspected by Rohde & Schwarz service. The service date is updated by the service technicians. For new instruments, the last service date (= date of production) is entered during production.

If the field contains no date, we recommend that you enter the date of last service according to the service certificates you received after the R&S FSWP has been serviced.

If the R&S FSWP has not been serviced yet, leave the field empty.

Remote command:

[DIAGnostic:SERvice:DATE](#) on page 644

Last Calibration Date

Opens a calendar to define the date that the R&S FSWP was calibrated. For new instruments, we recommend to enter the factory calibration date specified on the calibration certificate.

Remote command:

[DIAGnostic:SERvice:CALibration:DATE](#) on page 643

Next Calibration Due

Opens a calendar to define the date that the R&S FSWP needs its next calibration. The recommended calibration interval is specified in a read only field next to this input field.

This date must always be configured by the customer due to ISO17025.

Remote command:

Set date: [DIAGnostic:SERvice:CALibration:DUE:DATE](#) on page 643

Recommended interval: [DIAGnostic:SERvice:CALibration:INTerval?](#) on page 643

12.5.2 Self-test settings and results

Access: [Setup] > "Service" > "Selftest"

If the R&S FSWP fails you can perform a self-test of the instrument to identify any defective modules.

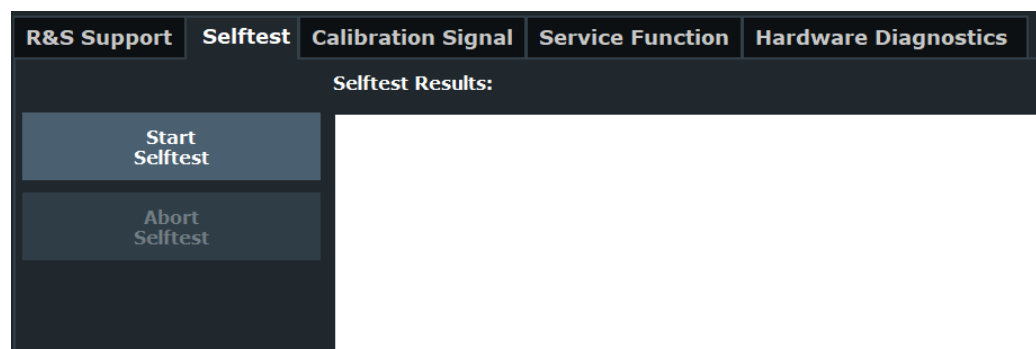

Once the self-test is started, all modules are checked consecutively and the test result is displayed. You can abort a running test.

In case of failure a short description of the failed test, the defective module, the associated value range and the corresponding test results are indicated.



A running Sequencer process is aborted when you start a self-test.

If you start a self-test remotely, then select "Local" while the test is still running, the instrument only returns to the manual operation state after the test is completed. In this case, the self-test cannot be aborted.

Remote command:

*TST? on page 412

DIAGnostic:SERvice:STEST:RESult? on page 616

12.5.3 Calibration signal display

Access: [Setup] > "Service" > "Calibration Signal"

As an alternative to the RF input signal from the front panel connector, you can use the instrument's calibration signal as the input signal, for example to perform service functions on.

R&S Support	Selftest	Calibration Signal	Service Function	Hardware Diagnostics
<input checked="" type="radio"/> None				
<input type="radio"/> Calibration Frequency RF				
Spectrum		<input checked="" type="radio"/> Narrowband	<input type="radio"/> Broadband	
Frequency		64.0 MHz		
<input type="radio"/> Calibration Frequency MW				
Distance		<input type="radio"/> Wide	<input checked="" type="radio"/> Small	

NONE.....	331
Calibration Frequency RF.....	331
L Spectrum.....	332
L Frequency.....	332
Calibration Frequency MW.....	332
Calibration Synthesizer 2.....	332

NONE

Uses the current RF signal at the input, i.e. no calibration signal (default).

Remote command:

DIAGnostic:SERvice:INPut[:SElect] on page 615

Calibration Frequency RF

Uses the internal calibration signal as the RF input signal.

Remote command:

[DIAGnostic:SERVice:INPut\[:SElect\]](#) on page 615

[DIAGnostic:SERVice:INPut:PULSed:CFrequency](#) on page 615

Spectrum ← Calibration Frequency RF

Defines whether a broadband or narrowband calibration signal is sent to the RF input.

"Narrowband" Used to calibrate the absolute level of the frontend at 64 MHz.

"Broadband" Used to calibrate the IF filter.

Remote command:

[DIAGnostic:SERVice:INPut:RF\[:SPECTrum\]](#) on page 615

Frequency ← Calibration Frequency RF

Defines the frequency of the internal broadband calibration signal to be used for IF filter calibration (max. 64 MHz).

For narrowband signals, 64 MHz is sent.

Calibration Frequency MW

Uses the microwave calibration signal as the RF input (for frequencies higher than 8 GHz). This function is used to calibrate the YIG-filter on the microwave converter. The microwave calibration signal is pulsed.

You can define whether the distance between input pulses is small or wide.

Remote command:

[DIAGnostic:SERVice:INPut\[:SElect\]](#) on page 615

[DIAGnostic:SERVice:INPut:MC\[:DISTance\]](#) on page 614

Calibration Synthesizer 2

This function is used to check the phase noise of the synthesizers on a certain frequency. You can define the frequency in the corresponding input field.

If you enter a frequency on which calibration is not possible, the R&S FSWP uses the next available frequency.

Available if the R&S FSWP is equipped with the optional hardware and has more than one synthesizer.

For more information on the calibration process, refer to the service manual.

Remote command:

[DIAGnostic:SERVice:INPut\[:SElect\]](#) on page 615

[DIAGnostic:SERVice:INPut:SYNThtwo\[:FREQuency\]](#) on page 616

12.5.4 Service functions

Access: [Setup] > "Service" > "Service Function"

NOTICE**Using service functions**

The service functions are not necessary for normal measurement operation. Incorrect use can affect correct operation and/or data integrity of the R&S FSWP.

Therefore, only user accounts with administrator rights can use service functions and many of the functions can only be used after entering a password. These functions are described in the instrument service manual.

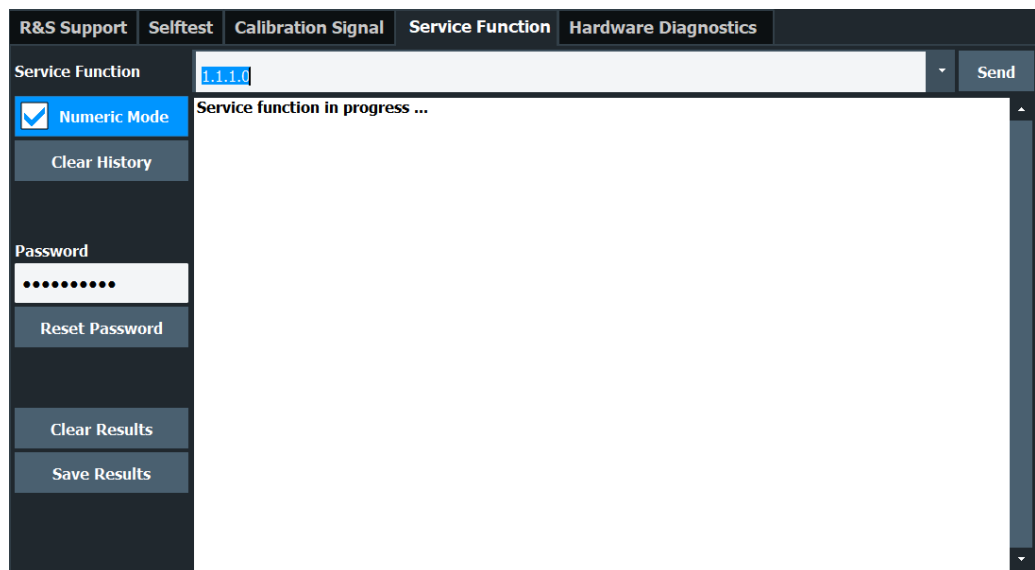

Service Function.....	333
Send.....	333
Numeric Mode.....	334
Clear History.....	334
Password.....	334
Clear Results.....	334
Save Results.....	334
Result List.....	334

Service Function

Selects the service function by its numeric code or textual name.

The selection list includes all functions previously selected (since the last "Clear History" action).

Remote command:

`DIAGnostic:SERvice:SFUNction` on page 641

Send

Starts the selected service function.

Remote command:

`DIAGnostic:SERvice:SFUNction` on page 641

Numeric Mode

If activated, the service function is selected by its numeric code. Otherwise, the function is selected by its textual name.

Clear History

Deletes the list of previously selected service functions.

Password

Most service functions require a special password as they may disrupt normal operation of the R&S FSWP. There are different levels of service functions, depending on how restrictive their use is handled. Each service level has a different password.

"Reset Password" clears any previously entered password and returns to the most restrictive service level.

Remote command:

[SYSTem:PASSword\[:CENable\]](#) on page 644

[SYSTem:PASSword:RESet](#) on page 644

Clear Results

Clears the result display for all previously performed service functions.

Remote command:

[DIAGnostic:SERvice:SFUNction:RESults:DELeTe](#) on page 642

Save Results

Saves the results of all previously performed service functions to a file stored as C:\R_S\INSTR\results\ServiceLog.txt.

Remote command:

[DIAGnostic:SERvice:SFUNction:RESults:SAVE](#) on page 642

Result List

The Results List indicates the status and results of the executed service functions.

12.5.5 Hardware diagnostics

In case problems occur with the instrument hardware, some diagnostic tools provide information that may support troubleshooting.

The hardware diagnostics tools are available in the "Hardware Diagnostics" tab of the "Service" dialog box.

Type	Counter
Mechanical Attenuation 5 dB	0
Mechanical Attenuation 10 dB	1
Mechanical Attenuation 20 dB	0
Mechanical Attenuation 40 dB	0
Calibration Source	0
AC/DC-Coupling	0
Electronic Attenuation	0
Preamplifier	0
Signal Source: Mechanical Attenuation 10 dB	0
Signal Source: Mechanical Attenuation 20 dB	0
Signal Source: Mechanical Attenuation 40 dB	0
Signal Source: Calibration Source	0

[Relays Cycle Counter](#)..... 335

Relays Cycle Counter

The hardware relays built into the R&S FSWP may fail after a large number of switching cycles (see data sheet). The counter indicates how many switching cycles the individual relays have performed since they were installed.

Remote command:

[DIAGnostic:INFO:CCOunt?](#) on page 635

13 Network operation and remote control

In addition to working with the R&S FSWP interactively, located directly at the instrument, it is also possible to operate and control it from a remote PC. Various methods for remote operation are supported:

- Connecting the instrument to a (LAN) network
- Using the web browser interface in a LAN network
- Using the Windows Remote Desktop application in a LAN network
- Connecting a PC via the GPIB interface

Basic information on operating the R&S FSWP via remote control is provided here. This information applies to all applications and operating modes on the R&S FSWP.



For additional information on remote control of spectrum analyzers see the following documents available from the Rohde & Schwarz website:

- [Remote control via SCPI](#)
- [1EF62: Hints and Tricks for Remote Control of Spectrum and Network Analyzers](#)
- [1MA171: How to use Rohde & Schwarz Instruments in MATLAB](#)
- [1MA208: Fast Remote Instrument Control with HiSLIP](#)

How to configure the remote control interfaces is described in [Chapter 13.7, "How to set up a network and remote control"](#), on page 387.

• Remote control interfaces and protocols	336
• Status reporting system	341
• GPIB languages	354
• The IECWIN tool	356
• Automating tasks with remote command scripts	357
• Network and remote control settings	369
• How to set up a network and remote control	387

13.1 Remote control interfaces and protocols

The instrument supports different interfaces and protocols for remote control. The following table gives an overview.



For a description of the protocols refer to [Remote control via SCPI](#).

Table 13-1: Remote control interfaces and protocols

Interface	Protocols, VISA ^{*)} address string	Port ^{**)}	Remarks
Local Area Network (LAN)	HiSLIP High-Speed LAN Instrument Protocol (IVI-6.1) TCPIP::host address::hislip0[::INSTR]	TCP port: 4880	A LAN connector is located on the rear panel of the instrument.
	VXI-11 TCPIP::host address::inst0[::INSTR] Library: VISA	TCP or UDP port: 111 TCP port: well-known ports (600 - 1023) for Linux or registered ports (1024 - 49151) for Windows	
	socket communication (Raw Ethernet, simple Telnet) TCPIP::host address[::LAN device name]::<port>::SOCKET Library: VISA or socket controller	SCPI raw, TCP port: 5025, 5125 SCPI telnet, TCP port: 5024, 5124	
	VNC	via VNC client: 5800/5900 Device web: 5850	
	Device web / web control	80	
GPIB (IEC/IEEE Bus Interface)	VISA ^{*)} address string: GPIB::primary address[::INSTR] (no secondary address)		A GPIB bus interface according to the IEC 625.1/IEEE 488.1 standard is located on the rear panel of the instrument.
USB	VISA ^{*)} address string: USB::<vendor ID>::<product_ID>::<serial_number>[::INSTR]		USB connectors are located on the front and rear panel of the instrument.
^{*)} VISA is a standardized software interface library providing input and output functions to communicate with instruments. A VISA installation on the controller is a prerequisite for remote control using the indicated interfaces. ^{**)} By default, R&S FSWP use these ports for communication via LAN control interface. If necessary, adapt your firewall to allow for use of these ports.			



Within this interface description, the term GPIB is used as a synonym for the IEC/IEEE bus interface.

13.1.1 LAN interface

To be integrated in a LAN, the instrument is equipped with a LAN interface, consisting of a connector, a network interface card and protocols. The network card can be operated with the following interfaces:

- 10 Mbit/s Ethernet IEEE 802.3
- 100 Mbit/s Ethernet IEEE 802.3u
- 1Gbit/s Ethernet IEEE 802.3ab

For remote control via a network, the PC and the instrument must be connected via the LAN interface to a common network with TCP/IP network protocol. They are connected using a commercial RJ45 cable (shielded or unshielded twisted pair category 5). The

TCP/IP network protocol and the associated network services are preconfigured on the instrument. Software for instrument control and the VISA program library must be installed on the controller.

IP address

Only the IP address or a valid DNS host name is required to set up the connection. The host address is part of the "VISA resource string" used by the programs to identify and control the instrument.

The VISA resource string has the form:

```
TCPIP::host address[::LAN device name][::INSTR]
```

or

```
TCPIP::host address::port::SOCKET
```

where:

- **TCPIP** designates the network protocol used
- **host address** is the IP address or host name of the device
- **LAN device name** defines the protocol and the instance number of a subinstrument;
 - `inst0` selects the VXI-11 protocol (default)
 - `hislip0` selects the HiSLIP protocol
- **INSTR** indicates the instrument resource class (optional)
- **port** determines the used port number
- **SOCKET** indicates the raw network socket resource class

Example:

- Instrument has the IP address *192.1.2.3*; the valid resource string using VXI-11 protocol is:

```
TCPIP::192.1.2.3::INSTR
```
- The DNS host name is *FSWP26-123456*; the valid resource string using HiSLIP is:

```
TCPIP::FSWP26-123456::hislip0
```
- A raw socket connection can be established using:

```
TCPIP::192.1.2.3::5025::SOCKET
```



Identifying instruments in a network

If several instruments are connected to the network, each instrument has its own IP address and associated resource string. The controller identifies these instruments by the resource string.

For details on configuring the LAN connection, see [Chapter 13.7, "How to set up a network and remote control"](#), on page 387.

- [LAN web browser interface](#)..... 339

13.1.1.1 LAN web browser interface

The LAN web browser interface allows for easy configuration of the LAN and remote control of the R&S FSWP without additional installation requirements.

The instrument's LAN web browser interface works correctly with all W3C compliant browsers.

Via the web browser interface to the R&S FSWP you can control the instrument remotely from another PC. Manual instrument controls are available via the front panel simulation. File upload and download between the instrument and the remote PC is also available. Using this feature, several users can access *and operate* the R&S FSWP simultaneously. This is useful for troubleshooting or training purposes.

For details, see [Chapter 13.7.1.4, "How to configure the LAN using the web browser interface"](#), on page 391 and [Chapter 13.7.5, "How to control the R&S FSWP via the web browser interface"](#), on page 397.



If you do not want other users in the LAN to be able to access and operate the R&S FSWP you can deactivate this function.

See [Chapter 13.7.6, "How to deactivate the web browser interface"](#), on page 398.



Restrictions

Only user accounts with administrator rights can use the LAN web browser functionality.

To display the LAN web browser interface

- In the address field of the browser on your PC, type the host name or IP address of the instrument, for example: `http://10.113.10.203`.

The instrument home page (welcome page) opens.

The screenshot displays the LAN web browser interface for the R&S FSWP. The page is titled "Instrument Properties" and features a navigation menu on the left with sections for LXI, Instrument Control, License Manager, and Help. The main content area shows the following details:

Instrument Model	FSWP-26 Phase Noise Analyzer
Manufacturer	Rohde & Schwarz GmbH & Co. KG
Serial Number	[REDACTED]
Description	R&S FSWP-90
LXI Version	1.4 LXI Core 2011
LXI Extended Features	LXI HISLIP
DNS Host Name(s)	FSWP-[REDACTED]
MAC Address	[REDACTED]
IP Address	[REDACTED]
Firmware Revision	1.10
Current Time	Tuesday, 2015/07/14, 13:16:22
Current Time source	Operating System
VISA resource string	TCPIP:[REDACTED]:inst0:INSTR TCPIP:[REDACTED]:hislip0:INSTR
Device Indicator	INACTIVE (press to toggle)

At the bottom of the page, a status bar indicates "No error" and a copyright notice for © 2015 ROHDE&SCHWARZ. All rights reserved.

The navigation pane of the browser interface contains the following elements:

- "LAN"
 - "Home" opens the instrument home page.
The home page displays device information, including the VISA resource string in read-only format.
"Device Indicator" allows you to physically identify the instrument. This is useful if you have several instruments and want to know which instrument the LAN home page belongs to. To identify the instrument, activate the "Device Indicator". Then check the "LAN Status" indicator of the instruments.
 - "LAN Configuration" allows you to configure LAN parameters and to initiate a ping.
(See ["LAN configuration"](#) on page 392.)
 - "Utilities" provides access to an event log.
- "Instrument Control"
 - "Web Control" provides remote access to the instrument via VNC (no installation required). Manual instrument controls are available via the front panel simulation.
 - "File Download" downloads files from the instrument.
 - "File Upload" uploads files to the instrument.
(See [step 4.](#))
- "License Manager"
 - "License Manager" allows you to install or uninstall license keys and to activate, register or unregister licenses.
- "Help"
 - "www.rohde-schwarz.com" opens the Rohde & Schwarz home page.

13.1.2 GPIB interface (IEC 625/IEEE 418 bus interface)

A GPIB interface is integrated on the rear panel of the instrument.

By connecting a PC to the R&S FSWP via the GPIB connection you can send remote commands to control and operate the instrument.

To be able to control the instrument via the GPIB bus, the instrument and the controller must be linked by a GPIB bus cable. A GPIB bus card, the card drivers and the program libraries for the programming language used must be provided in the controller. The controller must address the instrument with the GPIB bus address (see [Chapter 13.7.1.5, "How to change the GPIB instrument address"](#), on page 393). You can set the GPIB address and the ID response string. The GPIB language is set as SCPI by default and cannot be changed for the R&S FSWP.

Notes and Conditions

In connection with the GPIB interface, note the following:

- Up to 15 instruments can be connected

- The total cable length is restricted to a maximum of 15 m or 2 m times the number of devices, whichever is less; the cable length between two instruments should not exceed 2 m.
- A wired "OR"-connection is used if several instruments are connected in parallel.
- Any connected IEC-bus cables should be terminated by an instrument or controller.

13.1.3 USB interface

For remote control via the USB connection, the PC and the instrument must be connected via the USB type B interface.

A USB connection requires the VISA library to be installed. VISA detects and configures the R&S instrument automatically when the USB connection is established. You do not have to enter an address string or install a separate driver.

USB address

The used USB address string is:

```
USB::::<product ID>::[::INSTR]
```

where:

- <vendor ID> is the vendor ID for Rohde & Schwarz (0x0AAD)
- <product ID> is the product ID for the Rohde & Schwarz instrument
- <serial number> is the individual serial number on the rear of the instrument

Table 13-2: Product IDs for R&S FSWP

Instrument model	Product ID
FSWP8	11E
FSWP26	11F
FSWP50	120

Example:

```
USB::0x0AAD::0x0011F::100001::INSTR
```

0x0AAD is the vendor ID for Rohde & Schwarz

0x0011F is the product ID for the R&S FSWP26

100001 is the serial number of the particular instrument

13.2 Status reporting system

The status reporting system stores all information on the current operating state of the instrument, and on errors which have occurred. This information is stored in the status registers and in the error queue. Both can be queried via GPIB bus or LAN interface using the `STATus...` commands.

(See Chapter 14.11, "Using the status register", on page 654).

For details on the status reporting system, see Remote control via SCPI.

- Hierarchy of status registers..... 342
- Contents of the status registers..... 342
- Reset values of the status reporting system..... 354

13.2.1 Hierarchy of status registers

As shown in the following figure, the status information is of hierarchical structure.

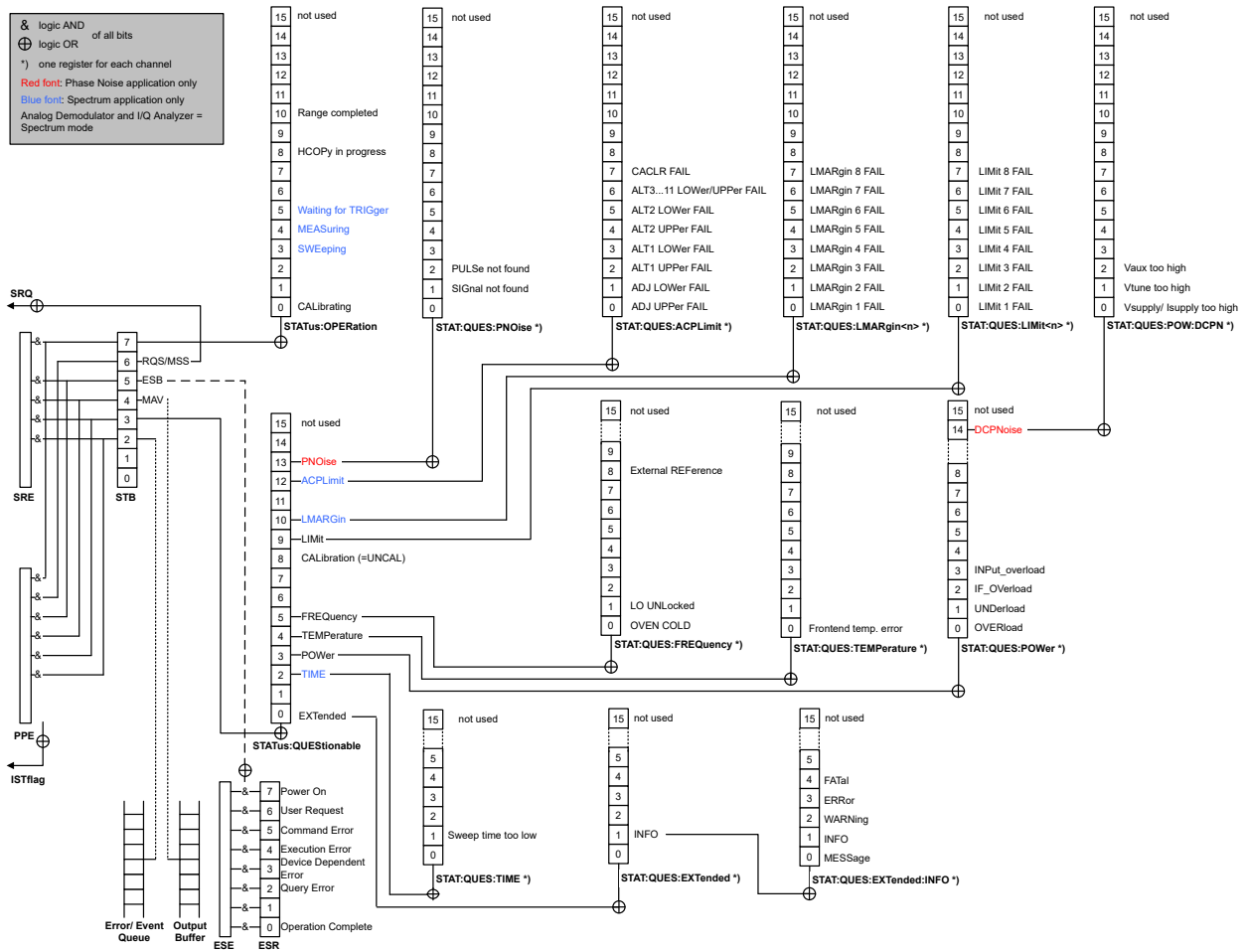

Figure 13-1: Graphical overview of the R&S FSWP status registers hierarchy

All status registers have the same internal structure.

13.2.2 Contents of the status registers

In the following sections, the contents of the status registers are described in more detail.

• Status byte (STB) and service request enable register (SRE).....	343
• IST flag and parallel poll enable register (PPE).....	344
• Event status register (ESR) and event status enable register (ESE).....	344
• STATus:OPERation register.....	345
• STATus:QUEStionable register.....	346
• STATus:QUEStionable:ACPLimit register.....	347
• STATus:QUEStionable:EXTended register.....	348
• STATus:QUEStionable:EXTended:INFO register.....	348
• STATus:QUEStionable:FREQuency register.....	349
• STATus:QUEStionable:LIMit register.....	350
• STATus:QUEStionable:LMARgin register.....	350
• STATus:QUEStionable:POWer register.....	351
• STATus:QUEStionable:POWer:DCPNoise.....	352
• STATus:QUEStionable:PNOise.....	352
• STATus:QUEStionable:TEMPerature register.....	353
• STATus:QUEStionable:TIME register.....	353

13.2.2.1 Status byte (STB) and service request enable register (SRE)

The `STatus Byte` (STB) is already defined in IEEE 488.2. It provides a rough overview of the instrument status by collecting the pieces of information of the lower registers. A special feature is that bit 6 acts as the sum bit of the remaining bits of the status byte.

The STB can thus be compared with the `CONDition` part of an SCPI register and assumes the highest level within the SCPI hierarchy.

The STB is read using the command `*STB?` or a serial poll.

The `STatus Byte` (STB) is linked to the `Service Request Enable` (SRE) register. Each bit of the STB is assigned a bit in the SRE. Bit 6 of the SRE is ignored. If a bit is set in the SRE and the associated bit in the STB changes from 0 to 1, a service request (SRQ) is generated. The SRE can be set using the command `*SRE` and read using the command `*SRE?`.

Table 13-3: Meaning of the bits used in the status byte

Bit No.	Meaning
0...1	Not used
2	Error Queue not empty The bit is set when an entry is made in the error queue. If this bit is enabled by the SRE, each entry of the error queue generates a service request. Thus an error can be recognized and specified in greater detail by polling the error queue. The poll provides an informative error message. This procedure is to be recommended since it considerably reduces the problems involved with remote control.
3	QUEStionable status register summary bit The bit is set if an <code>EVENT</code> bit is set in the <code>QUEStionable status register</code> and the associated <code>ENABLE</code> bit is set to 1. A set bit indicates a questionable instrument status, which can be specified in greater detail by querying the <code>STATus:QUEStionable status register</code> .

Bit No.	Meaning
4	MAV bit (message available) The bit is set if a message is available in the output queue which can be read. This bit can be used to enable data to be automatically read from the instrument to the controller.
5	ESB bit Sum bit of the event status register. It is set if one of the bits in the event status register is set and enabled in the event status enable register. Setting of this bit indicates a serious error which can be specified in greater detail by polling the event status register.
6	MSS bit (main status summary bit) The bit is set if the instrument triggers a service request. This is the case if one of the other bits of this registers is set together with its mask bit in the service request enable register SRE.
7	STATUS:OPERation status register summary bit The bit is set if an EVENT bit is set in the OPERATION status register and the associated ENABLE bit is set to 1. A set bit indicates that the instrument is just performing an action. The type of action can be determined by querying the STATUS:OPERation status register.

13.2.2.2 IST flag and parallel poll enable register (PPE)

As with the SRQ, the IST flag combines the entire status information in a single bit. It can be read by means of a parallel poll or using the command `*IST?`.

The parallel poll enable register (PPE) determines which bits of the STB contribute to the IST flag. The bits of the STB are "ANDed" with the corresponding bits of the PPE, with bit 6 being used as well in contrast to the SRE. The IST flag results from the "ORing" of all results. The PPE can be set using commands `*PRE` and read using command `*PRE?`.

13.2.2.3 Event status register (ESR) and event status enable register (ESE)

The ESR is defined in IEEE 488.2. It can be compared with the EVENT part of a SCPI register. The event status register can be read out using command `*ESR?`.

The ESE corresponds to the ENABLE part of a SCPI register. If a bit is set in the ESE and the associated bit in the ESR changes from 0 to 1, the ESB bit in the STB is set. The ESE register can be set using the command `*ESE` and read using the command `*ESE?`.

Table 13-4: Meaning of the bits used in the event status register

Bit No.	Meaning
0	Operation Complete This bit is set on receipt of the command <code>*OPC</code> exactly when all previous commands have been executed.
1	Not used
2	Query Error This bit is set if either the controller wants to read data from the instrument without having sent a query, or if it does not fetch requested data and sends new instructions to the instrument instead. The cause is often a query which is faulty and hence cannot be executed.

Bit No.	Meaning
3	Device-dependent Error This bit is set if a device-dependent error occurs. An error message with a number between -300 and -399 or a positive error number, which denotes the error in greater detail, is entered into the error queue.
4	Execution Error This bit is set if a received command is syntactically correct but cannot be performed for other reasons. An error message with a number between -200 and -300, which denotes the error in greater detail, is entered into the error queue.
5	Command Error This bit is set if a command is received, which is undefined or syntactically incorrect. An error message with a number between -100 and -200, which denotes the error in greater detail, is entered into the error queue.
6	User Request This bit is set when the instrument is switched over to manual control.
7	Power On (supply voltage on) This bit is set on switching on the instrument.

13.2.2.4 STATus:OPERation register

The `STATus:OPERation` register contains information on current activities of the R&S FSWP. It also contains information on activities that have been executed since the last read out.

Table 13-5: Meaning of the bits used in the `STATus:OPERation` register

Bit No.	Meaning
0	<code>CALibrating</code> This bit is set as long as the instrument is performing a calibration.
1-2	Not used
3	<code>SWEeping</code> Sweep is being performed in base unit (applications are not considered); identical to bit 4 Available in the optional Spectrum application.
4	<code>MEASuring</code> Measurement is being performed in base unit (applications are not considered); identical to bit 3 Available in the optional Spectrum application.
5	<code>Waiting for TRigger</code> Instrument is ready to trigger and waiting for trigger signal. Available in the optional Spectrum application.
6-7	Not used
8	<code>HardCOpy in progress</code> This bit is set while the instrument is printing a hardcopy.
9	Not used

Bit No.	Meaning
10	Range completed This bit is set when a range in the sweep list has been completed if "Stop after Range" has been activated. Available in the optional Spectrum application.
11-14	Not used
15	This bit is always 0.

13.2.2.5 STATus:QUEStionable register

The STATus:QUEStionable register contains information on instrument states that do not meet the specifications.

You can read out the register with `STAT:QUES:COND` or `STAT:QUES:EVEN`.



The STATus:QUEStionable register "sums up" the information from all subregisters (e.g. bit 2 sums up the information for all STATus:QUEStionable:TIME registers). For some subregisters, there may be separate registers for each active channel. Thus, if a status bit in the STATus:QUEStionable register indicates an error, the error may have occurred in any of the channel-specific subregisters. In this case, you must check the subregister of each channel to determine which channel caused the error. By default, querying the status of a subregister always returns the result for the currently selected channel.

Table 13-6: Meaning of the bits used in the STATus:QUEStionable register

Bit No.	Meaning
0 - 1	Unused
2	TIME This bit is set if a time error occurs in any of the active channels. The STATus:QUEStionable:TIME register provides more information on the error type. Available in the optional Spectrum application.
3	POWer This bit is set if the measured power level in any of the active channels is questionable. The STATus:QUEStionable:POWer register provides more information on the error type.
4	TEMPerature This bit is set if the temperature is questionable.
5	FREQuency This bit is set if there is anything wrong with the frequency of the local oscillator or the reference frequency in any of the active channels. The STATus:QUEStionable:FREQuency register provides more information on the error type.
6 - 7	Unused
8	CALibration This bit is set if the R&S FSWP is unaligned ("UNCAL" display)

Bit No.	Meaning
9	LIMit This bit is set if a limit value is violated in any of the active channels in any window. The STATus:QUEStionable:LIMit register provides more information on the error type.
10	LMARgin This bit is set if a margin is violated in any of the active channels in any window. The STATus:QUEStionable:LMARgin register provides more information on the error type. Available in the optional Spectrum application.
11	SYNC (device-specific) This bit is set if the R&S FSWP is not synchronized to the signal that is applied. The R&S FSWP is not synchronized if the results deviate too much from the expected value during premeasurements
12	ACPLimit This bit is set if a limit during ACLR measurements is violated in any of the active channels. The STATus:QUEStionable:ACPLimit register provides more information on the error type. Available in the optional Spectrum application.
13	PNOise This bit is set if an event occurs in the Phase Noise measurement. The Chapter 13.2.2.14, "STATus:QUEStionable:PNOise" , on page 352 provides more information on the event type.
15	This bit is always 0.

13.2.2.6 STATus:QUEStionable:ACPLimit register

Available for the Spectrum application.

The STATus:QUEStionable:ACPLimit register contains information about the results of a limit check during ACLR measurements. A separate ACPLimit register exists for each active channel.

You can read out the register with [STATus:QUEStionable:ACPLimit:CONDition?](#) or [STATus:QUEStionable:ACPLimit\[:EVENT\]?](#)

Table 13-7: Meaning of the bits used in the STATus:QUEStionable:ACPLimit register

Bit No.	Meaning
0	ADJ UPPer FAIL This bit is set if the limit is exceeded in the upper adjacent channel
1	ADJ LOWer FAIL This bit is set if the limit is exceeded in the lower adjacent channel.
2	ALT1 UPPer FAIL This bit is set if the limit is exceeded in the upper 1st alternate channel.
3	ALT1 LOWer FAIL This bit is set if the limit is exceeded in the lower 1st alternate channel.

Bit No.	Meaning
4	ALT2 UPPer FAIL This bit is set if the limit is exceeded in the upper 2nd alternate channel.
5	ALT2 LOWer FAIL This bit is set if the limit is exceeded in the lower 2nd alternate channel.
6	ALT3 ... 11 LOWer/UPPer FAIL This bit is set if the limit is exceeded in one of the lower or upper alternate channels 3 ... 11.
7	CACLR FAIL This bit is set if the CACLR limit is exceeded in one of the gap channels.
8	GAP ACLR FAIL This bit is set if the ACLR limit is exceeded in one of the gap channels.
9 to 14	Unused
15	This bit is always 0.

13.2.2.7 STATUS:QUESTIONable:EXTended register

The `STATUS:QUESTIONable:EXTended` register contains further status information not covered by the other status registers of the R&S FSWP. A separate `EXTended` register exists for each active channel.

You can read out the register with `STATUS:QUESTIONable:EXTended:CONDition?` or `STATUS:QUESTIONable:EXTended[:EVENT]?`

Table 13-8: Meaning of the bits used in the STATUS:QUESTIONable:EXTended register

Bit No.	Meaning
0	not used
1	INFO This bit is set if a status message is available for the application. Which type of message occurred is indicated in the <code>STATUS:QUESTIONable:EXTended:INFO</code> register.
2 to 14	Unused
15	This bit is always 0.

13.2.2.8 STATUS:QUESTIONable:EXTended:INFO register

The `STATUS:QUESTIONable:EXTended:INFO` register contains information on the type of messages that occur during operation of the R&S FSWP. A separate `INFO` register exists for each active channel.

You can read out the register with `STATUS:QUESTIONable:EXTended:INFO:CONDition?` or `STATUS:QUESTIONable:EXTended:INFO[:EVENT]?`. You can query all messages that occur for a specific channel using the command `SYSTEM:ERROR:EXTended?` on page 637.

Table 13-9: Meaning of the bits used in the STATUS:QUESTIONable:EXTended:INFO register

Bit No.	Meaning
0	MESSage This bit is set if event or state has occurred that may lead to an error during further operation.
1	INFO This bit is set if an informational status message is available for the application.
2	WARNing This bit is set if an irregular situation occurs during measurement, e.g. the settings no longer match the displayed results, or the connection to an external device was interrupted temporarily.
3	ERRor This bit is set if an error occurs during a measurement, e.g. due to missing data or wrong settings, so that the measurement cannot be completed correctly.
4	FATal This bit is set if a serious error occurs in the application and regular operation is no longer possible.
5 to 14	Unused
15	This bit is always 0.

13.2.2.9 STATUS:QUESTIONable:FREQUENCY register

The STATUS:QUESTIONable:FREQUENCY register contains information about the condition of the local oscillator and the reference frequency. A separate frequency register exists for each active channel.

You can read out the register with `STATUS:QUESTIONable:FREQUENCY:CONDition?` or `STATUS:QUESTIONable:FREQUENCY[:EVENT]?`.

Table 13-10: Meaning of the bits used in the STATUS:QUESTIONable:FREQUENCY register

Bit No.	Meaning
0	OVEN COLD This bit is set if the reference oscillator has not yet attained its operating temperature. "OCXO" is displayed.
1	LO UNLocked This bit is set if the local oscillator no longer locks. "LOUNL" is displayed.
2 to 7	Not used
8	EXTernalREFerence This bit is set if you have selected an external reference oscillator but did not connect a useable external reference source. In that case the synthesizer can not lock. The frequency in all probability is not accurate.
9 to 14	Not used
15	This bit is always 0.

13.2.2.10 STATUS:QUESTIONABLE:LIMIT register

The STATUS:QUESTIONABLE:LIMIT register contains information about the results of a limit check when you are working with limit lines.

A separate LIMIT register exists for each active channel and for each window.

Table 13-11: Meaning of the bits used in the STATUS:QUESTIONABLE:LIMIT register

Bit No.	Meaning
0	LIMIT 1 FAIL This bit is set if limit line 1 is violated.
1	LIMIT 2 FAIL This bit is set if limit line 2 is violated.
2	LIMIT 3 FAIL This bit is set if limit line 3 is violated.
3	LIMIT 4 FAIL This bit is set if limit line 4 is violated.
4	LIMIT 5 FAIL This bit is set if limit line 5 is violated.
5	LIMIT 6 FAIL This bit is set if limit line 6 is violated.
6	LIMIT 7 FAIL This bit is set if limit line 7 is violated.
7	LIMIT 8 FAIL This bit is set if limit line 8 is violated.
8 to 14	Unused
15	This bit is always 0.

13.2.2.11 STATUS:QUESTIONABLE:LMARGIN register

This register contains information about the observance of limit margins.

A separate LMARGIN register exists for each active channel and for each window.

It can be read using the commands

STATUS:QUESTIONABLE:LMARGIN:CONDITION? and
STATUS:QUESTIONABLE:LMARGIN[:EVENT]?

Table 13-12: Meaning of the bits used in the STATUS:QUESTIONABLE:LMARGIN register

Bit No.	Meaning
0	LMARGIN 1 FAIL This bit is set if limit margin 1 is violated.
1	LMARGIN 2 FAIL This bit is set if limit margin 2 is violated.

Bit No.	Meaning
2	LMARgin 3 FAIL This bit is set if limit margin 3 is violated.
3	LMARgin 4 FAIL This bit is set if limit margin 4 is violated.
4	LMARgin 5 FAIL This bit is set if limit margin 5 is violated.
5	LMARgin 6 FAIL This bit is set if limit margin 6 is violated.
6	LMARgin 7 FAIL This bit is set if limit margin 7 is violated.
7	LMARgin 8 FAIL This bit is set if limit margin 8 is violated.
8 to 14	Not used
15	This bit is always 0.

13.2.2.12 STATUS:QUESTIONABLE:POWER register

The `STATUS:QUESTIONABLE:POWER` register contains information about possible overload situations that may occur during operation of the R&S FSWP. A separate power register exists for each active channel.

You can read out the register with `STATUS:QUESTIONABLE:POWER:CONDITION?` or `STATUS:QUESTIONABLE:POWER[:EVENT]?`

Table 13-13: Meaning of the bits used in the STATUS:QUESTIONABLE:POWER register

Bit No.	Meaning
0	OVERload This bit is set if an overload occurs at the RF input, causing signal distortion but not yet causing damage to the device. The R&S FSWP displays the keyword "RF OVLD".
1	Unused
2	IF_OVERload This bit is set if an overload occurs in the IF path. The R&S FSWP displays the keyword "IF OVLD".
3	Input Overload This bit is set if the signal level at the RF input connector exceeds the maximum. The RF input is disconnected from the input mixer to protect the device. In order to re-enable measurement, decrease the level at the RF input connector and reconnect the RF input to the mixer input. The R&S FSWP displays the keyword "INPUT OVLD". (Available with the optional Spectrum application.)
4 to 13	Unused

Bit No.	Meaning
14	DCPNoise This bit is set in case of an event at the DC power supply. For more information see Chapter 13.2.2.13, "STATus:QUEStionable:POWer:DCPNoise" , on page 352.
15	This bit is always 0.

13.2.2.13 STATus:QUEStionable:POWer:DCPNoise

Available for the phase noise application.

The STATus:QUEStionable:POWer:DCPNoise register contains information about the state and condition of the DC power supply. A separate POWer:DCPNoise register exists for each active channel.

You can read out the register with [STATus:QUEStionable:POWer:DCPNoise:CONDition?](#) or [STATus:QUEStionable:POWer:DCPNoise\[:EVENT\]?](#).

Table 13-14: Meaning of the bits used in the STATus:QUEStionable:POWer:DCPNoise register

Bit No.	Meaning
0	$V_{\text{supply}} / I_{\text{supply}}$ This bit is set if something is wrong with the voltage or current supply.
1	V_{tune} This bit is set if something is wrong with the tuning voltage supply.
2	V_{aux} This bit is set if something is wrong with the auxiliary voltage supply.
3 to 14	Unused
15	This bit is always 0.

13.2.2.14 STATus:QUEStionable:PNOise

Available for the phase noise application.

The STATus:QUEStionable:PNOise register contains information about the state and condition of the phase noise application. A separate PNOise register exists for each active channel.

You can read out the register with [STATus:QUEStionable:PNOise:CONDition?](#) on page 655 or [STATus:QUEStionable:PNOise\[:EVENT\]?](#) on page 656.

Table 13-15: Meaning of the bits used in the STATus:QUEStionable:PNOise register

Bit No.	Meaning
0	Unused
1	SIGNal not found This bit is set when no signal could be found.

Bit No.	Meaning
2	PULSe not found This bit is set when no pulse could be found during the signal search of pulsed phase noise measurements.
3 to 14	Unused
15	This bit is always 0.

13.2.2.15 STATUS:QUESTIONable:TEMPerature register

The STATUS:QUESTIONable:TEMPerature register contains information about possible temperature deviations that may occur during operation of the R&S FSWP. A separate temperature register exists for each active channel.

You can read out the register with `STATUS:QUESTIONable:TEMPerature:CONDition?` or `STATUS:QUESTIONable:TEMPerature[:EVENT]?`

Table 13-16: Meaning of the bits used in the STATUS:QUESTIONable:TEMPerature register

Bit No.	Meaning
0	This bit is set if the frontend temperature sensor deviates by a certain degree from the self-alignment temperature. During warmup, this bit is always 1. For details see " Temperature check " on page 297.
1 to 14	Unused
15	This bit is always 0.

13.2.2.16 STATUS:QUESTIONable:TIME register

Available for the Spectrum application.

The STATUS:QUESTIONable:TIME register contains information about possible time errors that may occur during operation of the R&S FSWP. A separate time register exists for each active channel.

Table 13-17: Meaning of the bits used in the STATUS:QUESTIONable:TIME register

Bit No.	Meaning
0	not used
1	Sweep time too low This bit is set if the sweep time is too low.
2 to 14	Unused
15	This bit is always 0.

13.2.3 Reset values of the status reporting system

The following table contains the different commands and events causing the status reporting system to be reset. None of the commands, except *RST and SYSTem:PRESet, influence the functional instrument settings. In particular, DCL does not change the instrument settings.

Table 13-18: Resetting the status reporting system

Event	Switching on supply voltage Power-On-Status-Clear		DCL, SDC (Device Clear, Selected Device Clear)	*RST or SYS- Tem:PRE Set	STA- Tus:PRE- Set	*CLS
	0	1				
Effect						
Clear STB, ESR	-	yes	-	-	-	yes
Clear SRE, ESE	-	yes	-	-	-	-
Clear PPE	-	yes	-	-	-	-
Clear EVENT parts of the registers	-	yes	-	-	-	yes
Clear ENABLE parts of all OPERation and QUESTionable registers; Fill ENABLE parts of all other registers with "1".	-	yes	-	-	yes	-
Fill PTRansition parts with "1"; Clear NTRansition parts	-	yes	-	-	yes	-
Clear error queue	yes	yes	-	-	-	yes
Clear output buffer	yes	yes	yes	1)	1)	1)
Clear command processing and input buffer	yes	yes	yes	-	-	-

1) The first command in a command line that immediately follows a <PROGRAM MESSAGE TERMINATOR> clears the output buffer.

13.3 GPIB languages

The R&S FSWP analyzer family supports a subset of the GPIB commands used by other devices. Thus it can emulate other devices in order to use existing remote control programs.

In order to emulate device models that are not part of the selection list of the GPIB "Language" setting, you can modify the identification string received in response to the ID command ("Identification String" setting). Thus, any device model whose command set is compatible with one of the supported device models can be emulated.

Supported languages

Language	Comment
SCPI	
71100C	Compatible to 8566A/B
71200C	Compatible to 8566A/B
71209A	Compatible to 8566A/B
8560E	
8561E	
8562E	
8563E	
8564E	
8565E	
8566A	Command sets A and B are available. Command sets A and B differ in the rules regarding the command structure.
8566B	
8568A	Command sets A and B are available. Command sets A and B differ in the rules regarding the command structure.
8568A_DC	Uses DC input coupling by default if supported by the instrument
8568B	Command sets A and B are available. Command sets A and B differ in the rules regarding the command structure.
8568B_DC	Uses DC input coupling by default if supported by the instrument
8591E	Compatible to 8594E
8594E	Command sets A and B are available. Command sets A and B differ in the rules regarding the command structure.
PSA89600	
PSA	

Notes:

- If you select a language other than "SCPI", the GPIB address is set to 18 if it was 20 before.
- The Start/stop frequency, reference level and number of sweep points are adapted to the selected instrument model.
- When you switch between remote control languages, the following settings or changes are made:
 - SCPI:**
The instrument performs a PRESET.
 - 8566A/B, 8568A/B, 8594E; FSEA, FSEB, FSEM; FSEK:**
 - The instrument performs a PRESET.
 - The following instrument settings are changed:

Table 13-19: Instrument settings for emulation of 8566A/B, 8568A/B, 8594E; FSEA, FSEB, FSEM; FSEK instruments

Model	# of Trace Points	Start Freq.	Stop Freq.	Ref Level	Input Coupling
8566A/B	1001	2 GHz	22 GHz	0 dBm	AC
8568A/B	1001	0 Hz	1.5 GHz	0 dBm	AC
8560E	601	0 Hz	2.9 GHz	0 dBm	AC
8561E	601	0 Hz	6.5 GHz	0 dBm	AC
8562E	601	0 Hz	13.2 GHz	0 dBm	AC
8563E	601	0 Hz	26.5 GHz	0 dBm	AC
8564E	601	0 Hz	40 GHz	0 dBm	AC
8565E	601	0 Hz	50 GHz	0 dBm	AC
8594E	401	0 Hz	3 GHz	0 dBm	AC

Note: The stop frequency indicated in the table may be limited to the corresponding frequency of the R&S FSWP, if required.

13.4 The IECWIN tool

The R&S FSWP is delivered with *IECWIN* installed, an auxiliary tool provided free of charge by R&S. IECWIN is a program to send SCPI commands to a measuring instrument either interactively or from a command script.



The R&S IECWIN32 tool is provided free of charge. The functionality may change in a future version without notice.

IECWIN offers the following features:

- Connection to instrument via several interfaces/protocols (GPIB, VISA, named pipe (if IECWIN is run on the instrument itself), RSIB)
- Interactive command entry
- Browsing available commands on the instrument
- Error checking following every command
- Execution of command scripts
- Storing binary data to a file
- Reading binary data from a file
- Generation of a log file

For command scripts, IECWIN offers the following features:

- Synchronization with the instrument on every command
- Checking expected result for query commands (as string or numeric value)
- Checking for expected errors codes

- Optional pause on error
- Nested command scripts
- Single step mode
- Conditional execution, based on the *IDN and *OPT strings



You can use the IECWIN to try out the programming examples provided in the R&S FSWP User Manuals.

Starting IECWIN

IECWIN is available from the Windows "Start" menu on the R&S FSWP, or by executing the following file:

```
C:\Program Files (x86)\Rohde-Schwarz\FSWP\<>version>\iecwin32.exe
```

You can also copy the program to any Windows PC or laptop. Simply copy the `iecwin32.exe`, `iecwin.chm` and `rsib32.dll` files from the location above to the same folder on the target computer.

When the tool is started, a "Connection settings" dialog box is displayed. Define the connection from the computer the IECWIN tool is installed on to the R&S FSWP you want to control. If you are using the tool directly on the R&S FSWP, you can use an NT Pipe (COM Parser) connection, which requires no further configuration. For help on setting up other connection types, check the tool's online help (by clicking the "Help" button in the dialog box).



The IECWIN offers an online help with extensive information on how to work with the tool.

13.5 Automating tasks with remote command scripts

To configure a test setup quickly and make complex test setups or repetitive measurements reproducible, you can automate the required settings with scripts. A script contains a series of SCPI commands corresponding to the settings. When completed, it is converted to an executable format, saved in a file, and can be run whenever needed.

Creating a SCPI script

Using the SCPI Recorder functions, you can create a SCPI script directly on the instrument and then export the script for use on the controller. You can also edit or write a script manually, using a suitable editor on the controller. For manual creation, the instrument supports you by showing the corresponding command syntax for the current setting value.

You can create a SCPI script directly on the instrument at any time of operation, in the following ways:

- Recording individual steps manually

In manual recording mode, you can record an individual SCPI command using the "Add SCPI Command to Recording" function, see ["How to record SCPI commands manually"](#) on page 367.

- Recording all performed steps automatically
The instrument records the SCPI command and settings value of each step you perform, and then writes the commands to the file system, see ["How to record SCPI commands automatically"](#) on page 367. You can start, stop and resume automatic recording, and also record individual commands manually.
- Copying commands from the context-sensitive SCPI Recorder menu and pasting them into an editor
The SCPI Recorder enables you to copy the SCPI command and the current setting shown in the context-sensitive menu and paste them into any suitable editor, see ["To edit a SCPI command list"](#) on page 368.

13.5.1 The context-sensitive SCPI command menu

The SCPI Recorder provides information on the required SCPI command for the available measurement settings, functions, and results in a context-sensitive menu. The SCPI command menu is displayed when you tap and hold (right-click) any interface element that allows you to define a setting, perform a function, or displays results, for example:

- Softkeys
- Buttons or input fields in dialog boxes
- Traces or markers in a diagram

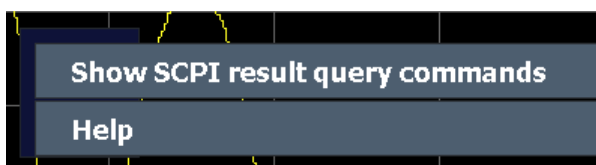

Figure 13-2: Context-sensitive SCPI command menu for a trace in a result display

The menu provides the syntax of the remote command with the current setting, and some functions to help you create your script.

Show SCPI result query commands.....	358
Show SCPI command.....	359
L Copy SCPI Command to Clipboard.....	359
L Help.....	359
L Add SCPI Command to Recording.....	359
Help.....	359

Show SCPI result query commands

This menu item is displayed if you selected a result display.

All possible commands to query the results in the diagram are displayed. Select the query command you are interested in to display the SCPI command dialog box, as described in ["Show SCPI command"](#) on page 359.

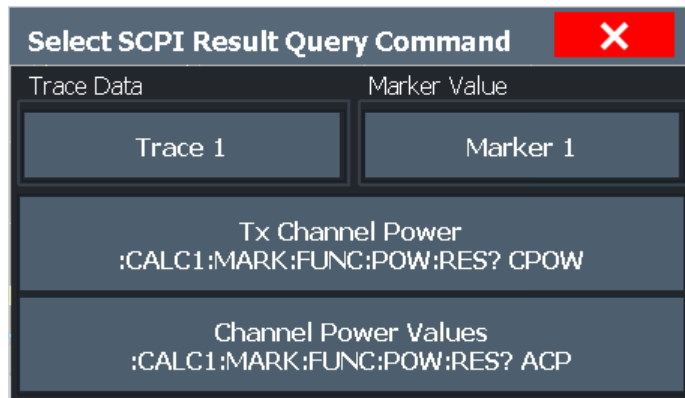

Figure 13-3: Possible result query commands for an ACLR measurement

Show SCPI command

This menu item is displayed if you selected a setting or function.

A dialog box displays the SCPI command required to perform the setting or function, or to query the trace or marker results.

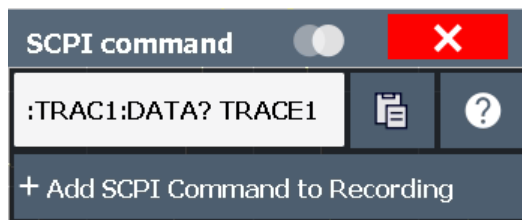

Figure 13-4: SCPI command dialog for a trace in a result display



Copy SCPI Command to Clipboard ← Show SCPI command

Copies the command and the current value for the selected setting to the clipboard.



Help ← Show SCPI command

Provides help on the displayed SCPI command, its syntax and possible parameter values.

Add SCPI Command to Recording ← Show SCPI command

Adds the command and the current value for the selected setting to the recorded SCPI list.

Help

Provides help on the selected setting, function, or result display, as opposed to the SCPI command itself. This function is identical to selecting the context-sensitive help icon  in the toolbar and then the interface element.

13.5.2 The SCPI recorder



Access: Toolbar

The SCPI Recorder displays a list of the currently recorded commands and provides functions to create and export a script of SCPI commands. Some additional settings for recording are provided on a separate tab in the dialog box.

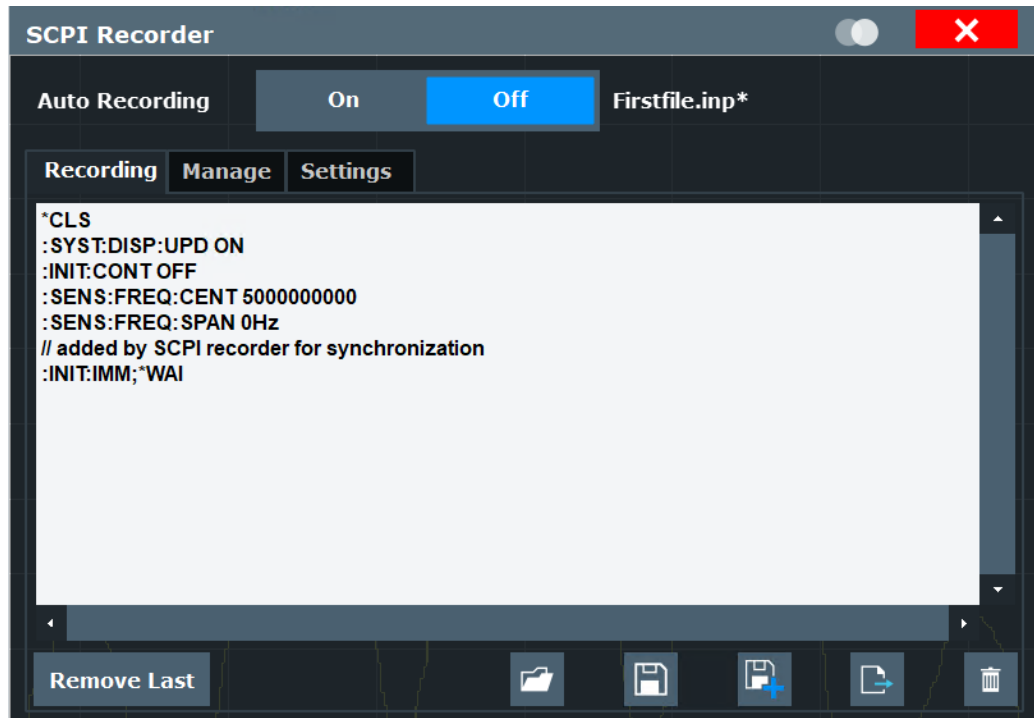

- [Recording](#)..... 360
- [Managing recordings](#)..... 363
- [Recording settings](#)..... 365

13.5.2.1 Recording

Auto Recording	360
List of recorded commands / script editor	361
Remove Last	361
Load Recording	361
Save	361
Save As	361
Export	362
Clear All	363

Auto Recording

If enabled, the SCPI Recorder automatically records the required SCPI commands and parameter values for the settings and functions you use while operating the R&S FSWP.

To view the list of currently recorded SCPI commands at any time, select the SCPI Recorder icon in the toolbar.

Recording is stopped when you deactivate "Auto Recording".

To continue recording, reactivate "Auto Recording".

To start a new SCPI command list, select  **Clear All** before activating "Auto Recording".

Note:

- Some parameters cannot be set by a SCPI command.
In this case, *no SCPI command found* is entered in the list instead of a command when you record settings automatically.
- The Phase Noise Analyzer automatically clears the SCPI command list after booting.

Remote command:

`SYSTem:SRECOder[:AUTO]` on page 650

List of recorded commands / script editor

The currently recorded commands are displayed in a basic editor directly in the SCPI Recorder dialog box. Right-click the editor to display a context-sensitive menu with basic editing functions for the list, such as copy, paste, delete, undo and redo.

Remote command:

`SYSTem:SRECOder:DATA[:ALL]?` on page 651

Remove Last

Deletes the last recorded SCPI command from the list.

 **Load Recording**

Loads an existing script in ASCII format (*.inp) from a file to the script editor. If the editor contains recorded commands, you must confirm a message to overwrite them. A file selection dialog box is displayed.

 **Save**

Saves the current SCPI command list to the currently loaded or most recently saved .inp recording file.

 **Save As**

Saves the current SCPI command list to a new file in the `C:\R_S\INSTR\ScpiRecordings` directory in ASCII format with the file extension .inp.

Tip: You can execute the command list in an .inp file without further editing using the IECWIN tool provided with the R&S FSWP, see [Chapter 13.4, "The IECWIN tool"](#), on page 356. You can also reload .inp files to the script editor later.

Export

Exports the current SCPI command list to the specified file and directory in the selected format. By default, the file is stored in the

C:\R_S\INSTR\ScpiRecordings directory. Besides the recorded commands themselves, the exported script includes all format-specific header data required to execute the script using an external program on the controller.

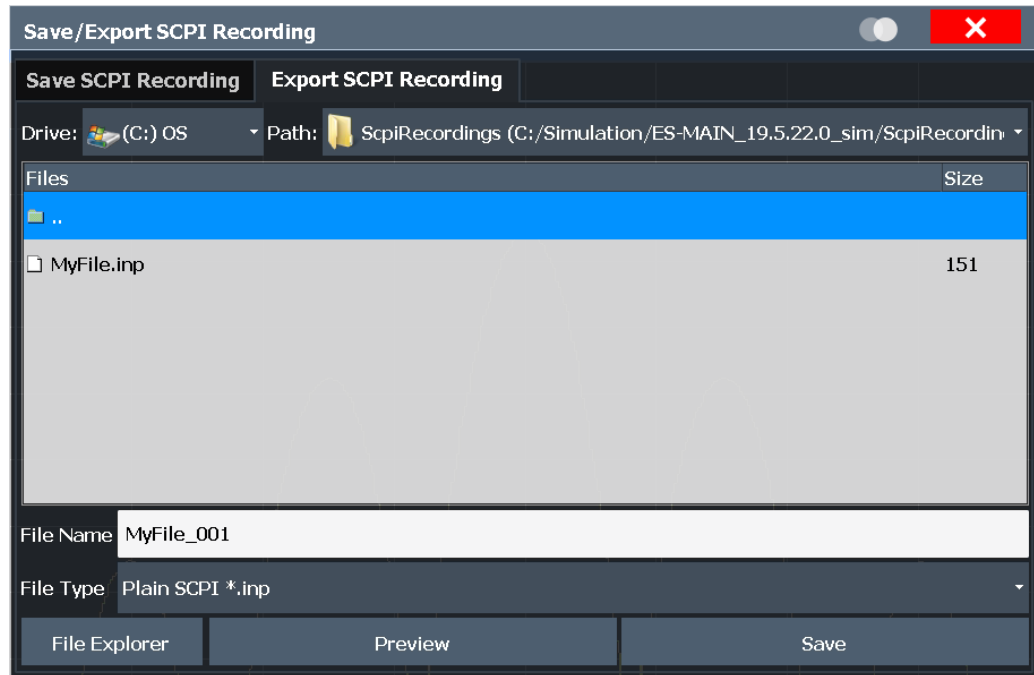

Before storing the file, you can display a **"Preview"** of the file in the selected format.

Currently, the following file formats are supported:

"C#" <ul style="list-style-type: none"> A commonly used general programming language for various applications (*.cs) 	
"C++" <ul style="list-style-type: none"> A commonly used general programming language for various applications (*.cpp) 	
"MATLAB (Instrument Control Toolbox)" <ul style="list-style-type: none"> A programming environment, frequently used in signal processing and test and measurement applications (*.m) You can use this format directly with the MATLAB® Instrument Control Toolbox. 	
"MATLAB (R&S Toolkit)" <ul style="list-style-type: none"> You can use this format directly with the MATLAB® Toolkit. 	
"NICVI" <ul style="list-style-type: none"> An ANSI C programming environment designed for measurements and tests (*.cvi) You can use this format directly with National Instruments LabWindows CVI. 	
"Plain SCPI" <ul style="list-style-type: none"> Represents SCPI base format, that is ASCII format, saved as a text file (*.inp); contains no additional header data Use this format to load a recorded script back to the editor later. 	

"Python" A commonly used general programming language for various applications (.py)

Remote command:

[SYSTem:SRERecorder:EXPort](#) on page 653

Clear All

Removes all recorded commands from the current SCPI command list.

Remote command:

[SYSTem:SRERecorder:CLEar](#) on page 651

13.5.2.2 Managing recordings

You can manage existing recordings in the C:\R_S\INSTR\ScpiRecordings directory directly from the SCPI recorder.

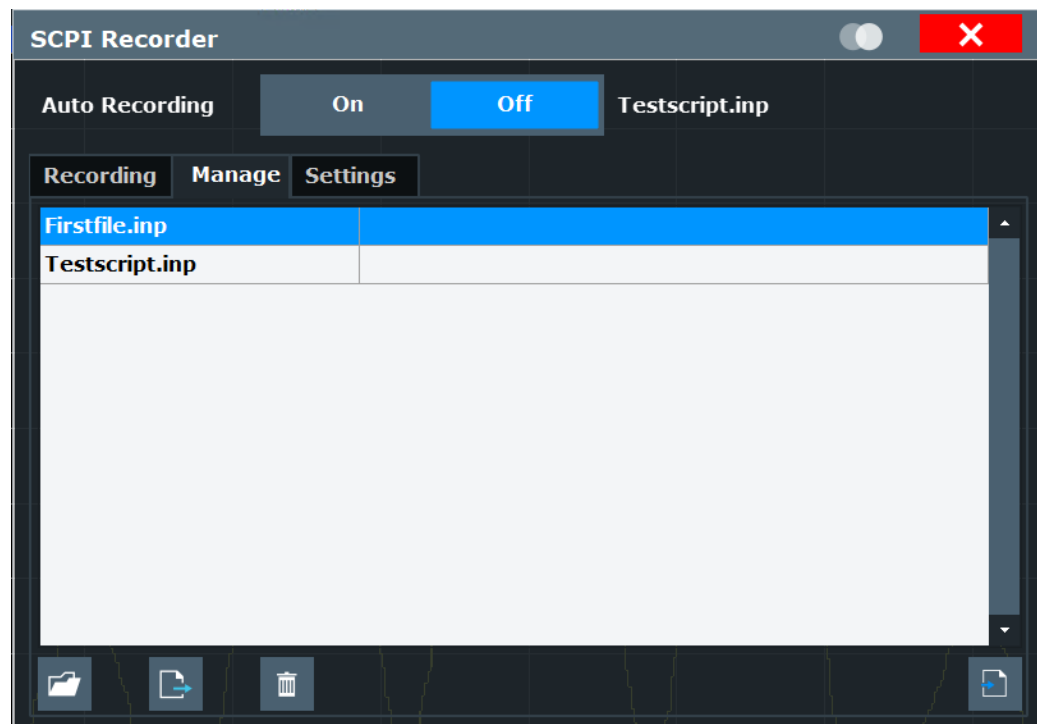

 Load Recording	363
 Export	364
Delete Recording	365
 Import Recording	365

Load Recording

Loads an existing script in ASCII format (*.inp) from a file to the script editor. If the editor contains recorded commands, you must confirm a message to overwrite them. A file selection dialog box is displayed.

Export

Exports the current SCPI command list to the specified file and directory in the selected format. By default, the file is stored in the

C:\R_S\INSTR\ScpiRecordings directory. Besides the recorded commands themselves, the exported script includes all format-specific header data required to execute the script using an external program on the controller.

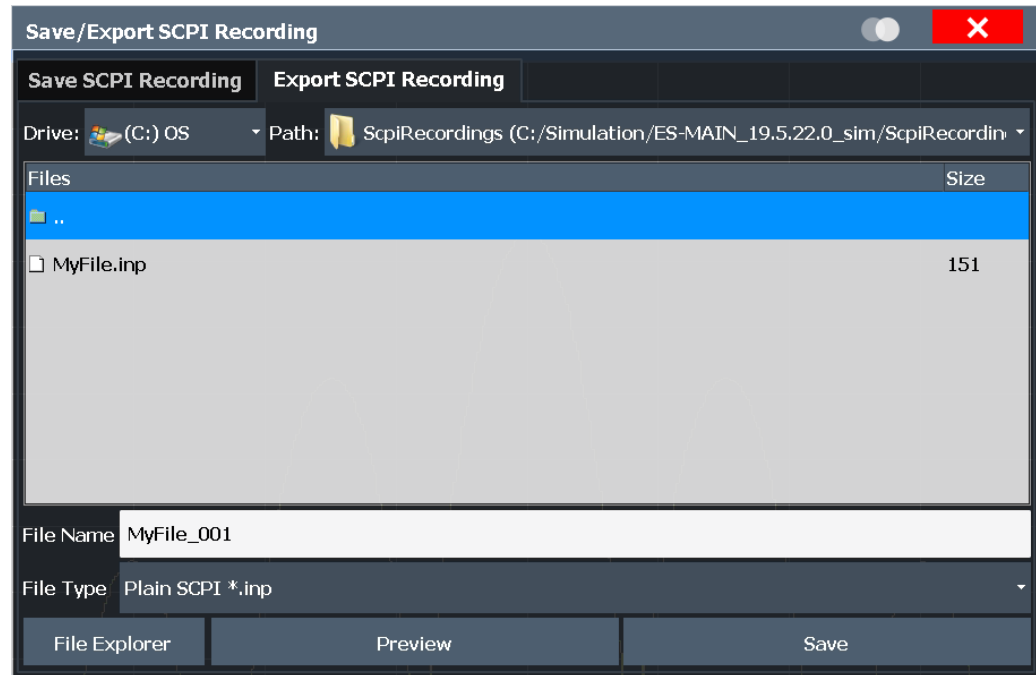

Before storing the file, you can display a **"Preview"** of the file in the selected format.

Currently, the following file formats are supported:

"C#" <ul style="list-style-type: none"> A commonly used general programming language for various applications (*.cs) 	
"C++" <ul style="list-style-type: none"> A commonly used general programming language for various applications (*.cpp) 	
"MATLAB (Instrument Control Toolbox)" <ul style="list-style-type: none"> A programming environment, frequently used in signal processing and test and measurement applications (*.m) You can use this format directly with the MATLAB® Instrument Control Toolbox. 	
"MATLAB (R&S Toolkit)" <ul style="list-style-type: none"> You can use this format directly with the MATLAB® Toolkit. 	
"NICVI" <ul style="list-style-type: none"> An ANSI C programming environment designed for measurements and tests (*.cvi) You can use this format directly with National Instruments LabWindows CVI. 	
"Plain SCPI" <ul style="list-style-type: none"> Represents SCPI base format, that is ASCII format, saved as a text file (*.inp); contains no additional header data Use this format to load a recorded script back to the editor later. 	

"Python" A commonly used general programming language for various applications (.py)

Remote command:

[SYSTem:SRECOder:EXPort](#) on page 653

Delete Recording

Deletes the selected recording file.

Import Recording

Imports the specified file to the script editor.

13.5.2.3 Recording settings

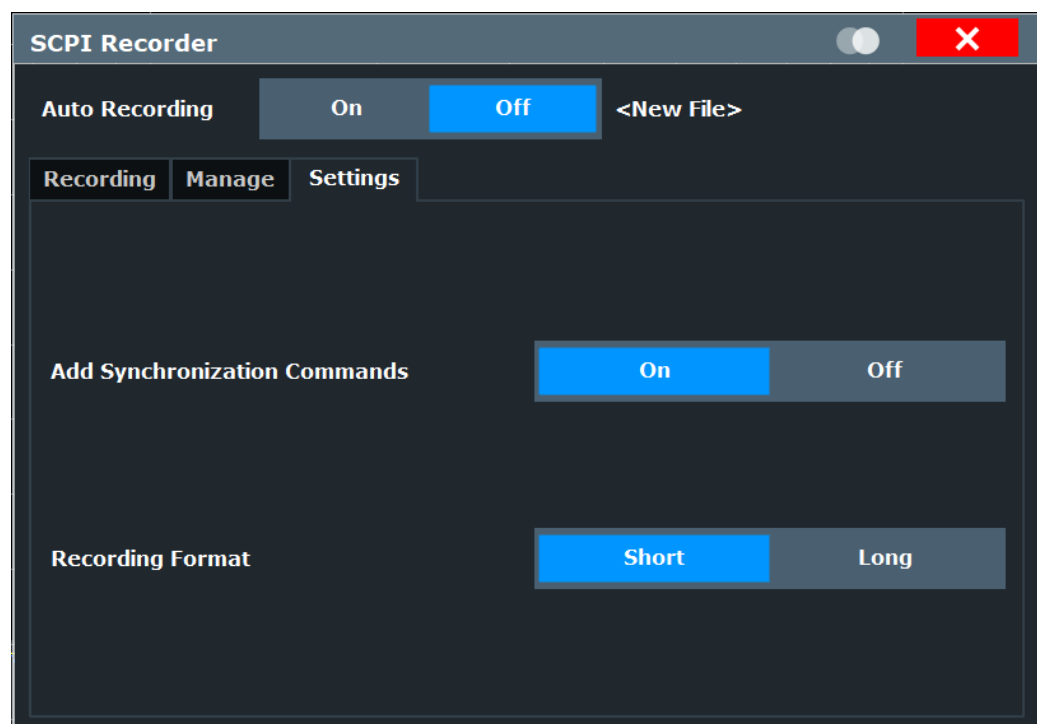

Some additional settings are available to configure the exported SCPI command files.

Add Synchronization Commands	365
Recording Format	366

Add Synchronization Commands

If enabled, additional commands are included in the script to synchronize the recorded commands when necessary. For instance, when a measurement is started, a *WAI command is inserted to ensure that the next command is only executed after the measurement has finished.

Remote command:

[SYSTem:SRECOder:SYNC](#) on page 654

Recording Format

Defines whether the commands are recorded using the short or long SCPI notation.

"Short" The shortform of the keyword is used.

Example: `FREQ:CENT`

"Long" The entire keyword is used.

Example: `FREQuency:CENTer`

Remote command:

`SYSTem:SRECOOrder:FORMat` on page 654

13.5.3 How to determine the required SCPI command

The SCPI Recorder provides information on the required SCPI command for the available measurement settings, functions, and results in a context-sensitive menu.

1. Define the setting or navigate to the function you need the SCPI command for.
To find the query command for trace or marker results, select the result diagram.
2. On the screen, tap and hold, or right-click the measurement setting, function, or result display.

The context-sensitive menu for that particular setting, function, or result is displayed.

Tip: If the SCPI command menu is not displayed, you probably tapped outside of a softkey or input field, for example in a block diagram. Tap within the corresponding softkey, button or input field, or in a result display, to display the context-sensitive SCPI command menu.

3. Select "Show SCPI result query commands" or "Show SCPI command", depending on which item you selected.

A dialog box with the required command and some functions is displayed.

If multiple commands are possible, for example to query different measurement results, all possible commands are displayed.

4. To display the SCPI command dialog box for a query command, select the query command you are interested in from the list.

13.5.4 How to create and export SCPI scripts

Using the SCPI Recorder functions, you can create a SCPI script directly on the instrument and then export the script for use on the controller. The SCPI Recorder allows you to record SCPI command lists either automatically or manually.

How to record SCPI commands automatically

The following procedure explains how to record SCPI commands automatically during operation.



1. On the toolbar, select the SCPI Recorder icon.
The SCPI Recorder dialog box is displayed.
2. Select "Auto Recording": "On".
From now on, the commands required to execute all steps you perform on the instrument are recorded.
3. To query results in the SCPI script:
 - a) Right-click (or tap and hold) in the result display.
All possible commands to query the results in the diagram are displayed in the SCPI command menu.
 - b) Select the results you want to query.
 - c) Select "Add SCPI Command to Recording".
4. To stop SCPI recording, select the SCPI Recorder icon again.
The SCPI Recorder dialog box with the recorded command list is displayed.
5. Select "Auto Recording": "Off".
6. Save the recorded command list to a file for later use.
 - a) Select "Save As".
 - b) Define a file name for the script file.

How to record SCPI commands manually

1. Determine the required SCPI command as described in [Chapter 13.5.3, "How to determine the required SCPI command"](#), on page 366.
2. From the SCPI command dialog box, select "Add SCPI Command to Recording".
The command is added to the SCPI Recorder command list.
3. Repeat these steps for any settings, functions, or results you want to record.
4. To check the progress of the recording, select the SCPI Recorder icon in the toolbar.
The SCPI Recorder dialog box with the currently recorded command list is displayed.
5. Save the recorded command list to a file for later use.
 - a) Select "Save As".
 - b) Define a file name for the script file.



To edit a SCPI command list

All command lists can be edited after recording, either directly on the instrument or in any suitable editor on the controller. The following functions describe how to edit the SCPI command list directly in the SCPI Recorder dialog box.



1. On the toolbar, select the SCPI Recorder icon.

The SCPI Recorder dialog box with the currently recorded command list is displayed.



2. To load a stored script in ASCII format:

- a) Select "Load Recording" in the SCPI Recorder dialog box.
- b) If necessary, confirm the message to overwrite existing commands in the editor.
- c) Select the stored *.inp file.
- d) Select "Select".

The stored commands are displayed in the editor.

3. To remove the most recently recorded command, select "Remove Last" in the SCPI Recorder dialog box.
4. To remove any other command in the recorded command list:
 - a) Select the command by tapping it or using the arrow keys.
 - b) Press [BACK SPACE] on the front panel of the instrument, or press [Delete] on a connected keyboard.
5. To insert a command within the recorded command list:
 - a) Define the setting or navigate to the function you want to record.
 - b) Select "Copy SCPI Command to ClipBoard".
 - c) Tap and hold or right-click the position in the SCPI command list at which you want to insert the new command.
 - d) From the context menu, select "Paste".
6. Select "Save As" to store the changes to the script.

How to check a SCPI script

The easiest way to check a script is to execute it, for example in the auxiliary tool IECWIN, which is provided with the R&S FSWP firmware (see [Chapter 13.4, "The IECWIN tool"](#), on page 356).

The tool shows an error message if a command could not be executed.

Some suggestions on how you can check and improve a recorded SCPI script:

- Search and remove missing command entries.
If a configured setting or performed function does not have a corresponding command, `:SYST:INF:SCPI 'SCPI command not available'` is entered in the list instead.
- Remove unnecessary commands written after a preset.

- Rearrange the commands to a reasonable order. For example, if you move a `STATE` command to the end of your script, you can avoid intermediate calculations of the signal.
- Check the script for completeness by comparing its results with the modified settings in manual mode.

How to export a SCPI script

When you save a command list to a file, only the recorded commands are stored in a text file. However, to execute a script in an external programming environment, it requires additional header data according to the specific format.



1. On the toolbar, select the SCPI Recorder icon.

The SCPI Recorder dialog box with the currently recorded command list is displayed.



2. Select "Export".
3. Define a file name and storage location for the script file.
4. Select the "File Type" which defines the format of the script.
5. Select "Save".

A script with the required header data for the selected format is stored to a file.

13.6 Network and remote control settings

Access: [SETUP] > "Network + Remote"



Network settings in secure user mode

Be sure to store all network settings before [SecureUser Mode](#) is enabled; see [Chapter 11.2, "Protecting data using the secure user mode"](#), on page 263.

If the currently stored network settings are not suitable, you must correct them each time you switch on the R&S FSWP in secure user mode, as the settings are not stored permanently in this case.

The remote commands required to define these settings are described in [Chapter 14.9.5, "Configuring network and remote control"](#), on page 623.

Step-by-step instructions are provided in [Chapter 13.7, "How to set up a network and remote control"](#), on page 387.

- [General network settings](#)..... 370
- [GPIB settings](#)..... 372
- [Compatibility settings](#)..... 375
- [LAN settings](#)..... 376

- [HUMS settings](#)..... 378
- [Remote errors](#)..... 384
- [Returning to manual mode \("local"\)](#)..... 386

13.6.1 General network settings

Access: [SETUP] > "Network + Remote" > "Network" tab

The R&S FSWP can be operated in a local area network (LAN), for example to control the instrument from a remote PC or use a network printer.



Network settings can only be edited in the firmware if a LAN cable is connected to the R&S FSWP.

NOTICE

Risk of network problems

All parameters can be edited here; however, beware that changing the computer name has major effects in a network.

For details, see [Chapter 13.7, "How to set up a network and remote control"](#), on page 387.



Network settings in secure user mode

Be sure to store all network settings before [SecureUser Mode](#) is enabled; see [Chapter 11.2, "Protecting data using the secure user mode"](#), on page 263.

If the currently stored network settings are not suitable, you must correct them each time you switch on the R&S FSWP in secure user mode, as the settings are not stored permanently in this case.

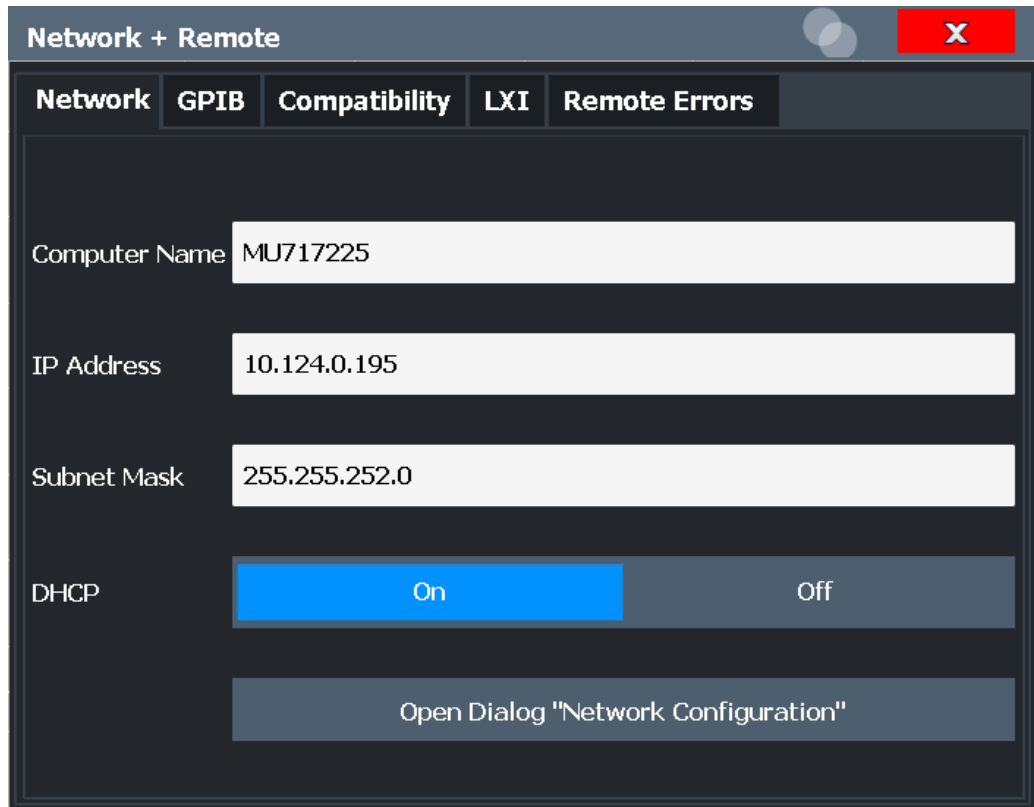

Computer Name.....371
 IP Address.....372
 Subnet Mask.....372
 DHCP.....372
 Network Configuration.....372

Computer Name

Each instrument is delivered with an assigned computer name, but this name can be changed. The naming conventions of Windows apply. If too many characters and/or numbers are entered, an error message is displayed in the status line.

The default instrument name is a non-case-sensitive string with the following syntax:

<Type><variant>-<serial_number>

For example FSWP26-123456

The serial number can be found on the rear panel of the instrument. It is the third part of the device ID printed on the bar code sticker:



IP Address

Defines the IP address. The TCP/IP protocol is preinstalled with the IP address 10.0.0.10. If the DHCP server is available ("DHCP On"), the setting is read-only.

The IP address consists of four number blocks separated by dots. Each block contains 3 numbers in maximum (e.g. 100.100.100.100), but also one or two numbers are allowed in a block (as an example see the preinstalled address).

Subnet Mask

Defines the subnet mask. The TCP/IP protocol is preinstalled with the subnet mask 255.255.255.0. If the DHCP server is available ("DHCP On"), this setting is read-only.

The subnet mask consists of four number blocks separated by dots. Each block contains 3 numbers in maximum (e.g. 100.100.100.100), but also one or two numbers are allowed in a block (as an example see the preinstalled address).

DHCP

Switches between DHCP server available (On) or not available (Off). If a DHCP server is available in the network, the IP address and subnet mask of the instrument are obtained automatically from the DHCP server.

Network Configuration

Opens the standard Windows "Network Configuration" dialog box for further configuration.

13.6.2 GPIB settings

Access: [SETUP] > "Network + Remote" > "GPIB" tab

Alternatively to connecting the R&S FSWP to a LAN, the GPIB interface can be used to connect a remote PC. For details see [Chapter 13.1, "Remote control interfaces and protocols"](#), on page 336).

Network	GPIB	Compatibility	LXI	Remote Errors
GPIB Address	18			
Identification String	arz,FSW-26,1312.8000K26/100005,4.50-19.8.4.0 Beta			
	Reset to Factory String			
Remote Display Update	On	Off		
GPIB Terminator	LFEOI	EOI		
*IDN Format	New	Legacy		
I/O Logging	On	Off		
Display Remote Errors	On	Off		
Set Hardware Immediately	On	Off		

GPIB Address.....	373
Identification String.....	373
Reset to Factory String.....	373
Remote Display Update.....	374
GPIB Terminator.....	374
*IDN Format.....	374
I/O Logging.....	374
Display Remote Errors.....	375
Set Hardware Immediately.....	375

GPIB Address

Defines the GPIB address. Values from 0 to 30 are allowed. The default address is 20.

Remote command:

`SYSTem:COMMunicate:GPIB[:SELF]:ADDRes` on page 624

Identification String

Defines the identification string for the R&S FSWP which is provided as a response to the *IDN? query. Maximum 36 characters are allowed.

Remote command:

`SYSTem:IDENtify[:STRing]` on page 626

Reset to Factory String

Restores the default identification string. Each R&S FSWP has a unique ID according to the following syntax:

Rohde&Schwarz,FSWP,<Unique number>,1.00

Remote command:

`SYSTem:IDENtify:FACTory` on page 626

Remote Display Update

Defines whether the display of the R&S FSWP is updated when changing from manual operation to remote control.

Turning off the display update function improves performance during remote control.

Note: Usually, this function remains available on the display during remote operation. However, it can be disabled remotely. In this case, the display is not updated during remote operation, and cannot be turned on again locally until local operation is resumed.

Remote command:

`SYSTem:DISPlay:UPDate` on page 625

GPIB Terminator

Changes the GPIB receive terminator.

- | | |
|---------|---|
| "LFEOI" | According to the standard, the terminator in ASCII is <LF> and/or <EOI>. |
| "EOI" | For binary data transfers (e.g. trace data) from the control computer to the instrument, the binary code used for <LF> might be included in the binary data block, and therefore should not be interpreted as a terminator in this particular case. This can be avoided by using only the receive terminator <code>EOI</code> . |

Remote command:

`SYSTem:COMMunicate:GPIB[:SELF]:RTERminator` on page 624

*IDN Format

Defines the response format to the remote command `*IDN?` (see `*IDN?` on page 410). This function is intended for re-use of existing control programs together with the R&S FSWP.

- | | |
|-------|--|
| "Leg" | Legacy format, as in the R&S FSP/FSU/FSQ family. |
| "New" | R&S FSWP format. |

Remote command:

`SYSTem:FORMat:IDENt` on page 639

I/O Logging

Activates or deactivates the SCPI error log function. All remote control commands received by the R&S FSWP are recorded in a log file. The files are named according to the following syntax:

```
C:\R_S\INSTR\ScpiLogging\ScpiLog.<no.>
```

where <no.> is a sequential number

A new log file is started each time logging was stopped and is restarted.

Logging the commands may be extremely useful for debug purposes, e.g. in order to find misspelled keywords in control programs.

Remote command:

[SYSTem:CLOGging](#) on page 605

Display Remote Errors

Activates and deactivates the display of errors that occur during remote operation of the R&S FSWP. If activated, the R&S FSWP displays a message box at the bottom of the screen that contains the type of error and the command that caused the error.



The error message remains in place when you switch to "Local" mode. To close the message box, select the  "Close" icon.

Only the most recent error is displayed in remote mode. However, in local mode, all errors that occurred during remote operation are listed in a separate tab of the "Network + Remote" dialog box (see [Chapter 13.6.6, "Remote errors"](#), on page 384).

Remote command:

[SYSTem:ERRor:DISPlay](#) on page 626

[SYSTem:ERRor:CLEar:REMote](#) on page 625

Set Hardware Immediately

Determines when the remote commands that change hardware settings on the R&S FSWP are executed.

If enabled (default), remote commands are always executed immediately when they are received by the instrument.

If disabled, remote commands that cause changes to the hardware are only executed when an appropriate command is executed explicitly.

Regardless of this setting, the firmware automatically sets the hardware when a sweep is started.

Postponing hardware changes is useful, for example, when switching measurement channels. When you switch channels, the settings from the previous channel are used by default. However, if you have to change the frequency and level values for the new channel measurement, the default settings cause unnecessary hardware settling times.

This setting is not changed by the preset function.

Remote command:

[SYSTem:SHIMmediate:STATe](#) on page 628

[SYSTem:SHIMmediate ONCE](#) on page 629

13.6.3 Compatibility settings

The R&S FSWP supports different system languages that are compatible to other products.

Note that aside from the "Language" feature (and for PSA compatibility, the "Wideband" feature), all other functions in this dialog are currently not supported.

Language.....	376
Wideband.....	376

Language

Defines the system language used to control the instrument.

The following languages are supported.

- SCPI
- 5052
For a list of supported commands, see [Chapter 14.9.9, "Reference: Command Set of 5052 Emulation"](#), on page 644.
- PSA
For a list of supported commands, see [Chapter 14.9.10, "Reference: command set of emulated PSA models"](#), on page 646.

The 5052 language is only available in the Phase Noise application. If you select the 5052 mode in an application other than the Phase Noise application, the R&S FSWP automatically closes all applications and opens one channel with the Phase Noise application.

The PSA language is only available for the Spectrum application. If you select the PSA mode in an application other than the Spectrum application, the R&S FSWP automatically closes all applications and opens one channel with the Spectrum application.

Remote command:

[SYSTem:LANGuage](#) on page 627

Wideband

This setting defines which option is returned when the *OPT? query is executed, depending on the state of the wideband option.

It is only available for PSA89600 emulation.

"Off"	No wideband is used. The option is indicated as "B7J".
"40 MHz"	The 40 MHz wideband is used. The option is indicated as "B7J, 140".
"80 MHz"	The 80 MHz wideband is used. The option is indicated as "B7J, 122".

Remote command:

[SYSTem:PSA:WIDeband](#) on page 628

13.6.4 LAN settings

Access: [SETUP] > "Network + Remote" > "LAN" tab

In a LAN network, the R&S FSWP can be accessed via any web browser (e.g. the Microsoft Internet Explorer) to perform the following tasks:

- Modifying network configurations

- Modifying device configurations
- Monitoring connections from the device to other devices

The "LAN" tab of the "Network + Remote" dialog box provides basic LAN configuration functions and information for the R&S FSWP.

Alternatively, you can change the LAN settings using the web browser interface.

For details see "[LAN configuration](#)" on page 392.

Only user accounts with administrator rights are able to use LAN configuration and web browser functionality.

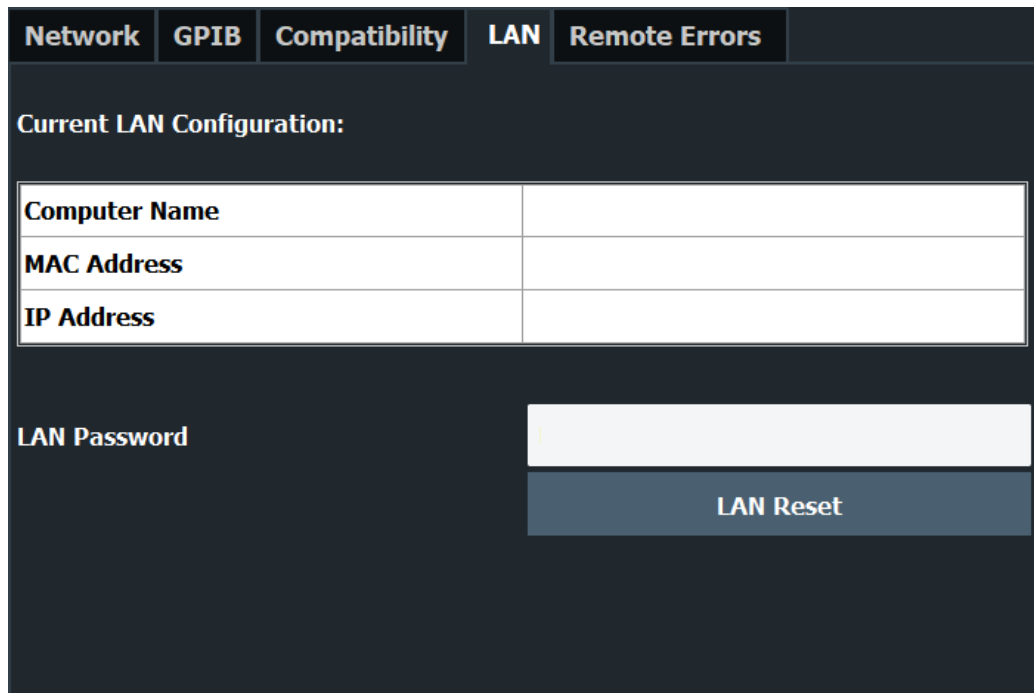

[Current LAN Configuration](#).....377
[LAN Password](#)..... 377
[LAN Reset](#).....378

Current LAN Configuration

Displays the current LAN information from the R&S FSWP (read-only).

- "Computer Name" Name of the R&S FSWP as defined in the operating system (see also "[Computer Name](#)" on page 371)
- "MAC address" Media Access Control address (MAC address), a unique identifier for the network card in the R&S FSWP
- "IP address" IP address of the R&S FSWP as defined in the operating system (see also "[IP Address](#)" on page 372).

LAN Password

Password for LAN configuration. The default password is *LxiWebIfc*.

Remote command:

[SYSTem:LXI:PASSword](#) on page 627

LAN Reset

Resets the "LAN" configuration to its default settings (LCI function).

Parameter	Value
TCP/IP Mode	DHCP + Auto IP Address
Dynamic DNS	Enabled
ICMP Ping	Enabled
Password for "LAN" configuration	LxiWebIfc

The LAN settings are configured in the "Network" tab of the "Network + Remote" dialog box or using the instrument's "LAN" web browser interface.

Remote command:

[SYSTem:LXI:LANReset](#) on page 627

13.6.5 HUMS settings

Available with option R&S FSWP-K980.

The R&S FSWP comes with a health and utilization monitoring system (HUMS) providing information about the R&S FSWP. Aim is to increase the overall utilization, to avoid downtime and to increase the overall security level of a fleet of instruments.

HUMS provides, for example, information about:

- Instrument identification, hardware components, software packages, licenses
- Usage of remote control, usage via keyboard / mouse, usage of test applications
- Hardware utilization and status, including S.M.A.R.T. data of the system drive
- User-defined static information, for example, an inventory code

Interfaces and protocols

The HUMS installation on the R&S FSWP includes an SNMP agent and a REST service with HTTP endpoints. So you can access the health and usage information via LAN, using the SNMP protocol or the REST protocol. Accessing the data does not interfere with remote control via SCPI commands or with measurement execution.

Reference information for both protocols is available on the R&S FSWP at the address <http://<instrument>/api/hums/v1/documents?name=<interface>>.

For *<instrument>*, enter the hostname (e.g. *fswp26-123456*) or the IP address (e.g. *10.121.0.34*) of your instrument, as for access to the GUI.

For *<interface>* = *snmp*, you get a `.zip` file containing the MIB files for SNMP. For *<interface>* = *rest*, you get a `.yaml` file with the OpenAPI specification of the REST API.

Address example: <http://fswp26-123456/api/hums/v1/documents?name=snmp>.

The following table lists the REST endpoints and the SNMP MIB filenames.

For further information about the HUMS service itself, see R&S HUMS user manual.

You can download or view the manual [on the internet](#).

- [Basic settings](#).....379
- [Protocol settings](#).....380
- [Device tags](#).....383

13.6.5.1 Basic settings

Access: [SETUP] > "Network + Remote" > "HUMS" tab

The "HUMS" tab of the "Network + Remote" dialog provides basic R&S HUMS configuration functions.

To export the complete HUMS history, use the REST API with the endpoint:

`http://<IP>/api/hums/v1/dump`

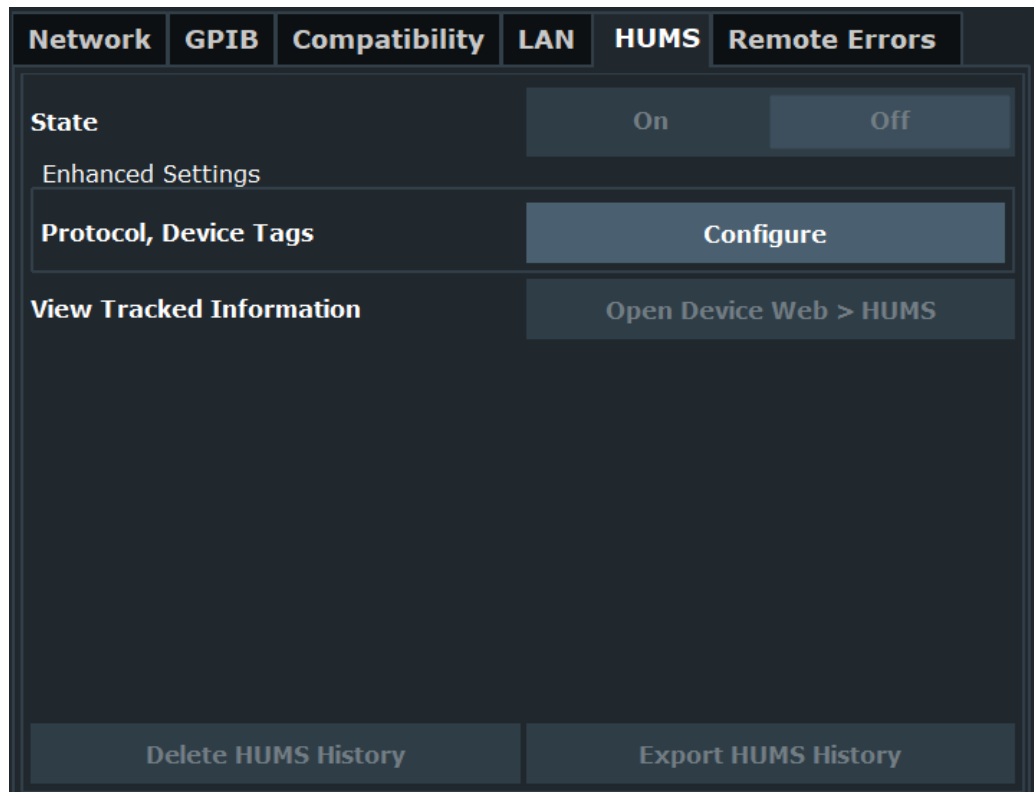

The remote commands to configure HUMS are described in [Chapter 14.9.6, "Configuring HUMS"](#), on page 629.

- [State](#).....380
- [Enhanced Settings](#).....380
- [View Tracked Information](#).....380
- [Delete Hums History](#).....380

State

Turns HUMS on or off.

If you want to track HUMS data, turn on this function.

If HUMS has been used before, turning on restores the previous [protocol settings](#).

Remote command:

[DIAGnostic:HUMS:STATe](#) on page 630

Enhanced Settings

Opens the dialog to configure the [protocol settings](#) and [device tags](#).

View Tracked Information

Opens the R&S HUMS device web in the web browser of the R&S FSWP.

For more information about the R&S HUMS device web, see its user manual.

You can also reach the device web from a remote PC by entering the following address into a browser's address bar:

<http://<instrumentaddress>/hums/>

The <instrumentaddress> is either the IP address of the instrument or the instrument name.

Delete HUMS History

Deletes complete HUMS data which includes the device history, device tags, SCPI connections, utilization history, utilization (table values).

Remote command:

[DIAGnostic:HUMS:DELeTe:ALL](#) on page 629

13.6.5.2 Protocol settings

Access: [SETUP] > "Network + Remote" > "HUMS" > "Enhanced Settings" > "Configure" > "Protocol"

The "Protocol" tab of the "Enhanced Settings" dialog provides protocol settings for SNMP or REST protocol.

User Name	Access	Security Level	Auth. Password	Priv. Password
rohdeschwarz	RO	authNoPriv	••••••••	
myName	RW	noAuthNoPriv		

SNMP	381
REST	381
SNMPv2c Configuration	381
L Access	382
L Community	382
SNMPv3 Configuration	382
L User Name	382
L Access	382
L Security Level	382
L Passwords	383
SNMP Location	383
SNMP Contact	383

SNMP

Selects the SNMP version to communicate with the service.

"None"	Do not use SNMP.
"v2c"	Select SNMP version v2c, which also activates v1. Unlocks the settings available for SNMP v2c.
"v3"	Select SNMP version v3. Unlocks the settings available for SNMP v3.
"v2c + v3"	Select both SNMP versions v2c and v3. Unlocks the settings for both SNMP v2c and v3.

Remote command:

[SYSTem:COMMunicate:SNMP:VERSion](#) on page 634

REST

Turns communication via REST API on or off.

Remote command:

[SYSTem:COMMunicate:REST:ENABLE](#) on page 631

SNMPv2c Configuration

For SNMPv2c/v1 authentication, you can define the "Access" and "Community".

Access ← SNMPv2c Configuration

Defines the access an SNMP user can have for a specific SNMP community: read-write = RW, read-only = RO.

"RW" Read-write access allows the user to read and change information. By default, the user has read-write access rights.

"RO" Read-only access allows the user to only read information.

Remote command:

[SYSTem:COMMunicate:SNMP:COMMunity:RO](#) on page 632

[SYSTem:COMMunicate:SNMP:COMMunity:RW](#) on page 632

Community ← SNMPv2c Configuration

Defines the SNMP community string. An SNMP community represents a collection of devices and agents grouped to monitor them. Authorized managers and the managed devices belong to an SNMP community.

You can define an individual community for each read-write and read-only access.

The default community is the serial number of the instrument (same community for read-only and for read-write).

Entering a community is mandatory.

SNMPv3 Configuration

For SNMPv3 authentication, you can define user profiles. You can manage them via a table.

To add a new user, select "Add" and enter the data.

To delete all user profiles, select "Delete All".

To delete a single user profile, select the "x" in the appropriate user line of the table.

Remote command:

Create user: [SYSTem:COMMunicate:SNMP:USM:USER](#) on page 633

Query all users: [SYSTem:COMMunicate:SNMP:USM:USER:ALL?](#) on page 633

Delete a single user: [SYSTem:COMMunicate:SNMP:USM:USER:DELeTe](#) on page 634

Delete all users: [SYSTem:COMMunicate:SNMP:USM:USER:DELeTe:ALL](#) on page 634

User Name ← SNMPv3 Configuration

Defines the name of the user who should have specific user rights.

Entering a user name is mandatory.

Access ← SNMPv3 Configuration

Defines the access right a user can have: read-write = RW, read-only = RO.

"RW" Read-write access allows the user to read and change information.

"RO" Read-only access allows the user to only read information.

Security Level ← SNMPv3 Configuration

Defines the security level for access: noAuthNoPriv, authNoPriv or authPriv.

For security reasons, we recommend that you only allow access via passwords.

"noAuthNo-Priv"	Low security level: no authentication, no data transfer encryption, user name query only. No authentication password and no privacy password to be defined.
"authNoPriv"	Medium security level: authentication, no data transfer encryption, user name and password query. Authentication password to be defined, privacy password is not available.
"authPriv"	High security level: authentication, data transfer encryption, user name, password and encryption password query. Authentication password and privacy password to be defined. If no privacy password is defined, the HUMS service uses the authentication password as privacy password.

Passwords ← SNMPv3 Configuration

Depending on the selected [Security Level](#), you have to define specific passwords: authentication password (Auth. Password) and privacy password (Priv. Password).

"Auth. Password"	For authentication, you have to define an authentication password. For authentication password, the R&S FSWP supports the MD5 protocol. Authentication passwords must have 8 to 12 characters with any combination of ASCII characters.
"Priv. Password"	For stronger encryption, you have to define a second password, the privacy password. For privacy password, the R&S FSWP supports the DES protocol. Private passwords must have at least 8 characters with any combination of ASCII characters.

SNMP Location

"SNMP Location" defines the SNMP location information. This information complies with the server's physical location and is used for identification of the SNMP server. By default, this input field is empty.

Remote command:

[SYSTem:COMMUnicate:SNMP:LOCation](#) on page 633

SNMP Contact

"SNMP Contact" defines the SNMP contact information. This information complies with the person who manages the SNMP server and is used for identification of the SNMP server. By default, this input field is empty.

Remote command:

[SYSTem:COMMUnicate:SNMP:CONtact](#) on page 632

13.6.5.3 Device tags

Access: [SETUP] > "Network + Remote" > "HUMS" > "Enhanced Settings" > "Configure" > "Device Tags"

The "Device Tags" tab of the "Enhanced Settings" dialogs displays the defined device tags. You can also add or delete device tags here.

A device tag is a label to assign to your instrument. You can create any device tag for your instrument and define it by a specific key and value.

Index	Key	Value	
0	location	munich	x
1	instrument	fsw	x

Add	384
Index	384
Key	384
Value	384
Delete All	384

Add

Adds a new device tag.

Remote command:

[DIAGnostic:HUMS:TAGS\[:VALue\]](#) on page 631

Index

Index (ID) of the created device tag. You can change the ID if necessary.

Key

Defines a key for your device tag. A device tag key represents the type of tag.

Value

Defines the actual value of the device tag or key.

Example:

- "Key" = Location
- "Value" = Building 1

Remote command:

[DIAGnostic:HUMS:TAGS:ALL?](#) on page 630

Delete All

Deletes all defined device tags.

Remote command:

Delete all device tags:[DIAGnostic:HUMS:TAGS:DELeTe:ALL](#) on page 630

Delete a single device tag:[DIAGnostic:HUMS:TAGS:DELeTe](#) on page 631

13.6.6 Remote errors

Access: [SETUP] > "Network + Remote" > "Remote Errors" tab

The error messages generated by the R&S FSWP during remote operation are displayed here.

The messages are displayed in the order of their occurrence; the most recent messages are placed at the top of the list.

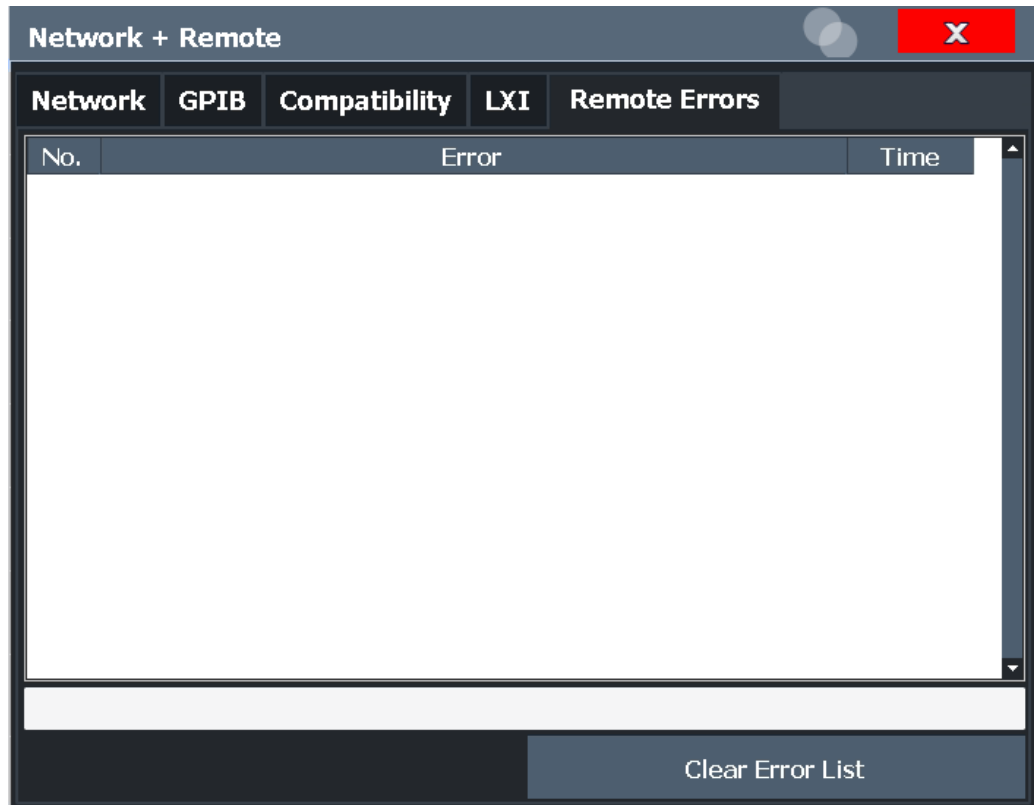

The most recent error message during remote operation can be displayed on the screen, see "[Display Remote Errors](#)" on page 375.

If the number of error messages exceeds the capacity of the error buffer, the oldest error message is removed before the newest one is inserted. To clear the message buffer use "Clear Error List". It is automatically cleared when the R&S FSWP is shut down.

The following information is available:

No	Device-specific error code
Error	Brief description of the error
Date/Time	Time the message occurred

Remote command:

`SYSTem:ERRor:LIST?` on page 638

Clear Error List

Deletes the error message buffer for remote operation.

Note: The remote error list is automatically cleared when the R&S FSWP is shut down.

Remote command:

`SYSTem:ERRor:CLEar:REMOte` on page 625

13.6.7 Returning to manual mode ("local")

When switched on, the instrument is always in the manual measurement mode and can be operated via the front panel. As soon as the instrument receives a remote command, it is switched to the remote control mode.

In remote control mode, all keys of the instrument are disabled. The "LOCAL" softkey and the [Remote Display Update](#) softkey are displayed.

Local

The instrument switches from remote to manual operation.

Note:

- If the local lockout function (`LLO` or `SYST:KLOC ON`) is activated in the remote control mode, manual operation is no longer available until `GTL` (or `SYST:KLOC OFF`) is executed.
- Before you switch back to manual operation, all remote command processing must be completed. Otherwise, the instrument will switch back to remote control immediately.
- If you select "Local" while a self-alignment or a self-test is still running (which was started remotely), the instrument only returns to the manual operation state when the alignment or test is completed.

Furthermore, when you return to manual operation, the following happens:

- All front panel keys are enabled.
- The main softkey menu of the current mode is displayed.
- The measurement diagrams, traces and display fields are displayed again.
- If, at the time of pressing "LOCAL", the synchronization mechanism via `*OPC`, `*OPC?` or `*WAI` is active, the currently running measurement procedure is aborted and synchronization is achieved by setting the corresponding bits in the registers of the status reporting system.
- Bit 6 (`User Request`) of the `Event` status register is set.
If the status reporting system is configured accordingly, this bit immediately causes the generation of a service request (SRQ) to inform the control software that the user wishes to return to front panel control. For example, this can be used to interrupt the control program and to correct instrument settings manually. This bit is set each time you select "LOCAL".

Remote command:

`SYST:COMM:INT:REM OFF`, see `SYSTem:COMMunicate:INTernal:REMOte` on page 624

13.7 How to set up a network and remote control

Remote operation

You can operate the instrument remotely from a connected computer using SCPI commands. Before you send remote commands, configure the instrument in a LAN network or connect it to a PC via the GPIB interface as described in [Chapter 13.7.1, "How to configure a network"](#), on page 387.

Remote Desktop

In production test and measurement, a common requirement is central monitoring of the T&M instruments for remote maintenance and remote diagnostics. Equipped with the Remote Desktop software of Windows, the R&S FSWP ideally meets requirements for use in production. The computer that is used for remote operation is called "controller" here.

The following tasks can be performed using Remote Desktop:

- Access to the control functions via a virtual front panel (soft front panel)
- Printout of measurement results directly from the controller
- Storage of measured data on the controller's hard disk

This documentation provides basic instructions on setting up the Remote Desktop for the R&S FSWP. For details refer to the Microsoft Windows operating system documentation.

13.7.1 How to configure a network

A precondition for operating or monitoring the instrument remotely is that it is connected to a LAN network or a PC connected to the GPIB interface. Setup is described here.



Windows Firewall Settings

A firewall protects an instrument by preventing unauthorized users from gaining access to it through a network. We highly recommend using the firewall on your instrument. Rohde & Schwarz instruments are shipped with the Windows firewall enabled and pre-configured in such a way that all ports and connections for remote control are enabled. For more details on firewall configuration, see the Microsoft Windows help system and the Rohde & Schwarz white paper (available from the Rohde & Schwarz website):

[1EF96: Malware Protection Windows 10](#)

13.7.1.1 How to connect the instrument to the network

There are two methods to establish a LAN connection to the instrument:

- A non-dedicated network (Ethernet) connection from the instrument to an existing network made with an ordinary RJ-45 network cable. The instrument is assigned

an IP address and can coexist with a computer and with other hosts on the same network.

- A dedicated network connection (Point-to-point connection) between the instrument and a single computer made with a (crossover) RJ-45 network cable. The computer must be equipped with a network adapter and be directly connected to the instrument. The use of hubs, switches, or gateways is not required, however, data transfer is still performed using the TCP/IP protocol. You have to assign an IP address to the instrument and the computer, see [Chapter 13.7.1.2, "How to assign the IP address"](#), on page 388.

Note: As the R&S FSWP uses a 1 GBit LAN, a crossover cable is not necessary (due to Auto-MDI(X) functionality).

NOTICE

Risk of network failure

Consult your network administrator before performing the following tasks:

- Connecting the instrument to the network
- Configuring the network
- Changing IP addresses
- Exchanging hardware

Errors can affect the entire network.

- ▶ To establish a non-dedicated network connection, connect a commercial RJ-45 cable to one of the LAN ports.
To establish a dedicated connection, connect a (crossover) RJ-45 cable between the instrument and a single PC.

If the instrument is connected to the LAN, Windows automatically detects the network connection and activates the required drivers.

The network card can be operated with a 1 GBit Ethernet IEEE 802.3u interface.

13.7.1.2 How to assign the IP address

Depending on the network capacities, the TCP/IP address information for the instrument can be obtained in different ways.

- If the network supports dynamic TCP/IP configuration using the Dynamic Host Configuration Protocol (DHCP), all address information can be assigned automatically.
- If the network does not support DHCP, or if the instrument is set to use alternate TCP/IP configuration, the addresses must be set manually.

By default, the instrument is configured to use dynamic TCP/IP configuration and obtain all address information automatically. Thus, it is safe to establish a physical connection to the LAN without any previous instrument configuration.



When a DHCP server is used, a new IP address can be assigned each time the PC is restarted. You have to determine this address on the PC itself. Thus, when using a DHCP server, we recommend using the permanent computer name, which determines the address via the DNS server (see ["Using a DNS server to determine the IP address"](#) on page 390).

Assigning the IP address on the instrument

NOTICE

Risk of network errors

Connection errors can affect the entire network. Contact your network administrator to obtain a valid IP address.

1. Press [SETUP].
2. Press "Network + Remote".
3. Select the "Network" tab.
4. In the "Network + Remote" dialog, toggle the "DHCP On/Off" setting to the required mode.
If DHCP is "Off", you must enter the IP address manually, as described in the following steps.
Note: When you switch DHCP from "On" to "Off", the previously set IP address and subnet mask are retrieved.
If DHCP is "On", the instrument obtains the IP address of the DHCP server automatically. The configuration is saved, and the R&S FSWP prompts you to restart the instrument. You can skip the remaining steps.
Note: When a DHCP server is used, a new IP address can be assigned each time you restart the instrument. You have to determine this address on the instrument itself. Thus, when using a DHCP server, we recommend using the permanent computer name. Then the address is determined via the DNS server.
(See ["Using a DNS server to determine the IP address"](#) on page 390 and [Chapter 13.7.1.3, "How to change the instrument name"](#), on page 390).
5. Enter the "IP Address", for example *192.0.2.0*. The IP address consists of four number blocks separated by dots. Every block contains a maximum of 3 numbers.
6. Enter the "Subnet Mask", for example *255.255.255.0*. The subnet mask consists of four number blocks separated by dots. Every block contains a maximum of 3 numbers.
7. Close the dialog box.
If you have entered an invalid IP address or subnet mask, the message "out of range" is displayed in the status line. If the settings are correct, the configuration is saved, and you are prompted to restart the instrument.
8. Confirm the displayed message to restart the instrument.

Using a DNS server to determine the IP address

If a DNS server is configured on the R&S FSWP, the server can determine the current IP address for the connection using the permanent computer name.

1. Obtain the name of your DNS domain and the IP addresses of the DNS and WINS servers on your network (see [Chapter 13.7.1.3, "How to change the instrument name"](#), on page 390).
2. Select [Setup] > "Network + Remote".
3. In the "Network" tab, select "Open Dialog 'Network Connections'".
4. Double-tap "Ethernet".
5. In the "Ethernet Status" dialog box, select "Properties".
The items used by the Ethernet connection are displayed.
6. Tap the entry named "Internet Protocol Version 4 (TCP/IPv4)" to highlight it.

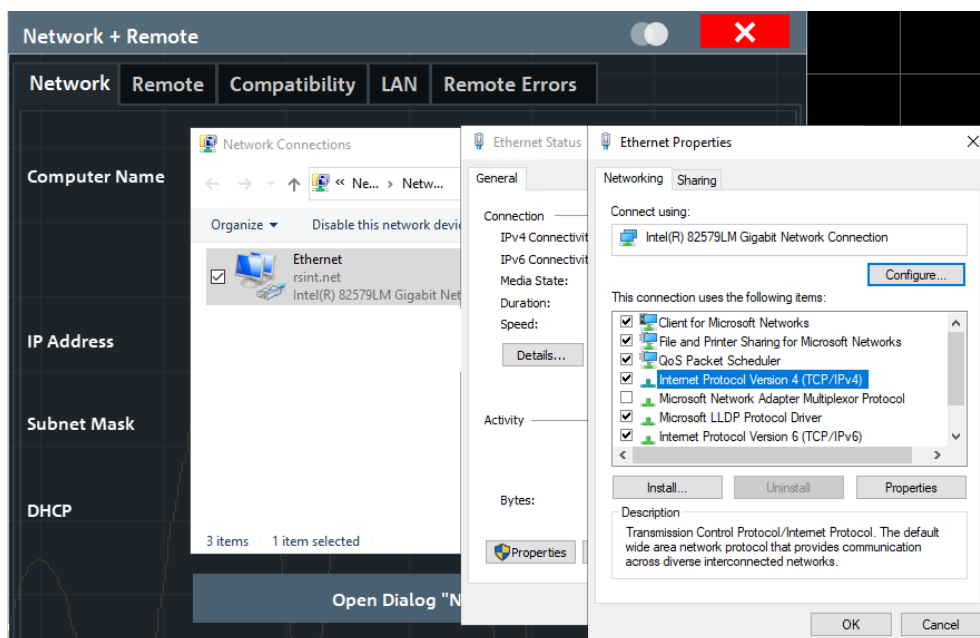

7. Select "Properties".
8. On the "General" tab, select "Use the following DNS server addresses".
9. Enter your own DNS addresses.

For more information, refer to the Microsoft Windows operating system Help.

13.7.1.3 How to change the instrument name

In a LAN that uses a DNS server, each PC or instrument connected in the LAN can be accessed via an unambiguous computer name instead of the IP address. The DNS server translates the host name to the IP address. Using the computer name is espe-

cially useful when a DHCP server is used, as a new IP address can be assigned each time the instrument is restarted.

Each instrument is delivered with an assigned computer name, but you can change this name.

To change the instrument's computer name

1. Press [Setup] and then "Network + Remote".
The current "Computer Name" is displayed in the "Network" tab.
2. Enter the new computer name.
3. Close the dialog box.
The configuration is saved, and you are prompted to restart the instrument.
4. Confirm the displayed message to restart the instrument.

13.7.1.4 How to configure the LAN using the web browser interface

The instrument's "LAN" web browser interface works correctly with all W3C compliant browsers.

- In the web browser, open the `http://<instrument-hostname>` or `http://<instrument-ip-address>` page, e.g. `http://10.113.10.203`.
The default password to change "LAN" configurations is *LxiWebIfc*.
The "Instrument Home Page" (welcome page) opens.

Instrument Model	FSWP-26 Phase Noise Analyzer
Manufacturer	Rohde & Schwarz GmbH & Co. KG
Serial Number	[REDACTED]
Description	R&S FSWP-90
LXI Version	1.4 LXI Core 2011
LXI Extended Features	LXI HISLIP
DNS Host Name(s)	FSWP-[REDACTED]
MAC Address	[REDACTED]
IP Address	[REDACTED]
Firmware Revision	1.10
Current Time	Tuesday, 2015/07/14, 13:16:22
Current Time source	Operating System
VISA resource string	TCPIP:[REDACTED]:inst0:INSTR TCPIP:[REDACTED]:hislip0:INSTR
Device Indicator	INACTIVE (press to toggle)

The instrument home page displays device information, including the VISA resource string, in read-only format.



- ▶ On the "Instrument Home Page", select "Device Indicator" to activate or deactivate the "LAN" status icon on the status bar of the R&S FSWP. The "Device Indicator" setting is not password-protected.

A green "LAN" status symbol indicates that a LAN connection is established.

A red symbol indicates an error, for example, that no LAN cable is connected.

When a device is connecting to the instrument, the "LAN" icon blinks.

The most important control elements in the navigation pane of the browser interface are the following:

- "LAN Configuration" opens the menu with configuration pages.
- "Status" displays information about the "LAN" status of the instrument.

LAN configuration

The LAN configuration consists of three parts:

- "IP configuration" provides all mandatory LAN parameters.
- "Advanced LAN Configuration" provides further LAN settings.
- "Ping Client" provides the ping utility to verify the connection between the instrument and other devices.

IP configuration

The "LAN Configuration > IP configuration" web page displays all mandatory LAN parameters and allows their modification.

The "TCP/IP Mode" configuration field controls how the IP address for the instrument gets assigned (see also [Chapter 13.7.1.2, "How to assign the IP address"](#), on page 388).

For the manual configuration mode, the static IP address, subnet mask, and default gateway are used to configure the LAN. The automatic configuration mode uses DHCP server or Dynamic Link Local Addressing (Automatic IP) to obtain the instrument IP address.



Changing the LAN configuration is password-protected. The default password is *Lxi-WebIfc* (notice upper and lower case characters).

You can change the LAN password in the "Network + Remote" dialog box, see [Chapter 13.6.4, "LAN settings"](#), on page 376.

Advanced LAN configuration

The "LAN Configuration > Advanced LAN Configuration" parameters are used as follows:

- "mDNS and DNS-SD" are two additional protocols: Multicast DNS and DNS Service Discovery. They are used for device communication in zero configuration networks working without DNS and DHCP
- "ICMP Ping" must be enabled to use the ping utility.
- "VXI-11" is the protocol that is used to detect the instrument in the LAN.

Ping client

Ping is a utility that verifies the connection between the instrument and another device. The ping command uses the ICMP echo request and echo reply packets to determine whether the LAN connection is functional. Ping is useful for diagnosing IP network or router failures. The ping utility is not password-protected.

To initiate a ping between the instrument and a second connected device:

To initiate a ping between the instrument and a second connected device

1. Enable "ICMP Ping" on the "Advanced LAN Configuration" page (enabled after an LCI).
2. Enter the IP address of the second device **without the ping command and without any further parameters** into the "Destination Address" field (e.g. *10.113.10.203*).
3. Select "Submit".

13.7.1.5 How to change the GPIB instrument address

To operate the instrument via remote control, it must be addressed using the GPIB address. The remote control address is factory-set to 20, but it can be changed if it does not fit in the network environment. For remote control, addresses 0 through 30 are allowed. The GPIB address is maintained after a reset of the instrument settings.

Setting the GPIB address

1. On the R&S FSWP, press [SETUP].
2. Press "Network + Remote".
3. In the "Network + Remote" dialog box, select the "GPIB" tab.
4. In the "GPIB Address" field, enter a value between 0 and 30.

Remote command:

```
SYST:COMM:GPIB:ADDR 18
```

13.7.2 How to operate the instrument without a network

To operate the instrument without a network connection either temporarily or permanently, no special measures are necessary. Microsoft Windows automatically detects the interruption of the network connection and does not set up the connection when the instrument is switched on.

If you are not prompted to enter the user name and password, proceed as described in [Chapter 13.7.3.3, "How to configure the automatic login mechanism"](#), on page 395.

13.7.3 How to log on to the network

Microsoft Windows requires that users identify themselves by entering a user name and password in a login window. You can set up two types of user accounts, either an administrator account with unrestricted access to the computer/domain or a standard user account with limited access.

The instrument provides an auto-login function for the administrator account, i.e. login with unrestricted access is carried out automatically in the background. By default, the user name for the administrator account is "Instrument", and the user name for the standard user account is "NormalUser".

In both cases the initial password is "894129". You can change the password in Microsoft Windows for any user at any time. Some administrative tasks require administrator rights (e.g. firmware updates or the configuration of a LAN network). If so, it is mentioned in the function descriptions.

At the same time you log on to the operating system, you are automatically logged on to the network. As a prerequisite, the user name and the password must be identical on the instrument and on the network.

13.7.3.1 How to create users

After the software for the network has been installed, the instrument issues an error message the next time it is switched on because there is no user named "instrument" (= default user ID for Windows auto-login) in the network. Thus, a matching user must be created in the R&S FSWP and in the network, the password must be adapted to the network password, and the auto-login mechanism must then be deactivated.

The network administrator is responsible for creating new users in the network.

1.



Select the "Windows" icon in the toolbar to access the operating system.

2. Select "Start > Settings > Accounts > Other users".
3. Select "Add someone else to this PC".
4. In the "Microsoft account" dialog box, enter the new user name and password.
5. Select "OK".
6. Select "Finish".
The new user is created.

13.7.3.2 How to change the user password

After the new user has been created on the instrument, the password must be adapted to the network password.

1. 

Select the "Windows" icon in the toolbar to access the operating system.

2. Press [Ctrl + Alt + Delete], then select "Change a password".
3. Enter the user account name.
4. Enter the old password.
5. Enter the new password twice.
6. Press [Enter].
The new password is now active.

13.7.3.3 How to configure the automatic login mechanism

Adapting the auto-login function to a new password

If you change the password that is used during auto-login, this function no longer works. Adapt the settings for the auto-login function first.



Changing the password for auto-login requires administrator rights.



1. Select the "Windows" icon in the toolbar to access the operating system of the R&S FSWP (see also ["To access the "Start" menu"](#) on page 33).
2. Open the `C:\R_S\INSTR\USER\AUTOLOGIN.REG` file in any text editor (e.g. Notepad).
3. In the line `"DefaultPassword"="894129"`, replace the default password (894129) by the new password for automatic login.
4. Save the changes to the file.
5. In the Windows "Start" menu, select "Run".
The "Run" dialog box is displayed.
6. Enter the command `C:\R_S\INSTR\USER\AUTOLOGIN.REG`.
7. Press [ENTER] to confirm.
The auto-login function is reactivated with the changed password. It is applied the next time you switch on the instrument.

Switching users when using the auto-login function

Which user account is used is defined during login. If auto-login is active, the login window is not displayed. However, you can switch the user account to be used even when the auto-login function is active.



1. Select the "Windows" icon in the toolbar to access the operating system of the R&S FSWP (see also ["To access the "Start" menu"](#) on page 33).
2. Press [CTRL] + [ALT] + [DEL], then select "Sign out".
The "Login" dialog box is displayed, in which you can enter the different user account name and password.

Deactivating the auto-login function

When shipped, the instrument is already configured to log on the "instrument" user automatically under Microsoft Windows. To deactivate the auto-login function, perform the following steps:

1. In the "Start" menu, select "Run".
The "Run" dialog box is displayed.
2. Enter the command `C:\R_S\INSTR\USER\NO_AUTOLOGIN.REG`.
3. Press [ENTER] to confirm.
The auto-login function is deactivated. The next time you switch on the instrument, the R&S FSWP prompts you to enter your user name and password before the firmware is started.

Reactivating the auto-login function

To reactivate the auto-login function after manually deactivating it, perform the following steps:

1. In the "Start" menu, select "Run".
The "Run" dialog box is displayed.
2. Enter the command `C:\R_S\INSTR\USER\AUTOLOGIN.REG`.
3. Press [ENTER] to confirm.
The auto-login function is reactivated. It is applied the next time you switch on the instrument.

13.7.4 How to share directories (only with Microsoft networks)

Sharing directories makes data available for other users. Sharing directories is only possible in Microsoft networks. Sharing is a property of a file or directory.

1. In the "Start" menu, select "Programs" > "Accessories" > "Windows Explorer".
2. Right-click the desired folder.
3. In the context menu, select "Sharing with" > "Specific people".

The dialog box for sharing a directory is displayed.

4. Select a user from the list or add a new name.
5. Select "Add"
6. Select "Share".
7. Select "Done" to close the dialog box.
The drive is shared and the selected users can access it.

13.7.5 How to control the R&S FSWP via the web browser interface

Via the LAN web browser interface to the R&S FSWP, one or more users can control the instrument remotely from another PC without additional installation. Most instrument controls are available via the front panel simulation. File upload and download between the instrument and the remote PC is also available.

To access the R&S FSWP via the web browser interface

1. Start a web browser that supports html5 (W3C compliant).
2. Enter the IP address of the R&S FSWP in the browser's address bar.
The R&S FSWP's Welcome page is displayed.
3. In the navigation pane, select "Instrument Control > Web Control".
The instrument's display is shown in a new browser window, with a software front panel displayed beside or below it.
4. Use the mouse cursor to access the functionality in the software front panel or in the display as you would directly on the instrument's front panel.

To exchange files with the R&S FSWP

You can download files, for example stored measurement data, from the R&S FSWP to the remote PC, or upload files, for example limit line definitions, from the PC to the R&S FSWP.

1. In the web browser, select the Welcome page window.
2. In the navigation pane, select "Instrument Control" > "File Upload" or "File Download".

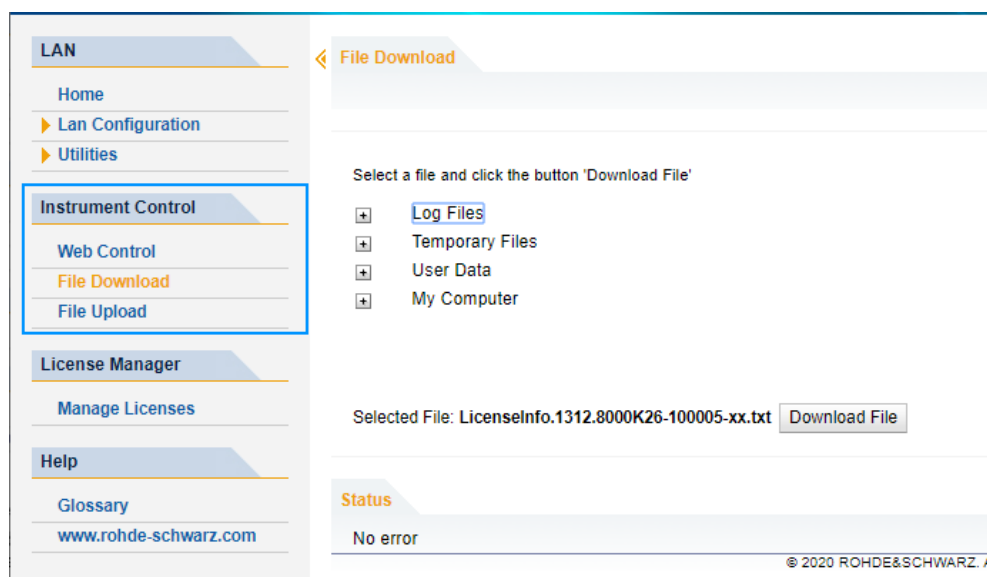

The most commonly used folders on the instrument are displayed. For example, folders that contain user data. From the top-most folder, *My Computer*, you can access all other folders on the instrument.

3. To download a file from the R&S FSWP:
 - a) Select the file from the displayed folders.
 - b) Select "Download File".
4. To upload a file to the R&S FSWP:
 - a) From the displayed folders in the web browser window, select the folder on the R&S FSWP to which you want to copy a file.
 - b) Under "File to Upload", select "Browse".
 - c) From the file selection dialog box, select the required file on the PC.
 - d) Select "Upload" to copy the file from the PC to the defined folder on the R&S FSWP.

13.7.6 How to deactivate the web browser interface

If you want to prevent other users in the LAN from accessing or operating the R&S FSWP via its LAN web browser interface, you must deactivate this function. Note that **after a firmware update** the function is **automatically active** again until you deactivate it manually.

To deactivate the LAN web browser interface

1.



Select the "Windows" icon in the toolbar to access the operating system.

2. In the "Start" menu, select "Control Panel".

3. Select "System and Security" > "Administrative Tools".
4. From the list on the right, select "Services".
5. From the list of local services, select "R&S TightVNC Server".

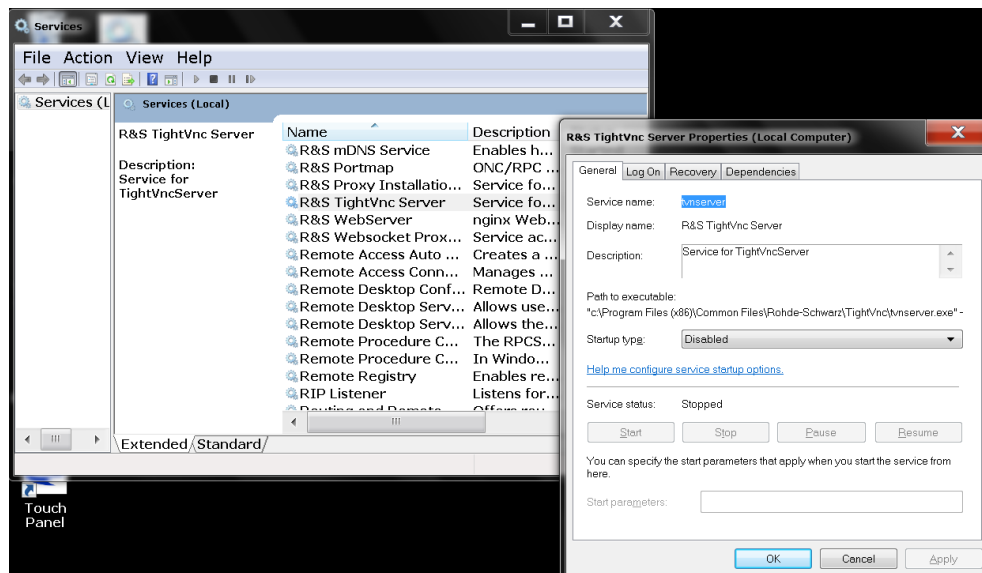

6. Set "Startup type" to "Disabled".
7. Select "Stop".
8. Select "Apply".

The next time a user enters the IP address of the instrument in a web browser, an error message is displayed:

```
Failed to connect to server (code. 1006)
```

13.7.7 How to set up remote desktop

Remote Desktop is a Windows application which can be used to access and control the instrument from a remote computer through a LAN connection. While the instrument is in operation, the instrument screen contents are displayed on the remote computer, and Remote Desktop provides access to all of the applications, files, and network resources of the instrument. Thus, remote operation of the R&S FSWP is possible.

With Microsoft Windows, Remote Desktop Client is part of the operating system. For other versions of Windows, Microsoft offers the Remote Desktop Client as an add-on. For details refer to the Microsoft Windows operating system documentation.

With the factory settings, the default "instrument" user can connect to the R&S FSWP with the Remote Desktop program of the controller immediately. No further configuration is required. However, if the connection fails or other users need to connect, this section provides basic instructions on setting up the Remote Desktop for the R&S FSWP.

13.7.7.1 How to configure the R&S FSWP for remote operation via remote desktop

1. Create a fixed IP address for the TCP/IP protocol as described in [Chapter 13.7.1.2, "How to assign the IP address"](#), on page 388.

Note: To avoid problems, use a fixed IP address.

When a DHCP server is used, a new IP address is assigned each time the instrument is restarted. This address must first be determined on the instrument itself. Thus, using a DHCP server is not suitable for remote operation of the R&S FSWP via Remote Desktop.



Select the "Windows" icon in the toolbar to access the operating system.

3. In the Windows "Start" menu, select "Settings > System".
4. Search for "remote access".
5. Select "Allow remote access to your computer".
6. Define which users can access the R&S FSWP via Remote Desktop.
Note: The currently used user account is automatically enabled for Remote Desktop.

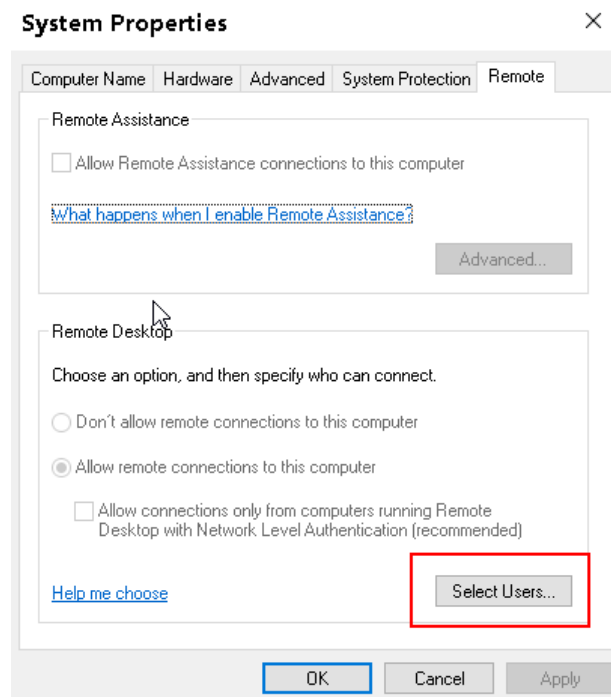

- a) Select "Select Users".
- b) Select the users or create new user accounts as described in [Chapter 13.7.3.1, "How to create users"](#), on page 394.

- c) Select "OK" to confirm the settings.
7. The R&S FSWP is now ready for connection setup with the Remote Desktop program of the controller.

13.7.7.2 How to configure the controller



Remote Desktop Client

With Microsoft Windows, Remote Desktop Client is part of the operating system and can be accessed via "Start > Programs > Accessories > Remote Desktop Connection". For other versions of Windows, Microsoft offers the Remote Desktop Client as an add-on.

1.



Select the "Windows" icon in the toolbar to access the operating system.

2. From the "Start" menu, select "All Programs" > "Accessories" > "Remote Desktop Connection".

The "Remote Desktop Connection" dialog box is displayed.

3. Select "Options >>".

The dialog box is expanded to display the configuration data.

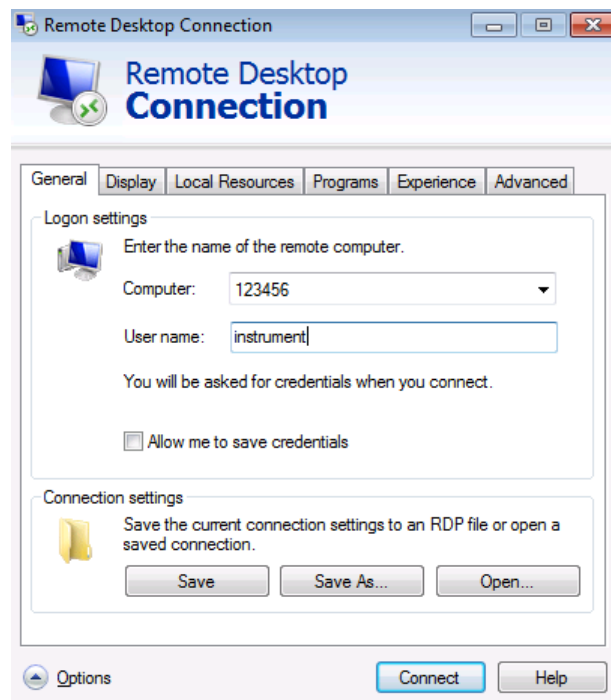

4. Open the "Experience" tab.
The settings on this tab select and optimize the connection speed.

5. In the list, select the appropriate connection (for example: "LAN (10 Mbps or higher)").
Depending on your selection (and how powerful the connection is), the options are activated or deactivated.
6. To improve the performance, you can deactivate the "Desktop background", "Show contents of window while dragging" and "Menu and window animation" options.
7. Open the "Local Resources" tab to enable printers, local drives and serial interfaces.
8. To access drives of the controller from the R&S FSWP, e.g. to store settings or to copy files from the controller to the R&S FSWP:
 - a) Select "More".

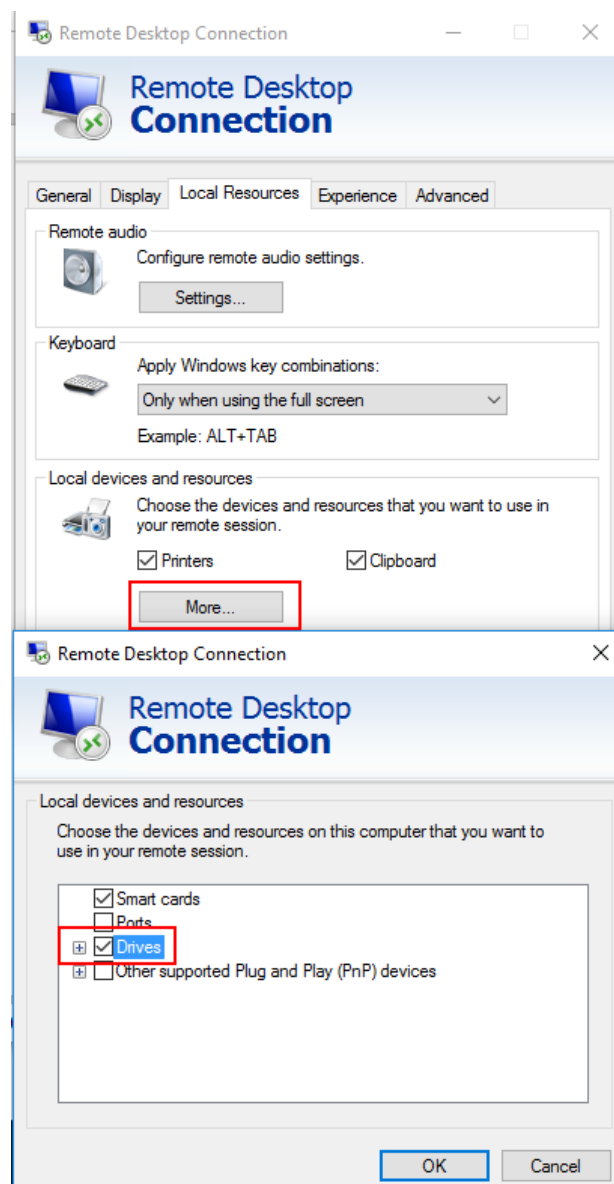

- b) Enable the "Drives" option.

Windows maps drives of the controller to the corresponding network drives.

9. To use printers connected to the controller while accessing them from the R&S FSWP, activate the "Printers" option. Do not change the remaining settings.
10. Open the "Display" tab.
The options for configuring the R&S FSWP screen display are displayed.
11. Under "Remote desktop size", you can set the size of the R&S FSWP window on the desktop of the controller.
12. Under "Colors", do not change the settings.
13. Set the "Display the connection bar when I use the full screen" option:
 - If activated, a bar showing the network address of the R&S FSWP appears at the top edge of the screen. You can use this bar to reduce, minimize or close the window.
 - If deactivated, the only way you can return to the controller desktop from the R&S FSWP screen in full screen mode is to select "Disconnect" from the "Start" menu.

13.7.7.3 How to start and close the remote desktop

To set up a connection to the R&S FSWP

1. In the "Remote Desktop Connection" dialog box (see [Chapter 13.7.7.2, "How to configure the controller"](#), on page 401), open the "General" tab.
2. In the "Computer" field, enter the IP address of the R&S FSWP.
In the "User name" field, enter *instrument* to log in as an administrator, or *Normal User* to log in as a standard user.
In the "Password" field, enter *894129*.
3. To save the connection configuration for later use:
 - a) Select "Save As".
The "Save As" dialog box is displayed.
 - b) Enter the name for the connection information (*.RDP).
4. To load an existing connection configuration:
 - a) Select "Open".
The "Open" dialog box is displayed.
 - b) Select the *.rdp file.
5. Select "Connect".
The connection is set up.
6. If the "Disk drives" option is enabled on the "Local Resources" tab, a warning is displayed indicating that the drives are enabled for access from the R&S FSWP. Select "OK" to confirm the warning.

After a few moments, the R&S FSWP screen is displayed.

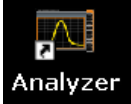
7. If a dark screen appears or a dark square appears in the upper left-hand corner of the screen, restart the R&S FSWP to see the modified screen resolution.
 - a) Press the key combination [ALT] + [F4].
The R&S FSWP firmware is shut down, which can take a few seconds.
 - b) 

On the desktop, double-tap the "Analyzer" icon.

The firmware restarts and then automatically opens the "Softfrontpanel", i.e. the user interface on which all front panel controls and the rotary knob are mapped to buttons.

For more information, see [Chapter 12.2.3, "How to work with the soft front panels"](#), on page 315.

8. To deactivate or activate the "Softfrontpanel", press [F6].

After the connection is established, the R&S FSWP screen is displayed in the "Remote Desktop" application window.



To access the Windows "Start" menu, expand the "Remote Desktop" window to full size.

During the connection with the controller, the login dialog box is displayed on the R&S FSWP screen.

To terminate Remote Desktop control

The controller or a user at the R&S FSWP can terminate the remote connection:

- ▶ ● On the controller, close the "Remote Desktop" window at any time.
The connection to the R&S FSWP is terminated.
- On the R&S FSWP, log on.
The connection to the controller is terminated. A message is displayed on the controller display indicating that another user has assumed control of the instrument.

Restoring the connection to the R&S FSWP

Follow the instructions above to set up a connection to the R&S FSWP. If the connection is terminated and then restored, the R&S FSWP remains in the same state.

13.7.7.4 How to shut down the R&S FSWP via remote operation

1. Select the R&S FSWP softfrontpanel.
2. Close the application with the key combination [ALT] + [F4].
3. Select the desktop.
4. Press the key combination [ALT] + [F4].
A safety query is displayed to warn you that the instrument cannot be reactivated via remote operation and asks you whether you want to continue the shutdown process.
5. Respond to the safety query with "Yes".
The connection with the controller is terminated and the R&S FSWP is shut down.

13.7.8 How to start a remote control session from a PC

When you switch on the R&S FSWP, it is always in manual operation state ("local" state) and can be operated via the front panel.

To start remote control

1. Send an addressed command (GTR - Go to Remote) from a controller to the instrument.

The instrument is switched to remote control ("remote" state). Operation via the front panel is disabled. Only the "Local" softkey is displayed to return to manual operation. The instrument remains in the remote state until it is reset to the manual state via the instrument or via remote control interfaces. Switching from manual operation to remote control and vice versa does not affect the other instrument settings.

2. During program execution, send the `SYSTem:DISPlay:UPDate ON` command to activate the display of results (see `SYSTem:DISPlay:UPDate` on page 625).

The changes in the device settings and the recorded measurement values are displayed on the instrument screen.

3. To obtain optimum performance during remote control, send the `SYSTem:DISPlay:UPDate OFF` command to hide the display of results and diagrams again (default setting in remote control).
4. To prevent unintentional return to manual operation, disable the keys of the instrument using the universal command `LLO`.

Switching to manual mode is only possible via remote control then. This function is only available for the GPIB interface.

5. To enable the keys of the R&S FSWP again, switch the instrument to local mode (`GTL` - Go to Local), i.e. deactivate the `REN` line of the remote control interface.



If the instrument is operated exclusively in remote control, it is recommended that you switch off the display. For details see "[Remote Display Update](#)" on page 374.

13.7.9 How to return to manual operation

Before you switch back to manual operation, all remote command processing must be completed. Otherwise, the instrument switches back to remote control immediately.

- ▶ ● Manual operation: Select "Local".
- Remote operation: Use the following GPIB command:

```
status = viGpibControlREN(vi, VI_GPIB_REN_ADDRESS_GTL)
```



If you select "Local" while a self-alignment or a self-test is still running (which was started remotely), the instrument only returns to the manual operation state when the alignment or test is completed.

14 Remote control

• Conventions used in SCPI command descriptions	407
• Common suffixes	408
• Common commands	408
• Selecting the operating mode and application	413
• Measurements and result displays	421
• Common measurement settings	437
• Common analysis and display functions	524
• Managing settings and results	577
• Configuring the R&S FSWP	604
• Recording SCPI Commands Automatically	650
• Using the status register	654
• Programming examples	659

14.1 Conventions used in SCPI command descriptions

The following conventions are used in the remote command descriptions:

- **Command usage**
If not specified otherwise, commands can be used both for setting and for querying parameters.
If a command can be used for setting or querying only, or if it initiates an event, the usage is stated explicitly.
- **Parameter usage**
If not specified otherwise, a parameter can be used to set a value and it is the result of a query.
Parameters required only for setting are indicated as **Setting parameters**.
Parameters required only to refine a query are indicated as **Query parameters**.
Parameters that are only returned as the result of a query are indicated as **Return values**.
- **Conformity**
Commands that are taken from the SCPI standard are indicated as **SCPI confirmed**. All commands used by the R&S FSWP follow the SCPI syntax rules.
- **Asynchronous commands**
A command which does not automatically finish executing before the next command starts executing (overlapping command) is indicated as an **Asynchronous command**.
- **Reset values (*RST)**
Default parameter values that are used directly after resetting the instrument (*RST command) are indicated as ***RST** values, if available.
- **Default unit**
The default unit is used for numeric values if no other unit is provided with the parameter.
- **Manual operation**

If the result of a remote command can also be achieved in manual operation, a link to the description is inserted.

14.2 Common suffixes

In the application, the following common suffixes are used in remote commands:

Table 14-1: Common suffixes used in remote commands in the application

Suffix	Value range	Description
<m>	1 to 16	Marker (or spot noise marker)
<n>	1 to 16	Window (in the currently selected channel)
<t>	1 to 6	Trace
	1 to 8	Limit line
<j>	1..10	Selects an integrated measurement range.
<k>	1..8 (Limit line) 1 2 (Display line)	Selects a limit or display line.
<r>	1..x	Selects a half decade. The value range depends on the number of half decades. The first half decade in the measurement always has the value "1". For subsequent half decades, add "1" to get the value "x" (the fourth half decade, for example, would have the value "4").
<s>	1..6	Selects a (user defined) spot noise marker.
<x>	1..2	Selects a mixer in the test setup.



Selecting windows in multiple channels

Note that the suffix <n> always refers to a window in the currently selected channel.

14.3 Common commands

*CAL?	409
*CLS	409
*ESE	409
*ESR?	409
*IDN?	410
*IST?	410
*OPC	410
*OPT?	410
*PCB	411
*PRE	411
*PSC	411

*RST.....	411
*SRE.....	411
*STB?.....	412
*TRG.....	412
*TST?.....	412
*WAI.....	412

*CAL?

Calibration query

Initiates a calibration of the instrument and then queries the calibration status. Responses > 0 indicate errors.

Note: If you start a self-alignment remotely, then select the "Local" softkey while the alignment is still running, the instrument only returns to the manual operation state after the alignment is completed.

Usage: Query only

Manual operation: See "[Start Self Alignment](#)" on page 300

*CLS

Clear status

Sets the status byte (STB), the standard event register (ESR) and the `EVENT` part of the `QUESTIONABLE` and the `OPERATION` registers to zero. The command does not alter the mask and transition parts of the registers. It clears the output buffer.

Usage: Setting only

*ESE <Value>

Event status enable

Sets the event status enable register to the specified value. The query returns the contents of the event status enable register in decimal form.

Parameters:

<Value> Range: 0 to 255

*ESR?

Event status read

Returns the contents of the event status register in decimal form and then sets the register to zero.

Return values:

<Contents> Range: 0 to 255

Usage: Query only

***IDN?**

Identification

Returns the instrument identification.

Return values:

<ID> "Rohde&Schwarz,<device type>,<part number>/<serial number>,<firmware version>"

Example: Rohde&Schwarz,FSWP-26,1322.8003K26/100005,1.00

Usage: Query only

***IST?**

Individual status query

Returns the contents of the IST flag in decimal form. The IST flag is the status bit which is sent during a parallel poll.

Return values:

<ISTflag> 0 | 1

Usage: Query only

***OPC**

Operation complete

Sets bit 0 in the event status register when all preceding commands have been executed. This bit can be used to initiate a service request. The query writes a "1" into the output buffer when all preceding commands have been executed, which is useful for command synchronization.

***OPT?**

Option identification query

Queries the options included in the instrument. For a list of all available options and their description, refer to the data sheet.

Return values:

<Options> The query returns a list of all installed and activated options, separated by commas, where:
B<number> describes hardware options.
K<number> describes software options.
Note that B3 (Audio demodulator), K9 (Power Meter) and K14 (Spectrograms) are displayed for compatibility reasons only; in fact they are standard functionality of the R&S FSWP base unit and do not require additional ordering.

Usage: Query only

***PCB** <Address>

Pass control back

Indicates the controller address to which remote control is returned after termination of the triggered action.

Setting parameters:

<Address> Range: 0 to 30

Usage: Setting only

***PRE** <Value>

Parallel poll register enable

Sets parallel poll enable register to the indicated value. The query returns the contents of the parallel poll enable register in decimal form.

Parameters:

<Value> Range: 0 to 255

***PSC** <Action>

Power on status clear

Determines whether the contents of the `ENABLE` registers are preserved or reset when the instrument is switched on. Thus a service request can be triggered when the instrument is switched on, if the status registers ESE and SRE are suitably configured. The query reads out the contents of the "power-on-status-clear" flag.

Parameters:

<Action> 0 | 1

0

The contents of the status registers are preserved.

1

Resets the status registers.

***RST**

Reset

Sets the instrument to a defined default status. The default settings are indicated in the description of commands.

The command is equivalent to `SYSTEM:PRESet`.

Usage: Setting only

***SRE** <Contents>

Service request enable

Sets the service request enable register to the indicated value. This command determines under which conditions a service request is triggered.

Parameters:

<Contents> Contents of the service request enable register in decimal form.
 Bit 6 (MSS mask bit) is always 0.
 Range: 0 to 255

***STB?**

Status byte query

Reads the contents of the status byte in decimal form.

Usage: Query only

***TRG**

Trigger

Triggers all actions waiting for a trigger event. In particular, *TRG generates a manual trigger signal. This common command complements the commands of the TRIGger subsystem.

*TRG corresponds to the INITiate:IMMediate command.

Usage: Event

***TST?**

Self-test query

Initiates self-tests of the instrument and returns an error code.

Note: If you start a self-test remotely, then select the "Local" softkey while the test is still running, the instrument only returns to the manual operation state after the test is completed. In this case, the self-test cannot be aborted.

Return values:

<ErrorCode> **integer > 0 (in decimal format)**
 An error occurred.
 (For details, see the Service Manual supplied with the instrument).
 0
 No errors occurred.

Usage: Query only

***WAI**

Wait to continue

Prevents servicing of the subsequent commands until all preceding commands have been executed and all signals have settled (see also command synchronization and *OPC).

Usage: Event

14.4 Selecting the operating mode and application

14.4.1 Selecting mode and applications

DISPlay:ATAB.....	413
INSTrument:CREate:DUPLicate.....	413
INSTrument:CREate:[NEW].....	414
INSTrument:CREate:REPLace.....	414
INSTrument:DELeTe.....	415
INSTrument:LIST?.....	415
INSTrument:REName.....	416
INSTrument[:SELect].....	416

DISPlay:ATAB <State>

This command switches between the MultiView tab and the most recently displayed channel. If only one channel is active, this command has no effect.

Parameters:

<State> ON | OFF | 0 | 1
 OFF | 0
 Switches off the function.
 ON | 1
 Switches on the function.

INSTrument:CREate:DUPLicate

Duplicates the currently selected channel, i.e creates a new channel of the same type and with the identical measurement settings. The name of the new channel is the same as the copied channel, extended by a consecutive number (e.g. "IQAnalyzer" -> "IQAnalyzer 2").

The channel to be duplicated must be selected first using the `INST:SEL` command.

Is not available if the MSRA primary channel is selected.

Example: `INST:SEL 'PhaseNoise'`
 `INST:CRE:DUPL`
 Duplicates the channel named 'PhaseNoise' and creates a new channel named 'PhaseNoise 2'.

Usage: Event

Manual operation: See ["Duplicate Current Channel"](#) on page 112

INSTRument:CREate[:NEW] <ChannelType>, <ChannelName>

Adds a measurement channel. You can configure up to 10 measurement channels at the same time (depending on available memory).

See also

- [INSTRument\[:SElect\]](#) on page 416
- [INSTRument:DELeTe](#) on page 415

Parameters:

<ChannelType> Channel type of the new channel.
For a list of available channel types, see [INSTRument:LIST?](#) on page 415.

<ChannelName> String containing the name of the channel.
Note that you cannot assign an existing channel name to a new channel. If you do, an error occurs.

Example: `INST:CRE SAN, 'Spectrum 2'`
Adds a spectrum display named "Spectrum 2".

Manual operation: See ["New Channel"](#) on page 111

INSTRument:CREate:REPLace <ChannelName1>, <ChannelType>, <ChannelName2>

Replaces a channel with another one.

Setting parameters:

<ChannelName1> String containing the name of the channel you want to replace.

<ChannelType> Channel type of the new channel.
For a list of available channel types, see [INSTRument:LIST?](#) on page 415.

<ChannelName2> String containing the name of the new channel.
Note: If the specified name for a new channel already exists, the default name, extended by a sequential number, is used for the new channel (see [INSTRument:LIST?](#) on page 415).
Channel names can have a maximum of 31 characters, and must be compatible with the Windows conventions for file names. In particular, they must not contain special characters such as ":", "*", "?".

Example: `INST:CRE:REPL 'PhaseNoise', PNO, 'PNO2'`
Replaces the channel named "PhaseNoise" by a new channel of type "Phase Noise" named "PNO2".

Usage: Setting only

Manual operation: See ["Replace Current Channel"](#) on page 112

INSTrument:DELeTe <ChannelName>

Deletes a channel.

If you delete the last channel, the default "Phase Noise" channel is activated.

Setting parameters:

<ChannelName> String containing the name of the channel you want to delete. A channel must exist to delete it.

Example: `INST:DEL 'PhaseNoise'`
Deletes the channel with the name 'PhaseNoise'.

Usage: Setting only

INSTrument:LIST?

Queries all active channels. The query is useful to obtain the names of the existing channels, which are required to replace or delete the channels.

Return values:

<ChannelType>, <ChannelName> For each channel, the command returns the channel type and channel name (see tables below).

Tip: to change the channel name, use the [INSTrument:REName](#) command.

Example: `INST:LIST?`
Result for 2 channels:
'PNO', 'PhaseNoise', 'PNO', 'Phase Noise 2'

Usage: Query only

Table 14-2: Available channel types and default channel names

Application	<ChannelType> Parameter	Default Channel Name*)
Phase Noise	PNOise	Phase Noise
Spectrum Monitor	SMONitor	Spectrum Monitor
Spectrum (R&S FSWP-B1)	SANalyzer	Spectrum
I/Q Analyzer (R&S FSWP-B1)	IQ	IQ Analyzer
Pulse Measurements (R&S FSWP-K6)	PULSe	Pulse
Analog Modulation Analysis (R&S FSWP-K7)	ADEMod	Analog Demod
Noise Figure Measurements (R&S FSWP-K30)	NOISe	Noise
Fast Spur Search (R&S FSWP-K50)	SPUR	Spurious

Note: the default channel name is also listed in the table. If the specified name for a new channel already exists, the default name, extended by a sequential number, is used for the new channel.

Application	<ChannelType> Parameter	Default Channel Name*)
Transient Analysis (R&S FSWP-K60)	TA	Transient Analysis
Vector Signal Analysis (R&S FSWP-K70)	DDEM	VSA

Note: the default channel name is also listed in the table. If the specified name for a new channel already exists, the default name, extended by a sequential number, is used for the new channel.

INSTrument:REName <ChannelName1>, <ChannelName2>

Renames a channel.

Setting parameters:

<ChannelName1> String containing the name of the channel you want to rename.

<ChannelName2> String containing the new channel name.
 Note that you cannot assign an existing channel name to a new channel. If you do, an error occurs.
 Channel names can have a maximum of 31 characters, and must be compatible with the Windows conventions for file names. In particular, they must not contain special characters such as ":", "*", "?".

Example: `INST:REN 'PhaseNoise', 'PNO'`
 Renames the channel with the name 'PhaseNoise' to 'PNO'.

Usage: Setting only

INSTrument[:SElect] <ChannelType> | <ChannelName>

Activates a new channel with the defined channel type, or selects an existing channel with the specified name.

Also see

- [INSTrument:CREate\[:NEW\]](#) on page 414
- [Chapter 14.4.3, "Programming example: performing a sequence of measurements"](#), on page 419

Parameters:

<ChannelType> Channel type of the new channel.
 For a list of available channel types see [INSTrument:LIST?](#) on page 415.

<ChannelName> String containing the name of the channel.

Example: `INST IQ`
 Activates a channel for the I/Q Analyzer application (evaluation mode).
`INST 'MyIQSpectrum'`
 Selects the channel named 'MyIQSpectrum' (for example before executing further commands for that channel).

Manual operation: See "Phase Noise" on page 108
 See "Spectrum Monitor" on page 108
 See "Spectrum" on page 109
 See "Analog Modulation Analysis" on page 109
 See "I/Q Analyzer" on page 109
 See "Noise Figure" on page 109
 See "Pulse Measurements" on page 110
 See "Spurious Measurements" on page 110
 See "Transient Analysis" on page 110
 See "Vector Signal Analysis (VSA)" on page 110
 See "New Channel" on page 111

14.4.2 Performing a sequence of measurements

INITiate:SEQuencer:ABORt	417
INITiate:SEQuencer:IMMediate	417
INITiate:SEQuencer:MODE	418
SYSTem:SEQuencer	418

INITiate:SEQuencer:ABORt

Stops the currently active sequence of measurements.

You can start a new sequence any time using [INITiate:SEQuencer:IMMediate](#) on page 417.

Usage: Event

Manual operation: See "[Sequencer State](#)" on page 114

INITiate:SEQuencer:IMMediate

Starts a new sequence of measurements by the Sequencer.

Its effect is similar to the [INITiate<n>\[:IMMediate\]](#) command used for a single measurement.

Before this command can be executed, the Sequencer must be activated (see [SYSTem:SEQuencer](#) on page 418).

Example:

```
SYST:SEQ ON
Activates the Sequencer.
INIT:SEQ:MODE SING
Sets single sequence mode so each active measurement is performed once.
INIT:SEQ:IMM
Starts the sequential measurements.
```

Manual operation: See "[Sequencer State](#)" on page 114

INITiate:SEQuencer:MODE <Mode>

Defines the capture mode for the entire measurement sequence and all measurement groups and channels it contains.

Note: To synchronize to the end of a measurement sequence using *OPC, *OPC? or *WAI, use **SINGLe** Sequencer mode.

Parameters:

<Mode>

SINGle

Each measurement group is started one after the other in the order of definition. All measurement channels in a group are started simultaneously and performed once. After *all* measurements are completed, the next group is started. After the last group, the measurement sequence is finished.

CONTInuous

Each measurement group is started one after the other in the order of definition. All measurement channels in a group are started simultaneously and performed once. After *all* measurements are completed, the next group is started. After the last group, the measurement sequence restarts with the first one and continues until it is stopped explicitly.

*RST: CONTInuous

Manual operation: See "[Sequencer Mode](#)" on page 115

SYSTem:SEQuencer <State>

Turns the Sequencer on and off. The Sequencer must be active before any other Sequencer commands (**INIT:SEQ. . .**) are executed, otherwise an error occurs.

A detailed programming example is provided in [Chapter 14.4.3, "Programming example: performing a sequence of measurements"](#), on page 419.

Parameters:

<State>

ON | OFF | 0 | 1

ON | 1

The Sequencer is activated and a sequential measurement is started immediately.

OFF | 0

The Sequencer is deactivated. Any running sequential measurements are stopped. Further Sequencer commands (**INIT:SEQ. . .**) are not available.

*RST: 0

Example:

```

SYST:SEQ ON
Activates the Sequencer.
INIT:SEQ:MODE SING
Sets single Sequencer mode so each active measurement is
performed once.
INIT:SEQ:IMM
Starts the sequential measurements.
SYST:SEQ OFF

```

Manual operation: See "[Sequencer State](#)" on page 114

14.4.3 Programming example: performing a sequence of measurements

This example demonstrates how to perform several measurements in a sequence in a remote environment.

Note that it is based on the optional Spectrum application. Doing this for the Phase Noise application, however, works the same way.

```

//2xSpectrumanalyzer + 2xIQ, start Sequencer at the end, test OPC?
// -----

//-----Preparing the instrument and first and second channel -----
*RST
//Activate new IQ channel
INSTrument:CREate:NEW IQ,'IQ 1'
//Set sweep count for new IQ channel
SENS:SWEEP:COUNT 6
//Change trace modes for IQ channel
DISP:TRAC1:MODE BLANK
DISP:TRAC2:MODE MAXH
DISP:TRAC3:MODE MINH
//Switch to single sweep mode
INIT:CONT OFF
//switch back to first (default) analyzer channel
INST:SEL 'Spectrum';*WAI
//Switch into SEM
SENSe:SWEEP:MODE ESpectrum
//Load Sem standard file for W-CDMA
SENSe:ESpectrum:PRESet:STANdard 'WCDMA\3GPP\DL\3GPP_DL.xml'
//Set sweep count in Spectrum channel
SENS:SWEEP:COUNT 5

//-----Creating a third measurement channel -----

//Create second IQ channel
INSTrument:CREate:NEW IQ,'IQ 2'
//Set sweep count

```

Selecting the operating mode and application

```

SENS:SWEEP:COUNT 2
//Change trace modes
DISP:TRAC1:MODE MAXH
DISP:TRAC2:MODE MINH
//Create new analyzer channel
INSTrument:CREate:NEW SANalyzer,'Spectrum 2'
//Activate ACLR measurement in channel 'Spectrum 2'
CALCulate:MARKer:FUNCTion:POWer:SElect ACPower
//Load W-CDMA Standard
CALCulate:MARKer:FUNCTion:POWer:PRESet FW3Gppcdma
//Change trace modes
DISP:TRAC2:MODE MAXH
DISP:TRAC1:MODE MINH

//-----Performing a sweep and retrieving results-----

//Change sweep count
SENS:SWEEp:COUNT 7
//Single Sweep mode
INIT:CONT OFF
//Switch back to first IQ channel
INST:SEL 'IQ 1';*WAI
//Perform a measurement
INIT:IMM;*OPC?
//Retrieve results
CALC:MARK:Y?
//Activate Multiview
DISPlay:ATAB ON

//-----Performing a sequence of measurements with the Sequencer-----
//Activate Sequencer
SYSTem:SEQuencer ON
//Start sweep in Sequencer
INITiate:SEQuencer:IMMediate;*OPC?
//Switch into first IQ channel to get results
INST:SEL 'IQ 1';*WAI
CALCulate:MARKer:MAXimum
CALC:MARK:Y?
//Change sweep time in IQ
SENS:SWE:TIME 300us
//Switch to single Sequencer mode
INITiate:SEQuencer:MODE SINGLE
//Sweep all channels once, taking the sweep count in each channel into account
INITiate:SEQuencer:IMMediate;*OPC?
//Set marker to maximum in IQ1 and query result
CALCulate:MARKer:MAXimum
CALC:MARK:Y?
//Switch to second IQ channel and retrieve results
INST:SEL 'IQ 2';*WAI
CALCulate:MARKer:MIN

```

```

CALC:MARK:Y?
//Switch to first Spectrum channel
INST:SEL 'Spectrum';*WAI
//Query one of the SEM results
CALCulate:MARKer:FUNCTion:POWer:RESult? CPOWer
//Switch to second Spectrum channel
INST:SEL 'Spectrum 2';*WAI
//Query channel power result
CALCulate:MARKer:FUNCTion:POWer:RESult? ACPower

```

14.5 Measurements and result displays

- [Measurement selection](#).....421
- [Performing measurements](#).....423
- [Querying results](#).....426
- [Programming examples](#).....436

14.5.1 Measurement selection

CONFigure:PNOise:MEASurement	421
CONFigure:SNTune:MEASurement[:STATe]	422
CONFigure:TRANSient:MEASurement[:STATe]	422
CONFigure:VCO:MEASurement[:STATe]	423

CONFigure:PNOise:MEASurement <Measurement>

This command selects the measurement.

- To select the Spot Noise vs Tune measurement, use [CONFigure:SNTune:MEASurement\[:STATe\]](#).
- To select the VCO characterization, use [CONFigure:VCO:MEASurement\[:STATe\]](#).
- To select the Transient Analysis measurement, use [CONFigure:TRANSient:MEASurement\[:STATe\]](#).

Parameters:

<Measurement>	BASEband Selects the Baseband Noise measurement.
	PNOise Select the Phase Noise measurement.
	PPNoise Selects the Pulsed Phase Noise measurement.
	PREsidual Selects the Additive Pulsed Phase Noise measurement.
	RESidual Selects the Additive Noise measurement.

*RST: PNOise

Example: //Select the phase noise measurement
CONF:PNO:MEAS PNO

Manual operation: See ["Phase noise Measurement"](#) on page 121
See ["Additive noise measurements \(optional\)"](#) on page 121
See ["Baseband noise measurement"](#) on page 121
See ["Pulsed phase noise measurements \(optional\)"](#)
on page 122
See ["Pulsed additive noise measurements \(optional\)"](#)
on page 122
See ["Selecting the noise measurement type"](#) on page 134

CONFigure:SNTune:MEASurement[:STATe] <State>

This command selects the Spot Noise vs Tune measurement.

- To select the VCO characterization measurement, use [CONFigure:VCO:MEASurement\[:STATe\]](#).
- To select the Transient Analysis measurement, use [CONFigure:TRANSient:MEASurement\[:STATe\]](#).
- To select other measurements, use [CONFigure:PNOise:MEASurement](#).

Parameters:

<State> **ON | 1**
Selects the Spot Noise vs Tune measurement.

OFF | 0
Selects the Phase Noise measurement (CONF:PNO:MEAS PNO).

*RST: OFF

Example: //Select the phase noise measurement
CONF:VCO:MEAS OFF

Manual operation: See ["Spot noise vs tune"](#) on page 121

CONFigure:TRANSient:MEASurement[:STATe] <State>

This command selects the PN Transient Analysis measurement.

- To select the Spot Noise vs Tune measurement, use [CONFigure:SNTune:MEASurement\[:STATe\]](#).
- To select the VCO characterization measurement, use [CONFigure:VCO:MEASurement\[:STATe\]](#).
- To select other measurements, use [CONFigure:PNOise:MEASurement](#).

Parameters:

<State> **ON | 1**
Selects the PN Transient Analysis measurement.

OFF | 0

Selects the Phase Noise measurement (CONF:PNO:MEAS PNO).

*RST: OFF

Example:

```
//Select the phase noise measurement
CONF:VCO:MEAS OFF
```

Manual operation: See "[PN Transient analysis](#)" on page 122

CONFigure:VCO:MEASurement[:STATe] <State>

This command selects the VCO Characterization measurement.

- To select the Spot Noise vs Tune measurement, use [CONFigure:SN Tune:MEASurement\[:STATe\]](#).
- To select the Transient Analysis measurement, use [CONFigure:TRANSient:MEASurement\[:STATe\]](#).
- To select other measurements, use [CONFigure:PNOise:MEASurement](#).

Parameters:

<State>

ON | 1

Selects the VCO Characterization measurement.

OFF | 0

Selects the Phase Noise measurement (CONF:PNO:MEAS PNO).

*RST: OFF

Example:

```
//Select the phase noise measurement
CONF:VCO:MEAS OFF
```

Manual operation: See "[VCO characterization](#)" on page 121

14.5.2 Performing measurements

ABORt	423
INITiate<n>:CONMeas	424
INITiate<n>:CONTinuous	425
INITiate<n>[:IMMEDIATE]	426

ABORt

Aborts the measurement in the current channel and resets the trigger system.

To prevent overlapping execution of the subsequent command before the measurement has been aborted successfully, use the *OPC? or *WAI command after ABOR and before the next command.

For details on overlapping execution see [Remote control via SCPI](#).

Note on blocked remote control programs:

If a sequential command cannot be completed, for example because a triggered sweep never receives a trigger, the remote control program will never finish and the remote channel to the R&S FSWP is blocked for further commands. In this case, you must interrupt processing on the remote channel first in order to abort the measurement.

To do so, send a "Device Clear" command from the control instrument to the R&S FSWP on a parallel channel to clear all currently active remote channels. Depending on the used interface and protocol, send the following commands:

- **Visa:** `viClear()`
- **GPIB:** `ibclr()`
- **RSIB:** `RSDLLibclr()`

Now you can send the `ABORt` command on the remote channel performing the measurement.

Example: `ABOR; :INIT:IMM`
Aborts the current measurement and immediately starts a new one.

Example: `ABOR; *WAI`
`INIT:IMM`
Aborts the current measurement and starts a new one once abortion has been completed.

Usage: Event

INITiate<n>:CONMeas

Restarts a (single) measurement that has been stopped (using `ABORt`) or finished in single measurement mode.

The measurement is restarted at the beginning, not where the previous measurement was stopped.

As opposed to `INITiate<n>[:IMMEDIATE]`, this command does not reset traces in maxhold, minhold or average mode. Therefore it can be used to continue measurements using maxhold or averaging functions.

Suffix:
<n> irrelevant

Example:	<pre>INIT:CONT OFF</pre> <p>Switches to single measurement mode.</p> <pre>DISP:WIND:TRAC:MODE AVER</pre> <p>Switches on trace averaging.</p> <pre>SWE:COUN 20</pre> <p>Setting the measurement counter to 20 measurements.</p> <pre>INIT;*WAI</pre> <p>Starts the measurement and waits for the end of the 20 measurements.</p> <pre>INIT:CONM;*WAI</pre> <p>Continues the measurement (next 20 measurements) and waits for the end.</p> <p>Result: Averaging is performed over 40 measurements.</p>
Usage:	Asynchronous command
Manual operation:	See " Continue Single Sweep " on page 120

INITiate<n>:CONTInuous <State>

Controls the measurement mode for an individual channel.

Note that in single measurement mode, you can synchronize to the end of the measurement with *OPC, *OPC? or *WAI. In continuous measurement mode, synchronization to the end of the measurement is not possible. Thus, it is not recommended that you use continuous measurement mode in remote control, as results like trace data or markers are only valid after a single measurement end synchronization.

For details on synchronization see [Remote control via SCPI](#).

If the measurement mode is changed for a channel while the Sequencer is active, the mode is only considered the next time the measurement in that channel is activated by the Sequencer.

Suffix:

<n> irrelevant

Parameters:

<State> ON | OFF | 0 | 1

ON | 1
Continuous measurement

OFF | 0
Single measurement

*RST: 1 (some applications can differ)

Example:	<pre>INIT:CONT OFF</pre> <p>Switches the measurement mode to single measurement.</p> <pre>INIT:CONT ON</pre> <p>Switches the measurement mode to continuous measurement.</p>
-----------------	--

Manual operation: See "[Continuous Sweep / Run Cont](#)" on page 120

INITiate<n>[:IMMediate]

Starts a (single) new measurement.

With measurement count or average count > 0, this means a restart of the corresponding number of measurements. With trace mode MAXHold, MINHold and AVERage, the previous results are reset on restarting the measurement.

You can synchronize to the end of the measurement with *OPC, *OPC? or *WAI.

For details on synchronization see [Remote control via SCPI](#).

Suffix:

<n> irrelevant

Usage:

Asynchronous command

Manual operation: See ["Single Sweep / Run Single"](#) on page 119

14.5.3 Querying results

Commands to query results described elsewhere:

- [CALCulate<n>:SNOise<ri>\[:TRACe<t>\]:DECades:X?](#) on page 491
- [CALCulate<n>:SNOise<ri>\[:TRACe<t>\]:DECades:Y?](#) on page 491
- [CALCulate<n>:SNOise<ri>\[:TRACe<t>\]:Y?](#) on page 492

FETCh<n>[:RANGe<ri>]:PNOise<t>:DUT:GAIN?	426
FETCh<n>:PNOise<t>:SPURs?	427
FETCh<n>:PNOise<t>:SPURs:COUNT?	427
FETCh<n>:PNOise<t>:SPURs:DIScrete?	428
FETCh<n>:PNOise<t>:SPURs:JITTer?	428
FETCh<n>:PNOise<t>:SPURs:RANDom?	429
FETCh<n>[:RANGe<ri>]:PNOise<t>:IPN?	429
FETCh<n>[:RANGe<ri>]:PNOise<t>:RAM?	429
FETCh<n>[:RANGe<ri>]:PNOise<t>:RFM?	430
FETCh<n>[:RANGe<ri>]:PNOise<t>:RMS?	430
FETCh<n>[:RANGe<ri>]:PNOise<t>:RPM?	431
MMEMory:STORe<n>:SPURs	431
[SENSe:]BWIDth:MEASurement?	432
TRACe<n>[:DATA]?	432
TRACe<n>[:DATA]:LINear?	433
TRACe<n>:POINts?	434
TRACe<n>[:DATA]:X?	435
TRACe<n>[:DATA]:X:POINts?	435
TRACe<n>[:DATA]:Y?	435
TRACe<n>[:DATA]:Y:POINts?	436

FETCh<n>[:RANGe<ri>]:PNOise<t>:DUT:GAIN?

This command queries the DUT gain.

The DUT gain is the ratio of the power measured at the DUT output and the power applied to the DUT input.

Suffix:

<n>	irrelevant
<ri>	irrelevant
<t>	irrelevant

Return values:

<values>	<numeric value>
	Default unit: dB

Example:

```
//Query DUT gain
FETC:RANG:PNO:DUT:GAIN?
would return, e.g.
2.28
```

Usage: Query only

FETCh<n>:PNOise<t>:SPURs?

This command queries the location and level of all spurs that have been detected.

Suffix:

<n>	Window
<t>	Trace

Return values:

<SpurCoordinates> Returns two values (frequency and level) for each each spur that has been detected.

Example:

```
//Query spur characteristics
FETC:PNO:SPUR?
would return, e.g.
1999.232666,-0.639974,6494.312500,-0.760579,
19992.324219,-0.639974
```

Usage: Query only

Manual operation: See "[Spurious List](#)" on page 125

FETCh<n>:PNOise<t>:SPURs:COUNT?

This command queries the number of spurious included in the spurious list.

Suffix:

<n>	1..n Window
<t>	1..n Trace

Return values:

<Count> Number of spurious

Example:

FETCH:PNO:SPURS:COUNT?

Usage:

Query only

Manual operation: See "[Spurious List](#)" on page 125

FETCH<n>:PNOise<t>:SPURs:DISCReTe?

This command queries the discrete jitter result.

Suffix:

<n> [Window](#)

<t> [Trace](#)

Return values:

<Jitter> <numeric value>

Default unit: s

Example:

//Query discrete jitter
FETCH:PNO:SPUR:DISC?
would return, e.g.
2.3e-08

Usage:

Query only

Manual operation: See "[Spurious List](#)" on page 125

FETCH<n>:PNOise<t>:SPURs:JITTeR?

This command queries the jitter of the measured spurs.

Suffix:

<n> [Window](#)

<t> [Trace](#)

Return values:

<Jitter> <numeric value>

Default unit: s

Example:

//Query jitter of spurs
FETCH:PNO:SPUR:JITT?
would return, e.g.
+2.199886328E+004,+2.440125142E-012,
+7.332938281E+004, [...]

Usage:

Query only

Manual operation: See "[Spurious List](#)" on page 125

FETCh<n>:PNOise<t>:SPURs:RANDom?

This command queries the random jitter result.

Suffix:

<n> [Window](#)

<t> [Trace](#)

Return values:

<arg0> <numeric value>

Default unit: s

Example:

```
//Query random jitter
FETC:PNO:SPUR:RAND?
would return, e.g.
3.59e-09
```

Usage: Query only

Manual operation: See "[Spurious List](#)" on page 125

FETCh<n>[:RANGe<ri>]:PNOise<t>:IPN?

This command queries the integrated phase noise.

Suffix:

<n> [Window](#)

<ri> [Integration range](#)

<t> [Trace](#)

Return values:

<Level> <numeric value>

Default unit: dBc

Example:

```
//Query integrated phase noise
FETC:RANG2:PNO2:IPN?
would return, e.g.
-16.79
```

Usage: Query only

Manual operation: See "[Integrated Measurements](#)" on page 124

FETCh<n>[:RANGe<ri>]:PNOise<t>:RAM?

This command queries the residual AM.

Suffix:

<n> [Window](#)

<ri> [Integration range](#)

<t> [Trace](#)

Return values:

<Am> <numeric value>
 In case of Baseband Noise measurements, the result is always 0.
 Default unit: PCT

Example:

```
//Query residual AM
FETC:RANG2:PNO:RAM?
would return, e.g.
0.01196555513888597
```

Usage:

Query only

Manual operation: See ["Integrated Measurements"](#) on page 124

FETCh<n>[:RANGe<ri>]:PNOise<t>:RFM?

This command queries the residual FM.

Suffix:

<n> [Window](#)
 <ri> [Integration range](#)
 <t> [Trace](#)

Return values:

<Frequency> <numeric value>
 In case of Baseband Noise measurements, the result is always 0.
 Default unit: Hz

Example:

```
//Query residual FM
FETC:RANG2:PNO:RFM?
would return, e.g.
88110000
```

Usage:

Query only

Manual operation: See ["Integrated Measurements"](#) on page 124

FETCh<n>[:RANGe<ri>]:PNOise<t>:RMS?

This command queries the residual RMS jitter.

Suffix:

<n> [Window](#)
 <ri> [Integration range](#)
 <t> [Trace](#)

Return values:

<Jitter> <numeric value>
 In case of Baseband Noise measurements, the result is always 0.
 Default unit: s

Example:

```
//Query RMS jitter
FETC:RANG2:PNO2:RMS?
would return, e.g.
0.02175
```

Usage:

Query only

Manual operation: See ["Integrated Measurements"](#) on page 124

FETCh<n>[:RANGe<ri>]:PNOise<t>:RPM?

This command queries the residual PM.

Suffix:

<n> [Window](#)
 <ri> [Integration range](#)
 <t> [Trace](#)

Return values:

<Phase> <numeric value>
 In case of Baseband Noise measurements, the result is always 0.
 Default unit: deg

Example:

```
//Query residual PM
FETC:RANG2:PNO:RPM?
would return, e.g.
11.73
```

Usage:

Query only

Manual operation: See ["Integrated Measurements"](#) on page 124

MMEMory:STORe<n>:SPURs <FileName>[, <Trace>]

This command exports the spur information to a file.

Secure User Mode

In secure user mode, settings that are stored on the instrument are stored to volatile memory, which is restricted to 256 MB. Thus, a "memory limit reached" error can occur although the hard disk indicates that storage space is still available.

To store data permanently, select an external storage location such as a USB memory device.

For details, see [Chapter 11.2, "Protecting data using the secure user mode"](#), on page 263.

Suffix:

<n> 1..n
[Window](#)

Setting parameters:

<FileName> String containing the path and name of the target file.
 <Trace> <numeric value> (integer only)
 Trace from which the spur information is collected.
 If you do not define a trace, all spurs over all traces are exported.

Example: //Store spur information of trace 1
 MMEM:STOR:SPUR 'c:\spurs.asc',1

Usage: Setting only

[SENSe:]BWIDth:MEASurement?

This command queries the measurement bandwidth of the frequency stability measurements (Allan variance and deviation).

Return values:

<Bandwidth> <numeric value>
 Default unit: Hz

Example: //Query measurement bandwidth
 BWID:MEAS?

Usage: Query only

Manual operation: See "[Allan Variance / Allan Deviation](#)" on page 127

TRACe<n>[:DATA]? <Trace>

This command queries the trace data (measurement results).

Suffix:

<n> 1..n
[Window](#)

Query parameters:

<Trace> **TRACE1 | ... | TRACE6**
 Queries the data of one of the colored line traces.
XGIndicator
 Queries the data of the cross-correlation gain indicator (gray area).

Return values:

<Result> • Phase noise measurements

Coordinates of the trace as list of comma-separated values, beginning at the nearest offset frequency.

- Baseband noise measurements

Coordinates of the trace as list of comma-separated values, beginning at the start frequency.

- VCO characterization

Coordinates of the trace as list of comma-separated values, beginning at the first sweep voltage.

- Spot noise vs tune

Coordinates of the trace as list of comma-separated values, beginning at the first sweep voltage.

- Transient analysis

Coordinates of the trace (frequency or phase) as a list of comma-separated values, over the defined measurement time.

Example: //Query trace data
 TRAC? TRACE1
 would return the data of trace 1, e.g.:
 1000.000000, -82.326393, 1011.579712, -82.411499,
 1023.292969, -82.538643, [...]

Usage: Query only

Manual operation: See ["Noise Diagram"](#) on page 123
 See ["Allan Variance / Allan Deviation"](#) on page 127
 See ["Frequency \(VCO Characterization\)"](#) on page 128
 See ["Sensitivity"](#) on page 128
 See ["Power"](#) on page 128
 See ["Current / Voltage"](#) on page 129
 See ["Power vs. Frequency"](#) on page 129
 See ["Harmonic Power"](#) on page 129
 See ["Spot Noise vs Tune PN"](#) on page 130
 See ["Spot Noise vs Tune AM"](#) on page 130
 See ["Frequency \(Transient Analysis\)"](#) on page 130
 See ["Frequency Deviation"](#) on page 131
 See ["Phase"](#) on page 131
 See ["Cross-correlation gain indicator"](#) on page 168

TRACe<n>[:DATA]:LINear? <Trace>, <Points>[, <Start>, <Stop>]

This command queries the trace data with linear interpolation.

Suffix:

<n> 1..n
 [Window](#)

Query parameters:

<Trace> **TRACE1 | ... | TRACE6**
 Queries the data of one of the colored line traces.

XGINdicator
 Queries the data of the cross-correlation gain indicator (gray area).

<Points>	<numeric value> (integer only) Defines the number of linearly spaced measurement points that are returned within the specified frequency range (defined by the start and stop values).
<Start>	<numeric value> Defines the start offset of the frequency range whose trace data you like to query. The start offset must be within the measurement range you have defined. If you do not define a start and stop offset, the command returns the trace data for the complete measurement range that was defined. Minimum start offset is 0 Hz. Default unit: Hz
<Stop>	<numeric value> Defines the stop offset of the frequency range whose trace data you like to query. The stop offset must be within the measurement range you have defined. If you do not define a start and stop offset, the command returns the trace data for the complete measurement range that was defined. Maximum stop offset depends on the measurement range. Default unit: Hz

Return values:

<Result>	String that contains the trace data as comma-separated values. Each data point consists of two values: offset frequency in Hz and level in dBc/Hz. The number of value pairs depends on the number of points you have defined.
----------	---

Example:

```
//Query linear trace data
TRAC:LIN? TRACE1,5,100,100000
would return, e.g.
100.000000,0.000000,25075.000000,-139.424408,
50050.000000,-140.380112,75025.000000,
-139.754211,100000.000000,-141.686478
```

Usage:	Query only
---------------	------------

TRACe<n>:POINTs? <Trace>

This command queries the number of measurement points of a specific trace.

Suffix:

<n>	1..n Window
-----	--------------------------------

Query parameters:

<Trace> TRACe1 | TRACe2 | TRACe3 | TRACe4 | TRACe5 | TRACe6 | XGINdicator

"XGINdicator" only available for phase noise measurements.

Return values:

<Points> <numeric value> (integer)

Example:

//Query number of measurement points of a trace in window 2
TRAC2:POIN? TRACE1

Usage:

Query only

TRACe<n>[:DATA]:X? <Trace>

Queries X trace values merged with spurs for a given window and trace.

Suffix:

<n> 1..n
[Window](#)

Query parameters:

<Trace> TRACe1 | TRACe2 | TRACe3 | TRACe4 | TRACe5 | TRACe6

Return values:

<Result> Comma separated list of X values

Usage:

Query only

Manual operation: See "[Noise Diagram](#)" on page 123

TRACe<n>[:DATA]:X:POINts? <Trace>

Queries number of points of trace data merged with spurs.

Suffix:

<n> 1..n
[Window](#)

Query parameters:

<Trace> TRACe1 | TRACe2 | TRACe3 | TRACe4 | TRACe5 | TRACe6

Return values:

<Points> <numeric value> (integer)

Usage:

Query only

Manual operation: See "[Noise Diagram](#)" on page 123

TRACe<n>[:DATA]:Y? <Trace>

Queries Y trace values merged with spurs for a given window and trace.

Suffix:

<n> 1..n
[Window](#)

Query parameters:

<Trace> TRACe1 | TRACe2 | TRACe3 | TRACe4 | TRACe5 | TRACe6

Return values:

<Result> Comma separated list of Y values

Usage: Query only

Manual operation: See "[Noise Diagram](#)" on page 123

TRACe<n>[:DATA]:Y:POINts? <Trace>

Queries number of points of trace data merged with spurs.

Suffix:

<n> 1..n
[Window](#)

Query parameters:

<Trace> TRACe1 | TRACe2 | TRACe3 | TRACe4 | TRACe5 | TRACe6

Return values:

<Points> <numeric value> (integer)

Usage: Query only

Manual operation: See "[Noise Diagram](#)" on page 123

14.5.4 Programming examples

Performing a phase noise measurement

```
//Preset
*RST
//Select single sweep mode
INIT:CONT OFF
// Configure start and stop offset
SENS:FREQ:START 1kHz
SENS:FREQ:STOP 1MHZ
// Configure RBW in %
LIST:BWID:RAT 10
// Configure cross correlation factor
SWE:XFAC 1
// Start synchronized measurement
INIT:IMM;*OPC?
// Turn on marker 1 in window 1
CALC1:MARK1:STAT ON
// Set marker 1 stimulus
```

```
CALC1:MARK1:X 300 kHz
// Query marker 1 result
CALC1:MARK1:Y?
```

14.6 Common measurement settings

- Remote commands to configure the input source.....437
- Output..... 451
- Remote commands to configure user ports..... 465
- Remote commands to configure level characteristics.....467
- Remote commands to configure the frequency..... 473
- Phase noise measurement configuration.....478
- Pulsed Phase Noise Configuration..... 498
- VCO characterization configuration..... 501
- Spot noise vs tune configuration.....504
- Transient analysis..... 508

14.6.1 Remote commands to configure the input source

- RF input.....437
- Baseband input..... 439
- External mixer..... 440

14.6.1.1 RF input

INPut<ip>:COUPling.....	437
INPut<ip>:SELect.....	438
INPut<ip>:LOSCillator:SOURce.....	438
INPut<ip>:LOSCillator:SOURce:EXTernal:LEVel.....	438

INPut<ip>:COUPling <CouplingType>

Selects the coupling type of the RF input.

Suffix:

<ip>	1 2 irrelevant
------	---------------------

Parameters:

<CouplingType>	AC DC AC AC coupling DC DC coupling *RST: AC
----------------	---

Example: INP:COUP DC

Manual operation: See ["Input Coupling"](#) on page 136

INPut<ip>:SELEct <Source>

Selects the signal source for measurements, i.e. it defines which connector is used to input data to the R&S FSWP.

Suffix:

<ip> 1 | 2
 irrelevant

Parameters:

<Source> **ABB**
 Analog Baseband signal

RF
 Radio Frequency ("RF INPUT" connector)

 *RST: RF

Manual operation: See ["Radio Frequency State"](#) on page 136

INPut<ip>:LOSCillator:SOURce <Location>

Selects the type of local oscillator in the test setup.

Prerequisites for this command

- Select additive noise or pulsed additive noise measurement ([CONFigure: PNOise:MEASurement](#)).

Suffix:

<ip> 1..n
 irrelevant

Parameters:

<Location> **EXTErnal**
 External local oscillator connected to the "LO AUX Input" of the R&S FSWP.

INTernAl
 Internal local oscillator of the R&S FSWP.

 *RST: INTernAl

Example:

```
//Select external oscillator
CONF:PNO:MEAS RES
INP:LOSC:SOUR EXT
```

Manual operation: See ["Local Oscillator"](#) on page 136

INPut<ip>:LOSCillator:SOURce:EXTErnal:LEVEl <Level>

Selects the level of an external LO signal that is fed into the R&S FSWP.

Prerequisites for this command

- Select additive noise or pulsed additive noise measurement (`CONFigure: PNOise:MEASurement`).
- Select an external local oscillator (`INPut<ip>:LOSCillator:SOURce`).

Suffix:

<ip> 1..n
 irrelevant

Parameters:

<Level> **HIGH**
 LO signal with high level characteristics.
LOW
 LO signal with low level characteristics.
*RST: HIGH

Example:

```
//Select an external LO with low signal level
CONF:PNO:MEAS RES
INP:LOSC:SOUR EXT
INP:LOSC:SOUR:EXT:LEV LOW
```

Manual operation: See "[Local Oscillator](#)" on page 136

14.6.1.2 Baseband input

[INPut<ip>:CONNector](#)..... 439

INPut<ip>:CONNector <Mode>

This command selects the measurement channel for baseband noise measurements.

Suffix:

<ip> 1..n
 irrelevant

Parameters:

<Mode> **CH1**
 Measurement on baseband channel 1.
CH2
 Measurement on baseband channel 2.
XCOR
 Measurement on both baseband channels (cross-correlation
 measurements).

Example:

```
//Perform measurement on baseband channel 1
INP:CONN CH1
```

14.6.1.3 External mixer

- [Mixer settings](#)..... 440
- [Basic settings](#)..... 446
- [Conversion loss table](#)..... 447

Mixer settings

[SENSe:]MIXer<x>:FREQuency:HANdOver	440
[SENSe:]MIXer<x>:FREQuency:STARt	440
[SENSe:]MIXer<x>:FREQuency:STOP	441
[SENSe:]MIXer<x>:HARMonic:BAND	441
[SENSe:]MIXer<x>:HARMonic:BAND:PRESet	442
[SENSe:]MIXer<x>:HARMonic:HIGH[:VALue]	442
[SENSe:]MIXer<x>:HARMonic:HIGH:STATe	442
[SENSe:]MIXer<x>:HARMonic:TYPE	443
[SENSe:]MIXer<x>:HARMonic[:LOW]	443
[SENSe:]MIXer<x>:LOSS:HIGH	443
[SENSe:]MIXer<x>:LOSS:TABLE:HIGH	444
[SENSe:]MIXer<x>:LOSS:TABLE[:LOW]	444
[SENSe:]MIXer<x>:LOSS[:LOW]	444
[SENSe:]MIXer<x>:PORTs	445
[SENSe:]MIXer<x>:RFOVerrange[:STATe]	445
[SENSe:]MIXer<x>:XCORr	445

[SENSe:]MIXer<x>:FREQuency:HANdOver <Frequency>

Defines the frequency at which the mixer switches from one range to the next (if two different ranges are selected). The handover frequency for each band can be selected freely within the overlapping frequency range.

Is only available if the external mixer is active (see [\[SENSe:\]MIXer<x>\[:STATe\]](#) on page 447).

Suffix:

<x>	1..n
	irrelevant

Parameters:

<Frequency>	Default unit: HZ
-------------	------------------

Example:

```
MIX ON
Activates the external mixer.
MIX:FREQ:HAND 78.0299GHz
Sets the handover frequency to 78.0299 GHz.
```

Manual operation: See "[Handover Freq](#)" on page 145

[SENSe:]MIXer<x>:FREQuency:STARt

Sets or queries the frequency at which the external mixer band starts.

Suffix:

<x> 1..n
irrelevant

Example:

MIX:FREQ:STAR?
Queries the start frequency of the band.

Manual operation: See "RF Start / RF Stop" on page 144

[SENSe:]MIXer<x>:FREQuency:STOP

Sets or queries the frequency at which the external mixer band stops.

Suffix:

<x> 1..n
irrelevant

Example:

MIX:FREQ:STOP?
Queries the stop frequency of the band.

Manual operation: See "RF Start / RF Stop" on page 144

[SENSe:]MIXer<x>:HARMonic:BAND <Band>

Selects the external mixer band. The query returns the currently selected band.

Is only available if the external mixer is active (see [SENSe:]MIXer<x>[:STATe] on page 447).

Suffix:

<x> 1..n
irrelevant

Parameters:

<Band> KA|Q|U|V|E|W|F|D|G|Y|J|USER
Standard waveguide band or user-defined band.

Manual operation: See "Band" on page 145

Table 14-3: Frequency ranges for pre-defined bands

Band	Frequency start [GHz]	Frequency stop [GHz]
KA (A) *)	26.5	40.0
Q	33.0	50.0
U	40.0	60.0
V	50.0	75.0
E	60.0	90.0
W	75.0	110.0
F	90.0	140.0

*) The band formerly referred to as "A" is now named "KA".

Band	Frequency start [GHz]	Frequency stop [GHz]
D	110.0	170.0
G	140.0	220.0
J	220.0	325.0
Y	325.0	500.0
USER	32.18 (default)	68.22 (default)

*) The band formerly referred to as "A" is now named "KA".

[SENSe:]MIXer<x>:HARMonic:BAND:PRESet

Restores the preset frequency ranges for the selected standard waveguide band.

Note: Changes to the band and mixer settings are maintained even after using the [PRESET] function. Use this command to restore the predefined band ranges.

Suffix:

<x> 1..n
 irrelevant

Example:

MIX:HARM:BAND:PRESet
Preset the selected waveguide band.

Manual operation: See "[Preset Band](#)" on page 145

[SENSe:]MIXer<x>:HARMonic:HIGH[:VALue] <HarmOrder>

Specifies the harmonic order to be used for the high (second) range.

Suffix:

<x> 1..n
 irrelevant

Parameters:

<HarmOrder> Range: 2 to 61 (USER band); for other bands: see band definition

Example:

MIX:HARM:HIGH:STAT ON
MIX:HARM:HIGH 3

Manual operation: See "[Harmonic Order](#)" on page 146

[SENSe:]MIXer<x>:HARMonic:HIGH:STATe <State>

Specifies whether a second (high) harmonic is to be used to cover the band's frequency range.

Suffix:

<x> 1..n

Parameters:

<State> ON | OFF
 *RST: ON

Example:

MIX:HARM:HIGH:STAT ON

Manual operation: See ["Range 1/Range 2"](#) on page 146

[SENSe:]MIXer<x>:HARMonic:TYPE <OddEven>

Specifies whether the harmonic order to be used should be odd, even, or both.

Which harmonics are supported depends on the mixer type.

Suffix:

<x> 1..n
 irrelevant

Parameters:

<OddEven> ODD | EVEN | EODD
ODD | EVEN | EODD
 *RST: EVEN

Example:

MIX:HARM:TYPE ODD

Manual operation: See ["Harmonic Type"](#) on page 146

[SENSe:]MIXer<x>:HARMonic[:LOW] <HarmOrder>

Specifies the harmonic order to be used for the low (first) range.

Suffix:

<x> 1..n
 irrelevant

Parameters:

<HarmOrder> Range: 2 to 61 (USER band); for other bands: see band definition
 *RST: 2 (for band F)

Example:

MIX:HARM 3

Manual operation: See ["Harmonic Order"](#) on page 146

[SENSe:]MIXer<x>:LOSS:HIGH <Average>

Defines the average conversion loss to be used for the entire high (second) range.

Suffix:

<x> 1..n
[Mixer](#)

Parameters:

<Average> Range: 0 to 100
 *RST: 24.0 dB
 Default unit: dB

Example: MIX:LOSS:HIGH 20dB

Manual operation: See "[Conversion Loss](#)" on page 146

[SENSe:]MIXer<x>:LOSS:TABLE:HIGH <FileName>

Defines the conversion loss table to be used for the high (second) range.

Suffix:

<x> 1..n
 [Mixer](#)

Parameters:

<FileName> String containing the path and name of the file, or the serial number of the external mixer whose file is required. The R&S FSWP automatically selects the correct cvl file for the current IF. As an alternative, you can also select a user-defined conversion loss table (.acl file).

Manual operation: See "[Conversion Loss](#)" on page 146

[SENSe:]MIXer<x>:LOSS:TABLE[:LOW] <FileName>

Defines the file name of the conversion loss table to be used for the low (first) range.

Suffix:

<x> 1..n
 [Mixer](#)

Parameters:

<FileName> String containing the path and name of the file, or the serial number of the external mixer whose file is required. The R&S FSWP automatically selects the correct cvl file for the current IF. As an alternative, you can also select a user-defined conversion loss table (.acl file).

Example: MIX:LOSS:TABLE '101567'
 MIX:LOSS:TABLE?
 //Result:
 '101567_MAG_6_B5000_3G5.B5G'

Manual operation: See "[Conversion Loss](#)" on page 146

[SENSe:]MIXer<x>:LOSS[:LOW] <Average>

Defines the average conversion loss to be used for the entire low (first) range.

Suffix:

<x> 1..n
Mixer

Parameters:

<Average> Range: 0 to 100
*RST: 24.0 dB
Default unit: dB

Example: MIX:LOSS 20dB

Manual operation: See "[Conversion Loss](#)" on page 146

[SENSe:]MIXer<x>:PORTs <PortType>

Queries the connected mixer type. Currently, only three-port mixers are supported.

Suffix:

<x> 1..n
irrelevant

Parameters:

<PortType> 2 | 3
2
Two-port mixer.
3
Three-port mixer.
*RST: 2

Example: MIX:PORT 3

[SENSe:]MIXer<x>:RFOVerrange[:STATe] <State>

If enabled, the band limits are extended beyond "RF Start" and "RF Stop" due to the capabilities of the used harmonics.

Suffix:

<x> 1..n
irrelevant

Parameters:

<State> ON | OFF | 1 | 0
*RST: 0

Manual operation: See "[RF Overrange](#)" on page 145

[SENSe:]MIXer<x>:XCORr <State>

This command turns cross-correlation with two external mixers on and off.

Suffix:

<x> 1..n
irrelevant

Parameters:

<State> ON | OFF | 1 | 0
*RST: ON

Example:

//Turn on cross-correlation with two mixers
MIX:XCOR ON

Manual operation: See "[Mixer XCORR](#)" on page 146

Basic settings

[SENSe:]MIXer<x>:BIAS:HIGH	446
[SENSe:]MIXer<x>:BIAS[:LOW]	446
[SENSe:]MIXer<x>[:STATe]	447
[SENSe:]MIXer<x>:LOPower	447

[SENSe:]MIXer<x>:BIAS:HIGH <BiasSetting>

Defines the bias current for the high (last) range.

Is only available if the external mixer is active (see [\[SENSe:\]MIXer<x>\[:STATe\]](#) on page 447).

Suffix:

<x> 1..n
irrelevant

Parameters:

<BiasSetting> *RST: 0.0 A
Default unit: A

Manual operation: See "[Bias Value](#)" on page 148

[SENSe:]MIXer<x>:BIAS[:LOW] <BiasSetting>

Defines the bias current for the low (first) range.

Is only available if the external mixer is active (see [\[SENSe:\]MIXer<x>\[:STATe\]](#) on page 447).

Suffix:

<x> 1..n
irrelevant

Parameters:

<BiasSetting> *RST: 0.0 A
Default unit: A

Manual operation: See "[Bias Value](#)" on page 148

[SENSe:]MIXer<x>[:STATe] <State>

Activates or deactivates the use of a connected external mixer as input for the measurement. This command is only available if the optional External Mixer is installed and an external mixer is connected.

Suffix:

<x> 1..n
 irrelevant

Parameters:

<State> ON | OFF | 1 | 0
 *RST: 0

Example: MIX ON

Manual operation: See "[External Mixer \(State\)](#)" on page 144

[SENSe:]MIXer<x>:LOPower <Level>

Specifies the LO level of the external mixer's LO port.

Suffix:

<x> 1..n
 irrelevant

Parameters:

<Level> Range: 13.0 dBm to 17.0 dBm
 Increment: 0.1 dB
 *RST: 15.5 dBm
 Default unit: DBM

Example: MIX:LOP 16.0dBm

Manual operation: See "[LO Level](#)" on page 148

Conversion loss table

[SENSe:]CORRection:CVL:BAND	448
[SENSe:]CORRection:CVL:BIAS	448
[SENSe:]CORRection:CVL:CATalog?	448
[SENSe:]CORRection:CVL:CLEar	449
[SENSe:]CORRection:CVL:COMMeNt	449
[SENSe:]CORRection:CVL:DATA	449
[SENSe:]CORRection:CVL:HARMonic	450
[SENSe:]CORRection:CVL:MIXer	450
[SENSe:]CORRection:CVL:PORTs	450
[SENSe:]CORRection:CVL:SElect	451
[SENSe:]CORRection:CVL:SNUMber	451

[SENSe:]CORRection:CVL:BAND <Band>

Defines the waveguide band for which the conversion loss table is to be used. This setting is checked against the current mixer setting before the table can be assigned to the range.

Before this command can be performed, the conversion loss table must be selected (see [SENSe:]CORRection:CVL:SElect on page 451).

Is only available with option B21 (External Mixer) installed.

Parameters:

<Band> K | KA | Q | U | V | E | W | F | D | G | Y | J | USER
Standard waveguide band or user-defined band.
For a definition of the frequency range for the pre-defined bands, see Table 14-3).

*RST: F (90 GHz - 140 GHz)

Example:

CORR:CVL:SEL 'LOSS_TAB_4'

Selects the conversion loss table.

CORR:CVL:BAND KA

Sets the band to KA (26.5 GHz - 40 GHz).

Manual operation: See "Band" on page 152

[SENSe:]CORRection:CVL:BIAS <BiasSetting>

Defines the bias setting to be used with the conversion loss table.

Before this command can be performed, the conversion loss table must be selected (see [SENSe:]CORRection:CVL:SElect on page 451).

Is only available with option B21 (External Mixer) installed.

Parameters:

<BiasSetting> *RST: 0.0 A
Default unit: A

Example:

CORR:CVL:SEL 'LOSS_TAB_4'

Selects the conversion loss table.

CORR:CVL:BIAS 3A

Manual operation: See "Write to CVL table" on page 149
See "Bias" on page 152

[SENSe:]CORRection:CVL:CATalog?

Queries all available conversion loss tables saved in the C:\R_S\INSTR\USER\cvl\ directory on the instrument.

Is only available with option B21 (External Mixer) installed.

Return values:

<Files> 'string'
Comma-separated list of strings containing the file names.

Example: CORR:CVL:CAT?

Usage: Query only

[SENSe:]CORRection:CVL:CLEar

Deletes the selected conversion loss table. Before this command can be performed, the conversion loss table must be selected (see [\[SENSe:\]CORRection:CVL:SELEct](#) on page 451).

Is only available with option B21 (External Mixer) installed.

Example: CORR:CVL:SEL 'LOSS_TAB_4'
Selects the conversion loss table.
CORR:CVL:CLE

Manual operation: See "[Delete Table](#)" on page 150

[SENSe:]CORRection:CVL:COMMeNT <Text>

Defines a comment for the conversion loss table. Before this command can be performed, the conversion loss table must be selected (see [\[SENSe:\]CORRection:CVL:SELEct](#) on page 451).

Is only available with option B21 (External Mixer) installed.

Parameters:

<Text>

Example: CORR:CVL:SEL 'LOSS_TAB_4'
Selects the conversion loss table.
CORR:CVL:COMM 'Conversion loss table for
FS_Z60'

Manual operation: See "[Comment](#)" on page 152

[SENSe:]CORRection:CVL:DATA {<Freq>, <Level>}...

Defines the reference values of the selected conversion loss tables. The values are entered as a set of frequency/level pairs. You can define a maximum of 500 frequency/level pairs. Before this command can be performed, you must select the conversion loss table (see [\[SENSe:\]CORRection:CVL:SELEct](#) on page 451).

Is only available with option B21 (External Mixer) installed.

Parameters:

<Freq> The frequencies have to be sent in ascending order.
Default unit: HZ

<Level> Default unit: DB

Example: CORR:CVL:SEL 'LOSS_TAB_4'
 Selects the conversion loss table.
 CORR:CVL:DATA 1MHZ,-30DB,2MHZ,-40DB

Manual operation: See "[Position/Value](#)" on page 153

[SENSe:]CORRection:CVL:HARMonic <HarmOrder>

Defines the harmonic order for which the conversion loss table is to be used. This setting is checked against the current mixer setting before the table can be assigned to the range.

Before this command can be performed, the conversion loss table must be selected (see [\[SENSe:\]CORRection:CVL:SElect](#) on page 451).

Is only available with option B21 (External Mixer) installed.

Parameters:

<HarmOrder> Range: 2 to 65

Example: CORR:CVL:SEL 'LOSS_TAB_4'
 Selects the conversion loss table.
 CORR:CVL:HARM 3

Manual operation: See "[Harmonic Order](#)" on page 152

[SENSe:]CORRection:CVL:MIXer <Type>

Defines the mixer name in the conversion loss table. This setting is checked against the current mixer setting before the table can be assigned to the range.

Before this command can be performed, the conversion loss table must be selected (see [\[SENSe:\]CORRection:CVL:SElect](#) on page 451).

Is only available with option B21 (External Mixer) installed.

Parameters:

<Type> string
 Name of mixer with a maximum of 16 characters

Example: CORR:CVL:SEL 'LOSS_TAB_4'
 Selects the conversion loss table.
 CORR:CVL:MIX 'FS_Z60'

Manual operation: See "[Mixer Name](#)" on page 152

[SENSe:]CORRection:CVL:PORTs <PortType>

Defines the mixer type in the conversion loss table. This setting is checked against the current mixer setting before the table can be assigned to the range.

Before this command can be performed, the conversion loss table must be selected (see [\[SENSe:\]CORRection:CVL:SElect](#) on page 451).

Is only available with option B21 (External Mixer) installed.

Parameters:

<PortType> 2 | 3
 *RST: 2

Example:

```
CORR:CVL:SEL 'LOSS_TAB_4'
Selects the conversion loss table.
CORR:CVL:PORT 3
```

Manual operation: See "[Mixer Type](#)" on page 153

[SENSe:]CORRection:CVL:SElect <FileName>

Selects the conversion loss table with the specified file name. If <file_name> is not available, a new conversion loss table is created.

Is only available with option B21 (External Mixer) installed.

Parameters:

<FileName> String containing the path and name of the file.

Example:

```
CORR:CVL:SEL 'LOSS_TAB_4'
```

Manual operation: See "[New Table](#)" on page 150
 See "[Edit Table](#)" on page 150
 See "[File Name](#)" on page 151

[SENSe:]CORRection:CVL:SNUMber <SerialNo>

Defines the serial number of the mixer for which the conversion loss table is to be used. This setting is checked against the current mixer setting before the table can be assigned to the range.

Before this command can be performed, the conversion loss table must be selected (see [\[SENSe:\]CORRection:CVL:SElect](#) on page 451).

Is only available with option B21 (External Mixer) installed.

Parameters:

<SerialNo> Serial number with a maximum of 16 characters

Example:

```
CORR:CVL:SEL 'LOSS_TAB_4'
Selects the conversion loss table.
CORR:CVL:MIX '123.4567'
```

Manual operation: See "[Mixer S/N](#)" on page 152

14.6.2 Output

- [DC power](#)..... 452
- [Signal source](#)..... 461
- [Miscellaneous output](#)..... 465

14.6.2.1 DC power

SOURce:CURRent:AUX:LIMit:HIGH?	452
SOURce:CURRent:CONTRol<i>:LIMit:HIGH?	452
SOURce:CURRent:POWer<i>:LIMit:HIGH	453
SOURce:CURRent:SEQuence:RESult?	453
SOURce:POWer:SEQuence:RESult?	454
SOURce:VOLTag:e:AUX:LEVel:AMPLitude	454
SOURce:VOLTag:e:AUX:LEVel:LIMit:HIGH	454
SOURce:VOLTag:e:AUX:LEVel:LIMit:LOW	454
SOURce:VOLTag:e:AUX:LEVel[:STATe]	455
SOURce:VOLTag:e:CHANnel:COUPling	455
SOURce:VOLTag:e:CONTRol<i>:LEVel:AMPLitude	456
SOURce:VOLTag:e:CONTRol<i>:LEVel:LIMit:HIGH	456
SOURce:VOLTag:e:CONTRol<i>:LEVel:LIMit:LOW	456
SOURce:VOLTag:e:CONTRol<i>:LEVel[:STATe]	457
SOURce:VOLTag:e:POWer<i>:LEVel:AMPLitude	457
SOURce:VOLTag:e:POWer<i>:LEVel:LIMit:HIGH	458
SOURce:VOLTag:e:POWer<i>:LEVel:LIMit:LOW	458
SOURce:VOLTag:e:POWer<i>:LEVel:MODE	458
SOURce:VOLTag:e:POWer<i>:LEVel[:STATe]	459
SOURce:VOLTag:e:POWer<i>:LIMit:HIGH	459
SOURce:VOLTag:e:SEQuence:RESult?	460
SOURce:VOLTag:e[:STATe]	460

SOURce:CURRent:AUX:LIMit:HIGH?

Returns the maximum current of the V_{aux} connector.

Return values:

<Current> <numeric value>
 The return value is always 0.1 A.

Example: //Query maximum current
 SOUR:CURR:AUX:LIM:HIGH?
 returns
 0.1

Usage: Query only

SOURce:CURRent:CONTRol<i>:LIMit:HIGH?

Returns the maximum current of the V_{tune} connector.

Suffix:

<i> 1..n
 irrelevant

Return values:

<Current> <numeric value>
 The return value is always 0.02 A.
 Default unit: A

Example:

```
//Query maximum current
SOUR:CURR:CONT:LIM:HIGH?
returns
0.02
```

Usage:

Query only

SOURce:CURRent:POWer<i>:LIMit:HIGH <Current>

Defines the maximum current of the V_{supply} connector.

Prerequisites for this command

- V_{supply} is controlled in terms of voltage (`SOURce:VOLTage:POWer<i>:LEVel:MODE`).

Suffix:

<i> 1..n
 irrelevant

Parameters:

<Current> <numeric value>
 Range: 0 to 2
 *RST: 2
 Default unit: A

Example:

```
//Define a maximum output current of 1000 mA
SOUR:CURR:POW:LIM:HIGH 1
```

Manual operation: See "[Defining the output level](#)" on page 180

SOURce:CURRent:SEQuence:RESult?

Queries the actually measured current on the DC power sources.

Prerequisites for this command

- Turn on the DC power source (`SOURce:VOLTage[:STATe]`).

Example:

```
//Query current on all DC power sources
SOUR:CURR:SEQ:RES?
would return, e.g.
0.000000, -0.100000, -0.020000
```

Usage:

Query only

Manual operation: See "[Reading the actual output levels](#)" on page 181

SOURce:POWer:SEQuence:RESult?

Queries the actually measured power ($U \cdot I$) on the DC power sources.

Prerequisites for this command

- Turn on DC power sources (`SOURce:VOLTage[:STATe]`).

Example: //Query power output by the DC power sources
 `SOUR:POW:SEQ:RES?`
 would return, e.g.
 `0.000000, 1.000000, 0.200000`

Usage: Query only

Manual operation: See "[Reading the actual output levels](#)" on page 181

SOURce:VOLTage:AUX:LEVel:AMPLitude <Voltage>

Defines the output voltage for the V_{aux} source.

Parameters:

<Voltage> <numeric value>
 Range: -10 to 10
 *RST: 0
 Default unit: V

Example: //Defines an output voltage of 1 V on the V_{aux} source
 `SOUR:VOLT:AUX:LEV:AMPL 1`

Manual operation: See "[Defining the output level](#)" on page 180

SOURce:VOLTage:AUX:LEVel:LIMit:HIGH <Voltage>

Defines the maximum voltage that may be supplied by the V_{aux} source.

Parameters:

<Voltage> <numeric value>
 Range: -10 to 10
 *RST: 0
 Default unit: V

Example: //Define a maximum voltage of 5 V
 `SOUR:VOLT:AUX:LEV:LIM:HIGH 5`

Manual operation: See "[Defining the output level](#)" on page 180

SOURce:VOLTage:AUX:LEVel:LIMit:LOW <Voltage>

Defines the minimum voltage that may be supplied by the V_{aux} source.

Parameters:

<Voltage> <numeric value>
 Range: -10 to 10
 *RST: 0
 Default unit: V

Example:

```
//Define a minimum voltage of -5 V
SOUR:VOLT:AUX:LEV:LIM:LOW -5
```

Manual operation: See ["Defining the output level"](#) on page 180

SOURce:VOLTage:AUX:LEVel[:STATe] <State>

Turns the auxiliary voltage source (V_{aux}) on and off.

Note that DC power is actually supplied only if you additionally activate the outputs in general.

Prerequisites for this command

- Turn on DC power sources (`SOURce:VOLTage[:STATe]`).

Parameters:

<State> ON | OFF | 1 | 0
 *RST: OFF

Example:

```
//Turns on the  $V_{aux}$  source.
SOUR:VOLT:AUX:LEV ON
```

Manual operation: See ["Turning the output on and off"](#) on page 179

SOURce:VOLTage:CHANnel:COUPling <State>

Couples or decouples the DC power configuration across measurement channels.

Parameters:

<State> **ON | 1**
 DC power configuration is the same across all measurement channels.
OFF | 0
 DC power configuration is different for each measurement channel.
 *RST: ON

Example:

```
//Use a different DC power setup for each active measurement
channel
SOUR:VOLT:CHAN:COUP OFF
```

Manual operation: See ["Coupling the output configuration across measurement channels"](#) on page 179

SOURce:VOLTage:CONTRol<i>:LEVel:AMPLitude <Voltage>

Defines the output voltage for the V_{tune} source.

Suffix:

<i> 1..n
 irrelevant

Parameters:

<Voltage> <numeric value>
Range: -10 to 28
*RST: 0
Default unit: V

Example: //Defines an output voltage of 1 V on the V_{tune} source
 SOUR:VOLT:CONT:LEV:AMPL 1

Manual operation: See ["Defining the output level"](#) on page 180

SOURce:VOLTage:CONTRol<i>:LEVel:LIMit:HIGH <Voltage>

Defines the maximum voltage that may be supplied by the V_{tune} source.

Suffix:

<i> 1..n
 irrelevant

Parameters:

<Voltage> <numeric value>
Range: -10 to 28
*RST: 0
Default unit: V

Example: //Defines a maximum voltage of 5 V
 SOUR:VOLT:CONT:LEV:LIM:HIGH 5

Manual operation: See ["Defining the output level"](#) on page 180

SOURce:VOLTage:CONTRol<i>:LEVel:LIMit:LOW <Voltage>

Defines the minimum voltage that may be supplied by the V_{tune} source.

Suffix:

<i> irrelevant

Parameters:

<Voltage> <numeric value>
Range: -10 to 28
*RST: 0
Default unit: V

Example: //Define a minimum voltage of -5 V
 SOUR:VOLT:CONT:LEV:LIM:LOW -5

Manual operation: See ["Defining the output level"](#) on page 180

SOURce:VOLTage:CONTRol<i>:LEVel[:STATe] <State>

Turns the tuning voltage source (V_{tune}) on and off.

Note that DC power is actually supplied only if you additionally activate the outputs in general.

Prerequisites for this command

- Turn on DC power sources (`SOURce:VOLTage[:STATe]`).

Suffix:

<i> 1..n
irrelevant

Parameters:

<State> ON | OFF | 1 | 0
*RST: OFF

Example: //Turn on the V_{tune} voltage source
`SOUR:VOLT:CONT:LEV ON`

Manual operation: See ["Turning the output on and off"](#) on page 179

SOURce:VOLTage:POWer<i>:LEVel:AMPLitude <Voltage/Current>

Defines the output voltage for the V_{supply} source.

Suffix:

<i> 1..n
irrelevant

Parameters:

<Voltage/Current> <numeric value>

The type of value depends on whether you control the output in terms of current or voltage (`SOURce:VOLTage:POWer<i>:LEVel:MODE`).

When you control it in terms of voltage, the value is a voltage (V). When you control it in terms of current, the value is the current (A).

Range: 0 to 16 V or 2000 mA

*RST: 0 V or 2000 mA

Default unit: V or A

Example: //Define an output voltage of 1 V on the V_{supply} source
`SOUR:VOLT:POW:LEV:AMPL 1`

Manual operation: See ["Defining the output level"](#) on page 180

SOURce:VOLTage:POWer<i>:LEVel:LIMit:HIGH <Voltage/Current>

Defines the maximum voltage that may be supplied by the V_{supply} source.

Suffix:

<i> 1..n
 irrelevant

Parameters:

<Voltage/Current> <numeric value>

The type of value depends on whether you control the output in terms of current or voltage (**SOURce:VOLTage:POWer<i>:LEVel:MODE**).

When you control it in terms of voltage, the value is a voltage (V). When you control it in terms of current, the value is the current (A).

Range: 0 to 16 V or 2000 mA

*RST: 16 V or 2000 mA

Default unit: V or A

Example:

```
//Define a maximum current of 1000 mA
SOUR:VOLT:POW:LEV:LIM:HIGH 1000MA
```

Manual operation: See ["Defining the output level"](#) on page 180

SOURce:VOLTage:POWer<i>:LEVel:LIMit:LOW <Voltage/Current>

Defines the minimum voltage that may be supplied by the V_{supply} source.

Suffix:

<i> irrelevant

Parameters:

<Voltage/Current> <numeric value>

The type of value depends on whether you control the output in terms of current or voltage (**SOURce:VOLTage:POWer<i>:LEVel:MODE**).

When you control it in terms of voltage, the value is a voltage (V). When you control it in terms of current, the value is the current (A).

Range: 0 to 16 V or 2000 mA

*RST: 16 V or 2000 mA

Default unit: V or A

Example:

```
//Define a minimum current of 500 mA
SOUR:VOLT:POW:LEV:LIM:LOW 500MA
```

Manual operation: See ["Defining the output level"](#) on page 180

SOURce:VOLTage:POWer<i>:LEVel:MODE <Mode>

Selects whether you want to control the output in terms of current or voltage.

Suffix:

<i> 1..n
irrelevant

Parameters:

<Mode> **CURRent**
Control the output in terms of current.
VOLTage
Controls the output in terms of voltage.
*RST: VOLTage

Example:

```
//Control the Vsupply source in terms of voltages
SOUR:VOLT:POW:LEV:MODE VOLT
```

Manual operation: See ["Selecting the output type \(Vsupply only\)"](#) on page 180

SOURce:VOLTage:POWer<i>:LEVel[:STATe] <State>

Turns the supply voltage source (V_{supply}) on and off.

Note that DC power is actually supplied only if you additionally activate the outputs in general.

Prerequisites for this command

- Turn on DC power sources (`SOURce:VOLTage[:STATe]`).

Suffix:

<i> 1..n
irrelevant

Parameters:

<State> ON | OFF | 1 | 0
*RST: ON

Example:

```
//Turn on the Vsupply voltage source
SOUR:VOLT:POW:LEV ON
```

Manual operation: See ["Turning the output on and off"](#) on page 179

SOURce:VOLTage:POWer<i>:LIMit:HIGH <Voltage>

Defines the maximum current or voltage that may be supplied by the V_{supply} source.

Suffix:

<i> 1..n
irrelevant

Parameters:

<Voltage>

<numeric value>

The type of value depends on whether you control the output in terms of current or voltage (`SOURce:VOLTage:POWer<i>:LEVel:MODE`).

When you control it in terms of voltage, the value is a current (A). When you control it in terms of current, the value is a voltage (V).

Range: 0 to 16 V or 2000 mA

*RST: 16 V or 2000 mA

Default unit: V or A

Example:

```
//Define a maximum output of 1000 mA
```

```
SOUR:VOLT:POW:LEV:MODE VOLT
```

```
SOUR:VOLT:POW:LIM:HIGH 1000MA
```

Manual operation: See ["Defining the output level"](#) on page 180

SOURce:VOLTage:SEQuence:RESult?

Queries the actually measured voltages on the DC power sources.

Prerequisites for this command

- Turn on DC power sources (`SOURce:VOLTage[:STATe]`).

Example:

```
//Query voltages of the DC power sources
```

```
SOUR:VOLT:SEQ:RES?
```

would return, e.g.

```
0.000000, -10.000000, -10.000000
```

Usage:

Query only

Manual operation: See ["Reading the actual output levels"](#) on page 181

SOURce:VOLTage[:STATe] <State>

Turns DC power sources on and off in general.

When you turn off the DC power sources, no power is supplied even when you have turned on one of the sources individually with one of the following commands.

- `SOURce:VOLTage:AUX:LEVel[:STATe]`
- `SOURce:VOLTage:CONTRol<i>:LEVel[:STATe]`
- `SOURce:VOLTage:POWer<i>:LEVel[:STATe]`

Note that you can turn on the global power supply if at least one of the individual supplies has been turned on.

Parameters:

<State>

ON | 1

DC power sources are ready for use.

OFF | 0

DC power sources are turned off.

*RST: OFF

Example:

```
//Turn on signal source
SOUR:VOLT:AUX:LEV ON
SOUR:VOLT ON
```

Manual operation: See ["Turning the DC output on and off"](#) on page 179

14.6.2.2 Signal source

SOURce:GENerator:DUTBypass.....	461
SOURce:GENerator:CHANnel:COUPling.....	461
SOURce:GENerator:FREQuency.....	462
SOURce:GENerator:FREQuency:STEP.....	462
SOURce:GENerator:LEVel.....	462
SOURce:GENerator:MODulation.....	463
SOURce:GENerator:PULSe:PERiod.....	463
SOURce:GENerator:PULSe:TRIGger:OUTPut.....	463
SOURce:GENerator:PULSe:WIDTh.....	464
SOURce:GENerator[:STATe].....	464

SOURce:GENerator:DUTBypass <State>

Turns the DUT bypass on and off.

When you turn on the bypass, the application measures the noise characteristics of the R&S FSWP.

The DUT bypass is available with the optional Signal Source hardware component.

Parameters:

<State> ON | OFF | 1 | 0
*RST: OFF

Example:

```
//Turn on DUT bypass
SOUR:GEN:DUTB ON
```

Manual operation: See ["Bypassing the DUT"](#) on page 184

SOURce:GENerator:CHANnel:COUPling <State>

Couples or decouples the signal source configuration across measurement channels.

Parameters:

<State> **ON | 1**
Signal source configuration is the same across all measurement channels.

OFF | 0
Signal source configuration is different for each measurement channel.

*RST: ON

Example: //Use the same signal source configuration across all channels
SOUR:GEN:CHAN:COUP ON

Manual operation: See ["Coupling the output configuration across measurement channels"](#) on page 179

SOURce:GENerator:FREQuency <Frequency>

Defines the frequency of the signal that is generated by the signal source.

Parameters:

<Frequency> <numeric value>
Default unit: Hz

Example: See `SOURce:GENerator[:STATe]` on page 464.

Manual operation: See ["Signal source frequency"](#) on page 183

SOURce:GENerator:FREQuency:STEP <Stepsize>

Defines the frequency stepsize of the signal generated by the optional signal source.

Parameters:

<Stepsize> 1 mHz | 1 Hz | 1 kHz | 1 MHz | 1 GHz
*RST: 1 MHz
Default unit: Hz

Example: //Define signal source stepsize
SOUR:GEN:FREQ:STEP 1KHZ

Manual operation: See ["Signal source frequency"](#) on page 183

SOURce:GENerator:LEVel <Level>

Defines the level of the signal that is generated by the signal source.

Parameters:

<Level> <numeric value>
Default unit: dBm

Example: See `SOURce:GENerator[:STATe]` on page 464.

Manual operation: See ["Signal source level"](#) on page 183

SOURce:GENerator:MODulation <State>

Turns internal pulse modulation for pulsed measurements on and off.

Parameters:

<State> **ON | 1**
 A pulse is output on the signal source.
 You can define the pulse characteristics with
 • [SOURce:GENerator:PULSe:PERiod](#)
 • [SOURce:GENerator:PULSe:WIDTh](#)

OFF | 0
 A sine signal is output on the signal source.
 *RST: OFF

Example: //Generate and output a pulse on the signal source
 SOUR:GEN:MOD ON
 SOUR:GEN:PULS:PER 10MS
 SOUR:GEN:PULS:WIDT 1MS

Manual operation: See "[Pulse modulation state](#)" on page 183

SOURce:GENerator:PULSe:PERiod <PulsePeriod>

Defines the pulse period (distance between two consecutive pulses) of the pulse that is generated.

Prerequisites for this command

- Optional pulsed phase noise measurements.
- Turn on signal source ([SOURce:GENerator\[:STATe\]](#)).
- Turn on pulse modulation ([SOURce:GENerator:MODulation](#)).

Parameters:

<PulsePeriod> <numeric value>
 *RST: 10 ms
 Default unit: s

Example: //Generate a pulse with a length of 15 ms and a pulse period of
 50 ms.
 SOUR:GEN ON
 SOUR:GEN:MOD ON
 SOUR:GEN:PULS:WIDT 15MS
 SOUR:GEN:PULS:PER 50MS

Manual operation: See "[Pulse characteristics](#)" on page 184

SOURce:GENerator:PULSe:TRIGger:OUTPut <SignalLevel>

Selects the signal type provided at the trigger output connector.

The signal can be used, for example, to control an external pulse modulator.

Parameters:

<SignalLevel>

HIGH

Provides a high active pulse at the trigger output.

Note that the signal is provided even if [internal pulse modulation](#) has been turned off.

You can define the pulse characteristics with

- [SOURce:GENerator:PULSe:WIDTh](#)
- [SOURce:GENerator:PULSe:PERiod](#)

LOW

Provides a low active pulse at the trigger output.

Note that the signal is provided even if [internal pulse modulation](#) has been turned off.

OFF | 0

Provides no signal at the trigger output.

*RST: OFF

Example:

```
//Generate a low pulse at the trigger output
SOUR:GENPULS:TRIG:OUTP LOW
```

Manual operation: See "[Pulse characteristics](#)" on page 184

SOURce:GENerator:PULSe:WIDTh <PulseWidth>

Defines the length of the pulse that is generated.

Prerequisites for this command

- Optional pulsed phase noise measurements.
- Turn on signal source ([SOURce:GENerator\[:STATe\]](#)).
- Turn on pulse modulation ([SOURce:GENerator:MODulation](#)).

Parameters:

<PulseWidth>

<numeric value>

*RST: 1 ms

Default unit: s

Example:

```
//Generate a pulse with a length of 15 ms
SOUR:GEN ON
SOUR:GEN:MOD ON
SOUR:GEN:PULS:WIDT 15MS
```

Manual operation: See "[Pulse characteristics](#)" on page 184

SOURce:GENerator[:STATe] <State>

Turns the optional signal source output on and off.

When you turn on the signal source, the R&S FSWP generates a signal with the frequency and level defined with [SOURce:GENerator:FREQuency](#) and [SOURce:GENerator:LEVel](#).

Parameters:

<State> ON | OFF | 1 | 0
 *RST: OFF

Example:

```
//Turn on the signal source output
SOUR:GEN:FREQ 100MHZ
//Generate a signal at 100 MHz and a level of -10 dBm.
SOUR:GEN:LEV -10
SOUR:GEN ON
```

Manual operation: See ["Signal source state"](#) on page 183

14.6.2.3 Miscellaneous output

[DIAGnostic:SERVice:NSOource](#).....465

DIAGnostic:SERVice:NSOource <State>

Turns the 28 V supply of the BNC connector labeled [noise source control] on the R&S FSWP on and off.

Parameters:

<State> ON | OFF | 0 | 1
OFF | 0
 Switches the function off
ON | 1
 Switches the function on

Example: DIAG:SERV:NSO ON

Manual operation: See ["Noise Source Control"](#) on page 186

14.6.3 Remote commands to configure user ports

[INPut:UPORt:STATe](#).....465
[INPut:UPORt\[:VALue\]](#).....466
[OUTPut<up>:UPORt:STATe](#).....466
[OUTPut:UPORt\[:VALue\]](#).....466

INPut:UPORt:STATe <State>

Toggles the control lines of the user ports for the **AUX PORT** connector. This 9-pole SUB-D male connector is located on the rear panel of the R&S FSWP.

See the R&S FSWP Getting Started manual for details.

Parameters:

<State> **ON | 1**
 User port is switched to INPut
OFF | 0
 User port is switched to OUTPut

*RST: 1

INPut:UPORt[:VALue]

Queries the control lines of the user ports.

For details see [OUTPut:UPORt\[:VALue\]](#) on page 466.

Return values:

<Level> bit values in hexadecimal format
 TTL type voltage levels (max. 5V)
 Range: #B00000000 to #B00111111

Example:

```
INP:UPOR?
//Result: #B00100100
Pins 5 and 7 are active.
```

OUTPut<up>:UPORt:STATe <State>

Toggles the control lines of the user ports for the **AUX PORT** connector. This 9-pole SUB-D male connector is located on the rear panel of the R&S FSWP.

Suffix:

<up> irrelevant

Parameters:

<State> ON | OFF | 0 | 1
OFF | 0
 User port is switched to INPut
ON | 1
 User port is switched to OUTPut

Example:

```
OUTP:UPOR:STAT ON
```

OUTPut:UPORt[:VALue] <Value>

Sets the control lines of the user ports.

The assignment of the pin numbers to the bits is as follows:

Bit	7	6	5	4	3	2	1	0
Pin	N/A	N/A	5	3	4	7	6	2

Bits 7 and 6 are not assigned to pins and must always be 0.

The user port is written to with the given binary pattern.

If the user port is programmed to input instead of output (see [INPut:UPORt:STATe](#) on page 465), the output value is temporarily stored.

Parameters:

<Value> bit values in hexadecimal format
 TTL type voltage levels (max. 5V)
 Range: #B00000000 to #B00111111

Example:

OUTP:UPOR #B00100100
 Sets pins 5 and 7 to 5 V.

14.6.4 Remote commands to configure level characteristics

Functions to configure level characteristics described elsewhere:

- `INPut<ip>:COUPling`
- `[SENSe:]POWer:RLEVel:MODE`

<code>DISPlay[:WINDow<n>]:TRACe<t>:X[:SCALe]</code>	467
<code>DISPlay[:WINDow<n>]:TRACe<t>:X[:SCALe]:AUTO</code>	468
<code>DISPlay[:WINDow<n>]:TRACe<t>:X:SPACing?</code>	468
<code>DISPlay[:WINDow<n>]:TRACe<t>:Y[:SCALe]</code>	468
<code>DISPlay[:WINDow<n>]:TRACe<t>:Y[:SCALe]:AUTO</code>	469
<code>DISPlay[:WINDow<n>]:TRACe<t>:Y[:SCALe]:RLEVel</code>	469
<code>DISPlay[:WINDow<n>]:TRACe<t>:Y[:SCALe]:RLEVel:LOWer</code>	470
<code>DISPlay[:WINDow<n>]:TRACe<t>:Y:UNIT</code>	470
<code>INPut<ip>:ATTenuation</code>	471
<code>INPut<ip>:ATTenuation:AUTO</code>	471
<code>[SENSe:]ADJust:CONFigure:LEVel:THReshold</code>	472
<code>[SENSe:]POWer:RLEVel?</code>	472
<code>[SENSe:]POWer:RLEVel:OFFSet</code>	472

`DISPlay[:WINDow<n>]:TRACe<t>:X[:SCALe] <Range>`

This command defines the display range of the x-axis.

Prerequisites for this command

- Turn off automatic scaling of the x-axis (`DISPlay[:WINDow<n>]:TRACe<t>:X[:SCALe]:AUTO`).

Suffix:

<n> 1..n
 Window
 <t> 1..n
 irrelevant

Parameters:

<Range> Default unit: Depending on the selected diagram

Example:

//Define a value range of 100 MHz.
`DISP:TRAC:X:AUTO OFF`
`DISP:TRAC:X 100 MHz`

DISPlay[:WINDow<n>]:TRACe<t>:X[:SCALe]:AUTO <Mode>

This command turns automatic configuration of the horizontal axis on and off.

Suffix:

<n>	1..n Window
<t>	1..n irrelevant

Parameters:

<Mode>	ON 1 Scales the x-axis after each measurement.
	OFF 0 Allows you to define the scale manually.
	ONCE Scales the x-axis once. The scale remains the same for subsequent measurements.
	*RST: ON

Example: //Select manual scaling of the x-axis.
DISP:TRAC:X:AUTO OFF

DISPlay[:WINDow<n>]:TRACe<t>:X:SPACing?

This command queries the scale of the x-axis in any measurement window.

Suffix:

<n>	1..n Window
<t>	1..n irrelevant

Return values:

<Spacing>	LINEar X-axis has a linear scale.
	LOGarithmic X-axis has a logarithmic scale.

Example: //Query scale of the x-axis in the second measurement window
DISP:WIND2:TRAC:X:SPAC?

Usage: Query only

DISPlay[:WINDow<n>]:TRACe<t>:Y[:SCALe] <Range>

This command defines the value range displayed on the y-axis.

Prerequisites for this command

- Turn off automatic scaling of the y-axis (`DISPlay[:WINDow<n>]:TRACe<t>:Y[:SCALe]:AUTO`).

Suffix:

<n>	1..n Window
<t>	1..n irrelevant

Parameters:

<Range>	<numeric value> Default unit: Depending on the selected diagram
---------	--

Example:

```
//Define a value range of 100 dB.
DISP:TRAC:Y:AUTO OFF
DISP:TRAC:Y 100
```

Manual operation: See "[Scaling the y-axis](#)" on page 157

DISPlay[:WINDow<n>]:TRACe<t>:Y[:SCALE]:AUTO <Mode>

This command turns automatic scaling of the y-axis in graphical result displays on and off.

Suffix:

<n>	1..n Window
<t>	1..n irrelevant

Parameters:

<Mode>	ON 1 Scales the y-axis after each measurement. OFF 0 Allows you to define the scale manually. ONCE Scales the y-axis once. The scale remains the same for subsequent measurements. *RST: ON
--------	---

Example:

```
//Select manual scaling of the y-axis.
DISP:TRAC:Y:AUTO OFF
```

Manual operation: See "[Scaling the y-axis](#)" on page 157
See "[Scaling the y-axis of the phase diagram](#)" on page 203

DISPlay[:WINDow<n>]:TRACe<t>:Y[:SCALE]:RLEVel <Level>

This command defines the maximum level displayed on the y-axis.

Prerequisites for this command

- Turn off automatic scaling of the y-axis (`DISPlay[:WINDow<n>]:TRACe<t>:Y[:SCALE]:AUTO`).

Suffix:

<n> 1..n
Window

<t> 1..n
irrelevant

Parameters:

<Level> <numeric value>
Default unit: Depending on the selected diagram

Example: //Define maximum level on the y-axis
DISP:TRAC:Y:RLEV -20

Manual operation: See "Scaling the y-axis" on page 157

DISPlay[:WINDow<n>]:TRACe<t>:Y[:SCALE]:RLEVel:LOWer <Level>

This command defines the minimum level displayed on the y-axis.

Prerequisites for this command

- Turn off automatic scaling of the y-axis (DISPlay[:WINDow<n>]:TRACe<t>:Y[:SCALE]:AUTO).

Suffix:

<n> 1..n
Window

<t> 1..n
irrelevant

Parameters:

<Level> <numeric value>
Default unit: Depending on the selected diagram

Example: //Query minimum level on the y-axis
DISP:TRAC:Y:RLEV:LOW?
would return, e.g.
-135

Manual operation: See "Scaling the y-axis" on page 157

DISPlay[:WINDow<n>]:TRACe<t>:Y:UNIT <Unit>

This command selects the unit of the y-axis.

Available for baseband noise measurements.

Suffix:

<n> 1..n
Window

<t> 1..n
irrelevant

Parameters:

<Unit> DB_hz | DBC | DBC_hz | DBM | DBM_hz | DBUV | DBUV_hz | NV | DBV | DBV_hz | HZ_Sqrt_hz | INV_Sqrt_hz | V | MA | V_Sqrt_hz
 *RST: DBM_hz

Example:

//Display the baseband noise results in the unit dBV/Hz.
 DISP:TRAC:Y:UNIT DBV

Manual operation: See "[Selecting the unit of the y-axis](#)" on page 158

INPut<ip>:ATTenuation <Attenuation>

This command defines the RF attenuation for the RF input.

Prerequisites for this command

- Turn off automatic attenuation configuration ([INPut<ip>:ATTenuation:AUTO](#)).

Suffix:

<ip> 1..n
 irrelevant

Parameters:

<Attenuation> <numeric value> (integer only)
 Range: See data sheet
 Increment: 5
 Default unit: dB

Example:

//Defines an attenuation of 10 dB
 INP:ATT:AUTO OFF
 INP:ATT 10

Manual operation: See "[Attenuating the signal](#)" on page 155

INPut<ip>:ATTenuation:AUTO <State>

This command turns automatic configuration of the attenuation on and off.

Suffix:

<ip> 1..n
 irrelevant

Parameters:

<State> **ON | 1**
 Automatically defines the ideal attenuation based on the current signal level.
OFF | 0
 Allows you to define the attenuation manually with [INPut<ip>:ATTenuation](#)
 *RST: ON

Example:

//Turn on automatic configuration of the attenuation
 INP:ATT:AUTO ON

Manual operation: See ["Attenuating the signal"](#) on page 155

[SENSe:]ADJJust:CONFIgure:LEVel:THReshold <Level>

This command defines the threshold of the signal search.

Prerequisites for this command

- Turn on the automatic signal search with `[SENSe:]ADJJust:CONFIgure:FREQuency:AUTosearch[:STATe]`

Parameters:

<Level> <numeric value>
 Default unit: dBm

Example: //Define a threshold of -10 dBm
 ADJ:CONF:LEV:THR -10

Manual operation: See ["Searching for the signal level"](#) on page 156

[SENSe:]POWer:RLEVel?

This command queries the currently measured signal level.

Return values:

<Level> <numeric value>
 Default unit: dBm

Example: //Query signal level
 POW:RLEV?
 would return, e.g.
 -9.28192

Usage: Query only

Manual operation: See ["Searching for the signal level"](#) on page 156

[SENSe:]POWer:RLEVel:OFFSet <Offset>

This command defines an arithmetic level offset. The offset is applied to the signal level.

The level offset takes external attenuation or gain into account.

Parameters:

<Offset> <numeric value>
 Range: -100 to 200
 *RST: 0
 Default unit: dB

Example: //Define a level offset of 20 dB
 POW:RLEV:OFFS 20

Manual operation: See ["Shifting the level"](#) on page 156

14.6.5 Remote commands to configure the frequency

[SENSe:]ADJust:CONFigure:FREQuency:AUTosearch[:STATe].....	473
[SENSe:]ADJust:CONFigure:FREQuency:COUNt.....	473
[SENSe:]ADJust:CONFigure:FREQuency:LIMit:HIGH.....	474
[SENSe:]ADJust:CONFigure:FREQuency:LIMit:LOW.....	474
[SENSe:]FILTer:LPASs:FREQuency:MANual.....	474
[SENSe:]FILTer:LPASs[:STATe].....	475
[SENSe:]FREQuency:CENTer.....	475
[SENSe:]FREQuency:START.....	476
[SENSe:]FREQuency:STOP.....	476
[SENSe:]POWer:RLEVel:MODE.....	477
[SENSe:]POWer:RLEVel:MODE:USED?.....	477
[SENSe:]SWEep:CAPTure:RANGe.....	478

[SENSe:]ADJust:CONFigure:FREQuency:AUTosearch[:STATe] <State>

This command turns the automatic (carrier) frequency search on and off.

When you turn of the automatic frequency search, you can define the signal frequency with [SENSe:]FREQuency:CENTer.

Parameters:

<State> ON | OFF | 1 | 0

Example:

```
//Define a signal frequency of 100 MHz
ADJ:CONF:FREQ:AUT OFF
FREQ:CENT 100MHZ
```

Manual operation: See "Searching for a signal" on page 160

[SENSe:]ADJust:CONFigure:FREQuency:COUNt <State>

This command turns verification of the signal frequency on and off.

Prerequisites for this command

- Turn off automatic signal search ([SENSe:]ADJust:CONFigure:FREQuency:AUTosearch[:STATe]).

Parameters:

<State> OFF | 0

Turns off the frequency counter and measures the frequency you have entered without verifying it.

ON | 1

Turns on the frequency counter and verifies the frequency you have entered.

*RST: OFF (automatic signal search is on)

Example:

```
//Turn off the frequency counter
ADJ:CONF:FREQ:AUT OFF
ADJ:CONF:FREQ:COUN OFF
FREQ:CENT 93.423MHZ
```

Manual operation: See ["Searching for a signal"](#) on page 160

[SENSe:]ADJJust:CONFigure:FREQuency:LIMit:HIGH <Frequency>

This command defines the upper limit of the frequency search range.

Prerequisites for this command

- Turn on the automatic signal search with `[SENSe:]ADJJust:CONFigure:FREQuency:AUTosearch[:STATe]`

Parameters:

<Frequency> <numeric value>
 Range: See data sheet
 *RST: 8 GHz
 Default unit: Hz

Example: //Define a frequency search range from 10 MHz to 500 MHz
 ADJ:CONF:FREQ:LIM:LOW 10MHZ
 ADJ:CONF:FREQ:LIM:HIGH 500MHZ

Manual operation: See ["Searching for a signal"](#) on page 160

[SENSe:]ADJJust:CONFigure:FREQuency:LIMit:LOW <Frequency>

This command defines the lower limit of the frequency search range.

Prerequisites for this command

- Turn on the automatic signal search with `[SENSe:]ADJJust:CONFigure:FREQuency:AUTosearch[:STATe]`

Parameters:

<Frequency> <numeric value>
 Range: See data sheet
 *RST: 1 MHz
 Default unit: Hz

Example: //Define a frequency search range from 10 MHz to 500 MHz
 ADJ:CONF:FREQ:LIM:LOW 10MHZ
 ADJ:CONF:FREQ:LIM:UPP 500MHZ

Manual operation: See ["Searching for a signal"](#) on page 160

[SENSe:]FILTer:LPASs:FREQuency:MANual <Frequency>

This command defines the cutoff frequency of the low pass filter you can use to measure small carrier frequencies.

Prerequisites for this command

- Turn on low pass filter (`[SENSe:]FILTer:LPASs[:STATe]`).

Parameters:

<Frequency> <numeric value>
 *RST: 1 MHz
 Default unit: Hz

Example:

```
//Configure low pass filter
FILT:LPAS ON
FILT:LPAS:FREQ:MAN 500KHZ
```

Manual operation: See ["Low signal frequencies"](#) on page 162
 See ["Low signal levels"](#) on page 162

[SENSe:]FILTer:LPASs[:STATe] <State>

This command turns a low pass filter for measurements on small carrier frequencies on and off.

Effects of using the low pass filter:

- Auto search feature is turned off (`[SENSe:]ADJust:CONFigure:FREQuency:AUToSearch[:STATe]`).
- Signal count is turned off (`[SENSe:]ADJust:CONFigure:FREQuency:COUNT`).
- The stop offset is limited to 20 % of the filter cut-off frequency (`[SENSe:]FREQuency:STOP`).
- DC coupling should be used for measurements on carrier frequencies below 1 MHz (`INPut<ip>:COUPling`).

Parameters:

<State> ON | OFF | 1 | 0
 When you turn on the filter, you can define a cutoff frequency with `[SENSe:]FILTer:LPASs:FREQuency:MANual`.
 *RST: OFF

Example:

```
//Turn on low pass filter
FILT:LPAS ON
```

Manual operation: See ["Low signal frequencies"](#) on page 162
 See ["Low signal levels"](#) on page 162

[SENSe:]FREQuency:CENTer <Frequency>**CW, pulsed and VCO measurements:**

This command defines or queries (in case of automatic frequency search) the current signal frequency.

Transient measurement:

This command defines the center frequency of the transient measurement.

Parameters:

<Frequency> <numeric value>
 Default unit: Hz

- Example:** //Query signal frequency
FREQ:CENT?
- Example:** //Define center frequency
FREQ:CENT 1GHZ
- Manual operation:** See ["Defining the signal frequency"](#) on page 159
See ["Searching for a signal"](#) on page 160
See ["Defining the frequency range of the measurement"](#) on page 197

[SENSe:]FREQUENCY:STARt <Frequency>

CW, pulsed and VCO measurements:

This command defines the start frequency offset of the measurement range.

Transient measurement:

This command defines the start frequency of the transient measurement.

Frequency stability measurement:

The start frequency offset is coupled to the stop time of the frequency stability measurement (**[SENSe:]TIME:STOP**).

If you change the start frequency offset, the stop time is adjusted accordingly. For example, 1 MHz corresponds to 1000 s.

Parameters:

<Frequency> Offset frequencies in half decade steps.
Range: See data sheet
*RST: 1 kHz
Default unit: Hz

Example: //Define a start offset of 10 kHz
FREQ:STAR 10KHZ

Example: //Define a span of 500 MHz from 500 MHz to 1 GHz
FREQ:STAR 500MHZ
FREQ:STOP 1GHZ

Manual operation: See ["Defining the measurement range"](#) on page 161
See ["Defining the frequency range of the measurement"](#) on page 197

[SENSe:]FREQUENCY:STOP <Frequency>

CW, pulsed and VCO measurements:

This command defines the stop frequency offset of the measurement range.

Transient measurement:

This command defines the stop frequency of the transient measurement.

Frequency stability measurement:

The stop frequency offset is coupled to the start time of the frequency stability measurement (`[SENSe:]TIME:START`).

If you change the stop frequency offset, the start time is adjusted accordingly. For example, 1 MHz corresponds to 1 ms.

Parameters:

<Frequency> Offset frequencies in half decade steps.
 Range: See data sheet
 *RST: 1 MHz
 Default unit: Hz

Example: //Define a stop offset of 10 MHz
`FREQ:STOP 10MHZ`

Example: //Define a span of 500 MHz from 500 MHz to 1 GHz
`FREQ:STAR 500MHZ`
`FREQ:STOP 1GHZ`

Manual operation: See "[Defining the measurement range](#)" on page 161
 See "[Defining the frequency range of the measurement](#)"
 on page 197

[SENSe:]POWer:RLEVel:MODE <Level>

This command selects the level measurement mode.

Parameters:

<Level>

AUTO

The R&S FSWP automatically selects the level setting that is best suited for the current measurement.

HIGH

Use this mode to measure normal signal levels.

LOW

Use this mode to measure low signal levels or if level setting "HIGH" delivers unexpected results.

The "AM Noise" trace is limited to a maximum offset of 10 MHz. When you select this mode, apply a low pass filter and define its characteristics with:

- `[SENSe:]FILTeR:LPASs[:STATe]`
- `[SENSe:]FILTeR:LPASs:FREQuency:MANual`

*RST: HIGH

Example: //Measure low level signal
`POW:RLEV:MODE LOW`

Manual operation: See "[Low signal levels](#)" on page 162

[SENSe:]POWer:RLEVel:MODE:USED?

Queries the current signal level setting of the measurement.

Return values:

<UsedLevel> LOW | HIGH

Example:

SENS:POWer:RLEV:MODE:USED?

Usage:

Query only

Manual operation: See "[Low signal levels](#)" on page 162

[SENSe:]SWEep:CAPTure:RANGe <CaptureRange>

This command selects the signal capture range.

Parameters:

<CaptureRange>

NORMal

Normal capture range for stable DUTs or DUTs whose frequency drifts slowly over a short distance.

WIDE

Wide capture range for DUTs whose frequency drifts quickly and over big distances.

R40Mhz

This setting is designed to work with carriers swept in -40 MHz to +40 MHz around the center frequency. Additional spurs and restrictions of the measurement accuracy are possible for CW signals. For specifics of the measurement accuracy, refer to the data sheet.

*RST: NORMal

Example:

```
//Select a wide signal capture range
SWE:CAPT:RANG WIDE
```

Manual operation: See "[Capture Range](#)" on page 161

14.6.6 Phase noise measurement configuration

- [Noise configuration](#)..... 478
- [Residual calculation configuration](#).....486
- [Spot noise configuration](#).....489
- [Spur display](#)..... 493

14.6.6.1 Noise configuration

Remote commands to configure the measurement range described elsewhere:

- [\[SENSe:\]FREQuency:START](#) on page 476
- [\[SENSe:\]FREQuency:STOP](#) on page 476

DISPlay:XGIndicator[:STATe]	479
[SENSe:]LIST:BWIDth[:RESolution]:RATio	479
[SENSe:]LIST:RANGe<ri>:BWIDth[:RESolution]	479
[SENSe:]LIST:RANGe<ri>:FREQuency:START?	480

[SENSe:]LIST:RANGe<ri>:FREQuency:STOP?	480
[SENSe:]LIST:RANGe<ri>:XCount	481
[SENSe:]LIST:BWIDth[:RESolution]:USMall	481
[SENSe:]SWEep:COUNT	482
[SENSe:]SWEep:FORWard	482
[SENSe:]SWEep:FSEGment	482
[SENSe:]SWEep:MODE	483
[SENSe:]SWEep:TIME	483
[SENSe:]SWEep:XFACTOR	484
[SENSe:]SWEep:XOPTimize[:STATe]	484
[SENSe:]SWEep:XOPTimize:THReshold	484
[SENSe:]TIME:START	485
[SENSe:]TIME:STOP	485

DISPlay: XGINdicator[:STATe] <State>

This command turns the cross-correlation gain indicator (gray area in the Noise Spectrum result display) on and off.

Parameters:

<State> ON | OFF | 1 | 0
 *RST: ON

Example: //Remove the gray area from the diagram area.
 DISP:XGIN OFF

Manual operation: See "[Cross-correlation gain indicator](#)" on page 168

[SENSe:]LIST:BWIDth[:RESolution]:RATio <Percentage>

This command defines the factor that the resolution bandwidth applied to each half decade is based on.

More information

Parameters:

<Percentage> <numeric value>
 Range: 0.1 to 30
 *RST: 10
 Default unit: PCT

Example: //Define an RBW factor of 3 %
 LIST:BWID:RAT 3

Manual operation: See "[Defining the resolution bandwidth](#)" on page 166

[SENSe:]LIST:RANGe<ri>:BWIDth[:RESolution] <BandWidth>

This command defines the resolution bandwidth applied in a half decade.

The application of the command depends on the half decade configuration mode ([SENSe:]SWEep:MODE):

- Automatic mode: The RBW can only be queried, because it is calculated based on an RBW factor.
- Manual mode: The RBW can be defined directly as an absolute value.

Suffix:

<ri> 1..n
Half decade

Parameters:

<BandWidth> <numeric value>
*RST: Automatic configuration mode is on.
Default unit: Hz

Example: //Define an RBW of 1 kHz for the fifth half decade
SWE:MODE MAN
LIST:RANG5:BWID 1KHZ

Manual operation: See "Defining the resolution bandwidth" on page 166
See "Working with the half decade configuration table" on page 169

[SENSe:]LIST:RANGe<ri>:FREQUENCY:START?

This command queries the start frequency offset of a half decade.

Suffix:

<ri> 1..n
Half decade

Return values:

<Frequency> <numeric value>
Default unit: Hz

Example: //Query start frequency for fifth half decade
LIST:RANG5:FREQ:STAR?
would return, e.g.
100000

Usage: Query only

Manual operation: See "Working with the half decade configuration table" on page 169

[SENSe:]LIST:RANGe<ri>:FREQUENCY:STOP?

This command queries the stop frequency offset of a half decade.

Suffix:

<ri> 1..n
Half decade

Return values:

<Frequency> <numeric value>
 Default unit: Hz

Example:

//Query stop frequency offset for fifth half decade
 LIST:RANG5:FREQ:STOP?
 would return, e.g.
 300000

Usage:

Query only

Manual operation: See "[Working with the half decade configuration table](#)"
 on page 169

[SENSe:]LIST:RANGe<ri>:XCOut <Count>

This command defines the number of cross-correlation operations done in a half decade.

The application of the command depends on the half decade configuration mode ([\[SENSe:\]SWEp:MODE](#)):

- Automatic mode: The number of cross-correlations can only be queried, because it is calculated based on an RBW factor.
- Manual mode: The number of cross-correlations can be defined directly as an absolute value.

Suffix:

<ri> 1..n
[Half decade](#)

Parameters:

<Count> <numeric value> (integer only)
 *RST: Automatic configuration mode is on.
 Default unit: ---

Example:

//Define 50 cross-correlation operations for the fifth half decade
 SWE:MODE MAN
 LIST:RANG5:XCO 50

Manual operation: See "[Defining cross-correlation parameters](#)" on page 167
 See "[Working with the half decade configuration table](#)"
 on page 169

[SENSe:]LIST:BWIDth[:RESolution]:USMall <State>

Provides functionality to enable ultra-small resolution bandwidths (RBW) for the current measurement.

Parameters:

<State> ON | OFF | 1 | 0
 *RST: OFF

Example:

SENS:LIST:BWID:RES:USM ON

Manual operation: See "[Ultra-Small RBWs](#)" on page 166

[SENSe:]SWEep:COUNT <SweepCount>

Defines the number of measurements that the application uses to average traces.

In continuous measurement mode, the application calculates the moving average over the average count.

In single measurement mode, the application stops the measurement and calculates the average after the average count has been reached.

Parameters:

<SweepCount> When you set a sweep count of 0 or 1, the R&S FSWP performs one single measurement in single measurement mode. In continuous measurement mode, if the sweep count is set to 0, a moving average over 10 measurements is performed.

Range: 0 to 200000

*RST: 0

Example:

SWE:COUN 64

Sets the number of measurements to 64.

INIT:CONT OFF

Switches to single measurement mode.

INIT;*WAI

Starts a measurement and waits for its end.

Manual operation: See "[Sweep/Average Count](#)" on page 169

[SENSe:]SWEep:FORWARD <SweepForward>

This command selects the sweep direction.

Parameters:

<SweepForward> **ON**
Measurement in forward direction.

OFF
Measurement in reverse direction.

*RST: OFF

Example:

//Sweep in forward direction

SWE:FORW ON

Manual operation: See "[Selecting the sweep direction](#)" on page 169

[SENSe:]SWEep:FSEgment

This command stops a measurement in any given half decade and resumes the measurement of the next half decade.

Usage: Event

Manual operation: See "[Defining cross-correlation parameters](#)" on page 167

[SENSe:]SWEep:MODE <Mode>

This command selects the configuration mode of the half decade table.

Parameters:

<Mode>

MANual

Manual mode: allows you to select a custom resolution bandwidth and number of cross-correlations for each half decade.

- Define the RBW for a half decade with `[SENSe:]LIST:RANGe<ri>:BWIDth[:RESolution]`.
- Define the number of cross-correlations for a half decade with `[SENSe:]LIST:RANGe<ri>:XCOutt`.

NORMal

Automatic mode: the application selects the resolution bandwidth and number of cross-correlations based on the RBW and XCORR factors.

- Define the RBW factor with `[SENSe:]LIST:BWIDth[:RESolution]:RATio`.
- Define the XCORR factor with `[SENSe:]SWEep:XFACTOR`.

FAST

Sets mode to NORMal and XCORR Count to 1. Only available remote.

AVERaged

Sets mode to NORMal and XCORR Count to 10. Only available remote.

*RST: NORMal

Example:

//Automatically select RBW and XCORR based on an RBW factor of 5 % and an XCORR factor of 1.5.

```
SWE:MODE NORM
LIST:BWID:RAT 5
LIST:RANG5:XCO 1.5
```

Manual operation:

See ["Defining the resolution bandwidth"](#) on page 166
 See ["Defining cross-correlation parameters"](#) on page 167
 See ["Working with the half decade configuration table"](#) on page 169

[SENSe:]SWEep:TIME <Time>**CW, pulsed and VCO measurements (query only):**

This command queries the estimated measurement time.

Transient measurement:

This command defines the measurement time

Parameters:

<Time>

<numeric value>

Default unit: s

Example: //Query measurement time
 SWE:TIME?
 would return, e.g.
 0.050432

Example: //Define measurement time
 SWE:TIME 2S

Manual operation: See ["Estimating the measurement time"](#) on page 165
 See ["Defining the measurement time"](#) on page 201

[SENSe:]SWEep:XFACTOR <Factor>

This command defines the cross-correlation factor (XCORR factor) that defines the cross-correlation operations in each half decade.

Parameters:

<Factor> <numeric value>
 Range: 1

Example: //Define an XCORR factor of 10
 SWE:XFAC 10

Manual operation: See ["Defining cross-correlation parameters"](#) on page 167

[SENSe:]SWEep:XOPTimize[:STATe] <State>

This command turns optimization of the cross-correlation operations on and off.

Parameters:

<State> ON | OFF | 1 | 0
 *RST: ON

Example: SWE:XOPT OFF
 Turns off optimization (always performs the full number of operations).

Manual operation: See ["Defining cross-correlation parameters"](#) on page 167

[SENSe:]SWEep:XOPTimize:THReshold <Threshold>

This command defines the threshold for the cross-correlation optimization feature.

When the threshold (distance between measured values and gain indicator) is reached in any given half decade, the measurement in that half decade stops and resumes to measure the next one.

Prerequisites for this command

- Turn on XCORR optimization ([\[SENSe:\]SWEep:XOPTimize\[:STATe\]](#) on page 484).

Parameters:

<Threshold> <numeric value>
 Default unit: dB

Example:

```
//Define a threshold of 15 dB
SWE:XOPT:THR 15
```

Manual operation: See ["Defining cross-correlation parameters"](#) on page 167

[SENSe:]TIME:START <Tau>

This command defines the start time for the frequency stability measurements.

Effects of this command

- The start time is coupled to the stop frequency offset of the measurement range of the phase noise measurement ([\[SENSe:\]FREQuency:STOP](#)).
 If you change the start time, the R&S FSWP adjusts the stop frequency offset accordingly. For example, 1 MHz stop offset corresponds to 1 µs.

Parameters:

<Tau> <numeric value>
 *RST: 1 ms
 Default unit: s

Example:

```
//Define start time for frequency stability measurement
TIME:STAR 1US
```

Manual operation: See ["Defining the measurement range"](#) on page 161

[SENSe:]TIME:STOP <Tau>

This command defines the stop time for the frequency stability measurements.

Effects of this command

- The stop time is coupled to the start frequency offset of the measurement range of the phase noise measurement ([\[SENSe:\]FREQuency:START](#)).
 If you change the stop time, the R&S FSWP adjusts the start frequency offset accordingly. For example, 1 mHz start offset corresponds to 1000 s.

Parameters:

<Tau> <numeric value>
 *RST: 1 ms
 Default unit: s

Example:

```
//Define stop time for frequency stability measurement
TIME:STAR 1000S
```

Manual operation: See ["Defining the measurement range"](#) on page 161

14.6.6.2 Residual calculation configuration

For manual operation, see [Chapter 9.5.4, "Integrated measurement configuration"](#), on page 170.

CALCulate<n>[:RANGe<ri>]:EVALuation:START	486
CALCulate<n>[:RANGe<ri>]:EVALuation:STOP	486
CALCulate<n>[:RANGe<ri>]:EVALuation:TRACe	487
CALCulate<n>[:RANGe<ri>]:EVALuation[:STATe]	487
CALCulate<n>[:RANGe<ri>]:EVALuation:WEIGHting	488
[SENSe:]CORRection:WEIGHting:COMMeNt	488
[SENSe:]CORRection:WEIGHting:DATA	488
[SENSe:]CORRection:WEIGHting:DELeTe	488
[SENSe:]CORRection:WEIGHting:NAME	489
[SENSe:]CORRection:WEIGHting:SELeCt	489

CALCulate<n>[:RANGe<ri>]:EVALuation:START <Frequency>

This command defines the start frequency of a custom integration range for residual effects calculation.

Prerequisites for this command

- Turn off integration over the complete measurement range ([CALCulate<n>\[:RANGe<ri>\]:EVALuation\[:STATe\]](#)).

Suffix:

<n>	Window
<ri>	Integration range

Parameters:

<Frequency>	<numeric value>
Range:	Depends on the measurement range.
*RST:	1 MHz
Default unit:	Hz

Example: See [CALCulate<n>\[:RANGe<ri>\]:EVALuation\[:STATe\]](#).

Manual operation: See ["Defining the integration range"](#) on page 171

CALCulate<n>[:RANGe<ri>]:EVALuation:STOP <Frequency>

This command defines the stop frequency of a custom integration range for residual effects calculation.

Prerequisites for this command

- Turn off integration over the complete measurement range ([CALCulate<n>\[:RANGe<ri>\]:EVALuation\[:STATe\]](#)).

Suffix:

<n>	Window
<ri>	Integration range

Parameters:

<Frequency> <numeric value>
 Range: Depends on the measurement range.
 *RST: 1 kHz
 Default unit: Hz

Example: See `CALCulate<n>[:RANGe<ri>]:EVALuation[:STATe]`.

Manual operation: See "Defining the integration range" on page 171

CALCulate<n>[:RANGe<ri>]:EVALuation:TRACe <Trace1>

This command selects the trace for calculation of residual effects.

Suffix:

<n> [Window](#)
 <ri> [Integration range](#)

Parameters:

<Trace1> **TRACE1 | ... | TRACE6**
 Selects the trace. You can select a trace that is inactive, but for residual effect calculation, it must be active.

NONE

Turns off residual calculation for the respective range.

*RST: Depends on the range.

Example: //Use trace 1 as the data source for range 2
`CALC:RANG2:EVAL:TRAC TRACE1`

Manual operation: See "Selecting the trace for residual calculations" on page 171

CALCulate<n>[:RANGe<ri>]:EVALuation[:STATe] <State>

This command turns integration of the entire measurement range for residual calculations on and off.

Suffix:

<n> [Window](#)
 <ri> [Integration range](#)

Parameters:

<State> **ON | 1**
 Integrates over the complete measurement range.
OFF | 0
 Integrates over a custom measurement range.

Example: //Define an integration range from 1 kHz to 3 kHz in range 2
`CALC:RANG2:EVAL OFF`
`CALC:RANG2:EVAL:STAR 100000`
`CALC:RANG2:EVAL:STOP 300000`

Manual operation: See "Defining the integration range" on page 171

CALCulate<n>[:RANGe<j>]:EVALuation:WEIGHting <Name>

This command selects a weighting filter whose values are applied to the calculation of residual effects.

Suffix:

<n> [Window](#)

<j> [Integration range](#)

Setting parameters:

<Name> String containing the name of the filter.

*RST: NONE

Example: //Apply a weighting filter to the residual calculations in integration range 1

```
CALC:RANG1:EVAL:WEIG 'A FILTER'
```

Manual operation: See ["Applying weighting filters"](#) on page 171

[SENSe:]CORRection:WEIGHting:COMMeNT <Name>

This command defines a comment for a weighting filter whose values are applied to the calculation of residual effects.

Setting parameters:

<Name> String containing the comment.

Example: See [\[SENSe:\]CORRection:WEIGHting:NAME](#) on page 489.

Manual operation: See ["Designing weighting filters"](#) on page 172

[SENSe:]CORRection:WEIGHting:DATA {<freq>, <level>}...

This command defines the shape of the weighting filter whose values are applied to the calculation of residual effects.

The shape of the weighting filter is defined by two or more pairs of frequency and level values.

Parameters:

<freq> <numeric value>

Default unit: Hz

<level> <numeric value>

Default unit: dB

Example: See [\[SENSe:\]CORRection:WEIGHting:NAME](#) on page 489.

Manual operation: See ["Designing weighting filters"](#) on page 172

[SENSe:]CORRection:WEIGHting:DELeTe

This command deletes the currently selected weighting filter.

Prerequisites for this command

- Select a weighting filter with `[SENSe:]CORRection:WEIGHting:SElect` on page 489.

Example: //Delete the currently selected weighting filter
CORR:WEIG:DEL

Usage: Event

Manual operation: See "[Managing weighting filters](#)" on page 172

[SENSe:]CORRection:WEIGHting:NAME <Name>

This command defines the name for a weighting filter whose values are applied to the calculation of residual effects.

Setting parameters:

<Name> String containing the name of the filter.

Example: //Create a weighting filter called "FILTER", with a comment and a few data points
CORR:WEIG:NAME 'FILTER'
CORR:WEIG:COMM 'Here's an example for a filter.'
CORR:WEIG:DATA 10MHZ,0DB,20MHZ,2DB,40MHZ,5DB

Manual operation: See "[Designing weighting filters](#)" on page 172

[SENSe:]CORRection:WEIGHting:SElect <Name>

This command selects a weighting filter whose values are applied to the calculation of residual effects.

Setting parameters:

<Name> String containing the name of the weighting filter.

Example: //Select a weighting filter called "filter"
CORR:WEIG:SEL 'FILTER'

Manual operation: See "[Managing weighting filters](#)" on page 172

14.6.6.3 Spot noise configuration

<code>CALCulate<n>:SNOise<ri>:AOFF</code>	490
<code>CALCulate<n>:SNOise<ri>:STATe</code>	490
<code>CALCulate<n>:SNOise<ri>:X</code>	490
<code>CALCulate<n>:SNOise<ri>[:TRACe<t>]:DECades:X?</code>	491
<code>CALCulate<n>:SNOise<ri>[:TRACe<t>]:DECades:Y?</code>	491
<code>CALCulate<n>:SNOise<ri>[:TRACe<t>]:DECades[:STATe]</code>	492
<code>CALCulate<n>:SNOise<ri>[:TRACe<t>]:USERdefined[:STATe]</code>	492
<code>CALCulate<n>:SNOise<ri>[:TRACe<t>]:Y?</code>	492
<code>DISPlay:SNINfo[:STATe]</code>	493
<code>DISPlay:SNINfo:TRACe</code>	493

CALCulate<n>:SNOise<ri>:AOFF

This command turns all spot noise information off (custom and 10^x information). It also turns user defined spot noise markers off.

In the Spot Noise vs Tune measurement, the command also selects "Trace Mode" = "Blank" for all traces.

Suffix:

<n> irrelevant

<ri> irrelevant

Example: //Turn off all spot noise information
CALC:SNO:AOFF

Usage: Event

CALCulate<n>:SNOise<ri>:STATe <State>

This command turns a custom spot noise position on and off.

In the Spot Noise vs Tune measurement, turning off a spot noise position also selects "Trace Mode" = "Blank" for the corresponding spot noise trace. Turning on a spot noise position selects the trace mode that was selected last for the corresponding spot noise trace.

Suffix:

<n> irrelevant

<ri> [Spot noise marker](#)

Parameters:

<State> ON | OFF | 1 | 0

*RST: All ON

Example: See [CALCulate<n>:SNOise<ri>\[:TRACe<t>\]:USERdefined\[:STATe\]](#).

CALCulate<n>:SNOise<ri>:X <Frequency>...

This command defines the horizontal position of a custom spot noise position. The position is changed in all windows.

Suffix:

<n> irrelevant

<ri> [Spot noise marker](#)

Parameters:

<Frequency> For minimum and maximum offsets, refer to the data sheet.
The default values are the decade edges (1 kHz, 10 kHz etc.)
Default unit: Hz

Example: See `CALCulate<n>:SNOise<ri>[:TRACe<t>]:USERdefined[:STATE]`.

`CALCulate<n>:SNOise<ri>[:TRACe<t>]:DECades:X?`

This command queries the horizontal position of the 10^x offset frequency spot noise information.

Suffix:

<n> irrelevant
 <ri> irrelevant
 <t> irrelevant

Return values:

<Frequency> List of offset frequencies, one for each 10^x spot noise position.
 The number of return values depends on the measurement range.
 Default unit: Hz

Example: //Query spot noise information
`CALC:SNO:DEC:X?`
 would return, e.g.
`1000,10000,100000,1000000`

Usage: Query only

Manual operation: See "[Spot Noise](#)" on page 126

`CALCulate<n>:SNOise<ri>[:TRACe<t>]:DECades:Y?`

This command queries the vertical position of the 10^x offset frequency spot noise information.

Suffix:

<n> [Window](#)
 <ri> irrelevant
 <t> [Trace](#)

Return values:

<Level> List of phase noise level values, one for each 10^x spot noise positions.
 The number of return values depends on the measurement range.
 Default unit: dBc/Hz

Example: //Query spot noise information
`CALC:SNO:DEC:Y?`
 would return, e.g.
`-152.560974121094,-136.443389892578,`
`-145.932891845703,-152.560974121094`

Usage: Query only
Manual operation: See "Spot Noise" on page 126

CALCulate<n>:SNOise<ri>[:TRACe<t>]:DECades[:STATe] <State>

This command turns the spot noise calculation on every 10^x offset frequency on and off.

Suffix:

<n> irrelevant
 <ri> irrelevant
 <t> irrelevant

Parameters:

<State> ON | OFF | 1 | 0
 *RST: ON

Example: //Turn on the spot noise calculation for all decade edges.
 CALC:SNO:DEC ON

CALCulate<n>:SNOise<ri>[:TRACe<t>]:USERdefined[:STATe] <State>

This command turns calculation of custom spot noise positions on and off

Suffix:

<n> irrelevant
 <ri> irrelevant
 <t> irrelevant

Parameters:

<State> ON | OFF | 1 | 0
 *RST: OFF

Example: //Turn on user defined spot noise positions
 CALC:SNO:USER ON
 //Turn on custom spot noise marker 2 at an offset of 500 kHz
 CALC:SNO3:STAT ON
 CALC:SNO3:X 500000
 //Query spot noise
 CALC:SNO3:Y?
 would return, e.g.
 -90.1154022217

CALCulate<n>:SNOise<ri>[:TRACe<t>]:Y?

This command queries the level measured for a custom spot noise position.

Prerequisites for this command

- Use custom spot noise positions (`CALCulate<n>:SNOise<ri>[:TRACe<t>]:USERdefined[:STATe]`).

Suffix:

<n>	Window
<ri>	Spot noise marker
<t>	Trace

Return values:

<Level>	Phase noise level at the spot noise position. Default unit: dBc/Hz
---------	---

Example: See `CALCulate<n>:SNOise<ri>[:TRACe<t>]:USERdefined[:STATe]`.

Usage: Query only

Manual operation: See "Spot Noise" on page 126

DISPlay:SNINfo[:STATe] <State>

This command turns the display of spot noise information in the diagram area on and off.

Parameters:

<State>	ON OFF 1 0
*RST:	ON

Example: //Display the spot noise information
`DISP:SNIN ON`

Manual operation: See "Displaying spot noise information" on page 173

DISPlay:SNINfo:TRACe <Trace>

This command selects the trace for which spot noise information is evaluated.

Parameters:

<Trace>	Range: 1 to 6
*RST:	1

Example: //Evaluate spot noise for trace 2.
`DISP:SNIN:TRAC 2`

Manual operation: See "Displaying spot noise information" on page 173

14.6.6.4 Spur display

<code>DISPlay[:WINDow<n>]:TRACe<t>:SPURs:SUPPress</code>	494
<code>DISPlay[:WINDow<n>]:TRACe<t>:SPURs:THReshold</code>	494
<code>[SENSe:]SPURs:SORT</code>	495

[SENSe:]SPURs:WEIGhting.....	495
[SENSe:]SPURs:FILTer:MODE.....	495
[SENSe:]SPURs:FILTer:HARMonics.....	496
[SENSe:]SPURs:FILTer:RANGe.....	496
[SENSe:]SPURs:FILTer:NAME?.....	496
[SENSe:]SPURs:FILTer:OFFSet.....	496
[SENSe:]SPURs:FILTer:CLEar.....	497
[SENSe:]SPURs:FILTer:SAVE.....	497
[SENSe:]SPURs:FILTer:LOAD.....	497
[SENSe:]SPURs:COLor.....	497

DISPlay[:WINDow<n>]:TRACe<t>:SPURs:SUPPRes <State>

Turns spur removal for a specific trace on and off.

When you turn on spur removal, you can define a level threshold with `DISPlay[:WINDow<n>]:TRACe<t>:SPURs:THReshold`.

In the Spot Noise vs Tune measurement, you can only remove spurs over all traces. Use `[SENSe:]SPURs:SUPPRes` in that case.

Suffix:

<n> 1..n
Window

<t> 1..n
Trace

Parameters:

<State> ON | OFF | 1 | 0
*RST: OFF

Example: See `DISPlay[:WINDow<n>]:TRACe<t>:SMOothing[STATE]`.

Manual operation: See "Hiding spurs" on page 175

DISPlay[:WINDow<n>]:TRACe<t>:SPURs:THReshold <Threshold>

This command defines a level threshold for spur removal.

Prerequisites for this command

- Turn on spur removal (`DISPlay[:WINDow<n>]:TRACe<t>:SPURs:THReshold`).

In the Spot Noise vs Tune measurement, you can only define a threshold that applies to all traces. Use `[SENSe:]SPURs:THReshold` in that case.

Suffix:

<n> 1..n
Window

<t> 1..n
Trace

Parameters:

<Threshold> <numeric value>
 *RST: 0
 Default unit: dB

Example:

See [DISPlay\[:WINDow<n>\]:TRACe<t>:SMOothing\[:STATe\]](#).

Manual operation: See ["Hiding spurs"](#) on page 175

[SENSe:]SPURs:SORT <Order>

This command selects the sort order of the spurs in the spur list.

Parameters:

<Order> **POWer**
 Sorts spurs according to their power.
OFFSet
 Sorts spurs according to their offset from the carrier.
 *RST: POWer

Example:

```
//Select spur sort order
SPUR: SORT POW
```

Manual operation: See ["Sorting spurs"](#) on page 175

[SENSe:]SPURs:WEIGhting <Weightingfilter>

This command selects a spurious weighting filter.

Setting parameters:

<Weightingfilter>

Example:

```
//Select no defined weighting filter
SENS: SPUR: WEIG NONE
```

Manual operation: See ["Applying a spurious weighting filter"](#) on page 176

[SENSe:]SPURs:FILTer:MODE <Mode>

This command defines the spurious filter mode

Parameters:

<Mode> OFF | SUPPpress | SHOW
OFF
 No spurious filter is applied.
SUPPpress
 The spurs in the spurious filter are removed from the spurious list, the diagram and dependent calculations.

SHOW

Only the spurs in the spurious filter are displayed in the spurious list, the diagram and dependent calculations.

Example: `SENS:SPUR:FILT:MOD OFF`

Manual operation: See "[Filtering spurs](#)" on page 176

[SENSe:]SPURs:FILTer:HARMonics <State>

This command defines if harmonics are included in the spurious filter.

Parameters:

<State>

Example: `//Exclude harmonics from the spurious filter`
`SENS:SPUR:FILT:HARM OFF`

Manual operation: See "[Filtering spurs](#)" on page 176

[SENSe:]SPURs:FILTer:RANGe <Range>

This command defines the range of the spurious filter. The range is defined as a multiple of the resolution bandwidth.

Parameters:

<Range>

Example: `SENS:SPUR:FILT:RANG 1`

Manual operation: See "[Filtering spurs](#)" on page 176

[SENSe:]SPURs:FILTer:NAME?

This command returns the name of the selected spurious filter.

Example: `SENS:SPUR:FILT:NAME?`

Usage: Query only

Manual operation: See "[Filtering spurs](#)" on page 176

[SENSe:]SPURs:FILTer:OFFSet <OffsetValues>...

This command creates a new offset table with defined frequency ranges.

Parameters:

<OffsetValues> Default unit: Hz

Example: `SENS:SPUR:FILT:OFFS 1.3e3, 2.6e5`

Manual operation: See "[Filtering spurs](#)" on page 176

[SENSe:]SPURs:FILTer:CLEar

This command clears the currently selected spurious filter.

Example: SENS:SPUR:FILT:CLE

Usage: Event

Manual operation: See "[Filtering spurs](#)" on page 176

[SENSe:]SPURs:FILTer:SAVE <Filename>

This command saves the spurious filter configuration to a file. The spurious filter name can be defined.

Location of filter files: C:\R_S\instr\SpuriousFilter\

Setting parameters:

<Filename>

Example: SENS:SPUR:FILT:SAVE "MyFile"

Usage: Setting only

Manual operation: See "[Filtering spurs](#)" on page 176

[SENSe:]SPURs:FILTer:LOAD <Filename>

This command loads an existing spurious filter configuration from a file.

Location of filter files: C:\R_S\instr\SpuriousFilter\

Setting parameters:

<Filename>

Example: SENS:SPUR:FILT:LOAD "MyFile"

Usage: Setting only

Manual operation: See "[Filtering spurs](#)" on page 176

[SENSe:]SPURs:COLor <Color>

Provides functionality to enable an automatic shift of the color of the displayed spurious lines.

Parameters:

<Color> TRACe | SHIFted

Example: SENS:SPUR:COL TRAC

Manual operation: See "[Defining the spurious color](#)" on page 176

14.6.7 Pulsed Phase Noise Configuration

[SENSe:]SWEep:EGATe:HOLDoff.....	498
[SENSe:]SWEep:EGATe:LENGth.....	498
[SENSe:]SWEep:EGATe:LEVel.....	499
[SENSe:]SWEep:EGATe:TYPE.....	499
[SENSe:]SWEep:PULSe:DETection.....	499
[SENSe:]SWEep:PULSe:GATE.....	500
[SENSe:]SWEep:PULSe:PRI.....	500

[SENSe:]SWEep:EGATe:HOLDoff <GateDelay>

This command defines the gate delay time.

Prerequisites for this command

- Optional pulsed phase noise measurement application.
- Turn off automatic pulse detection ([SENSe:]SWEep:PULSe:DETection).

Parameters:

<GateDelay> <numeric value>
 *RST: Automatic pulse detection is on.
 Default unit: s

Example: //Define a gate delay of 10 μ s.
 SWE:PULS:DET MAN
 SWE:EGAT:HOLD 10us

Manual operation: See "[Defining the shape of the gate](#)" on page 189

[SENSe:]SWEep:EGATe:LENGth <Length>

This command defines the gate length.

Prerequisites for this command

- Optional pulsed phase noise measurement application.
- Turn off automatic pulse detection ([SENSe:]SWEep:PULSe:DETection).
- Select gate mode "Edge" ([SENSe:]SWEep:EGATe:TYPE).

Parameters:

<Length> <numeric value>
 *RST: Automatic pulse detection is on.
 Default unit: s

Example: //Define a gate length of 200 μ s
 SWE:PULS:DET MAN
 SWE:EGAT:TYPE EDGE
 SWE:EGAT:LENG 200us

Manual operation: See "[Defining the shape of the gate](#)" on page 189

[SENSe:]SWEep:EGATe:LEVel <Level>

This command defines the gate level.

Prerequisites for this command

- Optional pulsed phase noise measurement application.
- Turn off automatic pulse detection (`[SENSe:]SWEep:PULSe:DETection`).

Parameters:

<Level> <numeric value>
 *RST: Automatic pulse detection is on.
 Default unit: dBm

Example: //Define a gate level of -10 dBm
 SWE:PULS:DET MAN
 SWE:EGAT:LEV -10

Manual operation: See ["Defining the shape of the gate"](#) on page 189

[SENSe:]SWEep:EGATe:TYPE <GateType>

This command selects the gate type.

Prerequisites for this command

- Optional pulsed phase noise measurement application.

Parameters:

<GateType> **EDGE**
 The gate opens when the gate level has been exceeded and
 closes when the time defined by the gate length has elapsed.
 LEVel
 The gate opens when the gate level has been exceeded and
 closes when the signal level again falls below the gate level.
 OFF
 The gate is off.

Example: //Select gate type
 SWE:EGAT:TYPE EDGE

Manual operation: See ["Selecting the gate type"](#) on page 189

[SENSe:]SWEep:PULSe:DETection <Mode>

This command selects the pulse detection mode.

Prerequisites for this command

- Optional pulsed phase noise measurement application.

Parameters:

<Mode>

AUTO

Initiates an automatic detection of the pulse characteristics with a subsequent configuration of the gate before you start a measurement.

MANual

Allows you to manually configure the pulse measurement characteristics.

ONCE

Initiates an immediate, automatic detection of the pulse characteristics with a subsequent configuration of the gate.

Example:

```
//Configure the measurement based on the detected pulse
SWE:PULS:DET AUTO
```

Manual operation: See ["Selecting the pulse detection mode"](#) on page 188

[SENSe:]SWEep:PULSe:GATE <PulseGate>

This command selects the source for the pulse gate.

Parameters:

<PulseGate>

EXTErnal

Selects an external pulse gate connected to trigger 1 connector.

Prerequisites:

- Turn off trigger 1 output (`SOURce:GENerator:PULSe:TRIGger:OUTPut`).

Effects:

- Pulse modulation is turned off (`SOURce:GENerator:MODulation`).

IFPower

Selects the internal IF power pulse gate.

*RST: IFPower

Example:

```
//Select internal pulse gate
SWE:PULS:GATE IFP
```

Manual operation: See ["Selecting the source for pulse gating"](#) on page 187

[SENSe:]SWEep:PULSe:PRI <Time>

This command defines the pulse repetition interval.

Prerequisites for this command

- Optional pulsed phase noise measurement application.
- Turn off automatic pulse detection (`[SENSe:]SWEep:PULSe:DETEction`).

Parameters:

<Time> <numeric value>
 *RST: Automatic pulse detection is on.
 Default unit: s

Example:

```
//Define a pulse repetition interval of 500 µs.
SWE:PULS:DET MAN
SWE:PULS:PRI 500US
```

Manual operation: See ["Defining the pulse repetition interval"](#) on page 188

14.6.8 VCO characterization configuration

- [Sweep configuration](#).....501

14.6.8.1 Sweep configuration

CONFigure:VCO:FIX:SOURce	501
CONFigure:VCO:SWEep:DELAy:INITial	501
CONFigure:VCO:SWEep:DELAy:POINtj	502
CONFigure:VCO:SWEep:FCOunter:RESolution	502
CONFigure:VCO:SWEep:POINts	502
CONFigure:VCO:SWEep:SOURce	503
CONFigure:VCO:SWEep:STARt	503
CONFigure:VCO:SWEep:STOP	503

CONFigure:VCO:FIX:SOURce <PowerSource>

This command selects the DC source that is considered in the [Current / Voltage](#) result display.

Parameters:

<PowerSource> **VAUX**
 Selects the V_{aux} connector.

VSUPply
 Selects the V_{supply} connector.

VTUNE
 Selects the V_{tune} connector.

*RST: VSUPply

Example:

```
//Measure the Vaux connector in the Supply Current / Voltage
result.
CONF:VCO:FIX:SOUR VAUX
```

CONFigure:VCO:SWEep:DELAy:INITial <SettlingTime>

This command defines an initial delay time that allows the DUT to settle before the first measurement starts.

Parameters:

<SettlingTime> <numeric value>
 *RST: 10 ms
 Default unit: s

Example:

//Define an initial settling time of a 100 ms.
 CONF:VCO:SWE:DEL:INIT 100MS

Manual operation: See ["Defining the settling time"](#) on page 193

CONFigure:VCO:SWEep:DELay[:POINTt] <SettlingTime>

This command defines a delay time that allows the DUT to settle when a new tuning voltage is applied and before the measurement starts.

Parameters:

<SettlingTime> <numeric value>
 *RST: 10 ms
 Default unit: s

Example:

//Define a settling time of a 100 ms.
 CONF:VCO:SWE:DEL 100MS

Manual operation: See ["Defining the settling time"](#) on page 193

CONFigure:VCO:SWEep:FCOunter:RESolution <Frequency>

This command selects the frequency resolution for VCO characterization.

Parameters:

<Frequency> <numeric value>
 If you select a frequency resolution that is not supported, the next available frequency resolution is selected.
 *RST: 1 kHz
 Default unit: Hz

Example:

//Select a frequency resolution of 100 Hz.
 CONF:VCO:SWE:FCO 100HZ

Manual operation: See ["Selecting the frequency resolution"](#) on page 193

CONFigure:VCO:SWEep:POINTs <MeasPoints>

This command defines the number of measurement points for the VCO measurement.

Parameters:

<MeasPoints> <numeric value> (integer only)
 *RST: 10

Example:

See [CONFigure:VCO:SWEep:SOURce](#).

Manual operation: See ["Defining the sweep range"](#) on page 192

CONFigure:VCO:SWEep:SOURce <PowerSource>

This command selects the source (connector) which tunes the VCO.

Parameters:

<PowerSource>

VAUX

Selects the V_{aux} connector as the sweep source.

VSUPly

Selects the V_{supply} connector as the sweep source.

VTUNE

Selects the V_{tune} connector as the sweep source.

Example:

```
//Select the  $V_{supply}$  connector as the tuning source
CONF:VCO:SWE:SOUR VSUP
//Select the type of output at the  $V_{supply}$  connector
SOUR:VOLT:POW:LEV:MODE VOLT
//Configure a tuning range with 10 measurement points
CONF:VCO:SWE:STAR 0V
CONF:VCO:SWE:STOP 5V
CONF:VCO:SWE:POIN 10
//Turn on the output of the tuning signal.
SOUR:VOLT:POW:LEV ON
```

CONFigure:VCO:SWEep:START <Value>

This command defines the start value of the tuning range.

Parameters:

<Value>

<numeric value>

The unit depends on whether you tune the VCO with a voltage or current (see [CONFigure:VCO:SWEep:SOURce](#)).

*RST: 0

Default unit: V or A

Example:

See [CONFigure:VCO:SWEep:SOURce](#).

Manual operation:

See "Defining the sweep range" on page 192

CONFigure:VCO:SWEep:STOP <Value>

This command defines the stop value of the tuning range.

Parameters:

<Value>

<numeric value>

The unit depends on whether you tune the VCO with a voltage or current (see [CONFigure:VCO:SWEep:SOURce](#)).

*RST: 0

Default unit: V or A

Example:

See [CONFigure:VCO:SWEep:SOURce](#).

Manual operation: See ["Defining the sweep range"](#) on page 192

14.6.9 Spot noise vs tune configuration

- [Sweep configuration](#).....504
- [Trace configuration](#)..... 506

14.6.9.1 Sweep configuration

CONFigure:SNtune:SWEep:DElAy:INITial	504
CONFigure:SNtune:SWEep:DElAy[:POINT]	504
CONFigure:SNtune:SWEep:POINTs	504
CONFigure:SNtune:SWEep:SOURce	505
CONFigure:SNtune:SWEep:STARt	505
CONFigure:SNtune:SWEep:STOP	505

CONFigure:SNtune:SWEep:DElAy:INITial <SettlingTime>

This command defines an initial delay time that allows the DUT to settle before the first measurement starts.

Parameters:

<SettlingTime> <numeric value>
 *RST: 10 ms
 Default unit: s

Example: //Define an initial settling time of a 100 ms.
 CONF:VCO:SWE:DEL:INIT 100MS

Manual operation: See ["Defining the settling time"](#) on page 193

CONFigure:SNtune:SWEep:DElAy[:POINT] <SettlingTime>

This command defines a delay time that allows the DUT to settle when a new tuning voltage is applied and before the measurement starts.

Parameters:

<SettlingTime> <numeric value>
 *RST: 10 ms
 Default unit: s

Example: //Define a settling time of a 100 ms
 CONF:SNt:SWE:DEL 100MS

Manual operation: See ["Defining the settling time"](#) on page 193

CONFigure:SNtune:SWEep:POINTs <MeasPoints>

This command defines the number of measurement points for the VCO measurement.

Parameters:

<MeasPoints> <numeric value> (integer only)
 *RST: 10

Example: See [CONFigure:SNTune:SWEep:SOURce](#).

Manual operation: See "[Defining the sweep range](#)" on page 192

CONFigure:SNTune:SWEep:SOURce <PowerSource>

This command selects the source (connector) which tunes the VCO.

Parameters:

<PowerSource> **VAUX**
 Selects the V_{aux} connector as the sweep source.
VSUPly
 Selects the V_{supply} connector as the sweep source.
VTUNE
 Selects the V_{tune} connector as the sweep source.

Example: //Selects the V_{supply} connector as the tuning source
 CONF:SNT:SWE:SOUR VSUP
 //Select the type of output at the V_{supply} connector
 SOUR:VOLT:POW:LEV:MODE VOLT
 //Configure a tuning range with 10 measurement points
 CONF:SNT:SWE:STAR 0V
 CONF:SNT:SWE:STOP 5V
 CONF:SNT:SWE:POIN 10
 //Turn on the output of the tuning signal
 SOUR:VOLT:POW:LEV ON

CONFigure:SNTune:SWEep:START <Value>

This command defines the start value of the tuning range.

Parameters:

<Value> <numeric value>
 The unit depends on whether you tune the VCO with a voltage or current (see [CONFigure:SNTune:SWEep:SOURce](#)).
 *RST: 0
 Default unit: V or A

Example: See [CONFigure:SNTune:SWEep:SOURce](#).

Manual operation: See "[Defining the sweep range](#)" on page 192

CONFigure:SNTune:SWEep:STOP <Value>

This command defines the stop value of the tuning range.

Parameters:

<Value> <numeric value>
 The unit depends on whether you tune the VCO with a voltage or current (see [CONFigure:SNtune:SWEep:SOURce](#)).
 *RST: 0
 Default unit: V or A

Example: See [CONFigure:SNtune:SWEep:SOURce](#).

Manual operation: See "Defining the sweep range" on page 192

14.6.9.2 Trace configuration

Commands to configure traces described elsewhere:

- [CALCulate<n>:SNOise<ri>:AOFF](#) on page 490
- [CALCulate<n>:SNOise<ri>:STATe](#) on page 490
- [CALCulate<n>:SNOise<ri>:X](#) on page 490
- [DISPlay\[:WINDow<n>\]\[:SUBWindow<w>\]:TRACe<t>:MODE](#) on page 537
- [DISPlay\[:WINDow<n>\]\[:SUBWindow<w>\]:TRACe<t>\[:STATe\]](#) on page 541

[SENSe:]SMOothing:APERture	506
[SENSe:]SMOothing[:STATe]	507
[SENSe:]SPURs:SUPPress	507
[SENSe:]SPURs:THReshold	507

[SENSe:]SMOothing:APERture <Value>

This command defines the magnitude (aperture) of trace smoothing.

Prerequisites for this command

- Select Spot Noise vs Tune measurement ([CONFigure:SNtune:MEASurement\[:STATe\]](#)).
- Turn on trace smoothing ([\[SENSe:\]SMOothing\[:STATe\]](#)).

This command smoothes all traces. If you need to smooth each trace separately (possible in all measurements except Spot Noise vs Tune), use [DISPlay\[:WINDow<n>\]:TRACe<t>:SMOothing:APERture](#).

Parameters:

<Value> <numeric value>
 Range: 1 to 20
 *RST: 1
 Default unit: PCT

Example: //Smooth the traces by a magnitude of 10 %
 SMO ON
 SMO:APER 10

Manual operation: See "Smoothing traces" on page 225

[SENSe:]SMOothing[:STATe] <State>

This command turns trace smoothing for a specific trace on and off.

When you turn on trace smoothing, you can define the smoothing magnitude with `[SENSe:]SMOothing:APERture`.

Prerequisites for this command

- Select Spot Noise vs Tune measurement (`CONFigure:SNtune:MEASurement[:STATe]`).

This command smoothes all traces. If you need to smooth each trace separately (possible in all measurements except Spot Noise vs Tune), use `DISPlay[:WINDow<n>]:TRACe<t>:SMOothing[:STATe]`.

Parameters:

<State> ON | OFF | 1 | 0

Example: //Smooth the traces by a magnitude of 10 %
SMO ON
SMO:APER 10

Manual operation: See "[Smoothing traces](#)" on page 225

[SENSe:]SPURs:SUPPpress <State>

Turns spur removal for all traces and windows on and off.

When you turn on spur removal, you can define a level threshold with `[SENSe:]SPURs:THReshold`.

Prerequisites for this command

- Select Spot Noise vs Tune measurement (`CONFigure:SNtune:MEASurement[:STATe]`).

If you need to remove spurs for each trace separately (possible in all measurements except Spot Noise vs Tune), use `DISPlay[:WINDow<n>]:TRACe<t>:SPURs:SUPPpress`.

Parameters:

<State> ON | OFF | 1 | 0

Example: //Remove spurs
SPUR:SUPP ON

Manual operation: See "[Hiding spurs](#)" on page 175

[SENSe:]SPURs:THReshold <Threshold>

This command defines a level threshold for spur removal.

Prerequisites for this command

- Select Spot Noise vs Tune measurement (`CONFigure:SNtune:MEASurement[:STATe]`).

- Turn on spur removal (`DISPlay[:WINDow<n>]:TRACe<t>:SPURs:THReshold`).

The threshold applies to all traces. If you need to define a threshold for each trace separately (possible in all measurements except Spot Noise vs Tune), use `DISPlay[:WINDow<n>]:TRACe<t>:SPURs:THReshold`.

Parameters:

<Threshold> <numeric value>
 *RST: 0
 Default unit: dB

Example: //Remove spurs
 SPUR:SUPP ON
 SPUR:THR 5

Manual operation: See "Hiding spurs" on page 175

14.6.10 Transient analysis

• Frequency configuration.....	508
• Amplitude configuration.....	511
• Data acquisition.....	511
• Trigger configuration.....	512
• Y-Axis scale.....	515
• Settling time.....	519
• Frequency deviation.....	522
• Trace configuration.....	524
• Marker configuration.....	524
• Limit lines.....	524

14.6.10.1 Frequency configuration

Commands to configure the frequency described elsewhere.

- Center frequency: `[SENSe:]FREQuency:CENTer`
- Start frequency: `[SENSe:]FREQuency:START`
- Stop frequency: `[SENSe:]FREQuency:STOP`

<code>CONFigure:TRANsient:MODE</code>	509
<code>[SENSe:]FREQuency:CENTer:STEP</code>	509
<code>[SENSe:]FREQuency:CENTer:STEP:LINK</code>	510
<code>[SENSe:]FREQuency:CENTer:STEP:LINK:FACTor</code>	510
<code>[SENSe:]FREQuency:SPAN</code>	511

CONFigure:TRANsient:MODE <OrderBy>

This command selects the transient measurement mode.

Parameters:

<OrderBy>

NARRow

Narrowband mode: For measurement with a frequency span < 40 MHz.

If you define a span < 40 MHz while wideband is selected, or define a frequency range outside the supported frequency range, the R&S FSWP automatically selects narrowband mode and adjusts the center, start and stop frequencies, if necessary.

WIDE

Wideband mode: For measurements with a frequency span > 40 MHz, but only in frequency range between 276 MHz and 7.980 GHz.

If you define a span > 40 MHz while narrowband mode is selected, the R&S FSWP automatically selects wideband mode, and adjusts the center, start and stop frequencies, if necessary.

*RST: WIDE

Example:

```
//Configure measurement with wideband mode
FREQ:CENT 1GHZ
FREQ:SPAN 100MHZ
CONF:TRAN:MODE?
//returns
WIDE
//Select narrowband mode instead - keeps center frequency but
reduces span
CONF:TRAN:MODE NARR
FREQ:CENT?
//returns
1000000000
FREQ:SPAN?
//returns
40000000
```

Manual operation: See "[Selecting the measurement mode](#)" on page 196

[SENSe:]FREQuency:CENTer:STEP <Frequency>

This command defines a frequency stepsize.

Prerequisites for this command

- Select custom stepsize ([\[SENSe:\]FREQuency:CENTer:STEP:LINK](#)).

Parameters:

<Frequency> <numeric value>
Default unit: Hz

Example: //Define frequency stepsize
 FREQ:CENT:STEP:LINK OFF
 FREQ:CENT:STEP 15MHZ

Manual operation: See ["Defining a frequency step size"](#) on page 197

[SENSe:]FREQuency:CENTer:STEP:LINK <Mode>

This command selects the frequency step size mode.

Parameters:

<Mode> The step size is either a function of the span (x % of the span) or an absolute value.

OFF

Step size is a custom percentage of the span or an absolute custom value in Hz.

You can define a percentage with [SENSe:]FREQuency:CENTer:STEP:LINK:FACTor.

You can define a custom value with [SENSe:]FREQuency:CENTer:STEP.

SPAN

Step size is 10 % of the span.

*RST: SPAN

Example: //Select a custom step size
 FREQ:CENT:STEP:LINK OFF
 FREQ:CENT:STEP:LINK:FACT 20

Manual operation: See ["Defining a frequency step size"](#) on page 197

[SENSe:]FREQuency:CENTer:STEP:LINK:FACTor <Percentage>

This command defines a custom frequency step size.

Parameters:

<Percentage> <numeric value>

The value is a percentage. The step size is a function of the percentage and the span:

Step size = x % * span

Range: 0 to 100

*RST: 10

Default unit: PCT

Example: //Select a custom step size
 FREQ:CENT:STEP:LINK OFF
 FREQ:CENT:STEP:LINK:FACT 20

Manual operation: See ["Defining a frequency step size"](#) on page 197

[SENSe:]AVERAge<n>:COUNT.....	512
[SENSe:]BWIDth:VIDeo.....	512
[SENSe:]BWIDth:VIDeo:AUTO.....	512

[SENSe:]AVERAge<n>:COUNT <AverageCount>

Defines the number of measurements that the application uses to average traces.

In case of continuous sweep mode, the application calculates the moving average over the average count.

In case of single sweep mode, the application stops the measurement and calculates the average after the average count has been reached.

Suffix:

<n> irrelevant

[SENSe:]BWIDth:VIDeo <Bandwidth>

This command defines the video bandwidth.

Prerequisites for this command

- Turn off automatic VBW selection ([SENSe:]BWIDth:VIDeo:AUTO).

Parameters:

<Bandwidth> Default unit: HZ

Example:

```
//Select VBW manually
BWID:VID:AUTO OFF
BWID:VID 819672
```

Manual operation: See "[Defining the video bandwidth](#)" on page 201

[SENSe:]BWIDth:VIDeo:AUTO <State>

This command turns automatic selection of the video bandwidth on and off.

Parameters:

<State> ON | OFF | 1 | 0
 *RST: ON

Example:

```
//Turn on automatic VBW selection
BWID:VID:AUTO ON
```

Manual operation: See "[Defining the video bandwidth](#)" on page 201

14.6.10.4 Trigger configuration

TRIGger[:SEQuence]:DTIME.....	513
TRIGger[:SEQuence]:FREQuency.....	513
TRIGger[:SEQuence]:FREQuency:HYSTeresis.....	513
TRIGger[:SEQuence]:HOLDoff[:TIME].....	514
TRIGger[:SEQuence]:IFPower:HOLDoff.....	514

TRIGger[:SEquence]:LEVel[:EXternal<1 2>].....	514
TRIGger[:SEquence]:SLOPe.....	515
TRIGger[:SEquence]:SOURce.....	515

TRIGger[:SEquence]:DTIME <Time>

This command defines the trigger drop-out time.

Parameters:

<Time> <numeric value>
 *RST: 0
 Default unit: s

Example: //Define a drop-out time
 TRIG:DTIM 200MS

Manual operation: See ["Defining a trigger drop-out time"](#) on page 200

TRIGger[:SEquence]:FREQuency <Frequency>

This command defines the trigger frequency.

Prerequisites for this command

- Select the frequency trigger ([TRIGger\[:SEquence\]:SOURce](#)).

Parameters:

<Frequency> <numeric value>
 Default unit: Hz

Example: //Configure frequency trigger
 TRIG:SOUR FREQ
 TRIG:FREQ 1GHZ

Manual operation: See ["Defining the trigger level and frequency"](#) on page 199

TRIGger[:SEquence]:FREQuency:HYSteresis <Hysteresis>

This command defines the trigger hysteresis.

Prerequisites for this command

- Select the frequency trigger ([TRIGger\[:SEquence\]:SOURce](#)).

Parameters:

<Hysteresis> <numeric value>
 *RST: 100 kHz
 Default unit: Hz

Example: //Define a trigger hysteresis
 TRIG:SOUR FREQ
 TRIG:FREQ:HYST 200KHZ

Manual operation: See ["Defining a trigger hysteresis"](#) on page 199

TRIGger[:SEQuence]:HOLDoff[:TIME] <Offset>

Defines the time offset between the trigger event and the start of the measurement.

Parameters:

<Offset> *RST: 0 s
 Default unit: S

Example: TRIG:HOLD 500us

Manual operation: See "[Trigger Offset](#)" on page 199

TRIGger[:SEQuence]:IFPower:HOLDoff <Period>

Defines the holding time before the next trigger event.

Note that this command can be used for **any trigger source**, not just IF Power (despite the legacy keyword).

Parameters:

<Period> Range: 0 s to 10 s
 *RST: 0 s
 Default unit: S

Example: TRIG:SOUR EXT
 Sets an external trigger source.
 TRIG:IFP:HOLD 200 ns
 Sets the holding time to 200 ns.

Manual operation: See "[Trigger Holdoff](#)" on page 199

TRIGger[:SEQuence]:LEVel[:EXTernal<1|2>] <Level>

This command defines the external trigger level.

Prerequisites for this command

- Select the external trigger ([TRIGger\[:SEQuence\]:SOURce](#)).

Suffix:

<1|2> 1|2
 Selects the trigger port.

Parameters:

<Level> <numeric value>
 Default unit: V

Example: //Configure external trigger on trigger port 2
 TRIG:SOUR EXT2
 TRIG:LEV:EXT2 1.4V

Manual operation: See "[Defining the trigger level and frequency](#)" on page 199

TRIGger[:SEQuence]:SLOPe <Slope>

This command selects the trigger slope.

Parameters:

<Slope>

NEGative
Triggering occurs on a falling signal edge.

POSitive
Triggering occurs on a rising signal edge.

*RST: POSitive

Example:

```
//Select trigger slope
TRIG:SLOP POS
```

Manual operation: See ["Defining a trigger slope"](#) on page 199

TRIGger[:SEQuence]:SOURce <Source>

This command selects the trigger source.

Parameters:

<Source>

EXTernal | EXT2
External trigger: The measurement starts when the signal applied to the input connector meets or exceeds a certain level.

FREQuency
Frequency trigger: The measurement starts when the signal applied to the RF input meets or exceeds a certain frequency.

IMMediate
Free run: No trigger is used.

IQPower
Power trigger: The measurement starts when the signal level within the demodulation bandwidth rises or falls by a certain amount.

*RST: IMMediate

Example:

```
//Select trigger source
TRIG:SOUR FREQ
```

Manual operation: See ["Selecting the trigger source"](#) on page 198

14.6.10.5 Y-Axis scale

Commands to scale the y-axis in the frequency result display described elsewhere.

- Center frequency: `[SENSe:]FREQuency:CENTer`
Start frequency: `[SENSe:]FREQuency:STARt`
Stop frequency: `[SENSe:]FREQuency:STOP`
Span: `[SENSe:]FREQuency:SPAN`
- Stepsize: `[SENSe:]FREQuency:CENTer:STEP:LINK`
- Stepsize factor: `[SENSe:]FREQuency:CENTer:STEP:LINK:FACTOR`

Commands to scale the y-axis in the phase result display described elsewhere.

- Mode: `DISPlay[:WINDow<n>]:TRACe<t>:Y[:SCALe]:AUTO`
- Auto scale once: `DISPlay[:WINDow<n>]:TRACe<t>:Y[:SCALe]:AUTO`

<code>CONFigure:TRANsient[:WINDow<n>]:AF:COUPling</code>	516
<code>CONFigure:TRANsient[:WINDow<n>]:AF:COUPling:RPOint:MODE</code>	516
<code>CONFigure:TRANsient[:WINDow<n>]:AF:COUPling:RPOint[:X]</code>	517
<code>DISPlay[:WINDow<n>]:TRACe<t>:Y[:SCALe]:MODE</code>	517
<code>DISPlay[:WINDow<n>]:TRACe<t>:Y[:SCALe]:PDIVision</code>	518
<code>DISPlay[:WINDow<n>]:TRACe<t>:Y[:SCALe]:RPOStion</code>	518
<code>DISPlay[:WINDow<n>]:TRACe<t>:Y[:SCALe]:RVALue</code>	519
<code>DISPlay[:WINDow<n>]:TRACe<t>:Y[:SCALe]:UNIT</code>	519

`CONFigure:TRANsient[:WINDow<n>]:AF:COUPling <Mode>`

This command selects the AF coupling mode.

Suffix:

<n> 1..n
Window

Parameters:

<Mode> **AC**
AC coupling: Frequency offset and phase offset are automatically corrected and DC signal contains a phase offset of $\pm\pi$.

DC
DC coupling: Phase runs according to the existing frequency offset.

*RST: AC

Example: //Select AF coupling mode
`CONF:TRAN:AF:COUP AC`

Manual operation: See "Selecting the AF coupling mode" on page 204

`CONFigure:TRANsient[:WINDow<n>]:AF:COUPling:RPOint:MODE <Mode>`

This command selects the zero phase positioning mode.

Suffix:

<n> 1..n
Window

Parameters:

<Mode> **AUTO**
Positions the zero phase at the end of the trace (right diagram border).

MANual
Manual selection the position of the zero phase.
You can define the zero phase position with `CONFigure:TRANsient[:WINDow<n>]:AF:COUPling:RPOint[:X]`.

*RST: AUTO

Example: //Select zero phase positioning mode
CONF:TRAN:AF:COUP:RPO:MODE AUTO

Manual operation: See "[Positioning the zero-phase](#)" on page 204

CONFigure:TRANSient[:WINDow<n>]:AF:COUPling:RPOint[:X] <Position>

This command defines the position of the zero phase.

Prerequisites for this command

- Turn on manual selection of the zero phase position ([CONFigure:TRANSient\[:WINDow<n>\]:AF:COUPling:RPOint:MODE](#)).
- Select "DC" AF coupling ([CONFigure:TRANSient\[:WINDow<n>\]:AF:COUPling](#) on page 516).

Suffix:

<n> 1..n
[Window](#)

Parameters:

<Position> <numeric value>
Default unit: s

Example: //Define position of the zero phase manually
CONF:TRAN:AF:COUP:RPO:MODE MAN
CONF:TRAN:AF:COUP:RPO 1US

Manual operation: See "[Positioning the zero-phase](#)" on page 204

DISPlay[:WINDow<n>]:TRACe<t>:Y[:SCALe]:MODE <Mode>

This command selects how frequencies are displayed on the y-axis.

Prerequisites for this command

- Frequency result display must be available and selected.

Suffix:

<n> 1..n
[Window](#)

<t> 1..n
irrelevant

Parameters:

<Mode> **ABSolute**
Displays the frequencies in absolute values.
RELative
Displays the frequencies as an offset to the center frequency.
*RST: ABSolute

Example: //Display frequencies in relative terms
DISP:TRAC:Y:MODE REL

Manual operation: See ["Scaling the y-axis of the frequency diagram"](#) on page 203

DISPlay[:WINDow<n>]:TRACe<t>:Y[:SCALe]:PDIVision <Value>

This command defines the range of a single diagram division on the y-axis of the phase result display.

Prerequisites for this command

- Phase result display must be available and selected.

Suffix:

<n> 1..n
[Window](#)

<t> 1..n
irrelevant

Parameters:

<Value> <numeric value>
Default unit: Depends on the selected unit (rad or deg)

Example: //Display 0.5 rad per grid division
DISP:TRAC:Y:UNIT
DISP:TRAC:Y:PDIV 0.5

Manual operation: See ["Scaling the y-axis of the phase diagram"](#) on page 203

DISPlay[:WINDow<n>]:TRACe<t>:Y[:SCALe]:RPOSition <Position>

This command defines the position of the reference value on the y-axis.

Prerequisites for this command

- Phase result display must be available and selected.

Suffix:

<n> 1..n
[Window](#)

<t> 1..n
irrelevant

Parameters:

<Position> Percentage of the diagram height with 100 % corresponding to the upper diagram border
*RST: 50
Default unit: PCT

Example: //Shift reference position to top of the diagram
DISP:TRAC:Y:RPOS 100

Manual operation: See ["Scaling the y-axis of the phase diagram"](#) on page 203

DISPlay[:WINDow<n>]:TRACe<t>:Y[:SCALe]:RVALue <RefValue>

This command defines the value assigned to the reference position.

Prerequisites for this command

- Phase result display must be available and selected.

Suffix:

<n>	1..n Window
<t>	1..n irrelevant

Parameters:

<RefValue>	<numeric value> *RST: 0 Default unit: Depends on the selected unit (deg or rad)
------------	---

Example: //Define reference value in rad
DISP:TRAC:Y:UNIT RAD
DISP:TRAC:Y:RVAL 5

Manual operation: See "[Scaling the y-axis of the phase diagram](#)" on page 203

DISPlay[:WINDow<n>]:TRACe<t>:Y[:SCALe]:UNIT <YScalUnit>

This command selects the unit in which the phase results are displayed.

Prerequisites for this command

- Phase result display must be available and selected.

Suffix:

<n>	1..n Window
<t>	1..n irrelevant

Parameters:

<YScalUnit>	DEG RAD *RST: RAD
-------------	------------------------

Example: //Select unit for phase results
DISP:TRAC:Y:UNIT DEG

Manual operation: See "[Scaling the y-axis of the phase diagram](#)" on page 203

14.6.10.6 Settling time

CALCulate<n>:SETTling:TIME:STATe.....	520
CALCulate<n>:SETTling:TIME:DIAGram.....	520
CALCulate<n>:SETTling:TIME:TRACe.....	520
CALCulate<n>:SETTling:TIME:FREQuency:LIMit:LOWer.....	520

CALCulate<n>:SETTling:TIME:FREQUency:LIMit:UPPer.....	521
CALCulate<n>:SETTling:TIME:PHASe:LIMit:LOWer.....	521
CALCulate<n>:SETTling:TIME:PHASe:LIMit:UPPer.....	521
CALCulate<n>:SETTling:TIME:RESult?.....	521

CALCulate<n>:SETTling:TIME:STATe <State>

This command defines the state of settling time measurement.

Suffix:

<n> irrelevant

Parameters:

<State> ON | OFF | 1 | 0
*RST: 0

Example: CALC1:SETT:TIME:STAT OFF

CALCulate<n>:SETTling:TIME:DIAGram <Diagram>

This command selects the diagram for settling time calculation.

Suffix:

<n> irrelevant

Parameters:

<Diagram> Number of the diagram

Example: CALC:SETT:TIME:DIAG 1

CALCulate<n>:SETTling:TIME:TRACe <Trace>

This command selects the trace for settling time calculation.

Suffix:

<n> irrelevant

Parameters:

<Trace> TRACe1 | TRACe2 | TRACe3 | TRACe4 | TRACe5 | TRACe6

Example: CALC:SETT:TIME:TRAC Trace1

CALCulate<n>:SETTling:TIME:FREQUency:LIMit:LOWer <Frequency>

This command defines the lower frequency of settling time measurement.

Suffix:

<n> irrelevant

Parameters:

<Frequency> Default unit: Hz

Example: CALC1:SETT:TIME:LOW:FREQ:LIM 100

CALCulate<n>:SETTling:TIME:FREQUency:LIMit:UPPer <Frequency>

This command defines the upper frequency of settling time measurement.

Suffix:

<n> irrelevant

Parameters:

<Frequency> Default unit: Hz

Example:

CALC1:SETT:TIME:UPP:FREQ:LIM 1000

CALCulate<n>:SETTling:TIME:PHASe:LIMit:LOWer <Phase>

Defines the lower phase limit of the settling time measurement.

Suffix:

<n> irrelevant

Parameters:

<Phase> <numeric value>
Default unit: DEG

Example:

CALC1:SETT:TIME:LOW:PHAS:LIM -1

CALCulate<n>:SETTling:TIME:PHASe:LIMit:UPPer <Phase>

Defines the upper phase limit of the settling time measurement.

Suffix:

<n> irrelevant

Parameters:

<Phase> <numeric value>
Default unit: DEG

Example:

CALC1:SETT:TIME:UPP:PHAS:LIM 1

CALCulate<n>:SETTling:TIME:RESult?

This command returns the settling time.

Suffix:

<n> irrelevant

Example:

CALC1:SETT:TIME:RES?

Usage:

Query only

14.6.10.7 Frequency deviation

CALCulate<n>:FREQUENCY:DEVIation:STATe.....	522
CALCulate<n>:FREQUENCY:DEVIation:DIAGram.....	522
CALCulate<n>:FREQUENCY:DEVIation:TRACe.....	522
CALCulate<n>:FREQUENCY:DEVIation:STARt.....	522
CALCulate<n>:FREQUENCY:DEVIation:STOP.....	523
CALCulate<n>:FREQUENCY:DEVIation:REGReSSion?.....	523
CALCulate<n>:FREQUENCY:DEVIation:REGReSSion:POINts?.....	523
CALCulate<n>:FREQUENCY:DEVIation:SLOPe?.....	523

CALCulate<n>:FREQUENCY:DEVIation:STATe <State>

This command defines the state of frequency deviation measurement.

Suffix:

<n> irrelevant

Parameters:

<State> ON | OFF | 1 | 0
*RST: 0

Example: CALC1:FREQ:DEV:STAT OFF

CALCulate<n>:FREQUENCY:DEVIation:DIAGram <Diagram>

This command selects the diagram for frequency deviation calculation.

Suffix:

<n> irrelevant

Parameters:

<Diagram> Number of the diagram

Example: CALC:FREQ:DEV:DIAG 1

CALCulate<n>:FREQUENCY:DEVIation:TRACe <Trace>

This command selects the trace for frequency deviation calculation.

Suffix:

<n> irrelevant

Parameters:

<Trace> TRACe1 | TRACe2 | TRACe3 | TRACe4 | TRACe5 | TRACe6

Example: CALC:FREQ:DEV:TRAC Trac1

CALCulate<n>:FREQUENCY:DEVIation:STARt <Range>

This command defines the start frequency of frequency deviation measurement.

Suffix:
<n> irrelevant

Parameters:
<Range> Default unit: s

Example: CALC1:FREQ:DEV:STAR 100

CALCulate<n>:FREQUency:DEVIation:STOP <Range>

This command defines the stop frequency of frequency deviation measurement.

Suffix:
<n> irrelevant

Parameters:
<Range> Default unit: s

Example: CALC1:FREQ:DEV:STOP 1000

CALCulate<n>:FREQUency:DEVIation:REGReSSion?

This command returns the data of the regression line.

Suffix:
<n> irrelevant

Example: CALC1:FREQ:DEV:REGR?

Usage: Query only

CALCulate<n>:FREQUency:DEVIation:REGReSSion:POINts?

This command queries the number of points of the regression line.

Suffix:
<n> irrelevant

Return values:
<Points>

Example: CALC1:FREQ:DEV:REGR:POIN?

Usage: Query only

CALCulate<n>:FREQUency:DEVIation:SLOPe?

This command returns the slope of the regression line. A single floating point value with the unit Hz/s is returned.

Suffix:
<n> irrelevant

Example: CALC1:FREQ:DEV:SLOP?

Usage: Query only

14.6.10.8 Trace configuration

Commands to configure transient analysis traces described elsewhere.

- Trace state: `DISPlay[:WINDow<n>][:SUBWindow<w>]:TRACe<t>[:STATe]`
- Trace mode: `DISPlay[:WINDow<n>][:SUBWindow<w>]:TRACe<t>:MODE`
- Persistence: `DISPlay[:WINDow<n>]:TRACe<t>:PERSistence[:STATe]`
- Decay: `DISPlay[:WINDow<n>]:TRACe<t>:PERSistence:DECay`
- Trace copy: `TRACe<n>:COPY`
- Trace labels: `DISPlay[:WINDow<n>]:TRACe<t>:LABel[:STATe]`
- Trace labels: `DISPlay[:WINDow<n>]:TRACe<t>:LABel:TEXT`
- Trace export: [Chapter 14.7.3.3, "Trace export and import"](#), on page 544
- Trace mathematics: [Chapter 14.7.3.4, "Trace mathematics"](#), on page 547

14.6.10.9 Marker configuration

See [Chapter 14.7.4, "Marker"](#), on page 549 for a complete list of commands to control markers.

14.6.10.10 Limit lines

See [Chapter 14.7.5, "Limit lines"](#), on page 563 for a complete list of commands to control limit lines.

14.7 Common analysis and display functions

- [Display configuration](#)..... 524
- [Zoom](#)..... 533
- [Trace configuration](#)..... 537
- [Marker](#)..... 549
- [Limit lines](#)..... 563
- [Examples: configuring the result display](#)..... 575

14.7.1 Display configuration

- `DISPlay:FORMat`..... 525
- `DISPlay:WSElect?`..... 525
- `DISPlay[:WINDow<n>][:SUBWindow<w>]:SElect`..... 525
- `DISPlay[:WINDow<n>]:SIZE`..... 526
- `LAYout:ADD[:WINDow]?`..... 526
- `LAYout:CATalog[:WINDow]?`..... 528
- `LAYout:IDENtify[:WINDow]?`..... 528

LAYout:MOVE[:WINDow].....	529
LAYout:REMove[:WINDow].....	529
LAYout:REPLace[:WINDow].....	529
LAYout:SPLitter.....	530
LAYout:WINDow<n>:ADD?.....	531
LAYout:WINDow<n>:IDENtify?.....	532
LAYout:WINDow<n>:REMove.....	532
LAYout:WINDow<n>:REPLace.....	532
LAYout:WINDow<n>:TYPE?.....	533

DISPlay:FORMat <Format>

Determines which tab is displayed.

Parameters:

<Format>	SPLit Displays the MultiView tab with an overview of all active channels
	SINGle Displays the measurement channel that was previously focused.
*RST:	SING

Example: DISP:FORM SPL

DISPlay:WSElect?

Queries the currently active window (the one that is focused) *in the currently selected measurement channel*.

Return values:

<SelectedWindow>	Index number of the currently active window.
Range:	1 to 16

Usage: Query only

DISPlay[:WINDow<n>][:SUBWindow<w>]:SElect

Sets the focus on the selected result display window.

This window is then the active window.

For measurements with multiple results in subwindows, the command also selects the subwindow. Use this command to select the (sub)window before querying trace data.

Suffix:

<n>	Window
<w>	subwindow Not supported by all applications

Example: //Put the focus on window 1
DISP:WIND1:SEL

Example: //Put the focus on subwindow 2 in window 1
DISP:WIND1:SUBW2:SEL

DISPlay[:WINDow<n>]:SIZE <Size>

Maximizes the size of the selected result display window *temporarily*. To change the size of several windows on the screen permanently, use the `LAY:SPL` command (see [LAYout:SPLitter](#) on page 530).

Suffix:

<n> [Window](#)

Parameters:

<Size>

LARGE

Maximizes the selected window to full screen.
Other windows are still active in the background.

SMALL

Reduces the size of the selected window to its original size.
If more than one measurement window was displayed originally, these are visible again.

*RST: SMALL

Example: DISP:WIND2:SIZE LARG

LAYout:ADD[:WINDow]? <WindowName>, <Direction>, <WindowType>

Adds a window to the display in the active channel.

Is always used as a query so that you immediately obtain the name of the new window as a result.

To replace an existing window, use the `LAYout:REPLace[:WINDow]` command.

Query parameters:

<WindowName> String containing the name of the existing window the new window is inserted next to.

By default, the name of a window is the same as its index. To determine the name and index of all active windows, use the `LAYout:CATalog[:WINDow]?` query.

<Direction> LEFT | RIGHT | ABOVE | BELOW

Direction the new window is added relative to the existing window.

<WindowType> text value

Type of result display (evaluation method) you want to add.
See the table below for available parameter values.

Return values:

<NewWindowName> When adding a new window, the command returns its name (by default the same as its number) as a result.

Example: LAY:ADD? '1', LEFT, MTAB
 Result:
 '2'
 Adds a new window named '2' with a marker table to the left of window 1.

Usage: Query only

Manual operation: See "[Marker Table](#)" on page 131

Table 14-4: <WindowType> parameter values for the phase noise application

Parameter value	Window type
ADEViation	Allan deviation ⁵
AMNoise	Noise spectrum with preconfigured AM traces ⁶
AVARiance	Allan variance ⁵
DIAGram	Noise spectrum with preconfigured PN traces ⁶ , Noise spectrum ⁷
FDEViation	Frequency Deviation ⁴
FREQuency	Frequency ^{2,4}
HARMonic	Harmonic power ²
INOise	Integrated noise ¹
LF	Noise spectrum L(f) ⁶
MTABLE	Marker table ^{1,2,3,4}
PFREquency	Power vs frequency ²
PHASe	Phase ⁴
PNOise	Noise spectrum with preconfigured PN traces ⁶ , Noise spectrum ⁷
POWER	Power ²
RNOise	Integrated noise ¹
SENSitivity	Sensitivity ²
SNOise	Spot noise ¹
SNTam	Spot noise vs tune AM ³
SNTPn	Spot noise vs tune PN ³
SNU	Noise spectrum Sv(f) ⁶
SPHI	Noise spectrum SΦ(f) ⁶
SPURs	Spurious list ¹
SUPPLY	Supply current / voltage ²

Parameter value	Window type
SY	Noise spectrum $S_y(f)$ ⁶
¹ Phase noise, additive noise, baseband noise, pulsed phase noise and pulsed additive noise measurements ² VCO characterization ³ Spot noise vs tune ⁴ Transient analysis ⁵ Phase noise ⁶ Phase noise, additive noise, pulsed phase noise and pulsed additive noise measurements ⁷ Baseband noise	

LAYout:CATalog[:WINDow]?

Queries the name and index of all active windows in the active channel from top left to bottom right. The result is a comma-separated list of values for each window, with the syntax:

<WindowName_1>,<WindowIndex_1>..

Return values:

<WindowName> string
 Name of the window.
 In the default state, the name of the window is its index.

<WindowIndex> **numeric value**
 Index of the window.

Example:

LAY:CAT?

Result:

'2',2,'1',1

Two windows are displayed, named '2' (at the top or left), and '1' (at the bottom or right).

Usage: Query only

LAYout:IDENTify[:WINDow]? <WindowName>

Queries the **index** of a particular display window in the active channel.

Note: to query the **name** of a particular window, use the [LAYout:WINDow<n>:IDENTify?](#) query.

Query parameters:

<WindowName> String containing the name of a window.

Return values:

<WindowIndex> Index number of the window.

Example: `LAY:IDEN:WIND? '2'`
 Queries the index of the result display named '2'.
Response:
 2

Usage: Query only

LAYout:MOVE[:WINDow] <WindowName>, <WindowName>, <Direction>

Setting parameters:

<WindowName> String containing the name of an existing window that is to be moved.
 By default, the name of a window is the same as its index. To determine the name and index of all active windows in the active channel, use the `LAYout:CATalog[:WINDow]?` query.

<WindowName> String containing the name of an existing window the selected window is placed next to or replaces.
 By default, the name of a window is the same as its index. To determine the name and index of all active windows in the active channel, use the `LAYout:CATalog[:WINDow]?` query.

<Direction> LEFT | RIGHT | ABOVE | BELOW | REPLACE
 Destination the selected window is moved to, relative to the reference window.

Example: `LAY:MOVE '4', '1', LEFT`
 Moves the window named '4' to the left of window 1.

Example: `LAY:MOVE '1', '3', REPL`
 Replaces the window named '3' by window 1. Window 3 is deleted.

Usage: Setting only

LAYout:REMOve[:WINDow] <WindowName>

Removes a window from the display in the active channel.

Setting parameters:

<WindowName> String containing the name of the window. In the default state, the name of the window is its index.

Example: `LAY:REM '2'`
 Removes the result display in the window named '2'.

Usage: Setting only

LAYout:REPLace[:WINDow] <WindowName>, <WindowType>

Replaces the window type (for example from "Diagram" to "Result Summary") of an already existing window in the active channel while keeping its position, index and window name.

To add a new window, use the `LAYout:ADD[:WINDow]?` command.

Setting parameters:

- <WindowName> String containing the name of the existing window.
By default, the name of a window is the same as its index. To determine the name and index of all active windows in the active channel, use the `LAYout:CATalog[:WINDow]?` query.
- <WindowType> Type of result display you want to use in the existing window.
See `LAYout:ADD[:WINDow]?` on page 526 for a list of available window types.

Example:

```
LAY:REPL:WIND '1',MTAB
```

Replaces the result display in window 1 with a marker table.

Usage:

Setting only

LAYout:SPLitter <Index1>, <Index2>, <Position>

Changes the position of a splitter and thus controls the size of the windows on each side of the splitter.

Compared to the `DISPlay[:WINDow<n>]:SIZE` on page 526 command, the `LAYout:SPLitter` changes the size of all windows to either side of the splitter permanently, it does not just maximize a single window temporarily.

Note that windows must have a certain minimum size. If the position you define conflicts with the minimum size of any of the affected windows, the command does not work, but does not return an error.

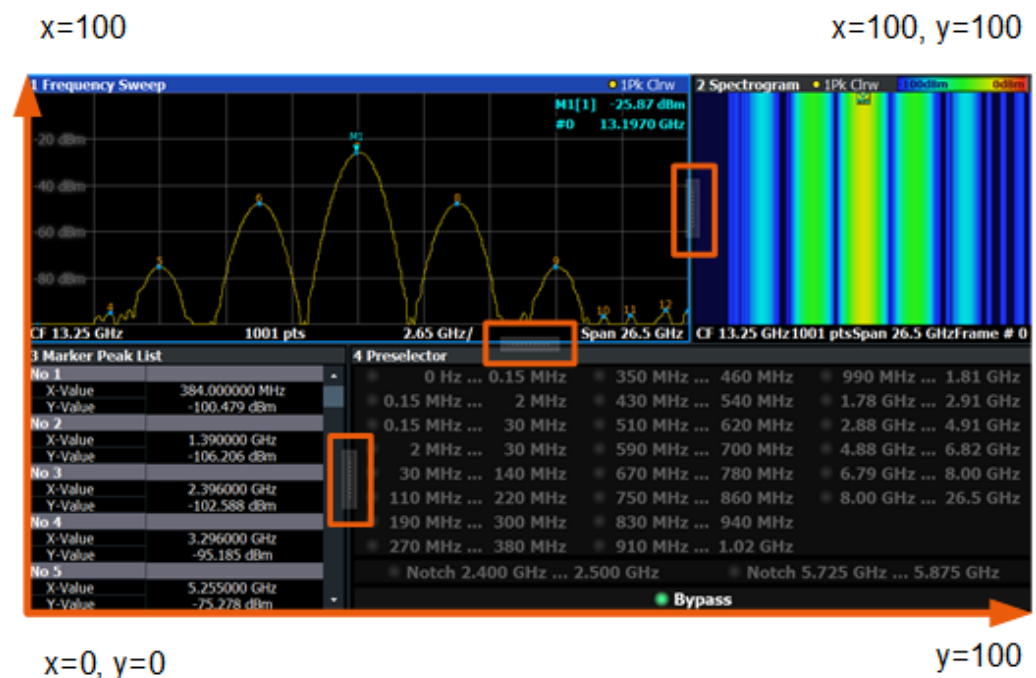

Figure 14-1: SmartGrid coordinates for remote control of the splitters

Setting parameters:

<Index1>	The index of one window the splitter controls.
<Index2>	The index of a window on the other side of the splitter.
<Position>	New vertical or horizontal position of the splitter as a fraction of the screen area (without channel and status bar and softkey menu). The point of origin (x = 0, y = 0) is in the lower left corner of the screen. The end point (x = 100, y = 100) is in the upper right corner of the screen. (See Figure 14-1 .) The direction in which the splitter is moved depends on the screen layout. If the windows are positioned horizontally, the splitter also moves horizontally. If the windows are positioned vertically, the splitter also moves vertically. Range: 0 to 100

Example:

```
LAY:SPL 1,3,50
```

Moves the splitter between window 1 ('Frequency Sweep') and 3 ('Marker Table') to the center (50%) of the screen, i.e. in the figure above, to the left.

Example:

```
LAY:SPL 1,4,70
```

Moves the splitter between window 1 ('Frequency Sweep') and 3 ('Marker Peak List') towards the top (70%) of the screen. The following commands have the exact same effect, as any combination of windows above and below the splitter moves the splitter vertically.

```
LAY:SPL 3,2,70
```

```
LAY:SPL 4,1,70
```

```
LAY:SPL 2,1,70
```

Usage:

Setting only

LAYout:WINDow<n>:ADD? <Direction>,<WindowType>

Adds a measurement window to the display. Note that with this command, the suffix <n> determines the existing window next to which the new window is added. Unlike [LAYout:ADD\[:WINDow\]?](#), for which the existing window is defined by a parameter.

To replace an existing window, use the [LAYout:WINDow<n>:REPLace](#) command.

Is always used as a query so that you immediately obtain the name of the new window as a result.

Suffix:

<n> [Window](#)

Query parameters:

<Direction>	LEFT RIGHT ABOVE BELOW
<WindowType>	Type of measurement window you want to add. See LAYout:ADD[:WINDow]? on page 526 for a list of available window types.

Return values:

<NewWindowName> When adding a new window, the command returns its name (by default the same as its number) as a result.

Example:

```
LAY:WIND1:ADD? LEFT,MTAB
```

Result:

```
'2'
```

Adds a new window named '2' with a marker table to the left of window 1.

Usage:

Query only

LAYout:WINDow<n>:IDENtify?

Queries the **name** of a particular display window (indicated by the <n> suffix) in the active channel.

Note: to query the **index** of a particular window, use the [LAYout:IDENtify\[:WINDow\]?](#) command.

Suffix:

<n> [Window](#)

Return values:

<WindowName> String containing the name of a window.
In the default state, the name of the window is its index.

Example:

```
LAY:WIND2:IDEN?
```

Queries the name of the result display in window 2.

Response:

```
'2'
```

Usage:

Query only

LAYout:WINDow<n>:REMOve

Removes the window specified by the suffix <n> from the display in the active channel.

The result of this command is identical to the [LAYout:REMOve\[:WINDow\]](#) command.

Suffix:

<n> [Window](#)

Example:

```
LAY:WIND2:REM
```

Removes the result display in window 2.

Usage:

Event

LAYout:WINDow<n>:REPLace <WindowType>

Changes the window type of an existing window (specified by the suffix <n>) in the active channel.

The effect of this command is identical to the `LAYout:REPLace[:WINDow]` command.

To add a new window, use the `LAYout:WINDow<n>:ADD?` command.

Suffix:

<n> [Window](#)

Setting parameters:

<WindowType> Type of measurement window you want to replace another one with.
See `LAYout:ADD[:WINDow]?` on page 526 for a list of available window types.

Example:

`LAY:WIND2:REPL MTAB`

Replaces the result display in window 2 with a marker table.

Usage:

Setting only

LAYout:WINDow<n>:TYPE?

Queries or defines the window type of the window specified by the index <n>. The window type determines which results are displayed. For a list of possible window types, see `LAYout:ADD[:WINDow]?` on page 526.

Note that this command is not available in all applications and measurements.

Suffix:

<n> 1..n
[Window](#)

Return values:

<ResultDisplay> <display_type>

Example:

`LAYout:WINDow1:TYPE?`

Usage:

Query only

14.7.2 Zoom

<code>DISPlay[:WINDow<n>][:SUBWindow<w>]:ZOOM:AREA</code>	533
<code>DISPlay[:WINDow<n>][:SUBWindow<w>]:ZOOM:MULTiple<zn>:AREA</code>	535
<code>DISPlay[:WINDow<n>][:SUBWindow<w>]:ZOOM:MULTiple<zn>[:STATe]</code>	536
<code>DISPlay[:WINDow<n>][:SUBWindow<w>]:ZOOM[:STATe]</code>	536

DISPlay[:WINDow<n>][:SUBWindow<w>]:ZOOM:AREA <x1>,<y1>,<x2>,<y2>

Defines the zoom area.

To define a zoom area, you first have to turn the zoom on.

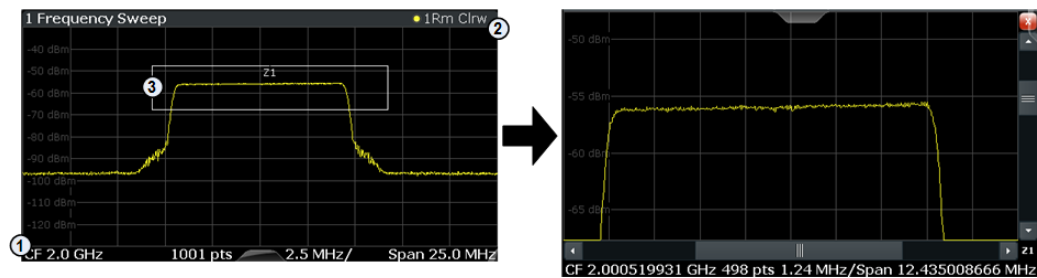

- 1 = origin of coordinate system (x1 = 0, y1 = 0)
 2 = end point of system (x2 = 100, y2 = 100)
 3 = zoom area (e.g. x1 = 60, y1 = 30, x2 = 80, y2 = 75)

Suffix:

- <n> [Window](#)
 <w> subwindow
 Not supported by all applications

Parameters:

- <x1> Diagram coordinates in % of the complete diagram that define the zoom area.
 The lower left corner is the origin of coordinate system. The upper right corner is the end point of the system.
 Range: 0 to 100
 Default unit: PCT
- <y1> Diagram coordinates in % of the complete diagram that define the zoom area.
 The lower left corner is the origin of coordinate system. The upper right corner is the end point of the system.
 Range: 0 to 100
 Default unit: PCT
- <x2> Diagram coordinates in % of the complete diagram that define the zoom area.
 The lower left corner is the origin of coordinate system. The upper right corner is the end point of the system.
 Range: 0 to 100
 Default unit: PCT
- <y2> Diagram coordinates in % of the complete diagram that define the zoom area.
 The lower left corner is the origin of coordinate system. The upper right corner is the end point of the system.
 Range: 0 to 100
 Default unit: PCT

Manual operation: See "[Single Zoom](#)" on page 214

DISPlay[:WINDow<n>][:SUBWindow<w>]:ZOOM:MULTiple<zn>:AREA
 <x1>,<y1>,<x2>,<y2>

Defines the zoom area for a multiple zoom.

To define a zoom area, you first have to turn the zoom on.

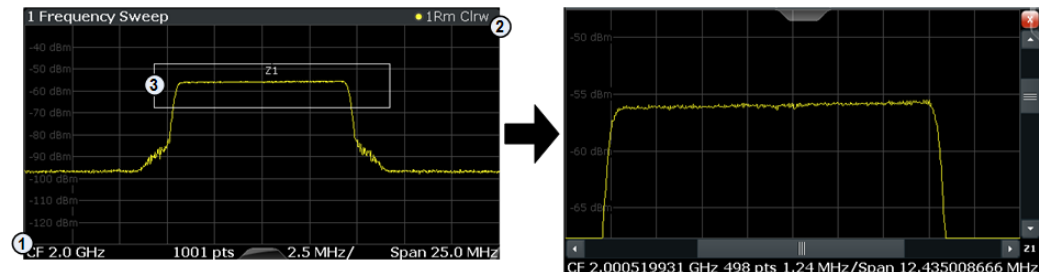

- 1 = origin of coordinate system (x1 = 0, y1 = 0)
- 2 = end point of system (x2 = 100, y2 = 100)
- 3 = zoom area (e.g. x1 = 60, y1 = 30, x2 = 80, y2 = 75)

Suffix:

- <n> [Window](#)
- <w> subwindow
Not supported by all applications
- <zn> Selects the zoom window.

Parameters:

- <x1> Diagram coordinates in % of the complete diagram that define the zoom area.
The lower left corner is the origin of coordinate system. The upper right corner is the end point of the system.
Range: 0 to 100
Default unit: PCT
- <y1> Diagram coordinates in % of the complete diagram that define the zoom area.
The lower left corner is the origin of coordinate system. The upper right corner is the end point of the system.
Range: 0 to 100
Default unit: PCT
- <x2> Diagram coordinates in % of the complete diagram that define the zoom area.
The lower left corner is the origin of coordinate system. The upper right corner is the end point of the system.
Range: 0 to 100
Default unit: PCT

<y2> Diagram coordinates in % of the complete diagram that define the zoom area.
The lower left corner is the origin of coordinate system. The upper right corner is the end point of the system.
Range: 0 to 100
Default unit: PCT

Manual operation: See "[Multi-Zoom](#)" on page 214

DISPlay[:WINDow<n>][:SUBWindow<w>]:ZOOM:MULTiple<zn>[:STATe] <State>

Turns the multiple zoom on and off.

Suffix:

<n> [Window](#)

<w> subwindow
Not supported by all applications

<zn> Selects the zoom window.
If you turn off one of the zoom windows, all subsequent zoom windows move up one position.

Parameters:

<State> ON | OFF | 0 | 1
OFF | 0
Switches the function off
ON | 1
Switches the function on

Manual operation: See "[Multi-Zoom](#)" on page 214

DISPlay[:WINDow<n>][:SUBWindow<w>]:ZOOM[:STATe] <State>

Turns the zoom on and off.

Suffix:

<n> [Window](#)

<w> subwindow
Not supported by all applications

Parameters:

<State> ON | OFF | 0 | 1
OFF | 0
Switches the function off
ON | 1
Switches the function on

Example: DISP:ZOOM ON
Activates the zoom mode.

Manual operation: See "Single Zoom" on page 214
See "Restore Original Display" on page 216

14.7.3 Trace configuration

- Trace characteristics..... 537
- Trace copy..... 543
- Trace export and import..... 544
- Trace mathematics..... 547
- Formats for returned values: ASCII format and binary format..... 549

14.7.3.1 Trace characteristics

Commands to configure traces described elsewhere.

- `DISPlay[:WINDow<n>]:TRACe<t>:SPURs:SUPPress`
- `DISPlay[:WINDow<n>]:TRACe<t>:SPURs:THReshold`

<code>DISPlay[:WINDow<n>][:SUBWindow<w>]:TRACe<t>:MODE</code>	537
<code>DISPlay[:WINDow<n>]:TRACe<t>:LABel[:STATe]</code>	538
<code>DISPlay[:WINDow<n>]:TRACe<t>:LABel:TEXT</code>	539
<code>DISPlay[:WINDow<n>]:TRACe<t>:PERsistence:DECay</code>	539
<code>DISPlay[:WINDow<n>]:TRACe<t>:PERsistence[:STATe]</code>	539
<code>DISPlay[:WINDow<n>]:TRACe<t>:RESult[:TYPE]</code>	540
<code>DISPlay[:WINDow]:TRACe:CLEar:AUTO</code>	540
<code>DISPlay[:WINDow<n>][:SUBWindow<w>]:TRACe<t>[:STATe]</code>	541
<code>DISPlay[:WINDow<n>]:TRACe<t>:Y[:SCALe]:RLEVel:OFFSet</code>	541
<code>DISPlay[:WINDow<n>]:TRACe<t>:Y[:SCALe]:RLEVel:OFFSet:STATe</code>	542
<code>DISPlay[:WINDow<n>]:TRACe<t>:SMOothing:APERture</code>	542
<code>DISPlay[:WINDow<n>]:TRACe<t>:SMOothing[:STATe]</code>	543

`DISPlay[:WINDow<n>][:SUBWindow<w>]:TRACe<t>:MODE <Mode>`

Selects the trace mode. If necessary, the selected trace is also activated.

For max hold, min hold or average trace mode, you can set the number of single measurements with `[SENSe:]SWEep:COUNT`. Note that synchronization to the end of the measurement is possible only in single sweep mode.

Suffix:

<code><n></code>	Window
<code><w></code>	subwindow Not supported by all applications
<code><t></code>	Trace

Parameters:

<code><Mode></code>	WRITE (default:) Overwrite mode: the trace is overwritten by each sweep.
---------------------------	--

AVERage

The average is formed over several sweeps. The "Sweep/Average Count" determines the number of averaging procedures.

MAXHold

The maximum value is determined over several sweeps and displayed. The R&S FSWP saves the sweep result in the trace memory only if the new value is greater than the previous one.

MINHold

The minimum value is determined from several measurements and displayed. The R&S FSWP saves the sweep result in the trace memory only if the new value is lower than the previous one.

VIEW

The current contents of the trace memory are frozen and displayed.

BLANK

Hides the selected trace.

WRHold

The trace is overwritten when new data is available, but only after all cross-correlation operations defined for a half decade are done.

*RST: Depends on the trace.

Example:

```
INIT:CONT OFF
Switching to single sweep mode.
SWE:COUN 16
Sets the number of measurements to 16.
DISP:TRAC3:MODE WRIT
Selects clear/write mode for trace 3.
INIT;*WAI
Starts the measurement and waits for the end of the measurement.
```

Manual operation: See ["Trace Mode"](#) on page 224

DISPlay[:WINDow<n>]:TRACe<t>:LABel[:STATe] <State>

This command turns the display of the trace label for a specific trace on and off.

The command can only be applied to active traces.

Suffix:

<n> 1..n
[Window](#)

<t> 1..n
[Trace](#)

Parameters:

<State> ON | OFF | 1 | 0
*RST: OFF

Example: //Turn on the label for trace 2
DISP:TRAC2:LAB ON

DISPlay[:WINDow<n>]:TRACe<t>:LABel:TEXT <Label>

This command defines the contents of a trace label.

Suffix:

<n> 1..n
Window

<t> 1..n
Trace

Parameters:

<Label> String containing the trace label.

Example: //Assign a label to trace 2.
DISP:TRAC2:LAB:TEXT 'A YELLOW TRACE'

DISPlay[:WINDow<n>]:TRACe<t>:PERSistence:DECay <Decay>

This command defines the time period that an event remains visible until it fades away (decay).

Prerequisites for this command

- Turn on persistence ([DISPlay\[:WINDow<n>\]:TRACe<t>:PERSistence\[:STATe\]](#)).

Suffix:

<n> 1..n
Window

<t> 1..n
Trace

Parameters:

<Decay> <numeric value>
Range: 0 s to 8 s
*RST: 0
Default unit: s

Example: //Turn on persistence for trace 2 with a decay of 2 seconds
DISP:TRAC2:PERS ON
DISP:TRAC2:PERS:DEC 2s

Manual operation: See "[Displaying persistence](#)" on page 225

DISPlay[:WINDow<n>]:TRACe<t>:PERSistence[:STATe] <State>

This command turns persistence for a trace on and off.

Suffix:

<n> 1..n
Window

<t> 1..n
Trace

Parameters:

<State> ON | OFF | 1 | 0
*RST: OFF

Example: //Turn on persistence for trace 2
DISP:TRAC2:PERS ON

Manual operation: See "[Displaying persistence](#)" on page 225

DISPlay[:WINDow<n>]:TRACe<t>:RESUlt[:TYPE] <Resulttype>

This command selects the type of noise represented by the trace.

Suffix:

<n> 1..n
Window

<t> 1..n
Trace

Parameters:

<Resulttype> **PN**
Phase noise results.
AM
AM noise results.
PNAM
Sum of phase noise and AM noise.

Example: //Show AM noise characteristics on trace 2
DISP:TRAC2:RES AM

Manual operation: See "[Selecting the displayed result](#)" on page 224

DISPlay[:WINDow]:TRACe:CLEAr:AUTO <State>

Clears all "Clear Write" traces from the last measurement at the start of a new sweep.

Parameters:

<State> ON | OFF | 1 | 0
ON | 1
Activates the option.
OFF | 0
Deactivates the option.
*RST: OFF

Example: //Clear all "Clear Write" traces
DISP:TRAC:CLE:ON

Manual operation: See "[Clear Old 'Clear Write' Traces](#)" on page 223

DISPlay[:WINDow<n>][:SUBWindow<w>]:TRACe<t>[:STATe] <State>

Turns a trace on and off.

The measurement continues in the background.

Suffix:

<n> [Window](#)
 <w> subwindow
 Not supported by all applications
 <t> [Trace](#)

Parameters:

<State> ON | OFF | 0 | 1
OFF | 0
 Switches the function off
ON | 1
 Switches the function on

Example: DISP:TRAC3 ON

Manual operation: See "[Trace 1/Trace 2/Trace 3/Trace 4/Trace 5/Trace 6](#)" on page 223

DISPlay[:WINDow<n>]:TRACe<t>:Y[:SCALe]:RLEVel:OFFSet <Offset>

This command defines the amount by which a trace is shifted.

Prerequisites for this command

- Turn on trace offset ([DISPlay\[:WINDow<n>\]:TRACe<t>:Y\[:SCALe\]:RLEVel:OFFSet:STATe](#)).

Suffix:

<n> 1..n
 irrelevant
 <t> 1..n
 irrelevant

Parameters:

<Offset> <numeric value>
 *RST: 0
 Default unit: dB

Example: //Define a level offset of 10 dB
DISP:TRAC:Y:RLEV:OFFS 10

Manual operation: See "[Shifting the trace](#)" on page 225

DISPlay[:WINDow<n>]:TRACe<t>:Y[:SCALe]:RLEVel:OFFSet:STATe <State>

This command turns the offset for a trace on and off.

When you turn that feature on, the trace is shifted vertically by a certain amount.

Suffix:

<n>	1..n Window
<t>	1..n Trace

Parameters:

<State>	ON OFF 1 0
*RST:	OFF

Example: //Shift trace 2 vertically by 10 dB.
 DISP:TRAC2:Y:RLEV:OFFS:STAT ON
 DISP:TRAC2:Y:RLEV:OFFS 10

Manual operation: See ["Shifting the trace"](#) on page 225

DISPlay[:WINDow<n>]:TRACe<t>:SMOothing:APERture <Aperture>

This command defines the magnitude (aperture) of trace smoothing.

Prerequisites for this command

- Turn on trace smoothing ([DISPlay\[:WINDow<n>\]:TRACe<t>:SMOothing\[:STATe\]](#)).

In the Spot Noise vs Tune measurement, trace smoothing applies to either all traces or none. Use [\[SENSe:\]SMOothing\[:STATe\]](#) in that case.

Suffix:

<n>	1..n Window
<t>	1..n Trace

Parameters:

<Aperture>	<numeric value>
Range:	1 to 20
*RST:	1
Default unit:	PCT

Example: See [DISPlay\[:WINDow<n>\]:TRACe<t>:SMOothing\[:STATe\]](#).

Manual operation: See ["Smoothing traces"](#) on page 225

DISPlay[:WINDow<n>]:TRACe<t>:SMOothing[:STATe] <State>

This command turns trace smoothing for a specific trace on and off.

When you turn on trace smoothing, you can define the smoothing magnitude with `DISPlay[:WINDow<n>]:TRACe<t>:SMOothing:APERture`.

In the Spot Noise vs Tune measurement, trace smoothing applies to either all traces or none. Use `[SENSe:]SMOothing[:STATe]` in that case.

Suffix:

<n> 1..n
Window

<t> 1..n
Trace

Parameters:

<State> ON | OFF | 1 | 0
*RST: Depends on the trace.

Example:

```
//Turns on trace 3 (average mode based on 10 measurements)
to display the AM noise results
DISP:TRAC3:MODE AVER
SWE:COUN 10
DISP:TRAC3:RES AM
//Smooth the trace by a magnitude of 10 %
DISP:TRAC3:SMO ON
DISP:TRAC3:SMO:APER 10
//Remove spurs from trace 3
DISP:TRAC3:SPUR:SUPP ON
DISP:TRAC3:SPUR:THR 5
```

Manual operation: See "[Smoothing traces](#)" on page 225

14.7.3.2 Trace copy

`TRACe<n>:COPY`..... 543

TRACe<n>:COPY <TraceNumber>, <TraceNumber>

Copies data from one trace to another.

Suffix:

<n> Window

Parameters:

<TraceNumber> **TRACE1 | TRACE2 | TRACE3 | TRACE4 | TRACE5 | TRACE6**
The first parameter is the destination trace, the second parameter is the source.
(Note the 'e' in the parameter is required!)

Example:

```
TRAC:COPY TRACE1,TRACE2
Copies the data from trace 2 to trace 1.
```

Manual operation: See "Copy Trace" on page 231

14.7.3.3 Trace export and import

FORMat[:DATA].....	544
FORMat:DEXPort:CSEParator.....	545
FORMat:DEXPort:DSEParator.....	545
FORMat:DEXPort:FORMat.....	545
FORMat:DEXPort:HEADer.....	546
FORMat:DEXPort:TRACes.....	546
MMEMory:LOAD<n>:TRACe.....	546

FORMat[:DATA] <Format>[, <BitLength>]

Selects the data format that is used for transmission of trace data from the R&S FSWP to the controlling computer.

Note that the command has no effect for data that you send to the R&S FSWP. The R&S FSWP automatically recognizes the data it receives, regardless of the format.

For details on data formats, see [Chapter 14.7.3.5, "Formats for returned values: ASCII format and binary format"](#), on page 549.

Parameters:

<Format>

AScii

AScii format, separated by commas.

This format is almost always suitable, regardless of the actual data format. However, the data is not as compact as other formats can be.

REAL

Floating-point numbers (according to IEEE 754) in the "definite length block format".

The format setting `REAL` is used for the binary transmission of trace data.

<BitLength>

Length in bits for floating-point results

16

16-bit floating-point numbers.

Compared to `REAL, 32` format, half as many numbers are returned.

32

32-bit floating-point numbers

For I/Q data, 8 bytes per sample are returned for this format setting.

64

64-bit floating-point numbers

Compared to `REAL, 32` format, twice as many numbers are returned.

Example:

```
FORM REAL, 32
```

FORMat:DEXPort:CSEParator <Separator>

Selects the column separator for exported trace data.

The selected value is not affected by a preset. The command therefore has no reset value.

Parameters:

<Separator>

COMMa

Selects a comma as a separator.

SEMicolon

Selects a semicolon as a separator.

TAB

Selects a tabulator as a separator.

*RST: n/a

Example:

```
//Select column separator
FORM:DEXP:CSEP TAB
```

Manual operation: See "[Column Separator](#)" on page 229

FORMat:DEXPort:DSEParator <Separator>

Selects the decimal separator for data exported in ASCII format.

Parameters:

<Separator>

POINT | COMMa

COMMa

Uses a comma as decimal separator, e.g. 4,05.

POINT

Uses a point as decimal separator, e.g. 4.05.

*RST: *RST has no effect on the decimal separator.
Default is POINT.

Example:

```
FORM:DEXP:DSEP POIN
Sets the decimal point as separator.
```

Manual operation: See "[Decimal Separator](#)" on page 229

FORMat:DEXPort:FORMat <FileFormat>

Determines the format of the ASCII file to be imported or exported. Depending on the external program that creates the data file or evaluates it, a comma-separated list (CSV) or a plain data format (DAT) file is required.

Parameters:

<FileFormat>

CSV | DAT

*RST: DAT

Example:

```
FORM:DEXP:FORM CSV
```

Manual operation: See "[File Type](#)" on page 229

FORMat:DEXPort:HEADer <State>

If enabled, additional instrument and measurement settings are included in the header of the export file for result data. If disabled, only the pure result data from the selected traces and tables is exported.

Parameters:

<State> ON | OFF | 0 | 1
*RST: 1

Manual operation: See ["Include Instrument & Measurement Settings"](#) on page 227

FORMat:DEXPort:TRACes <Selection>

Selects the data to be included in a data export file (see [MMEMory:STORe<n>:TRACe](#) on page 601).

Parameters:

<Selection> SINGle | ALL

SINGle

Only a single trace is selected for export, namely the one specified by the [MMEMory:STORe<n>:TRACe](#) command.

ALL

Selects all active traces and result tables (e.g. "Result Summary", marker peak list etc.) in the current application for export to an ASCII file.

The <trace> parameter for the [MMEMory:STORe<n>:TRACe](#) command is ignored.

*RST: SINGle

Manual operation: See ["Export all Traces and all Table Results"](#) on page 227

MMEMory:LOAD<n>:TRACe <FileName>[, <Window>, <Trace>, <Trace>]

This command imports a previously recorded trace.

Secure User Mode

In secure user mode, settings that are stored on the instrument are stored to volatile memory, which is restricted to 256 MB. Thus, a "memory limit reached" error can occur although the hard disk indicates that storage space is still available.

To store data permanently, select an external storage location such as a USB memory device.

For details, see [Chapter 11.2, "Protecting data using the secure user mode"](#), on page 263.

Suffix:

<n> 1..n
[Destination Window](#)

Parameters:

<FileName>	String that contains the location of the ASCII file you want to import. Supported file types are <code>.dat</code> and <code>.csv</code> .
<Window>	<numeric value> (integer only) Optional. Selects the source window of the trace that you want to import. Because the ASCII file can contain trace information for several result windows, you can select a specific result window whose trace(s) are imported. The selected window must be compatible to the destination windows selected by the suffix at the <code>LOAD<n></code> syntax element. For example if you want to import the data of a phase noise trace, a phase noise diagram must be active. If you omit the source window, the R&S FSWP checks if the import data is compatible to the diagram that you have selected. If not, the command throws an error and the data is not imported. Range: 1 to 16
<Trace>	<numeric value> (integer only) Optional. Selects the number of the source trace. The source trace is the trace you want to import. Range: 1 to 6
<Trace>	<numeric value> (integer only) Optional. Selects the number of the destination trace. The destination trace is the trace you want to write the imported trace to. Range: 1 to 6
Example:	<code>//Import all compatible traces from an ASCII file into window 2</code> <code>MMEM:LOAD2:TRAC 'c:\trace.dat'</code>
Example:	<code>//Import all traces stored as window 1 into window 2</code> <code>MMEM:LOAD2:TRAC 'c:\trace.dat',1</code>
Example:	<code>//Import a single trace from ASCII file</code> <code>MMEM:LOAD:TRAC 'c:\trace.dat',2,1,5</code>
Manual operation:	See " Select ASCII File " on page 229 See " Source Window / Source Trace " on page 230 See " Destination Trace " on page 230 See " Import " on page 230

14.7.3.4 Trace mathematics

<code>CALCulate<n>:MATH<t>:STATe.....</code>	548
<code>CALCulate<n>:MATH<t>[:EXPRession][:DEFine].....</code>	548

CALCulate<n>:MATH<t>:STATe <State>

Turns the trace mathematics on and off.

Suffix:

<n> [Window](#)

<t> irrelevant

Parameters:

<State> ON | OFF | 0 | 1

OFF | 0

Switches the function off

ON | 1

Switches the function on

Example:

CALC:MATH:STAT ON

Turns on trace mathematics.

Manual operation: See ["Trace Math Function"](#) on page 232

See ["Trace Math Off"](#) on page 232

CALCulate<n>:MATH<t>[:EXPRession][:DEFine] <Expression>

Selects the mathematical expression for trace mathematics.

Before you can use the command, you have to turn trace mathematics on.

Suffix:

<n> [Window](#)

<t> irrelevant

Parameters:

<Expression> **(TRACE1-TRACE2)**
Subtracts trace 2 from trace 1.

(TRACE1-TRACE3)
Subtracts trace 3 from trace 1.

(TRACE1-TRACE4)
Subtracts trace 4 from trace 1.

(TRACE1-TRACE5)
Subtracts trace 5 from trace 1.

(TRACE1-TRACE6)
Subtracts trace 6 from trace 1.

Example:

CALC:MATH:STAT ON

Turns trace mathematics on.

CALC:MATH:EXPR:DEF (TRACE1-TRACE3)

Subtracts trace 3 from trace 1.

Manual operation: See ["Trace Math Function"](#) on page 232

14.7.3.5 Formats for returned values: ASCII format and binary format

When trace data is retrieved using the `TRAC:DATA` or `TRAC:IQ:DATA` command, the data is returned in the format defined using the `FORMat[:DATA]` on page 544. The possible formats are described here.

- **ASCII Format (FORMat ASCII):**
The data is stored as a list of comma-separated values (CSV) of the measured values in floating point format.
- **Binary Format (FORMat REAL,16/32/64):**
The data is stored as binary data (definite length block data according to IEEE 488.2), each measurement value being formatted in 16-bit/32-bit/64-bit IEEE 754 floating-point-format.
The schema of the result string is as follows:
#<Length of length><Length of data><value1><value2>...<value n>
with:

<Length of length>	Number of digits of the following number of data bytes
<Length of data>	Number of following data bytes
<Value>	2-byte/4-byte/8-byte floating point value

Example: #41024<Data>... contains 1024 data bytes

Data blocks larger than 999,999,999 bytes

According to SCPI, the header of the block data format allows for a maximum of 9 characters to describe the data length. Thus, the maximum REAL 32 data that can be represented is 999,999,999 bytes. However, the R&S FSWP is able to send larger data blocks. In this case, the length of the data block is placed in brackets, e.g.

#(1234567890)<value1><value2>...



Reading out data in binary format is quicker than in ASCII format. Thus, binary format is recommended for large amounts of data.

14.7.4 Marker

- [Individual marker setup](#).....549
- [General marker settings](#).....555
- [Marker search](#).....556
- [Positioning markers](#).....557
- [Retrieving marker positions](#).....561

14.7.4.1 Individual marker setup

- `CALCulate<n>:DELTaMarker<m>:AOFF`.....550
- `CALCulate<n>:DELTaMarker<m>:LINK`.....550
- `CALCulate<n>:DELTaMarker<ms>:LINK:TO:MARKer<md>`.....550

CALCulate<n>:DELTamarker<m>:MODE.....	551
CALCulate<n>:DELTamarker<m>:MREFerence.....	551
CALCulate<n>:DELTamarker<m>[:STATE].....	552
CALCulate<n>:DELTamarker<m>:TRACe.....	552
CALCulate<n>:DELTamarker<m>:X.....	552
CALCulate<n>:MARKer<m>:AOFF.....	553
CALCulate<n>:MARKer<ms>:LINK:TO:MARKer<md>.....	553
CALCulate<n>:MARKer<m>[:STATE].....	554
CALCulate<n>:MARKer<m>:TRACe.....	554
CALCulate<n>:MARKer<m>:X.....	554

CALCulate<n>:DELTamarker<m>:AOFF

Turns off *all* delta markers.

Suffix:

<n> [Window](#)

<m> irrelevant

Example:

CALC : DELT : AOFF
Turns off all delta markers.

CALCulate<n>:DELTamarker<m>:LINK <State>

Links delta marker <m> to marker 1.

If you change the horizontal position (x-value) of marker 1, delta marker <m> changes its horizontal position to the same value.

Suffix:

<n> [Window](#)

<m> [Marker](#)

Parameters:

<State> ON | OFF | 0 | 1
OFF | 0
Switches the function off
ON | 1
Switches the function on

Example:

CALC : DELT2 : LINK ON

Manual operation: See "[Linking to Another Marker](#)" on page 246

CALCulate<n>:DELTamarker<ms>:LINK:TO:MARKer<md> <State>

Links the delta source marker <ms> to any active destination marker <md> (normal or delta marker).

Suffix:

<n> [Window](#)

<ms> source marker, see [Marker](#)
 <md> destination marker, see [Marker](#)

Parameters:

<State> ON | OFF | 0 | 1
OFF | 0
 Switches the function off
ON | 1
 Switches the function on

Example: CALC:DELT4:LINK:TO:MARK2 ON
 Links the delta marker 4 to the marker 2.

Manual operation: See "[Linking to Another Marker](#)" on page 246

CALCulate<n>:DELTaMarker<m>:MODE <Mode>

Defines whether the position of a delta marker is provided as an absolute value or relative to a reference marker. Note that this setting applies to *all* windows.

Note that when the position of a delta marker is *queried*, the result is always an absolute value (see [CALCulate<n>:DELTaMarker<m>:X](#) on page 552)!

Suffix:

<n> irrelevant
 <m> irrelevant

Parameters:

<Mode> **ABSolute**
 Delta marker position in absolute terms.
RELative
 Delta marker position in relation to a reference marker.
 *RST: RELative

Example: CALC:DELT:MODE ABS
 Absolute delta marker position.

CALCulate<n>:DELTaMarker<m>:MREFerence <Reference>

Selects a reference marker for a delta marker other than marker 1.

Suffix:

<n> [Window](#)
 <m> [Marker](#)

Parameters:

<Reference>

Example: CALC:DELT3:MREF 2
 Specifies that the values of delta marker 3 are relative to marker 2.

Manual operation: See ["Reference Marker"](#) on page 245

CALCulate<n>:DELTa**marker**<m>[:STATe] <State>

Turns delta markers on and off.

If necessary, the command activates the delta marker first.

No suffix at DELTmarker turns on delta marker 1.

Suffix:

<n> [Window](#)

<m> [Marker](#)

Parameters:

<State> ON | OFF | 0 | 1

OFF | 0

Switches the function off

ON | 1

Switches the function on

Example:

CALC:DELT2 ON

Turns on delta marker 2.

Manual operation: See ["Marker State"](#) on page 245
 See ["Marker Type"](#) on page 245
 See ["Select Marker"](#) on page 246

CALCulate<n>:DELTa**marker**<m>:TRACe <Trace>

Selects the trace a delta marker is positioned on.

Note that the corresponding trace must have a trace mode other than "Blank".

If necessary, the command activates the marker first.

Suffix:

<n> [Window](#)

<m> [Marker](#)

Parameters:

<Trace> Trace number the marker is assigned to.

Example:

CALC:DELT2:TRAC 2

Positions delta marker 2 on trace 2.

CALCulate<n>:DELTa**marker**<m>:X <Position>

Moves a delta marker to a particular coordinate on the x-axis.

If necessary, the command activates the delta marker and positions a reference marker to the peak power.

Suffix:<n> [Window](#)<m> [Marker](#)**Parameters:**

<Position> Numeric value that defines the marker position on the x-axis.
 Range: The value range and unit depend on the measurement and scale of the x-axis.

Example:

CALC:DELT:X?

Outputs the absolute x-value of delta marker 1.

Manual operation: See "[Marker Position X-value](#)" on page 245**CALCulate<n>:MARKer<m>:AOFF**

Turns off all markers.

Suffix:<n> [Window](#)<m> [Marker](#)**Example:**

CALC:MARK:AOFF

Switches off all markers.

Manual operation: See "[All Markers Off](#)" on page 247**CALCulate<n>:MARKer<ms>:LINK:TO:MARKer<md> <State>**

Links the normal source marker <ms> to any active destination marker <md> (normal or delta marker).

If you change the horizontal position of marker <md>, marker <ms> changes its horizontal position to the same value.

Suffix:<n> [Window](#)<ms> source marker, see [Marker](#)<md> destination marker, see [Marker](#)**Parameters:**

<State> ON | OFF | 0 | 1

OFF | 0

Switches the function off

ON | 1

Switches the function on

Example:

CALC:MARK4:LINK:TO:MARK2 ON

Links marker 4 to marker 2.

Manual operation: See "[Linking to Another Marker](#)" on page 246

CALCulate<n>:MARKer<m>[:STATe] <State>

Turns markers on and off. If the corresponding marker number is currently active as a delta marker, it is turned into a normal marker.

Suffix:

<n> [Window](#)

<m> [Marker](#)

Parameters:

<State> ON | OFF | 0 | 1

OFF | 0

Switches the function off

ON | 1

Switches the function on

Example:

```
CALC:MARK3 ON
```

Switches on marker 3.

Manual operation: See ["Marker State"](#) on page 245
 See ["Marker Type"](#) on page 245
 See ["Select Marker"](#) on page 246

CALCulate<n>:MARKer<m>:TRACe <Trace>

Selects the trace the marker is positioned on.

Note that the corresponding trace must have a trace mode other than "Blank".

If necessary, the command activates the marker first.

Suffix:

<n> [Window](#)

<m> [Marker](#)

Parameters:

<Trace>

Example:

```
//Assign marker to trace 1
```

```
CALC:MARK3:TRAC 2
```

Manual operation: See ["Assigning the Marker to a Trace"](#) on page 246

CALCulate<n>:MARKer<m>:X <Position>

Moves a marker to a specific coordinate on the x-axis.

If necessary, the command activates the marker.

If the marker has been used as a delta marker, the command turns it into a normal marker.

Suffix:

<n> [Window](#)

<m>	Marker
Parameters:	
<Position>	Numeric value that defines the marker position on the x-axis. The unit depends on the result display. Range: The range depends on the current x-axis range. Default unit: Hz
Example:	CALC:MARK2:X 1.7MHz Positions marker 2 to frequency 1.7 MHz.
Manual operation:	See "Marker Table" on page 131 See "Marker Position X-value" on page 245

14.7.4.2 General marker settings

DISPlay[:WINDow<n>]:MTABLE.....	555
CALCulate<n>:MARKer<m>:LINK.....	555

DISPlay[:WINDow<n>]:MTABLE <DisplayMode>

Turns the marker table on and off.

Suffix:

<n> irrelevant

Parameters:

<DisplayMode> **ON | 1**
Turns on the marker table.
OFF | 0
Turns off the marker table.
AUTO
Turns on the marker table if 3 or more markers are active.
*RST: AUTO

Example: DISP:MTAB ON
Activates the marker table.

Manual operation: See "Marker Table Display" on page 247

CALCulate<n>:MARKer<m>:LINK <State>

Defines whether the markers in all diagrams with the same x-axis are linked. If enabled, and you move one marker along the x-axis, all other markers are moved to the same x-axis position.

Suffix:

<m> irrelevant

<n> irrelevant

Parameters:

<State> ON | OFF | 1 | 0
 *RST: 0

Example:

CALC2:MARK:LINK ON
 Links all markers across all diagrams. The window selection 2 is irrelevant.

Manual operation: See "[Linked Markers](#)" on page 247

14.7.4.3 Marker search

CALCulate<n>:MARKer<m>:PEXCursion.....	556
CALCulate<n>:MARKer<m>:FUNCTion:SPTRacking:RANGe.....	556
CALCulate<n>:MARKer<m>:FUNCTion:SPTRacking[:STATe].....	557

CALCulate<n>:MARKer<m>:PEXCursion <Excursion>

Defines the peak excursion (for *all* markers).

The peak excursion sets the requirements for a peak to be detected during a peak search.

The unit depends on the measurement.

Suffix:

<n> [Window](#)
 <m> irrelevant

Example:

CALC:MARK:PEXC 10dB
 Defines peak excursion as 10 dB.

Manual operation: See "[Peak Excursion](#)" on page 249

CALCulate<n>:MARKer<m>:FUNCTion:SPTRacking:RANGe <Range>

This command defines the frequency range in which spur tracking takes place.

Prerequisites for this command

- Turn on spur tracking ([CALCulate<n>:MARKer<m>:FUNCTion:SPTRacking\[:STATe\]](#)).

Suffix:

<n> 1..n
 irrelevant
 <m> 1..n
 irrelevant

Parameters:

<Range> <numeric value>
 Number without unit that defines the frequency range as a function of the resolution bandwidth.
 Tracking range = x * RBW
 *RST: 1.0

Example:

```
//Turn on spur tracking and define a tracking range of 2 x RBW
CALC:MARK:FUNC:SPTR ON
CALC:MARK:FUNC:SPTR:RANG 2
```

Manual operation: See "[Spurious Tracking](#)" on page 249

CALCulate<n>:MARKer<m>:FUNCTion:SPTRacking[:STATe] <State>

This command turns spurious tracking on and off.

Suffix:

<n> 1..n
 irrelevant
 <m> 1..n
 irrelevant

Parameters:

<State> ON | OFF | 1 | 0
 *RST: OFF

Example:

```
//Turn on spur tracking
CALC:MARK:FUNC:SPTR ON
```

Manual operation: See "[Spurious Tracking](#)" on page 249

14.7.4.4 Positioning markers

CALCulate<n>:DELTamarker<m>:MAXimum:LEFT.....	558
CALCulate<n>:DELTamarker<m>:MAXimum:NEXT.....	558
CALCulate<n>:DELTamarker<m>:MAXimum:RIGHT.....	558
CALCulate<n>:DELTamarker<m>:MAXimum[:PEAK].....	558
CALCulate<n>:DELTamarker<m>:MINimum:LEFT.....	559
CALCulate<n>:DELTamarker<m>:MINimum:NEXT.....	559
CALCulate<n>:DELTamarker<m>:MINimum:RIGHT.....	559
CALCulate<n>:DELTamarker<m>:MINimum[:PEAK].....	559
CALCulate<n>:MARKer<m>:MAXimum:LEFT.....	559
CALCulate<n>:MARKer<m>:MAXimum:NEXT.....	560
CALCulate<n>:MARKer<m>:MAXimum:RIGHT.....	560
CALCulate<n>:MARKer<m>:MAXimum[:PEAK].....	560
CALCulate<n>:MARKer<m>:MINimum:LEFT.....	560
CALCulate<n>:MARKer<m>:MINimum:NEXT.....	561
CALCulate<n>:MARKer<m>:MINimum:RIGHT.....	561
CALCulate<n>:MARKer<m>:MINimum[:PEAK].....	561

CALCulate<n>:DELTaMarker<m>:MAXimum:LEFT

Moves a delta marker to the next positive peak value.

The search includes only measurement values to the left of the current marker position.

Suffix:

<n> [Window](#)

<m> [Marker](#)

Manual operation: See ["Search Next Peak"](#) on page 250

CALCulate<n>:DELTaMarker<m>:MAXimum:NEXT

Moves a marker to the next positive peak value.

Suffix:

<n> 1..n
[Window](#)

<m> 1..n
[Marker](#)

Manual operation: See ["Search Next Peak"](#) on page 250

CALCulate<n>:DELTaMarker<m>:MAXimum:RIGHT

Moves a delta marker to the next positive peak value on the trace.

The search includes only measurement values to the right of the current marker position.

Suffix:

<n> [Window](#)

<m> [Marker](#)

Manual operation: See ["Search Next Peak"](#) on page 250

CALCulate<n>:DELTaMarker<m>:MAXimum[:PEAK]

Moves a delta marker to the highest level.

If the marker is not yet active, the command first activates the marker.

Suffix:

<n> [Window](#)

<m> [Marker](#)

Manual operation: See ["Peak Search"](#) on page 250

CALCulate<n>:DELTaMarker<m>:MINimum:LEFT

Moves a delta marker to the next minimum peak value.

The search includes only measurement values to the right of the current marker position.

Suffix:

<n> [Window](#)

<m> [Marker](#)

Manual operation: See "[Search Next Minimum](#)" on page 250

CALCulate<n>:DELTaMarker<m>:MINimum:NEXT

Moves a marker to the next minimum peak value.

Suffix:

<n> [Window](#)

<m> [Marker](#)

Manual operation: See "[Search Next Minimum](#)" on page 250

CALCulate<n>:DELTaMarker<m>:MINimum:RIGHT

Moves a delta marker to the next minimum peak value.

The search includes only measurement values to the right of the current marker position.

Suffix:

<n> [Window](#)

<m> [Marker](#)

Manual operation: See "[Search Next Minimum](#)" on page 250

CALCulate<n>:DELTaMarker<m>:MINimum[:PEAK]

Moves a delta marker to the minimum level.

If the marker is not yet active, the command first activates the marker.

Suffix:

<n> [Window](#)

<m> [Marker](#)

Manual operation: See "[Search Minimum](#)" on page 250

CALCulate<n>:MARKer<m>:MAXimum:LEFT

Moves a marker to the next positive peak.

The search includes only measurement values to the left of the current marker position.

Suffix:

<n> [Window](#)

<m> [Marker](#)

Manual operation: See ["Search Next Peak"](#) on page 250

CALCulate<n>:MARKer<m>:MAXimum:NEXT

Moves a marker to the next positive peak.

Suffix:

<n> [Window](#)

<m> [Marker](#)

Manual operation: See ["Search Next Peak"](#) on page 250

CALCulate<n>:MARKer<m>:MAXimum:RIGHT

Moves a marker to the next positive peak.

The search includes only measurement values to the right of the current marker position.

Suffix:

<n> [Window](#)

<m> [Marker](#)

Manual operation: See ["Search Next Peak"](#) on page 250

CALCulate<n>:MARKer<m>:MAXimum[:PEAK]

Moves a marker to the highest level.

If the marker is not yet active, the command first activates the marker.

Suffix:

<n> [Window](#)

<m> [Marker](#)

Manual operation: See ["Peak Search"](#) on page 250

CALCulate<n>:MARKer<m>:MINimum:LEFT

Moves a marker to the next minimum peak value.

The search includes only measurement values to the right of the current marker position.

Suffix:<n> [Window](#)<m> [Marker](#)**Manual operation:** See "[Search Next Minimum](#)" on page 250**CALCulate<n>:MARKer<m>:MINimum:NEXT**

Moves a marker to the next minimum peak value.

Suffix:<n> [Window](#)<m> [Marker](#)**Manual operation:** See "[Search Next Minimum](#)" on page 250**CALCulate<n>:MARKer<m>:MINimum:RIGHT**

Moves a marker to the next minimum peak value.

The search includes only measurement values to the right of the current marker position.

Suffix:<n> [Window](#)<m> [Marker](#)**Manual operation:** See "[Search Next Minimum](#)" on page 250**CALCulate<n>:MARKer<m>:MINimum[:PEAK]**

Moves a marker to the minimum level.

If the marker is not yet active, the command first activates the marker.

Suffix:<n> [Window](#)<m> [Marker](#)**Manual operation:** See "[Search Minimum](#)" on page 250**14.7.4.5 Retrieving marker positions**

Commands useful to retrieve marker positions described elsewhere:

- [CALCulate<n>:DELTAmarker<m>:X](#)
- [CALCulate<n>:MARKer<m>:X](#)

CALCulate<n>:DELTAmarker<m>:X:RELative?	562
CALCulate<n>:DELTAmarker<m>:Y?	562
CALCulate<n>:MARKer<m>:Y?	562

CALCulate<n>:DELTaMarker<m>:X:RELative?

Queries the relative position of a delta marker on the x-axis.

If necessary, the command activates the delta marker first.

Suffix:

<n> [Window](#)

<m> [Marker](#)

Return values:

<Position> Position of the delta marker in relation to the reference marker.

Example:

```
CALC:DELT3:X:REL?
```

Outputs the frequency of delta marker 3 relative to marker 1 or relative to the reference position.

Usage: Query only

CALCulate<n>:DELTaMarker<m>:Y?

Queries the result at the position of the specified delta marker.

Suffix:

<n> 1..n

<m> 1..n

Return values:

<Result> Result at the position of the delta marker.
The unit is variable and depends on the one you have currently set.

Default unit: DBM

Usage: Query only

CALCulate<n>:MARKer<m>:Y?

Queries the result at the position of the specified marker.

Suffix:

<n> 1..n

<m> 1..n

Return values:

<Result> Default unit: DBM

Usage: Query only

14.7.5 Limit lines

- [Managing limit lines](#).....563
- [Designing limit lines](#).....567
- [Reading out the results of a limit check](#).....573
- [Programming Example: Using Limit Lines](#).....574

14.7.5.1 Managing limit lines

CALCulate<n>:LIMit:ACTive?	563
CALCulate<n>:LIMit:COMPatible?	563
CALCulate<n>:LIMit:COPY	564
CALCulate<n>:LIMit:DELete	564
CALCulate<n>:LIMit:LOWer:OFFSet	564
CALCulate<n>:LIMit:LOWer:STATe	565
CALCulate<n>:LIMit:STATe	565
CALCulate<n>:LIMit:TRACe<t>	566
CALCulate<n>:LIMit:TRACe<t>:CHECK	566
CALCulate<n>:LIMit:UPPer:STATe	567

CALCulate<n>:LIMit:ACTive?

Queries the names of *all* active limit lines.

Suffix:

<n>	irrelevant
	irrelevant

Return values:

<LimitLines> String containing the names of all active limit lines in alphabetical order.

Example:

CALC:LIM:ACT?
Queries the names of all active limit lines.

Usage:

Query only

Manual operation: See "[Visibility](#)" on page 255

CALCulate<n>:LIMit:COMPatible?

This command queries if the currently selected limit line is compatible to the current measurement configuration.

Suffix:

<n>	1..n
	irrelevant

 1..n
[Limit line](#)

Return values:

<MkrIndex> **1**
 Limit line is compatible to the current measurement settings.
0
 Limit line is not compatible to the current measurement settings.

Example:

```
//Query limit line compatibility
CALC:LIM:NAME 'Limit'
CALC:LIM:COMP?
```

Usage: Query only

CALCulate<n>:LIMit:COPY <Line>

Copies a limit line.

Suffix:

<n> [Window](#)

 [Limit line](#)

Parameters:

<Line> **1 to 8**
 number of the new limit line

<name>

String containing the name of the limit line.

Example:

```
CALC:LIM1:COPY 2
Copies limit line 1 to line 2.
CALC:LIM1:COPY 'FM2'
Copies limit line 1 to a new line named FM2.
```

Manual operation: See ["Copy Line"](#) on page 256

CALCulate<n>:LIMit:DELeTe

Deletes a limit line.

Suffix:

<n> [Window](#)

 [Limit line](#)

Manual operation: See ["Delete Line"](#) on page 256

CALCulate<n>:LIMit:LOWer:OFFSet <Offset>

Defines an offset for a complete lower limit line.

Compared to shifting the limit line, an offset does not actually change the limit line definition points.

Suffix:<n> [Window](#) [Limit line](#)**Parameters:**

<Offset> Numeric value.

*RST: 0

Default unit: dB

CALCulate<n>:LIMit:LOWer:STATe <State>

Turns a lower limit line on and off.

Before you can use the command, you have to select a limit line with [CALCulate<n>:LIMit:NAME](#) on page 571.

Suffix:

<n> irrelevant

 [Limit line](#)**Parameters:**

<State> ON | OFF | 0 | 1

OFF | 0

Switches the function off

ON | 1

Switches the function on

Manual operation: See "[Visibility](#)" on page 255**CALCulate<n>:LIMit:STATe <State>**

Turns the limit check for a specific limit line on and off.

To query the limit check result, use [CALCulate<n>:LIMit:FAIL?](#).

Note that a new command exists to activate the limit check and define the trace to be checked in one step (see [CALCulate<n>:LIMit:TRACe<t>:CHECK](#) on page 566).

Suffix:

<n> irrelevant

 [Limit line](#)**Parameters:**

<State> ON | OFF | 0 | 1

OFF | 0

Switches the function off

ON | 1

Switches the function on

Example: `CALC:LIM:STAT ON`
Switches on the limit check for limit line 1.

Manual operation: See "[Disable All Lines](#)" on page 256

CALCulate<n>:LIMit:TRACe<t> <TraceNumber>

Links a limit line to one or more traces.

Note that this command is maintained for compatibility reasons only. Limit lines no longer need to be assigned to a trace explicitly. The trace to be checked can be defined directly (as a suffix) in the new command to activate the limit check (see [CALCulate<n>:LIMit:TRACe<t>:CHECK](#) on page 566).

Suffix:

<n> [Window](#)
 [Limit line](#)
<t> irrelevant

Example: `CALC:LIM2:TRAC 3`
Assigns limit line 2 to trace 3.

CALCulate<n>:LIMit:TRACe<t>:CHECK <State>

Turns the limit check for a specific trace on and off.

To query the limit check result, use [CALCulate<n>:LIMit:FAIL?](#).

Note that this command replaces the two commands from previous signal and spectrum analyzers (which are still supported, however):

- [CALCulate<n>:LIMit:TRACe<t>](#) on page 566
- [CALCulate<n>:LIMit:STATe](#) on page 565

Suffix:

<n> [Window](#)
 [Limit line](#)
<t> [Trace](#)

Parameters:

<State> `ON | OFF | 0 | 1`
OFF | 0
Switches the function off
ON | 1
Switches the function on

Example: `CALC:LIM3:TRAC2:CHEC ON`
Switches on the limit check for limit line 3 on trace 2.

Manual operation: See "[Traces to be Checked](#)" on page 256

CALCulate<n>:LIMit:UPPer:STATe <State>

Turns an upper limit line on and off.

Before you can use the command, you have to select a limit line with [CALCulate<n>:LIMit:NAME](#) on page 571.

Suffix:

<n> irrelevant

 [Limit line](#)

Parameters:

<State> ON | OFF | 0 | 1

OFF | 0

Switches the function off

ON | 1

Switches the function on

Manual operation: See "[Visibility](#)" on page 255

14.7.5.2 Designing limit lines

CALCulate<n>:LIMit:COMMeNt	567
CALCulate<n>:LIMit:CONTRol[:DATA]	568
CALCulate<n>:LIMit:CONTRol:DOMain	568
CALCulate<n>:LIMit:CONTRol:MODE	568
CALCulate<n>:LIMit:CONTRol:SHIFt	569
CALCulate<n>:LIMit:CONTRol:SPACIng	569
CALCulate<n>:LIMit:LOWer[:DATA]	570
CALCulate<n>:LIMit:LOWer:MODE	570
CALCulate<n>:LIMit:LOWer:SHIFt	570
CALCulate<n>:LIMit:LOWer:SPACIng	571
CALCulate<n>:LIMit:NAME	571
CALCulate<n>:LIMit:UNIT	571
CALCulate<n>:LIMit:UPPer[:DATA]	572
CALCulate<n>:LIMit:UPPer:MODE	572
CALCulate<n>:LIMit:UPPer:SHIFt	572
CALCulate<n>:LIMit:UPPer:SPACIng	573

CALCulate<n>:LIMit:COMMeNt <Comment>

Defines a comment for a limit line.

Suffix:

<n> irrelevant

 [Limit line](#)

Parameters:

<Comment> String containing the description of the limit line.

Manual operation: See "[Comment](#)" on page 257

CALCulate<n>:LIMit:CONTrol[:DATA] <LimitLinePoints>

Defines the horizontal definition points of a limit line.

Suffix:

<n>	irrelevant
	Limit line

Parameters:

<LimitLinePoints>	Variable number of x-axis values. Note that the number of horizontal values has to be the same as the number of vertical values set with CALCulate<n>:LIMit:LOWer[:DATA] or CALCulate<n>:LIMit:UPPer[:DATA] . If not, the R&S FSWP either adds missing values or ignores surplus values.
*RST:	-
Default unit:	HZ

Manual operation: See "[Data Points](#)" on page 258

CALCulate<n>:LIMit:CONTrol:DOMain <SpanSetting>

Selects the domain of the limit line.

Suffix:

<n>	irrelevant
	Limit line

Parameters:

<SpanSetting>	FREquency TIME
	FREquency For limit lines that apply to a range of frequencies.
	TIME For limit lines that apply to a period of time.
	CURRent For limit lines that apply to a range of currents.
	VOLTage For limit lines that apply to a range of voltages.
*RST:	FREquency

Example: `CALC:LIM:CONT:DOM FREQ`
Select a limit line in the frequency domain.

Manual operation: See "[X-Axis](#)" on page 257

CALCulate<n>:LIMit:CONTrol:MODE <Mode>

Selects the horizontal limit line scaling.

Suffix:

<n> irrelevant

 [Limit line](#)

Parameters:

<Mode>

ABSolute

Limit line is defined by absolute physical values (Hz or s).

RELative

Limit line is defined by relative values related to the center frequency (frequency domain) or the left diagram border (time domain).

*RST: ABSolute

Manual operation: See "[X-Axis](#)" on page 257

CALCulate<n>:LIMit:CONTrol:SHIFt <Distance>

Moves a complete limit line horizontally.

Compared to defining an offset, this command actually changes the limit line definition points by the value you define.

Suffix:

<n> irrelevant

 [Limit line](#)

Parameters:

<Distance>

Numeric value.

The unit depends on the scale of the x-axis.

Default unit: HZ

Manual operation: See "[Shift x](#)" on page 258

CALCulate<n>:LIMit:CONTrol:SPACing <InterpolMode>

Selects linear or logarithmic interpolation for the calculation of limit lines from one horizontal point to the next.

Suffix:

<n> [Window](#)

 [Limit line](#)

Parameters:

<InterpolMode>

LINear | LOGarithmic

*RST: LIN

Example:

CALC:LIM:CONT:SPAC LIN

Manual operation: See "[X-Axis](#)" on page 257

CALCulate<n>:LIMit:LOWer[:DATA] <LimitLinePoints>

Defines the vertical definition points of a lower limit line.

Suffix:

<n>	irrelevant
	Limit line

Parameters:

<LimitLinePoints>	Variable number of level values. Note that the number of vertical values has to be the same as the number of horizontal values set with CALCulate<n>:LIMit:CONTRol[:DATA] . If not, the R&S FSWP either adds missing values or ignores surplus values.
*RST:	Limit line state is OFF
	Default unit: DBM

Manual operation: See "[Data Points](#)" on page 258

CALCulate<n>:LIMit:LOWer:MODE <Mode>

Selects the vertical limit line scaling.

Suffix:

<n>	Window
	Limit line

Parameters:

<Mode>	ABSolute Limit line is defined by absolute physical values. The unit is variable.
	RELative Limit line is defined by relative values related to the reference level (dB).
*RST:	ABSolute

Manual operation: See "[Y-Axis](#)" on page 257

CALCulate<n>:LIMit:LOWer:SHIFt <Distance>

Moves a complete lower limit line vertically.

Compared to defining an offset, this command actually changes the limit line definition points by the value you define.

Suffix:

<n>	Window
	Limit line

Parameters:

<Distance> Defines the distance that the limit line moves.
Default unit: DB

Manual operation: See "[Shift y](#)" on page 258

CALCulate<n>:LIMit:LOWer:SPACing <InterpolType>

Selects linear or logarithmic interpolation for the calculation of a lower limit line from one horizontal point to the next.

Suffix:

<n> [Window](#)

 [Limit line](#)

Parameters:

<InterpolType> LINear | LOGarithmic
*RST: LIN

Manual operation: See "[Y-Axis](#)" on page 257

CALCulate<n>:LIMit:NAME <Name>

Selects a limit line that already exists or defines a name for a new limit line.

Suffix:

<n> [Window](#)

 [Limit line](#)

Parameters:

<Name> String containing the limit line name.
*RST: REM1 to REM8 for lines 1 to 8

Manual operation: See "[Name](#)" on page 257

CALCulate<n>:LIMit:UNIT <Unit>

Defines the unit of a limit line.

Suffix:

<n> irrelevant

 [Limit line](#)

Parameters:

<Unit> If you select a dB-based unit for the limit line, the command automatically turns the limit line into a relative limit line.
*RST: DBM

Manual operation: See "[Y-Axis](#)" on page 257

CALCulate<n>:LIMit:UPPer[:DATA] <LimitLinePoints>...

Defines the vertical definition points of an upper limit line.

Suffix:

<n> irrelevant
 [Limit line](#)

Parameters:

<LimitLinePoints> Variable number of level values.
Note that the number of vertical values has to be the same as the number of horizontal values set with [CALCulate<n>:LIMit:CONTRol\[:DATA\]](#). If not, the R&S FSWP either adds missing values or ignores surplus values.
*RST: Limit line state is OFF
Default unit: DBM

Manual operation: See "[Data Points](#)" on page 258

CALCulate<n>:LIMit:UPPer:MODE <Mode>

Selects the vertical limit line scaling.

Suffix:

<n> [Window](#)
 [Limit line](#)

Parameters:

<Mode> **ABSolute**
Limit line is defined by absolute physical values.
The unit is variable.
RELative
Limit line is defined by relative values related to the reference level (dB).
*RST: ABSolute

Manual operation: See "[Y-Axis](#)" on page 257

CALCulate<n>:LIMit:UPPer:SHIFt <Distance>

Moves a complete upper limit line vertically.

Compared to defining an offset, this command actually changes the limit line definition points by the value you define.

Suffix:

<n> irrelevant
 [Limit line](#)

Parameters:

<Distance> Defines the distance that the limit line moves.

Manual operation: See "Shift y" on page 258

CALCulate<n>:LIMit:UPPer:SPACing <InterpolType>

Selects linear or logarithmic interpolation for the calculation of an upper limit line from one horizontal point to the next.

Suffix:

<n> [Window](#)

 [Limit line](#)

Parameters:

<InterpolType> LINear | LOGarithmic

*RST: LIN

Manual operation: See "Y-Axis" on page 257

14.7.5.3 Reading out the results of a limit check

[CALCulate<n>:LIMit:CLEar\[:IMMediate\]](#)..... 573

[CALCulate<n>:LIMit:FAIL?](#)..... 573

CALCulate<n>:LIMit:CLEar[:IMMediate]

Deletes the result of the current limit check.

The command works on *all* limit lines in *all* measurement windows at the same time.

Suffix:

<n> [Window](#)

 irrelevant

Example:

CALC:LIM:CLE

Deletes the result of the limit check.

CALCulate<n>:LIMit:FAIL?

Queries the result of a limit check in the specified window.

To get a valid result, you have to perform a complete measurement with synchronization to the end of the measurement before reading out the result. This is only possible for single measurement mode.

Suffix:

<n> [Window](#)

 [Limit line](#)

Return values:

<Result> 0
PASS

1

FAIL

Example:

INIT;*WAI

Starts a new sweep and waits for its end.

CALC2:LIM3:FAIL?

Queries the result of the check for limit line 3 in window 2.

Usage:

Query only

14.7.5.4 Programming Example: Using Limit Lines

```
//----- Creating and editing limit lines -----
//Select or create a limit line with index '1'
CALC:LIM1:NAME 'FM1'

//Define 5 horizontal definition points for limit line 1
calc:lim:cont 100hz,1khz,10khz,100khz,1000khz
//Select an absolute vertical scale for limit line 1
CALC:LIM1:UPP:MODE ABS
//Select the unit dBc_Hz for limit line 1
CALC:LIM1:UNIT DBC_HZ
//Define 5 vertical definition points for limit line 1
CALC:LIM1:UPP -60,-80,-90,-100,-110

//Shift the limit line 1 by -10 dB
CALC:LIM1:UPP:SHIF -10DB

//----- Configuring a limit check -----
//Activate upper limit FM1 as line 1
CALC:LIM1:UPP:STAT ON

//Activate the limit to be checked against trace 1 and 2
CALC:LIM1:TRAC1:CHEC ON
CALC:LIM1:TRAC2:CHEC ON
//Query the names of all active limit lines
CALC:LIM:ACT?
//Result: 'FM1'
//Clear the previous limit check results
CALC:LIM:CLE

//----- Performing the measurement-----
//Initiate a new measurement and wait until the last sweep has finished
INIT;*WAI

//----- Retrieving limit check results-----
//Query the result of the limit line check
CALC:LIM1:FAIL?
```

14.7.6 Examples: configuring the result display

The following example demonstrates how to configure result displays in a remote environment.

14.7.6.1 Example 1: adding and arranging windows

Starting from the default initial display in the Spectrum application (Frequency Sweep), we will configure the following result displays:

1 Frequency Sweep	3 "Marker Table"
2 Spectrogram	4 "Marker Peak List"

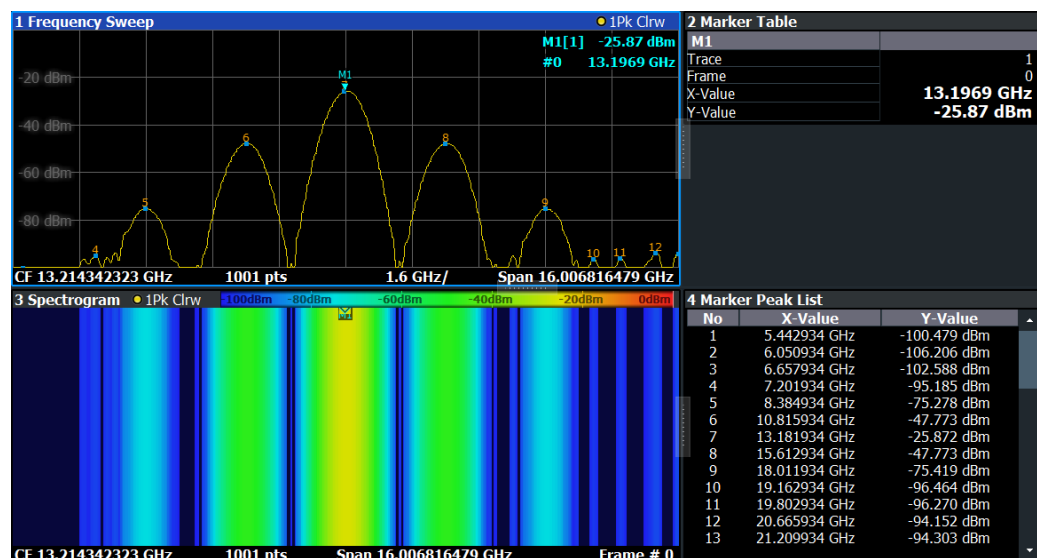

```
//-----Resetting the instrument -----
*RST
//----- Adding new windows -----
//Add a Spectrogram window beneath the Frequency Sweep window
LAY:ADD? '1',BEL,SGR
//Result: window number: '2'
//Add a Marker Table window to the right of the Frequency Sweep window
LAY:ADD? '1',RIGH,MTAB
//Result: window number: '3'
//Add a Marker Peak List window to the right of the Spectrogram window
LAY:WIND2:ADD? RIGH,PEAK
//Result: window number: '4'

//----- Changing the size of individual windows -----
//Move the splitter between the Frequency Sweep window and the Marker Table
//window to enlarge the spectrum display to 60% of the entire width.
LAY:SPL 1,3,60
//Move the splitter between the Spectrogram window and the Marker Peak List
//window to enlarge the Spectrogram display to 60% of the entire width.
```

```
LAY:SPL 2,4,60

//----- Querying all displayed windows -----
//Query the name and number of all displayed windows
//(from top left to bottom right)
LAY:CAT?
//Result : '1',1,'2',2,'3',3,'4',4

//----- Maximizing a Window -----
//Maximize the window "2 Spectrogram"
DISP:WIND2:SIZE LARG

//-----Restore multiple window display -----
DISP:WIND2:SIZE SMAL
```

14.7.6.2 Example 2: replacing and removing windows

Starting from the display configured in [Example 1: adding and arranging windows](#), we will remove and replace result displays to obtain the following configuration:

1 Frequency Sweep
4 "Marker Table"

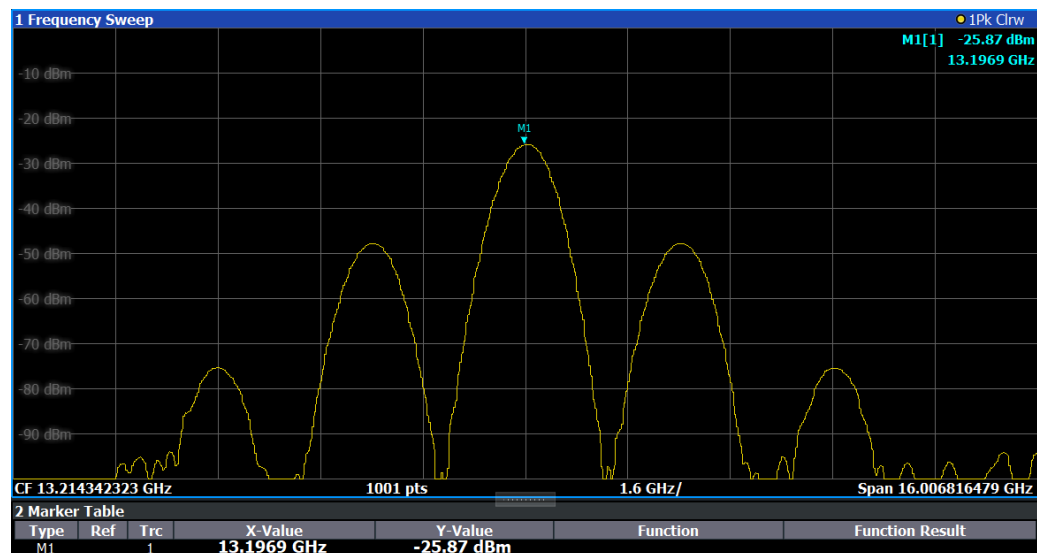

```
//----- Preparing the configuration from example 1 -----
*RST
LAY:ADD? '1',BEL,SGR
LAY:ADD? '1',RIGH,MTAB
LAY:WIND2:ADD? RIGH,PEAK
```



```

LAY:CAT?
//Result : '1',1,'2',2,'3',3,'4',4
//Remove Spectrogram
LAY:WIND2:REM //Remove Marker Table window
LAY:REM '3'
//Replace Marker Peak List window by Marker Table
LAY:REPL '4',MTAB

//----- Querying all displayed windows -----
//Query the name and number of all displayed windows (from top left to bottom right)
LAY:CAT?
//Result : '1',1,'4',4

//----- Changing the size of individual windows -----
//Move the splitter between the Frequency Sweep window and the Marker Table window
//to enlarge the spectrum display to 80% of the entire height.
LAY:SPL 1,4,80

```

14.8 Managing settings and results

The commands required to store and load instrument settings and import and export measurement results in a remote environment are described here. The tasks for manual operation are described in [Chapter 11, "Data management"](#), on page 262.

Addressing drives

The various drives can be addressed via the "mass storage instrument specifier" <msis> using the conventional Windows syntax. The internal hard disk is addressed by "C:". For details on storage locations refer to [Chapter 11.3.2.2, "Storage location and filename"](#), on page 270.

The file names (<FileName> parameter) are given as string parameters enclosed in quotation marks. They also comply with Windows conventions. Windows file names do not distinguish between uppercase and lowercase notation.

Wildcards

The two characters "*" and "?" can be used as "wildcards". Wildcards are variables for a selection of several files. The question mark "?" replaces exactly one character, the asterisk replaces any of the remaining characters in the file name. "*. *" thus means all files in a directory.

Path names

Storage locations can be specified either as absolute (including the entire path) or relative paths (including only subfolders of the current folder). Use the `MMEM:CDIR?` query to determine the current folder.



Secure user mode

In secure user mode, settings that are to be stored on the instrument are stored to volatile memory, which is restricted to 256 MHz. Thus, a "Memory full" error may occur although the hard disk indicates that storage space is still available.

- [Managing files](#).....578
- [Selecting items to store](#).....583
- [Saving and loading instrument settings](#).....586
- [Storing and printing screenshots](#).....590
- [Saving measurement results](#).....601
- [Examples: managing data](#).....601

14.8.1 Managing files

Commands to manage files described elsewhere:

- `FORMat [:DATA]`
- `FORMat:DEXPort:DSEparator`

MMEMory:CATalog	578
MMEMory:CATalog:LONG	579
MMEMory:CDIRectory	579
MMEMory:COMMent	579
MMEMory:COPIE	580
MMEMory:DATA	580
MMEMory:DELeTe:IMMEDIATE	581
MMEMory:MDIRectory	581
MMEMory:MOVE	581
MMEMory:MSIS	581
MMEMory:NAME	582
MMEMory:NETWork:DISConnect	582
MMEMory:NETWork:MAP	582
MMEMory:NETWork:UNUSeddrives?	583
MMEMory:NETWork:USEDdrives	583
MMEMory:RDIRectory	583

MMEMory:CATalog <FileName>

This command returns the contents of a particular directory.

Parameters:

- <FileName> String containing the path and directory
 If you leave out the path, the command returns the contents of the directory selected with [MMEMory:CDIRectory](#) on page 579.
 The path may be relative or absolute. Using wildcards ("*") is possible to query a certain type of files only.

If you use a specific file as a parameter, the command returns the name of the file if the file is found in the specified directory, or an error if the file is not found ("-256, "File name not found").

Example: `MMEM:CAT? 'C:\Data\SPOOL?.PNG'`
Returns all files in `C:\Data\` whose names start with `SPOOL`, have 6 characters and the extension `.PNG`, e.g.:
`SPOOL1.PNG, SPOOL2.PNG, SPOOL3.PNG`

Example: `MMEM:CAT? 'C:\Data\SPOOL6.PNG'`
Query whether the file '`SPOOL6.PNG`' also exists in the directory;
Result:
`-256,"File name not found;:MMEMory:CATalog?`
`'C:\Data\SPOOL6.PNG'`

Manual operation: See "[Selecting Storage Location - Drive/ Path/ Files](#)" on page 272

MMEMory:CATalog:LONG <Directory>

This command returns the contents of a particular directory with additional information about the files.

Parameters:

<Directory> String containing the path and directory.
If you leave out the path, the command returns the contents of the directory selected with [MMEMory:CDIRectory](#) on page 579.
The path may be relative or absolute. Using wildcards (*) is possible to query a certain type of files only.

MMEMory:CDIRectory <Directory>

This command changes the current directory.

Parameters:

<Directory> String containing the path to another directory.
The path may be relative or absolute.

MMEMory:COMMent <Comment>

Defines a comment for the stored settings.

Parameters:

<Comment> String containing the comment.

Example: `MMEemory:COMMENT "ACP measurement with Standard Tetra from 23.05."`
`MMEemory::MMEemory:STORE1:STATE 1, "ACP_T"`
 As a result, in the selection list for recall settings, the comment "ACP measurement with Standard Tetra from 23.05." is added to the ACP entry.

Manual operation: See "[Comment](#)" on page 272

MMEemory:COPY <FileName>, <FileName>

This command copies one or more files to another directory.

Parameters:

<FileName> String containing the path and file name of the source file. Special behavior if optional external mixer is active and the destination is `C:\R_S\INSTR\USER\cv1\`: the contents of the entire folder are copied. For details, see "[Conversion loss tables](#)" on page 141.

<FileName> String containing the path and name of the target file. The path may be relative or absolute.

MMEemory:DATA <FileName>[, <Data>]

MMEemory:DATA? <FileName>

This command writes block data into a file. The delimiter must be set to EOI to obtain error-free data transfer.

When you query the contents of a file, you can save them in a file on the remote control computer.

The command is useful for reading stored settings files or trace data from the instrument or for transferring them to the instrument

Parameters:

<Data> <block_data>
 Data block with the following structure.
 #
 Hash sign.
 <number>
 Length of the length information.
 <number>
 Length information of the binary data (number of bytes).
 <data>
 Binary data with the indicated <number> of bytes.

Parameters for setting and query:

<FileName>

Example:

```
MMEM:NAME '\Public\User\Testfile.txt'
```

Creates a new file called 'testfile.txt'.

```
MMEM:DATA 'Testfile.txt',#220
```

Contents of the file

The parameter means:

#2: hash sign and length of the length information (20 bytes = 2 digits)

20: indicates the number of subsequent binary data bytes.

Contents of the file: store 20 binary bytes (characters) to the file.

```
MMEM:DATA? 'Testfile.txt'
```

Returns the contents of the file.

MMEMory:DELeTe:IMMediate <FileName>

This command deletes a file.

Parameters:

<FileName> String containing the path and file name of the file to delete.
The path may be relative or absolute.

MMEMory:MDIRectory <Directory>

This command creates a new directory.

Parameters:

<Directory> String containing the path and new directory name
The path may be relative or absolute.

MMEMory:MOVE <FileName>, <FileName>

This command moves a file to another directory.

The command also renames the file if you define a new name in the target directory.

If you do not include a path for <NewFileName>, the command just renames the file.

Parameters:

<FileName> String containing the path and file name of the source file.

<FileName> String containing the path and name of the target file.

Example:

```
MMEM:MOVE 'C:\TEST01.CFG', 'SETUP.CFG'
```

Renames TEST01.CFG in SETUP.CFG in directory C:\.

MMEMory:MSIS <Device>

This command selects the default storage device used by all MMEMory commands.

Parameters:

<Device> 'A:' | 'C:' | ... | 'Z:'

String containing the device drive name

*RST: n.a.

MMEMory:NAME <FileName>

This command has several purposes, depending on the context it is used in.

- It creates a new and empty file.
- It defines the file name for screenshots taken with `HCOPY[:IMMEDIATE]`. Note that you have to route the printer output to a file.

Parameters:

<FileName> String containing the path and name of the target file.

Example:

```
MMEM:NAME 'C:\Data\PRINT1.BMP'
```

Selects the file name.

MMEMory:NETWork:DISConnect <Drive>[, <State>]

This command disconnects a network drive.

Parameters:

<Drive> String containing the drive name.

<State> 1 | 0 | ON | OFF

Optional: determines whether disconnection is forced or not

1 | ON

Disconnection is forced.

0 | OFF

Disconnect only if not in use.

*RST: 0

MMEMory:NETWork:MAP <FilePath>, <IP>[, <UserName>, <Password>, <State>]

This command maps a drive to a server or server directory of the network.

Note that you have to allow sharing for a server or folder in Microsoft networks first.

Parameters:

<FilePath> String containing the drive name or path of the directory you want to map.

<IP> String containing the host name of the computer or the IP address and the share name of the drive.
'<host name or IP address\share name>'

<UserName> String containing a user name in the network.
The user name is optional.

<Password> String containing the password corresponding to the <UserName>.
The password is optional.

<State> ON | OFF | 1 | 0

ON | 1

Reconnects at logon with the same user name.

OFF | 0

Does not reconnect at logon.

MMEMory:NETWork:UNUSeddrives?

This command returns a list of unused network drives.

Return values:

<DriveName> List of network drives in alphabetically descending order, e.g. 'W:,V:,U:,...'

Usage: Query only

MMEMory:NETWork:USEDdrives [<State>]

This command returns a list of all network drives in use.

Parameters:

<State> You do not have to use the parameter. If you do not include the parameter, the command returns a list of all drives in use. This is the same behavior as if you were using the parameter OFF.

ON | 1

Returns a list of all drives in use including the folder information.

OFF | 0

Returns a list of all drives in use.

MMEMory:RDIRectory <Directory>

This command deletes the indicated directory.

Parameters:

<Directory> String containing the path of the directory to delete. Note that the directory you want to remove must be empty.

14.8.2 Selecting items to store

The following commands select the items to be included in the configuration file.

Depending on the used command, either the items from the entire instrument (MMEMory:SElect[:ITEM]...), or only those from the currently selected channel (MMEM:SElect:CHANnel[:ITEM]...) are stored.

MMEMory:SElect:CHANnel[:ITEM]:ALL.....	584
MMEMory:SElect[:ITEM]:ALL.....	584
MMEMory:SElect:CHANnel[:ITEM]:DEFault.....	584
MMEMory:SElect[:ITEM]:DEFault.....	584
MMEMory:SElect:CHANnel[:ITEM]:HWSettings.....	584
MMEMory:SElect[:ITEM]:HWSettings.....	584
MMEMory:SElect:CHANnel[:ITEM]:LINes:ALL.....	585

<code>MMEemory:SElect[:ITEM]:LInes:ALL</code>	585
<code>MMEemory:SElect:CHANnel[:ITEM]:NONE</code>	585
<code>MMEemory:SElect[:ITEM]:NONE</code>	585
<code>MMEemory:SElect:CHANnel[:ITEM]:SGRam</code>	585
<code>MMEemory:SElect[:ITEM]:SGRam</code>	585
<code>MMEemory:SElect:CHANnel[:ITEM]:TRACe[:ACTive]</code>	586
<code>MMEemory:SElect[:ITEM]:TRACe<1...3>[:ACTive]</code>	586
<code>MMEemory:SElect:CHANnel[:ITEM]:TRANsducer:ALL</code>	586
<code>MMEemory:SElect[:ITEM]:TRANsducer:ALL</code>	586
<code>MMEemory:SElect:CHANnel[:ITEM]:WEIGHting</code>	586
<code>MMEemory:SElect[:ITEM]:WEIGHting</code>	586

MMEemory:SElect:CHANnel[:ITEM]:ALL

MMEemory:SElect[:ITEM]:ALL

This command includes all items when storing or loading a configuration file.

The items are:

- Hardware configuration: `MMEemory:SElect[:ITEM]:HWSettings` on page 584
- Limit lines: `MMEemory:SElect[:ITEM]:LInes:ALL` on page 585
- Spectrogram data: `MMEemory:SElect[:ITEM]:SGRam` on page 585
- Trace data: `MMEemory:SElect[:ITEM]:TRACe<1...3>[:ACTive]` on page 586

Example: `MME:SEL:ALL`

Manual operation: See "[Items:](#)" on page 272

MMEemory:SElect:CHANnel[:ITEM]:DEFault

MMEemory:SElect[:ITEM]:DEFault

This command selects the current settings as the only item to store to and load from a configuration file.

Manual operation: See "[Items:](#)" on page 272

MMEemory:SElect:CHANnel[:ITEM]:HWSettings <State>

MMEemory:SElect[:ITEM]:HWSettings <State>

This command includes or excludes measurement (hardware) settings when storing or loading a configuration file.

Measurement settings include:

- general channel configuration
- measurement hardware configuration including markers
- limit lines

Note that a configuration may include no more than 8 limit lines. This number includes active limit lines as well as inactive limit lines that were used last.

Therefore the combination of inactivate limit lines depends on the sequence of use with `MMEMemory:LOAD:STATE` on page 587.

- color settings
- configuration for the hardcopy output

Parameters:

<State> ON | OFF | 0 | 1
*RST: 1

Example: MMEM:SEL:HWS ON

Manual operation: See "Items:" on page 272

MMEMemory:SElect:CHANnel[:ITEM]:LINEs:ALL <State>

MMEMemory:SElect[:ITEM]:LINEs:ALL <State>

This command includes or excludes all limit lines (active and inactive) when storing or loading a configuration file.

Parameters:

<State> ON | OFF | 1 | 0
*RST: 0

Example: MMEM:SEL:LIN:ALL ON

Manual operation: See "Items:" on page 272

MMEMemory:SElect:CHANnel[:ITEM]:NONE

MMEMemory:SElect[:ITEM]:NONE

This command does not include any of the following items when storing or loading a configuration file.

- Hardware configuration: `MMEMemory:SElect[:ITEM]:HWSettings` on page 584
- Limit lines: `MMEMemory:SElect[:ITEM]:LINEs:ALL` on page 585
- Spectrogram data: `MMEMemory:SElect[:ITEM]:SGRam` on page 585
- Trace data: `MMEMemory:SElect[:ITEM]:TRACe<1...3>[:ACTIVE]` on page 586

Example: MMEM:SEL:NONE

Manual operation: See "Items:" on page 272

MMEMemory:SElect:CHANnel[:ITEM]:SGRam <State>

MMEMemory:SElect[:ITEM]:SGRam <State>

This command includes or excludes spectrogram data when storing or loading a configuration file.

Parameters:

<State> ON | OFF | 1 | 0
*RST: 0

Example: `MMEM:SEL:SGR ON`
Adds the spectrogram data to the list of data subsets.

Manual operation: See "[Items:](#)" on page 272

MMEemory:SElect:CHANnel[:ITEM]:TRACe[:ACTiVe] <State>
MMEemory:SElect[:ITEM]:TRACe<1...3>[:ACTiVe] <State>

This command includes or excludes trace data when storing or loading a configuration file.

Suffix:
<1...3> irrelevant

Parameters:
<State> ON | OFF | 1 | 0
*RST: 0, i.e. no traces are stored

Example: `MMEM:SEL:TRAC ON`

Manual operation: See "[Items:](#)" on page 272

MMEemory:SElect:CHANnel[:ITEM]:TRANsdUcer:ALL <State>
MMEemory:SElect[:ITEM]:TRANsdUcer:ALL <State>

This command includes or excludes transducer factors when storing or loading a configuration file.

The command is available in the optional Spectrum application.

Parameters:
<State> ON | OFF | 1 | 0
*RST: 0

Example: `MMEM:SEL:TRAN:ALL ON`

Manual operation: See "[Items:](#)" on page 272

MMEemory:SElect:CHANnel[:ITEM]:WEIGHting <State>
MMEemory:SElect[:ITEM]:WEIGHting <State>

Parameters:
<State>

14.8.3 Saving and loading instrument settings

MMEemory:CLEar:ALL	587
MMEemory:CLEar:STATe	587
MMEemory:LOAD:AUTO	587
MMEemory:LOAD:STATe	587
MMEemory:STORe<1 2>:STATe	588
MMEemory:STORe<1 2>:STATe:NEXT	589

MMEemory:STORe<1 2>:TYPE.....	589
SYSTem:PRESet.....	590
SYSTem:PRESet:CHANnel[:EXEC].....	590

MMEemory:CLEar:ALL

This command deletes all instrument configuration files in the current directory.

You can select the directory with [MMEemory:CDIRectory](#) on page 579.

Example: MMEemory:CLE:ALL

MMEemory:CLEar:STATe <1>, <FileName>

This command deletes an instrument configuration file.

Parameters:

<1>

<FileName> String containing the path and name of the file to delete.
The string may or may not contain the file's extension.

Example: MMEemory:CLE:STAT 1, 'TEST'

MMEemory:LOAD:AUTO <1>, <FileName>

This command restores an instrument configuration and defines that configuration as the default state.

The default state is restored after a preset ([*RST](#)) or after you turn on the R&S FSWP.

Parameters:

<1>

<FileName> '**Factory**'
Restores the factory settings as the default state.
'<file_name>
String containing the path and name of the configuration file.
Note that only *instrument* settings files can be selected for the
startup recall function; channel files cause an error.

Example: MMEemory:LOAD:AUTO 1, 'C:\R_S\INSTR\USER\TEST'

Manual operation: See "[Startup Recall](#)" on page 274

MMEemory:LOAD:STATe <1>, <FileName>

This command restores and activates the instrument configuration stored in a *.dfl file.

Note that files with other formats cannot be loaded with this command.

The contents that are reloaded from the file are defined by the last selection made either in the "Save/Recall" dialogs (manual operation) or through the `MMEMemory:SElect[:ITEM]` commands (remote operation; the settings are identical in both cases).

By default, the selection is limited to the user settings ("User Settings" selection in the dialogs, `HWSettings` in SCPI). The selection is not reset by `[Preset]` or `*RST`.

As a consequence, the results of a SCPI script using the `MMEMemory:LOAD:STATe` command without a previous `MMEMemory:SElect[:ITEM]` command may vary, depending on previous actions in the GUI or in previous scripts, even if the script starts with the `*RST` command.

It is therefore recommended that you use the appropriate `MMEMemory:SElect[:ITEM]` command before using `MMEMemory:LOAD:STATe`.

Parameters:

<1>

<FileName> String containing the path and name of the file to load.
The string may or may not include the file's extension.

Example:

```
MMEM:SEL:ALL
//Save all items (User Settings, All Traces, All Limit Lines) from
the R&S FSWP.
MME:LOAD:STAT 1, 'C:\R_S\INSTR\USER\TEST01'
//Reloads all items
In the "Recall" dialog, select only "User Settings" and "All Limit
Lines".
MME:LOAD:STAT 1, 'C:\R_S\INSTR\USER\TEST01'
//Reloads user settings and all limit lines.
*RST
//Reset instrument.
MME:LOAD:STAT 1, 'C:\R_S\INSTR\USER\TEST01'
//Selected items are retained. Reloads user settings and all limit
lines.
Restart the instrument.
(Switch the [ON/OFF] key off and on).
MME:LOAD:STAT 1, 'C:\R_S\INSTR\USER\TEST01'
// Selected items are set to default. Reloads only the user set-
tings.
```

Manual operation: See ["Recall"](#) on page 269
See ["Recall in New Channel / Recall in Current Channel"](#)
on page 273

MMEMemory:STORe<1|2>:STATe <1>, <FileName>

This command saves the current instrument configuration in a *.dfl file.

Suffix:

<1|2> irrelevant

Parameters:

<1>

<FileName> String containing the path and name of the target file.
The file extension is .dfl.

Example:

```
MMEM:STOR:STAT 1, 'Save'
```

Saves the current instrument settings in the file `Save.dfl`.

Manual operation: See ["Save File"](#) on page 273

MMEMory:STORe<1|2>:STATe:NEXT

This command saves the current instrument configuration in a *.dfl file.

The file name depends on the one you have set with `MMEMory:STORe<1|2>:STATe` on page 588. This command adds a consecutive number to the file name.

Suffix:

<1|2> irrelevant

Example:

```
MMEM:STOR:STAT 1, 'Save'
```

Saves the current instrument settings in the file `Save.dfl`.

```
MMEM:STOR:STAT:NEXT
```

Saves the current instrument settings in the file `Save_001.dfl`

```
MMEM:STOR:STAT:NEXT
```

Saves the current instrument settings in the file `Save_002.dfl`

Manual operation: See ["Save File"](#) on page 273

MMEMory:STORe<1|2>:TYPE <Type>

This command defines whether the data from the entire instrument or only from the current channel is stored with the subsequent `MMEM:STOR...` command.

Suffix:

<1|2> irrelevant

Parameters:

<Type> INSTRument | CHANnel

INSTRument

Stores data from the entire instrument.

CHANnel

Stores data from an individual channel.

```
*RST: INST
```

Example:

```
INST:SEL 'SPECTRUM2'
```

Selects channel 'SPECTRUM2'.

```
MMEM:STOR:TYPE CHAN
```

Specifies that channel data is to be stored.

SYSTem:PRESet

This command presets the R&S FSWP. It is identical to [*RST](#).

Example: SYST:PRESet

Usage: Event

SYSTem:PRESet:CHANnel[:EXEC]

Restores the default instrument settings in the current channel.

Use `INST:SEL` to select the channel.

Example: INST:SEL 'Spectrum2'
Selects the channel for "Spectrum2".
SYST:PRESet:CHAN:EXEC
Restores the factory default settings to the "Spectrum2" channel.

Usage: Event

Manual operation: See "[Preset Channel](#)" on page 135

14.8.4 Storing and printing screenshots

Useful commands to perform measurements described elsewhere:

- [MMEMoRY:NAME](#)

DISPlay:LOGO	591
HCOPy:ABORT	591
HCOPy:CMAP<it>:DEFault<ci>	591
HCOPy:CMAP<it>:HSL	592
HCOPy:CMAP<it>:PDEFined	592
HCOPy:CONTent	593
HCOPy:DESTination<di>	594
HCOPy:DEVice:COLor	595
HCOPy:DEVice:LANGuage	595
HCOPy[:IMMediate]	595
HCOPy[:IMMediate]:NEXT	595
HCOPy:ITEM:WINDow:TEXT	596
HCOPy:PAGE:COUNT:STATe	596
HCOPy:PAGE:MARGin:BOTTom	596
HCOPy:PAGE:MARGin:LEFT	596
HCOPy:PAGE:MARGin:RIGHT	597
HCOPy:PAGE:MARGin:TOP	597
HCOPy:PAGE:MARGin:UNIT	597
HCOPy:PAGE:ORientation	597
HCOPy:PAGE:WINDow:CHANnel:STATe	598
HCOPy:PAGE:WINDow:COUNT	598
HCOPy:PAGE:WINDow:SCALE	599
HCOPy:PAGE:WINDow:STATe	599
HCOPy:TDSamp:STATe	600

SYSTem:COMMunicate:PRINter:ENUMerate:FIRSt.....	600
SYSTem:COMMunicate:PRINter:ENUMerate[:NEXT].....	600
SYSTem:COMMunicate:PRINter:SELect<di>.....	600

DISPlay:LOGO <State>

Activates/deactivates the printout of the Rohde & Schwarz company logo at the top of each page.

Parameters:

<State> 1 | 0 | ON | OFF
 1 | ON
 Logo is printed.
 0 | OFF
 Logo is not printed.
 *RST: 1

Example: DISP:LOGO OFF

Manual operation: See "[Print Logo](#)" on page 281

HCOPy:ABORt

This command aborts a running hardcopy output.

Example: HCOP:ABOR

HCOPy:CMAP<it>:DEFault<ci>

This command defines the color scheme for print jobs.

For details see "[Print Colors](#)" on page 310.

Suffix:

<it> Irrelevant.
 <ci> See table below

Example: HCOP:CMAP:DEF2
 Selects the optimized color set for the color settings of a print-out.

Manual operation: See "[Print Colors](#)" on page 310

Gui setting	Description	Remote command
"Screen Colors (Print)"	Selects the current screen colors for the printout. The background is always printed in white and the grid in black.	HCOP:CMAP:DEF1
"Optimized Colors"	Selects an optimized color setting for the printout to improve the visibility of the colors (default setting). Trace 1 is blue, trace 2 black, trace 3 green, and the markers are turquoise. The background is always printed in white and the grid in black.	HCOP:CMAP:DEF2
"User Defined Colors"	Selects the user-defined color setting.	HCOP:CMAP:DEF3
"Screen Colors (Screenshot)"	Selects the current screen colors without any changes for a screenshot.	HCOP:CMAP:DEF4

HCOPY:CMAP<it>:HSL <hue>, <sat>, <lum>

This command selects the color for various screen elements in print jobs.

Suffix:

<it> Selects the item for which the color scheme is to be defined.
For more information see [Chapter 14.9.4.3, "CMAP suffix assignment"](#), on page 622.

Parameters:

<hue> **hue**
 tint
 Range: 0 to 1

<sat> **sat**
 saturation
 Range: 0 to 1

<lum> **lum**
 brightness
 Range: 0 to 1

Example: HCOPY:CMAP2:HSL 0.3,0.8,1.0
 Changes the grid color

Manual operation: See ["Defining User-specific Colors"](#) on page 312

HCOPY:CMAP<it>:PDEFined <Color>

This command selects a predefined color for various screen elements in print jobs.

Suffix:

<it> 1..n
 Selects the item for which the color scheme is to be defined.
For more information see [Chapter 14.9.4.3, "CMAP suffix assignment"](#), on page 622.

Parameters:

<Color> BLACK | BLUE | BROWn | GREen | CYAN | RED | MAGenta |
 YELLOW | WHITE | DGRay | LGRay | LBLue | LGReen | LCYan |
 LRED | LMAGenta

Example:

HCOP:CMAP2:PDEF GRE

Manual operation: See "[Predefined Colors](#)" on page 311

HCOPy:CONTent <Content>

This command determines the type of content included in the printout.

This setting is independent of the printing device.

Parameters:

<Content> WINDows | HCOPy

WINDows

Includes only the selected windows in the printout. All currently active windows for the current channel (or "MultiView") are available for selection. How many windows are printed on a each page of the printout is defined by [HCOPy:PAGE:WINDow:COUNT](#) on page 598.

This option is not available when copying to the clipboard ([HCOP:DEST 'SYST:COMM:CLIP'](#) or an image file (see [HCOPy:DEvIce:LANGuage](#) on page 595).

If the destination is currently set to an image file or the clipboard, it is automatically changed to be a PDF file for the currently selected printing device.

HCOPy

Selects all measurement results displayed on the screen for the current channel (or "MultiView"): diagrams, traces, markers, marker lists, limit lines, etc., including the channel bar and status bar, for printout on a single page. Displayed items belonging to the software user interface (e.g. softkeys) are not included. The size and position of the elements in the printout is identical to the screen display.

*RST: HCOPy

Example:

```
HCOP:DEST1 'SYST:COMM:CLIP'
HCOP:CONT WIND
HCOP:DEST1?
//Result: 'MMEM'
HCOP:DEV:LANG1?
//Result: 'PDF'
```

"Print to clipboard" is automatically switched to "print to PDF file" when the contents are switched to "multiple windows".

Manual operation:

See "[Print Screenshot](#)" on page 280

See "[Print Multiple Windows](#)" on page 281

HCOPY:DESTination<di> <Destination>

This command selects the destination of a print job.

Note: To print a screenshot to a file, see [HCOPY:DEVIce:LANGUage](#) on page 595.

Suffix:

<di> Printing device.

Parameters:

<Destination>

'MMEM'

Activates "Print to file". Thus, if the destination of the print function is set to "printer" (see [HCOP:DEST1 'SYSTEM:COMMUnicate:PRINter'](#) or [HCOP:DEV:LANG GDI](#)), the output is redirected to a .PRN file using the selected printer driver.

Select the file name with [MMEMory:NAME](#).

Note: To save a screenshot to a file, see [HCOPY:DEVIce:LANGUage](#) on page 595.

'SYSTEM:COMMUnicate:PRINter'

Sends the hardcopy to a printer and deactivates "print to file".

Select the printer with [SYSTEM:COMMUnicate:PRINter:SElect<di>](#).

'SYSTEM:COMMUnicate:CLIPboard'

Sends the hardcopy to the clipboard.

*RST: 'SYST:COMM:CLIP'

Example:

To print on a printer:

```
//Destination: printer, deactivate "print to file"
HCOP:DEST1 'SYSTEM:COMMUnicate:PRINter'
//Define the printer name
SYST:COMM:PRIN:SEL 'myFavoritePrinter'
//Print
HCOP:IMM
```

Example:

To print to a *PRN file:

```
//Destination: printer
HCOP:DEV:LANG GDI
//Define the printer name
SYST:COMM:PRIN:SEL 'myFavoritePrinter'
//Redirect the printer output to a file
HCOP:DEST1 'MMEM'
//Define file name
MMEM:NAME 'C:\R_S\instr\user\MeasurementTestReport.png'
//Print
HCOP:IMM
```

Manual operation:

See ["Destination: File"](#) on page 286

See ["Destination: Clipboard"](#) on page 286

See ["Destination: Printer"](#) on page 286

See ["Print to file"](#) on page 287

HCOPy:DEVice:COLor <State>

This command turns color printing on and off.

Parameters:

<State> ON | OFF | 0 | 1
 ON | 1
 Color printing
 OFF | 0
 Black and white printing
 *RST: 1

Example: HCOP:DEV:COL ON

HCOPy:DEVice:LANGuage <Language>

This command selects the file format for a print job or to store a screenshot to a file.

Parameters:

<Language> **GDI**
 Graphics Device Interface
 Default format for output to a printer configured under Windows.
 Must be selected for output to the printer interface.
 Can be used for output to a file. The printer driver configured
 under Windows is used to generate a printer-specific file format.
 BMP | JPG | PNG | PDF | SVG
 Data format for output to files

Example: To print a screenshot to a PNG file:

```
//Destination: PNG file
HCOP:DEV:LANG PNG
//Define file name
MMEM:NAME 'C:\R_S\instr\user\MeasurementTestReport.png'
//Print
HCOP:IMM
```

Manual operation: See "[Destination: File](#)" on page 286

HCOPy[:IMMEDIATE]

This command initiates a print job.

If you are printing to a file, the file name depends on [MMEMory:NAME](#).

Manual operation: See "[Print](#)" on page 284

HCOPy[:IMMEDIATE]:NEXT

This command initiates a print job.

If you are printing to a file, the file name depends on `MMEMory:NAME`. This command adds a consecutive number to the file name.

Manual operation: See ["Print"](#) on page 284

HCOPY:ITEM:WINDOW:TEXT <Comment>

This command defines a comment to be added to the printout.

Parameters:

<Comment> String containing the comment.

Manual operation: See ["Comment"](#) on page 281

HCOPY:PAGE:COUNT:STATE <State>

This command includes or excludes the page number for printouts consisting of multiple pages ([HCOPY:CONTENT](#) on page 593).

Parameters:

<State> 1 | 0 | ON | OFF
 1 | ON
 The page number is printed.
 0 | OFF
 The page number is not printed.
 *RST: 1

Example: HCOPY:PAGE:COUN:STAT ON

Manual operation: See ["Print Page Count"](#) on page 281

HCOPY:PAGE:MARGIN:BOTTOM <Bottom>

This command defines the margin at the bottom of the printout page on which no elements are printed. The margins are defined according to [HCOPY:PAGE:MARGIN:UNIT](#) on page 597.

Parameters:

<Bottom> *RST: 4.23 mm

Example: HCOPY:PAGE:MARG2:BOTT 2

Manual operation: See ["Margins"](#) on page 289

HCOPY:PAGE:MARGIN:LEFT <Left>

This command defines the margin at the left side of the printout page on which no elements are printed. The margins are defined according to [HCOPY:PAGE:MARGIN:UNIT](#) on page 597.

Parameters:

<Left> *RST: 4.23 mm

Example: HCOP:PAGE:MARG2:LEFT 2

Manual operation: See "[Margins](#)" on page 289

HCOPy:PAGE:MARGin:RIGHT <Right>

This command defines the margin at the right side of the printout page on which no elements are printed. The margins are defined according to [HCOPy:PAGE:MARGin:UNIT](#) on page 597.

Parameters:

<Right> *RST: 4.23 mm

Example: HCOP:PAGE:MARG2:RIGH 2

Manual operation: See "[Margins](#)" on page 289

HCOPy:PAGE:MARGin:TOP <Top>

This command defines the margin at the top of the printout page on which no elements are printed. The margins are defined according to [HCOPy:PAGE:MARGin:UNIT](#) on page 597.

Parameters:

<Top> *RST: 4.23 mm

Example: HCOP:PAGE:MARG2:TOP 2

Manual operation: See "[Margins](#)" on page 289

HCOPy:PAGE:MARGin:UNIT <Unit>

This command defines the unit in which the margins for the printout page are configured.

Parameters:

<Unit> MM | IN
MM
 millimeters
IN
 inches
 *RST: MM

Example: HCOP:PAGE:MARG2:BOTT 2

Manual operation: See "[Margins](#)" on page 289

HCOPy:PAGE:ORientation <Orientation>

The command selects the page orientation of the printout.

The command is only available if the output device is a printer or a PDF file.

Parameters:

<Orientation> LANDscape | PORTrait
 *RST: PORTrait

Example:

```
HCOP:DEV:LANG1 PDF
HCOP:PAGE:ORI2 LAND
```

Manual operation: See "[Orientation](#)" on page 288

HCOPY:PAGE:WINDow:CHANnel:STATe <Channel>, <State>

This command selects all windows of the specified channel to be included in the print-out for [HCOPY:CONTent](#) on page 593.

Parameters:

<Channel> String containing the name of the channel.
 For a list of available channel types use [INSTrument:LIST?](#) on page 415.

<State> 1 | 0 | ON | OFF
1 | ON
 The channel windows are included in the printout.
0 | OFF
 The channel windows are not included in the printout.
 *RST: 1

Example:

```
HCOP:CONT WIND
HCOP:PAGE:WIND2:CHAN 'IQ Analyzer',0
HCOP:PAGE:WIND2:STAT 'IQ Analyzer','1',1
Prints only window 1 in the IQ Analyzer channel.
```

Manual operation: See "[Print Multiple Windows](#)" on page 281

HCOPY:PAGE:WINDow:COUNT <Count>

This command defines how many windows are displayed on a single page of the print-out for [HCOPY:CONTent](#) on page 593.

Parameters:

<Count> integer
 *RST: 1

Example:

```
HCOP:PAGE:WIND2:COUN 2
```

Manual operation: See "[Windows Per Page](#)" on page 289

HCOPY:PAGE:WINDow:SCALe <Scale>

This command determines the scaling of the windows in the printout for [HCOPY:CONTent](#) on page 593.

Parameters:

<Scale>	1 0 ON OFF
	1 ON
	Each window is scaled to fit the page size optimally, not regarding the aspect ratio of the original display. If more than one window is printed on one page (see HCOPY:PAGE:WINDow:COUNT on page 598), each window is printed in equal size. ("Size to fit")
	0 OFF
	Each window is printed as large as possible while maintaining the aspect ratio of the original display. ("Maintain aspect ratio")
	*RST: 1

Example: `HCOPY:PAGE:WIND2:SCAL 0`

Manual operation: See "[Scaling](#)" on page 289

HCOPY:PAGE:WINDow:STATe <Channel>, <Window>, <State>

This command selects the windows to be included in the printout for [HCOPY:CONTent](#) on page 593.

Parameters:

<Channel>	String containing the name of the channel. For a list of available channel types use INSTRUMENT:LIST? on page 415.
<Window>	String containing the name of the existing window. By default, the name of a window is the same as its index. To determine the name and index of all active windows in the active channel, use the LAYout:CATalog[:WINDow]? query.
<State>	1 0 ON OFF
	1 ON
	The window is included in the printout.
	0 OFF
	The window is not included in the printout.
	*RST: 1

Example: `HCOPY:PAGE:WIND2:STAT 'IQ Analyzer','1',1`

Manual operation: See "[Print Multiple Windows](#)" on page 281

HCOPY:TDSTamp:STATe <State>

This command includes or excludes the time and date in the printout.

Parameters:

<State> 1 | 0 | ON | OFF
 1 | ON
 The time and date are printed.
 0 | OFF
 The time and date are not printed.
 *RST: 1

Manual operation: See "Print Date and Time" on page 282

SYSTem:COMMunicate:PRINter:ENUMerate:FIRSt

This command queries the name of the first available printer.

To query the name of other installed printers, use `SYSTem:COMMunicate:PRINter:ENUMerate[:NEXT]` on page 600.

Manual operation: See "Printer Name" on page 286

SYSTem:COMMunicate:PRINter:ENUMerate[:NEXT]

This command queries the name of available printers.

You have to use `SYSTem:COMMunicate:PRINter:ENUMerate:FIRSt` on page 600 for this command to work properly.

Manual operation: See "Printer Name" on page 286

SYSTem:COMMunicate:PRINter:SELect<di> <Printer>

This command selects the printer that processes jobs sent by the R&S FSWP.

Use `HCOPY:DESTination<di>` to select another output destination.

Suffix:

<di> 1..n
 Printing device.

Parameters:

<Printer> String containing the printer name.
 Use
 • `SYSTem:COMMunicate:PRINter:ENUMerate:FIRSt`
 on page 600 and
 • `SYSTem:COMMunicate:PRINter:ENUMerate[:NEXT]`
 on page 600
 to query all available printers.
 *RST: NONE

Manual operation: See ["Printer Name"](#) on page 286

14.8.5 Saving measurement results

Useful commands to store measurement results described elsewhere:

- [FORMat \[: DATA \]](#)

[MMEMory:STORe<n>:TRACe](#).....601

MMEMory:STORe<n>:TRACe <Trace>, <FileName>

Exports trace data from the specified window to an ASCII file.

For details on the file format, see [Chapter 10.3.8.1, "Reference: ASCII file export format"](#), on page 234.

Secure User Mode

In secure user mode, settings that are stored on the instrument are stored to volatile memory, which is restricted to 256 MB. Thus, a "memory limit reached" error can occur although the hard disk indicates that storage space is still available.

To store data permanently, select an external storage location such as a USB memory device.

For details, see [Chapter 11.2, "Protecting data using the secure user mode"](#), on page 263.

Suffix:

<n> [Window](#)

Parameters:

<Trace> Number of the trace to be stored

<FileName> String containing the path and name of the target file.

Example:

MMEM:STOR1:TRAC 1, 'C:\TEST.ASC'

Stores trace 1 from window 1 in the file TEST.ASC.

Manual operation: See ["Export Trace to ASCII File"](#) on page 228

14.8.6 Examples: managing data

- [Storing data](#).....602
- [Loading data](#).....602
- [Storing instrument settings](#).....603
- [Loading instrument settings](#).....603
- [Printing to a file](#).....603
- [Printing on a printer](#).....604

14.8.6.1 Storing data

```

MMEM:MSIS 'C:'
//Selects drive C: as the default storage device.

//-----Connecting a network drive-----
MMEM:NETW:USED?
//Returns a list of all drives in use in the network.
MMEM:NETW:UNUS?
//Returns a list of free drive names in the network.
MMEM:NETW:MAP 'Q:', 'Server\ACLRTest'
//Maps drive Q: to the directory 'Server\ACLRTest'

//-----Saving data on the instrument-----
MMEM:MDIR 'C:\R_S\INSTR\USER\Results'
//Creates a directory called 'Results' on drive C:
MMEM:NAME 'C:\R_S\INSTR\USER\Results\Test001.txt'
//Defines a file called 'Test001.txt'
MMEM:COMM 'ACLR test results'
//Creates a comment for the settings to be displayed in gui.
MMEM:DATA 'Test001.txt', #212FileContents
//Creates the file 'Test001.txt' and writes 12 characters to it

//-----Copying the data to another location---
MMEM:COPY 'C:\R_S\INSTR\USER\Results\Test001.txt', 'Q:'
//Copies the specified file to network drive Q:
MMEM:DEL 'C:\R_S\INSTR\USER\Results\Test001.txt'
//Deletes the specified file from the instrument hard disk.
//or
//MMEM:MOVE 'C:\R_S\INSTR\USER\Results\Test001.xml', 'Q:\TestResults.txt'//
//Moves the file 'Test001.txt' to drive Q:, renames it to 'Testresults.txt'
//and removes it from the instrument hard disk.
MMEM:RDIR 'C:\R_S\INSTR\USER\Results'
//Deletes the directory called 'Results' from drive C:, unless it still
//contains any content.

//-----Disconnecting the network drive---
MMEM:NETW:DISC 'Q:'
//Disconnect drive Q:

```

14.8.6.2 Loading data

```

MMEM:CDIR?
//Returns the path of the current directory.
//e.g.
C:\R_S\Instr\user\
MMEM:CDIR 'C:\R_S\INSTR\USER\Results'
//Changes the current directory.
MMEM:CAT? 'C:\R_S\INSTR\USER\Results\*.xml'

```

```
//or
MMEM:CAT? '*.xml'
//Returns a list of all xml files in the directory 'C:\R_S\INSTR\USER\Results'.
MMEM:CAT:LONG? '*.xml'
//Returns additional information about the xml files in the directory
// 'C:\R_S\INSTR\USER\Results'.
```

14.8.6.3 Storing instrument settings

In this example we will store the instrument settings for the "Spectrum" channel.

```
INST:SEL 'SPECTRUM'
//Selects measurement channel 'SPECTRUM'.
MEMM:STOR:TYPE CHAN
//Specifies that channel-specific data is to be stored.
MMEM:STOR:STAT 1, 'C:\R_S\Instr\user\Spectrum'
//Stores the channel settings from the 'Spectrum' channel
// to the file 'Spectrum.dfl'.
```

14.8.6.4 Loading instrument settings

In this example we will load the hardware settings from the configuration file Spectrum.dfl to a new "Spectrum2" channel.

```
MEMM:LOAD:TYPE NEW
//Specifies that settings will be loaded to a new channel besides the existing
//'Spectrum' channel.
MMEM:SEL:CHAN:HWS ON
//Selects only hardware settings to be loaded.
MMEM:LOAD:STAT 1, 'C:\R_S\Instr\user\Spectrum'
//Loads the channel-specific settings from the file 'C:\R_S\Instr\user\Spectrum.dfl'
//to a new channel. The new channel is named 'Spectrum2' to avoid a naming conflict
//with the existing 'Spectrum' channel.
INST:REN 'Spectrum2','Spectrum3'
//Renames the loaded channel to 'Spectrum3'.
```

14.8.6.5 Printing to a file

```
//Select bmp as the file format.
HCOP:DEV:LANG BMP
//Select the file name for the printout.
MMEM:NAME 'C:\R_S\INSTR\USER\Screenshot.bmp'
//Select all screen elements for printing
HCOP:ITEM:ALL
//Add a comment to the printout.
HCOP:ITEM:WIND:TEXT 'ACLRResults'
//Store the printout in a file called 'Screenshot.bmp'.
HCOP
```

```
//Store another printout in a file called 'Screenshot_001.bmp'.
HCOP:NEXT
```

14.8.6.6 Printing on a printer

```
HCOP:DEST2 'SYST:COMM:PRIN'
//Prints the data on a printer.
SYST:COMM:PRIN:ENUM:FIRS?
SYST:COMM:PRIN:ENUM?
//Returns the available printers, e.g.
//'LASER on LPT1'
//''
//Means that one printer is available.
SYST:COMM:PRIN:SEL2 'LASER on LPT1'
//Selects the printer for the print job on device 2.
HCOP:PAGE:ORI2 LAND
//Selects the landscape format for the printout.
HCOP:TDST:STAT2 ON
//Includes date and time on the printout.
HCOP:ITEM:ALL
//Prints all screen elements
HCOP
//Initiates the printout.
```

14.9 Configuring the R&S FSWP

• Basic instrument setup.....	604
• Configuring the reference frequency.....	606
• Calibrating the R&S FSWP and checking temperature.....	611
• Customizing the screen layout.....	617
• Configuring network and remote control.....	623
• Configuring HUMS.....	629
• Checking the system configuration.....	635
• Using service functions.....	641
• Reference: Command Set of 5052 Emulation.....	644
• Reference: command set of emulated PSA models.....	646

14.9.1 Basic instrument setup

SYSTem:CLOGging.....	605
SYSTem:REBoot.....	605
SYSTem:SHUTdown.....	605
SYSTem:DATE.....	605
SYSTem:TIME.....	605

SYSTem:CLOGging <State>

This command turns logging of remote commands on and off.

Parameters:

<State> ON | OFF | 1 | 0

ON | 1

Writes all remote commands that have been sent to a file.

The destination is C:\R_S\INSTR\ScpiLogging\
ScpiLog.<no.>.

where <no.> is a sequential number

A new log file is started each time logging was stopped and is restarted.

OFF | 0

*RST: 0

Manual operation: See "[I/O Logging](#)" on page 374

SYSTem:REBoot

This command reboots the instrument, including the operating system.

SYSTem:SHUTdown

This command shuts down the instrument.

SYSTem:DATE <Year>, <Month>, <Day>

Configures the date on the instrument.

Parameters:

<Year>

<Month>

<Day>

Example: SYST:DATE 2020,04,23

Manual operation: See "[Set Date and Time](#)" on page 305

SYSTem:TIME <Year>, <Month>, <Day>

Configures the time on the internal real-time clock on the instrument.

Parameters:

<Hour> Range: 0 to 23

<Minutes> Range: 0 to 59

<Seconds> Range: 0 to 59

Example: SYST:TIME 10,52,33

Manual operation: See ["Set Date and Time"](#) on page 305

14.9.2 Configuring the reference frequency

[SENSe:]ROSCillator:COUPling:BANDwidth.....	606
[SENSe:]ROSCillator:COUPling:BANDwidth:MODE.....	606
[SENSe:]ROSCillator:COUPling:MODE.....	607
[SENSe:]ROSCillator:LBWidth.....	607
[SENSe:]ROSCillator:O640.....	607
SOURce<si>:EXternal<ext>:ROSCillator:EXternal:FREQuency.....	608
[SENSe:]ROSCillator:OSYNc.....	608
[SENSe:]ROSCillator:SOURce.....	609
[SENSe:]ROSCillator:SOURce:EAUTO?.....	609
[SENSe:]ROSCillator:TRANge.....	610
[SENSe:]ROSCillator:EXternal:FALLback.....	610

[SENSe:]ROSCillator:COUPling:BANDwidth <Bandwidth>

This command defines coupling bandwidth for the internal reference frequency.

Prerequisites for this command

- Options R&S FSWP-B60 or -B61 must be available.
- Select manual bandwidth mode (`[SENSe:]ROSCillator:COUPling:BANDwidth:MODE`)

Parameters:

<Bandwidth> <numeric value>
 Bandwidths 20 mHz, 1 Hz and 100 kHz are supported.
 Default unit: Hz

Example: //Define coupling bandwidth
 ROSC:COUP:BAND:MODE MAN
 ROSC:COUP:BAND 1HZ

Manual operation: See ["Advanced reference frequency configuration"](#) on page 320

[SENSe:]ROSCillator:COUPling:BANDwidth:MODE <Mode>

This command selects coupling bandwidth mode for the internal reference frequency.

Prerequisites for this command

- Options R&S FSWP-B60 or -B61 must be available.

Parameters:

<Mode> **AUTO**
 Automatically selects an appropriate coupling bandwidth.

MANual
 Manual selection of coupling bandwidth. You can select the bandwidth with `[SENSe:]ROSCillator:COUPling:BANDwidth`.

*RST: AUTO

Example: //Select coupling bandwidth mode
ROSC:COUP:MODE AUTO

Manual operation: See "[Advanced reference frequency configuration](#)" on page 320

[SENSe:]ROSCillator:COUPling:MODE <State>

This command turns the coupling of the internal reference frequency on and off.

Prerequisites for this command

- Options R&S FSWP-B60 or -B61 must be available.

Parameters:

<State>

AUTO

Automatically turns the coupling on and off, depending on the current measurement scenario.

OFF

Decouples the reference frequencies.

ON

Couples the reference frequencies.

*RST: AUTO

Example: //Synchronize reference frequencies
ROSC:COUP:MODE ON

Manual operation: See "[Advanced reference frequency configuration](#)" on page 320

[SENSe:]ROSCillator:LBWidth <Bandwidth>

Defines the loop bandwidth, that is, the speed of internal synchronization with the reference frequency. The setting requires a compromise between performance and increasing phase noise.

For a variable external reference frequency with a narrow tuning range (± 0.5 ppm), the loop bandwidth is fixed to 0.1 Hz and cannot be changed.

Parameters:

<Bandwidth>

0.1 Hz | 1 Hz | 3 Hz | 10 Hz | 30 Hz | 100 Hz | 300 Hz

The possible values depend on the reference source and tuning range (see [Table 12-1](#)).

Default unit: Hz

Example: ROSC:LBW 3

Manual operation: See "[Loop Bandwidth](#)" on page 319

[SENSe:]ROSCillator:O640 <State>

This command turns the output of a reference signal on the corresponding connector ("Ref Output") on and off.

[SENSe:]ROSCillator:O100: Provides a 100 MHz reference signal on corresponding connector.

[SENSe:]ROSCillator:O640: Provides a 640 MHz reference signal on corresponding connector.

Parameters:

<State> ON | OFF | 1 | 0
 OFF | 0
 Switches the reference off.
 ON | 1
 Switches the reference on

Example: //Output reference signal of 100 MHz.
 ROSC:O100 ON

Manual operation: See ["Reference Frequency Output"](#) on page 319

SOURce<si>:EXTernal<ext>:ROSCillator:EXTernal:FREQUENCY <Frequency>

This command defines the frequency of the external reference oscillator.

If the external reference oscillator is selected, the reference signal must be connected to the rear panel of the instrument.

Suffix:

<si> 1..n
 <ext> 1..n

Parameters:

<Frequency> Range: 1 MHz to 50 MHz
 Default unit: HZ

Example: ROSC:EXT:FREQ 13MHZ
 Sets the frequency to 13 MHz.
 SOUR:EXT:ROSC:EXT:FREQ 13MHZ

Manual operation: See ["Reference Frequency Input"](#) on page 318

[SENSe:]ROSCillator:OSYNc <State>

If enabled, a 100 MHz reference signal is provided to the "SYNC TRIGGER OUTPUT" connector.

Parameters:

<State> ON | OFF | 1 | 0
 *RST: 0

Example: ROSC:OSYN ON

Manual operation: See ["Reference Frequency Output"](#) on page 319

[SENSe:]ROSCillator:SOURce <Source>

This command selects the reference oscillator.

If you want to select the external reference, it must be connected to the R&S FSWP.

Parameters:

<Source>

INTernal

The internal reference is used (10 MHz).

EXTernal | EXTernal1 | EXT1

The external reference from the "REF INPUT 10 MHZ" connector is used; if none is available, an error flag is displayed in the status bar.

E10

The external reference from "REF INPUT 1..50 MHZ" connector is used with a fixed 10 MHZ frequency; if none is available, an error flag is displayed in the status bar.

E100

The external reference from the "REF INPUT 100 MHZ / 1 GHz" connector is used with a fixed 100 MHZ frequency; if none is available, an error flag is displayed in the status bar.

E1000

The external reference from "REF INPUT 100 MHZ / 1 GHz" connector is used with a fixed 1 GHz frequency; if none is available, an error flag is displayed in the status bar.

EAUTO

The external reference is used as long as it is available, then the instrument switches to the internal reference.

SYNC

The external reference is used; if none is available, an error flag is displayed in the status bar.

Example:

ROSC:SOUR EXT

Manual operation: See ["Reference Frequency Input"](#) on page 318

[SENSe:]ROSCillator:SOURce:EAUTO?

This command queries the current reference type in case you have activated an automatic switch to the internal reference if the external reference is missing.

Return values:

<Reference>

INT | EXT

INT

internal reference

EXT

external reference

Example:

SENS:ROSC:SOUR:EAUT?

Queries the currently available reference type.

Usage: Query only

[SENSe:]ROSCillator:TRANge <Range>

Defines the tuning range. The tuning range is only available for the variable external reference frequency. It determines how far the frequency may deviate from the defined level in parts per million (10^{-6}).

Parameters:

<Range>

WIDE | SMALI

The possible values depend on the reference source (see [Table 12-1](#)).

SMALI

With this smaller deviation (± 0.5 ppm) a very narrow fixed loop bandwidth of 0.1 Hz is realized. With this setting the instrument can synchronize to an external reference signal with a very precise frequency. Due to the very narrow loop bandwidth, unwanted noise or spurious components on the external reference input signal are strongly attenuated. Furthermore, the loop requires about 30 seconds to reach a locked state. During this locking process, "NO REF" is displayed in the status bar.

WIDE

The larger deviation (± 6 ppm) allows the instrument to synchronize to less precise external reference input signals.

Example: `ROSC:TRAN WIDE`

Manual operation: See "[Tuning Range](#)" on page 319

[SENSe:]ROSCillator:EXternal:FALLback <State>

Defines how the instrument reacts if an external reference is selected but none is available.

Parameters:

<State>

ON | OFF | 0 | 1

OFF | 0

If no valid external reference signal is available, the error message "External reference missing" is displayed. Additionally, the flag "NO REF" is displayed to indicate that no synchronization was performed *for the last measurement*.

ON | 1

If no external reference is available, the instrument automatically switches back to the internal reference. Note that you must reactivate the external reference if it becomes available again at a later time.

*RST: 0

Manual operation: See "[Behavior in case of missing external reference](#)" on page 318

14.9.3 Calibrating the R&S FSWP and checking temperature

CALibration[:ALL]?	611
CALibration:REsult?	612
CALibration:DUE:WARMup	612
CALibration:DUE:SCHEdule	612
CALibration:DUE:DAYs	613
CALibration:DUE:TIME	614
CALibration:DUE:SHUTdown	614
DIAGnostic:SERVice:INPut:MC[:DISTance]	614
DIAGnostic:SERVice:INPut:PULSed:CFREquency	615
DIAGnostic:SERVice:INPut:RF[:SPECtrum]	615
DIAGnostic:SERVice:INPut[:SELect]	615
DIAGnostic:SERVice:INPut:SYNThtwo[:FREQuency]	616
DIAGnostic:SERVice:STESt:RESult?	616
SOURce<si>:TEMPerature:FRONtend	616

CALibration[:ALL]?

This command initiates a calibration (self-alignment) routine and queries if calibration was successful.

During the acquisition of correction data the instrument does not accept any remote control commands.

Note: If you start a self-alignment remotely, then select the "Local" softkey while the alignment is still running, the instrument only returns to the manual operation state after the alignment is completed.

In order to recognize when the acquisition of correction data is completed, the MAV bit in the status byte can be used. If the associated bit is set in the Service Request Enable (SRE) register, the instrument generates a service request after the acquisition of correction data has been completed.

Return values:

<CalibrationFailed> ON | OFF | 0 | 1

OFF | 0

Calibration was successful.

ON | 1

Calibration was not successful.

Example:

*CLS

Resets the status management.

*SRE 16

Enables MAV bit in the Service Request Enable register.

*CAL?

Starts the correction data recording, and then a service request is generated.

Usage:

Query only

Manual operation: See "[Start Self Alignment](#)" on page 300

CALibration:RESult?

This command returns the results collected during calibration.

Return values:

<CalibrationData> String containing the calibration data.

Example:

```
CAL:RES?
would return, e.g.
[...]
Total Calibration Status:
PASSED, Date (dd/mm/yyyy): 12/07/2004,
Time: 16:24:54, Runtime: 00.06
```

Usage: Query only

Manual operation: See "[Alignment Results:](#)" on page 302

CALibration:DUE:WARMup <State>

If enabled, self-alignment is started automatically after the warmup operation has completed.

Parameters:

<State> ON | OFF | 0 | 1
OFF | 0
Switches the function off
ON | 1
Switches the function on
*RST: 0

Example: //Schedule a self-alignment every Sunday at 2 AM after a warmup period, then shut down instrument.

```
CAL:DUE:WARM
CAL:DUE:SCH ON
CAL:DUE:DAY SUND
CAL:DUE:TIME '2:00'
CAL:DUE:SHUT
```

Manual operation: See "[Await Warm-Up Operation before Self Alignment](#)" on page 301

CALibration:DUE:SCHEdule <State>

If enabled, a self-alignment is performed regularly at specific days and time. Specify the date and time using the [CALibration:DUE:DAY S](#) and [CALibration:DUE:TIME](#) commands.

Parameters:

<State> ON | OFF | 0 | 1
OFF | 0
Switches the function off

ON | 1

Switches the function on

***RST:** 0**Example:** //Schedule a self-alignment every Sunday at 2 AM after a warmup period, then shut down instrument.

```

CAL:DUE:WARM
CAL:DUE:SCH ON
CAL:DUE:DAYS SUND
CAL:DUE:TIME '2:00'
CAL:DUE:SHUT

```

Manual operation: See "[Schedule](#)" on page 301

CALibration:DUE:DAYS <Day1>[, <Day2>, <Day3>, <Day4>, <Day5>, <Day6>, <Day7>]

Defines the days on which a self-alignment is scheduled for [CALibration:DUE:SCHe](#)dule ON. Up to 7 different days can be scheduled.

Parameters:

<Day1>	ALL MONDay TUESday WEDNesday THURsday FRIDay SATurday SUNDay
<Day2>	ALL MONDay TUESday WEDNesday THURsday FRIDay SATurday SUNDay
<Day3>	ALL MONDay TUESday WEDNesday THURsday FRIDay SATurday SUNDay
<Day4>	ALL MONDay TUESday WEDNesday THURsday FRIDay SATurday SUNDay
<Day5>	ALL MONDay TUESday WEDNesday THURsday FRIDay SATurday SUNDay
<Day6>	ALL MONDay TUESday WEDNesday THURsday FRIDay SATurday SUNDay
<Day7>	ALL MONDay TUESday WEDNesday THURsday FRIDay SATurday SUNDay

Example: //Schedule a self-alignment every Monday and Friday
 CAL:DUE:DAYS MOND,FRID

Example: //Schedule a self-alignment every Sunday at 2 AM after a warmup period, then shut down instrument.

```

CAL:DUE:WARM
CAL:DUE:SCH ON
CAL:DUE:DAYS SUND
CAL:DUE:TIME '2:00'
CAL:DUE:SHUT

```

Manual operation: See "[Schedule](#)" on page 301

CALibration:DUE:TIME <Time>

Defines the time at which a self-alignment is scheduled for the days specified by [CALibration:DUE:DAYs](#), if [CALibration:DUE:SCHEdule](#) ON.

Parameters:

<Time> string with format 'hh:mm' (24 hours)

Example:

//Schedule a self-alignment every Sunday at 2 AM after a warmup period, then shut down instrument.

```
CAL:DUE:WARM
CAL:DUE:SCH ON
CAL:DUE:DAYs SUND
CAL:DUE:TIME '2:00'
CAL:DUE:SHUT
```

Manual operation: See ["Schedule"](#) on page 301

CALibration:DUE:SHUTdown <State>

If activated, the R&S FSWP is automatically shut down after self-alignment is completed. Note that the instrument cannot be restarted via remote control.

Parameters:

<State> ON | OFF | 0 | 1
OFF | 0
 Switches the function off
ON | 1
 Switches the function on
 *RST: 0

Example:

//Schedule a self-alignment every Sunday at 2 AM after a warmup period, then shut down instrument.

```
CAL:DUE:WARM
CAL:DUE:SCH ON
CAL:DUE:DAYs SUND
CAL:DUE:TIME '2:00'
CAL:DUE:SHUT
```

Manual operation: See ["Shut down Device after Self Alignment"](#) on page 301

DIAGnostic:SERvice:INPut:MC[:DISTance] <Bandwidth>

This command selects the distance of the peaks of the microwave calibration signal for calibration of the YIG filter.

Parameters:

<Bandwidth> WIDE | SMALI
SMALI
 Small offset of combline frequencies.

WIDE

Wide offset of combine frequencies.

Manual operation: See ["Calibration Frequency MW"](#) on page 332

DIAGnostic:SERVice:INPut:PULSed:CFrequency <Frequency>

This command defines the frequency of the calibration signal.

Before you can use the command, you have to feed in a calibration signal with [DIAGnostic:SERVice:INPut\[:SElect\]](#) on page 615.

Manual operation: See ["Calibration Frequency RF"](#) on page 331

DIAGnostic:SERVice:INPut:RF[:SPECTrum] <Bandwidth>

This command selects the bandwidth of the calibration signal.

Parameters:

<Bandwidth> NARRowband | BROadband

NARRowband

Narrowband signal for power calibration of the frontend.

BROadband

Broadband signal for calibration of the IF filter.

Manual operation: See ["Spectrum"](#) on page 332

DIAGnostic:SERVice:INPut[:SElect] <Signal>

This command activates or deactivates the use of an internal calibration signal as input for the R&S FSWP.

Parameters:

<Signal>

CALibration

Uses the calibration signal as RF input.

MCALibration

Uses the calibration signal for the microwave range as RF input.

RF

Uses the signal from the RF input.

SYNTtwo

Uses the calibration signal to check the phase noise of the two synthesizers. A second synthesizer is available as a hardware option.

*RST: RF

Example:

```
//Select calibration signal source
DIAG:SERV:INP RF
```

Manual operation: See "NONE" on page 331
 See "Calibration Frequency RF" on page 331
 See "Calibration Frequency MW" on page 332
 See "Calibration Synthesizer 2" on page 332

DIAGnostic:SERVice:INPut:SYNThtwo[:FREQUENCY] <Frequency>

This command selects the frequency which the synthesizers are calibrated for.

The command is available when you select the synthesizer as the calibration source with `DIAGnostic:SERVice:INPut[:SElect]` on page 615.

Parameters:

<Frequency> Default unit: Hz

Example:

```
DIAG:SERV:INP:SEL SYNT
DIAG:SERV:INP:SYNT 10MHZ
```

Manual operation: See "Calibration Synthesizer 2" on page 332

DIAGnostic:SERVice:STESt:RESult?

This command queries the self-test results.

Return values:

<Results> String of data containing the results.
 The rows of the self-test result table are separated by commas.

Example:

```
DIAG:SERV:STES:RES?
would return, e.g.
"Total Selftest Status:
PASSED", "Date (dd/mm/yyyy): 09/07/2004 TIME:
16:24:54", "Runtime: 00:06", "..."
```

Usage:

Query only

SOURce<si>:TEMPerature:FRONTend

This command queries the current frontend temperature of the R&S FSWP.

During self-alignment, the instrument's (frontend) temperature is also measured (as soon as the instrument has warmed up completely). This temperature is used as a reference for a continuous temperature check during operation. If the current temperature deviates from the stored self-alignment temperature by a certain degree, a warning is displayed in the status bar indicating the resulting deviation in the measured power levels. A status bit in the `STATUS:QUESTionable:TEMPerature` register indicates a possible deviation.

(This feature is available in the optional Spectrum and Signal Analyzer application.)

Suffix:

<si> irrelevant

Return values:

<Temperature> Temperature in degrees Celsius.

Example:

SOUR:TEMP:FRON?

Queries the temperature of the frontend sensor.

14.9.4 Customizing the screen layout

- [Configuring screen elements](#)..... 617
- [Selecting colors and schemes](#)..... 620
- [CMAP suffix assignment](#)..... 622

14.9.4.1 Configuring screen elements

Useful commands to configure screen elements described elsewhere:

- `DISPlay[:WINDow<n>]:MTABLE`
- `DISPlay:FORMat`

<code>DISPlay:ANNotation:CBAR</code>	617
<code>DISPlay:ANNotation:FREQuency</code>	617
<code>DISPlay:SBAR[:STATe]</code>	618
<code>DISPlay:SKEYs[:STATe]</code>	618
<code>DISPlay:TBAR[:STATe]</code>	618
<code>DISPlay:TOUCHscreen[:STATe]</code>	618
<code>DISPlay[:WINDow<n>]:TIME</code>	619
<code>DISPlay[:WINDow<n>]:TIME:FORMat</code>	619
<code>SYSTem:DISPlay:FPANel[:STATe]</code>	619

DISPlay:ANNotation:CBAR <State>

This command hides or displays the channel bar information.

Parameters:

<State> ON | OFF | 0 | 1
 *RST: 1

Example: `DISP:ANN:CBAR OFF`

Manual operation: See "[Channel Bar](#)" on page 306

DISPlay:ANNotation:FREQuency <State>

This command turns the label of the x-axis on and off.

Parameters:

<State> ON | OFF | 0 | 1
 *RST: 1

Example: `DISP:ANN:FREQ OFF`

Manual operation: See "[Diagram Footer \(Annotation\)](#)" on page 306

DISPlay:SBAR[:STATe] <State>

This command turns the status bar on and off.

Parameters:

<State> ON | OFF | 0 | 1
*RST: 1

Example: DISP:SBAR:OFF

Manual operation: See "[Status Bar](#)" on page 306

DISPlay:SKEYs[:STATe] <State>

This command turns the softkey bar on and off.

Parameters:

<State> ON | OFF | 0 | 1
*RST: 1

Example: DISP:SKEY:OFF

Manual operation: See "[Softkey Bar](#)" on page 306

DISPlay:TBAR[:STATe] <State>

This command turns the toolbar on or off.

Parameters:

<State> ON | OFF | 1 | 0
*RST: 0

Example: DISP:TBAR ON

Manual operation: See "[Toolbar](#)" on page 306

DISPlay:TOUCHscreen[:STATe] <State>

This command controls the touch screen functionality.

Parameters:

<State> ON | FRAME | OFF | TCOFF
ON | 1
Touch screen is active for entire screen
OFF | 0
Touch screen is inactive for entire screen
FRAME
Touch screen is inactivate for the diagram area of the screen,
but active for softkeys, toolbars and menus.
*RST: 1

Example: DISP:TOUC:STAT ON

Manual operation: See ["Deactivating and Activating the Touchscreen"](#) on page 304

DISPlay[:WINDow<n>]:TIME <State>

This command adds or removes the date and time from the display.

Suffix:

<n> irrelevant

Parameters:

<State> ON | OFF | 1 | 0
*RST: 0

Example: DISP:TIME ON

Manual operation: See ["Date and Time"](#) on page 307

DISPlay[:WINDow<n>]:TIME:FORMat <Format>

This command selects the time and date format.

Suffix:

<n> irrelevant

Parameters:

<Format> US | DE | ISO
DE
dd.mm.yyyy hh:mm:ss
24 hour format.
US
mm/dd/yyyy hh:mm:ss
12 hour format.
ISO
yyyy-mm-dd hh:mm:ss
24 hour format.
*RST: ISO

Example: DISP:TIME ON
Switches the screen display of date and time on.
DISP:TIME:FORM US
Switches the date and time format to US.

Manual operation: See ["Date and Time Format"](#) on page 305

SYSTem:DISPlay:FPANel[:STATe] <State>

This command includes or excludes the front panel keys when working with the remote desktop.

Parameters:

<State> ON | OFF | 0 | 1
 *RST: 1

Manual operation: See "Front Panel" on page 307
 See "Mini Front Panel" on page 308

14.9.4.2 Selecting colors and schemes

Useful commands to select colors and schemes described elsewhere:

- `HCOPY:CMAP<it>:DEFault<ci>`
- `HCOPY:CMAP<it>:HSL`
- `HCOPY:CMAP<it>:PDEFined`

<code>DISPlay:CMAP<it>:DEFault<ci></code>	620
<code>DISPlay:CMAP<it>:HSL</code>	621
<code>DISPlay:CMAP<it>:PDEFined</code>	621
<code>DISPlay:THEMe:CATalog?</code>	621
<code>DISPlay:THEMe:SElect</code>	622

DISPlay:CMAP<it>:DEFault<ci>

This command selects the color scheme for the display. The query returns the default color scheme.

Suffix:

<it> Irrelevant.
 <ci> 1
 Default color set 1 with a black background and white grid.
 2
 Default color set 2 with a white background and a black grid.
 3
 User-defined colors.
 Suffix irrelevant for query

Return values:

<DefScheme> 1 | 2 | 3
 The default color scheme used for the screen, as specified by the <ci> suffix.

Example:

```
DISP:CMAP:DEF2
Selects default setting 2 (white background and a black grid) for
screen colors.
DISP:CMAP:DEF?
//Result: 2
```

Manual operation: See "Screen Colors" on page 310

DISPlay:CMAP<it>:HSL <hue>, <sat>, <lum>

This command selects the color for various screen elements in the display.

Suffix:

<it> 1..n
Selects the item for which the color scheme is to be defined.
For more information see [Chapter 14.9.4.3, "CMAP suffix assignment"](#), on page 622.

Parameters:

<hue> tint
Range: 0 to 1

<sat> saturation
Range: 0 to 1

<lum> brightness
Range: 0 to 1

Example: DISP:CMAP2:HSL 0.3,0.8,1.0
Changes the grid color.

DISPlay:CMAP<it>:PDEFined <Color>

This command selects a predefined color for various screen elements.

Suffix:

<it> 1..n
Selects the item for which the color scheme is to be defined.
For more information see [Chapter 14.9.4.3, "CMAP suffix assignment"](#), on page 622.

Parameters:

<Color> BLACK | BLUE | BROWn | GREen | CYAN | RED | MAGenta |
YELLow | WHITe | DGRay | LGRay | LBLue | LGReen | LCYan |
LRED | LMAGenta

Example: DISP:CMAP2:PDEF GRE

Manual operation: See ["Restoring the User Settings to Default Colors"](#) on page 312

DISPlay:THEMe:CATalog?

This command queries all available display themes.

Return values:

<Themes> String containing all available display themes.

Example: DISP:THEMe:CAT?

Usage: Query only

DISPlay:THEMe:SElect <Theme>

This command selects the display theme.

Parameters:

<Theme> String containing the name of the theme.
*RST: SPL

Example: DISP:THEM:SEL "BlueOcean"

Manual operation: See "[Theme](#)" on page 309

14.9.4.3 CMAP suffix assignment

Several commands to change the color settings of individual items of the display or printout are available. Which item is to be configured is defined using a <CMAP> suffix. The following assignment applies:

Suffix	Description
CMAP1	Background
CMAP2	Grid
CMAP3 *)	Common Text
CMAP4 *)	Check Status OK
CMAP5 *)	Check Status Error
CMAP6 *)	Text Special 1
CMAP7 *)	Text Special 2
CMAP8	Trace 1
CMAP9	Trace 2
CMAP10	Trace 3
CMAP11	Marker Info Text
CMAP12	Limit Lines
CMAP13	Limit and Margin Check – "Pass"
CMAP14	Limit and Margin Check – "Fail"
CMAP15 *)	Softkey Text
CMAP16 *)	Softkey Background
CMAP17 *)	Selected Field Text
CMAP18 *)	Selected Field Background
CMAP19 *)	Softkey 3D Bright Part
CMAP20 *)	Softkey 3D Dark Part
CMAP21 *)	Softkey State "On"
CMAP22 *)	Softkey State "Dialog open"

Suffix	Description
CMAP23 *)	Softkey Text Disabled
CMAP24	Logo
CMAP25	Trace 4
CMAP26	Grid – Minorlines
CMAP27	Marker
CMAP28	Display Lines
CMAP29 *)	Sweepcount – Text
CMAP30	Limit and Margin Check – Text
CMAP31	Limit and Margin Check – \\"Margin\"
CMAP32 *)	Table Overall – Title Text
CMAP33 *)	Table Overall – Title Background
CMAP34 *)	Table Overall – Text
CMAP35 *)	Table Overall – Background
CMAP36 *)	Table Value – Title Text
CMAP37 *)	Table Value – Title Background
CMAP38 *)	Table Value – Text
CMAP39 *)	Table Value – Background
CMAP40	Trace 5
CMAP41	Trace 6
*) these settings can only be defined via the theme (<code>DISPlay:THEMe:SELeCt</code>) and are thus ignored in the SCPI command	

14.9.5 Configuring network and remote control

<code>SYSTem:COMMunicate:GPIB[:SELF]:ADDRess</code>	624
<code>SYSTem:COMMunicate:GPIB[:SELF]:RTERminator</code>	624
<code>SYSTem:COMMunicate:INTErnal:REMote</code>	624
<code>SYSTem:DISPlay:LOCK</code>	625
<code>SYSTem:DISPlay:UPDate</code>	625
<code>SYSTem:ERRor:CLEar:REMote</code>	625
<code>SYSTem:ERRor:DISPlay</code>	626
<code>SYSTem:IDENtify:FACTory</code>	626
<code>SYSTem:IDENtify[:STRing]</code>	626
<code>SYSTem:KLOCK</code>	626
<code>SYSTem:LANGuage</code>	627
<code>SYSTem:LXI:LANReset</code>	627
<code>SYSTem:LXI:MDEscription</code>	627
<code>SYSTem:LXI:PASSword</code>	627

SYSTem:PSA:WIDeband.....	628
SYSTem:SHIMmediate:STATE.....	628
SYSTem:SHIMmediate ONCE.....	629

SYSTem:COMMunicate:GPIB[:SELF]:ADDRESS <Address>

This command sets the GPIB address of the R&S FSWP.

Parameters:

<Address> Range: 0 to 30
 *RST: (no influence on this parameter, factory default 20)

Example: SYST:COMM:GPIB:ADDR 18

Manual operation: See "[GPIB Address](#)" on page 373

SYSTem:COMMunicate:GPIB[:SELF]:RTERminator <Terminator>

This command selects the GPIB receive terminator.

Output of binary data from the instrument to the control computer does not require such a terminator change.

Parameters:

<Terminator> LFEOI | EOI

LFEOI
 According to the standard, the terminator in ASCII is <LF> and/or <EOI>.

EOI
 For binary data transfers (e.g. trace data) from the control computer to the instrument, the binary code used for <LF> might be included in the binary data block, and therefore should not be interpreted as a terminator in this particular case. This can be avoided by using only the receive terminator EOI.

*RST: LFEOI

Example: SYST:COMM:GPIB:RTER EOI

Manual operation: See "[GPIB Terminator](#)" on page 374

SYSTem:COMMunicate:INTernal:REMote <State>

The instrument switches between manual and remote operation.

Note: If the local lockout function (LLO or [SYST:KLOC ON](#)) has been activated in the remote control mode, manual operation is no longer available until [GTL](#) (or [SYST:KLOC OFF](#)) is executed.

For details, see [Chapter 13.6.7, "Returning to manual mode \("local"\)"](#), on page 386.

Parameters:

<State> ON | OFF | 0 | 1

OFF | 0

The instrument switches from remote to manual operation. You can operate the instrument locally.

ON | 1

The instrument switches from manual to remote operation.

*RST: 0

Example:

```
SYST:COMM:INT:REM OFF
```

The instrument switches from remote to manual operation (corresponds to @LOC or selecting the "Local" softkey).

Manual operation: See "[Local](#)" on page 386

SYSTem:DISPlay:LOCK <State>

Defines whether the "Display Update" function remains available in remote operation or not.

Parameters:

<State> ON | OFF | 0 | 1

OFF | 0

The function remains available.

ON | 1

The function is not available and the display is not updated during remote operation.

*RST: 0

SYSTem:DISPlay:UPDate <State>

This command turns the display during remote operation on and off.

If on, the R&S FSWP updates the diagrams, traces and display fields only.

The best performance is obtained if the display is off during remote control operation.

Parameters:

<State> ON | OFF | 1 | 0

*RST: 0

Example:

```
SYST:DISP:UPD ON
```

Manual operation: See "[Remote Display Update](#)" on page 374

SYSTem:ERRor:CLEar:REMote

This command deletes all contents of the "Remote Errors" table.

Note: The remote error list is automatically cleared when the R&S FSWP is shut down.

Example:

```
SYST:ERR:CLE:REM
```

Manual operation: See ["Display Remote Errors"](#) on page 375
See ["Clear Error List"](#) on page 386

SYSTem:ERRor:DISPlay <State>

This command switches the error display during remote operation on and off.

If activated, the R&S FSWP displays a message box at the bottom of the screen that contains the most recent type of error and the command that caused the error.

Parameters:

<State> ON | OFF | 1 | 0
*RST: 0

Example: SYST:ERR:DISP ON

Manual operation: See ["Display Remote Errors"](#) on page 375

SYSTem:IDENtify:FACTory

This command resets the query to `*IDN?` to its default value.

Usage: Event

Manual operation: See ["Reset to Factory String"](#) on page 373

SYSTem:IDENtify[:STRing] <String>

This command defines the response to `*IDN?`.

Parameters:

<String> String containing the description of the instrument.

Manual operation: See ["Identification String"](#) on page 373

SYSTem:KLOCK <State>

This command locks or unlocks manual operation.

Parameters:

<State> **ON**
LLO (local lockout). The instrument can only be operated remotely, not locally.

OFF
Unlocks the manual operation mode. To operate the instrument locally again, you must execute `SYST:COMM:INT:REM OFF` or select the "Local" softkey first.

*RST: state not affected by *RST

Example: SYST:KLOC ON
Activates LLO (remote control only)

Example: `SYST:KLOC OFF`
 `SYST:COMM:INT:REM OFF`
 You can operate the instrument locally.

SYSTem:LANGuage <Language>

This command selects the system language.

Parameters:

<Language> String containing the name of the language.

'SCPI'
 SCPI language.

'PSA'
 PSA emulation.
 For a list of supported commands, see [Chapter 14.9.10, "Reference: command set of emulated PSA models"](#), on page 646.

*RST: SCPI

Example: `SYST:LANG 'PSA'`
 Emulates the PSA.

Manual operation: See "[Language](#)" on page 376

SYSTem:LXI:LANReset

This command resets the LAN configuration, as well as the "LAN" password and instrument description.

Manual operation: See "[LAN Reset](#)" on page 378

SYSTem:LXI:MDEscription <Description>

This command defines the "LAN" instrument description.

Parameters:

<Description> String containing the instrument description.

SYSTem:LXI:PASSword <Password>

This command defines the "LAN" password.

Parameters:

<Password> String containing the password.

Return values:

<Password>

Manual operation: See "[LAN Password](#)" on page 377

SYSTem:PSA:WIDeband <State>

This command defines which option is returned when the *OPT? query is executed, depending on the state of the wideband option.

It is only available for PSA89600 emulation.

Parameters:

<State> ON | OFF | HIGH

OFF
The option is indicated as "B7J"

ON
The 40 MHz wideband is used.
The option is indicated as "B7J, 140".

HIGH
The 80 MHz wideband is used.
The option is indicated as "B7J, 122".

*RST: OFF

Manual operation: See "[Wideband](#)" on page 376

SYSTem:SHIMmediate:STATe <State>

Determines when the remote commands that change hardware settings on the R&S FSWP are executed.

Regardless of this setting, the firmware automatically sets the hardware when a sweep is started.

This setting is not changed by the preset function.

Parameters:

<State> ON | OFF | 0 | 1

OFF | 0
Remote commands that cause changes to the hardware are only executed when the `SYSTem:SHIMmediate ONCE` command is executed.

ON | 1
Remote commands are always executed immediately when they are received by the instrument.

*RST: 1

Example:

```
SYST:SHIM:STAT ON
...
SYST:SHIM ONCE
```

Manual operation: See "[Set Hardware Immediately](#)" on page 375

SYSTem:SHIMmediate ONCE

Executes any received remote commands that cause changes to the hardware and have not been executed yet due to a `SYST:SHIM:STAT OFF` command.

Example: `SYST:SHIM:STAT ON`
 ...
 `SYST:SHIM ONCE`

Usage: Event

Manual operation: See "[Set Hardware Immediately](#)" on page 375

14.9.6 Configuring HUMS

This section includes all commands needed for R&S HUMS remote operations.

<code>DIAGnostic:HUMS:DELeTe:ALL</code>	629
<code>DIAGnostic:HUMS:FORMat</code>	629
<code>DIAGnostic:HUMS:STATe</code>	630
<code>DIAGnostic:HUMS:TAGS:ALL?</code>	630
<code>DIAGnostic:HUMS:TAGS:DELeTe:ALL</code>	630
<code>DIAGnostic:HUMS:TAGS:DELeTe</code>	631
<code>DIAGnostic:HUMS:TAGS[:VALue]</code>	631
<code>SYSTem:COMMunicate:REST:ENABle</code>	631
<code>SYSTem:COMMunicate:SNMP:COMMunity:RO</code>	632
<code>SYSTem:COMMunicate:SNMP:COMMunity:RW</code>	632
<code>SYSTem:COMMunicate:SNMP:CONtact</code>	632
<code>SYSTem:COMMunicate:SNMP:LOCation</code>	633
<code>SYSTem:COMMunicate:SNMP:USM:USER</code>	633
<code>SYSTem:COMMunicate:SNMP:USM:USER:ALL?</code>	633
<code>SYSTem:COMMunicate:SNMP:USM:USER:DELeTe</code>	634
<code>SYSTem:COMMunicate:SNMP:USM:USER:DELeTe:ALL</code>	634
<code>SYSTem:COMMunicate:SNMP:VERSion</code>	634

DIAGnostic:HUMS:DELeTe:ALL

Deletes the complete HUMS data. This includes device history, device tags, SCPI connections, utilization history and utilizations.

Example: `//Delete HUMS data`
 `DIAG:HUMS:DEL:ALL`

Usage: Event

Manual operation: See "[Delete HUMS History](#)" on page 380

DIAGnostic:HUMS:FORMat <DataFormat>

Selects the format for the queried HUMS data. You can query the HUMS data either in JSON format or XML format.

The defined format affects all other commands that return block data.

Parameters:

<DataFormat> JSON | XML

JSON
Returns the HUMS data in *JSON* format.

XML
Returns the HUMS data in *XML* format.

*RST: JSON

Example:

```
//Return data in JSON format
DIAG:HUMS:FORM JSON
```

DIAGnostic:HUMS:STATe <State>

Turns the HUMS service and data collection on and off.

Parameters:

<State> ON | OFF | 1 | 0

*RST: ON

Example:

```
//Turn on HUMS service
DIAG:HUMS:STAT ON
```

Manual operation: See "[State](#)" on page 380

DIAGnostic:HUMS:TAgS:ALL?

Queries all key-value tags that you have assigned to the instrument. Depending on the set data format, the queried data is either displayed in *XML* or *JSON* format. For more information about setting the data format, see [DIAGnostic:HUMS:FORMat](#) on page 629.

Return values:

<ID> ID number of the defined tag.

<Key> String containing key name of the defined tag.

<Value> String containing value of the defined tag.

Example:

```
//Return all tags
DIAG:HUMS:TAgS:ALL?
1,"location","building_11",2,"time zone","CET"
```

Usage:

Query only

Manual operation: See "[Value](#)" on page 384

DIAGnostic:HUMS:TAgS:DELeTe:ALL

Deletes all key-value tags you have assigned to the instrument.

Example: //Delete all tags
DIAG:HUMS:TAGS:DEL:ALL

Usage: Event

Manual operation: See "[Delete All](#)" on page 384

DIAGnostic:HUMS:TAGS:DELeTe <ID>

Deletes a certain tag you assigned to your instrument, including its key and value.

Setting parameters:

<ID> ID number of the tag you want to delete.
To identify the ID number, query all device tags from the system first. For more information, see [DIAGnostic:HUMS:TAGS:ALL?](#) on page 630.

Example: //Delete tag
DIAG:HUMS:TAGS:DEL 0

Usage: Setting only

Manual operation: See "[Delete All](#)" on page 384

DIAGnostic:HUMS:TAGS[:VALue] <ID>, <Key>, <Value>

DIAGnostic:HUMS:TAGS[:VALue]? <ID>

Adds or modifies a key-value pair (device tag).

The query returns the key-value pair for a given ID or an empty string if the ID is unknown.

Parameters:

<Key> String containing key name of the queried tag.

<Value> String containing value of the queried tag.

Parameters for setting and query:

<ID> 0 - 31
ID number of the tag you want to modify or query.
To identify the ID number, query all device tags from the system first. For more information, read here [DIAGnostic:HUMS:TAGS:ALL?](#) on page 630.

Example: //Add or modify a tag (tag 1)
DIAG:HUMS:TAGS 1, 'location', 'building_11'

Manual operation: See "[Add](#)" on page 384

SYSTem:COMMunicate:REST:ENABle <RestState>

Turns communication via the REST API on and off.

Parameters:

<RestState> ON | OFF | 0 | 1

Example: //Return REST state
 SYST:COMM:REST:ENAB?

Manual operation: See "REST" on page 381

SYSTem:COMMunicate:SNMP:COMMunity:RO <CommunityString>

Defines the SNMP community string for read-only access.

Prerequisites for this command:

- Select an SNMP version that supports communities (**SYSTem:COMMunicate:SNMP:VERSion** on page 634).

Setting parameters:

<CommunityString> String containing the community name.

Example: //Set community name
 SYST:COMM:SNMP:VERS V12
 SYST:COMM:SNMP:COMM:RO 'ABC'

Usage: Setting only

Manual operation: See "Access" on page 382

SYSTem:COMMunicate:SNMP:COMMunity:RW <CommunityString>

Defines the SNMP community string for read-write access.

Prerequisites for this command:

- Select an SNMP version that supports communities (**SYSTem:COMMunicate:SNMP:VERSion** on page 634).

Setting parameters:

<CommunityString> String containing the community name.

Example: //Set read-write access
 SYST:COMM:SNMP:VERS V12
 SYST:COMM:SNMP:COMM:RW 'ABC'

Usage: Setting only

Manual operation: See "Access" on page 382

SYSTem:COMMunicate:SNMP:CONTact <SnmpContact>

Defines the SNMP contact information for the administrator.

You can also set the contact information via SNMP if you do not set it via SCPI.

Parameters for setting and query:

<SnmpContact> String containing SNMP contact.
 *RST: "" (empty string)

Example: //Set SNMP contact
 SYST:COMM:SNMP:CONT 'ABC'

Manual operation: See "[SNMP Contact](#)" on page 383

SYSTem:COMMunicate:SNMP:LOCation <SnmLocation>

Defines the SNMP location information for the administrator.

You can also set the location information via SNMP if you do not set it via SCPI.

Parameters for setting and query:

<SnmLocation> String containing SNMP location.
 *RST: "" (empty string)

Example: //Return SNMP location
 SYST:COMM:SNMP:LOC?

Manual operation: See "[SNMP Location](#)" on page 383

SYSTem:COMMunicate:SNMP:USM:USER <Name>, <Access>, <Level>[, <Auth_pwd>[, <Priv_pwd>]]

Defines an SNMP user profile.

Prerequisites for this command:

- Select SNMPv3 ([SYSTem:COMMunicate:SNMP:VERSion](#) on page 634).

Setting parameters:

<Name> String containing name of the user.
 <Access> RO | RW
 Defines the access right a user can have.
 <Level> NOAuth | AUTH | PRIVacy
 Defines the security level.
 <Auth_pwd> String containing the authentication password.
 <Priv_pwd> String containing the privacy password.

Example: //Create user profile
 SYST:COMM:SNMP:VERS V123
 SYST:COMM:SNMP:USM:USER 'Peter', 'RO', 'PRIV',
 '1234', 'XYZ'

Usage: Setting only

Manual operation: See "[SNMPv3 Configuration](#)" on page 382

SYSTem:COMMunicate:SNMP:USM:USER:ALL?

Queries the number of users and a list of all SNMP users for SNMPv3.

Prerequisites for this command:

- Select SNMPv3 ([SYSTem:COMMunicate:SNMP:VERSion](#) on page 634).

Return values:

<Count> Total number of registered SNMP users.
 <Name> List of all user names as a comma-separated list.

Example: //Return all SNMP users
 SYST:COMM:SNMP:USM:USER:ALL?

Usage: Query only

Manual operation: See "[SNMPv3 Configuration](#)" on page 382

SYSTem:COMMunicate:SNMP:USM:USER:DELeTe <UserName>

Deletes a specific SNMP user profile.

Setting parameters:

<UserName> String containing name of SNMP user profile to be deleted.

Example: //Delete SNMP user profile
 SYST:COMM:SNMP:USM:USER:DEL "Peter"

Usage: Setting only

Manual operation: See "[SNMPv3 Configuration](#)" on page 382

SYSTem:COMMunicate:SNMP:USM:USER:DELeTe:ALL

Deletes all SNMP user profiles.

Example: //Delete all SNMP user profiles
 SYST:COMM:SNMP:USM:USER:DEL:ALL

Usage: Event

Manual operation: See "[SNMPv3 Configuration](#)" on page 382

SYSTem:COMMunicate:SNMP:VERSion <SnmVersion>

Selects the SNMP version.

Parameters for setting and query:

<SnmVersion> OFF | V12 | V123 | V3 | DEFault

OFF

SNMP communication is off.

V12

SNMP communication with SNMPv2 or lower.

V123

SNMP communication with SNMPv2 and SNMPv3.

V3

SNMP communication with SNMPv3.

*RST: V123

Example: //Select the SNMP version
 SYST:COMM:SNMP:VERS V12

Manual operation: See "SNMP" on page 381

14.9.7 Checking the system configuration

Useful commands to check the system configuration described elsewhere:

- [DIAGnostic:SERvice:SINfo?](#)

DIAGnostic:INFO:CCOunt?	635
DIAGnostic:SERvice:BIOSinfo?	636
DIAGnostic:SERvice:HWInfo?	636
DIAGnostic:SERvice:VERSinfo?	636
SYSTem:ERRor:CLEar:ALL	637
SYSTem:ERRor:EXTended?	637
SYSTem:ERRor:LIST?	638
SYSTem:ERRor[:NEXT]?	638
SYSTem:FIRMware:UPDate	639
SYSTem:FORMat:IDENT	639
SYSTem:PRESet:COMPAtible	639
SYSTem:PRESet:FILTer	640
SYSTem:SECurity[:STATe]	640

DIAGnostic:INFO:CCOunt? <Relay>

This command queries how many switching cycles the individual relays have performed since they were installed.

Query parameters:

<Relay> See table below for an overview of supported parameters.

Return values:

<Cycles> Number of switching cycles.

Example: DIAG:INFO:CCO? CAL

Usage: Query only

Manual operation: See "Relays Cycle Counter" on page 335

SCPI parameter	Hardware component
ACDC	AC/DC coupling
ATT5	Mechanical attenuation 5 dB
ATT10	Mechanical attenuation 10 dB
ATT20	Mechanical attenuation 20 dB
ATT40	Mechanical attenuation 40 dB
CAL	Calibration source

SCPI parameter	Hardware component
EATT	Electronic attenuation
PREamp	Preamplifier
SATT10	Signal Source: Mechanical attenuation 10 dB
SATT20	Signal Source: Mechanical attenuation 20 dB
SATT40	Signal Source: Mechanical attenuation 40 dB
SCAL	Signal Source: Calibration source

DIAGnostic:SERVice:BIOSinfo?

This command queries the BIOS version of the CPU board.

Return values:

<BiosInformation> String containing the BIOS version.

Example:

```
DIAG:SERV:BIOS?
Returns the BIOS version.
```

Usage:

Query only

DIAGnostic:SERVice:HWInfo?

This command queries hardware information.

Return values:

<Hardware> String containing the following information for every hardware component.

- <component>: name of the hardware component
- <serial#>: serial number of the component
- <order#>: order number of the component
- <model>: model of the component
- <code>: code of the component
- <revision>: revision of the component
- <subrevision>: subrevision of the component

Example:

```
DIAG:SERV:HWInfo?
Queries the hardware information.
"FRONTEND|100001/003|1300.3009|03|01|00|00",
"MOTHERBOARD|123456/002|1300.3080|02|00|00|00",
...
```

Usage:

Query only

DIAGnostic:SERVice:VERSinfo?

This command queries information about the hardware and software components.

Return values:

<Information>

String containing the version of hardware and software components including the types of licenses for installed options.

Example:

```
DIAG:SERV:VERS?
```

Queries the version information.

Response:

```
Instrument Firmware |1.10,
BIOS |R&S ANALYZER BIOS V1.80-5-07-1 IPC11,
Image Version |1.6.0,
Device Installation Version |1.0.0,
PCIE-FPGA |13.06,
SA-FPGA |6.46,
MB-FPGA |2.1.3.0,
SYNTH-18G-FPGA |4.8.0.0,
SYNTH-18G-FPGA 2 |4.8.0.0,
REF-FPGA |3.4.0.0,
MWC-FPGA |3.4.0.0,
PNDIGIT-FPGA |0.46,
Data Sheet Version |01.00,
Time Control Management ||active,
Cross Correlation Measurements B60||,
Signal Source B64||,
80 MHz Analysis Bandwidth B80||permanent
```

Usage:

Query only

SYSTem:ERRor:CLEar:ALL

This command deletes all contents of the "System Messages" table.

Example:

```
SYST:ERR:CLE:ALL
```

SYSTem:ERRor:EXTended? <MessageType>[, <ChannelName>]

This command queries all system messages, or all messages of a defined type, displayed in the status bar for a specific channel (application).

Note: This command queries the strings displayed for manual operation. For remote programs, do not define processing steps depending on these results. Instead, query the results of the `STATUS:QUESTIONable:EXTended:INFO` status register, which indicates whether messages of a certain type have occurred (see [Chapter 13.2.2.8, "STATUS:QUESTIONable:EXTended:INFO register"](#), on page 348).

Parameters:

<MessageType>

ALL | INFO | WARNING | FATal | ERRor | MESSAge

<ChannelName>

String containing the name of the channel.

The parameter is optional. If you omit it, the command works for the currently active channel.

Return values:

<Messages> String containing all messages of the selected type for the specified channel. Each message is separated by a comma and inserted in parentheses. If no messages are available, empty parentheses are returned.

Example:

```
SYST:ERR:EXT? ALL
```

Returns all messages for the currently active application, e.g. "Message 1", "Message 2".

Example:

```
SYST:ERR:EXT? FAT, 'Spectrum2'
```

Queries fatal errors in the 'Spectrum2' application. If none have occurred, the result is: " ".

Usage:

Query only

SYSTem:ERRor:LIST? [<MessType>]

This command queries the error messages that occur during R&S FSWP operation.

Query parameters:

<MessType> SMSG | REMote

SMSG

(default) Queries the system messages which occurred during manual operation.

REMote

Queries the error messages that occurred during remote operation.

Note: The remote error list is automatically cleared when the R&S FSWP is shut down.

Return values:

<SystemMessages> String containing all messages in the "System Messages" table.

<RemoteErrors> <Error_no> | <Description> | <Command> | <Date> | <Time>
Comma-separated list of errors from the "Remote Errors" table, where:
<Error_no>: device-specific error code
<Description>: brief description of the error
<Command>: remote command causing the error
<Date> | <Time>: date and time the error occurred

Usage:

Query only

SYSTem:ERRor[:NEXT]?

This command queries the most recent error queue entry and deletes it.

Positive error numbers indicate device-specific errors, negative error numbers are error messages defined by SCPI. If the error queue is empty, the error number 0, "No error", is returned.

For details on error queues see [Chapter 13.2, "Status reporting system"](#), on page 341.

Usage: Query only

SYSTem:FIRMware:UPDate <Directory>

This command starts a firmware update using the *.msi files in the selected directory. The default path is D:\FW_UPDATE. The path is changed via the [MMEMemory:COMMENT](#) command. To store the update files the [MMEMemory:DATA](#) command is used.

Only user accounts with administrator rights can perform a firmware update.

Setting parameters:

<Directory>

Example: `SYST:FIRM:UPD 'D:\FW_UPDATE'`
Starts the firmware update from directory "D:\FW_UPDATE".

SYSTem:FORMat:IDENt <IDNFormat>

This command selects the response format to the *IDN? query.

Parameters:

<IDNFormat>

LEGacy

Format is compatible to R&S FSP/FSU/FSQ/FSG family.

NEW | FSL

R&S FSWP format

Format is also compatible to the R&S FSL and R&S FSV family

*RST: not reset!

Example: `SYST:FORM:IDEN LEG`
Adapts the return value of *IDN? to the R&S FSP/FSU/FSQ family.

Manual operation: See ["*IDN Format"](#) on page 374

SYSTem:PRESet:COMPAtible <OpMode>

Defines the operating mode that is activated when you switch on the R&S FSWP or press [PRESET].

Parameters:

<OpMode>

SANalyzer

Defines Signal and Spectrum Analyzer operating mode as the presetting.

OFF

Selects the phase noise application as the default application (default value).

Manual operation: See ["Preset Mode"](#) on page 326

SYSTem:PRESet:FILTer <FilterType>

This command selects the resolution filter type that is selected after a preset in the Spectrum application.

Parameters:

<FilterType> **NORMal**
Selects 3 dB filter.

NOISe
Selects 3 dB filter.
(NORMal and NOISe have the same effect.)

PULSe
Selects 6 dB filter.

*RST: NORMal

Example: //Select the 6 dB filters as the default filter type
SYST:PRESet:FILT PULS

SYSTem:SECurity[:STATE] <State>

Activates or queries secure user mode.

Note: Before you activate secure user mode, store any instrument settings that are required beyond the current session, such as predefined instrument settings, transducer files, or self-alignment data.

Note: Initially after installation of the R&S FSWP-K33 option, secure user mode must be enabled manually once before remote control is possible. This is necessary to prompt for a change of passwords.

For details on the secure user mode see [Chapter 11.2, "Protecting data using the secure user mode"](#), on page 263.

Parameters:

<State> ON | OFF | 0 | 1

ON | 1
The R&S FSWP automatically reboots and starts in secure user mode. In secure user mode, no data is written to the instrument's internal solid-state drive. Data that the R&S FSWP normally stores on the solid-state drive is redirected to SDRAM.

OFF | 0
The R&S FSWP is set to normal instrument mode. Data is stored to the internal solid-state drive.
Note: this parameter is for query only. Secure user mode cannot be deactivated via remote operation.

*RST: 0

Manual operation: See "[SecureUser Mode](#)" on page 326

14.9.8 Using service functions

DIAGnostic:SERVice:SFUNction.....	641
DIAGnostic:SERVice:SFUNction:LASTresult?.....	641
DIAGnostic:SERVice:SFUNction:RESults:DELeTe.....	642
DIAGnostic:SERVice:SFUNction:RESults:SAVE.....	642
DIAGnostic:SERVice:SINFo?.....	642
DIAGnostic:SERVice:CALibration:DATE.....	643
DIAGnostic:SERVice:CALibration:DUE:DATE.....	643
DIAGnostic:SERVice:CALibration:INTerval?.....	643
DIAGnostic:SERVice:DATE.....	644
SYSTem:PASSword:RESet.....	644
SYSTem:PASSword[:CENable].....	644

DIAGnostic:SERVice:SFUNction <ServiceFunction>

DIAGnostic:SERVice:SFUNction? <ServiceFunction>

This command starts a service function.

The service functions are available after you have entered the level 1 or level 2 system password.

Parameters for setting and query:

<ServiceFunction> String containing the ID of the service function.
 The ID of the service function is made up out of five numbers, separated by a point.

- function group number
- board number
- function number
- parameter 1 (see the Service Manual)
- parameter 2 (see the Service Manual)

Return values:

<Result>

Example:

```
DIAG:SERV:SFUN 'Function1'
DIAG:SERV:SFUN? 'Function2'
```

Manual operation: See "[Service Function](#)" on page 333
 See "[Send](#)" on page 333

DIAGnostic:SERVice:SFUNction:LASTresult?

This command queries the results of the most recent service function you have used.

Return values:

<Result>

Usage: Query only

DIAGnostic:SERvice:SFUNction:RESults:DELeTe

This command deletes the results in the output buffer for service functions you have used.

Usage: Event

Manual operation: See "[Clear Results](#)" on page 334

DIAGnostic:SERvice:SFUNction:RESults:SAVE [<FileName>]

This command saves the results in the output buffer for service functions you have used to a file.

If no <FileName> parameter is provided, the results are stored to C:\R_S\INSTR\results\ServiceLog.txt.

Note that if the buffer is empty, the function returns an error.

Parameters:

<FileName> String containing the path and file name.

Manual operation: See "[Save Results](#)" on page 334

DIAGnostic:SERvice:SIInfo?

This command creates a *.zip file with important support information. The *.zip file contains the system configuration information ("device footprint"), the current eeprom data and a screenshot of the screen display (if available).

This data is stored to the C:\R_S\INSTR\USER directory on the instrument.

As a result of this command, the created file name (including the drive and path) is returned.

You can use the resulting file name information as a parameter for the `MMEM:COPY` command to store the file on the controller PC.

(See [MMEMory:COPY](#) on page 580)

If you contact the Rohde & Schwarz support to get help for a certain problem, send this file to the support in order to identify and solve the problem faster.

Return values:

<FileName> C:\R_S\INSTR\USER
 \<R&S Device ID>_<CurrentDate>_<CurrentTime>
 String containing the drive, path and file name of the created support file, where the file name consists of the following elements:
<R&S Device ID>: The unique R&S device ID indicated in the "Versions + Options" information
<CurrentDate>: The date on which the file is created (<YYYYMMDD>)

<CurrentTime>: The time at which the file is created
(<HHMMSS>)

Example:

```
DIAG:SERV:SINF?
```

Result:

```
"C:
```

```
\R_S\INSTR\USER\FSWP26_1322.8003K26-100005-xx_20210420_113
```

```
MMEM:COPY "C:\R_S\INSTR\USER\FSWP26_1322.8003K26-100005-xx_20210420_11365
```

```
"S:\Debug\C:\R_S\INSTR\USER\FSWP26_1322.8003K26-100005-xx_20210420_113652
```

Usage:

Query only

Manual operation:

See "[Create R&S Support Information](#)" on page 329

DIAGnostic:SERvice:CALibration:DATE <CalibrationDate>

Defines last date and time the instrument was calibrated in ISO 8601 format.

Parameters:

<CalibrationDate> String containing calibration date of the instrument.

Example:

```
//Set calibration date
```

```
DIAG:SERV:CAL:DATE "2019-05-05T00:00:00Z"
```

Manual operation:

See "[Last Calibration Date](#)" on page 330

DIAGnostic:SERvice:CALibration:DUE:DATE <DueDate>

Defines next date and time the instrument needs calibration to be done in ISO 8601 format. The response may be empty in case of no fixed next calibration due.

Parameters:

<DueDate> String containing next calibration due date.
An empty string resets the date (= no due date).

Example:

```
//Set calibration due date
```

```
DIAG:SERV:CAL:DUE:DATE "2020-05-12T00:00:00Z"
```

Manual operation:

See "[Next Calibration Due](#)" on page 330

DIAGnostic:SERvice:CALibration:INTERval?

This command queries the recommended calibration interval (ISO 8601 duration).

Return values:

<Interval> String containing the recommended calibration interval.

Example:

```
//Query calibration interval
```

```
DIAG:SERV:CAL:INT?
```

```
//would return, for example (one year interval)
```

```
P1Y
```

Usage:

Query only

Manual operation:

See "[Next Calibration Due](#)" on page 330

DIAGnostic:SERvice:DATE <ServiceDate>

Defines the last date and time the instrument was serviced (ISO 8601 format).

Parameters:

<ServiceDate> String containing last service date.

Example:

```
//Return last service date
DIAG:SERV:DATE?
```

Manual operation: See "[Last Service Date](#)" on page 329

SYSTem:PASSword:RESet

Clears any previously provided password and returns to the most restrictive service level.

Manual operation: See "[Password](#)" on page 334

SYSTem:PASSword[:CENable] <arg0>

Provides a password for subsequent service functions.

Parameters:

<arg0> string

Example:

```
SYST:PASS:CEN '894129'
```

Manual operation: See "[Password](#)" on page 334

14.9.9 Reference: Command Set of 5052 Emulation

CALCulate:PN{xch}:DATA:CARRier
CALCulate:PN{xch}:TRACe{trc}:BDMarker:X:START
CALCulate:PN{xch}:TRACe{trc}:BDMarker:X:STATe
CALCulate:PN{xch}:TRACe{trc}:BDMarker:X:STOP
CALCulate:PN{xch}:TRACe{trc}:FUNCTion:INTegral:DATA
CALCulate:PN{xch}:TRACe{trc}:FUNCTion:DOMain:X
CALCulate:PN{xch}:TRACe{trc}:FUNCTion:DOMain:Y
CALCulate:PN{xch}:TRACe{trc}:FUNCTion:TYPE
CALCulate:PN{xch}:TRACe{trc}:LIMit:FAIL
CALCulate:PN{xch}:TRACe{trc}:LIMit:LOWer:SEGMENT:CLEar
CALCulate:PN{xch}:TRACe{trc}:LIMit:LOWer:SEGMENT:COUNT
CALCulate:PN{xch}:TRACe{trc}:LIMit:LOWer:SEGMENT:DATA

CALCulate:PN{xch}:TRACe{trc}:LIMit:STATe
CALCulate:PN{xch}:TRACe{trc}:LIMit:UPPer:SEGMENT:CLEar
CALCulate:PN{xch}:TRACe{trc}:LIMit:UPPer:SEGMENT:COUNT
CALCulate:PN{xch}:TRACe{trc}:LIMit:UPPer:SEGMENT:DATA
CALCulate:PN{xch}:TRACe{trc}:MARKer{mk}:SEARch:EXECute:LPEak
CALCulate:PN{xch}:TRACe{trc}:MARKer{mk}:SEARch:EXECute:MAXimum
CALCulate:PN{xch}:TRACe{trc}:MARKer{mk}:SEARch:EXECute:MINimum
CALCulate:PN{xch}:TRACe{trc}:MARKer{mk}:SEARch:EXECute:PEAK
CALCulate:PN{xch}:TRACe{trc}:MARKer{mk}:SEARch:EXECute:RPEak
CALCulate:PN{xch}:TRACe{trc}:MARKer{mk}:SEARch:PEAK:EXCursion
CALCulate:PN{xch}:TRACe{trc}:MARKer{mk}:STATe
CALCulate:PN{xch}:TRACe{trc}:MARKer{mk}:X
CALCulate:PN{xch}:TRACe{trc}:MARKer{mk}:Y
CALCulate:PN{xch}:TRACe{trc}:SMOothing:APERture
CALCulate:PN{xch}:TRACe{trc}:SMOothing:STATe
CALCulate:PN{xch}:TRACe{trc}:SPURious:OMISSion
CALCulate:PN{xch}:TRACe{trc}:SPURious:POWer
DISPlay:MAXimize
DISPlay:PN{xch}:MAXimize
DISPlay:PN{xch}:STATe
DISPlay:WINDow:ACTive
INITiate:PN{xch}:CONTinuous
INITiate:PN{xch}:IMMediate
[SENSe]:ATTenuation:LEVel
[SENSe]:PN{xch}:ASET
[SENSe]:PN{xch}:AVERage:CLEar
[SENSe]:PN{xch}:AVERage:STATe
[SENSe]:PN{xch}:AVERage:COUNT
[SENSe]:PN{xch}:CORRelation:COUNT
[SENSe]:PN{xch}:CRANge
[SENSe]:PN{xch}:FBANd
[SENSe]:PN{xch}:FREQuency:START
[SENSe]:PN{xch}:FREQuency:STOP
[SENSe]:PN{xch}:IFGain

[SENSe]:PN{xch}:LOBandwidth
[SENSe]:PN{xch}:ROSCillator:BANDwidth
[SENSe]:PN{xch}:ROSCillator:REFerence{ref}:SOURce
[SENSe]:PN{xch}:SEGTable:MEASurement:QUALity
[SENSe]:PN{xch}:SWEep:POINts
TRIGger:AVERage
TRIGger:MODE
TRIGger:PN:SOURce
TRIGger:SOPC

14.9.10 Reference: command set of emulated PSA models

The R&S FSWP analyzer family supports a subset of the GPIB commands of PSA89600 instruments.

Despite the differences in system architecture and device features, the supported commands have been implemented in a way to ensure a sufficiently high degree of correspondence with the original.

In many cases the selection of commands supported by the R&S FSWP is sufficient to run an existing GPIB program without adaptation.

Supported 89600 commands
*CAL?
*CLS
*ESE
*ESR?
*IDN?
*IST?
*OPC
*OPT?
*PCB
*PRE
*PSC
*RST
*SRE
*STB?
*TRG

Supported 89600 commands
*TST?
*WAI
:CALibration:AUTO OFF ON ALERT
:CALibration:TCORrections AUTO ON OFF
:CONFigure:WAVEform
:DIAGnostic:EABY ON OFF
:DIAGnostic:LATCh:VALue <numeric>
:DIAGnostic:LATCh:SElect <string>
:DISPlay:ANNotation:TITLe:DATA <string>
:DISPlay:ENABle OFF ON
:DISPlay:WINDow:TRACe:Y:[SCALe]:PDIVision <numeric>
:DISPlay:WINDow:TRACe:Y:[SCALe]:RLEVel <numeric>
:DISPlay:WINDow:TRACe:Y:[SCALe]:RLEVel:OFFSet <numeric>
:DISPlay:WINDow:TRACe:Y:[SCALe]:SPACing LINear LOGarithmic LDB
:FORMat:BORDER NORMAl SWAPped
:FORMat[:DATA] ASCii REAL UINT MATLAB,<numeric>
:INITiate:CONTInuous OFF ON
:INITiate[:IMMediate]
:INSTrument:CATalog?
:INSTrument:NSElect <numeric>
:MMEMory:CATalog? <dir_name>
:MMEMory:COpy <'file_name1'>,<'file_name2'>
:MMEMory:DATA <'file_name'>,<definite_length_block>
:MMEMory:DELeTe <'file_name'>
:MMEMory:LOAD:STATe 1,<'file_name'>
:MMEMory:LOAD:TRACe 1,<'file_name'>
:MMEMory:MDIRectory <'dir_name'>
:MMEMory:MOVE <'file_name1'>,<'file_name2'>
:MMEMory:STORE:STATe 1,<'file_name'>
:MMEMory:STORE:TRACe <numeric>,<'file_name'>
:READ:WAVform?
[:SENSe]:CORRection:CSET:AlI[STATe] <boolean>
[:SENSe]:FREQuency:CENTer <numeric>

Supported 89600 commands
[.SENSe]:FREQuency:STARt <numeric>
[.SENSe]:FREQuency:STOP <numeric>
[.SENSe]:FREQuency:SPAN <numeric>
[.SENSe]:POWer:ATTenuation <numeric>
[.SENSe]:ROSCillator:EXTernal:FREQuency <numeric>
[.SENSe]:ROSCillator:OUTPut OFF ON
[.SENSe]:ROSCillator:SOURce INTernal EXTernal EAUto
[.SENSe]:SPECtrum:TRIGger:SOURce EXTernal<1 2> IF IMMediate
[.SENSe]:WAVeform:ADC:RANGe P6
[.SENSe]:WAVeform:APER?
[.SENSe]:WAVeform:AVERage:TACount <numeric>
[.SENSe]:WAVeform:BWIDth:ACTive?
[.SENSe]:WAVeform:BWIDth:TYPE FLAT GAUSSian
[.SENSe]:WAVeform:IFGain <numeric>
[.SENSe]:WAVeform:IFPath NARRow WIDE
[.SENSe]:WAVeform:NCPTTrace ON OFF
[.SENSe]:WAVeform:PDIT ON OFF
[.SENSe]:WAVeform:SRATe <numeric>
[.SENSe]:WAVeform:SWEep:TIME <numeric>
[.SENSe]:WAVeform:TRIGger:EOFFset?
[.SENSe]:WAVeform:TRIGger:INTerpolation ON OFF
[.SENSe]:WAVeform:TRIGger:SOURce EXTernal<1 2> IF IMMediate
:STATus:QUEStionable:CONDition?
:STATus:QUEStionable:ENABle <number>
:STATus:QUEStionable:NTRansition <number>
:STATus:QUEStionable:PTRansition <number>
:STATus:QUEStionable[:EVENT]?
:STATus:QUEStionable:CALibration:CONDition?
:STATus:QUEStionable:CALibration:ENABle <number>
:STATus:QUEStionable:CALibration:NTRansition <number>
:STATus:QUEStionable:CALibration:PTRansition <number>
:STATus:QUEStionable:CALibration[:EVENT]?
:STATus:QUEStionable:FREQuency:CONDition?

Supported 89600 commands
:STATus:QUESTionable:FREQuency:ENABle <number>
:STATus:QUESTionable:FREQuency:NTRansition <number>
:STATus:QUESTionable:FREQuency:PTRansition <number>
:STATus:QUESTionable:FREQuency[:EVENT]?
:STATus:QUESTionable:INTegrity:CONDition?
:STATus:QUESTionable:INTegrity:ENABle <number>
:STATus:QUESTionable:INTegrity:NTRansition <number>
:STATus:QUESTionable:INTegrity:PTRansition <number>
:STATus:QUESTionable:INTegrity[:EVENT]?
:STATus:OPERation:CONDition?
:STATus:OPERation:ENABle <integer>
:STATus:OPERation:NTRansition <integer>
:STATus:OPERation:PTRansition <integer>
:STATus:OPERation[:EVENT]?
:SYSTem:COMMunicate:GPIB[:SELF]:ADDRess <integer>
:SYSTem:DATE <year>,<month>,<day>
:SYSTem:ERRor[:NEXT]?
:SYSTem:KLOCK?
:SYSTem:MESSage <string>
:SYSTem:PRESet
:SYSTem:TIME <hour>,<minute>,<second>
:SYSTem:VERSion?
:TRACe:COPY <src_trace>,<dest_trace>
:TRACe[:DATA] TRACE1 TRACE2 TRACE3 TRACE4 TRACE5 TRACE6, <definite_length_block> <comma_separated_ASCII_data>
:TRACe:MODE WRITe MAXHold MINHold VIEW BLANK
:TRIGger[:SEQuence]:DELay <numeric>
:TRIGger[:SEQuence]:DELay:STATe OFF ON 0 1
:TRIGger[:SEQuence]:EXTerMal:DELay <numeric>
:TRIGger[:SEQuence]:EXTerMal:LEVel <numeric>
:TRIGger[:SEQuence]:EXTerMal:SLOPe POSitive NEGative
:TRIGger[:SEQuence]:HOLDoff <numeric>
:TRIGger[:SEQuence]:IF:DELay <numeric>
:TRIGger[:SEQuence]:IF:LEVel <numeric>

Supported 89600 commands
:TRIGger[:SEquence]:IF:SLOPe POSitive NEGative
:TRIGger[:SEquence]:SLOPe POSitive NEGative
:TRIGger[:SEquence]:SOURce IMMEDIATE VIDeo EXTernal<1 2>
:TRIGger[:SEquence]:VIDeo:LEVel <numeric>
:TRIGger[:SEquence]:VIDeo:LEVel:FREQuency <freq>

14.10 Recording SCPI Commands Automatically

Using the SCPI Recorder functions, you can create a SCPI script directly on the instrument and then export the script for use on the controller.

See also [Chapter 13.5, "Automating tasks with remote command scripts"](#), on page 357.

SYSTem:SREcorder[:AUTO]	650
SYSTem:SREcorder:CLear	651
SYSTem:SREcorder:DATA[:ALL]?	651
SYSTem:SREcorder:EXPort	653
SYSTem:SREcorder:FORMat	654
SYSTem:SREcorder:SYNC	654

SYSTem:SREcorder[:AUTO] <State>

If enabled, the SCPI Recorder automatically records the required SCPI commands and parameter values for the settings and functions you use while operating the R&S FSWP.

See [Chapter 13.5, "Automating tasks with remote command scripts"](#), on page 357.

Parameters:

<State>	ON OFF 0 1
	OFF 0
	Switches the function off
	ON 1
	Switches the function on
*RST:	0

Example:

```
//Enable automatic recording
SYST:SREC:AUTO ON
//Include synchronization commands
SYST:SREC:SYNC ON
//Perform measurement task to record required commands
//...
//Display recorded commands
SYST:REC:DATA?
//Store commands to a file in python format
SYST:SREC:EXP PYTH, 'C:\TEMP\SCPI_EXAMPLE.py'
//Clear currently recorded commands
SYST:SREC:CLE
```

Manual operation: See ["Auto Recording"](#) on page 360

SYSTem:SREOrder:CLEar

Removes all recorded commands from the current SCPI command list.

Usage: Event

Manual operation: See ["Clear All"](#) on page 363

SYSTem:SREOrder:DATA[:ALL]?

Returns the currently recorded commands.

Return values:

<Result>	string
	String containing the complete SCPI recording. Each individual command is introduced by a "#" character.

Example: SYST:REC:DATA?

Usage: Query only

Manual operation: See ["List of recorded commands / script editor"](#) on page 361

Example:

Assume the following recorded commands:

```
*RST
*CLS
:SYST:DISP:UPD ON
:INIT:CONT OFF
:INST:CRE:NEW SANALYZER, 'Spectrum 2'
:INIT:CONT OFF
:CALC:MARK:FUNC:POW:SEL ACP
```

Result for SCPI format:

```

#*RST
#*CLS
#:SYST:DISP:UPD ON
#:INIT:CONT OFF
#:INST:CRE:NEW SANALYZER, 'Spectrum 2'
#:INIT:CONT OFF
#:CALC:MARK:FUNC:POW:SEL ACP

```

Result for PYTHon format:

```

# python script created by FSW: 24:08:2022 14:05:23
#import pyvisa as visa #def write_command(instrument, command) :
# instrument.write(command)
# return process_system_error(instrument)
#def write_query(instrument, command) :
# buffer = instrument.query(command)
# bSuccess = process_system_error(instrument)
# return bSuccess, buffer #def process_system_error(instrument) :
# bSuccess = True
# EsrErrorMask = 0x3C
# if ((get_esr(instrument) & EsrErrorMask) != 0) :
# print(instrument.query(":SYST:ERR?"))
# instrument.write("*CLS")
# bSuccess = False
# return bSuccess
#def get_esr(instrument) :
# esr = instrument.query("*ESR?")
# return int(esr)
#VisaResourceManager = visa.ResourceManager()
# connect to analyzer
#Analyzer = VisaResourceManager.open_resource("TCPIP::
10.111.0.161::inst0::INSTR")
#success = write_command( Analyzer, "*RST" )
#success = write_command( Analyzer, "*CLS" )
#success = write_command( Analyzer, ":SYST:DISP:UPD ON" )
#success = write_command( Analyzer, ":INIT:CONT OFF" )

```

```
#success = write_command( Analyzer, ":INST:CRE:NEW SANALYZER,
'Spectrum 2'" )

#success = write_command( Analyzer, ":INIT:CONT OFF" )

#success = write_command( Analyzer, ":CALC:MARK:FUNC:POW:SEL
ACP" )

# back to local mode

#success = write_command(Analyzer, "@LOC")

# cleanup #Analyzer.close()

#VisaResourceManager.close()
```

SYSTem:SREcorder:EXPort <Format>, <FileName>

Exports the current SCPI command list to the specified file and directory in the selected format. By default, the file is stored in the C:\R_S\INSTR\ScpiRecordings directory. Besides the recorded commands themselves, the exported script includes all format-specific header data required to execute the script using an external program on the controller.

Parameters:

<FileName> String containing the path and name of the file.

Setting parameters:

<Format> SCPI | PYTHon | MATLab | CPLusplus | CVI

CPLusplus

A commonly used general programming language for various applications (*.cpp)

MATLab (Instrument Control Toolbox)

A programming environment, frequently used in signal processing and test and measurement applications (*.m)

You can use this format directly with the MATLAB© Toolkit.

CVI

An ANSI C programming environment designed for measurements and tests (*.cvi)

You can use this format directly with National Instruments LabWindows CVI.

SCPI

Represents SCPI base format, that is ASCII format, saved as a text file (*.inp); contains no additional header data

Use this format to load a recorded script back to the editor later.

PYTHon

A commonly used general programming language for various applications (.py)

Example:

```
SYST:SREC:EXP PYTH, 'C:\TEMP\SCPI_EXAMPLE.py'
```

Usage:

Setting only

Manual operation: See "[Export](#)" on page 362

SYSTem:SREOrder:FORMat <Format>

Defines whether the commands are recorded using the short or long SCPI notation.

Parameters:

<Format>

SHORT | LONG

SHORT

The shortform of the keyword is used.

Example: `FREQ:CENT`

LONG

The entire keyword is used.

Example: `FREQuency:CENTer`

Manual operation: See "[Recording Format](#)" on page 366

SYSTem:SREOrder:SYNC <State>

If enabled, additional commands are included in the script to synchronize the recorded commands when necessary. For instance, when a measurement is started, a `*WAI` command is inserted to ensure that the next command is only executed after the measurement has finished.

Parameters:

<State>

ON | OFF | 0 | 1

OFF | 0

Switches the function off

ON | 1

Switches the function on

*RST: 0

Example: `SYST:SREC:SYNC ON`

Manual operation: See "[Add Synchronization Commands](#)" on page 365

14.11 Using the status register

For more information on the contents of the status registers see:

- [Remote control via SCPI](#)
- [Chapter 13.2.2.4, "STATUS:OPERation register"](#), on page 345
- [Chapter 13.2.2.6, "STATUS:QUESTionable:ACPLimit register"](#), on page 347
- [Chapter 13.2.2.7, "STATUS:QUESTionable:EXTended register"](#), on page 348
- [Chapter 13.2.2.9, "STATUS:QUESTionable:FREQuency register"](#), on page 349
- [Chapter 13.2.2.10, "STATUS:QUESTionable:LIMit register"](#), on page 350
- [Chapter 13.2.2.11, "STATUS:QUESTionable:LMARgin register"](#), on page 350

- Chapter 13.2.2.12, "STATus:QUEStionable:POWer register", on page 351
- Chapter 13.2.2.15, "STATus:QUEStionable:TEMPerature register", on page 353
- Chapter 13.2.2.16, "STATus:QUEStionable:TIME register", on page 353
- General status register commands..... 655
- Reading out the CONDition part..... 655
- Reading out the EVENt part..... 656
- Controlling the ENABle part..... 657
- Controlling the negative transition part..... 657
- Controlling the positive transition part..... 658

14.11.1 General status register commands

STATus:PRESet.....	655
STATus:QUEue[:NEXT]?	655

STATus:PRESet

Resets the edge detectors and ENABle parts of all registers to a defined value. All PTRansition parts are set to FFFFh, i.e. all transitions from 0 to 1 are detected. All NTRansition parts are set to 0, i.e. a transition from 1 to 0 in a CONDition bit is not detected. The ENABle part of the STATus:OPERation and STATus:QUEStionable registers are set to 0, i.e. all events in these registers are not passed on.

Usage: Event

STATus:QUEue[:NEXT]?

Queries the most recent error queue entry and deletes it.

Positive error numbers indicate device-specific errors, negative error numbers are error messages defined by SCPI. If the error queue is empty, the error number 0, "No error", is returned.

Is identical to the SYSTem:ERRor[:NEXT]? command.

Usage: Query only

14.11.2 Reading out the CONDition part

STATus:OPERation:CONDition?
 STATus:QUEStionable:CONDition?
 STATus:QUEStionable:ACPLimit:CONDition? <ChannelName>
 STATus:QUEStionable:EXTended:CONDition? <ChannelName>
 STATus:QUEStionable:EXTended:INFO:CONDition? <ChannelName>
 STATus:QUEStionable:FREQUENCY:CONDition? <ChannelName>
 STATus:QUEStionable:LIMit<n>:CONDition? <ChannelName>
 STATus:QUEStionable:LMARgin<n>:CONDition? <ChannelName>
 STATus:QUEStionable:PNOise:CONDition? <ChannelName>

STATus:QUESTionable:POWer:CONDition? <ChannelName>
STATus:QUESTionable:POWer:DCPNoise:CONDition? <ChannelName>
STATus:QUESTionable:TEMPerature:CONDition? <ChannelName>
STATus:QUESTionable:TIME:CONDition? <ChannelName>

These commands read out the CONDition section of the status register.

The commands do not delete the contents of the CONDition section.

Suffix:

<n> [Window](#)

Query parameters:

<ChannelName> String containing the name of the channel.
 The parameter is optional. If you omit it, the command works for the currently active channel.

Usage: Query only

14.11.3 Reading out the EVENT part

STATus:OPERation[:EVENT]?
STATus:QUESTionable[:EVENT]?
STATus:QUESTionable:ACPLimit[:EVENT]? <ChannelName>
STATus:QUESTionable:EXTended[:EVENT]? <ChannelName>
STATus:QUESTionable:EXTended:INFO[:EVENT]? <ChannelName>
STATus:QUESTionable:FREQuency[:EVENT]? <ChannelName>
STATus:QUESTionable:LIMit<n>[:EVENT]? <ChannelName>
STATus:QUESTionable:LMARgin<n>[:EVENT]? <ChannelName>
STATus:QUESTionable:PNOise[:EVENT]? <ChannelName>
STATus:QUESTionable:POWer[:EVENT]? <ChannelName>
STATus:QUESTionable:POWer:DCPNoise[:EVENT]? <ChannelName>
STATus:QUESTionable:TEMPerature[:EVENT]? <ChannelName>
STATus:QUESTionable:TIME[:EVENT]? <ChannelName>

These commands read out the EVENT section of the status register.

At the same time, the commands delete the contents of the EVENT section.

Suffix:

<n> [Window](#)

Query parameters:

<ChannelName> String containing the name of the channel.
 The parameter is optional. If you omit it, the command works for the currently active channel.

Usage: Query only

14.11.4 Controlling the ENABLE part

```

STATus:OPERation:ENABLE <SumBit>
STATus:QUESTionable:ENABLE <SumBit>
STATus:QUESTionable:ACPLimit:ENABLE <SumBit>,<ChannelName>
STATus:QUESTionable:EXTended:ENABLE <SumBit>,<ChannelName>
STATus:QUESTionable:EXTended:INFO:ENABLE <SumBit>,<ChannelName>
STATus:QUESTionable:FREQuency:ENABLE <SumBit>,<ChannelName>
STATus:QUESTionable:LIMit<n>:ENABLE <SumBit>,<ChannelName>
STATus:QUESTionable:LMARgin<n>:ENABLE <SumBit>,<ChannelName>
STATus:QUESTionable:PNOise:ENABLE <SumBit>,<ChannelName>
STATus:QUESTionable:POWER:ENABLE <SumBit>,<ChannelName>
STATus:QUESTionable:POWER:DCPNoise:ENABLE <SumBit>,<ChannelName>
STATus:QUESTionable:TEMPerature:ENABLE <SumBit>,<ChannelName>
STATus:QUESTionable:TIME:ENABLE <SumBit>,<ChannelName>

```

These commands control the ENABLE part of a register.

The ENABLE part allows true conditions in the EVENT part of the status register to be reported in the summary bit. If a bit is 1 in the enable register and its associated event bit transitions to true, a positive transition will occur in the summary bit reported to the next higher level.

Suffix:

<n> [Window](#)

Parameters:

<SumBit> Range: 0 to 65535

<ChannelName> String containing the name of the channel.
The parameter is optional. If you omit it, the command works for the currently active channel.

14.11.5 Controlling the negative transition part

```

STATus:OPERation:NTRansition <SumBit>
STATus:QUESTionable:NTRansition <SumBit>
STATus:QUESTionable:ACPLimit:NTRansition <SumBit>,<ChannelName>
STATus:QUESTionable:EXTended:NTRansition <SumBit>,<ChannelName>
STATus:QUESTionable:EXTended:INFO:NTRansition <SumBit>,<ChannelName>
STATus:QUESTionable:FREQuency:NTRansition <SumBit>,<ChannelName>
STATus:QUESTionable:LIMit<n>:NTRansition <SumBit>,<ChannelName>
STATus:QUESTionable:LMARgin<n>:NTRansition <SumBit>,<ChannelName>
STATus:QUESTionable:PNOise:NTRansition <SumBit>,<ChannelName>
STATus:QUESTionable:POWER:NTRansition <SumBit>,<ChannelName>
STATus:QUESTionable:POWER:DCPNoise:NTRansition <SumBit>,<ChannelName>
STATus:QUESTionable:TEMPerature:NTRansition <SumBit>,<ChannelName>
STATus:QUESTionable:TIME:NTRansition <SumBit>,<ChannelName>

```

These commands control the Negative TRansition part of a register.

Setting a bit causes a 1 to 0 transition in the corresponding bit of the associated register. The transition also writes a 1 into the associated bit of the corresponding EVENT register.

Suffix:

<n> [Window](#)

Parameters:

<SumBit> Range: 0 to 65535

<ChannelName> String containing the name of the channel.
The parameter is optional. If you omit it, the command works for the currently active channel.

14.11.6 Controlling the positive transition part

STATus:OPERation:PTRansition <SumBit>

STATus:QUESTionable:PTRansition <SumBit>

STATus:QUESTionable:ACPLimit:PTRansition <SumBit>,<ChannelName>

STATus:QUESTionable:EXTended:PTRansition <SumBit>,<ChannelName>

STATus:QUESTionable:EXTended:INFO:PTRansition <SumBit>,<ChannelName>

STATus:QUESTionable:FREQuency:PTRansition <SumBit>,<ChannelName>

STATus:QUESTionable:LIMit<n>:PTRansition <SumBit>,<ChannelName>

STATus:QUESTionable:LMARgin<n>:PTRansition <SumBit>,<ChannelName>

STATus:QUESTionable:PNOise:PTRansition <SumBit>,<ChannelName>

STATus:QUESTionable:POWER:PTRansition <SumBit>,<ChannelName>

STATus:QUESTionable:POWER:DCPNoise:PTRansition <SumBit>,<ChannelName>

STATus:QUESTionable:TEMPerature:PTRansition <SumBit>,<ChannelName>

STATus:QUESTionable:TIME:PTRansition <SumBit>,<ChannelName>

These commands control the Positive TRansition part of a register.

Setting a bit causes a 0 to 1 transition in the corresponding bit of the associated register. The transition also writes a 1 into the associated bit of the corresponding EVENT register.

Suffix:

<n> [Window](#)

Parameters:

<SumBit> Range: 0 to 65535

<ChannelName> String containing the name of the channel.
The parameter is optional. If you omit it, the command works for the currently active channel.

14.12 Programming examples

Some advanced programming examples for complex measurement tasks are provided here.

- [Service request](#)..... 659

14.12.1 Service request

The service request routine requires an extended initialization of the instrument in which the relevant bits of the transition and enable registers are set. In addition the service request event must be enabled in the VISA session.

14.12.1.1 Initiate service request

```

REM ---- Example of initialization of the SRQ in the case
' of errors -----
PUBLIC SUB SetupSRQ()
CALL InstrWrite (analyzer, "*CLS") 'Reset status reporting system
CALL InstrWrite (analyzer, "*SRE 168") 'Enable service request for
' STAT:OPER, STAT:QUES and ESR
' register
CALL InstrWrite (analyzer, "*ESE 60") 'Set event enable bit for
' command, execution, device-
' dependent and query error
CALL InstrWrite (analyzer, "STAT:OPER:ENAB 32767")
' Set OPERATION enable bit for
' all events
CALL InstrWrite (analyzer, "STAT:OPER:PTR 32767")
' Set appropriate OPERATION
' Ptransition bits
CALL InstrWrite (analyzer, "STAT:QUES:ENAB 32767")
' Set questionable enable bits
' for all events
CALL InstrWrite (analyzer, "STAT:QUES:PTR 32767")
' Set appropriate questionable
' Ptransition bits
CALL viEnableEvent(analyzer, VI_EVENT_SERVICE_REQ, VI_QUEUE, 0)
' Enable the event for service
' request
Status = viWaitOnEvent(analyzer, VI_EVENT_SERVICE_REQ, SRQWaitTimeout, VI_NULL,
VI_NULL)
IF (status = VI_SUCCESS) THEN CALL Srq
' If SRQ is recognized =>
' subroutine for evaluation
END SUB
REM *****

```

```

Private mbSession As MessageBasedSession

Sub Main()
    Console.WriteLine("Example of initialization _
                      of the SRQ in the case of errors.")
    Dim SRQWaitTimeout = 4000 ' Timeout As Integer for WaitOnEvent
    'Opening session
    Try
        'Analyzer is alias, instead of using resource string.
        'For example on TCP use TCPIP0::192.168.1.2::inst0::INSTR
        mbSession = CType(ResourceManager.GetLocalManager().Open("Analyzer"), _
                          MessageBasedSession)
        mbSession.TerminationCharacterEnabled = True
    Try
        mbSession.Write("*CLS") 'Reset status reporting system
        mbSession.Write("*SRE 168") 'Enable service request for
        'STAT:OPER, STAT:QUES and ESR register
        mbSession.Write("*ESE 60") 'Set event enable bit for
        'command, execution, device-dependent and query error
        mbSession.Write("STAT:OPER:ENAB 32767")
        'Set OPERation enable bit for all events
        mbSession.Write("STAT:OPER:PTR 32767")
        'Set appropriate OPERation Ptransition bits
        mbSession.Write("STAT:QUES:ENAB 32767")
        'Set questionable enable bits for all events
        mbSession.Write("STAT:QUES:PTR 32767")
        'Set appropriate questionable Ptransition bits
        Console.WriteLine("Wait on event - Blocking")
        mbSession.EnableEvent(MessageBasedSessionEventType.ServiceRequest, _
                              EventMechanism.Queue)

        'Enable the event for service request

        '-----
        ' Your command plase use here
        ' mbSession.Write("Your command")
        '-----

        Dim Status = mbSession.WaitOnEvent( _
            MessageBasedSessionEventType.ServiceRequest, SRQWaitTimeout)
        If (Status.EventType() = _
            MessageBasedSessionEventType.ServiceRequest) Then
            Console.WriteLine("SRQ is recognized")
            'If SRQ is recognized => subroutine for evaluation
            Srq()
        End If
    Catch exp As Exception
        Console.WriteLine(exp.Message)
    End Try
Catch exp As InvalidCastException
    Console.WriteLine("Resource selected must be a message-based session")

```

```

Catch exp As Exception
    Console.WriteLine(exp.Message)
End Try

' Close session
mbSession.Dispose()
' Wait for end
Console.WriteLine("Press any key to end")
Console.ReadKey()
End Sub

```

14.12.1.2 Waiting for the arrival of a service request

There are basically two methods of waiting for the arrival of a service request:

Blocking (user inputs not possible):

This method is appropriate if the waiting time until the event to be signaled by an SRQ is short (shorter than the selected timeout), if no response to user inputs is required during the waiting time, and if – as the main criterion – the event is absolutely certain to occur.

Reason:

From the time the `viWaitOnEvent()` function is called until the occurrence of the expected event, it does not allow the program to respond to mouse clicks or key entries during the waiting time. Moreover, it returns an error if the SRQ event does not occur within the predefined timeout period.

The method is, therefore, in many cases not suitable for waiting for measurement results, especially when using triggered measurements.

The following function calls are required:

```

Status = viWaitOnEvent(analyzer, VI_EVENT_SERVICE_REQ, SRQWaitTimeout, VI_NULL,
    VI_NULL)
'Wait for service request user
'inputs are not possible during
'the waiting time!
IF (status = VI_SUCCESS) THEN CALL Srq
'If SRQ is recognized =>
'subroutine for evaluation

'----- Sweep in first Spectrum Tab and query marker -----
Dim Status = mbSession.WaitOnEvent( _
MessageBasedSessionEventType.ServiceRequest, SRQWaitTimeout)
'Wait for service request user inputs are not possible
'during the waiting time!
If (Status.EventType() = MessageBasedSessionEventType.ServiceRequest) Then
'If SRQ is recognized => subroutine for evaluation
    Srq()
End If

```

Non-blocking (user inputs possible):

This method is recommended if the waiting time until the event to be signaled by an SRQ is long (longer than the selected timeout), and user inputs should be possible during the waiting time, or if the event is not certain to occur. This method is, therefore, the preferable choice for waiting for the end of measurements, i.e. the output of results, especially in the case of triggered measurements.

The method necessitates a waiting loop that checks the status of the SRQ line at regular intervals and returns control to the operating system during the time the expected event has not yet occurred. In this way, the system can respond to user inputs (mouse clicks, key entries) during the waiting time.

It is advisable to employ the Hold() auxiliary function, which returns control to the operating system for a selectable waiting time (see section [Waiting without blocking the keyboard and mouse](#)), so enabling user inputs during the waiting time.

```

result% = 0
For i = 1 To 10 'Abort after max. 10 loop
'iterations
Status = viWaitOnEvent(analyzer, VI_EVENT_SERVICE_REQ, VI_TMO_IMMEDIATE, VI_NULL,
VI_NULL)
'Check event queue
If (status = VI_SUCCESS) Then
result% = 1
CALL Srq 'If SRQ is recognized =>
'subroutine for evaluation
Else
CALL Hold(20) 'Call hold function with
'20 ms 'waiting time. User inputs
'are possible.
Endif
Next i
If result% = 0 Then
Debug.Print "Timeout Error; Program aborted" 'Output error message
STOP 'Stop software
Endif

```

14.12.1.3 Waiting without blocking the keyboard and mouse

A frequent problem with remote control programs using Visual Basic is to insert waiting times without blocking the keyboard and the mouse.

If the program is to respond to user inputs also during a waiting time, control over the program events during this time must be returned to the operating system. In Visual Basic, this is done by calling the DoEvents function. This function causes keyboard-or mouse-triggered events to be executed by the associated elements. For example, it allows the operation of buttons and input fields while the user waits for an instrument setting to be completed.

The following programming example describes the `Hold()` function, which returns control to the operating system for the period of the waiting time selectable in milliseconds.

```

Rem *****
Rem The waiting function below expects the transfer of the desired
Rem waiting time in milliseconds. The keyboard and the mouse remain
Rem operative during the waiting period, thus allowing desired elements
Rem to be controlled
Rem *****
Public Sub Hold(delayTime As Single)
Start = Timer 'Save timer count on calling the
'function
Do While Timer < Start + delayTime/1000 'Check timer count
DoEvents 'Return control to operating
'system to enable control of
'desired elements as long as
'timer has not elapsed
Loop
End Sub
Rem *****

```

The waiting procedure is activated simply by calling `Hold(<Waiting time in milliseconds>)`.

14.12.1.4 Service request routine

A service request is processed in the service request routine.



The variables `userN%` and `userM%` must be pre-assigned usefully!

```

REM ----- Service request routine -----
Public SUB Srq()
ON ERROR GOTO noDevice 'No user existing
CALL viReadSTB(analyzer, STB%) 'Serial poll, read status byte
IF STB% > 0 THEN 'This instrument has bits set in
'the STB
SRQFOUND% = 1
IF (STB% AND 16) > 0 THEN CALL Outputqueue
IF (STB% AND 4) > 0 THEN CALL ErrorQueueHandler
IF (STB% AND 8) > 0 THEN CALL Questionablestatus
IF (STB% AND 128) > 0 THEN CALL Operationstatus
IF (STB% AND 32) > 0 THEN CALL Esrread
END IF
noDevice:
END SUB 'End of SRQ routine
REM *****

```

```

REM ----- Subroutine for evaluation Service Request Routine -----

Public Sub Srq()
    Try
        Dim mySTB As Short = mbSession.ReadStatusByte()
                                'Serial poll, read status byte
        Console.WriteLine("Reading Service Request Routine:" + mySTB.ToString())
        If mySTB > 0 Then 'This instrument has bits set in the STB
            If (mySTB And 16) > 0 Then Call Outputqueue()
            If (mySTB And 4) > 0 Then Call ErrorQueueHandler()
            If (mySTB And 8) > 0 Then Call Questionablestatus()
            If (mySTB And 128) > 0 Then Call Operationstatus()
            If (mySTB And 32) > 0 Then Call Esrread()
        End If
    Catch exp As Exception
        Console.WriteLine(exp.Message)
    End Try
End Sub 'End of SRQ routine

```

Reading out the status event registers, the output buffer and the error/event queue is effected in subroutines.

14.12.1.5 Reading out the output buffer

```

REM ----- Subroutine for the individual STB bits -----
Public SUB Outputqueue() 'Reading the output buffer
result$ = SPACE$(100) 'Make space for response
CALL InstrRead(analyzer, result$)
Debug.Print "Contents of Output Queue:"; result$
END SUB
REM *****

REM ----- Subroutine for the output queue -----
Public Sub Outputqueue() 'Reading the output buffer
    Try
        Dim result As String = mbSession.ReadString()
        Console.WriteLine("Contents of Output Queue:" + result)
    Catch exp As Exception
        Console.WriteLine(exp.Message)
    End Try
End Sub

```

14.12.1.6 Reading error messages

```

REM ----- Subroutine for reading the error queue -----
Public SUB ErrorQueueHandler()
ERROR$ = SPACE$(100) 'Make space for error variable
CALL InstrWrite (analyzer, "SYSTEM:ERROR?")
CALL InstrRead(analyzer, ERROR$)
Debug.Print "Error Description:"; ERROR$

```



```

END SUB
REM *****
REM ----- Subroutine for reading the error queue -----
Sub ErrorQueueHandler()
    Dim result As String
    Dim hasErr As Boolean = True
    Do
        mbSession.Write("SYST:ERR?")
        result = mbSession.ReadString()
        Dim parts As String() = result.Split(",")
        If parts(0) = 0 Then
            hasErr = False
            Console.WriteLine(result)
        Else
            Console.WriteLine(result)
        End If
    Loop While hasErr
End Sub

```

14.12.1.7 Evaluation of SCPI status registers

```

REM ----- Subroutine for evaluating Questionable Status Register -----
Public SUB Questionablestatus()
    Ques$ = SPACE$(20)
    'Preallocate blanks to text
    'variable
    CALL InstrWrite (analyzer, "STATus:QUESTionable:EVENT?")
    CALL InstrRead(analyzer, Ques$)
    Debug.Print "Questionable Status: "; Ques$
END SUB
REM *****
REM ----- Subroutine for evaluating Operation Status Register -----
Public SUB Operationstatus()
    Oper$ = SPACE$(20) 'Preallocate blanks to text
    'variable
    CALL InstrWrite (analyzer, "STATus:OPERation:EVENT?")
    CALL InstrRead(analyzer, Oper$)
    Debug.Print "Operation Status: "; Oper$
END SUB
REM *****
REM ----- Subroutine for evaluating Questionable Status Register -----
Public Sub Questionablestatus()
    Dim myQSR As String = Nothing
    Try
        myQSR = mbSession.Query("STATus:QUESTionable:EVENT?") 'Read QSR
        Console.WriteLine("Questionable Status:" + myQSR)
    Catch exp As Exception
        Console.WriteLine(exp.Message)
    End Try
End Sub

```

```

        End Try
    End Sub

    REM ----- Subroutine for evaluating Operation Status Register -----
    Public Sub Operationstatus()
        Dim myOSR As String = Nothing
        Try
            myOSR = mbSession.Query("STATUS:OPERation:EVENT?") 'Read OSR
            Console.WriteLine("Operation Status:" + myOSR)
        Catch exp As Exception
            Console.WriteLine(exp.Message)
        End Try
    End Sub

```

14.12.1.8 Evaluation of event status register

```

    REM ----- Subroutine for evaluating the Event Status Register -----
    Public SUB Esrread()
    Esr$ = SPACE$(20) 'Preallocate blanks to text
    'variable
    CALL InstrWrite (analyzer, "*ESR?") 'Read ESR
    CALL InstrRead(analyzer, Esr$)
    IF (VAL(Esr$) AND 1) > 0 THEN Debug.Print "Operation complete"
    IF (VAL(Esr$) AND 2) > 0 THEN Debug.Print "Request Control"
    IF (VAL(Esr$) AND 4) > 0
    THEN Debug.Print "Query Error"
    IF (VAL(Esr$) AND 8) > 0
    THEN Debug.Print "Device dependent error"
    IF (VAL(Esr$) AND 16) > 0
    THEN Debug.Print "Execution Error; Program aborted" 'Output error message
    STOP 'Stop software
    END IF
    IF (VAL(Esr$) AND 32) > 0
    THEN Debug.Print "Command Error; Program aborted" 'Output error message
    STOP 'Stop software
    END IF
    IF (VAL(Esr$) AND 64) > 0 THEN Debug.Print "User request"
    IF (VAL(Esr$) AND 128) > 0 THEN Debug.Print "Power on"END SUB
    REM *****

    REM ----- Subroutine for evaluating the Event Status Register -----
    Public Sub Esrread()
        Try
            Dim myESR As Short = mbSession.Query("*ESR?") 'Read ESR
            If (myESR And 1) > 0 Then Console.WriteLine("Operation complete")
            If (myESR And 2) > 0 Then Console.WriteLine("Request Control")
            If (myESR And 4) > 0 Then Console.WriteLine("Query Error")
            If (myESR And 8) > 0 Then Console.WriteLine("Device dependent error")
            If (myESR And 16) > 0 Then
                Console.WriteLine("Execution Error; Program aborted") 'Output error message
            End If
        End Try
    End Sub

```

```
        Stop 'Stop software
    End If
    If (myESR And 32) > 0 Then
        Console.WriteLine("Command Error; Program aborted") 'Output error message
        Stop 'Stop software
    End If
    If (myESR And 64) > 0 Then Console.WriteLine("User request")
    If (myESR And 128) > 0 Then Console.WriteLine("Power on")
    Catch exp As Exception
        Console.WriteLine(exp.Message)
    End Try
End Sub
```

15 Troubleshooting

Blown fuse

If the product does not start, a blown fuse in the power supply can be the cause. Contact the Rohde & Schwarz customer service to confirm the fault symptoms. If the power supply has a blown fuse, you must return the product to the Rohde & Schwarz customer service to have the power supply replaced. Follow the instructions from the Rohde & Schwarz customer service.

15.1 Collecting information for support

If problems occur, the instrument generates error messages which in most cases will be sufficient for you to detect the cause of an error and find a remedy.

In addition, our customer support centers are there to assist you in solving any problems that you may encounter with your R&S FSWP. We will find solutions more quickly and efficiently if you provide us with the information listed below.

- **Windows Event Log Files**

Windows records important actions of applications and the operating system in event logs. You can create event log files to summarize and save the existing event logs (see ["To create windows event log files"](#) on page 669).

- **System Configuration:** The "System Configuration" dialog box (in the "Setup" menu) provides information on:

- **Hardware Info:** hardware assemblies
- **Versions and Options:** the status of all software and hardware options installed on your instrument
- **System Messages:** messages on any errors that may have occurred

An .xml file with information on the system configuration ("Device Footprint") can be created automatically (using the `DIAGNOSTIC:SERVICE:SINFO` command or as described in ["To collect the support information"](#) on page 668).

- **Error Log:** The `RSError.log` file (in the

`C:\Program Files (x86)\Rohde-Schwarz\FSWP\<version>\log` directory) contains a chronological record of errors.

- **Support file:** a *.zip file with important support information can be created automatically (in the

`C:\Program Files (x86)\Rohde-Schwarz\FSWP\<version>\user` directory). The *.zip file contains the system configuration information ("Device Footprint"), the current eeprom data and a screenshot of the screen display. See also the R&S FSWP User Manual, chapter "Service Functions".

To collect the support information

1. Press [Setup].
2. Select "Service" > "R&S Support" and then "Create R&S Support Information".

The file is stored as

```
C:\Program Files (x86)\Rohde-Schwarz\FSWP\<>version>\user\
FSWP_*.zip.
```

To create windows event log files



1. Select the "Windows Start Button" in the bottom left corner.
2. Enter *Event Viewer* and select "Enter".
3. Select and expand "Windows Logs" in the "Console Tree".
4. Right-click on each subsection and select "Save All Events As...".

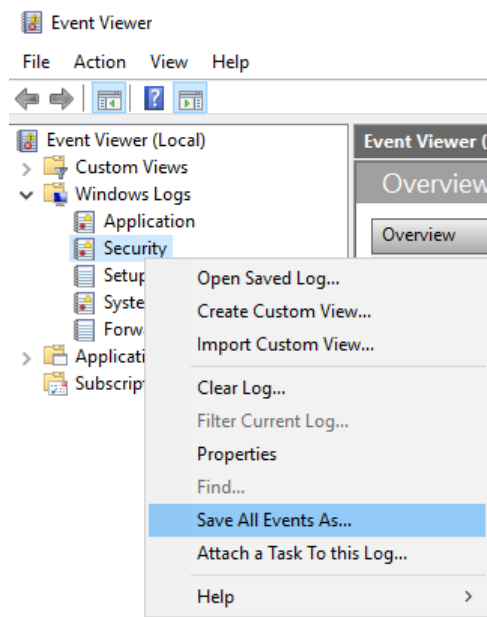

Figure 15-1: Event Viewer

5. Enter a file name and select "Save"

Collect the error information and log files and attach them to an email in which you describe the problem. Send the email to the customer support address for your region as described in [Chapter 15.2, "Contacting customer support"](#), on page 670.



Packing and transporting the instrument

If the instrument needs to be transported or shipped, observe the notes described in [Chapter 16, "Transporting"](#), on page 671.

15.2 Contacting customer support

Technical support – where and when you need it

For quick, expert help with any Rohde & Schwarz product, contact our customer support center. A team of highly qualified engineers provides support and works with you to find a solution to your query on any aspect of the operation, programming or applications of Rohde & Schwarz products.

Contact information

Contact our customer support center at www.rohde-schwarz.com/support, or follow this QR code:



Figure 15-2: QR code to the Rohde & Schwarz support page

16 Transporting

Lifting and carrying

See:

- ["Lifting and carrying the product"](#) on page 20
- [Chapter 3.1, "Lifting and carrying"](#), on page 25.

Packing

Use the original packaging material. It consists of antistatic wrap for electrostatic protection and packing material designed for the product.

If you do not have the original packaging, use similar materials that provide the same level of protection. You can also contact your local Rohde & Schwarz service center for advice.

Securing

When moving the product in a vehicle or using transporting equipment, make sure that the product is properly secured. Only use items intended for securing objects.

Transport altitude

The maximum transport altitude without pressure compensation is 4600 m above sea level.

17 Maintenance, storage, transport and disposal

The product does not require regular maintenance. It only requires occasional cleaning. It is however advisable to check the nominal data from time to time.

17.1 Cleaning

How to clean the product is described in "[Cleaning the product](#)" on page 21.

Do not use any liquids for cleaning. Cleaning agents, solvents, acids and bases can damage the front panel labeling, plastic parts and display.

17.2 Storage

Protect the product against dust. Ensure that the environmental conditions, e.g. temperature range and climatic load, meet the values specified in the data sheet.

17.3 Transporting

Lifting and carrying

See:

- "[Lifting and carrying the product](#)" on page 20
- [Chapter 3.1, "Lifting and carrying"](#), on page 25.

Packing

Use the original packaging material. It consists of antistatic wrap for electrostatic protection and packing material designed for the product.

If you do not have the original packaging, use similar materials that provide the same level of protection. You can also contact your local Rohde & Schwarz service center for advice.

Securing

When moving the product in a vehicle or using transporting equipment, make sure that the product is properly secured. Only use items intended for securing objects.

Transport altitude

The maximum transport altitude without pressure compensation is 4600 m above sea level.

17.4 Disposal

Rohde & Schwarz is committed to making careful, ecologically sound use of natural resources and minimizing the environmental footprint of our products. Help us by disposing of waste in a way that causes minimum environmental impact.

Disposing of electrical and electronic equipment

A product that is labeled as follows cannot be disposed of in normal household waste after it has come to the end of its life. Even disposal via the municipal collection points for waste electrical and electronic equipment is not permitted.



Figure 17-1: Labeling in line with EU directive WEEE

Rohde & Schwarz has developed a disposal concept for the eco-friendly disposal or recycling of waste material. As a manufacturer, Rohde & Schwarz completely fulfills its obligation to take back and dispose of electrical and electronic waste. Contact your local service representative to dispose of the product.

List of commands

[SENSe:]ADJust:CONFigure:FREQuency:AUTosearch[:STATE].....	473
[SENSe:]ADJust:CONFigure:FREQuency:COUNT.....	473
[SENSe:]ADJust:CONFigure:FREQuency:LIMit:HIGH.....	474
[SENSe:]ADJust:CONFigure:FREQuency:LIMit:LOW.....	474
[SENSe:]ADJust:CONFigure:LEVel:THReshold.....	472
[SENSe:]AVERAge<n>:COUNT.....	512
[SENSe:]BWIDth:MEASurement?.....	432
[SENSe:]BWIDth:VIDeo.....	512
[SENSe:]BWIDth:VIDeo:AUTO.....	512
[SENSe:]CORRection:CVL:BAND.....	448
[SENSe:]CORRection:CVL:BIAS.....	448
[SENSe:]CORRection:CVL:CATalog?.....	448
[SENSe:]CORRection:CVL:CLEar.....	449
[SENSe:]CORRection:CVL:COMMeNt.....	449
[SENSe:]CORRection:CVL:DATA.....	449
[SENSe:]CORRection:CVL:HARMonic.....	450
[SENSe:]CORRection:CVL:MIXer.....	450
[SENSe:]CORRection:CVL:PORTs.....	450
[SENSe:]CORRection:CVL:SElect.....	451
[SENSe:]CORRection:CVL:SNUMber.....	451
[SENSe:]CORRection:WEIGHting:COMMeNt.....	488
[SENSe:]CORRection:WEIGHting:DATA.....	488
[SENSe:]CORRection:WEIGHting:DELeTe.....	488
[SENSe:]CORRection:WEIGHting:NAME.....	489
[SENSe:]CORRection:WEIGHting:SElect.....	489
[SENSe:]FILTer:LPASs:FREQuency:MANual.....	474
[SENSe:]FILTer:LPASs[:STATE].....	475
[SENSe:]FREQuency:CENTer.....	475
[SENSe:]FREQuency:CENTer:STEP.....	509
[SENSe:]FREQuency:CENTer:STEP:LINK.....	510
[SENSe:]FREQuency:CENTer:STEP:LINK:FACTor.....	510
[SENSe:]FREQuency:SPAN.....	511
[SENSe:]FREQuency:STARt.....	476
[SENSe:]FREQuency:STOP.....	476
[SENSe:]LIST:BWIDth[:RESolution]:RATio.....	479
[SENSe:]LIST:BWIDth[:RESolution]:USMall.....	481
[SENSe:]LIST:RANGe<ri>:BWIDth[:RESolution].....	479
[SENSe:]LIST:RANGe<ri>:FREQuency:STARt?.....	480
[SENSe:]LIST:RANGe<ri>:FREQuency:STOP?.....	480
[SENSe:]LIST:RANGe<ri>:XCOUNt.....	481
[SENSe:]MIXer<x>:BIAS:HIGH.....	446
[SENSe:]MIXer<x>:BIAS[:LOW].....	446
[SENSe:]MIXer<x>:FREQuency:HANDover.....	440
[SENSe:]MIXer<x>:FREQuency:STARt.....	440
[SENSe:]MIXer<x>:FREQuency:STOP.....	441
[SENSe:]MIXer<x>:HARMonic:BAND.....	441
[SENSe:]MIXer<x>:HARMonic:BAND:PRESet.....	442

[SENSe:]MIXer<x>:HARMonic:HIGH:STATe.....	442
[SENSe:]MIXer<x>:HARMonic:HIGH[:VALue].....	442
[SENSe:]MIXer<x>:HARMonic:TYPE.....	443
[SENSe:]MIXer<x>:HARMonic[:LOW].....	443
[SENSe:]MIXer<x>:LOPower.....	447
[SENSe:]MIXer<x>:LOSS:HIGH.....	443
[SENSe:]MIXer<x>:LOSS:TABLE:HIGH.....	444
[SENSe:]MIXer<x>:LOSS:TABLE[:LOW].....	444
[SENSe:]MIXer<x>:LOSS[:LOW].....	444
[SENSe:]MIXer<x>:PORTs.....	445
[SENSe:]MIXer<x>:RFOVerrange[:STATe].....	445
[SENSe:]MIXer<x>:XCORr.....	445
[SENSe:]MIXer<x>[:STATe].....	447
[SENSe:]POWer:RLEVel:MODE.....	477
[SENSe:]POWer:RLEVel:MODE:USED?.....	477
[SENSe:]POWer:RLEVel:OFFSet.....	472
[SENSe:]POWer:RLEVel?.....	472
[SENSe:]ROSCillator:COUPling:BANDwidth.....	606
[SENSe:]ROSCillator:COUPling:BANDwidth:MODE.....	606
[SENSe:]ROSCillator:COUPling:MODE.....	607
[SENSe:]ROSCillator:EXTernal:FALLback.....	610
[SENSe:]ROSCillator:LBWidth.....	607
[SENSe:]ROSCillator:O640.....	607
[SENSe:]ROSCillator:OSYNc.....	608
[SENSe:]ROSCillator:SOURce.....	609
[SENSe:]ROSCillator:SOURce:EAUTo?.....	609
[SENSe:]ROSCillator:TRANge.....	610
[SENSe:]SMOothing:APERture.....	506
[SENSe:]SMOothing[:STATe].....	507
[SENSe:]SPURs:COLor.....	497
[SENSe:]SPURs:FILTer:CLEar.....	497
[SENSe:]SPURs:FILTer:HARMonics.....	496
[SENSe:]SPURs:FILTer:LOAD.....	497
[SENSe:]SPURs:FILTer:MODE.....	495
[SENSe:]SPURs:FILTer:NAME?.....	496
[SENSe:]SPURs:FILTer:OFFSet.....	496
[SENSe:]SPURs:FILTer:RANGe.....	496
[SENSe:]SPURs:FILTer:SAVE.....	497
[SENSe:]SPURs:SORT.....	495
[SENSe:]SPURs:SUPPress.....	507
[SENSe:]SPURs:THReshold.....	507
[SENSe:]SPURs:WEIGHting.....	495
[SENSe:]SWEep:CAPTure:RANGe.....	478
[SENSe:]SWEep:COUNT.....	482
[SENSe:]SWEep:EGATe:HOLDoff.....	498
[SENSe:]SWEep:EGATe:LENGth.....	498
[SENSe:]SWEep:EGATe:LEVel.....	499
[SENSe:]SWEep:EGATe:TYPE.....	499
[SENSe:]SWEep:FORWard.....	482
[SENSe:]SWEep:FSEGment.....	482

[SENSe:]SWEep:MODE.....	483
[SENSe:]SWEep:PULSe:DETEction.....	499
[SENSe:]SWEep:PULSe:GATE.....	500
[SENSe:]SWEep:PULSe:PRI.....	500
[SENSe:]SWEep:TIME.....	483
[SENSe:]SWEep:XFACTOR.....	484
[SENSe:]SWEep:XOPTimize:THREshold.....	484
[SENSe:]SWEep:XOPTimize[:STATe].....	484
[SENSe:]TIME:START.....	485
[SENSe:]TIME:STOP.....	485
*CAL?.....	409
*CLS.....	409
*ESE.....	409
*ESR?.....	409
*IDN?.....	410
*IST?.....	410
*OPC.....	410
*OPT?.....	410
*PCB.....	411
*PRE.....	411
*PSC.....	411
*RST.....	411
*SRE.....	411
*STB?.....	412
*TRG.....	412
*TST?.....	412
*WAI.....	412
ABORT.....	423
CALCulate<n>:DELTaMarker<m>:AOFF.....	550
CALCulate<n>:DELTaMarker<m>:LINK.....	550
CALCulate<n>:DELTaMarker<m>:MAXimum:LEFT.....	558
CALCulate<n>:DELTaMarker<m>:MAXimum:NEXT.....	558
CALCulate<n>:DELTaMarker<m>:MAXimum:RIGHT.....	558
CALCulate<n>:DELTaMarker<m>:MAXimum[:PEAK].....	558
CALCulate<n>:DELTaMarker<m>:MINimum:LEFT.....	559
CALCulate<n>:DELTaMarker<m>:MINimum:NEXT.....	559
CALCulate<n>:DELTaMarker<m>:MINimum:RIGHT.....	559
CALCulate<n>:DELTaMarker<m>:MINimum[:PEAK].....	559
CALCulate<n>:DELTaMarker<m>:MODE.....	551
CALCulate<n>:DELTaMarker<m>:MREference.....	551
CALCulate<n>:DELTaMarker<m>:TRACe.....	552
CALCulate<n>:DELTaMarker<m>:X.....	552
CALCulate<n>:DELTaMarker<m>:X:RELative?.....	562
CALCulate<n>:DELTaMarker<m>:Y?.....	562
CALCulate<n>:DELTaMarker<m>[:STATe].....	552
CALCulate<n>:DELTaMarker<ms>:LINK:TO:MARKer<md>.....	550
CALCulate<n>:FREQuency:DEVIation:DIAGram.....	522
CALCulate<n>:FREQuency:DEVIation:REGREssion:POINts?.....	523
CALCulate<n>:FREQuency:DEVIation:REGREssion?.....	523
CALCulate<n>:FREQuency:DEVIation:SLOPe?.....	523

CALCulate<n>:FREQuency:DEVIation:START.....	522
CALCulate<n>:FREQuency:DEVIation:STATe.....	522
CALCulate<n>:FREQuency:DEVIation:STOP.....	523
CALCulate<n>:FREQuency:DEVIation:TRACe.....	522
CALCulate<n>:LIMit:ACTive?.....	563
CALCulate<n>:LIMit:CLEar[:IMMediate].....	573
CALCulate<n>:LIMit:COMMeNt.....	567
CALCulate<n>:LIMit:COMPatible?.....	563
CALCulate<n>:LIMit:CONTRol:DOMain.....	568
CALCulate<n>:LIMit:CONTRol:MODE.....	568
CALCulate<n>:LIMit:CONTRol:SHIFt.....	569
CALCulate<n>:LIMit:CONTRol:SPACing.....	569
CALCulate<n>:LIMit:CONTRol[:DATA].....	568
CALCulate<n>:LIMit:COpy.....	564
CALCulate<n>:LIMit:DELeTe.....	564
CALCulate<n>:LIMit:FAIL?.....	573
CALCulate<n>:LIMit:LOWer:MODE.....	570
CALCulate<n>:LIMit:LOWer:OFFSet.....	564
CALCulate<n>:LIMit:LOWer:SHIFt.....	570
CALCulate<n>:LIMit:LOWer:SPACing.....	571
CALCulate<n>:LIMit:LOWer:STATe.....	565
CALCulate<n>:LIMit:LOWer[:DATA].....	570
CALCulate<n>:LIMit:NAME.....	571
CALCulate<n>:LIMit:STATe.....	565
CALCulate<n>:LIMit:TRACe<t>.....	566
CALCulate<n>:LIMit:TRACe<t>:CHECK.....	566
CALCulate<n>:LIMit:UNIT.....	571
CALCulate<n>:LIMit:UPPer:MODE.....	572
CALCulate<n>:LIMit:UPPer:SHIFt.....	572
CALCulate<n>:LIMit:UPPer:SPACing.....	573
CALCulate<n>:LIMit:UPPer:STATe.....	567
CALCulate<n>:LIMit:UPPer[:DATA].....	572
CALCulate<n>:MARKer<m>:AOFF.....	553
CALCulate<n>:MARKer<m>:FUNctioN:SPTRacking:RANGe.....	556
CALCulate<n>:MARKer<m>:FUNctioN:SPTRacking[:STATe].....	557
CALCulate<n>:MARKer<m>:LINK.....	555
CALCulate<n>:MARKer<m>:MAXimum:LEFT.....	559
CALCulate<n>:MARKer<m>:MAXimum:NEXT.....	560
CALCulate<n>:MARKer<m>:MAXimum:RIGHT.....	560
CALCulate<n>:MARKer<m>:MAXimum[:PEAK].....	560
CALCulate<n>:MARKer<m>:MINimum:LEFT.....	560
CALCulate<n>:MARKer<m>:MINimum:NEXT.....	561
CALCulate<n>:MARKer<m>:MINimum:RIGHT.....	561
CALCulate<n>:MARKer<m>:MINimum[:PEAK].....	561
CALCulate<n>:MARKer<m>:PEXCursion.....	556
CALCulate<n>:MARKer<m>:TRACe.....	554
CALCulate<n>:MARKer<m>:X.....	554
CALCulate<n>:MARKer<m>:Y?.....	562
CALCulate<n>:MARKer<m>[:STATe].....	554
CALCulate<n>:MARKer<ms>:LINK:TO:MARKer<md>.....	553

CALCulate<n>:MATH<t>:STATe.....	548
CALCulate<n>:MATH<t>[:EXPRession][:DEFine].....	548
CALCulate<n>:SETTLing:TIME:DIAGram.....	520
CALCulate<n>:SETTLing:TIME:FREQuency:LIMit:LOWer.....	520
CALCulate<n>:SETTLing:TIME:FREQuency:LIMit:UPPer.....	521
CALCulate<n>:SETTLing:TIME:PHASe:LIMit:LOWer.....	521
CALCulate<n>:SETTLing:TIME:PHASe:LIMit:UPPer.....	521
CALCulate<n>:SETTLing:TIME:RESult?.....	521
CALCulate<n>:SETTLing:TIME:STATe.....	520
CALCulate<n>:SETTLing:TIME:TRACe.....	520
CALCulate<n>:SNOise<ri>:AOFF.....	490
CALCulate<n>:SNOise<ri>:STATe.....	490
CALCulate<n>:SNOise<ri>:X.....	490
CALCulate<n>:SNOise<ri>[:TRACe<t>]:DECades:X?.....	491
CALCulate<n>:SNOise<ri>[:TRACe<t>]:DECades:Y?.....	491
CALCulate<n>:SNOise<ri>[:TRACe<t>]:DECades[:STATe].....	492
CALCulate<n>:SNOise<ri>[:TRACe<t>]:USERdefined[:STATe].....	492
CALCulate<n>:SNOise<ri>[:TRACe<t>]:Y?.....	492
CALCulate<n>[:RANGe<j>]:EVALUation:WEIGHting.....	488
CALCulate<n>[:RANGe<ri>]:EVALUation:START.....	486
CALCulate<n>[:RANGe<ri>]:EVALUation:STOP.....	486
CALCulate<n>[:RANGe<ri>]:EVALUation:TRACe.....	487
CALCulate<n>[:RANGe<ri>]:EVALUation[:STATe].....	487
CALibration:DUE:DAYs.....	613
CALibration:DUE:SCHedule.....	612
CALibration:DUE:SHUTdown.....	614
CALibration:DUE:TIME.....	614
CALibration:DUE:WARMup.....	612
CALibration:RESult?.....	612
CALibration[:ALL]?.....	611
CONFigure:PNOise:MEASurement.....	421
CONFigure:SNTune:MEASurement[:STATe].....	422
CONFigure:SNTune:SWEep:DELay:INITial.....	504
CONFigure:SNTune:SWEep:DELay[:POINT].....	504
CONFigure:SNTune:SWEep:POINTs.....	504
CONFigure:SNTune:SWEep:SOURce.....	505
CONFigure:SNTune:SWEep:START.....	505
CONFigure:SNTune:SWEep:STOP.....	505
CONFigure:TRANsient:MEASurement[:STATe].....	422
CONFigure:TRANsient:MODE.....	509
CONFigure:TRANsient[:WINDow<n>]:AF:COUPLing.....	516
CONFigure:TRANsient[:WINDow<n>]:AF:COUPLing:RPOint:MODE.....	516
CONFigure:TRANsient[:WINDow<n>]:AF:COUPLing:RPOint[:X].....	517
CONFigure:VCO:FIX:SOURce.....	501
CONFigure:VCO:MEASurement[:STATe].....	423
CONFigure:VCO:SWEep:DELay:INITial.....	501
CONFigure:VCO:SWEep:DELay[:POINT].....	502
CONFigure:VCO:SWEep:FCOUNTER:RESolution.....	502
CONFigure:VCO:SWEep:POINTs.....	502
CONFigure:VCO:SWEep:SOURce.....	503

CONFigure:VCO:SWEp:STARt.....	503
CONFigure:VCO:SWEp:STOP.....	503
DIAGnostic:HUMS:DELeTe:ALL.....	629
DIAGnostic:HUMS:FORMat.....	629
DIAGnostic:HUMS:STATe.....	630
DIAGnostic:HUMS:TAGS:ALL?.....	630
DIAGnostic:HUMS:TAGS:DELeTe.....	631
DIAGnostic:HUMS:TAGS:DELeTe:ALL.....	630
DIAGnostic:HUMS:TAGS[:VALue].....	631
DIAGnostic:INFO:CCOunt?.....	635
DIAGnostic:SERVice:BIOSinfo?.....	636
DIAGnostic:SERVice:CALibration:DATE.....	643
DIAGnostic:SERVice:CALibration:DUE:DATE.....	643
DIAGnostic:SERVice:CALibration:INTerval?.....	643
DIAGnostic:SERVice:DATE.....	644
DIAGnostic:SERVice:HWInfo?.....	636
DIAGnostic:SERVice:INPut:MC[:DISTance].....	614
DIAGnostic:SERVice:INPut:PULSed:CFRequency.....	615
DIAGnostic:SERVice:INPut:RF[:SPECTrum].....	615
DIAGnostic:SERVice:INPut:SYNThtwo[:FREQUency].....	616
DIAGnostic:SERVice:INPut[:SElect].....	615
DIAGnostic:SERVice:NSource.....	465
DIAGnostic:SERVice:SFUNction.....	641
DIAGnostic:SERVice:SFUNction:LASTresult?.....	641
DIAGnostic:SERVice:SFUNction:RESults:DELeTe.....	642
DIAGnostic:SERVice:SFUNction:RESults:SAVE.....	642
DIAGnostic:SERVice:SINfo?.....	642
DIAGnostic:SERVice:STESt:RESult?.....	616
DIAGnostic:SERVice:VERSinfo?.....	636
DISPlay:ANNotation:CBAR.....	617
DISPlay:ANNotation:FREQUency.....	617
DISPlay:ATAB.....	413
DISPlay:CMAP<it>:DEFault<ci>.....	620
DISPlay:CMAP<it>:HSL.....	621
DISPlay:CMAP<it>:PDEFined.....	621
DISPlay:FORMat.....	525
DISPlay:LOGO.....	591
DISPlay:SBAR[:STATe].....	618
DISPlay:SKEYs[:STATe].....	618
DISPlay:SNINfo:TRACe.....	493
DISPlay:SNINfo[:STATe].....	493
DISPlay:TBAR[:STATe].....	618
DISPlay:THEMe:CATalog?.....	621
DISPlay:THEMe:SElect.....	622
DISPlay:TOUCHscreen[:STATe].....	618
DISPlay:WSElect?.....	525
DISPlay:XGINdicator[:STATe].....	479
DISPlay[:WINDow]:TRACe:CLEar:AUTO.....	540
DISPlay[:WINDow<n>]:MTABLE.....	555
DISPlay[:WINDow<n>]:SIZE.....	526

DISPlay[:WINDow<n>]:TIME.....	619
DISPlay[:WINDow<n>]:TIME:FORMat.....	619
DISPlay[:WINDow<n>]:TRACe<t>:LABel:TEXT.....	539
DISPlay[:WINDow<n>]:TRACe<t>:LABel[:STATe].....	538
DISPlay[:WINDow<n>]:TRACe<t>:PERSistence:DECay.....	539
DISPlay[:WINDow<n>]:TRACe<t>:PERSistence[:STATe].....	539
DISPlay[:WINDow<n>]:TRACe<t>:RESult[:TYPE].....	540
DISPlay[:WINDow<n>]:TRACe<t>:SMOothing:APERture.....	542
DISPlay[:WINDow<n>]:TRACe<t>:SMOothing[:STATe].....	543
DISPlay[:WINDow<n>]:TRACe<t>:SPURs:SUPPress.....	494
DISPlay[:WINDow<n>]:TRACe<t>:SPURs:THReshold.....	494
DISPlay[:WINDow<n>]:TRACe<t>:X:SPACing?.....	468
DISPlay[:WINDow<n>]:TRACe<t>:X[:SCALE].....	467
DISPlay[:WINDow<n>]:TRACe<t>:X[:SCALE]:AUTO.....	468
DISPlay[:WINDow<n>]:TRACe<t>:Y:UNIT.....	470
DISPlay[:WINDow<n>]:TRACe<t>:Y[:SCALE].....	468
DISPlay[:WINDow<n>]:TRACe<t>:Y[:SCALE]:AUTO.....	469
DISPlay[:WINDow<n>]:TRACe<t>:Y[:SCALE]:MODE.....	517
DISPlay[:WINDow<n>]:TRACe<t>:Y[:SCALE]:PDIVision.....	518
DISPlay[:WINDow<n>]:TRACe<t>:Y[:SCALE]:RLEVel.....	469
DISPlay[:WINDow<n>]:TRACe<t>:Y[:SCALE]:RLEVel:LOWer.....	470
DISPlay[:WINDow<n>]:TRACe<t>:Y[:SCALE]:RLEVel:OFFSet.....	541
DISPlay[:WINDow<n>]:TRACe<t>:Y[:SCALE]:RLEVel:OFFSet:STATe.....	542
DISPlay[:WINDow<n>]:TRACe<t>:Y[:SCALE]:RPOSite.....	518
DISPlay[:WINDow<n>]:TRACe<t>:Y[:SCALE]:RVALue.....	519
DISPlay[:WINDow<n>]:TRACe<t>:Y[:SCALE]:UNIT.....	519
DISPlay[:WINDow<n>][:SUBWindow<w>]:SElect.....	525
DISPlay[:WINDow<n>][:SUBWindow<w>]:TRACe<t>:MODE.....	537
DISPlay[:WINDow<n>][:SUBWindow<w>]:TRACe<t>[:STATe].....	541
DISPlay[:WINDow<n>][:SUBWindow<w>]:ZOOM:AREA.....	533
DISPlay[:WINDow<n>][:SUBWindow<w>]:ZOOM:MULTiple<zn>:AREA.....	535
DISPlay[:WINDow<n>][:SUBWindow<w>]:ZOOM:MULTiple<zn>[:STATe].....	536
DISPlay[:WINDow<n>][:SUBWindow<w>]:ZOOM[:STATe].....	536
FETCh<n>:PNOise<t>:SPURs:COUNT?.....	427
FETCh<n>:PNOise<t>:SPURs:DISCrete?.....	428
FETCh<n>:PNOise<t>:SPURs:JITTer?.....	428
FETCh<n>:PNOise<t>:SPURs:RANDom?.....	429
FETCh<n>:PNOise<t>:SPURs?.....	427
FETCh<n>[:RANGe<ri>]:PNOise<t>:DUT:GAIN?.....	426
FETCh<n>[:RANGe<ri>]:PNOise<t>:IPN?.....	429
FETCh<n>[:RANGe<ri>]:PNOise<t>:RAM?.....	429
FETCh<n>[:RANGe<ri>]:PNOise<t>:RFM?.....	430
FETCh<n>[:RANGe<ri>]:PNOise<t>:RMS?.....	430
FETCh<n>[:RANGe<ri>]:PNOise<t>:RPM?.....	431
FORMat:DEXPort:CSEParator.....	545
FORMat:DEXPort:DSEParator.....	545
FORMat:DEXPort:FORMat.....	545
FORMat:DEXPort:HEADer.....	546
FORMat:DEXPort:TRACes.....	546
FORMat[:DATA].....	544

HCOPY:ABORt.....	591
HCOPY:CMAP<it>:DEFault<ci>.....	591
HCOPY:CMAP<it>:HSL.....	592
HCOPY:CMAP<it>:PDEFined.....	592
HCOPY:CONTent.....	593
HCOPY:DESTination<di>.....	594
HCOPY:DEVice:COLor.....	595
HCOPY:DEVice:LANGuage.....	595
HCOPY:ITEM:WINDow:TEXT.....	596
HCOPY:PAGE:COUNT:STATe.....	596
HCOPY:PAGE:MARGin:BOTTom.....	596
HCOPY:PAGE:MARGin:LEFT.....	596
HCOPY:PAGE:MARGin:RIGHT.....	597
HCOPY:PAGE:MARGin:TOP.....	597
HCOPY:PAGE:MARGin:UNIT.....	597
HCOPY:PAGE:ORlentation.....	597
HCOPY:PAGE:WINDow:CHANnel:STATe.....	598
HCOPY:PAGE:WINDow:COUNT.....	598
HCOPY:PAGE:WINDow:SCALE.....	599
HCOPY:PAGE:WINDow:STATe.....	599
HCOPY:TDSamp:STATe.....	600
HCOPY[:IMMEDIATE].....	595
HCOPY[:IMMEDIATE]:NEXT.....	595
INITiate:SEQuencer:ABORt.....	417
INITiate:SEQuencer:IMMEDIATE.....	417
INITiate:SEQuencer:MODE.....	418
INITiate<n>:CONMeas.....	424
INITiate<n>:CONTinuous.....	425
INITiate<n>[:IMMEDIATE].....	426
INPut:UPORt:STATe.....	465
INPut:UPORt[:VALue].....	466
INPut<ip>:ATTenuation.....	471
INPut<ip>:ATTenuation:AUTO.....	471
INPut<ip>:CONNector.....	439
INPut<ip>:COUPling.....	437
INPut<ip>:LOSCillator:SOURce.....	438
INPut<ip>:LOSCillator:SOURce:EXTernal:LEVel.....	438
INPut<ip>:RLEVel.....	511
INPut<ip>:SELEct.....	438
INSTRument:CREate:DUPLicate.....	413
INSTRument:CREate:REPLace.....	414
INSTRument:CREate[:NEW].....	414
INSTRument:DELeTe.....	415
INSTRument:LIST?.....	415
INSTRument:REName.....	416
INSTRument[:SELEct].....	416
LAYout:ADD[:WINDow]?.....	526
LAYout:CATalog[:WINDow]?.....	528
LAYout:IDENtify[:WINDow]?.....	528
LAYout:MOVE[:WINDow].....	529

LAYout:REMove[:WINDow].....	529
LAYout:REPLace[:WINDow].....	529
LAYout:SPLitter.....	530
LAYout:WINDow<n>:ADD?.....	531
LAYout:WINDow<n>:IDENtify?.....	532
LAYout:WINDow<n>:REMove.....	532
LAYout:WINDow<n>:REPLace.....	532
LAYout:WINDow<n>:TYPE?.....	533
MMEMory:CATalog.....	578
MMEMory:CATalog:LONG.....	579
MMEMory:CDIRectory.....	579
MMEMory:CLEar:ALL.....	587
MMEMory:CLEar:STATe.....	587
MMEMory:COMMeNt.....	579
MMEMory:COpy.....	580
MMEMory:DATA.....	580
MMEMory:DELEte:IMMediate.....	581
MMEMory:LOAD:AUTO.....	587
MMEMory:LOAD:STATe.....	587
MMEMory:LOAD<n>:TRACe.....	546
MMEMory:MDIRectory.....	581
MMEMory:MOVE.....	581
MMEMory:MSIS.....	581
MMEMory:NAME.....	582
MMEMory:NETWork:DISConnect.....	582
MMEMory:NETWork:MAP.....	582
MMEMory:NETWork:UNUSeddrives?.....	583
MMEMory:NETWork:USEDdrives.....	583
MMEMory:RDIRectory.....	583
MMEMory:SELEct:CHANnel[:ITEM]:ALL.....	584
MMEMory:SELEct:CHANnel[:ITEM]:DEFault.....	584
MMEMory:SELEct:CHANnel[:ITEM]:HWSettings.....	584
MMEMory:SELEct:CHANnel[:ITEM]:LINES:ALL.....	585
MMEMory:SELEct:CHANnel[:ITEM]:NONE.....	585
MMEMory:SELEct:CHANnel[:ITEM]:SGRam.....	585
MMEMory:SELEct:CHANnel[:ITEM]:TRACe[:ACTive].....	586
MMEMory:SELEct:CHANnel[:ITEM]:TRANsdUCer:ALL.....	586
MMEMory:SELEct:CHANnel[:ITEM]:WEIGHting.....	586
MMEMory:SELEct[:ITEM]:ALL.....	584
MMEMory:SELEct[:ITEM]:DEFault.....	584
MMEMory:SELEct[:ITEM]:HWSettings.....	584
MMEMory:SELEct[:ITEM]:LINES:ALL.....	585
MMEMory:SELEct[:ITEM]:NONE.....	585
MMEMory:SELEct[:ITEM]:SGRam.....	585
MMEMory:SELEct[:ITEM]:TRACe<1..3>[:ACTive].....	586
MMEMory:SELEct[:ITEM]:TRANsdUCer:ALL.....	586
MMEMory:SELEct[:ITEM]:WEIGHting.....	586
MMEMory:STORe<1 2>:STATe.....	588
MMEMory:STORe<1 2>:STATe:NEXT.....	589
MMEMory:STORe<1 2>:TYPE.....	589

MMEMory:STORe<n>:SPURs.....	431
MMEMory:STORe<n>:TRACe.....	601
OUTPut:UPORt[:VALue].....	466
OUTPut<up>:UPORt:STATe.....	466
SOURce:CURRent:AUX:LIMit:HIGH?.....	452
SOURce:CURRent:CONTRol<i>:LIMit:HIGH?.....	452
SOURce:CURRent:POWer<i>:LIMit:HIGH.....	453
SOURce:CURRent:SEQuence:RESult?.....	453
SOURce:GENerator:CHANnel:COUPling.....	461
SOURce:GENerator:DUTByPass.....	461
SOURce:GENerator:FREQuency.....	462
SOURce:GENerator:FREQuency:STEP.....	462
SOURce:GENerator:LEVel.....	462
SOURce:GENerator:MODulation.....	463
SOURce:GENerator:PULSe:PERiod.....	463
SOURce:GENerator:PULSe:TRIGger:OUTPut.....	463
SOURce:GENerator:PULSe:WIDTh.....	464
SOURce:GENerator[:STATe].....	464
SOURce:POWer:SEQuence:RESult?.....	454
SOURce:VOLTagE:AUX:LEVel:AMPLitude.....	454
SOURce:VOLTagE:AUX:LEVel:LIMit:HIGH.....	454
SOURce:VOLTagE:AUX:LEVel:LIMit:LOW.....	454
SOURce:VOLTagE:AUX:LEVel[:STATe].....	455
SOURce:VOLTagE:CHANnel:COUPling.....	455
SOURce:VOLTagE:CONTRol<i>:LEVel:AMPLitude.....	456
SOURce:VOLTagE:CONTRol<i>:LEVel:LIMit:HIGH.....	456
SOURce:VOLTagE:CONTRol<i>:LEVel:LIMit:LOW.....	456
SOURce:VOLTagE:CONTRol<i>:LEVel[:STATe].....	457
SOURce:VOLTagE:POWer<i>:LEVel:AMPLitude.....	457
SOURce:VOLTagE:POWer<i>:LEVel:LIMit:HIGH.....	458
SOURce:VOLTagE:POWer<i>:LEVel:LIMit:LOW.....	458
SOURce:VOLTagE:POWer<i>:LEVel:MODE.....	458
SOURce:VOLTagE:POWer<i>:LEVel[:STATe].....	459
SOURce:VOLTagE:POWer<i>:LIMit:HIGH.....	459
SOURce:VOLTagE:SEQuence:RESult?.....	460
SOURce:VOLTagE[:STATe].....	460
SOURce<si>:EXTernal<ext>:ROSCillator:EXTernal:FREQuency.....	608
SOURce<si>:TEMPerature:FRONtend.....	616
STATus:OPERation:CONDition?.....	655
STATus:OPERation:ENABLE.....	657
STATus:OPERation:NTRansition.....	657
STATus:OPERation:PTRansition.....	658
STATus:OPERation[:EVENT]?.....	656
STATus:PRESet.....	655
STATus:QUEStionable:ACPLimit:CONDition?.....	655
STATus:QUEStionable:ACPLimit:ENABLE.....	657
STATus:QUEStionable:ACPLimit:NTRansition.....	657
STATus:QUEStionable:ACPLimit:PTRansition.....	658
STATus:QUEStionable:ACPLimit[:EVENT]?.....	656
STATus:QUEStionable:CONDition?.....	655

STATus:QUESTionable:ENABle.....	657
STATus:QUESTionable:EXTended:CONDition?.....	655
STATus:QUESTionable:EXTended:ENABle.....	657
STATus:QUESTionable:EXTended:INFO:CONDition?.....	655
STATus:QUESTionable:EXTended:INFO:ENABle.....	657
STATus:QUESTionable:EXTended:INFO:NTRansition.....	657
STATus:QUESTionable:EXTended:INFO:PTRansition.....	658
STATus:QUESTionable:EXTended:INFO[:EVENT]?.....	656
STATus:QUESTionable:EXTended:NTRansition.....	657
STATus:QUESTionable:EXTended:PTRansition.....	658
STATus:QUESTionable:EXTended[:EVENT]?.....	656
STATus:QUESTionable:FREQuency:CONDition?.....	655
STATus:QUESTionable:FREQuency:ENABle.....	657
STATus:QUESTionable:FREQuency:NTRansition.....	657
STATus:QUESTionable:FREQuency:PTRansition.....	658
STATus:QUESTionable:FREQuency[:EVENT]?.....	656
STATus:QUESTionable:LIMit<n>:CONDition?.....	655
STATus:QUESTionable:LIMit<n>:ENABle.....	657
STATus:QUESTionable:LIMit<n>:NTRansition.....	657
STATus:QUESTionable:LIMit<n>:PTRansition.....	658
STATus:QUESTionable:LIMit<n>[:EVENT]?.....	656
STATus:QUESTionable:LMARgin<n>:CONDition?.....	655
STATus:QUESTionable:LMARgin<n>:ENABle.....	657
STATus:QUESTionable:LMARgin<n>:NTRansition.....	657
STATus:QUESTionable:LMARgin<n>:PTRansition.....	658
STATus:QUESTionable:LMARgin<n>[:EVENT]?.....	656
STATus:QUESTionable:NTRansition.....	657
STATus:QUESTionable:PNOise:CONDition?.....	655
STATus:QUESTionable:PNOise:ENABle.....	657
STATus:QUESTionable:PNOise:NTRansition.....	657
STATus:QUESTionable:PNOise:PTRansition.....	658
STATus:QUESTionable:PNOise[:EVENT]?.....	656
STATus:QUESTionable:POWer:CONDition?.....	656
STATus:QUESTionable:POWer:DCPNoise:CONDition?.....	656
STATus:QUESTionable:POWer:DCPNoise:ENABle.....	657
STATus:QUESTionable:POWer:DCPNoise:NTRansition.....	657
STATus:QUESTionable:POWer:DCPNoise:PTRansition.....	658
STATus:QUESTionable:POWer:DCPNoise[:EVENT]?.....	656
STATus:QUESTionable:POWer:ENABle.....	657
STATus:QUESTionable:POWer:NTRansition.....	657
STATus:QUESTionable:POWer:PTRansition.....	658
STATus:QUESTionable:POWer[:EVENT]?.....	656
STATus:QUESTionable:PTRansition.....	658
STATus:QUESTionable:TEMPerature:CONDition?.....	656
STATus:QUESTionable:TEMPerature:ENABle.....	657
STATus:QUESTionable:TEMPerature:NTRansition.....	657
STATus:QUESTionable:TEMPerature:PTRansition.....	658
STATus:QUESTionable:TEMPerature[:EVENT]?.....	656
STATus:QUESTionable:TIME:CONDition?.....	656
STATus:QUESTionable:TIME:ENABle.....	657

STATus:QUEStionable:TIME:NTRansition.....	657
STATus:QUEStionable:TIME:PTRansition.....	658
STATus:QUEStionable:TIME[:EVENT]?.....	656
STATus:QUEStionable[:EVENT]?.....	656
STATus:QUEue[:NEXT]?.....	655
SYSTem:CLOGging.....	605
SYSTem:COMMunicate:GPIB[:SELF]:ADDResS.....	624
SYSTem:COMMunicate:GPIB[:SELF]:RTERminator.....	624
SYSTem:COMMunicate:INTernal:REMote.....	624
SYSTem:COMMunicate:PRINter:ENUMerate:FIRSt.....	600
SYSTem:COMMunicate:PRINter:ENUMerate[:NEXT].....	600
SYSTem:COMMunicate:PRINter:SElect<di>.....	600
SYSTem:COMMunicate:REST:ENABLE.....	631
SYSTem:COMMunicate:SNMP:COMMunity:RO.....	632
SYSTem:COMMunicate:SNMP:COMMunity:RW.....	632
SYSTem:COMMunicate:SNMP:CONtact.....	632
SYSTem:COMMunicate:SNMP:LOCation.....	633
SYSTem:COMMunicate:SNMP:USM:USER.....	633
SYSTem:COMMunicate:SNMP:USM:USER:ALL?.....	633
SYSTem:COMMunicate:SNMP:USM:USER:DELete.....	634
SYSTem:COMMunicate:SNMP:USM:USER:DELete:ALL.....	634
SYSTem:COMMunicate:SNMP:VERSion.....	634
SYSTem:DATE.....	605
SYSTem:DISPlay:FPAneL[:STATe].....	619
SYSTem:DISPlay:LOCK.....	625
SYSTem:DISPlay:UPDate.....	625
SYSTem:ERRor:CLEar:ALL.....	637
SYSTem:ERRor:CLEar:REMote.....	625
SYSTem:ERRor:DISPlay.....	626
SYSTem:ERRor:EXTended?.....	637
SYSTem:ERRor:LIST?.....	638
SYSTem:ERRor[:NEXT]?.....	638
SYSTem:FIRMware:UPDate.....	639
SYSTem:FORMat:IDENT.....	639
SYSTem:IDENTify:FACTory.....	626
SYSTem:IDENTify[:STRing].....	626
SYSTem:KLOCK.....	626
SYSTem:LANGuage.....	627
SYSTem:LXI:LANReset.....	627
SYSTem:LXI:MDEscription.....	627
SYSTem:LXI:PASSword.....	627
SYSTem:PASSword:RESet.....	644
SYSTem:PASSword[:CENable].....	644
SYSTem:PRESet.....	590
SYSTem:PRESet:CHANnel[:EXEC].....	590
SYSTem:PRESet:COMPAtible.....	639
SYSTem:PRESet:FILTer.....	640
SYSTem:PSA:WIDeband.....	628
SYSTem:REBoot.....	605
SYSTem:SECurity[:STATe].....	640

SYSTem:SEQuencer.....	418
SYSTem:SHIMmediate ONCE.....	629
SYSTem:SHIMmediate:STATE.....	628
SYSTem:SHUTdown.....	605
SYSTem:SREOrder:CLEar.....	651
SYSTem:SREOrder:DATA[:ALL]?.....	651
SYSTem:SREOrder:EXPort.....	653
SYSTem:SREOrder:FORMat.....	654
SYSTem:SREOrder:SYNC.....	654
SYSTem:SREOrder[:AUTO].....	650
SYSTem:TIME.....	605
TRACe<n>:COPY.....	543
TRACe<n>:POINts?.....	434
TRACe<n>[:DATA]:LINear?.....	433
TRACe<n>[:DATA]:X:POINts?.....	435
TRACe<n>[:DATA]:X?.....	435
TRACe<n>[:DATA]:Y:POINts?.....	436
TRACe<n>[:DATA]:Y?.....	435
TRACe<n>[:DATA]?.....	432
TRIGger[:SEQuence]:DTIME.....	513
TRIGger[:SEQuence]:FREQuency.....	513
TRIGger[:SEQuence]:FREQuency:HYSteresis.....	513
TRIGger[:SEQuence]:HOLDoff[:TIME].....	514
TRIGger[:SEQuence]:IFPower:HOLDoff.....	514
TRIGger[:SEQuence]:LEVel[:EXTernal<1 2>].....	514
TRIGger[:SEQuence]:SLOPe.....	515
TRIGger[:SEQuence]:SOURce.....	515

Index

Symbols

*IDN
Format 374

A

Aborting
Sweep 119, 120
AC/DC coupling 136
Alignment
Basics 296
Performing 303
Results 297, 298, 302
Settings 298
touchscreen 297, 302
Touchscreen 298
Alphanumeric keys 42
Alphanumeric parameters 94
AM (trace information) 85
Analog Modulation Analysis
Application 109
Annotations
Hiding/restoring 306
Application cards 24
Application notes 24
Applications
Analog Modulation Analysis 109
I/Q Analyzer 109
Noise Figure 109
Phase Noise 108
Pulse 110
Spectrum 109
Spectrum Monitor 108
Spurious Measurements 110
Transient Analysis 110
Vector Signal Analysis (VSA) 110
Arranging
Windows 104, 212
ASCII trace export 234
Att (channel bar) 83
Autologin mechanism
Activating/Deactivating 395
AUX PORT
Connector 51
Average count 169
AVG (trace information) 84

B

Band
Conversion loss table 152
External Mixer 145
External Mixer (remote) 442
Baseband input 46
Bias
Conversion loss table 149, 152
External Mixer 140, 148
External Mixer (remote) 446
Brochures 24

C

Calibration
Frequency 331
Frequency MW 332
Frequency RF 331
Remote 409
Remote control 611
Results (remote control) 612
RF 331
Settings 331
Signal 331
Capture Range 161, 168
Channel
Creating (remote) 414, 416
Deleting (remote) 415
Duplicating (remote) 413
Querying (remote) 415
Renaming (remote) 416
Replacing (remote) 414
Selecting (remote) 416
Channel bar
Hiding/restoring 306
Information 82
channel settings
Presetting 263
Channel settings
Display 82
Channels
Duplicating 112
New 111
Replacing 112
see also Measurement channels 99
Sequential operation 112
Switching 82
Clear status
Remote 409
Close
Show SCPI command 359
Closing
Channels 100
Channels (remote) 415
Windows 103, 211
Windows (remote) 532
CLRW (trace information) 84
Colors
Assigning to object 311
Configuring 310, 314
Display 309
Editing 309
Predefined 311
Print 310
Printing 309
Restoring 312
Screen 310
User-defined 310
User-specific 312
Command sequence
Remote 412
Commands
Tracking 374

- Comment
 - Limit lines 257
 - Screenshots 281
 - Softkey 281
- Compatibility
 - Limit lines 251, 255
- Computer name 371
- Connector
 - AC power supply 49
 - AUX PORT 51
 - Baseband Input 46
 - Display Port 49
 - DVI 49
 - GPIO interface 51
 - IF/VIDEO/DEMODO 50
 - LAN 50
 - Noise source 46
 - Power sensor 45
 - Probe power 46
 - REF INPUT 52
 - USB 50
- Connectors
 - EXT REF 318
 - External generators 51
 - for External Mixer 47
 - OCXO 52
 - Probe Power 46
 - REF OUTPUT 319
 - RF INPUT 44
 - Signal source output 45
 - SYNC TRIGGER 51, 318
 - Trigger Input 46
 - Trigger Output 46
 - USB 45
- Context-sensitive menus 92
- Continue single sweep
 - Softkey 118, 120
- Continuous Sequencer
 - Softkey 115
- Continuous sweep
 - Softkey 118, 120
- Conventions
 - SCPI commands 407
- Conversion loss
 - External Mixer (remote) 443, 444
- Conversion loss tables 150
 - Available (remote) 448
 - Band (remote) 448
 - Bias (remote) 448
 - Configuring 150
 - Deleting (remote) 449
 - External Mixer 141, 146
 - External Mixer (remote) 444
 - Harmonic order (remote) 450
 - Importing (External Mixer) 150
 - Mixer type (remote) 450
 - Saving (External Mixer) 153
 - Selecting (remote) 451
 - Shifting values (External Mixer) 153
 - Values (External Mixer) 153
- Copy
 - Show SCPI command 359
- Copying
 - Channel (remote) 413
 - Traces 231
- Count (channel bar) 84
- Cross-correlation 167
- Cursor keys 43, 44
- Customer support 670
- D**
- Data format
 - ASCII 549
 - Binary 549
 - Remote 546
- Data sheets 24
- Date
 - Format 305
 - Hiding/restoring 307
 - Instrument setting 305
- Date and Time
 - Printing 282
- DC connectors 178
- DC power 178
- DC source
 - Fix 191
 - Sweep 191
 - Tuning 191
- Decimal separator
 - Trace export 229
- Default
 - Restoring settings 262
- Default values
 - Remote 411
- Deleting
 - Limit line values 258
- Delta markers 245
 - Defining 245
- Device
 - Softkey 281, 286, 288
- Device ID 329
- DHCP 372, 388
- Diagnostics
 - Hardware 334
- Diagram area
 - Status display 87
 - Trace information 84
- Diagram footer 87
 - Hiding/restoring 306
- Diagram scale 157
- Dialog boxes
 - Slider 94
 - Transparency 94
- Dialogs
 - Printing 282
 - Suppressing file selection 286
- Display
 - Colors 309, 314
 - Config (Softkey) 208
 - Evaluation bar 103, 211
 - Evaluation methods 208
 - Information 81
 - SCPI list 360
 - Settings 303
 - SmartGrid 100, 208
 - Theme 309
 - Update (remote) 374
 - Update rate 305
- Display Port
 - Connector 49
- Displayed items
 - Touchscreen 305
- Disposal 672

- DNS server
 - IP Address 390
- Duplicating
 - Channel (remote) 413
- DVI
 - Connector 49
- E**
- Enable registers
 - Remote 411
- Entering data 93
- EOI
 - GPIO terminator 374
- Error log 668
- Error messages
 - Status bar 88
- Error queue 343
- Errors
 - IF OVLD 89, 351
 - INPUT OVLD 351
 - LOUNL 89
 - NO REF 89
 - RF OVLD 351
 - UNCAL 89
 - UNLD 351
 - WRONG_FW 89, 296, 324
- ESE (event status enable register) 344
- ESR (event status register) 344
- Evaluation
 - Modes 208
 - Modes, adding 103, 211
- Evaluation bar
 - Using 103, 211
- Evaluation methods
 - Remote 526
- Event status enable register (ESE) 344
 - Remote 409
- Event status register (ESR) 342, 344
 - Remote 409
- Export
 - SCPI list 362, 364, 365
- Export format
 - Traces 234
- Exporting
 - Data 278
 - Functions 271
 - I/Q data 278
 - Measurement settings 227
 - Softkey 278
 - Trace data 233
 - Traces 228, 278
- EXT REF
 - Status message 87
- External generators 51
- External Mixer 47, 144
 - Activating (remote) 447
 - Band 145, 440, 441
 - Bias current 140
 - Conversion loss 146
 - Conversion loss tables 141, 150
 - Frequency range 139, 144
 - General information 139
 - Handover frequency 145
 - Harmonic Order 146
 - Harmonic Type 146
 - Name 152
 - Range 146
 - Restoring bands 145
 - RF overrange 145, 445
 - RF Start/RF Stop 144
 - Serial number 152
 - Type 153, 445
- External monitor
 - Connectors 49
- External reference
 - Frequency 319
 - Input 318
 - Loop bandwidth 319
 - Missing 318
 - Output 319
 - Settings 317
 - Status message 87
 - Tuning range 319
- F**
- File format
 - Export Files 234
 - Trace export 234
- File type
 - Storage settings 272
- filename
 - Data files 270
 - Settings 272, 275
- Firmware
 - Updating 324
- Firmware Update
 - Remote control 639
- Focus
 - Changing 93
- Format
 - Data 549
 - Data (remote) 546
 - Date and time 305
 - see also File format 234
- Frequency
 - External reference 319
 - Offset 161
 - Reference 317
- Frequency (channel bar) 83
- Frequency range
 - Extending 139
 - External Mixer 139
- Frequency response 195
- Frequency search 160
- Front panel
 - Hiding/restoring 307
- Frontend
 - Temperature 297
 - Temperature (remote) 616
 - Temperature, status bit 353
- Full screen mode 40
- Function keys
 - Details - see user manual 41
 - Overview 41
- G**
- Getting started 23
- GPIO 337
 - Address 373, 393
 - Characteristics 340
 - Language (remote control) 627

Settings	372
Terminator	374
GPIB bus control	
Remote	411
GPIB interface	
Configuring - see User Manual	51
Connector	51
Remote control	106
GPIB Language	354
Graphical zoom	98

H

Handover frequency	
External Mixer	140, 145
External Mixer (remote)	440
Hard drive	49
Hardware	
Check	324
Diagnostics	334
Information	321
Supported	324
Harmonics	
Conversion loss table	152
External Mixer (remote)	443
LO	139
Order (External Mixer)	146
Type (External Mixer)	146
Hiding/restoring	
Display items	305
HiSLIP	
Resource string	338

I

I/O Logging	374
I/Q Analyzer	
Application	109
I/Q data	
Exporting	278
ID String User	354
Identification	
Remote	410
String, R&S FSWP	373
String, resetting (R&S FSWP)	373
IEC/IEEE bus	
see GPIB	337
IECWIN	356
IF OVLD	
Error	89
IF/VIDEO/DEMOD	
Connector	50
Importing	
Functions	271
Softkey	278
Information	
Hardware	321
Options	321
Version	321
Input	
Coupling	136
RF	136
Input ExtMix (channel bar)	84
Input source	135
Inserting	
Limit line values	258

Installing	
Options	323
Instrument name	
Changing	390
Instrument security procedures	24
Instrument settings	
Secure user mode	266
Integrated Measurements	170
Remote Configuration	486
Interfaces	
GPIB	340
LAN	337
USB	341
IP address	338
Assigning	388
Network	372
IP Address	
DNS server	390
IP configuration	
LAN	392
IST	342
IST flag	344
Remote	410
Items	
Saving	270
Settings	272

K

Key	
POWER	40
Redo	44
Undo	44
Keyboard	
On-screen	92
Keypad	95
Key layout	95
Overview	42
Keys	
MKR	244
MKR ->	248
MKR →	250
Peak Search	250
PRESET	262
RUN CONT	118, 120
RUN SINGLE	118, 119, 120

L

LAN	
Configuration	377
Configuring	391
Connector	50
Interface	337
IP address	338
LAN configuration	392
Password	377
Ping	393
Remote control interface	336
Reset	378
Settings	376
Web browser interface	391
Legacy format	
*IDN	374
Level (channel bar)	83
Level offset	156
Level search	156

- LFEOI
 - GPIB terminator 374
- Limit check
 - Activating/Deactivating 259
 - Results 253
- Limit lines 251, 254
 - Activating/Deactivating 255
 - Comment 257
 - Compatibility 251, 255
 - Compatible 259
 - Copying 256, 259
 - Creating 256, 260
 - Data points 258
 - Deactivating 256
 - Defining 258
 - Deleting 256, 260
 - Deleting values 258
 - Details 256
 - Editing 256, 259
 - Inserting values 258
 - Managing 255
 - Name 257
 - Offsets 252
 - Recalling 266
 - Saving 258, 266, 270
 - Shifting 252, 258, 261
 - Storing 254
 - Threshold 252
 - Traces 256
 - View filter 256
 - Violation 253
 - Visibility 255
 - X-axis 257
 - Y-axis 257
- Lines
 - Configuration 254
 - Limit, see Limit lines 254
- Linking
 - Markers 246, 247
- LO
 - Harmonics 139
 - Level (External Mixer) 148
- Loading
 - Functions 271
 - Instrument settings 275
 - Settings 265, 267
- Login
 - Network 394
- Logo
 - Printing 281
- Loop bandwidth
 - External reference 319
- LOUNL
 - Error 89
- M**
- Maintenance 672
- Margins
 - Violation 253
- Marker
 - Information 85
- Marker table
 - Evaluation method 131
 - Information 85
- Marker to Trace 246
- Markers
 - Assigned trace 246
 - Basic settings 244
 - Configuration 244, 247
 - Deactivating 247
 - Delta markers 245
 - Linked 247
 - Linking 246
 - Minimum 250
 - Next minimum 250
 - Next peak 250
 - Peak 250
 - Position 245
 - Positioning 250
 - State 245
 - Table 247
 - Table (evaluation method) 131
 - Tips 241
 - Type 245
 - X-value 245
- MAX (trace information) 84
- Maximize
 - Window 105
- Maximizing
 - Windows (remote) 526
- Meas Time (channel bar) 83
- Measurement
 - Continuous 118
 - Performing 118
 - Single 118
- Measurement channels
 - Activating 99
 - Closing 100
 - Measurement range 161
 - Measurement sequence 169
 - Measurement time 165
 - Measurement zoom 98
- Measurements
 - Evaluation methods 208
- Menus
 - Context-sensitive 92
- Microsoft Windows
 - Access 32
- MIN (trace information) 84
- Mini front panel
 - Hiding/restoring 308
 - Key combination 308
 - Using 315
- Minimum 250
 - Marker positioning 250
 - Next 250
- MKR
 - Key 244
- MKR ->
 - Key 248
- MKR →
 - Key 250
- Monitor
 - External 313
 - Settings 313
- Multiple zoom 213, 214
- MultiView
 - Status display 87
 - Tab 107, 112

N

Name	
Limit lines	257
Navigation control	43
NCor (enhancement label)	84
Network	
Auto-login	395
Changing user passwords	395
Configuration (dialog box)	372
Configuring	336, 387
Connecting the instrument	387
Creating users	394
DNS server	390
Login	394
Operating the instrument	393
Setting up	387
Settings	370
Sharing directories	396
Next Minimum	250
Marker positioning	250
Next Peak	250
Marker positioning	250
NO REF	
Error	89
Noise	
Saving settings	270
Source	185, 186
Noise Figure	
Application	109
Noise source	
Connector	46
Numeric parameters	94

O

OCCO	52
Offset	
level	156
Limit lines	252
Offset frequency	161
On-screen keyboard	92, 94
Online keyboard	40
Operating mode	
Presetting	326
Operating temperature	301
Operation complete	
Remote	410
Options	
Identification (remote)	410
Information	321
Installing	321, 323
Secure user mode (K33)	263
Orientation	
Screenshot	288
Output	185
Buffer	342
External reference	319
Noise source	185, 186
Signal source (optional)	181
OVEN (status display)	89
Overheating	
Shutdown	29

P

Parallel poll register enable	
Remote	411
Parameters	
Entering	94
Password	
Secure user mode	327
Passwords	
Changing	395
Secure user mode	265
Service functions	334
Peak excursion	249
Peak list	
Peak excursion	249
Peak search	
Key	250
Mode	248
Peaks	
Marker positioning	250
Next	250
Softkey	250
Phase Noise	
Application	108
Phase response	195
Ping	393
PN (trace information)	85
PN + AM (trace information)	85
PN Transient analysis	195
Ports	
External Mixer (remote)	445
User	466
Position	
Limit line values	258
POWER	
Key	40
Power sensors	45
Power supply	
Connector	49
PPE register	342, 344
Preset	
Bands (External Mixer, remote)	442
channel settings	263
External Mixer	145
Key	262
Recalling settings	277
Presetting	
Channels	135
Pretrigger	199
Print Screen	
Softkey	284
Printer	
Selecting	286
Printers	
Installing	287
Printing	
Colors	309, 310, 314
Medium	286
Screenshots	284, 290
Probe power	46
Product IDs	341
Programming examples	
Sequencer	419
Service request	659
PSA emulation	646
PSA89600	
Wideband	376

- Pulse
 - Application 110
- Pushing measurements 190, 194
- Q**
- Quick recall
 - Settings 267
- Quick save
 - Secure user mode 267, 269
 - Settings 267
- R**
- R&S FSP
 - Emulating (remote) 627
- R&S FSQ
 - Emulating (remote) 627
- R&S FSU
 - Emulating (remote) 627
- R&S FSV
 - Emulating (remote) 627
- R&S Support 329
- RBW 166
- RBW (channel bar) 83
- Ready for trigger
 - Status register 345
- Rebooting
 - Remote control 605
- Recalling
 - Settings 265, 267, 271, 274
 - Settings for preset 277
 - Softkey 271
- Redo 43, 44
- REF INPUT
 - Connector 52
- Reference
 - External 317
 - Frequency 317
 - Internal 317
 - Softkey 317
- Reference frequency
 - Default 320
 - Input 318
 - Output 319
- Reference level
 - External Mixer 143
- Reference marker 245
- Registers 342
- Relay Cycle Counter 335
- Release notes 24
- Remote control 106
 - Interfaces 336
 - LAN settings 376
 - Protocols 336
- Remote Desktop 387, 399
 - Client 401
 - Ending session 403
 - Setting up a connection 403
 - Setting up controller 401
 - Setting up instrument 400
- Remote display
 - Update 374
- Remote operation
 - Configuring 336
 - Deactivating the instrument 405
 - GPIB address 393
 - GPIB settings 372
 - see also Remote control 336
 - Setting up 387
 - Settings 369
 - Starting 405
 - Stopping 406
- Removable hard drive 49
- Reset values
 - Remote 411
- Residual effects 170
 - Remote Configuration 486
- Resolution bandwidth 166
- Restoring
 - Channel settings 135
- Restricted operation
 - Secure user mode 264
- Restrictions
 - Storage space 264
- Result displays
 - Marker table 131
 - Programming example 575
- Results
 - Data format (remote) 546
 - Displaying 99
 - Exporting 227
 - Managing 262
- RF input 44, 135
- RF overrange
 - External Mixer 140, 145, 445
- RF OVLN (status display) 89
- Rotary knob 43
- RUN CONT
 - Key 118, 120
- RUN SINGLE
 - Key 118, 119, 120
- S**
- Safety instructions 19, 24
- Save/Recall Mode
 - Settings 272
- Savesets
 - Settings 268
- Saving
 - Classified data 263
 - Data types 270
 - Functions 271
 - Instrument settings 275
 - Limit lines 258
 - Screenshots 290
 - Settings 271
 - Softkey 271
- Scale
 - Y-axis 157
- SCPI list
 - Display 360
 - Export 362, 364, 365
- SCPI Recorder 357
- Screen
 - See Touchscreen 310
- Screenshots
 - Printing 284, 290
 - Saving 284, 290
- Search
 - Frequency 160
 - Level 156

- Searching
 - Configuration 248
- Secure user mode
 - Activating 326
 - Activating/deactivating 264
 - Background information 263
 - Instrument settings 266
 - Passwords 265
 - Quick save 267, 269
 - Redirecting storage 263
 - Remote 640
 - Restricted operation 264
 - Self-alignment 300, 322, 324, 369, 370
 - Self-alignment data 264
 - Storage location 270, 272, 274
- SecureUser 264
- Security procedures 24
- Select Marker 246
- Self-alignment 298
 - Aborting 301
 - Secure user mode 264, 300, 322, 324, 369, 370
 - Starting 300
- Self-test
 - Performing 302, 330
 - Remote 412
 - Results 330, 616
 - Settings 330
 - Temperature 302
- Sequencer 83
 - Aborted 300, 331
 - Activating (remote) 417
 - Channels 112
 - Example 113
 - Mode 112, 115
 - Programming example 419
 - Remote 425
 - Run Single 114
 - Setting up 115
 - Single Sweep 114
 - Softkey 114
 - State 114
- Sequences
 - Aborting (remote) 417
 - Mode (remote) 418
- Service functions 328, 332, 333
 - Numeric mode 334
 - Passwords 334
 - Results 334
- Service manual 23
- Service request (SRQ) 336, 342, 343
- Service request enable register (SRE) 342, 343
 - Remote 411
- Settings
 - filename 272, 275
 - Loading 275
 - Managing 262
 - Recalling 265, 267
 - Recalling; restrictions 266
 - Saving 270, 275
 - Storage location 272, 274
 - Storing 265, 267
- SGL (channel bar) 83
- Shift x
 - Limit lines 258
- Shift y
 - Limit lines 258
- Shifting
 - Limit lines 252
- Show SCPI command 358
 - Close 359
 - Copy 359
- Shutdown
 - Automatic 301
 - Remote control 605
- Signal frequency 160
- Signal frequency (channel bar) 83
- Signal level 156
- Signal level (channel bar) 83
- Signal source (optional) 181
- Signal source output 45
- Single Sequencer
 - Softkey 115
- Single sweep
 - Softkey 118, 119
- Single zoom 213, 214
- SmartGrid
 - Activating 102, 210
 - Arranging windows 104, 212
 - Display 100, 208
 - Evaluation bar 103, 211
 - Features 100, 208
 - Mode 102, 210
 - Programming example 575
- Smoothing 225
 - Traces 221
- Soft front panels
 - Using 315
- Softkey bar
 - Hiding/restoring 306
- Softkeys
 - Clear All Messages (remote control) 638
 - Comment 281
 - Continue single sweep 118
 - Continue Single Sweep 120
 - Continuous Sequencer 115
 - Continuous sweep 118
 - Continuous Sweep 120
 - Device 281, 286, 288
 - Display Config 208
 - Export 278
 - Export config 278
 - I/Q Export 278
 - Import 278
 - Install Printer 287
 - Line Config 254
 - Marker Config 244, 247
 - Marker to Trace 246
 - Min 250
 - Next Min 250
 - Next Peak 250
 - Norm/Delta 245
 - Peak 250
 - Print Screen 284
 - R&S Support 329
 - Recall 271
 - Recall File 269, 273
 - Reference 317
 - Save 271
 - Save File 273
 - Search Config 248
 - Select Marker 246
 - Sequencer 114
 - Single Sequencer 115

Single sweep	118
Single Sweep	119
Startup Recall	273
Startup Recall (On/Off)	274
Status	91
Sweep Count	169
System Messages (remote control)	638
Trace Config	231
Trigger Offset	199
Source frequency (channel bar)	83
Source level (channel bar)	83
Specifics for	
Configuration	135
Spectrum	
Application	109
Spectrum Monitor	
Application	108
Split	
Window	105
Split screen mode	40
Splitters	
Window size	104
Spot noise	173
Spur Color	176
Spur removal	85, 175
Spurious Color	176
Spurious Measurements	
Application	110
SRE (service request enable register)	343
SRQ (service request)	343
Start frequency	161
Startup recall	
Remote	587
Startup Recall	
Softkey	274
Status bar	
Color coding	88
Error messages	88
Hiding/restoring	306
Secure user mode	264
Status byte	
Remote	409, 412
Status byte (STB)	343
Status byte register (STB)	342
Status display	87
Status registers	342
STATus:OPERation	345
STATus:QUESTionable	346
STATus:QUESTionable:ACPLimit	347
STATus:QUESTionable:EXTended	348
STATus:QUESTionable:EXTended:INFO	348
STATus:QUESTionable:FREQuency	349
STATus:QUESTionable:LIMit	350
STATus:QUESTionable:LMARgin	350
STATus:QUESTionable:POWer	351
STATus:QUESTionable:POWer:DCPNoise	352
STATus:QUESTionable:POWer:PNOise	352
STATus:QUESTionable:TEMPerature	353
STATus:QUESTionable:TEMPerature	297, 616
STATus:QUESTionable:TIMe	353
Status reporting system	341
Stop frequency	161
Storage	672
Storage location	
Data files	270
Secure user mode	270, 272, 274
Settings	272, 274
Storage settings	
File type	272
Storing	
Settings	265, 267
Subnet Mask	372
Suffixes	
Common	408
Supply voltage	178
Support	668
Information	328, 329
Suppressing	
File name dialog	286
Sweep	
Aborting	119, 120
Mode	118
Sweep Count	169
Sweep direction	169
Sweep range	192
Sweep status	
Status register	345
Sweep voltage	192
SYNC TRIGGER	
Connector	51
System	
Configuration	321
Messages	323
Preset operating mode	326
System keys	40
T	
Table	
Half decades	169
Tabs	
All	99
MultiTab	82
MultiView	107
Switching	82
Technical support	668
Temperature	
Check	297
Check (remote)	616
Excessive	29
Frontend	297
Frontend (remote)	616
Frontend, status bit	297, 353
Self-alignment	297
Self-alignment (remote)	616
Status register	353
Test setup	135
Theme	
Display	309
Threshold	
Limit lines	252
Time	
Format	305
Hiding/restoring	307
Instrument setting	305
Toolbar	
Hiding/restoring	306
Overview	90
touchscreen	
Alignment	297, 302
Touchscreen	
Alignment	298, 303
Colors	309, 310
De-/Activating	304

- Displayed items 305
 - Overview 39
 - Settings 304
 - Theme 309
 - Trace information 84
 - Trace number 84
 - Window title bar 84
 - Trace labels 232
 - Trace math 232
 - Functions 232
 - Settings 231
 - Trace mode 193
 - Trace offset 85
 - Trace smoothing 85, 221, 225
 - Traces 231
 - Configuration (Softkey) 231
 - Copying 231
 - Copying (remote control) 543
 - Export format 229
 - Exporting 227, 228, 233
 - Mode 224
 - Mode (remote) 537
 - Saving 270
 - Traces to be Checked 256
 - Limit lines 256
 - Transducers 266
 - Recalling 266
 - Saving 266, 270
 - Transient analysis 195
 - Transient Analysis 110
 - Application 110
 - Trigger 412
 - Event (remote) 412
 - Holdoff 199
 - Input 46
 - Offset 199
 - Output 46
 - Status register 345
 - Troubleshooting 587
 - File name error 587
 - Hardware 334
 - Remote control programs 374
 - Tuning 190, 194
 - Tuning range 192
 - External reference 319
 - Tuning voltage 192
- U**
- Ultra-Small RBWs 166
 - UNCAL 89
 - Error 89
 - Undo 43, 44
 - Update Path 639
 - Remote control 639
 - Update rate 305
 - Display 305
 - Updating 324
 - Firmware 324
 - USB 341
 - Address 341
 - Connector 50
 - Interfaces 341
 - USB port 45
 - User ports 466
 - Remote control 466
- Users**
- Network 394
 - Password 395
- V**
- VCO measurements 190, 194
 - Vendor ID 341
 - Rohde & Schwarz 341
 - Version information 321
 - VIEW (trace information) 84
 - View filter 256
 - Limit lines 256
 - VISA 337
 - Resource string 338
 - Visible 255
 - Limit lines 255
 - Volatile memory 263
 - Secure user mode 263
 - Voltage supply 178
 - VSA (Vector Signal Analysis) 110
 - Application 110
- W**
- Wait 412
 - Remote 412
 - Waiting for trigger 345
 - Status register 345
 - Warmup time 301
 - Web browser 391
 - Configuration interface 391
 - White papers 24
 - Wideband 376
 - PSA89600 376
 - Window title bar 84
 - Windows 103, 211
 - Adding 103, 211
 - Adding (remote) 526
 - Arranging 104, 212
 - Closing 103, 211
 - Closing (remote) 532
 - Configuring 135
 - Dialog boxes 94
 - Layout (remote) 530
 - Maximizing (remote) 526
 - Querying (remote) 528
 - Replacing (remote) 529
 - Size 104
 - Splitting (remote) 526
 - Types (remote) 526
 - WRH (trace information) 84
 - WRONG_FW 89, 296, 324
 - Error 89, 296, 324
- X**
- X-axis 257
 - Limit lines 257
 - X-value 245
 - Marker 245
 - XCORR 167
 - XCORR Factor (channel bar) 83

Y

Y-axis

Limit lines	257
Scale	157

Z

Zoom

Graphical	98
Measurement	98

Zooming

Activating (remote)	536
Area (Multiple mode, remote)	535
Area (remote)	533
Multiple mode	213, 214
Multiple mode (remote)	536
Restoring original display	216
Single mode	213, 214