

# R&S® FPL1000

## I/Q Analyzer

### User Manual

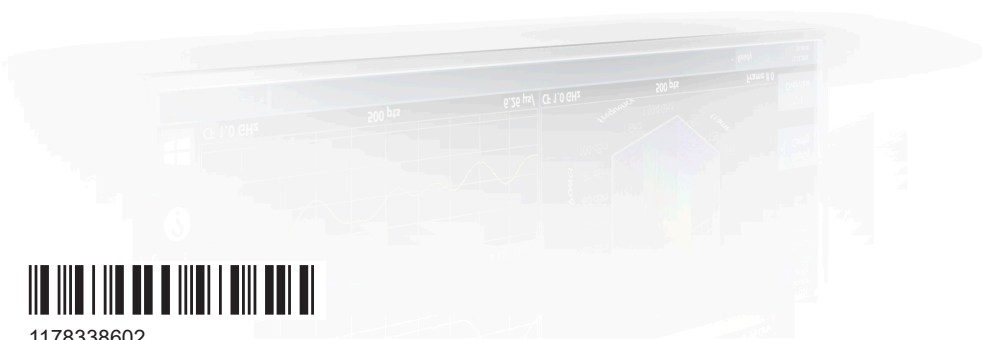
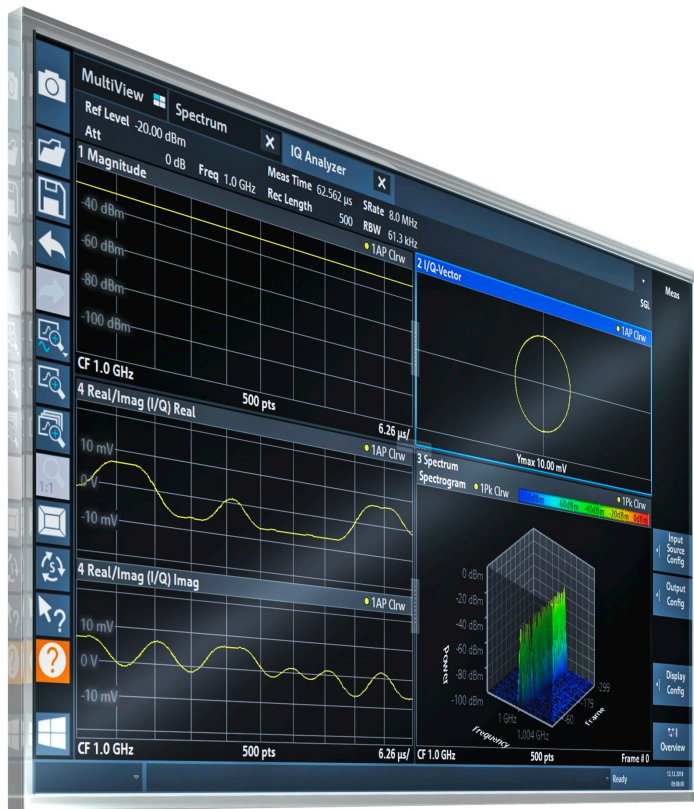

1178338602  
Version 14



This manual applies to the following R&S®FPL1000 models with firmware version 2.10 and later:

- R&S®FPL1003 (1304.0004K03) - FPL1000 with maximum frequency 3 GHz
- R&S®FPL1007 (1304.0004K07) - FPL1000 with maximum frequency 7.5 GHz
- R&S®FPL1014 (1304.0004K14) - FPL1000 with maximum frequency 14 GHz
- R&S®FPL1026 (1304.0004K26) - FPL1000 with maximum frequency 26.5 GHz

In addition to the I/Q Analyzer application in the base unit, the following options are described:

- R&S FPL1-B5, Additional Interfaces (1323.1883.02)
- R&S FPL1-B40, Bandwidth extension 40 MHz (1323.1931.02)
- R&S FPL1-K9 Power Sensor Support(1323.1754.02)

© 2023 Rohde & Schwarz GmbH & Co. KG  
Muehldorfstr. 15, 81671 Muenchen, Germany  
Phone: +49 89 41 29 - 0  
Email: [info@rohde-schwarz.com](mailto:info@rohde-schwarz.com)  
Internet: [www.rohde-schwarz.com](http://www.rohde-schwarz.com)

Subject to change – data without tolerance limits is not binding.

R&S® is a registered trademark of Rohde & Schwarz GmbH & Co. KG.

All other trademarks are the properties of their respective owners.

1178.3386.02 | Version 14 | R&S®FPL1000 | COMPANY RESTRICTED

Throughout this manual, products from Rohde & Schwarz are indicated without the ® symbol, e.g. R&S®FPL is indicated as R&S FPL.

# Contents

<b>1</b>	<b>Preface.....</b>	<b>5</b>
1.1	Documentation overview.....	5
1.2	Conventions used in the documentation.....	7
<b>2</b>	<b>Welcome to the I/Q Analyzer application.....</b>	<b>9</b>
2.1	Starting the I/Q Analyzer application.....	9
2.2	Understanding the display information.....	10
<b>3</b>	<b>Measurement and result displays.....</b>	<b>13</b>
<b>4</b>	<b>Basics on I/Q data acquisition and processing.....</b>	<b>18</b>
4.1	Processing analog I/Q data from RF input.....	18
4.2	Basics on FFT.....	21
4.3	Basics on input from I/Q data files.....	27
4.4	I/Q data import and export.....	27
<b>5</b>	<b>Configuration.....</b>	<b>29</b>
5.1	Configuration overview.....	29
5.2	Import/export functions.....	31
5.3	Receiving data input and providing data output.....	34
5.4	Amplitude.....	44
5.5	Frequency settings.....	50
5.6	Trigger settings.....	51
5.7	Data acquisition and bandwidth settings.....	55
5.8	Display configuration.....	61
5.9	Adjusting settings automatically.....	61
<b>6</b>	<b>Analysis.....</b>	<b>65</b>
6.1	Trace settings.....	65
6.2	Spectrogram settings.....	70
6.3	Trace / data export configuration.....	75
6.4	Marker usage.....	78
<b>7</b>	<b>How to perform measurements in the I/Q Analyzer application....</b>	<b>102</b>
7.1	How to capture baseband (I/Q) data as RF input.....	102

7.2	How to analyze data in the I/Q Analyzer.....	103
8	How to export and import I/Q data.....	104
9	Remote commands to perform measurements with I/Q data.....	106
9.1	Introduction.....	106
9.2	Common suffixes.....	111
9.3	Activating I/Q Analyzer measurements.....	111
9.4	Configuring I/Q Analyzer measurements.....	116
9.5	Configuring the result display.....	155
9.6	Capturing data and performing sweeps.....	163
9.7	I/Q Analysis.....	169
9.8	Retrieving results.....	219
9.9	Importing and exporting I/Q data and results.....	230
9.10	Programming examples.....	232
	<b>Annex.....</b>	<b>235</b>
A	Formats for returned values: ASCII format and binary format.....	235
B	Reference: format description for I/Q data files.....	236
C	I/Q data file format (iq-tar).....	238
C.1	I/Q parameter XML file specification.....	239
C.2	I/Q data binary file.....	243
	<b>List of commands.....</b>	<b>246</b>
	<b>Index.....</b>	<b>253</b>

# 1 Preface

This chapter provides safety-related information, an overview of the user documentation and the conventions used in the documentation.

## 1.1 Documentation overview

This section provides an overview of the R&S FPL1000 user documentation. Unless specified otherwise, you find the documents at:

[www.rohde-schwarz.com/manual/FPL1000](http://www.rohde-schwarz.com/manual/FPL1000)

### 1.1.1 Getting started manual

Introduces the R&S FPL1000 and describes how to set up and start working with the product. Includes basic operations, typical measurement examples, and general information, e.g. safety instructions, etc.

A printed version is delivered with the instrument. A PDF version is available for download on the Internet.

### 1.1.2 User manuals and help

Separate user manuals are provided for the base unit and the firmware applications:

- **Base unit manual**  
Contains the description of all instrument modes and functions. It also provides an introduction to remote control, a complete description of the remote control commands with programming examples, and information on maintenance, instrument interfaces and error messages. Includes the contents of the getting started manual.
- **Firmware application manual**  
Contains the description of the specific functions of a firmware application, including remote control commands. Basic information on operating the R&S FPL1000 is not included.

The contents of the user manuals are available as help in the R&S FPL1000. The help offers quick, context-sensitive access to the complete information for the base unit and the firmware applications.

All user manuals are also available for download or for immediate display on the Internet.

### 1.1.3 Service manual

Describes the performance test for checking compliance with rated specifications, firmware update, troubleshooting, adjustments, installing options and maintenance.

The service manual is available for registered users on the global Rohde & Schwarz information system (GLORIS):

<https://gloris.rohde-schwarz.com>

#### **1.1.4 Instrument security procedures**

Deals with security issues when working with the R&S FPL1000 in secure areas. It is available for download on the internet.

#### **1.1.5 Printed safety instructions**

Provides safety information in many languages. The printed document is delivered with the product.

#### **1.1.6 Data sheets and brochures**

The data sheet contains the technical specifications of the R&S FPL1000. It also lists the firmware applications and their order numbers, and optional accessories.

The brochure provides an overview of the instrument and deals with the specific characteristics.

See [www.rohde-schwarz.com/brochure-datasheet/FPL1000](http://www.rohde-schwarz.com/brochure-datasheet/FPL1000)

#### **1.1.7 Release notes and open source acknowledgment (OSA)**

The release notes list new features, improvements and known issues of the current firmware version, and describe the firmware installation.

The software makes use of several valuable open source software packages. An open source acknowledgment document provides verbatim license texts of the used open source software.

See [www.rohde-schwarz.com/firmware/FPL1000](http://www.rohde-schwarz.com/firmware/FPL1000)

#### **1.1.8 Application notes, application cards, white papers, etc.**

These documents deal with special applications or background information on particular topics.

See [www.rohde-schwarz.com/application/FPL1000](http://www.rohde-schwarz.com/application/FPL1000)

#### **1.1.9 Video tutorials**

Video tutorials that show you how to get started and perform basic tasks with the R&S FPL1000 are available on the Rohde & Schwarz internet site:

[https://www.rohde-schwarz.com/manual/r-s-fpl1000-trying-out-basic-measurement-tasks-manuals\\_78701-567115.html](https://www.rohde-schwarz.com/manual/r-s-fpl1000-trying-out-basic-measurement-tasks-manuals_78701-567115.html)

### 1.1.10 Calibration certificate

The document is available on <https://gloris.rohde-schwarz.com/calcert>. You need the device ID of your instrument, which you can find on a label on the rear panel.

## 1.2 Conventions used in the documentation

### 1.2.1 Typographical conventions

The following text markers are used throughout this documentation:

Convention	Description
"Graphical user interface elements"	All names of graphical user interface elements on the screen, such as dialog boxes, menus, options, buttons, and softkeys are enclosed by quotation marks.
[Keys]	Key and knob names are enclosed by square brackets.
<code>Filenames, commands, program code</code>	Filenames, commands, coding samples and screen output are distinguished by their font.
<i>Input</i>	Input to be entered by the user is displayed in italics.
<a href="#">Links</a>	Links that you can click are displayed in blue font.
"References"	References to other parts of the documentation are enclosed by quotation marks.

### 1.2.2 Conventions for procedure descriptions

When operating the instrument, several alternative methods may be available to perform the same task. In this case, the procedure using the touchscreen is described. Any elements that can be activated by touching can also be clicked using an additionally connected mouse. The alternative procedure using the keys on the instrument or the on-screen keyboard is only described if it deviates from the standard operating procedures.

The term "select" may refer to any of the described methods, i.e. using a finger on the touchscreen, a mouse pointer in the display, or a key on the instrument or on a keyboard.

### 1.2.3 Notes on screenshots

When describing the functions of the product, we use sample screenshots. These screenshots are meant to illustrate as many as possible of the provided functions and possible interdependencies between parameters. The shown values may not represent realistic usage scenarios.

The screenshots usually show a fully equipped product, that is: with all options installed. Thus, some functions shown in the screenshots may not be available in your particular product configuration.



## 2 Welcome to the I/Q Analyzer application

The R&S FPL1 I/Q Analyzer is a firmware application that adds functionality to perform I/Q data acquisition and analysis to the R&S FPL1000.

The R&S FPL1 I/Q Analyzer features:

- Acquisition of analog I/Q data
- Import of stored I/Q data from other applications
- Spectrum, magnitude, I/Q vector and separate I and Q component analysis of any I/Q data on the instrument
- Export of I/Q data to other applications

This user manual contains a description of the functionality that the application provides, including remote control operation.

All functions not discussed in this manual are the same as in the base unit and are described in the R&S FPL1000 User Manual. The latest version is available for download at the product homepage <http://www.rohde-schwarz.com/product/FPL1000>.

### Additional information

Several application notes discussing I/Q analysis are available from the Rohde & Schwarz website:

[1EF85: Converting R&S I/Q data files](#)

[1EF92: Wideband Signal Analysis](#)

[1MA257: Wideband mm-Wave Signal Generation and Analysis](#)

[1EF84: Differential measurements with Spectrum Analyzers and Probes](#)

### Installation

The R&S FPL1 I/Q Analyzer application is part of the standard base unit and requires no further installation.

## 2.1 Starting the I/Q Analyzer application

The I/Q Analyzer is an application on the R&S FPL1000.

### To activate the I/Q Analyzer application

1. Select the [MODE] key.  
A dialog box opens that contains all applications currently available on your R&S FPL1000.
2. Select the "I/Q Analyzer" item.



The R&S FPL1000 opens a new channel setup for the I/Q Analyzer application.

The measurement is started immediately with the default settings.

It can be configured in the I/Q Analyzer "Overview" dialog box, which is displayed when you select the "Overview" softkey from any menu (see [Chapter 5.1, "Configuration overview"](#), on page 29).

### Multiple Channel setups and Sequencer Function

When you activate an application, a new channel setup is created which determines the measurement settings for that application (channel setup). The same application can be activated with different measurement settings by creating several channel setups for the same application.

The number of channel setups that can be configured at the same time depends on the available memory on the instrument.

Only one measurement can be performed at any time, namely the one in the currently active channel setup. However, in order to perform the configured measurements consecutively, a Sequencer function is provided.

If activated, the measurements configured in the currently defined channel setups are performed one after the other in the order of the tabs. The currently active measurement is indicated by a  symbol in the tab label.

The result displays of the individual channel setups are updated in the tabs (as well as the "MultiView") as the measurements are performed. Sequential operation itself is independent of the currently *displayed* tab.

For details on the Sequencer function see the R&S FPL1000 User Manual.

## 2.2 Understanding the display information

The following figure shows a measurement diagram during I/Q Analyzer operation. All different information areas are labeled. They are explained in more detail in the following sections.



**Figure 2-1: Screen elements in the I/Q Analyzer application**

- 1+4 = Window title bar with diagram-specific (trace) information
- 2 = Channel setup bar for firmware and measurement settings
- 3 = Diagram area
- 5 = Diagram footer with diagram-specific information, depending on result display
- 6 = Instrument status bar with error messages and date/time display

### Channel setup bar information

In the I/Q Analyzer application, the R&S FPL1000 shows the following settings:

**Table 2-1: Information displayed in the channel setup bar for the I/Q Analyzer application**

"Ref Level"	Reference level
"m.+el.Att"	Mechanical and electronic RF attenuation
"Ref Offset"	Reference level offset
"Freq"	Center frequency
"Meas Time"	Measurement time
"Rec Length"	Defined record length (number of samples to capture)
"SRate"	Defined sample rate for data acquisition
"RBW"	(Spectrum evaluation only) Resolution bandwidth calculated from the sample rate and record length

In addition, the channel setup bar also displays information on instrument settings that affect the measurement results even though this is not immediately apparent from the display of the measured values (e.g. transducer or trigger settings). This information is displayed only when applicable for the current measurement.

For details see the R&S FPL1000 Getting Started manual.

### Window title bar information

For each diagram, the header provides the following information:



**Figure 2-2: Window title bar information in the I/Q Analyzer application**

- 1 = Window number
- 2 = Window type
- 3 = Trace color
- 4 = Trace number
- 5 = Detector
- 6 = Trace mode

### Diagram footer information

The information in the diagram footer (beneath the diagram) depends on the evaluation:

- Center frequency
- Number of sweep points
- Range per division (x-axis)
- Span (Spectrum)

### Status bar information

Global instrument settings, the instrument status and any irregularities are indicated in the status bar beneath the diagram.

## 3 Measurement and result displays

**Access:** "Overview" > "Display Config"

**Or:** [MEAS] > "Display Config"

The I/Q Analyzer can capture I/Q data. The I/Q data that was captured by or imported to the R&S FPL1000 can then be evaluated in various different result displays. Select the result displays using the SmartGrid functions.

For details on working with the SmartGrid see the R&S FPL1000 Getting Started manual.

### Result displays for I/Q data:

Magnitude.....	13
Spectrum.....	13
I/Q-Vector.....	14
Real/Imag (I/Q).....	15
Phase vs. Time.....	15
Marker Table.....	16
Marker Peak List.....	16

### Magnitude

Shows the level values in time domain.

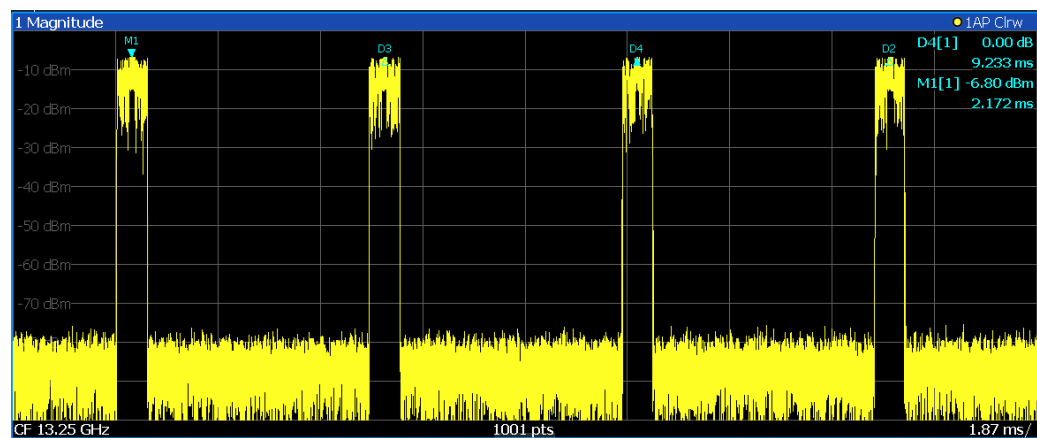

Remote command:

LAY:ADD:WIND? '1', RIGH, MAGN, see LAYout:ADD[:WINDow]? on page 156

Results:

TRACe<n>[:DATA]? on page 224

### Spectrum

Displays the frequency spectrum of the captured I/Q samples.

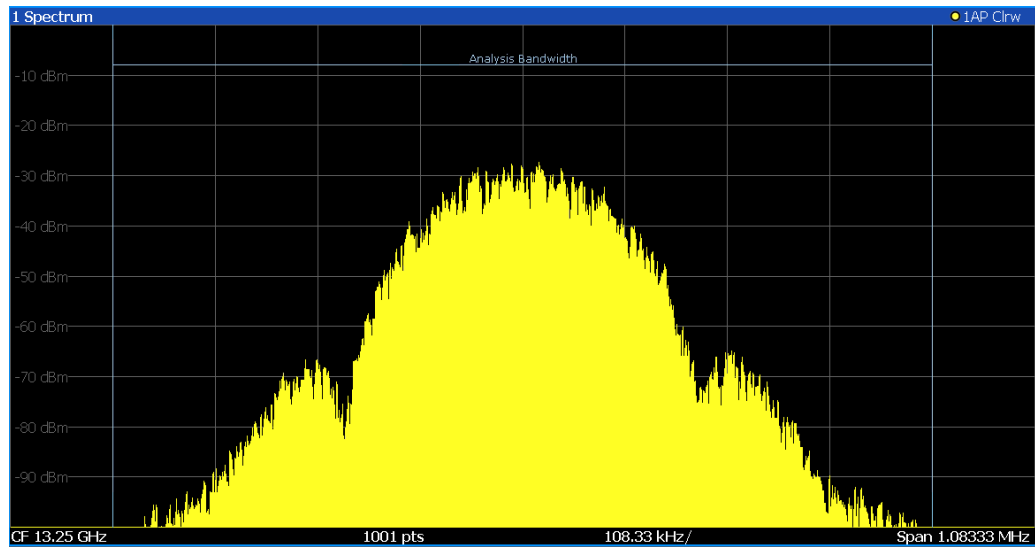

The specified **Analysis Bandwidth** is indicated by vertical blue lines.

Note that a peak search is performed only within the indicated **Analysis Bandwidth**, unless you specify **Search Limits (Left / Right)** in the marker settings.

Remote command:

LAY:ADD:WIND? '1', RIGH, FREQ, see **LAYout:ADD[:WINDow]?** on page 156

Results:

**TRACe**<n>[:DATA]? on page 224

### I/Q-Vector

Displays the captured samples in an I/Q-plot. The samples are connected by a line.

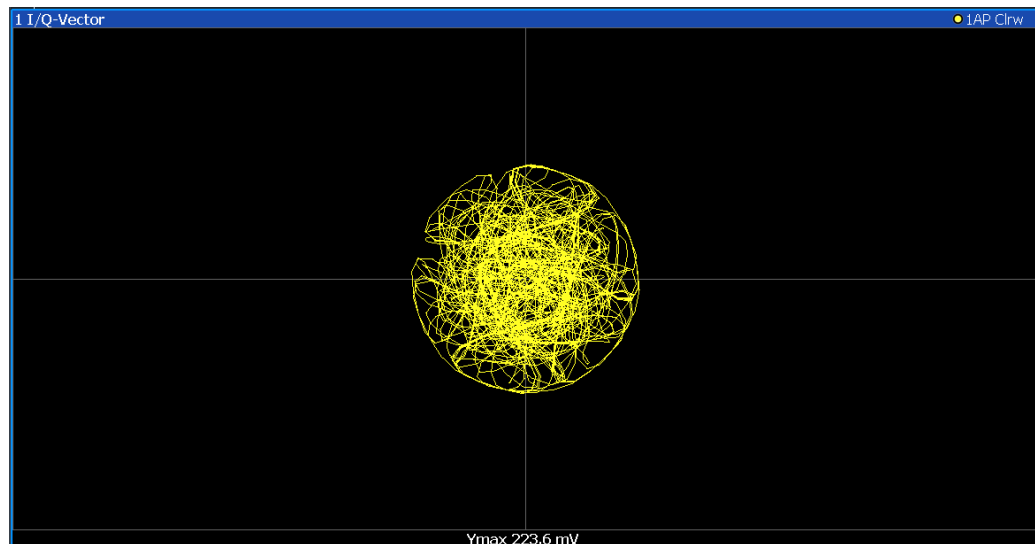

**Note:** For the I/Q vector result display, the number of I/Q samples to record ("Record Length") must be identical to the number of trace points to be displayed ("Sweep Points"; for I/Q Analyzer: 10001). For record lengths outside the valid range of sweep points the diagram does not show valid results.

Remote command:

LAY:ADD:WIND? '1', RIGH, VECT, see LAYout:ADD[:WINDow]? on page 156

Results:

TRACe<n>[:DATA]? on page 224

### Real/Imag (I/Q)

Displays the I and Q values in separate diagrams.

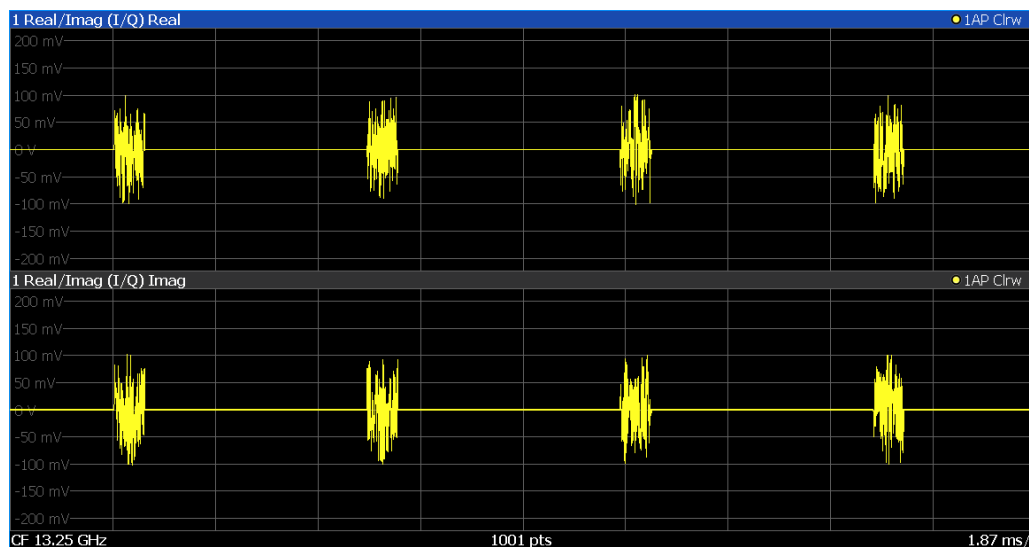

Remote command:

LAY:ADD:WIND? '1', RIGH, RIM, see LAYout:ADD[:WINDow]? on page 156

Results:

TRACe<n>[:DATA]? on page 224

### Phase vs. Time

Shows the phase values in the time domain.

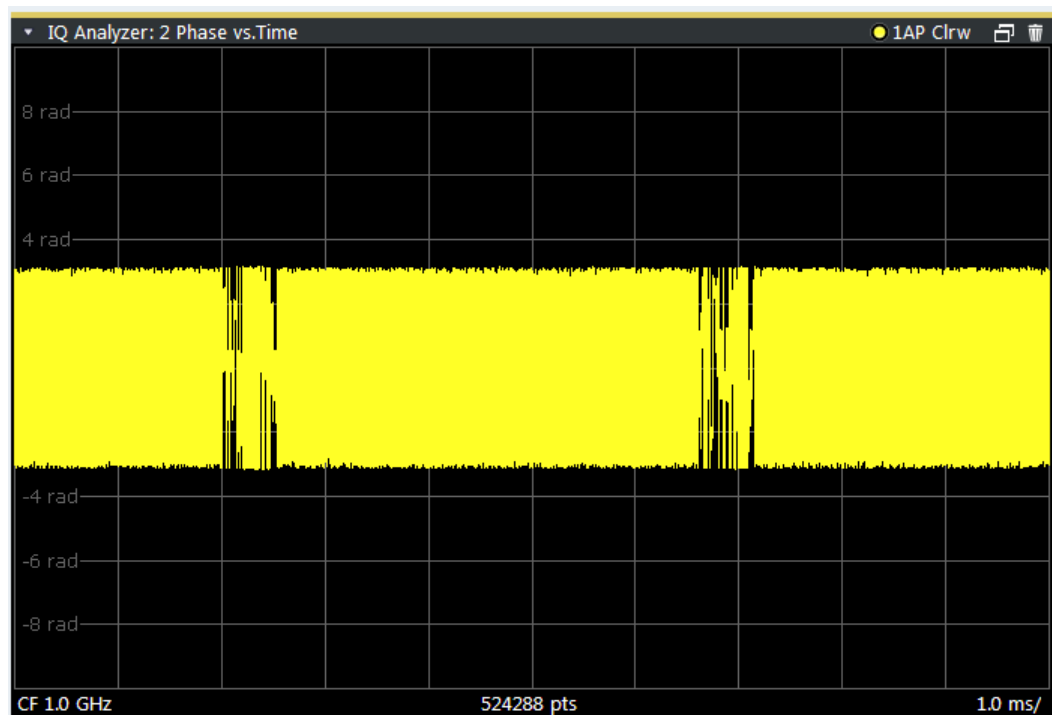

Remote command:

LAY:ADD? '1',RIGH, PHASe, see [LAYout:ADD\[:WINDow\]?](#) on page 156

### Marker Table

Displays a table with the current marker values for the active markers.

This table is displayed automatically if configured accordingly.

(See "[Marker Table Display](#)" on page 82).

2 Marker							
Type	Ref	Trc	Stimulus	Response	Function	Function Result	
N1		1	13.197 GHz	-25.87 dBm	Count	13.197057	
D1	N1	1	-7.942 GHz	-49.41 dB			
D2	N1	2	-3.918 GHz	-21.90 dB			
D3	N1	3	4.024 GHz	-21.99 dB			

**Tip:** To navigate within long marker tables, simply scroll through the entries with your finger on the touchscreen.

Remote command:

LAY:ADD? '1',RIGH, MTAB, see [LAYout:ADD\[:WINDow\]?](#) on page 156

Results:

[CALCulate<n>:MARKer<m>:X](#) on page 190

[CALCulate<n>:MARKer<m>:Y?](#) on page 229

### Marker Peak List

The marker peak list determines the frequencies and levels of peaks in the spectrum or time domain. How many peaks are displayed can be defined, as well as the sort order. In addition, the detected peaks can be indicated in the diagram. The peak list can also be exported to a file for analysis in an external application.



3 Marker Peak List			
Wnd	No	X-Value	Y-Value
2	1	1.086245 ms	-75.810 dBm
2	2	2.172490 ms	-6.797 dBm
2	3	3.258736 ms	-76.448 dBm
2	4	4.831918 ms	-76.676 dBm
2	5	6.255274 ms	-76.482 dBm
2	6	6.798397 ms	-6.800 dBm
2	7	9.233084 ms	-76.519 dBm
2	8	10.075861 ms	-76.172 dBm
2	9	11.405574 ms	-6.801 dBm

**Tip:** To navigate within long marker peak lists, simply scroll through the entries with your finger on the touchscreen.

Remote command:

LAY:ADD? '1',RIGH, PEAK, see LAYout:ADD[:WINDow]? on page 156

Results:

CALCulate<n>:MARKer<m>:X on page 190

CALCulate<n>:MARKer<m>:Y? on page 229

## 4 Basics on I/Q data acquisition and processing

Some background knowledge on basic terms and principles used when describing I/Q data acquisition on the R&S FPL1000 in general, and in the I/Q Analyzer application in particular, is provided here for a better understanding of the required configuration settings.

The I/Q Analyzer provides various possibilities to acquire the I/Q data to be analyzed:

- Capturing analog I/Q data from the [RF Input] connector
- Importing I/Q data from a file

Background information for all these scenarios and more is provided in the following sections.

- [Processing analog I/Q data from RF input](#)..... 18
- [Basics on FFT](#)..... 21
- [Basics on input from I/Q data files](#)..... 27
- [I/Q data import and export](#)..... 27

### 4.1 Processing analog I/Q data from RF input

#### Complex baseband data

In the telephone systems of the past, baseband data was transmitted unchanged as an analog signal. In modern phone systems and in radio communication, however, the baseband data is modulated on a carrier frequency, which is then transmitted. The receiver must demodulate the data based on the carrier frequency. When using modern modulation methods (e.g. QPSK, QAM etc.), the baseband signal becomes complex. Complex data (or: I/Q data) consists of an imaginary (I) and a real (Q) component.

#### Sweep vs sampling

The standard Spectrum application on the R&S FPL1000 performs frequency sweeps on the input signal and measurements in the frequency and time domain. Other applications on the R&S FPL1000, such as the I/Q Analyzer, sample and process the individual I and Q components of the complex signal.

#### I/Q Analyzer - processing complex data from RF input

The I/Q Analyzer is a standard application used to capture and analyze I/Q data on the R&S FPL1000. By default, it assumes the I/Q data is modulated on a carrier frequency and input via the "RF Input" connector on the R&S FPL1000.

The A/D converter samples the IF signal at a rate of 100 MHz. The digital signal is down-converted to the complex baseband, lowpass-filtered, and the sample rate is

reduced. The analog filter stages in the analyzer cause a frequency response which adds to the modulation errors. An **equalizer filter** before the **resampler** compensates for this frequency response. The continuously adjustable sample rates are realized using an optimal decimation filter and subsequent resampling on the set sample rate.

A dedicated memory (**capture buffer**) is available in the R&S FPL1000 for a maximum of 25 Msamples ( $25 \times 1000 \times 1000$ ) of complex samples (pairs of I and Q data). The number of complex samples to be captured can be defined (for restrictions refer to [Chapter 4.1.1, "Sample rate and maximum usable I/Q bandwidth for RF input"](#), on page 19).

The block diagram in [Figure 4-1](#) shows the analyzer hardware from the IF section to the processor.

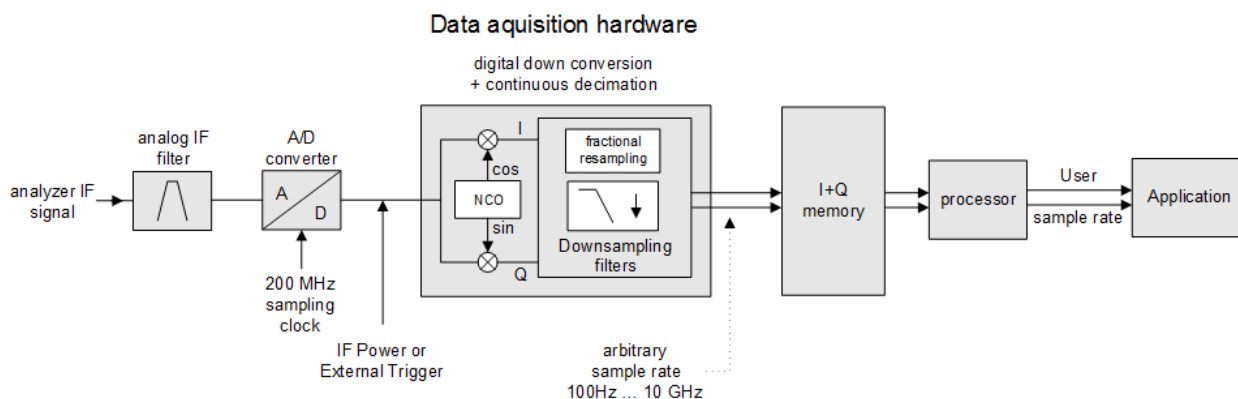

**Figure 4-1: Block diagram illustrating the R&S FPL1000 signal processing for analog I/Q data (without bandwidth extension options)**

### 4.1.1 Sample rate and maximum usable I/Q bandwidth for RF input

#### Definitions

- **Input sample rate (ISR):** the sample rate of the useful data provided by the device connected to the input of the R&S FPL1000
- (User, Output) **Sample rate (SR):** the user-defined sample rate (e.g. in the "Data Acquisition" dialog box in the "I/Q Analyzer" application) which is used as the basis for analysis or output
- **Usable I/Q (Analysis) bandwidth:** the bandwidth range in which the signal remains undistorted in regard to amplitude characteristic and group delay; this range can be used for accurate analysis by the R&S FPL1000
- **Record length:** Number of I/Q samples to capture during the specified measurement time; calculated as the measurement time multiplied by the sample rate

For the I/Q data acquisition, digital decimation filters are used internally in the R&S FPL1000. The passband of these digital filters determines the *maximum usable I/Q bandwidth*. In consequence, signals within the usable I/Q bandwidth (passband) remain unchanged, while signals outside the usable I/Q bandwidth (passband) are

suppressed. Usually, the suppressed signals are noise, artifacts, and the second IF side band. If frequencies of interest to you are also suppressed, try to increase the output sample rate, which increases the maximum usable I/Q bandwidth.



### Bandwidth extension options

You can extend the maximum usable I/Q bandwidth provided by the R&S FPL1000 in the basic installation by adding options. These options can either be included in the initial installation (B-options) or updated later (U-options). The maximum bandwidth provided by the individual option is indicated by its number, for example, B40 extends the bandwidth to 40 MHz.

As a rule, the usable I/Q bandwidth is proportional to the output sample rate. Yet, when the I/Q bandwidth reaches the bandwidth of the analog IF filter (at very high output sample rates), the curve breaks.

- [Relationship between sample rate, record length and usable I/Q bandwidth.....](#) 20

#### 4.1.1.1 Relationship between sample rate, record length and usable I/Q bandwidth

Up to the maximum bandwidth, the following rule applies:

$$\text{Usable I/Q bandwidth} = 0.8 * \text{Output sample rate}$$

Regarding the record length, the following rule applies:

$$\text{Record length} = \text{Measurement time} * \text{sample rate}$$

#### Maximum record length for RF input

The maximum record length is the maximum number of samples that can be captured.

**Table 4-1: Maximum record length**

Sample rate	Maximum record length
100 Hz to 100 MHz	25 Msamples

The [Figure 4-2](#) shows the maximum usable I/Q bandwidths depending on the output sample rates.

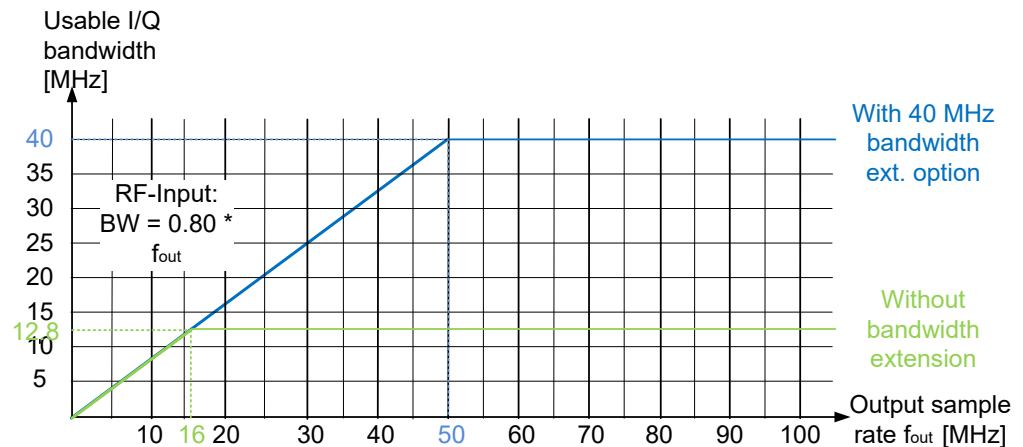
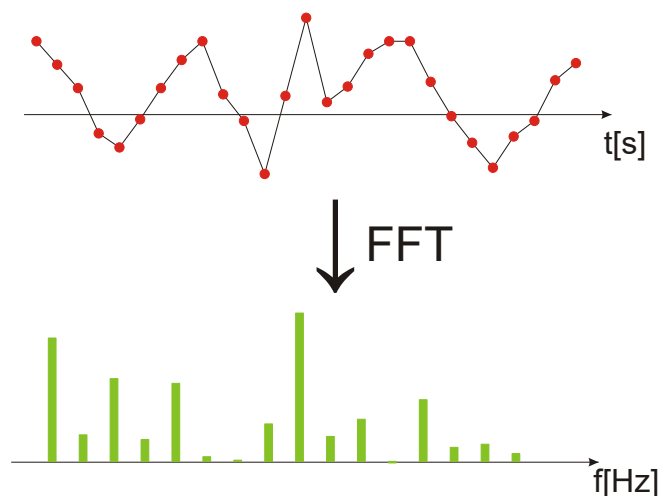

Figure 4-2: Relationship between maximum usable I/Q bandwidth and output sample rate

## 4.2 Basics on FFT

The I/Q Analyzer measures the power of the signal input over time. To convert the time domain signal to a frequency spectrum, an FFT (Fast Fourier Transformation) is performed which converts a vector of input values into a discrete spectrum of frequencies.



### 4.2.1 Window functions

The Fourier transformation is not performed on the entire captured data in one step. Only a limited number of samples is used to calculate an individual result. This process is called windowing.

After sampling in the time domain, each window is multiplied with a specific window function. Windowing helps minimize the discontinuities at the end of the measured signal interval and thus reduces the effect of spectral leakage, increasing the frequency resolution.

Various different window functions are provided in the R&S FPL1000 to suit different input signals. Each of the window functions has specific characteristics, including some advantages and some trade-offs. Consider these characteristics to find the optimum solution for the measurement task.



#### Ignoring the window function - rectangular window

The rectangular window function is in effect not a function at all, it maintains the original sampled data. This may be useful to minimize the required bandwidth. However, be aware that if the window does not contain exactly one period of your signal, heavy sidelobes may occur, which do not exist in the original signal.

**Table 4-2: Characteristics of typical FFT window functions**

Window type	Frequency resolution	Magnitude resolution	Sidelobe suppression	Measurement recommendation
Rectangular	Best	Worst	Worst	No function applied. Separation of two tones with almost equal amplitudes and a small frequency distance
Blackman-Harris (default)	Good	Good	Good	Harmonic detection and spurious emission detection
Gauss (Alpha = 0.4)	Good	Good	Good	Weak signals and short duration
Flattop	Worst	Best	Good	Accurate single tone measurements
5-Term	Good	Good	Best	Measurements with very high dynamic range

### 4.2.2 Overlapping

The I/Q Analyzer calculates multiple FFTs per measurement by dividing one captured record into several windows. Furthermore, the I/Q Analyzer allows consecutive windows to overlap. Overlapping "reuses" samples that were already used to calculate the preceding FFT result.

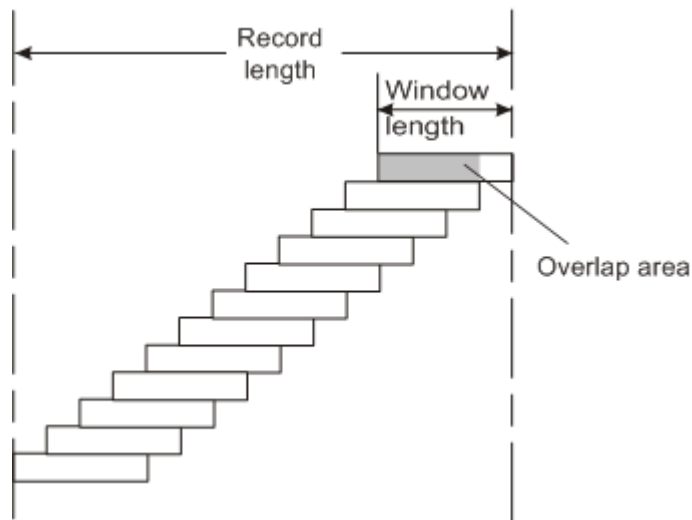

In advanced FFT mode with averaging, the overlapping factor can be set freely. The higher the overlap factor, the more windows are used. This leads to more individual results and improves detection of transient signal effects. However, it also extends the duration of the calculation. The size of the window can be defined manually according to the record length, the overlap factor, and the FFT length.

An FFT overlap of 67%, for example, means the second FFT calculation uses the last 67% of the data of the first FFT. It uses only 33% new data. The third FFT still covers 33% of the first FFT and 67% of the second FFT, and so on.

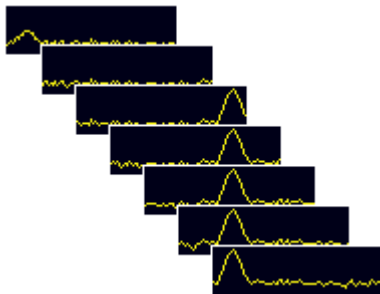

**Figure 4-3: Overlapping FFTs**

In "Manual" or "Auto" FFT mode, an FFT length of 4096 and a window length of 4096 (or the record length, if shorter) is used to calculate the spectrum.

### Combining results - trace detector

If the record length permits, multiple overlapping windows are calculated and combined to create the final spectrum using the selected trace detector. If necessary, the trace detector is also used to reduce the number of calculated frequency points (defined by the FFT length) to the defined number of sweep points. By default, the Autopeak trace detector is used.



Since the frequency points are reduced to the number of sweep points, using a detector other than "Auto Peak" and fewer than 4096 sweep points can lead to false level results.

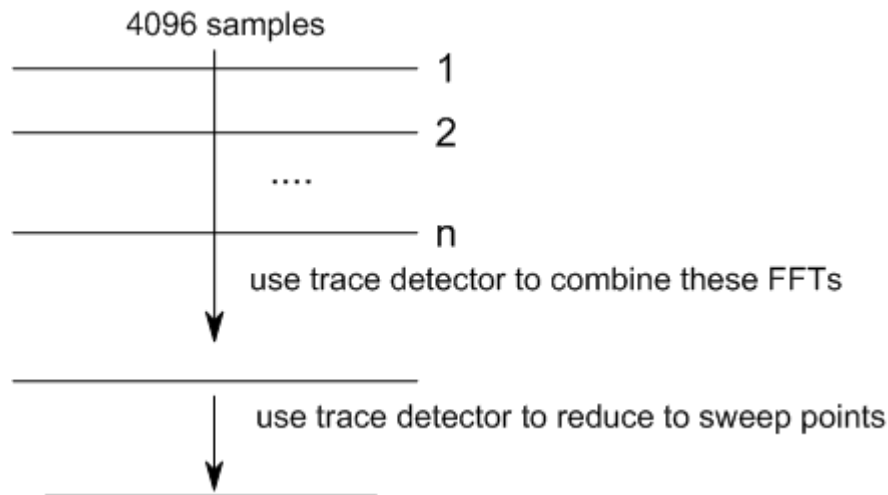

### 4.2.3 Dependencies between FFT parameters

FFT analysis in the R&S FPL1000 is highly configurable. Several parameters, including the resolution bandwidth, record length, and FFT length, are user-definable. Note, however, that several parameters are correlated and not all can be configured independently of the others.

#### Record Length

Defines the number of I/Q samples to capture. By default, the number of sweep points is used. The record length is calculated as the measurement time multiplied by the sample rate.

If you change the record length, the [Meas Time](#) is automatically changed, as well.

For FFTs using only a single window ("Single" mode), the record length (which is then identical to the FFT length) must not exceed 512k.

#### FFT Length

Defines the number of frequency points determined by each FFT calculation. The more points are used, the higher the resolution in the spectrum becomes, but the longer the calculation takes.

In "Auto" or "Manual" mode, an FFT length of 4096 is used.

If the FFT length is longer than the [Window Length](#) the sample data is filled up with zeros up to the FFT length. The FFT is then performed using interpolated frequency points.

For an FFT length that is not a power of 2, a DFT (discrete Fourier transform) is performed, which requires more time for calculation, but avoids the effects of interpolation.



To display all calculated frequency points (defined by the FFT length), the number of sweep points is set to the FFT length automatically in advanced FFT mode.

### Window Length

Defines the number of samples to be included in a single window in averaging mode. (In single mode, the window length corresponds to the "Record Length" on page 57.)

Values from 3 to 4096 are available in "Manual" mode; in "Advanced" FFT mode, values from 3 to 524288 are available. However, the window length must not be longer than the [FFT Length](#).

If the window length is shorter than the [FFT Length](#), the sample data is filled up with zeros up to the FFT length.

If the window length is longer than the [Record Length](#) (that is, not enough samples are available), a window length the size of the [Record Length](#) is used for calculation.

The window length and the [Window Overlap](#) determine how many FFT calculations must be performed for each record in averaging mode (see "[Transformation Algorithm](#)" on page 58).

## 4.2.4 Frequency resolution of FFT results - RBW

The **resolution bandwidth** defines the minimum frequency separation at which the individual components of a spectrum can be distinguished. Small values result in high precision, as the distance between two distinguishable frequencies is small. Higher values decrease the precision, but increase measurement speed.

The RBW is determined by the following equation:

$$RBW = \text{Normalized Bandwidth} * \frac{\text{Sample Rate}}{\text{Window Length}}$$

*Equation 4-1: Definition of RBW*

(Note: The normalized bandwidth is a fixed value that takes the noise bandwidth of the window function into consideration.)

The maximum RBW is restricted by the [Analysis Bandwidth](#), or by the following equation, whichever is higher:

$$RBW_{max} = \frac{\text{Normalized Bandwidth} * \text{Sample Rate}}{3}$$

If a higher spectral resolution is required, the number of samples must be increased by using a higher sample rate or longer record length.

The minimum achievable RBW depends on the sample rate and record length, according to the following equation:

$$RBW_{min} = \frac{\text{Normalized Bandwidth} * \text{Sample Rate}}{\min(4096, \text{Record Length})}$$

To simplify operation, some parameters are coupled and automatically calculated, such as record length and RBW.

### **RBW mode**

Depending on the selected RBW mode, the resolution bandwidth is either determined automatically or can be defined manually.

#### **Auto mode:**

This is the default mode in the I/Q Analyzer. The RBW is determined automatically depending on the [Sample Rate](#) and [Window Length](#), where the window length corresponds to the [Record Length](#), or a maximum of 4096.

If the record length is larger than the window length, multiple windows are combined; the FFT length is 4096.

A Flatop window function is used.

#### **Manual mode:**

The RBW is user-definable.

The [Window Length](#) is adapted to comply with [Equation 4-1](#). Since only window lengths with integer values can be employed, the [Sample Rate](#) is adapted, if necessary, to obtain an integer window length value.

If the record length is larger than the window length, multiple windows are combined; the FFT length is 4096.

A Flatop window function is used.

#### **Advanced FFT mode**

The RBW is determined by the [advanced FFT parameters](#), depending on the selected [FFT calculation methods](#) method.

## **4.2.5 FFT calculation methods**

FFT calculation can be performed using different methods.

### **Single**

In single mode, one FFT is calculated for the entire record length, that means the window length is identical to the record length.

If the defined [FFT Length](#) is larger than the record length, zeros are appended to the captured data to reach the FFT length.



Figure 4-4: FFT parameters for single FFT calculation

### Averaging

In averaging mode, several overlapping FFTs are calculated for each record; the results are combined to determine the final FFT result for the record.

The number of FFTs to be combined is determined by the [Window Overlap](#) and the [Window Length](#).



Figure 4-5: FFT parameters for averaged FFT calculation

## 4.3 Basics on input from I/Q data files

The I/Q data to be evaluated in a particular R&S FPL1000 application cannot only be captured by the application itself, it can also be loaded from a file, provided it has the correct format. The file is then used as the input source for the application.

The I/Q data must be stored in a format with the file extension `.iq.tar`. For a detailed description, see [Chapter C, "I/Q data file format \(iq-tar\)"](#), on page 238.



An application note on converting Rohde & Schwarz I/Q data files is available from the Rohde & Schwarz website:

[1EF85: Converting R&S I/Q data files](#)

When using input from an I/Q data file, the [RUN SINGLE] function starts a single measurement (i.e. analysis) of the stored I/Q data, while the [RUN CONT] function repeatedly analyzes the same data from the file.

## 4.4 I/Q data import and export

Baseband signals mostly occur as so-called complex baseband signals, i.e. a signal representation that consists of two channels; the inphase (I) and the quadrature (Q)

channel. Such signals are referred to as I/Q signals. The complete modulation information and even distortion that originates from the RF, IF or baseband domains can be analyzed in the I/Q baseband.

Importing and exporting I/Q signals is useful for various applications:

- Generating and saving I/Q signals in an RF or baseband signal generator or in external software tools to analyze them with the R&S FPL1000 later.
- Capturing and saving I/Q signals with the R&S FPL1000 to analyze them with the R&S FPL1000 or an external software tool later



As opposed to storing trace data, which can be averaged or restricted to peak values, I/Q data is stored as it was captured, without further processing. Multi-channel data is not supported.

The data is stored as complex values in 32-bit floating-point format. The I/Q data is stored in a format with the file extension `.iq.tar`.



An application note on converting Rohde & Schwarz I/Q data files is available from the Rohde & Schwarz website:

[1EF85: Converting R&S I/Q data files](#)

The import and export functions are available in the "Save/Recall" menu which is displayed when you select the  "Save" or  "Open" icon in the toolbar (see [Chapter 5.2, "Import/export functions"](#), on page 31).

## 5 Configuration

**Access:** [MODE] > "I/Q Analyzer"

The I/Q Analyzer is a special application on the R&S FPL1000.

For details see the "Applications, measurement channels, and result displays" chapter in the R&S FPL1000 User Manual.

When you switch to an I/Q Analyzer channel setup the first time, a set of parameters is passed on from the currently active application. After initial setup, the parameters for the channel setup are stored upon exiting and restored upon re-entering the channel setup. Thus, you can switch between applications quickly and easily.

When you activate a channel setup for the I/Q Analyzer application, data acquisition from the input signal is started automatically with the default configuration. The "I/Q Analyzer" menu is displayed and provides access to the most important configuration functions.

The remote commands required to perform these tasks are described in [Chapter 9, "Remote commands to perform measurements with I/Q data"](#), on page 106.



### Importing and Exporting I/Q Data

The I/Q data to be evaluated in the I/Q Analyzer application can not only be captured by the I/Q Analyzer itself, it can also be imported to the R&S FPL1000, provided it has the correct format. Furthermore, the captured I/Q data from the I/Q Analyzer can be exported for further analysis in external applications.

For details see [Chapter 4.4, "I/Q data import and export"](#), on page 27.

- [Configuration overview](#).....29
- [Import/export functions](#).....31
- [Receiving data input and providing data output](#).....34
- [Amplitude](#).....44
- [Frequency settings](#).....50
- [Trigger settings](#).....51
- [Data acquisition and bandwidth settings](#).....55
- [Display configuration](#).....61
- [Adjusting settings automatically](#).....61

### 5.1 Configuration overview



**Access:** all menus

Throughout the channel setup configuration, an overview of the most important currently defined settings is provided in the "Overview".



### Multiple access paths to functionality

The easiest way to configure a channel setup is via the "Overview" dialog box, which is available from all menus.

Alternatively, you can access the individual dialog boxes from the corresponding menu items, or via tools in the toolbars, if available.

In this documentation, only the most convenient method of accessing the dialog boxes is indicated - usually via the "Overview".

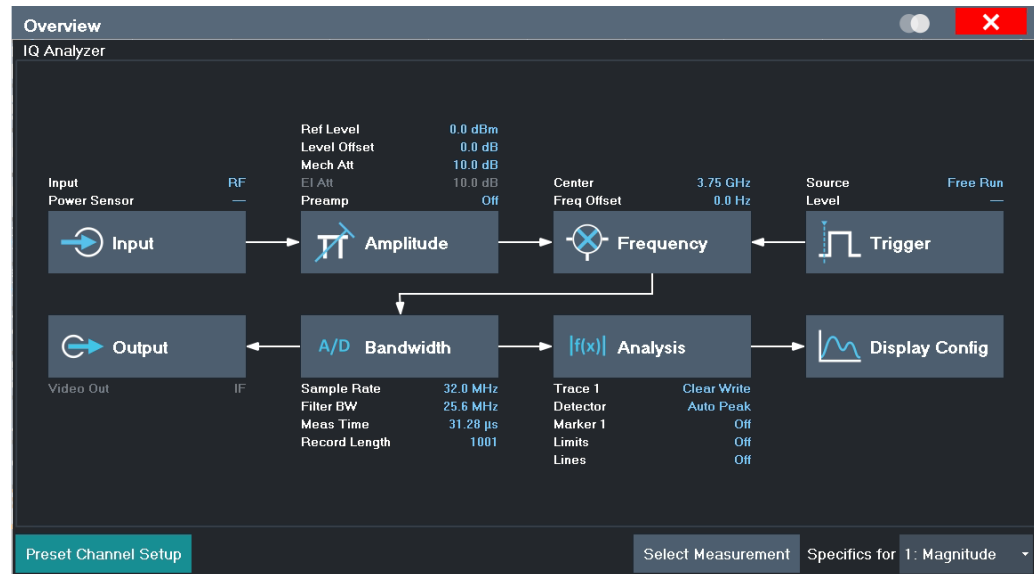

Figure 5-1: Configuration Overview for I/Q Analyzer primary

In addition to the main measurement settings, the "Overview" provides quick access to the main settings dialog boxes. The individual configuration steps are displayed in the order of the data flow. Thus, you can easily configure an entire channel setup from input over processing to output and analysis by stepping through the dialog boxes as indicated in the "Overview".

The "Overview" for the I/Q Analyzer provides quick access to the following configuration dialog boxes (listed in the recommended order of processing):

1. Input settings  
See [Chapter 5.3.1, "Radio frequency input"](#), on page 34
2. Amplitude settings  
See [Chapter 5.4, "Amplitude"](#), on page 44
3. Frequency settings  
See [Chapter 5.5, "Frequency settings"](#), on page 50
4. Optionally, Trigger/Gate settings  
See [Chapter 5.6, "Trigger settings"](#), on page 51
5. Bandwidth settings  
See [Chapter 5.7, "Data acquisition and bandwidth settings"](#), on page 55

6. Analysis settings and functions  
See [Chapter 6, "Analysis"](#), on page 65
7. Display configuration  
See [Chapter 5.8, "Display configuration"](#), on page 61

### To configure settings

- ▶ Select any button in the "Overview" to open the corresponding dialog box.  
Select a setting in the channel bar (at the top of the channel setup tab) to change a specific setting.

For step-by-step instructions on configuring I/Q Analyzer measurements, see [Chapter 7, "How to perform measurements in the I/Q Analyzer application"](#), on page 102.

### Preset Channel setup

Select the "Preset Channel" button in the lower left-hand corner of the "Overview" to restore all measurement settings *in the current channel setup* to their default values.

**Note:** Do not confuse the "Preset Channel" button with the [Preset] key, which restores the entire instrument to its default values and thus closes *all channel setups* on the R&S FPL1000 (except for the default channel setup)!

Remote command:

`SYSTem:PRESet:CHANnel [:EXEC]` on page 115

### Specific Settings for

The channel setup can contain several windows for different results. Thus, the settings indicated in the "Overview" and configured in the dialog boxes vary depending on the selected window.

Select an active window from the "Specific Settings for" selection list that is displayed in the "Overview" and in all window-specific configuration dialog boxes.

The "Overview" and dialog boxes are updated to indicate the settings for the selected window.

## 5.2 Import/export functions



**Access:** "Save"/ "Open" icon in the toolbar > "Import" / "Export"



The R&S FPL1000 provides various evaluation methods for the results of the performed measurements. However, you may want to evaluate the data with further, external applications. In this case, you can export the measurement data to a standard format file (ASCII or XML). Some of the data stored in these formats can also be re-imported to the R&S FPL1000 for further evaluation later, for example in other applications.

The following data types can be exported (depending on the application):

- Trace data
- Table results, such as result summaries, marker peak lists etc.

- I/Q data

The following data types can be imported (depending on the application):

- I/Q data



I/Q data can only be imported and exported in applications that process I/Q data, such as the I/Q Analyzer or optional applications.

See the corresponding user manuals for those applications for details.



These functions are only available if no measurement is running.

In particular, if **Continuous Sweep / Run Cont** is active, the import/export functions are not available.

Import.....	32
L I/Q Import.....	32
L File Explorer.....	32
Export.....	32
L Export Trace to ASCII File.....	33
L File Type.....	33
L Decimal Separator.....	33
L File Explorer.....	34
L Export Configuration.....	34
L I/Q Export.....	34
L File Explorer.....	34



### Import

**Access:** "Save/Recall" > Import



Provides functions to import data.

#### I/Q Import ← Import

Opens a file selection dialog box to select an import file that contains I/Q data. This function is only available in single sweep mode and only in applications that process I/Q data, such as the I/Q Analyzer or optional applications.

Input from I/Q data files is imported as it was stored, including any correction factors, for example from transducers or SnP files. Any currently configured correction factors at the time of import, however, are not applied.

Remote command:

`MMEMoRy:LOAD:IQ:STATe` on page 230

#### File Explorer ← I/Q Import ← Import

Opens the Microsoft Windows File Explorer.

Remote command:

not supported



### Export

**Access:** "Save/Recall" > Export



Opens a submenu to configure data export.



**Export Trace to ASCII File ← Export**

Saves the selected trace or all traces in the currently active result display to the specified file and directory in the selected ASCII format.

"File Explorer": Instead of using the file manager of the R&S FPL1000 firmware, you can also use the Microsoft Windows File Explorer to manage files.

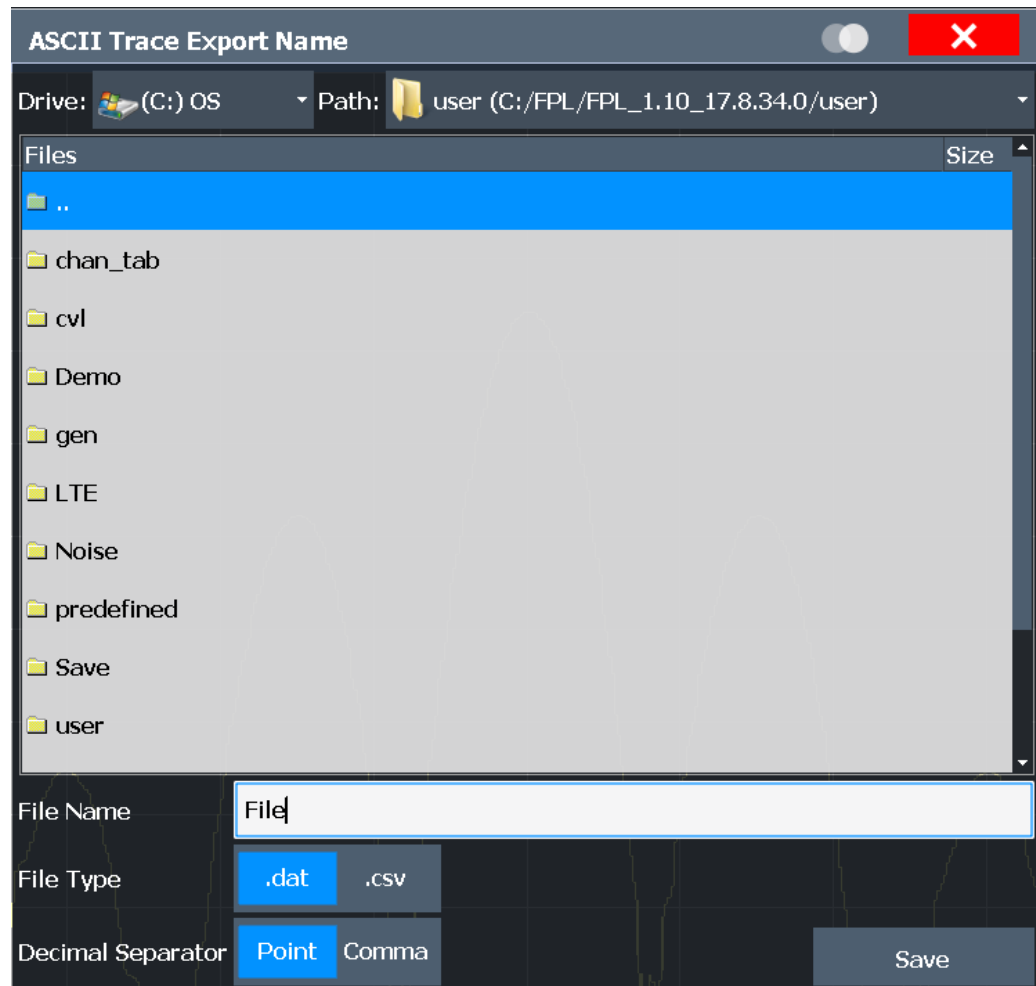

Remote command:

[MMEMory:STORe<n>:TRACe](#) on page 228

**File Type ← Export Trace to ASCII File ← Export**

Determines the format of the ASCII file to be imported or exported.

Depending on the external program in which the data file was created or is evaluated, a comma-separated list (CSV) or a plain data format (DAT) file is required.

Remote command:

[FORMat:DEXPort:FORMat](#) on page 227

**Decimal Separator ← Export Trace to ASCII File ← Export**

Defines the decimal separator for floating-point numerals for the data export/import files. Evaluation programs require different separators in different languages.

Remote command:

[FORMat:DEXPort:DSEParator](#) on page 226

#### **File Explorer ← Export Trace to ASCII File ← Export**

Opens the Microsoft Windows File Explorer.

Remote command:

not supported

#### **Export Configuration ← Export**

Opens the "Traces" dialog box to configure the trace and data export settings.

#### **I/Q Export ← Export**

Opens a file selection dialog box to define an export file name to which the I/Q data is stored. This function is only available in single sweep mode.

It is not available in the Spectrum application, only in applications that process I/Q data, such as the I/Q Analyzer or optional applications.

For details, see the description in the R&S FPL1000 I/Q Analyzer User Manual ("Importing and Exporting I/Q Data").

**Note:** Storing large amounts of I/Q data (several Gigabytes) can exceed the available (internal) storage space on the R&S FPL1000. In this case, it can be necessary to use an external storage medium.

Remote command:

[MMEMory:STORe<n>:IQ:STATe](#) on page 231

[MMEMory:STORe<n>:IQ:COMMeNt](#) on page 230

#### **File Explorer ← I/Q Export ← Export**

Opens the Microsoft Windows File Explorer.

Remote command:

not supported

## 5.3 Receiving data input and providing data output

The R&S FPL1000 can analyze signals from different input sources and provide various types of output (such as noise source control signals).

Internal generator settings are described in the R&S FPL1000 User Manual.

- [Radio frequency input](#)..... 34
- [Settings for input from I/Q data files](#)..... 37
- [Power sensors](#)..... 37
- [Output settings](#)..... 44

### 5.3.1 Radio frequency input

**Access:** "Overview" > "Input" > "Input Source" > "Radio Frequency"

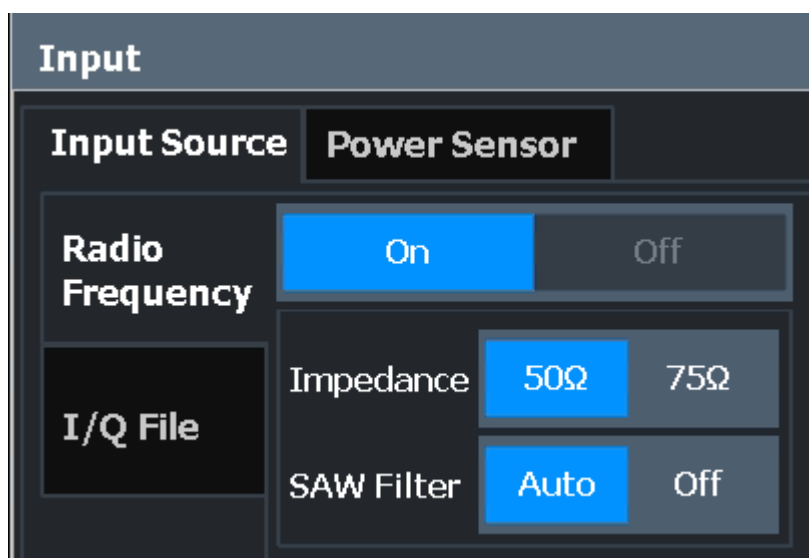

### RF Input Protection

The RF input connector of the R&S FPL1000 must be protected against signal levels that exceed the ranges specified in the data sheet. Therefore, the R&S FPL1000 is equipped with an overload protection mechanism. This mechanism becomes active as soon as the power at the input mixer exceeds the specified limit. It ensures that the connection between RF input and input mixer is cut off.

The RF input connector of the R&S FPL1000 must be protected against signal levels that exceed the ranges specified in the data sheet. Therefore, the R&S FPL1000 is equipped with an overload protection mechanism for DC and signal frequencies up to 30 MHz. This mechanism becomes active as soon as the power at the input mixer exceeds the specified limit. It ensures that the connection between RF input and input mixer is cut off.

When the overload protection is activated, an error message is displayed in the status bar ("INPUT OVLD"), and a message box informs you that the RF input was disconnected. Furthermore, a status bit (bit 3) in the `STAT:QUES:POW` status register is set. In this case, you must decrease the level at the RF input connector and then close the message box. Then measurement is possible again. Reactivating the RF input is also possible via the remote command `INPut:ATTenuation:PROTection:RESet`.



The power sensor functions are described in the R&S FPL1000 User Manual.

<a href="#">Radio Frequency State</a> .....	35
<a href="#">Impedance</a> .....	36
<a href="#">YIG-Preselector</a> .....	36
<a href="#">SAW filter</a> .....	36

### Radio Frequency State

Activates input from the "RF Input" connector.

Remote command:

`INPut<ip>:SElect` on page 118

### Impedance

For some measurements, the reference impedance for the measured levels of the R&S FPL1000 can be set to 50  $\Omega$  or 75  $\Omega$ .

Select 75  $\Omega$  if the 50  $\Omega$  input impedance is transformed to a higher impedance using a 75  $\Omega$  adapter of the RAZ type. (That corresponds to 25 $\Omega$  in series to the input impedance of the instrument.) The correction value in this case is 1.76 dB = 10 log (75 $\Omega$ /50 $\Omega$ ).

This value also affects the unit conversion (see "Reference Level" on page 46).

Remote command:

`INPut<ip>:IMPedance` on page 118

### YIG-Preselector

Enables or disables the YIG-preselector.

This setting requires the option R&S FPL1-B11 on the R&S FPL1000.

An internal YIG-preselector at the input of the R&S FPL1000 ensures that image frequencies are rejected. However, image rejection is only possible for a restricted bandwidth. To use the maximum bandwidth for signal analysis you can disable the YIG-preselector at the input of the R&S FPL1000. However, disabling the YIG-preselector can lead to image-frequency display.

**Note:** Note that the YIG-preselector is active only on frequencies greater than 6 GHz (for models R&S FPL1014 and R&S FPL1026). Therefore, switching the YIG-preselector on or off has no effect if the frequency is below that value.

For the following measurements, the "YIG-Preselector" is off by default (if available).

- I/Q Analyzer
- VSA

For measurements that require I/Q analysis in large bandwidths at frequencies higher than 6 GHz, it is strongly recommended that you disable the YIG-preselector.

Remote command:

`INPut<ip>:FILTer:YIG[:STATe]` on page 117

### SAW filter

The R&S FPL1000 hardware contains both a wide and a narrow IF path. Depending on the used analysis bandwidth, the R&S FPL1000 determines which IF path to use automatically. The wide IF path allows for a smoother signal at the center frequency, while the narrow IF path suppresses possibly distorting signals further away from the center frequency. Using this setting, you can affect which IF path is used.

"Auto"                    The R&S FPL1000 determines which IF path to use automatically, depending on the used analysis bandwidth.

"Off"                     The wide IF path is always used.

Remote command:

`INPut<ip>:FILTer:SAW` on page 117

### 5.3.2 Settings for input from I/Q data files

**Access:** "Overview" > "Input/Frontend" > "Input Source" > "I/Q File"

**Or:** [INPUT/OUTPUT] > "Input Source Config" > "Input Source" > "I/Q File"

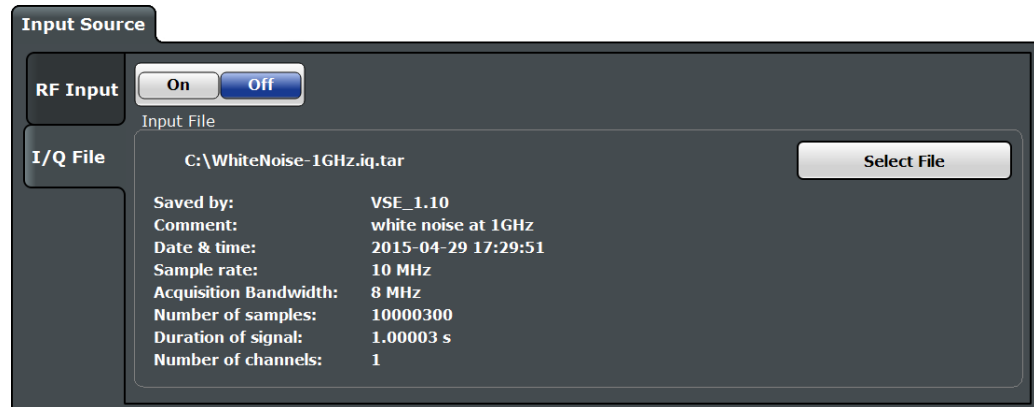

For details, see [Chapter 4.3, "Basics on input from I/Q data files"](#), on page 27.

<a href="#">I/Q Input File State</a> .....	37
<a href="#">Select I/Q data file</a> .....	37

#### I/Q Input File State

Enables input from the selected I/Q input file.

If enabled, the application performs measurements on the data from this file. Thus, most measurement settings related to data acquisition (attenuation, center frequency, measurement bandwidth, sample rate) cannot be changed. The measurement time can only be decreased to perform measurements on an extract of the available data only.

**Note:** Even when the file input is disabled, the input file remains selected and can be enabled again quickly by changing the state.

Remote command:

`INPut<ip>:SElect` on page 118

#### Select I/Q data file

Opens a file selection dialog box to select an input file that contains I/Q data.

The I/Q data must have a specific format (.iq.tar) as described in [Chapter C, "I/Q data file format \(iq-tar\)"](#), on page 238.

The default storage location for I/Q data files is

`C:\Users\Public\Documents\Rohde-Schwarz\Analyzer\user.`

Remote command:

`INPut<ip>:FILE:PATH` on page 120

### 5.3.3 Power sensors

The R&S FPL1000 can also analyze data from a connected power sensor.



The "Sensor" connector is provided by the "Additional Interfaces" option R&S FPL1-B5. Additionally, the power sensor measurement requires the option R&S FPL1-K9.

- [Basics on power sensors](#)..... 38
- [Power sensor settings](#)..... 38
- [How to work with a power sensor](#)..... 42

### 5.3.3.1 Basics on power sensors

For precise power measurement, up to 4 power sensors can be connected to the instrument via the optional power sensor interface (on the rear panel) or the USB connectors. Both manual operation and remote control are supported.



For a detailed list of supported sensors, see the data sheet.

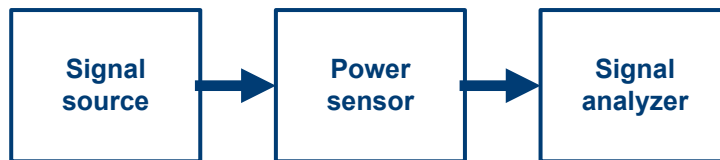

Figure 5-2: Power sensor support – standard test setup



#### Using the power sensor with several applications

The power sensor cannot be used from the R&S FPL1000 firmware and the R&S Power Viewer Plus (virtual power meter for displaying results of the R&S NRP power sensors) simultaneously.

#### Result display

The results of the power sensor measurements are displayed in the marker table. For each power sensor, a row is inserted. The sensor index is indicated in the "Type" column.

2 Marker Table			
Type	Ref	Trc	X-Value
PWR1			-70.00 dBm
PWR2			-70.00 dBm

Function Result	
PWR123456 NRP-Z81	
PWR111111 NRP-Z11	

### 5.3.3.2 Power sensor settings

**Access:** "Overview" > "Input" > "Power Sensor" tab



The power sensor measurement requires the option R&S FPL1-K9.

For details on working with power sensors, see the R&S FPL1000 User Manual.

Each sensor is configured on a separate tab.

Input			
Input Source		Power Sensor	
State	On	Off	Continuous Update
	On	Off	On
	Off	Off	Off
Sensor1	<input type="checkbox"/> Select	123456 NRP-Z81	<input checked="" type="checkbox"/> Auto
Sensor2	Zeroing Power Sensor		Meas -> Ref
Sensor3	<input type="radio"/> Frequency Manual	3.75 GHz	Reference Value 0.0 dBm
Sensor4	<input checked="" type="radio"/> Frequency Coupling	Center	<input checked="" type="checkbox"/> Use Ref Level Offset
	Unit/Scale	dBm	<input type="checkbox"/> Number of Readings 1
	Meas Time/Average	Normal	<input type="checkbox"/> Duty Cycle 99.999 %

State.....	39
Continuous Value Update.....	39
Select.....	39
Zeroing Power Sensor.....	40
Frequency Manual.....	40
Frequency Coupling.....	40
Unit/Scale.....	40
Meas Time/Average.....	41
Setting the Reference Level from the Measurement Meas -> Ref.....	41
Reference Value.....	41
Use Ref Level Offset.....	41
Sensor Level Offset.....	41
Average Count (Number of Readings).....	41
Duty Cycle.....	42

### State

Switches the power measurement for all power sensors on or off. Note that in addition to this general setting, each power sensor can be activated or deactivated individually by the [Select](#) setting on each tab. However, the general setting overrides the individual settings.

### Continuous Value Update

If activated, the power sensor data is updated continuously during a sweep with a long sweep time, and even after a single sweep has completed.

This function cannot be activated for individual sensors.

Remote command:

[\[SENSe:\] PMETer<p>:UPDate \[:STATe\]](#) on page 128

### Select

Selects the individual power sensor for usage if power measurement is generally activated ([State](#) function).

The detected **serial numbers** of the power sensors connected to the instrument are provided in a selection list. For each of the four available power sensor indexes ("Power Sensor 1"..."Power Sensor 4"), which correspond to the tabs in the configuration dialog, one of the detected serial numbers can be assigned. The physical sensor is thus assigned to the configuration setting for the selected power sensor index.

By default, serial numbers not yet assigned are automatically assigned to the next free power sensor index for which "Auto Assignment" is selected.

Alternatively, you can assign the sensors manually by deactivating the "Auto" option and selecting a serial number from the list.

Remote command:

[\[SENSe:\] PMETer<p>\[:STATe\]](#) on page 127

[SYSTem:COMMunicate:RDEvice:PMETer<p>:DEFine](#) on page 121

[SYSTem:COMMunicate:RDEvice:PMETer<p>:CONFigure:AUTO\[:STATe\]](#)  
on page 120

[SYSTem:COMMunicate:RDEvice:PMETer<p>:COUNT?](#) on page 121

### Zeroing Power Sensor

Starts zeroing of the power sensor.

For details on the zeroing process refer to the R&S FPL1000 User Manual.

Remote command:

[CALibration:PMETer<p>:ZERO:AUTO ONCE](#) on page 122

### Frequency Manual

Defines the frequency of the signal to be measured. The power sensor has a memory with frequency-dependent correction factors. This allows extreme accuracy for signals of a known frequency.

Remote command:

[\[SENSe:\] PMETer<p>:FREQuency](#) on page 125

### Frequency Coupling

Selects the coupling option. The frequency can be coupled automatically to the center frequency of the instrument or to the frequency of marker 1.

Remote command:

[\[SENSe:\] PMETer<p>:FREQuency:LINK](#) on page 125

### Unit/Scale

Selects the unit with which the measured power is to be displayed. Available units are dBm, dB, W and %.

If dB or % is selected, the display is relative to the reference value that is defined with either the "Meas -> Ref" setting or the "Reference Value" setting.

Remote command:

[UNIT<n>:PMETer<p>:POWer](#) on page 128

[UNIT<n>:PMETer<p>:POWer:RATio](#) on page 128



**Meas Time/Average**

Selects the measurement time or switches to manual averaging mode. In general, results are more precise with longer measurement times. The following settings are recommended for different signal types to obtain stable and precise results:

"Short"	Stationary signals with high power (> -40dBm), because they require only a short measurement time and short measurement time provides the highest repetition rates.
"Normal"	Signals with lower power or modulated signals
"Long"	Signals at the lower end of the measurement range (<-50 dBm) or Signals with lower power to minimize the influence of noise
"Manual"	Manual averaging mode. The average count is set with the <a href="#">Average Count (Number of Readings)</a> setting.

Remote command:

[\[SENSe:\] PMETer<p>:MTIME](#) on page 126

[\[SENSe:\] PMETer<p>:MTIME:AVERAge\[:STATe\]](#) on page 126

**Setting the Reference Level from the Measurement Meas -> Ref**

Sets the currently measured power as a reference value for the relative display. The reference value can also be set manually via the [Reference Value](#) setting.

Remote command:

[CALCulate<n>:PMETer<p>:RELative\[:MAGNitude\]:AUTO ONCE](#) on page 123

**Reference Value**

Defines the reference value in dBm used for relative power meter measurements.

Remote command:

[CALCulate<n>:PMETer<p>:RELative\[:MAGNitude\]](#) on page 123

**Use Ref Level Offset**

If activated, takes the reference level offset defined for the analyzer into account for the measured power (see "[Shifting the Display \(Offset\)](#)" on page 46).

If deactivated, takes the [Sensor Level Offset](#) into account.

Remote command:

[\[SENSe:\] PMETer<p>:ROFFset\[:STATe\]](#) on page 127

**Sensor Level Offset**

Takes the specified offset into account for the measured power. Only available if [Use Ref Level Offset](#) is disabled.

Remote command:

[\[SENSe:\] PMETer<p>:SOFFset](#) on page 127

**Average Count (Number of Readings)**

Defines the number of readings (averages) to be performed after a single sweep has been started. This setting is only available if manual averaging is selected ([Meas Time/Average](#) setting).

The values for the average count range from 0 to 256 in binary steps (1, 2, 4, 8, ...). For average count = 0 or 1, one reading is performed. The general averaging and sweep count for the trace are independent from this setting.

Results become more stable with extended average, particularly if signals with low power are measured. This setting can be used to minimize the influence of noise in the power sensor measurement.

Remote command:

[SENSe:] PMETer<p>:MTIME:AVERAge:COUNT on page 126

### Duty Cycle

Sets the duty cycle to a percent value for the correction of pulse-modulated signals and activates the duty cycle correction. With the correction activated, the sensor calculates the signal pulse power from this value and the mean power.

Remote command:

[SENSe:] PMETer<p>:DCYCLE[:STATe] on page 124

[SENSe:] PMETer<p>:DCYCLE:VALue on page 124

### 5.3.3.3 How to work with a power sensor

The following step-by-step instructions demonstrate how to set up a power sensor. For details on individual functions and settings see [Chapter 5.3.3.2, "Power sensor settings"](#), on page 38.

The remote commands required to perform these tasks are described in [Chapter 9.4.1.3, "Working with power sensors"](#), on page 120.

#### How to set up a power sensor

Up to 4 external power sensors can be configured separately and used for precise power measurement. All power sensors can be activated and deactivated individually.

The following procedure describes in detail how to configure and activate power sensors.

1. To display the "Power Sensor" tab of the "Input" dialog box, do one of the following:
  - Select "Input" from the "Overview".
  - Select the [INPUT/OUTPUT] key and then the "Power Sensor Config" softkey.
2. Select the tab for the power sensor index you want to configure, e.g. "Power Sensor 1".
3. Press "Select" to analyze the power sensor data according to the current configuration when power measurement is activated.
4. From the selection list with serial numbers of connected power sensors, select the sensor you want to configure.  
To have newly connected power sensors assigned to a tab automatically (default), select "Auto".
5. Define the frequency of the signal whose power you want to measure.

- a) To define the frequency manually, select "Frequency Manual" and enter a frequency.
  - b) To determine the frequency automatically, select "Frequency Coupling" and then either "Center", to use the center frequency, or "Marker", to use the frequency defined by marker 1.
6. Select the unit for the power result display.
  7. Select the measurement time for which the average is calculated, or define the number of readings to average. To define the number of readings to be taken into account manually, select "Manual" and enter the number in the "Number of Readings" field.
  8. To activate the duty cycle correction, select "DutyCycle" and enter a percentage as the correction value.
  9. If you selected "dB" or "%" as units (relative display), define a reference value:
    - a) To set the currently measured power as a reference value, press the "Meas -> Ref" button.
    - b) Alternatively, enter a value manually in the "Reference Value" field.
    - c) Optionally, select the "Use Ref Level Offset" option to take the reference level offset set for the analyzer into account for the measured power.
  10. If necessary, repeat steps 3-10 for another power sensor.
  11. Set the "Power Sensor State" at the top of the "Power Sensor" tab to "On" to activate power measurement for the selected power sensors.

The results of the power measurement are displayed in the marker table (Function: "Sensor <1...4>").

### How to zero the power sensor

1. To display the "Power Sensor" tab of the "Input" dialog box, do one of the following:
  - Select "Input" from the "Overview".
  - Select the [INPUT/OUTPUT] key and then the "Power Sensor Config" softkey.
2. Select the tab that is assigned to the power sensor you want to zero.
3. Press the "Zeroing Power Sensor" button.

A dialog box is displayed that prompts you to disconnect all signals from the input of the power sensor.
4. Disconnect all signals sending input to the power sensor and press [ENTER] to continue.
5. Wait until zeroing is complete.

A corresponding message is displayed.

### 5.3.4 Output settings

**Access:** "Overview" > "Output"

The R&S FPL1000 can provide signals to different output connectors.

These connectors are only available if the R&S FPL1-B5 option is installed.

For details on connectors, refer to the R&S FPL1000 Getting Started manual, "Front / Rear Panel View" chapters.

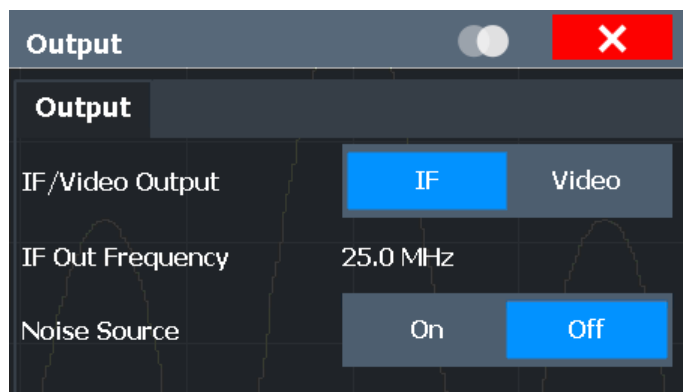

[Noise Source Control](#)..... 44

#### Noise Source Control

Enables or disables the 28 V voltage supply for an external noise source connected to the "Noise source control / Power sensor") connector. By switching the supply voltage for an external noise source on or off in the firmware, you can enable or disable the device as required.

This connector is only available if the R&S FPL1-B5 option is installed.

External noise sources are useful when you are measuring power levels that fall below the noise floor of the R&S FPL1000 itself, for example when measuring the noise level of an amplifier.

In this case, you can first connect an external noise source (whose noise power level is known in advance) to the R&S FPL1000 and measure the total noise power. From this value, you can determine the noise power of the R&S FPL1000. Then when you measure the power level of the actual DUT, you can deduct the known noise level from the total power to obtain the power level of the DUT.

Remote command:

[DIAGnostic:SERvice:NSOurce](#) on page 129

## 5.4 Amplitude

**Access:** "Overview" > "Amplitude"

Amplitude settings are identical to the Spectrum application, except for a new scaling function for I/Q Vector and Real/Imag results (see "[Y-Axis Max](#)" on page 50).

For background information on amplitude settings see the R&S FPL1000 User Manual.



The "Auto Settings" are described in [Chapter 5.9, "Adjusting settings automatically"](#), on page 61.

### 5.4.1 Amplitude settings

**Access:** "Overview" > "Amplitude"

Amplitude settings determine how the R&S FPL1000 must process or display the expected input power levels.

Configuring amplitude settings allows you to:

- Adapt the instrument hardware to the expected maximum signal level by setting the [Reference Level](#) to this maximum
- Consider an external attenuator or preamplifier (using the "Offset").
- Optimize the SNR of the measurement for low signal levels by configuring the [Reference Level](#) as high as possible without introducing compression, clipping or overload. Use early amplification by the preamplifier and a low attenuation.
- Optimize the SNR for high signal levels and ensure that the instrument hardware is not damaged, using high attenuation and AC coupling (for DC input voltage).
- Adapt the reference impedance for power results when measuring in a 75-Ohm system by connecting an external matching pad to the RF input.

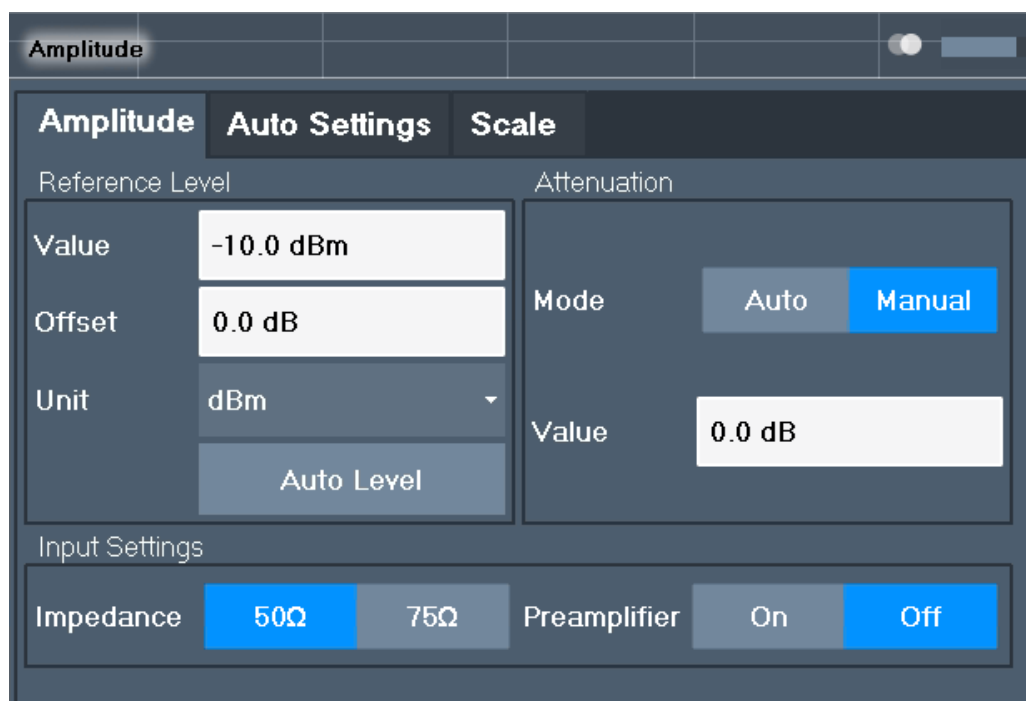

Reference Level.....	46
└ Shifting the Display (Offset).....	46
└ Unit.....	46

L Setting the Reference Level Automatically (Auto Level).....	47
Attenuation Mode / Value.....	47
Attenuation Mode / Value.....	47
Impedance.....	48
Preamplifier.....	48

### Reference Level

Defines the expected maximum reference level. Signal levels above this value are possibly not measured correctly. Signals above the reference level are indicated by an "IF Overload" status display.

The reference level can also be used to scale power diagrams; the reference level is then used for the calculation of the maximum on the y-axis.

Since the hardware of the R&S FPL1000 is adapted according to this value, it is recommended that you set the reference level close above the expected maximum signal level. Thus you ensure an optimal measurement (no compression, good signal-to-noise ratio).

Remote command:

`DISPlay[:WINDow<n>][:SUBWindow<w>]:TRACe<t>:Y[:SCALe]:RLEVel`  
on page 133

### Shifting the Display (Offset) ← Reference Level

Defines an arithmetic level offset. This offset is added to the measured level. In some result displays, the scaling of the y-axis is changed accordingly.

Define an offset if the signal is attenuated or amplified before it is fed into the R&S FPL1000 so the application shows correct power results. All displayed power level results are shifted by this value.

The setting range is  $\pm 200$  dB in 0.01 dB steps.

Note, however, that the *internal* reference level (used to adjust the hardware settings to the expected signal) ignores any "Reference Level Offset". Thus, it is important to keep in mind the actual power level the R&S FPL1000 must handle. Do not rely on the displayed reference level (internal reference level = displayed reference level - offset).

Remote command:

`DISPlay[:WINDow<n>][:SUBWindow<w>]:TRACe<t>:Y[:SCALe]:RLEVel:`  
`OFFSet` on page 133

### Unit ← Reference Level

The R&S FPL1000 measures the signal voltage at the RF input.

In the default state, the level is displayed at a power level of 1 mW (= dBm). Via the known input impedance (50  $\Omega$  or 75  $\Omega$ , see "[Impedance](#)" on page 36), conversion to other units is possible.

The following units are available and directly convertible:

- dBm
- dBmV
- dB $\mu$ V
- dB $\mu$ A
- dBpW
- Volt

- Ampere
- Watt

Remote command:

[INPut<ip>:IMPedance](#) on page 118

[CALCulate<n>:UNIT:POWer](#) on page 132

### Setting the Reference Level Automatically (Auto Level) ← Reference Level

Automatically determines a reference level which ensures that no overload occurs at the R&S FPL1000 for the current input data. At the same time, the internal attenuators are adjusted. As a result, the signal-to-noise ratio is optimized, while signal compression and clipping are minimized.

To determine the required reference level, a level measurement is performed on the R&S FPL1000.

If necessary, you can optimize the reference level further. Decrease the attenuation level manually to the lowest possible value before an overload occurs, then decrease the reference level in the same way.

You can change the measurement time for the level measurement if necessary (see "[Changing the Automatic Measurement Time \(Meas Time Manual\)](#)" on page 63).

Remote command:

[\[SENSe:\]ADJust:LEVel](#) on page 155

### Attenuation Mode / Value

Defines the attenuation applied to the RF input of the R&S FPL1000.

The RF attenuation can be set automatically as a function of the selected reference level (Auto mode). Automatic attenuation ensures that no overload occurs at the RF Input connector for the current reference level. It is the default setting.

In "Manual" mode, you can set the RF attenuation in 5 dB steps down to 0 dB (with option R&S FPL1-B25: in 1 dB steps). Other entries are rounded to the next integer value. The range is specified in the data sheet. If the defined reference level cannot be set for the defined RF attenuation, the reference level is adjusted accordingly and the warning "limit reached" is displayed.

**NOTICE!** Risk of hardware damage due to high power levels. When decreasing the attenuation manually, ensure that the power level does not exceed the maximum level allowed at the RF input, as an overload can lead to hardware damage.

Remote command:

[INPut<ip>:ATTenuation](#) on page 134

[INPut<ip>:ATTenuation:AUTO](#) on page 134

### Attenuation Mode / Value

Defines the attenuation applied to the RF input of the R&S FPL1000.

The RF attenuation can be set automatically as a function of the selected reference level (Auto mode). Automatic attenuation ensures that no overload occurs at the RF Input connector for the current reference level. It is the default setting.

In "Manual" mode, you can set the RF attenuation in 5 dB steps down to 0 dB (with option R&S FPL1-B25: in 1 dB steps). Other entries are rounded to the next integer value. The range is specified in the data sheet. If the defined reference level cannot be set for the defined RF attenuation, the reference level is adjusted accordingly and the warning "limit reached" is displayed.

**NOTICE!** Risk of hardware damage due to high power levels. When decreasing the attenuation manually, ensure that the power level does not exceed the maximum level allowed at the RF input, as an overload can lead to hardware damage.

Remote command:

[INPut<ip>:ATTenuation](#) on page 134

[INPut<ip>:ATTenuation:AUTO](#) on page 134

### Impedance

For some measurements, the reference impedance for the measured levels of the R&S FPL1000 can be set to 50  $\Omega$  or 75  $\Omega$ .

Select 75  $\Omega$  if the 50  $\Omega$  input impedance is transformed to a higher impedance using a 75  $\Omega$  adapter of the RAZ type. (That corresponds to 25 $\Omega$  in series to the input impedance of the instrument.) The correction value in this case is 1.76 dB = 10 log (75 $\Omega$ /50 $\Omega$ ).

This value also affects the unit conversion (see "Reference Level" on page 46).

Remote command:

[INPut<ip>:IMPedance](#) on page 118

### Preamplifier

If the (optional) internal preamplifier hardware is installed on the R&S FPL1000, a preamplifier can be activated for the RF input signal.

You can use a preamplifier to analyze signals from DUTs with low output power.

**Note:** If an optional external preamplifier is activated, the internal preamplifier is automatically disabled, and vice versa.

The input signal is amplified by 20 dB if the preamplifier option is activated.

Remote command:

[INPut<ip>:GAIN:STATe](#) on page 135

## 5.4.2 Scaling the y-axis

The individual scaling settings that affect the vertical axis are described here.

**Access:** "Overview" > "Amplitude" > "Scale" tab

**Or:** [AMPT] > "Scale Config"



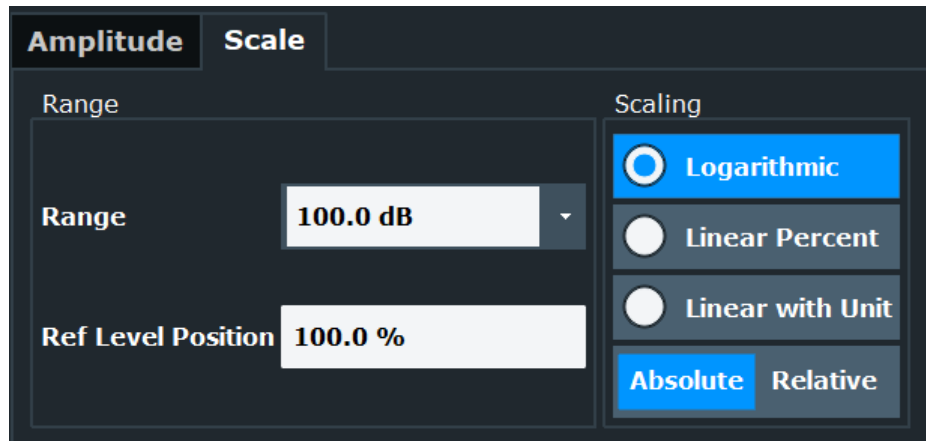

Range.....	49
Ref Level Position.....	49
Scaling.....	49
Y-Axis Max.....	50

### Range

Defines the displayed y-axis range in dB.

The default value is 100 dB.

Remote command:

`DISPlay[:WINDow<n>][:SUBWindow<w>]:TRACe<t>:Y[:SCALE]` on page 135

### Ref Level Position

Defines the reference level position, i.e. the position of the maximum AD converter value on the level axis in %.

0 % corresponds to the lower and 100 % to the upper limit of the diagram.

Values from -120 % to +280 % are available.

Larger values are useful for small scales, such as a power range of 10 dB or 20 dB, and low signal levels, for example 60 dB below the reference level. In this case, large reference level position values allow you to see the trace again.

Remote command:

`DISPlay[:WINDow<n>][:SUBWindow<w>]:TRACe<t>:Y[:SCALE]:RPOSITION` on page 136

### Scaling

Defines the scaling method for the y-axis.

"Logarithmic"	Logarithmic scaling (only available for logarithmic units - dB..., and A, V, Watt)
"Linear with Unit"	Linear scaling in the unit of the measured signal
"Linear Percent"	Linear scaling in percentages from 0 to 100
"Absolute"	The labeling of the level lines refers to the absolute value of the reference level (not available for "Linear Percent")

"Relative" The scaling is in dB, relative to the reference level (only available for logarithmic units - dB...). The upper line of the grid (reference level) is always at 0 dB.

Remote command:

`DISPlay[:WINDow<n>][:SUBWindow<w>]:TRACe<t>:Y:SPACing` on page 137  
`DISPlay[:WINDow<n>][:SUBWindow<w>]:TRACe<t>:Y[:SCALE]:MODE`  
 on page 136

### Y-Axis Max

Defines the maximum value of the y-axis in the currently selected diagram in either direction (in Volts). Thus, the y-axis scale starts at -<Y-Axis Max> and ends at +<Y-Axis Max>.

The maximum y-axis value depends on the current reference level. If the reference level is changed, the "Y-Axis Max" value is automatically set to the new reference level (in V).

This command is only available if the evaluation mode for the I/Q Analyzer is set to "I/Q-Vector" or "Real/Imag (I/Q)".

Remote command:

`DISPlay[:WINDow<n>][:SUBWindow<w>]:TRACe<t>:Y[:SCALE]` on page 135

## 5.5 Frequency settings

Access: "Overview" > "Frequency"

The screenshot shows a software dialog box titled "Frequency". It contains the following settings:

- Center:** 4.0 GHz
- Center Frequency Stepsize:** Manual (dropdown menu) and Value: 1.0 MHz
- Frequency Offset:** Value: 0 Hz

Center Frequency.....	50
Center Frequency Stepsize.....	51
Frequency Offset.....	51

### Center Frequency

Defines the center frequency of the signal in Hertz.

The allowed range of values for the center frequency depends on the frequency span.

$$\text{span} > 0: \text{span}_{\min}/2 \leq f_{\text{center}} \leq f_{\text{max}} - \text{span}_{\min}/2$$

$f_{\max}$  and  $\text{span}_{\min}$  depend on the instrument and are specified in the data sheet.

Remote command:

[SENSe:] FREQuency:CENTer on page 138

### Center Frequency Stepsize

Defines the step size by which the center frequency is increased or decreased using the arrow keys.

The step size can be coupled to another value or it can be manually set to a fixed value.

"= Center" Sets the step size to the value of the center frequency. The used value is indicated in the "Value" field.

"Manual" Defines a fixed step size for the center frequency. Enter the step size in the "Value" field.

Remote command:

[SENSe:] FREQuency:CENTer:STEP on page 138

### Frequency Offset

Shifts the displayed frequency range along the x-axis by the defined offset.

This parameter has no effect on the instrument's hardware, on the captured data, or on data processing. It is simply a manipulation of the final results in which absolute frequency values are displayed. Thus, the x-axis of a spectrum display is shifted by a constant offset if it shows absolute frequencies. However, if it shows frequencies relative to the signal's center frequency, it is not shifted.

A frequency offset can be used to correct the display of a signal that is slightly distorted by the measurement setup, for example.

The allowed values range from -1 THz to 1 THz. The default setting is 0 Hz.

Remote command:

[SENSe:] FREQuency:OFFSet on page 139

## 5.6 Trigger settings

**Access:** "Overview" > "Trigger" (> "Trigger In/Out")

Trigger settings determine when the input signal is measured.

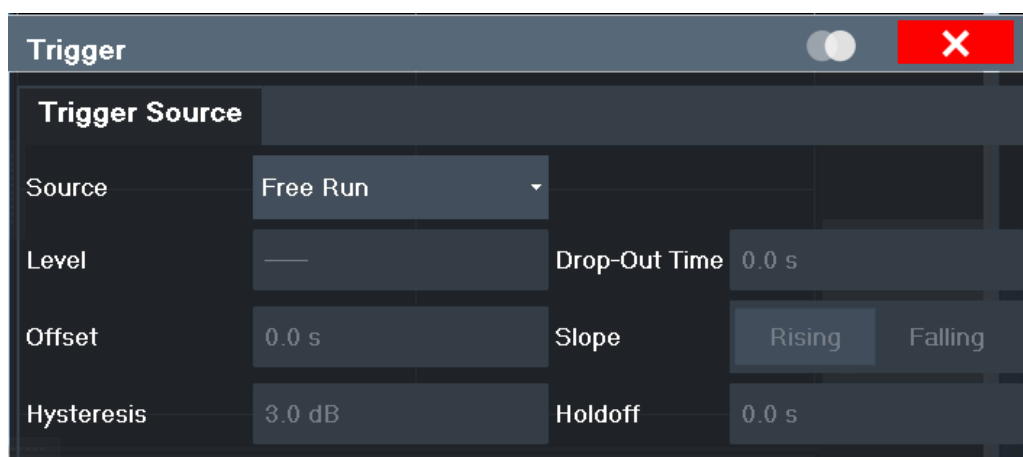

Conventional gating as in the Spectrum application is not available for the I/Q Analyzer; however, a special gating mode is available in remote control, see [Chapter 9.4.4.2, "Configuring I/Q gating"](#), on page 144.

For step-by-step instructions on configuring triggered measurements, see the R&S FPL1000 User Manual.

Trigger Source.....	52
L Trigger Source.....	52
L Free Run.....	52
L External Trigger 1.....	53
L IF Power.....	53
L I/Q Power.....	53
L Time.....	53
L Trigger Level.....	53
L Repetition Interval.....	54
L Drop-Out Time.....	54
L Trigger Offset.....	54
L Slope.....	54
L Hysteresis.....	55
L Trigger Holdoff.....	55

### Trigger Source

The trigger settings define the beginning of a measurement.

#### Trigger Source ← Trigger Source

Selects the trigger source. If a trigger source other than "Free Run" is set, "TRG" is displayed in the channel bar and the trigger source is indicated.

Remote command:

`TRIGger [ : SEquence ] : SOURce` on page 142

#### Free Run ← Trigger Source ← Trigger Source

No trigger source is considered. Data acquisition is started manually or automatically and continues until stopped explicitly.

Remote command:

TRIG:SOUR IMM, see [TRIGger\[:SEquence\]:SOURce](#) on page 142

#### **External Trigger 1 ← Trigger Source ← Trigger Source**

Data acquisition starts when the TTL signal fed into the trigger input connector of the R&S FPL1000 meets or exceeds the specified trigger level.

(See ["Trigger Level"](#) on page 53).

Remote command:

TRIG:SOUR EXT

See [TRIGger\[:SEquence\]:SOURce](#) on page 142

#### **IF Power ← Trigger Source ← Trigger Source**

The R&S FPL1000 starts capturing data as soon as the trigger level is exceeded around the third intermediate frequency.

For frequency sweeps, the third IF represents the start frequency. The trigger threshold depends on the defined trigger level, as well as on the RF attenuation and preamplification. A reference level offset, if defined, is also considered. The trigger bandwidth at the intermediate frequency depends on the RBW and sweep type. For details on available trigger levels and trigger bandwidths, see the instrument data sheet.

For measurements on a fixed frequency (e.g. zero span or I/Q measurements), the third IF represents the center frequency.

This trigger source is only available for RF input.

For details on available trigger levels and trigger bandwidths, see the data sheet.

Remote command:

TRIG:SOUR IFP, see [TRIGger\[:SEquence\]:SOURce](#) on page 142

#### **I/Q Power ← Trigger Source ← Trigger Source**

This trigger source is only available in the I/Q Analyzer application.

Triggers the measurement when the magnitude of the sampled I/Q data exceeds the trigger threshold.

The trigger bandwidth corresponds to the bandwidth setting for I/Q data acquisition.

(See ["Analysis Bandwidth"](#) on page 57).

Remote command:

TRIG:SOUR IQP, see [TRIGger\[:SEquence\]:SOURce](#) on page 142

#### **Time ← Trigger Source ← Trigger Source**

Triggers in a specified repetition interval.

See ["Repetition Interval"](#) on page 54.

Remote command:

TRIG:SOUR TIME, see [TRIGger\[:SEquence\]:SOURce](#) on page 142

#### **Trigger Level ← Trigger Source**

Defines the trigger level for the specified trigger source.

For details on supported trigger levels, see the instrument data sheet.

For time triggers, the repetition interval is defined. See "[Repetition Interval](#)" on page 54.

Remote command:

[TRIGger\[:SEquence\]:LEVel:IFPower](#) on page 141

[TRIGger\[:SEquence\]:LEVel:IQPower](#) on page 142

[TRIGger\[:SEquence\]:LEVel\[:EXternal<port>\]](#) on page 141

#### Repetition Interval ← Trigger Source

Defines the repetition interval for a time trigger.

The shortest interval is 2 ms.

Set the repetition interval to the exact pulse period, burst length, frame length or other repetitive signal characteristic. If the required interval cannot be set with the available granularity, configure a multiple of the interval that can be set. Thus, the trigger remains synchronized to the signal.

Remote command:

[TRIGger\[:SEquence\]:TIME:RINterval](#) on page 143

#### Drop-Out Time ← Trigger Source

Defines the time that the input signal must stay below the trigger level before triggering again.

Remote command:

[TRIGger\[:SEquence\]:DTIME](#) on page 140

#### Trigger Offset ← Trigger Source

Defines the time offset between the trigger event and the start of the sweep.

Offset > 0:	Start of the sweep is delayed
Offset < 0:	Sweep starts earlier (pretrigger) Only possible for zero span (e.g. I/Q Analyzer application) and gated trigger switched off Maximum allowed range limited by the sweep time: $\text{Pretrigger}_{\text{max}} = \text{sweep time}_{\text{max}}$

**Tip:** To determine the trigger point in the sample (for "External" or "IF Power" trigger source), use the [TRACe:IQ:TPISample?](#) command.

For the "Time" trigger source, this function is not available.

Remote command:

[TRIGger\[:SEquence\]:HOLDoff\[:TIME\]](#) on page 140

#### Slope ← Trigger Source

For all trigger sources except time, you can define whether triggering occurs when the signal rises to the trigger level or falls down to it.

For gated measurements in "Edge" mode, the slope also defines whether the gate starts on a falling or rising edge.

Remote command:

[TRIGger\[:SEquence\]:SLOPe](#) on page 142

**Hysteresis ← Trigger Source**

Defines the distance in dB to the trigger level that the trigger source must exceed before a trigger event occurs. Setting a hysteresis avoids unwanted trigger events caused by noise oscillation around the trigger level.

This setting is only available for "IF Power" trigger sources. The range of the value is between 3 dB and 50 dB with a step width of 1 dB.

Remote command:

[TRIGger\[:SEquence\]:IFPower:HYSteresis](#) on page 141

**Trigger Holdoff ← Trigger Source**

Defines the minimum time (in seconds) that must pass between two trigger events. Trigger events that occur during the holdoff time are ignored.

Remote command:

[TRIGger\[:SEquence\]:IFPower:HOLDoFF](#) on page 140

## 5.7 Data acquisition and bandwidth settings

**Access:** "Overview" > "Bandwidth"

- [Data acquisition](#).....55
- [Sweep settings](#).....59

### 5.7.1 Data acquisition

**Access:** "Overview" > "Bandwidth" > "Data Acquisition" tab

The data acquisition settings define which parts of the input signal are captured for further evaluation in the applications.

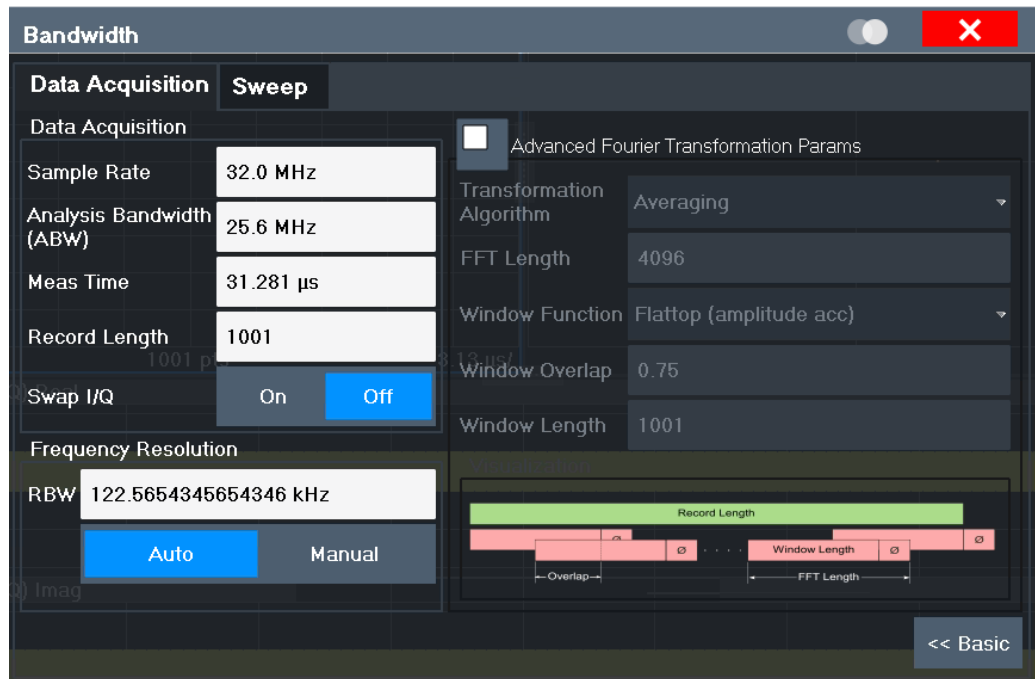

Figure 5-3: Data acquisition settings with advanced FFT parameters

Sample Rate.....	56
Analysis Bandwidth.....	57
Meas Time.....	57
Record Length.....	57
Swap I/Q.....	57
RBW.....	57
Advanced FFT mode / Basic Settings.....	58
L Transformation Algorithm.....	58
L FFT Length.....	58
L Window Function.....	59
L Window Overlap.....	59
L Window Length.....	59

### Sample Rate

Defines the I/Q data sample rate of the R&S FPL1000. This value depends on the defined [Analysis Bandwidth](#).

Up to the maximum bandwidth (12.8 MHz without extension options), the following rule applies:

$$\text{sample rate} = \text{analysis bandwidth} / 0.8$$

For details on the dependencies see [Chapter 4.1.1, "Sample rate and maximum usable I/Q bandwidth for RF input"](#), on page 19.

Remote command:

TRACe: IQ:SRATe on page 151



**Analysis Bandwidth**

Defines the flat, usable bandwidth of the final I/Q data. This value depends on the defined [Sample Rate](#).

Up to the maximum bandwidth (12.8 MHz without extension options), the following rule applies:

$$\text{analysis bandwidth} = 0.8 * \text{sample rate}$$

Remote command:

[TRACe: IQ: BWIDth](#) on page 149

**Meas Time**

Defines the I/Q acquisition time. By default, the measurement time is calculated as the number of I/Q samples ("Record Length") divided by the sample rate. If you change the measurement time, the [Record Length](#) is automatically changed, as well.

Remote command:

[\[SENSe:\] SWEep: TIME](#) on page 168

**Record Length**

Defines the number of I/Q samples to record. By default, the number of sweep points is used. The record length is calculated as the measurement time multiplied by the sample rate. If you change the record length, the [Meas Time](#) is automatically changed, as well.

**Note:** For the I/Q vector result display, the number of I/Q samples to record ("Record Length") must be identical to the number of trace points to be displayed ("Sweep Points"). Thus, the sweep points are not editable for this result display. If the "Record Length" is edited, the sweep points are adapted automatically.

Remote command:

[TRACe: IQ: RLENgth](#) on page 150

[TRACe: IQ: SET](#) on page 150

**Swap I/Q**

Activates or deactivates the inverted I/Q modulation. If the I and Q parts of the signal from the DUT are interchanged, the R&S FPL1000 can do the same to compensate for it.

On	I and Q signals are interchanged Inverted sideband, $Q+j*I$
Off	I and Q signals are not interchanged Normal sideband, $I+j*Q$

Remote command:

[\[SENSe:\] SWAPiq](#) on page 149

**RBW**

Defines the resolution bandwidth for Spectrum results. The available RBW values depend on the sample rate and record length.

(See [Chapter 4.2.4, "Frequency resolution of FFT results - RBW"](#), on page 25).

Depending on the selected RBW mode, the value is either determined automatically or can be defined manually. As soon as you enter a value in the input field, the RBW mode is changed to "Manual".

If the "Advanced Fourier Transformation Params" option is enabled, advanced FFT mode is selected and the RBW cannot be defined directly.

Note that the RBW is correlated with the [Sample Rate](#) and [Record Length](#) (and possibly the [Window Function](#) and [Window Length](#)). Changing any one of these parameters may cause a change to one or more of the other parameters. For more information see [Chapter 4.2, "Basics on FFT"](#), on page 21.

"Auto mode"	(Default) The RBW is determined automatically depending on the <a href="#">Sample Rate</a> and <a href="#">Record Length</a> .
"Manual mode"	The RBW can be defined by the user. The user-defined RBW is used and the <a href="#">Window Length</a> (and possibly <a href="#">Sample Rate</a> ) are adapted accordingly.
"Advanced FFT mode"	This mode is used if the "Advanced Fourier Transformation Params" option is enabled. The RBW is determined by the <a href="#">advanced FFT parameters</a> .

Remote command:

[\[SENSe:\] IQ:BWIDth:MODE](#) on page 146

[\[SENSe:\] IQ:BWIDth:RESolution](#) on page 147

#### Advanced FFT mode / Basic Settings

Shows or hides the "Advanced Fourier Transformation" parameters in the "Data Acquisition" dialog box.

Note that if the advanced FFT mode is used, the [RBW](#) settings are not available.

#### Transformation Algorithm ← Advanced FFT mode / Basic Settings

Defines the FFT calculation method.

"Single"	One FFT is calculated for the entire record length; if the <a href="#">FFT Length</a> is larger than the record length, zeros are appended to the captured data.
"Averaging"	Several overlapping FFTs are calculated for each record; the results are combined to determine the final FFT result for the record. The number of FFTs to be averaged is determined by the <a href="#">Window Overlap</a> and the <a href="#">Window Length</a> .

Remote command:

[\[SENSe:\] IQ:FFT:ALGORITHM](#) on page 147

#### FFT Length ← Advanced FFT mode / Basic Settings

Defines the number of frequency points determined by each FFT calculation. The more points are used, the higher the resolution in the spectrum becomes, but the longer the calculation takes.

**Note:** If you enter the value manually, any integer value from 3 to 524288 is available.

Remote command:

[\[SENSe:\] IQ:FFT:LENGTH](#) on page 148

**Window Function** ← **Advanced FFT mode / Basic Settings**

In the I/Q analyzer you can select one of several FFT window types.

The following window types are available:

- Blackman-Harris
- Flattop
- Gauss
- Rectangular
- 5-Term

Remote command:

[SENSe:] IQ:FFT:WINDow:TYPE on page 149

**Window Overlap** ← **Advanced FFT mode / Basic Settings**

Defines the part of a single FFT window that is re-calculated by the next FFT calculation when using multiple FFT windows.

Remote command:

[SENSe:] IQ:FFT:WINDow:OVERlap on page 148

**Window Length** ← **Advanced FFT mode / Basic Settings**

Defines the number of samples to be included in a single FFT window in averaging mode. (In single mode, the window length corresponds to the "Record Length" on page 57.)

However, the window length may not be longer than the [FFT Length](#).

Remote command:

[SENSe:] IQ:FFT:WINDow:LENGth on page 148

## 5.7.2 Sweep settings

**Access:** "Overview" > "Bandwidth" > "Sweep" tab

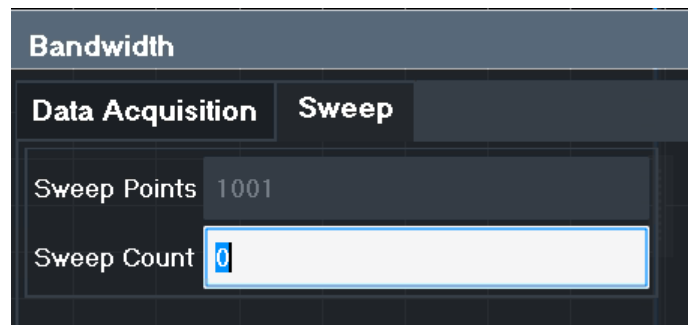

Sweep Points.....	60
This is Sweep/Average Count ok?.....	60
Continuous Sweep / Run Cont.....	60
Single Sweep / Run Single.....	60
Continue Single Sweep.....	61

### Sweep Points

In the I/Q Analyzer application, a specific frequency bandwidth is swept for a specified measurement time. During this time, a defined number of samples (= "Record Length") are captured. These samples are then evaluated by the applications. Therefore, in this case the number of sweep points does not define the amount of data to be acquired, but rather the number of trace points that are evaluated and displayed in the result diagrams.

Remote command:

`[SENSe:] SWEEp[:WINDow<n>]:POINTs` on page 168

### This is Sweep/Average Count ok?

Defines the number of sweeps to be performed in the single sweep mode. Values from 0 to 200000 are allowed. If the values 0 or 1 are set, one sweep is performed.

The sweep count is applied to all the traces in all diagrams.

If the trace modes "Average", "Max Hold" or "Min Hold" are set, this value also determines the number of averaging or maximum search procedures.

In continuous sweep mode, if "Sweep Count" = 0 (default), averaging is performed over 10 sweeps. For "Sweep Count" = 1, no averaging, maxhold or minhold operations are performed.

Remote command:

`[SENSe:] SWEEp:COUNT` on page 167

`[SENSe:] AVERAge<n>:COUNT` on page 174

### Continuous Sweep / Run Cont

After triggering, starts the measurement and repeats it continuously until stopped.

While the measurement is running, the "Continuous Sweep" softkey and the [RUN CONT] key are highlighted. The running measurement can be aborted by selecting the highlighted softkey or key again. The results are not deleted until a new measurement is started.

**Note:** Sequencer. If the Sequencer is active, the "Continuous Sweep" softkey only controls the sweep mode for the currently selected channel setup. However, the sweep mode only takes effect the next time the Sequencer activates that channel setup, and only for a channel-defined sequence. In this case, a channel setup in continuous sweep mode is swept repeatedly.

Furthermore, the [RUN CONT] key controls the Sequencer, not individual sweeps. [RUN CONT] starts the Sequencer in continuous mode.

For details on the Sequencer, see the R&S FPL1000 User Manual.

Remote command:

`INITiate<n>:CONTinuous` on page 165

### Single Sweep / Run Single

After triggering, starts the number of sweeps set in "Sweep Count". The measurement stops after the defined number of sweeps has been performed.

While the measurement is running, the "Single Sweep" softkey and the [RUN SINGLE] key are highlighted. The running measurement can be aborted by selecting the highlighted softkey or key again.

**Note:** Sequencer. If the Sequencer is active, the "Single Sweep" softkey only controls the sweep mode for the currently selected channel setup. However, the sweep mode only takes effect the next time the Sequencer activates that channel setup, and only for a channel-defined sequence. In this case, the Sequencer sweeps a channel setup in single sweep mode only once.

Furthermore, the [RUN SINGLE] key controls the Sequencer, not individual sweeps. [RUN SINGLE] starts the Sequencer in single mode.

If the Sequencer is off, only the evaluation for the currently displayed channel setup is updated.

For details on the Sequencer, see the R&S FPL1000 User Manual.

Remote command:

`INITiate<n>[:IMMEDIATE]` on page 165

### Continue Single Sweep

After triggering, repeats the number of sweeps set in "Sweep Count", without deleting the trace of the last measurement.

While the measurement is running, the "Continue Single Sweep" softkey and the [RUN SINGLE] key are highlighted. The running measurement can be aborted by selecting the highlighted softkey or key again.

Remote command:

`INITiate<n>:CONMeas` on page 164

## 5.8 Display configuration



**Access:** "Overview" > "Display Config"

The captured signal can be displayed using various evaluation methods. All evaluation methods available for the current application are displayed in the evaluation bar in SmartGrid mode.

For a description of the available evaluation methods see [Chapter 3, "Measurement and result displays"](#), on page 13.



Up to 6 evaluations can be displayed in the I/Q Analyzer at any time, including several graphical diagrams, marker tables or peak lists.

The selected evaluation method not only affects the result display in a window, but also the results of the trace data query in remote control (see `TRACe<n>[:DATA]?` on page 224).

## 5.9 Adjusting settings automatically

**Access:** "Overview" > "Amplitude"/"Frequency" > "Auto Settings"

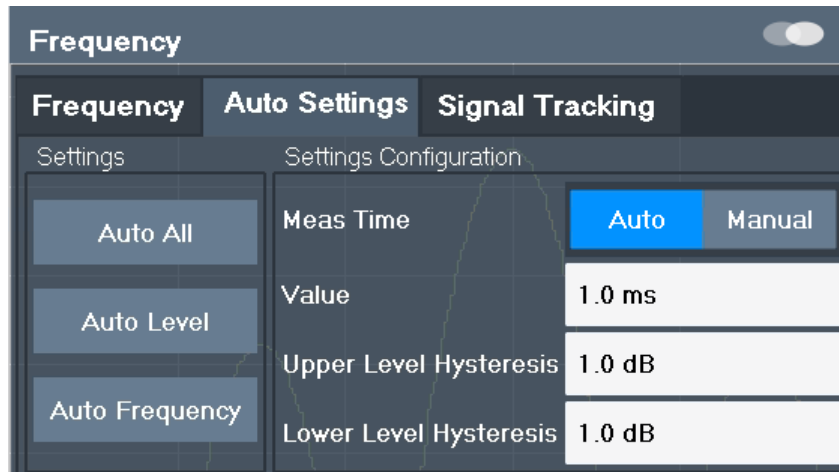

Some settings can be adjusted by the R&S FPL1000 automatically according to the current measurement settings. To do so, a measurement is performed. You can configure this measurement.



**Adjusting settings automatically during triggered measurements**

When you select an auto adjust function, a measurement is performed to determine the optimal settings. If you select an auto adjust function for a triggered measurement, you are asked how you want the R&S FPL1000 to behave:

- (default:) The measurement for adjustment waits for the next trigger
- The measurement for adjustment is performed without waiting for a trigger. The trigger source is temporarily set to "Free Run". After the measurement is completed, the original trigger source is restored. The trigger level is adjusted as follows:
  - For IF Power and RF Power triggers:  
Trigger Level = Reference Level - 15 dB
  - For Video trigger:  
Trigger Level = 85 %

**Remote command:**

[SENSe:]ADJust:CONFigure:TRIGger on page 154

Adjusting all Determinable Settings Automatically (Auto All)..... 62  
 Adjusting the Center Frequency Automatically (Auto Frequency)..... 63  
 Setting the Reference Level Automatically (Auto Level)..... 63  
 Resetting the Automatic Measurement Time (Meas Time Auto)..... 63  
 Changing the Automatic Measurement Time (Meas Time Manual)..... 63  
 Upper Level Hysteresis..... 64  
 Lower Level Hysteresis..... 64

**Adjusting all Determinable Settings Automatically (Auto All)**

Activates all automatic adjustment functions for the current measurement settings, including:

- Auto Frequency

- [Auto Level](#)

Remote command:

[\[SENSe:\]ADJust:ALL](#) on page 152

### Adjusting the Center Frequency Automatically (Auto Frequency)

The R&S FPL1000 adjusts the center frequency automatically.

The optimum center frequency is the frequency with the highest S/N ratio in the frequency span. As this function uses the signal counter, it is intended for use with sinusoidal signals.

To set the optimal reference level, see "[Setting the Reference Level Automatically \(Auto Level\)](#)" on page 47).

Remote command:

[\[SENSe:\]ADJust:FREQuency](#) on page 155

### Setting the Reference Level Automatically (Auto Level)

Automatically determines a reference level which ensures that no overload occurs at the R&S FPL1000 for the current input data. At the same time, the internal attenuators are adjusted. As a result, the signal-to-noise ratio is optimized, while signal compression and clipping are minimized.

To determine the required reference level, a level measurement is performed on the R&S FPL1000.

If necessary, you can optimize the reference level further. Decrease the attenuation level manually to the lowest possible value before an overload occurs, then decrease the reference level in the same way.

You can change the measurement time for the level measurement if necessary (see "[Changing the Automatic Measurement Time \(Meas Time Manual\)](#)" on page 63).

Remote command:

[\[SENSe:\]ADJust:LEVel](#) on page 155

### Resetting the Automatic Measurement Time (Meas Time Auto)

Resets the measurement duration for automatic settings to the default value.

Remote command:

[\[SENSe:\]ADJust:CONFigure:LEVel:DURation:MODE](#) on page 153

### Changing the Automatic Measurement Time (Meas Time Manual)

This function allows you to change the measurement duration for automatic setting adjustments. Enter the value in seconds.

**Note:** The maximum measurement duration depends on the currently selected measurement and the installed (optional) hardware. Thus, the measurement duration actually used to determine the automatic settings can be shorter than the value you define here.

Remote command:

[\[SENSe:\]ADJust:CONFigure:LEVel:DURation:MODE](#) on page 153

[\[SENSe:\]ADJust:CONFigure:LEVel:DURation](#) on page 153

**Upper Level Hysteresis**

When the reference level is adjusted automatically using the [Auto Level](#) function, the internal attenuators and the preamplifier are also adjusted. To avoid frequent adaptation due to small changes in the input signal, you can define a hysteresis. This setting defines an upper threshold that the signal must exceed (compared to the last measurement) before the reference level is adapted automatically.

Remote command:

[\[SENSe:\]ADJust:CONFigure:HYSTeresis:UPPer](#) on page 154

**Lower Level Hysteresis**

When the reference level is adjusted automatically using the [Auto Level](#) function, the internal attenuators and the preamplifier are also adjusted. To avoid frequent adaptation due to small changes in the input signal, you can define a hysteresis. This setting defines a lower threshold that the signal must fall below (compared to the last measurement) before the reference level is adapted automatically.

Remote command:

[\[SENSe:\]ADJust:CONFigure:HYSTeresis:LOWer](#) on page 154



## 6 Analysis

**Access:** "Overview" > "Analysis"

General result analysis settings concerning the trace, markers etc. are identical to the analysis functions in the Spectrum application, except for the lines and special marker functions, which are not available for I/Q data.

The remote commands required to perform these tasks are described in [Chapter 6, "Analysis"](#), on page 65.

- [Trace settings](#).....65
- [Spectrogram settings](#).....70
- [Trace / data export configuration](#).....75
- [Marker usage](#).....78

### 6.1 Trace settings

**Access:** "Overview" > "Analysis" > "Traces"

Or: [TRACE] > "Trace Config"

You can configure the settings for up to 6 individual traces in the same result display. Each trace is displayed in a different color, indicated in the window title bar and the trace settings.



Trace data can also be exported to an ASCII file for further analysis. For details see [Chapter 6.3, "Trace / data export configuration"](#), on page 75.

For I/Q Vector evaluation mode, only 1 trace is available and the detector is not editable.

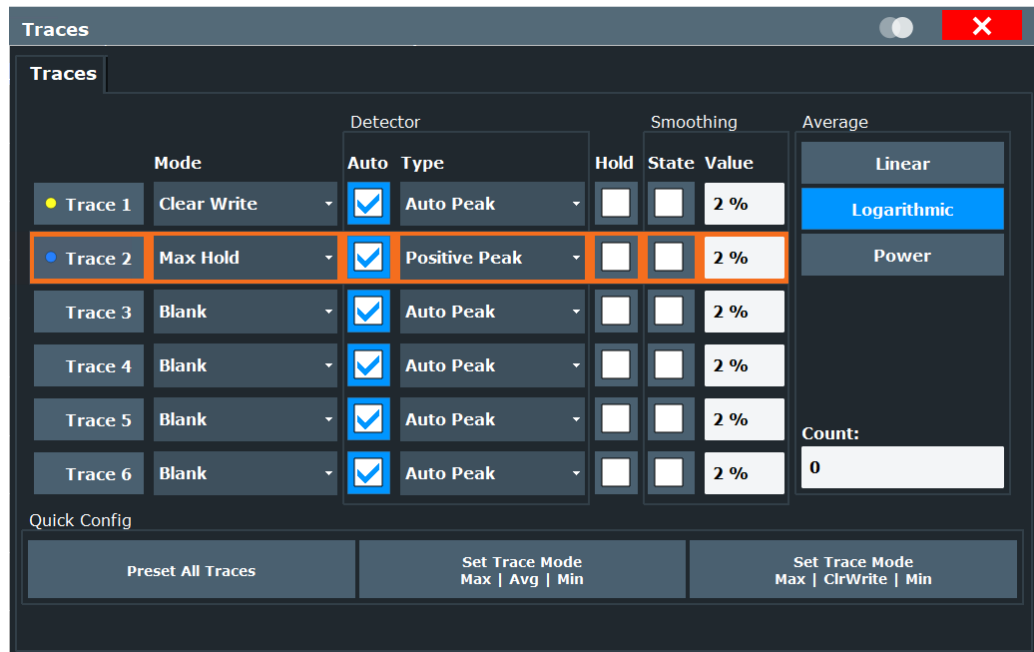

Trace 1/Trace 2/Trace 3/Trace 4/Trace 5/Trace 6.....66

Trace Mode..... 66

Detector.....67

Hold.....68

Smoothing..... 68

Average Mode..... 68

Predefined Trace Settings - Quick Config..... 69

Trace 1/ Trace 2/ Trace 3/ Trace 4 (Softkeys).....69

Copy Trace.....69

**Trace 1/Trace 2/Trace 3/Trace 4/Trace 5/Trace 6**

Selects the corresponding trace for configuration. The currently selected trace is highlighted.

Remote command:

Selected via numeric suffix of:TRACe<1 . . . 6> commands

DISPlay[:WINDow<n>][:SUBWindow<w>]:TRACe<t>[:STATE] on page 171

**Trace Mode**

Defines the update mode for subsequent traces.

- "Clear/ Write"      Overwrite mode (default): the trace is overwritten by each sweep. All available detectors can be selected.
- "Max Hold"      The maximum value is determined over several measurements and displayed. The R&S FPL1000 saves the sweep result in the trace memory only if the new value is greater than the previous one. This mode is especially useful with modulated or pulsed signals. The signal spectrum is filled up upon each sweep until all signal components are detected in a kind of envelope. This mode is not available for statistics measurements.

- "Min Hold" The minimum value is determined from several measurements and displayed. The R&S FPL1000 saves the sweep result in the trace memory only if the new value is lower than the previous one. This mode is useful for example for making an unmodulated carrier in a composite signal visible. Noise, interference signals or modulated signals are suppressed, whereas a CW signal is recognized by its constant level. This mode is not available for statistics measurements.
- "Average" The average is formed over several sweeps. The [This is Sweep/Average Count ok?](#) determines the number of averaging procedures. This mode is not available for statistics measurements.
- "View" The current contents of the trace memory are frozen and displayed. **Note:** If a trace is frozen, you can change the measurement settings, apart from scaling settings, without impact on the displayed trace. The fact that the displayed trace no longer matches the current measurement settings is indicated by a yellow asterisk \* on the tab label. If you change any parameters that affect the scaling of the diagram axes, the R&S FPL1000 automatically adapts the trace data to the changed display range. Thus, you can zoom into the diagram after the measurement to show details of the trace.
- "Blank" Removes the selected trace from the display.

Remote command:

`DISPlay[:WINDow<n>][:SUBWindow<w>]:TRACe<t>:MODE` on page 170

### Detector

Defines the trace detector to be used for trace analysis.

The trace detector is used to combine multiple FFT window results to create the final spectrum. (Note: in previous versions of the R&S FPL1000, the I/Q Analyzer always used the linear average detector.) If necessary, the trace detector is also used to reduce the number of calculated frequency points (defined by the FFT length) to the defined number of sweep points. By default, the Autopeak trace detector is used.

**Note:** Using a detector other than Auto Peak and fewer than 4096 sweep points can lead to wrong level results. For details, see ["Combining results - trace detector"](#) on page 23.

- "Auto" (default:) Selects the optimum detector for the selected trace and filter mode

"Type" Defines the selected detector type.

**Note:** If the EMI (R&S FPL1-K54) measurement option is installed, additional detectors are available, even if EMI measurement is not active. If you select a CISPR trace detector, the RBW filter type is automatically also set to CISPR.

CISPR detectors are only available under the following conditions:

- Time domain measurements and frequency measurements in sweep mode (not FFT mode, not power measurements, emission measurements, or statistics measurements)
- Trigger mode "Free Run" or "External" (trigger offset  $\geq 0$  only for "External")
- Gate mode: "Off"

Remote command:

`[SENSe:] [WINDow<n>:] DETector<t> [:FUNction]` on page 173

`[SENSe:] [WINDow<n>:] DETector<t> [:FUNction]:AUTO` on page 174

### Hold

If activated, traces in "Min Hold", "Max Hold" and "Average" mode are not reset after specific parameter changes have been made.

Normally, the measurement is started again after parameter changes, before the measurement results are analyzed (e.g. using a marker). In all cases that require a new measurement after parameter changes, the trace is reset automatically to avoid false results (e.g. with span changes). For applications that require no reset after parameter changes, the automatic reset can be switched off.

The default setting is off.

Remote command:

`DISPlay[:WINDow<n>] [:SUBWindow<w>]:TRACe<t>:MODE:HCONTinuous`  
on page 171

### Smoothing

If enabled, the trace is smoothed by the specified value (between 1 % and 50 %). The smoothing value is defined as a percentage of the display width. The larger the smoothing value, the greater the smoothing effect.

For more information, see the R&S FPL1000 User Manual.

Remote command:

`DISPlay[:WINDow<n>] [:SUBWindow<w>]:TRACe<t>:SMOothing[:STATe]`  
on page 172

`DISPlay[:WINDow<n>] [:SUBWindow<w>]:TRACe<t>:SMOothing:APERture`  
on page 172

### Average Mode

Defines the mode with which the trace is averaged over several sweeps.

This setting is generally applicable if trace mode "Average" is selected.

For FFT sweeps, the setting also affects the VBW (regardless of whether the trace is averaged).

(See the chapter on ACLR power measurements in the R&S FPL1000 User Manual.)

How many sweeps are averaged is defined by the "This is Sweep/Average Count ok?" on page 60.

"Linear"	The power level values are converted into linear units before averaging. After the averaging, the data is converted back into its original unit.
"Logarithmic"	For logarithmic scaling, the values are averaged in dBm. For linear scaling, the behavior is the same as with linear averaging.
"Power"	Activates linear power averaging. The power level values are converted into unit Watt before averaging. After the averaging, the data is converted back into its original unit. Use this mode to average power values in Volts or Amperes correctly. In particular, for small VBW values (smaller than the RBW), use power averaging mode for correct power measurements in FFT sweep mode.

Remote command:

[SENSe:] AVERage<n>:TYPE on page 173

### Predefined Trace Settings - Quick Config

Commonly required trace settings have been predefined and can be applied very quickly by selecting the appropriate button.

Function	Trace Settings	
Preset All Traces	Trace 1:	Clear Write
	Traces 2-6:	Blank
Set Trace Mode Max   Avg   Min	Trace 1:	Max Hold
	Trace 2:	Average
	Trace 3:	Min Hold
	Traces 4-6:	Blank
Set Trace Mode Max   ClrWrite   Min	Trace 1:	Max Hold
	Trace 2:	Clear Write
	Trace 3:	Min Hold
	Traces 4-6:	Blank

### Trace 1/ Trace 2/ Trace 3/ Trace 4 (Softkeys)

Displays the "Traces" settings and focuses the "Mode" list for the selected trace.

Remote command:

DISPlay[:WINDow<n>] [:SUBWindow<w>]:TRACe<t>[:STATe] on page 171

### Copy Trace

Access: "Overview" > "Analysis" > "Traces" > "Copy Trace"

Or: [TRACE] > "Copy Trace"

Copies trace data to another trace.

The first group of buttons (labeled "Trace 1" to "Trace 6") selects the source trace. The second group of buttons (labeled "Copy to Trace 1" to "Copy to Trace 6") selects the destination.

Remote command:

`TRACe<n>:COPY` on page 174

## 6.2 Spectrogram settings

**Access:** [TRACE] > "Spectrogram Config"

The individual settings available for spectrogram display are described here. For settings on color mapping, see [Chapter 6.2.2, "Color map settings"](#), on page 73.

Settings concerning the frames and how they are handled during a sweep are provided as additional sweep settings for spectrogram display.

See [Chapter 5.7.2, "Sweep settings"](#), on page 59.

Search functions for spectrogram markers are described in [Chapter 6.4.2.2, "Marker search settings for spectrograms"](#), on page 86.

- [General spectrogram settings](#).....70
- [Color map settings](#).....73

### 6.2.1 General spectrogram settings

**Access:** [TRACE] > "Spectrogram Config"

This section describes general settings for spectrogram display.

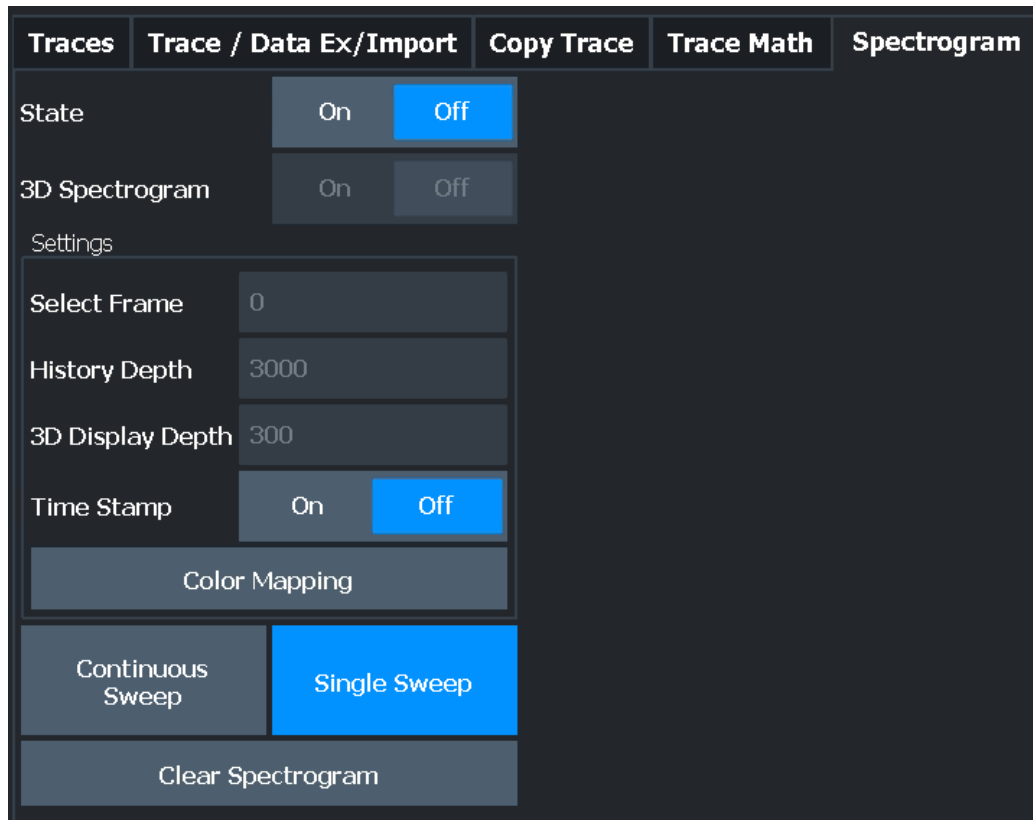

State.....71  
 3D Spectrogram State.....71  
 Select Frame.....72  
 History Depth.....72  
 3-D Display Depth.....72  
 Time Stamp.....72  
 Color Mapping.....72  
 Continuous Sweep / Run Cont.....72  
 Single Sweep / Run Single.....73  
 Clear Spectrogram.....73

**State**

Activates and deactivates a Spectrogram subwindow.

"On" Displays the Spectrogram as a subwindow in the original result display.

"Off" Closes the Spectrogram subwindow.

Remote command:

[CALCulate<n>:SPECTrogram:LAYout](#) on page 178

**3D Spectrogram State**

Activates and deactivates a 3-dimensional spectrogram. As opposed to the common 2-dimensional spectrogram, the power is not only indicated by a color mapping, but also in a third dimension, the z-axis.

For details see the R&S FPL1000 User Manual.

Remote command:

[CALCulate<n>:SPECTrogram:THReedim\[:STATe\]](#) on page 179

### Select Frame

Selects a specific frame, loads the corresponding trace from the memory, and displays it in the Spectrum window.

Note that activating a marker or changing the position of the active marker automatically selects the frame that belongs to that marker.

This function is only available in single sweep mode or if the sweep is stopped, and only if a spectrogram is selected.

The most recent frame is number 0, all previous frames have a negative number.

For more details, see the R&S FPL1000 User Manual.

Remote command:

[CALCulate<n>:SPECTrogram:FRAMe:SElect](#) on page 177

### History Depth

Sets the number of frames that the R&S FPL1000 stores in its memory.

The maximum number of frames depends on the "Sweep Points" on page 60.

For an overview of the maximum number of frames depending on the number of sweep points, see the R&S FPL1000 User Manual.

If the memory is full, the R&S FPL1000 deletes the oldest frames stored in the memory and replaces them with the new data.

Remote command:

[CALCulate<n>:SPECTrogram:HDEPth](#) on page 178

### 3-D Display Depth

Defines the number of frames displayed in a 3-dimensional spectrogram.

For details see the R&S FPL1000 User Manual.

### Time Stamp

Activates and deactivates the timestamp. The timestamp shows the system time while the measurement is running. In single sweep mode or if the sweep is stopped, the timestamp shows the time and date of the end of the sweep.

When active, the timestamp replaces the display of the frame number.

Remote command:

[CALCulate<n>:SPECTrogram:TSTamp\[:STATe\]](#) on page 181

[CALCulate<n>:SPECTrogram:TSTamp:DATA?](#) on page 180

### Color Mapping

Opens the "Color Mapping" dialog.

For details see the R&S FPL1000 User Manual.

### Continuous Sweep / Run Cont

After triggering, starts the measurement and repeats it continuously until stopped.



While the measurement is running, the "Continuous Sweep" softkey and the [RUN CONT] key are highlighted. The running measurement can be aborted by selecting the highlighted softkey or key again. The results are not deleted until a new measurement is started.

**Note:** Sequencer. If the Sequencer is active, the "Continuous Sweep" softkey only controls the sweep mode for the currently selected channel setup. However, the sweep mode only takes effect the next time the Sequencer activates that channel setup, and only for a channel-defined sequence. In this case, a channel setup in continuous sweep mode is swept repeatedly.

Furthermore, the [RUN CONT] key controls the Sequencer, not individual sweeps. [RUN CONT] starts the Sequencer in continuous mode.

For details on the Sequencer, see the R&S FPL1000 User Manual.

Remote command:

`INITiate<n>:CONTInuous` on page 165

### Single Sweep / Run Single

After triggering, starts the number of sweeps set in "Sweep Count". The measurement stops after the defined number of sweeps has been performed.

While the measurement is running, the "Single Sweep" softkey and the [RUN SINGLE] key are highlighted. The running measurement can be aborted by selecting the highlighted softkey or key again.

**Note:** Sequencer. If the Sequencer is active, the "Single Sweep" softkey only controls the sweep mode for the currently selected channel setup. However, the sweep mode only takes effect the next time the Sequencer activates that channel setup, and only for a channel-defined sequence. In this case, the Sequencer sweeps a channel setup in single sweep mode only once.

Furthermore, the [RUN SINGLE] key controls the Sequencer, not individual sweeps. [RUN SINGLE] starts the Sequencer in single mode.

If the Sequencer is off, only the evaluation for the currently displayed channel setup is updated.

For details on the Sequencer, see the R&S FPL1000 User Manual.

Remote command:

`INITiate<n>[:IMMEDIATE]` on page 165

### Clear Spectrogram

Resets the spectrogram result display and clears the history buffer.

This function is only available if a spectrogram is selected.

Remote command:

`CALCulate<n>:SPECTrogram:CLEar[:IMMEDIATE]` on page 176

## 6.2.2 Color map settings

**Access:** "Overview" > "Analysis" > "Traces" > "Spectrogram" > "Color Mapping"

**or:** [TRACE] > "Spectrogram Config" > "Color Mapping"

In addition to the available color settings, the dialog box displays the current color map and provides a preview of the display with the current settings.

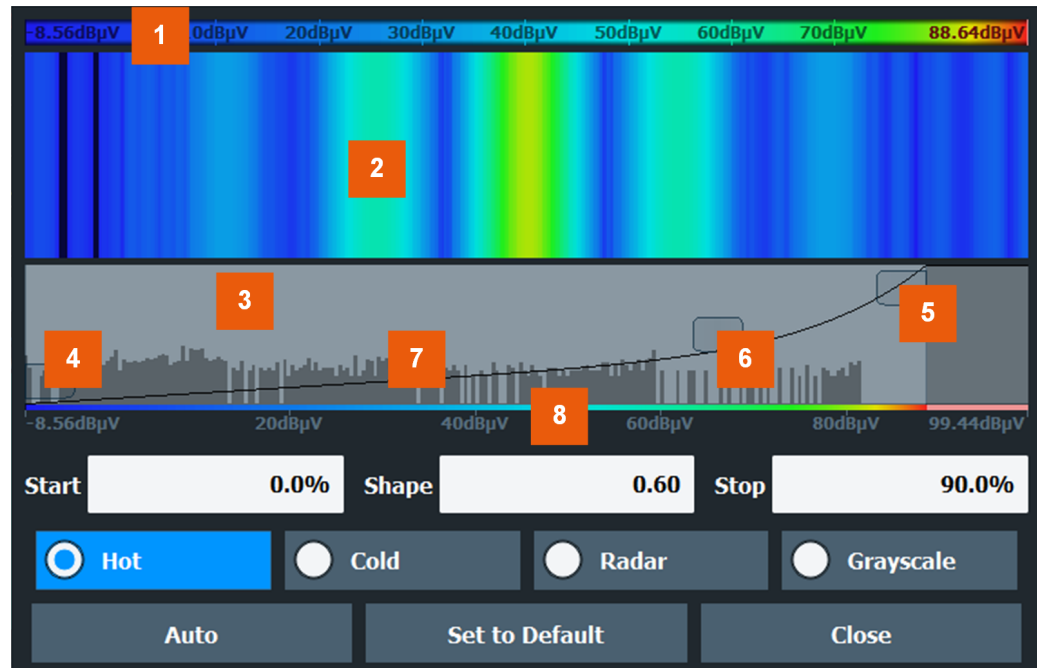

**Figure 6-1: Color Mapping dialog box**

- 1 = Color map: shows the current color distribution
- 2 = Preview pane: shows a preview of the spectrogram with any changes that you make to the color scheme
- 3 = Color curve pane: graphical representation of all settings available to customize the color scheme
- 4/5 = Color range start and stop sliders: define the range of the color map or amplitudes for the spectrogram
- 6 = Color curve slider: adjusts the focus of the color curve
- 7 = Histogram: shows the distribution of measured values
- 8 = Scale of the horizontal axis (value range)

Start / Stop.....	74
Shape.....	74
Hot/Cold/Radar/Grayscale.....	75
Auto.....	75
Set to Default.....	75
Close.....	75

### Start / Stop

Defines the lower and upper boundaries of the value range of the spectrogram.

Remote command:

`DISPlay[:WINDow<n>]:SPECTrogram:COLor:LOWer` on page 182

`DISPlay[:WINDow<n>]:SPECTrogram:COLor:UPPer` on page 182

### Shape

Defines the shape and focus of the color curve for the spectrogram result display.

"-1 to <0" More colors are distributed among the lower values

"0" Colors are distributed linearly among the values

">0 to 1" More colors are distributed among the higher values

Remote command:

`DISPlay[:WINDow<n>]:SPECTrogram:COLor:SHApe` on page 182

#### Hot/Cold/Radar/Grayscale

Sets the color scheme for the spectrogram.

Remote command:

`DISPlay[:WINDow<n>]:SPECTrogram:COLor[:STYLE]` on page 183

#### Auto

Defines the color range automatically according to the existing measured values for optimized display.

#### Set to Default

Sets the color mapping to the default settings.

Remote command:

`DISPlay[:WINDow<n>]:SPECTrogram:COLor:DEFault` on page 181

#### Close

Saves the changes and closes the dialog box.

## 6.3 Trace / data export configuration



**Access:** "Save" > "Export" > "Export Configuration"

**Or:** [TRACE] > "Trace Config" > "Trace / Data Export"

The R&S FPL1000 provides various evaluation methods for the results of the performed measurements. However, if you want to evaluate the data with other, external applications, you can export the measurement data to an ASCII file.



The standard data management functions (e.g. saving or loading instrument settings) that are available for all R&S FPL1000 applications are not described here.

See the R&S FPL1000 base unit user manual for a description of the standard functions.

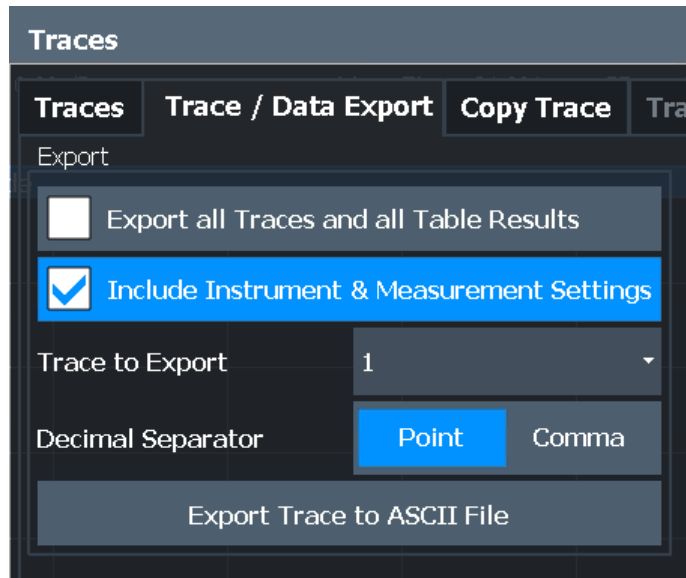

Export all Traces and all Table Results.....	76
Include Instrument & Measurement Settings.....	76
Trace to Export.....	76
Decimal Separator.....	77
Export Trace to ASCII File.....	77
L File Type.....	77
L Decimal Separator.....	78
L File Explorer.....	78

### Export all Traces and all Table Results

Selects all displayed traces and result tables (e.g. "Result Summary", marker table etc.) in the current application for export to an ASCII file.

Alternatively, you can select one specific trace only for export (see [Trace to Export](#)).

The results are output in the same order as they are displayed on the screen: window by window, trace by trace, and table row by table row.

Remote command:

`FORMat:DEXPort:TRACes` on page 227

### Include Instrument & Measurement Settings

Includes additional instrument and measurement settings in the header of the export file for result data.

Remote command:

`FORMat:DEXPort:HEADer` on page 227

### Trace to Export

Defines an individual trace to be exported to a file.

This setting is not available if [Export all Traces and all Table Results](#) is selected.

**Decimal Separator**

Defines the decimal separator for floating-point numerals for the data export/import files. Evaluation programs require different separators in different languages.

Remote command:

[FORMat:DEXPort:DSEParator](#) on page 226

**Export Trace to ASCII File**

Saves the selected trace or all traces in the currently active result display to the specified file and directory in the selected ASCII format.

"File Explorer": Instead of using the file manager of the R&S FPL1000 firmware, you can also use the Microsoft Windows File Explorer to manage files.

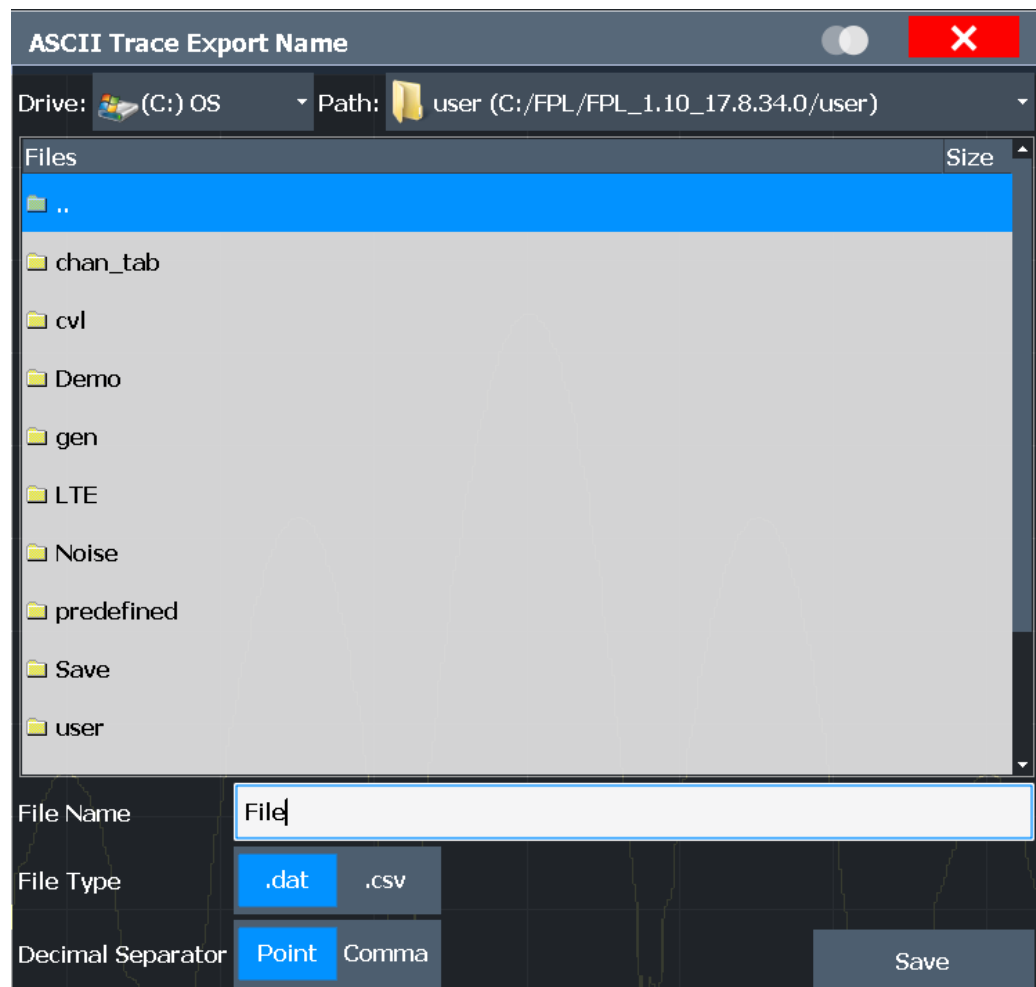

Remote command:

[MMEMory:STORe<n>:TRACe](#) on page 228

**File Type ← Export Trace to ASCII File**

Determines the format of the ASCII file to be imported or exported.

Depending on the external program in which the data file was created or is evaluated, a comma-separated list (CSV) or a plain data format (DAT) file is required.

Remote command:

[FORMat:DEXPort:FORMat](#) on page 227

#### **Decimal Separator ← Export Trace to ASCII File**

Defines the decimal separator for floating-point numerals for the data export/import files. Evaluation programs require different separators in different languages.

Remote command:

[FORMat:DEXPort:DSEParator](#) on page 226

#### **File Explorer ← Export Trace to ASCII File**

Opens the Microsoft Windows File Explorer.

Remote command:

not supported

## 6.4 Marker usage

**Access:** "Overview" > "Analysis"

The following marker settings and functions are available in the I/Q Analyzer application.



For "I/Q-Vector" displays markers are not available.



In the I/Q Analyzer application, the resolution with which the frequency can be measured with a marker is always the filter bandwidth, which is derived from the defined sample rate.

(See [Chapter 4.1.1, "Sample rate and maximum usable I/Q bandwidth for RF input"](#), on page 19).

- [Marker settings](#).....78
- [Marker search settings and positioning functions](#)..... 83
- [Marker search settings for spectrograms](#).....91
- [Marker functions](#).....94

### 6.4.1 Marker settings

Or: [MKR] > "Marker Config"

The remote commands required to define these settings are described in [Chapter 9.7.3.1, "Setting up individual markers"](#), on page 183.

- [Individual marker setup](#).....79
- [General marker settings](#).....82

### 6.4.1.1 Individual marker setup

Up to 17 markers or delta markers can be activated for each window simultaneously. Initial marker setup is performed using the "Marker" dialog box.

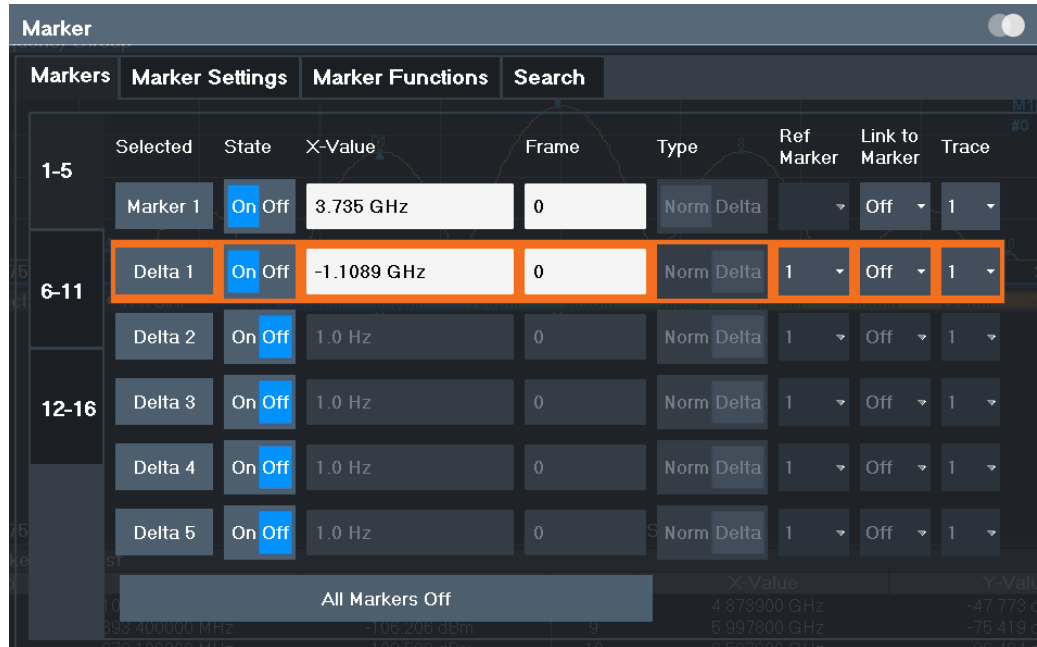

The markers are distributed among 3 tabs for a better overview. By default, the first marker is defined as a normal marker, whereas all others are defined as delta markers with reference to the first marker. All markers are assigned to trace 1, but only the first marker is active.

Selected Marker.....	79
Marker State.....	79
Marker Position X-value.....	80
Frame (Spectrogram only).....	80
Marker Type.....	80
Reference Marker.....	80
Linking to Another Marker.....	80
Assigning the Marker to a Trace.....	81
Select Marker.....	81
All Markers Off.....	81

#### Selected Marker

Marker name. The marker which is currently selected for editing is highlighted orange.

Remote command:

Marker selected via suffix <m> in remote commands.

#### Marker State

Activates or deactivates the marker in the diagram.

Remote command:

[CALCulate<n>:MARKer<m>\[:STATe\]](#) on page 189

[CALCulate<n>:DELTAmarker<m>\[:STATe\]](#) on page 186

### Marker Position X-value

Defines the position (x-value) of the marker in the diagram. For normal markers, the absolute position is indicated. For delta markers, the position relative to the reference marker is provided.

Remote command:

[CALCulate<n>:MARKer<m>:X](#) on page 190

[CALCulate<n>:DELTAmarker<m>:X](#) on page 187

### Frame (Spectrogram only)

Spectrogram frame the marker is assigned to.

Remote command:

[CALCulate<n>:MARKer<m>:SPECTrogram:FRAME](#) on page 197

[CALCulate<n>:DELTAmarker<m>:SPECTrogram:FRAME](#) on page 202

### Marker Type

Toggles the marker type.

The type for marker 1 is always "Normal", the type for delta marker 1 is always "Delta". These types cannot be changed.

**Note:** If normal marker 1 is the active marker, switching the "Mkr Type" activates an additional delta marker 1. For any other marker, switching the marker type does not activate an additional marker, it only switches the type of the selected marker.

"Normal"            A normal marker indicates the absolute value at the defined position in the diagram.

"Delta"            A delta marker defines the value of the marker relative to the specified reference marker (marker 1 by default).

Remote command:

[CALCulate<n>:MARKer<m>\[:STATe\]](#) on page 189

[CALCulate<n>:DELTAmarker<m>\[:STATe\]](#) on page 186

### Reference Marker

Defines a marker as the reference marker which is used to determine relative analysis results (delta marker values).

If the reference marker is deactivated, the delta marker referring to it is also deactivated.

Remote command:

[CALCulate<n>:DELTAmarker<m>:MREference](#) on page 186

### Linking to Another Marker

Links the current marker to the marker selected from the list of active markers. If the x-axis value of the initial marker is changed, the linked marker follows to the same position on the x-axis. Linking is off by default.



Using this function you can set two markers on different traces to measure the difference (e.g. between a max hold trace and a min hold trace or between a measurement and a reference trace).

Remote command:

[CALCulate<n>:MARKer<ms>:LINK:TO:MARKer<md>](#) on page 188

[CALCulate<n>:DELTAmarker<ms>:LINK:TO:MARKer<md>](#) on page 185

[CALCulate<n>:DELTAmarker<m>:LINK](#) on page 184

### Assigning the Marker to a Trace

The "Trace" setting assigns the selected marker to an active trace. The trace determines which value the marker shows at the marker position. If the marker was previously assigned to a different trace, the marker remains on the previous frequency or time, but indicates the value of the new trace.

If a trace is turned off, the assigned markers and marker functions are also deactivated.

Remote command:

[CALCulate<n>:MARKer<m>:TRACe](#) on page 189

### Select Marker

The "Select Marker" function opens a dialog box to select and activate or deactivate one or more markers quickly.



Remote command:

[CALCulate<n>:MARKer<m>\[:STATe\]](#) on page 189

[CALCulate<n>:DELTAmarker<m>\[:STATe\]](#) on page 186

### All Markers Off

Deactivates all markers in one step.

Remote command:

[CALCulate<n>:MARKer<m>:AOFF](#) on page 188

### 6.4.1.2 General marker settings

Some general marker settings allow you to influence the marker behavior for all markers.

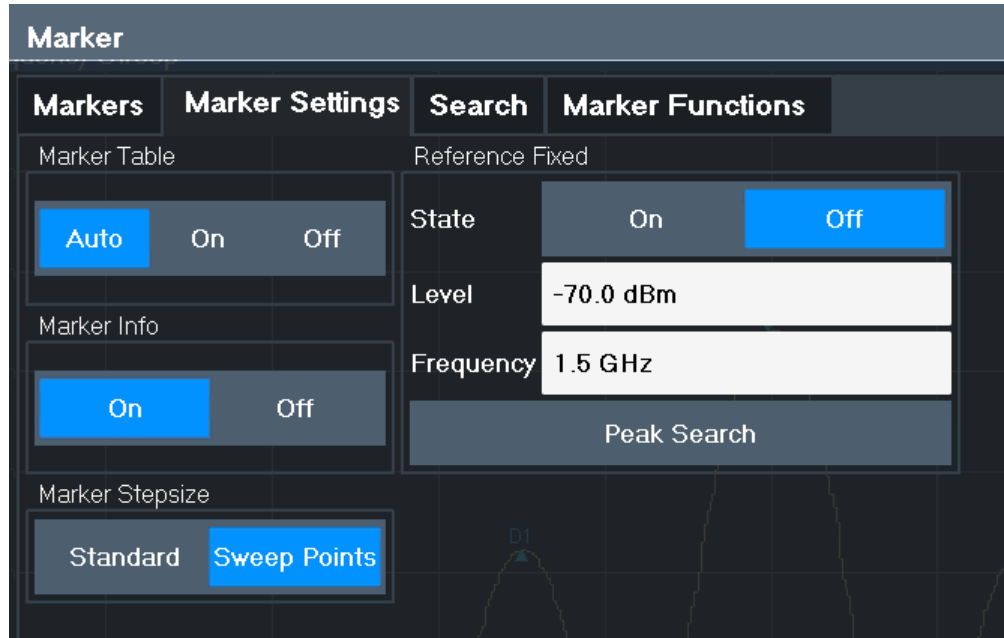

Marker Table Display.....	82
Marker Info.....	82
Marker Stepsize.....	83

#### Marker Table Display

Defines how the marker information is displayed.

"On"	Displays the marker information in a table in a separate area beneath the diagram.
"Off"	No separate marker table is displayed. If <b>Marker Info</b> is active, the marker information is displayed within the diagram area.
"Auto"	(Default) If more than two markers are active, the marker table is displayed automatically. If <b>Marker Info</b> is active, the marker information for up to two markers is displayed in the diagram area.

Remote command:

`DISPlay[:WINDow<n>]:MTABLE` on page 190

#### Marker Info

Turns the marker information displayed in the diagram on and off.

1AP Clrw	
M1[1]	81.13 dB $\mu$ V 177.610 MHz
D2[1]	-22.18 dB -28.980 MHz

Remote command:

`DISPlay[:WINDow<n>]:MINFo[:STATe]` on page 191

### Marker Stepsize

Defines the size of the steps that the marker position is moved using the rotary knob.

"Standard"	The marker position is moved in steps of (Span/1000), which corresponds approximately to the number of pixels for the default display of 1001 sweep points. This setting is most suitable to move the marker over a larger distance.
"Sweep Points"	The marker position is moved from one sweep point to the next. This setting is required for a very precise positioning if more sweep points are collected than the number of pixels that can be displayed on the screen. It is the default mode.

Remote command:

`CALCulate<n>:MARKer<m>:X:SSIZE` on page 191

## 6.4.2 Marker search settings and positioning functions

**Access:** "Overview" > "Analysis" > "Marker" > "Search"

**or:** [MKR TO]

Several functions are available to set the marker to a specific position very quickly and easily, or to use the current marker position to define another characteristic value. In order to determine the required marker position, searches may be performed. The search results can be influenced by special settings.

For more information on searching for signal peaks see [Chapter 6.4.4.2, "Marker peak list"](#), on page 97.



In I/Q Analyzer mode, the search settings for "Real/Imag (I/Q)" evaluation include an additional parameter, see ["Branch for Peaksearch"](#) on page 86.

Note that in the Spectrum diagram in I/Q mode, a peak search is performed only within the indicated [Analysis Bandwidth](#), unless you specify [Search Limits \(Left / Right\)](#) in the marker settings.

The remote commands required to define these settings are described in [Chapter 9.7.3.5, "Positioning the marker"](#), on page 206.

- [Marker search settings](#).....84
- [Marker search settings for spectrograms](#).....86
- [Positioning functions](#)..... 89

**6.4.2.1 Marker search settings**

**Access:** [MKR TO] > "Search Config"

Markers are commonly used to determine peak values, i.e. maximum or minimum values, in the measured signal. Configuration settings allow you to influence the peak search results.



For Spectrograms, special marker settings are available, see [Chapter 6.4.2.2, "Marker search settings for spectrograms"](#), on page 86.

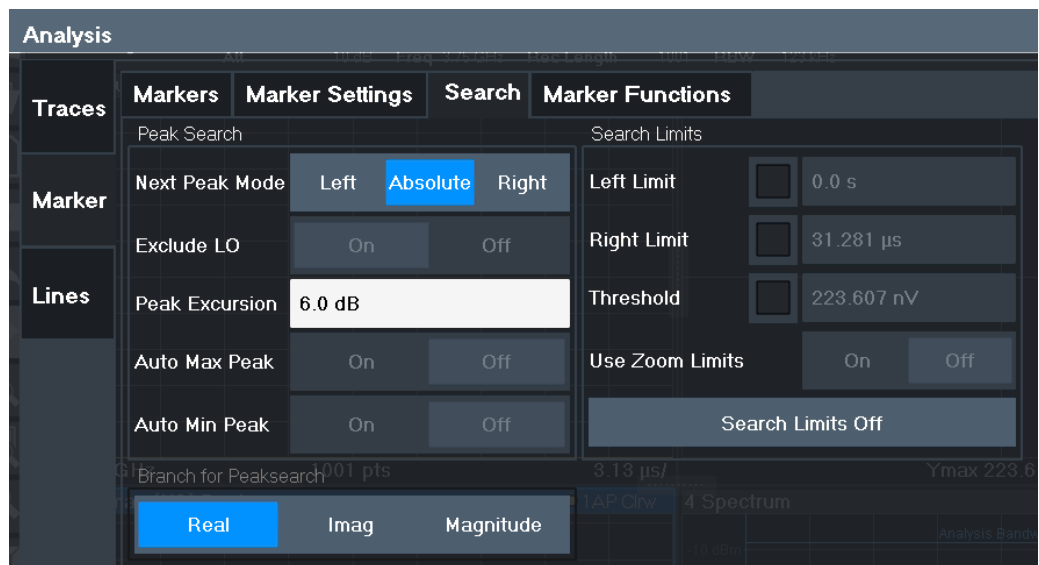

- [Search Mode for Next Peak](#)..... 84
- [Exclude LO](#).....85
- [Peak Excursion](#)..... 85
- [Auto Max Peak Search / Auto Min Peak Search](#).....85
- [Search Limits](#)..... 85
  - └ [Search Limits \(Left / Right\)](#)..... 85
  - └ [Search Threshold](#).....86
  - └ [Use Zoom Limits](#)..... 86
  - └ [Search Limits Off](#)..... 86
- [Branch for Peaksearch](#).....86

**Search Mode for Next Peak**

Selects the search mode for the next peak search.

"Left"                      Determines the next maximum/minimum to the left of the current peak.

"Absolute"	Determines the next maximum/minimum to either side of the current peak.
"Right"	Determines the next maximum/minimum to the right of the current peak.

Remote command:

[Chapter 9.7.3.5, "Positioning the marker"](#), on page 206

### Exclude LO

If activated, restricts the frequency range for the marker search functions.

"On"	The minimum frequency included in the peak search range is $\geq 5 \times$ resolution bandwidth (RBW). Due to the interference by the first local oscillator to the first intermediate frequency at the input mixer, the LO is represented as a signal at 0 Hz. To avoid the peak marker jumping to the LO signal at 0 Hz, this frequency is excluded from the peak search.
"Off"	No restriction to the search range. The frequency 0 Hz is included in the marker search functions.

Remote command:

[CALCulate<n>:MARKer<m>:LOEXclude](#) on page 192

### Peak Excursion

Defines the minimum level value by which a signal must rise or fall so that it is identified as a maximum or a minimum by the search functions.

Entries from 0 dB to 80 dB are allowed; the resolution is 0.1 dB. The default setting for the peak excursion is 6 dB.

For Analog Modulation Analysis, the unit and value range depend on the selected result display type.

For more information, see [Chapter 6.4.4.2, "Marker peak list"](#), on page 97.

Remote command:

[CALCulate<n>:MARKer<m>:PEXCursion](#) on page 192

### Auto Max Peak Search / Auto Min Peak Search

If activated, a maximum or minimum peak search is performed automatically for marker 1 after each sweep.

For spectrogram displays, define which frame the peak is to be searched in.

Remote command:

[CALCulate<n>:MARKer<m>:MAXimum:AUTO](#) on page 206

[CALCulate<n>:MARKer<m>:MINimum:AUTO](#) on page 208

### Search Limits

The search results can be restricted by limiting the search area or adding search conditions.

### Search Limits (Left / Right) ← Search Limits

If activated, limit lines are defined and displayed for the search. Only results within the limited search range are considered.

Remote command:

[CALCulate<n>:MARKer<m>:X:SLIMits\[:STATe\]](#) on page 193

[CALCulate<n>:MARKer<m>:X:SLIMits:LEFT](#) on page 194

[CALCulate<n>:MARKer<m>:X:SLIMits:RIGHT](#) on page 194

#### Search Threshold ← Search Limits

Defines an absolute threshold as an additional condition for the peak search. If enabled, only peaks that exceed the threshold are detected.

Remote command:

[CALCulate<n>:THReshold:STATe](#) on page 196

[CALCulate<n>:THReshold](#) on page 195

#### Use Zoom Limits ← Search Limits

If activated, the peak search is restricted to the active zoom area defined for a single zoom.

Remote command:

[CALCulate<n>:MARKer<m>:X:SLIMits:ZOOM\[:STATe\]](#) on page 195

#### Search Limits Off ← Search Limits

Deactivates the search range limits.

Remote command:

[CALCulate<n>:MARKer<m>:X:SLIMits\[:STATe\]](#) on page 193

[CALCulate<n>:THReshold:STATe](#) on page 196

#### Branch for Peaksearch

Defines which data is used for marker search functions in I/Q data.

This function is only available for the display configuration "Real/Imag (I/Q)" (see "Real/Imag (I/Q)" on page 15).

**Note:** The search settings apply to all markers, not only the currently selected one.

"Real"

Marker search functions are performed on the real trace of the I/Q measurement.

"Imag"

Marker search functions are performed on the imaginary trace of the I/Q measurement.

"Magnitude"

Marker search functions are performed on the magnitude of the I and Q data.

Remote command:

[CALCulate<n>:MARKer<m>:SEARch](#) on page 193

#### 6.4.2.2 Marker search settings for spectrograms

**Access:** "Overview" > "Analysis" > "Markers" > "Search"

or: [MKR TO] > "Search Config"

Spectrograms show not only the current sweep results, but also the sweep history. Thus, when searching for peaks, you must define the search settings within a single time frame (x-direction) and within several time frames (y-direction).

These settings are only available for spectrogram displays.

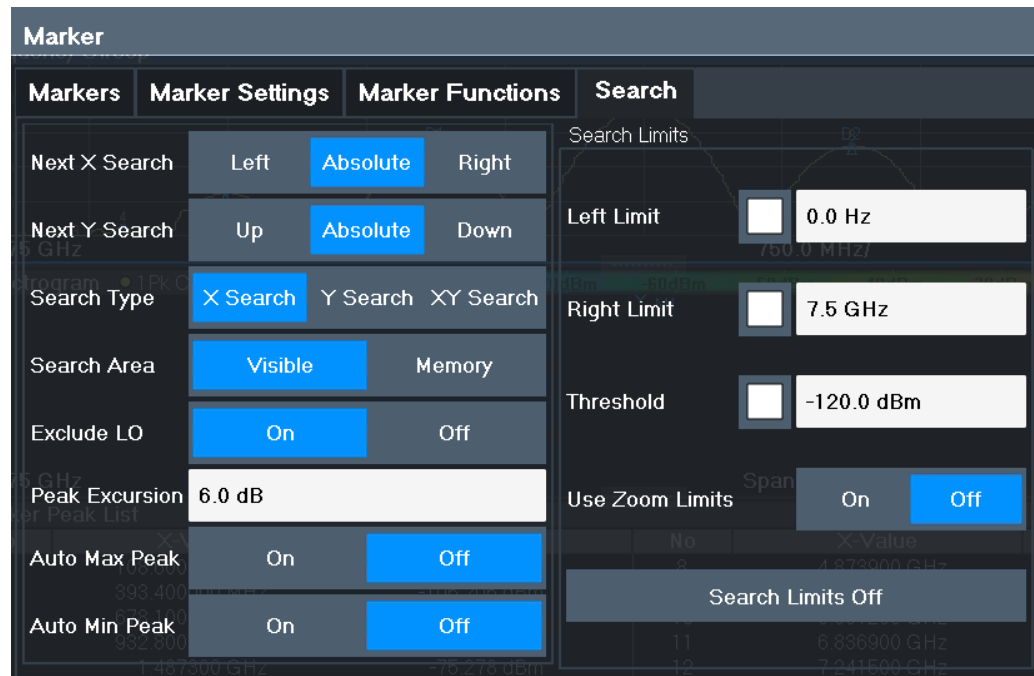

Search Mode for Next Peak in X-Direction.....	87
Search Mode for Next Peak in Y-Direction.....	88
Marker Search Type.....	88
Marker Search Area.....	88
Peak Excursion.....	89
Search Limits.....	89
L Search Limits (Left / Right).....	89
L Search Threshold.....	89
L Use Zoom Limits.....	89
L Search Limits Off.....	89

### Search Mode for Next Peak in X-Direction

Selects the search mode for the next peak search within the currently selected frame.

"Left"	Determines the next maximum/minimum to the left of the current peak.
"Absolute"	Determines the next maximum/minimum to either side of the current peak.
"Right"	Determines the next maximum/minimum to the right of the current peak.

Remote command:

[Chapter 9.7.3.5, "Positioning the marker"](#), on page 206

**Search Mode for Next Peak in Y-Direction**

Selects the search mode for the next peak search within all frames at the current marker position.

"Up"	Determines the next maximum/minimum above the current peak (in more recent frames).
"Absolute"	Determines the next maximum/minimum above or below the current peak (in all frames).
"Down"	Determines the next maximum/minimum below the current peak (in older frames).

Remote command:

[CALCulate<n>:MARKer<m>:SPECTrogram:Y:MAXimum:ABOVE](#) on page 199

[CALCulate<n>:DELTaMarker<m>:SPECTrogram:Y:MAXimum:ABOVE](#)  
on page 203

[CALCulate<n>:MARKer<m>:SPECTrogram:Y:MAXimum:BELOW](#) on page 199

[CALCulate<n>:DELTaMarker<m>:SPECTrogram:Y:MAXimum:BELOW](#)  
on page 204

[CALCulate<n>:MARKer<m>:SPECTrogram:Y:MAXimum:NEXT](#) on page 199

[CALCulate<n>:DELTaMarker<m>:SPECTrogram:Y:MAXimum:NEXT](#) on page 204

[CALCulate<n>:MARKer<m>:SPECTrogram:Y:MINimum:ABOVE](#) on page 200

[CALCulate<n>:DELTaMarker<m>:SPECTrogram:Y:MINimum:ABOVE](#)  
on page 204

[CALCulate<n>:MARKer<m>:SPECTrogram:Y:MINimum:BELOW](#) on page 200

[CALCulate<n>:DELTaMarker<m>:SPECTrogram:Y:MINimum:BELOW](#)  
on page 205

[CALCulate<n>:MARKer<m>:SPECTrogram:Y:MINimum:NEXT](#) on page 200

[CALCulate<n>:DELTaMarker<m>:SPECTrogram:Y:MINimum:NEXT](#) on page 205

**Marker Search Type**

Defines the type of search to be performed in the spectrogram.

"X-Search"	Searches only within the currently selected frame.
"Y-Search"	Searches within all frames but only at the current frequency position.
"XY-Search"	Searches in all frames at all positions.

Remote command:

Defined by the search function, see [Chapter 9.7.3.4, "Marker search \(spectrograms\)"](#), on page 196

**Marker Search Area**

Defines which frames the search is performed in.

"Visible"	Only the visible frames are searched.
"Memory"	All frames stored in the memory are searched.

Remote command:

[CALCulate<n>:MARKer<m>:SPECTrogram:SARea](#) on page 198

[CALCulate<n>:DELTaMarker<m>:SPECTrogram:SARea](#) on page 202



**Peak Excursion**

Defines the minimum level value by which a signal must rise or fall so that it is identified as a maximum or a minimum by the search functions.

Entries from 0 dB to 80 dB are allowed; the resolution is 0.1 dB. The default setting for the peak excursion is 6 dB.

For Analog Modulation Analysis, the unit and value range depend on the selected result display type.

For more information, see [Chapter 6.4.4.2, "Marker peak list"](#), on page 97.

Remote command:

[CALCulate<n>:MARKer<m>:PEXCursion](#) on page 192

**Search Limits**

The search results can be restricted by limiting the search area or adding search conditions.

**Search Limits (Left / Right) ← Search Limits**

If activated, limit lines are defined and displayed for the search. Only results within the limited search range are considered.

Remote command:

[CALCulate<n>:MARKer<m>:X:SLIMits\[:STATe\]](#) on page 193

[CALCulate<n>:MARKer<m>:X:SLIMits:LEFT](#) on page 194

[CALCulate<n>:MARKer<m>:X:SLIMits:RIGHT](#) on page 194

**Search Threshold ← Search Limits**

Defines an absolute threshold as an additional condition for the peak search. If enabled, only peaks that exceed the threshold are detected.

Remote command:

[CALCulate<n>:THReshold:STATe](#) on page 196

[CALCulate<n>:THReshold](#) on page 195

**Use Zoom Limits ← Search Limits**

If activated, the peak search is restricted to the active zoom area defined for a single zoom.

Remote command:

[CALCulate<n>:MARKer<m>:X:SLIMits:ZOOM\[:STATe\]](#) on page 195

**Search Limits Off ← Search Limits**

Deactivates the search range limits.

Remote command:

[CALCulate<n>:MARKer<m>:X:SLIMits\[:STATe\]](#) on page 193

[CALCulate<n>:THReshold:STATe](#) on page 196

**6.4.2.3 Positioning functions**

**Access:** [MKR ->]

The following functions set the currently selected marker to the result of a peak search or set other characteristic values to the current marker value.

Peak Search.....	90
Search Next Peak.....	90
Search Minimum.....	90
Search Next Minimum.....	90
Center Frequency = Marker Frequency.....	91
Reference Level = Marker Level.....	91

### Peak Search

Sets the selected marker/delta marker to the maximum of the trace. If no marker is active, marker 1 is activated.

Remote command:

`CALCulate<n>:MARKer<m>:MAXimum[:PEAK]` on page 207

`CALCulate<n>:DELTamarker<m>:MAXimum[:PEAK]` on page 210

### Search Next Peak

Sets the selected marker/delta marker to the next (lower) maximum of the assigned trace. If no marker is active, marker 1 is activated.

Remote command:

`CALCulate<n>:MARKer<m>:MAXimum:NEXT` on page 207

`CALCulate<n>:MARKer<m>:MAXimum:RIGHT` on page 207

`CALCulate<n>:MARKer<m>:MAXimum:LEFT` on page 206

`CALCulate<n>:DELTamarker<m>:MAXimum:NEXT` on page 210

`CALCulate<n>:DELTamarker<m>:MAXimum:RIGHT` on page 210

`CALCulate<n>:DELTamarker<m>:MAXimum:LEFT` on page 209

### Search Minimum

Sets the selected marker/delta marker to the minimum of the trace. If no marker is active, marker 1 is activated.

Remote command:

`CALCulate<n>:MARKer<m>:MINimum[:PEAK]` on page 209

`CALCulate<n>:DELTamarker<m>:MINimum[:PEAK]` on page 211

### Search Next Minimum

Sets the selected marker/delta marker to the next (higher) minimum of the selected trace. If no marker is active, marker 1 is activated.

For spectrogram displays, define which frame the next minimum is to be searched in.

Remote command:

`CALCulate<n>:MARKer<m>:MINimum:NEXT` on page 208

`CALCulate<n>:MARKer<m>:MINimum:LEFT` on page 208

`CALCulate<n>:MARKer<m>:MINimum:RIGHT` on page 209

`CALCulate<n>:DELTamarker<m>:MINimum:NEXT` on page 211

`CALCulate<n>:DELTamarker<m>:MINimum:LEFT` on page 211

`CALCulate<n>:DELTamarker<m>:MINimum:RIGHT` on page 211

**Center Frequency = Marker Frequency**

Sets the center frequency to the selected marker or delta marker frequency. A peak can thus be set as center frequency, for example to analyze it in detail with a smaller span.

This function is not available for zero span measurements.

Remote command:

CALCulate<n>:MARKer<m>:FUNction:CENTer on page 137

**Reference Level = Marker Level**

Sets the reference level to the selected marker level.

Remote command:

CALCulate<n>:MARKer<m>:FUNction:REFerence on page 132

**6.4.3 Marker search settings for spectrograms**

**Access:** "Overview" > "Analysis" > "Markers" > "Search"

**or:** [MKR TO] > "Search Config"

Spectrograms show not only the current sweep results, but also the sweep history. Thus, when searching for peaks, you must define the search settings within a single time frame (x-direction) and within several time frames (y-direction).

These settings are only available for spectrogram displays.

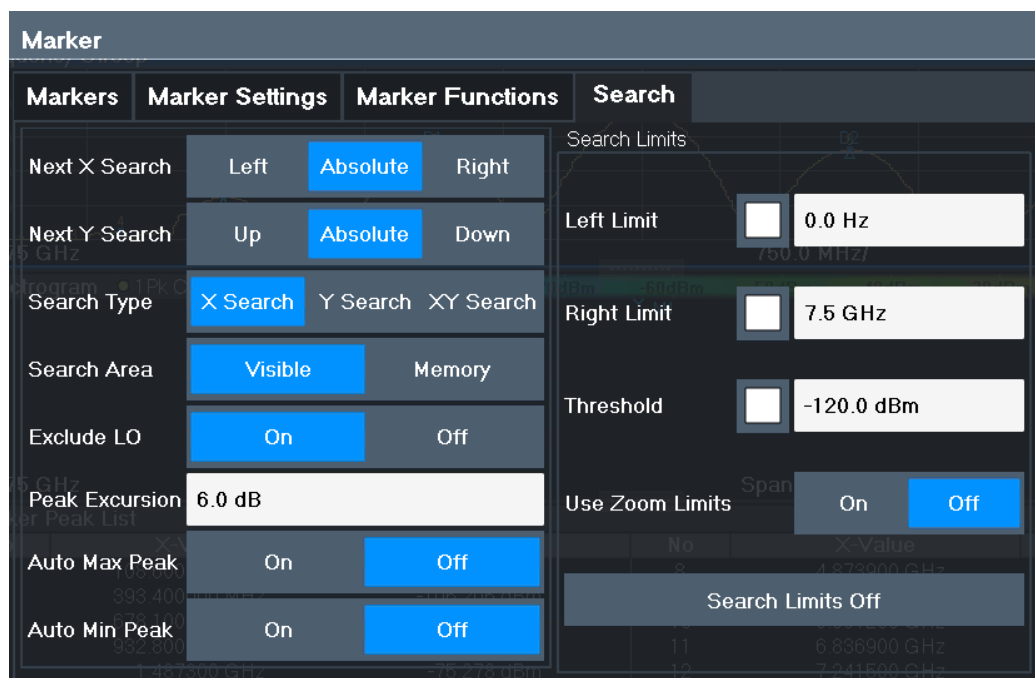

Search Mode for Next Peak in X-Direction.....	92
Search Mode for Next Peak in Y-Direction.....	92
Marker Search Type.....	92
Marker Search Area.....	93

Peak Excursion.....	93
Search Limits.....	93
L Search Limits (Left / Right).....	93
L Search Threshold.....	93
L Use Zoom Limits.....	94
L Search Limits Off.....	94

### Search Mode for Next Peak in X-Direction

Selects the search mode for the next peak search within the currently selected frame.

"Left"	Determines the next maximum/minimum to the left of the current peak.
"Absolute"	Determines the next maximum/minimum to either side of the current peak.
"Right"	Determines the next maximum/minimum to the right of the current peak.

Remote command:

[Chapter 9.7.3.5, "Positioning the marker"](#), on page 206

### Search Mode for Next Peak in Y-Direction

Selects the search mode for the next peak search within all frames at the current marker position.

"Up"	Determines the next maximum/minimum above the current peak (in more recent frames).
"Absolute"	Determines the next maximum/minimum above or below the current peak (in all frames).
"Down"	Determines the next maximum/minimum below the current peak (in older frames).

Remote command:

[CALCulate<n>:MARKer<m>:SPECTrogram:Y:MAXimum:ABOVE](#) on page 199

[CALCulate<n>:DELTamarker<m>:SPECTrogram:Y:MAXimum:ABOVE](#)  
on page 203

[CALCulate<n>:MARKer<m>:SPECTrogram:Y:MAXimum:BELOW](#) on page 199

[CALCulate<n>:DELTamarker<m>:SPECTrogram:Y:MAXimum:BELOW](#)  
on page 204

[CALCulate<n>:MARKer<m>:SPECTrogram:Y:MAXimum:NEXT](#) on page 199

[CALCulate<n>:DELTamarker<m>:SPECTrogram:Y:MAXimum:NEXT](#) on page 204

[CALCulate<n>:MARKer<m>:SPECTrogram:Y:MINimum:ABOVE](#) on page 200

[CALCulate<n>:DELTamarker<m>:SPECTrogram:Y:MINimum:ABOVE](#)  
on page 204

[CALCulate<n>:MARKer<m>:SPECTrogram:Y:MINimum:BELOW](#) on page 200

[CALCulate<n>:DELTamarker<m>:SPECTrogram:Y:MINimum:BELOW](#)  
on page 205

[CALCulate<n>:MARKer<m>:SPECTrogram:Y:MINimum:NEXT](#) on page 200

[CALCulate<n>:DELTamarker<m>:SPECTrogram:Y:MINimum:NEXT](#) on page 205

### Marker Search Type

Defines the type of search to be performed in the spectrogram.

- "X-Search"      Searches only within the currently selected frame.
- "Y-Search"      Searches within all frames but only at the current frequency position.
- "XY-Search"     Searches in all frames at all positions.

Remote command:

Defined by the search function, see [Chapter 9.7.3.4, "Marker search \(spectrograms\)"](#), on page 196

### Marker Search Area

Defines which frames the search is performed in.

- "Visible"        Only the visible frames are searched.
- "Memory"        All frames stored in the memory are searched.

Remote command:

[CALCulate<n>:MARKer<m>:SPECTrogram:SARea](#) on page 198

[CALCulate<n>:DELTamarker<m>:SPECTrogram:SARea](#) on page 202

### Peak Excursion

Defines the minimum level value by which a signal must rise or fall so that it is identified as a maximum or a minimum by the search functions.

Entries from 0 dB to 80 dB are allowed; the resolution is 0.1 dB. The default setting for the peak excursion is 6 dB.

For Analog Modulation Analysis, the unit and value range depend on the selected result display type.

For more information, see [Chapter 6.4.4.2, "Marker peak list"](#), on page 97.

Remote command:

[CALCulate<n>:MARKer<m>:PEXCursion](#) on page 192

### Search Limits

The search results can be restricted by limiting the search area or adding search conditions.

#### Search Limits (Left / Right) ← Search Limits

If activated, limit lines are defined and displayed for the search. Only results within the limited search range are considered.

Remote command:

[CALCulate<n>:MARKer<m>:X:SLIMits\[:STATe\]](#) on page 193

[CALCulate<n>:MARKer<m>:X:SLIMits:LEFT](#) on page 194

[CALCulate<n>:MARKer<m>:X:SLIMits:RIGHT](#) on page 194

#### Search Threshold ← Search Limits

Defines an absolute threshold as an additional condition for the peak search. If enabled, only peaks that exceed the threshold are detected.

Remote command:

[CALCulate<n>:THReshold:STATe](#) on page 196

[CALCulate<n>:THReshold](#) on page 195

**Use Zoom Limits ← Search Limits**

If activated, the peak search is restricted to the active zoom area defined for a single zoom.

Remote command:

`CALCulate<n>:MARKer<m>:X:SLIMits:ZOOM[:STATe]` on page 195

**Search Limits Off ← Search Limits**

Deactivates the search range limits.

Remote command:

`CALCulate<n>:MARKer<m>:X:SLIMits[:STATe]` on page 193

`CALCulate<n>:THReshold:STATe` on page 196

**6.4.4 Marker functions**

Some special marker functions are available in the I/Q Analyzer application.

- [Measuring the power in a channel \(band power marker\)](#).....94
- [Marker peak list](#).....97
- [Deactivating all marker functions](#)..... 101

**6.4.4.1 Measuring the power in a channel (band power marker)**

**Access:** "Overview" > "Analysis" > "Marker Functions" > "Band Power" > "Band Power Config"

**or:** [MKR FUNC] > "Select Marker Function" > "Band Power"

**or:** [MKR] > "Select Marker Function" > "Band Power"

To determine the noise power in a transmission channel, you can use a noise marker and multiply the result with the channel bandwidth. However, the results are only accurate for flat noise.

Band power markers allow you to measure the integrated power for a defined span (band) around a marker (similar to ACP measurements). By default, 5 % of the current span is used. The span is indicated by limit lines in the diagram. You can easily change the span by moving the limit lines in the diagram. They are automatically aligned symmetrically to the marker frequency. They are also moved automatically if you move the marker on the screen.

The results can be displayed either as a power (dBm) or density (dBm/Hz) value and are indicated in the "marker table" for each band power marker.



### Relative band power markers

The results for band power markers which are defined as *delta* markers and thus have a reference value can also be calculated as reference power values (in dB).

In this case, the result of the band power deltamarker is the difference between the absolute power in the band around the delta marker and the absolute power for the reference marker. The powers are subtracted logarithmically, so the result is a dB value.

$[Relative\ band\ power\ (Delta2)\ in\ dB] = [absolute\ band\ power\ (Delta2)\ in\ dBm] - [absolute\ (band)\ power\ of\ reference\ marker\ in\ dBm]$

The measured power for the reference marker may be an absolute power at a single point (if the reference marker is not a band power marker), or the power in a band (if the reference marker is a band power marker itself).

If the reference marker for the band power marker is also a delta marker, the absolute power level for the reference marker is used for calculation.



For the I/Q Analyzer application, band power markers are only available for Spectrum displays.

The entire band must lie within the display. If it is moved out of the display, the result cannot be calculated (indicated by "- -" as the "Function Result"). However, the width of the band is maintained so that the band power can be calculated again when it returns to the display.

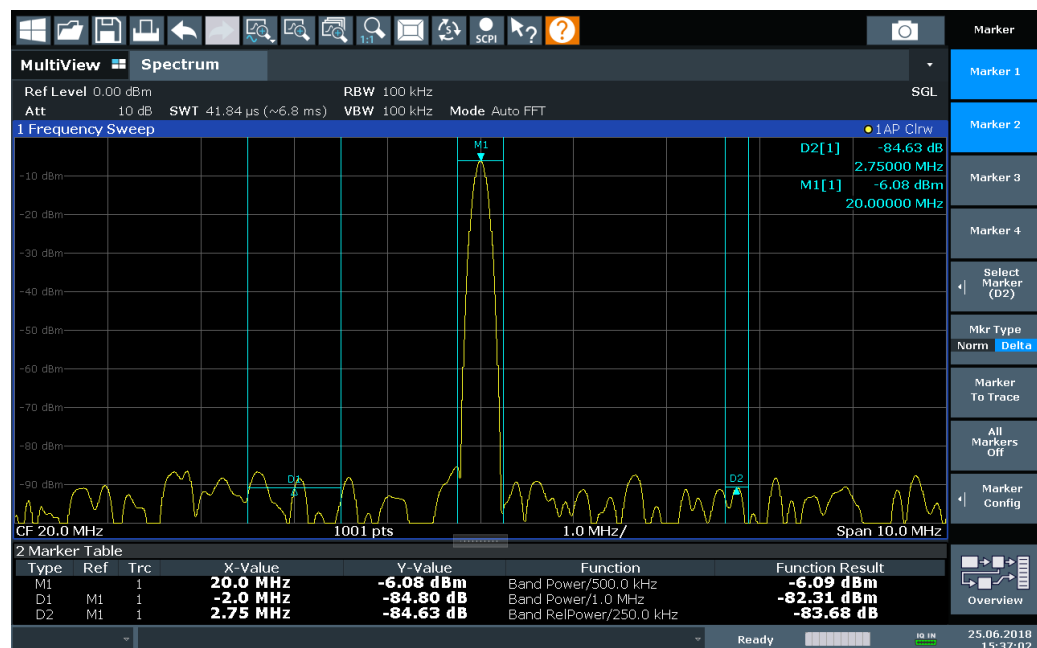

All markers can be defined as band power markers, each with a different span. When a band power marker is activated, if no marker is active yet, marker 1 is activated. Otherwise, the currently active marker is used as a band power marker (all other marker functions for this marker are deactivated).

If the detector mode for the marker trace is set to "Auto", the RMS detector is used.

The individual marker settings correspond to those defined in the "Marker" dialog box (see Chapter 6.4.1.1, "Individual marker setup", on page 79). Any settings to the marker state or type changed in the "Marker Function" dialog box are also changed in the "Marker" dialog box and vice versa.

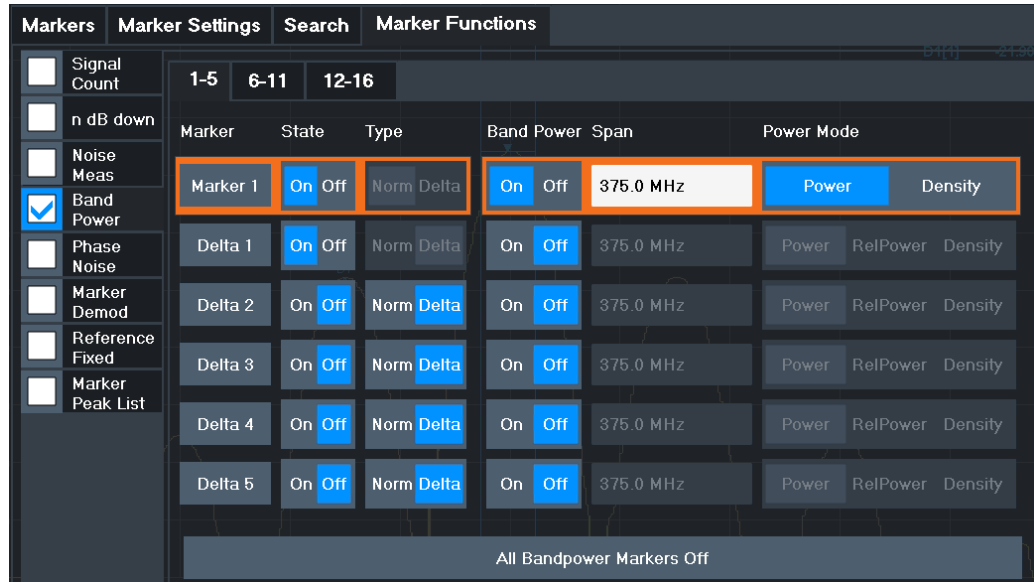

**Remote commands:**

CALCulate<n>:MARKer<m>:FUNCTION:BPOWER[:STATE] on page 213

CALCulate<n>:MARKer<m>:FUNCTION:BPOWER:RESult? on page 213

Band Power Measurement State..... 96

Span.....96

Power Mode..... 97

Switching All Band Power Measurements Off.....97

**Band Power Measurement State**

Activates or deactivates band power measurement for the marker in the diagram.

Band power markers are only available for standard frequency measurements (not zero span) in the Spectrum application.

If activated, the markers display the power or density measured in the band around the current marker position.

For details see Chapter 6.4.4.1, "Measuring the power in a channel (band power marker)", on page 94.

Remote command:

CALCulate<n>:MARKer<m>:FUNCTION:BPOWER[:STATE] on page 213

CALCulate<n>:DELTAmarker<m>:FUNCTION:BPOWER[:STATE] on page 215

**Span**

Defines the span (band) around the marker for which the power is measured.



The span is indicated by lines in the diagram. You can easily change the span by moving the limit lines in the diagram. They are automatically aligned symmetrically to the marker frequency. They are also moved automatically if you move the marker on the screen.

Remote command:

[CALCulate<n>:MARKer<m>:FUNCTION:BPOWER:SPAN](#) on page 213

[CALCulate<n>:DELTAmarker<m>:FUNCTION:BPOWER:SPAN](#) on page 215

### Power Mode

Defines the mode of the power measurement result.

For Analog Modulation Analysis, the power mode is not editable for AM, FM, or PM spectrum results. In this case, the marker function does not determine a power value, but rather the deviation within the specified span.

"Power"	The result is an absolute power level. The power unit depends on the <a href="#">Unit</a> setting.
"Relative Power"	This setting is only available for a delta band power marker. The result is the difference between the absolute power in the band around the delta marker and the absolute power for the reference marker (see <a href="#">"Reference Marker"</a> on page 80). The powers are subtracted logarithmically, so the result is a dB value. <i>[Relative band power (Delta2) in dB] = [absolute band power (Delta2) in dBm] - [absolute (band) power of reference marker in dBm]</i> For details see <a href="#">"Relative band power markers"</a> on page 95
"Density"	The result is a power level in relation to the bandwidth, displayed in dBm/Hz.

Remote command:

[CALCulate<n>:MARKer<m>:FUNCTION:BPOWER:MODE](#) on page 212

[CALCulate<n>:DELTAmarker<m>:FUNCTION:BPOWER:MODE](#) on page 214

### Switching All Band Power Measurements Off

Deactivates band power measurement for all markers.

Remote command:

[CALCulate<n>:MARKer<m>:FUNCTION:BPOWER\[:STATe\]](#) on page 213

[CALCulate<n>:DELTAmarker<m>:FUNCTION:BPOWER\[:STATe\]](#) on page 215

#### 6.4.4.2 Marker peak list

**Access:** "Overview" > "Analysis" > "Marker Functions" > "Marker Peak List"

**Or:** [MKR] > "Select Marker Function" > "Marker Peak List"

A common measurement task is to determine peak values, i.e. maximum or minimum signal levels. The R&S FPL1000 provides various peak search functions and applications:

- Setting a marker to a peak value once (Peak Search)
- Searching for a peak value within a restricted search area (Search Limits)

- Creating a "marker table" with all or a defined number of peak values for one sweep ("Marker Peak List")
- Updating the marker position to the current peak value automatically after each sweep (Auto Peak Search)

### Peak search limits

The peak search can be restricted to a search area. The search area is defined by limit lines which are also indicated in the diagram. In addition, a minimum value (threshold) can be defined as a further search condition.

### When is a peak a peak? - Peak excursion

During a peak search, noise values are detected as a peak if the signal is very flat or does not contain many peaks. Therefore, you can define a relative threshold ("Peak Excursion"). The signal level must increase by the threshold value before falling again before a peak is detected. To avoid identifying noise peaks as maxima or minima, enter a peak excursion value that is higher than the difference between the highest and the lowest value measured for the displayed inherent noise.

### Effect of peak excursion settings (example)

The following figure shows a trace to be analyzed.

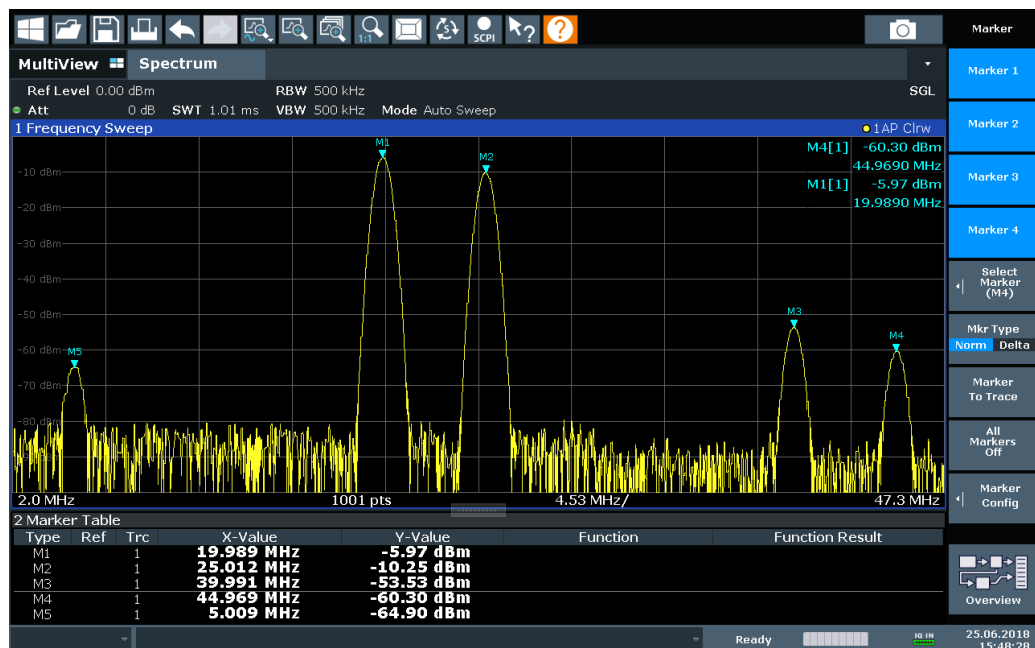

Figure 6-2: Trace example

The following table lists the peaks as indicated by the marker numbers in the diagram above, as well as the minimum decrease in amplitude to either side of the peak:

Marker #	Min. amplitude decrease to either side of the signal
1	80 dB
2	80 dB
3	55 dB
4	39 dB
5	32 dB

To eliminate the smaller peaks M3, M4 and M5 in the example above, a peak excursion of at least 60 dB is required. In this case, the amplitude must rise at least 60 dB before falling again before a peak is detected.

### Marker peak list

The marker peak list determines the frequencies and levels of peaks in the spectrum. It is updated automatically after each sweep. How many peaks are displayed can be defined, as well as the sort order. In addition, the detected peaks can be indicated in the diagram. The peak list can also be exported to a file for analysis in an external application.

### Remote commands:

`CALCulate<n>:MARKer<m>:FUNction:FPEaks:STATe` on page 218

TRAC? LIST,

See [TRACe<n>\[:DATA\]?](#) on page 224

<a href="#">Peak List State</a> .....	100
<a href="#">Sort Mode</a> .....	100
<a href="#">Maximum Number of Peaks</a> .....	100
<a href="#">Peak Excursion</a> .....	100
<a href="#">Display Marker Numbers</a> .....	100
<a href="#">Export Peak List</a> .....	101

### Peak List State

Activates/deactivates the marker peak list. If activated, the peak list is displayed and the peaks are indicated in the trace display.

For each listed peak, the frequency/time ("X-value") and level ("Y-Value") values are given.

Remote command:

[CALCulate<n>:MARKer<m>:FUNCTION:FPEaks:STATE](#) on page 218

### Sort Mode

Defines whether the peak list is sorted according to the x-values or y-values. In either case, the values are sorted in ascending order.

Remote command:

[CALCulate<n>:MARKer<m>:FUNCTION:FPEaks:SORT](#) on page 218

### Maximum Number of Peaks

Defines the maximum number of peaks to be determined and displayed.

Remote command:

[CALCulate<n>:MARKer<m>:FUNCTION:FPEaks:LIST:SIZE](#) on page 217

### Peak Excursion

Defines the minimum level value by which a signal must rise or fall so that it is identified as a maximum or a minimum by the search functions.

Entries from 0 dB to 80 dB are allowed; the resolution is 0.1 dB. The default setting for the peak excursion is 6 dB.

For Analog Modulation Analysis, the unit and value range depend on the selected result display type.

For more information, see [Chapter 6.4.4.2, "Marker peak list"](#), on page 97.

Remote command:

[CALCulate<n>:MARKer<m>:PEXCursion](#) on page 192

### Display Marker Numbers

By default, the marker numbers are indicated in the diagram so you can find the peaks from the list. However, for large numbers of peaks, the marker numbers can decrease readability; in this case, deactivate the marker number display.

Remote command:

[CALCulate<n>:MARKer<m>:FUNCTION:FPEaks:ANNotation:LABel\[:STATE\]](#) on page 216

**Export Peak List**

The peak list can be exported to an ASCII file (.DAT) for analysis in an external application.

Remote command:

[MMEMory:STORe<n>:PEAK](#) on page 219

[FORMat:DEXPort:DSEParator](#) on page 226

**6.4.4.3 Deactivating all marker functions**

**Access:** "Overview" > "Analysis" > "Marker Functions" > "All Functions Off"

**Or:** [MKR] > "All Functions Off"

All special marker functions can be deactivated in one step.

**Remote command:**

## 7 How to perform measurements in the I/Q Analyzer application

The following step-by-step instructions demonstrate how to capture I/Q data on the R&S FPL1000 and how to analyze data in the I/Q Analyzer application.

- [How to capture baseband \(I/Q\) data as RF input](#).....102
- [How to analyze data in the I/Q Analyzer](#)..... 103

### 7.1 How to capture baseband (I/Q) data as RF input

By default, the I/Q Analyzer assumes the I/Q data is modulated on a carrier frequency and input via the "RF Input" connector on the R&S FPL1000.

1. Select the [MODE] key and select the "I/Q Analyzer" application.
2. Select the "Overview" softkey to display the "Overview" for an I/Q Analyzer measurement.
3. Select the "Input" button to select and configure the "RF Input" signal source.
4. Select the "Amplitude" button to define the attenuation, reference level or other settings that affect the input signal's amplitude and scaling.
5. Select the "Frequency" button to define the input signal's center frequency.
6. Optionally, select the "Trigger" button and define a trigger for data acquisition, for example an I/Q Power trigger to start capturing data only when a specific power is exceeded.
7. Select the "Bandwidth" button and define the bandwidth parameters for data acquisition:
  - "Sample Rate" or "Analysis Bandwidth" the span of the input signal to be captured for analysis, or the rate at which samples are captured (both values are correlated)
  - "Measurement Time" how long the data is to be captured
  - "Record Length": the number of samples to be captured (also defined by sample rate and measurement time)
8. Select the "Display Config" button and select up to six displays that are of interest to you.  
Arrange them on the display to suit your preferences.
9. Exit the SmartGrid mode.
10. Start a new sweep with the defined settings.
  - a) Select the Sequencer icon ( from the toolbar.
  - b) Set the Sequencer state to "Off".

- c) Select the [RUN SINGLE] key.

## 7.2 How to analyze data in the I/Q Analyzer

1. Select the [MODE] key and select the "I/Q Analyzer" application.
2. Select the "Overview" softkey to display the "Overview" for an I/Q Analyzer measurement.
3. Select the "Display Config" button and select up to six displays that are of interest to you.  
Arrange them on the display to suit your preferences.
4. Exit the SmartGrid mode and select the "Overview" softkey to display the "Overview" again.
5. Select the "Analysis" button in the "Overview" to make use of the advanced analysis functions in the displays.
  - Configure a trace to display the average over a series of sweeps (on the "Trace" tab; if necessary, increase the "Average Count").
  - Configure markers and delta markers to determine deviations and offsets within the signal (on the "Marker" tab).

## 8 How to export and import I/Q data



I/Q data can only be exported in applications that process I/Q data, such as the I/Q Analyzer or optional applications.

### Capturing and exporting I/Q data

1. Press the [PRESET] key.
2. Press the [MODE] key and select the I/Q Analyzer application or any other application that supports I/Q data.
3. Configure the data acquisition.
4. Press the [RUN SINGLE] key to perform a single sweep measurement.
5. Select the  "Save" icon in the toolbar.
6. Select the "I/Q Export" softkey.
7. In the file selection dialog box, select a storage location and enter a file name.
8. Select "Save".

The captured data is stored to a file with the extension `.iq.tar`.

### Importing I/Q data

1. Press the [MODE] key and select the "I/Q Analyzer" or any other application that supports I/Q data.
2. If necessary, switch to single sweep mode by pressing the [RUN SINGLE] key.
3. Select the  "Open" icon in the toolbar.
4. Select the "I/Q Import" softkey.
5. Select the storage location and the file name with the `.iq.tar` file extension.
6. Select "Open".

The stored data is loaded from the file and displayed in the current application.

### Previewing the I/Q data in a web browser

The `iq-tar` file format allows you to preview the I/Q data in a web browser.

1. Use an archive tool (e.g. WinZip® or PowerArchiver®) to unpack the `iq-tar` file into a folder.
2. Locate the folder using Windows Explorer.
3. Open your web browser.



4. Drag the I/Q parameter XML file, e.g. `example.xml`, into your web browser.

**xzy.xml (of .iq.tar file)**

Description	
Saved by	FSV IQ Analyzer
Comment	Here is a comment
Date & Time	2011-03-03 14:33:05
Sample rate	6.5 MHz
Number of samples	65000
Duration of signal	10 ms
Data format	complex, float32
Data filename	xzy.complex.1ch.float32
Scaling factor	1 V

Channel 1	
Comment	Channel 1 of 1
<b>Power vs time</b> y-axis: 10 dB /div x-axis: 1 ms /div	
<b>Spectrum</b> y-axis: 20 dB /div x-axis: 500 kHz /div	

E-mail: [info@rohde-schwarz.com](mailto:info@rohde-schwarz.com)  
 Internet: <http://www.rohde-schwarz.com>  
 Fileformat version: 1

## 9 Remote commands to perform measurements with I/Q data



Note that basic tasks that are also performed in the base unit in the same way are not described here. For a description of such tasks, see the R&S FPL1000 User Manual.

In particular, this includes:

- Basic instrument configuration, e.g. checking the system configuration, customizing the screen layout, or configuring networks and remote operation
- Using the common status registers

The following tasks specific to the I/Q Analyzer application are described here:

• <a href="#">Introduction</a> .....	106
• <a href="#">Common suffixes</a> .....	111
• <a href="#">Activating I/Q Analyzer measurements</a> .....	111
• <a href="#">Configuring I/Q Analyzer measurements</a> .....	116
• <a href="#">Configuring the result display</a> .....	155
• <a href="#">Capturing data and performing sweeps</a> .....	163
• <a href="#">I/Q Analysis</a> .....	169
• <a href="#">Retrieving results</a> .....	219
• <a href="#">Importing and exporting I/Q data and results</a> .....	230
• <a href="#">Programming examples</a> .....	232

### 9.1 Introduction

Commands are program messages that a controller (e.g. a PC) sends to the instrument or software. They operate its functions ('setting commands' or 'events') and request information ('query commands'). Some commands can only be used in one way, others work in two ways (setting and query). If not indicated otherwise, the commands can be used for settings and queries.

The syntax of a SCPI command consists of a header and, usually, one or more parameters. To use a command as a query, you have to append a question mark after the last header element, even if the command contains a parameter.

A header contains one or more keywords, separated by a colon. Header and parameters are separated by a "white space" (ASCII code 0 to 9, 11 to 32 decimal, e.g. blank). If there is more than one parameter for a command, they are separated by a comma from one another.

Only the most important characteristics that you need to know when working with SCPI commands are described here. For a more complete description, refer to the user manual of the R&S FPL1000.



### Remote command examples

Note that some remote command examples mentioned in this general introduction are possibly not supported by this particular application.

## 9.1.1 Conventions used in descriptions

The following conventions are used in the remote command descriptions:

- **Command usage**

If not specified otherwise, commands can be used both for setting and for querying parameters.

If a command can be used for setting or querying only, or if it initiates an event, the usage is stated explicitly.

- **Parameter usage**

If not specified otherwise, a parameter can be used to set a value and it is the result of a query.

Parameters required only for setting are indicated as **Setting parameters**.

Parameters required only to refine a query are indicated as **Query parameters**.

Parameters that are only returned as the result of a query are indicated as **Return values**.

- **Conformity**

Commands that are taken from the SCPI standard are indicated as **SCPI confirmed**. All commands used by the R&S FPL1000 follow the SCPI syntax rules.

- **Asynchronous commands**

A command which does not automatically finish executing before the next command starts executing (overlapping command) is indicated as an **Asynchronous command**.

- **Reset values (\*RST)**

Default parameter values that are used directly after resetting the instrument (\*RST command) are indicated as \*RST values, if available.

- **Default unit**

The default unit is used for numeric values if no other unit is provided with the parameter.

- **Manual operation**

If the result of a remote command can also be achieved in manual operation, a link to the description is inserted.

## 9.1.2 Long and short form

The keywords have a long and a short form. You can use either the long or the short form, but no other abbreviations of the keywords.

The short form is emphasized in uppercase letters. Note however, that this emphasis only serves the purpose to distinguish the short from the long form in the manual. For the instrument, the case does not matter.

**Example:**

SENSe:FREQuency:CENTer is the same as SENS:FREQ:CENT.

**9.1.3 Numeric suffixes**

Some keywords have a numeric suffix if the command can be applied to multiple instances of an object. In that case, the suffix selects a particular instance (e.g. a measurement window).

Numeric suffixes are indicated by angular brackets (<n>) next to the keyword.

If you do not quote a suffix for keywords that support one, a 1 is assumed.

**Example:**

DISPlay[:WINDow<1...4>]:ZOOM:STATe enables the zoom in a particular measurement window, selected by the suffix at WINDow.

DISPlay:WINDow4:ZOOM:STATe ON refers to window 4.

**9.1.4 Optional keywords**

Some keywords are optional and are only part of the syntax because of SCPI compliance. You can include them in the header or not.



If an optional keyword has a numeric suffix and you need to use the suffix, you have to include the optional keyword. Otherwise, the suffix of the missing keyword is assumed to be the value 1.

Optional keywords are emphasized with square brackets.

**Example:**

Without a numeric suffix in the optional keyword:

[SENSe:]FREQuency:CENTer is the same as FREQuency:CENTer

With a numeric suffix in the optional keyword:

DISPlay[:WINDow<1...4>]:ZOOM:STATe

DISPlay:ZOOM:STATe ON enables the zoom in window 1 (no suffix).

DISPlay:WINDow4:ZOOM:STATe ON enables the zoom in window 4.

**9.1.5 Alternative keywords**

A vertical stroke indicates alternatives for a specific keyword. You can use both keywords to the same effect.

**Example:**

```
[SENSe:]BANDwidth|BWIDth[:RESolution]
```

In the short form without optional keywords, `BAND 1MHZ` would have the same effect as `BWID 1MHZ`.

**9.1.6 SCPI parameters**

Many commands feature one or more parameters.

If a command supports more than one parameter, they are separated by a comma.

**Example:**

```
LAYout:ADD:WINDow Spectrum,LEFT,MTABLE
```

Parameters can have different forms of values.

- [Numeric values](#)..... 109
- [Boolean](#)..... 110
- [Character data](#)..... 110
- [Character strings](#)..... 111
- [Block data](#)..... 111

**9.1.6.1 Numeric values**

Numeric values can be entered in any form, i.e. with sign, decimal point or exponent. For physical quantities, you can also add the unit. If the unit is missing, the command uses the basic unit.

**Example:**

With unit: `SENSe:FREQuency:CENTer 1GHZ`

Without unit: `SENSe:FREQuency:CENTer 1E9` would also set a frequency of 1 GHz.

Values exceeding the resolution of the instrument are rounded up or down.

If the number you have entered is not supported (e.g. for discrete steps), the command returns an error.

Instead of a number, you can also set numeric values with a text parameter in special cases.

- **MIN/MAX**  
Defines the minimum or maximum numeric value that is supported.
- **DEF**  
Defines the default value.
- **UP/DOWN**  
Increases or decreases the numeric value by one step. The step size depends on the setting. Sometimes, you can customize the step size with a corresponding command.

### Querying numeric values

When you query numeric values, the system returns a number. For physical quantities, it applies the basic unit (e.g. Hz for frequencies). The number of digits after the decimal point depends on the type of numeric value.

#### Example:

Setting: `SENSe:FREQuency:CENTer 1GHZ`

Query: `SENSe:FREQuency:CENTer?` would return `1E9`

Sometimes, numeric values are returned as text.

- `INF/NINF`  
Infinity or negative infinity. Represents the numeric values `9.9E37` or `-9.9E37`.
- `NAN`  
Not a number. Represents the numeric value `9.91E37`. `NAN` is returned if errors occur.

### 9.1.6.2 Boolean

Boolean parameters represent two states. The "on" state (logically true) is represented by `"ON"` or the numeric value `1`. The "off" state (logically untrue) is represented by `"OFF"` or the numeric value `0`.

#### Querying Boolean parameters

When you query Boolean parameters, the system returns either the value `1` (`"ON"`) or the value `0` (`"OFF"`).

#### Example:

Setting: `DISPlay:WINDow:ZOOM:STATe ON`

Query: `DISPlay:WINDow:ZOOM:STATe?` would return `1`

### 9.1.6.3 Character data

Character data follows the syntactic rules of keywords. You can enter text using a short or a long form. For more information, see [Chapter 9.1.2, "Long and short form"](#), on page 107.

#### Querying text parameters

When you query text parameters, the system returns its short form.

#### Example:

Setting: `SENSe:BANDwidth:RESolution:TYPE NORMal`

Query: `SENSe:BANDwidth:RESolution:TYPE?` would return `NORM`

#### 9.1.6.4 Character strings

Strings are alphanumeric characters. They have to be in straight quotation marks. You can use a single quotation mark ( ' ) or a double quotation mark ( " ).

**Example:**

```
INSTRument:DELeTe 'Spectrum'
```

#### 9.1.6.5 Block data

Block data is a format which is suitable for the transmission of large amounts of data.

The ASCII character # introduces the data block. The next number indicates how many of the following digits describe the length of the data block. The data bytes follow. During the transmission of these data bytes, all end or other control signs are ignored until all bytes are transmitted. #0 specifies a data block of indefinite length. The use of the indefinite format requires an NL^END message to terminate the data block. This format is useful when the length of the transmission is not known or if speed or other considerations prevent segmentation of the data into blocks of definite length.

## 9.2 Common suffixes

In the I/Q Analyzer application, the following common suffixes are used in remote commands:

*Table 9-1: Common suffixes used in remote commands in the I/Q Analyzer application*

Suffix	Value range	Description
<m>	1 to 16	Marker
<n>	1 to 6	Window (in the currently selected channel setup)
<t>	1 to 6	Trace
<li>	1 to 8	Limit line

## 9.3 Activating I/Q Analyzer measurements

I/Q Analyzer measurements require a special channel setup on the R&S FPL1000. It can be activated using the common `INSTRument:CREate[:NEW]` or `INSTRument:CREate:REPLace` commands. In this case, some - but not all - parameters from the previously selected application are passed on to the I/Q Analyzer channel setup. In order to retain *all* relevant parameters from the current application for the I/Q measurement, use the `TRACe:IQ[:STATe]` command to change the application of the current channel setup.

A measurement is started immediately with the default settings when the channel setup is activated.



### Different remote modes available

In remote control, two different modes for the I/Q Analyzer measurements are available:

- A quick mode for pure data acquisition  
This mode is activated by default with the `TRACe:IQ[:STATe]` command. The evaluation functions are not available; however, performance is slightly improved.
- A more sophisticated mode for acquisition and analysis.  
This mode is activated when a new channel setup is opened for the I/Q Analyzer application (`INST:CRE:NEW/INST:CRE:REPL`) or by an additional command (see `TRACe:IQ:EVAL` on page 115).

<code>INSTrument:CREate:DUPLicate</code> .....	112
<code>INSTrument:CREate[:NEW]</code> .....	112
<code>INSTrument:CREate:REPLace</code> .....	113
<code>INSTrument:DELeTe</code> .....	113
<code>INSTrument:LIST?</code> .....	113
<code>INSTrument:REName</code> .....	114
<code>INSTrument[:SELeCt]</code> .....	115
<code>SYSTem:PRESet:CHANnel[:EXEC]</code> .....	115
<code>TRACe:IQ:EVAL</code> .....	115
<code>TRACe:IQ[:STATe]</code> .....	116

---

### `INSTrument:CREate:DUPLicate`

This command duplicates the currently selected channel setup, i.e. creates a new channel setup of the same type and with the identical measurement settings. The name of the new channel setup is the same as the copied channel setup, extended by a consecutive number (e.g. "IQAnalyzer" -> "IQAnalyzer 2").

The channel setup to be duplicated must be selected first using the `INST:SEL` command.

**Example:**

```
INST:SEL 'IQAnalyzer'
```

```
INST:CRE:DUPL
```

Duplicates the channel setup named 'IQAnalyzer' and creates a new channel setup named 'IQAnalyzer2'.

**Usage:** Event

---

### `INSTrument:CREate[:NEW]` <ChannelType>, <ChannelName>

This command adds a measurement channel. You can configure up to 10 measurement channels at the same time (depending on available memory).

**Parameters:**

<ChannelType> Channel type of the new channel.  
For a list of available channel types, see `INSTrument:LIST?` on page 113.



<ChannelName> String containing the name of the channel.  
Note that you cannot assign an existing channel name to a new channel. If you do, an error occurs.

**Example:** `INST:CRE SAN, 'Spectrum 2'`  
Adds a spectrum display named "Spectrum 2".

### **INSTrument:CREate:REPLace** <ChannelName1>,<ChannelType>,<ChannelName2>

This command replaces a channel setup with another one.

#### **Setting parameters:**

<ChannelName1> String containing the name of the channel setup you want to replace.

<ChannelType> Channel type of the new channel setup.  
For a list of available channel setup types, see [INSTrument:LIST?](#) on page 113.

<ChannelName2> String containing the name of the new channel setup.  
**Note:** If the specified name for a new channel setup already exists, the default name, extended by a sequential number, is used for the new channel setup (see [INSTrument:LIST?](#) on page 113).  
Channel names can have a maximum of 31 characters, and must be compatible with the Windows conventions for file names. In particular, they must not contain special characters such as ":", "\*", "?".

**Example:** `INST:CRE:REPL 'IQAnalyzer2',IQ,'IQAnalyzer'`  
Replaces the channel setup named "IQAnalyzer2" by a new channel setup of type "IQ Analyzer" named "IQAnalyzer".

**Usage:** Setting only

### **INSTrument:DELeTe** <ChannelName>

This command deletes a channel setup.

#### **Setting parameters:**

<ChannelName> String containing the name of the channel setup you want to delete.  
A channel setup must exist to delete it.

**Usage:** Setting only

### **INSTrument:LIST?**

This command queries all active channel setups. The query is useful to obtain the names of the existing channel setups, which are required to replace or delete the channel setups.

**Return values:**

<ChannelType>  
<ChannelName>

For each channel setup, the command returns the channel setup type and channel setup name (see tables below).

Tip: to change the channel setup name, use the `INSTrument:REName` command.

**Example:**

```
INST:LIST?
```

Result for 3 channel setups:

```
'ADEM', 'Analog Demod', 'IQ', 'IQ Analyzer', 'IQ', 'IQ Analyzer2'
```

**Usage:**

Query only

**Table 9-2: Available channel setup types and default channel setup names**

Application	<ChannelType> Parameter	Default Channel setup Name*)
Spectrum	SANALYZER	Spectrum
AM/FM/PM Modulation Analysis	ADEM	Analog Demod
I/Q Analyzer	IQ	IQ Analyzer
Noise Figure Measurements	NOISE	Noise
Vector Signal Analysis (VSA)	DDEM	VSA

Note: the default channel setup name is also listed in the table. If the specified name for a new channel setup already exists, the default name, extended by a sequential number, is used for the new channel setup.

**INSTrument:REName** <ChannelName1>, <ChannelName2>

This command renames a channel setup.

**Setting parameters:**

<ChannelName1> String containing the name of the channel setup you want to rename.

<ChannelName2> String containing the new channel setup name.  
Note that you cannot assign an existing channel setup name to a new channel setup. If you do, an error occurs.  
Channel names can have a maximum of 31 characters, and must be compatible with the Windows conventions for file names. In particular, they must not contain special characters such as ":", "\*", "?".

**Example:**

```
INST:REN 'IQAnalyzer2', 'IQAnalyzer3'
```

Renames the channel setup with the name 'IQAnalyzer2' to 'IQAnalyzer3'.

**Usage:**

Setting only

**INSTrument[:SElect]** <ChannelType> | <ChannelName>

This command activates a new channel setup with the defined channel setup type, or selects an existing channel setup with the specified name.

Also see

- [INSTrument:CREate\[:NEW\]](#) on page 112

**Parameters:**

<ChannelType> Channel type of the new channel setup.  
For a list of available channel setup types see [INSTrument:LIST?](#) on page 113.

<ChannelName> String containing the name of the channel setup.

**Example:**

```
INST IQ
INST 'MyIQSpectrum'
```

Selects the channel setup named 'MyIQSpectrum' (for example before executing further commands for that channel setup).

**SYSTem:PRESet:CHANnel[:EXEC]**

This command restores the default instrument settings in the current channel setup.

Use `INST:SEL` to select the channel setup.

**Example:**

```
INST:SEL 'Spectrum2'
```

Selects the channel setup for "Spectrum2".

```
SYST:PRESet:CHAN:EXEC
```

Restores the factory default settings to the "Spectrum2" channel setup.

**Usage:** Event

**Manual operation:** See "[Preset Channel setup](#)" on page 31

**TRACe:IQ:EVAL** <State>

This command turns I/Q data analysis on and off.

Before you can use this command, you have to turn on the I/Q data acquisition using `INST:CRE:NEW IQ` or `INST:CRE:REPL`, or using the [TRACe:IQ\[:STATE\]](#) command to replace the current channel setup while retaining the settings.

**Parameters:**

<State> ON | OFF | 0 | 1

**OFF | 0**  
Switches the function off

**ON | 1**  
Switches the function on

**Example:**            `TRAC:IQ ON`  
                           Enables I/Q data acquisition  
                           `TRAC:IQ:EVAL ON`  
                           Enables the I/Q data analysis mode.

---

### **TRACe:IQ[:STATe] <State>**

Executing this command also has the following effects:

- The sweep, amplitude, input and trigger settings from the measurement are retained.
- All measurements are turned off.
- All traces are set to "Blank" mode.
- The I/Q data analysis mode is turned off (`TRAC:IQ:EVAL OFF`).

**Note:** To turn trace display back on or to enable the evaluation functions of the I/Q Analyzer, execute the `TRAC:IQ:EVAL ON` command (see [TRACe:IQ:EVAL](#) on page 115).

#### **Parameters:**

<State>                `ON | OFF | 0 | 1`  
                           **OFF | 0**  
                           Switches the function off  
                           **ON | 1**  
                           Switches the function on

**Example:**            `TRAC:IQ ON`  
                           Switches on I/Q data acquisition

## 9.4 Configuring I/Q Analyzer measurements

The following commands configure the I/Q Analyzer measurements.

- [Configuring the data input and output](#)..... 116
- [Configuring the vertical axis \(amplitude, scaling\)](#)..... 131
- [Frequency](#)..... 137
- [Triggering](#)..... 139
- [Configuring data acquisition](#)..... 146
- [Adjusting settings automatically](#)..... 152

### 9.4.1 Configuring the data input and output

The following commands are required to configure data input and output.

- [RF input](#)..... 117
- [Input from I/Q data files](#)..... 119
- [Working with power sensors](#)..... 120
- [Configuring the outputs](#)..... 129

### 9.4.1.1 RF input

INPut:ATTenuation:PROTection:RESet.....	117
INPut<ip>:FILTer:SAW.....	117
INPut<ip>:FILTer:YIG[:STATe].....	117
INPut<ip>:IMPedance.....	118
INPut<ip>:SElect.....	118
INPut<ip>:UPORt:STATe.....	119
INPut<ip>:UPORt[:VALue].....	119

---

#### INPut:ATTenuation:PROTection:RESet

This command resets the attenuator and reconnects the RF input with the input mixer for the R&S FPL1000 after an overload condition occurred and the protection mechanism intervened. The error status bit (bit 3 in the `STAT:QUES:POW` status register) and the `INPUT OVLD` message in the status bar are cleared.

The command works only if the overload condition has been eliminated first.

For details on the protection mechanism, see "[RF Input Protection](#)" on page 35.

**Example:** `INP:ATT:PROT:RES`

---

#### INPut<ip>:FILTer:SAW <State>

Determines which IF path the R&S FPL1000 hardware uses.

##### Suffix:

<ip>                    1 | 2  
                          irrelevant

##### Parameters:

<State>                AUTO | OFF

##### AUTO

The R&S FPL1000 determines which IF path to use automatically, depending on the used analysis bandwidth.

##### OFF

The wide IF path is always used.

\*RST:            I/Q Analyzer: AUTO; VSA: OFF

**Example:** `INP:FILT:SAW AUTO`

**Manual operation:** See "[SAW filter](#)" on page 36

---

#### INPut<ip>:FILTer:YIG[:STATe] <State>

Enables or disables the YIG filter.

##### Suffix:

<ip>                    1 | 2  
                          irrelevant

**Parameters:****<State>** ON | OFF | 0 | 1**Example:**

INP:FILT:YIG OFF

Deactivates the YIG-preselector.

**Manual operation:** See "YIG-Preselector" on page 36**INPut<ip>:IMPedance <Impedance>**

This command selects the nominal input impedance of the RF input. In some applications, only 50 Ω are supported.

**Suffix:**

**<ip>** 1 | 2  
irrelevant

**Parameters:****<Impedance>** 50 | 75**numeric value**

User-defined impedance from 50 Ohm to 100000000 Ohm (=100 MOhm)

User-defined values are only available for the Spectrum application, the I/Q Analyzer, and some optional applications.

\*RST: 50 Ω

Default unit: OHM

**Example:**

INP:IMP 75

**Manual operation:** See "Impedance" on page 36

See "Unit" on page 46

**INPut<ip>:SElect <Source>**

This command selects the signal source for measurements, i.e. it defines which connector is used to input data to the R&S FPL1000.

If no additional input options are installed, only RF input or file input is supported.

**Suffix:**

**<ip>** 1 | 2  
irrelevant

**Parameters:**

**<Source>** **RF**  
Radio Frequency ("RF INPUT" connector)

\*RST: RF

**Manual operation:** See "Radio Frequency State" on page 35

See "I/Q Input File State" on page 37

**INPut<ip>:UPORt:STATe <State>**

This command toggles the control lines of the user ports for the **AUX PORT** connector. This 9-pole SUB-D male connector is located on the rear panel of the R&S FPL1000.

See the R&S FPL1000 Getting Started manual for details.

**Suffix:**

<ip> 1 | 2  
irrelevant

**Parameters:**

<State> **ON | 1**  
User port is switched to INPut  
**OFF | 0**  
User port is switched to OUTPut  
\*RST: 1

**INPut<ip>:UPORt[:VALue]**

This command queries the control lines of the user ports.

For details see [OUTPut<up>:UPORt\[:VALue\]](#) on page 130.

**Suffix:**

<ip> 1 | 2  
irrelevant

**Return values:**

<Level> bit values in hexadecimal format  
TTL type voltage levels (max. 5V)  
Range: #B00000000 to #B00111111

**Example:**

```
INP:UPOR?
//Result: #B00100100
Pins 5 and 7 are active.
```

**9.4.1.2 Input from I/Q data files**

The input for measurements can be provided from I/Q data files. The commands required to configure the use of such files are described here.

For details see [Chapter 4.3, "Basics on input from I/Q data files"](#), on page 27.

Useful commands for retrieving results described elsewhere:

- [INPut<ip>:SElect](#) on page 118

**Remote commands exclusive to input from I/Q data files:**

[INPut<ip>:FILE:PATH](#)..... 120

---

**INPut**<ip>:FILE:PATH <FileName>[, <AnalysisBW>]

This command selects the I/Q data file to be used as input for further measurements.

The I/Q data must have a specific format as described in [Chapter C, "I/Q data file format \(iq-tar\)"](#), on page 238.

**Suffix:**

<ip>                    1 | 2  
                          irrelevant

**Parameters:**

<FileName>            String containing the path and name of the source file.  
                          The file extension is \*.iq.tar.

<AnalysisBW>        Optionally: The analysis bandwidth to be used by the measurement. The bandwidth must be smaller than or equal to the bandwidth of the data that was stored in the file.  
  
                          Default unit: HZ

**Example:**

INP:FILE:PATH 'C:\R\_S\Instr\user\data.iq.tar'  
Uses I/Q data from the specified file as input.

**Manual operation:** See "[Select I/Q data file](#)" on page 37

### 9.4.1.3 Working with power sensors

The following commands describe how to work with power sensors.

These commands require the use of a Rohde & Schwarz power sensor. For a list of supported sensors, see the data sheet.



The [Sensor] connector is provided by the "Additional Interfaces" option R&S FPL1-B5. Additionally, the power sensor measurement requires the option R&S FPL1-K9.

- [Configuring power sensors](#)..... 120
- [Configuring power sensor measurements](#)..... 122

#### Configuring power sensors

SYSTem:COMMunicate:RDEvice:PMETer<p>:CONFigure:AUTO[:STATe]..... 120  
SYSTem:COMMunicate:RDEvice:PMETer<p>:COUNT?..... 121  
SYSTem:COMMunicate:RDEvice:PMETer<p>:DEFine..... 121

---

**SYSTem:COMMunicate:RDEvice:PMETer<p>:CONFigure:AUTO[:STATe]** <State>

This command turns automatic assignment of a power sensor to the power sensor index on and off.

**Suffix:**

<p>                    Power sensor index



**Parameters:**

<State> ON | OFF | 0 | 1  
 \*RST: 1

**Example:**

SYST:COMM:RDEV:PMET:CONF:AUTO OFF

**Manual operation:** See "Select" on page 39

**SYSTem:COMMunicate:RDEvice:PMETer<p>:COUNT?**

This command queries the number of power sensors currently connected to the R&S FPL1000.

**Suffix:**

<p> Power sensor index

**Return values:**

<NumberSensors> Number of connected power sensors.

**Example:**

SYST:COMM:RDEV:PMET:COUN?

**Usage:**

Query only

**Manual operation:** See "Select" on page 39

**SYSTem:COMMunicate:RDEvice:PMETer<p>:DEFine <Placeholder>, <Type>, <Interface>, <SerialNo>**

This command assigns the power sensor with the specified serial number to the selected power sensor index (configuration).

The query returns the power sensor type and serial number of the sensor assigned to the specified index.

**Suffix:**

<p> Power sensor index

**Parameters:**

<Placeholder> Currently not used

<Type> Detected power sensor type, e.g. "NRP-Z81".

<Interface> Interface the power sensor is connected to; always "USB"

<SerialNo> Serial number of the power sensor assigned to the specified index

**Example:** `SYST:COMM:RDEV:PMET2:DEF '', 'NRP-Z81', '', '123456'`  
 Assigns the power sensor with the serial number '123456' to the configuration "Power Sensor 2".  
`SYST:COMM:RDEV:PMET2:DEF?`  
 Queries the sensor assigned to "Power Sensor 2".  
**Result:**  
`'', 'NRP-Z81', 'USB', '123456'`  
 The NRP-Z81 power sensor with the serial number '123456' is assigned to the "Power Sensor 2".

**Manual operation:** See "[Select](#)" on page 39

### Configuring power sensor measurements

<a href="#">CALibration:PMETer&lt;p&gt;:ZERO:AUTO ONCE</a> .....	122
<a href="#">CALCulate&lt;n&gt;:PMETer&lt;p&gt;:RELative[:MAGNitude]</a> .....	123
<a href="#">CALCulate&lt;n&gt;:PMETer&lt;p&gt;:RELative[:MAGNitude]:AUTO ONCE</a> .....	123
<a href="#">CALCulate&lt;n&gt;:PMETer&lt;p&gt;:RELative:STATe</a> .....	123
<a href="#">FETCh:PMETer&lt;p&gt;?</a> .....	124
<a href="#">READ:PMETer&lt;p&gt;?</a> .....	124
<a href="#">[SENSe:]PMETer&lt;p&gt;:DCYClE[:STATe]</a> .....	124
<a href="#">[SENSe:]PMETer&lt;p&gt;:DCYClE:VALue</a> .....	124
<a href="#">[SENSe:]PMETer&lt;p&gt;:FREQuency</a> .....	125
<a href="#">[SENSe:]PMETer&lt;p&gt;:FREQuency:LINK</a> .....	125
<a href="#">[SENSe:]PMETer&lt;p&gt;:MTIME</a> .....	126
<a href="#">[SENSe:]PMETer&lt;p&gt;:MTIME:AVERAge:COUNT</a> .....	126
<a href="#">[SENSe:]PMETer&lt;p&gt;:MTIME:AVERAge[:STATe]</a> .....	126
<a href="#">[SENSe:]PMETer&lt;p&gt;:ROFFset[:STATe]</a> .....	127
<a href="#">[SENSe:]PMETer&lt;p&gt;:SOFFset</a> .....	127
<a href="#">[SENSe:]PMETer&lt;p&gt;[:STATe]</a> .....	127
<a href="#">[SENSe:]PMETer&lt;p&gt;:UPDate[:STATe]</a> .....	128
<a href="#">UNIT&lt;n&gt;:PMETer&lt;p&gt;:POWer</a> .....	128
<a href="#">UNIT&lt;n&gt;:PMETer&lt;p&gt;:POWer:RATIo</a> .....	128

---

### **CALibration:PMETer<p>:ZERO:AUTO ONCE**

This command zeroes the power sensor.

Note that you have to disconnect the signals from the power sensor input before you start to zero the power sensor. Otherwise, results are invalid.

**Suffix:**

<p> Power sensor index

**Example:**

`CAL:PMET2:ZERO:AUTO ONCE;*WAI`

Starts zeroing the power sensor 2 and delays the execution of further commands until zeroing is concluded.

**Usage:**

Event

**Manual operation:** See "[Zeroing Power Sensor](#)" on page 40

**CALCulate<n>:PMETer<p>:RELative[:MAGNitude] <RefValue>**

This command defines the reference value for relative measurements.

**Suffix:**

<n> [Window](#)

<p> Power sensor index

**Parameters:**

<RefValue> Range: -200 dBm to 200 dBm  
 \*RST: 0  
 Default unit: DBM

**Example:**

`CALC:PMET2:REL -30`

Sets the reference value for relative measurements to -30 dBm for power sensor 2.

**Manual operation:** See ["Reference Value"](#) on page 41

**CALCulate<n>:PMETer<p>:RELative[:MAGNitude]:AUTO ONCE**

This command sets the current measurement result as the reference level for relative measurements.

**Suffix:**

<n> [Window](#)

<p> Power sensor index

**Example:**

`CALC:PMET2:REL:AUTO ONCE`

Takes the current measurement value as reference value for relative measurements for power sensor 2.

**Usage:**

Event

**Manual operation:** See ["Setting the Reference Level from the Measurement Measurements -> Ref"](#) on page 41

**CALCulate<n>:PMETer<p>:RELative:STATe <State>**

This command turns relative power sensor measurements on and off.

**Suffix:**

<n> [Window](#)

<p> Power sensor index

**Parameters:**

<State> ON | OFF | 0 | 1  
**OFF | 0**  
 Switches the function off  
**ON | 1**  
 Switches the function on

**Example:** `CALC:PMET2:REL:STAT ON`  
 Activates the relative display of the measured value for power sensor 2.

---

#### **FETCh:PMETer<p>?**

This command queries the results of power sensor measurements.

**Suffix:**  
 <p> Power sensor index

**Usage:** Query only

---

#### **READ:PMETer<p>?**

This command initiates a power sensor measurement and queries the results.

**Suffix:**  
 <p> Power sensor index

**Usage:** Query only

---

#### **[SENSe:]PMETer<p>:DCYClE[:STATe] <State>**

This command turns the duty cycle correction on and off.

**Suffix:**  
 <p> Power sensor index

**Parameters:**  
 <State> `ON | OFF | 0 | 1`  
**OFF | 0**  
 Switches the function off  
**ON | 1**  
 Switches the function on

**Example:** `PMET2:DCYC:STAT ON`

**Manual operation:** See "[Duty Cycle](#)" on page 42

---

#### **[SENSe:]PMETer<p>:DCYClE:VALue <Percentage>**

This command defines the duty cycle for the correction of pulse signals.

The power sensor uses the duty cycle in combination with the mean power to calculate the power of the pulse.

**Suffix:**  
 <p> Power sensor

**Parameters:**

<Percentage>      Range:      0.001 to 99.999  
                          \*RST:      99.999  
                          Default unit: %

**Example:**

PMET2:DCYC:STAT ON  
 Activates the duty cycle correction.  
 PMET2:DCYC:VAL 0.5  
 Sets the correction value to 0.5%.

**Manual operation:** See "[Duty Cycle](#)" on page 42

**[SENSe:]PMETer<p>:FREQUency <Frequency>**

This command defines the frequency of the power sensor.

**Suffix:**

<p>                      Power sensor index

**Parameters:**

<Frequency>      The available value range is specified in the data sheet of the power sensor in use.  
                          \*RST:      50 MHz  
                          Default unit: HZ

**Example:**

PMET2:FREQ 1GHZ  
 Sets the frequency of the power sensor to 1 GHz.

**Manual operation:** See "[Frequency Manual](#)" on page 40

**[SENSe:]PMETer<p>:FREQUency:LINK <Coupling>**

This command selects the frequency coupling for power sensor measurements.

**Suffix:**

<p>                      Power sensor index

**Parameters:**

<Coupling>      **CENTer**  
                          Couples the frequency to the center frequency of the analyzer  
                          **MARKer1**  
                          Couples the frequency to the position of marker 1  
                          **OFF**  
                          Switches the frequency coupling off  
                          \*RST:      CENTer

**Example:**

PMET2:FREQ:LINK CENT  
 Couples the frequency to the center frequency of the analyzer

**Manual operation:** See "[Frequency Coupling](#)" on page 40

**[SENSe:]PMETer<p>:MTIMe <Duration>**

This command selects the duration of power sensor measurements.

**Suffix:**

<p> Power sensor index

**Parameters:**

<Duration> SHORt | NORMAl | LONG  
\*RST: NORMAl

**Example:**

PMET2:MTIM SHOR

Sets a short measurement duration for measurements of stationary high power signals for the selected power sensor.

**Manual operation:** See "[Meas Time/Average](#)" on page 41

**[SENSe:]PMETer<p>:MTIMe:AVERAge:COUNT <NumberReadings>**

This command sets the number of power readings included in the averaging process of power sensor measurements.

Extended averaging yields more stable results for power sensor measurements, especially for measurements on signals with a low power, because it minimizes the effects of noise.

**Suffix:**

<p> Power sensor index

**Parameters:**

<NumberReadings> An average count of 0 or 1 performs one power reading.  
Range: 0 to 256  
Increment: binary steps (1, 2, 4, 8, ...)

**Example:**

PMET2:MTIM:AVER ON

Activates manual averaging.

PMET2:MTIM:AVER:COUN 8

Sets the number of readings to 8.

**Manual operation:** See "[Average Count \(Number of Readings\)](#)" on page 41

**[SENSe:]PMETer<p>:MTIMe:AVERAge[:STATe] <State>**

This command turns averaging for power sensor measurements on and off.

**Suffix:**

<p> Power sensor index

**Parameters:**

<State> ON | OFF | 0 | 1  
**OFF | 0**  
Switches the function off

**ON | 1**

Switches the function on

**Example:** PMET2:MTIM:AVER ON  
Activates manual averaging.

**Manual operation:** See "[Meas Time/Average](#)" on page 41

**[SENSe:]PMETer<p>:ROFFset[:STATe] <State>**

This command includes or excludes the reference level offset of the analyzer for power sensor measurements.

**Suffix:**

<p> Power sensor index

**Parameters:**

<State> ON | OFF | 0 | 1

**OFF | 0**

Switches the function off

**ON | 1**

Switches the function on

**Example:** PMET2:ROFF OFF  
Takes no offset into account for the measured power.

**Manual operation:** See "[Use Ref Level Offset](#)" on page 41

**[SENSe:]PMETer<p>:SOFFset <SensorOffset>**

Takes the specified offset into account for the measured power. Only available if [\[SENSe:\]PMETer<p>:ROFFset\[:STATe\]](#) is disabled.

**Suffix:**

<p> Power sensor index

**Parameters:**

<SensorOffset> Default unit: DB

**Example:** PMET2:SOFF 0.001

**Manual operation:** See "[Sensor Level Offset](#)" on page 41

**[SENSe:]PMETer<p>[:STATe] <State>**

This command turns a power sensor on and off.

**Suffix:**

<p> Power sensor index

**Parameters:**

<State> ON | OFF | 0 | 1

**OFF | 0**

Switches the function off

**ON | 1**

Switches the function on

**Example:**

PMET1 ON

Switches the power sensor measurements on.

**Manual operation:** See "[Select](#)" on page 39**[SENSe:]PMETer<p>:UPDate[:STATe] <State>**

This command turns continuous update of power sensor measurements on and off.

If on, the results are updated even if a single sweep is complete.

**Suffix:**

&lt;p&gt; Power sensor index

**Parameters:**

&lt;State&gt; ON | OFF | 0 | 1

**OFF | 0**

Switches the function off

**ON | 1**

Switches the function on

**Example:**

PMET1:UPD ON

The data from power sensor 1 is updated continuously.

**Manual operation:** See "[Continuous Value Update](#)" on page 39**UNIT<n>:PMETer<p>:POWer <Unit>**

This command selects the unit for absolute power sensor measurements.

**Suffix:**

&lt;n&gt; irrelevant

&lt;p&gt; Power sensor index

**Parameters:**

&lt;Unit&gt; DBM | WATT | W | DB | PCT

\*RST: DBM

**Example:**

UNIT:PMET:POW DBM

**Manual operation:** See "[Unit/Scale](#)" on page 40**UNIT<n>:PMETer<p>:POWer:RATio <Unit>**

This command selects the unit for relative power sensor measurements.

**Suffix:**

&lt;n&gt; irrelevant

&lt;p&gt; Power sensor index



**Parameters:**

<Unit> DB | PCT  
 \*RST: DB

**Example:**

UNIT:PMET:POW:RAT DB

**Manual operation:** See "Unit/Scale" on page 40

**9.4.1.4 Configuring the outputs**

The following commands are required to provide output from the R&S FPL1000.

Output functions require the option R&S FPL1-B5 to be installed on the R&S FPL1000.

DIAGnostic:SERVice:NSOource.....	129
OUTPut<up>:UPORt:STATe.....	129
OUTPut<up>:UPORt[:VALue].....	130
OUTPut:UPORt:WTRigger:POLarity.....	130
SYSTem:SPEaker[:STATe].....	130
SYSTem:SPEaker:MUTE.....	131
SYSTem:SPEaker:VOLume.....	131

**DIAGnostic:SERVice:NSOource <State>**

This command turns the 28 V supply of the BNC connector labeled [noise source control] on the R&S FPL1000 on and off.

**Parameters:**

<State> ON | OFF | 0 | 1  
**OFF | 0**  
 Switches the function off  
**ON | 1**  
 Switches the function on

**Example:**

DIAG:SERV:NSO ON

**Manual operation:** See "Noise Source Control" on page 44

**OUTPut<up>:UPORt:STATe <State>**

This command toggles the control lines of the user ports for the **AUX PORT** connector. This 9-pole SUB-D male connector is located on the rear panel of the R&S FPL1000.

**Suffix:**

<up> irrelevant

**Parameters:**

<State> ON | OFF | 0 | 1  
**OFF | 0**  
 User port is switched to INPut  
**ON | 1**  
 User port is switched to OUTPut

**Example:** `OUTP:UPOR:STAT ON`

---

### **OUTPut<up>:UPORt[:VALue] <Value>**

This command sets the control lines of the user ports.

The assignment of the pin numbers to the bits is as follows:

Bit	7	6	5	4	3	2	1	0
Pin	N/A	N/A	5	3	4	7	6	2

Bits 7 and 6 are not assigned to pins and must always be 0.

The user port is written to with the given binary pattern.

If the user port is programmed to input instead of output (see [INPut<ip>:UPORt:STATe](#) on page 119), the output value is temporarily stored.

#### **Suffix:**

<up> irrelevant

#### **Parameters:**

<Value> bit values in hexadecimal format  
 TTL type voltage levels (max. 5V)  
 Range: #B00000000 to #B00111111

**Example:** `OUTP:UPOR #B00100100`  
 Sets pins 5 and 7 to 5 V.

---

### **OUTPut:UPORt:WTRigger:POLarity <State>**

Defines the signal polarity that indicates the trigger availability at the optional [AUX PORT] connector of the R&S FPL1000.

#### **Parameters:**

<State> HIGH | LOW

#### **LOW**

A low signal (= 0 V) indicates the instrument is ready to receive a trigger.

#### **HIGH**

A high signal (= 5 V) indicates the instrument is ready to receive a trigger.

**Example:** `OUTP:UPOR:WTR:POL HIGH`  
 The R&S FPL1000 waits for a 5-V-signal at the AUX PORT connector before accepting a trigger signal.

---

### **SYSTem:SPEaker[:STATe] <State>**

This command switches the built-in loudspeaker on or off for demodulated signals. This setting applies only to the current application.

The command is available in the time domain in Spectrum mode and in Analog Modulation Analysis mode.

To set the volume, use the `SYSTem:SPEaker:VOLume` command.

**Parameters:**

<State>                    ON | OFF | 0 | 1  
                               **OFF | 0**  
                               Switches the function off  
                               **ON | 1**  
                               Switches the function on

**Example:**                `SYST:SPE ON`  
                               `SYST:SPE:VOL 0.5`  
                               Sets the loudspeaker to half the full volume.

### **SYSTem:SPEaker:MUTE**

Temporarily disables the audio output via the built-in loudspeakers.

**Example:**                `SYST:SPE:MUTE`

### **SYSTem:SPEaker:VOLume <Volume>**

This command defines the volume of the built-in loudspeaker for demodulated signals. This setting is maintained for all applications.

The command is available in the time domain in Spectrum mode and in Analog Modulation Analysis mode.

Note that you must switch the loudspeaker on first, using the `SYSTem:SPEaker[:STATe]` command.

**Parameters:**

<Volume>                    Percentage of the maximum possible volume.  
                                   Range:     0 to 1  
                                   \*RST:     0.5

**Example:**                `SYST:SPE:VOL 0`  
                               Switches the loudspeaker to mute.

## **9.4.2 Configuring the vertical axis (amplitude, scaling)**

The following commands are required to configure the amplitude and vertical axis settings in a remote environment.

- [Amplitude settings](#).....132
- [Configuring the attenuation](#).....133
- [Configuring a preamplifier](#).....134
- [Scaling the Y-axis](#).....135

### 9.4.2.1 Amplitude settings

Useful commands for amplitude configuration described elsewhere:

- [\[SENSe:\]ADJust:LEVel](#) on page 155

Remote commands exclusive to amplitude configuration:

<a href="#">CALCulate&lt;n&gt;:MARKer&lt;m&gt;:FUNCTion:REFerence</a> .....	132
<a href="#">UNIT&lt;n&gt;:POWer</a> .....	132
<a href="#">CALCulate&lt;n&gt;:UNIT:POWer</a> .....	132
<a href="#">DISPlay[:WINDow&lt;n&gt;][:SUBWindow&lt;w&gt;]:TRACe&lt;t&gt;:Y[:SCALe]:RLEVel</a> .....	133
<a href="#">DISPlay[:WINDow&lt;n&gt;][:SUBWindow&lt;w&gt;]:TRACe&lt;t&gt;:Y[:SCALe]:RLEVel:OFFSet</a> .....	133

---

#### **CALCulate<n>:MARKer<m>:FUNCTion:REFerence**

This command matches the reference level to the power level of a marker.

If you use the command in combination with a delta marker, that delta marker is turned into a normal marker.

##### **Suffix:**

<n>                      [Window](#)

<m>                      [Marker](#)

##### **Example:**

`CALC:MARK2:FUNC:REF`

Sets the reference level to the level of marker 2.

**Manual operation:** See "[Reference Level = Marker Level](#)" on page 91

---

#### **UNIT<n>:POWer <Unit>**

#### **CALCulate<n>:UNIT:POWer <Unit>**

This command selects the unit of the y-axis.

The unit applies to all power-based measurement windows with absolute values.

##### **Suffix:**

<n>                      irrelevant

##### **Parameters:**

<Unit>                      DBM | V | A | W | DBPW | WATT | DBUV | DBMV | VOLT |  
DBUA | AMPere  
(Units based on 1 MHz require installed R&S FPL1-K54 (EMI  
measurements) option.)

\*RST:                      dBm

##### **Example:**

`CALC:UNIT:POW DBM`

Sets the power unit to dBm.

**Manual operation:** See "[Unit](#)" on page 46

---

**DISPlay[:WINDow<n>][:SUBWindow<w>]:TRACe<t>:Y[:SCALe]:RLEVel**  
 <ReferenceLevel>

This command defines the reference level (for all traces in all windows).

With a reference level offset  $\neq 0$ , the value range of the reference level is modified by the offset.

**Suffix:**

<n>	irrelevant
<w>	subwindow Not supported by all applications
<t>	irrelevant

**Parameters:**

<ReferenceLevel>	The unit is variable. Range: see datasheet *RST: 0 dBm Default unit: DBM
------------------	---

**Example:** DISP:TRAC:Y:RLEV -60dBm

**Manual operation:** See "[Reference Level](#)" on page 46

---

**DISPlay[:WINDow<n>][:SUBWindow<w>]:TRACe<t>:Y[:SCALe]:RLEVel:OFFSet**  
 <Offset>

This command defines a reference level offset (for all traces in all windows).

**Suffix:**

<n>	irrelevant
<w>	subwindow Not supported by all applications
<t>	irrelevant

**Parameters:**

<Offset>	Range: -200 dB to 200 dB *RST: 0dB Default unit: DB
----------	---

**Example:** DISP:TRAC:Y:RLEV:OFFS -10dB

**Manual operation:** See "[Shifting the Display \(Offset\)](#)" on page 46

#### 9.4.2.2 Configuring the attenuation

INPut<ip>:ATTenuation.....	134
INPut<ip>:EATT:AUTO.....	134
INPut<ip>:ATTenuation:AUTO.....	134

**INPut<ip>:ATTenuation <Attenuation>**

This command defines the total attenuation for RF input.

If you set the attenuation manually, it is no longer coupled to the reference level, but the reference level is coupled to the attenuation. Thus, if the current reference level is not compatible with an attenuation that has been set manually, the command also adjusts the reference level.

**Suffix:**

<ip>                    1 | 2  
                          irrelevant

**Parameters:**

<Attenuation>        Range:        see data sheet  
                          Increment:   5 dB (with optional electr. attenuator: 1 dB)  
                          \*RST:        10 dB (AUTO is set to ON)  
                          Default unit: DB

**Example:**

INP:ATT 30dB

Defines a 30 dB attenuation and decouples the attenuation from the reference level.

**Manual operation:** See "[Attenuation Mode / Value](#)" on page 47

**INPut<ip>:EATT:AUTO <State>****INPut<ip>:ATTenuation:AUTO <State>**

This command couples or decouples the attenuation to the reference level. Thus, when the reference level is changed, the R&S FPL1000 determines the signal level for optimal internal data processing and sets the required attenuation accordingly.

For the R&S FPL1000, these commands are identical.

**Suffix:**

<ip>                    1 | 2  
                          irrelevant

**Parameters:**

<State>                ON | OFF | 0 | 1  
                          \*RST:        1

**Example:**

INP:ATT:AUTO ON

Couples the attenuation to the reference level.

**Manual operation:** See "[Attenuation Mode / Value](#)" on page 47

**9.4.2.3 Configuring a preamplifier**

[INPut<ip>:GAIN:STATE](#)..... 135

**INPut<ip>:GAIN:STATe <State>**

This command turns the internal preamplifier on and off. It requires the optional preamplifier hardware.

If activated, the input signal is amplified by 20 dB. The preamplifier is only active below 3 GHz (R&S FPL1003) or 7.5 GHz (R&S FPL1007).

**Suffix:**

<ip>                    1 | 2  
                          irrelevant

**Parameters:**

<State>                ON | OFF | 0 | 1  
                          **OFF | 0**  
                          Switches the function off  
                          **ON | 1**  
                          Switches the function on  
                          \*RST:        0

**Example:**            INP:GAIN:STAT ON  
                          Switches on 20 dB preamplification.

**Manual operation:** See "Preamplifier" on page 48

**9.4.2.4 Scaling the Y-axis**

DISPlay[:WINDow<n>][:SUBWindow<w>]:TRACe<t>:Y[:SCALe].....	135
DISPlay[:WINDow<n>][:SUBWindow<w>]:TRACe<t>:Y[:SCALe]:AUTO ONCE.....	136
DISPlay[:WINDow<n>][:SUBWindow<w>]:TRACe<t>:Y[:SCALe]:MODE.....	136
DISPlay[:WINDow<n>][:SUBWindow<w>]:TRACe<t>:Y[:SCALe]:RPOSition.....	136
DISPlay[:WINDow<n>][:SUBWindow<w>]:TRACe<t>:Y:SPACing.....	137

**DISPlay[:WINDow<n>][:SUBWindow<w>]:TRACe<t>:Y[:SCALe] <Range>**

This command defines the display range of the y-axis (for all traces).

Note that the command works only for a logarithmic scaling. You can select the scaling with `DISPlay[:WINDow<n>][:SUBWindow<w>]:TRACe<t>:Y:SPACing`.

**Suffix:**

<n>                    [Window](#)  
                          subwindow  
                          Not supported by all applications  
  
<t>                    irrelevant

**Parameters:**

<Range>              Range:        1 dB to 200 dB  
                          \*RST:        100 dB  
                          Default unit: HZ

**Example:**            DISP:TRAC:Y 110dB

**Manual operation:** See "Range" on page 49  
See "Y-Axis Max" on page 50

---

**DISPlay[:WINDow<n>][:SUBWindow<w>]:TRACe<t>:Y[:SCALe]:AUTO ONCE**

Automatic scaling of the y-axis is performed once, then switched off again (for all traces).

**Suffix:**

<n>                      Window  
<t>                      irrelevant

---

**DISPlay[:WINDow<n>][:SUBWindow<w>]:TRACe<t>:Y[:SCALe]:MODE <Mode>**

This command selects the type of scaling of the y-axis (for all traces).

When the display update during remote control is off, this command has no immediate effect.

**Suffix:**

<n>                      Window  
<w>                      subwindow  
<t>                      irrelevant

**Parameters:**

<Mode>                      **ABSolute**  
absolute scaling of the y-axis  
**RELative**  
relative scaling of the y-axis  
\*RST:                      ABSolute

**Example:**                      DISP:TRAC:Y:MODE REL

**Manual operation:** See "Scaling" on page 49

---

**DISPlay[:WINDow<n>][:SUBWindow<w>]:TRACe<t>:Y[:SCALe]:RPOSITION  
<Position>**

This command defines the vertical position of the reference level on the display grid (for all traces).

The R&S FPL1000 adjusts the scaling of the y-axis accordingly.

For measurements with the optional tracking generator, the command defines the position of the reference line.

**Suffix:**

<n>                      Window  
<w>                      subwindow  
Not supported by all applications



<t> irrelevant

**Parameters:**

<Position> 0 PCT corresponds to the lower display border, 100 percent corresponds to the upper display border.

\*RST: frequency display: 90 PCT; time display: 50 PCT;  
AF spectrum display (K7): 100 PCT;

Default unit: PCT

**Example:**

DISP:TRAC:Y:RPOS 50PCT

**Manual operation:** See "Ref Level Position" on page 49

**DISPlay[:WINDow<n>][:SUBWindow<w>]:TRACe<t>:Y:SPACing <ScalingType>**

This command selects the scaling of the y-axis (for all traces, <t> is irrelevant).

**Suffix:**

<n> [Window](#)

<w> subwindow

<t> [Trace](#)

**Parameters:**

<ScalingType> **LOGarithmic**  
Logarithmic scaling.

**LINear**  
Linear scaling in %.

**LDB**  
Linear scaling in the specified unit.

**PERCent**  
Linear scaling in %.

\*RST: LOGarithmic

**Example:**

DISP:TRAC:Y:SPAC LIN  
Selects linear scaling in %.

**Manual operation:** See "Scaling" on page 49

### 9.4.3 Frequency

<a href="#">CALCulate&lt;n&gt;:MARKer&lt;m&gt;:FUNCTion:CENTer</a> .....	137
<a href="#">[SENSe:]FREQUency:CENTer</a> .....	138
<a href="#">[SENSe:]FREQUency:CENTer:STEP</a> .....	138
<a href="#">[SENSe:]FREQUency:CENTer:STEP:AUTO</a> .....	138
<a href="#">[SENSe:]FREQUency:OFFSet</a> .....	139

**CALCulate<n>:MARKer<m>:FUNCTion:CENTer**

This command matches the center frequency to the frequency of a marker.

If you use the command in combination with a delta marker, that delta marker is turned into a normal marker.

**Suffix:**

<n> [Window](#)

<m> [Marker](#)

**Example:**

```
CALC:MARK2:FUNC:CENT
```

Sets the center frequency to the frequency of marker 2.

**Manual operation:** See "[Center Frequency = Marker Frequency](#)" on page 91

**[SENSe:]FREQUENCY:CENTer <Frequency>**

This command defines the center frequency.

**Parameters:**

<Frequency> The allowed range and  $f_{max}$  is specified in the data sheet.

\*RST:  $f_{max}/2$

Default unit: Hz

**Example:**

```
FREQ:CENT 100 MHz
```

```
FREQ:CENT:STEP 10 MHz
```

```
FREQ:CENT UP
```

Sets the center frequency to 110 MHz.

**Manual operation:** See "[Center Frequency](#)" on page 50

**[SENSe:]FREQUENCY:CENTer:STEP <StepSize>**

This command defines the center frequency step size.

You can increase or decrease the center frequency quickly in fixed steps using the `SENS:FREQ UP` AND `SENS:FREQ DOWN` commands, see [\[SENSe:\]FREQUENCY:CENTer](#) on page 138.

**Parameters:**

<StepSize>  $f_{max}$  is specified in the data sheet.

Range: 1 to fMAX

\*RST: 0.1 x span

Default unit: Hz

**Example:**

```
//Set the center frequency to 110 MHz.
```

```
FREQ:CENT 100 MHz
```

```
FREQ:CENT:STEP 10 MHz
```

```
FREQ:CENT UP
```

**Manual operation:** See "[Center Frequency Stepsize](#)" on page 51

**[SENSe:]FREQUENCY:CENTer:STEP:AUTO <State>**

This command couples or decouples the center frequency step size to the span.

In time domain (zero span) measurements, the center frequency is coupled to the RBW.

**Parameters:**

<State> ON | OFF | 0 | 1  
\*RST: 1

**Example:**

FREQ:CENT:STEP:AUTO ON  
Activates the coupling of the step size to the span.

**[SENSe:]FREQuency:OFFSet <Offset>**

This command defines a frequency offset.

If this value is not 0 Hz, the application assumes that the input signal was frequency shifted outside the application. All results of type "frequency" will be corrected for this shift numerically by the application.

See also "[Frequency Offset](#)" on page 51.

**Parameters:**

<Offset> Range: -1 THz to 1 THz  
\*RST: 0 Hz  
Default unit: HZ

**Example:**

FREQ:OFFS 1GHZ

**Manual operation:** See "[Frequency Offset](#)" on page 51

## 9.4.4 Triggering

The following remote commands are required to configure a triggered measurement in a remote environment. More details are described for manual operation in [Chapter 5.6](#), "[Trigger settings](#)", on page 51.



\*OPC should be used after requesting data. This will hold off any subsequent changes to the selected trigger source, until after the sweep is completed and the data is returned.

- [Configuring the triggering conditions](#)..... 139
- [Configuring I/Q gating](#)..... 144

### 9.4.4.1 Configuring the triggering conditions

The following commands are required to configure a triggered measurement.

<a href="#">TRIGger[:SEQuence]:DTIME</a> .....	140
<a href="#">TRIGger[:SEQuence]:HOLDoff[:TIME]</a> .....	140
<a href="#">TRIGger[:SEQuence]:IFPower:HOLDoff</a> .....	140
<a href="#">TRIGger[:SEQuence]:IFPower:HYSTeresis</a> .....	141
<a href="#">TRIGger[:SEQuence]:LEVel[:EXTernal&lt;port&gt;]</a> .....	141

TRIGger[:SEQuence]:LEVel:IFPower.....	141
TRIGger[:SEQuence]:LEVel:IQPower.....	142
TRIGger[:SEQuence]:SLOPe.....	142
TRIGger[:SEQuence]:SOURce.....	142
TRIGger[:SEQuence]:TIME:RINTerval.....	143

---

#### TRIGger[:SEQuence]:DTIME <DropoutTime>

Defines the time the input signal must stay below the trigger level before a trigger is detected again.

##### Parameters:

<DropoutTime> Dropout time of the trigger.  
 Range: 0 s to 10.0 s  
 \*RST: 0 s  
 Default unit: S

**Manual operation:** See "[Drop-Out Time](#)" on page 54

---

#### TRIGger[:SEQuence]:HOLDoff[:TIME] <Offset>

Defines the time offset between the trigger event and the start of the sweep.

##### Parameters:

<Offset> For measurements in the frequency domain, the range is 0 s to 30 s.  
 For measurements in the time domain, the range is the negative sweep time to 30 s.  
 \*RST: 0 s  
 Default unit: S

**Example:** TRIG:HOLD 500us

**Manual operation:** See "[Trigger Offset](#)" on page 54

---

#### TRIGger[:SEQuence]:IFPower:HOLDoff <Period>

This command defines the holding time before the next trigger event.

Note that this command can be used for **any trigger source**, not just IF Power (despite the legacy keyword).

**Note:** If you perform gated measurements in combination with the IF Power trigger, the R&S FPL1000 ignores the holding time for frequency sweep, FFT sweep, zero span and I/Q data measurements.

##### Parameters:

<Period> Range: 0 s to 10 s  
 \*RST: 0 s  
 Default unit: S

**Example:**           TRIG:SOUR EXT  
Sets an external trigger source.  
TRIG:IFP:HOLD 200 ns  
Sets the holding time to 200 ns.

**Manual operation:** See "[Trigger Holdoff](#)" on page 55

#### TRIGger[:SEQuence]:IFPower:HYSTeresis <Hysteresis>

This command defines the trigger hysteresis, which is only available for "IF Power" trigger sources.

**Parameters:**

<Hysteresis>           Range:       3 dB to 50 dB  
                          \*RST:        3 dB  
                          Default unit: DB

**Example:**           TRIG:SOUR IFP  
Sets the IF power trigger source.  
TRIG:IFP:HYST 10DB  
Sets the hysteresis limit value.

**Manual operation:** See "[Hysteresis](#)" on page 55

#### TRIGger[:SEQuence]:LEVel[:EXTernal<port>] <TriggerLevel>

This command defines the level the external signal must exceed to cause a trigger event.

In the I/Q Analyzer application, only EXTERNAL1 is supported.

**Suffix:**

<port>                 Selects the trigger port.  
                          1 = trigger port 1 (TRIG IN connector on rear panel)  
                          2 = trigger port 2 (TRIG AUX connector on rear panel)

**Parameters:**

<TriggerLevel>       For the R&S FPL1000, the external trigger level is always 1.4 V.  
                          It cannot be changed.  
                          \*RST:        1.4 V

**Manual operation:** See "[Trigger Level](#)" on page 53

#### TRIGger[:SEQuence]:LEVel:IFPower <TriggerLevel>

This command defines the power level at the third intermediate frequency that must be exceeded to cause a trigger event.

Note that any RF attenuation or preamplification is considered when the trigger level is analyzed. If defined, a reference level offset is also considered.

**Parameters:**

<TriggerLevel> For details on available trigger levels and trigger bandwidths, see the data sheet.

\*RST: -20 dBm

Default unit: DBM

**Example:**

TRIG:LEV:IFP -30DBM

**Manual operation:** See ["Trigger Level"](#) on page 53

**TRIGger[:SEQUence]:LEVel:IQPower** <TriggerLevel>

This command defines the magnitude the I/Q data must exceed to cause a trigger event.

Note that any RF attenuation or preamplification is considered when the trigger level is analyzed. If defined, a reference level offset is also considered.

**Parameters:**

<TriggerLevel> Range: -130 dBm to 30 dBm

\*RST: -20 dBm

Default unit: DBM

**Example:**

TRIG:LEV:IQP -30DBM

**Manual operation:** See ["Trigger Level"](#) on page 53

**TRIGger[:SEQUence]:SLOPe** <Type>

For all trigger sources except time, you can define whether triggering occurs when the signal rises to the trigger level or falls down to it.

**Parameters:**

<Type> POSitive | NEGative

**POSitive**

Triggers when the signal rises to the trigger level (rising edge).

**NEGative**

Triggers when the signal drops to the trigger level (falling edge).

\*RST: POSitive

**Example:**

TRIG:SLOP NEG

**Manual operation:** See ["Slope"](#) on page 54

**TRIGger[:SEQUence]:SOURce** <Source>

This command selects the trigger source.

For details on trigger sources, see ["Trigger Source"](#) on page 52.

**Note on external triggers:**

If a measurement is configured to wait for an external trigger signal in a remote control program, remote control is blocked until the trigger is received and the program can continue. Make sure that this situation is avoided in your remote control programs.

**Parameters:**

<Source>	<b>IMMediate</b> Free Run
	<b>EXTernal</b> Trigger signal from the "Trigger Input" connector. Trigger signal from the "Trigger In" connector.
	<b>IFPower</b> Second intermediate frequency
	<b>IQPower</b> Magnitude of sampled I/Q data
	<b>TIME</b> Time interval
	<b>VIDeo</b> Video mode is available in the time domain and only in the Spectrum application.
	*RST: IMMediate

**Example:** TRIG:SOUR EXT  
Selects the external trigger input as source of the trigger signal

**Manual operation:** See ["Trigger Source"](#) on page 52  
See ["Free Run"](#) on page 52  
See ["External Trigger 1"](#) on page 53  
See ["IF Power"](#) on page 53  
See ["I/Q Power"](#) on page 53  
See ["Time"](#) on page 53

**TRIGger[:SEquence]:TIME:RINTerval <Interval>**

This command defines the repetition interval for the time trigger.

**Parameters:**

<Interval>	numeric value
	Range: 2 ms to 5000 s
	*RST: 1.0 s
	Default unit: S

**Example:** TRIG:SOUR TIME  
Selects the time trigger input for triggering.  
TRIG:TIME:RINT 5  
The sweep starts every 5 s.

**Manual operation:** See ["Repetition Interval"](#) on page 54

### 9.4.4.2 Configuring I/Q gating

Usually in spectrum analysis, measurements are based on a certain length of time called the gate area. With I/Q gating, you can define the gate area using the gate length, the distance between the capture periods and the number of periods. The gate length and the distance between the capture periods are specified in samples.



I/Q gating is only available using remote commands; manual configuration is not possible.

It is only possible up to a bandwidth of 12.8 MHz.

Using I/Q gating, the gate area can be defined using the following methods:

- Edge triggered capturing  
After a trigger signal, the gate period is defined by a gate length and a gate distance. All data in the gate period is captured until the required number of samples has been captured.

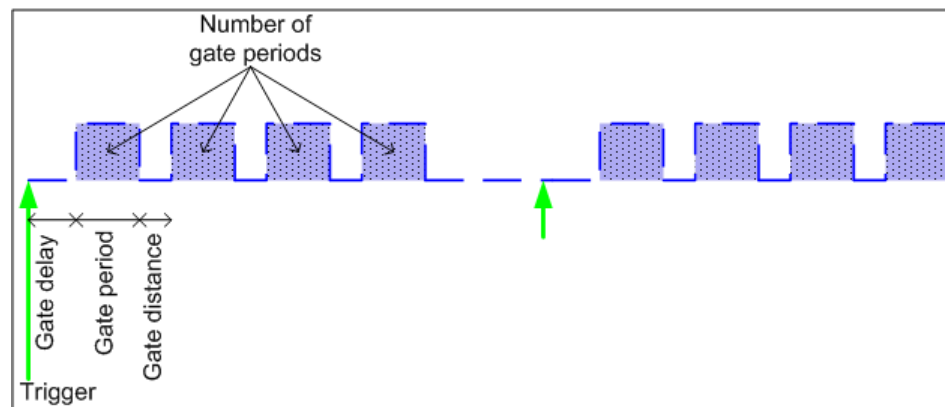

- Level triggered capturing  
After a trigger signal, all data is captured in which the gate signal is set to 1, which means it has exceeded a level. In this case, the gate signal can be generated by the IFP trigger, for example: each time the IFP level is exceeded, the IFP trigger signal is set to 1 and the samples in this area are captured as gate samples.

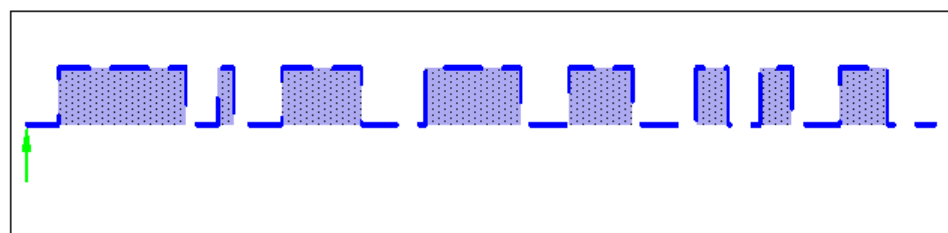

The number of complex samples to be captured prior to the trigger event can be selected (see [TRACe:IQ:SET](#) on page 150) for all available trigger sources, except for "Free Run".

---

**TRACe:IQ:EGATe[:STATe]** <State>

This command turns gated measurements with the I/Q analyzer on and off.



Before you can use the command you have to turn on the I/Q analyzer and select an external or IF power trigger source.

**Parameters:**

<State> ON | OFF

**Example:** TRAC:IQ:EGAT ON

**TRACe:IQ:EGATe:GAP** <Samples>

This command defines the interval between several gate periods for gated measurements with the I/Q analyzer.

**Parameters:**

<Samples> <numeric value>

Max = (440 MS \* sample rate/200MHz) -1  
pretrigger samples defined by [TRACe:IQ:SET](#);  
sample rate defined by [TRACe:IQ:SRATe](#))

Range: 1...Max (samples)

\*RST: 1

**Example:** TRAC:IQ:EGAT:GAP 2

**TRACe:IQ:EGATe:LENGth** <GateLength>

This command defines the gate length for gated measurements with the I/Q analyzer.

**Parameters:**

<GateLength> <numeric value>

Max = (440 MS \* sample rate/200MHz) -1  
pretrigger samples defined by [TRACe:IQ:SET](#);  
sample rate defined by [TRACe:IQ:SRATe](#))

Range: 1...Max (samples)

\*RST: 100

**Example:** TRAC:IQ:EGAT:LENG 2000

**TRACe:IQ:EGATe:NOF** <Number>

This command defines the number of gate periods after the trigger signal for gated measurements with the I/Q analyzer.

**Parameters:**

<Number> Range: 1 to 1023

\*RST: 1

**Example:** TRAC:IQ:EGAT:NOF 2

**TRACe:IQ:EGATe:TYPE** <Type>

This command selects the gate mode for gated measurements with the I/Q analyzer.

**Note:** The IF power trigger holdoff time is ignored if you are using the "Level" gate mode in combination with an IF Power trigger.

**Parameters:**

<Type>                    **LEVEL**  
                               **EDGE**  
                               \*RST:        EDGE

**Example:**                TRAC:IQ:EGAT:TYPE LEV

## 9.4.5 Configuring data acquisition

The following commands are required to capture data in the I/Q Analyzer.

### Useful commands for I/Q data acquisition described elsewhere

- [SENSe:]SWEep:COUNT on page 167
- [SENSe:]SWEep[:WINDow<n>]:POINTs on page 168
- [SENSe:]SWEep:TIME on page 168

### Remote commands exclusive to I/Q data acquisition

[SENSe:]IQ:BANDwidth:MODE.....	146
[SENSe:]IQ:BWIDth:MODE.....	146
[SENSe:]IQ:BANDwidth:RESolution.....	147
[SENSe:]IQ:BWIDth:RESolution.....	147
[SENSe:]IQ:FFT:ALGorithm.....	147
[SENSe:]IQ:FFT:LENGth.....	148
[SENSe:]IQ:FFT:WINDow:LENGth.....	148
[SENSe:]IQ:FFT:WINDow:OVERlap.....	148
[SENSe:]IQ:FFT:WINDow:TYPE.....	149
[SENSe:]SWAPiq.....	149
TRACe:IQ:BWIDth.....	149
TRACe:IQ:RLENGth.....	150
TRACe:IQ:SET.....	150
TRACe:IQ:SRATe.....	151
TRACe:IQ:TPISample?.....	151

[SENSe:]IQ:BANDwidth:MODE <Mode>

[SENSe:]IQ:BWIDth:MODE <Mode>

This command defines how the resolution bandwidth is determined.

**Parameters:**

<Mode>                    AUTO | MANual | FFT

**AUTO**

(Default) The RBW is determined automatically depending on the sample rate and record length.

**MANual**

The user-defined RBW is used and the (FFT) window length (and possibly the sample rate) are adapted accordingly. The RBW is defined using the `[SENSe:]IQ:BWIDth:RESolution` command.

**FFT**

The RBW is determined by the FFT parameters.

\*RST: AUTO

**Example:**

```
IQ:BAND:MODE MAN
Switches to manual RBW mode.
IQ:BAND:RES 120000
Sets the RBW to 120 kHz.
```

**Manual operation:** See "RBW" on page 57

`[SENSe:]IQ:BANDwidth:RESolution <Bandwidth>`

`[SENSe:]IQ:BWIDth:RESolution <Bandwidth>`

This command defines the resolution bandwidth manually if `[SENSe:]IQ:BWIDth:MODE` is set to `MAN`.

Defines the resolution bandwidth. The available RBW values depend on the sample rate and record length.

**Parameters:**

<Bandwidth> refer to data sheet  
 \*RST: RBW: AUTO mode is used  
 Default unit: HZ

**Example:**

```
IQ:BAND:MODE MAN
Switches to manual RBW mode.
IQ:BAND:RES 120000
Sets the RBW to 120 kHz.
```

**Manual operation:** See "RBW" on page 57

`[SENSe:]IQ:FFT:ALGORITHM <Method>`

Defines the FFT calculation method.

**Parameters:**

<Method> **SINGLE**  
 One FFT is calculated for the entire record length; if the FFT length is larger than the record length (see `[SENSe:]IQ:FFT:LENGTH` and `TRACe:IQ:RLENGTH`), zeros are appended to the captured data.

**AVERage**

Several overlapping FFTs are calculated for each record; the results are averaged to determine the final FFT result for the record.

The user-defined window length and window overlap are used. See [SENSe:] IQ:FFT:WINDow:LENGth and [SENSe:] IQ:FFT:WINDow:OVERlap.

\*RST: AVER

**Example:** IQ:FFT:ALG SING

**Manual operation:** See "[Transformation Algorithm](#)" on page 58

**[SENSe:]IQ:FFT:LENGth <NoOfBins>**

Defines the number of frequency points determined by each FFT calculation. The more points are used, the higher the resolution in the spectrum becomes, but the longer the calculation takes.

**Parameters:**

<NoOfBins> integer value  
 Range: 3 to 524288  
 \*RST: 4096

**Example:** IQ:FFT:LENG 2048

**Manual operation:** See "[FFT Length](#)" on page 58

**[SENSe:]IQ:FFT:WINDow:LENGth <NoOfFFT>**

Defines the number of samples to be included in a single FFT window when multiple FFT windows are used.

**Parameters:**

<NoOfFFT> integer value  
 Range: 3 to 4096  
 \*RST: record length

**Example:** IQ:FFT:WIND:LENG 500

**Manual operation:** See "[Window Length](#)" on page 59

**[SENSe:]IQ:FFT:WINDow:OVERlap <Rate>**

Defines the part of a single FFT window that is re-calculated by the next FFT calculation.

**Parameters:**

<Rate> double value  
 Percentage rate  
 Range: 0 to 1  
 \*RST: 0.75

**Example:** `IQ:FFT:WIND:OVER 0.5`  
Half of each window overlaps the previous window in FFT calculation.

**Manual operation:** See "[Window Overlap](#)" on page 59

**[SENSe:]IQ:FFT:WINDow:TYPE <Function>**

In the I/Q Analyzer you can select one of several FFT window types.

**Parameters:**

<Function>

- BLACkharris**  
Blackman-Harris
- FLATtop**  
Flattop
- GAUSSian**  
Gauss
- RECTangular**  
Rectangular
- P5**  
5-Term

\*RST:        FLAT

**Example:** `IQ:FFT:WIND:TYPE GAUS`

**Manual operation:** See "[Window Function](#)" on page 59

**[SENSe:]SWAPiq <State>**

This command defines whether or not the recorded I/Q pairs should be swapped (I<->Q) before being processed. Swapping I and Q inverts the sideband.

This is useful if the DUT interchanged the I and Q parts of the signal; then the R&S FPL1000 can do the same to compensate for it.

**Parameters:**

<State>

- ON | 1**  
I and Q signals are interchanged  
Inverted sideband,  $Q+j*I$
- OFF | 0**  
I and Q signals are not interchanged  
Normal sideband,  $I+j*Q$

\*RST:        0

**Manual operation:** See "[Swap I/Q](#)" on page 57

**TRACe:IQ:BWIDth**

This command defines or queries the bandwidth of the resampling filter.

The bandwidth of the resampling filter depends on the sample rate.

**Parameters:**

<Bandwidth>                      Default unit: HZ

**Manual operation:**    See "[Analysis Bandwidth](#)" on page 57

**TRACe:IQ:RLEnGth** <NoOfSamples>

This command sets the record length for the acquired I/Q data.

Increasing the record length also increases the measurement time.

**Note:** Alternatively, you can define the measurement time using the `SENS:SWE:TIME` command.

**Parameters:**

<NoOfSamples>                      Number of samples to record.

\*RST:                      1001

**Example:**                      `TRAC:IQ:RLEN 256`

**Manual operation:**    See "[Record Length](#)" on page 57

**TRACe:IQ:SET** <NORM>, <0>, <SampleRate>, <TriggerMode>, <TriggerSlope>, <PretriggerSamp>, <NumberSamples>

This command sets up the R&S FPL1000 for I/Q measurements.

If you do not use this command to set up I/Q measurements, the R&S FPL1000 will use its current settings for I/Q measurements.

If the I/Q Analyzer has not been turned on previously, the command also switches to the I/Q Analyzer.

**Note:** If you use the default settings with `TRACe:IQ:DATA??`, the following minimum buffer sizes for the response data are recommended:

ASCII format: 10 kBytes

Binary format: 2 kBytes

**Parameters:**

Norm                                      This value is always `NORM`.

0    Default unit: HZ  
This value is always 0.

<SampleRate>                              Sample rate for the data acquisition.  
Range:                      100 Hz to 10 GHz, continuously adjustable  
\*RST:                              32000000  
Default unit: HZ

<TriggerMode>                              Selection of the trigger source used for the measurement.  
**IMM**ediate | **EX**Ternal | **EX**T2 | **EX**T3 | **IF**Power  
For IMM mode, gating is automatically deactivated.  
\*RST:                              IMM

<TriggerSlope>	Used trigger slope. <b>POSitive   NEGative</b> *RST: POS
<PretriggerSamp>	Defines the trigger offset in terms of pretrigger samples. Negative values correspond to a trigger delay. This value also defines the interval between the trigger signal and the gate edge in samples. Range: -1399999999 to 1399999999 *RST: 0
<NumberSamples>	Number of measurement values to record (including the pretrigger samples). *RST: 1001

**Example:**

```
TRAC:IQ:SET NORM,0,32MHz,EXT,POS,0,2048
Reads 2048 I/Q-values starting at the trigger point.
sample rate = 32 MHz
trigger = External
slope = Positive
TRAC:IQ:SET NORM,0,4 MHz,EXT,POS,1024,512
Reads 512 I/Q-values from 1024 measurement points before the
trigger point.
filter type = NORMAL
sample rate = 4 MHz
trigger = External
slope = Positive
```

**Manual operation:** See "[Record Length](#)" on page 57

**TRACe:IQ:SRATe** <SampleRate>

This command sets the final user sample rate for the acquired I/Q data. Thus, the user sample rate can be modified without affecting the actual data capturing settings on the R&S FPL1000.

**Parameters:**

<SampleRate> \*RST: 32 MHz  
Default unit: HZ

**Manual operation:** See "[Sample Rate](#)" on page 56

**TRACe:IQ:TPISample?**

This command queries the time offset from the sample start to the trigger event (trigger point in sample = TPIS). Since the R&S FPL1000 usually samples with a much higher sample rate than the specific application actually requires, the trigger point determined internally is much more precise than the one determined from the (downsampled) data in the application. Thus, the TPIS indicates the offset from the sample start to the actual trigger event.

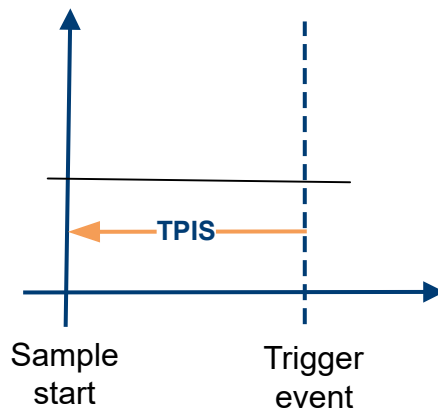

This value can only be determined in triggered measurements using external or IFPower triggers, otherwise the value is 0.

**Return values:**

<TPIS> numeric value  
Default unit: s

**Example:**

TRAC:IQ:TPIS?

Result for a sample rate of 1 MHz: between 0 and 1/1 MHz, i.e. between 0 and 1  $\mu$ s (the duration of 1 sample).

**Usage:**

Query only

### 9.4.6 Adjusting settings automatically

The commands required to adjust settings automatically in a remote environment are described here.

[SENSe:]ADJust:ALL.....	152
[SENSe:]ADJust:CONFigure:LEVel:DURation.....	153
[SENSe:]ADJust:CONFigure:LEVel:DURation:MODE.....	153
[SENSe:]ADJust:CONFigure:HYSTeresis:LOWer.....	154
[SENSe:]ADJust:CONFigure:HYSTeresis:UPPer.....	154
[SENSe:]ADJust:CONFigure:TRIGger.....	154
[SENSe:]ADJust:FREQuency.....	155
[SENSe:]ADJust:LEVel.....	155

#### [SENSe:]ADJust:ALL

This command initiates a measurement to determine and set the ideal settings for the current task automatically (only once for the current measurement).

This includes:

- Reference level

**Example:** ADJ:ALL



**Manual operation:** See ["Adjusting all Determinable Settings Automatically \(Auto All\)"](#) on page 62

---

**[SENSe:]ADJust:CONFigure:LEVel:DURation <Duration>**

To determine the ideal reference level, the R&S FPL1000 performs a measurement on the current input data. This command defines the length of the measurement if [\[SENSe:\]ADJust:CONFigure:LEVel:DURation:MODE](#) is set to `MANual`.

**Parameters:**

<Duration>            Numeric value in seconds  
 Range:            0.001 to 16000.0  
 \*RST:            0.001  
 Default unit: s

**Example:**

`ADJ:CONF:DUR:MODE MAN`

Selects manual definition of the measurement length.

`ADJ:CONF:LEV:DUR 5ms`

Length of the measurement is 5 ms.

**Manual operation:** See ["Changing the Automatic Measurement Time \(Meas Time Manual\)"](#) on page 63

---

**[SENSe:]ADJust:CONFigure:LEVel:DURation:MODE <Mode>**

To determine the ideal reference level, the R&S FPL1000 performs a measurement on the current input data. This command selects the way the R&S FPL1000 determines the length of the measurement .

**Parameters:**

<Mode>            **AUTO**  
 The R&S FPL1000 determines the measurement length automatically according to the current input data.

**MANual**  
 The R&S FPL1000 uses the measurement length defined by [\[SENSe:\]ADJust:CONFigure:LEVel:DURation](#) on page 153.

\*RST:            AUTO

**Manual operation:** See ["Resetting the Automatic Measurement Time \(Meas Time Auto\)"](#) on page 63  
 See ["Changing the Automatic Measurement Time \(Meas Time Manual\)"](#) on page 63

**[SENSe:]ADJust:CONFigure:HYSTerisis:LOWer <Threshold>**

When the reference level is adjusted automatically using the [\[SENSe:\]ADJust:LEVel](#) on page 155 command, the internal attenuators and the preamplifier are also adjusted. To avoid frequent adaptation due to small changes in the input signal, you can define a hysteresis. This setting defines a lower threshold the signal must fall below (compared to the last measurement) before the reference level is adapted automatically.

**Parameters:**

<Threshold>                    Range:        0 dB to 200 dB  
                                      \*RST:        +1 dB  
                                      Default unit: dB

**Example:**

SENS:ADJ:CONF:HYST:LOW 2

For an input signal level of currently 20 dBm, the reference level is only adjusted when the signal level falls below 18 dBm.

**Manual operation:** See "[Lower Level Hysteresis](#)" on page 64

**[SENSe:]ADJust:CONFigure:HYSTerisis:UPPer <Threshold>**

When the reference level is adjusted automatically using the [\[SENSe:\]ADJust:LEVel](#) on page 155 command, the internal attenuators and the preamplifier are also adjusted. To avoid frequent adaptation due to small changes in the input signal, you can define a hysteresis. This setting defines an upper threshold the signal must exceed (compared to the last measurement) before the reference level is adapted automatically.

**Parameters:**

<Threshold>                    Range:        0 dB to 200 dB  
                                      \*RST:        +1 dB  
                                      Default unit: dB

**Example:**

SENS:ADJ:CONF:HYST:UPP 2

**Example:**

For an input signal level of currently 20 dBm, the reference level is only adjusted when the signal level rises above 22 dBm.

**Manual operation:** See "[Upper Level Hysteresis](#)" on page 64

**[SENSe:]ADJust:CONFigure:TRIGger <State>**

Defines the behavior of the measurement when adjusting a setting automatically (using `SENS:ADJ:LEV ON`, for example).

See "[Adjusting settings automatically during triggered measurements](#)" on page 62.

**Parameters:**

<State>                        ON | OFF | 0 | 1  
                                      **OFF | 0**  
                                      Switches the function off

**ON | 1**

Switches the function on

**[SENSe:]ADJust:FREQuency**

This command sets the center frequency to the frequency with the highest signal level in the current frequency range.

**Example:** ADJ:FREQ

**Manual operation:** See ["Adjusting the Center Frequency Automatically \(Auto Frequency\)"](#) on page 63

**[SENSe:]ADJust:LEVel**

Initiates a single (internal) measurement that evaluates and sets the ideal reference level for the current input data and measurement settings. Thus, the settings of the RF attenuation and the reference level are optimized for the signal level. The R&S FPL1000 is not overloaded and the dynamic range is not limited by an S/N ratio that is too small.

**Example:** ADJ:LEV

**Manual operation:** See ["Setting the Reference Level Automatically \(Auto Level\)"](#) on page 47

## 9.5 Configuring the result display

The commands required to configure the screen display in a remote environment are described here.

- [General window commands](#)..... 155
- [Working with windows in the display](#)..... 156

### 9.5.1 General window commands

The following commands are required to configure general window layout, independent of the application.

Note that the suffix <n> always refers to the window *in the currently selected channel setup* (see [INSTrument\[:SElect\]](#) on page 115).

[DISPlay\[:WINDow<n>\]:SIZE](#)..... 155

**DISPlay[:WINDow<n>]:SIZE <Size>**

This command maximizes the size of the selected result display window *temporarily*. To change the size of several windows on the screen permanently, use the [LAY:SPL](#) command (see [LAYout:SPLitter](#) on page 160).

**Suffix:**<n> [Window](#)**Parameters:**

&lt;Size&gt;

**LARGe**

Maximizes the selected window to full screen.  
Other windows are still active in the background.

**SMALI**

Reduces the size of the selected window to its original size.  
If more than one measurement window was displayed originally, these are visible again.

\*RST: SMALI

**Example:**

DISP:WIND2:SIZE LARG

## 9.5.2 Working with windows in the display

The following commands are required to change the evaluation type and rearrange the screen layout for a channel setup as you do using the SmartGrid in manual operation. Since the available evaluation types depend on the selected application, some parameters for the following commands also depend on the selected channel setup.

Note that the suffix <n> always refers to the window *in the currently selected channel setup*.

(See [INSTrument \[:SELect\]](#) on page 115).

<a href="#">LAYout:ADD[:WINDow]?</a> .....	156
<a href="#">LAYout:CATalog[:WINDow]?</a> .....	158
<a href="#">LAYout:IDENtify[:WINDow]?</a> .....	158
<a href="#">LAYout:MOVE[:WINDow]</a> .....	158
<a href="#">LAYout:REMOve[:WINDow]</a> .....	159
<a href="#">LAYout:REPLace[:WINDow]</a> .....	159
<a href="#">LAYout:SPLitter</a> .....	160
<a href="#">LAYout:WINDow&lt;n&gt;:ADD?</a> .....	161
<a href="#">LAYout:WINDow&lt;n&gt;:IDENtify?</a> .....	162
<a href="#">LAYout:WINDow&lt;n&gt;:REMOve</a> .....	162
<a href="#">LAYout:WINDow&lt;n&gt;:REPLace</a> .....	162
<a href="#">LAYout:WINDow&lt;n&gt;:TYPE</a> .....	163

---

**LAYout:ADD[:WINDow]?** <WindowName>, <Direction>, <WindowType>

This command adds a window to the display in the active channel setup.

This command is always used as a query so that you immediately obtain the name of the new window as a result.

To replace an existing window, use the [LAYout:REPLace\[:WINDow\]](#) command.

**Query parameters:**

<WindowName>	String containing the name of the existing window the new window is inserted next to. By default, the name of a window is the same as its index. To determine the name and index of all active windows, use the <a href="#">LAYout:CATalog[:WINDow]? query</a> .
<Direction>	LEFT   RIGHT   ABOVE   BELOW Direction the new window is added relative to the existing window.
<WindowType>	text value Type of result display (evaluation method) you want to add. See the table below for available parameter values.

**Return values:**

<NewWindowName>	When adding a new window, the command returns its name (by default the same as its number) as a result.
-----------------	---

**Example:**

```
LAY:ADD? '1', LEFT, MTAB
```

Result:

```
'2'
```

Adds a new window named '2' with a marker table to the left of window 1.

**Usage:**

Query only

**Manual operation:**

See "[Magnitude](#)" on page 13  
 See "[Spectrum](#)" on page 13  
 See "[I/Q-Vector](#)" on page 14  
 See "[Real/Imag \(I/Q\)](#)" on page 15  
 See "[Phase vs. Time](#)" on page 15  
 See "[Marker Table](#)" on page 16  
 See "[Marker Peak List](#)" on page 16

**Table 9-3: <WindowType> parameter values for IQ Analyzer application**

Parameter value	Window type
FREQ	"Spectrum"
MAGN	"Magnitude"
MTABle	"Marker table"
PEAKlist	"Marker peak list"
PHASe	"Phase vs. time"
RIMAG	"Real/Imag (I/Q)"
VECT	"I/Q Vector"

**LAYout:CATalog[:WINDow]?**

This command queries the name and index of all active windows in the active channel setup from top left to bottom right. The result is a comma-separated list of values for each window, with the syntax:

<WindowName\_1>,<WindowIndex\_1>..<WindowName\_n>,<WindowIndex\_n>

**Return values:**

<WindowName>      string  
Name of the window.  
In the default state, the name of the window is its index.

<WindowIndex>    **numeric value**  
Index of the window.

**Example:**

LAY:CAT?

Result:

'2',2,'1',1

Two windows are displayed, named '2' (at the top or left), and '1' (at the bottom or right).

**Usage:**            Query only

**LAYout:IDENtify[:WINDow]? <WindowName>**

This command queries the **index** of a particular display window in the active channel setup.

**Note:** to query the **name** of a particular window, use the [LAYout:WINDow<n>:IDENtify?](#) query.

**Query parameters:**

<WindowName>    String containing the name of a window.

**Return values:**

<WindowIndex>    Index number of the window.

**Example:**

LAY:IDEN:WIND? '2'

Queries the index of the result display named '2'.

Response:

2

**Usage:**            Query only

**LAYout:MOVE[:WINDow] <WindowName>, <WindowName>, <Direction>****Setting parameters:**

<WindowName>    String containing the name of an existing window that is to be moved.

By default, the name of a window is the same as its index. To determine the name and index of all active windows in the active channel setup, use the [LAYout:CATalog\[:WINDow\]?](#) query.

<WindowName>	String containing the name of an existing window the selected window is placed next to or replaces. By default, the name of a window is the same as its index. To determine the name and index of all active windows in the active channel setup, use the <code>LAYout:CATalog[:WINDow]?</code> query.
<Direction>	LEFT   RIGHT   ABOVE   BELOW   REPLACE Destination the selected window is moved to, relative to the reference window.
<b>Example:</b>	<code>LAY:MOVE '4', '1', LEFT</code> Moves the window named '4' to the left of window 1.
<b>Example:</b>	<code>LAY:MOVE '1', '3', REPL</code> Replaces the window named '3' by window 1. Window 3 is deleted.
<b>Usage:</b>	Setting only

**LAYout:REMOve[:WINDow] <WindowName>**

This command removes a window from the display in the active channel.

**Setting parameters:**

<WindowName> String containing the name of the window. In the default state, the name of the window is its index.

**Example:** `LAY:REM '2'`  
Removes the result display in the window named '2'.

**Usage:** Setting only

**LAYout:REPLace[:WINDow] <WindowName>, <WindowType>**

This command replaces the window type (for example from "Diagram" to "Result Summary") of an already existing window in the active channel setup while keeping its position, index and window name.

To add a new window, use the `LAYout:ADD[:WINDow]?` command.

**Setting parameters:**

<WindowName> String containing the name of the existing window.  
By default, the name of a window is the same as its index. To determine the name and index of all active windows in the active channel setup, use the `LAYout:CATalog[:WINDow]?` query.

<WindowType> Type of result display you want to use in the existing window.  
See `LAYout:ADD[:WINDow]?` on page 156 for a list of available window types.

**Example:** `LAY:REPL:WIND '1', MTAB`  
Replaces the result display in window 1 with a marker table.

**Usage:** Setting only

**LAYout:SPLitter** <Index1>, <Index2>, <Position>

This command changes the position of a splitter and thus controls the size of the windows on each side of the splitter.

Note that windows must have a certain minimum size. If the position you define conflicts with the minimum size of any of the affected windows, the command does not work, but does not return an error.

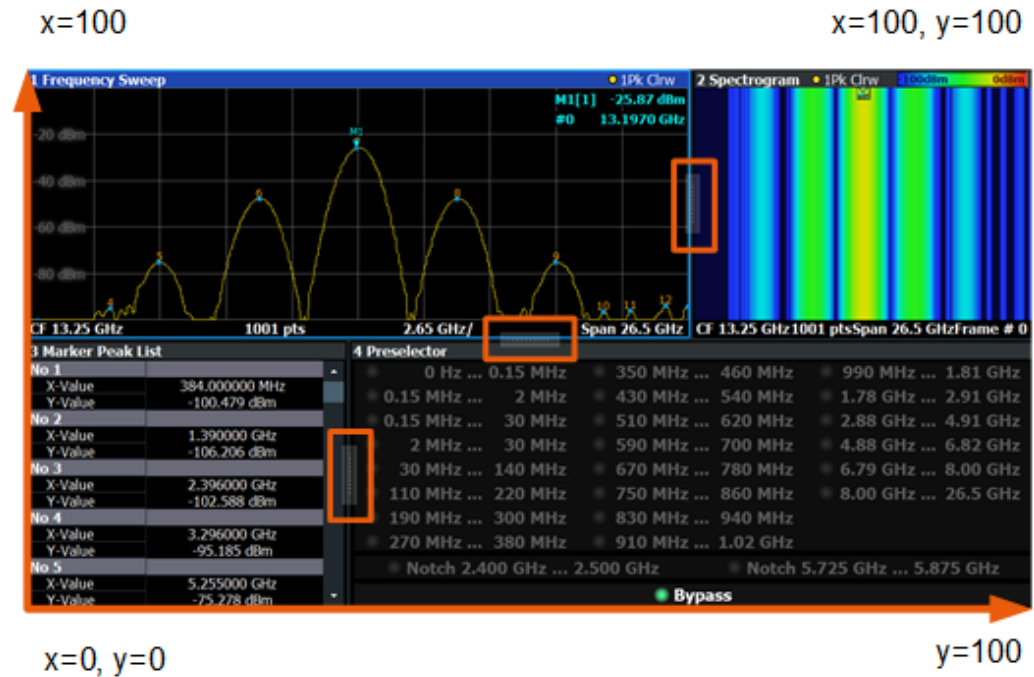

Figure 9-1: SmartGrid coordinates for remote control of the splitters

**Setting parameters:**

- <Index1> The index of one window the splitter controls.
- <Index2> The index of a window on the other side of the splitter.
- <Position> New vertical or horizontal position of the splitter as a fraction of the screen area (without channel and status bar and softkey menu).  
The point of origin ( $x = 0$ ,  $y = 0$ ) is in the lower left corner of the screen. The end point ( $x = 100$ ,  $y = 100$ ) is in the upper right corner of the screen. (See Figure 9-1.)  
The direction in which the splitter is moved depends on the screen layout. If the windows are positioned horizontally, the splitter also moves horizontally. If the windows are positioned vertically, the splitter also moves vertically.
- Range: 0 to 100



**Example:** `LAY:SPL 1,3,50`  
 Moves the splitter between window 1 ('Frequency Sweep') and 3 ('Marker Table') to the center (50%) of the screen, i.e. in the figure above, to the left.

**Example:** `LAY:SPL 1,4,70`  
 Moves the splitter between window 1 ('Frequency Sweep') and 3 ('Marker Peak List') towards the top (70%) of the screen. The following commands have the exact same effect, as any combination of windows above and below the splitter moves the splitter vertically.

`LAY:SPL 3,2,70`

`LAY:SPL 4,1,70`

`LAY:SPL 2,1,70`

**Usage:** Setting only

#### **LAYout:WINDow<n>:ADD? <Direction>,<WindowType>**

This command adds a measurement window to the display. Note that with this command, the suffix <n> determines the existing window next to which the new window is added. Unlike `LAYout:ADD[:WINDow]?`, for which the existing window is defined by a parameter.

To replace an existing window, use the `LAYout:WINDow<n>:REPLace` command.

This command is always used as a query so that you immediately obtain the name of the new window as a result.

#### **Suffix:**

<n> [Window](#)

#### **Query parameters:**

<Direction> LEFT | RIGHT | ABOVE | BELOW

<WindowType> Type of measurement window you want to add.  
 See `LAYout:ADD[:WINDow]?` on page 156 for a list of available window types.

#### **Return values:**

<NewWindowName> When adding a new window, the command returns its name (by default the same as its number) as a result.

**Example:** `LAY:WIND1:ADD? LEFT,MTAB`  
 Result:  
 '2'  
 Adds a new window named '2' with a marker table to the left of window 1.

**Usage:** Query only

**LAYout:WINDow<n>:IDENTify?**

This command queries the **name** of a particular display window (indicated by the <n> suffix) in the active channel setup.

**Note:** to query the **index** of a particular window, use the `LAYout:IDENTify[:WINDow]?` command.

**Suffix:**

<n> [Window](#)

**Return values:**

<WindowName> String containing the name of a window.  
In the default state, the name of the window is its index.

**Example:**

LAY:WIND2:IDEN?

Queries the name of the result display in window 2.

Response:

'2'

**Usage:**

Query only

**LAYout:WINDow<n>:REMOve**

This command removes the window specified by the suffix <n> from the display in the active channel setup.

The result of this command is identical to the `LAYout:REMOve[:WINDow]` command.

**Suffix:**

<n> [Window](#)

**Example:**

LAY:WIND2:REM

Removes the result display in window 2.

**Usage:**

Event

**LAYout:WINDow<n>:REPLace <WindowType>**

This command changes the window type of an existing window (specified by the suffix <n>) in the active channel setup.

The effect of this command is identical to the `LAYout:REPLace[:WINDow]` command.

To add a new window, use the `LAYout:WINDow<n>:ADD?` command.

**Suffix:**

<n> [Window](#)

**Setting parameters:**

<WindowType> Type of measurement window you want to replace another one with.

See `LAYout:ADD[:WINDow]?` on page 156 for a list of available window types.

**Example:** `LAY:WIND2:REPL MTAB`  
Replaces the result display in window 2 with a marker table.

**Usage:** Setting only

---

#### **LAYout:WINDow<n>:TYPE** <WindowType>

Queries or defines the window type of the window specified by the index <n>. The window type determines which results are displayed. For a list of possible window types, see [LAYout:ADD\[:WINDow\]?](#) on page 156.

Note that this command is not available in all applications and measurements.

#### **Suffix:**

<n> 1..n  
[Window](#)

#### **Parameters:**

<WindowType>

**Example:** `LAY:WIND2:TYPE?`

## 9.6 Capturing data and performing sweeps



### Different measurement procedures

Two different procedures to capture I/Q data remotely are available:

- Measurement and result query with one command (see [TRACe:IQ:DATA?](#) on page 220)  
This method causes the least delay between measurement and output of the result data, but it requires the control computer to wait actively for the response data.
- Setting up the instrument, starting the measurement via `INIT` and querying the result list at the end of the measurement (see [TRACe:IQ:DATA:MEMory?](#) on page 222)  
With this method, the control computer can be used for other activities during the measurement. However, the additional time needed for synchronization via service request must be taken into account.

<a href="#">ABORT</a> .....	164
<a href="#">INITiate&lt;n&gt;:CONMeas</a> .....	164
<a href="#">INITiate&lt;n&gt;:CONTinuous</a> .....	165
<a href="#">INITiate&lt;n&gt;[:IMMEDIATE]</a> .....	165
<a href="#">INITiate:SEQuencer:ABORT</a> .....	166
<a href="#">INITiate:SEQuencer:IMMEDIATE</a> .....	166
<a href="#">INITiate:SEQuencer:MODE</a> .....	166
<a href="#">[SENSe:]SWEEp:COUNT</a> .....	167
<a href="#">[SENSe:]SWEEp:COUNT:CURRENT?</a> .....	167

[SENSe:]SWEep[:WINDow<n>]:POINts.....	168
[SENSe:]SWEep:TIME.....	168
SYSTem:SEQuencer.....	168

---

## ABORt

This command aborts the measurement in the current channel setup and resets the trigger system.

To prevent overlapping execution of the subsequent command before the measurement has been aborted successfully, use the \*OPC? or \*WAI command after ABOR and before the next command.

For details on overlapping execution see [Remote control via SCPI](#).

To abort a sequence of measurements by the Sequencer, use the [INITiate:SEQuencer:ABORt](#) command.

### Note on blocked remote control programs:

If a sequential command cannot be completed, for example because a triggered sweep never receives a trigger, the remote control program will never finish and the remote channel to the R&S FPL1000 is blocked for further commands. In this case, you must interrupt processing on the remote channel first in order to abort the measurement.

To do so, send a "Device Clear" command from the control instrument to the R&S FPL1000 on a parallel channel to clear all currently active remote channels. Depending on the used interface and protocol, send the following commands:

- **Visa:** `viClear()`

Now you can send the `ABORt` command on the remote channel performing the measurement.

**Example:** `ABOR; :INIT:IMM`  
Aborts the current measurement and immediately starts a new one.

**Example:** `ABOR; *WAI`  
`INIT:IMM`  
Aborts the current measurement and starts a new one once abortion has been completed.

**Usage:** Event

---

## INITiate<n>:CONMeas

This command restarts a (single) measurement that has been stopped (using `ABORt`) or finished in single sweep mode.

The measurement is restarted at the beginning, not where the previous measurement was stopped.

**Suffix:**  
<n> irrelevant

**Example:**

```
INIT:CONT OFF
Switches to single sweep mode.
DISP:WIND:TRAC:MODE AVER
Switches on trace averaging.
SWE:COUN 20
Setting the sweep counter to 20 sweeps.
INIT;*WAI
Starts the measurement and waits for the end of the 20 sweeps.
INIT:CONM;*WAI
Continues the measurement (next 20 sweeps) and waits for the end.
Result: Averaging is performed over 40 sweeps.
```

**Manual operation:** See "[Continue Single Sweep](#)" on page 61

### INITiate<n>:CONTInuous <State>

This command controls the sweep mode for an individual channel setup.

Note that in single sweep mode, you can synchronize to the end of the measurement with \*OPC, \*OPC? or \*WAI. In continuous sweep mode, synchronization to the end of the measurement is not possible. Thus, it is not recommended that you use continuous sweep mode in remote control, as results like trace data or markers are only valid after a single sweep end synchronization.

For details on synchronization see [Remote control via SCPI](#).

If the sweep mode is changed for a channel setup while the Sequencer is active (see [INITiate:SEQuencer:IMMediate](#) on page 166), the mode is only considered the next time the measurement in that channel setup is activated by the Sequencer.

#### Suffix:

<n> irrelevant

#### Parameters:

<State> ON | OFF | 0 | 1

**ON | 1**

Continuous sweep

**OFF | 0**

Single sweep

\*RST: 1 (some applications can differ)

**Example:**

```
INIT:CONT OFF
Switches the sweep mode to single sweep.
INIT:CONT ON
Switches the sweep mode to continuous sweep.
```

**Manual operation:** See "[Continuous Sweep / Run Cont](#)" on page 60

### INITiate<n>[:IMMediate]

This command starts a (single) new measurement.

With sweep count or average count > 0, this means a restart of the corresponding number of measurements. With trace mode MAXHold, MINHold and AVERage, the previous results are reset on restarting the measurement.

You can synchronize to the end of the measurement with \*OPC, \*OPC? or \*WAI.

For details on synchronization see [Remote control via SCPI](#).

**Suffix:**

<n> irrelevant

**Example:**

INIT:CONT OFF

Switches to single sweep mode.

DISP:WIND:TRAC:MODE AVER

Switches on trace averaging.

SWE:COUN 20

Sets the sweep counter to 20 sweeps.

INIT;\*WAI

Starts the measurement and waits for the end of the 20 sweeps.

**Manual operation:** See "[Single Sweep / Run Single](#)" on page 60

**INITiate:SEQuencer:ABORt**

This command stops the currently active sequence of measurements.

You can start a new sequence any time using [INITiate:SEQuencer:IMMEDIATE](#) on page 166.

**Usage:** Event

**INITiate:SEQuencer:IMMEDIATE**

This command starts a new sequence of measurements by the Sequencer.

Before this command can be executed, the Sequencer must be activated (see [SYSTem:SEQuencer](#) on page 168).

**Example:**

SYST:SEQ ON

Activates the Sequencer.

INIT:SEQ:MODE SING

Sets single sequence mode so each active measurement is performed once.

INIT:SEQ:IMM

Starts the sequential measurements.

**INITiate:SEQuencer:MODE <Mode>**

Defines the capture mode for the entire measurement sequence and all measurement groups and channels it contains.

**Note:** To synchronize to the end of a measurement sequence using \*OPC, \*OPC? or \*WAI, use `SINGLE` Sequencer mode.

**Parameters:**

<Mode>

**SINGLE**

Each measurement group is started one after the other in the order of definition. All measurement channels in a group are started simultaneously and performed once. After *all* measurements are completed, the next group is started. After the last group, the measurement sequence is finished.

**CONTInuous**

Each measurement group is started one after the other in the order of definition. All measurement channels in a group are started simultaneously and performed once. After *all* measurements are completed, the next group is started. After the last group, the measurement sequence restarts with the first one and continues until it is stopped explicitly.

\*RST:       CONTInuous

---

**[SENSe:]SWEep:COUNT <SweepCount>**

This command defines the number of sweeps that the application uses to average traces.

In continuous sweep mode, the application calculates the moving average over the average count.

In single sweep mode, the application stops the measurement and calculates the average after the average count has been reached.

**Example:**

SWE:COUN 64

Sets the number of sweeps to 64.

INIT:CONT OFF

Switches to single sweep mode.

INIT;\*WAI

Starts a sweep and waits for its end.

**Manual operation:** See "[This is Sweep/Average Count ok?](#)" on page 60

---

**[SENSe:]SWEep:COUNT:CURRent?**

This query returns the current number of started sweeps or measurements. This command is only available if a sweep count value is defined and the instrument is in single sweep mode.

**Return values:**

<CurrentCount>

**Example:**           SWE:COUNT 64  
                       Sets sweep count to 64  
                       INIT:CONT OFF  
                       Switches to single sweep mode  
                       INIT  
                       Starts a sweep (without waiting for the sweep end!)  
                       SWE:COUN:CURR?  
                       Queries the number of started sweeps

**Usage:**            Query only

#### **[SENSe:]SWEep[:WINDow<n>]:POINTs <SweepPoints>**

This command defines the number of sweep points to analyze after a sweep.

Note that the number of sweep points is limited to 10001 when measuring spurious emissions.

#### **Suffix:**

<n>

#### **Parameters:**

<SweepPoints>      Range:      101 to 100001  
                           \*RST:        1001

**Example:**           SWE:POIN 251

**Manual operation:** See "[Sweep Points](#)" on page 60

#### **[SENSe:]SWEep:TIME <Time>**

This command defines the sweep time. It automatically decouples the time from any other settings.

#### **Parameters:**

<Time>               refer to data sheet  
                           \*RST:        depends on current settings (determined automatically)  
                           Default unit: S

**Manual operation:** See "[Meas Time](#)" on page 57

#### **SYSTem:SEQuencer <State>**

This command turns the Sequencer on and off. The Sequencer must be active before any other Sequencer commands (INIT:SEQ . . .) are executed, otherwise an error occurs.

A detailed programming example is provided in the "Operating Modes" chapter in the R&S FPL1000 User Manual.

#### **Parameters:**

<State>              ON | OFF | 0 | 1



**ON | 1**

The Sequencer is activated and a sequential measurement is started immediately.

**OFF | 0**

The Sequencer is deactivated. Any running sequential measurements are stopped. Further Sequencer commands (INIT:SEQ...) are not available.

\*RST: 0

**Example:**

SYST:SEQ ON

Activates the Sequencer.

INIT:SEQ:MODE SING

Sets single Sequencer mode so each active measurement is performed once.

INIT:SEQ:IMM

Starts the sequential measurements.

SYST:SEQ OFF

## 9.7 I/Q Analysis

General result analysis settings concerning the trace, markers, etc. can be configured using the following commands. They are identical to the analysis functions in the Spectrum application except for the special marker functions.

- [Configuring standard traces](#)..... 169
- [Configuring spectrograms](#)..... 175
- [Using markers](#)..... 183

### 9.7.1 Configuring standard traces

#### Useful commands for trace configuration described elsewhere

- [DISPlay\[:WINDow<n>\]\[:SUBWindow<w>\]:TRACe<t>:Y:SPACing](#)  
on page 137
- [DISPlay\[:WINDow<n>\]\[:SUBWindow<w>\]:TRACe<t>:Y\[:SCALe\]](#)  
on page 135

#### Remote commands exclusive to trace configuration

<a href="#">DISPlay[:WINDow&lt;n&gt;][:SUBWindow&lt;w&gt;]:TRACe&lt;t&gt;:MODE</a> .....	170
<a href="#">DISPlay[:WINDow&lt;n&gt;][:SUBWindow&lt;w&gt;]:TRACe&lt;t&gt;:MODE:HCONTinuous</a> .....	171
<a href="#">DISPlay[:WINDow&lt;n&gt;][:SUBWindow&lt;w&gt;]:TRACe&lt;t&gt;[:STATe]</a> .....	171
<a href="#">DISPlay[:WINDow&lt;n&gt;][:SUBWindow&lt;w&gt;]:TRACe&lt;t&gt;:SMOothing:APERture</a> .....	172
<a href="#">DISPlay[:WINDow&lt;n&gt;][:SUBWindow&lt;w&gt;]:TRACe&lt;t&gt;:SMOothing[:STATe]</a> .....	172
<a href="#">[SENSe:]AVERage&lt;n&gt;:TYPE</a> .....	173
<a href="#">[SENSe:][:WINDow&lt;n&gt;:]DETEctor&lt;t&gt;[:FUNction]</a> .....	173
<a href="#">[SENSe:][:WINDow&lt;n&gt;:]DETEctor&lt;t&gt;[:FUNction]:AUTO</a> .....	174

TRACe<n>:COPY.....	174
[SENSe:]AVERAge<n>:COUNT.....	174
TRACe:IQ:AVERAge:COUNT.....	174
[SENSe:]AVERAge<n>[:STATe<t>].....	175
TRACe:IQ:AVERAge[:STATe].....	175

---

### DISPlay[:WINDow<n>][:SUBWindow<w>]:TRACe<t>:MODE <Mode>

This command selects the trace mode. If necessary, the selected trace is also activated.

For max hold, min hold or average trace mode, you can set the number of single measurements with [SENSe:]SWEep:COUNT. Note that synchronization to the end of the measurement is possible only in single sweep mode.

#### Suffix:

<n>	Window
<w>	subwindow Not supported by all applications
<t>	Trace

#### Parameters:

<Mode>

#### WRITE

(default:) Overwrite mode: the trace is overwritten by each sweep.

#### AVERAge

The average is formed over several sweeps. The "Sweep/Average Count" determines the number of averaging procedures.

#### MAXHold

The maximum value is determined over several sweeps and displayed. The R&S FPL1000 saves the sweep result in the trace memory only if the new value is greater than the previous one.

#### MINHold

The minimum value is determined from several measurements and displayed. The R&S FPL1000 saves the sweep result in the trace memory only if the new value is lower than the previous one.

#### VIEW

The current contents of the trace memory are frozen and displayed.

#### BLANK

Hides the selected trace.

\*RST: Trace 1: WRITE, Trace 2-6: BLANK

**Example:**

```
INIT:CONT OFF
Switching to single sweep mode.
SWE:COUN 16
Sets the number of measurements to 16.
DISP:TRAC3:MODE WRIT
Selects clear/write mode for trace 3.
INIT;*WAI
Starts the measurement and waits for the end of the measurement.
```

**Manual operation:** See "[Trace Mode](#)" on page 66

**DISPlay[:WINDow<n>][:SUBWindow<w>]:TRACe<t>:MODE:HCONtinuous**  
<State>

This command turns an automatic reset of a trace on and off after a parameter has changed.

The reset works for trace modes min hold, max hold and average.

Note that the command has no effect if critical parameters like the span have been changed to avoid invalid measurement results

**Suffix:**

<n> [Window](#)

<w> subwindow

<t> [Trace](#)

**Parameters:**

<State> ON | OFF | 0 | 1

**OFF | 0**

Switches the function off

**ON | 1**

Switches the function on

**Example:**

```
DISP:WIND:TRAC3:MODE:HCON ON
Switches off the reset function.
```

**Manual operation:** See "[Hold](#)" on page 68

**DISPlay[:WINDow<n>][:SUBWindow<w>]:TRACe<t>[:STATE]** <State>

This command turns a trace on and off.

The measurement continues in the background.

**Suffix:**

<n> [Window](#)

<w> subwindow  
Not supported by all applications

<t> [Trace](#)

**Parameters:**

<State> ON | OFF | 0 | 1  
**OFF | 0**  
 Switches the function off  
**ON | 1**  
 Switches the function on

**Example:** DISP:TRAC3 ON

**Manual operation:** See "[Trace 1/Trace 2/Trace 3/Trace 4/Trace 5/Trace 6](#)" on page 66  
 See "[Trace 1/ Trace 2/ Trace 3/ Trace 4 \(Softkeys\)](#)" on page 69

**DISPlay[:WINDow<n>][:SUBWindow<w>]:TRACe<t>:SMOothing:APERture**  
 <Aperture>

This command defines the degree (aperture) of the trace smoothing, if `DISPlay[:WINDow<n>][:SUBWindow<w>]:TRACe<t>:SMOothing[:STATe]` TRUE.

**Suffix:**

<n> [Window](#)  
 <w> subwindow  
 <t> [Trace](#)

**Parameters:**

<Aperture> Range: 1 to 50  
 \*RST: 2  
 Default unit: PCT

**Example:** DISP3:TRAC2:SMO:APER 5  
 Defines an aperture of 5% for trace 2 in window 3

**Manual operation:** See "[Smoothing](#)" on page 68

**DISPlay[:WINDow<n>][:SUBWindow<w>]:TRACe<t>:SMOothing[:STATe]** <State>

This command turns trace smoothing for a particular trace on and off.

If enabled, the trace is smoothed by the value specified using `DISPlay[:WINDow<n>][:SUBWindow<w>]:TRACe<t>:SMOothing:APERture` on page 172.

For more information see the R&S FPL1000 User Manual.

**Suffix:**

<n> [Window](#)  
 <w> subwindow  
 <t> [Trace](#)

**Parameters:**

<State> ON | OFF | 0 | 1

**OFF | 0**

Switches the function off

**ON | 1**

Switches the function on

**Example:** `DISP3:TRAC2:SMO ON`  
Turns on trace smoothing for trace 2 in window 3

**Manual operation:** See "[Smoothing](#)" on page 68

**[SENSe:]AVERAge<n>:TYPE <Mode>**

This command selects the trace averaging mode.

**Suffix:**

<n> 1..n  
[Window](#)

**Parameters:**

<Mode> **LOGarithmic**  
The logarithmic power values are averaged.

**LINEar**  
The power values are averaged before they are converted to logarithmic values.

**POWER**  
The power level values are converted into unit Watt prior to averaging. After the averaging, the data is converted back into its original unit.

**Example:** `AVER:TYPE LIN`  
Switches to linear average calculation.

**Manual operation:** See "[Average Mode](#)" on page 68

**[SENSe:][WINDow<n>:]DETEctor<t>[:FUNCTion] <Detector>**

Defines the trace detector to be used for trace analysis.

**Suffix:**

<n> [Window](#)

<t> [Trace](#)

**Parameters:**

<Detector> **APEak**  
Autopeak

**NEGative**  
Negative peak

**POSitive**  
Positive peak

**SAMPLE**  
First value detected per trace point

**RMS**

RMS value

**AVERAge**

Average

\*RST: APEak

**Example:** DET POS  
Sets the detector to "positive peak".

**Manual operation:** See "[Detector](#)" on page 67

**[SENSe:][WINDow<n>:]DETEctor<t>[:FUNction]:AUTO <State>**

This command couples and decouples the detector to the trace mode.

**Suffix:**

<n> [Window](#)

<t> [Trace](#)

**Parameters:**

<State> ON | OFF | 0 | 1

\*RST: 1

**Example:** DET:AUTO OFF  
The selection of the detector is not coupled to the trace mode.

**Manual operation:** See "[Detector](#)" on page 67

**TRACe<n>:COPY <TraceNumber>, <TraceNumber>**

This command copies data from one trace to another.

**Suffix:**

<n> [Window](#)

**Parameters:**

<TraceNumber> **TRACE1 | TRACE2 | TRACE3 | TRACE4 | TRACE5 | TRACE6**

The first parameter is the destination trace, the second parameter is the source.

(Note the 'e' in the parameter is required!)

**Example:** TRAC:COPY TRACE1, TRACE2  
Copies the data from trace 2 to trace 1.

**Manual operation:** See "[Copy Trace](#)" on page 69

**[SENSe:]AVERAge<n>:COUNT <AverageCount>**

**TRACe:IQ:AVERAge:COUNT <NumberSets>**

This command defines the number of I/Q data sets that the averaging is based on.

**Parameters:**

<NumberSets>      Range:      0 to 32767  
 \*RST:                0

**Example:**

```
TRAC:IQ ON
Switches on acquisition of I/Q data.
TRAC:IQ:AVER ON
Enables averaging of the I/Q measurement data
TRAC:IQ:AVER:COUN 10
Selects averaging over 10 data sets
TRAC:IQ:DATA?
Starts the measurement and reads out the averaged data.
```

---

**[SENSe:]AVERAge<n>[:STATe<t>] <State>**

**TRACe:IQ:AVERAge[:STATe] <State>**

This command turns averaging of the I/Q data on and off.

Before you can use the command you have to turn the I/Q data acquisition on with [TRACe:IQ\[:STATe\]](#).

If averaging is on, the maximum amount of I/Q data that can be recorded is 512kS (524288 samples).

**Parameters:**

<State>                ON | OFF | 0 | 1  
**OFF | 0**  
 Switches the function off  
**ON | 1**  
 Switches the function on

**Example:**

```
TRAC:IQ ON
Switches on acquisition of I/Q data.
TRAC:IQ:AVER ON
Enables averaging of the I/Q measurement data.
TRAC:IQ:AVER:COUN 10
Selects averaging over 10 data sets.
TRAC:IQ:DATA?
Starts the measurement and reads out the averaged data.
```

## 9.7.2 Configuring spectrograms

In addition to the standard "level versus frequency" or "level versus time" spectrum traces, the R&S FPL1000 also provides a spectrogram display of the measured data. A spectrogram shows how the spectral density of a signal varies over time. The x-axis shows the frequency, the y-axis shows the time. The commands required to configure spectrograms in a remote environment are described here. For details and manual operation see [Chapter 6.2, "Spectrogram settings"](#), on page 70.



When configuring spectrograms, the window suffix is irrelevant. The settings are always applied to the spectrogram window, or to all spectrogram windows, if several are active for the same channel setup.

For commands to set markers in spectrograms, see [Chapter 9.7.3.4, "Marker search \(spectrograms\)"](#), on page 196.

9.7.2.1	Configuring a spectrogram measurement.....	176
9.7.2.2	Configuring the color map.....	181

### 9.7.2.1 Configuring a spectrogram measurement

CALCulate<n>:SGRam:CLEar[:IMMediate]	.....	176
CALCulate<n>:SPEctrogram:CLEar[:IMMediate]	.....	176
CALCulate<n>:SGRam:CONTinuous	.....	177
CALCulate<n>:SPEctrogram:CONTinuous	.....	177
CALCulate<n>:SGRam:FRAMe:COUNT	.....	177
CALCulate<n>:SPEctrogram:FRAMe:COUNT	.....	177
CALCulate<n>:SGRam:FRAMe:SElect	.....	177
CALCulate<n>:SPEctrogram:FRAMe:SElect	.....	177
CALCulate<n>:SGRam:HDEPth	.....	178
CALCulate<n>:SPEctrogram:HDEPth	.....	178
CALCulate<n>:SGRam:LAYout	.....	178
CALCulate<n>:SPEctrogram:LAYout	.....	178
CALCulate<n>:SGRam[:STATe]	.....	179
CALCulate<n>:SPEctrogram[:STATe]	.....	179
CALCulate<n>:SGRam:THReedim[:STATe]	.....	179
CALCulate<n>:SPEctrogram:THReedim[:STATe]	.....	179
CALCulate<n>:SGRam:TRACe	.....	180
CALCulate<n>:SPEctrogram:TRACe	.....	180
CALCulate<n>:SGRam:TSTamp:DATA?	.....	180
CALCulate<n>:SPEctrogram:TSTamp:DATA?	.....	180
CALCulate<n>:SGRam:TSTamp[:STATe]	.....	181
CALCulate<n>:SPEctrogram:TSTamp[:STATe]	.....	181

---

**CALCulate<n>:SGRam:CLEar[:IMMediate]**

**CALCulate<n>:SPEctrogram:CLEar[:IMMediate]**

This command resets the spectrogram and clears the history buffer.

**Suffix:**

<n>                      [Window](#)

**Example:**

```
//Reset the result display and clear the memory
CALC:SGR:CLE
```

**Manual operation:** See ["Clear Spectrogram"](#) on page 73



---

**CALCulate<n>:SGRam:CONTInuous <State>**

**CALCulate<n>:SPECTrogram:CONTInuous <State>**

This command determines whether the results of the last measurement are deleted before starting a new measurement in single sweep mode.

This setting applies to all spectrograms in the channel setup.

**Suffix:**

<n> [Window](#)

**Parameters:**

<State> ON | OFF | 0 | 1

**OFF | 0**

Switches the function off

**ON | 1**

Switches the function on

**Example:**

```
INIT:CONT OFF
```

Selects single sweep mode.

```
INIT;*WAI
```

Starts the sweep and waits for the end of the sweep.

```
CALC:SGR:CONT ON
```

Repeats the single sweep measurement without deleting the results of the last measurement.

---

**CALCulate<n>:SGRam:FRAMe:COUNT <Frames>**

**CALCulate<n>:SPECTrogram:FRAMe:COUNT <Frames>**

This command defines the number of frames to be recorded in a single sweep.

This value applies to all spectrograms in the channel setup.

**Suffix:**

<n> [Window](#)

**Parameters:**

<Frames> The maximum number of frames depends on the history depth.

Range: 1 to history depth

Increment: 1

\*RST: 1

**Example:**

```
//Select single sweep mode
```

```
INIT:CONT OFF
```

```
//Set the number of frames to 200
```

```
CALC:SGR:FRAM:COUN 200
```

---

**CALCulate<n>:SGRam:FRAMe:SELEct <Frame> | <Time>**

**CALCulate<n>:SPECTrogram:FRAMe:SELEct <Frame> | <Time>**

This command selects a specific frame for further analysis.

The command is available if no measurement is running or after a single sweep has ended.

**Suffix:**

<n> [Window](#)

**Parameters:**

<Frame> Selects a frame directly by the frame number. Valid if the time stamp is off.  
The range depends on the history depth.  
Default unit: S

<Time> Selects a frame via its time stamp. Valid if the time stamp is on.  
The number is the distance to frame 0 in seconds. The range depends on the history depth.

**Example:**

```
INIT:CONT OFF
Stop the continuous sweep.
CALC:SGR:FRAM:SEL -25
Selects frame number -25.
```

**Manual operation:** See ["Select Frame"](#) on page 72

**CALCulate<n>:SGRam:HDEPth <History>**

**CALCulate<n>:SPECTrogram:HDEPth <History>**

This command defines the number of frames to be stored in the R&S FPL1000 memory.

**Suffix:**

<n> [Window](#)

**Parameters:**

<History> The maximum number of frames depends on the number of sweep points.  
Range: 781 to 20000  
Increment: 1  
\*RST: 3000

**Example:**

```
//Set the history depth to 1500
CALC:SGR:SPEC 1500
```

**Manual operation:** See ["History Depth"](#) on page 72

**CALCulate<n>:SGRam:LAYout <State>**

**CALCulate<n>:SPECTrogram:LAYout <State>**

This command selects the state and size of spectrograms.

The command is available for result displays that support spectrograms.

**Suffix:**<n> [Window](#)**Parameters:**

&lt;State&gt;

**ON**

Spectrogram and trace diagram share a window.

**OFF**

Only the trace diagram is displayed, the spectrogram is not.

\*RST: OFF

**Example:**

CALC4:SPEC:LAY FULL

Shows the spectrogram in window 4. The corresponding trace diagram is hidden.

**Manual operation:** See ["State"](#) on page 71**CALCulate<n>:SGRam[:STATe] <State>****CALCulate<n>:SPECtrogram[:STATe] <State>**

This command turns the spectrogram on and off.

**Parameters:**

&lt;State&gt;

ON | OFF | 0 | 1

**OFF | 0**

Switches the function off

**ON | 1**

Switches the function on

**Example:**

CALC:SGR ON

Activates the Spectrogram result display.

**CALCulate<n>:SGRam:THReedim[:STATe] <State>****CALCulate<n>:SPECtrogram:THReedim[:STATe] <State>**

Activates or deactivates a 3-dimensional spectrogram for the selected result display.

**Suffix:**<n> [Window](#)**Parameters:**

&lt;State&gt;

ON | OFF | 0 | 1

**OFF | 0**

Switches the function off

**ON | 1**

Switches the function on

\*RST: 0

**Example:**

CALC:SPEC:THR:STAT ON

**Manual operation:** See ["3D Spectrogram State"](#) on page 71

---

**CALCulate**<n>:SGRam:TRACe <Trace>

**CALCulate**<n>:SPECtrogram:TRACe <Trace>

This command determines the trace in the result display the Spectrogram is based on.

**Suffix:**

<n> [Window](#)

**Parameters:**

<Trace> TRACE1 | TRACE2 | TRACE3 | TRACE4 | TRACE5 | TRACE6  
How many traces are available depends on the selected result display.

**Example:** CALC2:SPEC:TRAC TRACE3

---

**CALCulate**<n>:SGRam:TSTamp:DATA? <Frames>

**CALCulate**<n>:SPECtrogram:TSTamp:DATA? <Frames>

This command queries the starting time of the frames.

The return values consist of four values for each frame. If the "Spectrogram" is empty, the command returns '0,0,0,0'. The times are given as delta values, which simplifies evaluating relative results; however, you can also calculate the absolute date and time as displayed on the screen.

The frame results themselves are returned with TRAC:DATA? SGR

**Suffix:**

<n> [Window](#)

**Query parameters:**

<Frames> **CURRent**  
Returns the starting time of the current frame.  
**ALL**  
Returns the starting time for all frames. The results are sorted in descending order, beginning with the current frame.

**Return values:**

<Seconds> Number of seconds that have passed since 01.01.1970 until the frame start

<Nanoseconds> Number of nanoseconds that have passed *in addition to the* <Seconds> since 01.01.1970 until the frame start.

<Reserved> The third value is reserved for future uses.

<Reserved> The fourth value is reserved for future uses.

**Example:** CALC:SGR:TST:DATA? ALL  
Returns the starting times of all frames sorted in a descending order.

**Usage:** Query only

**Manual operation:** See "[Time Stamp](#)" on page 72

---

**CALCulate<n>:SGRam:TSTamp[:STATe] <State>**

**CALCulate<n>:SPECTrogram:TSTamp[:STATe] <State>**

This command activates and deactivates the time stamp.

If the time stamp is active, some commands do not address frames as numbers, but as (relative) time values:

- [CALCulate<n>:DELTaMarker<m>:SPECTrogram:FRaME](#) on page 202
- [CALCulate<n>:MARKEr<m>:SPECTrogram:FRaME](#) on page 197
- [CALCulate<n>:SPECTrogram:FRaME:SELEct](#) on page 177

**Suffix:**

<n>                    1..n  
[Window](#)

**Parameters:**

<State>                ON | OFF | 0 | 1  
**OFF | 0**  
 Switches the function off  
**ON | 1**  
 Switches the function on

**Example:**            //Activates the time stamp  
 CALC:SGR:TST ON

**Manual operation:** See "[Time Stamp](#)" on page 72

### 9.7.2.2 Configuring the color map

<a href="#">DISPlay[:WINDow&lt;n&gt;]:SGRam:COLor:DEFault</a> .....	181
<a href="#">DISPlay[:WINDow&lt;n&gt;]:SPECTrogram:COLor:DEFault</a> .....	181
<a href="#">DISPlay[:WINDow&lt;n&gt;]:SGRam:COLor:LOWer</a> .....	182
<a href="#">DISPlay[:WINDow&lt;n&gt;]:SPECTrogram:COLor:LOWer</a> .....	182
<a href="#">DISPlay[:WINDow&lt;n&gt;]:SGRam:COLor:SHAPE</a> .....	182
<a href="#">DISPlay[:WINDow&lt;n&gt;]:SPECTrogram:COLor:SHAPE</a> .....	182
<a href="#">DISPlay[:WINDow&lt;n&gt;]:SGRam:COLor:UPPer</a> .....	182
<a href="#">DISPlay[:WINDow&lt;n&gt;]:SPECTrogram:COLor:UPPer</a> .....	182
<a href="#">DISPlay[:WINDow&lt;n&gt;]:SGRam:COLor[:STYLe]</a> .....	183
<a href="#">DISPlay[:WINDow&lt;n&gt;]:SPECTrogram:COLor[:STYLe]</a> .....	183

---

**DISPlay[:WINDow<n>]:SGRam:COLor:DEFault**

**DISPlay[:WINDow<n>]:SPECTrogram:COLor:DEFault**

This command restores the original color map.

**Suffix:**

<n>                    [Window](#)

**Manual operation:** See "[Set to Default](#)" on page 75

---

**DISPlay[:WINDow<n>]:SGRam:COLor:LOWer** <Percentage>

**DISPlay[:WINDow<n>]:SPECtrogram:COLor:LOWer** <Percentage>

This command defines the starting point of the color map.

**Suffix:**

<n> [Window](#)

**Parameters:**

<Percentage> Statistical frequency percentage.

Range: 0 to 66

\*RST: 0

Default unit: %

**Example:**

DISP:WIND:SGR:COL:LOW 10

Sets the start of the color map to 10%.

**Manual operation:** See ["Start / Stop"](#) on page 74

---

**DISPlay[:WINDow<n>]:SGRam:COLor:SHAPE** <Shape>

**DISPlay[:WINDow<n>]:SPECtrogram:COLor:SHAPE** <Shape>

This command defines the shape and focus of the color curve for the spectrogram result display.

**Suffix:**

<n> [Window](#)

**Parameters:**

<Shape> Shape of the color curve.

Range: -1 to 1

\*RST: 0

**Manual operation:** See ["Shape"](#) on page 74

---

**DISPlay[:WINDow<n>]:SGRam:COLor:UPPer** <Percentage>

**DISPlay[:WINDow<n>]:SPECtrogram:COLor:UPPer** <Percentage>

This command defines the end point of the color map.

**Suffix:**

<n> [Window](#)

**Parameters:**

<Percentage> Statistical frequency percentage.

Range: 0 to 66

\*RST: 0

Default unit: %

**Example:**

DISP:WIND:SGR:COL:UPP 95

Sets the start of the color map to 95%.

**Manual operation:** See ["Start / Stop"](#) on page 74

**DISPlay[:WINDow<n>]:SGRam:COLor[:STYLE] <ColorScheme>**  
**DISPlay[:WINDow<n>]:SPECTrogram:COLor[:STYLE] <ColorScheme>**

This command selects the color scheme.

**Parameters:**

<ColorScheme>

**HOT**

Uses a color range from blue to red. Blue colors indicate low levels, red colors indicate high ones.

**COLD**

Uses a color range from red to blue. Red colors indicate low levels, blue colors indicate high ones.

**RADar**

Uses a color range from black over green to light turquoise with shades of green in between.

**GRAYscale**

Shows the results in shades of gray.

\*RST: HOT

**Example:**

DISP:WIND:SPEC:COL GRAY

Changes the color scheme of the spectrogram to black and white.

**Manual operation:** See "[Hot/Cold/Radar/Grayscale](#)" on page 75

### 9.7.3 Using markers

The following commands are available for marker settings and functions in the I/Q Analyzer application.



For "I/Q Vector" displays markers are not available.

- [Setting up individual markers](#)..... 183
- [General marker settings](#)..... 190
- [Configuring and performing a marker search](#)..... 192
- [Marker search \(spectrograms\)](#)..... 196
- [Positioning the marker](#)..... 206
- [Band power marker](#)..... 212
- [Marker peak lists](#)..... 216

#### 9.7.3.1 Setting up individual markers

The following commands define the position of markers in the diagram.

- [CALCulate<n>:DELTamarker<m>:AOFF](#)..... 184
- [CALCulate<n>:DELTamarker<m>:LINK](#)..... 184
- [CALCulate<n>:DELTamarker<ms>:LINK:TO:DELTA<md>](#)..... 185
- [CALCulate<n>:DELTamarker<ms>:LINK:TO:MARKer<md>](#)..... 185

CALCulate<n>:DELTamarker<m>:MODE.....	186
CALCulate<n>:DELTamarker<m>:MREFerence.....	186
CALCulate<n>:DELTamarker<m>[:STATe].....	186
CALCulate<n>:DELTamarker<m>:TRACe.....	187
CALCulate<n>:DELTamarker<m>:X.....	187
CALCulate<n>:MARKer<m>:AOFF.....	188
CALCulate<n>:MARKer<ms>:LINK:TO:DELTa<md>.....	188
CALCulate<n>:MARKer<ms>:LINK:TO:MARKer<md>.....	188
CALCulate<n>:MARKer<m>[:STATe].....	189
CALCulate<n>:MARKer<m>:TRACe.....	189
CALCulate<n>:MARKer<m>:X.....	190

---

### CALCulate<n>:DELTamarker<m>:AOFF

This command turns off *all* delta markers.

#### Suffix:

<n> [Window](#)

<m> irrelevant

#### Example:

CALC:DELT:AOff

Turns off all delta markers.

---

### CALCulate<n>:DELTamarker<m>:LINK <State>

This command links delta marker <m> to marker 1.

If you change the horizontal position (x-value) of marker 1, delta marker <m> changes its horizontal position to the same value.

**Tip:** to link any marker to a different marker than marker 1, use the [CALCulate<n>:DELTamarker<ms>:LINK:TO:MARKer<md>](#) or [CALCulate<n>:MARKer<ms>:LINK:TO:MARKer<md>](#) commands.

#### Suffix:

<n> [Window](#)

<m> [Marker](#)

#### Parameters:

<State> ON | OFF | 0 | 1

**OFF | 0**

Switches the function off

**ON | 1**

Switches the function on

#### Example:

CALC:DELT2:LINK ON

**Manual operation:** See "[Linking to Another Marker](#)" on page 80



**CALCulate<n>:DELTamarker<ms>:LINK:TO:DELTa<md> <State>**

This command links the delta source marker <ms> to any active destination delta marker <md>.

If you change the horizontal position of marker <md>, marker <ms> changes its horizontal position to the same value.

**Suffix:**

<n>	<a href="#">Window</a>
<ms>	source marker, see <a href="#">Marker</a>
<md>	destination marker, see <a href="#">Marker</a>

**Parameters:**

<State>	ON   OFF   0   1
	<b>OFF   0</b>
	Switches the function off
	<b>ON   1</b>
	Switches the function on

**Example:**

```
CALC:DELT2:LINK:TO:DELT3 ON
Links D2 and D3.
```

**CALCulate<n>:DELTamarker<ms>:LINK:TO:MARKer<md> <State>**

This command links the delta source marker <ms> to any active destination marker <md> (normal or delta marker).

In I/Q Analyzer mode, if <md> is the reference marker for the delta marker <ms>, the relative distance (delta) between the two markers is maintained when you move the normal marker.

In other applications, the delta marker is set to the same horizontal position as the marker <md>, and if <md> is moved along the x-axis, <ms> follows to the same horizontal position.

**Suffix:**

<n>	<a href="#">Window</a>
<ms>	source marker, see <a href="#">Marker</a>
<md>	destination marker, see <a href="#">Marker</a>

**Parameters:**

<State>	ON   OFF   0   1
	<b>OFF   0</b>
	Switches the function off
	<b>ON   1</b>
	Switches the function on

**Example:**

```
CALC:DELT4:LINK:TO:MARK2 ON
Links the delta marker 4 to the marker 2.
```

**Manual operation:** See ["Linking to Another Marker"](#) on page 80

---

### CALCulate<n>:DELTaMarker<m>:MODE <Mode>

This command defines whether the position of a delta marker is provided as an absolute value or relative to a reference marker. Note that this setting applies to *all* windows.

Note that when the position of a delta marker is *queried*, the result is always an absolute value (see [CALCulate<n>:DELTaMarker<m>:X](#) on page 187)!

**Suffix:**

<n> irrelevant

<m> irrelevant

**Parameters:**

<Mode>

**ABSolute**

Delta marker position in absolute terms.

**RELative**

Delta marker position in relation to a reference marker.

\*RST: RELative

**Example:**

CALC:DELT:MODE ABS

Absolute delta marker position.

---

### CALCulate<n>:DELTaMarker<m>:MREFerence <Reference>

This command selects a reference marker for a delta marker other than marker 1.

The reference may be another marker or the fixed reference.

**Suffix:**

<n> [Window](#)

<m> [Marker](#)

**Parameters:**

<Reference>

**1 to 16**

Selects markers 1 to 16 as the reference.

**FIXed**

Selects the fixed reference as the reference.

**Example:**

CALC:DELT3:MREF 2

Specifies that the values of delta marker 3 are relative to marker 2.

**Manual operation:** See ["Reference Marker"](#) on page 80

---

### CALCulate<n>:DELTaMarker<m>[:STATE] <State>

This command turns delta markers on and off.

If necessary, the command activates the delta marker first.

No suffix at DELTmarker turns on delta marker 1.

**Suffix:**

<n> [Window](#)

<m> [Marker](#)

**Parameters:**

<State> ON | OFF | 0 | 1

**OFF | 0**

Switches the function off

**ON | 1**

Switches the function on

**Example:**

CALC:DELT2 ON

Turns on delta marker 2.

**Manual operation:**

See "[Marker State](#)" on page 79

See "[Marker Type](#)" on page 80

See "[Select Marker](#)" on page 81

**CALCulate<n>:DELTmarker<m>:TRACe <Trace>**

This command selects the trace a delta marker is positioned on.

Note that the corresponding trace must have a trace mode other than "Blank".

If necessary, the command activates the marker first.

**Suffix:**

<n> [Window](#)

<m> [Marker](#)

**Parameters:**

<Trace> Trace number the marker is assigned to.

**Example:**

CALC:DELT2:TRAC 2

Positions delta marker 2 on trace 2.

**CALCulate<n>:DELTmarker<m>:X <Position>**

This command moves a delta marker to a particular coordinate on the x-axis.

If necessary, the command activates the delta marker and positions a reference marker to the peak power.

**Suffix:**

<n> [Window](#)

<m> [Marker](#)

**Parameters:**

<Position> Numeric value that defines the marker position on the x-axis.

Range: The value range and unit depend on the measurement and scale of the x-axis.

**Example:** `CALC:DELT:X?`  
Outputs the absolute x-value of delta marker 1.

**Manual operation:** See "[Marker Position X-value](#)" on page 80

#### **CALCulate<n>:MARKer<m>:AOFF**

This command turns off all markers.

**Suffix:**

<n> [Window](#)

<m> [Marker](#)

**Example:** `CALC:MARK:AOFF`  
Switches off all markers.

**Manual operation:** See "[All Markers Off](#)" on page 81

#### **CALCulate<n>:MARKer<ms>:LINK:TO:DELTA<md> <State>**

This command links the normal source marker <ms> to any active delta destination marker <md>.

If you change the horizontal position of marker <md>, marker <ms> changes its horizontal position to the same value.

**Suffix:**

<n> [Window](#)

<ms> source marker, see [Marker](#)

<md> destination marker, see [Marker](#)

**Parameters:**

<State> `ON | OFF | 0 | 1`  
**OFF | 0**  
Switches the function off  
**ON | 1**  
Switches the function on

**Example:** `CALC:MARK4:LINK:TO:DELTA2 ON`  
Links marker 4 to delta marker 2.

#### **CALCulate<n>:MARKer<ms>:LINK:TO:MARKer<md> <State>**

This command links the normal source marker <ms> to any active destination marker <md> (normal or delta marker).

If you change the horizontal position of marker <md>, marker <ms> changes its horizontal position to the same value.

**Suffix:**

<n> [Window](#)

<ms> source marker, see [Marker](#)  
 <md> destination marker, see [Marker](#)

**Parameters:**

<State> ON | OFF | 0 | 1  
**OFF | 0**  
 Switches the function off  
**ON | 1**  
 Switches the function on

**Example:** CALC:MARK4:LINK:TO:MARK2 ON  
 Links marker 4 to marker 2.

**Manual operation:** See "[Linking to Another Marker](#)" on page 80

**CALCulate<n>:MARKer<m>[:STATe] <State>**

This command turns markers on and off. If the corresponding marker number is currently active as a delta marker, it is turned into a normal marker.

**Suffix:**

<n> [Window](#)  
 <m> [Marker](#)

**Parameters:**

<State> ON | OFF | 0 | 1  
**OFF | 0**  
 Switches the function off  
**ON | 1**  
 Switches the function on

**Example:** CALC:MARK3 ON  
 Switches on marker 3.

**Manual operation:** See "[Marker State](#)" on page 79  
 See "[Marker Type](#)" on page 80  
 See "[Select Marker](#)" on page 81

**CALCulate<n>:MARKer<m>:TRACe <Trace>**

This command selects the trace the marker is positioned on.

Note that the corresponding trace must have a trace mode other than "Blank".

If necessary, the command activates the marker first.

**Suffix:**

<n> [Window](#)  
 <m> [Marker](#)

**Parameters:**

<Trace>

**Example:** //Assign marker to trace 1  
CALC:MARK3:TRAC 2

**Manual operation:** See ["Assigning the Marker to a Trace"](#) on page 81

### CALCulate<n>:MARKer<m>:X <Position>

This command moves a marker to a specific coordinate on the x-axis.

If necessary, the command activates the marker.

If the marker has been used as a delta marker, the command turns it into a normal marker.

**Suffix:**

<n> [Window](#)

<m> [Marker](#)

**Parameters:**

<Position> Numeric value that defines the marker position on the x-axis.  
The unit depends on the result display.

Range: The range depends on the current x-axis range.  
Default unit: Hz

**Example:** CALC:MARK2:X 1.7MHz  
Positions marker 2 to frequency 1.7 MHz.

**Manual operation:** See ["Marker Table"](#) on page 16  
See ["Marker Peak List"](#) on page 16  
See ["Marker Position X-value"](#) on page 80

### 9.7.3.2 General marker settings

The following commands control general marker functionality.

#### Remote commands exclusive to general marker functionality

<a href="#">DISPlay[:WINDow&lt;n&gt;]:MTABLE</a> .....	190
<a href="#">DISPlay[:WINDow&lt;n&gt;]:MINFo[:STATe]</a> .....	191
<a href="#">CALCulate&lt;n&gt;:MARKer&lt;m&gt;:X:SSize</a> .....	191

### DISPlay[:WINDow<n>]:MTABLE <DisplayMode>

This command turns the marker table on and off.

**Suffix:**

<n> irrelevant

**Parameters:**

<DisplayMode> **ON | 1**  
Turns on the marker table.  
**OFF | 0**  
Turns off the marker table.

**AUTO**

Turns on the marker table if 3 or more markers are active.

\*RST: AUTO

**Example:**

DISP:MTAB ON

Activates the marker table.

**Manual operation:** See "[Marker Table Display](#)" on page 82

**DISPlay[:WINDow<n>]:MINFo[:STATe] <State>**

This command turns the marker information in all diagrams on and off.

**Suffix:**

<n> irrelevant

**Parameters:**

<State>

**ON | 1**

Displays the marker information in the diagrams.

**OFF | 0**

Hides the marker information in the diagrams.

\*RST: 1

**Example:**

DISP:MINF OFF

Hides the marker information.

**Manual operation:** See "[Marker Info](#)" on page 82

**CALCulate<n>:MARKer<m>:X:SSIZe <StepSize>**

This command selects the marker step size mode for *all* markers in *all* windows.

The step size defines the distance the marker moves when you move it with the rotary knob.

It therefore takes effect in manual operation only.

**Suffix:**

<n> irrelevant

<m> irrelevant

**Parameters:**

<StepSize>

**STANDARD**

the marker moves from one pixel to the next

**POINTS**

the marker moves from one sweep point to the next

\*RST: POINTs

**Example:**

CALC:MARK:X:SSIZ STAN

Sets the marker step size to one pixel.

**Manual operation:** See "[Marker Stepsize](#)" on page 83

### 9.7.3.3 Configuring and performing a marker search

The following commands control the marker search.

CALCulate<n>:MARKer<m>:LOEXclude.....	192
CALCulate<n>:MARKer<m>:PEXCursion.....	192
CALCulate<n>:MARKer<m>:SEARch.....	193
CALCulate<n>:MARKer<m>:X:SLIMits[:STATe].....	193
CALCulate<n>:MARKer<m>:X:SLIMits:LEFT.....	194
CALCulate<n>:MARKer<m>:X:SLIMits:RIGHT.....	194
CALCulate<n>:MARKer<m>:X:SLIMits:ZOOM[:STATe].....	195
CALCulate<n>:THReshold.....	195
CALCulate<n>:THReshold:STATe.....	196

---

#### CALCulate<n>:MARKer<m>:LOEXclude <State>

This command turns the suppression of the local oscillator during automatic marker positioning on and off (for *all* markers in *all* windows).

##### Suffix:

<n> irrelevant

<m> irrelevant

##### Parameters:

<State> ON | OFF | 0 | 1

\*RST: 1

**Example:** CALC:MARK:LOEX ON

**Manual operation:** See "Exclude LO" on page 85

---

#### CALCulate<n>:MARKer<m>:PEXCursion <Excursion>

This command defines the peak excursion (for *all* markers in *all* windows).

The peak excursion sets the requirements for a peak to be detected during a peak search.

The unit depends on the measurement.

Application/Result display	Unit
Spectrum	dB

##### Suffix:

<n> irrelevant

<m> irrelevant



**Parameters:**

<Excursion> The excursion is the distance to a trace maximum that must be attained before a new maximum is recognized, or the distance to a trace minimum that must be attained before a new minimum is recognized

\*RST: 6 dB in the Spectrum application and RF displays  
Default unit: DB

**Example:**

CALC:MARK:PEXC 10dB  
Defines peak excursion as 10 dB.

**Manual operation:** See "[Peak Excursion](#)" on page 85

**CALCulate<n>:MARKer<m>:SEARch <MarkReallmag>**

This command selects the trace type a marker search is performed on.

**Suffix:**

<n> irrelevant  
<m> irrelevant

**Parameters:**

<MarkReallmag> **REAL**  
Marker search functions are performed on the real trace of the "I/Q" measurement.

**IMAG**  
Marker search functions are performed on the imaginary trace of the "I/Q" measurement.

**MAGN**  
Marker search functions are performed on the magnitude of the I and Q data.

\*RST: REAL

**Example:**

CALC4:MARK:SEAR IMAG

**Manual operation:** See "[Branch for Peaksearch](#)" on page 86

**CALCulate<n>:MARKer<m>:X:SLIMits[:STATe] <State>**

This command turns marker search limits on and off for *all* markers in *all* windows.

If you perform a measurement in the time domain, this command limits the range of the trace to be analyzed.

**Suffix:**

<n> irrelevant  
<m> irrelevant

**Parameters:**

<State> ON | OFF | 0 | 1

**OFF | 0**

Switches the function off

**ON | 1**

Switches the function on

**Example:**`CALC:MARK:X:SLIM ON`

Switches on search limitation.

**Manual operation:**See "[Search Limits \(Left / Right\)](#)" on page 85See "[Search Limits Off](#)" on page 86**CALCulate<n>:MARKer<m>:X:SLIMits:LEFT <SearchLimit>**

This command defines the left limit of the marker search range for *all* markers in *all* windows.

If you perform a measurement in the time domain, this command limits the range of the trace to be analyzed.

**Suffix:**

&lt;n&gt; irrelevant

&lt;m&gt; irrelevant

**Parameters:**

&lt;SearchLimit&gt;

The value range depends on the frequency range or sweep time.

The unit is Hz for frequency domain measurements and s for time domain measurements.

\*RST: left diagram border

Default unit: HZ

**Example:**`CALC:MARK:X:SLIM ON`

Switches the search limit function on.

`CALC:MARK:X:SLIM:LEFT 10MHz`

Sets the left limit of the search range to 10 MHz.

**Manual operation:**See "[Search Limits \(Left / Right\)](#)" on page 85**CALCulate<n>:MARKer<m>:X:SLIMits:RIGHT <SearchLimit>**

This command defines the right limit of the marker search range for *all* markers in *all* windows.

If you perform a measurement in the time domain, this command limits the range of the trace to be analyzed.

**Suffix:**

&lt;n&gt; irrelevant

&lt;m&gt; irrelevant

**Parameters:**

<Limit> The value range depends on the frequency range or sweep time.  
The unit is Hz for frequency domain measurements and s for time domain measurements.  
\*RST: right diagram border  
Default unit: HZ

**Example:**

```
CALC:MARK:X:SLIM ON
Switches the search limit function on.
CALC:MARK:X:SLIM:RIGH 20MHz
Sets the right limit of the search range to 20 MHz.
```

**Manual operation:** See "[Search Limits \(Left / Right\)](#)" on page 85

**CALCulate<n>:MARKer<m>:X:SLIMits:ZOOM[:STATe] <State>**

This command adjusts the marker search range to the zoom area for *all* markers in *all* windows.

**Suffix:**

<n> irrelevant

<m> irrelevant

**Parameters:**

<State> ON | OFF | 0 | 1  
**OFF | 0**  
Switches the function off  
**ON | 1**  
Switches the function on

**Example:**

```
CALC:MARK:X:SLIM:ZOOM ON
Switches the search limit function on.
CALC:MARK:X:SLIM:RIGH 20MHz
Sets the right limit of the search range to 20 MHz.
```

**Manual operation:** See "[Use Zoom Limits](#)" on page 86

**CALCulate<n>:THReshold <Level>**

This command defines a threshold level for the marker peak search (for *all* markers in *all* windows).

Note that you must enable the use of the threshold using [CALCulate<n>:THReshold:STATe](#) on page 196.

**Suffix:**

<n> irrelevant

**Parameters:**

<Level> Numeric value. The value range and unit are variable.

\*RST: -120 dBm

Default unit: DBM

**Example:**

CALC:THR:STAT ON

**Example:**

CALC:THR -82DBM

Enables the search threshold and sets the threshold value to -82 dBm.

**Manual operation:** See ["Search Threshold"](#) on page 86

**CALCulate<n>:THReshold:STATe <State>**

This command turns a threshold for the marker peak search on and off (for *all* markers in *all* windows).

**Suffix:**

<n> irrelevant

**Parameters:**

<State> ON | OFF | 0 | 1

**OFF | 0**

Switches the function off

**ON | 1**

Switches the function on

**Example:**

CALC:THR:STAT ON

Switches on the threshold line.

**Manual operation:** See ["Search Threshold"](#) on page 86

See ["Search Limits Off"](#) on page 86

**9.7.3.4 Marker search (spectrograms)**

The following commands automatically define the marker and delta marker position in the spectrogram.

**Using markers**

The following commands control spectrogram markers.

**Useful commands for spectrogram markers described elsewhere**

The following commands define the horizontal position of the markers.

- [CALCulate<n>:MARKer<m>:MAXimum:LEFT](#) on page 206
- [CALCulate<n>:MARKer<m>:MAXimum:NEXT](#) on page 207
- [CALCulate<n>:MARKer<m>:MAXimum\[:PEAK\]](#) on page 207
- [CALCulate<n>:MARKer<m>:MAXimum:RIGHT](#) on page 207
- [CALCulate<n>:MARKer<m>:MINimum:LEFT](#) on page 208

- `CALCulate<n>:MARKer<m>:MINimum:NEXT` on page 208
- `CALCulate<n>:MARKer<m>:MINimum[:PEAK]` on page 209
- `CALCulate<n>:MARKer<m>:MINimum:RIGHT` on page 209

### Remote commands exclusive to spectrogram markers

<code>CALCulate&lt;n&gt;:MARKer&lt;m&gt;:SGRam:FRAME</code> .....	197
<code>CALCulate&lt;n&gt;:MARKer&lt;m&gt;:SPEctrogram:FRAME</code> .....	197
<code>CALCulate&lt;n&gt;:MARKer&lt;m&gt;:SGRam:SARea</code> .....	198
<code>CALCulate&lt;n&gt;:MARKer&lt;m&gt;:SPEctrogram:SARea</code> .....	198
<code>CALCulate&lt;n&gt;:MARKer&lt;m&gt;:SGRam:XY:MAXimum[:PEAK]</code> .....	198
<code>CALCulate&lt;n&gt;:MARKer&lt;m&gt;:SPEctrogram:XY:MAXimum[:PEAK]</code> .....	198
<code>CALCulate&lt;n&gt;:MARKer&lt;m&gt;:SGRam:XY:MINimum[:PEAK]</code> .....	198
<code>CALCulate&lt;n&gt;:MARKer&lt;m&gt;:SPEctrogram:XY:MINimum[:PEAK]</code> .....	198
<code>CALCulate&lt;n&gt;:MARKer&lt;m&gt;:SGRam:Y:MAXimum:ABOVe</code> .....	199
<code>CALCulate&lt;n&gt;:MARKer&lt;m&gt;:SPEctrogram:Y:MAXimum:ABOVe</code> .....	199
<code>CALCulate&lt;n&gt;:MARKer&lt;m&gt;:SGRam:Y:MAXimum:BELOW</code> .....	199
<code>CALCulate&lt;n&gt;:MARKer&lt;m&gt;:SPEctrogram:Y:MAXimum:BELOW</code> .....	199
<code>CALCulate&lt;n&gt;:MARKer&lt;m&gt;:SGRam:Y:MAXimum:NEXT</code> .....	199
<code>CALCulate&lt;n&gt;:MARKer&lt;m&gt;:SPEctrogram:Y:MAXimum:NEXT</code> .....	199
<code>CALCulate&lt;n&gt;:MARKer&lt;m&gt;:SGRam:Y:MAXimum[:PEAK]</code> .....	199
<code>CALCulate&lt;n&gt;:MARKer&lt;m&gt;:SPEctrogram:Y:MAXimum[:PEAK]</code> .....	199
<code>CALCulate&lt;n&gt;:MARKer&lt;m&gt;:SGRam:Y:MINimum:ABOVe</code> .....	200
<code>CALCulate&lt;n&gt;:MARKer&lt;m&gt;:SPEctrogram:Y:MINimum:ABOVe</code> .....	200
<code>CALCulate&lt;n&gt;:MARKer&lt;m&gt;:SGRam:Y:MINimum:BELOW</code> .....	200
<code>CALCulate&lt;n&gt;:MARKer&lt;m&gt;:SPEctrogram:Y:MINimum:BELOW</code> .....	200
<code>CALCulate&lt;n&gt;:MARKer&lt;m&gt;:SGRam:Y:MINimum:NEXT</code> .....	200
<code>CALCulate&lt;n&gt;:MARKer&lt;m&gt;:SPEctrogram:Y:MINimum:NEXT</code> .....	200
<code>CALCulate&lt;n&gt;:MARKer&lt;m&gt;:SGRam:Y:MINimum[:PEAK]</code> .....	201
<code>CALCulate&lt;n&gt;:MARKer&lt;m&gt;:SPEctrogram:Y:MINimum[:PEAK]</code> .....	201

**`CALCulate<n>:MARKer<m>:SGRam:FRAME` <Frame>**

**`CALCulate<n>:MARKer<m>:SPEctrogram:FRAME` <Frame> | <Time>**

This command positions a marker on a particular frame.

#### Suffix:

<n>                      Window

<m>                      Marker

#### Parameters:

<Frame>                      Selects a frame directly by the frame number. Valid if the time stamp is off.

The range depends on the history depth.

Default unit: S

<Time>                      Selects a frame via its time stamp. Valid if the time stamp is on.  
The number is the (negative) distance to frame 0 in seconds.  
The range depends on the history depth.

**Example:** `CALC:MARK:SGR:FRAM -20`  
Sets the marker on the 20th frame before the present.  
`CALC:MARK2:SGR:FRAM -2s`  
Sets second marker on the frame 2 seconds ago.

**Manual operation:** See "[Frame \(Spectrogram only\)](#)" on page 80

**CALCulate<n>:MARKer<m>:SGRam:SARea <SearchArea>**  
**CALCulate<n>:MARKer<m>:SPECTrogram:SARea <SearchArea>**

This command defines the marker search area for all spectrogram markers in the channel setup.

**Suffix:**

<n> irrelevant

<m> irrelevant

**Parameters:**

<SearchArea>

**VISible**

Performs a search within the visible frames.

Note that the command does not work if the spectrogram is not visible for any reason (e.g. if the display update is off).

**MEMory**

Performs a search within all frames in the memory.

\*RST: VISible

**Manual operation:** See "[Marker Search Area](#)" on page 88

**CALCulate<n>:MARKer<m>:SGRam:XY:MAXimum[:PEAK]**  
**CALCulate<n>:MARKer<m>:SPECTrogram:XY:MAXimum[:PEAK]**

This command moves a marker to the highest level of the spectrogram.

**Suffix:**

<n> [Window](#)

<m> [Marker](#)

**CALCulate<n>:MARKer<m>:SGRam:XY:MINimum[:PEAK]**  
**CALCulate<n>:MARKer<m>:SPECTrogram:XY:MINimum[:PEAK]**

This command moves a marker to the minimum level of the spectrogram.

**Suffix:**

<n> [Window](#)

<m> [Marker](#)

---

**CALCulate<n>:MARKer<m>:SGRam:Y:MAXimum:ABOVe**  
**CALCulate<n>:MARKer<m>:SPECTrogram:Y:MAXimum:ABOVe**

This command moves a marker vertically to the next lower peak level for the current frequency.

The search includes only frames above the current marker position. It does not change the horizontal position of the marker.

**Suffix:**

<n> [Window](#)

<m> [Marker](#)

**Manual operation:** See "[Search Mode for Next Peak in Y-Direction](#)" on page 88

---

**CALCulate<n>:MARKer<m>:SGRam:Y:MAXimum:BELOW**  
**CALCulate<n>:MARKer<m>:SPECTrogram:Y:MAXimum:BELOW**

This command moves a marker vertically to the next lower peak level for the current frequency.

The search includes only frames below the current marker position. It does not change the horizontal position of the marker.

**Suffix:**

<n> [Window](#)

<m> [Marker](#)

**Manual operation:** See "[Search Mode for Next Peak in Y-Direction](#)" on page 88

---

**CALCulate<n>:MARKer<m>:SGRam:Y:MAXimum:NEXT**  
**CALCulate<n>:MARKer<m>:SPECTrogram:Y:MAXimum:NEXT**

This command moves a marker vertically to the next lower peak level for the current frequency.

The search includes all frames. It does not change the horizontal position of the marker.

**Suffix:**

<n> [Window](#)

<m> [Marker](#)

**Manual operation:** See "[Search Mode for Next Peak in Y-Direction](#)" on page 88

---

**CALCulate<n>:MARKer<m>:SGRam:Y:MAXimum[:PEAK]**  
**CALCulate<n>:MARKer<m>:SPECTrogram:Y:MAXimum[:PEAK]**

This command moves a marker vertically to the highest level for the current frequency.

The search includes all frames. It does not change the horizontal position of the marker.

If the marker hasn't been active yet, the command looks for the peak level in the whole spectrogram.

**Suffix:**

<n> [Window](#)

<m> [Marker](#)

**CALCulate<n>:MARKer<m>:SGRam:Y:MINimum:ABOVE****CALCulate<n>:MARKer<m>:SPECTrogram:Y:MINimum:ABOVE**

This command moves a marker vertically to the next higher minimum level for the current frequency.

The search includes only frames above the current marker position. It does not change the horizontal position of the marker.

**Suffix:**

<n> [Window](#)

<m> [Marker](#)

**Manual operation:** See "[Search Mode for Next Peak in Y-Direction](#)" on page 88

**CALCulate<n>:MARKer<m>:SGRam:Y:MINimum:BELOW****CALCulate<n>:MARKer<m>:SPECTrogram:Y:MINimum:BELOW**

This command moves a marker vertically to the next higher minimum level for the current frequency.

The search includes only frames below the current marker position. It does not change the horizontal position of the marker.

**Suffix:**

<n> [Window](#)

<m> [Marker](#)

**Manual operation:** See "[Search Mode for Next Peak in Y-Direction](#)" on page 88

**CALCulate<n>:MARKer<m>:SGRam:Y:MINimum:NEXT****CALCulate<n>:MARKer<m>:SPECTrogram:Y:MINimum:NEXT**

This command moves a marker vertically to the next higher minimum level for the current frequency.

The search includes all frames. It does not change the horizontal position of the marker.

**Suffix:**

<n> [Window](#)

<m> [Marker](#)

**Manual operation:** See "[Search Mode for Next Peak in Y-Direction](#)" on page 88



**CALCulate<n>:MARKer<m>:SGRam:Y:MINimum[:PEAK]****CALCulate<n>:MARKer<m>:SPECTrogram:Y:MINimum[:PEAK]**

This command moves a marker vertically to the minimum level for the current frequency.

The search includes all frames. It does not change the horizontal position of the marker.

If the marker hasn't been active yet, the command first looks for the peak level for all frequencies and moves the marker vertically to the minimum level.

**Suffix:**

<n>                      Window

<m>                      Marker

**Using delta markers**

The following commands control spectrogram delta markers.

**Useful commands for spectrogram markers described elsewhere**

The following commands define the horizontal position of the delta markers.

- [CALCulate<n>:DELTamarker<m>:MAXimum:LEFT](#) on page 209
- [CALCulate<n>:DELTamarker<m>:MAXimum:NEXT](#) on page 210
- [CALCulate<n>:DELTamarker<m>:MAXimum\[:PEAK\]](#) on page 210
- [CALCulate<n>:DELTamarker<m>:MAXimum:RIGHT](#) on page 210
- [CALCulate<n>:DELTamarker<m>:MINimum:LEFT](#) on page 211
- [CALCulate<n>:DELTamarker<m>:MINimum:NEXT](#) on page 211
- [CALCulate<n>:DELTamarker<m>:MINimum\[:PEAK\]](#) on page 211
- [CALCulate<n>:DELTamarker<m>:MINimum:RIGHT](#) on page 211

**Remote commands exclusive to spectrogram markers**

<a href="#">CALCulate&lt;n&gt;:DELTamarker&lt;m&gt;:SGRam:FRAMe</a> .....	202
<a href="#">CALCulate&lt;n&gt;:DELTamarker&lt;m&gt;:SPECTrogram:FRAMe</a> .....	202
<a href="#">CALCulate&lt;n&gt;:DELTamarker&lt;m&gt;:SGRam:SARea</a> .....	202
<a href="#">CALCulate&lt;n&gt;:DELTamarker&lt;m&gt;:SPECTrogram:SARea</a> .....	202
<a href="#">CALCulate&lt;n&gt;:DELTamarker&lt;m&gt;:SGRam:XY:MAXimum[:PEAK]</a> .....	203
<a href="#">CALCulate&lt;n&gt;:DELTamarker&lt;m&gt;:SPECTrogram:XY:MAXimum[:PEAK]</a> .....	203
<a href="#">CALCulate&lt;n&gt;:DELTamarker&lt;m&gt;:SGRam:XY:MINimum[:PEAK]</a> .....	203
<a href="#">CALCulate&lt;n&gt;:DELTamarker&lt;m&gt;:SPECTrogram:XY:MINimum[:PEAK]</a> .....	203
<a href="#">CALCulate&lt;n&gt;:DELTamarker&lt;m&gt;:SGRam:Y:MAXimum:ABOVE</a> .....	203
<a href="#">CALCulate&lt;n&gt;:DELTamarker&lt;m&gt;:SPECTrogram:Y:MAXimum:ABOVE</a> .....	203
<a href="#">CALCulate&lt;n&gt;:DELTamarker&lt;m&gt;:SGRam:Y:MAXimum:BELOW</a> .....	204
<a href="#">CALCulate&lt;n&gt;:DELTamarker&lt;m&gt;:SPECTrogram:Y:MAXimum:BELOW</a> .....	204
<a href="#">CALCulate&lt;n&gt;:DELTamarker&lt;m&gt;:SGRam:Y:MAXimum:NEXT</a> .....	204
<a href="#">CALCulate&lt;n&gt;:DELTamarker&lt;m&gt;:SPECTrogram:Y:MAXimum:NEXT</a> .....	204
<a href="#">CALCulate&lt;n&gt;:DELTamarker&lt;m&gt;:SGRam:Y:MAXimum[:PEAK]</a> .....	204

CALCulate<n>:DELTamarker<m>:SPECtrogram:Y:MAXimum[:PEAK].....	204
CALCulate<n>:DELTamarker<m>:SGRam:Y:MINimum:ABOVE.....	204
CALCulate<n>:DELTamarker<m>:SPECtrogram:Y:MINimum:ABOVE.....	204
CALCulate<n>:DELTamarker<m>:SGRam:Y:MINimum:BELOW.....	205
CALCulate<n>:DELTamarker<m>:SPECtrogram:Y:MINimum:BELOW.....	205
CALCulate<n>:DELTamarker<m>:SGRam:Y:MINimum:NEXT.....	205
CALCulate<n>:DELTamarker<m>:SPECtrogram:Y:MINimum:NEXT.....	205
CALCulate<n>:DELTamarker<m>:SGRam:Y:MINimum[:PEAK].....	205
CALCulate<n>:DELTamarker<m>:SPECtrogram:Y:MINimum[:PEAK].....	205

---

**CALCulate<n>:DELTamarker<m>:SGRam:FRAME <Frame>**
**CALCulate<n>:DELTamarker<m>:SPECtrogram:FRAME <Frame>**

This command positions a delta marker on a particular frame. The frame is relative to the position of marker 1.

The command is available for the spectrogram.

**Suffix:**

<n>                      Window

<m>                      Marker

**Parameters:**

<Frame>                Selects a frame either by its frame number or time stamp. The frame number is available if the time stamp is off. The range depends on the history depth. The time stamp is available if the time stamp is on. The number is the distance to frame 0 in seconds. The range depends on the history depth.

Default unit: S

**Example:**

```
CALC:DELT4:SGR:FRAM -20
```

Sets fourth deltamarker 20 frames below marker 1.

```
CALC:DELT4:SGR:FRAM 2 s
```

Sets fourth deltamarker 2 seconds above the position of marker 1.

**Manual operation:** See "[Frame \(Spectrogram only\)](#)" on page 80

---

**CALCulate<n>:DELTamarker<m>:SGRam:SAREa <SearchArea>**
**CALCulate<n>:DELTamarker<m>:SPECtrogram:SAREa <SearchArea>**

This command defines the marker search area for *all* spectrogram markers in the channel setup.

**Suffix:**

<n>                      irrelevant

<m> irrelevant

**Parameters:**

<SearchArea>

**VISible**

Performs a search within the visible frames.

Note that the command does not work if the spectrogram is not visible for any reason (e.g. if the display update is off).

**MEMory**

Performs a search within all frames in the memory.

\*RST: VISible

**Manual operation:** See "[Marker Search Area](#)" on page 88

**CALCulate<n>:DELTamarker<m>:SGRam:XY:MAXimum[:PEAK]**

**CALCulate<n>:DELTamarker<m>:SPECTrogram:XY:MAXimum[:PEAK]**

This command moves a marker to the highest level of the spectrogram over all frequencies.

**Suffix:**

<n> [Window](#)

<m> [Marker](#)

**CALCulate<n>:DELTamarker<m>:SGRam:XY:MINimum[:PEAK]**

**CALCulate<n>:DELTamarker<m>:SPECTrogram:XY:MINimum[:PEAK]**

This command moves a delta marker to the minimum level of the spectrogram over all frequencies.

**Suffix:**

<n> [Window](#)

<m> [Marker](#)

**CALCulate<n>:DELTamarker<m>:SGRam:Y:MAXimum:ABOVE**

**CALCulate<n>:DELTamarker<m>:SPECTrogram:Y:MAXimum:ABOVE**

This command moves a marker vertically to the next higher level for the current frequency.

The search includes only frames above the current marker position. It does not change the horizontal position of the marker.

**Suffix:**

<n> [Window](#)

<m> [Marker](#)

**Manual operation:** See "[Search Mode for Next Peak in Y-Direction](#)" on page 88

---

**CALCulate<n>:DELTaMarker<m>:SGRam:Y:MAXimum:BELOW**  
**CALCulate<n>:DELTaMarker<m>:SPECTrogram:Y:MAXimum:BELOW**

This command moves a marker vertically to the next higher level for the current frequency.

The search includes only frames below the current marker position. It does not change the horizontal position of the marker.

**Suffix:**

<n> [Window](#)

<m> [Marker](#)

**Manual operation:** See "[Search Mode for Next Peak in Y-Direction](#)" on page 88

---

**CALCulate<n>:DELTaMarker<m>:SGRam:Y:MAXimum:NEXT**  
**CALCulate<n>:DELTaMarker<m>:SPECTrogram:Y:MAXimum:NEXT**

This command moves a delta marker vertically to the next higher level for the current frequency.

The search includes all frames. It does not change the horizontal position of the marker.

**Suffix:**

<n> [Window](#)

<m> [Marker](#)

**Manual operation:** See "[Search Mode for Next Peak in Y-Direction](#)" on page 88

---

**CALCulate<n>:DELTaMarker<m>:SGRam:Y:MAXimum[:PEAK]**  
**CALCulate<n>:DELTaMarker<m>:SPECTrogram:Y:MAXimum[:PEAK]**

This command moves a delta marker vertically to the highest level for the current frequency.

The search includes all frames. It does not change the horizontal position of the marker.

If the marker hasn't been active yet, the command looks for the peak level in the whole spectrogram.

**Suffix:**

<n> [Window](#)

<m> [Marker](#)

---

**CALCulate<n>:DELTaMarker<m>:SGRam:Y:MINimum:ABOVE**  
**CALCulate<n>:DELTaMarker<m>:SPECTrogram:Y:MINimum:ABOVE**

This command moves a delta marker vertically to the next minimum level for the current frequency.

The search includes only frames above the current marker position. It does not change the horizontal position of the marker.

**Suffix:**

<n> [Window](#)

<m> [Marker](#)

**Manual operation:** See "[Search Mode for Next Peak in Y-Direction](#)" on page 88

**CALCulate<n>:DELTamarker<m>:SGRam:Y:MINimum:BELOW**

**CALCulate<n>:DELTamarker<m>:SPECTrogram:Y:MINimum:BELOW**

This command moves a delta marker vertically to the next minimum level for the current frequency.

The search includes only frames below the current marker position. It does not change the horizontal position of the marker.

**Suffix:**

<n> [Window](#)

<m> [Marker](#)

**Manual operation:** See "[Search Mode for Next Peak in Y-Direction](#)" on page 88

**CALCulate<n>:DELTamarker<m>:SGRam:Y:MINimum:NEXT**

**CALCulate<n>:DELTamarker<m>:SPECTrogram:Y:MINimum:NEXT**

This command moves a delta marker vertically to the next minimum level for the current frequency.

The search includes all frames. It does not change the horizontal position of the marker.

**Suffix:**

<n> [Window](#)

<m> [Marker](#)

**Manual operation:** See "[Search Mode for Next Peak in Y-Direction](#)" on page 88

**CALCulate<n>:DELTamarker<m>:SGRam:Y:MINimum[:PEAK]**

**CALCulate<n>:DELTamarker<m>:SPECTrogram:Y:MINimum[:PEAK]**

This command moves a delta marker vertically to the minimum level for the current frequency.

The search includes all frames. It does not change the horizontal position of the marker.

If the marker hasn't been active yet, the command first looks for the peak level in the whole spectrogram and moves the marker vertically to the minimum level.

**Suffix:**

<n> [Window](#)

<m> [Marker](#)

### 9.7.3.5 Positioning the marker

This chapter contains remote commands necessary to position the marker on a trace.

- [Positioning normal markers](#).....206
- [Positioning delta markers](#).....209

#### Positioning normal markers

The following commands position markers on the trace.

<a href="#">CALCulate&lt;n&gt;:MARKer&lt;m&gt;:MAXimum:AUTO</a> .....	206
<a href="#">CALCulate&lt;n&gt;:MARKer&lt;m&gt;:MAXimum:LEFT</a> .....	206
<a href="#">CALCulate&lt;n&gt;:MARKer&lt;m&gt;:MAXimum:NEXT</a> .....	207
<a href="#">CALCulate&lt;n&gt;:MARKer&lt;m&gt;:MAXimum[:PEAK]</a> .....	207
<a href="#">CALCulate&lt;n&gt;:MARKer&lt;m&gt;:MAXimum:RIGHT</a> .....	207
<a href="#">CALCulate&lt;n&gt;:MARKer&lt;m&gt;:MINimum:AUTO</a> .....	208
<a href="#">CALCulate&lt;n&gt;:MARKer&lt;m&gt;:MINimum:LEFT</a> .....	208
<a href="#">CALCulate&lt;n&gt;:MARKer&lt;m&gt;:MINimum:NEXT</a> .....	208
<a href="#">CALCulate&lt;n&gt;:MARKer&lt;m&gt;:MINimum[:PEAK]</a> .....	209
<a href="#">CALCulate&lt;n&gt;:MARKer&lt;m&gt;:MINimum:RIGHT</a> .....	209

---

#### **CALCulate<n>:MARKer<m>:MAXimum:AUTO <State>**

This command turns an automatic marker peak search for a trace maximum on and off (using marker 1). The R&S FPL1000 performs the peak search after each sweep.

##### Suffix:

<n> [Window](#)  
 <m> irrelevant

##### Parameters:

<State> ON | OFF | 0 | 1  
**OFF | 0**  
 Switches the function off  
**ON | 1**  
 Switches the function on

##### Example:

CALC:MARK:MAX:AUTO ON  
 Activates the automatic peak search function for marker 1 at the end of each particular sweep.

**Manual operation:** See "[Auto Max Peak Search / Auto Min Peak Search](#)" on page 85

---

#### **CALCulate<n>:MARKer<m>:MAXimum:LEFT**

This command moves a marker to the next positive peak.

The search includes only measurement values to the left of the current marker position.

In the spectrogram, the command moves a marker horizontally to the maximum level in the currently selected frame. The vertical marker position remains the same.

**Suffix:**

<n> [Window](#)

<m> [Marker](#)

**Manual operation:** See "[Search Next Peak](#)" on page 90

**CALCulate<n>:MARKer<m>:MAXimum:NEXT**

This command moves a marker to the next positive peak.

In the spectrogram, the command moves a marker horizontally to the maximum level in the currently selected frame. The vertical marker position remains the same.

**Suffix:**

<n> [Window](#)

<m> [Marker](#)

**Manual operation:** See "[Search Next Peak](#)" on page 90

**CALCulate<n>:MARKer<m>:MAXimum[:PEAK]**

This command moves a marker to the highest level.

In the spectrogram, the command moves a marker horizontally to the maximum level in the currently selected frame. The vertical marker position remains the same.

If the marker is not yet active, the command first activates the marker.

**Suffix:**

<n> [Window](#)

<m> [Marker](#)

**Manual operation:** See "[Peak Search](#)" on page 90

**CALCulate<n>:MARKer<m>:MAXimum:RIGHT**

This command moves a marker to the next positive peak.

The search includes only measurement values to the right of the current marker position.

In the spectrogram, the command moves a marker horizontally to the maximum level in the currently selected frame. The vertical marker position remains the same.

**Suffix:**

<n> [Window](#)

<m> [Marker](#)

**Manual operation:** See ["Search Next Peak"](#) on page 90

---

#### **CALCulate<n>:MARKer<m>:MINimum:AUTO <State>**

This command turns an automatic marker peak search for a trace minimum on and off (using marker 1). The R&S FPL1000 performs the peak search after each sweep.

**Suffix:**

<n> [Window](#)

<m> irrelevant

**Parameters:**

<State> ON | OFF | 0 | 1

**OFF | 0**

Switches the function off

**ON | 1**

Switches the function on

**Example:**

`CALC:MARK:MIN:AUTO ON`

Activates the automatic minimum value search function for marker 1 at the end of each particular sweep.

**Manual operation:** See ["Auto Max Peak Search / Auto Min Peak Search"](#) on page 85

---

#### **CALCulate<n>:MARKer<m>:MINimum:LEFT**

This command moves a marker to the next minimum peak value.

The search includes only measurement values to the right of the current marker position.

In the spectrogram, the command moves a marker horizontally to the minimum level in the currently selected frame. The vertical marker position remains the same.

**Suffix:**

<n> [Window](#)

<m> [Marker](#)

**Manual operation:** See ["Search Next Minimum"](#) on page 90

---

#### **CALCulate<n>:MARKer<m>:MINimum:NEXT**

This command moves a marker to the next minimum peak value.

In the spectrogram, the command moves a marker horizontally to the minimum level in the currently selected frame. The vertical marker position remains the same.

**Suffix:**

<n> [Window](#)

<m> [Marker](#)



**Manual operation:** See ["Search Next Minimum"](#) on page 90

---

### CALCulate<n>:MARKer<m>:MINimum[:PEAK]

This command moves a marker to the minimum level.

In the spectrogram, the command moves a marker horizontally to the minimum level in the currently selected frame. The vertical marker position remains the same.

If the marker is not yet active, the command first activates the marker.

**Suffix:**

<n> [Window](#)

<m> [Marker](#)

**Manual operation:** See ["Search Minimum"](#) on page 90

---

### CALCulate<n>:MARKer<m>:MINimum:RIGHT

This command moves a marker to the next minimum peak value.

The search includes only measurement values to the right of the current marker position.

In the spectrogram, the command moves a marker horizontally to the minimum level in the currently selected frame. The vertical marker position remains the same.

**Suffix:**

<n> [Window](#)

<m> [Marker](#)

**Manual operation:** See ["Search Next Minimum"](#) on page 90

### Positioning delta markers

The following commands position delta markers on the trace.

CALCulate<n>:DELTamarker<m>:MAXimum:LEFT.....	209
CALCulate<n>:DELTamarker<m>:MAXimum:NEXT.....	210
CALCulate<n>:DELTamarker<m>:MAXimum[:PEAK].....	210
CALCulate<n>:DELTamarker<m>:MAXimum:RIGHT.....	210
CALCulate<n>:DELTamarker<m>:MINimum:LEFT.....	211
CALCulate<n>:DELTamarker<m>:MINimum:NEXT.....	211
CALCulate<n>:DELTamarker<m>:MINimum[:PEAK].....	211
CALCulate<n>:DELTamarker<m>:MINimum:RIGHT.....	211

---

### CALCulate<n>:DELTamarker<m>:MAXimum:LEFT

This command moves a delta marker to the next positive peak value.

The search includes only measurement values to the left of the current marker position.

In the spectrogram, the command moves a marker horizontally to the maximum level in the currently selected frame. The vertical marker position remains the same.

**Suffix:**

<n> [Window](#)

<m> [Marker](#)

**Manual operation:** See "[Search Next Peak](#)" on page 90

**CALCulate<n>:DELTaMarker<m>:MAXimum:NEXT**

This command moves a marker to the next positive peak value.

In the spectrogram, the command moves a marker horizontally to the maximum level in the currently selected frame. The vertical marker position remains the same.

**Suffix:**

<n> 1..n  
[Window](#)

<m> 1..n  
[Marker](#)

**Manual operation:** See "[Search Next Peak](#)" on page 90

**CALCulate<n>:DELTaMarker<m>:MAXimum[:PEAK]**

This command moves a delta marker to the highest level.

In the spectrogram, the command moves a marker horizontally to the maximum level in the currently selected frame. The vertical marker position remains the same.

If the marker is not yet active, the command first activates the marker.

**Suffix:**

<n> [Window](#)

<m> [Marker](#)

**Manual operation:** See "[Peak Search](#)" on page 90

**CALCulate<n>:DELTaMarker<m>:MAXimum:RIGHT**

This command moves a delta marker to the next positive peak value on the trace.

The search includes only measurement values to the right of the current marker position.

In the spectrogram, the command moves a marker horizontally to the maximum level in the currently selected frame. The vertical marker position remains the same.

**Suffix:**

<n> [Window](#)

<m> [Marker](#)

**Manual operation:** See ["Search Next Peak"](#) on page 90

---

#### **CALCulate<n>:DELTamarker<m>:MINimum:LEFT**

This command moves a delta marker to the next minimum peak value.

The search includes only measurement values to the right of the current marker position.

In the spectrogram, the command moves a marker horizontally to the minimum level in the currently selected frame. The vertical marker position remains the same.

**Suffix:**

<n> [Window](#)

<m> [Marker](#)

**Manual operation:** See ["Search Next Minimum"](#) on page 90

---

#### **CALCulate<n>:DELTamarker<m>:MINimum:NEXT**

This command moves a marker to the next minimum peak value.

In the spectrogram, the command moves a marker horizontally to the minimum level in the currently selected frame. The vertical marker position remains the same.

**Suffix:**

<n> [Window](#)

<m> [Marker](#)

**Manual operation:** See ["Search Next Minimum"](#) on page 90

---

#### **CALCulate<n>:DELTamarker<m>:MINimum[:PEAK]**

This command moves a delta marker to the minimum level.

In the spectrogram, the command moves a marker horizontally to the minimum level in the currently selected frame. The vertical marker position remains the same.

If the marker is not yet active, the command first activates the marker.

**Suffix:**

<n> [Window](#)

<m> [Marker](#)

**Manual operation:** See ["Search Minimum"](#) on page 90

---

#### **CALCulate<n>:DELTamarker<m>:MINimum:RIGHT**

This command moves a delta marker to the next minimum peak value.

The search includes only measurement values to the right of the current marker position.

In the spectrogram, the command moves a marker horizontally to the minimum level in the currently selected frame. The vertical marker position remains the same.

**Suffix:**

<n> [Window](#)

<m> [Marker](#)

**Manual operation:** See "[Search Next Minimum](#)" on page 90

**9.7.3.6 Band power marker**

The following commands control the marker for band power measurements.

**Using markers**

<a href="#">CALCulate&lt;n&gt;:MARKer&lt;m&gt;:FUNCTION:BPOWER:AOFF</a> .....	212
<a href="#">CALCulate&lt;n&gt;:MARKer&lt;m&gt;:FUNCTION:BPOWER:MODE</a> .....	212
<a href="#">CALCulate&lt;n&gt;:MARKer&lt;m&gt;:FUNCTION:BPOWER:RESult?</a> .....	213
<a href="#">CALCulate&lt;n&gt;:MARKer&lt;m&gt;:FUNCTION:BPOWER:SPAN</a> .....	213
<a href="#">CALCulate&lt;n&gt;:MARKer&lt;m&gt;:FUNCTION:BPOWER[:STATe]</a> .....	213

**CALCulate<n>:MARKer<m>:FUNCTION:BPOWER:AOFF**

Removes all band power markers in the specified window.

**Suffix:**

<n> [Window](#)

<m> irrelevant

**Example:** `CALC:MARK:FUNC:BPOW:AOFF`

**CALCulate<n>:MARKer<m>:FUNCTION:BPOWER:MODE <Mode>**

This command selects the way the results for a band power marker are displayed.

(Note: relative power results are only available for delta markers, see [.CALCulate<n>:DELTAmarker<m>:FUNCTION:BPOWER:MODE](#) on page 214)

**Suffix:**

<n> [Window](#)

<m> [Marker](#)

**Parameters:**

<Mode>

**POWER**

Result is displayed as an absolute power. The power unit depends on the [CALCulate<n>:UNIT:POWER](#) setting.

**DENSITY**

Result is displayed as a density in dBm/Hz.

\*RST: POWER

**Example:** `CALC:MARK4:FUNC:BPOW:MODE DENS`  
Configures marker 4 to show the measurement results in dBm/Hz.

**Manual operation:** See "Power Mode" on page 97

#### **CALCulate<n>:MARKer<m>:FUNction:BPOWer:RESult?**

This command queries the results of the band power measurement.

**Suffix:**

<n> [Window](#)

<m> [Marker](#)

**Return values:**

<Power> Signal power over the marker bandwidth.

**Example:**

Activate the band power marker:

`CALC:MARK:FUNC:BPOW:STAT ON`

Select the density mode for the result:

`CALC:MARK:FUNC:BPOW:MODE DENS`

Query the result:

`CALC:MARK:FUNC:BPOW:RES?`

Response:

20dBm/Hz

**Usage:** Query only

#### **CALCulate<n>:MARKer<m>:FUNction:BPOWer:SPAN <Span>**

This command defines the bandwidth around the marker position.

**Suffix:**

<n> [Window](#)

<m> [Marker](#)

**Parameters:**

<Span> Frequency. The maximum span depends on the marker position and R&S FPL1000 model.

\*RST: 5% of current span

Default unit: Hz

**Example:**

`CALC:MARK:FUNC:BPOW:SPAN 2MHz`

Measures the band power over 2 MHz around the marker.

**Manual operation:** See "Span" on page 96

#### **CALCulate<n>:MARKer<m>:FUNction:BPOWer[:STATe] <State>**

This command turns markers for band power measurements on and off.

**Suffix:**<n> [Window](#)<m> [Marker](#)**Parameters:**

&lt;State&gt; ON | OFF | 0 | 1

**OFF | 0**

Switches the function off

**ON | 1**

Switches the function on

**Example:**

CALC:MARK4:FUNC:BPOW:STAT ON

Activates or turns marker 4 into a band power marker.

**Manual operation:**See ["Band Power Measurement State"](#) on page 96See ["Switching All Band Power Measurements Off"](#) on page 97**Using delta markers**

<a href="#">CALCulate&lt;n&gt;:DELTamarker&lt;m&gt;:FUNCTion:BPOWer:MODE</a> .....	214
<a href="#">CALCulate&lt;n&gt;:DELTamarker&lt;m&gt;:FUNCTion:BPOWer:RESult?</a> .....	215
<a href="#">CALCulate&lt;n&gt;:DELTamarker&lt;m&gt;:FUNCTion:BPOWer:SPAN</a> .....	215
<a href="#">CALCulate&lt;n&gt;:DELTamarker&lt;m&gt;:FUNCTion:BPOWer[:STATe]</a> .....	215

**CALCulate<n>:DELTamarker<m>:FUNCTion:BPOWer:MODE <Mode>**

This command selects the way the results for a band power delta marker are displayed.

**Suffix:**<n> [Window](#)<m> [Marker](#)**Parameters:**

&lt;Mode&gt;

**POWer**

Result is displayed as an absolute power. The power unit depends on the [CALCulate<n>:UNIT:POWer](#) setting.

**DENSity**

Result is displayed as a density in dBm/Hz.

**RPOWer**

This setting is only available for a delta band power marker. The result is the difference between the absolute power in the band around the delta marker and the absolute power for the reference marker. The powers are subtracted logarithmically, so the result is a dB value.

$$[\text{Relative band power (Delta2) in dB}] = [\text{absolute band power (Delta2) in dBm}] - [\text{absolute (band) power of reference marker in dBm}]$$

For details see ["Relative band power markers"](#) on page 95.

\*RST:      POWer

**Manual operation:** See ["Power Mode"](#) on page 97

---

### CALCulate<n>:DELTamarker<m>:FUNction:BPOWER:RESult?

This command queries the results of the band power measurement.

**Suffix:**

<n> [Window](#)

<m> [Marker](#)

**Return values:**

<Power> Signal power over the delta marker bandwidth.

**Usage:** Query only

---

### CALCulate<n>:DELTamarker<m>:FUNction:BPOWER:SPAN <Span>

This command defines the bandwidth around the delta marker position.

**Suffix:**

<n> [Window](#)

<m> [Marker](#)

**Parameters:**

<Span> Frequency. The maximum span depends on the marker position and R&S FPL1000 model.

\*RST: 5% of current span

Default unit: Hz

**Manual operation:** See ["Span"](#) on page 96

---

### CALCulate<n>:DELTamarker<m>:FUNction:BPOWER[:STATe] <State>

This command turns delta markers for band power measurements on and off.

If necessary, the command also turns on a reference marker.

**Suffix:**

<n> [Window](#)

<m> [Marker](#)

**Parameters:**

<State> ON | OFF | 0 | 1

**OFF | 0**

Switches the function off

**ON | 1**

Switches the function on

**Manual operation:** See ["Band Power Measurement State"](#) on page 96  
See ["Switching All Band Power Measurements Off"](#) on page 97

### 9.7.3.7 Marker peak lists

#### Useful commands for peak lists described elsewhere

- `CALCulate<n>:MARKer<m>:PEXCursion` on page 192
- `MMEMemory:STORe<n>:PEAK` on page 219

#### Remote commands exclusive to peak lists

<code>CALCulate&lt;n&gt;:MARKer&lt;m&gt;:FUNCTION:FPEaks:ANNOtation:LABel[:STATe]</code> .....	216
<code>CALCulate&lt;n&gt;:MARKer&lt;m&gt;:FUNCTION:FPEaks:COUNT?</code> .....	216
<code>CALCulate&lt;n&gt;:MARKer&lt;m&gt;:FUNCTION:FPEaks[:IMMEDIATE]</code> .....	217
<code>CALCulate&lt;n&gt;:MARKer&lt;m&gt;:FUNCTION:FPEaks:LIST:SIZE</code> .....	217
<code>CALCulate&lt;n&gt;:MARKer&lt;m&gt;:FUNCTION:FPEaks:SORT</code> .....	218
<code>CALCulate&lt;n&gt;:MARKer&lt;m&gt;:FUNCTION:FPEaks:STATE</code> .....	218
<code>CALCulate&lt;n&gt;:MARKer&lt;m&gt;:FUNCTION:FPEaks:X?</code> .....	218
<code>CALCulate&lt;n&gt;:MARKer&lt;m&gt;:FUNCTION:FPEaks:Y?</code> .....	219
<code>MMEMemory:STORe&lt;n&gt;:PEAK</code> .....	219

---

#### `CALCulate<n>:MARKer<m>:FUNCTION:FPEaks:ANNOtation:LABel[:STATe]` <State>

This command turns labels for peaks found during a peak search on and off.

The labels correspond to the marker number in the marker peak list.

#### Suffix:

<n>	Window
<m>	Marker

#### Parameters:

<State>	ON   OFF   0   1
*RST:	1

#### Example:

```
CALC:MARK:FUNC:FPE:ANN:LAB:STAT OFF
Removes the peak labels from the diagram
```

**Manual operation:** See "[Display Marker Numbers](#)" on page 100

---

#### `CALCulate<n>:MARKer<m>:FUNCTION:FPEaks:COUNT?`

This command queries the number of peaks that have been found during a peak search.

The actual number of peaks that have been found may differ from the number of peaks you have set to be found because of the peak excursion.

#### Suffix:

<n>	irrelevant
<m>	irrelevant



**Return values:**

&lt;NumberOfPeaks&gt;

**Example:**

CALC:MARK:FUNC:FPE:COUN?

Queries the number of peaks.

**Usage:**

Query only

**CALCulate<n>:MARKer<m>:FUNction:FPEaks[:IMMediate] <Peaks>**

This command initiates a peak search.

**Suffix:**<n> [Window](#)<m> [Marker](#)**Parameters:**

&lt;Peaks&gt; This parameter defines the number of peaks to find during the search.

Note that the actual number of peaks found during the search also depends on the peak excursion you have set with [CALCulate<n>:MARKer<m>:PEXCursion](#).

Range: 1 to 200

**Example:**

CALC:MARK:PEXC 5

Defines a peak excursion of 5 dB, i.e. peaks must be at least 5 dB apart to be detected as a peak.

CALC:MARK:FUNC:FPE 10

Initiates a search for 10 peaks on the current trace.

**CALCulate<n>:MARKer<m>:FUNction:FPEaks:LIST:SIZE <MaxNoPeaks>**

This command defines the maximum number of peaks that the R&amp;S FPL1000 looks for during a peak search.

**Suffix:**<n> [Window](#)<m> [Marker](#)**Parameters:**

&lt;MaxNoPeaks&gt; Maximum number of peaks to be determined.

Range: 1 to 500

\*RST: 50

**Example:**

CALC:MARK:FUNC:FPE:LIST:SIZE 10

The marker peak list will contain a maximum of 10 peaks.

**Manual operation:**See "[Maximum Number of Peaks](#)" on page 100

**CALCulate<n>:MARKer<m>:FUNction:FPEaks:SORT <SortMode>**

This command selects the order in which the results of a peak search are returned.

**Suffix:**

<n> [Window](#)

<m> [Marker](#)

**Parameters:**

<SortMode> **X**  
Sorts the peaks according to increasing position on the x-axis.  
**Y**  
Sorts the peaks according to decreasing position on the y-axis.  
\*RST: X

**Example:** `CALC:MARK:FUNC:FPE:SORT Y`  
Sets the sort mode to decreasing y values

**Manual operation:** See "[Sort Mode](#)" on page 100

**CALCulate<n>:MARKer<m>:FUNction:FPEaks:STATE <State>**

This command turns a peak search on and off.

**Suffix:**

<n> [Window](#)

<m> [Marker](#)

**Parameters:**

<State> **ON | OFF | 0 | 1**  
**OFF | 0**  
Switches the function off  
**ON | 1**  
Switches the function on

**Example:** `CALC:MARK:FUNC:FPE:STAT ON`  
Activates marker peak search

**Manual operation:** See "[Peak List State](#)" on page 100

**CALCulate<n>:MARKer<m>:FUNction:FPEaks:X?**

This command queries the position of the peaks on the x-axis.

The order depends on the sort order that has been set with [CALCulate<n>:MARKer<m>:FUNction:FPEaks:SORT](#).

**Suffix:**

<n> irrelevant

<m> irrelevant

**Return values:**

<PeakPosition> Position of the peaks on the x-axis. The unit depends on the measurement.

**Usage:** Query only

**CALCulate<n>:MARKer<m>:FUNCTion:FPEaks:Y?**

This command queries the position of the peaks on the y-axis.

The order depends on the sort order that has been set with [CALCulate<n>:MARKer<m>:FUNCTion:FPEaks:SORT](#).

**Suffix:**

<n> irrelevant

<m> irrelevant

**Return values:**

<PeakPosition> Position of the peaks on the y-axis. The unit depends on the measurement.

**Usage:** Query only

**MMEMory:STORe<n>:PEAK <FileName>**

This command exports the marker peak list to a file.

**Suffix:**

<n> [Window](#)

**Parameters:**

<FileName> String containing the path, name and extension of the target file.

**Example:**

```
MMEM:STOR:PEAK 'test.dat'
```

Saves the current marker peak list in the file `test.dat`.

**Manual operation:** See "[Export Peak List](#)" on page 101

## 9.8 Retrieving results

The following commands can be used to retrieve the results of the I/Q Analyzer measurement.



### Storing large amounts of I/Q data

When storing large amounts of I/Q data to a file, consider the following tips to improve performance:

- If capturing and storing the I/Q data is the main goal of the measurement and evaluation functions are not required, use the basic I/Q data acquisition mode (see [TRACe: IQ\[:STATe\]](#) on page 116).
- Use a HiSlip or raw socket connection to export the data from the R&S FPL1000 to a PC.
- Export the data in binary format rather than ASCII format (see [Chapter A, "Formats for returned values: ASCII format and binary format"](#), on page 235).
- Use the "Compatible" or "IQPair" data mode (see [Chapter B, "Reference: format description for I/Q data files"](#), on page 236).
- If only an extract of the available data is relevant, use the [TRACe<n>\[:DATA\]:MEMory?](#) command to store only the required section of data.

• <a href="#">Retrieving captured I/Q data</a> .....	220
• <a href="#">Retrieving I/Q trace data</a> .....	223
• <a href="#">Exporting traces and data</a> .....	226
• <a href="#">Retrieving marker results</a> .....	228

## 9.8.1 Retrieving captured I/Q data

The raw captured I/Q data is output in the form of a list.

<a href="#">TRACe:IQ:DATA?</a> .....	220
<a href="#">TRACe:IQ:DATA:FORMat</a> .....	221
<a href="#">TRACe:IQ:DATA:MEMory?</a> .....	222

---

### TRACe:IQ:DATA?

This command initiates a measurement with the current settings and returns the captured data from I/Q measurements.

This command corresponds to:

```
INIT:IMM;*WAI;:TRACe:IQ:DATA:MEMory?
```

However, the [TRACe:IQ:DATA?](#) command is quicker in comparison.

**Note:** Using the command with the \*RST values for the [TRACe:IQ:SET](#) command, the following minimum buffer sizes for the response data are recommended: ASCII format 10 kBytes, binary format: 2 kBytes

**Return values:**

&lt;Results&gt;

Measured voltage for I and Q component for each sample that has been captured during the measurement.

The number of samples depends on `TRACe:IQ:SET`. In ASCII format, the number of results is 2\* the number of samples.

The data format depends on `TRACe:IQ:DATA:FORMat` on page 221.

Default unit: V

**Example:**

```
TRAC:IQ:STAT ON
```

Enables acquisition of I/Q data

```
TRAC:IQ:SET NORM,10MHz,32MHz,EXT,POS,0,4096
```

Measurement configuration:

Sample Rate = 32 MHz

Trigger Source = External

Trigger Slope = Positive

Pretrigger Samples = 0

Number of Samples = 4096

```
FORMat REAL,32
```

Selects format of response data

```
TRAC:IQ:DATA?
```

Starts measurement and reads results

**Usage:**

Query only

**TRACe:IQ:DATA:FORMat <Format>**

This command selects the order of the I/Q data.

For details see [Chapter B, "Reference: format description for I/Q data files"](#), on page 236.

**Parameters:**

&lt;Format&gt;

COMPatible | IQBLock | IQPair

**COMPatible**

I and Q values are separated and collected in blocks: A block (512k) of I values is followed by a block (512k) of Q values, followed by a block of I values, followed by a block of Q values etc. (I,I,I,I,Q,Q,Q,Q,I,I,I,I,Q,Q,Q,Q...)

**IQBLock**

First all I-values are listed, then the Q-values (I,I,I,I,I,...Q,Q,Q,Q,Q,Q)

**IQPair**

One pair of I/Q values after the other is listed (I,Q,I,Q,I,Q...).

\*RST: IQBL

**TRACe:IQ:DATA:MEMory?** [<OffsetSamples>,<NoOfSamples>]

This command queries the I/Q data currently stored in the capture buffer of the R&S FPL1000.

By default, the command returns all I/Q data in the memory. You can, however, narrow down the amount of data that the command returns using the optional parameters.

If no parameters are specified with the command, the entire trace data is retrieved.

In this case, the command returns the same results as [TRACe:IQ:DATA?](#). (Note, however, that the [TRACe:IQ:DATA?](#) command initiates a new measurement before returning the captured values, rather than returning the existing data in the memory.)

The command returns a comma-separated list of the measured values in floating point format (comma-separated values = CSV). The number of values returned is 2 \* the number of complex samples.

The total number of complex samples is displayed in the channel bar in manual operation and can be calculated as:

<SampleRate> \* <CaptureTime>

(See [TRACe:IQ:SET](#), [TRACe:IQ:SRATe](#) on page 151 and [\[SENSe:\]SWEep:TIME](#) on page 168)

**Query parameters:**

<b>&lt;OffsetSamples&gt;</b>	Selects an offset at which the output of data should start in relation to the first data. If omitted, all captured samples are output, starting with the first sample. Range: 0 to <# of samples> – 1, with <# of samples> being the maximum number of captured values *RST: 0
<b>&lt;NoOfSamples&gt;</b>	Number of samples you want to query, beginning at the offset you have defined. If omitted, all captured samples (starting at offset) are output. Range: 1 to <# of samples> - <offset samples> with <# of samples> maximum number of captured values *RST: <# of samples>

**Return values:**

<b>&lt;IQData&gt;</b>	Measured value pair (I,Q) for each sample that has been recorded. By default, the first half of the list contains the I values, the second half the Q values. The order can be configured using <a href="#">TRACe:IQ:DATA:FORMat</a> . The data format of the individual values depends on <a href="#">FORMat[:DATA]</a> on page 223. Default unit: V
-----------------------	--

**Example:**

```
TRAC:IQ:STAT ON
```

Enables acquisition of I/Q data

```
TRAC:IQ:SET NORM,10MHz,32MHz,EXT,POS,100,4096
```

**Measurement configuration:**

Sample Rate = 32 MHz

Trigger Source = External

Trigger Slope = Positive

Pretrigger Samples = 100

Number of Samples = 4096

```
INIT;*WAI
```

Starts measurement and wait for sync

```
FORMat REAL,32
```

Determines output format

**To read the results:**

```
TRAC:IQ:DATA:MEM?
```

Reads all 4096 I/Q data

```
TRAC:IQ:DATA:MEM? 0,2048
```

Reads 2048 I/Q data starting at the beginning of data acquisition

```
TRAC:IQ:DATA:MEM? 2048,1024
```

Reads 1024 I/Q data from half of the recorded data

```
TRAC:IQ:DATA:MEM? 100,512
```

Reads 512 I/Q data starting at the trigger point (<Pretrigger Samples> was 100)

**Example:**

```
// Perform a single I/Q capture.
```

```
INIT;*WAI
```

```
// Determine output format (binary float32)
```

```
FORMat REAL,32
```

```
// Read 1024 I/Q samples starting at sample 2048.
```

```
TRAC:IQ:DATA:MEM? 2048,1024
```

**Usage:**

Query only

### 9.8.2 Retrieving I/Q trace data

In addition to the raw captured I/Q data, the results from I/Q analysis as shown in the result displays can also be retrieved.

FORMat[:DATA].....	223
TRACe<n>[:DATA]?.....	224
TRACe<n>[:DATA]:MEMory?.....	225
TRACe<n>[:DATA]:X?.....	226

---

**FORMat[:DATA]** <Format>[, <BitLength>]

This command selects the data format that is used for transmission of trace data from the R&S FPL1000 to the controlling computer.

Note that the command has no effect for data that you send to the R&S FPL1000. The R&S FPL1000 automatically recognizes the data it receives, regardless of the format.

**Parameters:**

&lt;Format&gt;

**ASCII**

ASCII format, separated by commas.

This format is almost always suitable, regardless of the actual data format. However, the data is not as compact as other formats can be.

**REAL**

Floating-point numbers (according to IEEE 754) in the "definite length block format".

In the Spectrum application, the format setting `REAL` is used for the binary transmission of trace data.

&lt;BitLength&gt;

Length in bits for floating-point results

**16**

16-bit floating-point numbers.

Compared to `REAL, 32` format, half as many numbers are returned.

**32**

32-bit floating-point numbers

For I/Q data, 8 bytes per sample are returned for this format setting.

**64**

64-bit floating-point numbers

Compared to `REAL, 32` format, twice as many numbers are returned.

**Example:**

```
FORM REAL, 32
```

**TRACe<n>[:DATA]? <ResultType>**

This command queries current trace data and measurement results.

The data format depends on `FORMat [ : DATA ]` on page 223.

**Suffix:**

&lt;n&gt;

[Window](#)

**Query parameters:**

&lt;ResultType&gt;

Selects the type of result to be returned.

See [Table 9-4](#).

**Example:**

```
TRAC? TRACE3
```

Queries the data of trace 3.

**Manual operation:**

See ["Magnitude"](#) on page 13

See ["Spectrum"](#) on page 13

See ["I/Q-Vector"](#) on page 14

See ["Real/Imag \(I/Q\)"](#) on page 15



Table 9-4: Return values for result type parameters

Parameter	Result display / measurement	Results
TRACE1   ...   TRACE6		Returns the sweep point values as shown in the result display. For the auto peak detector, the command returns positive peak values only. (To retrieve negative peak values, define a second trace with a negative peak detector.)
	"Magnitude" "Spectrum"	Magnitude of the I and Q values (I+jQ) for each sweep point (=1001 values)
	"Real/Imag (I/Q)"	First the real parts for each trace point, then the imaginary parts (I <sub>1</sub> ,...,I <sub>1001</sub> , Q <sub>1</sub> ,...,Q <sub>1001</sub> ).
	"I/Q Vector"	The I and Q values for each trace point are returned (1001 pairs of I and Q values).
LIST	SEM measurements	Peak list evaluation, one peak per range is returned.
	Spurious emission measurements	Peak list evaluation For each peak, the command returns 11 values in the following order: <ul style="list-style-type: none"> <li>• &lt;No&gt;: range number</li> <li>• &lt;StartFreq&gt;,&lt;StopFreq&gt;: start and stop frequency of the range</li> <li>• &lt;RBW&gt;: resolution bandwidth</li> <li>• &lt;PeakFreq&gt;: frequency of the peak in a range</li> <li>• &lt;PowerAbs&gt;: absolute power of the peak in dBm</li> <li>• &lt;PowerRel&gt;: power of the peak in relation to the channel power in dBc</li> <li>• &lt;PowerDelta&gt;: distance from the peak to the limit line in dB, positive values indicate a failed limit check</li> <li>• &lt;LimitCheck&gt;: state of the limit check (0 = PASS, 1 = FAIL)</li> <li>• &lt;Unused1&gt;,&lt;Unused2&gt;: reserved (0.0)</li> </ul>
SPURious		Peak list evaluation of Spurious Emission measurements.
SPECTrogram   SGRam		For every frame in the spectrogram, the command returns the power levels that have been measured, one for each sweep point. The number of frames depends on the size of the history depth. The power level depends on the configured unit. Only REAL, 32 format is supported.

**TRACe<n>[:DATA]:MEMory? <Trace>,<OffsSwPoint>,<NoOfSwPoints>**

This command queries the previously captured trace data for the specified trace from the memory. As an offset and number of sweep points to be retrieved can be specified, the trace data can be retrieved in smaller portions, making the command faster than the TRAC:DATA? command. This is useful if only specific parts of the trace data are of interest.

If no parameters are specified with the command, the entire trace data is retrieved; in this case, the command returns the same results as TRAC:DATA? TRACE1.

**Suffix:**

<n> [Window](#)

**Query parameters:**

<Trace> TRACE1 | TRACE2 | TRACE3 | TRACE4 | TRACE5 | TRACE6

<OffsSwPoint> The offset in sweep points related to the start of the measurement at which data retrieval is to start.

<NoOfSwPoints> Number of sweep points to be retrieved from the trace.

**Return values:**

<SweepPointValues>

**Example:** `TRAC:DATA:MEM? TRACE1,25,100`  
Retrieves 100 sweep points from trace 1, starting at sweep point 25.

**Usage:** Query only

**TRACe<n>[:DATA]:X? <TraceNumber>**

This command queries the horizontal trace data for each sweep point in the specified window, for example the frequency in frequency domain or the time in time domain measurements.

This is especially useful for traces with non-equidistant x-values.

**Suffix:**

<n> [Window](#)

**Query parameters:**

<TraceNumber> Trace number.

**TRACE1 | ... | TRACE6**

**Example:** `TRAC3:X? TRACE1`  
Returns the x-values for trace 1 in window 3.

**Usage:** Query only

### 9.8.3 Exporting traces and data

The following commands are required to export traces and spectrograms.

<a href="#">FORMat:DEXPort:DSEParator</a> .....	226
<a href="#">FORMat:DEXPort:FORMat</a> .....	227
<a href="#">FORMat:DEXPort:HEADer</a> .....	227
<a href="#">FORMat:DEXPort:TRACes</a> .....	227
<a href="#">MMEMory:STORe&lt;n&gt;:TRACe</a> .....	228

**FORMat:DEXPort:DSEParator <Separator>**

This command selects the decimal separator for data exported in ASCII format.

**Parameters:**

<Separator> **POINT | COMMa**

**COMMa**

Uses a comma as decimal separator, e.g. *4,05*.

**POINT**

Uses a point as decimal separator, e.g. 4.05.

\*RST:        \*RST has no effect on the decimal separator.  
Default is POINT.

**Example:**                FORM:DEXP:DSEP POIN  
Sets the decimal point as separator.

**Manual operation:**    See "[Decimal Separator](#)" on page 33  
See "[Export Peak List](#)" on page 101

**FORMat:DEXPort:FORMat <FileFormat>**

Determines the format of the ASCII file to be imported or exported. Depending on the external program that creates the data file or evaluates it, a comma-separated list (CSV) or a plain data format (DAT) file is required.

**Parameters:**

<FileFormat>            CSV | DAT  
\*RST:                DAT

**Example:**                FORM:DEXP:FORM CSV

**Manual operation:**    See "[File Type](#)" on page 33

**FORMat:DEXPort:HEADer <State>**

If enabled, additional instrument and measurement settings are included in the header of the export file for result data. If disabled, only the pure result data from the selected traces and tables is exported.

**Parameters:**

<State>                ON | OFF | 0 | 1  
\*RST:                1

**Manual operation:**    See "[Include Instrument & Measurement Settings](#)" on page 76

**FORMat:DEXPort:TRACes <Selection>**

This command selects the data to be included in a data export file (see [MMEMoRY:STORe<n>:TRACe](#) on page 228).

**Parameters:**

<Selection>            SINGLE | ALL

**SINGLE**

Only a single trace is selected for export, namely the one specified by the [MMEMoRY:STORe<n>:TRACe](#) command.

**ALL**

Selects all active traces and result tables (e.g. "Result Summary", marker peak list etc.) in the current application for export to an ASCII file.

The <trace> parameter for the `MMEMory:STORe<n>:TRACe` command is ignored.

\*RST: SINGLE

**Manual operation:** See "Export all Traces and all Table Results" on page 76

**MMEMory:STORe<n>:TRACe** <Trace>, <FileName>

This command exports trace data from the specified window to an ASCII file.

**Suffix:**

<n> [Window](#)

**Parameters:**

<Trace> Number of the trace to be stored

<FileName> String containing the path and name of the target file.

**Example:**

`MMEM:STOR1:TRAC 1, 'C:\TEST.ASC'`  
Stores trace 1 from window 1 in the file TEST.ASC.

**Manual operation:** See "Export Trace to ASCII File" on page 33

## 9.8.4 Retrieving marker results

The following commands are required to retrieve the results of markers.

Useful commands for retrieving marker results described elsewhere:

- [CALCulate<n>:DELTaMarker<m>:X](#) on page 187
- [CALCulate<n>:MARKer<m>:X](#) on page 190
- [CALCulate<n>:MARKer<m>:FUNctIon:FPEaks:X?](#) on page 218
- [CALCulate<n>:MARKer<m>:FUNctIon:FPEaks:Y?](#) on page 219

**Remote commands exclusive to retrieving marker results:**

<a href="#">CALCulate&lt;n&gt;:DELTaMarker&lt;m&gt;:X:RELative?</a> .....	228
<a href="#">CALCulate&lt;n&gt;:DELTaMarker&lt;m&gt;:Y?</a> .....	229
<a href="#">CALCulate&lt;n&gt;:MARKer&lt;m&gt;:Y?</a> .....	229
<a href="#">MMEMory:STORe&lt;n&gt;:LIST</a> .....	229

**CALCulate<n>:DELTaMarker<m>:X:RELative?**

This command queries the relative position of a delta marker on the x-axis.

If necessary, the command activates the delta marker first.

**Suffix:**

<n> [Window](#)

<m> [Marker](#)

**Return values:**

<Position> Position of the delta marker in relation to the reference marker.

**Example:**

CALC:DELT3:X:REL?

Outputs the frequency of delta marker 3 relative to marker 1 or relative to the reference position.

**Usage:** Query only

**CALCulate<n>:DELTaMarker<m>:Y?**

Queries the result at the position of the specified delta marker.

**Suffix:**

<n> 1..n

<m> 1..n

**Return values:**

<Result> Result at the position of the delta marker.  
The unit is variable and depends on the one you have currently set.

Default unit: DBM

**Usage:** Query only

**CALCulate<n>:MARKer<m>:Y?**

Queries the result at the position of the specified marker.

**Suffix:**

<n> 1..n

<m> 1..n

**Return values:**

<Result> Default unit: DBM

**Usage:** Query only

**Manual operation:** See "[Marker Table](#)" on page 16  
See "[Marker Peak List](#)" on page 16

**MMEMory:STORe<n>:LIST <FileName>**

This command exports the SEM and spurious emission list evaluation to a file.

The file format is \*.dat.

**Suffix:**

<n> [Window](#)

**Parameters:**

<FileName> String containing the path and name of the target file.

**Example:** `MMEM:STOR:LIST 'test'`  
Stores the current list evaluation results in the `test.dat` file.

## 9.9 Importing and exporting I/Q data and results

Alternatively to capturing I/Q data by the I/Q Analyzer itself, stored I/Q data from previous measurements or other applications can be imported to the I/Q Analyzer. Furthermore, I/Q data processed in the I/Q Analyzer can be stored to a file for further evaluation in other applications.



I/Q data can only be exported in applications that process I/Q data, such as the I/Q Analyzer or optional applications.

For details see [Chapter 4.4, "I/Q data import and export"](#), on page 27.

<a href="#">MMEMory:LOAD:IQ:STATe</a> .....	230
<a href="#">MMEMory:STORe&lt;n&gt;:IQ:COMMeNt</a> .....	230
<a href="#">MMEMory:STORe&lt;n&gt;:IQ:FORMat</a> .....	231
<a href="#">MMEMory:STORe&lt;n&gt;:IQ:STATe</a> .....	231

---

### **MMEMory:LOAD:IQ:STATe** 1, <FileName>

This command restores I/Q data from a file.

The file extension is \*.iq.tar.

#### **Setting parameters:**

<FileName>                    string  
String containing the path and name of the source file.

**Example:**                    `MMEM:LOAD:IQ:STAT 1, 'C:  
  \R_S\Instr\user\data.iq.tar'`  
Loads IQ data from the specified file.

**Usage:**                      Setting only

**Manual operation:**        See "[I/Q Import](#)" on page 32

---

### **MMEMory:STORe<n>:IQ:COMMeNt** <Comment>

This command adds a comment to a file that contains I/Q data.

#### **Suffix:**

<n>                              irrelevant

#### **Parameters:**

<Comment>                    String containing the comment.

**Example:** `MMEM:STOR:IQ:COMM 'Device test 1b'`  
Creates a description for the export file.  
`MMEM:STOR:IQ:STAT 1, 'C:`  
`\R_S\Instr\user\data.iq.tar'`  
Stores I/Q data and the comment to the specified file.

**Manual operation:** See "[I/Q Export](#)" on page 34

### **MMEMory:STORe<n>:IQ:FORMat <Format>,<DataFormat>**

This command sets or queries the format of the I/Q data to be stored.

**Suffix:**

<n> irrelevant

**Parameters:**

<Format> **FLOat32**  
32-bit floating point format.

**INT32**  
32-bit integer format.

\*RST: FLOat32

<DataFormat> **COMPLex**  
Exports complex data.

**REAL**  
Exports real data.

\*RST: COMPLex

**Example:** `MMEM:STOR:IQ:FORM INT32,REAL`

### **MMEMory:STORe<n>:IQ:STATe <1>, <FileName>**

This command writes the captured I/Q data to a file.

The file extension is \*.iq.tar. By default, the contents of the file are in 32-bit floating point format.

**Suffix:**

<n> 1..n

**Parameters:**

<1>

<FileName> String containing the path and name of the target file.

**Example:** `MMEM:STOR:IQ:STAT 1, 'C:`  
`\R_S\Instr\user\data.iq.tar'`  
Stores the captured I/Q data to the specified file.

**Manual operation:** See "[I/Q Export](#)" on page 34

## 9.10 Programming examples

The following programming examples demonstrate how to capture I/Q data and perform I/Q data analysis using the I/Q Analyzer in a remote environment.

- [I/Q analysis with graphical evaluation](#)..... 232
- [Basic I/Q analysis with improved performance](#)..... 233

### 9.10.1 I/Q analysis with graphical evaluation

This example demonstrates how to configure and perform a basic I/Q data acquisition and analyze the data using the I/Q Analyzer in a remote environment.

```
//-----Activating the I/Q Analyzer application -----
*RST
//Reset the instrument
INST:CRE IQ,'IQANALYZER'
//Creates a new measurement channel named 'IQANALYZER'.
INIT:CONT OFF
//Switches to single sweep mode

//-----Configuring Data Acquisition-----
TRAC:IQ:SRAT 32MHZ
//Defines the sample rate.
TRAC:IQ:RLEN 1000
//Sets the record length (number of samples to capture) to 1000 samples.
TRAC:IQ:BWID?
//Queries the bandwidth of the resampling filter, determined by the sample rate
FORM:DATA REAL,32
//Formats the data as 32-byte real values.
TRAC:IQ:DATA:FORM IQBL
//Lists all I values first, then all Q values in the trace results.

//-----Configuring the Trace-----
TRAC:IQ:AVER ON
//Defines averaging for the I/Q trace.
TRAC:IQ:AVER:COUN 10
//Defines an average over 10 sweeps.

DISP:TRAC1:MODE WRIT
DISP:TRAC2:MODE MAXH
DISP:TRAC3:MODE MINH
//Changes the trace modes.

//-----Performing the Measurement-----
INIT;*WAI
//Initiates a new measurement and waits until the sweep has finished.

//-----Retrieving Results-----
```



```

TRAC:DATA? TRACE1
TRAC:DATA? TRACE2
TRAC:DATA? TRACE3
//Returns the magnitude for each sweep point

LAY:REPL:WIND '1',RIMAG
//Changes the result display to Real/Imag (I/Q)

CALC:MARK:SEAR MAGN
//Configures searches to search both I and Q branches.
CALC:MARK:Y?
//Queries the result of the peak search on both branches.

TRAC:IQ:DATA:MEM? 0,500
//Returns the first 500 samples of the stored I/Q data for the measurement.
//For each sample, first the I-value, then the Q-value is listed.

TRAC:IQ:DATA:MEM? 500,500
//Returns the second half of the 1000 captured sample values.

```

### 9.10.2 Basic I/Q analysis with improved performance

This example demonstrates how to configure and perform a basic I/Q data acquisition and analyze the data using the I/Q Analyzer functionality in a remote environment.

```

//-----Activating the I/Q Analyzer application -----
*RST
//Reset the instrument

INIT:CONT OFF
//Switches to single sweep mode
TRACE:IQ ON
//Switches the (internal) operating mode of the current measurement channel to
//simple I/Q data acquisition mode while retaining the relevant parameters
//from the Spectrum mode.

//-----Configuring Data Acquisition-----
TRACE:IQ:SET NORM,0,32000000,IQP,POS,0,1000
//Configures the sample rate as 32 MHz, IQP trigger, positive trigger slope,
//no pretrigger samples, 1000 samples to capture
FORM REAL,32
//The data is formatted as real values.

//-----Configuring I/Q Gating-----
TRAC:IQ:EGAT ON
//Turns on gated measurement.
TRAC:IQ:EGAT:TYPE LEV

```

```
//Select the level gate type.
TRAC:IQ:EGAT:LENG 20
//Sets the gate length to 20 samples.
TRAC:IQ:EGAT:GAP 20
//Sets the interval between gate periods to 20 samples.
TRAC:IQ:EGAT:NOF 2
//Sets the number of gate periods after the trigger signal to 2.
TRIG:SOUR IQP
//Defines the magnitude of the sampled I/Q data to be used as a trigger.
TRIG:LEV:IQP -30dbm
//Sets the trigger level.

//-----Performing the Measurement and Retrieving Results-----
TRAC:IQ:DATA?; *WAI;
//Performs a measurement and returns the RF input voltage at each sample point
//(first 1000 I-values, then 1000 Q-values).

TRAC:IQ:DATA:MEM? 0,500
//Returns the first 500 samples of the stored trace data for the measurement.
//For each sample, first the I-value, then the Q-value is listed.

TRAC:IQ:DATA:MEM? 500,500
//Returns the second half of the 1000 captured sample values.
```

## Annex

# A Formats for returned values: ASCII format and binary format

When trace data is retrieved using the `TRAC:DATA` or `TRAC:IQ:DATA` command, the data is returned in the format defined using the `FORMat[:DATA]` on page 223. The possible formats are described here.

- **ASCII Format (FORMat ASCII):**  
The data is stored as a list of comma-separated values (CSV) of the measured values in floating point format.
- **Binary Format (FORMat REAL,16/32/64):**  
The data is stored as binary data (definite length block data according to IEEE 488.2), each measurement value being formatted in 16-bit/32-bit/64-bit IEEE 754 floating-point-format.  
The schema of the result string is as follows:  
#<Length of length><Length of data><value1><value2>...<value n>  
with:

<Length of length>	Number of digits of the following number of data bytes
<Length of data>	Number of following data bytes
<Value>	2-byte/4-byte/8-byte floating point value

**Example:** #41024<Data>... contains 1024 data bytes

### Data blocks larger than 999,999,999 bytes

According to SCPI, the header of the block data format allows for a maximum of 9 characters to describe the data length. Thus, the maximum REAL 32 data that can be represented is 999,999,999 bytes. However, the R&S FPL1000 is able to send larger data blocks. In this case, the length of the data block is placed in brackets, e.g.  
#(1234567890)<value1><value2>...



Reading out data in binary format is quicker than in ASCII format. Thus, binary format is recommended for large amounts of data.

## B Reference: format description for I/Q data files

This section describes how I/Q data is transferred to the memory during remote control (see `TRACe: IQ: DATA: FORMat` command).

For details on the format of the individual values, see [Chapter A, "Formats for returned values: ASCII format and binary format"](#), on page 235.

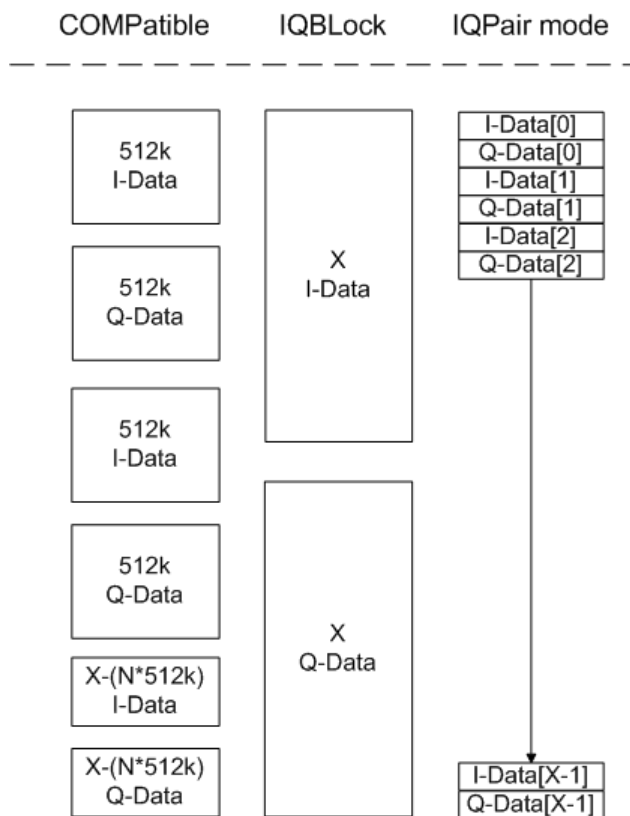

**Figure B-1:** I/Q data formats

**Note:** 512k corresponds to 524288 samples

For maximum performance, the formats "Compatible" or "IQPair" should be used. Furthermore, for large amounts of data, the data should be in binary format to improve performance.

In binary format, the number of I- and Q-data can be calculated as follows:

$$\# \text{ of I-Data} = \# \text{ of Q-Data} = \frac{\# \text{ of DataBytes}}{8}$$

For the format "QBLock", the offset of Q-data in the output buffer can be calculated as follows:

$$Q - \text{Data} - \text{Offset} = \frac{(\# \text{ of } \text{DataBytes})}{2} + \text{LengthIndicatorDigits}$$

with "LengthIndicatorDigits" being the number of digits of the length indicator including the #. In the example above (#41024...), this results in a value of 6 for "LengthIndicatorDigits" and the offset for the Q-data results in  $512 + 6 = 518$ .

## C I/Q data file format (iq-tar)

I/Q data is packed in a file with the extension `.iq.tar`. An `iq-tar` file contains I/Q data in binary format together with meta information that describes the nature and the source of data, e.g. the sample rate. The objective of the `iq-tar` file format is to separate I/Q data from the meta information while still having both inside one file. In addition, the file format allows you to include user-specific data and to preview the I/Q data in a web browser (not supported by all web browsers).

The `iq-tar` container packs several files into a single `.tar` archive file. Files in `.tar` format can be unpacked using standard archive tools (see [http://en.wikipedia.org/wiki/Comparison\\_of\\_file\\_archivers](http://en.wikipedia.org/wiki/Comparison_of_file_archivers)) available for most operating systems. The advantage of `.tar` files is that the archived files inside the `.tar` file are not changed (not compressed) and thus it is possible to read the I/Q data directly within the archive without the need to unpack (`untar`) the `.tar` file first.



### Sample iq-tar files

Some sample `iq-tar` files are provided in the `C:\Users\Public\Documents\Rohde-Schwarz\Analyzer\user\Demo\` directory on the R&S FPL1000.



An application note on converting Rohde & Schwarz I/Q data files is available from the Rohde & Schwarz website:

[1EF85: Converting R&S I/Q data files](#)

### Contained files

An `iq-tar` file must contain the following files:

- **I/Q parameter XML file**, e.g. `xyz.xml`  
Contains meta information about the I/Q data (e.g. sample rate). The filename can be defined freely, but there must be only one single I/Q parameter XML file inside an `iq-tar` file.
- **I/Q data binary file**, e.g. `xyz.complex.float32`  
Contains the binary I/Q data of all channels. There must be only one single I/Q data binary file inside an `iq-tar` file.

Optionally, an `iq-tar` file can contain the following file:

- **I/Q preview XSLT file**, e.g. `open_IqTar_xml_file_in_web_browser.xslt`  
Contains a stylesheet to display the I/Q parameter XML file and a preview of the I/Q data in a web browser (not supported by all web browsers).  
A sample stylesheet is available at [http://www.rohde-schwarz.com/file/open\\_IqTar\\_xml\\_file\\_in\\_web\\_browser.xslt](http://www.rohde-schwarz.com/file/open_IqTar_xml_file_in_web_browser.xslt).

- [I/Q parameter XML file specification](#)..... 239
- [I/Q data binary file](#)..... 243

## C.1 I/Q parameter XML file specification



The content of the I/Q parameter XML file must comply with the XML schema `RsIqTar.xsd` available at: <http://www.rohde-schwarz.com/file/RsIqTar.xsd>.

In particular, the order of the XML elements must be respected, i.e. `iq-tar` uses an "ordered XML schema". For your own implementation of the `iq-tar` file format make sure to validate your XML file against the given schema.

The following example shows an I/Q parameter XML file. The XML elements and attributes are explained in the following sections.

### Sample I/Q parameter XML file: xyz.xml

```
<?xml version="1.0" encoding="UTF-8"?>
<?xml-stylesheet type="text/xsl"
href="open_IqTar_xml_file_in_web_browser.xslt"?>
<RS_IQ_TAR_FileFormat fileFormatVersion="1"
xsi:noNamespaceSchemaLocation="RsIqTar.xsd"
xmlns:xsi="http://www.w3.org/2001/XMLSchema-instance">
  <Name>R&S FPL1000</Name>
  <Comment>Here is a comment</Comment>
  <DateTime>2011-01-24T14:02:49</DateTime>
  <Samples>68751</Samples>
  <Clock unit="Hz">6.5e+006</Clock>
  <Format>complex</Format>
  <DataType>float32</DataType>
  <ScalingFactor unit="V">1</ScalingFactor>
  <NumberOfChannels>1</NumberOfChannels>
  <DataFilename>xyz.complex.float32</DataFilename>
  <UserData>
    <UserDefinedElement>Example</UserDefinedElement>
  </UserData>
  <PreviewData>...</PreviewData>
</RS_IQ_TAR_FileFormat>
```

### C.1.1 Minimum data elements

The following data elements are the minimum required for a valid `iq-tar` file. They are always provided by an `iq-tar` file export from a Rohde & Schwarz product. If not specified otherwise, it must be available in all `iq-tar` files used to import data to a Rohde & Schwarz product.

Element	Possible Values	Description
<RS_IQ_TAR_FileFormat>	-	The root element of the XML file. It must contain the attribute <code>fileFormatVersion</code> that contains the number of the file format definition.
<Name>	string	Optional: describes the device or application that created the file.
<Comment>	string	Optional: contains text that further describes the contents of the file.
<DateTime>	yyyy-mm-ddThh:mm:ss	Contains the date and time of the creation of the file. Its type is <code>xs:dateTime</code> (see <code>RsIqTar.xsd</code> ).
<Samples>	integer	Contains the number of samples of the I/Q data. For multi-channel signals all channels have the same number of samples. One sample can be: <ul style="list-style-type: none"> <li>• A complex number represented as a pair of I and Q values</li> <li>• A complex number represented as a pair of magnitude and phase values</li> <li>• A real number represented as a single real value</li> </ul> See also <Format> element.
<Clock>	double	Contains the clock frequency in Hz, i.e. the sample rate of the I/Q data. A signal generator typically outputs the I/Q data at a rate that equals the clock frequency. If the I/Q data was captured with a signal analyzer, the signal analyzer used the clock frequency as the sample rate. The attribute <code>unit</code> must be set to "Hz".
<Format>	complex   real   polar	Specifies how the binary data is saved in the I/Q data binary file (see <DataFilename> element). Every sample must be in the same format. The format can be one of the following: <ul style="list-style-type: none"> <li>• <code>complex</code>: Complex number in cartesian format, i.e. I and Q values interleaved. I and Q are unitless</li> <li>• <code>real</code>: Real number (unitless)</li> <li>• <code>polar</code>: Complex number in polar format, i.e. magnitude (unitless) and phase (rad) values interleaved. Requires <code>DataType = float32 or float64</code></li> </ul>
<DataType>	int8   int16   int32   float32   float64	Specifies the binary format used for samples in the I/Q data binary file (see <DataFilename> element and <a href="#">Chapter C.2, "I/Q data binary file"</a> , on page 243). The following data types are allowed: <ul style="list-style-type: none"> <li>• <code>int8</code>: 8 bit signed integer data</li> <li>• <code>int16</code>: 16 bit signed integer data</li> <li>• <code>int32</code>: 32 bit signed integer data</li> <li>• <code>float32</code>: 32 bit floating point data (IEEE 754)</li> <li>• <code>float64</code>: 64 bit floating point data (IEEE 754)</li> </ul>
<ScalingFactor>	double	Optional: describes how the binary data can be transformed into values in the unit Volt. The binary I/Q data itself has no unit. To get an I/Q sample in the unit Volt the saved samples have to be multiplied by the value of the <ScalingFactor>. For polar data only the magnitude value has to be multiplied. For multi-channel signals the <ScalingFactor> must be applied to all channels. The attribute <code>unit</code> must be set to "v".  The <ScalingFactor> must be > 0. If the <ScalingFactor> element is not defined, a value of 1 V is assumed.



Element	Possible Values	Description
<NumberOfChannels>	integer	Optional: specifies the number of channels, e.g. of a MIMO signal, contained in the I/Q data binary file. For multi-channels, the I/Q samples of the channels are expected to be interleaved within the I/Q data file (see <a href="#">Chapter C.2, "I/Q data binary file"</a> , on page 243). If the <NumberOfChannels> element is not defined, one channel is assumed.
<DataFilename>		Contains the filename of the I/Q data binary file that is part of the iq-tar file.  It is recommended that the filename uses the following convention: <xyz>.<Format>.<Channels>ch.<Type> <ul style="list-style-type: none"> <li>• &lt;xyz&gt; = a valid Windows file name</li> <li>• &lt;Format&gt; = complex, polar or real (see <a href="#">Format</a> element)</li> <li>• &lt;Channels&gt; = Number of channels (see <a href="#">NumberOfChannels</a> element)</li> <li>• &lt;Type&gt; = float32, float64, int8, int16, int32 or int64 (see <a href="#">DataType</a> element)</li> </ul> Examples: <ul style="list-style-type: none"> <li>• xyz.complex.1ch.float32</li> <li>• xyz.polar.1ch.float64</li> <li>• xyz.real.1ch.int16</li> <li>• xyz.complex.16ch.int8</li> </ul>
<UserData>	xml	Optional: contains user, application or device-specific XML data which is not part of the iq-tar specification. This element can be used to store additional information, e.g. the hardware configuration. User data must be valid XML content.
<PreviewData>	xml	Optional: contains further XML elements that provide a preview of the I/Q data. The preview data is determined by the routine that saves an iq-tar file (e.g. R&S FPL1000). For the definition of this element refer to the <a href="#">RsIqTar.xsd</a> schema. Note that the preview can be only displayed by current web browsers that have JavaScript enabled and if the XSLT stylesheet <a href="#">open_IqTar_xml_file_in_web_browser.xslt</a> is available.

## C.1.2 Example

The following example demonstrates the XML description inside the iq-tar file. Note that this preview is not supported by all web browsers.

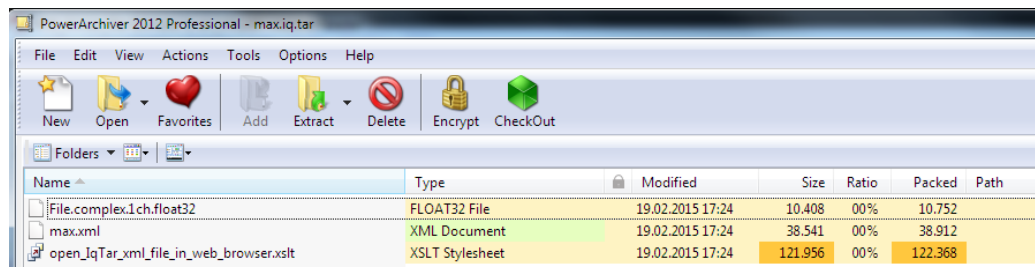

Open the xml file in a web browser. If the stylesheet [open\\_IqTar\\_xml\\_file\\_in\\_web\\_browser.xslt](#) is in the same directory, the web browser displays the xml file in a readable format.

**max.xml (of .iq.tar file)**

Description	
Saved by	VSE_1.10
Date & Time	2014-11-24 14:34:06
Sample rate	32 MHz
Number of samples	3200300
Duration of signal	100.009 ms
Data format	complex, float32
Data filename	File.complex.1ch.float32
Scaling factor	1 V

**IQ Analyzer**

**Power vs time**  
y-axis: 10 dB /div  
x-axis: 10 ms /div

**Spectrum**  
y-axis: 10 dB /div  
x-axis: 5 MHz /div

**I/Q**

```
<?xml version="1.0" encoding="UTF-8"?>
<?xml-stylesheet type="text/xsl" href="open_IqTar_xml_file_in_web_browser.xslt"?>
<RS_IQ_TAR_FileFormat fileFormatVersion="1" xsi:noNamespaceSchemaLocation=
"http://www.rohde-schwarz.com/file/RsIqTar.xsd" xmlns:xsi=
"http://www.w3.org/2001/XMLSchema-instance">
  <Name>VSE_1.10a 29 Beta</Name>
  <Comment></Comment>
  <DateTime>2015-02-19T15:24:58</DateTime>
  <Samples>1301</Samples>
  <Clock unit="Hz">32000000</Clock>
  <Format>complex</Format>
  <DataType>float32</DataType>
```

```

<ScalingFactor unit="V">1</ScalingFactor>
<NumberOfChannels>1</NumberOfChannels>
<DataFilename>File.complex.1ch.float32</DataFilename>

<UserData>
  <RohdeSchwarz>
    <DataImportExport_MandatoryData>
      <ChannelNames>
        <ChannelName>IQ Analyzer</ChannelName>
      </ChannelNames>
      <CenterFrequency unit="Hz">0</CenterFrequency>
    </DataImportExport_MandatoryData>
    <DataImportExport_OptionalData>
      <Key name="Ch1_NumberOfPostSamples">150</Key>
      <Key name="Ch1_NumberOfPreSamples">150</Key>
    </DataImportExport_OptionalData>
  </RohdeSchwarz>
</UserData>

</RS_IQ_TAR_FileFormat>

```

**Example: ScalingFactor**

Data stored as int16 and a desired full scale voltage of 1 V

ScalingFactor = 1 V / maximum int16 value = 1 V / 2<sup>15</sup> = 3.0517578125e-5 V

Scaling Factor	Numerical value	Numerical value x ScalingFactor
Minimum (negative) int16 value	- 2 <sup>15</sup> = - 32768	-1 V
Maximum (positive) int16 value	2 <sup>15</sup> -1= 32767	0.999969482421875 V

## C.2 I/Q data binary file

The I/Q data is saved in binary format according to the format and data type specified in the XML file (see <Format> element and <DataType> element). To allow reading and writing of streamed I/Q data, all data is interleaved, i.e. complex values are interleaved pairs of I and Q values and multi-channel signals contain interleaved (complex) samples for channel 0, channel 1, channel 2 etc. If the <NumberOfChannels> element is not defined, one channel is presumed.

**Example: Element order for real data (1 channel)**

```

I[0],           // Real sample 0
I[1],           // Real sample 1
I[2],           // Real sample 2
...

```

**Example: Element order for complex cartesian data (1 channel)**

```
I[0], Q[0],           // Real and imaginary part of complex sample 0
I[1], Q[1],           // Real and imaginary part of complex sample 1
I[2], Q[2],           // Real and imaginary part of complex sample 2
...
```

**Example: Element order for complex polar data (1 channel)**

```
Mag[0], Phi[0],       // Magnitude and phase part of complex sample 0
Mag[1], Phi[1],       // Magnitude and phase part of complex sample 1
Mag[2], Phi[2],       // Magnitude and phase part of complex sample 2
...
```

**Example: Element order for complex cartesian data (3 channels)**

Complex data: I[channel no][time index], Q[channel no][time index]

```
I[0][0], Q[0][0],     // Channel 0, Complex sample 0
I[1][0], Q[1][0],     // Channel 1, Complex sample 0
I[2][0], Q[2][0],     // Channel 2, Complex sample 0

I[0][1], Q[0][1],     // Channel 0, Complex sample 1
I[1][1], Q[1][1],     // Channel 1, Complex sample 1
I[2][1], Q[2][1],     // Channel 2, Complex sample 1

I[0][2], Q[0][2],     // Channel 0, Complex sample 2
I[1][2], Q[1][2],     // Channel 1, Complex sample 2
I[2][2], Q[2][2],     // Channel 2, Complex sample 2
...
```

**Example: Element order for complex cartesian data (1 channel)**

This example demonstrates how to store complex cartesian data in float32 format using MATLAB®.

```
% Save vector of complex cartesian I/Q data, i.e. iqiqli...
N = 100
iq = randn(1,N)+1j*randn(1,N)
fid = fopen('xyz.complex.float32','w');
for k=1:length(iq)
    fwrite(fid, single(real(iq(k))), 'float32');
    fwrite(fid, single(imag(iq(k))), 'float32');
end
fclose(fid)
```

**Example: PreviewData in XML**

```
<PreviewData>
  <ArrayOfChannel length="1">
    <Channel>
      <PowerVsTime>
        <Min>
```

```

        <ArrayOfFloat length="256">
            <float>-134</float>
            <float>-142</float>
            ...
            <float>-140</float>
        </ArrayOfFloat>
    </Min>
    <Max>
        <ArrayOfFloat length="256">
            <float>-70</float>
            <float>-71</float>
            ...
            <float>-69</float>
        </ArrayOfFloat>
    </Max>
</PowerVsTime>
<Spectrum>
    <Min>
        <ArrayOfFloat length="256">
            <float>-133</float>
            <float>-111</float>
            ...
            <float>-111</float>
        </ArrayOfFloat>
    </Min>
    <Max>
        <ArrayOfFloat length="256">
            <float>-67</float>
            <float>-69</float>
            ...
            <float>-70</float>
            <float>-69</float>
        </ArrayOfFloat>
    </Max>
</Spectrum>
<IQ>
    <Histogram width="64" height="64">0123456789...0</Histogram>
</IQ>
</Channel>
</ArrayOfChannel>
</PreviewData>

```

## List of commands

[SENSe:] [WINDow<n>:] DETector<t>[:FUNCTION]	173
[SENSe:] [WINDow<n>:] DETector<t>[:FUNCTION]:AUTO	174
[SENSe:]ADJust:ALL	152
[SENSe:]ADJust:CONFigure:HYSTeresis:LOWer	154
[SENSe:]ADJust:CONFigure:HYSTeresis:UPPer	154
[SENSe:]ADJust:CONFigure:LEVel:DURation	153
[SENSe:]ADJust:CONFigure:LEVel:DURation:MODE	153
[SENSe:]ADJust:CONFigure:TRIGger	154
[SENSe:]ADJust:FREQuency	155
[SENSe:]ADJust:LEVel	155
[SENSe:]AVERage<n>:COUNT	174
[SENSe:]AVERage<n>:TYPE	173
[SENSe:]AVERage<n>[:STATe<t>]	175
[SENSe:]FREQuency:CENTer	138
[SENSe:]FREQuency:CENTer:STEP	138
[SENSe:]FREQuency:CENTer:STEP:AUTO	138
[SENSe:]FREQuency:OFFSet	139
[SENSe:]IQ: BANDwidth:MODE	146
[SENSe:]IQ: BANDwidth:RESolution	147
[SENSe:]IQ: BWIDth:MODE	146
[SENSe:]IQ: BWIDth:RESolution	147
[SENSe:]IQ: FFT:ALGorithm	147
[SENSe:]IQ: FFT:LENGth	148
[SENSe:]IQ: FFT:WINDow:LENGth	148
[SENSe:]IQ: FFT:WINDow:OVERlap	148
[SENSe:]IQ: FFT:WINDow:TYPE	149
[SENSe:]PMETer<p>:DCYCLe:VALue	124
[SENSe:]PMETer<p>:DCYCLe[:STATe]	124
[SENSe:]PMETer<p>:FREQuency	125
[SENSe:]PMETer<p>:FREQuency:LINK	125
[SENSe:]PMETer<p>:MTIME	126
[SENSe:]PMETer<p>:MTIME:AVERage:COUNT	126
[SENSe:]PMETer<p>:MTIME:AVERage[:STATe]	126
[SENSe:]PMETer<p>:ROFFset[:STATe]	127
[SENSe:]PMETer<p>:SOFFset	127
[SENSe:]PMETer<p>:UPDate[:STATe]	128
[SENSe:]PMETer<p>[:STATe]	127
[SENSe:]SWAPiq	149
[SENSe:]SWEep:COUNT	167
[SENSe:]SWEep:COUNT:CURRent?	167
[SENSe:]SWEep:TIME	168
[SENSe:]SWEep[:WINDow<n>]:POINTs	168
ABORT	164
CALCulate<n>:DELTAmarker<m>:AOFF	184
CALCulate<n>:DELTAmarker<m>:FUNCTION:BPOWer:MODE	214
CALCulate<n>:DELTAmarker<m>:FUNCTION:BPOWer:RESult?	215
CALCulate<n>:DELTAmarker<m>:FUNCTION:BPOWer:SPAN	215

CALCulate<n>:DELTamarker<m>:FUNction:BPOWer[:STATe].....	215
CALCulate<n>:DELTamarker<m>:LINK.....	184
CALCulate<n>:DELTamarker<m>:MAXimum:LEFT.....	209
CALCulate<n>:DELTamarker<m>:MAXimum:NEXT.....	210
CALCulate<n>:DELTamarker<m>:MAXimum:RIGHT.....	210
CALCulate<n>:DELTamarker<m>:MAXimum[:PEAK].....	210
CALCulate<n>:DELTamarker<m>:MINimum:LEFT.....	211
CALCulate<n>:DELTamarker<m>:MINimum:NEXT.....	211
CALCulate<n>:DELTamarker<m>:MINimum:RIGHT.....	211
CALCulate<n>:DELTamarker<m>:MINimum[:PEAK].....	211
CALCulate<n>:DELTamarker<m>:MODE.....	186
CALCulate<n>:DELTamarker<m>:MREFerence.....	186
CALCulate<n>:DELTamarker<m>:SGRam:FRAMe.....	202
CALCulate<n>:DELTamarker<m>:SGRam:SARea.....	202
CALCulate<n>:DELTamarker<m>:SGRam:XY:MAXimum[:PEAK].....	203
CALCulate<n>:DELTamarker<m>:SGRam:XY:MINimum[:PEAK].....	203
CALCulate<n>:DELTamarker<m>:SGRam:Y:MAXimum:ABOVe.....	203
CALCulate<n>:DELTamarker<m>:SGRam:Y:MAXimum:BELow.....	204
CALCulate<n>:DELTamarker<m>:SGRam:Y:MAXimum:NEXT.....	204
CALCulate<n>:DELTamarker<m>:SGRam:Y:MAXimum[:PEAK].....	204
CALCulate<n>:DELTamarker<m>:SGRam:Y:MINimum:ABOVe.....	204
CALCulate<n>:DELTamarker<m>:SGRam:Y:MINimum:BELow.....	205
CALCulate<n>:DELTamarker<m>:SGRam:Y:MINimum:NEXT.....	205
CALCulate<n>:DELTamarker<m>:SGRam:Y:MINimum[:PEAK].....	205
CALCulate<n>:DELTamarker<m>:SPECTrogram:FRAMe.....	202
CALCulate<n>:DELTamarker<m>:SPECTrogram:SARea.....	202
CALCulate<n>:DELTamarker<m>:SPECTrogram:XY:MAXimum[:PEAK].....	203
CALCulate<n>:DELTamarker<m>:SPECTrogram:XY:MINimum[:PEAK].....	203
CALCulate<n>:DELTamarker<m>:SPECTrogram:Y:MAXimum:ABOVe.....	203
CALCulate<n>:DELTamarker<m>:SPECTrogram:Y:MAXimum:BELow.....	204
CALCulate<n>:DELTamarker<m>:SPECTrogram:Y:MAXimum:NEXT.....	204
CALCulate<n>:DELTamarker<m>:SPECTrogram:Y:MAXimum[:PEAK].....	204
CALCulate<n>:DELTamarker<m>:SPECTrogram:Y:MINimum:ABOVe.....	204
CALCulate<n>:DELTamarker<m>:SPECTrogram:Y:MINimum:BELow.....	205
CALCulate<n>:DELTamarker<m>:SPECTrogram:Y:MINimum:NEXT.....	205
CALCulate<n>:DELTamarker<m>:SPECTrogram:Y:MINimum[:PEAK].....	205
CALCulate<n>:DELTamarker<m>:TRACe.....	187
CALCulate<n>:DELTamarker<m>:X.....	187
CALCulate<n>:DELTamarker<m>:X:RELative?.....	228
CALCulate<n>:DELTamarker<m>:Y?.....	229
CALCulate<n>:DELTamarker<m>[:STATe].....	186
CALCulate<n>:DELTamarker<ms>:LINK:TO:DELTa<md>.....	185
CALCulate<n>:DELTamarker<ms>:LINK:TO:MARKer<md>.....	185
CALCulate<n>:MARKer<m>:AOFF.....	188
CALCulate<n>:MARKer<m>:FUNction:BPOWer:AOFF.....	212
CALCulate<n>:MARKer<m>:FUNction:BPOWer:MODE.....	212
CALCulate<n>:MARKer<m>:FUNction:BPOWer:RESult?.....	213
CALCulate<n>:MARKer<m>:FUNction:BPOWer:SPAN.....	213
CALCulate<n>:MARKer<m>:FUNction:BPOWer[:STATe].....	213
CALCulate<n>:MARKer<m>:FUNction:CENTer.....	137

CALCulate<n>:MARKer<m>:FUNction:FPEaks:ANNotation:LABel[:STATe].....	216
CALCulate<n>:MARKer<m>:FUNction:FPEaks:COUNt?.....	216
CALCulate<n>:MARKer<m>:FUNction:FPEaks:LIST:SIZE.....	217
CALCulate<n>:MARKer<m>:FUNction:FPEaks:SORT.....	218
CALCulate<n>:MARKer<m>:FUNction:FPEaks:STATe.....	218
CALCulate<n>:MARKer<m>:FUNction:FPEaks:X?.....	218
CALCulate<n>:MARKer<m>:FUNction:FPEaks:Y?.....	219
CALCulate<n>:MARKer<m>:FUNction:FPEaks[:IMMediate].....	217
CALCulate<n>:MARKer<m>:FUNction:REFerence.....	132
CALCulate<n>:MARKer<m>:LOEXclude.....	192
CALCulate<n>:MARKer<m>:MAXimum:AUTO.....	206
CALCulate<n>:MARKer<m>:MAXimum:LEFT.....	206
CALCulate<n>:MARKer<m>:MAXimum:NEXT.....	207
CALCulate<n>:MARKer<m>:MAXimum:RIGHT.....	207
CALCulate<n>:MARKer<m>:MAXimum[:PEAK].....	207
CALCulate<n>:MARKer<m>:MINimum:AUTO.....	208
CALCulate<n>:MARKer<m>:MINimum:LEFT.....	208
CALCulate<n>:MARKer<m>:MINimum:NEXT.....	208
CALCulate<n>:MARKer<m>:MINimum:RIGHT.....	209
CALCulate<n>:MARKer<m>:MINimum[:PEAK].....	209
CALCulate<n>:MARKer<m>:PEXCursion.....	192
CALCulate<n>:MARKer<m>:SEARch.....	193
CALCulate<n>:MARKer<m>:SGRam:FRAMe.....	197
CALCulate<n>:MARKer<m>:SGRam:SARea.....	198
CALCulate<n>:MARKer<m>:SGRam:XY:MAXimum[:PEAK].....	198
CALCulate<n>:MARKer<m>:SGRam:XY:MINimum[:PEAK].....	198
CALCulate<n>:MARKer<m>:SGRam:Y:MAXimum:ABOVe.....	199
CALCulate<n>:MARKer<m>:SGRam:Y:MAXimum:BELOW.....	199
CALCulate<n>:MARKer<m>:SGRam:Y:MAXimum:NEXT.....	199
CALCulate<n>:MARKer<m>:SGRam:Y:MAXimum[:PEAK].....	199
CALCulate<n>:MARKer<m>:SGRam:Y:MINimum:ABOVe.....	200
CALCulate<n>:MARKer<m>:SGRam:Y:MINimum:BELOW.....	200
CALCulate<n>:MARKer<m>:SGRam:Y:MINimum:NEXT.....	200
CALCulate<n>:MARKer<m>:SGRam:Y:MINimum[:PEAK].....	201
CALCulate<n>:MARKer<m>:SPECTrogram:FRAMe.....	197
CALCulate<n>:MARKer<m>:SPECTrogram:SARea.....	198
CALCulate<n>:MARKer<m>:SPECTrogram:XY:MAXimum[:PEAK].....	198
CALCulate<n>:MARKer<m>:SPECTrogram:XY:MINimum[:PEAK].....	198
CALCulate<n>:MARKer<m>:SPECTrogram:Y:MAXimum:ABOVe.....	199
CALCulate<n>:MARKer<m>:SPECTrogram:Y:MAXimum:BELOW.....	199
CALCulate<n>:MARKer<m>:SPECTrogram:Y:MAXimum:NEXT.....	199
CALCulate<n>:MARKer<m>:SPECTrogram:Y:MAXimum[:PEAK].....	199
CALCulate<n>:MARKer<m>:SPECTrogram:Y:MINimum:ABOVe.....	200
CALCulate<n>:MARKer<m>:SPECTrogram:Y:MINimum:BELOW.....	200
CALCulate<n>:MARKer<m>:SPECTrogram:Y:MINimum:NEXT.....	200
CALCulate<n>:MARKer<m>:SPECTrogram:Y:MINimum[:PEAK].....	201
CALCulate<n>:MARKer<m>:TRACe.....	189
CALCulate<n>:MARKer<m>:X.....	190
CALCulate<n>:MARKer<m>:X:SLIMits:LEFT.....	194
CALCulate<n>:MARKer<m>:X:SLIMits:RIGHT.....	194



CALCulate<n>:MARKer<m>:X:SLIMits:ZOOM[:STATe].....	195
CALCulate<n>:MARKer<m>:X:SLIMits[:STATe].....	193
CALCulate<n>:MARKer<m>:X:SSIZe.....	191
CALCulate<n>:MARKer<m>:Y?.....	229
CALCulate<n>:MARKer<m>[:STATe].....	189
CALCulate<n>:MARKer<ms>:LINK:TO:DELTA<md>.....	188
CALCulate<n>:MARKer<ms>:LINK:TO:MARKer<md>.....	188
CALCulate<n>:PMETer<p>:RELative:STATe.....	123
CALCulate<n>:PMETer<p>:RELative[:MAGNitude].....	123
CALCulate<n>:PMETer<p>:RELative[:MAGNitude]:AUTO ONCE.....	123
CALCulate<n>:SGRam:CLEAr[:IMMEDIATE].....	176
CALCulate<n>:SGRam:CONTInuous.....	177
CALCulate<n>:SGRam:FRAMe:COUNT.....	177
CALCulate<n>:SGRam:FRAMe:SELEct.....	177
CALCulate<n>:SGRam:HDEPth.....	178
CALCulate<n>:SGRam:LAYout.....	178
CALCulate<n>:SGRam:THReedim[:STATe].....	179
CALCulate<n>:SGRam:TRACe.....	180
CALCulate<n>:SGRam:TSTamp:DATA?.....	180
CALCulate<n>:SGRam:TSTamp[:STATe].....	181
CALCulate<n>:SGRam[:STATe].....	179
CALCulate<n>:SPECtrogram:CLEAr[:IMMEDIATE].....	176
CALCulate<n>:SPECtrogram:CONTInuous.....	177
CALCulate<n>:SPECtrogram:FRAMe:COUNT.....	177
CALCulate<n>:SPECtrogram:FRAMe:SELEct.....	177
CALCulate<n>:SPECtrogram:HDEPth.....	178
CALCulate<n>:SPECtrogram:LAYout.....	178
CALCulate<n>:SPECtrogram:THReedim[:STATe].....	179
CALCulate<n>:SPECtrogram:TRACe.....	180
CALCulate<n>:SPECtrogram:TSTamp:DATA?.....	180
CALCulate<n>:SPECtrogram:TSTamp[:STATe].....	181
CALCulate<n>:SPECtrogram[:STATe].....	179
CALCulate<n>:THReshold.....	195
CALCulate<n>:THReshold:STATe.....	196
CALCulate<n>:UNIT:POWER.....	132
CALibration:PMETer<p>:ZERO:AUTO ONCE.....	122
DIAGnostic:SERVice:NSOURce.....	129
DISPlay[:WINDow<n>]:MINFo[:STATe].....	191
DISPlay[:WINDow<n>]:MTABLe.....	190
DISPlay[:WINDow<n>]:SGRam:COLor:DEFault.....	181
DISPlay[:WINDow<n>]:SGRam:COLor:LOWer.....	182
DISPlay[:WINDow<n>]:SGRam:COLor:SHAPE.....	182
DISPlay[:WINDow<n>]:SGRam:COLor:UPPer.....	182
DISPlay[:WINDow<n>]:SGRam:COLor[:STYLe].....	183
DISPlay[:WINDow<n>]:SIZE.....	155
DISPlay[:WINDow<n>]:SPECtrogram:COLor:DEFault.....	181
DISPlay[:WINDow<n>]:SPECtrogram:COLor:LOWer.....	182
DISPlay[:WINDow<n>]:SPECtrogram:COLor:SHAPE.....	182
DISPlay[:WINDow<n>]:SPECtrogram:COLor:UPPer.....	182
DISPlay[:WINDow<n>]:SPECtrogram:COLor[:STYLe].....	183

DISPlay[:WINDow<n>][:SUBWindow<w>]:TRACe<t>:MODE.....	170
DISPlay[:WINDow<n>][:SUBWindow<w>]:TRACe<t>:MODE:HCONtinuous.....	171
DISPlay[:WINDow<n>][:SUBWindow<w>]:TRACe<t>:SMOothing:APERture.....	172
DISPlay[:WINDow<n>][:SUBWindow<w>]:TRACe<t>:SMOothing[:STATe].....	172
DISPlay[:WINDow<n>][:SUBWindow<w>]:TRACe<t>:Y:SPACing.....	137
DISPlay[:WINDow<n>][:SUBWindow<w>]:TRACe<t>:Y[:SCALe].....	135
DISPlay[:WINDow<n>][:SUBWindow<w>]:TRACe<t>:Y[:SCALe]:AUTO ONCE.....	136
DISPlay[:WINDow<n>][:SUBWindow<w>]:TRACe<t>:Y[:SCALe]:MODE.....	136
DISPlay[:WINDow<n>][:SUBWindow<w>]:TRACe<t>:Y[:SCALe]:RLEVel.....	133
DISPlay[:WINDow<n>][:SUBWindow<w>]:TRACe<t>:Y[:SCALe]:RLEVel:OFFSet.....	133
DISPlay[:WINDow<n>][:SUBWindow<w>]:TRACe<t>:Y[:SCALe]:RPOSition.....	136
DISPlay[:WINDow<n>][:SUBWindow<w>]:TRACe<t>[:STATe].....	171
FETCh:PMEter<p>?.....	124
FORMat:DEXPort:DSEParator.....	226
FORMat:DEXPort:FORMat.....	227
FORMat:DEXPort:HEADer.....	227
FORMat:DEXPort:TRACes.....	227
FORMat[:DATA].....	223
INITiate:SEQuencer:ABORT.....	166
INITiate:SEQuencer:IMMediate.....	166
INITiate:SEQuencer:MODE.....	166
INITiate<n>:CONMeas.....	164
INITiate<n>:CONtinuous.....	165
INITiate<n>[:IMMediate].....	165
INPut:ATTenuation:PROTection:RESet.....	117
INPut<ip>:ATTenuation.....	134
INPut<ip>:ATTenuation:AUTO.....	134
INPut<ip>:EATT:AUTO.....	134
INPut<ip>:FILE:PATH.....	120
INPut<ip>:FILTer:SAW.....	117
INPut<ip>:FILTer:YIG[:STATe].....	117
INPut<ip>:GAIN:STATe.....	135
INPut<ip>:IMPedance.....	118
INPut<ip>:SELEct.....	118
INPut<ip>:UPORt:STATe.....	119
INPut<ip>:UPORt[:VALue].....	119
INSTrument:CREate:DUPLicate.....	112
INSTrument:CREate:REPLace.....	113
INSTrument:CREate[:NEW].....	112
INSTrument:DELEte.....	113
INSTrument:LIST?.....	113
INSTrument:REName.....	114
INSTrument[:SELEct].....	115
LAYout:ADD[:WINDow]?.....	156
LAYout:CATalog[:WINDow]?.....	158
LAYout:IDENtify[:WINDow]?.....	158
LAYout:MOVE[:WINDow].....	158
LAYout:REMove[:WINDow].....	159
LAYout:REPLace[:WINDow].....	159
LAYout:SPLitter.....	160

LAYout:WINDow<n>:ADD?	161
LAYout:WINDow<n>:IDENtify?	162
LAYout:WINDow<n>:REMOve	162
LAYout:WINDow<n>:REPLace	162
LAYout:WINDow<n>:TYPE	163
MMEMory:LOAD:IQ:STATe	230
MMEMory:STORe<n>:IQ:COMMeNt	230
MMEMory:STORe<n>:IQ:FORMat	231
MMEMory:STORe<n>:IQ:STATe	231
MMEMory:STORe<n>:LIST	229
MMEMory:STORe<n>:PEAK	219
MMEMory:STORe<n>:TRACe	228
OUTPut:UPORt:WTRigger:POLarity	130
OUTPut<up>:UPORt:STATe	129
OUTPut<up>:UPORt[:VALue]	130
READ:PMETER<p>?	124
SYSTem:COMMunicate:RDEvice:PMETER<p>:CONFIgure:AUTO[:STATe]	120
SYSTem:COMMunicate:RDEvice:PMETER<p>:COUNT?	121
SYSTem:COMMunicate:RDEvice:PMETER<p>:DEFine	121
SYSTem:PRESet:CHANnel[:EXEC]	115
SYSTem:SEQuencer	168
SYSTem:SPEaker:MUTE	131
SYSTem:SPEaker:VOLume	131
SYSTem:SPEaker[:STATe]	130
TRACe:IQ:AVERage:COUNT	174
TRACe:IQ:AVERage[:STATe]	175
TRACe:IQ:BWIDth	149
TRACe:IQ:DATA:FORMat	221
TRACe:IQ:DATA:MEMory?	222
TRACe:IQ:DATA?	220
TRACe:IQ:EGATe:GAP	145
TRACe:IQ:EGATe:LENGth	145
TRACe:IQ:EGATe:NOF	145
TRACe:IQ:EGATe:TYPE	145
TRACe:IQ:EGATe[:STATe]	144
TRACe:IQ:EVAL	115
TRACe:IQ:RLENGth	150
TRACe:IQ:SET	150
TRACe:IQ:SRATe	151
TRACe:IQ:TPISAmple?	151
TRACe:IQ[:STATe]	116
TRACe<n>:COPY	174
TRACe<n>[:DATA]:MEMory?	225
TRACe<n>[:DATA]:X?	226
TRACe<n>[:DATA]?	224
TRIGger[:SEQuence]:DTIME	140
TRIGger[:SEQuence]:HOLDoff[:TIME]	140
TRIGger[:SEQuence]:IFPower:HOLDoff	140
TRIGger[:SEQuence]:IFPower:HYSTeresis	141
TRIGger[:SEQuence]:LEVel:IFPower	141

TRIGger[:SEQuence]:LEVel:IQPower.....	142
TRIGger[:SEQuence]:LEVel[:EXTernal<port>].....	141
TRIGger[:SEQuence]:SLOPe.....	142
TRIGger[:SEQuence]:SOURce.....	142
TRIGger[:SEQuence]:TIME:RINTerval.....	143
UNIT<n>:PMETer<p>:POWer.....	128
UNIT<n>:PMETer<p>:POWer:RATio.....	128
UNIT<n>:POWer.....	132

# Index

## Symbols

\*OPC ..... 139

## A

Aborting  
Sweep ..... 60, 61, 72, 73

Activating  
I/Q Analyzer (remote) ..... 111

All Functions Off ..... 101

Amplitude  
Configuration ..... 45  
Scaling ..... 49  
Settings ..... 44, 45

Analysis  
Bandwidth ..... 57  
Bandwidth, definition ..... 19  
I/Q data (remote) ..... 169  
Settings ..... 65

Application cards ..... 6

Application notes ..... 6

Applications  
I/Q Analyzer (remote) ..... 111

Att (channel setting) ..... 11

Attenuation  
Auto ..... 47  
Manual ..... 47  
Protective (remote) ..... 117

Audio demodulation  
Volume (remote control) ..... 130, 131

Auto adjustment  
Triggered measurement ..... 154

Auto all ..... 62

Auto frequency ..... 63

Auto level  
Hysteresis ..... 64  
Reference level ..... 47, 63  
Softkey ..... 47, 63

Auto settings  
Meastime Auto ..... 63  
Meastime Manual ..... 63

Average count ..... 60  
Power sensor ..... 41

Average mode  
Traces ..... 68

Averaging  
Traces (remote control) ..... 173

## B

Band power measurement  
Activating/Deactivating ..... 96  
Deactivating ..... 97  
Power mode ..... 97  
Span ..... 96

Band power measurement (remote control) ..... 212

Bandwidth  
Analysis ..... 57  
Extension options ..... 20  
I/Q Analyzer ..... 19  
Maximum usable ..... 19

Relationship to sample rate ..... 20  
Settings ..... 55

Basic Measurement Examples  
see User Manual ..... 5

Branch for peak search  
I/Q Analyzer ..... 86

Brochures ..... 6

## C

Calibration certificate ..... 7

Capture time  
see also Measurement time ..... 168

Capturing  
I/Q data, see Data acquisition ..... 163

Center = Mkr Freq ..... 91

Center frequency ..... 50  
Automatic configuration ..... 63  
Displayed ..... 11  
Setting to marker ..... 91  
Softkey ..... 50  
Step size ..... 51

Channel setup  
Creating (remote) ..... 113, 115  
Deleting (remote) ..... 113  
Duplicating (remote) ..... 112  
Querying (remote) ..... 113  
Renaming (remote) ..... 114  
Replacing (remote) ..... 113  
Selecting (remote) ..... 115

Closing  
Channel setups (remote) ..... 113  
Windows (remote) ..... 162

Color curve  
Shape ..... 74

Color mapping  
Color curve ..... 74  
Color range ..... 74, 75  
Color scheme ..... 75  
Softkey ..... 72  
Spectrograms ..... 72, 73

Color scheme  
Spectrogram ..... 75

Configuring  
Data acquisition (remote) ..... 146  
I/Q Analyzer (remote) ..... 116  
Markers (remote) ..... 183

Continue single sweep  
Softkey ..... 61

Continuous sweep  
Softkey ..... 60, 72

Conventions  
SCPI commands ..... 107

Copying  
Channel setup (remote) ..... 112  
Traces ..... 69

## D

Data acquisition  
Configuring (remote) ..... 146  
I/Q Analyzer ..... 18

- I/Q data (remote) ..... 163
- Settings ..... 55
- Data format
  - ASCII ..... 235
  - Binary ..... 235
  - Remote ..... 227
- Data sheets ..... 6
- Decimal separator
  - Trace export ..... 33, 77, 78
- Decimation
  - Data processing ..... 18
- Delta markers ..... 80
  - Defining ..... 80
- Demodulation
  - Display ..... 61
- Detectors
  - Remote control ..... 173
  - Trace ..... 67
- Diagram area
  - Hardware settings ..... 11
- Diagram footer information ..... 12
- Display configuration
  - Softkey ..... 61
- Drop-out time
  - Trigger ..... 54
- Duplicating
  - Channel setup (remote) ..... 112
- Duty cycle
  - Power sensor ..... 42
- E**
- Edge gate
  - Triggering ..... 144
- Electronic input attenuation ..... 47
- Equalizer
  - Data processing ..... 18
- Errors
  - IF OVLD ..... 46
- Evaluation methods
  - Remote ..... 156
- Exclude LO ..... 85
  - Remote ..... 192
- Exporting
  - Data ..... 34
  - I/Q data ..... 27, 29, 34, 104, 238, 243
  - I/Q data (remote) ..... 230
  - Measurement settings ..... 76
  - Peak list ..... 101
  - Softkey ..... 32
  - Traces ..... 33, 34, 75, 77
- External trigger ..... 53
  - Level (remote) ..... 141
- F**
- FFT
  - Fundamentals ..... 22
  - Measurement speed ..... 25
  - Window functions ..... 21, 59
- Files
  - Format, I/Q data ..... 238
  - I/Q data binary XML ..... 243
  - I/Q data input ..... 27, 37
  - I/Q parameter XML ..... 239
- Filters
  - Bandwidth, I/Q data ..... 57
  - Equalizer ..... 18
  - YIG (remote) ..... 117
- Format
  - Data ..... 235
  - Data (remote) ..... 227
  - I/Q data files ..... 236
- Frames
  - Spectrogram marker ..... 80
- Free Run
  - Trigger ..... 52
- Frequency
  - Configuration ..... 50
  - Configuration (remote) ..... 137
  - Coupling (power sensor) ..... 40
  - Offset ..... 51
  - Power sensor ..... 40
- G**
- Gating
  - I/Q data ..... 144
  - Source ..... 52
- Getting started ..... 5
- Group delay
  - Smoothing ..... 68
- H**
- Hardware settings
  - Displayed ..... 11
- History
  - Spectrograms ..... 72
- History Depth
  - Softkey ..... 72
- Hold
  - Trace setting ..... 68
- Hysteresis
  - Lower (Auto level) ..... 64
  - Trigger ..... 55
  - Upper (Auto level) ..... 64
- I**
- I/Q Analyzer
  - Data acquisition ..... 18
  - Evaluation ..... 13
  - I/Q Vector evaluation ..... 14
  - Magnitude evaluation ..... 13
  - Maximum bandwidth ..... 19
  - Modes ..... 112
  - Programming example ..... 232, 233
  - Real/Imag (I/Q) evaluation ..... 15
  - Results ..... 13
  - Sample rate ..... 19
  - Spectrum evaluation ..... 13
- I/Q data
  - Analog, processing ..... 18
  - Export file binary data description ..... 243
  - Export file parameter description ..... 239
  - Exporting ..... 29, 34
  - Exporting (remote) ..... 230
  - Exporting/Importing ..... 104
  - File format description ..... 236
  - Importing ..... 29, 32
  - Importing (remote) ..... 230

- Importing/Exporting ..... 27
- Input file ..... 37
- Input files ..... 27, 37
- Maximum bandwidth ..... 19
- Sample rate ..... 19
- Trigger point in sample (TPIS) ..... 151
- I/Q gating
  - Edge triggered ..... 144
  - Level triggered ..... 144
- I/Q measurements
  - Methods ..... 163
- I/Q Power
  - Trigger ..... 53
  - Trigger level (remote) ..... 142
- I/Q Vector
  - Evaluation method ..... 14
  - I/Q Analyzer ..... 14
  - Markers ..... 78, 183
  - Y-axis scaling ..... 50
- IF Power
  - Trigger ..... 53
  - Trigger level (remote) ..... 141
- Impedance
  - Setting ..... 36, 48
- Importing
  - I/Q data ..... 27, 29, 32, 104, 239
  - I/Q data (remote) ..... 230
  - Softkey ..... 32
- Input
  - I/Q data files ..... 37
  - Overload (remote) ..... 117
  - RF ..... 35
  - Signal, parameters ..... 34
- Input sample rate (ISR)
  - Definition ..... 19
- Input sources
  - I/Q data file ..... 37
  - I/Q data files ..... 27, 37
- Installation ..... 9
- Instrument security procedures ..... 6
- iq-tar
  - Example file ..... 241
  - Mandatory data elements ..... 239
- IQBlock
  - I/Q data files ..... 236
- IQPair
  - I/Q data files ..... 236
- K**
- Keys
  - LINES (not used) ..... 29
  - MKR ..... 78
  - MKR -> ..... 83, 89
  - Peak Search ..... 90
  - RUN CONT ..... 60, 72
  - RUN SINGLE ..... 60, 61, 73
- L**
- Level
  - Triggered gate ..... 144
- Limit lines
  - OBW ..... 85, 89, 93
  - Peak search ..... 85, 89, 93
- Linking
  - Markers ..... 80
- Lower Level Hysteresis ..... 64
- M**
- Magnitude
  - Evaluation method ..... 13
  - I/Q Analyzer ..... 13
- Marker
  - Search area (softkey) ..... 88, 93
  - Search type (softkey) ..... 88, 92
- Marker functions
  - Deactivating ..... 101
- Marker peak list
  - see Peak list ..... 100
- Marker search area
  - Remote control ..... 192
- Marker table
  - Evaluation method ..... 16
- Marker to Trace ..... 81
- Markers
  - Assigned trace ..... 81
  - Band power (remote control) ..... 212
  - Basic settings ..... 79
  - Configuration ..... 79, 82
  - Configuration (remote control) ..... 183
  - Deactivating ..... 81
  - Delta markers ..... 80
  - Fixed reference (remote control) ..... 190
  - I/Q vector ..... 78, 183
  - Linking ..... 80
  - Minimum ..... 90
  - Minimum (remote control) ..... 192, 206
  - Next minimum ..... 90
  - Next minimum (remote control) ..... 192, 206
  - Next peak ..... 90
  - Next peak (remote control) ..... 192, 206
  - Peak ..... 90
  - Peak (remote control) ..... 192, 206
  - Peak list (remote control) ..... 216
  - Position ..... 80
  - Positioning ..... 89
  - Positioning (remote control) ..... 183
  - Retrieving results (remote) ..... 228
  - Search (remote control) ..... 192
  - Setting center frequency ..... 91
  - Setting reference level ..... 91
  - Spectrograms (remote control) ..... 196
  - State ..... 79
  - Step size ..... 83
  - Step size (remote control) ..... 190
  - Table ..... 82
  - Table (evaluation method) ..... 16
  - Table (remote control) ..... 190
  - Type ..... 80
  - X-value ..... 80
- Maximizing
  - Windows (remote) ..... 155, 180
- Meas Time (hardware setting) ..... 11
- Measurement time
  - Auto settings ..... 63
  - Displayed ..... 11
  - I/Q data ..... 57
  - Power sensor ..... 41
  - Remote ..... 168
- Minimum ..... 90
  - Marker positioning ..... 90
  - Next ..... 90

- MKR
  - Key ..... 78
- MKR ->
  - Key ..... 83, 89
- Modulation
  - Inverted (I/Q, remote) ..... 149
  - Inverted (I/Q) ..... 57
- Multiple
  - Channel setups ..... 10
- N**
- Next Minimum ..... 90
  - Marker positioning ..... 90
- Next Mode X
  - Softkey ..... 87, 92
- Next Mode Y
  - Softkey ..... 88, 92
- Next Peak ..... 90
  - Marker positioning ..... 90
- Noise
  - Source ..... 44
- Number of Readings
  - Power sensor ..... 41
- O**
- OBW
  - Limits ..... 85, 89, 93
- Offset
  - Displayed ..... 11
  - Frequency ..... 51
  - Reference level ..... 46
- Options
  - Bandwidth extension ..... 20
  - Preamplifier ..... 48
- Output
  - Configuration (remote) ..... 129
  - Noise source ..... 44
  - Parameters ..... 34
  - Sample rate, definition ..... 19
- Overload
  - RF input (remote) ..... 117
- Overview
  - Configuration ..... 29
- P**
- Parameters
  - Input signal ..... 34
  - Output ..... 34
- Peak excursion ..... 85, 89, 93, 98, 100
- Peak list ..... 99
  - Configuring ..... 97
  - Displaying ..... 97
  - Evaluation method ..... 16
  - Exporting ..... 101
  - Marker numbers ..... 100
  - Maximum number of peaks ..... 100
  - Peak excursion ..... 85, 89, 93, 100
  - Remote control ..... 216
  - Sort mode ..... 100
  - State ..... 100
- Peak search
  - Area (spectrograms) ..... 88, 93
  - Automatic ..... 85
  - Deactivating limits ..... 86, 89, 94
  - Excursion ..... 98
  - Key ..... 90
  - Limits ..... 85, 89, 93, 98
  - List ..... 99
  - Mode ..... 84, 87, 92
  - Mode (spectrograms) ..... 86, 88, 91, 92
  - Retrieving results (remote) ..... 228
  - Threshold ..... 86, 89, 93
  - Type (spectrograms) ..... 88, 92
  - Zoom limits ..... 86, 89, 94
- Peaks
  - Marker positioning ..... 90
  - Next ..... 90
  - Softkey ..... 90
- Performance
  - FFT parameters ..... 25
- Performing
  - I/Q Analyzer measurement ..... 102
- Phase vs. Time
  - Evaluation method ..... 15
- Ports
  - User ..... 130
- Power mode
  - Band power measurement ..... 97
- Power sensors
  - Activating/Deactivating ..... 39
  - Applications ..... 38
  - Average count ..... 41
  - Configuration (softkey) ..... 38
  - Continuous Value Update ..... 39
  - Duty cycle ..... 42
  - Frequency ..... 40
  - Frequency Coupling ..... 40
  - Measurement time ..... 41
  - Number of readings ..... 41
  - R&S Power Viewer ..... 38
  - Reference level ..... 41
  - Reference level offset ..... 41
  - Results ..... 38
  - Selecting ..... 39
  - Setting up ..... 42
  - Settings ..... 38
  - Unit/Scale ..... 40
  - Using ..... 42
  - Zeroing ..... 40, 43
- Preamplifier
  - Setting ..... 48
  - Softkey ..... 48
- Presetting
  - Channels ..... 31
- Pretrigger ..... 54
- Programming examples
  - I/Q Analyzer ..... 232, 233
- Protection
  - RF input (remote) ..... 117
- Q**
- Quick Config
  - Traces ..... 69
- R**
- R&S Power Viewer Plus ..... 38
- Range ..... 49
- RBW (hardware setting) ..... 11



Real/Imag (I/Q)	
Evaluation method .....	15
I/Q Analyzer .....	15
Rec Length (hardware setting) .....	11
Record length	
Definition .....	19
I/Q data .....	57
Relationship to sample rate .....	20
Ref Level (hardware setting) .....	11
Ref Lvl = Mkr Lvl .....	91
Reference level .....	46
Auto level .....	47, 63
Offset .....	46
Offset (Power sensor) .....	41
Position .....	49
Power sensor .....	41
Setting to marker .....	91
Unit .....	46
Value .....	46
Reference marker .....	80
Release notes .....	6
Remote commands	
Basics on syntax .....	106
Boolean values .....	110
Capitalization .....	107
Character data .....	110
Data blocks .....	111
Numeric values .....	109
Optional keywords .....	108
Parameters .....	109
Strings .....	111
Suffixes .....	108
Remote control	
Modes .....	112
Repetition interval .....	54
Resampler	
Data processing .....	18
Resetting	
RF input protection .....	117
Restoring	
Channel settings .....	31
Result displays	
I/Q Vector .....	14
Magnitude .....	13
Marker table .....	16
Peak list .....	16
Phase vs. Time .....	15
Real/Imag (I/Q) .....	15
Spectrum .....	13
Results	
Analyzing .....	65
Data format (remote) .....	227
Exporting .....	76
I/Q Analyzer (remote) .....	219
Retrieving (remote) .....	219
RF attenuation	
Auto .....	47
Manual .....	47
RF input	
Overload protection (remote) .....	117
Remote .....	117
RUN CONT	
Key .....	60, 72
RUN SINGLE	
Key .....	60, 61, 73
<b>S</b>	
Safety instructions .....	6
Sample rate	
Definition .....	19
Displayed .....	11
I/Q Analyzer .....	19
I/Q data .....	56
Maximum .....	19
Relationship to bandwidth .....	20
Remote .....	151
Scaling	
Configuration .....	48
Y-axis .....	49
Y-axis (remote control) .....	137
Search limits	
Deactivating .....	86, 89, 94
Search Limits	
Activating .....	85, 89, 93
Search Mode	
Spectrogram markers .....	86, 91
Search settings	
I/Q Analyzer .....	86
Searching	
Configuration .....	84
Configuration (softkey) .....	86, 91
Security procedures .....	6
Select Frame	
Softkey .....	72
Select Marker .....	81
Sequencer .....	10
Activating (remote) .....	166
Remote .....	165
Sequences	
Aborting (remote) .....	166
Mode (remote) .....	166
Service manual .....	5
Signal capturing	
Duration (remote) .....	168
Signal processing	
Diagram .....	19
Single sweep	
Softkey .....	60, 73
Slope	
Trigger .....	54, 142
Smoothing	
Traces (group delay) .....	68
Softkeys	
All Functions Off .....	101
Amplitude Config .....	45
Auto All .....	62
Auto Freq .....	63
Auto Level .....	47, 63
Center .....	50
Center = Mkr Freq .....	91
Clear Spectrogram .....	73
Color Mapping .....	72
Continue Single Sweep .....	61
Continuous Sweep .....	60, 72
Display Config .....	61
Export .....	32
Export config .....	34
External .....	53
Free Run .....	52
History Depth .....	72
I/Q Export .....	34
I/Q Import .....	32

- IF Power ..... 53
- Import ..... 32
- Lower Level Hysteresis ..... 64
- Marker Config ..... 79, 82
- Marker Search Area ..... 88, 93
- Marker Search Type ..... 88, 92
- Marker to Trace ..... 81
- Meastime Auto ..... 63
- Meastime Manual ..... 63
- Min ..... 90
- Next Min ..... 90
- Next Mode X ..... 87, 92
- Next Mode Y ..... 88, 92
- Next Peak ..... 90
- Norm/Delta ..... 80
- Peak ..... 90
- Power Sensor Config ..... 38
- Preamp ..... 48
- Ref Level ..... 46
- Ref Level Offset ..... 46
- RF Atten Auto ..... 47
- RF Atten Manual ..... 47
- Search Config ..... 84, 86, 91
- Select Frame ..... 72
- Select Marker ..... 81
- Single Sweep ..... 60, 73
- Time ..... 53
- Timestamp ..... 72
- Trace 1/2/3/4 ..... 69
- Trace Config ..... 65
- Trigger Config ..... 51
- Trigger Offset ..... 54
- Upper Level Hysteresis ..... 64
- Sort mode
  - Peak list ..... 100
- Span
  - Band power measurement ..... 96
- Speaker
  - Remote control ..... 130, 131
- Specifics for
  - Configuration ..... 31
- Spectrograms
  - 3-dimensional ..... 71, 72
  - Activating/Deactivating ..... 71
  - Clearing ..... 73
  - Color curve ..... 74
  - Color mapping ..... 72, 73
  - Color mapping (remote control) ..... 181
  - Color scheme ..... 75
  - Configuring (remote control) ..... 175
  - Display depth (3-D) ..... 72
  - Frames (remote control) ..... 176
  - History depth ..... 72
  - Markers (remote control) ..... 196
  - Selecting frames ..... 72
  - Settings ..... 70
  - Size ..... 71
  - Timestamps ..... 72
- Spectrum
  - I/Q Analyzer ..... 13
  - I/Q Evaluation method ..... 13
- SRate (hardware setting) ..... 11
- Status registers
  - STAT:QUES:POW ..... 117
- Step size
  - Markers ..... 83
  - Markers (remote control) ..... 190
- Subwindows
  - Spectrogram ..... 71
- Suffixes
  - Common ..... 111
  - Remote commands ..... 108
- Swap I/Q ..... 57
  - Remote ..... 149
- Sweep
  - Aborting ..... 60, 61, 72, 73
  - Performing (remote) ..... 163
  - Points (I/Q Analyzer) ..... 60
  - Settings ..... 59
  - Time (remote) ..... 168
- Sweep Count ..... 60
- T**
- Threshold
  - Peak search ..... 86, 89, 93
- Time frames
  - Selecting ..... 72
- Time trigger
  - Repetition interval ..... 54
  - Softkey ..... 53
- Timestamps
  - Softkey (Spectrogram) ..... 72
  - Spectrograms ..... 72
- TPIS
  - I/Q data ..... 151
- Traces ..... 69
  - Average mode ..... 68
  - Averaging (remote control) ..... 173
  - Configuration ..... 65
  - Configuring (remote control) ..... 169
  - Copying ..... 69
  - Copying (remote control) ..... 174
  - Detector ..... 67
  - Detector (remote control) ..... 173
  - Export format ..... 33, 77, 78
  - Exporting ..... 33, 75, 76, 77
  - Hold ..... 68
  - Mode ..... 66
  - Mode (remote) ..... 170
  - Retrieving (remote) ..... 220
  - Settings (remote control) ..... 169
  - Settings, predefined ..... 69
- Trigger
  - Configuration (softkey) ..... 51
  - Drop-out time ..... 54
  - External (remote) ..... 142
  - Holdoff ..... 55
  - Hysteresis ..... 55
  - Offset ..... 54
  - Remote control ..... 139
  - Slope ..... 54, 142
- Trigger level ..... 53
  - External trigger (remote) ..... 141
  - I/Q Power (remote) ..... 142
  - IF Power (remote) ..... 141
- Trigger source ..... 52
  - External ..... 53
  - Free Run ..... 52
  - I/Q Power ..... 53
  - IF Power ..... 53
  - Time ..... 53
- Troubleshooting
  - Input overload ..... 117

**U**

Units	
Power sensor .....	40
Reference level .....	46
Upper Level Hysteresis .....	64
Usable I/Q bandwidth	
Definition .....	19
User ports	
Remote control .....	130
User sample rate	
Definition .....	19

**V**

Volume	
Remote control .....	130, 131

**W**

White papers .....	6
Window functions	
Characteristics .....	22
FFT .....	21
Window title bar information .....	12
Windows	
Adding (remote) .....	156
Closing (remote) .....	162
Configuring .....	31
Layout (remote) .....	160
Maximizing (remote) .....	155, 180
Querying (remote) .....	158
Replacing (remote) .....	159
Splitting (remote) .....	155, 180
Types (remote) .....	156

**X**

X-value	
Marker .....	80

**Y**

Y-axis	
Scaling .....	49
Scaling (I/Q Vector) .....	50
Settings .....	48
YIG-preselector	
Activating/Deactivating .....	36
Activating/Deactivating (remote) .....	117

**Z**

Zeroing	
Power sensor .....	40
Zoom limits	
Using for searches .....	86, 89, 94