

R&S® FPL1-K7

AM/FM/PM Modulation Analysis

Option

User Manual

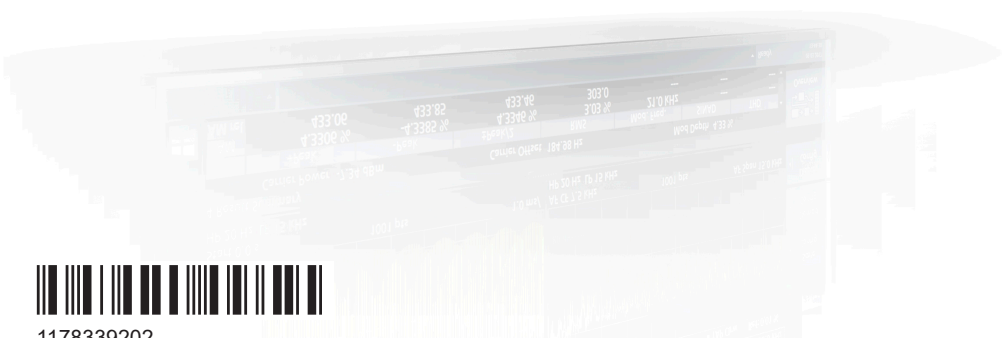
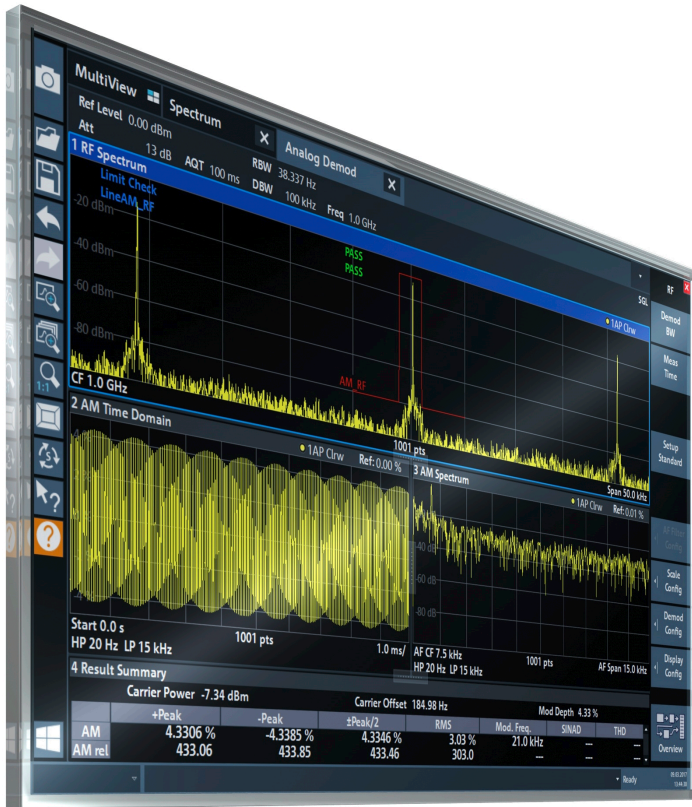

1178339202
Version 11



This manual applies to the following R&S®FPL1000 models with firmware version 2.10 and later:

- R&S®FPL1003 (1304.0004K03) - FPL1000 with maximum frequency 3 GHz
- R&S®FPL1007 (1304.0004K07) - FPL1000 with maximum frequency 7.5 GHz
- R&S®FPL1014 (1304.0004K14) - FPL1000 with maximum frequency 14 GHz
- R&S®FPL1026 (1304.0004K26) - FPL1000 with maximum frequency 26.5 GHz

The following firmware options are described:

- R&S FPL1-K7 (1323.1731.02)

© 2023 Rohde & Schwarz GmbH & Co. KG
Muehldorfstr. 15, 81671 Muenchen, Germany
Phone: +49 89 41 29 - 0
Email: info@rohde-schwarz.com
Internet: www.rohde-schwarz.com

Subject to change – data without tolerance limits is not binding.

R&S® is a registered trademark of Rohde & Schwarz GmbH & Co. KG.

All other trademarks are the properties of their respective owners.

1178.3392.02 | Version 11 | R&S®FPL1-K7 | COMPANY RESTRICTED

Throughout this manual, products from Rohde & Schwarz are indicated without the ® symbol, e.g. R&S®FPL1000 is indicated as R&S FPL1000.

Contents

1	Preface	7
1.1	Documentation overview	7
1.1.1	Getting started manual.....	7
1.1.2	User manuals and help.....	7
1.1.3	Service manual.....	7
1.1.4	Instrument security procedures.....	8
1.1.5	Printed safety instructions.....	8
1.1.6	Data sheets and brochures.....	8
1.1.7	Release notes and open source acknowledgment (OSA).....	8
1.1.8	Application notes, application cards, white papers, etc.....	8
1.1.9	Video tutorials.....	8
1.1.10	Calibration certificate.....	9
1.2	Conventions used in the documentation	9
1.2.1	Typographical conventions.....	9
1.2.2	Conventions for procedure descriptions.....	9
1.2.3	Notes on screenshots.....	10
2	Welcome to the R&S FPL1-K7 AM/FM/PM Modulation Analysis application	11
2.1	Starting AM/FM/PM Modulation Analysis	11
2.2	Understanding the display information	12
3	Measurements and result displays	15
4	Measurement basics	26
4.1	Demodulation process.....	26
4.2	Demodulation bandwidth.....	28
4.3	Sample rate and demodulation bandwidth.....	29
4.4	AF triggers.....	30
4.5	AF filters.....	31
4.6	Time domain zoom.....	31
5	Configuration	33
5.1	Configuration overview	33

5.2 Configuration according to standards.....	35
5.3 Input and frontend settings.....	37
5.3.1 Radio frequency input.....	37
5.3.2 Settings for input from I/Q data files.....	39
5.3.3 Amplitude settings.....	40
5.3.4 Frequency.....	44
5.4 Trigger configuration.....	45
5.4.1 Trigger source settings.....	46
5.5 Data acquisition.....	49
5.5.1 Bandwidth settings.....	49
5.5.2 Sweep settings.....	50
5.6 Demodulation display.....	54
5.7 Demodulation.....	54
5.7.1 Basic demodulation measurement parameters (Demod).....	54
5.7.2 Demodulation spectrum.....	57
5.7.3 AF filter.....	60
5.7.4 Scaling.....	63
5.7.5 Units.....	68
5.7.6 Result table settings.....	68
5.7.7 Settling time.....	71
5.8 Output settings.....	73
5.9 Adjusting settings automatically.....	73
6 Analysis.....	77
6.1 Trace settings.....	77
6.2 Spectrogram settings.....	81
6.2.1 General spectrogram settings.....	81
6.2.2 Color map settings.....	85
6.3 Trace / data export configuration.....	86
6.4 Working with markers in the R&S FPL1-K7 AM/FM/PM Modulation Analysis application.....	89
6.4.1 Marker settings.....	89
6.4.2 Marker search settings and positioning functions.....	94
6.4.3 Marker search settings for spectrograms.....	97

6.4.4	Marker function configuration.....	99
7	I/Q data import and export.....	109
8	How to perform measurements in the R&S FPL1-K7 AM/FM/PM Modulation Analysis application.....	110
8.1	How to export trace data and numerical results.....	111
9	Measurement example: demodulating an FM signal.....	112
10	Optimizing and troubleshooting the measurement.....	117
11	Remote commands for AM/FM/PM Modulation Analysis.....	118
11.1	Introduction.....	119
11.1.1	Conventions used in descriptions.....	119
11.1.2	Long and short form.....	120
11.1.3	Numeric suffixes.....	120
11.1.4	Optional keywords.....	121
11.1.5	Alternative keywords.....	121
11.1.6	SCPI parameters.....	121
11.2	Common suffixes.....	124
11.3	Activating analog modulation analysis.....	124
11.4	Configuring the measurement.....	127
11.4.1	Managing standard settings.....	128
11.4.2	Configuring the input.....	129
11.4.3	Configuring the output.....	133
11.4.4	Frequency settings.....	134
11.4.5	Configuring the vertical axis (amplitude, scaling).....	136
11.4.6	Configuring data acquisition.....	142
11.4.7	Triggering.....	146
11.4.8	Configuring demodulation.....	151
11.4.9	Adjusting settings automatically.....	171
11.5	Capturing data and performing sweeps.....	175
11.6	Configuring the result display.....	179
11.6.1	General window commands.....	179
11.6.2	Working with windows in the display.....	179
11.7	Retrieving results.....	187

11.7.1	Retrieving trace results.....	187
11.7.2	Exporting trace results.....	190
11.7.3	Retrieving result summary values.....	192
11.7.4	Formats for returned values: ASCII format and binary format.....	197
11.7.5	Reference: ASCII file export format.....	197
11.8	Analyzing results.....	199
11.8.1	Configuring spectrograms.....	200
11.8.2	Configuring standard traces.....	208
11.8.3	Working with markers remotely.....	214
11.8.4	Marker search (spectrograms).....	248
11.8.5	Defining limit checks.....	258
11.9	Importing and exporting I/Q data and results.....	273
11.10	Deprecated commands.....	275
11.11	Programming example.....	276
	Annex.....	278
A	Predefined standards and settings.....	278
	List of commands (Analog Modulation Analysis).....	280
	Index.....	289

1 Preface

This chapter provides safety-related information, an overview of the user documentation and the conventions used in the documentation.

1.1 Documentation overview

This section provides an overview of the R&S FPL1000 user documentation. Unless specified otherwise, you find the documents at:

www.rohde-schwarz.com/manual/FPL1000

1.1.1 Getting started manual

Introduces the R&S FPL1000 and describes how to set up and start working with the product. Includes basic operations, typical measurement examples, and general information, e.g. safety instructions, etc.

A printed version is delivered with the instrument. A PDF version is available for download on the Internet.

1.1.2 User manuals and help

Separate user manuals are provided for the base unit and the firmware applications:

- **Base unit manual**
Contains the description of all instrument modes and functions. It also provides an introduction to remote control, a complete description of the remote control commands with programming examples, and information on maintenance, instrument interfaces and error messages. Includes the contents of the getting started manual.
- **Firmware application manual**
Contains the description of the specific functions of a firmware application, including remote control commands. Basic information on operating the R&S FPL1000 is not included.

The contents of the user manuals are available as help in the R&S FPL1000. The help offers quick, context-sensitive access to the complete information for the base unit and the firmware applications.

All user manuals are also available for download or for immediate display on the Internet.

1.1.3 Service manual

Describes the performance test for checking compliance with rated specifications, firmware update, troubleshooting, adjustments, installing options and maintenance.

The service manual is available for registered users on the global Rohde & Schwarz information system (GLORIS):

<https://gloris.rohde-schwarz.com>

1.1.4 Instrument security procedures

Deals with security issues when working with the R&S FPL1000 in secure areas. It is available for download on the internet.

1.1.5 Printed safety instructions

Provides safety information in many languages. The printed document is delivered with the product.

1.1.6 Data sheets and brochures

The data sheet contains the technical specifications of the R&S FPL1000. It also lists the firmware applications and their order numbers, and optional accessories.

The brochure provides an overview of the instrument and deals with the specific characteristics.

See www.rohde-schwarz.com/brochure-datasheet/FPL1000

1.1.7 Release notes and open source acknowledgment (OSA)

The release notes list new features, improvements and known issues of the current firmware version, and describe the firmware installation.

The software makes use of several valuable open source software packages. An open source acknowledgment document provides verbatim license texts of the used open source software.

See www.rohde-schwarz.com/firmware/FPL1000

1.1.8 Application notes, application cards, white papers, etc.

These documents deal with special applications or background information on particular topics.

See www.rohde-schwarz.com/application/FPL1000

1.1.9 Video tutorials

Video tutorials that show you how to get started and perform basic tasks with the R&S FPL1000 are available on the Rohde & Schwarz internet site:

https://www.rohde-schwarz.com/manual/r-s-fpl1000-trying-out-basic-measurement-tasks-manuals_78701-567115.html

1.1.10 Calibration certificate

The document is available on <https://gloris.rohde-schwarz.com/calcert>. You need the device ID of your instrument, which you can find on a label on the rear panel.

1.2 Conventions used in the documentation

1.2.1 Typographical conventions

The following text markers are used throughout this documentation:

Convention	Description
"Graphical user interface elements"	All names of graphical user interface elements on the screen, such as dialog boxes, menus, options, buttons, and softkeys are enclosed by quotation marks.
[Keys]	Key and knob names are enclosed by square brackets.
Filenames, commands, program code	Filenames, commands, coding samples and screen output are distinguished by their font.
<i>Input</i>	Input to be entered by the user is displayed in italics.
Links	Links that you can click are displayed in blue font.
"References"	References to other parts of the documentation are enclosed by quotation marks.

1.2.2 Conventions for procedure descriptions

When operating the instrument, several alternative methods may be available to perform the same task. In this case, the procedure using the touchscreen is described. Any elements that can be activated by touching can also be clicked using an additionally connected mouse. The alternative procedure using the keys on the instrument or the on-screen keyboard is only described if it deviates from the standard operating procedures.

The term "select" may refer to any of the described methods, i.e. using a finger on the touchscreen, a mouse pointer in the display, or a key on the instrument or on a keyboard.

1.2.3 Notes on screenshots

When describing the functions of the product, we use sample screenshots. These screenshots are meant to illustrate as many as possible of the provided functions and possible interdependencies between parameters. The shown values may not represent realistic usage scenarios.

The screenshots usually show a fully equipped product, that is: with all options installed. Thus, some functions shown in the screenshots may not be available in your particular product configuration.

2 Welcome to the R&S FPL1-K7 AM/FM/PM Modulation Analysis application

The R&S FPL1-K7 AM/FM/PM Modulation Analysis application option converts the R&S FPL1000 into an analog modulation analyzer for amplitude-, frequency- or phase-modulated signals. It measures not only characteristics of the useful modulation, but also factors such as residual FM or synchronous modulation.

The R&S FPL1-K7 AM/FM/PM Modulation Analysis application features:

- AM, FM, and PM demodulation, with various result displays:
 - Modulation signal versus time
 - Spectrum of the modulation signal (FFT)
 - RF signal power versus time
 - Spectrum of the RF signal
- Determining maximum, minimum and average or current values in parallel over a selected number of measurements
- Maximum accuracy and temperature stability due to sampling (digitization) already at the IF and digital down-conversion to the baseband (I/Q)
- Error-free AM to FM conversion and vice versa, without deviation errors, frequency response or frequency drift at DC coupling
- Relative demodulation, in relation to a user-defined or measured reference value



Availability of the R&S FPL1-K7 AM/FM/PM Modulation Analysis application

Using the R&S FPL1-K7 AM/FM/PM Modulation Analysis application requires the optional AM/FM/PM Modulation Analysis firmware.

This user manual contains a description of the functionality that the application provides, including remote control operation.

All functions not discussed in this manual are the same as in the base unit and are described in the R&S FPL1000 User Manual. The latest version is available for download at the product homepage <http://www.rohde-schwarz.com/product/FPL1000>.

2.1 Starting AM/FM/PM Modulation Analysis

AM/FM/PM Modulation Analysis is a separate application on the R&S FPL1000.

To activate AM/FM/PM Modulation Analysis

1. Select the [MODE] key.

A dialog box opens that contains all operating modes and applications currently available on your R&S FPL1000.
2. Select the "AM FM PM Analog Demod" item.



The R&S FPL1000 opens a new channel setup for the application for analog modulation analysis.

The measurement is started immediately with the default settings. It can be configured in the analog modulation analysis "Overview" dialog box, which is displayed when you select the "Overview" softkey from any menu (see [Chapter 5.1, "Configuration overview"](#), on page 33).

Multiple Channel setups and Sequencer Function

When you activate an application, a new channel setup is created which determines the measurement settings for that application ("Channel"). The same application can be activated with different measurement settings by creating several "Channel"s for the same application.

The number of channel setups that can be configured at the same time depends on the available memory on the instrument.

Only one measurement can be performed at any time, namely the one in the currently active channel setup. However, to perform the configured measurements consecutively, a Sequencer function is provided.

If activated, the measurements configured in the currently defined "Channel"s are performed one after the other in the order of the tabs. The currently active measurement is indicated by a  symbol in the tab label.

The result displays of the individual channel setups are updated in the tabs (as well as the "MultiView") as the measurements are performed. Sequential operation itself is independent of the currently *displayed* tab.

For details on the Sequencer function, see the R&S FPL1000 User Manual.

2.2 Understanding the display information

The following figure shows a measurement diagram during analog modulation analysis. All different information areas are labeled. They are explained in more detail in the following sections.



- 1 = Channel setup bar for firmware and measurement settings
- 2 = Diagram area
- 3 = Window title bar with diagram-specific (trace) information
- 4 = Diagram footer with diagram-specific information, depending on result display
- 5 = Instrument status bar with error messages and date/time display

Channel setup bar information

In the Analog Modulation Analysis application, the R&S FPL1000 shows the following settings:

Table 2-1: Information displayed in the channel setup bar in the application for analog modulation analysis

Ref Level	Reference level
Att	RF attenuation applied to input
Offset	Reference level offset
AQT	Measurement time for data acquisition.
RBW	Resolution bandwidth
DBW	Demodulation bandwidth
Freq	Center frequency for the RF signal

Window title bar information

For each diagram, the header provides the following information:



Figure 2-1: Window title bar information in the application for analog modulation analysis

- 1 = Window number
- 2 = Window type
- 3 = Trace color
- 4 = Trace number
- 5 = Detector
- 6 = Trace mode
- 7 = Reference value (at the defined reference position)
- 8 = AF coupling (AC/DC), only in AF time domains, if applicable
- 9 = Results are selected for demodulation output

Diagram footer information

The diagram footer (beneath the diagram) contains the following information, depending on the evaluation:

"RF Spectrum"		
CF: Center frequency of input signal	Sweep points	Span: measured span

RF Time domain		
CF: Center frequency of input signal	Sweep points	Time per division

AF Spectrum		
AF CF: center frequency of demodulated signal	Sweep points	AF Span: evaluated span

AF Time domain		
CF: Center frequency of input signal	Sweep points	Time per division

For most modes, the number of sweep points shown in the display are indicated in the diagram footer. In zoom mode, the (rounded) number of currently displayed points are indicated.

Status bar information

Global instrument settings, the instrument status and any irregularities are indicated in the status bar beneath the diagram.

3 Measurements and result displays

Access: "Overview" > "Display Config"

Or: [MEAS] > "Display Config"

The data that was measured by the R&S FPL1000 can be evaluated using various different methods. In the Analog Modulation Analysis application, up to six evaluation methods can be displayed simultaneously in separate windows. The results can be displayed as absolute deviations or relative to a reference value or level.



The abbreviation "AF" (for Audio Frequency) refers to the demodulated AM, FM or PM signal.

Basis for evaluation

All evaluations are based on the I/Q data set acquired during the measurement. The spectrum of the modulated signal to be evaluated is determined by the demodulation bandwidth. However, it can be restricted to a limited span ("AF Span") if only part of the signal is of interest. Furthermore, the time base for evaluations in the time domain can be restricted to analyze a smaller extract in more detail, see [Chapter 4.6, "Time domain zoom"](#), on page 31.

AM Time Domain	15
FM Time Domain	16
PM Time Domain	17
AM Spectrum	18
FM Spectrum	19
PM Spectrum	20
RF Time Domain	21
RF Spectrum	22
Result Summary	23
Marker Table	25
Marker Peak List	25

AM Time Domain

Displays the modulation depth of the demodulated AM signal (in %) versus time.

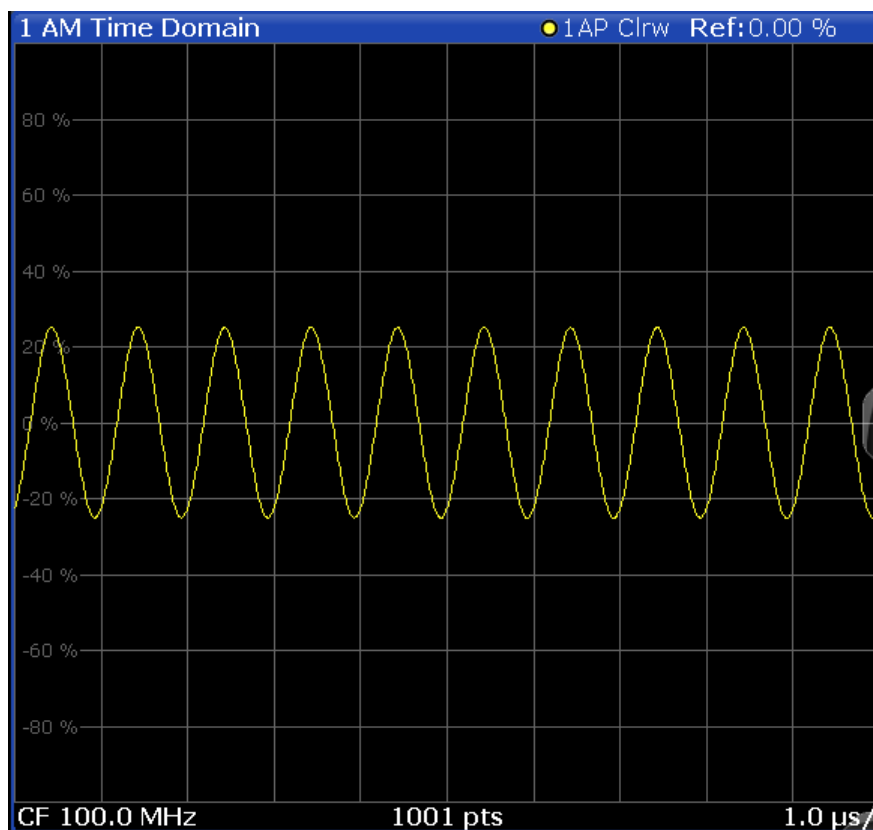

Optionally, the settling time can be evaluated and displayed, see [Chapter 5.7.7, "Settling time"](#), on page 71.

Remote command:

```
LAY:ADD? '1',RIGHT,'XTIM:AM:REL'
```

(See [LAYout:ADD\[:WINDow\]?](#) on page 180)

FM Time Domain

Displays the frequency spectrum of the demodulated FM signal versus time.

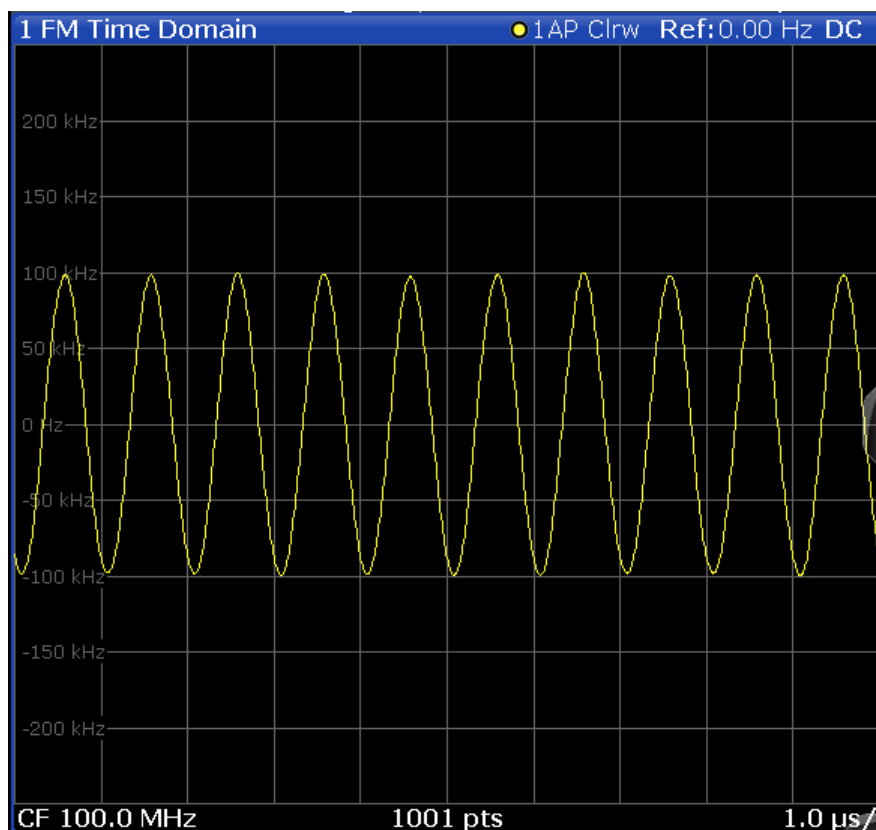

Optionally, the settling time can be evaluated and displayed, see [Chapter 5.7.7, "Settling time"](#), on page 71.

Remote command:

```
LAY:ADD? '1',RIGH,'XTIM:FM'
```

(See [LAYout:ADD\[:WINDow\]?](#) on page 180)

PM Time Domain

Displays the phase deviations of the demodulated PM signal (in rad or °) versus time.

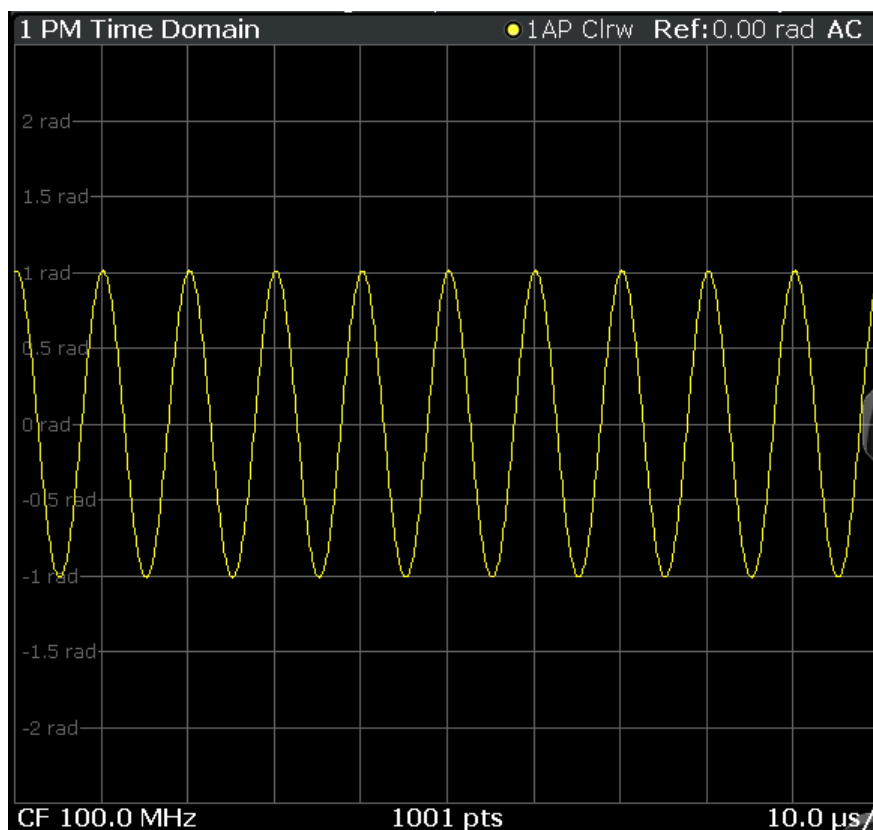

Optionally, the settling time can be evaluated and displayed, see [Chapter 5.7.7, "Settling time"](#), on page 71.

Remote command:

```
LAY:ADD? '1', RIGH, 'XTIM:PM'
```

(See [LAYout:ADD\[:WINDow\]?](#) on page 180)

AM Spectrum

Displays the modulation depth of the demodulated AM signal (in % or dB) versus AF span. The spectrum is calculated from the demodulated AM signal in the time domain via FFT.

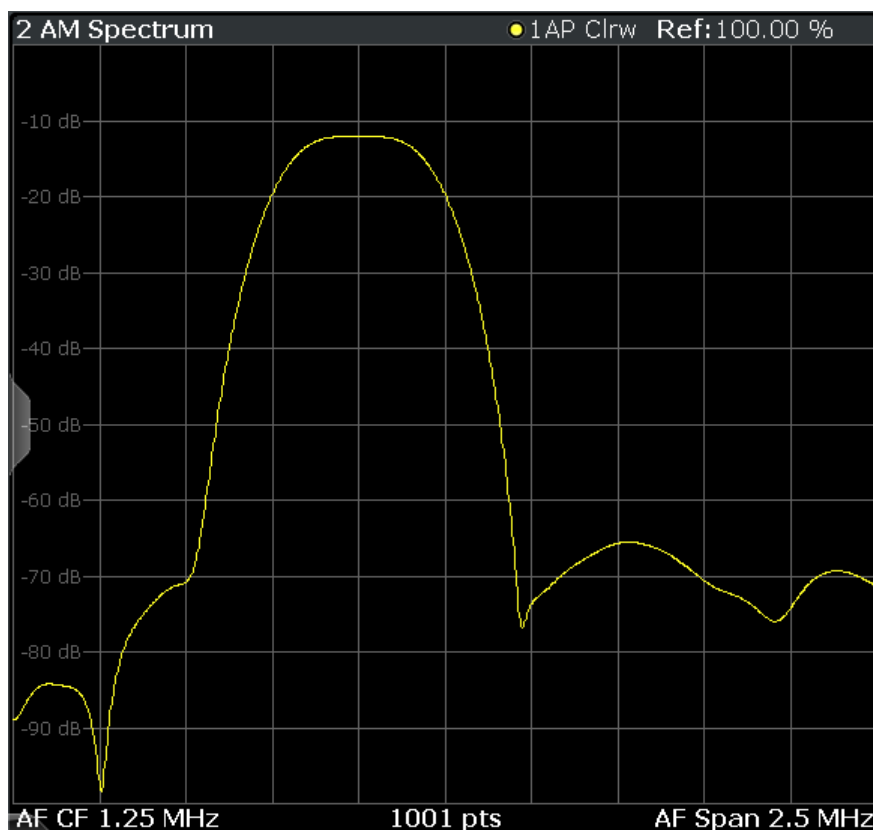

Note: If a high pass or low pass AF filter is defined, the filter is indicated by a vertical red line in the spectrum display.

Remote command:

```
LAY:ADD? '1',RIGH,'XTIME:AM:REL:AFSPpectrum1'
```

(see [LAYout:ADD\[:WINDow\]?](#) on page 180)

FM Spectrum

Displays the frequency deviations of the demodulated FM signal (in Hz or dB) versus AF span. The spectrum is calculated from the demodulated AM signal in the time domain via FFT.

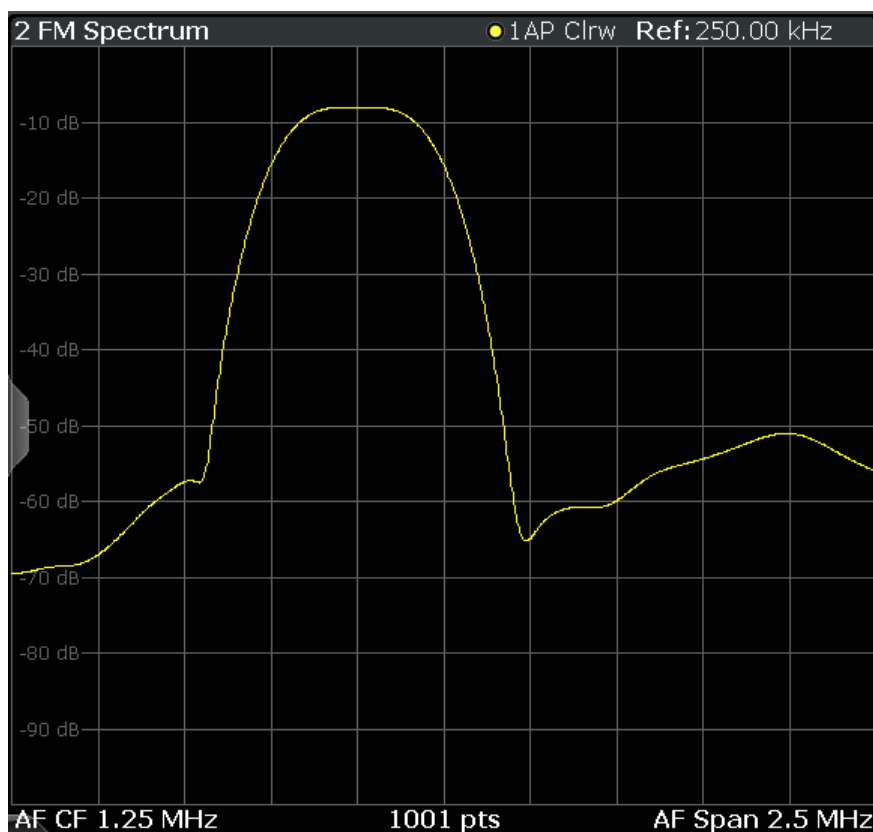

Note: If a high pass or low pass AF filter is defined, the filter is indicated by a vertical red line in the spectrum display.

Remote command:

```
LAY:ADD? '1',RIGH,'XTIME:FM:AFSPpectrum1'
```

(see [LAYout:ADD\[:WINDow\]?](#) on page 180)

PM Spectrum

Displays the phase deviations of the demodulated PM signal (in rad, ° or dB) versus AF span. The spectrum is calculated from the demodulated AM signal in the time domain via FFT.

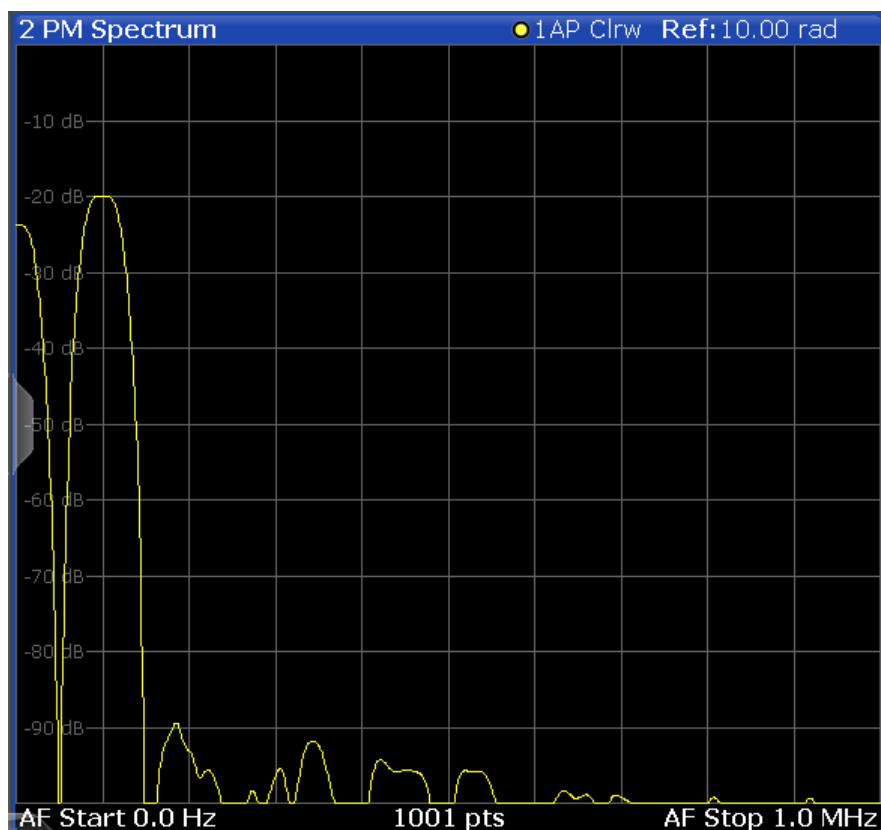

Note: If a high pass or low pass AF filter is defined, the filter is indicated by a vertical red line in the spectrum display.

Remote command:

```
LAY:ADD? '1',RIGH,'XTIME:PM:AFSPpectrum1'
```

(see [LAYout:ADD\[:WINDow\]?](#) on page 180)

RF Time Domain

Displays the RF power of the input signal versus time. The level values represent the magnitude of the I/Q data set.

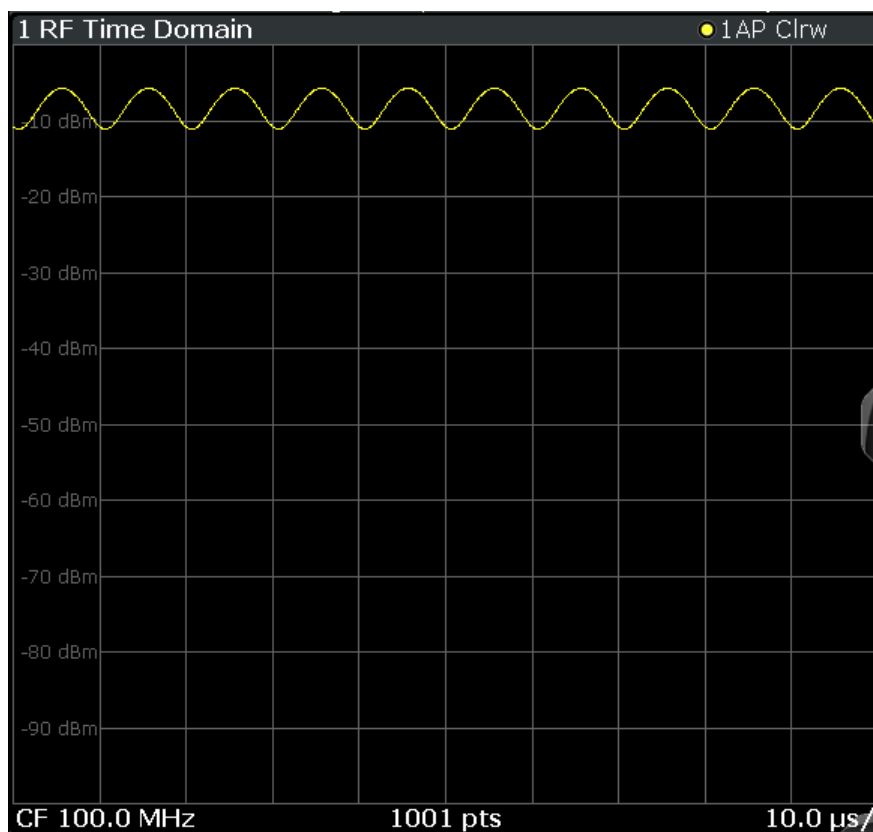

Optionally, the settling time can be evaluated and displayed, see [Chapter 5.7.7, "Settling time"](#), on page 71.

Remote command:

```
LAY:ADD? '1',RIGH,'XTIM:AM'
```

(see [LAYout:ADD\[:WINDow\]?](#) on page 180)

RF Spectrum

Displays the spectrum of the input signal. In contrast to the Spectrum application, the frequency values are determined using FFT from the recorded I/Q data set.

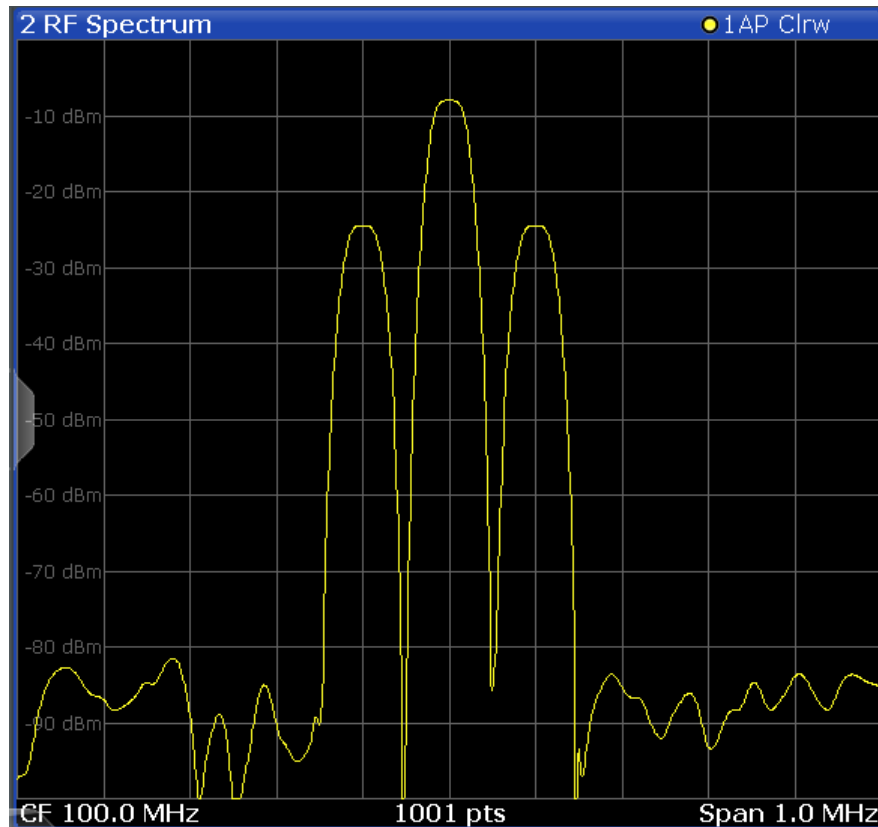

Remote command:

```
LAY:ADD? '1',RIGH,'XTIM:SPECTRUM'
```

(see [LAYout:ADD\[:WINDow\]?](#) on page 180)

Result Summary

The "result summary" displays the results of the demodulation functions for all windows in a table.

4 Result Summary									
	Carrier Power -20.69 dBm				Carrier Offset 390.56 Hz				
	Settling Time	+Peak	-Peak	±Peak/2	RMS	Mod. Freq.	SINAD	DISTORT	THD
FM	1.022 µs	4.8423 MHz	-1.8343 MHz	3.3383 MHz	1.1283 MHz	---	---	---	---

The following general results are provided:

For each demodulation, the following results are provided:

Label	Description
"Carr Power"	Measured carrier power
"Carr Offset"	Carrier offset to nominal center frequency
"Mod. Depth"	Modulation depth

Table 3-1: Result summary description

Label	Description
"Settling Time"	Time after which signal remains in a specified value range. Only evaluated and displayed if enabled, see Chapter 5.7.7, "Settling time" , on page 71.
"Peak"	Positive peak (maximum)
"-Peak"	Negative peak (minimum)
"Peak/2"	Average of positive and negative peaks
"RMS"	Root Mean Square value
"Mod Freq"	Modulation frequency
"SINAD"	Signal-to-noise-and-distortion (Calculated only if AF Spectrum is displayed) Measures the ratio of the total power to the power of noise and harmonic distortions. The noise and harmonic power is calculated inside the AF spectrum span. The DC offset is removed before the calculation. $SINAD[dB] = 20 \cdot \log \left[\frac{P_{total}}{P_{Noise} + P_{distortion}} \right]$
"DISTORT"	Modulation distortion in % (Calculated only if "SINAD" is also calculated) Measures the distortion of the modulation in relation to the total power of the signal inside the AF spectrum span. Indicates the quality of the modulation. $Modulation\ distortion = \frac{\sqrt{P_{total} - P_{signal}}}{\sqrt{P_{total}}} * 100\%$
"THD"	Total harmonic distortion The ratio of the harmonics to the fundamental and harmonics. All harmonics inside the AF spectrum span are considered up to the tenth harmonic. (Calculated only if AF Spectrum is displayed) $THD[dB] = 20 \cdot \log \left[\frac{\sqrt{\sum_{i=2}^{\infty} U_i^2}}{\sqrt{\sum_{i=1}^{\infty} U_i^2}} \right]$

Note: Relative demodulation results. Optionally, the demodulation results in relation to user-defined or measured reference values are determined. See [Chapter 5.7.6, "Result table settings"](#), on page 68.

In addition, the following general information for the input signal is provided:

- "Carrier Power": the power of the carrier without modulation
- "Carrier Offset": the deviation of the calculated carrier frequency to the ideal carrier frequency
- "Modulation Depth" (AM or "RF Time Domain" only): the difference in amplitude the carrier signal is modulated with

Remote command:

LAY:ADD? '1', RIGH, RSUM, see [LAYout:ADD\[:WINDow\]?](#) on page 180

Results:

[Chapter 11.7.3, "Retrieving result summary values"](#), on page 192

Marker Table

Displays a table with the current marker values for the active markers.

This table is displayed automatically if configured accordingly.

(See ["Marker Table Display"](#) on page 93).

1 Marker Table							
Wnd	Type	Ref	Trc	X-Value	Y-Value	Function	Function Result
2	M1		1	2.1725 ms	-6.80 dBm		
2	D2	M1	1	13.859 ms	-0.00 dB		
2	D3	M1	1	4.6259 ms	-0.00 dB		
2	D4	M1	1	9.2331 ms	-0.00 dB		

Tip: To navigate within long marker tables, simply scroll through the entries with your finger on the touchscreen.

Remote command:

LAY:ADD? '1', RIGH, MTAB, see [LAYout:ADD\[:WINDow\]?](#) on page 180

Results:

[CALCulate<n>:MARKer<m>:X](#) on page 216

[CALCulate<n>:MARKer<m>:Y?](#) on page 217

Marker Peak List

The marker peak list determines the frequencies and levels of peaks in the spectrum or time domain. How many peaks are displayed can be defined, as well as the sort order. In addition, the detected peaks can be indicated in the diagram. The peak list can also be exported to a file for analysis in an external application.

3 Marker Peak List				
Wnd	No	X-Value	Y-Value	
2	1	1.086245 ms	-75.810 dBm	
2	2	2.172490 ms	-6.797 dBm	
2	3	3.258736 ms	-76.448 dBm	
2	4	4.831918 ms	-76.676 dBm	
2	5	6.255274 ms	-76.482 dBm	
2	6	6.798397 ms	-6.800 dBm	
2	7	9.233084 ms	-76.519 dBm	
2	8	10.075861 ms	-76.172 dBm	
2	9	11.405574 ms	-6.801 dBm	

Tip: To navigate within long marker peak lists, simply scroll through the entries with your finger on the touchscreen.

Remote command:

LAY:ADD? '1', RIGH, PEAK, see [LAYout:ADD\[:WINDow\]?](#) on page 180

Results:

[CALCulate<n>:MARKer<m>:X](#) on page 216

[CALCulate<n>:MARKer<m>:Y?](#) on page 217

4 Measurement basics

Some background knowledge on basic terms and principles used in Analog Modulation Analysis measurements is provided here for a better understanding of the required configuration settings.

- [Demodulation process](#)..... 26
- [Demodulation bandwidth](#).....28
- [Sample rate and demodulation bandwidth](#).....29
- [AF triggers](#).....30
- [AF filters](#).....31
- [Time domain zoom](#).....31

4.1 Demodulation process

The demodulation process is shown in [Figure 4-1](#). All calculations are performed simultaneously with the same I/Q data set. Magnitude (= amplitude) and phase of the complex I/Q pairs are determined. The frequency result is obtained from the differential phase.

For details on general I/Q data processing in the R&S FPL1000, refer to the reference part of the I/Q Analysis remote control description in the R&S FPL1000 User Manual.

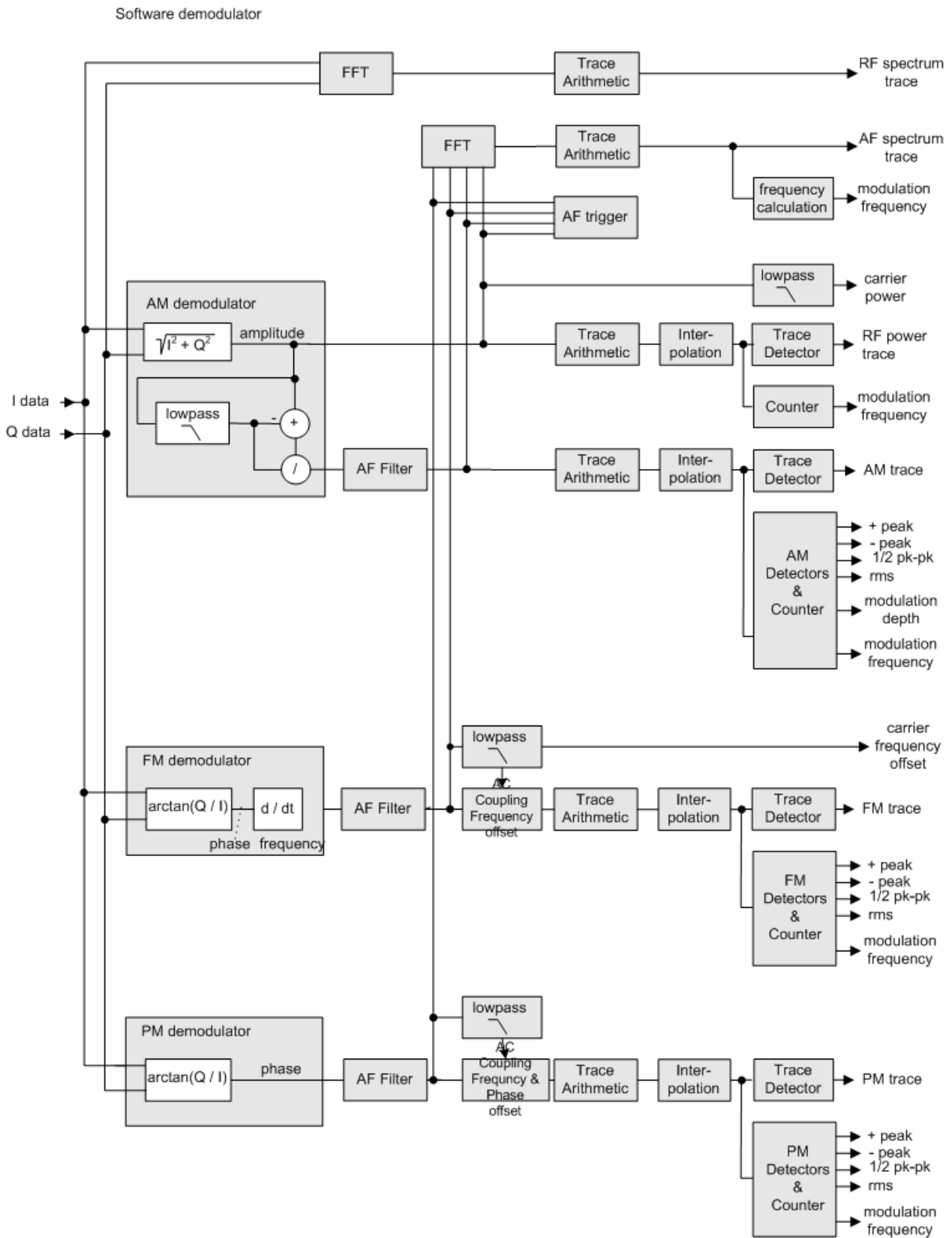

Figure 4-1: Block diagram of software demodulator

The AM DC, FM DC and PM DC raw data of the demodulators is fed into the "Trace Arithmetic" block that combines consecutive data sets. Possible trace modes are: Clear Write, Max Hold, Min Hold and Average. The output data of the "Trace Arithmetic" block can be read via remote control ([SENS:]ADEM:<evaluation>:RES?, see [SENSe:]ADEMod:AM[:ABSolute] [:TDOMain]:RESult? on page 188.

The collected measured values are evaluated by the selected detector. The result is displayed on the screen and can be read out via remote control.

In addition, important parameters are calculated:

- A counter determines the modulation frequency for AM, FM, and PM.
- average power = carrier power (RF power)
- average frequency = carrier frequency offset (FM)
- The modulation depth or the frequency or phase deviation; the deviations are determined from the trace data

AC coupling is possible with FM and PM display.

4.2 Demodulation bandwidth

The demodulation bandwidth determines the span of the signal that is demodulated. It is not the 3-dB bandwidth of the filter, but the useful bandwidth which is distortion-free regarding phase and amplitude.

Therefore the following formulas apply:

- AM: demodulation bandwidth $\geq 2 \times$ modulation frequency
- FM: demodulation bandwidth $\geq 2 \times$ (frequency deviation + modulation frequency)
- PM: demodulation bandwidth $\geq 2 \times$ modulation frequency \times (1 + phase deviation)



If the center frequency of the analyzer is not set exactly to the signal frequency, the demodulation bandwidth must be increased by the carrier offset, in addition to the requirement described above. The bandwidth must also be increased if FM or PM AC coupling is selected.

In general, select the demodulation bandwidth as narrow as possible to improve the S/N ratio. The residual FM caused by noise floor and phase noise increases dramatically with the bandwidth, especially with FM.

For help on determining the adequate demodulation bandwidth, see "[Determining the demodulation bandwidth](#)" on page 117.

A practical example is described in [Chapter 9, "Measurement example: demodulating an FM signal"](#), on page 112.

4.3 Sample rate and demodulation bandwidth

The maximum demodulation bandwidths that can be obtained during the measurement, depending on the sample rate, are listed in the tables below for different demodulation filter types. The allowed value range of the measurement time and trigger offset depends on the selected demodulation bandwidth and demodulation filter. If the AF filter or the AF trigger are not active, the measurement time increases by 20 %.



A maximum of 24 million samples can be captured, assuming sufficient memory is available; thus the maximum measurement time can be determined according to the following formula:

$$\text{Meas.time}_{\text{max}} = \text{Sample count}_{\text{max}} / \text{sample rate}$$

The minimum trigger offset is $(-\text{Meas.time}_{\text{max}})$

Table 4-1: Available demodulation bandwidths and corresponding sample rates

Demodulation BW	Sample Rate (Flat Top)	Sample Rate (Gaussian Top)
100 Hz	122.0703125 Hz	400 Hz
200 Hz	244.140625 Hz	800 Hz
400 Hz	488.28125 Hz	1.6 kHz
800 Hz	976.5625 Hz	3.2 kHz
1.6 kHz	1.953125 kHz	6.4 kHz
3.2 kHz	3.90625 kHz	12.8 kHz
6.4 kHz	7.8125 kHz	25.6 kHz
12.5 kHz	15.625 kHz	50 kHz
25 kHz	31.25 kHz	100 kHz
50 kHz	62.5 kHz	200 kHz
100 kHz	125 kHz	400 kHz
200 kHz	250 kHz	800 kHz
400 kHz	500 kHz	1.6 MHz
800 kHz	1 MHz	3.2 MHz
1.6 MHz	2 MHz	6.4 MHz
3 MHz	4 MHz	12 MHz
5 MHz	8 MHz	20 MHz
8 MHz	16 MHz	32 MHz**
10 MHz	32 MHz	40 MHz**
18 MHz*	32 MHz**	72 MHz**
* Gaussian filter curve is limited by I/Q bandwidth;		
**requires bandwidth extension option R&S FPL1-B40		

Demodulation BW	Sample Rate (Flat Top)	Sample Rate (Gaussian Top)
28 MHz*	64 MHz**	
40 MHz*	64 MHz**	
* Gaussian filter curve is limited by I/Q bandwidth; **requires bandwidth extension option R&S FPL1-B40		



Flat top filters require an I/Q bandwidth at least the size of the demodulation bandwidth on the R&S FPL1000. Gauss filters require at least twice the size of the demodulation bandwidth on the R&S FPL1000. If necessary, install optional bandwidth extensions on the R&S FPL1000 to use the required demodulation filter.

Large numbers of samples

Principally, the R&S FPL1000 can handle up to 24 million samples. However, when 480001 samples are exceeded, all traces that are not currently being displayed in a window are deactivated to improve performance. The traces can only be activated again when the samples are reduced.



Effects of measurement time on the stability of measurement results

Despite amplitude and frequency modulation, the display of carrier power and carrier frequency offset is stable.

Stability is achieved by a digital filter which sufficiently suppresses the modulation. As a prerequisite, the measurement time must be $\geq 3 \times 1 / \text{modulation frequency}$, i.e. at least three periods of the AF signal are recorded.

The mean carrier power for calculating the AM is also calculated with a digital filter. The filter returns stable results after a measurement time of $\geq 3 \times 1 / \text{modulation frequency}$, i.e. at least three cycles of the AF signal must be recorded before a stable AM can be shown.

4.4 AF triggers

The Analog Modulation Analysis application allows triggering to the demodulated signal. The display is stable if a minimum of five modulation periods are within the recording time.

Triggering is always DC-coupled. Therefore triggering is possible directly to the point where a specific carrier level, phase or frequency is exceeded or not attained.

4.5 AF filters

Additional filters applied after demodulation help filter out unwanted signals, or correct pre-emphasized input signals. A CCITT filter allows you to evaluate the signal by simulating the characteristics of human hearing.

4.6 Time domain zoom

For evaluations in the time domain, the demodulated data for a particular time span can be extracted and displayed in more detail using the "Time Domain Zoom" function. Zooming is useful if the measurement time is very large and thus each sweep point represents a large time span. The time domain zoom function distributes the available sweep points only among the time span defined by the zoom area length. The time span displayed per division of the diagram is decreased. Thus, the display of the extracted time span becomes more precise.

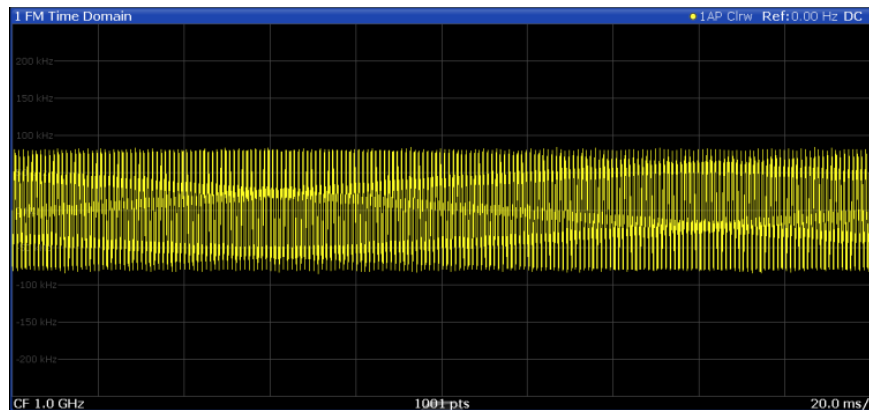

Figure 4-2: FM time domain measurement with a very long measurement time (200 ms)

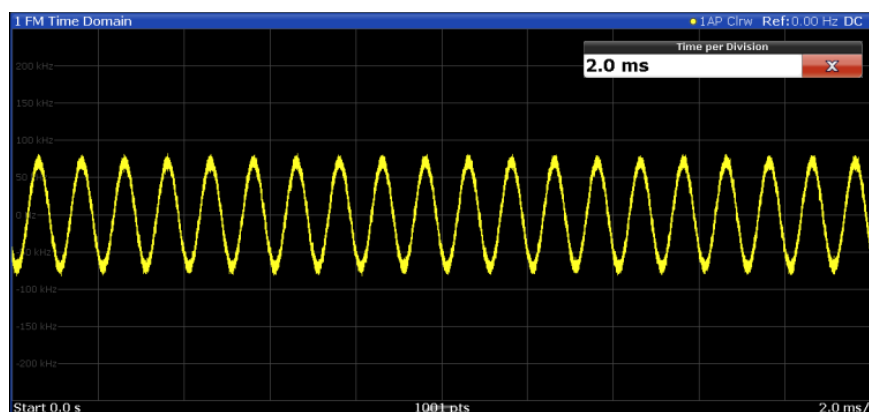
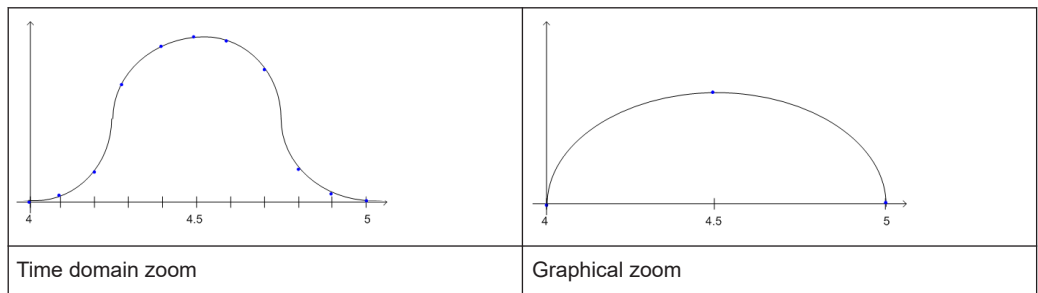
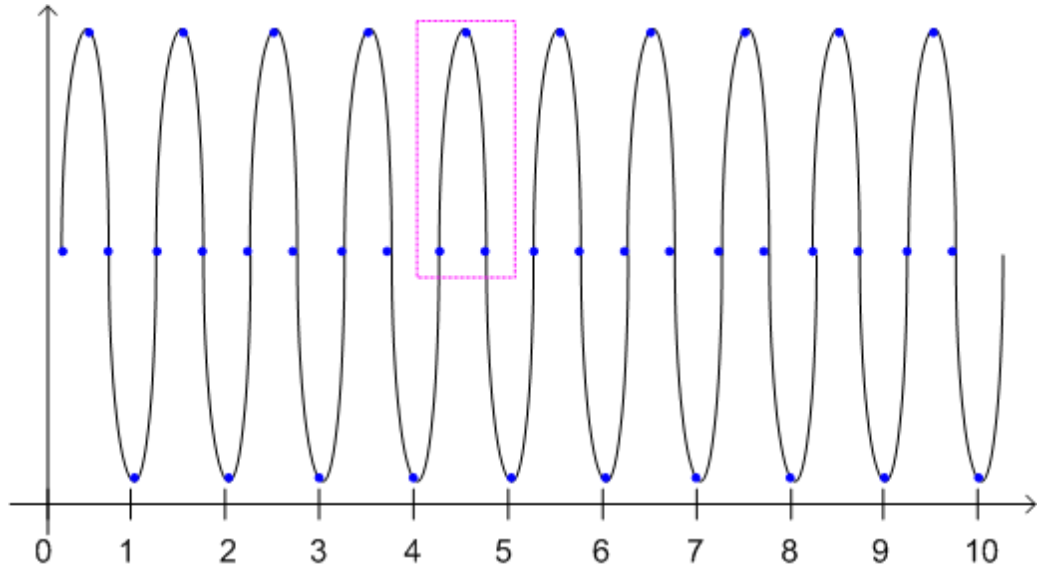

Figure 4-3: FM time domain measurement with time domain zoom (2.0 ms per division)

The time domain zoom area affects not only the diagram display, but the entire evaluation for the current window.

In contrast to the time domain zoom, the graphical zoom is available for all diagram evaluations. However, the graphical zoom is useful only if more measured values than trace points are available. The (time) span represented by each measurement point remains the same.



5 Configuration

Access: [MODE] > "AM FM PM Analog Demod"

Analog Modulation Analysis requires a special application on the R&S FPL1000.

When you activate an R&S FPL1-K7 AM/FM/PM Modulation Analysis application the first time, a set of parameters is passed on from the currently active application. After initial setup, the parameters for the channel setup are stored upon exiting and restored upon re-entering the channel setup. Thus, you can switch between applications quickly and easily.

When you activate the R&S FPL1-K7 AM/FM/PM Modulation Analysis application, Analog Modulation Analysis for the input signal is started automatically with the default configuration. The "AM FM PM Analog Demod" menu is displayed and provides access to the most important configuration functions.

The remote commands required to perform these tasks are described in [Chapter 11, "Remote commands for AM/FM/PM Modulation Analysis"](#), on page 118.

Predefined settings

For commonly performed measurements, standard setup files are provided for quick and easy configuration. Simply load an existing standard settings file and, if necessary, adapt the measurement settings to your specific requirements.

For an overview of predefined standards and settings see [Chapter A, "Predefined standards and settings"](#), on page 278.

- [Configuration overview](#).....33
- [Configuration according to standards](#)..... 35
- [Input and frontend settings](#).....37
- [Trigger configuration](#)..... 45
- [Data acquisition](#).....49
- [Demodulation display](#).....54
- [Demodulation](#)..... 54
- [Output settings](#).....73
- [Adjusting settings automatically](#).....73

5.1 Configuration overview



Access: "Meas Config" > "Overview"

Using the R&S FPL1-K7 AM/FM/PM Modulation Analysis application you can perform Analog Modulation Analysis using predefined standard setting files, or independently of standards using user-defined measurement settings. Such settings can be stored for recurrent use.

Thus, configuring AM/FM/PM Modulation Analysis measurements requires one of the following tasks:

- Selecting an existing standard settings file and, if necessary, adapting the measurement settings to your specific requirements.
- Configuring the measurement settings and, if necessary, storing the settings in a file.

"Overview" window

Throughout the channel setup configuration, an overview of the most important currently defined settings is provided in the "Overview".

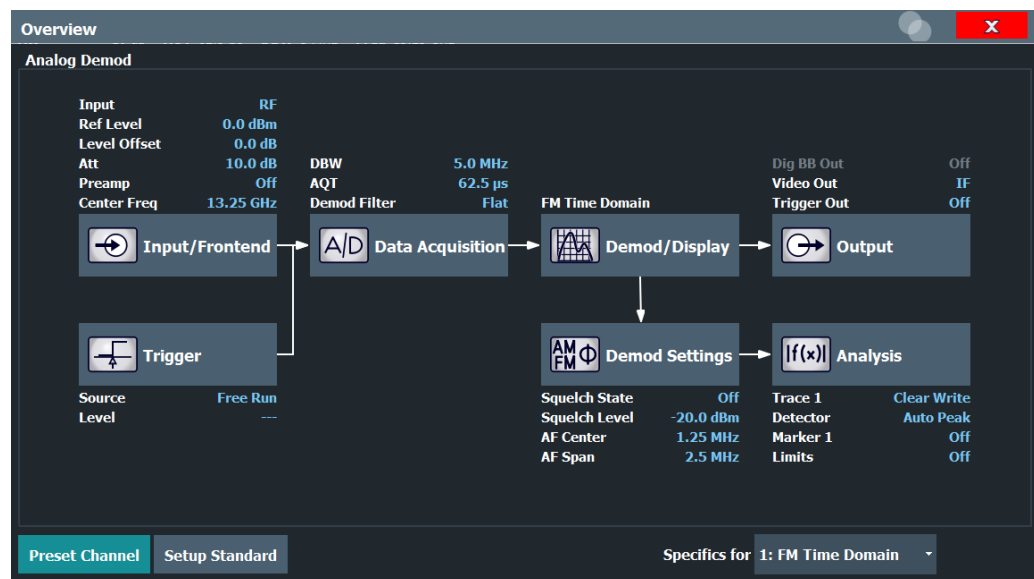

In addition to the main measurement settings, the "Overview" provides quick access to the main settings dialog boxes. The individual configuration steps are displayed in the order of the data flow. In particular, the "Overview" provides quick access to the following configuration dialog boxes (listed in the recommended order of processing):

1. Input/Frontend
See [Chapter 5.3, "Input and frontend settings"](#), on page 37
2. Trigger
See [Chapter 5.4, "Trigger configuration"](#), on page 45
3. Data Acquisition
See [Chapter 5.5, "Data acquisition"](#), on page 49
4. Demod/Display
See [Chapter 5.6, "Demodulation display"](#), on page 54
5. Demodulation Settings
See [Chapter 5.7, "Demodulation"](#), on page 54
6. Analysis
See [Chapter 6, "Analysis"](#), on page 77

7. (Optionally:) Outputs

See [Chapter 5.8, "Output settings"](#), on page 73

To configure settings

- ▶ Select any button in the "Overview" to open the corresponding dialog box.
Select a setting in the channel setup bar (at the top of the channel setup tab) to change a specific setting.

Preset Channel setup

Select the "Preset Channel" button in the lower left-hand corner of the "Overview" to restore all measurement settings *in the current channel setup* to their default values.

Note: Do not confuse the "Preset Channel" button with the [Preset] key, which restores the entire instrument to its default values and thus closes *all channel setups* on the R&S FPL1000 (except for the default channel setup)!

Remote command:

`SYSTem:PRESet:CHANnel [:EXEC]` on page 127

Setup Standard

Opens a file selection dialog box to select a predefined setup file. See ["Setup Standard"](#) on page 36.

Specific Settings for

The channel setup can contain several windows for different results. Thus, the settings indicated in the "Overview" and configured in the dialog boxes vary depending on the selected window.

Select an active window from the "Specific Settings for" selection list that is displayed in the "Overview" and in all window-specific configuration dialog boxes.

The "Overview" and dialog boxes are updated to indicate the settings for the selected window.

5.2 Configuration according to standards

Access: "Overview" > "Setup Standard"

Various predefined settings files for common standards are provided for use with the R&S FPL1-K7 AM/FM/PM Modulation Analysis application. In addition, you can create your own settings files for user-specific measurements.

For details on which settings are defined and an overview of predefined standards see [Chapter A, "Predefined standards and settings"](#), on page 278.

Setup Standard.....	36
L Selecting Storage Location - Drive/ Path/ Files.....	36
L File Name.....	36
L Load Standard.....	37

↳ Save Standard.....	37
↳ Delete Standard.....	37
↳ Restore Standard Files.....	37

Setup Standard

Opens a file selection dialog box to select a predefined setup file. The predefined settings are configured in the R&S FPL1-K7 AM/FM/PM Modulation Analysis application, which allows for quick and easy configuration for commonly performed measurements.

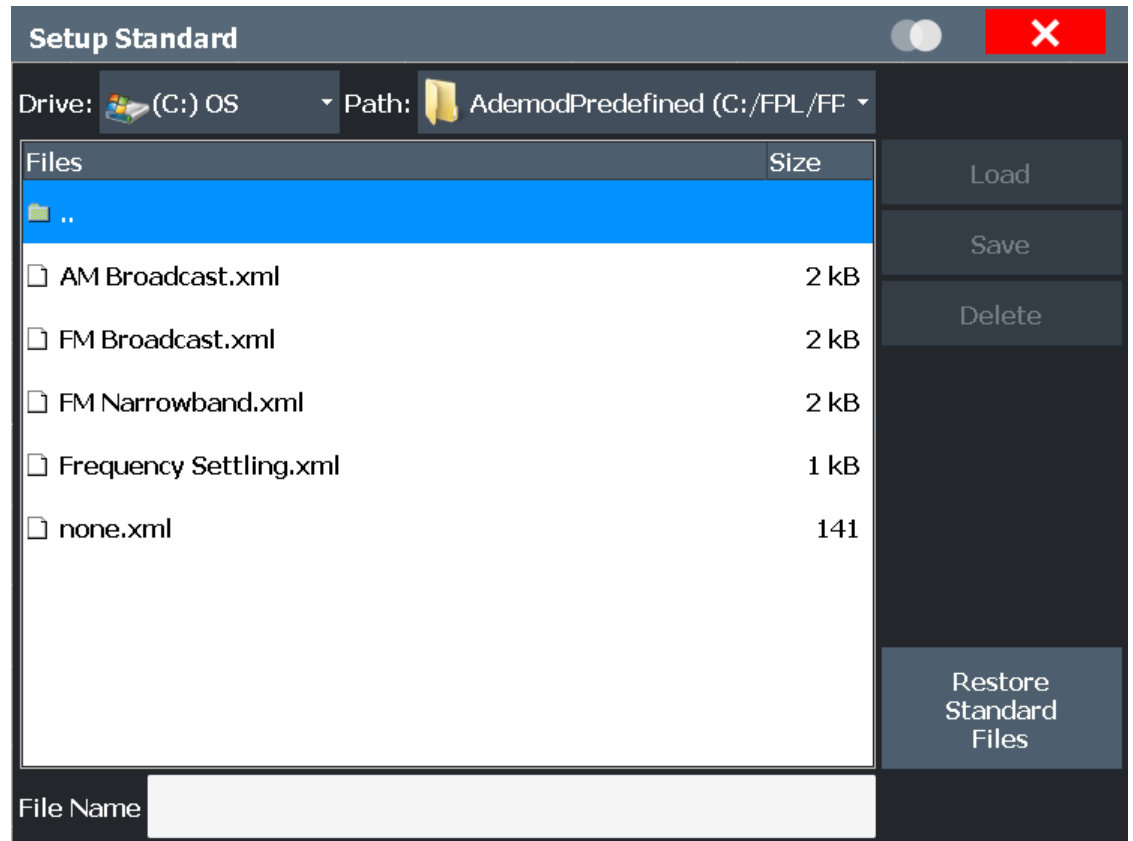

Selecting Storage Location - Drive/ Path/ Files ← Setup Standard

Select the storage location of the file on the instrument or an external drive.

The default storage location for the settings files is:

C:\Users\Public\Documents\Rohde-Schwarz\Analyzer\user\predefined\AdemodPredefined.

File Name ← Setup Standard

Contains the name of the data file without the path or extension.

File names must be compatible with the Windows conventions for file names. In particular, they must not contain special characters such as ":", "*", "?".

For details on the filename and location, see the "Data Management" topic in the R&S FPL1000 User Manual.

Load Standard ← Setup Standard

Loads the selected measurement settings file.

Remote command:

[SENSe:]ADEMod:PRESet[:STANdard] on page 128

Save Standard ← Setup Standard

Saves the current measurement settings for a specific standard as a file with the defined name.

Remote command:

[SENSe:]ADEMod:PRESet:STORe on page 128

Delete Standard ← Setup Standard

Deletes the selected standard. Standards predefined by Rohde & Schwarz can also be deleted. A confirmation query is displayed to avoid unintentional deletion of the standard.

Note: Restoring predefined standard files. The standards predefined by Rohde & Schwarz available at the time of delivery can be restored using the "Restore Standard Files" function (see "Restore Standard Files" on page 37).

Restore Standard Files ← Setup Standard

Restores the standards predefined by Rohde & Schwarz available at the time of delivery.

Note that this function overwrites customized standards that have the same name as predefined standards.

Remote command:

[SENSe:]ADEMod:PRESet:RESTore on page 128

5.3 Input and frontend settings

Access: "Overview" > "Input/Frontend"

The source and characteristics of the input signal to be demodulated are configured in the "Input/Frontend Settings" dialog box.

Power sensor settings are described in the R&S FPL1000 User Manual.

Internal generator settings are described in the R&S FPL1000 User Manual.

- [Radio frequency input](#)..... 37
- [Settings for input from I/Q data files](#)..... 39
- [Amplitude settings](#)..... 40
- [Frequency](#)..... 44

5.3.1 Radio frequency input

Access: "Overview" > "Input" > "Input Source" > "Radio Frequency"

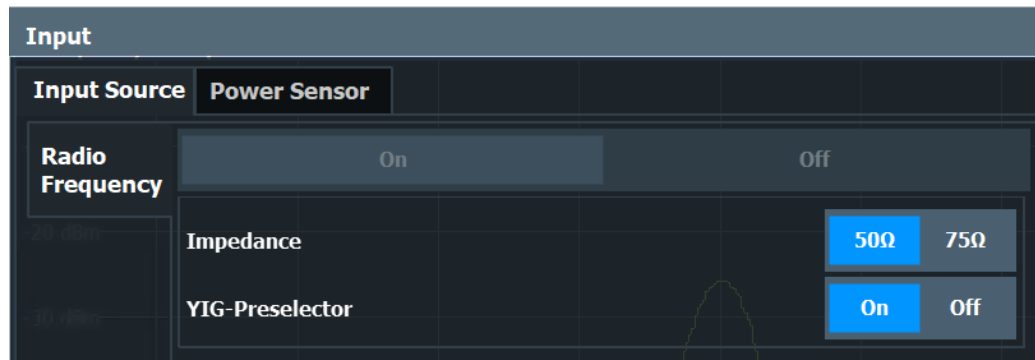

RF Input Protection

The RF input connector of the R&S FPL1000 must be protected against signal levels that exceed the ranges specified in the data sheet. Therefore, the R&S FPL1000 is equipped with an overload protection mechanism. This mechanism becomes active as soon as the power at the input mixer exceeds the specified limit. It ensures that the connection between RF input and input mixer is cut off.

The RF input connector of the R&S FPL1000 must be protected against signal levels that exceed the ranges specified in the data sheet. Therefore, the R&S FPL1000 is equipped with an overload protection mechanism for DC and signal frequencies up to 30 MHz. This mechanism becomes active as soon as the power at the input mixer exceeds the specified limit. It ensures that the connection between RF input and input mixer is cut off.

When the overload protection is activated, an error message is displayed in the status bar ("INPUT OVLD"), and a message box informs you that the RF input was disconnected. Furthermore, a status bit (bit 3) in the `STAT:QUES:POW` status register is set. In this case, you must decrease the level at the RF input connector and then close the message box. Then measurement is possible again. Reactivating the RF input is also possible via the remote command `INPut:ATTenuation:PROTection:RESet`.



The power sensor functions are described in the R&S FPL1000 User Manual.

Radio Frequency State	38
Impedance	38
YIG-Preselector	39
SAW filter	39

Radio Frequency State

Activates input from the "RF Input" connector.

Remote command:

`INPut<ip>:SELeCt` on page 130

Impedance

For some measurements, the reference impedance for the measured levels of the R&S FPL1000 can be set to 50 Ω or 75 Ω .

Select 75 Ω if the 50 Ω input impedance is transformed to a higher impedance using a 75 Ω adapter of the RAZ type. (That corresponds to 25 Ω in series to the input impedance of the instrument.) The correction value in this case is 1.76 dB = 10 log (75 Ω /50 Ω).

This value also affects the unit conversion (see "Reference Level" on page 41).

Remote command:

`INPut<ip>:IMPedance` on page 130

YIG-Preselector

Enables or disables the YIG-preselector.

This setting requires the option R&S FPL1-B11 on the R&S FPL1000.

An internal YIG-preselector at the input of the R&S FPL1000 ensures that image frequencies are rejected. However, image rejection is only possible for a restricted bandwidth. To use the maximum bandwidth for signal analysis you can disable the YIG-preselector at the input of the R&S FPL1000. However, disabling the YIG-preselector can lead to image-frequency display.

Note: Note that the YIG-preselector is active only on frequencies greater than 6 GHz (for models R&S FPL1014 and R&S FPL1026). Therefore, switching the YIG-preselector on or off has no effect if the frequency is below that value.

For measurements that require I/Q analysis in large bandwidths at frequencies higher than 6 GHz, it is strongly recommended that you disable the YIG-preselector.

Remote command:

`INPut<ip>:FILTer:YIG[:STATe]` on page 129

SAW filter

The R&S FPL1000 hardware contains both a wide and a narrow IF path. Depending on the used analysis bandwidth, the R&S FPL1000 determines which IF path to use automatically. The wide IF path allows for a smoother signal at the center frequency, while the narrow IF path suppresses possibly distorting signals further away from the center frequency. Using this setting, you can affect which IF path is used.

"Auto" The R&S FPL1000 determines which IF path to use automatically, depending on the used analysis bandwidth.

"Off" The wide IF path is always used.

Remote command:

`INPut<ip>:FILTer:SAW` on page 129

5.3.2 Settings for input from I/Q data files

Access: "Overview" > "Input/Frontend" > "Input Source" > "I/Q File"

Or: [INPUT/OUTPUT] > "Input Source Config" > "Input Source" > "I/Q File"

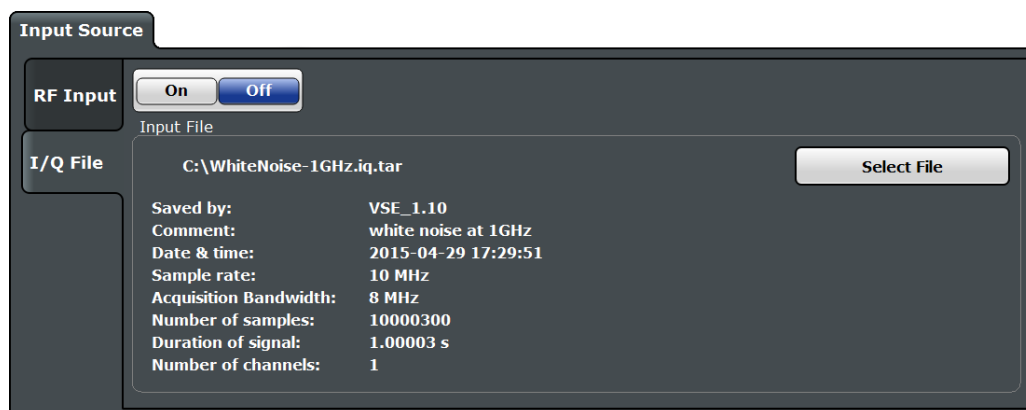

I/Q Input File State	40
Select I/Q data file	40

I/Q Input File State

Enables input from the selected I/Q input file.

If enabled, the application performs measurements on the data from this file. Thus, most measurement settings related to data acquisition (attenuation, center frequency, measurement bandwidth, sample rate) cannot be changed. The measurement time can only be decreased to perform measurements on an extract of the available data only.

Note: Even when the file input is disabled, the input file remains selected and can be enabled again quickly by changing the state.

Remote command:

[INPut<ip>:SElect](#) on page 130

Select I/Q data file

Opens a file selection dialog box to select an input file that contains I/Q data.

The I/Q data must have a specific format (.iq.tar) as described in R&S FPL1000 I/Q Analyzer and I/Q Input user manual.

The default storage location for I/Q data files is

C:\Users\Public\Documents\Rohde-Schwarz\Analyzer\user.

Remote command:

[INPut<ip>:FILE:PATH](#) on page 131

5.3.3 Amplitude settings

Access: "Overview" > "Input/Frontend" > "Amplitude"

Amplitude settings determine how the R&S FPL1000 must process or display the expected input power levels.

Configuring amplitude settings allows you to:

- Adapt the instrument hardware to the expected maximum signal level by setting the [Reference Level](#) to this maximum

- Consider an external attenuator or preamplifier (using the "Offset").
- Optimize the SNR of the measurement for low signal levels by configuring the [Reference Level](#) as high as possible without introducing compression, clipping or overload. Use early amplification by the preamplifier and a low attenuation.
- Optimize the SNR for high signal levels and ensure that the instrument hardware is not damaged, using high attenuation and AC coupling (for DC input voltage).
- Adapt the reference impedance for power results when measuring in a 75-Ohm system by connecting an external matching pad to the RF input.

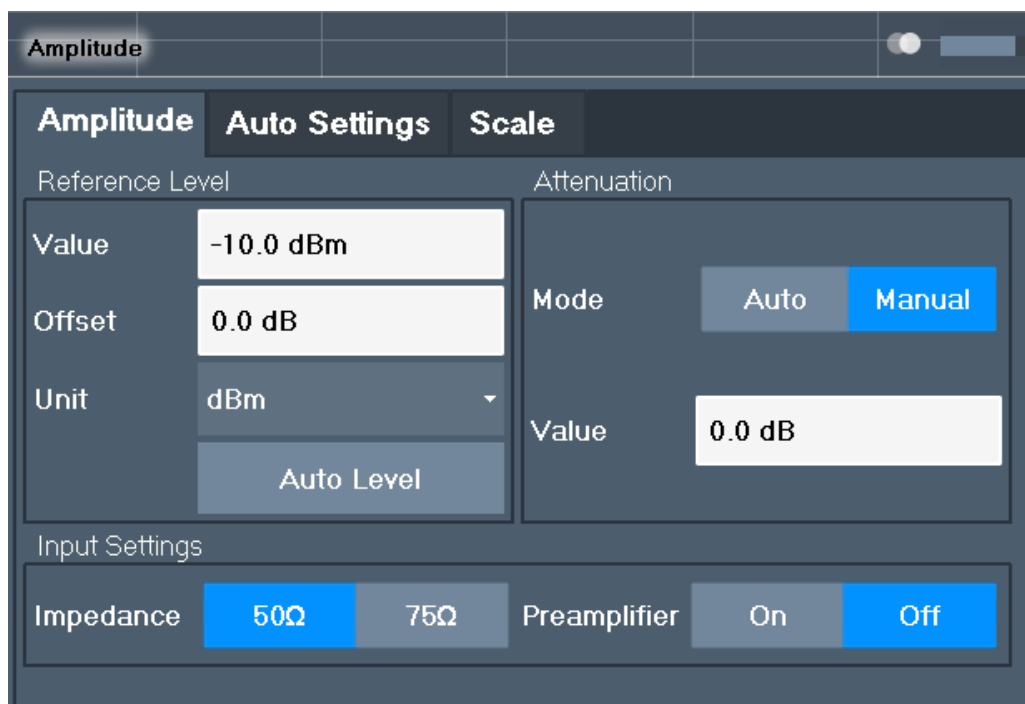

Reference Level.....	41
L Shifting the Display (Offset).....	42
L Unit.....	42
L Setting the Reference Level Automatically (Auto Level).....	42
Attenuation Mode / Value.....	43
Attenuation Mode / Value.....	43
Impedance.....	44
Preamplifier.....	44

Reference Level

Defines the expected maximum reference level. Signal levels above this value are possibly not measured correctly. Signals above the reference level are indicated by an "IF Overload" status display.

The reference level can also be used to scale power diagrams; the reference level is then used for the calculation of the maximum on the y-axis.

Since the hardware of the R&S FPL1000 is adapted according to this value, it is recommended that you set the reference level close above the expected maximum signal level. Thus you ensure an optimal measurement (no compression, good signal-to-noise ratio).

Remote command:

`DISPlay[:WINDow<n>][:SUBWindow<w>]:TRACe<t>:Y[:SCALe]:RLEVel`
on page 137

Shifting the Display (Offset) ← Reference Level

Defines an arithmetic level offset. This offset is added to the measured level. In some result displays, the scaling of the y-axis is changed accordingly.

Define an offset if the signal is attenuated or amplified before it is fed into the R&S FPL1000 so the application shows correct power results. All displayed power level results are shifted by this value.

The setting range is ± 200 dB in 0.01 dB steps.

Note, however, that the *internal* reference level (used to adjust the hardware settings to the expected signal) ignores any "Reference Level Offset". Thus, it is important to keep in mind the actual power level the R&S FPL1000 must handle. Do not rely on the displayed reference level (internal reference level = displayed reference level - offset).

Remote command:

`DISPlay[:WINDow<n>][:SUBWindow<w>]:TRACe<t>:Y[:SCALe]:RLEVel:OFFSet` on page 137

Unit ← Reference Level

The R&S FPL1000 measures the signal voltage at the RF input.

In the default state, the level is displayed at a power level of 1 mW (= dBm). Via the known input impedance (50 Ω or 75 Ω , see "[Impedance](#)" on page 38), conversion to other units is possible.

The following units are available and directly convertible:

- dBm
- dBmV
- dB μ V
- dB μ A
- dBpW
- Volt
- Ampere
- Watt

Remote command:

`INPut<ip>:IMPedance` on page 130
`CALCulate<n>:UNIT:POWer` on page 136

Setting the Reference Level Automatically (Auto Level) ← Reference Level

Automatically determines a reference level which ensures that no overload occurs at the R&S FPL1000 for the current input data. At the same time, the internal attenuators are adjusted. As a result, the signal-to-noise ratio is optimized, while signal compression and clipping are minimized.

To determine the required reference level, a level measurement is performed on the R&S FPL1000.

If necessary, you can optimize the reference level further. Decrease the attenuation level manually to the lowest possible value before an overload occurs, then decrease the reference level in the same way.

You can change the measurement time for the level measurement if necessary (see "[Changing the Automatic Measurement Time \(Meas Time Manual\)](#)" on page 75).

Remote command:

[\[SENSe:\]ADJust:LEVel](#) on page 174

Attenuation Mode / Value

Defines the attenuation applied to the RF input of the R&S FPL1000.

The RF attenuation can be set automatically as a function of the selected reference level (Auto mode). Automatic attenuation ensures that no overload occurs at the RF Input connector for the current reference level. It is the default setting.

In "Manual" mode, you can set the RF attenuation in 5 dB steps down to 0 dB (with option R&S FPL1-B25: in 1 dB steps). Other entries are rounded to the next integer value. The range is specified in the data sheet. If the defined reference level cannot be set for the defined RF attenuation, the reference level is adjusted accordingly and the warning "limit reached" is displayed.

NOTICE! Risk of hardware damage due to high power levels. When decreasing the attenuation manually, ensure that the power level does not exceed the maximum level allowed at the RF input, as an overload can lead to hardware damage.

Remote command:

[INPut<ip>:ATTenuation](#) on page 138

[INPut<ip>:ATTenuation:AUTO](#) on page 138

Attenuation Mode / Value

Defines the attenuation applied to the RF input of the R&S FPL1000.

The RF attenuation can be set automatically as a function of the selected reference level (Auto mode). Automatic attenuation ensures that no overload occurs at the RF Input connector for the current reference level. It is the default setting.

In "Manual" mode, you can set the RF attenuation in 5 dB steps down to 0 dB (with option R&S FPL1-B25: in 1 dB steps). Other entries are rounded to the next integer value. The range is specified in the data sheet. If the defined reference level cannot be set for the defined RF attenuation, the reference level is adjusted accordingly and the warning "limit reached" is displayed.

NOTICE! Risk of hardware damage due to high power levels. When decreasing the attenuation manually, ensure that the power level does not exceed the maximum level allowed at the RF input, as an overload can lead to hardware damage.

Remote command:

[INPut<ip>:ATTenuation](#) on page 138

[INPut<ip>:ATTenuation:AUTO](#) on page 138

Impedance

For some measurements, the reference impedance for the measured levels of the R&S FPL1000 can be set to 50 Ω or 75 Ω.

Select 75 Ω if the 50 Ω input impedance is transformed to a higher impedance using a 75 Ω adapter of the RAZ type. (That corresponds to 25Ω in series to the input impedance of the instrument.) The correction value in this case is 1.76 dB = 10 log (75Ω/50Ω).

This value also affects the unit conversion (see "Reference Level" on page 41).

Remote command:

`INPut<ip>:IMPedance` on page 130

Preamplifier

If the (optional) internal preamplifier hardware is installed on the R&S FPL1000, a preamplifier can be activated for the RF input signal.

You can use a preamplifier to analyze signals from DUTs with low output power.

Note: If an optional external preamplifier is activated, the internal preamplifier is automatically disabled, and vice versa.

The input signal is amplified by 20 dB if the preamplifier option is activated.

Remote command:

`INPut<ip>:GAIN:STATe` on page 139

5.3.4 Frequency

Access: "Overview" > "Input/Frontend" > "Frequency" tab

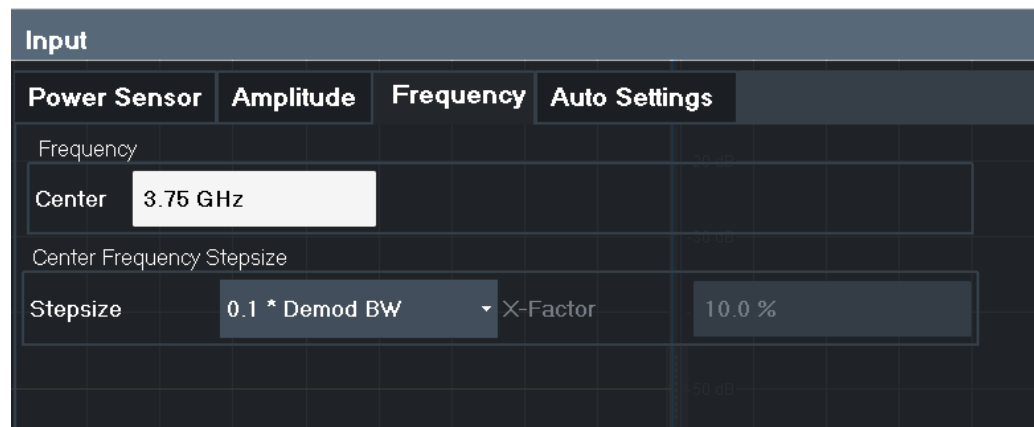

Center Frequency.....	44
Center Frequency Stepsize.....	45

Center Frequency

Defines the center frequency of the signal in Hertz.

The allowed range of values for the center frequency depends on the frequency span.

$$\text{span} > 0: \text{span}_{\min}/2 \leq f_{\text{center}} \leq f_{\text{max}} - \text{span}_{\min}/2$$

f_{\max} and span_{\min} depend on the instrument and are specified in the data sheet.

Remote command:

[\[SENSe:\] FREQuency:CENTer](#) on page 134

Center Frequency Stepsize

Defines the step size of the center frequency. The step size can be coupled to the demodulation bandwidth, or you can set it to a fixed value manually.

"0.1 * Demod BW"	(default:) Sets the step size for the center frequency to 10 % of the demodulation bandwidth.
"0.5 * Demod BW"	Sets the step size for the center frequency to 50 % of the demodulation bandwidth.
"X * Demod BW"	Sets the step size for the center frequency to a manually defined factor of the demodulation bandwidth. The "X-Factor" defines the percentage of the demodulation bandwidth. Values between 1 % and 100 % in steps of 1 % are allowed. The default setting is 10 %.
"= Center"	Sets the step size to the value of the center frequency and removes the coupling of the step size to the demodulation bandwidth. The used value is indicated in the "Value" field.
"Manual"	Defines a fixed step size for the center frequency. Enter the step size in the "Value" field.

Remote command:

[\[SENSe:\] FREQuency:CENTer:STEP:LINK](#) on page 135

[\[SENSe:\] FREQuency:CENTer:STEP:LINK:FACTOR](#) on page 135

[\[SENSe:\] FREQuency:CENTer:STEP](#) on page 134

5.4 Trigger configuration

Access: "Overview" > "Trigger"

Triggering means to capture the interesting part of the signal. Choosing the right trigger type and configuring all trigger settings correctly allows you to detect various incidents in your demodulated signals.

Optionally, the trigger signal used by the R&S FPL1000 can be output to a connected device, and an external trigger signal from a connected device can be used by the R&S FPL1000.

Trigger settings are identical to the base unit, except for the available trigger sources. Gating is not available for Analog Modulation Analysis.

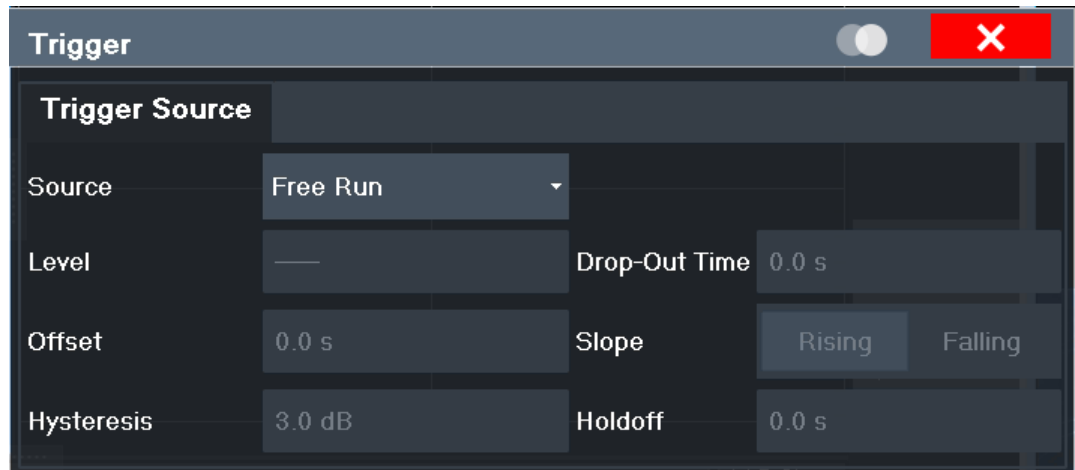

- [Trigger source settings](#).....46

5.4.1 Trigger source settings

Access: "Overview" > "Trigger" > "Trigger Source" tab

Trigger Source.....	46
L Free Run.....	46
L External Trigger 1.....	47
L IF Power.....	47
L FM (Offline) / AM (Offline) / PM (Offline) / RF (Offline).....	47
L Time.....	47
Trigger Level.....	47
Repetition Interval.....	48
Trigger Offset.....	48
Hysteresis.....	48
Drop-Out Time.....	48
Slope.....	48
Trigger Holdoff.....	48

Trigger Source

In the R&S FPL1-K7 AM/FM/PM Modulation Analysis application, the next measurement can be triggered if the selected input signal exceeds the threshold specified using the "Trigger Level" setting (see "[Trigger Level](#)" on page 47). Thus, a periodic signal modulated onto the carrier frequency can be displayed. It is recommended that the measurement time covers at least five periods of the audio signal.

Remote command:

[TRIGger \[:SEquence \] :SOURce](#) on page 150

Free Run ← Trigger Source

No trigger source is considered. Data acquisition is started manually or automatically and continues until stopped explicitly.

Remote command:

TRIG:SOUR IMM, see [TRIGger \[:SEquence \] :SOURce](#) on page 150

External Trigger 1 ← Trigger Source

Data acquisition starts when the TTL signal fed into the trigger input connector of the R&S FPL1000 meets or exceeds the specified trigger level.

(See ["Trigger Level"](#) on page 47).

Remote command:

TRIG:SOUR EXT

See [TRIGger\[:SEquence\]:SOURce](#) on page 150

IF Power ← Trigger Source

The R&S FPL1000 starts capturing data as soon as the trigger level is exceeded around the third intermediate frequency.

For frequency sweeps, the third IF represents the start frequency. The trigger threshold depends on the defined trigger level, as well as on the RF attenuation and preamplification. A reference level offset, if defined, is also considered. The trigger bandwidth at the intermediate frequency depends on the RBW and sweep type. For details on available trigger levels and trigger bandwidths, see the instrument data sheet.

For measurements on a fixed frequency (e.g. zero span or I/Q measurements), the third IF represents the center frequency.

This trigger source is only available for RF input.

For details on available trigger levels and trigger bandwidths, see the data sheet.

Remote command:

TRIG:SOUR IFP, see [TRIGger\[:SEquence\]:SOURce](#) on page 150

FM (Offline) / AM (Offline) / PM (Offline) / RF (Offline) ← Trigger Source

Triggers when the demodulated input signal exceeds the trigger level.

Remote command:

[TRIGger\[:SEquence\]:SOURce](#) on page 150

Time ← Trigger Source

Triggers in a specified repetition interval.

See ["Repetition Interval"](#) on page 48.

Remote command:

TRIG:SOUR TIME, see [TRIGger\[:SEquence\]:SOURce](#) on page 150

Trigger Level

Defines the trigger level for the specified trigger source.

For details on supported trigger levels, see the instrument data sheet.

Remote command:

[TRIGger\[:SEquence\]:LEVel:IFPower](#) on page 148

[TRIGger\[:SEquence\]:LEVel\[:EXternal<port>\]](#) on page 148

[TRIGger\[:SEquence\]:LEVel:AM:RELative](#) on page 149

[TRIGger\[:SEquence\]:LEVel:AM\[:ABSolute\]](#) on page 149

[TRIGger\[:SEquence\]:LEVel:FM](#) on page 149

[TRIGger\[:SEquence\]:LEVel:PM](#) on page 149

Repetition Interval

Defines the repetition interval for a time trigger.

The shortest interval is 2 ms.

Set the repetition interval to the exact pulse period, burst length, frame length or other repetitive signal characteristic. If the required interval cannot be set with the available granularity, configure a multiple of the interval that can be set. Thus, the trigger remains synchronized to the signal.

Remote command:

[TRIGger\[:SEquence\]:TIME:RINterval](#) on page 151

Trigger Offset

Defines the time offset between the trigger event and the start of the sweep.

Offset > 0:	Start of the sweep is delayed
Offset < 0:	Sweep starts earlier (pretrigger)

For the "Time" trigger source, this function is not available.

Remote command:

[TRIGger\[:SEquence\]:HOLDoFF\[:TIME\]](#) on page 147

Hysteresis

Defines the distance in dB to the trigger level that the trigger source must exceed before a trigger event occurs. Setting a hysteresis avoids unwanted trigger events caused by noise oscillation around the trigger level.

This setting is only available for "IF Power" trigger sources. The range of the value is between 3 dB and 50 dB with a step width of 1 dB.

(For details see the R&S FPL1000 I/Q Analyzer and I/Q Input User Manual.)

Remote command:

[TRIGger\[:SEquence\]:IFPower:HYSTeresis](#) on page 148

Drop-Out Time

Defines the time that the input signal must stay below the trigger level before triggering again.

Remote command:

[TRIGger\[:SEquence\]:DTIME](#) on page 147

Slope

For all trigger sources except time, you can define whether triggering occurs when the signal rises to the trigger level or falls down to it.

Remote command:

[TRIGger\[:SEquence\]:SLOPe](#) on page 150

Trigger Holdoff

Defines the minimum time (in seconds) that must pass between two trigger events. Trigger events that occur during the holdoff time are ignored.

Remote command:

[TRIGger \[:SEquence\] :IFPower:HOLDoff](#) on page 147

5.5 Data acquisition

Access: "Overview" > "Data Acquisition"

You configure how data is acquired and then demodulated in the "Data Acquisition" dialog box.

- [Bandwidth settings](#).....49
- [Sweep settings](#).....50

5.5.1 Bandwidth settings

Access: "Overview" > "Data Acquisition" > "Bandwidth" tab

The bandwidth settings define which parts of the input signal are acquired and then demodulated.

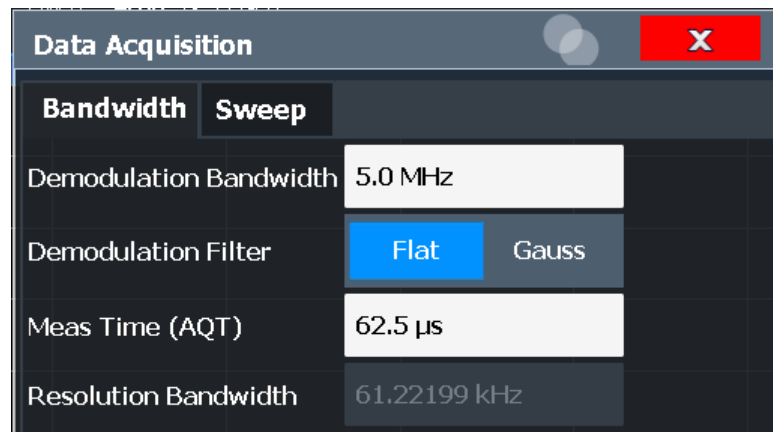

- [Demodulation Bandwidth](#)..... 49
- [Demodulation Filter](#)..... 49
- [Measurement Time \(AQT\)](#)..... 50
- [Resolution Bandwidth](#)..... 50

Demodulation Bandwidth

Defines the demodulation bandwidth of the measurement. The demodulation bandwidth determines the sample rate with which the input signal is captured and analyzed.

For recommendations on finding the correct demodulation bandwidth, see [Chapter 4.2, "Demodulation bandwidth"](#), on page 28.

Remote command:

[\[SENSe:\] BWIDth:DEMod](#) on page 144

Demodulation Filter

Defines the filter to be used for demodulation.

For details on sample rates, measurement times and trigger offsets for various demodulation bandwidths when using a Gaussian filter, see [Chapter 4.3, "Sample rate and demodulation bandwidth"](#), on page 29.

"Flat" Default

"Gauss" Optimizes the settling behavior of the filter

Remote command:

[\[SENSe:\] BWIDth:DEMod:TYPE](#) on page 145

Measurement Time (AQT)

Defines how long data is acquired for demodulation.

Remote command:

[\[SENSe:\] ADEMod:MTIME](#) on page 143

Resolution Bandwidth

Defines the resolution bandwidth for data acquisition. The available range is specified in the data sheet.

Remote command:

[\[SENSe:\] BANDwidth\[:RESolution\]](#) on page 145

5.5.2 Sweep settings

Access: "Overview" > "Data Acquisition" > "Sweep" tab

The sweep settings define how often data from the input signal is acquired and then demodulated.

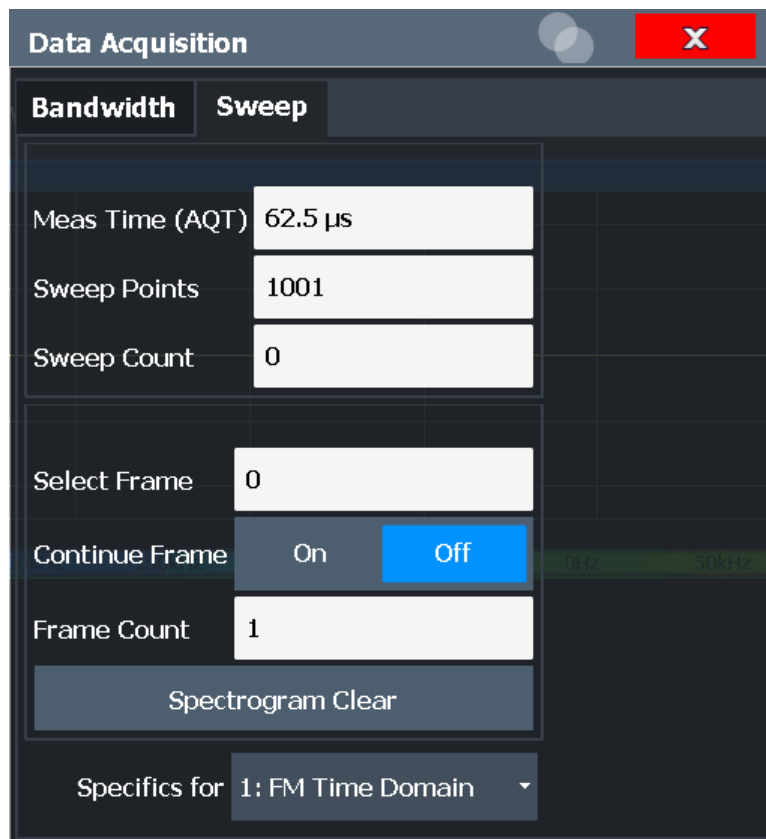

Continuous Sweep / Run Cont.....	51
Single Sweep / Run Single.....	52
Continue Single Sweep.....	52
Measurement Time (AQT).....	52
Sweep Points.....	52
This is Sweep/Average Count ok?.....	52
Select Frame.....	53
Continue Frame.....	53
Frame Count.....	53
Clear Spectrogram.....	53

Continuous Sweep / Run Cont

After triggering, starts the measurement and repeats it continuously until stopped.

While the measurement is running, the "Continuous Sweep" softkey and the [RUN CONT] key are highlighted. The running measurement can be aborted by selecting the highlighted softkey or key again. The results are not deleted until a new measurement is started.

Note: Sequencer. If the Sequencer is active, the "Continuous Sweep" softkey only controls the sweep mode for the currently selected channel setup. However, the sweep mode only takes effect the next time the Sequencer activates that channel setup, and only for a channel-defined sequence. In this case, a channel setup in continuous sweep mode is swept repeatedly.

Furthermore, the [RUN CONT] key controls the Sequencer, not individual sweeps. [RUN CONT] starts the Sequencer in continuous mode.

For details on the Sequencer, see the R&S FPL1000 User Manual.

Remote command:

`INITiate<n>:CONTinuous` on page 176

Single Sweep / Run Single

After triggering, starts the number of sweeps set in "Sweep Count". The measurement stops after the defined number of sweeps has been performed.

While the measurement is running, the "Single Sweep" softkey and the [RUN SINGLE] key are highlighted. The running measurement can be aborted by selecting the highlighted softkey or key again.

Note: Sequencer. If the Sequencer is active, the "Single Sweep" softkey only controls the sweep mode for the currently selected channel setup. However, the sweep mode only takes effect the next time the Sequencer activates that channel setup, and only for a channel-defined sequence. In this case, the Sequencer sweeps a channel setup in single sweep mode only once.

Furthermore, the [RUN SINGLE] key controls the Sequencer, not individual sweeps. [RUN SINGLE] starts the Sequencer in single mode.

If the Sequencer is off, only the evaluation for the currently displayed channel setup is updated.

For details on the Sequencer, see the R&S FPL1000 User Manual.

Remote command:

`INITiate<n>[:IMMEDIATE]` on page 177

Continue Single Sweep

After triggering, repeats the number of sweeps set in "Sweep Count", without deleting the trace of the last measurement.

While the measurement is running, the "Continue Single Sweep" softkey and the [RUN SINGLE] key are highlighted. The running measurement can be aborted by selecting the highlighted softkey or key again.

Remote command:

`INITiate<n>:CONMeas` on page 176

Measurement Time (AQT)

Defines how long data is acquired for demodulation.

Remote command:

`[SENSe:]ADEMod:MTIME` on page 143

Sweep Points

Defines the number of measured values to be collected during one sweep.

All values from 101 to 100001 can be set. The default value is 1001 sweep points.

Remote command:

`[SENSe:]SWEep[:WINDow<n>]:POINTs` on page 146

This is Sweep/Average Count ok?

Defines the number of sweeps to be performed in the single sweep mode. Values from 0 to 200000 are allowed. If the values 0 or 1 are set, one sweep is performed.

The sweep count is applied to all the traces in all diagrams.

If the trace modes "Average", "Max Hold" or "Min Hold" are set, this value also determines the number of averaging or maximum search procedures.

In continuous sweep mode, if "Sweep Count" = 0 (default), averaging is performed over 10 sweeps. For "Sweep Count" =1, no averaging, maxhold or minhold operations are performed.

Remote command:

[\[SENSe:\] SWEEp:COUNT](#) on page 145

[\[SENSe:\] AVERAge<n>:COUNT](#) on page 212

Select Frame

Selects a specific frame, loads the corresponding trace from the memory, and displays it in the Spectrum window.

Note that activating a marker or changing the position of the active marker automatically selects the frame that belongs to that marker.

This function is only available in single sweep mode or if the sweep is stopped, and only if a spectrogram is selected.

The most recent frame is number 0, all previous frames have a negative number.

For more details, see the R&S FPL1000 User Manual.

Remote command:

[CALCulate<n>:SPECTrogram:FRAMe:SElect](#) on page 202

Continue Frame

Determines whether the results of the previous sweeps are included in the analysis of the next sweeps for trace modes "Max Hold", "Min Hold", and "Average".

This function is available in single sweep mode only.

- **On**
When the average or peak values are determined for the new sweep, the results of the previous sweeps in the spectrogram are also considered.
- **Off**
The average or peak values are determined from the results of the newly swept frames only.

Remote command:

[CALCulate<n>:SPECTrogram:CONTInuous](#) on page 201

Frame Count

Determines how many frames are plotted during a single sweep (as opposed to a continuous sweep). The maximum number of possible frames depends on the history depth (see "[History Depth](#)" on page 83).

Remote command:

[CALCulate<n>:SPECTrogram:FRAMe:COUNT](#) on page 201

Clear Spectrogram

Resets the spectrogram result display and clears the history buffer.

This function is only available if a spectrogram is selected.

Remote command:

[CALCulate<n>:SPECTrogram:CLEar\[:IMMEDIATE\]](#) on page 201

5.6 Demodulation display



Access: "Overview" > "Demod/Display"

The demodulated signal can be displayed using various evaluation methods. All evaluation methods available for the Analog Modulation Analysis application are displayed in the evaluation bar in SmartGrid mode when you do one of the following:

Up to six evaluation methods can be displayed simultaneously in separate windows. The Analog Modulation Analysis evaluation methods are described in [Chapter 3, "Measurements and result displays"](#), on page 15.



For details on working with the SmartGrid, see the R&S FPL1000 Getting Started manual.

5.7 Demodulation

Access: "Overview" > "Demod Settings"

Or: "Meas Setup" > "Demod"

- [Basic demodulation measurement parameters \(Demod\)](#).....54
- [Demodulation spectrum](#)..... 57
- [AF filter](#).....60
- [Scaling](#)..... 63
- [Units](#)..... 68
- [Result table settings](#).....68
- [Settling time](#)..... 71

5.7.1 Basic demodulation measurement parameters (Demod)

Access: "Overview" > "Demod Settings" > "Demod"

Or: "Meas Setup" > "Demod" > "Demod" tab

The basic demodulation measurement parameters define how the measurement is performed.

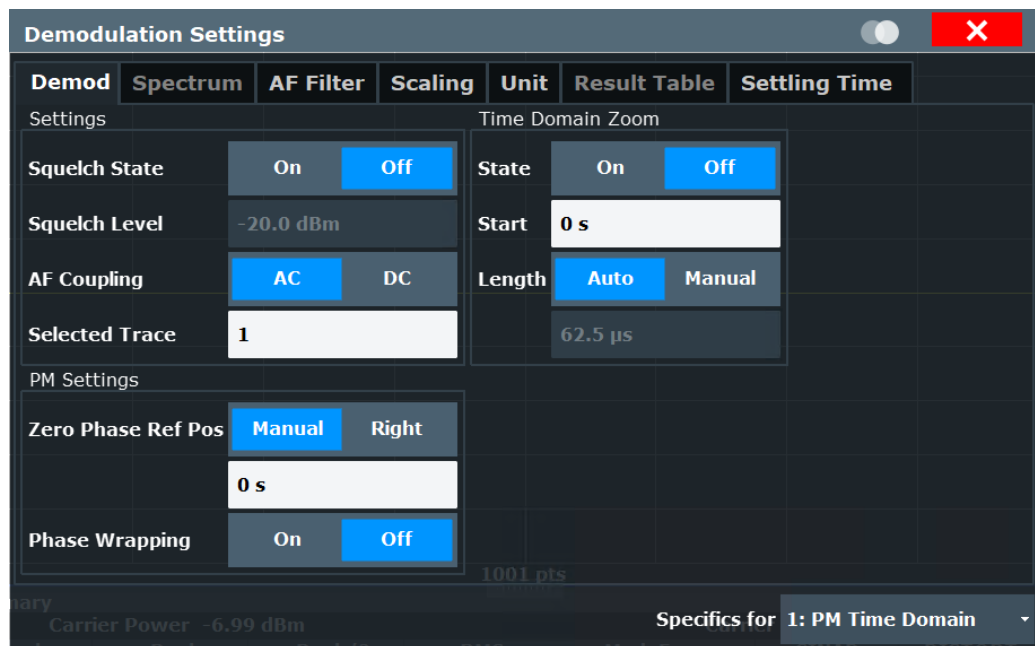

Squelch State.....	55
Squelch Level.....	55
AF Coupling.....	55
Selected Trace.....	56
Time Domain Zoom.....	56
L State.....	56
L Start.....	56
L Length.....	57
Zero Phase Reference Position (PM Time Domain only).....	57
Phase Wrap On/Off (PM Time Domain only).....	57

Squelch State

Activates the squelch function, that is: if the signal falls below a defined threshold, the demodulated data is automatically set to 0. This is useful, for example, to avoid demodulation noise during transmission breaks.

This function is only available for FM demodulation.

Remote command:

`[SENSe:]ADEMod:SQUelch[:STATe]` on page 153

Squelch Level

Defines the level threshold below which the demodulated data is set to 0 if squelching is enabled. The squelch level is an absolute value.

Remote command:

`[SENSe:]ADEMod:SQUelch:LEVel` on page 154

AF Coupling

Controls the automatic correction of the frequency offset and phase offset of the input signal:

This function is only available for FM or PM time domain evaluations.

- **FM time evaluation**
If DC is selected, the absolute frequency is displayed. That means, an input signal with an offset relative to the center frequency is not displayed symmetrically to the zero line.
If AC is selected, the frequency offset is automatically corrected, i.e. the trace is always symmetric to the zero line.
- **PM time evaluation**
If DC is selected, the phase runs according to the existing frequency offset. In addition, the DC signal contains a phase offset of $\pm \pi$.
If AC is selected, the frequency offset and phase offset are automatically corrected, i.e. the trace is always symmetric to the zero line.

Remote command:

[\[SENSe:\]ADEMod<n>:AF:COUPling](#) on page 152

Selected Trace

Defines the trace used to determine the results in the "Result Summary".

Time Domain Zoom

Using the time domain zoom, the demodulated data for a particular time span is extracted and displayed in more detail. Time domain zoom is useful if the measurement time is very large and thus each sweep point represents a large time span. The time domain zoom function distributes the available sweep points only among the time span defined by the zoom area length. The time span displayed per division of the diagram is decreased. Thus, the display of the extracted time span becomes more precise. Note that the time domain zoom area affects not only the diagram display, but the entire evaluation for the current window.

This function is only available for evaluations in the time domain.

Tip: In addition to the Time Domain Zoom, a graphical zoom is available for all diagram evaluations. However, the graphical zoom is useful only if more measured values than trace points are available. The (time) span represented by each measurement point remains the same.

For details see the R&S FPL1000 User Manual.

State ← Time Domain Zoom

Activates or deactivates the time domain zoom mode.

- | | |
|-------|--|
| "On" | Activates the time domain zoom. |
| "Off" | Deactivates the time domain zoom and restores the original display. If more measured values than measurement points are available, several measured values are combined in one measurement point according to the method of the selected trace detector. |

Remote command:

[\[SENSe:\]ADEMod<n>:ZOOM\[:STATe\]](#) on page 156

Start ← Time Domain Zoom

Defines the start time for the time domain zoom area. For spectrum evaluations, the start time is always 0.

Remote command:

[SENSe:]ADEMod<n>:ZOOM:START on page 156

Length ← Time Domain Zoom

Defines the length of the time domain zoom area. Enter the length as a time value manually, or use the "Auto" setting to set the length to the current number of sweep points automatically.

Remote command:

[SENSe:]ADEMod<n>:ZOOM:LENGTh on page 155

[SENSe:]ADEMod<n>:ZOOM:LENGTh:MODE on page 155

Zero Phase Reference Position (PM Time Domain only)

Defines the position in time at which the phase of the PM-demodulated signal is set to 0 rad.

In the default setting, the time of the first measured value is set to 0 rad. You can define a different position manually, or select the time of the last measured value (i.e. the furthest to the right in the diagram) as the reference position. The time of the last measured value corresponds to the total acquisition time, considering the trigger event and trigger offset, if applicable. If the acquisition time or the trigger values are changed, the reference position is automatically adapted.

This setting is only available for PM time domain displays with DC coupling.

Remote command:

[SENSe:]ADEMod:PM:RPOint[:X] on page 152

[SENSe:]ADEMod:PM:RPOint[:X]:MODE on page 153

Phase Wrap On/Off (PM Time Domain only)

Activates/deactivates the phase wrap.

On	The phase is displayed in the range $\pm 180^\circ$ ($\pm \Pi$). For example, if the phase exceeds $+180^\circ$, 360° is subtracted from the phase value, with the display thus showing $>-180^\circ$.
Off	The phase is not wrapped.

This setting is only available for PM time domain displays with DC coupling.

Remote command:

CALC:FORM PHAS/CALC:FORM UPH, see CALCulate<n>:FORMat on page 154

5.7.2 Demodulation spectrum

Access: "Overview" > "Demod Settings" > "Spectrum"

Or: "Meas Setup" > "Demod" > "Spectrum" tab

The demodulation spectrum defines which span of the demodulated data is evaluated.

Depending on the evaluation (AF or RF display), the settings vary.

- [AF evaluation](#)..... 58
- [RF evaluation](#)..... 59

5.7.2.1 AF evaluation

Access: "Overview" > "Demod Settings" > "Spectrum"

Or: "Meas Setup" > "Demod" > "Spectrum" tab

These settings are only available for AF Spectrum evaluations, not in the time domain.

The screenshot shows the 'Demodulation Settings' dialog box with the 'Spectrum' tab active. The 'Settings' section contains the following parameters:

Parameter	Value
AF Center	1.25 MHz
AF Start	0 Hz
AF Stop	2.5 MHz
AF Span	2.5 MHz

Below the input fields is a button labeled 'AF Full Span'. At the bottom right, the 'Specifics for' dropdown menu is set to '1: FM Spectrum'.

AF Center.....	58
AF Start.....	58
AF Stop.....	58
AF Span.....	59
AF Full Span.....	59

AF Center

Defines the center frequency of the demodulated data to evaluate.

Remote command:

[SENSe:]ADEMod:AF:CENTer on page 157

AF Start

Defines the start frequency of the demodulated data to evaluate.

Remote command:

[SENSe:]ADEMod:AF:START on page 158

AF Stop

Defines the stop frequency of the demodulated data to evaluate.

The maximum AF stop frequency corresponds to half the demodulation bandwidth.

Remote command:

[SENSe:]ADEMod:AF:STOP on page 158

AF Span

Defines the span (around the center frequency) of the demodulated data to evaluate. The maximum span is DBW/2.

Remote command:

[SENSe:]ADEMod:AF:SPAN on page 157

AF Full Span

Sets the span (around the center frequency) of the demodulated data to the maximum of DBW/2.

Remote command:

[SENSe:]ADEMod:AF:SPAN:FULL on page 157

5.7.2.2 RF evaluation

Access: "Overview" > "Demod Settings" > "Spectrum"

Or: "Meas Setup" > "Demod" > "Spectrum" tab

These settings are only available for RF evaluation, both in time and frequency domain. Note that for RF data the center frequency and demodulation bandwidth correspond to the settings defined in the "Input" and "Data Acquisition" configuration.

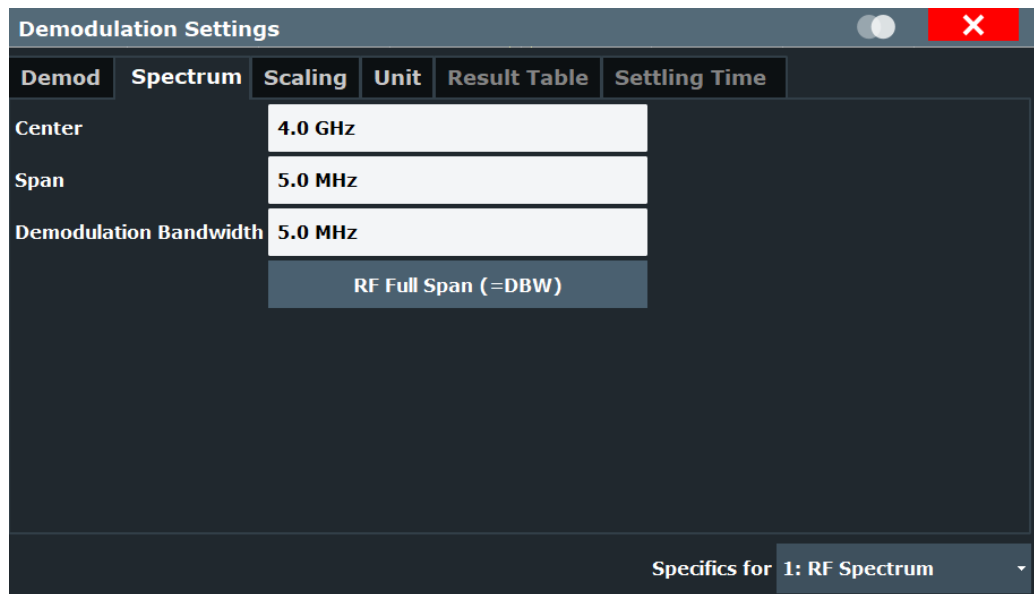

Center Frequency..... 59

Span..... 60

Demodulation Bandwidth..... 60

RF Full Span..... 60

Center Frequency

Defines the center frequency of the signal in Hertz.

The allowed range of values for the center frequency depends on the frequency span.

$$\text{span} > 0: \text{span}_{\min}/2 \leq f_{\text{center}} \leq f_{\text{max}} - \text{span}_{\min}/2$$

f_{\max} and span_{\min} depend on the instrument and are specified in the data sheet.

Remote command:

[SENSe:] FREQuency:CENTer on page 134

Span

Defines the frequency span. The center frequency is kept constant. The following range is allowed:

span = 0: 0 Hz

span >0:

$\text{span}_{\min} \leq f_{\text{span}} \leq f_{\max}$

and $f_{\max} = \text{DBW}/2$

f_{\max} and span_{\min} are specified in the data sheet.

Remote command:

[SENSe:] ADEMod:SPECTrum:SPAN[:MAXimum] on page 159

[SENSe:] ADEMod:SPECTrum:SPAN:ZOOM on page 158

Demodulation Bandwidth

Defines the demodulation bandwidth of the measurement. The demodulation bandwidth determines the sample rate with which the input signal is captured and analyzed.

For recommendations on finding the correct demodulation bandwidth, see [Chapter 4.2, "Demodulation bandwidth"](#), on page 28.

Remote command:

[SENSe:] BWIDth:DEMod on page 144

RF Full Span

Sets the span (around the center frequency) of the RF data to be evaluated to the demodulation bandwidth.

Remote command:

[SENSe:] ADEMod:SPECTrum:SPAN[:MAXimum] on page 159

5.7.3 AF filter

Access: "Overview" > "Demod Settings" > "AF Filter"

Or: "Meas Setup" > "Demod" > "AF Filter" tab

The AF filter reduces the evaluated bandwidth of the demodulated signal and can define a weighting function.



AF filters are only available for AF evaluations, not for RF evaluation.

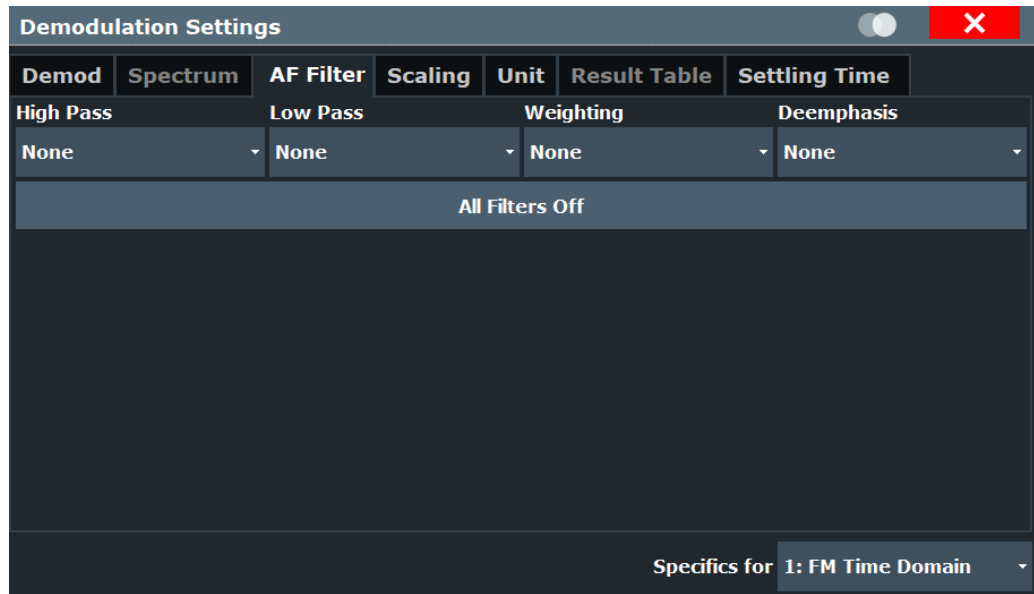

High Pass.....61
 Low Pass.....61
 Weighting..... 62
 Deemphasis..... 63
 Deactivating all AF Filters..... 63

High Pass

Defines a high pass filter with the given limit to separate the DC component. The filters are indicated by the 3 dB cutoff frequency. The 50 Hz and 300 Hz filters are designed as 2nd-order Butterworth filter (12 dB/octave). The 20 Hz filter is designed as 3rd-order Butterworth filter (18 dB/octave).

The high pass filters are active in the following demodulation bandwidth range:

None	No AF Filter used (default)
20 Hz	100 Hz ≤ demodulation bandwidth ≤ 1.6 MHz
50 Hz:	200 Hz ≤ demodulation bandwidth ≤ 3 MHz
300 Hz:	800 Hz ≤ demodulation bandwidth ≤ 8 MHz
Manual:	A high pass filter with the manually defined frequency is used.

Remote command:

[SENSe:] FILTer<n>:HPASs[:STATe] on page 163

[SENSe:] FILTer<n>:HPASs:FREQuency[:ABSolute] on page 162

[SENSe:] FILTer<n>:HPASs:FREQuency:MANual on page 162

Low Pass

Defines a low pass filter type. Relative and absolute low pass filter are available.

- Absolute low pass filters:

Absolute filters are indicated by the 3 dB cutoff frequency. The 3 kHz, 15 kHz and 23 kHz filters are designed as 5th-order Butterworth filters (30 dB/octave). The 150 kHz filter is designed as 8th-order Butterworth filter (48 dB/octave).

The absolute low pass filters are active in the following demodulation bandwidth range:

Filter type	Demodulation bandwidth
3 kHz:	$6.4 \text{ kHz} \leq \text{demodulation bandwidth} \leq 3 \text{ MHz}$
15 kHz:	$50 \text{ kHz} \leq \text{demodulation bandwidth} \leq 8 \text{ MHz}$
23 kHz	$50 \text{ kHz} \leq \text{demodulation bandwidth} \leq 18 \text{ MHz}$
150 kHz:	$400 \text{ kHz} \leq \text{demodulation bandwidth} \leq 8 \text{ MHz}$
Manual:	A low pass filter with the manually defined frequency is used.

- Relative low pass filters:
Relative filters (3 dB) can be selected in % of the demodulation bandwidth. The filters are designed as 5th-order Butterworth filter (30 dB/octave) and active for all demodulation bandwidths.
- "NONE" deactivates the AF low pass filter (default).

Remote command:

[\[SENSe:\] FILTer<n>:LPASs\[:STATe\]](#) on page 164

[\[SENSe:\] FILTer<n>:LPASs:FREQuency\[:ABSolute\]](#) on page 163

[\[SENSe:\] FILTer<n>:LPASs:FREQuency:RELative](#) on page 164

[\[SENSe:\] FILTer<n>:LPASs:FREQuency:MANual](#) on page 163

Weighting

Selects a weighting AF filter. By default, no weighting filter is active.

"A weighted"	Switches on the A weighted filter. The weighting filter is active in the following demodulation bandwidth range: $100 \text{ kHz} \leq \text{demodulation bandwidth} \leq 800 \text{ kHz}$
"CCITT"	Switches on a CCITT P.53 weighting filter. The weighting filter is active in the following demodulation bandwidth range: $20 \text{ kHz} \leq \text{demodulation bandwidth} \leq 3 \text{ MHz}$
"CCIR weighted"	Switches on the CCIR weighted filter. The weighting filter is active in the following demodulation bandwidth range: $100 \text{ kHz} \leq \text{demodulation bandwidth} \leq 3.0 \text{ MHz}$
"CCIR unweighted"	Switches on the CCIR unweighted filter, which is the combination of the 20 Hz highpass and 23 kHz low pass filter. The weighting filter is active in the following demodulation bandwidth range: $50 \text{ kHz} \leq \text{demodulation bandwidth} \leq 1.6 \text{ MHz}$

Remote command:

[\[SENSe:\] FILTer<n>:CCITt\[:STATe\]](#) on page 161

[\[SENSe:\] FILTer<n>:CCIR\[:UNWeighted\] \[:STATe\]](#) on page 160

[\[SENSe:\] FILTer<n>:CCIR:WEIGHTed\[:STATe\]](#) on page 160

[\[SENSe:\] FILTer<n>:AWEighted\[:STATe\]](#) on page 159

Deemphasis

Activates a deemphasis filter with the given time constant.

Sometimes a modulated signal is extorted by a pre-emphasis filter before transmission, for example to eliminate frequencies that are more prone to interferences. In this case, the emphasis function must be reversed after demodulation, which is done by the deemphasis filter.

The deemphasis filter is active in the following demodulation bandwidth range:

25 μ s:	25 kHz \leq demodulation bandwidth \leq 40 MHz
50 μ s:	6.4 kHz \leq demodulation bandwidth \leq 18 MHz
75 μ s:	6.4 kHz \leq demodulation bandwidth \leq 18 MHz
750 μ s:	800 Hz \leq demodulation bandwidth \leq 3 MHz

Depending on the deemphasis filter, a minimum demodulation bandwidth is required for an error less than 0.5 dB, up to a maximum AF frequency. The following table shows the dependencies.

Deemphasis [μ s]	25 μ s	50 μ s	75 μ s	750 μ s
Max. AF frequency	25 kHz	12 kHz	8 kHz	800 Hz
Required demodulation bandwidth	\geq 200 kHz	\geq 100 kHz	\geq 50 kHz	\geq 6.4 kHz

For higher AF frequencies, the demodulation bandwidth must be increased.

Remote command:

[\[SENSe:\]FILTer<n>:DEMPHasis\[:STATe\]](#) on page 161

[\[SENSe:\]FILTer<n>:DEMPHasis:TCONstant](#) on page 161

Deactivating all AF Filters

The "All Filter Off" button deactivates all AF filters for the selected evaluation.

Remote command:

[\[SENSe:\]FILTer<n>:AOFF](#) on page 160

5.7.4 Scaling

Access: "Overview" > "Demod Settings" > "Scaling"

Or: "Meas Setup" > "Demod" > "Scaling" tab

The scaling parameters define the range of the demodulated data to be displayed.

- [AF evaluation](#)..... 63
- [RF evaluation](#)..... 66

5.7.4.1 AF evaluation

Access: "Overview" > "Demod Settings" > "Scaling"

Or: "Meas Setup" > "Demod" > "Scaling" tab

These settings are only available for AF evaluations.

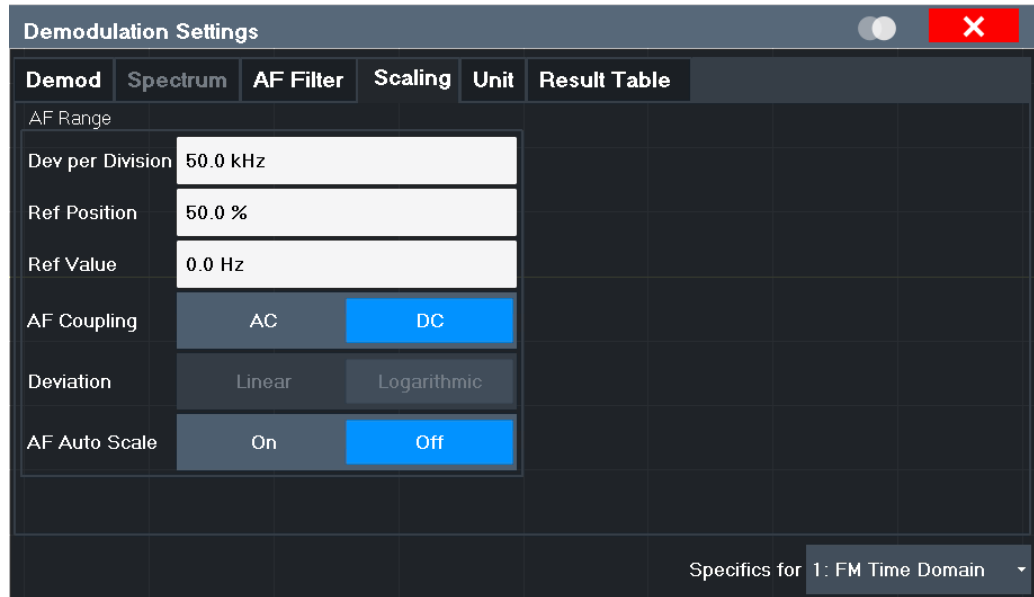

Dev per Division/ dB per Division..... 64
 Reference Value Position..... 64
 Reference Value..... 65
 AF Coupling..... 65
 Deviation..... 66
 AF Auto Scale..... 66

Dev per Division/ dB per Division

Defines the modulation depth or the phase deviation or frequency deviation per division (logarithmic: 0.1 dB to 20 dB):

AM display:	0.0001 % to 1000 %
FM display:	
PM display:	0.0001 rad/div to 1000 rad/div

Note: The value defined per division refers to the default display of 10 divisions on the y-axis. If fewer divisions are displayed (e.g. because the window is reduced in height), the range per division is increased. Thus, the same result range is displayed in the smaller window. In this case, the per division value does not correspond to the actual display.

Remote command:

`DISPlay[:WINDow<n>][:SUBWindow<w>]:TRACe<t>:Y[:SCALe]:PDIVision`
 on page 140

Reference Value Position

Determines the position of the reference value for the modulation depth or the phase deviation or frequency deviation on the y-axis of the diagram.

The position is entered as a percentage of the diagram height with 100 % corresponding to the upper diagram border. The default setting is 50 % (diagram center) for the AF time evaluations and 100 % (upper diagram border) for the AF spectrum evaluations.

Remote command:

`DISPlay[:WINDow<n>][:SUBWindow<w>]:TRACe<t>:Y[:SCALe]:RPOSition`
on page 141

Reference Value

Determines the modulation depth or the phase deviation or the frequency deviation at the reference line of the y-axis. The reference value can be set specifically for each evaluation.

- AF time display
The trace display takes individual frequency/phase offsets into account (in contrast, the **AF Coupling** setting permits automatic correction by the average frequency/phase offset of the signal, and therefore cannot be activated simultaneously).
- AF spectrum display
In the default setting, the reference value defines the modulation depth or the FM/PM deviation at the upper diagram border.

Possible values:

- AM: 0 and ± 10000 %
- FM: 0 and ± 10 MHz
- PM: 0 and ± 10000 rad

Note: The reference value for the AF range in the **window title bar** is displayed with respect to the defined reference *position*. The position can vary for different windows. For time domain and frequency domain windows, for example, a different reference value can be displayed, although the same reference is actually used (but the positions vary).

Remote command:

`DISPlay[:WINDow<n>][:SUBWindow<w>]:TRACe<t>:Y[:SCALe]:RVALue`
on page 165

AF Coupling

Controls the automatic correction of the frequency offset and phase offset of the input signal:

This function is only available for FM or PM time domain evaluations.

- FM time evaluation
If DC is selected, the absolute frequency is displayed. That means, an input signal with an offset relative to the center frequency is not displayed symmetrically to the zero line.
If AC is selected, the frequency offset is automatically corrected, i.e. the trace is always symmetric to the zero line.
- PM time evaluation
If DC is selected, the phase runs according to the existing frequency offset. In addition, the DC signal contains a phase offset of $\pm \pi$.
If AC is selected, the frequency offset and phase offset are automatically corrected, i.e. the trace is always symmetric to the zero line.

Remote command:

[SENSe:]ADEMod<n>:AF:COUPling on page 152

Deviation

Switches between logarithmic and linear display of the modulation depth or the phase deviation or the frequency deviation.

Remote command:

DISPlay[:WINDow<n>] [:SUBWindow<w>]:TRACe<t>:Y:SPACing on page 142

AF Auto Scale

Activates automatic scaling of the y-axis for AF measurements. RF power and RF spectrum measurements are not affected by the auto-scaling.

Remote command:

[SENSe:]ADJJust:SCALE[:Y]:AUTO[:CONTinuous] on page 174

5.7.4.2 RF evaluation

Access: "Overview" > "Demod Settings" > "Scaling"

Or: "Meas Setup" > "Demod" > "Scaling" tab

These settings are only available for RF evaluations and the "result summary".

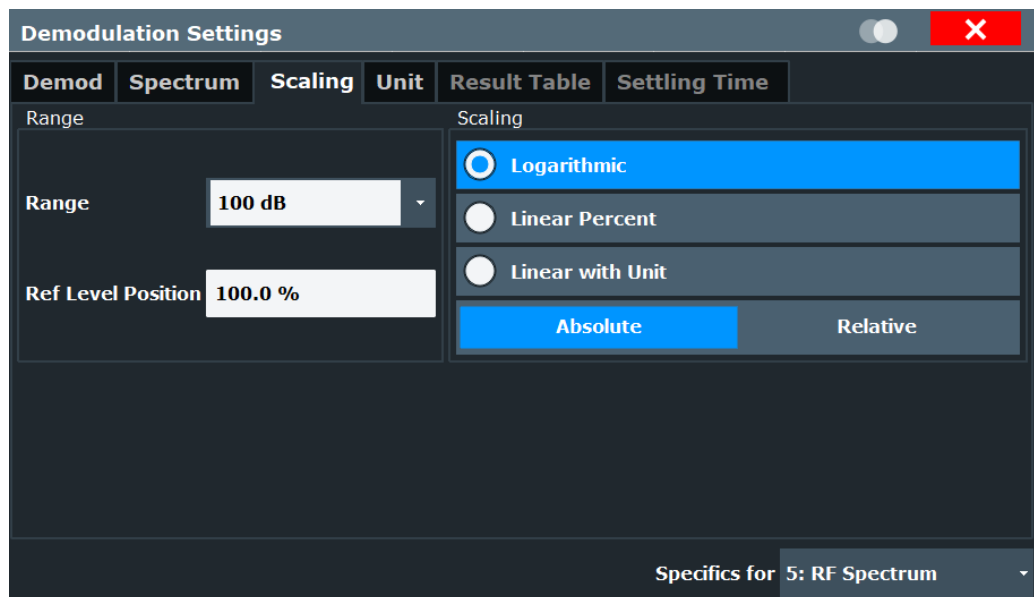

Range.....66
 Ref Level Position..... 67
 Auto Scale Once..... 67
 Scaling..... 67

Range

Defines the displayed y-axis range in dB.

The default value is 100 dB.

For Analog Modulation Analysis measurements, time domain scaling is defined in Hz (default: 500 kHz).

Remote command:

`DISPlay[:WINDow<n>][:SUBWindow<w>]:TRACe<t>:Y[:SCALe]` on page 139

Ref Level Position

Defines the reference level position, i.e. the position of the maximum AD converter value on the level axis in %.

0 % corresponds to the lower and 100 % to the upper limit of the diagram.

Values from -120 % to +280 % are available.

Larger values are useful for small scales, such as a power range of 10 dB or 20 dB, and low signal levels, for example 60 dB below the reference level. In this case, large reference level position values allow you to see the trace again.

Only available for RF measurements.

Remote command:

`DISPlay[:WINDow<n>][:SUBWindow<w>]:TRACe<t>:Y[:SCALe]:RPOSition` on page 141

Auto Scale Once

Automatically determines the optimal range and reference level position to be displayed for the current measurement settings.

The display is only set once; it is not adapted further if the measurement settings are changed again.

Remote command:

`DISPlay[:WINDow<n>][:SUBWindow<w>]:TRACe<t>:Y[:SCALe]:AUTO ONCE` on page 140

Scaling

Defines the scaling method for the y-axis.

"Logarithmic"	Logarithmic scaling (only available for logarithmic units - dB..., and A, V, Watt)
"Linear with Unit"	Linear scaling in the unit of the measured signal
"Linear Percent"	Linear scaling in percentages from 0 to 100
"Absolute"	The labeling of the level lines refers to the absolute value of the reference level (not available for "Linear Percent")
"Relative"	The scaling is in dB, relative to the reference level (only available for logarithmic units - dB...). The upper line of the grid (reference level) is always at 0 dB.

Remote command:

`DISPlay[:WINDow<n>][:SUBWindow<w>]:TRACe<t>:Y:SPACing` on page 142
`DISPlay[:WINDow<n>][:SUBWindow<w>]:TRACe<t>:Y[:SCALe]:MODE`
 on page 140

5.7.5 Units

Access: "Overview" > "Demod Settings" > "Unit"

Or: "Meas Setup" > "Demod" > "Unit" tab

The units define how the demodulated data is displayed.

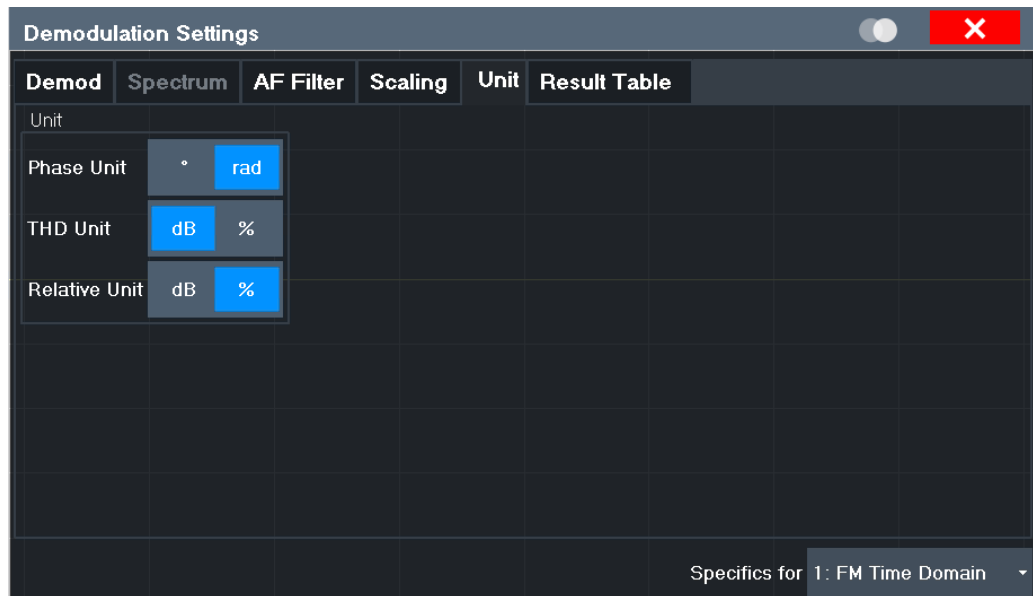

Phase Unit (Rad/Deg).....	68
THD Unit (%/ DB).....	68
Relative Unit.....	68

Phase Unit (Rad/Deg)

Sets the phase unit to rad or deg for displaying PM signals.

Remote command:

`UNIT<n>:ANGLE` on page 166

THD Unit (%/ DB)

Sets the unit to percent or DB for the calculation of the THD (in the "Result Summary").

Remote command:

`UNIT<n>:THD` on page 166

Relative Unit

Defines the unit for relative demodulation results (see [Chapter 5.7.6, "Result table settings"](#), on page 68).

Remote command:

`CONFigure:ADEMod:RESults:UNIT` on page 169

5.7.6 Result table settings

Access: "Overview" > "Demod Settings" > "Result Table"

Or: "Meas Setup" > "Demod" > "Result Table" tab

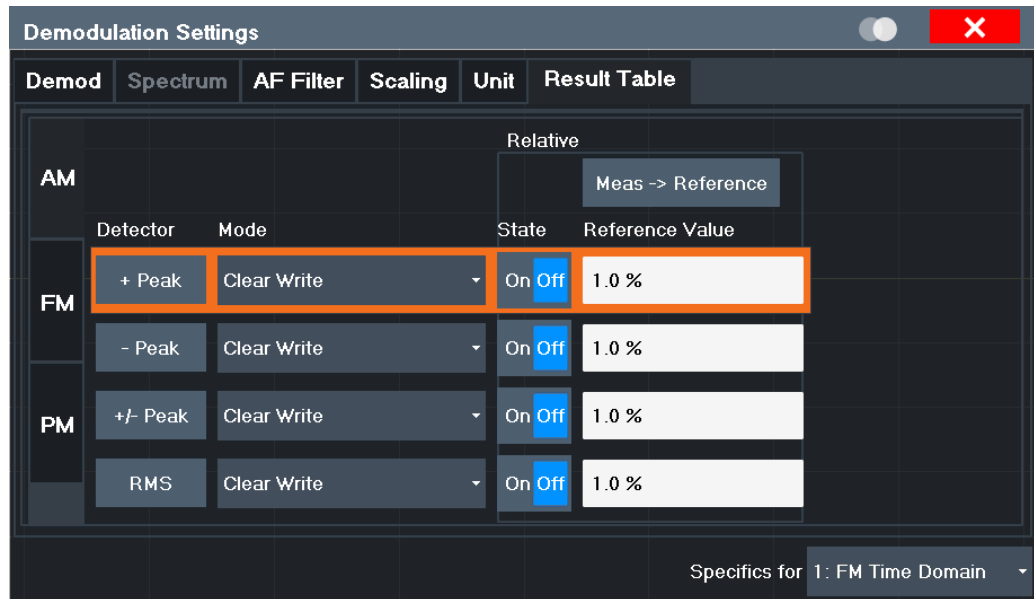

The demodulation results are displayed in the "Result Summary" table (see also "Result Summary" on page 23). The detectors used to determine the results can be configured.

In addition to common absolute demodulation, the R&S FPL1-K7 AM/FM/PM Modulation Analysis application also provides demodulation results relative to user-defined or measured reference values in the "Result Summary".

The settings for the "Result Summary" can be defined individually for the different modulation types (FM, AM, PM). For each modulation, a separate tab is provided in the dialog box.

Detector.....69
 Mode..... 69
 State.....70
 Reference Value.....70
 Meas -> Reference.....70

Detector

Detector type for demodulation results

- "+ Peak" Positive peak
- "- Peak" Negative peak
- "+/- Peak" Autopick
- "RMS" Root mean square

Remote command:

The detector is specified by the DETector<det> suffix in
 CONFigure:RELative:AM|FM|PM:DETector<det>... commands.

Mode

Defines the mode with which the demodulation result is determined.

The modes are similar to those for the entire trace (see ["Trace Mode"](#) on page 78).

- "Clear Write" Overwrite mode: the detector value is overwritten by each sweep. This is the default setting.
- "Max Hold" The maximum value is determined over several sweeps and displayed. The R&S FPL1000 saves each result only if the new value is greater than the previous one.
- "Average" The average result is determined over all sweeps.

Remote command:

[CONFigure:ADEMod:RESults:AM:DETEctor<det>:MODE](#) on page 169

[CONFigure:ADEMod:RESults:FM:DETEctor<det>:MODE](#) on page 169

[CONFigure:ADEMod:RESults:PM:DETEctor<det>:MODE](#) on page 169

State

Activates relative demodulation for the selected detector. If activated, the demodulated result is set in relation to the [Reference Value](#).

Remote command:

[CONFigure:ADEMod:RESults:AM:DETEctor<det>:STATE](#) on page 167

[CONFigure:ADEMod:RESults:FM:DETEctor<det>:STATE](#) on page 167

[CONFigure:ADEMod:RESults:PM:DETEctor<det>:STATE](#) on page 167

Reference Value

Defines the reference value to be used for relative demodulation results and recalculates the results. If necessary, the detector is activated.

Note: A reference value 0 would provide infinite results and is thus automatically corrected to 0.1.

Remote command:

[CONFigure:ADEMod:RESults:AM:DETEctor<det>:REFerence](#) on page 167

[CONFigure:ADEMod:RESults:FM:DETEctor<det>:REFerence](#) on page 167

[CONFigure:ADEMod:RESults:PM:DETEctor<det>:REFerence](#) on page 167

Meas -> Reference

Sets the [Reference Value](#) to be used for relative demodulation results to the currently measured value *for all relative detectors*.

Note: A reference value 0 would provide infinite results and is thus automatically corrected to 0.1.

If necessary, the detectors are activated.

Remote command:

[CONFigure:ADEMod:RESults:AM:DETEctor<det>:REFerence:MEASStoref<t>](#)
on page 168

[CONFigure:ADEMod:RESults:FM:DETEctor<det>:REFerence:MEASStoref<t>](#)
on page 168

[CONFigure:ADEMod:RESults:PM:DETEctor<det>:REFerence:MEASStoref<t>](#)
on page 168

5.7.7 Settling time

Access: "Overview" > "Demod Settings" > "Settling Time"

Or: "Meas Setup" > "Demod" > "Settling Time" tab

The settling time defines when the signal remains within a specified target corridor. The corridor is defined by the upper and lower settling limit. The function is available for all time domain displays.

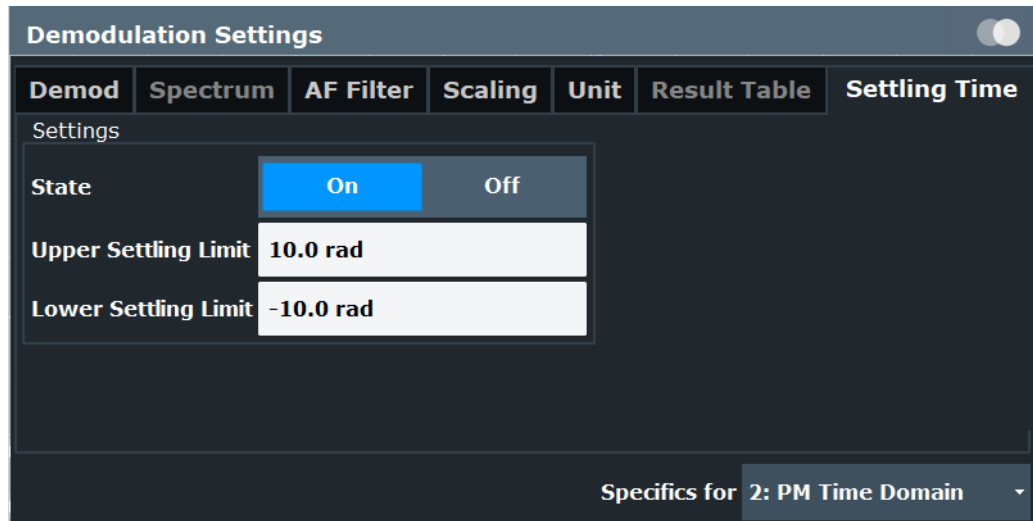

If enabled, the time is determined by evaluating the signal values from the end of the measurement. The last position at which the signal exceeds the corridor is the settling time. The settling time is defined with reference to the start of the data acquisition or the trigger event. A possible trigger offset is not considered.

The settling time is indicated by a temporary marker in the time domain diagram. The result is also indicated in the "result summary". The settling time is evaluated for each time domain window for the selected trace (see ["Selected Trace"](#) on page 56).

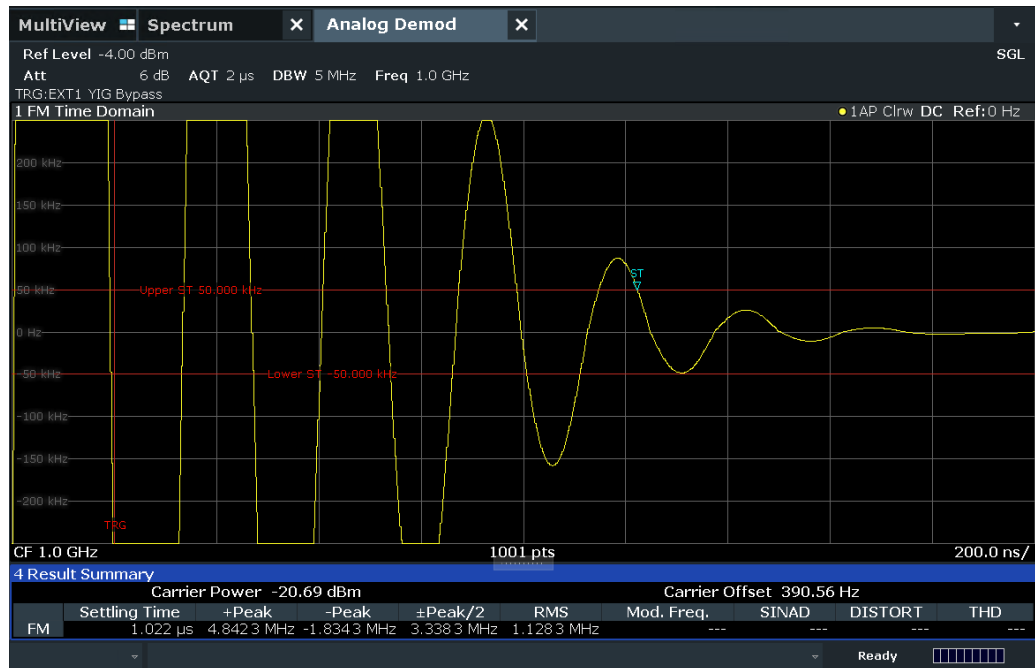

State.....	72
Upper Settling Limit.....	72
Lower Settling Limit.....	72

State

Enables or disables the calculation and display of the settling time.

Remote command:

[SENSe:]ADEMod:SETTling:TIME:STATE on page 170

Result: [SENSe:]ADEMod:SETTling:TIME:RESult<t>? on page 196

Upper Settling Limit

Defines the upper limit of the settling time corridor. The value is defined with reference to the reference value, see also "Reference Value" on page 65 and "Zero Phase Reference Position (PM Time Domain only)" on page 57.

Remote command:

[SENSe:]ADEMod:SETTling:TIME:LIMit:UPPer on page 170

Lower Settling Limit

Defines the lower limit of the settling time corridor. The value is defined with reference to the reference value, see also "Reference Value" on page 65 and "Zero Phase Reference Position (PM Time Domain only)" on page 57.

Remote command:

[SENSe:]ADEMod:SETTling:TIME:LIMit:LOWer on page 170

5.8 Output settings

Access: "Overview" > "Output"

The R&S FPL1000 can provide signals to different output connectors.

These connectors are only available if the R&S FPL1-B5 option is installed.

For details on connectors, refer to the R&S FPL1000 Getting Started manual, "Front / Rear Panel View" chapters.

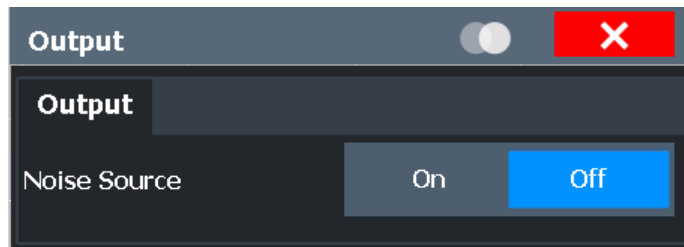

[Noise Source Control](#)..... 73

Noise Source Control

Enables or disables the 28 V voltage supply for an external noise source connected to the "Noise source control / Power sensor") connector. By switching the supply voltage for an external noise source on or off in the firmware, you can enable or disable the device as required.

This connector is only available if the R&S FPL1-B5 option is installed.

External noise sources are useful when you are measuring power levels that fall below the noise floor of the R&S FPL1000 itself, for example when measuring the noise level of an amplifier.

In this case, you can first connect an external noise source (whose noise power level is known in advance) to the R&S FPL1000 and measure the total noise power. From this value, you can determine the noise power of the R&S FPL1000. Then when you measure the power level of the actual DUT, you can deduct the known noise level from the total power to obtain the power level of the DUT.

Remote command:

[DIAGnostic:SERVice:NSource](#) on page 133

5.9 Adjusting settings automatically

Access: "Overview" > "Amplitude"/"Frequency" > "Auto Settings"

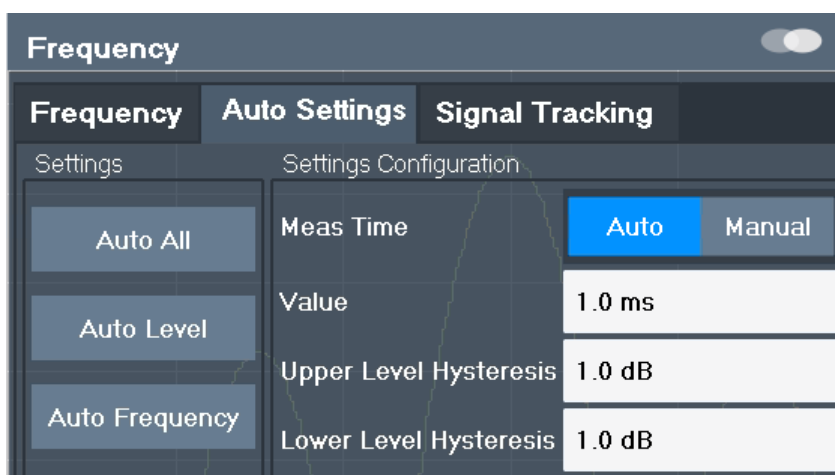

Some settings can be adjusted by the R&S FPL1000 automatically according to the current measurement settings. To do so, a measurement is performed. You can configure this measurement.



Adjusting settings automatically during triggered measurements

When you select an auto adjust function, a measurement is performed to determine the optimal settings. If you select an auto adjust function for a triggered measurement, you are asked how you want the R&S FPL1000 to behave:

- (default:) The measurement for adjustment waits for the next trigger
- The measurement for adjustment is performed without waiting for a trigger. The trigger source is temporarily set to "Free Run". After the measurement is completed, the original trigger source is restored. The trigger level is adjusted as follows:
 - For IF Power and RF Power triggers:
Trigger Level = Reference Level - 15 dB
 - For Video trigger:
Trigger Level = 85 %

Remote command:

[SENSe:]ADJust:CONFigure:TRIGger on page 174

Adjusting all Determinable Settings Automatically (Auto All).....	74
Adjusting the Center Frequency Automatically (Auto Frequency).....	75
AF Auto Scale.....	75
Setting the Reference Level Automatically (Auto Level).....	75
Resetting the Automatic Measurement Time (Meas Time Auto).....	75
Changing the Automatic Measurement Time (Meas Time Manual).....	75
Upper Level Hysteresis.....	76
Lower Level Hysteresis.....	76

Adjusting all Determinable Settings Automatically (Auto All)

Activates all automatic adjustment functions for the current measurement settings, including:

- [Auto Frequency](#)
- [Auto Level](#)
- ["AF Auto Scale"](#) on page 66

Remote command:

`[SENSe:]ADJust:ALL` on page 171

Adjusting the Center Frequency Automatically (Auto Frequency)

The R&S FPL1000 adjusts the center frequency automatically.

The optimum center frequency is the frequency with the highest S/N ratio in the frequency span. As this function uses the signal counter, it is intended for use with sinusoidal signals.

To set the optimal reference level, see ["Setting the Reference Level Automatically \(Auto Level\)"](#) on page 42).

Remote command:

`[SENSe:]ADJust:FREQuency` on page 174

AF Auto Scale

Activates automatic scaling of the y-axis for AF measurements. RF power and RF spectrum measurements are not affected by the auto-scaling.

Remote command:

`[SENSe:]ADJust:SCALe[:Y]:AUTO[:CONTInuous]` on page 174

Setting the Reference Level Automatically (Auto Level)

Automatically determines a reference level which ensures that no overload occurs at the R&S FPL1000 for the current input data. At the same time, the internal attenuators are adjusted. As a result, the signal-to-noise ratio is optimized, while signal compression and clipping are minimized.

To determine the required reference level, a level measurement is performed on the R&S FPL1000.

If necessary, you can optimize the reference level further. Decrease the attenuation level manually to the lowest possible value before an overload occurs, then decrease the reference level in the same way.

You can change the measurement time for the level measurement if necessary (see ["Changing the Automatic Measurement Time \(Meas Time Manual\)"](#) on page 75).

Remote command:

`[SENSe:]ADJust:LEVel` on page 174

Resetting the Automatic Measurement Time (Meas Time Auto)

Resets the measurement duration for automatic settings to the default value.

(Spectrum and AM/FM/PM modulation analysis application: 1 ms)

Remote command:

`[SENSe:]ADJust:CONFigure:LEVel:DURation:MODE` on page 172

Changing the Automatic Measurement Time (Meas Time Manual)

This function allows you to change the measurement duration for automatic setting adjustments. Enter the value in seconds.

Note: The maximum measurement duration depends on the currently selected measurement and the installed (optional) hardware. Thus, the measurement duration actually used to determine the automatic settings can be shorter than the value you define here.

Remote command:

[\[SENSe:\]ADJust:CONFigure:LEVel:DURation:MODE](#) on page 172

[\[SENSe:\]ADJust:CONFigure:LEVel:DURation](#) on page 172

Upper Level Hysteresis

When the reference level is adjusted automatically using the [Auto Level](#) function, the internal attenuators and the preamplifier are also adjusted. To avoid frequent adaptation due to small changes in the input signal, you can define a hysteresis. This setting defines an upper threshold that the signal must exceed (compared to the last measurement) before the reference level is adapted automatically.

Remote command:

[\[SENSe:\]ADJust:CONFigure:HYSTeresis:UPPer](#) on page 173

Lower Level Hysteresis

When the reference level is adjusted automatically using the [Auto Level](#) function, the internal attenuators and the preamplifier are also adjusted. To avoid frequent adaptation due to small changes in the input signal, you can define a hysteresis. This setting defines a lower threshold that the signal must fall below (compared to the last measurement) before the reference level is adapted automatically.

Remote command:

[\[SENSe:\]ADJust:CONFigure:HYSTeresis:LOWer](#) on page 173

6 Analysis

Access: "Overview" > "Analysis"

General result analysis settings concerning the trace, markers, lines etc. are identical to the analysis functions in the base unit except for the special marker functions.

For a description of the lines functionality, see the R&S FPL1000 User Manual.

The remote commands required to perform these tasks are described in [Chapter 11, "Remote commands for AM/FM/PM Modulation Analysis"](#), on page 118.

- [Trace settings](#).....77
- [Spectrogram settings](#).....81
- [Trace / data export configuration](#).....86
- [Working with markers in the R&S FPL1-K7 AM/FM/PM Modulation Analysis application](#).....89

6.1 Trace settings

Access: "Overview" > "Analysis" > "Traces"

Or: [TRACE] > "Trace Config"

You can configure the settings for up to 6 individual traces in the same result display. Each trace is displayed in a different color, indicated in the window title bar and the trace settings.



In the R&S FPL1-K7 AM/FM/PM Modulation Analysis application, when you configure the traces for a window with a specific evaluation (e.g. AM time domain), the traces in all windows with the same evaluation are configured identically.



Trace data can also be exported to an ASCII file for further analysis. For details see [Chapter 6.3, "Trace / data export configuration"](#), on page 86.

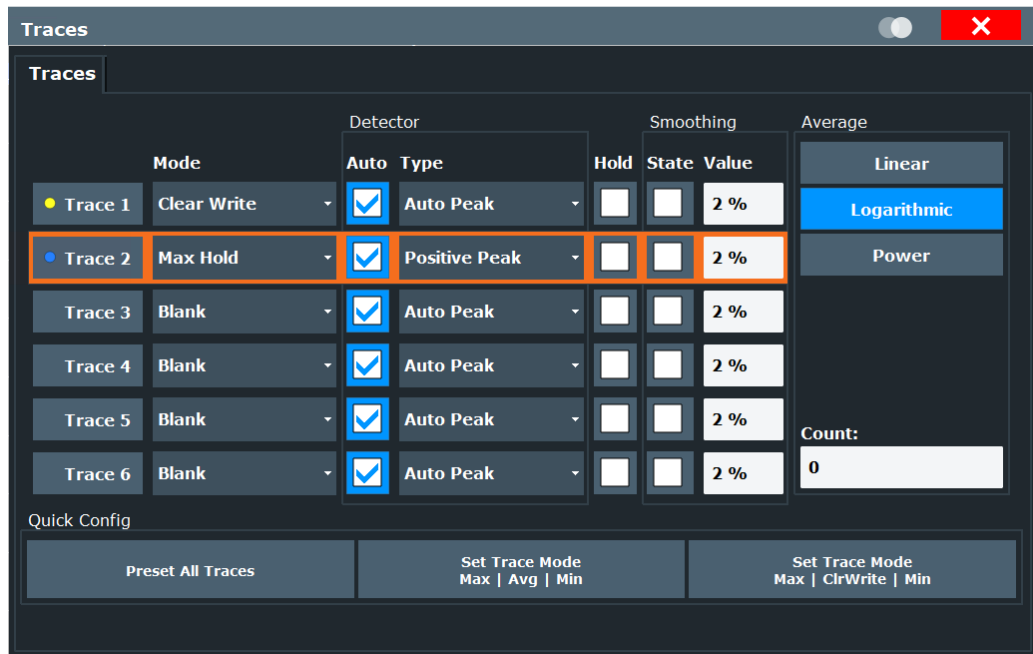

Trace 1/Trace 2/Trace 3/Trace 4/Trace 5/Trace 6..... 78

Trace Mode..... 78

Detector..... 79

Hold..... 80

Average Mode..... 80

Average Count..... 80

Predefined Trace Settings - Quick Config..... 80

Trace 1/ Trace 2/ Trace 3/ Trace 4 (Softkeys)..... 81

Trace 1/Trace 2/Trace 3/Trace 4/Trace 5/Trace 6

Selects the corresponding trace for configuration. The currently selected trace is highlighted.

Remote command:

Selected via numeric suffix of:TRACe<1... 6> commands

DISPlay[:WINDow<n>] [:SUBWindow<w>]:TRACe<t>[:STATe] on page 210

Trace Mode

Defines the update mode for subsequent traces.

- "Clear/ Write" Overwrite mode (default): the trace is overwritten by each sweep. All available detectors can be selected.
- "Max Hold" The maximum value is determined over several measurements and displayed. The R&S FPL1000 saves the sweep result in the trace memory only if the new value is greater than the previous one. This mode is especially useful with modulated or pulsed signals. The signal spectrum is filled up upon each sweep until all signal components are detected in a kind of envelope. This mode is not available for statistics measurements.

"Min Hold"	<p>The minimum value is determined from several measurements and displayed. The R&S FPL1000 saves the sweep result in the trace memory only if the new value is lower than the previous one.</p> <p>This mode is useful for example for making an unmodulated carrier in a composite signal visible. Noise, interference signals or modulated signals are suppressed, whereas a CW signal is recognized by its constant level.</p> <p>This mode is not available for statistics measurements.</p>
"Average"	<p>The average is formed over several sweeps.</p> <p>The This is Sweep/Average Count ok? determines the number of averaging procedures.</p> <p>This mode is not available for statistics measurements.</p>
"View"	<p>The current contents of the trace memory are frozen and displayed.</p> <p>Note: If a trace is frozen, you can change the measurement settings, apart from scaling settings, without impact on the displayed trace. The fact that the displayed trace no longer matches the current measurement settings is indicated by a yellow asterisk  on the tab label. If you change any parameters that affect the scaling of the diagram axes, the R&S FPL1000 automatically adapts the trace data to the changed display range. Thus, you can zoom into the diagram after the measurement to show details of the trace.</p>
"Blank"	Removes the selected trace from the display.

Remote command:

[DISPlay\[:WINDow<n>\]\[:SUBWindow<w>\]:TRACe<t>:MODE](#) on page 208

Detector

Defines the trace detector to be used for trace analysis.

"Auto"	(default:) Selects the optimum detector for the selected trace and filter mode
"Type"	<p>Defines the selected detector type.</p> <p>Note: If the EMI (R&S FPL1-K54) measurement option is installed, additional detectors are available, even if EMI measurement is not active. If you select a CISPR trace detector, the RBW filter type is automatically also set to CISPR.</p> <p>CISPR detectors are only available under the following conditions:</p> <ul style="list-style-type: none"> • Time domain measurements and frequency measurements in sweep mode (not FFT mode, not power measurements, emission measurements, or statistics measurements) • Trigger mode "Free Run" or "External" (trigger offset ≥ 0 only for "External") • Gate mode: "Off"

Remote command:

[\[SENSe:\] \[WINDow<n>:\] DETector<t>\[:FUNCTION\]](#) on page 213

[\[SENSe:\] \[WINDow<n>:\] DETector<t>\[:FUNCTION\]:AUTO](#) on page 214

Hold

If activated, traces in "Min Hold", "Max Hold" and "Average" mode are not reset after specific parameter changes have been made.

Normally, the measurement is started again after parameter changes, before the measurement results are analyzed (e.g. using a marker). In all cases that require a new measurement after parameter changes, the trace is reset automatically to avoid false results (e.g. with span changes). For applications that require no reset after parameter changes, the automatic reset can be switched off.

The default setting is off.

Remote command:

`DISPlay[:WINDow<n>][:SUBWindow<w>]:TRACe<t>:MODE:HCONTinuous`
on page 209

Average Mode

Defines the mode with which the trace is averaged over several sweeps.

This setting is generally applicable if trace mode "Average" is selected.

For FFT sweeps, the setting also affects the VBW (regardless of whether the trace is averaged).

(See the chapter on ACLR power measurements in the R&S FPL1000 User Manual.)

- | | |
|---------------|--|
| "Linear" | The power level values are converted into linear units before averaging. After the averaging, the data is converted back into its original unit. |
| "Logarithmic" | For logarithmic scaling, the values are averaged in dBm. For linear scaling, the behavior is the same as with linear averaging. |
| "Power" | Activates linear power averaging.
The power level values are converted into unit Watt before averaging. After the averaging, the data is converted back into its original unit. Use this mode to average power values in Volts or Amperes correctly. In particular, for small VBW values (smaller than the RBW), use power averaging mode for correct power measurements in FFT sweep mode. |

Remote command:

`[SENSe:]AVERAge<n>:TYPE` on page 213

Average Count

Determines the number of averaging or maximum search procedures If the trace modes "Average", "Max Hold" or "Min Hold" are set.

In continuous sweep mode, if sweep count = 0 (default), averaging is performed over 10 sweeps. For sweep count = 1, no averaging, Max Hold or Min Hold operations are performed.

Remote command:

`[SENSe:]AVERAge<n>:COUNT` on page 212

Predefined Trace Settings - Quick Config

Commonly required trace settings have been predefined and can be applied very quickly by selecting the appropriate button.

Function	Trace Settings	
Preset All Traces	Trace 1:	Clear Write
	Traces 2-6:	Blank
Set Trace Mode Max Avg Min	Trace 1:	Max Hold
	Trace 2:	Average
	Trace 3:	Min Hold
	Traces 4-6:	Blank
Set Trace Mode Max ClrWrite Min	Trace 1:	Max Hold
	Trace 2:	Clear Write
	Trace 3:	Min Hold
	Traces 4-6:	Blank

Trace 1/ Trace 2/ Trace 3/ Trace 4 (Softkeys)

Displays the "Traces" settings and focuses the "Mode" list for the selected trace.

Remote command:

`DISPlay[:WINDow<n>] [:SUBWindow<w>]:TRACe<t>[:STATe]` on page 210

6.2 Spectrogram settings

Access: [TRACE] > "Spectrogram Config"

The individual settings available for spectrogram display are described here. For settings on color mapping, see [Chapter 6.2.2, "Color map settings"](#), on page 85.

Settings concerning the frames and how they are handled during a sweep are provided as additional sweep settings for spectrogram display.

See [Chapter 5.5, "Data acquisition"](#), on page 49.

Search functions for spectrogram markers are described in [Chapter 6.4.3, "Marker search settings for spectrograms"](#), on page 97.

- [General spectrogram settings](#).....81
- [Color map settings](#)..... 85

6.2.1 General spectrogram settings

Access: [TRACE] > "Spectrogram Config"

This section describes general settings for spectrogram display.

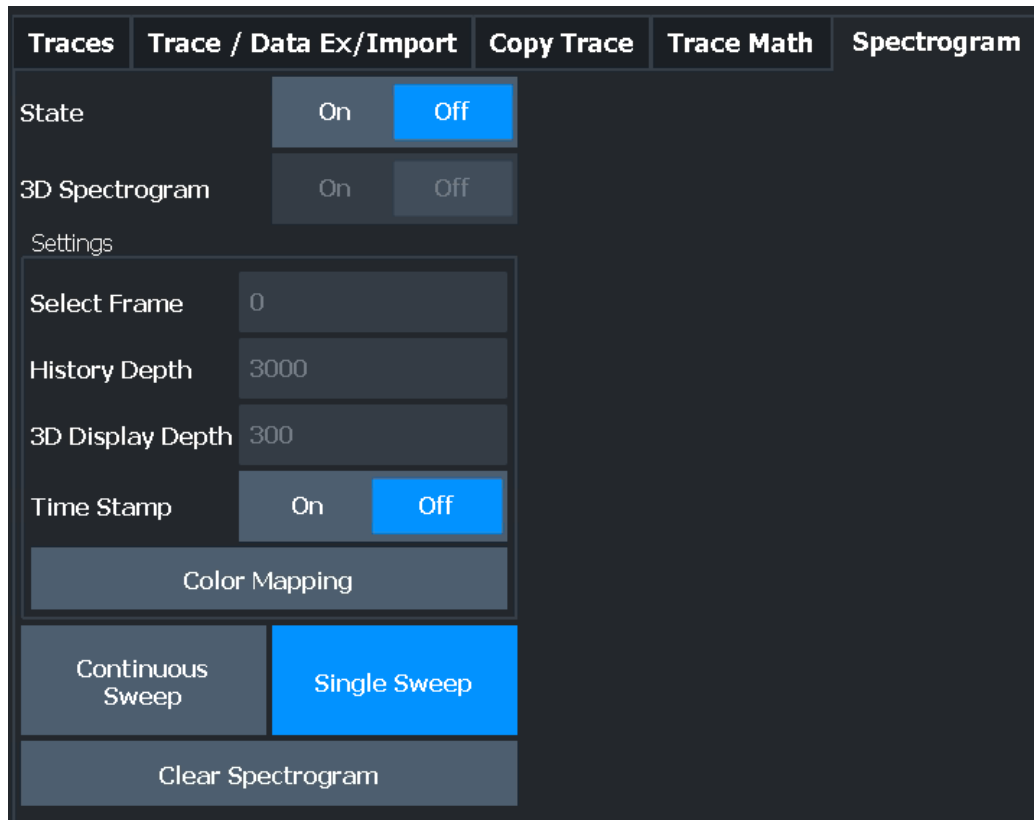

State..... 82
 3D Spectrogram State..... 82
 Select Frame..... 83
 History Depth..... 83
 3-D Display Depth..... 83
 Trace..... 83
 Time Stamp..... 83
 Color Mapping..... 84
 Continuous Sweep / Run Cont..... 84
 Single Sweep / Run Single..... 84
 Clear Spectrogram..... 84

State

Activates and deactivates a Spectrogram subwindow.

"On" Displays the Spectrogram as a subwindow in the original result display.

"Off" Closes the Spectrogram subwindow.

Remote command:

[CALCulate<n>:SPECTrogram:LAYout](#) on page 203

3D Spectrogram State

Activates and deactivates a 3-dimensional spectrogram. As opposed to the common 2-dimensional spectrogram, the power is not only indicated by a color mapping, but also in a third dimension, the z-axis.

For details see the R&S FPL1000 User Manual.

Remote command:

[CALCulate<n>:SPECTrogram:THReedim\[:STATe\]](#) on page 204

Select Frame

Selects a specific frame, loads the corresponding trace from the memory, and displays it in the Spectrum window.

Note that activating a marker or changing the position of the active marker automatically selects the frame that belongs to that marker.

This function is only available in single sweep mode or if the sweep is stopped, and only if a spectrogram is selected.

The most recent frame is number 0, all previous frames have a negative number.

For more details, see the R&S FPL1000 User Manual.

Remote command:

[CALCulate<n>:SPECTrogram:FRAMe:SElect](#) on page 202

History Depth

Sets the number of frames that the R&S FPL1000 stores in its memory.

The maximum number of frames depends on the [Sweep Points](#).

For an overview of the maximum number of frames depending on the number of sweep points, see the R&S FPL1000 User Manual.

If the memory is full, the R&S FPL1000 deletes the oldest frames stored in the memory and replaces them with the new data.

Remote command:

[CALCulate<n>:SPECTrogram:HDEPth](#) on page 202

3-D Display Depth

Defines the number of frames displayed in a 3-dimensional spectrogram.

For details see the R&S FPL1000 User Manual.

Trace

Selects the diagram trace on which the spectrogram is based.

Remote command:

[CALCulate<n>:SGRam:TRACe](#) on page 204

Time Stamp

Activates and deactivates the timestamp. The timestamp shows the system time while the measurement is running. In single sweep mode or if the sweep is stopped, the timestamp shows the time and date of the end of the sweep.

When active, the timestamp replaces the display of the frame number.

Remote command:

[CALCulate<n>:SPECTrogram:TSTamp\[:STATe\]](#) on page 205

[CALCulate<n>:SPECTrogram:TSTamp:DATA?](#) on page 204

Color Mapping

Opens the "Color Mapping" dialog.

For details see the R&S FPL1000 User Manual.

Continuous Sweep / Run Cont

After triggering, starts the measurement and repeats it continuously until stopped.

While the measurement is running, the "Continuous Sweep" softkey and the [RUN CONT] key are highlighted. The running measurement can be aborted by selecting the highlighted softkey or key again. The results are not deleted until a new measurement is started.

Note: Sequencer. If the Sequencer is active, the "Continuous Sweep" softkey only controls the sweep mode for the currently selected channel setup. However, the sweep mode only takes effect the next time the Sequencer activates that channel setup, and only for a channel-defined sequence. In this case, a channel setup in continuous sweep mode is swept repeatedly.

Furthermore, the [RUN CONT] key controls the Sequencer, not individual sweeps.

[RUN CONT] starts the Sequencer in continuous mode.

For details on the Sequencer, see the R&S FPL1000 User Manual.

Remote command:

`INITiate<n>:CONTinuous` on page 176

Single Sweep / Run Single

After triggering, starts the number of sweeps set in "Sweep Count". The measurement stops after the defined number of sweeps has been performed.

While the measurement is running, the "Single Sweep" softkey and the [RUN SINGLE] key are highlighted. The running measurement can be aborted by selecting the highlighted softkey or key again.

Note: Sequencer. If the Sequencer is active, the "Single Sweep" softkey only controls the sweep mode for the currently selected channel setup. However, the sweep mode only takes effect the next time the Sequencer activates that channel setup, and only for a channel-defined sequence. In this case, the Sequencer sweeps a channel setup in single sweep mode only once.

Furthermore, the [RUN SINGLE] key controls the Sequencer, not individual sweeps.

[RUN SINGLE] starts the Sequencer in single mode.

If the Sequencer is off, only the evaluation for the currently displayed channel setup is updated.

For details on the Sequencer, see the R&S FPL1000 User Manual.

Remote command:

`INITiate<n>[:IMMediate]` on page 177

Clear Spectrogram

Resets the spectrogram result display and clears the history buffer.

This function is only available if a spectrogram is selected.

Remote command:

`CALCulate<n>:SPECTrogram:CLEar[:IMMediate]` on page 201

6.2.2 Color map settings

Access: "Overview" > "Analysis" > "Traces" > "Spectrogram" > "Color Mapping"

or: [TRACE] > "Spectrogram Config" > "Color Mapping"

In addition to the available color settings, the dialog box displays the current color map and provides a preview of the display with the current settings.

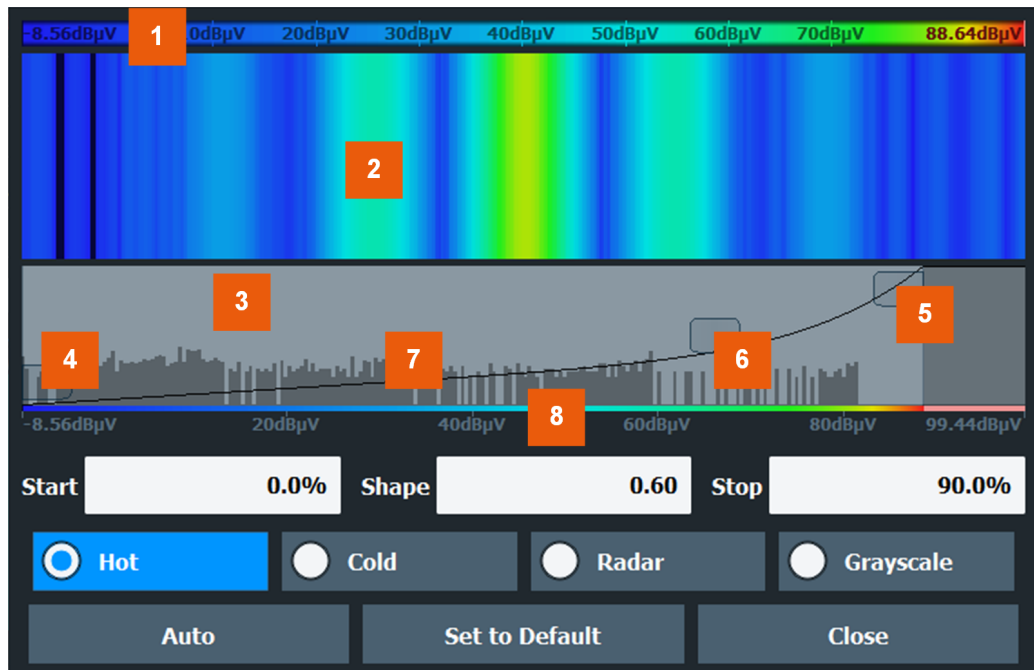

Figure 6-1: Color Mapping dialog box

- 1 = Color map: shows the current color distribution
- 2 = Preview pane: shows a preview of the spectrogram with any changes that you make to the color scheme
- 3 = Color curve pane: graphical representation of all settings available to customize the color scheme
- 4/5 = Color range start and stop sliders: define the range of the color map or amplitudes for the spectrogram
- 6 = Color curve slider: adjusts the focus of the color curve
- 7 = Histogram: shows the distribution of measured values
- 8 = Scale of the horizontal axis (value range)

Start / Stop.....	85
Shape.....	86
Hot/Cold/Radar/Grayscale.....	86
Auto.....	86
Set to Default.....	86
Close.....	86

Start / Stop

Defines the lower and upper boundaries of the value range of the spectrogram.

Remote command:

`DISPlay[:WINDow<n>]:SPECTrogram:COLor:LOWer` on page 206

`DISPlay[:WINDow<n>]:SPECTrogram:COLor:UPPer` on page 207

Shape

Defines the shape and focus of the color curve for the spectrogram result display.

"-1 to <0"	More colors are distributed among the lower values
"0"	Colors are distributed linearly among the values
">0 to 1"	More colors are distributed among the higher values

Remote command:

[DISPlay\[:WINDow<n>\]:SPECTrogram:COLor:SHAPE](#) on page 206

Hot/Cold/Radar/Grayscale

Sets the color scheme for the spectrogram.

Remote command:

[DISPlay\[:WINDow<n>\]:SPECTrogram:COLor\[:STYLE\]](#) on page 207

Auto

Defines the color range automatically according to the existing measured values for optimized display.

Set to Default

Sets the color mapping to the default settings.

Remote command:

[DISPlay\[:WINDow<n>\]:SPECTrogram:COLor:DEFault](#) on page 206

Close

Saves the changes and closes the dialog box.

6.3 Trace / data export configuration



Access: "Save" > "Export" > "Export Configuration"

Or: [TRACE] > "Trace Config" > "Trace / Data Export"



The standard data management functions (e.g. saving or loading instrument settings) that are available for all R&S FPL1000 applications are not described here.

See the R&S FPL1000 base unit user manual for a description of the standard functions.

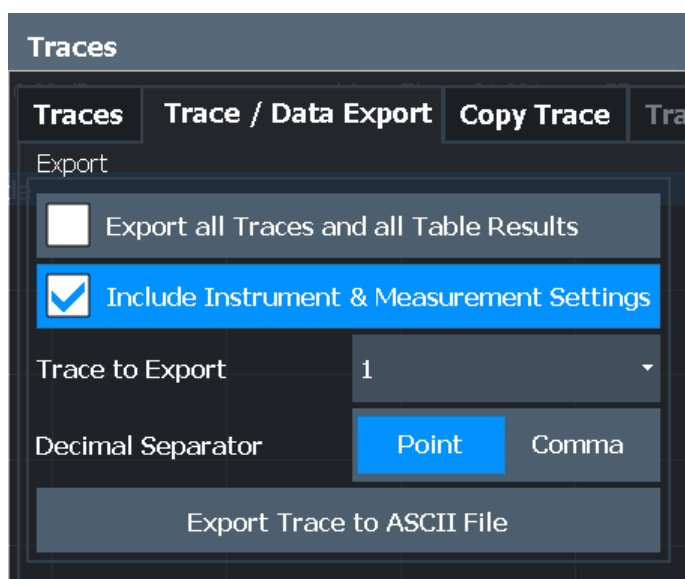

Export all Traces and all Table Results.....	87
Include Instrument & Measurement Settings.....	87
Trace to Export.....	87
Decimal Separator.....	88
Export Trace to ASCII File.....	88
L File Type.....	88
L Decimal Separator.....	89
L File Explorer.....	89

Export all Traces and all Table Results

Selects all displayed traces and result tables (e.g. "Result Summary", marker table etc.) in the current application for export to an ASCII file.

Alternatively, you can select one specific trace only for export (see [Trace to Export](#)).

The results are output in the same order as they are displayed on the screen: window by window, trace by trace, and table row by table row.

Remote command:

`FORMat:DEXPort:TRACes` on page 191

Include Instrument & Measurement Settings

Includes additional instrument and measurement settings in the header of the export file for result data.

See the R&S FPL1000 base unit user manual for details.

Remote command:

`FORMat:DEXPort:HEADer` on page 191

Trace to Export

Defines an individual trace to be exported to a file.

This setting is not available if [Export all Traces and all Table Results](#) is selected.

Decimal Separator

Defines the decimal separator for floating-point numerals for the data export/import files. Evaluation programs require different separators in different languages.

Remote command:

[FORMat:DEXPort:DSEParator](#) on page 191

Export Trace to ASCII File

Saves the selected trace or all traces in the currently active result display to the specified file and directory in the selected ASCII format.

"File Explorer": Instead of using the file manager of the R&S FPL1000 firmware, you can also use the Microsoft Windows File Explorer to manage files.

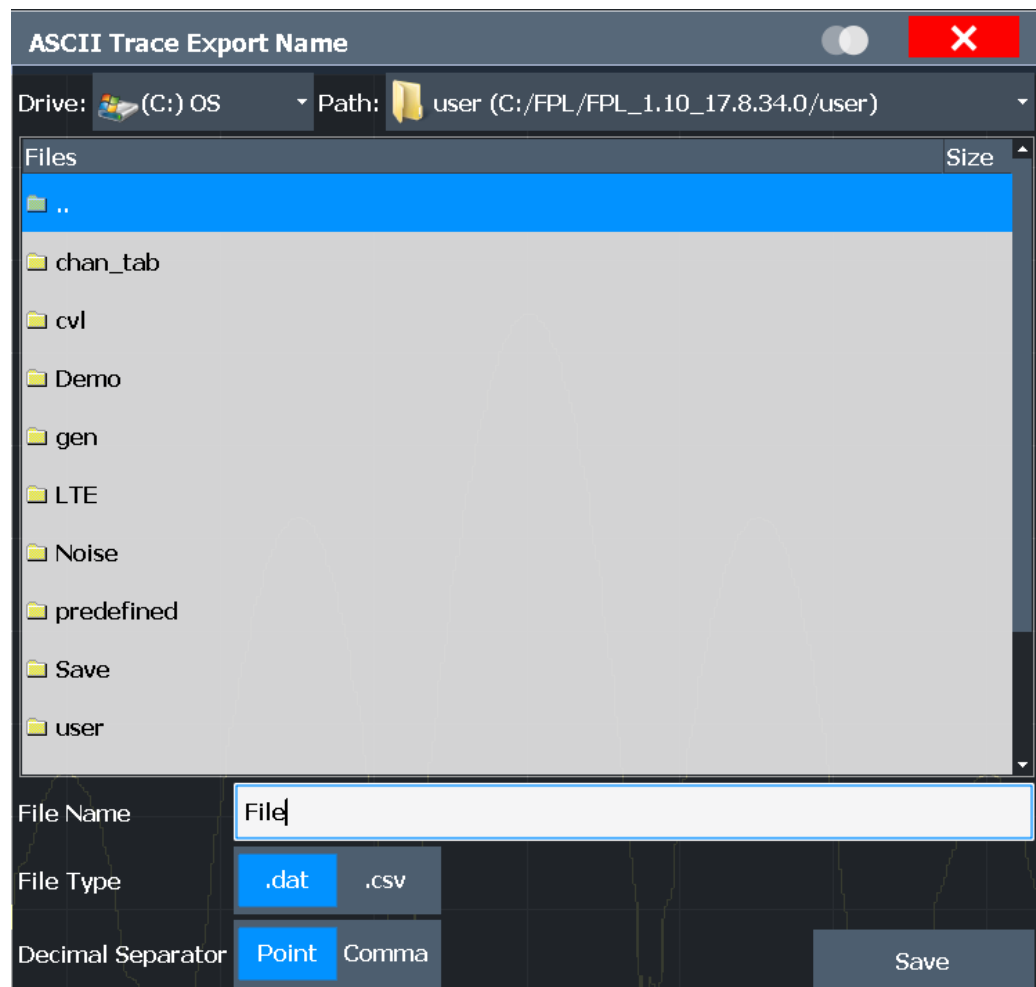

Remote command:

[MMEMory:STORe<n>:TRACe](#) on page 192

File Type ← Export Trace to ASCII File

Determines the format of the ASCII file to be imported or exported.

Depending on the external program in which the data file was created or is evaluated, a comma-separated list (CSV) or a plain data format (DAT) file is required.

Working with markers in the R&S FPL1-K7 AM/FM/PM Modulation Analysis application

Remote command:

[FORMat:DEXPort:FORMat](#) on page 190

Decimal Separator ← Export Trace to ASCII File

Defines the decimal separator for floating-point numerals for the data export/import files. Evaluation programs require different separators in different languages.

Remote command:

[FORMat:DEXPort:DSEParator](#) on page 191

File Explorer ← Export Trace to ASCII File

Opens the Microsoft Windows File Explorer.

Remote command:

not supported

6.4 Working with markers in the R&S FPL1-K7 AM/FM/PM Modulation Analysis application

Access: "Overview" > "Analysis"

Basically, markers in the R&S FPL1-K7 AM/FM/PM Modulation Analysis application are very similar to those in the Spectrum application. However, some additional functions are available.

- [Marker settings](#).....89
- [Marker search settings and positioning functions](#)..... 94
- [Marker search settings for spectrograms](#).....97
- [Marker function configuration](#).....99

6.4.1 Marker settings

Access: "Overview" > "Analysis" > "Marker" > "Markers"

Or: "Marker" > "Markers"

The remote commands required to define these settings are described in [Chapter 11.8.3, "Working with markers remotely"](#), on page 214.

- [Individual marker setup](#).....89
- [General marker settings](#).....92

6.4.1.1 Individual marker setup

Access: "Overview" > "Analysis" > "Marker" > "Markers"

Or: "Marker" > "Markers" tab

In the R&S FPL1-K7 AM/FM/PM Modulation Analysis application, up to 17 markers or delta markers can be activated for each window simultaneously.

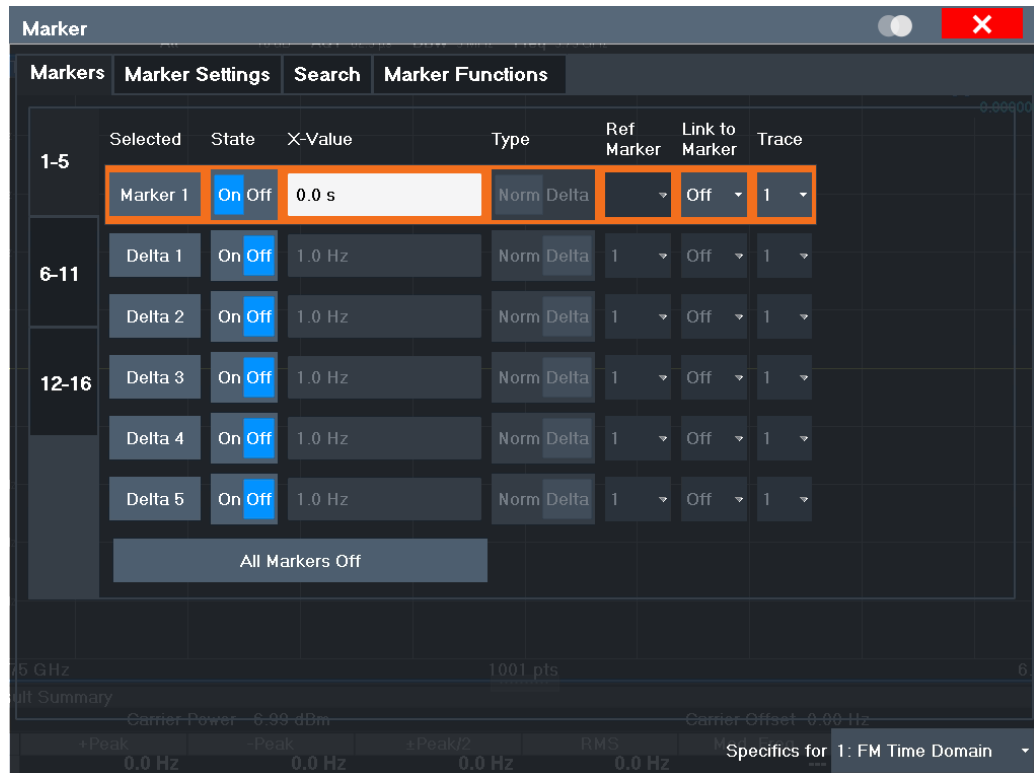

The markers are distributed among 3 tabs for a better overview. By default, the first marker is defined as a normal marker, whereas all others are defined as delta markers with reference to the first marker. All markers are assigned to trace 1, but only the first marker is active.

Selected Marker.....	90
Marker State.....	90
Marker Position X-value.....	91
Marker Type.....	91
Reference Marker.....	91
Linking to Another Marker.....	91
Assigning the Marker to a Trace.....	92
All Markers Off.....	92

Selected Marker

Marker name. The marker which is currently selected for editing is highlighted orange.

Remote command:

Marker selected via suffix <m> in remote commands.

Marker State

Activates or deactivates the marker in the diagram.

Remote command:

CALCulate<n>:MARKer<m>[:STATe] on page 215

CALCulate<n>:DELTAmarker<m>[:STATe] on page 219

Working with markers in the R&S FPL1-K7 AM/FM/PM Modulation Analysis application

Marker Position X-value

Defines the position (x-value) of the marker in the diagram. For normal markers, the absolute position is indicated. For delta markers, the position relative to the reference marker is provided.

Remote command:

[CALCulate<n>:MARKer<m>:X](#) on page 216

[CALCulate<n>:DELTamarker<m>:X](#) on page 220

Marker Type

Toggles the marker type.

The type for marker 1 is always "Normal", the type for delta marker 1 is always "Delta". These types cannot be changed.

Note: If normal marker 1 is the active marker, switching the "Mkr Type" activates an additional delta marker 1. For any other marker, switching the marker type does not activate an additional marker, it only switches the type of the selected marker.

"Normal" A normal marker indicates the absolute value at the defined position in the diagram.

"Delta" A delta marker defines the value of the marker relative to the specified reference marker (marker 1 by default).

Remote command:

[CALCulate<n>:MARKer<m>\[:STATe\]](#) on page 215

[CALCulate<n>:DELTamarker<m>\[:STATe\]](#) on page 219

Reference Marker

Defines a marker as the reference marker which is used to determine relative analysis results (delta marker values).

If the reference marker is deactivated, the delta marker referring to it is also deactivated.

If a fixed reference point is configured (see ["Defining a Fixed Reference"](#) on page 93), the reference point ("FXD") can also be selected instead of another marker.

Remote command:

[CALCulate<n>:DELTamarker<m>:MREFerence](#) on page 219

Linking to Another Marker

Links the current marker to the marker selected from the list of active markers. If the x-axis value of the initial marker is changed, the linked marker follows to the same position on the x-axis. Linking is off by default.

Using this function you can set two markers on different traces to measure the difference (e.g. between a max hold trace and a min hold trace or between a measurement and a reference trace).

Remote command:

[CALCulate<n>:MARKer<ms>:LINK:TO:MARKer<md>](#) on page 215

[CALCulate<n>:DELTamarker<ms>:LINK:TO:MARKer<md>](#) on page 218

[CALCulate<n>:DELTamarker<m>:LINK](#) on page 217

Working with markers in the R&S FPL1-K7 AM/FM/PM Modulation Analysis application

Assigning the Marker to a Trace

The "Trace" setting assigns the selected marker to an active trace. The trace determines which value the marker shows at the marker position. If the marker was previously assigned to a different trace, the marker remains on the previous frequency or time, but indicates the value of the new trace.

If a trace is turned off, the assigned markers and marker functions are also deactivated.

Remote command:

`CALCulate<n>:MARKer<m>:TRACe` on page 216

All Markers Off

Deactivates all markers in one step.

Remote command:

`CALCulate<n>:MARKer<m>:AOFF` on page 215

6.4.1.2 General marker settings

Access: "Overview" > "Analysis" > "Marker" > "Marker Settings"

Or: "Marker" > "Marker Settings" tab

Some general marker settings allow you to influence the marker behavior for all markers.

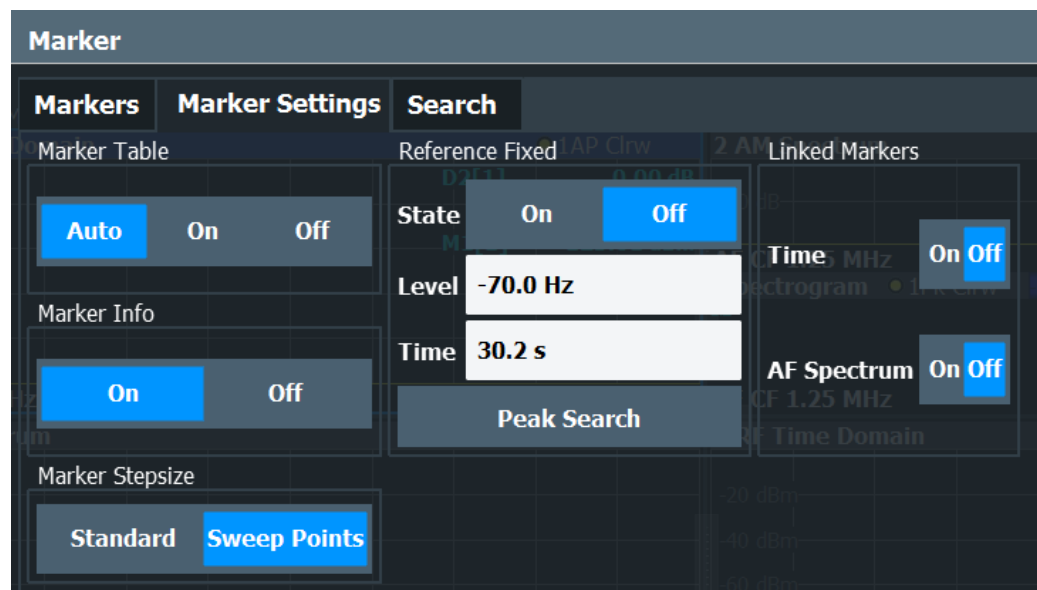

Marker Table Display.....	93
Marker Info.....	93
Marker Stepsize.....	93
Defining a Fixed Reference.....	93
Link Time Marker.....	94
Link AF Spectrum Marker.....	94

Working with markers in the R&S FPL1-K7 AM/FM/PM Modulation Analysis application

Marker Table Display

Defines how the marker information is displayed.

"On"	Displays the marker information in a table in a separate area beneath the diagram.
"Off"	No separate marker table is displayed. If Marker Info is active, the marker information is displayed within the diagram area.
"Auto"	(Default) If more than two markers are active, the marker table is displayed automatically. If Marker Info is active, the marker information for up to two markers is displayed in the diagram area.

Remote command:

[DISPlay\[:WINDow<n>\]:MTABLE](#) on page 223

Marker Info

Turns the marker information displayed in the diagram on and off.

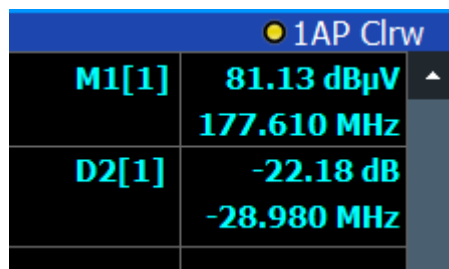

1AP Clrw	
M1[1]	81.13 dBµV 177.610 MHz
D2[1]	-22.18 dB -28.980 MHz

Remote command:

[DISPlay\[:WINDow<n>\]:MINFo\[:STATE\]](#) on page 222

Marker Stepsize

Defines the size of the steps that the marker position is moved using the rotary knob.

"Standard"	The marker position is moved in steps of (Span/1000), which corresponds approximately to the number of pixels for the default display of 1001 sweep points. This setting is most suitable to move the marker over a larger distance.
"Sweep Points"	The marker position is moved from one sweep point to the next. This setting is required for a very precise positioning if more sweep points are collected than the number of pixels that can be displayed on the screen. It is the default mode.

Remote command:

[CALCulate<n>:MARKer<m>:X:SSIZE](#) on page 221

Defining a Fixed Reference

Instead of using a reference marker whose position can vary depending on the measurement results, you can define a fixed reference marker for trace analysis.

Note that this function is not available in all result displays.

Working with markers in the R&S FPL1-K7 AM/FM/PM Modulation Analysis application

For "State" = "On", a vertical and a horizontal red display line are displayed, marked as "FXD". The normal marker 1 is activated and set to the peak value of the trace assigned to marker 1, and a delta marker to the next peak. The fixed reference marker is set to the position of marker 1 at the peak value. The delta marker refers to the fixed reference marker.

The "Level" and "Frequency" or "Time" settings define the position and value of the reference marker. To move the fixed reference, move the red display lines marked "FXD" in the diagram, or change the position settings in the "Marker Settings" tab of the "Marker" dialog box.

Peak Search sets the fixed reference marker to the current maximum value of the trace assigned to marker 1.

If activated, the fixed reference marker ("FXD") can also be selected as a [Reference Marker](#) instead of another marker.

Remote command:

`CALCulate<n>:DELTAmarker<m>:FUNCTION:FIXed[:STATE]` on page 239

`CALCulate<n>:DELTAmarker<m>:FUNCTION:FIXed:RPOINT:Y` on page 239

`CALCulate<n>:DELTAmarker<m>:FUNCTION:FIXed:RPOINT:X` on page 238

`CALCulate<n>:DELTAmarker<m>:FUNCTION:FIXed:RPOINT:MAXimum[:PEAK]` on page 238

Link Time Marker

Links the markers in all time domain diagrams.

Remote command:

`CALCulate<n>:MARKer<m>:LINK` on page 222

Link AF Spectrum Marker

Links the markers in all AF spectrum displays.

Remote command:

`CALCulate<n>:MARKer<m>:LINK` on page 222

6.4.2 Marker search settings and positioning functions

Access: "Overview" > "Analysis" > "Marker" > "Search"

or: "Marker" > "Search"

Several functions are available to set the marker to a specific position very quickly and easily, or to use the current marker position to define another characteristic value. To determine the required marker position, searches are performed. You can influence the search results using special settings.

The remote commands required to define these settings are described in [Chapter 11.8.3, "Working with markers remotely"](#), on page 214.

- [Marker search settings](#).....95
- [Positioning functions](#)..... 95

6.4.2.1 Marker search settings

Access: "Overview" > "Analysis" > "Marker" > "Search"

or: "Marker" > "Search"

Markers are commonly used to determine peak values, i.e. maximum or minimum values, in the measured signal. Configuration settings allow you to influence the peak search results.

[Peak Excursion](#)..... 95

Peak Excursion

Defines the minimum level value by which a signal must rise or fall so that it is identified as a maximum or a minimum by the search functions.

Entries from 0 dB to 80 dB are allowed; the resolution is 0.1 dB. The default setting for the peak excursion is 6 dB.

For Analog Modulation Analysis, the unit and value range depend on the selected result display type.

Remote command:

[CALCulate<n>:MARKer<m>:PEXCursion](#) on page 232

6.4.2.2 Positioning functions

The following functions set the currently selected marker to the result of a peak search or set other characteristic values to the current marker value.

[Select Marker](#)..... 95
[Peak Search](#)..... 96
[Search Next Peak](#)..... 96
[Search Minimum](#)..... 96
[Search Next Minimum](#)..... 97

Select Marker

The "Select Marker" function opens a dialog box to select and activate or deactivate one or more markers quickly.

Working with markers in the R&S FPL1-K7 AM/FM/PM Modulation Analysis application



Remote command:

[CALCulate<n>:MARKer<m>\[:STATE\]](#) on page 215

[CALCulate<n>:DELTamarker<m>\[:STATE\]](#) on page 219

Peak Search

Sets the selected marker/delta marker to the maximum of the trace. If no marker is active, marker 1 is activated.

Remote command:

[CALCulate<n>:MARKer<m>:MAXimum\[:PEAK\]](#) on page 234

[CALCulate<n>:DELTamarker<m>:MAXimum\[:PEAK\]](#) on page 236

Search Next Peak

Sets the selected marker/delta marker to the next (lower) maximum of the assigned trace. If no marker is active, marker 1 is activated.

Remote command:

[CALCulate<n>:MARKer<m>:MAXimum:NEXT](#) on page 234

[CALCulate<n>:MARKer<m>:MAXimum:RIGHT](#) on page 234

[CALCulate<n>:MARKer<m>:MAXimum:LEFT](#) on page 233

[CALCulate<n>:DELTamarker<m>:MAXimum:NEXT](#) on page 236

[CALCulate<n>:DELTamarker<m>:MAXimum:RIGHT](#) on page 236

[CALCulate<n>:DELTamarker<m>:MAXimum:LEFT](#) on page 236

Search Minimum

Sets the selected marker/delta marker to the minimum of the trace. If no marker is active, marker 1 is activated.

Remote command:

[CALCulate<n>:MARKer<m>:MINimum\[:PEAK\]](#) on page 235

[CALCulate<n>:DELTamarker<m>:MINimum\[:PEAK\]](#) on page 237

Working with markers in the R&S FPL1-K7 AM/FM/PM Modulation Analysis application

Search Next Minimum

Sets the selected marker/delta marker to the next (higher) minimum of the selected trace. If no marker is active, marker 1 is activated.

Remote command:

CALCulate<n>:MARKer<m>:MINimum:NEXT on page 235

CALCulate<n>:MARKer<m>:MINimum:LEFT on page 234

CALCulate<n>:MARKer<m>:MINimum:RIGHT on page 235

CALCulate<n>:DELTamarker<m>:MINimum:NEXT on page 237

CALCulate<n>:DELTamarker<m>:MINimum:LEFT on page 237

CALCulate<n>:DELTamarker<m>:MINimum:RIGHT on page 237

6.4.3 Marker search settings for spectrograms

Access: "Overview" > "Analysis" > "Markers" > "Search"

or: [MKR TO] > "Search Config"

Spectrograms show not only the current sweep results, but also the sweep history. Thus, when searching for peaks, you must define the search settings within a single time frame (x-direction) and within several time frames (y-direction).

These settings are only available for spectrogram displays.

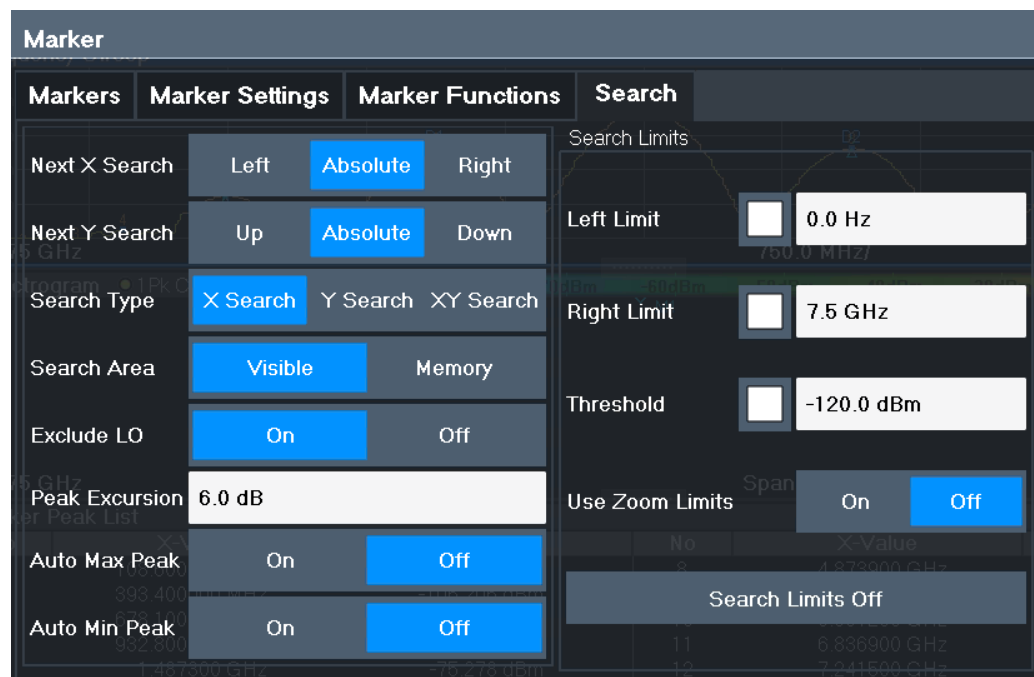

Search Mode for Next Peak in X-Direction.....	98
Search Mode for Next Peak in Y-Direction.....	98
Marker Search Type.....	98
Marker Search Area.....	99
Peak Excursion.....	99

Working with markers in the R&S FPL1-K7 AM/FM/PM Modulation Analysis application

Search Mode for Next Peak in X-Direction

Selects the search mode for the next peak search within the currently selected frame.

"Left"	Determines the next maximum/minimum to the left of the current peak.
"Absolute"	Determines the next maximum/minimum to either side of the current peak.
"Right"	Determines the next maximum/minimum to the right of the current peak.

Remote command:

[Chapter 11.8.3.5, "Positioning the marker"](#), on page 233

Search Mode for Next Peak in Y-Direction

Selects the search mode for the next peak search within all frames at the current marker position.

"Up"	Determines the next maximum/minimum above the current peak (in more recent frames).
"Absolute"	Determines the next maximum/minimum above or below the current peak (in all frames).
"Down"	Determines the next maximum/minimum below the current peak (in older frames).

Remote command:

[CALCulate<n>:MARKer<m>:SPECTrogram:Y:MAXimum:ABOVE](#) on page 225

[CALCulate<n>:DELTamarker<m>:SPECTrogram:Y:MAXimum:ABOVE](#)

on page 230

[CALCulate<n>:MARKer<m>:SPECTrogram:Y:MAXimum:BELOW](#) on page 226

[CALCulate<n>:DELTamarker<m>:SPECTrogram:Y:MAXimum:BELOW](#)

on page 230

[CALCulate<n>:MARKer<m>:SPECTrogram:Y:MAXimum:NEXT](#) on page 226

[CALCulate<n>:DELTamarker<m>:SPECTrogram:Y:MAXimum:NEXT](#) on page 231

[CALCulate<n>:MARKer<m>:SPECTrogram:Y:MINimum:ABOVE](#) on page 227

[CALCulate<n>:DELTamarker<m>:SPECTrogram:Y:MINimum:ABOVE](#)

on page 231

[CALCulate<n>:MARKer<m>:SPECTrogram:Y:MINimum:BELOW](#) on page 227

[CALCulate<n>:DELTamarker<m>:SPECTrogram:Y:MINimum:BELOW](#)

on page 231

[CALCulate<n>:MARKer<m>:SPECTrogram:Y:MINimum:NEXT](#) on page 227

[CALCulate<n>:DELTamarker<m>:SPECTrogram:Y:MINimum:NEXT](#) on page 232

Marker Search Type

Defines the type of search to be performed in the spectrogram.

"X-Search"	Searches only within the currently selected frame.
"Y-Search"	Searches within all frames but only at the current frequency position.
"XY-Search"	Searches in all frames at all positions.

Working with markers in the R&S FPL1-K7 AM/FM/PM Modulation Analysis application

Remote command:

Defined by the search function, see [Chapter 11.8.3.3, "Marker search \(spectrograms\)"](#), on page 223

Marker Search Area

Defines which frames the search is performed in.

"Visible" Only the visible frames are searched.

"Memory" All frames stored in the memory are searched.

Remote command:

[CALCulate<n>:MARKer<m>:SPECTrogram:SARea](#) on page 225

[CALCulate<n>:DELTAmarker<m>:SPECTrogram:SARea](#) on page 229

Peak Excursion

Defines the minimum level value by which a signal must rise or fall so that it is identified as a maximum or a minimum by the search functions.

Entries from 0 dB to 80 dB are allowed; the resolution is 0.1 dB. The default setting for the peak excursion is 6 dB.

For Analog Modulation Analysis, the unit and value range depend on the selected result display type.

Remote command:

[CALCulate<n>:MARKer<m>:PEXCursion](#) on page 232

6.4.4 Marker function configuration

Access: "Overview" > "Analysis" > "Marker Functions" > "Phase Noise"

Special marker functions can be selected via the "Marker Function" dialog box.



The fixed reference marker is described under ["Defining a Fixed Reference"](#) on page 93.

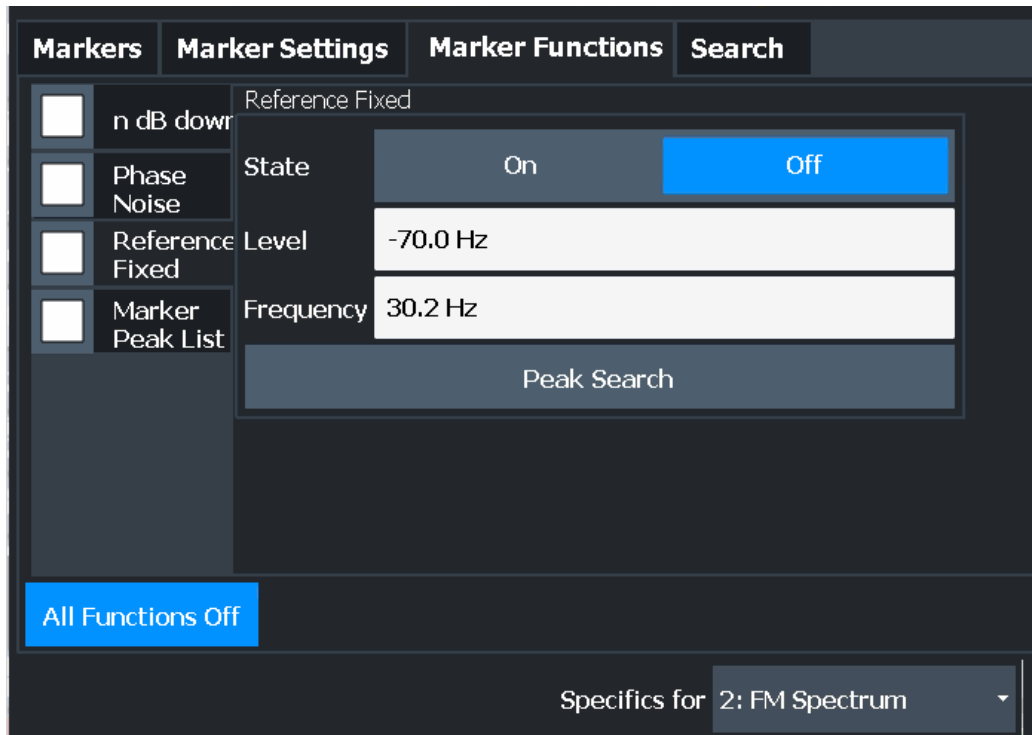

Not all marker functions are available for all evaluations. The following table indicates which functions are available for which evaluations.

Evaluation	n dB down	Phase Noise	Reference Fixed	"Marker Peak List"
AM/FM/PM time	-	-	X	X
AF/FM/PM spectrum	X	X	X	X
RF time	X	-	X	X
RF spectrum	X	X	X	X

The remote commands required to define these settings are described in [Chapter 11.8.3.6, "Configuring special marker functions"](#), on page 238.



The Fixed Reference Marker settings are described in ["Defining a Fixed Reference"](#) on page 93.

- [Measuring characteristic bandwidths \(n db down marker\)](#)..... 101
- [Phase noise measurement marker](#)..... 102
- [Marker peak list](#)..... 105
- [Deactivating all marker functions](#)..... 108

6.4.4.1 Measuring characteristic bandwidths (n dB down marker)

Access: "Overview" > "Analysis" > "Marker Functions" > "n dB down" > "n dB Down Config"

Or: [MKR] > "Select Marker Function" > "n dB down" > "n dB Down Config"

When characterizing the shape of a signal, the bandwidth at a specified offset from its peak level is often of interest. The offset is specified as a relative decrease in amplitude of n dB. To measure this bandwidth, you could use several markers and delta markers and determine the bandwidth manually. However, using the n dB down marker function makes the task very simple and quick.

The n dB down marker function uses the current value of marker 1 as the reference point. It activates two temporary markers T1 and T2 located on the signal, whose level is n dB below the level of the reference point. Marker T1 is placed to the left and marker T2 to the right of the reference marker. The default setting for n is 3 dB, but it can be changed.

If a positive offset is entered, the markers T1 and T2 are placed below the active reference point. If a negative value is entered (for example for notch filter measurements), the markers T1 and T2 are placed above the active reference point.

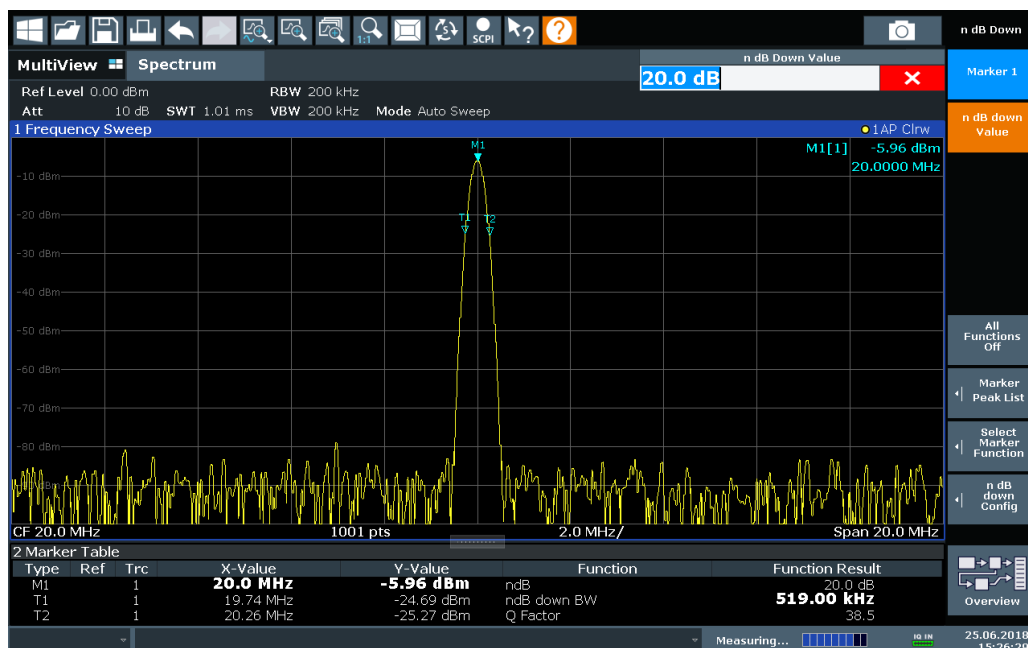

Figure 6-2: n dB down marker function

The following marker function results are displayed:

Table 6-1: n dB down marker function results

Label	Description
M1	Current position and level of marker 1
ndB	Offset value (n dB down)

Working with markers in the R&S FPL1-K7 AM/FM/PM Modulation Analysis application

Label	Description
ndB down Bw / PWid	Determined bandwidth or pulse width (zero span) at the offset
Q-factor	Center frequency / n-dB-down-bandwidth Quality factor of the determined bandwidth (characteristic of damping or resonance)
T1, T2	Current position and level of the temporary markers

If the required position for the temporary markers cannot be determined uniquely, for example due to noise, dashes are displayed as a result.

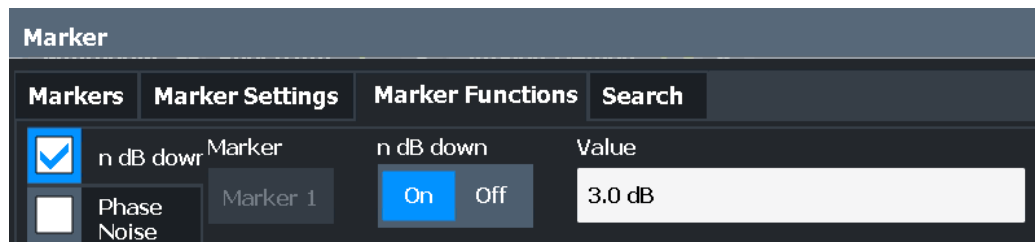

Remote commands:

[CALCulate<n>:MARKer<m>:FUNCTion:NDBDown:STATe](#) on page 246

[CALCulate<n>:MARKer<m>:FUNCTion:NDBDown:RESult?](#) on page 246

[n dB down Marker State](#).....102
[n dB down Value](#)..... 102

n dB down Marker State

Activates or deactivates the special n dB down marker function.

Remote command:

[CALCulate<n>:MARKer<m>:FUNCTion:NDBDown:STATe](#) on page 246

[CALCulate<n>:MARKer<m>:FUNCTion:NDBDown:RESult?](#) on page 246

n dB down Value

Defines the delta level from the reference marker 1 used to determine the bandwidth or time span.

Remote command:

[CALCulate<n>:MARKer<m>:FUNCTion:NDBDown:FREQuency?](#) on page 245

[CALCulate<n>:MARKer<m>:FUNCTion:NDBDown:TIME?](#) on page 247

6.4.4.2 Phase noise measurement marker

Access: "Overview" > "Analysis" > "Marker Functions" > "Phase Noise" > "Phase Noise Config"

Or: [MKR] > "Select Marker Function" > "Phase Noise" > "Phase Noise Config"

For each of the 16 markers, you can activate a phase noise measurement.

Note that phase noise markers are available:

- for spectrum results
- for normal markers
- not for time domain results

Phase noise is unintentional modulation of a carrier; it creates frequencies next to the carrier frequency. A phase noise measurement consists of noise density measurements at defined offsets from the carrier; the results are given in relation to the carrier level (dBc). The phase noise marker function measures the noise power at the delta markers referred to 1 Hz bandwidth. Marker 1 is used as the reference for the phase noise measurement. By default, the current frequency and level of marker 1 are used as the fixed reference marker. However, you can start a peak search to use the current signal peak as the reference point, or you can define a reference point manually.

The reference point for the phase noise measurement is fixed. After phase noise measurement is started, you can set the reference level or the center frequency so that the carrier is outside the displayed frequency range. You can also activate a notch filter to suppress the carrier.

Alternatively, the reference point can be determined automatically by a peak search after each sweep. Use this function to track a drifting source during a phase noise measurement. The delta marker 2, which shows the phase noise measurement result, keeps the delta frequency value. Thus, the phase noise measurement leads to reliable results in a certain offset although the source is drifting. Only if the marker 2 reaches the border of the span, the delta marker value is adjusted to be within the span. In these cases, select a larger span.

The result of the phase noise measurement is the difference in level between the reference point and the noise power density. It is indicated as the function result of the phase noise marker in the "marker table".

The sample detector is automatically used and the video bandwidth set to 0.1 times the resolution bandwidth (RBW). The two settings are considered in the correction values used for the noise power measurement. To obtain stable results, two pixels on the right and the left of the delta marker position are taken for the measurement.

The individual marker settings correspond to those defined in the "Marker" dialog box. Any settings to the marker state or type changed in the "Marker Function" dialog box are also changed in the "Marker" dialog box and vice versa.

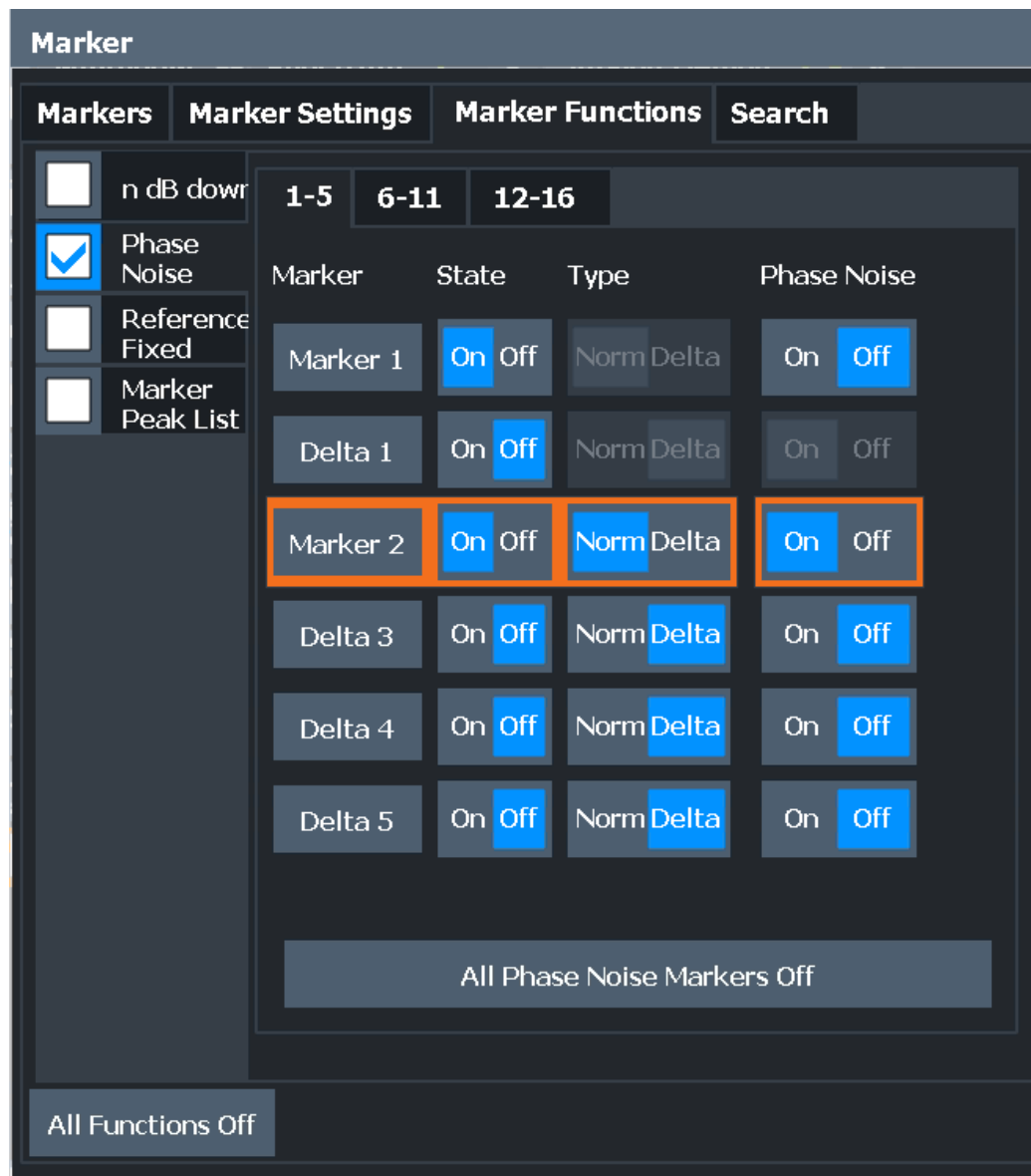
**Remote commands:**

[CALCulate<n>:MARKer<m>:FUNCTION:PNOise\[:STATE\]](#) on page 248

[CALCulate<n>:MARKer<m>:FUNCTION:PNOise:RESULT?](#) on page 248

[Phase Noise Measurement State](#)..... 104

[Switching All Phase Noise Measurements Off](#)..... 105

Phase Noise Measurement State

Activates or deactivates phase noise measurement at the marker position in the diagram.

In the R&S FPL1-K7 AM/FM/PM Modulation Analysis application, this function is only available for normal markers.

Working with markers in the R&S FPL1-K7 AM/FM/PM Modulation Analysis application

If activated, the normal markers display the phase noise measured at their current position in the "marker table".

For details see [Chapter 6.4.4.2, "Phase noise measurement marker"](#), on page 102.

Remote command:

`CALCulate<n>:MARKer<m>:FUNction:PNOise[:STATe]` on page 248

`CALCulate<n>:MARKer<m>:FUNction:PNOise:RESult?` on page 248

Switching All Phase Noise Measurements Off

Deactivates phase noise measurement for all markers.

Remote command:

`CALCulate<n>:MARKer<m>:FUNction:PNOise[:STATe]` on page 248

6.4.4.3 Marker peak list

Access: "Overview" > "Analysis" > "Marker Functions" > "Marker Peak List"

Or: [MKR] > "Select Marker Function" > "Marker Peak List"

A common measurement task is to determine peak values, i.e. maximum or minimum signal levels. The R&S FPL1000 provides various peak search functions and applications:

- Setting a marker to a peak value once (Peak Search)
- Searching for a peak value within a restricted search area (Search Limits)
- Creating a "marker table" with all or a defined number of peak values for one sweep ("Marker Peak List")
- Updating the marker position to the current peak value automatically after each sweep (Auto Peak Search)

Peak search limits

The peak search can be restricted to a search area. The search area is defined by limit lines which are also indicated in the diagram. In addition, a minimum value (threshold) can be defined as a further search condition.

When is a peak a peak? - Peak excursion

During a peak search, noise values are detected as a peak if the signal is very flat or does not contain many peaks. Therefore, you can define a relative threshold ("Peak Excursion"). The signal level must increase by the threshold value before falling again before a peak is detected. To avoid identifying noise peaks as maxima or minima, enter a peak excursion value that is higher than the difference between the highest and the lowest value measured for the displayed inherent noise.

Effect of peak excursion settings (example)

The following figure shows a trace to be analyzed.

Working with markers in the R&S FPL1-K7 AM/FM/PM Modulation Analysis application

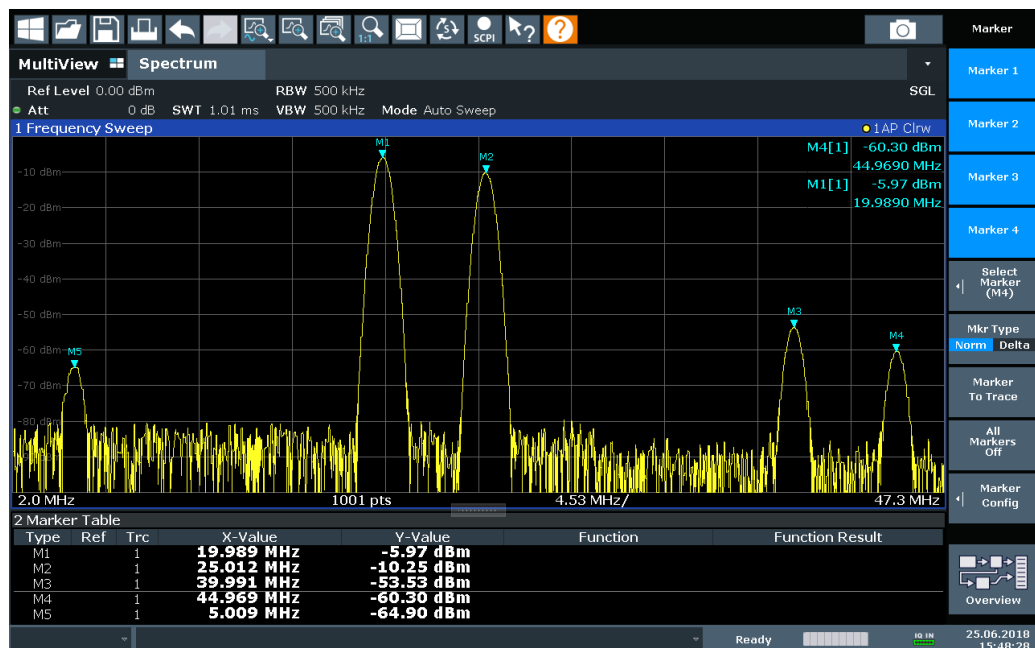

Figure 6-3: Trace example

The following table lists the peaks as indicated by the marker numbers in the diagram above, as well as the minimum decrease in amplitude to either side of the peak:

Marker #	Min. amplitude decrease to either side of the signal
1	80 dB
2	80 dB
3	55 dB
4	39 dB
5	32 dB

To eliminate the smaller peaks M3, M4 and M5 in the example above, a peak excursion of at least 60 dB is required. In this case, the amplitude must rise at least 60 dB before falling again before a peak is detected.

Marker peak list

The marker peak list determines the frequencies and levels of peaks in the spectrum. It is updated automatically after each sweep. How many peaks are displayed can be defined, as well as the sort order. In addition, the detected peaks can be indicated in the diagram. The peak list can also be exported to a file for analysis in an external application.

In the R&S FPL1-K7 AM/FM/PM Modulation Analysis application, the search limits are not available.

Working with markers in the R&S FPL1-K7 AM/FM/PM Modulation Analysis application

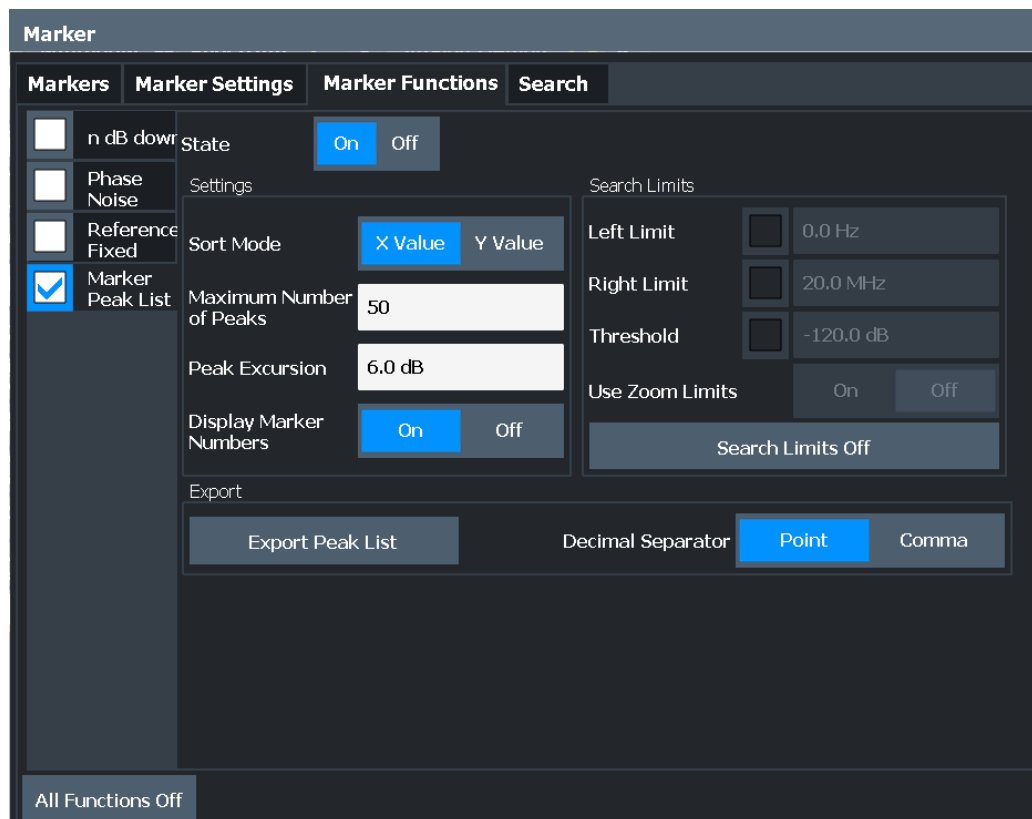
**Remote commands:**

[CALCulate<n>:MARKer<m>:FUNCTION:FPEaks:STATE](#) on page 242

TRAC? LIST,

Peak List State	107
Sort Mode	107
Maximum Number of Peaks	108
Peak Excursion	108
Display Marker Numbers	108
Export Peak List	108

Peak List State

Activates/deactivates the marker peak list. If activated, the peak list is displayed and the peaks are indicated in the trace display.

For each listed peak, the frequency/time ("X-value") and level ("Y-Value") values are given.

Remote command:

[CALCulate<n>:MARKer<m>:FUNCTION:FPEaks:STATE](#) on page 242

Sort Mode

Defines whether the peak list is sorted according to the x-values or y-values. In either case, the values are sorted in ascending order.

Working with markers in the R&S FPL1-K7 AM/FM/PM Modulation Analysis application

Remote command:

`CALCulate<n>:MARKer<m>:FUNCTION:FPEaks:SORT` on page 242

Maximum Number of Peaks

Defines the maximum number of peaks to be determined and displayed.

Remote command:

`CALCulate<n>:MARKer<m>:FUNCTION:FPEaks:LIST:SIZE` on page 242

Peak Excursion

Defines the minimum level value by which a signal must rise or fall so that it is identified as a maximum or a minimum by the search functions.

Entries from 0 dB to 80 dB are allowed; the resolution is 0.1 dB. The default setting for the peak excursion is 6 dB.

For Analog Modulation Analysis, the unit and value range depend on the selected result display type.

Remote command:

`CALCulate<n>:MARKer<m>:PEXCursion` on page 232

Display Marker Numbers

By default, the marker numbers are indicated in the diagram so you can find the peaks from the list. However, for large numbers of peaks, the marker numbers can decrease readability; in this case, deactivate the marker number display.

Remote command:

`CALCulate<n>:MARKer<m>:FUNCTION:FPEaks:ANNOtation:LABel[:STATe]` on page 240

Export Peak List

The peak list can be exported to an ASCII file (.DAT) for analysis in an external application.

Remote command:

`MMEMOry:STORe<n>:PEAK` on page 244

`FORMat:DEXPort:DSEParator` on page 191

6.4.4.4 Deactivating all marker functions

Access: "Overview" > "Analysis" > "Marker Functions" > "All Functions Off"

Or: [MKR] > "All Functions Off"

All special marker functions can be deactivated in one step.

Remote command:

7 I/Q data import and export

Baseband signals mostly occur as so-called complex baseband signals, i.e. a signal representation that consists of two channels; the inphase (I) and the quadrature (Q) channel. Such signals are referred to as I/Q signals. The complete modulation information and even distortion that originates from the RF, IF or baseband domains can be analyzed in the I/Q baseband.

Importing and exporting I/Q signals is useful for various applications:

- Generating and saving I/Q signals in an RF or baseband signal generator or in external software tools to analyze them with the R&S FPL1000 later.
- Capturing and saving I/Q signals with the R&S FPL1000 to analyze them with the R&S FPL1000 or an external software tool later

As opposed to storing trace data, which can be averaged or restricted to peak values, I/Q data is stored as it was captured, without further processing. Multi-channel data is not supported.

The data is stored as complex values in 32-bit floating-point format. The I/Q data is stored in a format with the file extension `.iq.tar`.

For a detailed description, see the R&S FPL1000 I/Q Analyzer and I/Q Input User Manual.

For example, you can capture I/Q data using the I/Q Analyzer application, if available, and then analyze that data later using the R&S FPL1-K7 AM/FM/PM Modulation Analysis application.



An application note on converting Rohde & Schwarz I/Q data files is available from the Rohde & Schwarz website:

[1EF85: Converting R&S I/Q data files](#)

8 How to perform measurements in the R&S FPL1-K7 AM/FM/PM Modulation Analysis application

1. Press the [MODE] key.
2. Select the "AM/FM/PM Modulation Analysis" application.
3. Select "Overview" to display the "Overview" for AM/FM/PM Modulation Analysis.
4. Select "Input/Frontend" > "Frequency" tab to define the input signal's center frequency.
5. Select "Data Acquisition" and define the bandwidth parameters for the input signal:
 - "Demodulation Bandwidth": the span of the input signal to demodulate
 - "Measurement Time": how long the input signal is measured
 - "Resolution Bandwidth": how precise the signal is demodulated
 - "Capture Offset" (multistandard mode only): the offset of the analysis interval from the start of the capture buffer
6. Optionally, select "Trigger" and define a trigger for data acquisition, for example an offline demodulation trigger to start capturing data only when a useful signal is transmitted.
7. Select "Demod/Display" and select the demodulation displays that are of interest to you (up to 6).
Arrange them on the display to suit your preferences.
8. Exit the SmartGrid mode and select "Overview" to display the "Overview" again.
9. Select "Demodulation Settings" to define demodulation parameters for each evaluation:
 - Configure the "Squelch" function (on the "Demod" tab) to suppress noise during demodulation.
 - For time domain evaluations, zoom into the areas of interest by defining a zoom area (on the "Demod" tab).
 - For AF evaluations, use special filters to eliminate certain effects of demodulation or to correct pre-emphasized modulated signals (on the "AF Filters" tab).
 - Adapt the diagram scaling to the displayed data (on the "Scaling" tab).
10. Select "Overview" > "Analysis" to use the advanced analysis functions in the demodulation displays.
 - Configure a trace to display the average over a series of sweeps (on the "Trace" tab. If necessary, increase the "Sweep Count" in the "Data Acquisition" settings).
 - Configure markers and delta markers to determine deviations and offsets within the demodulated signal (on the "Marker" tab).

- Use special marker functions to calculate phase noise or an n-dB-down bandwidth (on the "Marker Config" tab).
 - Configure a limit check to detect excessive deviations (on the "Lines" tab).
11. Start a new sweep with the defined settings.
In multistandard mode, to stop the continuous measurement mode by the Sequencer and perform a single data acquisition:
 - a) Select the Sequencer () from the toolbar.
 - b) Set the Sequencer state to "Off".
 - c) Press [RUN SINGLE].
 12. Optionally, export the trace data of the demodulated signal to a file.
 - a) In the "Traces" tab of the "Analysis" dialog box, switch to the "Trace Export" tab.
 - b) Select "Export Trace to ASCII File".
 - c) Define a file name and storage location and select "OK".

8.1 How to export trace data and numerical results

The measured trace data and numerical measurement results in tables can be exported to an ASCII file. For each sweep point, the measured trace position and value are output.

The file is stored with a `.DAT` extension. For details on the storage format, see [Chapter 11.7.5, "Reference: ASCII file export format"](#), on page 197.

To export trace data and table results

1. Select [TRACE] > "Trace Config" > "Trace / Data Export" tab.
2. Select "Export all Traces and all Table Results" to export all available measurement result data for the current application, or select a specific "Trace to Export".
3. Optionally, select "Include Instrument & Measurement Settings" to insert additional information in the export file header.
4. If necessary, change the decimal separator for the ASCII export file.
5. Select "Export Trace to ASCII File".
6. In the file selection dialog box, select the storage location and file name for the export file.
7. Select "Save" to close the dialog box and export the data to the file.

9 Measurement example: demodulating an FM signal

A practical example for a basic Analog Modulation Analysis measurement is provided here. It demonstrates how operating and measurement errors can be avoided using correct configuration settings.

The measurement is performed using the following devices:

- An R&S FPL1000 with application firmware R&S FPL1-K7: Analog Modulation Analysis
- A vector signal generator, e.g. R&S SMW



Figure 9-1: Test setup

Signal generator settings (e.g. R&S SMW):

Frequency:	500 MHz
Level:	-10 dBm
Modulation:	FM
Modulation frequency:	10 kHz
Frequency deviation:	50 kHz

Procedure:

1. Preset the R&S FPL1000.
2. Set the center frequency to *500 MHz*.
3. Set the reference level to *0 dBm*.
4. Select the [MODE] key and then the "AM FM PM Analog Demod" button.
By default, the "FM Time Domain" result display and a "Result Summary" are shown.

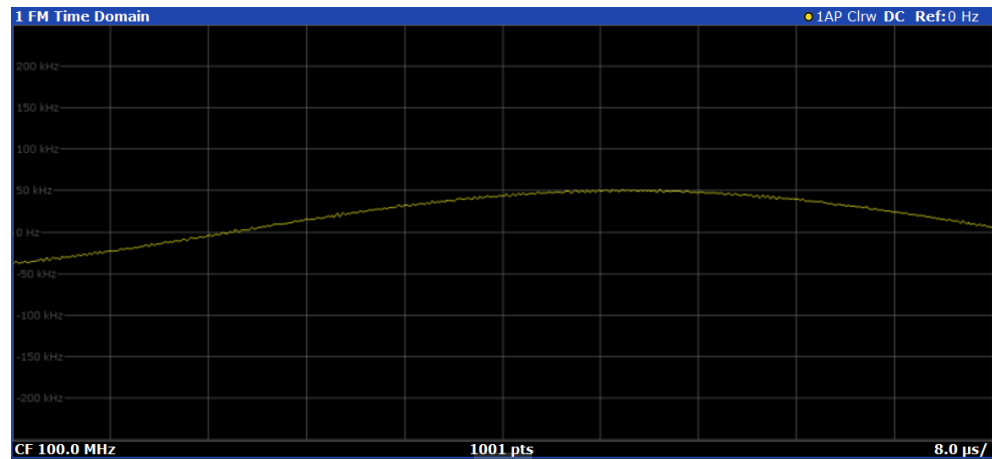

Figure 9-2: Default Analog Modulation Analysis measurement result display

5. Set the measurement time (AQT) to 1 ms to measure 10 periods of the signal.
6. Adjust the y-axis scaling to the measured frequency deviation automatically by selecting "Scale Config" > "Scaling" tab > "AF Auto Scale": "On".

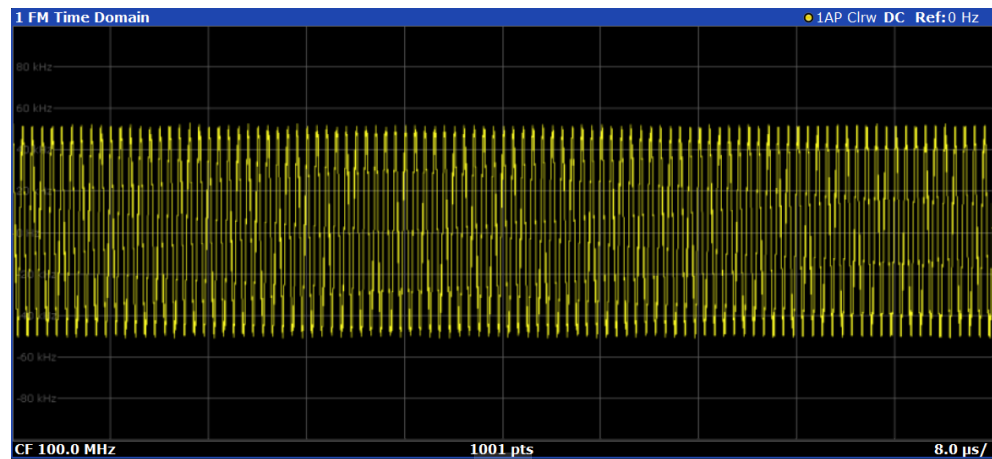

Figure 9-3: Auto-scaled measurement of 10 signal periods (continuous)

7. Display the RF spectrum of the measured signal to determine the required demodulation bandwidth. Select "Display Config" and add an "RF Spectrum" window to the display.

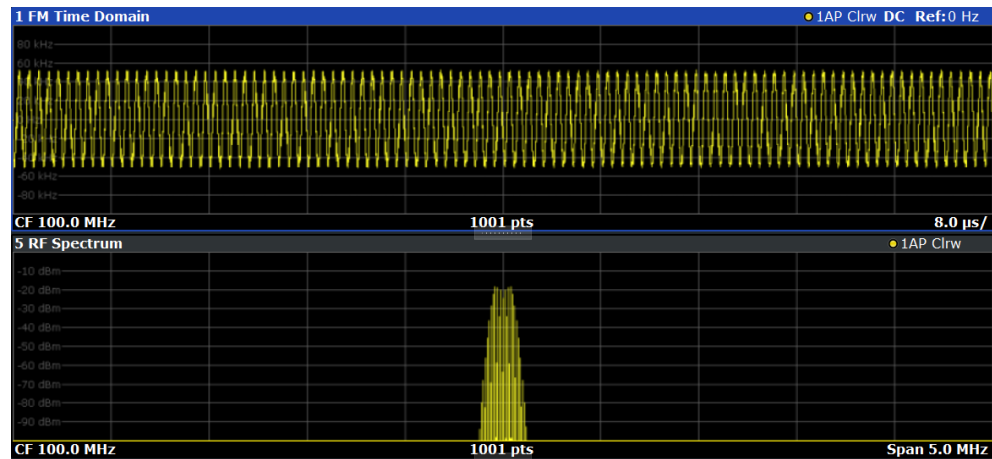

Figure 9-4: RF spectrum of FM signal with default demodulation bandwidth = 5 MHz

8. As you can see in Figure 9-4, the default demodulation bandwidth of 5 MHz is much too large - the actual signal takes up only a small part of the displayed range. That means that any noise or additional signals apart from the FM signal of interest may be included in the measured results. Select "Demod BW" and reduce the value to 200 kHz.

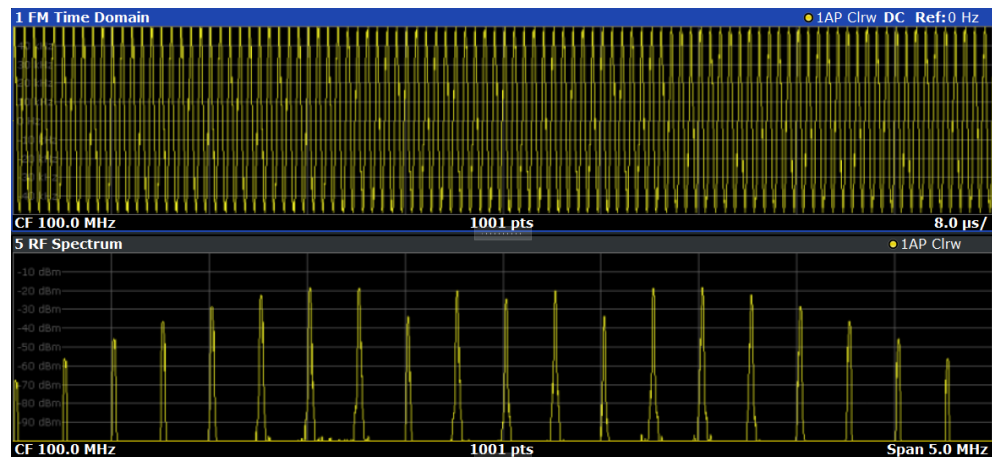

Figure 9-5: RF spectrum with demodulation bandwidth = 200 kHz

The span is automatically reduced to 200 kHz as well, as only the demodulated range can be displayed.

9. Now the RF spectrum shows that part of the FM signal is cut off. The missing signal parts are not included in the calculated results. Increase the demodulation bandwidth to 400 kHz to include the entire signal, but no interfering frequencies.

The span is not automatically increased for the wider DBW since it may be useful to display only a small range from the demodulated bandwidth. However, this means the RF spectrum will still not show the entire signal.

10. Increase the span manually to show the entire demodulated bandwidth:
a) Select the "RF Spectrum" window.

- b) Press [SPAN].
- c) Select "Full Span".

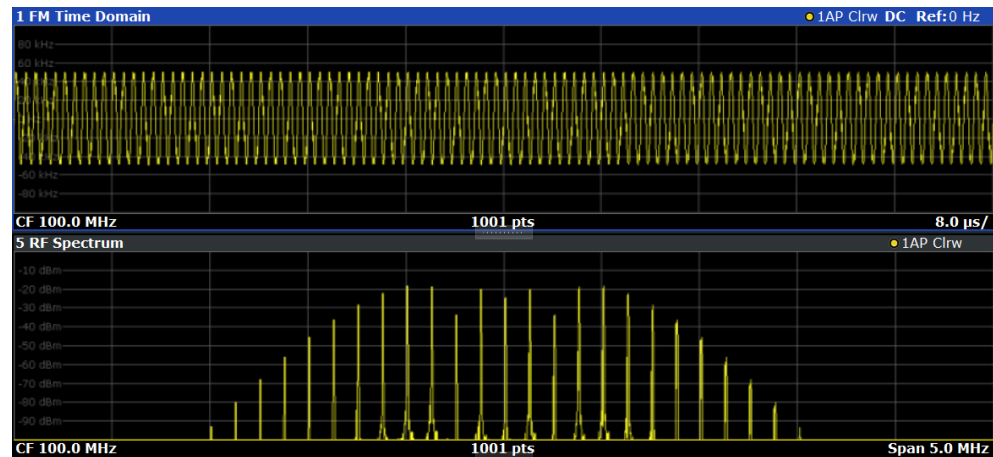

Figure 9-6: RF spectrum with demodulation bandwidth = 400 kHz

11. Once the correct DBW has been determined, you can replace the RF spectrum by the FM spectrum result display to analyze the spectrum of the FM signal. Select "Display Config" and move an "FM Spectrum" window over the "RF Spectrum" window in the display.

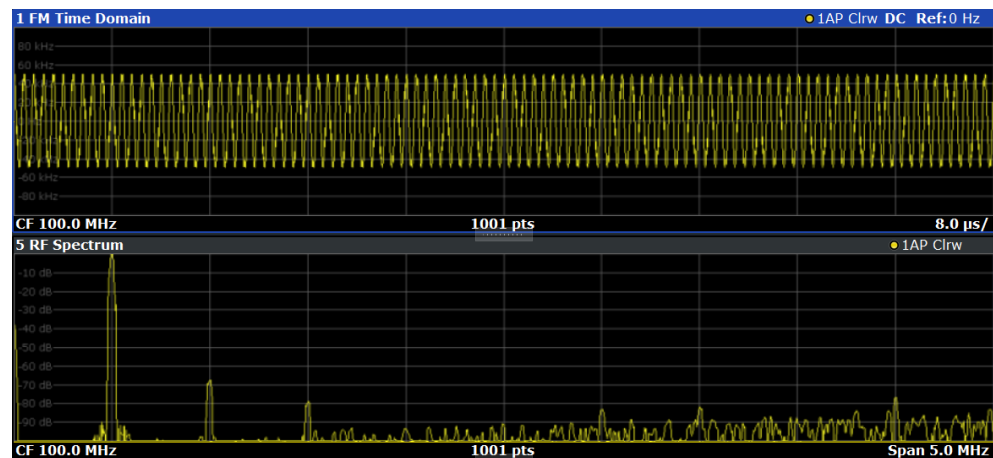
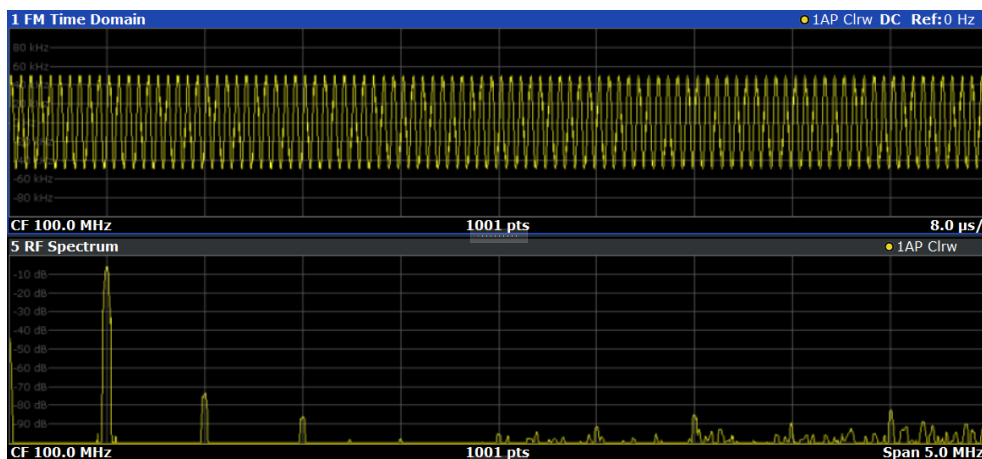

Figure 9-7: FM spectrum and Result Summary including SINAD and THD values

From the FM spectrum, the SINAD and THD are also calculated and displayed in the "Result Summary".

12. Since the "AF Auto Scale" function is enabled, the "FM Spectrum" diagram is scaled according to the current measurement automatically. Each diagram is scaled individually, so that the reference values at the top of the two diagrams can differ (100 kHz in the "FM Time Domain" versus 50 kHz in the "FM Spectrum"). However, you can adjust the values manually.
 - a) Select the "FM Spectrum" window to set the focus in it.
 - b) Press [AMPT].

- c) Select "Scale Config".
- d) Disable the "AF Auto Scale" function.
- e) Define the new reference value (at 100% = top of the diagram) as *100 kHz*.



Note that while the reference values at the top of both y-axes are now identical, the reference values indicated in the window title bars are not. This is due to the fact that, by default, in AF time domain displays the reference value is defined at the reference position 50 % (=center of diagram), while in AF frequency domains it is defined at the position 100 % (= top of diagram).

10 Optimizing and troubleshooting the measurement

If the results do not meet your expectations, consider the following notes and tips to optimize the measurement.

Determining the demodulation bandwidth

A frequent cause for measurement errors and false results is an **incorrectly defined demodulation bandwidth (DBW)**.

If the DBW is too large, the actual signal takes up only a small part of the demodulated range. That means that any noise or additional signal parts can be included in the measured results, which are then false.

On the other hand, if the DBW is too small, part of the signal is cut off and thus not included in the calculation of the results.

An easy way to determine the required DBW is to display the RF spectrum of the input signal. If the entire signal is displayed there and takes up most of the diagram width, the DBW is probably appropriate.

For further recommendations on finding the correct demodulation bandwidth, see [Chapter 4.2, "Demodulation bandwidth"](#), on page 28.

Adjusting the displayed span

Be aware that the span of the "RF Spectrum" display is not automatically increased for a wider DBW. Sometimes, it can be useful to display only a small range from the demodulated bandwidth. Thus, if the RF spectrum does not show the entire demodulated bandwidth, you must increase the span manually to show the entire signal.

Determining the SINAD and THD

The signal-to-noise-and-distortion ratio (SINAD) and the total harmonic distortion (THD) of the demodulated signal are a good indicator of the signal quality sent by the DUT. Both values are calculated inside the AF spectrum span and thus only if an AF spectrum window is displayed. If either value deviates strongly from the expected result, make sure that the demodulation bandwidth is defined correctly (see [Determining the demodulation bandwidth](#)).

11 Remote commands for AM/FM/PM Modulation Analysis

The commands required to perform measurements in the R&S FPL1-K7 AM/FM/PM Modulation Analysis application in a remote environment are described here.

It is assumed that the R&S FPL1000 has already been set up for remote control in a network as described in the R&S FPL1000 User Manual.



A programming example at the end of the remote commands description demonstrates the most important commands in a typical application scenario, see [Chapter 11.11, "Programming example"](#), on page 276.



Note that basic tasks that are also performed in the base unit in the same way are not described here. For a description of such tasks, see the R&S FPL1000 User Manual.

In particular:

- Basic instrument configuration, e.g. checking the system configuration, customizing the screen layout, or configuring networks and remote operation
- Using the common status registers



Status registers

The R&S FPL1-K7 option uses the status registers of the base unit (except for the `STATus:QUEStionable:ACPLimit` register).

For a description, see the R&S FPL1000 User Manual.

General R&S FPL1000 Remote Commands

The application-independent remote commands for general tasks on the R&S FPL1000 are also available for AM/FM/PM Modulation Analysis and are described in the R&S FPL1000 User Manual. In particular:

- Managing settings and results
- Setting up the instrument
- Using the status register

Channel setup-specific commands

Apart from a few general commands on the R&S FPL1000, most commands refer to the currently active channel setup. Thus, always remember to activate an Analog Modulation Analysis channel setup before starting a remote program for an Analog Modulation Analysis.

- [Introduction](#)..... 119
- [Common suffixes](#)..... 124
- [Activating analog modulation analysis](#)..... 124
- [Configuring the measurement](#)..... 127

• Capturing data and performing sweeps.....	175
• Configuring the result display.....	179
• Retrieving results.....	187
• Analyzing results.....	199
• Importing and exporting I/Q data and results.....	273
• Deprecated commands.....	275
• Programming example.....	276

11.1 Introduction

Commands are program messages that a controller (e.g. a PC) sends to the instrument or software. They operate its functions ('setting commands' or 'events') and request information ('query commands'). Some commands can only be used in one way, others work in two ways (setting and query). If not indicated otherwise, the commands can be used for settings and queries.

The syntax of a SCPI command consists of a header and, usually, one or more parameters. To use a command as a query, you have to append a question mark after the last header element, even if the command contains a parameter.

A header contains one or more keywords, separated by a colon. Header and parameters are separated by a "white space" (ASCII code 0 to 9, 11 to 32 decimal, e.g. blank). If there is more than one parameter for a command, they are separated by a comma from one another.

Only the most important characteristics that you need to know when working with SCPI commands are described here. For a more complete description, refer to the user manual of the R&S FPL1000.



Remote command examples

Note that some remote command examples mentioned in this general introduction are possibly not supported by this particular application.

11.1.1 Conventions used in descriptions

The following conventions are used in the remote command descriptions:

- **Command usage**
If not specified otherwise, commands can be used both for setting and for querying parameters.
If a command can be used for setting or querying only, or if it initiates an event, the usage is stated explicitly.
- **Parameter usage**
If not specified otherwise, a parameter can be used to set a value and it is the result of a query.
Parameters required only for setting are indicated as **Setting parameters**.
Parameters required only to refine a query are indicated as **Query parameters**.

Parameters that are only returned as the result of a query are indicated as **Return values**.

- **Conformity**

Commands that are taken from the SCPI standard are indicated as **SCPI confirmed**. All commands used by the R&S FPL1000 follow the SCPI syntax rules.

- **Asynchronous commands**

A command which does not automatically finish executing before the next command starts executing (overlapping command) is indicated as an **Asynchronous command**.

- **Reset values (*RST)**

Default parameter values that are used directly after resetting the instrument (*RST command) are indicated as ***RST** values, if available.

- **Default unit**

The default unit is used for numeric values if no other unit is provided with the parameter.

- **Manual operation**

If the result of a remote command can also be achieved in manual operation, a link to the description is inserted.

11.1.2 Long and short form

The keywords have a long and a short form. You can use either the long or the short form, but no other abbreviations of the keywords.

The short form is emphasized in uppercase letters. Note however, that this emphasis only serves the purpose to distinguish the short from the long form in the manual. For the instrument, the case does not matter.

Example:

`SENSe:FREQuency:CENTer` is the same as `SENS:FREQ:CENT`.

11.1.3 Numeric suffixes

Some keywords have a numeric suffix if the command can be applied to multiple instances of an object. In that case, the suffix selects a particular instance (e.g. a measurement window).

Numeric suffixes are indicated by angular brackets (<n>) next to the keyword.

If you do not quote a suffix for keywords that support one, a 1 is assumed.

Example:

`DISPlay[:WINDow<1...4>]:ZOOM:STATe` enables the zoom in a particular measurement window, selected by the suffix at `WINDow`.

`DISPlay:WINDow4:ZOOM:STATe ON` refers to window 4.

11.1.4 Optional keywords

Some keywords are optional and are only part of the syntax because of SCPI compliance. You can include them in the header or not.



If an optional keyword has a numeric suffix and you need to use the suffix, you have to include the optional keyword. Otherwise, the suffix of the missing keyword is assumed to be the value 1.

Optional keywords are emphasized with square brackets.

Example:

Without a numeric suffix in the optional keyword:

```
[SENSe:]FREQuency:CENTer is the same as FREQuency:CENTer
```

With a numeric suffix in the optional keyword:

```
DISPlay[:WINDow<1...4>]:ZOOM:STATe
```

DISPlay:ZOOM:STATe ON enables the zoom in window 1 (no suffix).

DISPlay:WINDow4:ZOOM:STATe ON enables the zoom in window 4.

11.1.5 Alternative keywords

A vertical stroke indicates alternatives for a specific keyword. You can use both keywords to the same effect.

Example:

```
[SENSe:]BANDwidth|BWIDth[:RESolution]
```

In the short form without optional keywords, BAND 1MHZ would have the same effect as BWID 1MHZ.

11.1.6 SCPI parameters

Many commands feature one or more parameters.

If a command supports more than one parameter, they are separated by a comma.

Example:

```
LAYout:ADD:WINDow Spectrum,LEFT,MTABLE
```

Parameters can have different forms of values.

- [Numeric values](#)..... 122
- [Boolean](#)..... 122
- [Character data](#)..... 123
- [Character strings](#)..... 123
- [Block data](#)..... 123

11.1.6.1 Numeric values

Numeric values can be entered in any form, i.e. with sign, decimal point or exponent. For physical quantities, you can also add the unit. If the unit is missing, the command uses the basic unit.

Example:

With unit: `SENSe:FREQuency:CENTer 1GHZ`

Without unit: `SENSe:FREQuency:CENTer 1E9` would also set a frequency of 1 GHz.

Values exceeding the resolution of the instrument are rounded up or down.

If the number you have entered is not supported (e.g. for discrete steps), the command returns an error.

Instead of a number, you can also set numeric values with a text parameter in special cases.

- **MIN/MAX**
Defines the minimum or maximum numeric value that is supported.
- **DEF**
Defines the default value.
- **UP/DOWN**
Increases or decreases the numeric value by one step. The step size depends on the setting. Sometimes, you can customize the step size with a corresponding command.

Querying numeric values

When you query numeric values, the system returns a number. For physical quantities, it applies the basic unit (e.g. Hz for frequencies). The number of digits after the decimal point depends on the type of numeric value.

Example:

Setting: `SENSe:FREQuency:CENTer 1GHZ`

Query: `SENSe:FREQuency:CENTer?` would return `1E9`

Sometimes, numeric values are returned as text.

- **INF/NINF**
Infinity or negative infinity. Represents the numeric values 9.9E37 or -9.9E37.
- **NAN**
Not a number. Represents the numeric value 9.91E37. NAN is returned if errors occur.

11.1.6.2 Boolean

Boolean parameters represent two states. The "on" state (logically true) is represented by "ON" or the numeric value 1. The "off" state (logically untrue) is represented by "OFF" or the numeric value 0.

Querying Boolean parameters

When you query Boolean parameters, the system returns either the value 1 ("ON") or the value 0 ("OFF").

Example:

Setting: `DISPlay:WINDow:ZOOM:STATe ON`

Query: `DISPlay:WINDow:ZOOM:STATe?` would return 1

11.1.6.3 Character data

Character data follows the syntactic rules of keywords. You can enter text using a short or a long form. For more information, see [Chapter 11.1.2, "Long and short form"](#), on page 120.

Querying text parameters

When you query text parameters, the system returns its short form.

Example:

Setting: `SENSe:BANDwidth:RESolution:TYPE NORMal`

Query: `SENSe:BANDwidth:RESolution:TYPE?` would return NORM

11.1.6.4 Character strings

Strings are alphanumeric characters. They have to be in straight quotation marks. You can use a single quotation mark (') or a double quotation mark (").

Example:

`INSTRument:DELeTe 'Spectrum'`

11.1.6.5 Block data

Block data is a format which is suitable for the transmission of large amounts of data.

The ASCII character # introduces the data block. The next number indicates how many of the following digits describe the length of the data block. The data bytes follow. During the transmission of these data bytes, all end or other control signs are ignored until all bytes are transmitted. #0 specifies a data block of indefinite length. The use of the indefinite format requires an `NL^END` message to terminate the data block. This format is useful when the length of the transmission is not known or if speed or other considerations prevent segmentation of the data into blocks of definite length.

11.2 Common suffixes

In the R&S FPL1-K7 AM/FM/PM Modulation Analysis application, the following common suffixes are used in remote commands:

Table 11-1: Common suffixes used in remote commands in the R&S FPL1-K7 AM/FM/PM Modulation Analysis application

Suffix	Value range	Description
<m>	1 to 16	Marker
<n>	1 to 6	Window (in the currently selected channel setup)
<t>	1 to 6	Trace
	1 to 8	Limit line

11.3 Activating analog modulation analysis

Analog Modulation Analysis require a special application on the R&S FPL1000. The measurement is started immediately with the default settings.

INSTrument:CREate:DUPLicate	124
INSTrument:CREate[:NEW]	125
INSTrument:CREate:REPLace	125
INSTrument:DELeTe	125
INSTrument:LIST?	126
INSTrument:REName	126
INSTrument[:SELeCt]	127
SYSTem:PRESet:CHANnel[:EXEC]	127

INSTrument:CREate:DUPLicate

This command duplicates the currently selected channel setup, i.e creates a new channel setup of the same type and with the identical measurement settings. The name of the new channel setup is the same as the copied channel setup, extended by a consecutive number (e.g. "IQAnalyzer" -> "IQAnalyzer 2").

The channel setup to be duplicated must be selected first using the `INST:SEL` command.

Example:

```
INST:SEL 'IQAnalyzer'
```

```
INST:CRE:DUPL
```

Duplicates the channel setup named 'IQAnalyzer' and creates a new channel setup named 'IQAnalyzer2'.

Usage: Event

INSTRument:CREate[:NEW] <ChannelType>, <ChannelName>

This command adds a measurement channel. You can configure up to 10 measurement channels at the same time (depending on available memory).

Parameters:

- <ChannelType> Channel type of the new channel.
For a list of available channel types, see [INSTRument:LIST?](#) on page 126.
- <ChannelName> String containing the name of the channel.
Note that you cannot assign an existing channel name to a new channel. If you do, an error occurs.

Example: `INST:CRE SAN, 'Spectrum 2'`
Adds a spectrum display named "Spectrum 2".

INSTRument:CREate:REPLace <ChannelName1>,<ChannelType>,<ChannelName2>

This command replaces a channel setup with another one.

Setting parameters:

- <ChannelName1> String containing the name of the channel setup you want to replace.
- <ChannelType> Channel type of the new channel setup.
For a list of available channel setup types, see [INSTRument:LIST?](#) on page 126.
- <ChannelName2> String containing the name of the new channel setup.
Note: If the specified name for a new channel setup already exists, the default name, extended by a sequential number, is used for the new channel setup (see [INSTRument:LIST?](#) on page 126).
Channel names can have a maximum of 31 characters, and must be compatible with the Windows conventions for file names. In particular, they must not contain special characters such as ":", "*", "?".

Example: `INST:CRE:REPL 'IQAnalyzer2',IQ,'IQAnalyzer'`
Replaces the channel setup named "IQAnalyzer2" by a new channel setup of type "IQ Analyzer" named "IQAnalyzer".

Usage: Setting only

INSTRument:DELeTe <ChannelName>

This command deletes a channel setup.

Setting parameters:

- <ChannelName> String containing the name of the channel setup you want to delete.
A channel setup must exist to delete it.

Usage: Setting only

INSTrument:LIST?

This command queries all active channel setups. The query is useful to obtain the names of the existing channel setups, which are required to replace or delete the channel setups.

Return values:

<ChannelType>, For each channel setup, the command returns the channel setup type and channel setup name (see tables below).
<ChannelName>

Tip: to change the channel setup name, use the [INSTrument:REName](#) command.

Example:

```
INST:LIST?
```

Result for 3 channel setups:

```
'ADEM', 'Analog Demod', 'IQ', 'IQ Analyzer', 'IQ', 'IQ Analyzer2'
```

Usage: Query only

Table 11-2: Available channel setup types and default channel setup names

Application	<ChannelType> Parameter	Default Channel setup Name*)
Spectrum	SANALYZER	Spectrum
AM/FM/PM Modulation Analysis	ADEM	Analog Demod
I/Q Analyzer	IQ	IQ Analyzer
Noise Figure Measurements	NOISE	Noise
Vector Signal Analysis (VSA)	DDEM	VSA

Note: the default channel setup name is also listed in the table. If the specified name for a new channel setup already exists, the default name, extended by a sequential number, is used for the new channel setup.

INSTrument:REName <ChannelName1>, <ChannelName2>

This command renames a channel setup.

Setting parameters:

<ChannelName1> String containing the name of the channel setup you want to rename.

<ChannelName2> String containing the new channel setup name.
Note that you cannot assign an existing channel setup name to a new channel setup. If you do, an error occurs.
Channel names can have a maximum of 31 characters, and must be compatible with the Windows conventions for file names. In particular, they must not contain special characters such as ":", "*", "?".

Example: `INST:REN 'IQAnalyzer2','IQAnalyzer3'`
 Renames the channel setup with the name 'IQAnalyzer2' to 'IQAnalyzer3'.

Usage: Setting only

INSTrument[:SElect] <ChannelType>

Selects the channel type for the current channel.

See also `INSTrument:CREate[:NEW]` on page 125.

For a list of available channel types, see `INSTrument:LIST?` on page 126.

Parameters:

<ChannelType> **ADEMod**
 Optional Analog Modulation Analysis application.

SYSTem:PRESet:CHANnel[:EXEC]

This command restores the default instrument settings in the current channel setup.

Use `INST:SEL` to select the channel setup.

Example: `INST:SEL 'Spectrum2'`
 Selects the channel setup for "Spectrum2".
`SYST:PRESet:CHAN:EXEC`
 Restores the factory default settings to the "Spectrum2"channel setup.

Usage: Event

Manual operation: See "Preset Channel setup" on page 35

11.4 Configuring the measurement

The following remote commands are required to configure an Analog Modulation Analysis.

Specific commands:

- [Managing standard settings](#)..... 128
- [Configuring the input](#)..... 129
- [Configuring the output](#)..... 133
- [Frequency settings](#)..... 134
- [Configuring the vertical axis \(amplitude, scaling\)](#)..... 136
- [Configuring data acquisition](#)..... 142
- [Triggering](#)..... 146
- [Configuring demodulation](#)..... 151
- [Adjusting settings automatically](#)..... 171

11.4.1 Managing standard settings

You can configure the R&S FPL1-K7 AM/FM/PM Modulation Analysis application using predefined standard settings, allowing for quick and easy configuration for commonly performed measurements.

For details, see [Chapter 5.2, "Configuration according to standards"](#), on page 35.

For an overview of predefined standards and settings, see [Chapter A, "Predefined standards and settings"](#), on page 278.

[SENSe:]ADEMod:PRESet[:STANdard].....	128
[SENSe:]ADEMod:PRESet:RESTore.....	128
[SENSe:]ADEMod:PRESet:STORe.....	128

[SENSe:]ADEMod:PRESet[:STANdard] <Standard>

This command loads a measurement configuration.

Standard definitions are stored in an xml file. The default directory for Analog Modulation Analysis standards is C :

```
\Users\Public\Documents\Rohde-Schwarz\Analyzer\user\predefined\AdemodPredef
.
```

Parameters:

<Standard> String containing the file name.
If you have stored the file in a subdirectory of the directory mentioned above, you have to include the relative path to the file.

Manual operation: See "[Load Standard](#)" on page 37

[SENSe:]ADEMod:PRESet:RESTore

Manual operation: See "[Restore Standard Files](#)" on page 37

[SENSe:]ADEMod:PRESet:STORe <Standard>

This command saves the current Analog Modulation Analysis measurement configuration.

Standard definitions are stored in an XML file. The default directory for Analog Modulation Analysis standards is C :

```
\Users\Public\Documents\Rohde-Schwarz\Analyzer\user\predefined\AdemodPredef
.
```

Parameters:

<Standard> String containing the file name.
You can save the file in a subdirectory of the directory mentioned above. In that case, you have to include the relative path to the file.

Manual operation: See "[Save Standard](#)" on page 37

11.4.2 Configuring the input

- RF input..... 129
- Configuring file input..... 131
- Independant CW source commands..... 131

11.4.2.1 RF input

INPut:ATTenuation:PROTection:RESet.....	129
INPut<ip>:FILTer:SAW.....	129
INPut<ip>:FILTer:YIG[:STATe].....	129
INPut<ip>:IMPedance.....	130
INPut<ip>:SELect.....	130

INPut:ATTenuation:PROTection:RESet

This command resets the attenuator and reconnects the RF input with the input mixer for the R&S FPL1000 after an overload condition occurred and the protection mechanism intervened. The error status bit (bit 3 in the `STAT:QUES:POW` status register) and the `INPUT OVL` message in the status bar are cleared.

(For details on the status register see the R&S FPL1000 base unit user manual).

The command works only if the overload condition has been eliminated first.

Example: `INP:ATT:PROT:RES`

INPut<ip>:FILTer:SAW <State>

Determines which IF path the R&S FPL1000 hardware uses.

Suffix:

<ip> 1 | 2
 irrelevant

Parameters:

<State> AUTO | OFF

AUTO

The R&S FPL1000 determines which IF path to use automatically, depending on the used analysis bandwidth.

OFF

The wide IF path is always used.

*RST: I/Q Analyzer: AUTO; VSA: OFF

Example: `INP:FILT:SAW AUTO`

Manual operation: See "[SAW filter](#)" on page 39

INPut<ip>:FILTer:YIG[:STATe] <State>

Enables or disables the YIG filter.

Suffix:

<ip> 1 | 2
irrelevant

Parameters:

<State> ON | OFF | 0 | 1

Example:

INP:FILT:YIG OFF
Deactivates the YIG-preselector.

Manual operation: See "[YIG-Preselector](#)" on page 39

INPut<ip>:IMPedance <Impedance>

This command selects the nominal input impedance of the RF input. In some applications, only 50 Ω are supported.

Suffix:

<ip> 1 | 2
irrelevant

Parameters:

<Impedance> 50 | 75
*RST: 50 Ω
Default unit: OHM

Example:

INP:IMP 75

Manual operation: See "[Impedance](#)" on page 38
See "[Unit](#)" on page 42

INPut<ip>:SElect <Source>

This command selects the signal source for measurements, i.e. it defines which connector is used to input data to the R&S FPL1000.

If no additional input options are installed, only RF input is supported.

Tip: The I/Q data to be analyzed for AM/FM/PM Modulation Analysis cannot only be measured by the R&S FPL1-K7 AM/FM/PM Modulation Analysis application itself, it can also be imported to the application, provided it has the correct format. Furthermore, the analyzed I/Q data from the R&S FPL1-K7 AM/FM/PM Modulation Analysis application can be exported for further analysis in external applications.

For details, see the R&S FPL1000 I/Q Analyzer and I/Q Input User Manual.

Suffix:

<ip> 1 | 2
irrelevant

Parameters:

<Source> **RF**
Radio Frequency ("RF INPUT" connector)
*RST: RF

Manual operation: See "Radio Frequency State" on page 38
See "I/Q Input File State" on page 40

11.4.2.2 Configuring file input

The following commands are required to define input from a file.

Useful commands for configuring file input described elsewhere:

- `INPut<ip>:SElect` on page 130

Remote commands exclusive to configuring input from files:

`INPut<ip>:FILE:PATH.....` 131

INPut<ip>:FILE:PATH <FileName>[, <AnalysisBW>]

This command selects the I/Q data file to be used as input for further measurements.

The I/Q data must have a specific format as described in R&S FPL1000 I/Q Analyzer and I/Q Input User Manual.

Suffix:

<ip>	1 2
	irrelevant

Parameters:

<FileName>	String containing the path and name of the source file. The file extension is *.iq.tar.
<AnalysisBW>	Optionally: The analysis bandwidth to be used by the measurement. The bandwidth must be smaller than or equal to the bandwidth of the data that was stored in the file. Default unit: HZ

Example: `INP:FILE:PATH 'C:\R_S\Instr\user\data.iq.tar'`
Uses I/Q data from the specified file as input.

Manual operation: See "Select I/Q data file" on page 40

11.4.2.3 Independant CW source commands

The following commands are required to configure an internal generator as an independant CW source.

<code>OUTPut<up>[:STATe].....</code>	131
<code>SOURce<si>:INTernal:FREQuency.....</code>	132
<code>SOURce<si>:POWer[:LEVel][:IMMediate][:AMPLitude].....</code>	132
<code>SOURce<si>:POWer[:LEVel][:IMMediate]:OFFSet.....</code>	132

OUTPut<up>[:STATe] <State>

Enables or disables the internal generator. The generator signal is output at the GEN Output 50 Ω connector on the front panel.

Suffix:

<up>

Parameters:

<State>

ON | OFF | 0 | 1

OFF | 0

Switches the function off

ON | 1

Switches the function on

*RST: 0

Example:

OUTP ON

SOURce<si>:INTernal:FREQuency <Frequency>

Defines the frequency of the internal generator signal.

Suffix:

<si>

irrelevant

Parameters:

<Frequency>

Range: 5 kHz to 3 GHz

Increment: 0.1 Hz

*RST: 1 GHz

Default unit: HZ

Example:

SOUR:INT:FREQ 2 GHz

SOURce<si>:POWer[:LEVel][:IMMEDIATE][:AMPLitude] <Amplitude>

Defines the output power of the internal generator.

Suffix:

<si>

irrelevant

Parameters:

<Amplitude>

Range: -60 dBm to +10 dBm

Increment: 0.1 dB

*RST: -20 dBm

Default unit: DBM

Example:

SOUR:POW -30dBm

SOURce<si>:POWer[:LEVel][:IMMEDIATE]:OFFSet <Offset>

This command defines a level offset for the internal generator level. Thus, for example, attenuators or amplifiers at the output of the internal generator can be considered for the setting.

Suffix:

<si>

irrelevant

Parameters:

<Offset> Range: -200 dB to +200 dB
 *RST: 0dB
 Default unit: DB

Example: SOUR:POW:OFFS -10dB

11.4.3 Configuring the output

The following commands configure signal output.

DIAGnostic:SERVice:NSource	133
SYSTem:SPEaker[:STATe]	133
SYSTem:SPEaker:VOLume	134

DIAGnostic:SERVice:NSource <State>

This command turns the 28 V supply of the BNC connector labeled [noise source control] on the R&S FPL1000 on and off.

Parameters:

<State> ON | OFF | 0 | 1
 OFF | 0
 Switches the function off
 ON | 1
 Switches the function on

Example: DIAG:SERV:NSO ON

Manual operation: See "[Noise Source Control](#)" on page 73

SYSTem:SPEaker[:STATe] <State>

This command switches the built-in loudspeaker on or off for demodulated signals. This setting applies only to the current application.

The command is available in the time domain in Spectrum mode and in Analog Modulation Analysis mode.

To set the volume, use the [SYSTem:SPEaker:VOLume](#) command.

Parameters:

<State> ON | OFF | 0 | 1
 OFF | 0
 Switches the function off
 ON | 1
 Switches the function on

Example: SYST:SPE ON
 SYST:SPE:VOL 0.5
 Sets the loudspeaker to half the full volume.

SYSTem:SPEaker:VOLume <Volume>

This command defines the volume of the built-in loudspeaker for demodulated signals. This setting is maintained for all applications.

The command is available in the time domain in Spectrum mode and in Analog Modulation Analysis mode.

Note that you must switch the loudspeaker on first, using the [SYSTem:SPEaker \[: STATE\]](#) command.

Parameters:

<Volume> Percentage of the maximum possible volume.
 Range: 0 to 1
 *RST: 0.5

Example:

```
SYST:SPE:VOL 0
```

Switches the loudspeaker to mute.

11.4.4 Frequency settings

[SENSe:]FREQuency:CENTer	134
[SENSe:]FREQuency:CENTer:STEP	134
[SENSe:]FREQuency:CENTer:STEP:LINK	135
[SENSe:]FREQuency:CENTer:STEP:LINK:FACTor	135

[SENSe:]FREQuency:CENTer <Frequency>

This command defines the center frequency.

Parameters:

<Frequency> The allowed range and f_{max} is specified in the data sheet.
 *RST: $f_{max}/2$
 Default unit: Hz

Example:

```
FREQ:CENT 100 MHz
FREQ:CENT:STEP 10 MHz
FREQ:CENT UP
```

Sets the center frequency to 110 MHz.

Manual operation: See "[Center Frequency](#)" on page 44

[SENSe:]FREQuency:CENTer:STEP <StepSize>

This command defines the center frequency step size.

You can increase or decrease the center frequency quickly in fixed steps using the [SENS:FREQ UP](#) AND [SENS:FREQ DOWN](#) commands, see [\[SENSe:\]FREQuency:CENTer](#) on page 134.

Parameters:

<StepSize> f_{\max} is specified in the data sheet.
 Range: 1 to fMAX
 *RST: 0.1 x span
 Default unit: Hz

Example:

```
//Set the center frequency to 110 MHz.
FREQ:CENT 100 MHz
FREQ:CENT:STEP 10 MHz
FREQ:CENT UP
```

Manual operation: See "[Center Frequency Stepsize](#)" on page 45

[SENSe:]FREQuency:CENTer:STEP:LINK <CouplingType>

This command couples and decouples the center frequency step size to the span or the resolution bandwidth.

Parameters:

<CouplingType> SPAN | RBW | OFF

SPAN
 Couples the step size to the span. Available for measurements in the frequency domain.
 (for RF spectrum result display)

RBW
 Couples the step size to the resolution bandwidth. Available for measurements in the time domain.
 (for all result displays except RF spectrum)

OFF
 Decouples the step size.
 *RST: SPAN

Example:

```
//Couple step size to span
FREQ:CENT:STEP:LINK SPAN
```

Manual operation: See "[Center Frequency Stepsize](#)" on page 45

[SENSe:]FREQuency:CENTer:STEP:LINK:FACTor <Factor>

This command defines a step size factor if the center frequency step size is coupled to the span or the resolution bandwidth.

Parameters:

<Factor> 1 to 100 PCT
 *RST: 10
 Default unit: PCT

Example:

```
//Couple frequency step size to span and define a step size factor
FREQ:CENT:STEP:LINK SPAN
FREQ:CENT:STEP:LINK:FACT 20PCT
```

Manual operation: See "Center Frequency Stepsize" on page 45

11.4.5 Configuring the vertical axis (amplitude, scaling)

The following commands are required to configure the amplitude and vertical axis settings in a remote environment.

- [Amplitude settings](#)..... 136
- [Configuring the attenuation](#)..... 138
- [Configuring a preamplifier](#)..... 139
- [Scaling the Y-axis](#)..... 139

11.4.5.1 Amplitude settings

Useful commands for amplitude configuration described elsewhere:

- [\[SENSe:\]ADJust:LEVel](#) on page 174

Remote commands exclusive to amplitude configuration:

CALCulate<n>:MARKer<m>:FUNction:REFerence	136
UNIT<n>:POWer	136
CALCulate<n>:UNIT:POWer	136
DISPlay[:WINDow<n>][:SUBWindow<w>]:TRACe<t>:Y[:SCALe]:RLEVel	137
DISPlay[:WINDow<n>][:SUBWindow<w>]:TRACe<t>:Y[:SCALe]:RLEVel:OFFSet	137

CALCulate<n>:MARKer<m>:FUNction:REFerence

This command matches the reference level to the power level of a marker.

If you use the command in combination with a delta marker, that delta marker is turned into a normal marker.

Suffix:

<n> [Window](#)

<m> [Marker](#)

Example:

`CALC:MARK2:FUNC:REF`

Sets the reference level to the level of marker 2.

UNIT<n>:POWer <Unit>

CALCulate<n>:UNIT:POWer <Unit>

This command selects the unit of the y-axis.

The unit applies to all power-based measurement windows with absolute values.

Suffix:

<n> irrelevant

Parameters:

<Unit> DBM | V | A | W | DBPW | WATT | DBUV | DBMV | VOLT |
 DBUA | AMPere
 (Units based on 1 MHz require installed R&S FPL1-K54 (EMI measurements) option.)
 *RST: dBm

Example:

CALC:UNIT:POW DBM
 Sets the power unit to dBm.

Manual operation: See "Unit" on page 42

DISPlay[:WINDow<n>][:SUBWindow<w>]:TRACe<t>:Y[:SCALe]:RLEVel
 <ReferenceLevel>

This command defines the reference level (for all traces in all windows).

With a reference level offset ≠ 0, the value range of the reference level is modified by the offset.

Suffix:

<n> irrelevant
 <w> subwindow
 Not supported by all applications
 <t> irrelevant

Parameters:

<ReferenceLevel> The unit is variable.
 Range: see datasheet
 *RST: 0 dBm
 Default unit: DBM

Example:

DISP:TRAC:Y:RLEV -60dBm

Manual operation: See "Reference Level" on page 41

DISPlay[:WINDow<n>][:SUBWindow<w>]:TRACe<t>:Y[:SCALe]:RLEVel:OFFSet
 <Offset>

This command defines a reference level offset (for all traces in all windows).

Suffix:

<n> irrelevant
 <w> subwindow
 Not supported by all applications
 <t> irrelevant

Parameters:

<Offset> Range: -200 dB to 200 dB
 *RST: 0dB
 Default unit: DB

Example: `DISP:TRAC:Y:RLEV:OFFS -10dB`

Manual operation: See ["Shifting the Display \(Offset\)"](#) on page 42

11.4.5.2 Configuring the attenuation

<code>INPut<ip>:ATTenuation</code>	138
<code>INPut<ip>:EATT:AUTO</code>	138
<code>INPut<ip>:ATTenuation:AUTO</code>	138

`INPut<ip>:ATTenuation <Attenuation>`

This command defines the total attenuation for RF input.

If you set the attenuation manually, it is no longer coupled to the reference level, but the reference level is coupled to the attenuation. Thus, if the current reference level is not compatible with an attenuation that has been set manually, the command also adjusts the reference level.

Suffix:

<ip> 1 | 2
 irrelevant

Parameters:

<Attenuation> Range: see data sheet
 Increment: 5 dB (with optional electr. attenuator: 1 dB)
 *RST: 10 dB (AUTO is set to ON)
 Default unit: DB

Example:

`INP:ATT 30dB`

Defines a 30 dB attenuation and decouples the attenuation from the reference level.

Manual operation: See ["Attenuation Mode / Value"](#) on page 43

`INPut<ip>:EATT:AUTO <State>`

`INPut<ip>:ATTenuation:AUTO <State>`

This command couples or decouples the attenuation to the reference level. Thus, when the reference level is changed, the R&S FPL1000 determines the signal level for optimal internal data processing and sets the required attenuation accordingly.

For the R&S FPL1000, these commands are identical.

Suffix:

<ip> 1 | 2
 irrelevant

Parameters:

<State> ON | OFF | 0 | 1
 *RST: 1

Example:

`INP:ATT:AUTO ON`

Couples the attenuation to the reference level.

Manual operation: See "Attenuation Mode / Value" on page 43

11.4.5.3 Configuring a preamplifier

INPut<ip>:GAIN:STATe..... 139

INPut<ip>:GAIN:STATe <State>

This command turns the internal preamplifier on and off. It requires the optional preamplifier hardware.

If activated, the input signal is amplified by 20 dB. The preamplifier is only active below 3 GHz (R&S FPL1003) or 7.5 GHz (R&S FPL1007).

Suffix:

<ip> 1 | 2
 irrelevant

Parameters:

<State> ON | OFF | 0 | 1
 OFF | 0
 Switches the function off
 ON | 1
 Switches the function on
 *RST: 0

Example: INP:GAIN:STAT ON
 Switches on 20 dB preamplification.

Manual operation: See "Preamplifier" on page 44

11.4.5.4 Scaling the Y-axis

DISPlay[:WINDow<n>][:SUBWindow<w>]:TRACe<t>:Y[:SCALe]..... 139
DISPlay[:WINDow<n>][:SUBWindow<w>]:TRACe<t>:Y[:SCALe]:AUTO ONCE..... 140
DISPlay[:WINDow<n>][:SUBWindow<w>]:TRACe<t>:Y[:SCALe]:MODE..... 140
DISPlay[:WINDow<n>][:SUBWindow<w>]:TRACe<t>:Y[:SCALe]:PDIVision..... 140
DISPlay[:WINDow<n>][:SUBWindow<w>]:TRACe<t>:Y[:SCALe]:RPOSition..... 141
DISPlay[:WINDow<n>][:SUBWindow<w>]:TRACe<t>:Y:SPACing..... 142

DISPlay[:WINDow<n>][:SUBWindow<w>]:TRACe<t>:Y[:SCALe] <Range>

This command defines the display range of the y-axis (for all traces).

Suffix:

<n> Window
<w> subwindow
 Not supported by all applications
<t> irrelevant

Parameters:

<Range>

If the y-axis shows the power, the unit is dB with a range from 10 dB to 200 dB.

If the y-axis shows the frequency, the unit is Hz with a variable range.

*RST: 100 dB (frequency domain), 500 kHz (time domain)

Example:

```
DISP:TRAC:Y 110dB
```

Manual operation: See "[Range](#)" on page 66

DISPlay[:WINDow<n>][:SUBWindow<w>]:TRACe<t>:Y[:SCALe]:AUTO ONCE

Automatic scaling of the y-axis is performed once, then switched off again (for all traces).

Suffix:

<n> [Window](#)

<t> irrelevant

Manual operation: See "[Auto Scale Once](#)" on page 67

DISPlay[:WINDow<n>][:SUBWindow<w>]:TRACe<t>:Y[:SCALe]:MODE <Mode>

This command selects the type of scaling of the y-axis (for all traces).

When the display update during remote control is off, this command has no immediate effect.

Suffix:

<n> [Window](#)

<w> subwindow

<t> irrelevant

Parameters:

<Mode>

ABSolute

absolute scaling of the y-axis

RELative

relative scaling of the y-axis

*RST: ABSolute

Example:

```
DISP:TRAC:Y:MODE REL
```

Manual operation: See "[Scaling](#)" on page 67

**DISPlay[:WINDow<n>][:SUBWindow<w>]:TRACe<t>:Y[:SCALe]:PDIVision
<Value>**

This remote command determines the grid spacing on the Y-axis for all diagrams, where possible.

In spectrum displays, for example, this command is not available.

Suffix:

<n>	Window
<w>	subwindow Not supported by all applications
<t>	irrelevant

Parameters:

<Value>	numeric value WITHOUT UNIT (unit according to the result display) Defines the range per division (total range = 10* <Value>) *RST: depends on the result display Default unit: DBM
---------	--

Example:

```
DISP:TRAC:Y:PDIV 10
```

Sets the grid spacing to 10 units (e.g. dB) per division

Manual operation: See "[Dev per Division/ dB per Division](#)" on page 64

DISPlay[:WINDow<n>][:SUBWindow<w>]:TRACe<t>:Y[:SCALe]:RPOSition
<Position>

This command defines the vertical position of the reference level on the display grid (for all traces).

The R&S FPL1000 adjusts the scaling of the y-axis accordingly.

For measurements with the optional tracking generator, the command defines the position of the reference line.

Suffix:

<n>	Window
<w>	subwindow Not supported by all applications
<t>	irrelevant

Parameters:

<Position>	0 PCT corresponds to the lower display border, 100 percent corresponds to the upper display border. *RST: frequency display: 90 PCT; time display: 50 PCT; AF spectrum display (K7): 100 PCT; Default unit: PCT
------------	--

Example:

```
DISP:TRAC:Y:RPOS 50PCT
```

Manual operation: See "[Reference Value Position](#)" on page 64
See "[Ref Level Position](#)" on page 67

DISPlay[:WINDow<n>][:SUBWindow<w>]:TRACe<t>:Y:SPACing <ScalingType>

This command selects the scaling of the y-axis (for all traces, <t> is irrelevant).

For AF spectrum displays, only the parameters "LINear" and "LOGarithmic" are permitted.

Suffix:

<n>	Window
<w>	subwindow
<t>	Trace

Parameters:

<ScalingType>	LOGarithmic Logarithmic scaling.
	LINear Linear scaling in %.
	LDB Linear scaling in the specified unit.
	PERCent Linear scaling in %.
*RST:	LOGarithmic

Example:

DISP:TRAC:Y:SPAC LIN
Selects linear scaling in %.

Manual operation: See "Deviation" on page 66
See "Scaling" on page 67

11.4.6 Configuring data acquisition

The following remote commands are required to configure which data is to be acquired and then demodulated in a remote environment.

[SENSe:]ADEMod:MTIME.....	143
[SENSe:]ADEMod:RLENgth.....	143
[SENSe:]ADEMod:SET.....	143
[SENSe:]ADEMod<n>:SPECtrum:BANDwidth[:RESolution].....	144
[SENSe:]ADEMod:SPECtrum:BWIDth[:RESolution].....	144
[SENSe:]ADEMod:SRATE.....	144
[SENSe:]BANDwidth:DEMod.....	144
[SENSe:]BWIDth:DEMod.....	144
[SENSe:]BANDwidth:DEMod:TYPE.....	145
[SENSe:]BWIDth:DEMod:TYPE.....	145
[SENSe:]BANDwidth[:RESolution].....	145
[SENSe:]SWEep:COUNT.....	145
[SENSe:]SWEep[:WINDow<n>]:POINts.....	146

[SENSe:]ADEMod:MTIME <Time>

This command defines the measurement time for Analog Modulation Analysis.

Parameters:

<Time> *RST: 62.5us
Default unit: S

Example: ADEM:MTIM 62.5us
Sets the measurement time to 62.5 μs.

Manual operation: See "Measurement Time (AQT)" on page 50

[SENSe:]ADEMod:RLENGth**[SENSe:]ADEMod:SET <SampleRate>, <RecordLength>, <TriggerSource>, <TriggerSlope>, <OffsetSamples>, <NoOfMeas>**

This command configures the analog demodulator of the instrument.

Parameters:

<SampleRate>	<p>numeric value The frequency at which measurement values are taken from the A/D-converter and stored in I/Q memory. *RST: 8 MHz Default unit: HZ</p>
<RecordLength>	<p>Number of samples to be stored in I/Q memory. Range: 1 to 400001 with AF filter or AF trigger active, 1 to 480001 with both AF filter and AF trigger deactive *RST: 501)</p>
<TriggerSource>	<p>Note: After selecting IF Power, the trigger threshold can be set with the <code>TRIGger[:SEQuence]:LEVel:IFPower</code> command. *RST: IMMEDIATE</p>
<TriggerSlope>	<p>POSitive NEGative Used slope of the trigger signal. The value indicated here will be ignored for <trigger source> = IMMEDIATE. *RST: POSitive</p>
<OffsetSamples>	<p>Number of samples to be used as an offset to the trigger signal. The value indicated here is ignored for <trigger source> = "IMMEDIATE". *RST: 0</p>

<NoOfMeas> Number of repetitions of the measurement to be executed. The value indicated here is especially necessary for the average/maxhold/minhold function.

Range: 0 to 32767

*RST: 0

Example:

ADEM:SET 8MHz,32000,EXT,POS,-500,30

Performs a measurement at:

sample rate = 8 MHz

record length = 32000

trigger source = EXTERNAL

trigger slope = POSITIVE

offset samples = -500 (500 samples before trigger occurred)

of meas = 30

[SENSe:]ADEMod<n>:SPECtrum:BANDwidth[:RESolution] <Bandwidth>

[SENSe:]ADEMod:SPECtrum:BWIDth[:RESolution] <Bandwidth>

Defines the resolution bandwidth for data acquisition.

From the specified RBW and the demodulation span set by [SENSe:]ADEMod:SPECtrum:SPAN[:MAXimum] on page 159 or [SENSe:]BWIDth:DEMod on page 144, the required measurement time is calculated. If the available measurement time is not sufficient for the given bandwidth, the measurement time is set to its maximum and the resolution bandwidth is increased to the resulting bandwidth.

This command is identical to SENS:BAND:RES, see the R&S FPL1000 User Manual.

Parameters:

<Bandwidth> refer to data sheet

*RST: 61.2 kHz

Default unit: HZ

Example:

ADEM:SPEC:BAND 61.2kHz

Sets the resolution bandwidth to 61.2 kHz.

[SENSe:]ADEMod:SRATe

[SENSe:]BANDwidth:DEMod <Bandwidth>

[SENSe:]BWIDth:DEMod <Bandwidth>

This command sets the bandwidth for Analog Modulation Analysis. Depending on the selected demodulation bandwidth, the instrument selects the required sample rate.

This command is identical to SENS:ADEM:BAND:DEM.

Parameters:

<Bandwidth> *RST: 5 MHz

Default unit: HZ

Example:

BAND:DEM 1MHz

Sets demodulation bandwidth to 1 MHz

Manual operation: See "[Demodulation Bandwidth](#)" on page 49

[SENSe:]BANDwidth:DEMod:TYPE <FilterType>

[SENSe:]BWIDth:DEMod:TYPE <FilterType>

This command defines the type of demodulation filter to be used.

This command is identical to `SENS:ADEM:BAND:DEM:TYPE:`

Parameters:

<FilterType>

FLAT

Standard flat demodulation filter

GAUSS

Gaussian filter for optimized settling behavior

*RST: FLAT

Manual operation: See "[Demodulation Filter](#)" on page 49

[SENSe:]BANDwidth[:RESolution] <Bandwidth>

This command defines the resolution bandwidth and decouples the resolution bandwidth from the span.

For statistics measurements, this command defines the **demodulation** bandwidth.

Parameters:

<Bandwidth>

refer to data sheet

*RST: RBW: AUTO is set to ON; DBW: 3MHz

Default unit: Hz

Example:

`BAND 1 MHz`

Sets the resolution bandwidth to 1 MHz

Manual operation: See "[Resolution Bandwidth](#)" on page 50

[SENSe:]SWEep:COUNT <SweepCount>

This command defines the number of sweeps that the application uses to average traces.

In continuous sweep mode, the application calculates the moving average over the average count.

In single sweep mode, the application stops the measurement and calculates the average after the average count has been reached.

Parameters:

<SweepCount>

When you set a sweep count of 0 or 1, the R&S FPL1000 performs one single sweep in single sweep mode.

In continuous sweep mode, if the sweep count is set to 0, a moving average over 10 sweeps is performed.

Range: 0 to 200000

*RST: 0

Example: SWE:COUN 64
Sets the number of sweeps to 64.
INIT:CONT OFF
Switches to single sweep mode.
INIT;*WAI
Starts a sweep and waits for its end.

Manual operation: See ["This is Sweep/Average Count ok?"](#) on page 52

[SENSe:]SWEep[:WINDow<n>]:POINts <SweepPoints>

This command defines the number of sweep points to analyze after a sweep.

Suffix:
<n>

Parameters:
<SweepPoints> Range: 101 to 100001
 *RST: 1001

Example: SWE:POIN 251

Manual operation: See ["Sweep Points"](#) on page 52

11.4.7 Triggering

The following remote commands are required to configure a triggered measurement in a remote environment. More details are described for manual operation in [Chapter 5.4, "Trigger configuration"](#), on page 45.



*OPC should be used after requesting data. This will hold off any subsequent changes to the selected trigger source, until after the sweep is completed and the data is returned.

- [Configuring the triggering conditions](#).....146

11.4.7.1 Configuring the triggering conditions

The following commands are required to configure a triggered measurement.

TRIGger[:SEQuence]:DTIME.....	147
TRIGger[:SEQuence]:HOLDoff[:TIME].....	147
TRIGger[:SEQuence]:IFPower:HOLDoff.....	147
TRIGger[:SEQuence]:IFPower:HYSteresis.....	148
TRIGger[:SEQuence]:LEVel[:EXternal<port>].....	148
TRIGger[:SEQuence]:LEVel:IFPower.....	148
TRIGger[:SEQuence]:LEVel:AM:RELative.....	149
TRIGger[:SEQuence]:LEVel:AM[:ABSolute].....	149
TRIGger[:SEQuence]:LEVel:FM.....	149
TRIGger[:SEQuence]:LEVel:PM.....	149

TRIGger[:SEQuence]:SLOPe.....	150
TRIGger[:SEQuence]:SOURce.....	150
TRIGger[:SEQuence]:TIME:RINTerval.....	151

TRIGger[:SEQuence]:DTIME <DropoutTime>

Defines the time the input signal must stay below the trigger level before a trigger is detected again.

Parameters:

<DropoutTime> Dropout time of the trigger.
 Range: 0 s to 10.0 s
 *RST: 0 s
 Default unit: S

Manual operation: See "[Drop-Out Time](#)" on page 48

TRIGger[:SEQuence]:HOLDoff[:TIME] <Offset>

Defines the time offset between the trigger event and the start of the sweep.

Parameters:

<Offset> *RST: 0 s
 Default unit: S

Example: TRIG:HOLD 500us

Manual operation: See "[Trigger Offset](#)" on page 48

TRIGger[:SEQuence]:IFPower:HOLDoff <Period>

This command defines the holding time before the next trigger event.

Note that this command can be used for **any trigger source**, not just IF Power (despite the legacy keyword).

Note: If you perform gated measurements in combination with the IF Power trigger, the R&S FPL1000 ignores the holding time for frequency sweep, FFT sweep, zero span and I/Q data measurements.

Parameters:

<Period> Range: 0 s to 10 s
 *RST: 0 s
 Default unit: S

Example: TRIG:SOUR EXT
 Sets an external trigger source.
 TRIG:IFP:HOLD 200 ns
 Sets the holding time to 200 ns.

Manual operation: See "[Trigger Holdoff](#)" on page 48

TRIGger[:SEQuence]:IFPower:HYSTeresis <Hysteresis>

This command defines the trigger hysteresis, which is only available for "IF Power" trigger sources.

Parameters:

<Hysteresis> Range: 3 dB to 50 dB
 *RST: 3 dB
 Default unit: DB

Example:

TRIG:SOUR IFP
 Sets the IF power trigger source.
 TRIG:IFP:HYST 10DB
 Sets the hysteresis limit value.

Manual operation: See ["Hysteresis"](#) on page 48

TRIGger[:SEQuence]:LEVel[:EXTernal<port>] <TriggerLevel>

This command defines the level the external signal must exceed to cause a trigger event.

Suffix:

<port> Selects the trigger port.
 1 = trigger port 1 (TRIG IN connector on rear panel)
 2 = trigger port 2 (TRIG AUX connector on rear panel)

Parameters:

<TriggerLevel> For the R&S FPL1000, the external trigger level is always 1.4 V.
 It cannot be changed.
 *RST: 1.4 V

Manual operation: See ["Trigger Level"](#) on page 47

TRIGger[:SEQuence]:LEVel:IFPower <TriggerLevel>

This command defines the power level at the third intermediate frequency that must be exceeded to cause a trigger event.

Note that any RF attenuation or preamplification is considered when the trigger level is analyzed. If defined, a reference level offset is also considered.

Parameters:

<TriggerLevel> For details on available trigger levels and trigger bandwidths,
 see the data sheet.
 *RST: -20 dBm
 Default unit: DBM

Example:

TRIG:LEV:IFP -30DBM

Manual operation: See ["Trigger Level"](#) on page 47

TRIGger[:SEquence]:LEVel:AM:RELative <Level>

The command sets the level when AM-modulated signals are used as trigger source.

For triggering to be successful, the measurement time must cover at least 5 periods of the audio signal.

Parameters:

<Level> Range: -100 to +100
 *RST: 0 %
 Default unit: %

Example:

TRIG:LEV:AM:REL -20 %
 Sets the AM trigger threshold to -20 %

Manual operation: See "[Trigger Level](#)" on page 47

TRIGger[:SEquence]:LEVel:AM[:ABSolute] <Level>

The command sets the level when RF power signals are used as trigger source.

For triggering to be successful, the measurement time must cover at least 5 periods of the audio signal.

Parameters:

<Level> Range: -100 to +30
 *RST: -20 dBm
 Default unit: dBm

Example:

TRIG:LEV:AM -30 dBm
 Sets the RF power signal trigger threshold to -30 dBm

Manual operation: See "[Trigger Level](#)" on page 47

TRIGger[:SEquence]:LEVel:FM <Level>

The command sets the level when FM-modulated signals are used as trigger source.

For triggering to be successful, the measurement time must cover at least 5 periods of the audio signal.

Parameters:

<Level> Range: -10 to +10
 *RST: 0 Hz
 Default unit: MHz

Example:

TRIG:LEV:FM 10 kHz
 Sets the FM trigger threshold to 10 kHz

Manual operation: See "[Trigger Level](#)" on page 47

TRIGger[:SEquence]:LEVel:PM <Level>

The command sets the level when PM-modulated signals are used as trigger source.

For triggering to be successful, the measurement time must cover at least 5 periods of the audio signal.

Parameters:

<Level> Range: -1000 to +1000
 *RST: 0 RAD
 Default unit: RAD | DEG

Example:

TRIG:LEV:PM 1.2 RAD
 Sets the PM trigger threshold to 1.2 rad

Manual operation: See "[Trigger Level](#)" on page 47

TRIGger[:SEQUence]:SLOPe <Type>

For all trigger sources except time, you can define whether triggering occurs when the signal rises to the trigger level or falls down to it.

Parameters:

<Type> POSitive | NEGative
POSitive
 Triggers when the signal rises to the trigger level (rising edge).
NEGative
 Triggers when the signal drops to the trigger level (falling edge).
 *RST: POSitive

Example:

TRIG:SLOP NEG

Manual operation: See "[Slope](#)" on page 48

TRIGger[:SEQUence]:SOURce <Source>

This command selects the trigger source.

For triggering with AF, AM, AMRelative, FM, and PM trigger sources to be successful, the measurement time must cover at least 5 periods of the audio signal. For details on trigger sources, see "[Trigger Source](#)" on page 46.

Note on external triggers:

If a measurement is configured to wait for an external trigger signal in a remote control program, remote control is blocked until the trigger is received and the program can continue. Make sure that this situation is avoided in your remote control programs.

Parameters:

<Source> **IMMediate**
 Free Run
 EXTernal
 Trigger signal from the "Trigger Input" connector.
 Trigger signal from the "Trigger In" connector.
 IFPower
 Second intermediate frequency

TIME

Time interval

AF

AF power signal

FM

FM power signal

AM

corresponds to the RF power signal

AMRelative

corresponds to the AM signal

PM

PM power signal

*RST: IMMEDIATE

Example:

TRIG:SOUR EXT

Selects the external trigger input as source of the trigger signal

Manual operation:See ["Trigger Source"](#) on page 46See ["Free Run"](#) on page 46See ["External Trigger 1"](#) on page 47See ["IF Power"](#) on page 47See ["FM \(Offline\) / AM \(Offline\) / PM \(Offline\) / RF \(Offline\)"](#)
on page 47See ["Time"](#) on page 47**TRIGger[:SEquence]:TIME:RINterval <Interval>**

This command defines the repetition interval for the time trigger.

Parameters:

<Interval>

numeric value

Range: 2 ms to 5000 s

*RST: 1.0 s

Default unit: S

Example:

TRIG:SOUR TIME

Selects the time trigger input for triggering.

TRIG:TIME:RINT 5

The sweep starts every 5 s.

Manual operation:See ["Repetition Interval"](#) on page 48

11.4.8 Configuring demodulation

The following remote commands are required to configure the demodulation parameters in a remote environment. The tasks for manual operation are described in [Chapter 5.7, "Demodulation"](#), on page 54.

• Basic demodulation settings.....	152
• Time domain zoom settings.....	154
• Configuring the demodulation spectrum.....	157
• (Post-processing) AF filters.....	159
• Defining the scaling and units.....	165
• Scaling for AF evaluation.....	165
• Scaling for RF evaluation.....	165
• Units.....	166
• Relative demodulation results.....	166
• Settling time.....	169

11.4.8.1 Basic demodulation settings

The basic demodulation measurement parameters define how the measurement is performed.

Useful commands described elsewhere:

- [Chapter 11.4.8.2, "Time domain zoom settings"](#), on page 154

Basic demodulation commands:

[SENSe:]ADEMod<n>:AF:COUPling.....	152
[SENSe:]ADEMod:PM:RPOint[:X].....	152
[SENSe:]ADEMod:PM:RPOint[:X]:MODE.....	153
[SENSe:]ADEMod:SQUelch[:STATe].....	153
[SENSe:]ADEMod:SQUelch:LEVel.....	154
CALCulate<n>:FORMat.....	154

[SENSe:]ADEMod<n>:AF:COUPling <Coupling>

This command selects the coupling of the AF path of the analyzer in the specified window.

Suffix:

<n> irrelevant

Parameters:

<Coupling> AC | DC
 *RST: AC (PM); DC (FM)

Example:

ADEM:AF:COUP DC
 Switches on DC coupling.

Manual operation: See "[AF Coupling](#)" on page 55

[SENSe:]ADEMod:PM:RPOint[:X] <Time>

This command determines the position where the phase of the PM-demodulated signal is set to 0 rad. The maximum value depends on the measurement time selected in the instrument; this value is output in response to the query ADEM:PM:RPO:X? MAX.

Parameters:

<Time> 0 s to measurement time
 *RST: 0 s
 Default unit: S

Example:

ADEM:PM:RPO 500us
 Sets the position where the phase to 0 rad setting to 500 µs.

Manual operation: See ["Zero Phase Reference Position \(PM Time Domain only\)"](#) on page 57

[SENSe:]ADEMod:PM:RPOint[:X]:MODE <Mode>

Defines how the reference position in time for 0 rad is determined.

Parameters:

<Mode> MANual | RIGHT
MANual
 The time is defined using [\[SENSe:\]ADEMod:PM:RPOint\[:X\]](#) on page 152.
RIGHT
 The time of the last measured value is used as the reference position. The time of the last measured value corresponds to the acquisition time, regarding the trigger event and trigger offset, if applicable. If the acquisition time or the trigger values are changed, the reference position is automatically adapted.
 *RST: MANual

Example:

ADEM:MTIM 500us
 ADEM:PM:RPO:MODE RIGHT
 Sets the position of the 0 rad phase setting to 500 µs.

Manual operation: See ["Zero Phase Reference Position \(PM Time Domain only\)"](#) on page 57

[SENSe:]ADEMod:SQUelch[:STATe] <State>

This command activates the squelch function, i.e. if the signal falls below a defined threshold (see [\[SENSe:\]ADEMod:SQUelch:LEVel](#) on page 154), the demodulated data is automatically set to 0.

Parameters:

<State> ON | OFF | 0 | 1
OFF | 0
 Switches the function off
ON | 1
 Switches the function on

Example:

DEM:SQU ON
 Signals below the level threshold are squelched.

Manual operation: See ["Squelch State"](#) on page 55

[SENSe:]ADEMod:SQUelch:LEVel <Threshold>

This command defines the level threshold below which the demodulated data is set to 0 if squelching is enabled (see [\[SENSe:\]ADEMod:SQUelch\[:STATe\]](#) on page 153).

Parameters:

<Threshold> numeric value
 The absolute threshold level
 Range: -150 dBm to 30 dBm
 *RST: -40 dBm

Example: DEM:SQU:LEV -80
 If the signal drops below -80 dBm, the demodulated data is set to 0.

Manual operation: See ["Squelch Level"](#) on page 55

CALCulate<n>:FORMat <Evaluation>

This command activates/deactivates the phase wrap for the specified PM time domain display with DC coupling.

Suffix:

<n> 1..n

Parameters:

<Evaluation> **PHAS**
 The phase is wrapped.
 UPH
 The phase is not wrapped.
 *RST: UPH

Example: LAY:ADD? '1',BEL,'XTIM:PM'
 Activates PM time domain display. Result: window '2'
 INP:COUP DC
 Selects DC coupling.
 CALC2:FORM PHAS
 Selects a wrapped phase display in the PM time domain window.

Manual operation: See ["Phase Wrap On/Off \(PM Time Domain only\)"](#) on page 57

11.4.8.2 Time domain zoom settings

Using the time domain zoom, the demodulated data for a particular time span is extracted and displayed in more detail.

[SENSe:]ADEMod<n>:ZOOM:LENGth.....	155
[SENSe:]ADEMod<n>:ZOOM:LENGth:MODE.....	155
[SENSe:]ADEMod<n>:ZOOM:STARt.....	156
[SENSe:]ADEMod<n>:ZOOM[:STATe].....	156

[SENSe:]ADEMod<n>:ZOOM:LENGth <Length>

The command allows you to define the length of the time domain zoom area for the analog-demodulated measurement data in the specified window manually. If the length is defined manually using this command, the zoom mode is also set to manual.

Suffix:

<n> [Window](#)

Parameters:

<Length> *RST: sweep time
 Default unit: S
 Length of the zoom area in seconds.

Example:

ADEM:ZOOM:LENG 2s
 Zoom mode is set to manual and the zoom length to 2 seconds.

Manual operation: See "[Length](#)" on page 57

[SENSe:]ADEMod<n>:ZOOM:LENGth:MODE <Mode>

The command defines whether the length of the zoom area for the analog-demodulated measurement data is defined automatically or manually in the specified window.

Suffix:

<n> [Window](#)

Parameters:

<Mode> AUTO | MAN
AUTO
 (Default:) The number of sweep points is used as the zoom length.

MAN

The zoom length is defined manually using [\[SENSe:\]ADEMod<n>:ZOOM:LENGth](#).

*RST: AUTO

Example:

ADEM:ZOOM:LENG:MODE MAN
 Zoom function uses the length defined manually.

Manual operation: See "[Length](#)" on page 57

[SENSe:]ADEMod<n>:ZOOM:STARt <Time>

The command selects the start time for the zoomed display of analog-demodulated measurements in the specified window. The maximum value depends on the measurement time, which is set and can be queried with the [\[SENSe:\]ADEMod:MTIME](#) command.

If the zoom function is enabled, the defined number of sweep points are displayed from the start time specified with this command.

Suffix:

<n> [Window](#)

Parameters:

<Time> Range: 0 s to (measurement time – zoom length)
 *RST: 0 s
 Default unit: S

Example:

```
ADEM:ZOOM:STAT ON
Switches on the zoom function
ADEM:ZOOM:STAR 500us
Sets the starting point of the display to 500 µs.
```

Manual operation: See ["Start"](#) on page 56

[SENSe:]ADEMod<n>:ZOOM[:STATe] <State>

The command enables or disables the time domain zoom function for the analog-demodulated measurement data in the specified window.

If the zoom function is enabled, the defined number of sweep points are displayed from the start time specified with [\[SENSe:\]ADEMod<n>:ZOOM:STARt](#) on page 156.

If the zoom function is disabled, data reduction is used to adapt the measurement points to the number of points available on the display.

Suffix:

<n> [Window](#)

Parameters:

<State> ON | OFF | 0 | 1
 OFF | 0
 Switches the function off
 ON | 1
 Switches the function on

Example:

```
ADEM:ZOOM ON
Switches on the zoom function
```

Manual operation: See ["State"](#) on page 56

11.4.8.3 Configuring the demodulation spectrum

The demodulation spectrum defines which span of the demodulated data is evaluated.

- [AF evaluation](#)..... 157
- [RF evaluation](#)..... 158

AF evaluation

These settings are only available for AF Spectrum evaluations, not in the time domain.

[SENSe:]ADEMod:AF:CENTer	157
[SENSe:]ADEMod:AF:SPAN	157
[SENSe:]ADEMod:AF:SPAN:FULL	157
[SENSe:]ADEMod:AF:STARt	158
[SENSe:]ADEMod:AF:STOP	158

[SENSe:]ADEMod:AF:CENTer <Frequency>

This command sets the center frequency for AF spectrum result display.

Parameters:

<Frequency> *RST: 1.25 MHz
 Default unit: HZ

Manual operation: See "[AF Center](#)" on page 58

[SENSe:]ADEMod:AF:SPAN

This command sets the span (around the center frequency) for AF spectrum result display.

The span is limited to DBW/2 (see [\[SENSe:\]BWIDth:DEMod](#) on page 144).

Parameters:

 *RST: 9 MHz
 Default unit: HZ

Example: ADEM:AF:SPAN 200 kHz
 Sets the AF span to 200 kHz

Manual operation: See "[AF Span](#)" on page 59

[SENSe:]ADEMod:AF:SPAN:FULL

This command sets the maximum span for AF spectrum result display.

The maximum span corresponds to DBW/2 (see [\[SENSe:\]BWIDth:DEMod](#) on page 144).

Example: ADEM:BAND 5 MHz
 Sets the demodulation bandwidth to 5 MHz
 ADEM:AF:SPAN:FULL
 Sets the AF span to 2.5 MHz

Manual operation: See ["AF Full Span"](#) on page 59

[SENSe:]ADEMod:AF:STARt <Frequency>

This command sets the start frequency for AF spectrum result display.

Parameters:

<Frequency> *RST: 0 MHz
 Default unit: HZ

Example:

ADEM:AF:STAR 0 kHz
 Sets the AF start frequency to 0 kHz
 ADEM:AF:STOP 500 kHz
 Sets the AF stop frequency to 500 kHz

Manual operation: See ["AF Start"](#) on page 58

[SENSe:]ADEMod:AF:STOP <Frequency>

This command sets the stop frequency for AF spectrum result display.

Parameters:

<Frequency> *RST: 9 MHz
 Default unit: HZ

Example:

ADEM:AF:STAR 0 kHz
 Sets the AF start frequency to 0 kHz
 ADEM:AF:STOP 500 kHz
 Sets the AF stop frequency to 500 kHz

Manual operation: See ["AF Stop"](#) on page 58

RF evaluation

These settings are only available for RF evaluation, both in time and frequency domain.

Useful commands described elsewhere

- [\[SENSe:\]FREQuency:CENTer](#) on page 134
- [\[SENSe:\]BWIDth:DEMod](#) on page 144

Specific commands:

[\[SENSe:\]ADEMod:SPECTrum:SPAN:ZOOM](#)..... 158
[\[SENSe:\]ADEMod:SPECTrum:SPAN\[:MAXimum\]](#)..... 159

[SENSe:]ADEMod:SPECTrum:SPAN:ZOOM

This command sets the span (around the center frequency) for RF spectrum result display.

The span is limited to the demodulation bandwidth (see [\[SENSe:\]BWIDth:DEMod](#) on page 144).

Parameters:

 *RST: 5 MHz
Default unit: HZ

Example:

ADEM:SPEC:SPAN:ZOOM 200 kHz

Sets the rF span to 200 kHz

Manual operation: See "Span" on page 60

[SENSe:]ADEMod:SPECTrum:SPAN[:MAXimum] <FreqRange>

Sets the DBW to the specified value and the span (around the center frequency) of the RF data to be evaluated to its new maximum (the demodulation bandwidth).

Parameters:

<FreqRange> *RST: 5 MHz
Default unit: Hz

Manual operation: See "Span" on page 60
See "RF Full Span" on page 60

11.4.8.4 (Post-processing) AF filters

The AF filter reduces the evaluated bandwidth of the demodulated signal and can define a weighting function. AF filters are only available for AM or FM time domain evaluations.

[SENSe:]FILTer<n>:AWEighted[:STATE].....	159
[SENSe:]FILTer<n>:AOFF.....	160
[SENSe:]FILTer<n>:CCIR:WEIGhted[:STATE].....	160
[SENSe:]FILTer<n>:CCIR[:UNWeighted][:STATE].....	160
[SENSe:]FILTer<n>:CCITt[:STATE].....	161
[SENSe:]FILTer<n>:DEMPHasis:TCONstant.....	161
[SENSe:]FILTer<n>:DEMPHasis[:STATE].....	161
[SENSe:]FILTer<n>:HPASs:FREQUency[:ABSolute].....	162
[SENSe:]FILTer<n>:HPASs:FREQUency:MANual.....	162
[SENSe:]FILTer<n>:HPASs[:STATE].....	163
[SENSe:]FILTer<n>:LPASs:FREQUency[:ABSolute].....	163
[SENSe:]FILTer<n>:LPASs:FREQUency:MANual.....	163
[SENSe:]FILTer<n>:LPASs:FREQUency:RELative.....	164
[SENSe:]FILTer<n>:LPASs[:STATE].....	164

[SENSe:]FILTer<n>:AWEighted[:STATE] <State>

This command activates/deactivates the "A" weighting filter for the specified evaluation.

For details on weighting filters, see "Weighting" on page 62.

Suffix:<n> [Window](#)**Parameters:**

<State> ON | OFF | 0 | 1
OFF | 0
 Switches the function off
ON | 1
 Switches the function on

Example:

FILT:AWE ON
 Activates the A weighting filter.

Manual operation: See ["Weighting"](#) on page 62

[SENSe:]FILTer<n>:AOFF**Suffix:**

<n> 1..n

Manual operation: See ["Deactivating all AF Filters"](#) on page 63

[SENSe:]FILTer<n>:CCIR:WEIGhted[:STATE] <State>

This command activates/deactivates the weighted CCIR filter for the specified evaluation.

For details on weighting filters, see ["Weighting"](#) on page 62.

Suffix:<n> [Window](#)**Parameters:**

<State> ON | OFF | 0 | 1
OFF | 0
 Switches the function off
ON | 1
 Switches the function on

Example:

FILT:CCIR:WEIG ON
 Activates the weighted CCIR filter.

Manual operation: See ["Weighting"](#) on page 62

[SENSe:]FILTer<n>:CCIR[:UNWeighted][:STATE] <State>

This command activates/deactivates the unweighted CCIR filter in the specified window.

For details on weighting filters, see ["Weighting"](#) on page 62.

Suffix:<n> [Window](#)**Parameters:**

<State> ON | OFF | 0 | 1
OFF | 0
 Switches the function off
ON | 1
 Switches the function on

Example:

FILT:CCIR:UNW ON
 Activates the unweighted CCIR filter.

Manual operation: See "[Weighting](#)" on page 62

[SENSe:]FILTer<n>:CCITt[:STATe] <State>

Suffix:

<n> 1..n

Parameters:

<State>

Manual operation: See "[Weighting](#)" on page 62

[SENSe:]FILTer<n>:DEMPHasis:TCONstant <Value>

This command selects the deemphasis for the specified evaluation.

For details on deemphasis refer to "[Deemphasis](#)" on page 63.

Suffix:<n> [Window](#)**Parameters:**

<Value> 25 us | 50 us | 75 us | 750 us
 *RST: 50 us
 Default unit: S

Example:

FILT:DEMP:TCON 750us
 Selects the deemphasis for the demodulation bandwidth range from 800 Hz to 4 MHz with a time constant of 750 µs.

Manual operation: See "[Deemphasis](#)" on page 63

[SENSe:]FILTer<n>:DEMPHasis[:STATe] <State>

This command activates/deactivates the selected deemphasis for the specified evaluation.

For details about deemphasis refer to "[Deemphasis](#)" on page 63.

Suffix:<n> [Window](#)**Parameters:**

<State> ON | OFF | 0 | 1
OFF | 0
 Switches the function off
ON | 1
 Switches the function on

Example:

FILT:DEMP ON
 Activates the selected deemphasis.

Manual operation: See "[Deemphasis](#)" on page 63

[SENSe:]FILTer<n>:HPASs:FREQuency[:ABSolute] <Frequency>

This command selects the high pass filter type for the specified evaluation.

For details on the high pass filters, refer to "[High Pass](#)" on page 61.

Suffix:<n> [Window](#)**Parameters:**

<Frequency> 20 Hz | 50 Hz | 300 Hz
 *RST: 300Hz
 Default unit: Hz

Example:

FILT:HPAS:FREQ 300Hz
 Selects the high pass filter for the demodulation bandwidth range from 800 Hz to 8 MHz.

Manual operation: See "[High Pass](#)" on page 61

[SENSe:]FILTer<n>:HPASs:FREQuency:MANual <Frequency>

This command selects the cutoff frequency of the high pass filter for the specified evaluation.

For details on the high pass filters, refer to "[High Pass](#)" on page 61.

Suffix:<n> [Window](#)**Parameters:**

<Frequency> numeric value
 Range: 0 to 3 MHz
 *RST: 15kHz
 Default unit: HZ

Example:

FILT:HPAS:FREQ:MAN 3MHz
 The AF results are restricted to frequencies lower than 3 MHz.

Manual operation: See "High Pass" on page 61

[SENSe:]FILTeR<n>:HPASs[:STATe] <State>

This command activates/deactivates the selected high pass filter for the specified evaluation.

For details on the high pass filter, refer to "High Pass" on page 61.

Suffix:

<n> [Window](#)

Parameters:

<State> ON | OFF | 0 | 1
OFF | 0
 Switches the function off
ON | 1
 Switches the function on

Example:

FILT:HPAS ON
 Activates the selected high pass filter.

Manual operation: See "High Pass" on page 61

[SENSe:]FILTeR<n>:LPASs:FREQuency[:ABSolute] <Frequency>

This command selects the absolute low pass filter type for the specified evaluation

For details on the low pass filter, refer to "Low Pass" on page 61.

Suffix:

<n> [Window](#)

Parameters:

<Frequency> 3kHz | 15kHz | 150kHz
 *RST: 15kHz
 Default unit: HZ

Example:

FILT:LPAS:FREQ 150kHz
 Selects the low pass filter for the demodulation bandwidth range from 400 kHz to 16 MHz.

Manual operation: See "Low Pass" on page 61

[SENSe:]FILTeR<n>:LPASs:FREQuency:MANual <Frequency>

This command selects the cutoff frequency of the low pass filter for the specified evaluation.

For details on the low pass filter, refer to "Low Pass" on page 61.

Suffix:

<n> [Window](#)

Parameters:

<Frequency> numeric value
 Range: 0 to 3 MHz
 *RST: 15kHz
 Default unit: HZ

Example:

```
FILT:LPAS:FREQ:MAN 150kHz
```

The AF results are restricted to frequencies lower than 150 kHz.

Manual operation: See "[Low Pass](#)" on page 61

[SENSe:]FILTer<n>:LPASs:FREQuency:RELative <Frequency>

This command selects the relative low pass filter type for the specified evaluation

For details on the low pass filter, refer to "[Low Pass](#)" on page 61.

Suffix:

<n> [Window](#)

Parameters:

<Frequency> 5PCT | 10PCT | 25PCT
 *RST: 25PCT
 Default unit: PCT

Example:

```
FILT:LPAS:FREQ:REL 25PCT
```

Selects the low pass filter as 25 % of the demodulation bandwidth.

Manual operation: See "[Low Pass](#)" on page 61

[SENSe:]FILTer<n>:LPASs[:STATe] <State>

This command activates/deactivates the selected low pass filter for the specified evaluation.

For details on the low pass filter, refer to "[Low Pass](#)" on page 61.

Suffix:

<n> [Window](#)

Parameters:

<State> ON | OFF | 0 | 1
OFF | 0
 Switches the function off
ON | 1
 Switches the function on

Example:

```
FILT:LPAS ON
```

Activates the selected low pass filter.

Manual operation: See "[Low Pass](#)" on page 61

11.4.8.5 Defining the scaling and units

The scaling parameters define the range of the demodulated data to be displayed.

11.4.8.6 Scaling for AF evaluation

These settings are only available for AF evaluations.

Useful commands described elsewhere:

- `[SENSe:]ADJust:SCALe[:Y]:AUTO[:CONTinuous]` on page 174
- `[SENSe:]ADEMod<n>:AF:COUPling` on page 152
- `DISPlay[:WINDow<n>][:SUBWindow<w>]:TRACe<t>:Y[:SCALe]:RPOSition` on page 141
- `DISPlay[:WINDow<n>][:SUBWindow<w>]:TRACe<t>:Y:SPACing` on page 142

Specific commands:

`DISPlay[:WINDow<n>][:SUBWindow<w>]:TRACe<t>:Y[:SCALe]:RVALue.....` 165

DISPlay[:WINDow<n>][:SUBWindow<w>]:TRACe<t>:Y[:SCALe]:RVALue <Value>

This command defines the reference value assigned to the reference position in the specified window. Separate reference values are maintained for the various displays.

Suffix:

<n>	Window
<w>	subwindow
<t>	irrelevant

Parameters:

<Value>	Default unit: DB
---------	------------------

Example:

```
DISP:TRAC:Y:RVAL 0
Sets the value assigned to the reference position to 0 Hz
```

Manual operation: See "Reference Value" on page 65

11.4.8.7 Scaling for RF evaluation

These commands are required for RF evaluations and the "result summary".

- `DISPlay[:WINDow<n>][:SUBWindow<w>]:TRACe<t>:Y[:SCALe]:RPOSition` on page 141
- `DISPlay[:WINDow<n>][:SUBWindow<w>]:TRACe<t>:Y:SPACing` on page 142
- `DISPlay[:WINDow<n>][:SUBWindow<w>]:TRACe<t>:Y[:SCALe]` on page 139

- `DISPlay[:WINDow<n>][:SUBWindow<w>]:TRACe<t>:Y[:SCALE]:MODE`
on page 140

11.4.8.8 Units

The units define how the demodulated data is displayed.

<code>CALCulate<n>:UNIT:ANGLE</code>	166
<code>UNIT<n>:ANGLE</code>	166
<code>CALCulate<n>:UNIT:THD</code>	166
<code>UNIT<n>:THD</code>	166

CALCulate<n>:UNIT:ANGLE <Unit>

UNIT<n>:ANGLE <Unit>

This command selects the unit for angles (for PM display, <n> is irrelevant).

This command is identical to `CALC:UNIT:ANGL`

Suffix:

<n> [Window](#)

Parameters:

<Unit> DEG | RAD
*RST: RAD

Example: `UNIT:ANGL DEG`

Manual operation: See "[Phase Unit \(Rad/Deg\)](#)" on page 68

CALCulate<n>:UNIT:THD <Unit>

UNIT<n>:THD <Mode>

Selects the unit for THD measurements (<n> is irrelevant).

This command is identical to `CALC:UNIT:THD`

Suffix:

<n> [Window](#)

Parameters:

<Mode> DB | PCT
*RST: DB

Example: `UNIT:THD PCT`

Manual operation: See "[THD Unit \(%/ DB\)](#)" on page 68

11.4.8.9 Relative demodulation results

The following commands are required to obtain relative demodulation results.

CONFigure:ADEMod:RESults:AM:DETEctor<det>:REFerence.....	167
CONFigure:ADEMod:RESults:FM:DETEctor<det>:REFerence.....	167
CONFigure:ADEMod:RESults:PM:DETEctor<det>:REFerence.....	167
CONFigure:ADEMod:RESults:AM:DETEctor<det>:STATe.....	167
CONFigure:ADEMod:RESults:FM:DETEctor<det>:STATe.....	167
CONFigure:ADEMod:RESults:PM:DETEctor<det>:STATe.....	167
CONFigure:ADEMod:RESults:AM:DETEctor<det>:REFerence:MEASStoref<t>.....	168
CONFigure:ADEMod:RESults:FM:DETEctor<det>:REFerence:MEASStoref<t>.....	168
CONFigure:ADEMod:RESults:PM:DETEctor<det>:REFerence:MEASStoref<t>.....	168
CONFigure:ADEMod:RESults:AM:DETEctor<det>:MODE.....	169
CONFigure:ADEMod:RESults:FM:DETEctor<det>:MODE.....	169
CONFigure:ADEMod:RESults:PM:DETEctor<det>:MODE.....	169
CONFigure:ADEMod:RESults:UNIT.....	169

CONFigure:ADEMod:RESults:AM:DETEctor<det>:REFerence <RefValue>

CONFigure:ADEMod:RESults:FM:DETEctor<det>:REFerence <RefValue>

CONFigure:ADEMod:RESults:PM:DETEctor<det>:REFerence <RefValue>

Defines the reference value to be used for relative demodulation results and recalculates the results. If necessary, the detector is activated.

A reference value 0 would provide infinite results and is thus automatically corrected to 0.1.

Suffix:

<det> Detector function used for relative demodulation

Parameters:

<RefValue> double value
 The unit depends on the demodulation type:
 ACV: V
 AM: %
 FM: Hz
 PM: depends on UNIT<n>:ANGLE setting
 *RST: 1.0
 Default unit: RAD

Example: See CONFigure:ADEMod:RESults:PM:DETEctor<det>:STATe on page 167

Manual operation: See "Reference Value" on page 70

CONFigure:ADEMod:RESults:AM:DETEctor<det>:STATe <State>

CONFigure:ADEMod:RESults:FM:DETEctor<det>:STATe <State>

CONFigure:ADEMod:RESults:PM:DETEctor<det>:STATe <State>

Activates relative demodulation for the selected detector. If activated, the demodulated result is set in relation to the reference value defined by CONFigure:ADEMod:RESults:PM:DETEctor<det>:REFerence.

Suffix:

<det> Detector function used for relative demodulation

Parameters:

<State> ON | OFF | 0 | 1
OFF | 0
 Switches the function off
ON | 1
 Switches the function on

Example:

```
CONF:ADEM:RES:PM:DET2:STAT ON
```

Activates relative demodulation for the negative peak detector.

```
CONF:ADEM:RES:UNIT PCT
```

Defines the unit for relative values as percent.

```
CONF:ADEM:RES:PM:DET2:REF 1.415%
```

Sets the reference value for the negative peak detector to 1.415 %.

```
CONF:ADEM:RES:PM:DET2:MODE AVER
```

Sets the negative peak detector to average mode.

```
CONF:ADEM:RES:PM:DET2:REF:MEAS2
```

Sets the reference value for the negative peak detector to the average of the currently calculated value and the previous reference value on trace 2.

Manual operation: See "State" on page 70

CONFigure:ADEMod:RESults:AM:DETEctor<det>:REFerence:MEASStoref<t>

CONFigure:ADEMod:RESults:FM:DETEctor<det>:REFerence:MEASStoref<t>

CONFigure:ADEMod:RESults:PM:DETEctor<det>:REFerence:MEASStoref<t>

Sets the reference value to be used for relative demodulation results to the currently measured value on the specified trace *for all relative detectors*.

If necessary, the detectors are activated.

A reference value 0 would provide infinite results and is thus automatically corrected to 0.1.

Suffix:

<det> irrelevant

<t> 1..n
[Trace](#)

Example:

See [CONFigure:ADEMod:RESults:PM:DETEctor<det>:STATE](#) on page 167

Manual operation: See "Meas -> Reference" on page 70

CONFigure:ADEMod:RESults:AM:DETEctor<det>:MODE <Mode>

CONFigure:ADEMod:RESults:FM:DETEctor<det>:MODE <Mode>

CONFigure:ADEMod:RESults:PM:DETEctor<det>:MODE <Mode>

Defines the mode with which the demodulation result is determined.

Suffix:

<det> Detector function used for relative demodulation

Parameters:

<Mode>

WRITe

Overwrite mode: the detector value is overwritten by each sweep. This is the default setting.

AVERage

The average result is determined over all sweeps.

MAXHold

The maximum value is determined over several sweeps and displayed. The R&S FPL1000 saves each result only if the new value is greater than the previous one.

*RST: WRITe

Example: See [CONFigure:ADEMod:RESults:PM:DETEctor<det>:STATe](#) on page 167

Manual operation: See "[Mode](#)" on page 69

CONFigure:ADEMod:RESults:UNIT <Unit>

This command selects the unit for relative demodulation results.

Parameters:

<Unit>

PCT | DB

*RST: PCT

Example:

CONF:ADEM:RES:AM:DET2:STAT ON

Activates relative demodulation for the negative peak detector.

CONF:ADEM:RES:AM:DET2:MODE AVER

Sets the negative peak detector to average mode.

CONF:ADEM:RES:UNIT PCT

Defines the unit for relative values as percent.

CONF:ADEM:RES:AM:DET2:REF 1.415%

Sets the reference value for relative results to 1.415 %.

Manual operation: See "[Relative Unit](#)" on page 68

11.4.8.10 Settling time

Optionally, the settling time can be evaluated for time domain measurements.

Useful commands for the settling time described elsewhere:

- [\[SENSe:\]ADEMod:SETTling:TIME:RESult<t>?](#) on page 196

Remote commands exclusive to configuring the settling time:

[SENSe:]ADEMod:SETTLing:TIME:LIMit:LOWer.....	170
[SENSe:]ADEMod:SETTLing:TIME:LIMit:UPPer.....	170
[SENSe:]ADEMod:SETTLing:TIME:STATe.....	170

[SENSe:]ADEMod:SETTLing:TIME:LIMit:LOWer <Position>

Defines the upper limit of the settling time corridor. The value is defined with reference to the reference value, see also `DISPlay[:WINDow<n>][:SUBWindow<w>]:TRACe<t>:Y[:SCALE]:RVALue` on page 165 and `[SENSe:]ADEMod:PM:RPOint[:X]` on page 152.

For details, see [Chapter 5.7.7, "Settling time"](#), on page 71.

Parameters:

<Position> Default unit: depends on result type

Example:

ADEM:SETT:TIME:LIM:LOW -10 RAD

Manual operation: See "[Lower Settling Limit](#)" on page 72

[SENSe:]ADEMod:SETTLing:TIME:LIMit:UPPer <Position>

Defines the upper limit of the settling time corridor. The value is defined with reference to the reference value, see also `DISPlay[:WINDow<n>][:SUBWindow<w>]:TRACe<t>:Y[:SCALE]:RVALue` on page 165 and `[SENSe:]ADEMod:PM:RPOint[:X]` on page 152.

For details, see [Chapter 5.7.7, "Settling time"](#), on page 71.

Parameters:

<Position> Default unit: depends on result type

Example:

ADEM:SETT:TIME:LIM:UPP 10 RAD

Manual operation: See "[Upper Settling Limit](#)" on page 72

[SENSe:]ADEMod:SETTLing:TIME:STATe <State>

Enables or disables the calculation and display of the settling time. The function is available for all time domain displays.

For details, see [Chapter 5.7.7, "Settling time"](#), on page 71.

Parameters:

<State> ON | OFF | 0 | 1

OFF | 0

Switches the function off

ON | 1

Switches the function on

*RST: 0

Example:

```
//Define a PM time domain result display
LAY:ADD? '1',RIGH,'XTIM:PM'
//Define a second maxhold trace
DISP:WIND2:TRAC2:MODE MAXH
//Enable settling time calculation
ADEM:SETT:TIME:STAT ON
//Define the settling limit corridor as +/-10 RAD
ADEM:SETT:TIME:LIM:UPP 10 RAD
ADEM:SETT:TIME:LIM:LOW -10 RAD
//Set the zero RAD reference to the last measurement value
ADEM:PM:RPO:MODE LAST
//Perform the measurement
INIT;*WAI
//Query the settling time
ADEM:SETT:TIME:RES2?
//Result: 29.950000us
//After 29.95 us the signal is settled.
```

Manual operation: See "State" on page 72

11.4.9 Adjusting settings automatically

The following remote commands are required to adjust settings automatically in a remote environment. The tasks for manual operation are described in [Chapter 5.9, "Adjusting settings automatically"](#), on page 73.

[SENSe:]ADJust:ALL.....	171
[SENSe:]ADJust:CONFigure:LEVel:DURation.....	172
[SENSe:]ADJust:CONFigure:LEVel:DURation:MODE.....	172
[SENSe:]ADJust:CONFigure:HYSTeresis:LOWer.....	173
[SENSe:]ADJust:CONFigure:HYSTeresis:UPPer.....	173
[SENSe:]ADJust:CONFigure:SMODE.....	173
[SENSe:]ADJust:CONFigure:TRIGger.....	174
[SENSe:]ADJust:FREQuency.....	174
[SENSe:]ADJust:LEVel.....	174
[SENSe:]ADJust:SCALe[:Y]:AUTO[:CONTInuous].....	174

[SENSe:]ADJust:ALL

This command initiates a measurement to determine and set the ideal settings for the current task automatically (only once for the current measurement).

This includes:

- Center frequency
- Reference level
- Scaling

Example: ADJ:ALL

Manual operation: See ["Adjusting all Determinable Settings Automatically \(Auto All\)"](#) on page 74

[SENSe:]ADJust:CONFigure:LEVel:DURation <Duration>

To determine the ideal reference level, the R&S FPL1000 performs a measurement on the current input data. This command defines the length of the measurement if [\[SENSe:\]ADJust:CONFigure:LEVel:DURation:MODE](#) is set to `MANual`.

Parameters:

<Duration> Numeric value in seconds
 Range: 0.001 to 16000.0
 *RST: 0.001
 Default unit: s

Example:

```
ADJ:CONF:DUR:MODE MAN
Selects manual definition of the measurement length.
ADJ:CONF:LEV:DUR 5ms
Length of the measurement is 5 ms.
```

Manual operation: See ["Changing the Automatic Measurement Time \(Meas Time Manual\)"](#) on page 75

[SENSe:]ADJust:CONFigure:LEVel:DURation:MODE <Mode>

To determine the ideal reference level, the R&S FPL1000 performs a measurement on the current input data. This command selects the way the R&S FPL1000 determines the length of the measurement .

Parameters:

<Mode> **AUTO**
 The R&S FPL1000 determines the measurement length automatically according to the current input data.

MANual
 The R&S FPL1000 uses the measurement length defined by [\[SENSe:\]ADJust:CONFigure:LEVel:DURation](#) on page 172.

*RST: AUTO

Manual operation: See ["Resetting the Automatic Measurement Time \(Meas Time Auto\)"](#) on page 75
 See ["Changing the Automatic Measurement Time \(Meas Time Manual\)"](#) on page 75

[SENSe:]ADJust:CONFigure:HYSTerisis:LOWer <Threshold>

When the reference level is adjusted automatically using the [\[SENSe:\]ADJust:LEVel](#) on page 174 command, the internal attenuators and the preamplifier are also adjusted. To avoid frequent adaptation due to small changes in the input signal, you can define a hysteresis. This setting defines a lower threshold the signal must fall below (compared to the last measurement) before the reference level is adapted automatically.

Parameters:

<Threshold> Range: 0 dB to 200 dB
 *RST: +1 dB
 Default unit: dB

Example:

SENS:ADJ:CONF:HYST:LOW 2

For an input signal level of currently 20 dBm, the reference level is only adjusted when the signal level falls below 18 dBm.

Manual operation: See "[Lower Level Hysteresis](#)" on page 76

[SENSe:]ADJust:CONFigure:HYSTerisis:UPPer <Threshold>

When the reference level is adjusted automatically using the [\[SENSe:\]ADJust:LEVel](#) on page 174 command, the internal attenuators and the preamplifier are also adjusted. To avoid frequent adaptation due to small changes in the input signal, you can define a hysteresis. This setting defines an upper threshold the signal must exceed (compared to the last measurement) before the reference level is adapted automatically.

Parameters:

<Threshold> Range: 0 dB to 200 dB
 *RST: +1 dB
 Default unit: dB

Example:

SENS:ADJ:CONF:HYST:UPP 2

Example:

For an input signal level of currently 20 dBm, the reference level is only adjusted when the signal level rises above 22 dBm.

Manual operation: See "[Upper Level Hysteresis](#)" on page 76

[SENSe:]ADJust:CONFigure:SMODE <Search Mode>

Determines the search mode for the automatic measurement performed to determine the optimal measurement configuration.

Parameters:

<Search Mode> FAST | POPTimized

FAST

The measurement is optimized for speed.

POPTimized

The measurement is optimized to analyze pulse signals adequately.

Example: `ADJ:CONF:SMOD POPT`

[SENSe:]ADJust:CONFigure:TRIGger <State>

Defines the behavior of the measurement when adjusting a setting automatically (using `SENS:ADJ:LEV ON`, for example).

See ["Adjusting settings automatically during triggered measurements"](#) on page 74.

Parameters:

<State> `ON | OFF | 0 | 1`
OFF | 0
 Switches the function off
ON | 1
 Switches the function on

[SENSe:]ADJust:FREQuency

This command sets the center frequency to the frequency with the highest signal level in the current frequency range.

Example: `ADJ:FREQ`

Manual operation: See ["Adjusting the Center Frequency Automatically \(Auto Frequency\)"](#) on page 75

[SENSe:]ADJust:LEVel

Initiates a single (internal) measurement that evaluates and sets the ideal reference level for the current input data and measurement settings. Thus, the settings of the RF attenuation and the reference level are optimized for the signal level. The R&S FPL1000 is not overloaded and the dynamic range is not limited by an S/N ratio that is too small.

Example: `ADJ:LEV`

Manual operation: See ["Setting the Reference Level Automatically \(Auto Level\)"](#) on page 42

[SENSe:]ADJust:SCALe[:Y]:AUTO[:CONTInuous] <State>

Activates automatic scaling of the y-axis in all diagrams according to the current measurement results. Currently auto-scaling is only available for AF measurements. RF power and RF spectrum measurements are not affected by the auto-scaling.

Parameters:

<State> `ON | OFF | 0 | 1`

OFF | 0

Switches the function off

ON | 1

Switches the function on

Example: `SENS:ADJ:SCAL:Y:AUTO ON`**Manual operation:** See "[AF Auto Scale](#)" on page 66

11.5 Capturing data and performing sweeps

The following commands are required to capture data.

ABORt	175
INITiate<n>:CONMeas	176
INITiate<n>:CONTinuous	176
INITiate<n>[:IMMediate]	177
INITiate:SEQuencer:ABORt	177
INITiate:SEQuencer:IMMediate	177
INITiate:SEQuencer:MODE	177
SYSTem:SEQuencer	178

ABORt

This command aborts the measurement in the current channel setup and resets the trigger system.

To prevent overlapping execution of the subsequent command before the measurement has been aborted successfully, use the `*OPC?` or `*WAI` command after `ABOR` and before the next command.

For details on overlapping execution see [Remote control via SCPI](#).

To abort a sequence of measurements by the Sequencer, use the `INITiate:SEQuencer:ABORt` command.

Note on blocked remote control programs:

If a sequential command cannot be completed, for example because a triggered sweep never receives a trigger, the remote control program will never finish and the remote channel to the R&S FPL1000 is blocked for further commands. In this case, you must interrupt processing on the remote channel first in order to abort the measurement.

To do so, send a "Device Clear" command from the control instrument to the R&S FPL1000 on a parallel channel to clear all currently active remote channels. Depending on the used interface and protocol, send the following commands:

- **Visa:** `viClear()`

Now you can send the `ABORt` command on the remote channel performing the measurement.

Example:	ABOR; :INIT:IMM Aborts the current measurement and immediately starts a new one.
Example:	ABOR; *WAI INIT:IMM Aborts the current measurement and starts a new one once abortion has been completed.
Usage:	Event

INITiate<n>:CONMeas

This command restarts a (single) measurement that has been stopped (using `ABORT`) or finished in single sweep mode.

The measurement is restarted at the beginning, not where the previous measurement was stopped.

Suffix:

<n> irrelevant

Manual operation: See "[Continue Single Sweep](#)" on page 52

INITiate<n>:CONTInuous <State>

This command controls the sweep mode for an individual channel setup.

Note that in single sweep mode, you can synchronize to the end of the measurement with `*OPC`, `*OPC?` or `*WAI`. In continuous sweep mode, synchronization to the end of the measurement is not possible. Thus, it is not recommended that you use continuous sweep mode in remote control, as results like trace data or markers are only valid after a single sweep end synchronization.

For details on synchronization see [Remote control via SCPI](#).

If the sweep mode is changed for a channel setup while the Sequencer is active (see [INITiate:SEQuencer:IMMediate](#) on page 177), the mode is only considered the next time the measurement in that channel setup is activated by the Sequencer.

Suffix:

<n> irrelevant

Parameters:

<State> ON | OFF | 0 | 1

ON | 1

Continuous sweep

OFF | 0

Single sweep

*RST: 1 (some applications can differ)

Example: `INIT:CONT OFF`
Switches the sweep mode to single sweep.
 `INIT:CONT ON`
Switches the sweep mode to continuous sweep.

Manual operation: See "[Continuous Sweep / Run Cont](#)" on page 51

INITiate<n>[:IMMEDIATE]

This command starts a (single) new measurement.

With sweep count or average count > 0, this means a restart of the corresponding number of measurements. With trace mode MAXHold, MINHold and AVERage, the previous results are reset on restarting the measurement.

You can synchronize to the end of the measurement with *OPC, *OPC? or *WAI.

For details on synchronization see [Remote control via SCPI](#).

Suffix:

<n> irrelevant

Manual operation: See "[Single Sweep / Run Single](#)" on page 52

INITiate:SEQuencer:ABORt

This command stops the currently active sequence of measurements.

You can start a new sequence any time using [INITiate:SEQuencer:IMMEDIATE](#) on page 177.

Usage: Event

INITiate:SEQuencer:IMMEDIATE

This command starts a new sequence of measurements by the Sequencer.

Before this command can be executed, the Sequencer must be activated (see [SYSTEM:SEQuencer](#) on page 178).

Example: `SYST:SEQ ON`
Activates the Sequencer.
 `INIT:SEQ:MODE SING`
Sets single sequence mode so each active measurement is performed once.
 `INIT:SEQ:IMM`
Starts the sequential measurements.

INITiate:SEQuencer:MODE <Mode>

Defines the capture mode for the entire measurement sequence and all measurement groups and channels it contains.

Note: To synchronize to the end of a measurement sequence using *OPC, *OPC? or *WAI, use `SINGLE` Sequencer mode.

Parameters:

<Mode>

SINGLE

Each measurement group is started one after the other in the order of definition. All measurement channels in a group are started simultaneously and performed once. After *all* measurements are completed, the next group is started. After the last group, the measurement sequence is finished.

CONTInuous

Each measurement group is started one after the other in the order of definition. All measurement channels in a group are started simultaneously and performed once. After *all* measurements are completed, the next group is started. After the last group, the measurement sequence restarts with the first one and continues until it is stopped explicitly.

*RST: CONTInuous

SYSTem:SEQuencer <State>

This command turns the Sequencer on and off. The Sequencer must be active before any other Sequencer commands (`INIT:SEQ...`) are executed, otherwise an error occurs.

A detailed programming example is provided in the "Operating Modes" chapter in the R&S FPL1000 User Manual.

Parameters:

<State>

ON | OFF | 0 | 1

ON | 1

The Sequencer is activated and a sequential measurement is started immediately.

OFF | 0

The Sequencer is deactivated. Any running sequential measurements are stopped. Further Sequencer commands (`INIT:SEQ...`) are not available.

*RST: 0

Example:

```
SYST:SEQ ON
```

Activates the Sequencer.

```
INIT:SEQ:MODE SING
```

Sets single Sequencer mode so each active measurement is performed once.

```
INIT:SEQ:IMM
```

Starts the sequential measurements.

```
SYST:SEQ OFF
```

11.6 Configuring the result display

The following remote commands are required to configure the screen display in a remote environment.

- [General window commands](#)..... 179
- [Working with windows in the display](#)..... 179

11.6.1 General window commands

The following commands are required to configure general window layout, independent of the application.

Note that the suffix <n> always refers to the window *in the currently selected channel setup* (see [INSTrument\[:SElect\]](#) on page 127).

[DISPlay\[:WINDow<n>\]:SIZE](#)..... 179

DISPlay[:WINDow<n>]:SIZE <Size>

This command maximizes the size of the selected result display window *temporarily*. To change the size of several windows on the screen permanently, use the [LAY:SPL](#) command (see [LAYout:SPLitter](#) on page 183).

Suffix:

<n> [Window](#)

Parameters:

<Size>

LARGE

Maximizes the selected window to full screen.
Other windows are still active in the background.

SMALI

Reduces the size of the selected window to its original size.
If more than one measurement window was displayed originally, these are visible again.

*RST: SMALI

Example:

DISP:WIND2:SIZE LARG

11.6.2 Working with windows in the display

The following commands are required to change the evaluation type and rearrange the screen layout for a channel setup as you do using the SmartGrid in manual operation. Since the available evaluation types depend on the selected application, some parameters for the following commands also depend on the selected channel setup.

Note that the suffix <n> always refers to the window *in the currently selected channel setup*.

(See [INSTrument\[:SElect\]](#) on page 127).

LAYout:ADD[:WINDow]?	180
LAYout:CATalog[:WINDow]?	181
LAYout:IDENtify[:WINDow]?	182
LAYout:MOVE[:WINDow]	182
LAYout:REMOve[:WINDow]	183
LAYout:REPLace[:WINDow]	183
LAYout:SPLitter	183
LAYout:WINDow<n>:ADD?	185
LAYout:WINDow<n>:IDENtify?	185
LAYout:WINDow<n>:REMOve	186
LAYout:WINDow<n>:REPLace	186
LAYout:WINDow<n>:TYPE	187

LAYout:ADD[:WINDow]? <WindowName>, <Direction>, <WindowType>

This command adds a window to the display in the active channel setup.

This command is always used as a query so that you immediately obtain the name of the new window as a result.

To replace an existing window, use the `LAYout:REPLace[:WINDow]` command.

Query parameters:

<WindowName>	String containing the name of the existing window the new window is inserted next to. By default, the name of a window is the same as its index. To determine the name and index of all active windows, use the <code>LAYout:CATalog[:WINDow]?</code> query.
<Direction>	LEFT RIGHT ABOVE BELOW Direction the new window is added relative to the existing window.
<WindowType>	text value Type of result display (evaluation method) you want to add. See the table below for available parameter values.

Return values:

<NewWindowName> When adding a new window, the command returns its name (by default the same as its number) as a result.

Example: `LAY:ADD? '1',BEL,'XTIM:AM:RElative[:TDOMain]'`
Adds an "AM Time Domain" display below window 1.

Usage: Query only

Manual operation: See "AM Time Domain" on page 15
 See "FM Time Domain" on page 16
 See "PM Time Domain" on page 17
 See "AM Spectrum" on page 18
 See "FM Spectrum" on page 19
 See "PM Spectrum" on page 20
 See "RF Time Domain" on page 21
 See "RF Spectrum" on page 22
 See "Result Summary" on page 23
 See "Marker Table" on page 25
 See "Marker Peak List" on page 25

Table 11-3: <WindowType> parameter values for AnalogDemod application

Parameter value	Window type
MTABle	"Marker table"
PEAKlist	"Marker peak list"
RSUMmary	"Result summary"
'XTIM:AM'	"RF Time Domain" (= RF power)
'XTIM:AM:RELative'	"AM Time Domain"
'XTIM:AM:RELative:AFSPec-trum'	"AM Spectrum"
'XTIM:FM'	"FM Time Domain"
'XTIM:FM:AFSPpectrum'	"FM Spectrum"
'XTIM:PM'	"PM Time Domain"
'XTIM:PM:AFSPpectrum'	"PM Spectrum"
'XTIM:SPECTrum'	"RF Spectrum"

LAYout:CATalog[:WINDow]?

This command queries the name and index of all active windows in the active channel setup from top left to bottom right. The result is a comma-separated list of values for each window, with the syntax:

<WindowName_1>,<WindowIndex_1>..<WindowName_n>,<WindowIndex_n>

Return values:

<WindowName> string
 Name of the window.
 In the default state, the name of the window is its index.

<WindowIndex> **numeric value**
 Index of the window.

Example: LAY:CAT?
 Result:
 '2',2,'1',1
 Two windows are displayed, named '2' (at the top or left), and '1' (at the bottom or right).

Usage: Query only

LAYout:IDENtify[:WINDow]? <WindowName>

This command queries the **index** of a particular display window in the active channel setup.

Note: to query the **name** of a particular window, use the [LAYout:WINDow<n>:IDENtify?](#) query.

Query parameters:

<WindowName> String containing the name of a window.

Return values:

<WindowIndex> Index number of the window.

Example: LAY:IDEN:WIND? '2'
 Queries the index of the result display named '2'.
 Response:
 2

Usage: Query only

LAYout:MOVE[:WINDow] <WindowName>, <WindowName>, <Direction>

Setting parameters:

<WindowName> String containing the name of an existing window that is to be moved.
 By default, the name of a window is the same as its index. To determine the name and index of all active windows in the active channel setup, use the [LAYout:CATalog\[:WINDow\]?](#) query.

<WindowName> String containing the name of an existing window the selected window is placed next to or replaces.
 By default, the name of a window is the same as its index. To determine the name and index of all active windows in the active channel setup, use the [LAYout:CATalog\[:WINDow\]?](#) query.

<Direction> LEFT | RIGHT | ABOVE | BELOW | REPLACE
 Destination the selected window is moved to, relative to the reference window.

Example: LAY:MOVE '4','1',LEFT
 Moves the window named '4' to the left of window 1.

Example: `LAY:MOVE '1','3',REPL`
Replaces the window named '3' by window 1. Window 3 is deleted.

Usage: Setting only

LAYout:REMove[:WINDow] <WindowName>

This command removes a window from the display in the active channel.

Setting parameters:

<WindowName> String containing the name of the window. In the default state, the name of the window is its index.

Example: `LAY:REM '2'`
Removes the result display in the window named '2'.

Usage: Setting only

LAYout:REPLace[:WINDow] <WindowName>,<WindowType>

This command replaces the window type (for example from "Diagram" to "Result Summary") of an already existing window in the active channel setup while keeping its position, index and window name.

To add a new window, use the `LAYout:ADD[:WINDow]?` command.

Setting parameters:

<WindowName> String containing the name of the existing window.
By default, the name of a window is the same as its index. To determine the name and index of all active windows in the active channel setup, use the `LAYout:CATalog[:WINDow]?` query.

<WindowType> Type of result display you want to use in the existing window.
See `LAYout:ADD[:WINDow]?` on page 180 for a list of available window types.

Example: `LAY:REPL:WIND '1',MTAB`
Replaces the result display in window 1 with a marker table.

Usage: Setting only

LAYout:SPLitter <Index1>, <Index2>, <Position>

This command changes the position of a splitter and thus controls the size of the windows on each side of the splitter.

Note that windows must have a certain minimum size. If the position you define conflicts with the minimum size of any of the affected windows, the command does not work, but does not return an error.

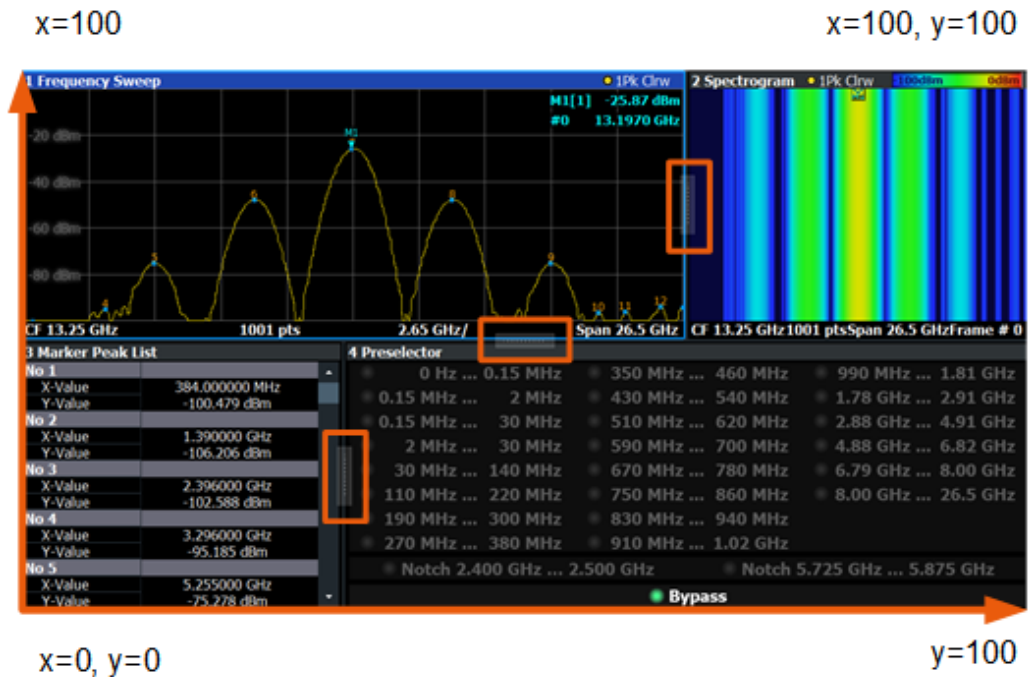

Figure 11-1: SmartGrid coordinates for remote control of the splitters

Setting parameters:

- <Index1> The index of one window the splitter controls.
- <Index2> The index of a window on the other side of the splitter.
- <Position> New vertical or horizontal position of the splitter as a fraction of the screen area (without channel and status bar and softkey menu).
The point of origin (x = 0, y = 0) is in the lower left corner of the screen. The end point (x = 100, y = 100) is in the upper right corner of the screen. (See Figure 11-1.)
The direction in which the splitter is moved depends on the screen layout. If the windows are positioned horizontally, the splitter also moves horizontally. If the windows are positioned vertically, the splitter also moves vertically.

Range: 0 to 100

Example:

LAY:SPL 1,3,50

Moves the splitter between window 1 ("Frequency Sweep") and 3 ("Marker Table") to the center (50%) of the screen, i.e. in the figure above, to the left.

Example: `LAY:SPL 1,4,70`
 Moves the splitter between window 1 ('Frequency Sweep') and 3 ('Marker Peak List') towards the top (70%) of the screen. The following commands have the exact same effect, as any combination of windows above and below the splitter moves the splitter vertically.

`LAY:SPL 3,2,70`
`LAY:SPL 4,1,70`
`LAY:SPL 2,1,70`

Usage: Setting only

LAYout:WINDow<n>:ADD? <Direction>,<WindowType>

This command adds a measurement window to the display. Note that with this command, the suffix <n> determines the existing window next to which the new window is added. Unlike [LAYout:ADD\[:WINDow\]?](#), for which the existing window is defined by a parameter.

To replace an existing window, use the [LAYout:WINDow<n>:REPLace](#) command.

This command is always used as a query so that you immediately obtain the name of the new window as a result.

Suffix:

<n> [Window](#)

Query parameters:

<Direction> LEFT | RIGHT | ABOVE | BELOW

<WindowType> Type of measurement window you want to add.
 See [LAYout:ADD\[:WINDow\]?](#) on page 180 for a list of available window types.

Return values:

<NewWindowName> When adding a new window, the command returns its name (by default the same as its number) as a result.

Example: `LAY:WIND1:ADD? LEFT,MTAB`
Result:
 '2'
 Adds a new window named '2' with a marker table to the left of window 1.

Usage: Query only

LAYout:WINDow<n>:IDENTify?

This command queries the **name** of a particular display window (indicated by the <n> suffix) in the active channel setup.

Note: to query the **index** of a particular window, use the [LAYout:IDENTify\[:WINDow\]?](#) command.

Suffix:	
<n>	Window
Return values:	
<WindowName>	String containing the name of a window. In the default state, the name of the window is its index.
Example:	LAY:WIND2:IDEN? Queries the name of the result display in window 2. Response: '2'
Usage:	Query only

LAYout:WINDow<n>:REMove

This command removes the window specified by the suffix <n> from the display in the active channel setup.

The result of this command is identical to the [LAYout:REMove\[:WINDow\]](#) command.

Suffix:	
<n>	Window
Example:	LAY:WIND2:REM Removes the result display in window 2.
Usage:	Event

LAYout:WINDow<n>:REPLace <WindowType>

This command changes the window type of an existing window (specified by the suffix <n>) in the active channel setup.

The effect of this command is identical to the [LAYout:REPLace\[:WINDow\]](#) command.

To add a new window, use the [LAYout:WINDow<n>:ADD?](#) command.

Suffix:	
<n>	Window
Setting parameters:	
<WindowType>	Type of measurement window you want to replace another one with. See LAYout:ADD[:WINDow]? on page 180 for a list of available window types.
Example:	LAY:WIND2:REPL MTAB Replaces the result display in window 2 with a marker table.
Usage:	Setting only

LAYout:WINDow<n>:TYPE <WindowType>

Queries or defines the window type of the window specified by the index <n>. The window type determines which results are displayed. For a list of possible window types, see [LAYout:ADD\[:WINDow\]?](#) on page 180.

Note that this command is not available in all applications and measurements.

Suffix:

<n> 1..n
Window

Parameters:

<WindowType>

Example: LAY:WIND2:TYPE?

11.7 Retrieving results

The following remote commands are required to retrieve the results from an Analog Modulation Analysis in a remote environment.



In the Analog Modulation Analysis when you configure the traces for a window with a specific evaluation (e.g. AM time domain), the traces in all windows with the same evaluation are configured identically.

Specific commands:

- [Retrieving trace results](#)..... 187
- [Exporting trace results](#)..... 190
- [Retrieving result summary values](#)..... 192
- [Formats for returned values: ASCII format and binary format](#)..... 197
- [Reference: ASCII file export format](#)..... 197

11.7.1 Retrieving trace results

The following remote commands are required to retrieve the trace results in a remote environment.

[SENSe:]ADEMod:ACV:AFSPectrum:RESult?	188
[SENSe:]ADEMod:ACV[:TDOMain]:RESult?	188
[SENSe:]ADEMod:AM[:ABSolute]:AFSPectrum:RESult?	188
[SENSe:]ADEMod:AM[:ABSolute][:TDOMain]:RESult?	188
[SENSe:]ADEMod:AM:RELative:AFSPectrum:RESult?	188
[SENSe:]ADEMod:AM:RELative[:TDOMain]:RESult?	188
[SENSe:]ADEMod:FM:AFSPectrum:RESult?	188
[SENSe:]ADEMod:FM[:TDOMain]:RESult?	188
[SENSe:]ADEMod:PM:AFSPectrum:RESult?	188
[SENSe:]ADEMod:PM[:TDOMain]:RESult?	188

[SENSe:]ADEMod:SPECTrum:RESult?.....	188
FORMat[:DATA].....	189
FORMat:DEXPort:FORMat.....	190
TRACe<n>[:DATA].....	190

[SENSe:]ADEMod:ACV:AFSPectrum:RESult? <TraceMode>
[SENSe:]ADEMod:ACV[:TDOMain]:RESult? <TraceMode>
[SENSe:]ADEMod:AM[:ABSolute]:AFSPectrum:RESult? <TraceMode>
[SENSe:]ADEMod:AM[:ABSolute][:TDOMain]:RESult? <TraceMode>
[SENSe:]ADEMod:AM:RELative:AFSPectrum:RESult? <TraceMode>
[SENSe:]ADEMod:AM:RELative[:TDOMain]:RESult? <TraceMode>
[SENSe:]ADEMod:FM:AFSPectrum:RESult? <TraceMode>
[SENSe:]ADEMod:FM[:TDOMain]:RESult? <TraceMode>
[SENSe:]ADEMod:PM:AFSPectrum:RESult? <TraceMode>
[SENSe:]ADEMod:PM[:TDOMain]:RESult? <TraceMode>
[SENSe:]ADEMod:SPECTrum:RESult? <TraceMode>

This command reads the result data of the evaluated signal in the specified trace mode. The data format of the output data block is defined by the FORMat command (see FORMat [: DATA] on page 189).

The trace results are configured for a specific evaluation. The following table indicates which command syntax refers to which evaluation method, as well as the output unit of the results.

Command syntax	Evaluation method	Output unit
ACV[:TDOMain]	AC-Video time domain	V
ACV:AFSPectrum	AC-Video spectrum	V
AM[:ABSolute][:TDOMain]	RF time domain	dBm
AM:RELative[:TDOMain]	AM time domain	%
AM:RELative:AFSPectrum	AM spectrum	%
FM[:TDOMain]	FM time domain	kHz
FM:AFSPectrum	FM spectrum	kHz
PM[:TDOMain]	PM time domain	rad or °
PM:AFSPectrum	PM spectrum	rad or °
SPECTrum	RF spectrum	dBm (logarithmic display) or V (linear display).

Query parameters:

<TraceMode> WRITe | AVERage | MAXHold | MINHold

Return values:

<TraceModeResult> The specified trace mode must be one of those configured by SENS:ADEM:<Evaluation>:TYPE, see [SENSe:]ADEMod:SPECTrum[:TYPE] on page 211. Otherwise a query error is generated.

Example:

```

ADEM:AM AVER,MAXH,MINH
Sets up RF time domain results to be measured
INIT; *WAI
Starts measurement and waits for sync
FORM ASC
Selects output format
ADEM:AM:RES? AVER
Reads RF time domain average results
ADEM:AM:RES? MAXH
Reads RF time domain max hold results
ADEM:AM:RES? MINH
Reads RF time domain min hold results

```

Usage: Query only

FORMat[:DATA] <Format>[, <BitLength>]

This command selects the data format that is used for transmission of trace data from the R&S FPL1000 to the controlling computer.

Note that the command has no effect for data that you send to the R&S FPL1000. The R&S FPL1000 automatically recognizes the data it receives, regardless of the format.

Parameters:

<Format>

ASCii

ASCII format, separated by commas.

This format is almost always suitable, regardless of the actual data format. However, the data is not as compact as other formats can be.

REAL

Floating-point numbers (according to IEEE 754) in the "definite length block format".

In the Spectrum application, the format setting `REAL` is used for the binary transmission of trace data.

<BitLength>

Length in bits for floating-point results

16

16-bit floating-point numbers.

Compared to `REAL, 32` format, half as many numbers are returned.

32

32-bit floating-point numbers

For I/Q data, 8 bytes per sample are returned for this format setting.

64

64-bit floating-point numbers

Compared to `REAL, 32` format, twice as many numbers are returned.

Example:

```
FORM REAL, 32
```

FORMat:DEXPort:FORMat <FileFormat>

Determines the format of the ASCII file to be imported or exported. Depending on the external program that creates the data file or evaluates it, a comma-separated list (CSV) or a plain data format (DAT) file is required.

Parameters:

<FileFormat> CSV | DAT
 *RST: DAT

Example: FORM:DEXP:FORM CSV

Manual operation: See "File Type" on page 88

TRACe<n>[:DATA]

This command queries current trace data and measurement results.

The data format depends on [FORMat \[:DATA\]](#) on page 189.

Suffix:

<n> [Window](#)

Query parameters:

<ResultType> Selects the type of result to be returned.

TRACE1 | ... | TRACE6

Returns the trace data for the corresponding trace.

The trace data consists of a list of measured power levels. The number of power levels in the list depends on the currently selected number of sweep points. The unit depends on the measurement and on the configured unit.

For the auto peak detector, the command returns positive peak values only. (To retrieve negative peak values, define a second trace with a negative peak detector.)

Example: TRAC? TRACE3
 Queries the data of trace 3.

11.7.2 Exporting trace results

Trace results can be exported to a file.

For more commands concerning data and results storage, see the R&S FPL1000 User Manual.

FORMat:DEXPort:DSEPARATOR	191
FORMat:DEXPort:HEADER	191
FORMat:DEXPort:TRACES	191
MMEMory:STORE<n>:SPECTrogram	192
MMEMory:STORE<n>:TRACe	192

FORMat:DEXPort:DSEParator <Separator>

This command selects the decimal separator for data exported in ASCII format.

Parameters:

<Separator> POINT | COMMa

COMMa

Uses a comma as decimal separator, e.g. 4,05.

POINT

Uses a point as decimal separator, e.g. 4.05.

*RST: *RST has no effect on the decimal separator.
Default is POINT.

Example:

FORM:DEXP:DSEP POIN

Sets the decimal point as separator.

Manual operation: See "[Decimal Separator](#)" on page 88
See "[Export Peak List](#)" on page 108

FORMat:DEXPort:HEADer <State>

If enabled, additional instrument and measurement settings are included in the header of the export file for result data. If disabled, only the pure result data from the selected traces and tables is exported.

See [Chapter 11.7.5, "Reference: ASCII file export format"](#), on page 197 for details.

Parameters:

<State> ON | OFF | 0 | 1

*RST: 1

Manual operation: See "[Include Instrument & Measurement Settings](#)" on page 87

FORMat:DEXPort:TRACes <Selection>

This command selects the data to be included in a data export file (see [MMEMory:STORe<n>:TRACe](#) on page 192).

Parameters:

<Selection> SINGLE | ALL

SINGLE

Only a single trace is selected for export, namely the one specified by the [MMEMory:STORe<n>:TRACe](#) command.

ALL

Selects all active traces and result tables (e.g. "Result Summary", marker peak list etc.) in the current application for export to an ASCII file.

The <trace> parameter for the [MMEMory:STORe<n>:TRACe](#) command is ignored.

*RST: SINGLE

Manual operation: See ["Export all Traces and all Table Results"](#) on page 87

MMEMory:STORe<n>:SPECTrogram <FileName>

This command exports spectrogram data to an ASCII file.

The file contains the data for every frame in the history buffer. The data corresponding to a particular frame begins with information about the frame number and the time that frame was recorded.

Note that, depending on the size of the history buffer, the process of exporting the data can take a while.

Suffix:

<n> [Window](#)

Parameters:

<FileName> String containing the path and name of the target file.

Example:

```
MMEM:STOR:SGR 'Spectrogram'
Copies the spectrogram data to a file.
```

MMEMory:STORe<n>:TRACe <Trace>, <FileName>

This command exports trace data from the specified window to an ASCII file.

Suffix:

<n> [Window](#)

Parameters:

<Trace> Number of the trace to be stored
(This parameter is ignored if the option "Export all Traces and all Table Results" is activated in the Export configuration settings, see [FORMat:DEXPort:TRACes](#) on page 191).

<FileName> String containing the path and name of the target file.

Example:

```
MMEM:STOR1:TRAC 1, 'C:\TEST.ASC'
Stores trace 1 from window 1 in the file TEST.ASC.
```

Manual operation: See ["Export Trace to ASCII File"](#) on page 88

11.7.3 Retrieving result summary values

The result summary contains measurement values that are calculated from the trace data.

For details see ["Result Summary"](#) on page 23.

CALCulate<n>:MARKer<m>:FUNCTion:ADEMod:AFRequency[:RESult<t>]?	193
CALCulate<n>:MARKer<m>:FUNCTion:ADEMod:AM[:RESult<t>]?	193
CALCulate<n>:MARKer<m>:FUNCTion:ADEMod:FM[:RESult<t>]?	193
CALCulate<n>:MARKer<m>:FUNCTion:ADEMod:PM[:RESult<t>]?	193
CALCulate<n>:MARKer<m>:FUNCTion:ADEMod:AM[:RESult<t>]:RELative?	194

CALCulate<n>:MARKer<m>:FUNcTion:ADEMod:FM[:RESult<t>]:RELative?.....	194
CALCulate<n>:MARKer<m>:FUNcTion:ADEMod:PM[:RESult<t>]:RELative?.....	194
CALCulate<n>:MARKer<m>:FUNcTion:ADEMod:CARRier[:RESult<t>]?.....	195
CALCulate<n>:MARKer<m>:FUNcTion:ADEMod:DISTortion[:WRITe]:RESult<t>?.....	195
CALCulate<n>:MARKer<m>:FUNcTion:ADEMod:FERRor[:RESult<t>]?.....	195
CALCulate<n>:MARKer<m>:FUNcTion:ADEMod:SINad:RESult<t>?.....	196
CALCulate<n>:MARKer<m>:FUNcTion:ADEMod:THD:RESult<t>?.....	196
[SENSe:]ADEMod:SETTling:TIME:RESult<t>?.....	196

CALCulate<n>:MARKer<m>:FUNcTion:ADEMod:AFRequency[:RESult<t>]?

This command queries the modulation (audio) frequency for the demodulation method in the specified window.

Suffix:

<n>	Window
<m>	irrelevant
<t>	Trace

Return values:

<ModFreq>	Modulation frequency in Hz.
-----------	-----------------------------

Usage: Query only

CALCulate<n>:MARKer<m>:FUNcTion:ADEMod:AM[:RESult<t>]? <MeasType>

CALCulate<n>:MARKer<m>:FUNcTion:ADEMod:FM[:RESult<t>]? <MeasType>

CALCulate<n>:MARKer<m>:FUNcTion:ADEMod:PM[:RESult<t>]? <MeasType>

This command queries the current value of the demodulated signal for the specified trace (as displayed in the "Result Summary" in manual operation).

Note that all windows with the same evaluation method have the same traces, thus the window is irrelevant.

Suffix:

<n>	Window
<m>	irrelevant
<t>	Trace

Query parameters:

<MeasType>	PPEak MPEak MIDDLE RMS
------------	------------------------------

PPEak

Positive peak (+PK)

MPEak | NPEak

Negative peak (-PK)

MIDDLE

Average of positive and negative peaks $\pm PK/2$

RMS

Root mean square value

Return values:

<MeasTypeResult>

Example:

CALC:FEED 'XTIM:PM:TDOM'

Switches on the PM time domain result display.

DISP:TRAC ON

Switches on the trace.

CALC:MARK:FUNC:ADEM:PM? PPE

Queries the peak value of the demodulated PM trace.

Usage:

Query only

CALCulate<n>:MARKer<m>:FUNCTION:ADEMod:AM[:RESult<t>]:RELative?
 <MeasType>

CALCulate<n>:MARKer<m>:FUNCTION:ADEMod:FM[:RESult<t>]:RELative?
 <MeasType>

CALCulate<n>:MARKer<m>:FUNCTION:ADEMod:PM[:RESult<t>]:RELative?
 <MeasType>

This command queries the current *relative* value of the demodulated signal for the specified trace (as displayed in the "Result Summary" in manual operation).

Note that all windows with the same evaluation method have the same traces.

The unit of the results depends on the `CONFigure:ADEMod:RESults:UNIT` setting.

Suffix:

<n> irrelevant

<m> irrelevant

<t> [Trace](#)**Query parameters:**

<MeasType>

PPEak

Positive peak (+PK)

MPEak | NPEak

Negative peak (-PK)

MIDDLEAverage of positive and negative peaks \pm PK/2**RMS**

Root mean square value

Return values:

<MeasTypeResult>

Example:

CALC:FEED 'XTIM:PM:TDOM'

Switches on the PM time domain result display.

DISP:TRAC ON

Switches on the trace.

CALC:MARK:FUNC:ADEM:PM? PPE

Queries the peak value of the demodulated PM trace.

Usage:

Query only

CALCulate<n>:MARKer<m>:FUNCTION:ADEMod:CARRier[:RESult<t>]?

This command queries the carrier power, which is determined from the Clr/Write data.

Suffix:

<n>	Window
<m>	irrelevant
<t>	Trace

Return values:

<CPower> Power of the carrier without modulation in dBm.

Usage: Query only

CALCulate<n>:MARKer<m>:FUNCTION:ADEMod:DISToRTion[:WRITe]:RESult<t>?

This command queries the result of the modulation distortion measurement in the specified window for the specified trace.

Note that this value is only calculated if an AF Spectrum window is displayed.

Suffix:

<n>	Window
<m>	irrelevant
<t>	Trace

Return values:

<DISTORT> numeric value
Modulation distortion in percent.
Default unit: %

Usage: Query only

CALCulate<n>:MARKer<m>:FUNCTION:ADEMod:FERRor[:RESult<t>]?

This command queries the carrier offset (= frequency error) for FM and PM demodulation. The carrier offset is determined from the current measurement data (CLR/ WRITE). The modulation is removed using low pass filtering.

Suffix:

<n>	Window
<m>	irrelevant
<t>	Trace

Return values:

<CarrOffset> The deviation of the calculated carrier frequency to the ideal carrier frequency in Hz.

Usage: Query only

CALCulate<n>:MARKer<m>:FUNCTION:ADEMod:SINad:RESult<t>?

This command queries the result of the signal-to-noise-and-distortion (SINAD) measurement in the specified window for the specified trace.

Note that this value is only calculated if an AF Spectrum window is displayed.

Suffix:

<n> [Window](#)

<m> irrelevant

<t> [Trace](#)

Return values:

<SINAD> The signal-to-noise-and-distortion ratio in dB.

Usage: Query only

CALCulate<n>:MARKer<m>:FUNCTION:ADEMod:THD:RESult<t>?

This command queries the result of the total harmonic distortion (THD) measurement in the specified window.

Note that this value is only calculated if an AF Spectrum window is displayed.

Suffix:

<n> [Window](#)

<m> irrelevant

<t> [Trace](#)

Return values:

<THD> Total harmonic distortion of the demodulated signal in dB.

Usage: Query only

[SENSe:]ADEMod:SETTling:TIME:RESult<t>?

Returns the settling time after which the signal remains within a specified target corridor. The settling time is evaluated for the selected trace in each time domain window. The value is only determined for `[SENSe:]ADEMod:SETTling:TIME:STATeON`.

For details, see [Chapter 5.7.7, "Settling time"](#), on page 71.

Suffix:

<t> 1..n
[Trace](#)

Return values:

<Time> Default unit: s

Example:

```
ADEM:SETT:TIME:RES2?
//Result: 29.950000us
After 29.95 us, the signal is settled.
```

- Usage:** Query only
- Manual operation:** See "State" on page 72

11.7.4 Formats for returned values: ASCII format and binary format

When trace data is retrieved using the `TRAC:DATA` or `TRAC:IQ:DATA` command, the data is returned in the format defined using the `FORMat[:DATA]` on page 189. The possible formats are described here.

- **ASCII Format (FORMat ASCII):**
The data is stored as a list of comma-separated values (CSV) of the measured values in floating point format.
- **Binary Format (FORMat REAL,16/32/64):**
The data is stored as binary data (definite length block data according to IEEE 488.2), each measurement value being formatted in 16-bit/32-bit/64-bit IEEE 754 floating-point-format.
The schema of the result string is as follows:
#<Length of length><Length of data><value1><value2>...<value n>
with:

<Length of length>	Number of digits of the following number of data bytes
<Length of data>	Number of following data bytes
<Value>	2-byte/4-byte/8-byte floating point value

Example: #41024<Data>... contains 1024 data bytes

Data blocks larger than 999,999,999 bytes

According to SCPI, the header of the block data format allows for a maximum of 9 characters to describe the data length. Thus, the maximum REAL 32 data that can be represented is 999,999,999 bytes. However, the R&S FPL1000 is able to send larger data blocks. In this case, the length of the data block is placed in brackets, e.g.
(1234567890) <value1><value2>...



Reading out data in binary format is quicker than in ASCII format. Thus, binary format is recommended for large amounts of data.

11.7.5 Reference: ASCII file export format

Trace data can be exported to a file in ASCII format for further evaluation in other applications. This reference describes in detail the format of the export files for result data.

The file consists of the header containing important scaling parameters and a data section containing the trace data. Optionally, the header can be excluded from the file (see "Include Instrument & Measurement Settings" on page 87).

The data of the file header consist of three columns, each separated by a semicolon: parameter name; numeric value; basic unit. The data section starts with the keyword "Trace <n>" (<n> = number of stored trace). The measured data follows in one or several columns (depending on the measurement), which are also separated by a semicolon.

The results are output in the same order as they are displayed on the screen: window by window, trace by trace, and table row by table row.

Generally, the format of this ASCII file can be processed by spreadsheet calculation programs, e.g. MS-Excel. Different language versions of evaluation programs can require a different handling of the decimal point. Thus, you can define the decimal separator to use (decimal point or comma, see "[Decimal Separator](#)" on page 88).

Table 11-4: ASCII file format for trace export in the Spectrum application

File contents	Description
Header data	
Type;R&S FPL1000;	Instrument model
Version;1.00;	Firmware version
Date;01.Oct 2006;	Date of data set storage
Mode;ANALYZER;	Operating mode
Preamplifier;OFF	Preamplifier status
Transducer; OFF	Transducer status
Center Freq;55000;Hz	Center frequency
Freq Offset;0;Hz	Frequency offset
Start;10000;Hz Stop;100000;Hz	Start/stop of the display range. Unit: Hz for span > 0, s for span = 0, dBm/dB for statistics measurements
Span;90000;Hz	Frequency range (0 Hz in zero span and statistics measurements)
Ref Level;-30;dBm	Reference level
Level Offset;0;dB	Level offset
Rf Att;20;dB	Input attenuation
EI Att;2.0;dB	Electrical attenuation
RBW;100000;Hz	Resolution bandwidth
VBW;30000;Hz	Video bandwidth
SWT;0.005;s	Sweep time
Sweep Count;20;	Number of sweeps set
Ref Position;75;%	Position of reference level referred to diagram limits (0 % = lower edge)
Level Range;100;dB	Display range in y direction. Unit: dB with x-axis LOG, % with x-axis LIN

File contents	Description
x-Axis;LIN;	Scaling of x-axis linear (LIN) or logarithmic (LOG)
y-Axis;LOG;	Scaling of y-axis linear (LIN) or logarithmic (LOG)
x-Unit;Hz;	Unit of x values: Hz with span > 0; s with span = 0; dBm/dB with statistics measurements
y-Unit;dBm;	Unit of y values: dB*/V/A/W depending on the selected unit with y-axis LOG or % with y-axis LIN
Data section for individual window	
Window;1;Frequency Sweep	Window number and name
Trace 1;;	Selected trace
Trace Mode;AVERAGE;	Display mode of trace: CLR/WRITE,AVERAGE,MAXHOLD,MINHOLD
Detector;AUTOPEAK;	Selected detector
Values; 1001;	Number of measurement points
10000;-10.3;-15.7 10130;-11.5;-16.9 10360;-12.0;-17.4 ...;...;	Measured values: <x value>, <y1>, <y2>; <y2> being available only with detector AUTOPEAK and containing in this case the smallest of the two measured values for a measurement point.
Data section for individual trace	
Trace 2;;	Next trace in same window
...	
Data section for individual window	
Window;2 ..;	Name of next window
Data section for individual trace	
Trace 1;;	First trace
...	

11.8 Analyzing results

The following remote commands are required to configure general result analysis settings concerning the trace, markers, lines etc. in a remote environment. They are identical to the analysis functions in the base unit except for some special marker functions and spectrograms, which are not available in the R&S FPL1-K7 AM/FM/PM Modulation Analysis application.

More details are described for manual operation in [Chapter 6, "Analysis"](#), on page 77.

• Configuring spectrograms.....	200
• Configuring standard traces.....	208
• Working with markers remotely.....	214
• Marker search (spectrograms).....	248
• Defining limit checks.....	258

11.8.1 Configuring spectrograms

In addition to the standard "level versus frequency" or "level versus time" spectrum traces, the R&S FPL1000 also provides a spectrogram display of the measured data. A spectrogram shows how the spectral density of a signal varies over time. The x-axis shows the frequency, the y-axis shows the time. The commands required to configure spectrograms in a remote environment are described here. For details and manual operation see [Chapter 6.2, "Spectrogram settings"](#), on page 81.



When configuring spectrograms, the window suffix is irrelevant. The settings are always applied to the spectrogram window, or to all spectrogram windows, if several are active for the same channel setup.

For commands to set markers in spectrograms, see [Chapter 11.8.3.3, "Marker search \(spectrograms\)"](#), on page 223.

11.8.1.1	Configuring a spectrogram measurement.....	200
11.8.1.2	Configuring the color map.....	206

11.8.1.1 Configuring a spectrogram measurement

CALCulate<n>:SGRam:CLEAr[:IMMediate].....	201
CALCulate<n>:SPECtrogram:CLEAr[:IMMediate].....	201
CALCulate<n>:SGRam:CONTInuous.....	201
CALCulate<n>:SPECtrogram:CONTInuous.....	201
CALCulate<n>:SGRam:FRAMe:COUNT.....	201
CALCulate<n>:SPECtrogram:FRAMe:COUNT.....	201
CALCulate<n>:SGRam:FRAMe:SELEct.....	202
CALCulate<n>:SPECtrogram:FRAMe:SELEct.....	202
CALCulate<n>:SGRam:HDEPth.....	202
CALCulate<n>:SPECtrogram:HDEPth.....	202
CALCulate<n>:SGRam:LAYout.....	203
CALCulate<n>:SPECtrogram:LAYout.....	203
CALCulate<n>:SGRam[:STATe].....	203
CALCulate<n>:SPECtrogram[:STATe].....	203
CALCulate<n>:SGRam:THReedim[:STATe].....	204
CALCulate<n>:SPECtrogram:THReedim[:STATe].....	204
CALCulate<n>:SGRam:TRACe.....	204
CALCulate<n>:SPECtrogram:TRACe.....	204
CALCulate<n>:SGRam:TSTamp:DATA?.....	204
CALCulate<n>:SPECtrogram:TSTamp:DATA?.....	204

CALCulate<n>:SGRam:TSTamp[:STATE].....	205
CALCulate<n>:SPECtrogram:TSTamp[:STATE].....	205

CALCulate<n>:SGRam:CLEar[:IMMediate]**CALCulate<n>:SPECtrogram:CLEar[:IMMediate]**

This command resets the spectrogram and clears the history buffer.

Suffix:

<n> [Window](#)

Example:

```
//Reset the result display and clear the memory
CALC:SGR:CLE
```

Manual operation: See "[Clear Spectrogram](#)" on page 53

CALCulate<n>:SGRam:CONTInuous <State>**CALCulate<n>:SPECtrogram:CONTInuous <State>**

This command determines whether the results of the last measurement are deleted before starting a new measurement in single sweep mode.

This setting applies to all spectrograms in the channel setup.

Suffix:

<n> [Window](#)

Parameters:

<State> ON | OFF | 0 | 1

OFF | 0

Switches the function off

ON | 1

Switches the function on

Example:

```
INIT:CONT OFF
```

Selects single sweep mode.

```
INIT;*WAI
```

Starts the sweep and waits for the end of the sweep.

```
CALC:SGR:CONT ON
```

Repeats the single sweep measurement without deleting the results of the last measurement.

Manual operation: See "[Continue Frame](#)" on page 53

CALCulate<n>:SGRam:FRAME:COUNT <Frames>**CALCulate<n>:SPECtrogram:FRAME:COUNT <Frames>**

This command defines the number of frames to be recorded in a single sweep.

This value applies to all spectrograms in the channel setup.

Suffix:

<n> [Window](#)

Parameters:

<Frames> The maximum number of frames depends on the history depth.
 Range: 1 to history depth
 Increment: 1
 *RST: 1

Example:

```
//Select single sweep mode
INIT:CONT OFF
//Set the number of frames to 200
CALC:SGR:FRAM:COUN 200
```

Manual operation: See "[Frame Count](#)" on page 53

CALCulate<n>:SGRam:FRAMe:SElect <Frame> | <Time>

CALCulate<n>:SPECTrogram:FRAMe:SElect <Frame> | <Time>

This command selects a specific frame for further analysis.

The command is available if no measurement is running or after a single sweep has ended.

Suffix:

<n> [Window](#)

Parameters:

<Frame> Selects a frame directly by the frame number. Valid if the time stamp is off.
 The range depends on the history depth.
 Default unit: S

<Time> Selects a frame via its time stamp. Valid if the time stamp is on.
 The number is the distance to frame 0 in seconds. The range depends on the history depth.

Example:

```
INIT:CONT OFF
Stop the continuous sweep.
CALC:SGR:FRAM:SEL -25
Selects frame number -25.
```

Manual operation: See "[Select Frame](#)" on page 53

CALCulate<n>:SGRam:HDEPth <History>

CALCulate<n>:SPECTrogram:HDEPth <History>

This command defines the number of frames to be stored in the R&S FPL1000 memory.

Suffix:

<n> [Window](#)

Parameters:

<History> The maximum number of frames depends on the number of sweep points.

Range: 781 to 20000

Increment: 1

*RST: 3000

Example:

//Set the history depth to 1500

CALC:SGR:SPEC 1500

Manual operation: See "[History Depth](#)" on page 83

CALCulate<n>:SGRam:LAYout <State>

CALCulate<n>:SPECtrogram:LAYout <State>

This command selects the state and size of spectrograms.

The command is available for result displays that support spectrograms.

Suffix:

<n> [Window](#)

Parameters:

<State>

ON

Spectrogram and trace diagram share a window.

OFF

Only the trace diagram is displayed, the spectrogram is not.

*RST: OFF

Example:

CALC4:SPEC:LAY FULL

Shows the spectrogram in window 4. The corresponding trace diagram is hidden.

Manual operation: See "[State](#)" on page 82

CALCulate<n>:SGRam[:STATe] <State>

CALCulate<n>:SPECtrogram[:STATe] <State>

This command turns the spectrogram on and off.

Parameters:

<State>

ON | OFF | 0 | 1

OFF | 0

Switches the function off

ON | 1

Switches the function on

Example:

CALC:SGR ON

Activates the Spectrogram result display.

CALCulate<n>:SGRam:THReedim[:STATe] <State>

CALCulate<n>:SPECtrogram:THReedim[:STATe] <State>

Activates or deactivates a 3-dimensional spectrogram for the selected result display.

Suffix:

<n> [Window](#)

Parameters:

<State> ON | OFF | 0 | 1

OFF | 0

Switches the function off

ON | 1

Switches the function on

*RST: 0

Example: CALC:SPEC:THR:STAT ON

Manual operation: See "[3D Spectrogram State](#)" on page 82

CALCulate<n>:SGRam:TRACe <Trace>

CALCulate<n>:SPECtrogram:TRACe <Trace>

This command determines the trace in the result display the Spectrogram is based on.

Suffix:

<n> [Window](#)

Parameters:

<Trace> TRACE1 | TRACE2 | TRACE3 | TRACE4 | TRACE5 | TRACE6

How many traces are available depends on the selected result display.

Example: CALC2:SPEC:TRAC TRACE3

CALCulate<n>:SGRam:TSTamp:DATA? <Frames>

CALCulate<n>:SPECtrogram:TSTamp:DATA? <Frames>

This command queries the starting time of the frames.

The return values consist of four values for each frame. If the "Spectrogram" is empty, the command returns '0,0,0,0'. The times are given as delta values, which simplifies evaluating relative results; however, you can also calculate the absolute date and time as displayed on the screen.

The frame results themselves are returned with TRAC:DATA? SGR

Suffix:

<n> [Window](#)

Query parameters:

<Frames> **CURRent**

Returns the starting time of the current frame.

ALL

Returns the starting time for all frames. The results are sorted in descending order, beginning with the current frame.

Return values:

<Seconds>	Number of seconds that have passed since 01.01.1970 until the frame start
<Nanoseconds>	Number of nanoseconds that have passed <i>in addition to the</i> <Seconds> since 01.01.1970 until the frame start.
<Reserved>	The third value is reserved for future uses.
<Reserved>	The fourth value is reserved for future uses.

Example:

```
CALC:SGR:TST:DATA? ALL
```

Returns the starting times of all frames sorted in a descending order.

Usage:

Query only

Manual operation: See "[Time Stamp](#)" on page 83

CALCulate<n>:SGRam:TSTamp[:STATE] <State>

CALCulate<n>:SPECTrogram:TSTamp[:STATE] <State>

This command activates and deactivates the time stamp.

If the time stamp is active, some commands do not address frames as numbers, but as (relative) time values:

- [CALCulate<n>:DELTaMarker<m>:SPECTrogram:FRAME](#) on page 229
- [CALCulate<n>:MARKer<m>:SPECTrogram:FRAME](#) on page 224
- [CALCulate<n>:SPECTrogram:FRAME:SElect](#) on page 202

Suffix:

<n> 1..n
[Window](#)

Parameters:

<State> ON | OFF | 0 | 1
OFF | 0
Switches the function off
ON | 1
Switches the function on

Example:

```
//Activates the time stamp
CALC:SGR:TST ON
```

Manual operation: See "[Time Stamp](#)" on page 83

11.8.1.2 Configuring the color map

DISPlay[:WINDow<n>]:SGRam:COLor:DEFault.....	206
DISPlay[:WINDow<n>]:SPECTrogram:COLor:DEFault.....	206
DISPlay[:WINDow<n>]:SGRam:COLor:LOWer.....	206
DISPlay[:WINDow<n>]:SPECTrogram:COLor:LOWer.....	206
DISPlay[:WINDow<n>]:SGRam:COLor:SHAPe.....	206
DISPlay[:WINDow<n>]:SPECTrogram:COLor:SHAPe.....	206
DISPlay[:WINDow<n>]:SGRam:COLor:UPPer.....	207
DISPlay[:WINDow<n>]:SPECTrogram:COLor:UPPer.....	207
DISPlay[:WINDow<n>]:SGRam:COLor[:STYLe].....	207
DISPlay[:WINDow<n>]:SPECTrogram:COLor[:STYLe].....	207

DISPlay[:WINDow<n>]:SGRam:COLor:DEFault DISPlay[:WINDow<n>]:SPECTrogram:COLor:DEFault

This command restores the original color map.

Suffix:

<n> Window

Manual operation: See "Set to Default" on page 86

DISPlay[:WINDow<n>]:SGRam:COLor:LOWer <Percentage> DISPlay[:WINDow<n>]:SPECTrogram:COLor:LOWer <Percentage>

This command defines the starting point of the color map.

Suffix:

<n> Window

Parameters:

<Percentage> Statistical frequency percentage.
Range: 0 to 66
*RST: 0
Default unit: %

Example: DISP:WIND:SGR:COL:LOW 10
Sets the start of the color map to 10%.

Manual operation: See "Start / Stop" on page 85

DISPlay[:WINDow<n>]:SGRam:COLor:SHAPe <Shape> DISPlay[:WINDow<n>]:SPECTrogram:COLor:SHAPe <Shape>

This command defines the shape and focus of the color curve for the spectrogram result display.

Suffix:

<n> Window

Parameters:

<Shape> Shape of the color curve.
 Range: -1 to 1
 *RST: 0

Manual operation: See "[Shape](#)" on page 86

DISPlay[:WINDow<n>]:SGRam:COLor:UPPer <Percentage>

DISPlay[:WINDow<n>]:SPECtrogram:COLor:UPPer <Percentage>

This command defines the end point of the color map.

Suffix:

<n> [Window](#)

Parameters:

<Percentage> Statistical frequency percentage.
 Range: 0 to 66
 *RST: 0
 Default unit: %

Example:

DISP:WIND:SGR:COL:UPP 95

Sets the start of the color map to 95%.

Manual operation: See "[Start / Stop](#)" on page 85

DISPlay[:WINDow<n>]:SGRam:COLor[:STYLE] <ColorScheme>

DISPlay[:WINDow<n>]:SPECtrogram:COLor[:STYLE] <ColorScheme>

This command selects the color scheme.

Parameters:

<ColorScheme>

HOT

Uses a color range from blue to red. Blue colors indicate low levels, red colors indicate high ones.

COLD

Uses a color range from red to blue. Red colors indicate low levels, blue colors indicate high ones.

RADar

Uses a color range from black over green to light turquoise with shades of green in between.

GRAYscale

Shows the results in shades of gray.

*RST: HOT

Example:

DISP:WIND:SPEC:COL GRAY

Changes the color scheme of the spectrogram to black and white.

Manual operation: See "[Hot/Cold/Radar/Grayscale](#)" on page 86

11.8.2 Configuring standard traces

Useful commands for trace configuration described elsewhere

- `DISPlay[:WINDow<n>][:SUBWindow<w>]:TRACe<t>:Y:SPACing`
on page 142
- `DISPlay[:WINDow<n>][:SUBWindow<w>]:TRACe<t>:Y[:SCALe]`
on page 139

Remote commands exclusive to trace configuration

<code>DISPlay[:WINDow<n>][:SUBWindow<w>]:TRACe<t>:MODE</code>	208
<code>DISPlay[:WINDow<n>][:SUBWindow<w>]:TRACe<t>:MODE:HCONTinuous</code>	209
<code>DISPlay[:WINDow<n>][:SUBWindow<w>]:TRACe<t>:SELect</code>	210
<code>DISPlay[:WINDow<n>][:SUBWindow<w>]:TRACe<t>[:STATe]</code>	210
<code>[SENSe:]ADEMod:AM:RELative:AFSPectrum[:TYPE]</code>	211
<code>[SENSe:]ADEMod:AM:RELative:TDOMain[:TYPE]</code>	211
<code>[SENSe:]ADEMod:AM:ABSolute:AFSPectrum[:TYPE]</code>	211
<code>[SENSe:]ADEMod:AM:ABSolute[:TDOMain[:TYPE]</code>	211
<code>[SENSe:]ADEMod:FM:AFSPectrum[:TYPE]</code>	211
<code>[SENSe:]ADEMod:FM:TDOMain[:TYPE]</code>	211
<code>[SENSe:]ADEMod:PM:AFSPectrum[:TYPE]</code>	211
<code>[SENSe:]ADEMod:PM:TDOMain[:TYPE]</code>	211
<code>[SENSe:]ADEMod:SPECtrum[:TYPE]</code>	211
<code>[SENSe:]AVERAge<n>:COUNT</code>	212
<code>[SENSe:]AVERAge<n>[:STATe<t>]</code>	212
<code>[SENSe:]AVERAge<n>:TYPE</code>	213
<code>[SENSe:][:WINDow<n>]:DETector<t>[:FUNction]</code>	213
<code>[SENSe:][:WINDow<n>]:DETector<t>[:FUNction]:AUTO</code>	214

`DISPlay[:WINDow<n>][:SUBWindow<w>]:TRACe<t>:MODE <Mode>`

This command selects the trace mode. If necessary, the selected trace is also activated.

For max hold, min hold or average trace mode, you can set the number of single measurements with `[SENSe:]SWEep:COUNT`. Note that synchronization to the end of the measurement is possible only in single sweep mode.

In the R&S FPL1-K7 AM/FM/PM Modulation Analysis application, when you configure the traces for a window with a specific evaluation (e.g. AM time domain), the traces in all windows with the same evaluation are configured identically.

Suffix:

<n>	Window
<w>	subwindow
	Not supported by all applications

<t>

Trace

Parameters:

<Mode>

WRITE

(default:) Overwrite mode: the trace is overwritten by each sweep.

AVERage

The average is formed over several sweeps. The "Sweep/Average Count" determines the number of averaging procedures.

MAXHold

The maximum value is determined over several sweeps and displayed. The R&S FPL1000 saves the sweep result in the trace memory only if the new value is greater than the previous one.

MINHold

The minimum value is determined from several measurements and displayed. The R&S FPL1000 saves the sweep result in the trace memory only if the new value is lower than the previous one.

VIEW

The current contents of the trace memory are frozen and displayed.

BLANK

Hides the selected trace.

*RST: Trace 1: WRITE, Trace 2-6: BLANK

Example:

```
INIT:CONT OFF
```

Switching to single sweep mode.

```
SWE:COUN 16
```

Sets the number of measurements to 16.

```
DISP:TRAC3:MODE WRIT
```

Selects clear/write mode for trace 3.

```
INIT;*WAI
```

Starts the measurement and waits for the end of the measurement.

Manual operation: See "[Trace Mode](#)" on page 78

DISPlay[:WINDow<n>][:SUBWindow<w>]:TRACe<t>:MODE:HCONtinuous
<State>

This command turns an automatic reset of a trace on and off after a parameter has changed.

The reset works for trace modes min hold, max hold and average.

Note that the command has no effect if critical parameters like the span have been changed to avoid invalid measurement results

Suffix:

<n>

Window

<w> subwindow

<t> [Trace](#)

Parameters:

<State> ON | OFF | 0 | 1

OFF | 0

Switches the function off

ON | 1

Switches the function on

Example:

DISP:WIND:TRAC3:MODE:HCON ON

Switches off the reset function.

Manual operation: See "[Hold](#)" on page 80

DISPlay[:WINDow<n>][:SUBWindow<w>]:TRACe<t>:SElect

This command selects the trace specified by the index <t> in the window specified by the index <n>. Only traces that are active in the specified result display can be selected. The selected trace is used to determine the "Result Summary" for the corresponding result display.

The query returns the number of the currently selected trace in the window specified by the index <n> (trace index is ignored). Traces can only be queried for graphical result displays (not "Result Summary", "Marker Table" or Peak Marker List).

Suffix:

<n> [Window](#)

<w> subwindow

<t> irrelevant

Example:

DISP:TRAC3:SEL

DISPlay[:WINDow<n>][:SUBWindow<w>]:TRACe<t>[:STATe] <State>

This command turns a trace on and off.

The measurement continues in the background.

Suffix:

<n> [Window](#)

<w> subwindow
Not supported by all applications

<t> [Trace](#)

Parameters:

<State> ON | OFF | 0 | 1

OFF | 0

Switches the function off

ON | 1

Switches the function on

Example: DISP:TRAC3 ON**Manual operation:** See "[Trace 1/Trace 2/Trace 3/Trace 4/Trace 5/Trace 6](#)" on page 78
See "[Trace 1/ Trace 2/ Trace 3/ Trace 4 \(Softkeys\)](#)" on page 81

```
[SENSe:]ADEMod:AM:RELative:AFSPectrum[:TYPE] <TraceMode>...
[SENSe:]ADEMod:AM:RELative[:TDOMain][:TYPE] <TraceMode>...
[SENSe:]ADEMod:AM[:ABSolute]:AFSPectrum[:TYPE] <TraceMode>...
[SENSe:]ADEMod:AM[:ABSolute][:TDOMain][:TYPE] <TraceMode>...
[SENSe:]ADEMod:FM:AFSPectrum[:TYPE] <TraceMode>...
[SENSe:]ADEMod:FM[:TDOMain][:TYPE] <TraceMode>...
[SENSe:]ADEMod:PM:AFSPectrum[:TYPE] <TraceMode>...
[SENSe:]ADEMod:PM[:TDOMain][:TYPE] <TraceMode>...
[SENSe:]ADEMod:SPECtrum[:TYPE] <TraceMode>...
```

This command selects the trace modes of the evaluated signal to be measured simultaneously. For each of the six available traces a mode can be defined.

The trace modes are configured identically for all windows with a specific evaluation. The following table indicates which command syntax refers to which evaluation method.

Command syntax	Evaluation method
AM[:ABSolute][:TDOMain]	RF time domain
AM:RELative[:TDOMain]	AM time domain
AM:RELative:AFSPectrum	AM spectrum (relative)
FM[:TDOMain]	FM time domain
FM:AFSPectrum	FM spectrum
PM[:TDOMain]	PM time domain
PM:AFSPectrum	PM spectrum
SPECtrum	RF spectrum

Parameters:

<TraceMode> WRITE | AVERage | MAXHold | MINHold | VIEW | OFF

WRITE

Overwrite mode: the trace is overwritten by each sweep. This is the default setting.

AVERage

The average is formed over several sweeps.

MAXHold

The maximum value is determined over several sweeps and displayed. The R&S FPL1000 saves the sweep result in the trace memory only if the new value is greater than the previous one.

MINHold

The minimum value is determined from several measurements and displayed. The R&S FPL1000 saves the sweep result in the trace memory only if the new value is lower than the previous one.

VIEW

The current contents of the trace memory are frozen and displayed.

OFF

Hides the selected trace.

*RST: WRITe,OFF,OFF,OFF,OFF,OFF

Example:

ADEM:AM AVER,MAXH,MINH,OFF,OFF,OFF

Determines average, max hold and min hold values simultaneously for the traces 1-3 of the RF time domain evaluation.

ADEM:AM WRIT,OFF,OFF,OFF,OFF,OFF

Determines only the current measurement values for trace 1.

ADEM:AM OFF,OFF,OFF,OFF,OFF,OFF

Switches AM demodulation off.

[SENSe:]AVERage<n>:COUNT <AverageCount>

This command defines the number of sweeps that the application uses to average traces.

In case of continuous sweep mode, the application calculates the moving average over the average count.

In case of single sweep mode, the application stops the measurement and calculates the average after the average count has been reached.

Suffix:

<n> irrelevant

Parameters:

<AverageCount> If you set an average count of 0 or 1, the application performs one single sweep in single sweep mode.
In continuous sweep mode, if the average count is set to 0, a moving average over 10 sweeps is performed.

Range: 0 to 200000

*RST: 0

Manual operation: See ["This is Sweep/Average Count ok?"](#) on page 52
See ["Average Count"](#) on page 80

[SENSe:]AVERage<n>[:STATe<t>] <State>

This command turns averaging for a particular trace in a particular window on and off.

Suffix:

<n> [Window](#)

<t> [Trace](#)

Parameters:

<State> ON | OFF | 1 | 0

[SENSe:]AVERAge<n>:TYPE <Mode>

This command selects the trace averaging mode.

Suffix:

<n> 1..n
[Window](#)

Parameters:

<Mode> **LOGarithmic**
The logarithmic power values are averaged.

LINear

The power values are averaged before they are converted to logarithmic values.

POWER

The power level values are converted into unit Watt prior to averaging. After the averaging, the data is converted back into its original unit.

Example:

AVER:TYPE LIN
Switches to linear average calculation.

Manual operation: See "[Average Mode](#)" on page 80

[SENSe:][WINDow<n>:]DETEctor<t>[:FUNCTion] <Detector>

Defines the trace detector to be used for trace analysis.

Suffix:

<n> [Window](#)

<t> [Trace](#)

Parameters:

<Detector> **APEak**
Autopeak

NEGative
Negative peak

POSitive
Positive peak

SAMPlE
First value detected per trace point

RMS
RMS value

AVERAge
Average

Example: *RST: APEak
DET POS
Sets the detector to "positive peak".

Manual operation: See "Detector" on page 79

[SENSe:][WINDow<n>:]DETEctor<t>[:FUNctIon]:AUTO <State>

This command couples and decouples the detector to the trace mode.

Suffix:

<n> Window

<t> Trace

Parameters:

<State> ON | OFF | 0 | 1

*RST: 1

Example: DET:AUTO OFF
The selection of the detector is not coupled to the trace mode.

Manual operation: See "Detector" on page 79

11.8.3 Working with markers remotely

In the R&S FPL1-K7 AM/FM/PM Modulation Analysis application, up to 16 markers or delta markers can be activated for each window simultaneously.

More details are described for manual operation in [Chapter 6.4.4, "Marker function configuration"](#), on page 99.

- [Setting up individual markers](#).....214
- [General marker settings](#).....221
- [Marker search \(spectrograms\)](#).....223
- [Marker search settings](#).....232
- [Positioning the marker](#).....233
- [Configuring special marker functions](#).....238

11.8.3.1 Setting up individual markers

The following commands define the position of markers in the diagram.

CALCulate<n>:MARKer<m>:AOFF	215
CALCulate<n>:MARKer<ms>:LINK:TO:MARKer<md>	215
CALCulate<n>:MARKer<m>[:STATe]	215
CALCulate<n>:MARKer<m>:TRACe	216
CALCulate<n>:MARKer<m>:X	216
CALCulate<n>:MARKer<m>:Y?	217
CALCulate<n>:DELTaMarker<m>:AOFF	217
CALCulate<n>:DELTaMarker<m>:LINK	217
CALCulate<n>:DELTaMarker<ms>:LINK:TO:MARKer<md>	218

CALCulate<n>:DELTaMarker<m>:MODE.....	218
CALCulate<n>:DELTaMarker<m>:MREFerence.....	219
CALCulate<n>:DELTaMarker<m>[:STATe].....	219
CALCulate<n>:DELTaMarker<m>:TRACe.....	220
CALCulate<n>:DELTaMarker<m>:X.....	220
CALCulate<n>:DELTaMarker<m>:X:RELative?.....	220
CALCulate<n>:DELTaMarker<m>:Y?.....	221

CALCulate<n>:MARKer<m>:AOFF

This command turns off all markers.

Suffix:

<n>	Window
<m>	Marker

Example: CALC:MARK:AOFF
Switches off all markers.

Manual operation: See "[All Markers Off](#)" on page 92

CALCulate<n>:MARKer<ms>:LINK:TO:MARKer<md> <State>

This command links the normal source marker <ms> to any active destination marker <md> (normal or delta marker).

If you change the horizontal position of marker <md>, marker <ms> changes its horizontal position to the same value.

Suffix:

<n>	Window
<ms>	source marker, see Marker
<md>	destination marker, see Marker

Parameters:

<State>	ON OFF 0 1
	OFF 0 Switches the function off
	ON 1 Switches the function on

Example: CALC:MARK4:LINK:TO:MARK2 ON
Links marker 4 to marker 2.

Manual operation: See "[Linking to Another Marker](#)" on page 91

CALCulate<n>:MARKer<m>[:STATe] <State>

This command turns markers on and off. If the corresponding marker number is currently active as a delta marker, it is turned into a normal marker.

Suffix:<n> [Window](#)<m> [Marker](#)**Parameters:**

<State> ON | OFF | 0 | 1

OFF | 0

Switches the function off

ON | 1

Switches the function on

Example:

CALC:MARK3 ON

Switches on marker 3.

Manual operation:See "[Marker State](#)" on page 90See "[Marker Type](#)" on page 91See "[Select Marker](#)" on page 95**CALCulate<n>:MARKer<m>:TRACe <Trace>**

This command selects the trace the marker is positioned on.

Note that the corresponding trace must have a trace mode other than "Blank".

If necessary, the command activates the marker first.

Suffix:<n> [Window](#)<m> [Marker](#)**Parameters:**<Trace> **1 to 6**

Trace number the marker is assigned to.

Example:

//Assign marker to trace 1

CALC:MARK3:TRAC 2

Manual operation:See "[Assigning the Marker to a Trace](#)" on page 92**CALCulate<n>:MARKer<m>:X <Position>**

This command moves a marker to a specific coordinate on the x-axis.

If necessary, the command activates the marker.

If the marker has been used as a delta marker, the command turns it into a normal marker.

Suffix:<n> [Window](#)<m> [Marker](#)

Parameters:

<Position> Numeric value that defines the marker position on the x-axis. The unit depends on the result display.

Range: The range depends on the current x-axis range.
Default unit: Hz

Example:

CALC:MARK2:X 1.7MHz

Positions marker 2 to frequency 1.7 MHz.

Manual operation:

See "[Marker Table](#)" on page 25

See "[Marker Peak List](#)" on page 25

See "[Marker Position X-value](#)" on page 91

CALCulate<n>:MARKer<m>:Y?

Queries the result at the position of the specified marker.

Suffix:

<n> 1..n

<m> 1..n

Return values:

<Result> Default unit: DBM

Usage: Query only

Manual operation:

See "[Marker Table](#)" on page 25

See "[Marker Peak List](#)" on page 25

CALCulate<n>:DELTamarker<m>:AOFF

This command turns off *all* delta markers.

Suffix:

<n> [Window](#)

<m> irrelevant

Example:

CALC:DELT:AOFF

Turns off all delta markers.

CALCulate<n>:DELTamarker<m>:LINK <State>

This command links delta marker <m> to marker 1.

If you change the horizontal position (x-value) of marker 1, delta marker <m> changes its horizontal position to the same value.

Suffix:

<n> [Window](#)

<m> [Marker](#)

Parameters:

<State> ON | OFF | 0 | 1
OFF | 0
 Switches the function off
ON | 1
 Switches the function on

Example: CALC:DELT2:LINK ON

Manual operation: See "[Linking to Another Marker](#)" on page 91

CALCulate<n>:DELTaMarker<ms>:LINK:TO:MARKer<md> <State>

This command links the delta source marker <ms> to any active destination marker <md> (normal or delta marker).

Suffix:

<n> [Window](#)
 <ms> source marker, see [Marker](#)
 <md> destination marker, see [Marker](#)

Parameters:

<State> ON | OFF | 0 | 1
OFF | 0
 Switches the function off
ON | 1
 Switches the function on

Example: CALC:DELT4:LINK:TO:MARK2 ON
 Links the delta marker 4 to the marker 2.

Manual operation: See "[Linking to Another Marker](#)" on page 91

CALCulate<n>:DELTaMarker<m>:MODE <Mode>

This command defines whether the position of a delta marker is provided as an absolute value or relative to a reference marker. Note that this setting applies to *all* windows.

Note that when the position of a delta marker is *queried*, the result is always an absolute value (see [CALCulate<n>:DELTaMarker<m>:X](#) on page 220)!

Suffix:

<n> irrelevant
 <m> irrelevant

Parameters:

<Mode> **ABSolute**
 Delta marker position in absolute terms.

RELative

Delta marker position in relation to a reference marker.

*RST: RELative

Example:

CALC:DELT:MODE ABS

Absolute delta marker position.

CALCulate<n>:DELTamarker<m>:MREFerence <Reference>

This command selects a reference marker for a delta marker other than marker 1.

The reference may be another marker or the fixed reference.

Suffix:

<n> [Window](#)

<m> [Marker](#)

Parameters:

<Reference> **1 to 16**

Selects markers 1 to 16 as the reference.

FIXed

Selects the fixed reference as the reference.

Example:

CALC:DELT3:MREF 2

Specifies that the values of delta marker 3 are relative to marker 2.

Manual operation: See "[Reference Marker](#)" on page 91

CALCulate<n>:DELTamarker<m>[:STATE] <State>

This command turns delta markers on and off.

If necessary, the command activates the delta marker first.

No suffix at DELTmarker turns on delta marker 1.

Suffix:

<n> [Window](#)

<m> [Marker](#)

Parameters:

<State> ON | OFF | 0 | 1

OFF | 0

Switches the function off

ON | 1

Switches the function on

Example:

CALC:DELT2 ON

Turns on delta marker 2.

Manual operation: See ["Marker State"](#) on page 90
 See ["Marker Type"](#) on page 91
 See ["Select Marker"](#) on page 95

CALCulate<n>:DELTamarker<m>:TRACe <Trace>

This command selects the trace a delta marker is positioned on.

Note that the corresponding trace must have a trace mode other than "Blank".

If necessary, the command activates the marker first.

Suffix:

<n> [Window](#)

<m> [Marker](#)

Parameters:

<Trace> Trace number the marker is assigned to.

Example:

`CALC:DELT2:TRAC 2`
 Positions delta marker 2 on trace 2.

CALCulate<n>:DELTamarker<m>:X <Position>

This command moves a delta marker to a particular coordinate on the x-axis.

If necessary, the command activates the delta marker and positions a reference marker to the peak power.

Suffix:

<n> [Window](#)

<m> [Marker](#)

Parameters:

<Position> Numeric value that defines the marker position on the x-axis. The position is relative to the reference marker. To select an absolute position you have to change the delta marker mode with `CALCulate<n>:DELTamarker<m>:MODE` on page 218.

A query returns the absolute position of the delta marker.

Range: The value range and unit depend on the measurement and scale of the x-axis.

Default unit: HZ

Example:

`CALC:DELT:X?`
 Outputs the absolute x-value of delta marker 1.

Manual operation: See ["Marker Position X-value"](#) on page 91

CALCulate<n>:DELTamarker<m>:X:RELative?

This command queries the relative position of a delta marker on the x-axis.

If necessary, the command activates the delta marker first.

Suffix:

<n> [Window](#)

<m> [Marker](#)

Return values:

<Position> Position of the delta marker in relation to the reference marker.

Example:

`CALC:DELT3:X:REL?`

Outputs the frequency of delta marker 3 relative to marker 1 or relative to the reference position.

Usage:

Query only

CALCulate<n>:DELTaMarker<m>:Y?

Queries the result at the position of the specified delta marker.

Suffix:

<n> 1..n

<m> 1..n

Return values:

<Result> Result at the position of the delta marker.
The unit is variable and depends on the one you have currently set.

Default unit: DBM

Usage:

Query only

11.8.3.2 General marker settings

The following commands control general marker functionality.

See also "[Fixed reference marker settings](#)" on page 238

CALCulate<n>:MARKer<m>:X:SSIZE	221
CALCulate<n>:MARKer<m>:LINK	222
DISPlay[:WINDow<n>]:MINFo[:STATe]	222
DISPlay[:WINDow<n>]:MTABLE	223

CALCulate<n>:MARKer<m>:X:SSIZE <StepSize>

This command selects the marker step size mode for *all* markers in *all* windows.

The step size defines the distance the marker moves when you move it with the rotary knob.

It therefore takes effect in manual operation only.

Suffix:

<n> irrelevant

<m> irrelevant

Parameters:

<StepSize>

STANDARD

the marker moves from one pixel to the next

POINTS

the marker moves from one sweep point to the next

*RST: POINTs

Example:

CALC:MARK:X:SSIZ STAN

Sets the marker step size to one pixel.

Manual operation: See "[Marker Stepsize](#)" on page 93

CALCulate<n>:MARKer<m>:LINK <DisplayType>

Links the specified marker in all displays of the specified type.

Suffix:

<n> irrelevant

<m> [Marker](#)

Parameters:

<DisplayType>

TIME | SPECTrum | BOTH | NONE

TIME

Links the markers in all time domain diagrams

SPECTrum

Links the markers in all AF Spectrum displays

BOTH

Links the markers both in the time domain diagrams and in the AF Spectrum displays

NONE

Markers are not linked.

*RST: NONE

Manual operation: See "[Link Time Marker](#)" on page 94
See "[Link AF Spectrum Marker](#)" on page 94

DISPlay[:WINDow<n>]:MINFo[:STATE] <State>

This command turns the marker information in all diagrams on and off.

Suffix:

<n> irrelevant

Parameters:

<State>

ON | 1

Displays the marker information in the diagrams.

OFF | 0

Hides the marker information in the diagrams.

*RST: 1

Example: DISP:MINF OFF
Hides the marker information.

Manual operation: See "[Marker Info](#)" on page 93

DISPlay[:WINDow<n>]:MTABLE <DisplayMode>

This command turns the marker table on and off.

Suffix:
<n> irrelevant

Parameters:
<DisplayMode>

ON | 1
Turns on the marker table.

OFF | 0
Turns off the marker table.

AUTO
Turns on the marker table if 3 or more markers are active.

*RST: AUTO

Example: DISP:MTAB ON
Activates the marker table.

Manual operation: See "[Marker Table Display](#)" on page 93

11.8.3.3 Marker search (spectrograms)

The following commands automatically define the marker and delta marker position in the spectrogram.

Using markers

The following commands control spectrogram markers.

Useful commands for spectrogram markers described elsewhere

The following commands define the horizontal position of the markers.

- [CALCulate<n>:MARKer<m>:MAXimum:LEFT](#) on page 233
- [CALCulate<n>:MARKer<m>:MAXimum:NEXT](#) on page 234
- [CALCulate<n>:MARKer<m>:MAXimum\[:PEAK\]](#) on page 234
- [CALCulate<n>:MARKer<m>:MAXimum:RIGHT](#) on page 234
- [CALCulate<n>:MARKer<m>:MINimum:LEFT](#) on page 234
- [CALCulate<n>:MARKer<m>:MINimum:NEXT](#) on page 235
- [CALCulate<n>:MARKer<m>:MINimum\[:PEAK\]](#) on page 235
- [CALCulate<n>:MARKer<m>:MINimum:RIGHT](#) on page 235

Remote commands exclusive to spectrogram markers

<code>CALCulate<n>:MARKer<m>:SGRam:FRAME</code>	224
<code>CALCulate<n>:MARKer<m>:SPEctrogram:FRAME</code>	224
<code>CALCulate<n>:MARKer<m>:SGRam:SARea</code>	225
<code>CALCulate<n>:MARKer<m>:SPEctrogram:SARea</code>	225
<code>CALCulate<n>:MARKer<m>:SGRam:XY:MAXimum[:PEAK]</code>	225
<code>CALCulate<n>:MARKer<m>:SPEctrogram:XY:MAXimum[:PEAK]</code>	225
<code>CALCulate<n>:MARKer<m>:SGRam:XY:MINimum[:PEAK]</code>	225
<code>CALCulate<n>:MARKer<m>:SPEctrogram:XY:MINimum[:PEAK]</code>	225
<code>CALCulate<n>:MARKer<m>:SGRam:Y:MAXimum:ABOVe</code>	225
<code>CALCulate<n>:MARKer<m>:SPEctrogram:Y:MAXimum:ABOVe</code>	225
<code>CALCulate<n>:MARKer<m>:SGRam:Y:MAXimum:BELOW</code>	226
<code>CALCulate<n>:MARKer<m>:SPEctrogram:Y:MAXimum:BELOW</code>	226
<code>CALCulate<n>:MARKer<m>:SGRam:Y:MAXimum:NEXT</code>	226
<code>CALCulate<n>:MARKer<m>:SPEctrogram:Y:MAXimum:NEXT</code>	226
<code>CALCulate<n>:MARKer<m>:SGRam:Y:MAXimum[:PEAK]</code>	226
<code>CALCulate<n>:MARKer<m>:SPEctrogram:Y:MAXimum[:PEAK]</code>	226
<code>CALCulate<n>:MARKer<m>:SGRam:Y:MINimum:ABOVe</code>	227
<code>CALCulate<n>:MARKer<m>:SPEctrogram:Y:MINimum:ABOVe</code>	227
<code>CALCulate<n>:MARKer<m>:SGRam:Y:MINimum:BELOW</code>	227
<code>CALCulate<n>:MARKer<m>:SPEctrogram:Y:MINimum:BELOW</code>	227
<code>CALCulate<n>:MARKer<m>:SGRam:Y:MINimum:NEXT</code>	227
<code>CALCulate<n>:MARKer<m>:SPEctrogram:Y:MINimum:NEXT</code>	227
<code>CALCulate<n>:MARKer<m>:SGRam:Y:MINimum[:PEAK]</code>	227
<code>CALCulate<n>:MARKer<m>:SPEctrogram:Y:MINimum[:PEAK]</code>	227

`CALCulate<n>:MARKer<m>:SGRam:FRAME` <Frame>

`CALCulate<n>:MARKer<m>:SPEctrogram:FRAME` <Frame> | <Time>

This command positions a marker on a particular frame.

Suffix:

<n> Window

<m> Marker

Parameters:

<Frame> Selects a frame directly by the frame number. Valid if the time stamp is off.
The range depends on the history depth.
Default unit: S

<Time> Selects a frame via its time stamp. Valid if the time stamp is on.
The number is the (negative) distance to frame 0 in seconds.
The range depends on the history depth.

Example:

`CALC:MARK:SGR:FRAM -20`

Sets the marker on the 20th frame before the present.

`CALC:MARK2:SGR:FRAM -2s`

Sets second marker on the frame 2 seconds ago.

CALCulate<n>:MARKer<m>:SGRam:SARea <SearchArea>

CALCulate<n>:MARKer<m>:SPECTrogram:SARea <SearchArea>

This command defines the marker search area for all spectrogram markers in the channel setup.

Suffix:

<n> irrelevant

<m> irrelevant

Parameters:

<SearchArea>

VISible

Performs a search within the visible frames.

Note that the command does not work if the spectrogram is not visible for any reason (e.g. if the display update is off).

MEMory

Performs a search within all frames in the memory.

*RST: VISible

Manual operation: See "[Marker Search Area](#)" on page 99

CALCulate<n>:MARKer<m>:SGRam:XY:MAXimum[:PEAK]

CALCulate<n>:MARKer<m>:SPECTrogram:XY:MAXimum[:PEAK]

This command moves a marker to the highest level of the spectrogram.

Suffix:

<n> [Window](#)

<m> [Marker](#)

CALCulate<n>:MARKer<m>:SGRam:XY:MINimum[:PEAK]

CALCulate<n>:MARKer<m>:SPECTrogram:XY:MINimum[:PEAK]

This command moves a marker to the minimum level of the spectrogram.

Suffix:

<n> [Window](#)

<m> [Marker](#)

CALCulate<n>:MARKer<m>:SGRam:Y:MAXimum:ABOVE

CALCulate<n>:MARKer<m>:SPECTrogram:Y:MAXimum:ABOVE

This command moves a marker vertically to the next lower peak level for the current frequency.

The search includes only frames above the current marker position. It does not change the horizontal position of the marker.

Suffix:

<n> [Window](#)

<m> [Marker](#)

Manual operation: See ["Search Mode for Next Peak in Y-Direction"](#) on page 98

CALCulate<n>:MARKer<m>:SGRam:Y:MAXimum:BELOW

CALCulate<n>:MARKer<m>:SPECTrogram:Y:MAXimum:BELOW

This command moves a marker vertically to the next lower peak level for the current frequency.

The search includes only frames below the current marker position. It does not change the horizontal position of the marker.

Suffix:

<n> [Window](#)

<m> [Marker](#)

Manual operation: See ["Search Mode for Next Peak in Y-Direction"](#) on page 98

CALCulate<n>:MARKer<m>:SGRam:Y:MAXimum:NEXT

CALCulate<n>:MARKer<m>:SPECTrogram:Y:MAXimum:NEXT

This command moves a marker vertically to the next lower peak level for the current frequency.

The search includes all frames. It does not change the horizontal position of the marker.

Suffix:

<n> [Window](#)

<m> [Marker](#)

Manual operation: See ["Search Mode for Next Peak in Y-Direction"](#) on page 98

CALCulate<n>:MARKer<m>:SGRam:Y:MAXimum[:PEAK]

CALCulate<n>:MARKer<m>:SPECTrogram:Y:MAXimum[:PEAK]

This command moves a marker vertically to the highest level for the current frequency.

The search includes all frames. It does not change the horizontal position of the marker.

If the marker hasn't been active yet, the command looks for the peak level in the whole spectrogram.

Suffix:

<n> [Window](#)

<m> [Marker](#)

CALCulate<n>:MARKer<m>:SGRam:Y:MINimum:ABOVE**CALCulate<n>:MARKer<m>:SPECTrogram:Y:MINimum:ABOVE**

This command moves a marker vertically to the next higher minimum level for the current frequency.

The search includes only frames above the current marker position. It does not change the horizontal position of the marker.

Suffix:

<n> [Window](#)

<m> [Marker](#)

Manual operation: See "[Search Mode for Next Peak in Y-Direction](#)" on page 98

CALCulate<n>:MARKer<m>:SGRam:Y:MINimum:BELOW**CALCulate<n>:MARKer<m>:SPECTrogram:Y:MINimum:BELOW**

This command moves a marker vertically to the next higher minimum level for the current frequency.

The search includes only frames below the current marker position. It does not change the horizontal position of the marker.

Suffix:

<n> [Window](#)

<m> [Marker](#)

Manual operation: See "[Search Mode for Next Peak in Y-Direction](#)" on page 98

CALCulate<n>:MARKer<m>:SGRam:Y:MINimum:NEXT**CALCulate<n>:MARKer<m>:SPECTrogram:Y:MINimum:NEXT**

This command moves a marker vertically to the next higher minimum level for the current frequency.

The search includes all frames. It does not change the horizontal position of the marker.

Suffix:

<n> [Window](#)

<m> [Marker](#)

Manual operation: See "[Search Mode for Next Peak in Y-Direction](#)" on page 98

CALCulate<n>:MARKer<m>:SGRam:Y:MINimum[:PEAK]**CALCulate<n>:MARKer<m>:SPECTrogram:Y:MINimum[:PEAK]**

This command moves a marker vertically to the minimum level for the current frequency.

The search includes all frames. It does not change the horizontal position of the marker.

If the marker hasn't been active yet, the command first looks for the peak level for all frequencies and moves the marker vertically to the minimum level.

Suffix:

<n> Window

<m> Marker

Using delta markers

The following commands control spectrogram delta markers.

Useful commands for spectrogram markers described elsewhere

The following commands define the horizontal position of the delta markers.

- `CALCulate<n>:DELTamarker<m>:MAXimum:LEFT` on page 236
- `CALCulate<n>:DELTamarker<m>:MAXimum:NEXT` on page 236
- `CALCulate<n>:DELTamarker<m>:MAXimum[:PEAK]` on page 236
- `CALCulate<n>:DELTamarker<m>:MAXimum:RIGHT` on page 236
- `CALCulate<n>:DELTamarker<m>:MINimum:LEFT` on page 237
- `CALCulate<n>:DELTamarker<m>:MINimum:NEXT` on page 237
- `CALCulate<n>:DELTamarker<m>:MINimum[:PEAK]` on page 237
- `CALCulate<n>:DELTamarker<m>:MINimum:RIGHT` on page 237

Remote commands exclusive to spectrogram markers

<code>CALCulate<n>:DELTamarker<m>:SGRam:FRAMe</code>	229
<code>CALCulate<n>:DELTamarker<m>:SPECTrogram:FRAMe</code>	229
<code>CALCulate<n>:DELTamarker<m>:SGRam:SARea</code>	229
<code>CALCulate<n>:DELTamarker<m>:SPECTrogram:SARea</code>	229
<code>CALCulate<n>:DELTamarker<m>:SGRam:XY:MAXimum[:PEAK]</code>	230
<code>CALCulate<n>:DELTamarker<m>:SPECTrogram:XY:MAXimum[:PEAK]</code>	230
<code>CALCulate<n>:DELTamarker<m>:SGRam:XY:MINimum[:PEAK]</code>	230
<code>CALCulate<n>:DELTamarker<m>:SPECTrogram:XY:MINimum[:PEAK]</code>	230
<code>CALCulate<n>:DELTamarker<m>:SGRam:Y:MAXimum:ABOVe</code>	230
<code>CALCulate<n>:DELTamarker<m>:SPECTrogram:Y:MAXimum:ABOVe</code>	230
<code>CALCulate<n>:DELTamarker<m>:SGRam:Y:MAXimum:BELow</code>	230
<code>CALCulate<n>:DELTamarker<m>:SPECTrogram:Y:MAXimum:BELow</code>	230
<code>CALCulate<n>:DELTamarker<m>:SGRam:Y:MAXimum:NEXT</code>	231
<code>CALCulate<n>:DELTamarker<m>:SPECTrogram:Y:MAXimum:NEXT</code>	231
<code>CALCulate<n>:DELTamarker<m>:SGRam:Y:MAXimum[:PEAK]</code>	231
<code>CALCulate<n>:DELTamarker<m>:SPECTrogram:Y:MAXimum[:PEAK]</code>	231
<code>CALCulate<n>:DELTamarker<m>:SGRam:Y:MINimum:ABOVe</code>	231
<code>CALCulate<n>:DELTamarker<m>:SPECTrogram:Y:MINimum:ABOVe</code>	231
<code>CALCulate<n>:DELTamarker<m>:SGRam:Y:MINimum:BELow</code>	231
<code>CALCulate<n>:DELTamarker<m>:SPECTrogram:Y:MINimum:BELow</code>	231
<code>CALCulate<n>:DELTamarker<m>:SGRam:Y:MINimum:NEXT</code>	232
<code>CALCulate<n>:DELTamarker<m>:SPECTrogram:Y:MINimum:NEXT</code>	232

CALCulate<n>:DELTamarker<m>:SGRam:Y:MINimum[:PEAK].....	232
CALCulate<n>:DELTamarker<m>:SPECTrogram:Y:MINimum[:PEAK].....	232

CALCulate<n>:DELTamarker<m>:SGRam:FRAMe <Frame>

CALCulate<n>:DELTamarker<m>:SPECTrogram:FRAMe <Frame>

This command positions a delta marker on a particular frame. The frame is relative to the position of marker 1.

The command is available for the spectrogram.

Suffix:

<n> [Window](#)

<m> [Marker](#)

Parameters:

<Frame> Selects a frame either by its frame number or time stamp. The frame number is available if the time stamp is off. The range depends on the history depth. The time stamp is available if the time stamp is on. The number is the distance to frame 0 in seconds. The range depends on the history depth. Default unit: S

Example:

`CALC:DELT4:SGR:FRAM -20`

Sets fourth deltamarker 20 frames below marker 1.

`CALC:DELT4:SGR:FRAM 2 s`

Sets fourth deltamarker 2 seconds above the position of marker 1.

CALCulate<n>:DELTamarker<m>:SGRam:SARea <SearchArea>

CALCulate<n>:DELTamarker<m>:SPECTrogram:SARea <SearchArea>

This command defines the marker search area for *all* spectrogram markers in the channel setup.

Suffix:

<n> irrelevant

<m> irrelevant

Parameters:

<SearchArea>

VISible

Performs a search within the visible frames.

Note that the command does not work if the spectrogram is not visible for any reason (e.g. if the display update is off).

MEMory

Performs a search within all frames in the memory.

*RST: VISible

Manual operation: See "[Marker Search Area](#)" on page 99

CALCulate<n>:DELTamarker<m>:SGRam:XY:MAXimum[:PEAK]

CALCulate<n>:DELTamarker<m>:SPECTrogram:XY:MAXimum[:PEAK]

This command moves a marker to the highest level of the spectrogram over all frequencies.

Suffix:

<n> [Window](#)

<m> [Marker](#)

CALCulate<n>:DELTamarker<m>:SGRam:XY:MINimum[:PEAK]

CALCulate<n>:DELTamarker<m>:SPECTrogram:XY:MINimum[:PEAK]

This command moves a delta marker to the minimum level of the spectrogram over all frequencies.

Suffix:

<n> [Window](#)

<m> [Marker](#)

CALCulate<n>:DELTamarker<m>:SGRam:Y:MAXimum:ABOVE

CALCulate<n>:DELTamarker<m>:SPECTrogram:Y:MAXimum:ABOVE

This command moves a marker vertically to the next higher level for the current frequency.

The search includes only frames above the current marker position. It does not change the horizontal position of the marker.

Suffix:

<n> [Window](#)

<m> [Marker](#)

Manual operation: See ["Search Mode for Next Peak in Y-Direction"](#) on page 98

CALCulate<n>:DELTamarker<m>:SGRam:Y:MAXimum:BELOW

CALCulate<n>:DELTamarker<m>:SPECTrogram:Y:MAXimum:BELOW

This command moves a marker vertically to the next higher level for the current frequency.

The search includes only frames below the current marker position. It does not change the horizontal position of the marker.

Suffix:

<n> [Window](#)

<m> [Marker](#)

Manual operation: See ["Search Mode for Next Peak in Y-Direction"](#) on page 98

CALCulate<n>:DELTamarker<m>:SGRam:Y:MAXimum:NEXT

CALCulate<n>:DELTamarker<m>:SPECTrogram:Y:MAXimum:NEXT

This command moves a delta marker vertically to the next higher level for the current frequency.

The search includes all frames. It does not change the horizontal position of the marker.

Suffix:

<n> [Window](#)

<m> [Marker](#)

Manual operation: See "[Search Mode for Next Peak in Y-Direction](#)" on page 98

CALCulate<n>:DELTamarker<m>:SGRam:Y:MAXimum[:PEAK]

CALCulate<n>:DELTamarker<m>:SPECTrogram:Y:MAXimum[:PEAK]

This command moves a delta marker vertically to the highest level for the current frequency.

The search includes all frames. It does not change the horizontal position of the marker.

If the marker hasn't been active yet, the command looks for the peak level in the whole spectrogram.

Suffix:

<n> [Window](#)

<m> [Marker](#)

CALCulate<n>:DELTamarker<m>:SGRam:Y:MINimum:ABOVE

CALCulate<n>:DELTamarker<m>:SPECTrogram:Y:MINimum:ABOVE

This command moves a delta marker vertically to the next minimum level for the current frequency.

The search includes only frames above the current marker position. It does not change the horizontal position of the marker.

Suffix:

<n> [Window](#)

<m> [Marker](#)

Manual operation: See "[Search Mode for Next Peak in Y-Direction](#)" on page 98

CALCulate<n>:DELTamarker<m>:SGRam:Y:MINimum:BELOW

CALCulate<n>:DELTamarker<m>:SPECTrogram:Y:MINimum:BELOW

This command moves a delta marker vertically to the next minimum level for the current frequency.

The search includes only frames below the current marker position. It does not change the horizontal position of the marker.

Suffix:

<n> [Window](#)

<m> [Marker](#)

Manual operation: See "[Search Mode for Next Peak in Y-Direction](#)" on page 98

CALCulate<n>:DELTaMarker<m>:SGRam:Y:MINimum:NEXT

CALCulate<n>:DELTaMarker<m>:SPECTrogram:Y:MINimum:NEXT

This command moves a delta marker vertically to the next minimum level for the current frequency.

The search includes all frames. It does not change the horizontal position of the marker.

Suffix:

<n> [Window](#)

<m> [Marker](#)

Manual operation: See "[Search Mode for Next Peak in Y-Direction](#)" on page 98

CALCulate<n>:DELTaMarker<m>:SGRam:Y:MINimum[:PEAK]

CALCulate<n>:DELTaMarker<m>:SPECTrogram:Y:MINimum[:PEAK]

This command moves a delta marker vertically to the minimum level for the current frequency.

The search includes all frames. It does not change the horizontal position of the marker.

If the marker hasn't been active yet, the command first looks for the peak level in the whole spectrogram and moves the marker vertically to the minimum level.

Suffix:

<n> [Window](#)

<m> [Marker](#)

11.8.3.4 Marker search settings

The following commands define criteria for searches.

[CALCulate<n>:MARKer<m>:PEXCursion](#).....232

CALCulate<n>:MARKer<m>:PEXCursion <Excursion>

This command defines the peak excursion (for *all* markers in *all* windows).

The peak excursion sets the requirements for a peak to be detected during a peak search.

The unit depends on the measurement.

Application/Result display	Unit
Spectrum	dB
ADEMOD, RF	dB
ADEMOD, AM	PCT
ADEMOD, FM	kHz
ADEMOD, PM	RAD

Suffix:

<n>	irrelevant
<m>	irrelevant

Parameters:

<Excursion>	The excursion is the distance to a trace maximum that must be attained before a new maximum is recognized, or the distance to a trace minimum that must be attained before a new minimum is recognized
*RST:	5 PCT in AM displays, 50 kHz in FM displays, (0.5 RAD in PM displays)

Example:

CALC:MARK:PEXC 10dB
 Defines peak excursion as 10 dB.

Manual operation: See "[Peak Excursion](#)" on page 95

11.8.3.5 Positioning the marker

This chapter contains remote commands necessary to position the marker on a trace.

- [Positioning normal markers](#).....233
- [Positioning delta markers](#).....235

Positioning normal markers

The following commands position markers on the trace.

CALCulate<n>:MARKer<m>:MAXimum:LEFT.....	233
CALCulate<n>:MARKer<m>:MAXimum:NEXT.....	234
CALCulate<n>:MARKer<m>:MAXimum[:PEAK].....	234
CALCulate<n>:MARKer<m>:MAXimum:RIGHT.....	234
CALCulate<n>:MARKer<m>:MINimum:LEFT.....	234
CALCulate<n>:MARKer<m>:MINimum:NEXT.....	235
CALCulate<n>:MARKer<m>:MINimum[:PEAK].....	235
CALCulate<n>:MARKer<m>:MINimum:RIGHT.....	235

CALCulate<n>:MARKer<m>:MAXimum:LEFT

This command moves a marker to the next positive peak.

The search includes only measurement values to the left of the current marker position.

Suffix:

<n> [Window](#)

<m> [Marker](#)

Manual operation: See ["Search Next Peak"](#) on page 96

CALCulate<n>:MARKer<m>:MAXimum:NEXT

This command moves a marker to the next positive peak.

Suffix:

<n> [Window](#)

<m> [Marker](#)

Manual operation: See ["Search Next Peak"](#) on page 96

CALCulate<n>:MARKer<m>:MAXimum[:PEAK]

This command moves a marker to the highest level.

If the marker is not yet active, the command first activates the marker.

Suffix:

<n> [Window](#)

<m> [Marker](#)

Manual operation: See ["Peak Search"](#) on page 96

CALCulate<n>:MARKer<m>:MAXimum:RIGHT

This command moves a marker to the next positive peak.

The search includes only measurement values to the right of the current marker position.

Suffix:

<n> [Window](#)

<m> [Marker](#)

Manual operation: See ["Search Next Peak"](#) on page 96

CALCulate<n>:MARKer<m>:MINimum:LEFT

This command moves a marker to the next minimum peak value.

The search includes only measurement values to the right of the current marker position.

Suffix:<n> [Window](#)<m> [Marker](#)**Manual operation:** See "[Search Next Minimum](#)" on page 97**CALCulate<n>:MARKer<m>:MINimum:NEXT**

This command moves a marker to the next minimum peak value.

Suffix:<n> [Window](#)<m> [Marker](#)**Manual operation:** See "[Search Next Minimum](#)" on page 97**CALCulate<n>:MARKer<m>:MINimum[:PEAK]**

This command moves a marker to the minimum level.

If the marker is not yet active, the command first activates the marker.

Suffix:<n> [Window](#)<m> [Marker](#)**Manual operation:** See "[Search Minimum](#)" on page 96**CALCulate<n>:MARKer<m>:MINimum:RIGHT**

This command moves a marker to the next minimum peak value.

The search includes only measurement values to the right of the current marker position.

Suffix:<n> [Window](#)<m> [Marker](#)**Manual operation:** See "[Search Next Minimum](#)" on page 97**Positioning delta markers**

The following commands position delta markers on the trace.

CALCulate<n>:DELTamarker<m>:MAXimum:LEFT	236
CALCulate<n>:DELTamarker<m>:MAXimum:NEXT	236
CALCulate<n>:DELTamarker<m>:MAXimum[:PEAK]	236
CALCulate<n>:DELTamarker<m>:MAXimum:RIGHT	236
CALCulate<n>:DELTamarker<m>:MINimum:LEFT	237

CALCulate<n>:DELTamarker<m>:MINimum:NEXT.....	237
CALCulate<n>:DELTamarker<m>:MINimum[:PEAK].....	237
CALCulate<n>:DELTamarker<m>:MINimum:RIGHT.....	237

CALCulate<n>:DELTamarker<m>:MAXimum:LEFT

This command moves a delta marker to the next positive peak value.

The search includes only measurement values to the left of the current marker position.

Suffix:

<n> Window

<m> Marker

Manual operation: See "Search Next Peak" on page 96

CALCulate<n>:DELTamarker<m>:MAXimum:NEXT

This command moves a marker to the next positive peak value.

Suffix:

<n> 1..n
 Window

<m> 1..n
 Marker

Manual operation: See "Search Next Peak" on page 96

CALCulate<n>:DELTamarker<m>:MAXimum[:PEAK]

This command moves a delta marker to the highest level.

If the marker is not yet active, the command first activates the marker.

Suffix:

<n> Window

<m> Marker

Manual operation: See "Peak Search" on page 96

CALCulate<n>:DELTamarker<m>:MAXimum:RIGHT

This command moves a delta marker to the next positive peak value on the trace.

The search includes only measurement values to the right of the current marker position.

Suffix:

<n> Window

<m> Marker

Manual operation: See ["Search Next Peak"](#) on page 96

CALCulate<n>:DELTaMarker<m>:MINimum:LEFT

This command moves a delta marker to the next minimum peak value.

The search includes only measurement values to the right of the current marker position.

Suffix:

<n> [Window](#)

<m> [Marker](#)

Manual operation: See ["Search Next Minimum"](#) on page 97

CALCulate<n>:DELTaMarker<m>:MINimum:NEXT

This command moves a marker to the next minimum peak value.

Suffix:

<n> [Window](#)

<m> [Marker](#)

Manual operation: See ["Search Next Minimum"](#) on page 97

CALCulate<n>:DELTaMarker<m>:MINimum[:PEAK]

This command moves a delta marker to the minimum level.

If the marker is not yet active, the command first activates the marker.

Suffix:

<n> [Window](#)

<m> [Marker](#)

Manual operation: See ["Search Minimum"](#) on page 96

CALCulate<n>:DELTaMarker<m>:MINimum:RIGHT

This command moves a delta marker to the next minimum peak value.

The search includes only measurement values to the right of the current marker position.

Suffix:

<n> [Window](#)

<m> [Marker](#)

Manual operation: See ["Search Next Minimum"](#) on page 97

11.8.3.6 Configuring special marker functions

The following commands are required to configure the special marker functions that are available in the R&S FPL1-K7 AM/FM/PM Modulation Analysis application.

- [Fixed reference marker settings](#).....238
- [Marker peak lists](#).....240
- [N db down marker](#).....244
- [Phase noise measurement marker](#).....247

Fixed reference marker settings

The following commands configure a fixed reference marker.

CALCulate<n>:DELTamarker<m>:FUNCTION:FIXed:RPOint:MAXimum[:PEAK]	238
CALCulate<n>:DELTamarker<m>:FUNCTION:FIXed:RPOint:X	238
CALCulate<n>:DELTamarker<m>:FUNCTION:FIXed:RPOint:Y	239
CALCulate<n>:DELTamarker<m>:FUNCTION:FIXed:RPOint:Y:OFFSet	239
CALCulate<n>:DELTamarker<m>:FUNCTION:FIXed[:STATE]	239

CALCulate<n>:DELTamarker<m>:FUNCTION:FIXed:RPOint:MAXimum[:PEAK]

This command moves the fixed reference marker to the peak power.

Suffix:

<n> [Window](#)

<m> [Marker](#)

Example:

`CALC:DELT:FUNC:FIX:RPO:MAX`

Sets the reference point level for delta markers to the peak of the selected trace.

Manual operation: See "[Defining a Fixed Reference](#)" on page 93

CALCulate<n>:DELTamarker<m>:FUNCTION:FIXed:RPOint:X <RefPoint>

This command defines the horizontal position of the fixed delta marker reference point. The coordinates of the reference may be anywhere in the diagram.

Suffix:

<n> [Window](#)

<m> [Marker](#)

Parameters:

<RefPoint> Numeric value that defines the horizontal position of the reference.
 For frequency domain measurements, it is a frequency in Hz.
 For time domain measurements, it is a point in time in s.
 *RST: Fixed Reference: OFF
 Default unit: HZ

Example: `CALC:DELTA:FUNC:FIX:RPO:X 128 MHz`
Sets the frequency reference to 128 MHz.

Manual operation: See ["Defining a Fixed Reference"](#) on page 93

CALCulate<n>:DELTamarker<m>:FUNctioN:FIXed:RPOint:Y <RefPointLevel>

This command defines the vertical position of the fixed delta marker reference point. The coordinates of the reference may be anywhere in the diagram.

Suffix:

<n> [Window](#)

<m> [Marker](#)

Parameters:

<RefPoint> Numeric value that defines the vertical position of the reference. The unit and value range is variable.

*RST: Fixed Reference: OFF

Default unit: DBM

Example: `CALC:DELTA:FUNC:FIX:RPO:Y -10dBm`
Sets the reference point level for delta markers to -10 dBm.

Manual operation: See ["Defining a Fixed Reference"](#) on page 93

CALCulate<n>:DELTamarker<m>:FUNctioN:FIXed:RPOint:Y:OFFSet <Offset>

This command defines a level offset for the fixed delta marker reference point.

Suffix:

<n> [Window](#)

<m> [Marker](#)

Parameters:

<Offset> Numeric value

*RST: 0

Default unit: dB

CALCulate<n>:DELTamarker<m>:FUNctioN:FIXed[:STATe] <State>

This command activates or deactivates a marker that defines a fixed reference point for relative marker analysis.

If necessary, the command activates a marker and positions it on the peak power.

Subsequently, you can change the coordinates of the fixed reference independent of the marker. The fixed reference is independent of the trace and is applied to all active delta markers.

Suffix:

<n> [Window](#)

<m> [Marker](#)

Parameters:

<State> ON | OFF | 0 | 1
OFF | 0
 Switches the function off
ON | 1
 Switches the function on

Example:

CALC:DELT:FUNC:FIX ON
 Switches on the measurement with fixed reference value for all delta markers.
 CALC:DELT:FUNC:FIX:RPO:X 128 MHZ
 Sets the frequency reference to 128 MHz.
 CALC:DELT:FUNC:FIX:RPO:Y 30 DBM
 Sets the reference level to +30 dBm.

Manual operation: See ["Defining a Fixed Reference"](#) on page 93

Marker peak lists

Useful commands for peak lists described elsewhere

- [CALCulate<n>:MARKer<m>:PEXCursion](#) on page 232
- [MMEMemory:STORe<n>:PEAK](#) on page 244
- [Chapter 11.8.3.4, "Marker search settings"](#), on page 232

Remote commands exclusive to peak lists

CALCulate<n>:MARKer<m>:FUNCTION:FPEaks:ANNOtation:LABel[:STATe]	240
CALCulate<n>:MARKer<m>:FUNCTION:FPEaks:COUNT?	241
CALCulate<n>:MARKer<m>:FUNCTION:FPEaks[:IMMEDIATE]	241
CALCulate<n>:MARKer<m>:FUNCTION:FPEaks:LIST:SIZE	242
CALCulate<n>:MARKer<m>:FUNCTION:FPEaks:SORT	242
CALCulate<n>:MARKer<m>:FUNCTION:FPEaks:STATe	242
CALCulate<n>:MARKer<m>:FUNCTION:FPEaks:X?	243
CALCulate<n>:MARKer<m>:FUNCTION:FPEaks:Y?	243
MMEMemory:STORe<n>:LIST	243
MMEMemory:STORe<n>:PEAK	244

CALCulate<n>:MARKer<m>:FUNCTION:FPEaks:ANNOtation:LABel[:STATe]
 <State>

This command turns labels for peaks found during a peak search on and off.

The labels correspond to the marker number in the marker peak list.

Suffix:

<n> [Window](#)
 <m> [Marker](#)

Parameters:

<State> ON | OFF | 0 | 1
 *RST: 1

Example:

CALC:MARK:FUNC:FPE:ANN:LAB:STAT OFF
 Removes the peak labels from the diagram

Manual operation: See "[Display Marker Numbers](#)" on page 108

CALCulate<n>:MARKer<m>:FUNCTION:FPEaks:COUNT?

This command queries the number of peaks that have been found during a peak search.

The actual number of peaks that have been found may differ from the number of peaks you have set to be found because of the peak excursion.

Suffix:

<n> irrelevant
 <m> irrelevant

Return values:

<NumberOfPeaks>

Example:

CALC:MARK:FUNC:FPE:COUN?
 Queries the number of peaks.

Usage:

Query only

CALCulate<n>:MARKer<m>:FUNCTION:FPEaks[:IMMEDIATE] <Peaks>

This command initiates a peak search.

Suffix:

<n> [Window](#)
 <m> [Marker](#)

Parameters:

<Peaks> This parameter defines the number of peaks to find during the search.
 Note that the actual number of peaks found during the search also depends on the peak excursion you have set with [CALCulate<n>:MARKer<m>:PEXCursion](#).
 Range: 1 to 200

Example:

CALC:MARK:PEXC 5
 Defines a peak excursion of 5 dB, i.e. peaks must be at least 5 dB apart to be detected as a peak.
 CALC:MARK:FUNC:FPE 10
 Initiates a search for 10 peaks on the current trace.

CALCulate<n>:MARKer<m>:FUNction:FPEaks:LIST:SIZE <MaxNoPeaks>

This command defines the maximum number of peaks that the R&S FPL1000 looks for during a peak search.

Suffix:

<n> [Window](#)

<m> [Marker](#)

Parameters:

<MaxNoPeaks> Maximum number of peaks to be determined.

Range: 1 to 500

*RST: 50

Example:

CALC:MARK:FUNC:FPE:LIST:SIZE 10

The marker peak list will contain a maximum of 10 peaks.

Manual operation: See "[Maximum Number of Peaks](#)" on page 108

CALCulate<n>:MARKer<m>:FUNction:FPEaks:SORT <SortMode>

This command selects the order in which the results of a peak search are returned.

Suffix:

<n> [Window](#)

<m> [Marker](#)

Parameters:

<SortMode> **X**

Sorts the peaks according to increasing position on the x-axis.

Y

Sorts the peaks according to decreasing position on the y-axis.

*RST: X

Example:

CALC:MARK:FUNC:FPE:SORT Y

Sets the sort mode to decreasing y values

Manual operation: See "[Sort Mode](#)" on page 107

CALCulate<n>:MARKer<m>:FUNction:FPEaks:STATe <State>

This command turns a peak search on and off.

Suffix:

<n> [Window](#)

<m> [Marker](#)

Parameters:

<State> ON | OFF | 0 | 1

OFF | 0

Switches the function off

ON | 1

Switches the function on

Example: `CALC:MARK:FUNC:FPE:STAT ON`
Activates marker peak search

Manual operation: See "[Peak List State](#)" on page 107

CALCulate<n>:MARKer<m>:FUNCTion:FPEaks:X?

This command queries the position of the peaks on the x-axis.

The order depends on the sort order that has been set with `CALCulate<n>:MARKer<m>:FUNCTion:FPEaks:SORT`.

Suffix:`<n>` irrelevant`<m>` irrelevant**Return values:**

`<PeakPosition>` Position of the peaks on the x-axis. The unit depends on the measurement.

Usage: Query only

CALCulate<n>:MARKer<m>:FUNCTion:FPEaks:Y?

This command queries the position of the peaks on the y-axis.

The order depends on the sort order that has been set with `CALCulate<n>:MARKer<m>:FUNCTion:FPEaks:SORT`.

Suffix:`<n>` irrelevant`<m>` irrelevant**Return values:**

`<PeakPosition>` Position of the peaks on the y-axis. The unit depends on the measurement.

Usage: Query only

MMEory:STORe<n>:LIST <FileName>

This command exports the SEM and spurious emission list evaluation to a file.

The file format is *.dat.

Suffix:`<n>` [Window](#)**Parameters:**

`<FileName>` String containing the path and name of the target file.

Example: `MMEM:STOR:LIST 'test'`
Stores the current list evaluation results in the `test.dat` file.

MMEMory:STORe<n>:PEAK <FileName>

This command exports the marker peak list to a file.

Suffix:

<n> [Window](#)

Parameters:

<FileName> String containing the path, name and extension of the target file.

Example: `MMEM:STOR:PEAK 'test.dat'`
Saves the current marker peak list in the file `test.dat`.

Manual operation: See "[Export Peak List](#)" on page 108

N db down marker

The following commands control the n dB down markers.

CALCulate<n>:MARKer<m>:FUNCTion:NDBDown	244
CALCulate<n>:MARKer<m>:FUNCTion:NDBDown:FREQuency?	245
CALCulate<n>:MARKer<m>:FUNCTion:NDBDown:QFACtor?	245
CALCulate<n>:MARKer<m>:FUNCTion:NDBDown:RESult?	246
CALCulate<n>:MARKer<m>:FUNCTion:NDBDown:STATe	246
CALCulate<n>:MARKer<m>:FUNCTion:NDBDown:TIME?	247

CALCulate<n>:MARKer<m>:FUNCTion:NDBDown <Distance>

This command defines the distance of the n dB down markers to the reference marker.

Suffix:

<n> [Window](#)

<m> [Marker](#)

Parameters:

<Distance> Distance of the temporary markers to the reference marker in dB.
For a positive offset, the markers T1 and T2 are placed *below* the active reference point.
For a negative offset (for example for notch filter measurements), the markers T1 and T2 are placed *above* the active reference point.

*RST: 6dB
Default unit: DB

Example: `CALC:MARK:FUNC:NDBD 3dB`
Sets the distance to the reference marker to 3 dB.

CALCulate<n>:MARKer<m>:FUNCtion:NDBDown:FREQuency?

This command queries the position of the n dB down markers on the x-axis when measuring in the frequency domain.

To get a valid result, you have to perform a complete measurement with synchronization to the end of the measurement before reading out the result. This is only possible for single sweep mode.

See also [INITiate<n>:CONTinuous](#) on page 176.

Suffix:

<n> irrelevant

<m> irrelevant

Return values:

<Frequency>

<frequency 1>

absolute frequency of the n dB marker to the left of the reference marker in Hz

<frequency 2>

absolute frequency of the n dB marker to the right of the reference marker in Hz.

Example:

```
INIT:CONT OFF
```

Switches to single sweep mode.

```
CALC:MARK:FUNC:NDBD ON
```

Switches on the n dB down function.

```
INIT;*WAI
```

Starts a sweep and waits for the end.

```
CALC:MARK:FUNC:NDBD:FREQ?
```

This command would return, for example, 100000000, 200000000, meaning that the first marker position is at 100 MHz, the second marker position is at 200 MHz

Usage: Query only

Manual operation: See "[n dB down Value](#)" on page 102

CALCulate<n>:MARKer<m>:FUNCtion:NDBDown:QFACtor?

This command queries the Q factor of n dB down measurements.

Suffix:

<n> irrelevant

<m> irrelevant

Return values:

<QFactor>

Usage: Query only

CALCulate<n>:MARKer<m>:FUNCtion:NDBDown:RESult?

This command queries the distance of the n dB down markers from each other.

To get a valid result, you have to perform a complete measurement with synchronization to the end of the measurement before reading out the result. This is only possible for single sweep mode.

See also [INITiate<n>:CONTinuous](#) on page 176.

Suffix:

<n> irrelevant

<m> irrelevant

Return values:

<Distance> The result depends on the span.
In case of frequency domain measurements, the command returns the bandwidth between the two n dB down markers in Hz.
In case of time domain measurements, the command returns the pulse width between the two n dB down markers in seconds.

Example:

```
INIT:CONT OFF
Switches to single sweep mode.
CALC:MARK:FUNC:NDBD ON
Switches on the n dB down function.
INIT;*WAI
Starts a sweep and waits for the end.
CALC:MARK:FUNC:NDBD:RES?
Outputs the measured value.
```

Usage: Query only

Manual operation: See "[n dB down Marker State](#)" on page 102

CALCulate<n>:MARKer<m>:FUNCtion:NDBDown:STATe <State>

This command turns the n dB Down marker function on and off.

Suffix:

<n> irrelevant

<m> irrelevant

Parameters:

<State> ON | OFF | 0 | 1
OFF | 0
Switches the function off
ON | 1
Switches the function on

Example:

```
CALC:MARK:FUNC:NDBD:STAT ON
Turns the n dB Down marker on.
```

Manual operation: See "[n dB down Marker State](#)" on page 102

CALCulate<n>:MARKer<m>:FUNCtion:NDBDown:TIME?

This command queries the position of the n dB down markers on the x-axis when measuring in the time domain.

To get a valid result, you have to perform a complete measurement with synchronization to the end of the measurement before reading out the result. This is only possible for single sweep mode.

See also [INITiate<n>:CONTinuous](#) on page 176.

Suffix:

<n> irrelevant

<m> irrelevant

Return values:

<TimeX1> absolute position in time of the n dB marker to the left of the reference marker in seconds

<TimeX2> absolute position in time of the n dB marker to the right of the reference marker in seconds

Example:

```
INIT:CONT OFF
```

Switches to single sweep mode

```
CALC:MARK:FUNC:NDBD ON
```

Switches on the n dB down function.

```
INIT;*WAI
```

Starts a sweep and waits for the end.

```
CALC:MARK:FUNC:NDBD:TIME?
```

Outputs the time values of the temporary markers.

Usage: Query only

Manual operation: See "[n dB down Value](#)" on page 102

Phase noise measurement marker

The following commands control the phase noise measurement marker function.

[CALCulate<n>:MARKer<m>:FUNCtion:PNOise:AOff](#).....247

[CALCulate<n>:MARKer<m>:FUNCtion:PNOise\[:STATe\]](#)..... 248

[CALCulate<n>:MARKer<m>:FUNCtion:PNOise:RESult?](#)..... 248

CALCulate<n>:MARKer<m>:FUNCtion:PNOise:AOff

Removes all phase noise markers in the specified window.

Suffix:

<n> [Window](#)

<m> irrelevant

Example:

```
CALC:MARK:FUNC:PNO:AOff
```

CALCulate<n>:MARKer<m>:FUNction:PNOise[:STATe] <State>

This command turns the phase noise measurement at the marker position on and off.

Suffix:

<n> [Window](#)

<m> [Marker](#)

Parameters:

<State> ON | OFF | 0 | 1

OFF | 0

Switches the function off

ON | 1

Switches the function on

Example:

CALC:MARK2:FUNC:PNO ON

Switches on the phase-noise measurement for the marker 2.

Manual operation:

See ["Phase Noise Measurement State"](#) on page 104

See ["Switching All Phase Noise Measurements Off"](#) on page 105

CALCulate<n>:MARKer<m>:FUNction:PNOise:RESult?

This command queries the result of a phase noise measurement.

If necessary, the command activates the measurement first.

Suffix:

<n> [Window](#)

<m> [Marker](#)

Return values:

<PhaseNoise> numeric value

The difference between the measured carrier power and the noise power at the position of the specified (normal) marker.

Example:

CALC:MARK2:FUNC:PNO:RES?

Outputs the result of phase-noise measurement of the marker 2.

Usage:

Query only

Manual operation:

See ["Phase Noise Measurement State"](#) on page 104

11.8.4 Marker search (spectrograms)

The following commands automatically define the marker and delta marker position in the spectrogram.

11.8.4.1 Using markers

The following commands control spectrogram markers.

Useful commands for spectrogram markers described elsewhere

The following commands define the horizontal position of the markers.

- `CALCulate<n>:MARKer<m>:MAXimum:LEFT` on page 233
- `CALCulate<n>:MARKer<m>:MAXimum:NEXT` on page 234
- `CALCulate<n>:MARKer<m>:MAXimum[:PEAK]` on page 234
- `CALCulate<n>:MARKer<m>:MAXimum:RIGHT` on page 234
- `CALCulate<n>:MARKer<m>:MINimum:LEFT` on page 234
- `CALCulate<n>:MARKer<m>:MINimum:NEXT` on page 235
- `CALCulate<n>:MARKer<m>:MINimum[:PEAK]` on page 235
- `CALCulate<n>:MARKer<m>:MINimum:RIGHT` on page 235

Remote commands exclusive to spectrogram markers

<code>CALCulate<n>:MARKer<m>:SGRam:FRAME</code>	249
<code>CALCulate<n>:MARKer<m>:SPEctrogram:FRAME</code>	249
<code>CALCulate<n>:MARKer<m>:SGRam:SARea</code>	250
<code>CALCulate<n>:MARKer<m>:SPEctrogram:SARea</code>	250
<code>CALCulate<n>:MARKer<m>:SGRam:XY:MAXimum[:PEAK]</code>	250
<code>CALCulate<n>:MARKer<m>:SPEctrogram:XY:MAXimum[:PEAK]</code>	250
<code>CALCulate<n>:MARKer<m>:SGRam:XY:MINimum[:PEAK]</code>	251
<code>CALCulate<n>:MARKer<m>:SPEctrogram:XY:MINimum[:PEAK]</code>	251
<code>CALCulate<n>:MARKer<m>:SGRam:Y:MAXimum:ABOVE</code>	251
<code>CALCulate<n>:MARKer<m>:SPEctrogram:Y:MAXimum:ABOVE</code>	251
<code>CALCulate<n>:MARKer<m>:SGRam:Y:MAXimum:BELOW</code>	251
<code>CALCulate<n>:MARKer<m>:SPEctrogram:Y:MAXimum:BELOW</code>	251
<code>CALCulate<n>:MARKer<m>:SGRam:Y:MAXimum:NEXT</code>	251
<code>CALCulate<n>:MARKer<m>:SPEctrogram:Y:MAXimum:NEXT</code>	251
<code>CALCulate<n>:MARKer<m>:SGRam:Y:MAXimum[:PEAK]</code>	252
<code>CALCulate<n>:MARKer<m>:SPEctrogram:Y:MAXimum[:PEAK]</code>	252
<code>CALCulate<n>:MARKer<m>:SGRam:Y:MINimum:ABOVE</code>	252
<code>CALCulate<n>:MARKer<m>:SPEctrogram:Y:MINimum:ABOVE</code>	252
<code>CALCulate<n>:MARKer<m>:SGRam:Y:MINimum:BELOW</code>	252
<code>CALCulate<n>:MARKer<m>:SPEctrogram:Y:MINimum:BELOW</code>	252
<code>CALCulate<n>:MARKer<m>:SGRam:Y:MINimum:NEXT</code>	252
<code>CALCulate<n>:MARKer<m>:SPEctrogram:Y:MINimum:NEXT</code>	252
<code>CALCulate<n>:MARKer<m>:SGRam:Y:MINimum[:PEAK]</code>	253
<code>CALCulate<n>:MARKer<m>:SPEctrogram:Y:MINimum[:PEAK]</code>	253

`CALCulate<n>:MARKer<m>:SGRam:FRAME` <Frame>

`CALCulate<n>:MARKer<m>:SPEctrogram:FRAME` <Frame> | <Time>

This command positions a marker on a particular frame.

Suffix:<n> [Window](#)<m> [Marker](#)**Parameters:**

<Frame> Selects a frame directly by the frame number. Valid if the time stamp is off.
The range depends on the history depth.
Default unit: S

<Time> Selects a frame via its time stamp. Valid if the time stamp is on.
The number is the (negative) distance to frame 0 in seconds.
The range depends on the history depth.

Example:

```
CALC:MARK:SGR:FRAM -20
```

Sets the marker on the 20th frame before the present.

```
CALC:MARK2:SGR:FRAM -2s
```

Sets second marker on the frame 2 seconds ago.

```
CALCulate<n>:MARKer<m>:SGRam:SARea <SearchArea>
```

```
CALCulate<n>:MARKer<m>:SPECTrogram:SARea <SearchArea>
```

This command defines the marker search area for all spectrogram markers in the channel setup.

Suffix:

<n> irrelevant

<m> irrelevant

Parameters:

<SearchArea>

VISible

Performs a search within the visible frames.

Note that the command does not work if the spectrogram is not visible for any reason (e.g. if the display update is off).

MEMory

Performs a search within all frames in the memory.

```
*RST: VISible
```

Manual operation: See "[Marker Search Area](#)" on page 99

```
CALCulate<n>:MARKer<m>:SGRam:XY:MAXimum[:PEAK]
```

```
CALCulate<n>:MARKer<m>:SPECTrogram:XY:MAXimum[:PEAK]
```

This command moves a marker to the highest level of the spectrogram.

Suffix:<n> [Window](#)<m> [Marker](#)

CALCulate<n>:MARKer<m>:SGRam:XY:MINimum[:PEAK]
CALCulate<n>:MARKer<m>:SPECTrogram:XY:MINimum[:PEAK]

This command moves a marker to the minimum level of the spectrogram.

Suffix:

<n> [Window](#)

<m> [Marker](#)

CALCulate<n>:MARKer<m>:SGRam:Y:MAXimum:ABOVE
CALCulate<n>:MARKer<m>:SPECTrogram:Y:MAXimum:ABOVE

This command moves a marker vertically to the next lower peak level for the current frequency.

The search includes only frames above the current marker position. It does not change the horizontal position of the marker.

Suffix:

<n> [Window](#)

<m> [Marker](#)

Manual operation: See ["Search Mode for Next Peak in Y-Direction"](#) on page 98

CALCulate<n>:MARKer<m>:SGRam:Y:MAXimum:BELOW
CALCulate<n>:MARKer<m>:SPECTrogram:Y:MAXimum:BELOW

This command moves a marker vertically to the next lower peak level for the current frequency.

The search includes only frames below the current marker position. It does not change the horizontal position of the marker.

Suffix:

<n> [Window](#)

<m> [Marker](#)

Manual operation: See ["Search Mode for Next Peak in Y-Direction"](#) on page 98

CALCulate<n>:MARKer<m>:SGRam:Y:MAXimum:NEXT
CALCulate<n>:MARKer<m>:SPECTrogram:Y:MAXimum:NEXT

This command moves a marker vertically to the next lower peak level for the current frequency.

The search includes all frames. It does not change the horizontal position of the marker.

Suffix:

<n> [Window](#)

<m> [Marker](#)

Manual operation: See ["Search Mode for Next Peak in Y-Direction"](#) on page 98

**CALCulate<n>:MARKer<m>:SGRam:Y:MAXimum[:PEAK]
CALCulate<n>:MARKer<m>:SPECTrogram:Y:MAXimum[:PEAK]**

This command moves a marker vertically to the highest level for the current frequency.

The search includes all frames. It does not change the horizontal position of the marker.

If the marker hasn't been active yet, the command looks for the peak level in the whole spectrogram.

Suffix:

<n> [Window](#)

<m> [Marker](#)

**CALCulate<n>:MARKer<m>:SGRam:Y:MINimum:ABOVE
CALCulate<n>:MARKer<m>:SPECTrogram:Y:MINimum:ABOVE**

This command moves a marker vertically to the next higher minimum level for the current frequency.

The search includes only frames above the current marker position. It does not change the horizontal position of the marker.

Suffix:

<n> [Window](#)

<m> [Marker](#)

Manual operation: See ["Search Mode for Next Peak in Y-Direction"](#) on page 98

**CALCulate<n>:MARKer<m>:SGRam:Y:MINimum:BELOW
CALCulate<n>:MARKer<m>:SPECTrogram:Y:MINimum:BELOW**

This command moves a marker vertically to the next higher minimum level for the current frequency.

The search includes only frames below the current marker position. It does not change the horizontal position of the marker.

Suffix:

<n> [Window](#)

<m> [Marker](#)

Manual operation: See ["Search Mode for Next Peak in Y-Direction"](#) on page 98

**CALCulate<n>:MARKer<m>:SGRam:Y:MINimum:NEXT
CALCulate<n>:MARKer<m>:SPECTrogram:Y:MINimum:NEXT**

This command moves a marker vertically to the next higher minimum level for the current frequency.

The search includes all frames. It does not change the horizontal position of the marker.

Suffix:

<n> [Window](#)

<m> [Marker](#)

Manual operation: See "[Search Mode for Next Peak in Y-Direction](#)" on page 98

CALCulate<n>:MARKer<m>:SGRam:Y:MINimum[:PEAK]

CALCulate<n>:MARKer<m>:SPECTrogram:Y:MINimum[:PEAK]

This command moves a marker vertically to the minimum level for the current frequency.

The search includes all frames. It does not change the horizontal position of the marker.

If the marker hasn't been active yet, the command first looks for the peak level for all frequencies and moves the marker vertically to the minimum level.

Suffix:

<n> [Window](#)

<m> [Marker](#)

11.8.4.2 Using delta markers

The following commands control spectrogram delta markers.

Useful commands for spectrogram markers described elsewhere

The following commands define the horizontal position of the delta markers.

- [CALCulate<n>:DELTamarker<m>:MAXimum:LEFT](#) on page 236
- [CALCulate<n>:DELTamarker<m>:MAXimum:NEXT](#) on page 236
- [CALCulate<n>:DELTamarker<m>:MAXimum\[:PEAK\]](#) on page 236
- [CALCulate<n>:DELTamarker<m>:MAXimum:RIGHT](#) on page 236
- [CALCulate<n>:DELTamarker<m>:MINimum:LEFT](#) on page 237
- [CALCulate<n>:DELTamarker<m>:MINimum:NEXT](#) on page 237
- [CALCulate<n>:DELTamarker<m>:MINimum\[:PEAK\]](#) on page 237
- [CALCulate<n>:DELTamarker<m>:MINimum:RIGHT](#) on page 237

Remote commands exclusive to spectrogram markers

CALCulate<n>:DELTamarker<m>:SGRam:FRAMe	254
CALCulate<n>:DELTamarker<m>:SPECTrogram:FRAMe	254
CALCulate<n>:DELTamarker<m>:SGRam:SARea	254
CALCulate<n>:DELTamarker<m>:SPECTrogram:SARea	254
CALCulate<n>:DELTamarker<m>:SGRam:XY:MAXimum[:PEAK]	255
CALCulate<n>:DELTamarker<m>:SPECTrogram:XY:MAXimum[:PEAK]	255

CALCulate<n>:DELTamarker<m>:SGRam:XY:MINimum[:PEAK].....	255
CALCulate<n>:DELTamarker<m>:SPECTrogram:XY:MINimum[:PEAK].....	255
CALCulate<n>:DELTamarker<m>:SGRam:Y:MAXimum:ABOVe.....	255
CALCulate<n>:DELTamarker<m>:SPECTrogram:Y:MAXimum:ABOVe.....	255
CALCulate<n>:DELTamarker<m>:SGRam:Y:MAXimum:BELow.....	256
CALCulate<n>:DELTamarker<m>:SPECTrogram:Y:MAXimum:BELow.....	256
CALCulate<n>:DELTamarker<m>:SGRam:Y:MAXimum:NEXT.....	256
CALCulate<n>:DELTamarker<m>:SPECTrogram:Y:MAXimum:NEXT.....	256
CALCulate<n>:DELTamarker<m>:SGRam:Y:MAXimum[:PEAK].....	256
CALCulate<n>:DELTamarker<m>:SPECTrogram:Y:MAXimum[:PEAK].....	256
CALCulate<n>:DELTamarker<m>:SGRam:Y:MINimum:ABOVe.....	256
CALCulate<n>:DELTamarker<m>:SPECTrogram:Y:MINimum:ABOVe.....	256
CALCulate<n>:DELTamarker<m>:SGRam:Y:MINimum:BELow.....	257
CALCulate<n>:DELTamarker<m>:SPECTrogram:Y:MINimum:BELow.....	257
CALCulate<n>:DELTamarker<m>:SGRam:Y:MINimum:NEXT.....	257
CALCulate<n>:DELTamarker<m>:SPECTrogram:Y:MINimum:NEXT.....	257
CALCulate<n>:DELTamarker<m>:SGRam:Y:MINimum[:PEAK].....	257
CALCulate<n>:DELTamarker<m>:SPECTrogram:Y:MINimum[:PEAK].....	257

CALCulate<n>:DELTamarker<m>:SGRam:FRAMe <Frame>

CALCulate<n>:DELTamarker<m>:SPECTrogram:FRAMe <Frame>

This command positions a delta marker on a particular frame. The frame is relative to the position of marker 1.

The command is available for the spectrogram.

Suffix:

<n> Window

<m> Marker

Parameters:

<Frame> Selects a frame either by its frame number or time stamp.
 The frame number is available if the time stamp is off. The range depends on the history depth.
 The time stamp is available if the time stamp is on. The number is the distance to frame 0 in seconds. The range depends on the history depth.
 Default unit: S

Example:

CALC:DELT4:SGR:FRAM -20

Sets fourth deltamarker 20 frames below marker 1.

CALC:DELT4:SGR:FRAM 2 s

Sets fourth deltamarker 2 seconds above the position of marker 1.

CALCulate<n>:DELTamarker<m>:SGRam:SARea <SearchArea>

CALCulate<n>:DELTamarker<m>:SPECTrogram:SARea <SearchArea>

This command defines the marker search area for *all* spectrogram markers in the channel setup.

Suffix:

<n> irrelevant

<m> irrelevant

Parameters:

<SearchArea>

VISible

Performs a search within the visible frames.

Note that the command does not work if the spectrogram is not visible for any reason (e.g. if the display update is off).

MEMory

Performs a search within all frames in the memory.

*RST: VISible

Manual operation: See "[Marker Search Area](#)" on page 99

CALCulate<n>:DELTamarker<m>:SGRam:XY:MAXimum[:PEAK]

CALCulate<n>:DELTamarker<m>:SPECTrogram:XY:MAXimum[:PEAK]

This command moves a marker to the highest level of the spectrogram over all frequencies.

Suffix:

<n> [Window](#)

<m> [Marker](#)

CALCulate<n>:DELTamarker<m>:SGRam:XY:MINimum[:PEAK]

CALCulate<n>:DELTamarker<m>:SPECTrogram:XY:MINimum[:PEAK]

This command moves a delta marker to the minimum level of the spectrogram over all frequencies.

Suffix:

<n> [Window](#)

<m> [Marker](#)

CALCulate<n>:DELTamarker<m>:SGRam:Y:MAXimum:ABOVE

CALCulate<n>:DELTamarker<m>:SPECTrogram:Y:MAXimum:ABOVE

This command moves a marker vertically to the next higher level for the current frequency.

The search includes only frames above the current marker position. It does not change the horizontal position of the marker.

Suffix:

<n> [Window](#)

<m> [Marker](#)

Manual operation: See "[Search Mode for Next Peak in Y-Direction](#)" on page 98

CALCulate<n>:DELTamarker<m>:SGRam:Y:MAXimum:BELOW
CALCulate<n>:DELTamarker<m>:SPECTrogram:Y:MAXimum:BELOW

This command moves a marker vertically to the next higher level for the current frequency.

The search includes only frames below the current marker position. It does not change the horizontal position of the marker.

Suffix:

<n> [Window](#)

<m> [Marker](#)

Manual operation: See "[Search Mode for Next Peak in Y-Direction](#)" on page 98

CALCulate<n>:DELTamarker<m>:SGRam:Y:MAXimum:NEXT
CALCulate<n>:DELTamarker<m>:SPECTrogram:Y:MAXimum:NEXT

This command moves a delta marker vertically to the next higher level for the current frequency.

The search includes all frames. It does not change the horizontal position of the marker.

Suffix:

<n> [Window](#)

<m> [Marker](#)

Manual operation: See "[Search Mode for Next Peak in Y-Direction](#)" on page 98

CALCulate<n>:DELTamarker<m>:SGRam:Y:MAXimum[:PEAK]
CALCulate<n>:DELTamarker<m>:SPECTrogram:Y:MAXimum[:PEAK]

This command moves a delta marker vertically to the highest level for the current frequency.

The search includes all frames. It does not change the horizontal position of the marker.

If the marker hasn't been active yet, the command looks for the peak level in the whole spectrogram.

Suffix:

<n> [Window](#)

<m> [Marker](#)

CALCulate<n>:DELTamarker<m>:SGRam:Y:MINimum:ABOVE
CALCulate<n>:DELTamarker<m>:SPECTrogram:Y:MINimum:ABOVE

This command moves a delta marker vertically to the next minimum level for the current frequency.

The search includes only frames above the current marker position. It does not change the horizontal position of the marker.

Suffix:

<n> [Window](#)

<m> [Marker](#)

Manual operation: See ["Search Mode for Next Peak in Y-Direction"](#) on page 98

CALCulate<n>:DELTamarker<m>:SGRam:Y:MINimum:BELOW

CALCulate<n>:DELTamarker<m>:SPECTrogram:Y:MINimum:BELOW

This command moves a delta marker vertically to the next minimum level for the current frequency.

The search includes only frames below the current marker position. It does not change the horizontal position of the marker.

Suffix:

<n> [Window](#)

<m> [Marker](#)

Manual operation: See ["Search Mode for Next Peak in Y-Direction"](#) on page 98

CALCulate<n>:DELTamarker<m>:SGRam:Y:MINimum:NEXT

CALCulate<n>:DELTamarker<m>:SPECTrogram:Y:MINimum:NEXT

This command moves a delta marker vertically to the next minimum level for the current frequency.

The search includes all frames. It does not change the horizontal position of the marker.

Suffix:

<n> [Window](#)

<m> [Marker](#)

Manual operation: See ["Search Mode for Next Peak in Y-Direction"](#) on page 98

CALCulate<n>:DELTamarker<m>:SGRam:Y:MINimum[:PEAK]

CALCulate<n>:DELTamarker<m>:SPECTrogram:Y:MINimum[:PEAK]

This command moves a delta marker vertically to the minimum level for the current frequency.

The search includes all frames. It does not change the horizontal position of the marker.

If the marker hasn't been active yet, the command first looks for the peak level in the whole spectrogram and moves the marker vertically to the minimum level.

Suffix:

<n> [Window](#)

<m> Marker

11.8.5 Defining limit checks

Note that in remote control, upper and lower limit lines are configured using separate commands. Thus, you must decide in advance which you want to configure. The x-values for both upper and lower limit lines are defined as a common control line. This control line is the reference for the y-values for both upper and lower limit lines.

- [Configuring limit lines](#)..... 258
- [Managing limit lines](#)..... 267
- [Checking the results of a limit check](#)..... 269
- [Programming example: using limit lines](#)..... 270

11.8.5.1 Configuring limit lines

CALCulate<n>:LIMit:COMMeNT	258
CALCulate<n>:LIMit:CONTRol[:DATA]	259
CALCulate<n>:LIMit:CONTRol:DOMain	259
CALCulate<n>:LIMit:CONTRol:MODE	259
CALCulate<n>:LIMit:CONTRol:OFFSet	260
CALCulate<n>:LIMit:CONTRol:SHIFt	260
CALCulate<n>:LIMit:CONTRol:SPACing	260
CALCulate<n>:LIMit:LOWer[:DATA]	261
CALCulate<n>:LIMit:LOWer:MARGin	261
CALCulate<n>:LIMit:LOWer:MODE	261
CALCulate<n>:LIMit:LOWer:OFFSet	262
CALCulate<n>:LIMit:LOWer:SHIFt	262
CALCulate<n>:LIMit:LOWer:SPACing	262
CALCulate<n>:LIMit:LOWer:STATe	263
CALCulate<n>:LIMit:LOWer:THReshold	263
CALCulate<n>:LIMit:NAME	263
CALCulate<n>:LIMit:UNIT	264
CALCulate<n>:LIMit:UPPer[:DATA]	264
CALCulate<n>:LIMit:UPPer:MARGin	264
CALCulate<n>:LIMit:UPPer:MODE	265
CALCulate<n>:LIMit:UPPer:OFFSet	265
CALCulate<n>:LIMit:UPPer:SHIFt	265
CALCulate<n>:LIMit:UPPer:SPACing	266
CALCulate<n>:LIMit:UPPer:STATe	266
CALCulate<n>:LIMit:UPPer:THReshold	266

CALCulate<n>:LIMit:COMMeNT <Comment>

This command defines a comment for a limit line.

Suffix:

<n>	irrelevant
	Limit line

Parameters:

<Comment> String containing the description of the limit line.

CALCulate<n>:LIMit:CONTrol[:DATA] <LimitLinePoints>

This command defines the horizontal definition points of a limit line.

Suffix:

<n> irrelevant

 [Limit line](#)

Parameters:

<LimitLinePoints> Variable number of x-axis values.
 Note that the number of horizontal values has to be the same as the number of vertical values set with [CALCulate<n>:LIMit:LOWer\[:DATA\]](#) or [CALCulate<n>:LIMit:UPPer\[:DATA\]](#). If not, the R&S FPL1000 either adds missing values or ignores surplus values.
 The unit is Hz or s.

*RST: -

Default unit: HZ

CALCulate<n>:LIMit:CONTrol:DOMain <SpanSetting>

This command selects the domain of the limit line.

Suffix:

<n> irrelevant

 [Limit line](#)

Parameters:

<SpanSetting> FREQUENCY | TIME

FREQUENCY

For limit lines that apply to a range of frequencies.

TIME

For limit lines that apply to a period of time.

*RST: FREQUENCY

Example:

CALC:LIM:CONT:DOM FREQ

Select a limit line in the frequency domain.

CALCulate<n>:LIMit:CONTrol:MODE <Mode>

This command selects the horizontal limit line scaling.

Suffix:

<n> irrelevant

 [Limit line](#)

Parameters:

<Mode>

ABSolute

Limit line is defined by absolute physical values (Hz or s).

RELative

Limit line is defined by relative values related to the center frequency (frequency domain) or the left diagram border (time domain).

*RST: ABSolute

CALCulate<n>:LIMit:CONTrol:OFFSet <Offset>

This command defines an offset for a complete limit line.

Compared to shifting the limit line, an offset does not actually change the limit line definition points.

Suffix:

<n> irrelevant

 [Limit line](#)

Parameters:

<Offset>

Numeric value.

The unit depends on the scale of the x-axis.

*RST: 0

Default unit: HZ

CALCulate<n>:LIMit:CONTrol:SHIFt <Distance>

This command moves a complete limit line horizontally.

Compared to defining an offset, this command actually changes the limit line definition points by the value you define.

Suffix:

<n> irrelevant

 [Limit line](#)

Parameters:

<Distance>

Numeric value.

The unit depends on the scale of the x-axis.

Default unit: HZ

CALCulate<n>:LIMit:CONTrol:SPACing <InterpolMode>

This command selects linear or logarithmic interpolation for the calculation of limit lines from one horizontal point to the next.

Suffix:<n> [Window](#) [Limit line](#)**Parameters:**

<InterpolMode> LINear | LOGarithmic

*RST: LIN

Example:

CALC:LIM:CONT:SPAC LIN

CALCulate<n>:LIMit:LOWer[:DATA] <LimitLinePoints>

This command defines the vertical definition points of a lower limit line.

Suffix:

<n> irrelevant

 [Limit line](#)**Parameters:**

<LimitLinePoints> Variable number of level values.

Note that the number of vertical values has to be the same as

the number of horizontal values set with [CALCulate<n>:](#)

[LIMit:CONTrol\[:DATA\]](#). If not, the R&S FPL1000 either

adds missing values or ignores surplus values.

The unit depends on [CALCulate<n>:LIMit:UNIT](#)

on page 264.

*RST: Limit line state is OFF

Default unit: DBM

CALCulate<n>:LIMit:LOWer:MARGin <Margin>

This command defines an area around a lower limit line where limit check violations are still tolerated.

Suffix:

<n> irrelevant

 [Limit line](#)**Parameters:**<Margin> **numeric value**

*RST: 0

Default unit: dB

CALCulate<n>:LIMit:LOWer:MODE <Mode>

This command selects the vertical limit line scaling.

Suffix:<n> [Window](#)

 [Limit line](#)

Parameters:

<Mode>

ABSolute

Limit line is defined by absolute physical values.

The unit is variable.

RELative

Limit line is defined by relative values related to the reference level (dB).

*RST: ABSolute

CALCulate<n>:LIMit:LOWer:OFFSet <Offset>

This command defines an offset for a complete lower limit line.

Compared to shifting the limit line, an offset does not actually change the limit line definition points.

Suffix:

<n> [Window](#)

 [Limit line](#)

Parameters:

<Offset>

Numeric value.

*RST: 0

Default unit: dB

CALCulate<n>:LIMit:LOWer:SHIFt <Distance>

This command moves a complete lower limit line vertically.

Compared to defining an offset, this command actually changes the limit line definition points by the value you define.

Suffix:

<n> [Window](#)

 [Limit line](#)

Parameters:

<Distance>

Defines the distance that the limit line moves.

The unit depends on [CALCulate<n>:LIMit:UNIT](#) on page 264.

Default unit: DB

CALCulate<n>:LIMit:LOWer:SPACing <InterpolType>

This command selects linear or logarithmic interpolation for the calculation of a lower limit line from one horizontal point to the next.

Suffix:<n> [Window](#) [Limit line](#)**Parameters:**

<InterpolType> LINear | LOGarithmic

*RST: LIN

CALCulate<n>:LIMit:LOWer:STATe <State>

This command turns a lower limit line on and off.

Before you can use the command, you have to select a limit line with [CALCulate<n>:LIMit:NAME](#) on page 263.

Suffix:

<n> irrelevant

 [Limit line](#)**Parameters:**

<State> ON | OFF | 0 | 1

OFF | 0

Switches the function off

ON | 1

Switches the function on

CALCulate<n>:LIMit:LOWer:THReshold <Threshold>

This command defines a threshold for relative limit lines.

The R&S FPL1000 uses the threshold for the limit check, if the limit line violates the threshold.

Suffix:

<n> irrelevant

 [Limit line](#)**Parameters:**

<Threshold> Numeric value.

The unit depends on [CALCulate<n>:LIMit:UNIT](#) on page 264.

*RST: -200 dBm

Default unit: DBM

CALCulate<n>:LIMit:NAME <Name>

This command selects a limit line that already exists or defines a name for a new limit line.

Suffix:<n> [Window](#) [Limit line](#)**Parameters:**

<Name> String containing the limit line name.

*RST: REM1 to REM8 for lines 1 to 8

CALCulate<n>:LIMit:UNIT <Unit>

This command defines the unit of a limit line.

Suffix:

<n> irrelevant

 [Limit line](#)**Parameters:**

<Unit> If you select a dB-based unit for the limit line, the command automatically turns the limit line into a relative limit line.

*RST: DBM

CALCulate<n>:LIMit:UPPer[:DATA] <LimitLinePoints>

This command defines the vertical definition points of an upper limit line.

Suffix:

<n> irrelevant

 [Limit line](#)**Parameters:**

<LimitLinePoints> Variable number of level values.

Note that the number of vertical values has to be the same as the number of horizontal values set with [CALCulate<n>:LIMit:CONTRol\[:DATA\]](#). If not, the R&S FPL1000 either adds missing values or ignores surplus values.

The unit depends on [CALCulate<n>:LIMit:UNIT](#) on page 264.

*RST: Limit line state is OFF

Default unit: DBM

CALCulate<n>:LIMit:UPPer:MARGin <Margin>

This command defines an area around an upper limit line where limit check violations are still tolerated.

Suffix:

<n> irrelevant

 [Limit line](#)

Parameters:

<Margin> **numeric value**
 *RST: 0
 Default unit: dB

CALCulate<n>:LIMit:UPPer:MODE <Mode>

This command selects the vertical limit line scaling.

Suffix:

<n> [Window](#)

 [Limit line](#)

Parameters:

<Mode> **ABSolute**
 Limit line is defined by absolute physical values.
 The unit is variable.

RELative
 Limit line is defined by relative values related to the reference
 level (dB).

*RST: ABSolute

CALCulate<n>:LIMit:UPPer:OFFSet <Offset>

This command defines an offset for a complete upper limit line.

Compared to shifting the limit line, an offset does not actually change the limit line definition points.

Suffix:

<n> irrelevant

 [Limit line](#)

Parameters:

<Offset> Numeric value.
 *RST: 0
 Default unit: dB

CALCulate<n>:LIMit:UPPer:SHIFt <Distance>

This command moves a complete upper limit line vertically.

Compared to defining an offset, this command actually changes the limit line definition points by the value you define.

Suffix:

<n> irrelevant

 [Limit line](#)

Parameters:

<Distance> Defines the distance that the limit line moves.
The unit depends on [CALCulate<n>:LIMit:UNIT](#) on page 264.

CALCulate<n>:LIMit:UPPer:SPACing <InterpolType>

This command selects linear or logarithmic interpolation for the calculation of an upper limit line from one horizontal point to the next.

Suffix:

<n> [Window](#)

 [Limit line](#)

Parameters:

<InterpolType> LINear | LOGarithmic
*RST: LIN

CALCulate<n>:LIMit:UPPer:STATe <State>

This command turns an upper limit line on and off.

Before you can use the command, you have to select a limit line with [CALCulate<n>:LIMit:NAME](#) on page 263.

Suffix:

<n> irrelevant

 [Limit line](#)

Parameters:

<State> ON | OFF | 0 | 1
OFF | 0
Switches the function off
ON | 1
Switches the function on

CALCulate<n>:LIMit:UPPer:THReshold <Limit>

This command defines an absolute limit for limit lines with a relative scale.

The R&S FPL1000 uses the threshold for the limit check, if the limit line violates the threshold.

Suffix:

<n> irrelevant

 [Limit line](#)

Parameters:

<Limit> Numeric value.
 The unit depends on [CALCulate<n>:LIMit:UNIT](#)
 on page 264.

*RST: -200
 Default unit: dBm

11.8.5.2 Managing limit lines

Useful commands for managing limit lines described in the R&S FPL1000 User Manual:

- `MMEM:SEL[:ITEM]:LIN:ALL`
- `MMEM:STOR:TYPE`

Remote commands exclusive to managing limit lines:

CALCulate<n>:LIMit:ACTive?	267
CALCulate<n>:LIMit:COpy	267
CALCulate<n>:LIMit:DELeTe	268
CALCulate<n>:LIMit:STATe	268
CALCulate<n>:LIMit:TRACe<t>:CHECK	268
MMEMory:LOAD<n>:LIMit	269
MMEMory:STORe<n>:LIMit	269

CALCulate<n>:LIMit:ACTive?

This command queries the names of *all* active limit lines.

Suffix:

<n> irrelevant
 irrelevant

Return values:

<LimitLines> String containing the names of all active limit lines in alphabetical order.

Example:

`CALC:LIM:ACT?`
 Queries the names of all active limit lines.

Usage:

Query only

CALCulate<n>:LIMit:COpy <Line>

This command copies a limit line.

Suffix:

<n> [Window](#)

 [Limit line](#)

Parameters:

<Line> **1 to 8**
number of the new limit line

<name>

String containing the name of the limit line.

Example:

`CALC:LIM1:COPY 2`

Copies limit line 1 to line 2.

`CALC:LIM1:COPY 'FM2'`

Copies limit line 1 to a new line named FM2.

CALCulate<n>:LIMit:DELeTe

This command deletes a limit line.

Suffix:

<n> [Window](#)

 [Limit line](#)

CALCulate<n>:LIMit:STATe <State>

This command turns the limit check for a specific limit line on and off.

To query the limit check result, use [CALCulate<n>:LIMit:FAIL?](#).

Note that a new command exists to activate the limit check and define the trace to be checked in one step (see [CALCulate<n>:LIMit:TRACe<t>:CHECK](#) on page 268).

Suffix:

<n> irrelevant

 [Limit line](#)

Parameters:

<State> **ON | OFF | 0 | 1**

OFF | 0

Switches the function off

ON | 1

Switches the function on

Example:

`CALC:LIM:STAT ON`

Switches on the limit check for limit line 1.

CALCulate<n>:LIMit:TRACe<t>:CHECK <State>

This command turns the limit check for a specific trace on and off.

To query the limit check result, use [CALCulate<n>:LIMit:FAIL?](#).

Suffix:

<n>	Window
	Limit line
<t>	Trace

Parameters:

<State>	ON OFF 0 1
	OFF 0
	Switches the function off
	ON 1
	Switches the function on

Example:

CALC:LIM3:TRAC2:CHEC ON
Switches on the limit check for limit line 3 on trace 2.

MMEMory:LOAD<n>:LIMit <FileName>

Loads the limit line from the selected file in .CSV format.

Suffix:

<n>	irrelevant
-----	------------

Parameters:

<FileName>	String containing the path and name of the CSV import file.
------------	---

Example:

MMEM:LOAD:LIM 'C:\TEST.CSV'

MMEMory:STORe<n>:LIMit <FileName>, <LimitLineName>

This command exports limit line data to an ASCII (CSV) file.

For details on the file format see the R&S FPL1000 User Manual.

Suffix:

<n>	irrelevant
-----	------------

Parameters:

<FileName>	String containing the path and name of the target file.
<LimitLineName>	Name of the limit line to be exported.

Example:

MMEM:STOR:LIM 'C:\TEST', 'UpperLimitLine'
Stores the limit line named "UpperLimitLine" in the file
TEST.CSV.

11.8.5.3 Checking the results of a limit check

CALCulate<n>:LIMit:CLEar[:IMMEDIATE].....	270
CALCulate<n>:LIMit:FAIL?.....	270

CALCulate<n>:LIMit:CLEar[:IMMEDIATE]

This command deletes the result of the current limit check.

The command works on *all* limit lines in *all* measurement windows at the same time.

Suffix:

<n> [Window](#)

 irrelevant

Example:

CALC:LIM:CLE

Deletes the result of the limit check.

CALCulate<n>:LIMit:FAIL?

This command queries the result of a limit check in the specified window.

To get a valid result, you have to perform a complete measurement with synchronization to the end of the measurement before reading out the result. This is only possible for single sweep mode.

See also [INITiate<n>:CONTinuous](#) on page 176.

Suffix:

<n> [Window](#)

 [Limit line](#)

Return values:

<Result> **0**
 PASS
 1
 FAIL

Example:

INIT;*WAI

Starts a new sweep and waits for its end.

CALC2:LIM3:FAIL?

Queries the result of the check for limit line 3 in window 2.

Usage:

Query only

11.8.5.4 Programming example: using limit lines

The following examples demonstrate how to work with limit lines in a remote environment.

- [Example: configuring limit lines](#).....270
- [Example: performing a limit check](#)..... 272

Example: configuring limit lines

This example demonstrates how to configure 2 limit lines - an upper and a lower limit - for a measurement in a remote environment.

```

//----- Configuing the limit lines -----
CALC:LIM1:NAME 'FM1'
//Names limit line 1 'FM1'.

CALC:LIM1:CONT:MODE ABS
//Selects absolute scaling for the horizontal axis.
CALC:LIM1:CONT 1 MHz,50MHz,100 MHz,150MHz,200MHz
//Defines 5 horizontal definition points for limit line 1.
CALC:LIM1:UPP:MODE ABS
//Selects an absolute vertical scale for limit line 1.
CALC:LIM1:UNIT DBM
//Selects the unit dBm for limit line 1.
CALC:LIM1:UPP -10,-5,0,-5,-10
//Defines 5 definition points for limit line 1.

CALC:LIM1:UPP:MARG 5dB
//Defines an area of 5 dB around limit line 1 where limit check violations
//are still tolerated.

CALC:LIM1:UPP:SHIF -10DB
//Shifts the limit line 1 by -10 dB.
CALC:LIM1:UPP:OFFS -3dB
//Defines an additional -3 dB offset for limit line 1.

CALC:LIM3:NAME 'FM3'
//Names limit line 3 'FM3'.

CALC:LIM3:LOW:MODE REL
//Selects a relative vertical scale for limit line 3.
CALC:LIM3:UNIT DB

CALC:LIM3:CONT 1 MHz,50MHz,100 MHz,150MHz,200MHz
//Defines 5 horizontal definition points for limit line 3.
CALC:LIM3:LOW -90,-60,-40,-60,-90
//Defines 5 definition points relative to the reference level for limit line 3.

CALC:LIM3:LOW:SHIF 2
//Shifts the limit line 3 by 2dB.
CALC:LIM3:LOW:OFFS 3
//Defines an additional 3 dB offset for limit line 3.

CALC:LIM3:LOW:THR -200DBM
//Defines a power threshold of -200dBm that must be exceeded for limit to be checked

CALC:LIM3:LOW:MARG 5dB
//Defines an area of 5dB around limit line 3 where limit check violations
//are still tolerated.

//----- Storing the limit lines -----
MMEM:SEL:CHAN:LIN:ALL ON

```

```
MMEM:STOR:TYPE CHAN
MMEM:STOR:STAT 1,'LimitLines_FM1_FM3'
```

Example: performing a limit check

This example demonstrates how to perform a limit check during a basic frequency sweep measurement in a remote environment. The limit lines configured in "Example: configuring limit lines" on page 270 are assumed to exist and be active.

```
//-----Preparing the instrument -----
*RST
//Resets the instrument
INIT:CONT OFF
//Selects single sweep mode.

//-----Configuring the measurement -----
FREQ:CENT 100MHz
//Defines the center frequency
FREQ:SPAN 200MHz
//Sets the span to 100 MHz on either side of the center frequency.
SENS:SWE:COUN 10
//Defines 10 sweeps to be performed in each measurement.
DISP:TRAC1:Y:RLEV 0dBm
//Sets the reference level to 0 dBm.
TRIG:SOUR IFP
TRIG:LEV:IFP -10dBm
//Defines triggering when the second intermediate frequency rises to a level
//of -10 dBm.

//-----Configuring the Trace-----
DISP:TRAC2 ON
DISP:TRAC2:MODE AVER
DISP:TRAC3 ON
DISP:TRAC3:MODE MAXH
//Configures 3 traces: 1 (default): clear/write; 2: average; 3: max hold

//----- Configuring the limit check -----
MMEM:LOAD:TYPE REPL
MMEM:LOAD:STAT 1,'LimitLines_FM1_FM3'
//Loads the limit lines stored in 'LimitLines_FM1_FM3'
CALC:LIM1:NAME 'FM1'
CALC:LIM1:UPP:STAT ON
//Activates upper limit FM1 as line 1.
CALC:LIM3:NAME 'FM3'
CALC:LIM3:LOW:STAT ON
//Activates lower limit line FM3 as line 3.
CALC:LIM:ACT?
//Queries the names of all active limit lines
//Result: 'FM1,FM3'
CALC:LIM1:TRAC3:CHEC ON
//Activates the upper limit to be checked against trace3 (maxhold trace)
```



```
CALC:LIM3:TRAC2:CHEC ON
//Activates the upper limit to be checked against trace2 (average trace)
CALC:LIM:CLE
//Clears the previous limit check results

//----- Performing the measurement-----
INIT;*WAI
//Initiates a new measurement and waits until the last sweep has finished.

//----- Retrieving limit check results-----

CALC:LIM1:FAIL?
//Queries the result of the upper limit line check
CALC:LIM3:FAIL?
//Queries the result of the lower limit line check
```

11.9 Importing and exporting I/Q data and results

The I/Q data to be evaluated in the AM/FM/PM Modulation Analysis application can not only be measured by the AM/FM/PM Modulation Analysis application itself, it can also be imported to the application, provided it has the correct format. Furthermore, the evaluated I/Q data from the AM/FM/PM Modulation Analysis application can be exported for further analysis in external applications.

For details see [Chapter 7, "I/Q data import and export"](#), on page 109.

MMEMory:LOAD:IQ:STATE	273
MMEMory:STORE<n>:IQ:COMMENT	273
MMEMory:STORE<n>:IQ:FORMAT	274
MMEMory:STORE<n>:IQ:STATE	274

MMEMory:LOAD:IQ:STATE 1, <FileName>

This command restores I/Q data from a file.

Setting parameters:

<FileName> string
 String containing the path and name of the source file.

Example: Loads IQ data from the specified file.

Usage: Setting only

MMEMory:STORE<n>:IQ:COMMENT <Comment>

This command adds a comment to a file that contains I/Q data.

Suffix:

<n> irrelevant

Parameters:

<Comment> String containing the comment.

Example:

```
MMEM:STOR:IQ:COMM 'Device test 1b'
Creates a description for the export file.
MMEM:STOR:IQ:STAT 1, 'C:
\R_S\Instr\user\data.iq.tar'
Stores I/Q data and the comment to the specified file.
```

MMEMory:STORe<n>:IQ:FORMat <Format>,<DataFormat>

This command sets or queries the format of the I/Q data to be stored.

Suffix:

<n> irrelevant

Parameters:

<Format> **FLOat32**
32-bit floating point format.

INT32
32-bit integer format.

*RST: FLOat32

<DataFormat> **COMPLex**
Exports complex data.

REAL
Exports real data.

*RST: COMPLex

Example:

```
MMEM:STOR:IQ:FORM INT32,REAL
```

MMEMory:STORe<n>:IQ:STATe <1>, <FileName>

This command writes the captured I/Q data to a file.

The file extension is *.iq.tar. By default, the contents of the file are in 32-bit floating point format.

Suffix:

<n> 1..n

Parameters:

<1>

<FileName> String containing the path and name of the target file.

Example:

```
MMEM:STOR:IQ:STAT 1, 'C:
\R_S\Instr\user\data.iq.tar'
Stores the captured I/Q data to the specified file.
```

11.10 Deprecated commands

The following commands are provided for compatibility to other signal analyzers only. For new remote control programs use the specified alternative commands.

[CALCulate<n>:FEED](#)..... 275

CALCulate<n>:FEED <Evaluation>

This command selects the evaluation method of the measured data that is to be displayed in the specified window.

Note that this command is maintained for compatibility reasons only. Use the `LAYout` commands for new remote control programs (see [Chapter 11.6.2, "Working with windows in the display"](#), on page 179).

Suffix:

<n> [Window](#)

Parameters:

<Evaluation> Type of evaluation you want to display.
See the table below for available parameter values.

Example:

```
INST:SEL ADEM
Activates Analog Modulation Analysis.
CALC:FEED 'XTIM:FM'
Selects the display of the FM signal.
```

Table 11-5: <Evaluation> parameter values for the R&S FPL1-K7 AM/FM/PM Modulation Analysis application

Parameter	Evaluation
'XTIM:AM:RELative'	"AM Time Domain"
'XTIM:AM:RELative:AFSPectrum'	"AM Spectrum"
'XTIM:FM'	"FM Time Domain"
'XTIM:FM:AFSPectrum'	"FM Spectrum"
'XTIM:PM'	"PM Time Domain"
'XTIM:PM:AFSPectrum'	"PM Spectrum"
'XTIM:SPECTrum'	"RF Spectrum"
'XTIM:AM' 'XTIM:RFPower'	"RF Time Domain" (= RF power)
'XTIM:AMSummary' 'XTIM:AMSummary:RELative' 'XTIM:FMSummary' 'XTIM:FMSummary:RELative' 'XTIM:PMSummary' 'XTIM:PMSummary:RELative' 'XTIM:SUMMARY'	Result summary

11.11 Programming example

In this example we will configure and perform an Analog Modulation Analysis measurement to demonstrate the remote control commands.

Signal generator settings (e.g. R&S SMW):

Frequency:	500 MHz
Level:	-10 dBm
Modulation:	FM
Modulation frequency:	10 kHz
Frequency deviation:	50 kHz

```
//-----Preparing the measurement -----
//Reset the instrument
*RST

//Set the center frequency to 500 MHz
FREQ:CENT 500 MHz
//Set the reference level to 0 dBm
DISP:TRAC:Y:SCAL:RLEV 0

//----- Activating an Analog Modulation Analysis measurement channel -----
//Activate an Analog Modulation Analysis measurement channel named "FMDemodulation"
INST:CRE:NEW ADEM, 'FMDemodulation'

//----- Configuring data acquisition -----
//Set the measurement time to 1 ms (=10 periods)
ADEM:MTIM 1ms
//Optimize the scaling of the y-axis for the current measurement (continuously)
SENS:ADJ:SCAL:Y:AUTO ON
//Set the demodulation bandwidth to 400 kHz
BAND:DEM 400 kHz
//Trigger when magnitude of I/Q data reaches -50dBm
TRIG:SOUR IQP
TRIG:LEV:IQP -50

//----- Configuring the result display -----

//Add an FM Spectrum result display below FM Time Domain
LAY:ADD:WIND? '1',BEL,'XTIM:FM:AFSP'
//Define two traces in the FM Spectrum: 1: Clear/write, 2: average
ADEM:FM:AFSP WRIT,AVER,OFF,OFF,OFF,OFF
//Set analog demodulator to execute 30 sweeps with 32000 samples each
//at a sample rate of 8 MHz; use IQ trigger, trigger on positive slope
```

```

//with a pretrigger offset of 500 samples
ADEM:SET 8MHz,32000,IQP,POS,-500,30

//-----Performing the Measurement-----

//Stop continuous sweep
INIT:CONT OFF

//Start a new measurement with 30 sweeps and wait for the end
INIT;*WAI

//-----Retrieving Results-----
//Query the carrier power
CALC:MARK:FUNC:ADEM:CARR?
//Result: -10.37 [dBm]

//Query the signal-to-noise-and-distortion ratio from the FM Spectrum
CALC2:MARK:FUNC:ADEM:SIN:RES?
//Result: 65.026 [dB]

//Query the total harmonic distortion of the demodulated signal
//from the FM Spectrum
CALC2:MARK:FUNC:ADEM:THD:RES?
//Result: -66.413 [dB]

//Query the FM carrier offset (=frequency error) for the most recent
//measurement (trace 1)
CALC:MARK:FUNC:ADEM:FERR?
//Result: 649.07 [Hz]

//Query FM carrier offset averaged over 30 measurements
ADEM:FM:OFFS? AVER
//Result: 600 [Hz]

//Retrieve the trace data of the most recent measurement (trace 1)
TRAC:DATA? TRACE1
//Result: -1.201362252,-1.173495054,-1.187217355,-1.186594367,-1.171583891,
//-1.188250422,-1.204138160,-1.181404829,-1.186317205,-1.197872400, [...]

//Retrieve the averaged trace data for all 30 measurements (trace 2)
TRAC:DATA? TRACE2//Result: -1.201362252,-1.173495054,-1.187217355,-1.186594367,-1.171583891,
//-1.188250422,-1.204138160,-1.181404829,-1.186317205,-1.197872400, [...]

```

Annex

A Predefined standards and settings

You can configure the Analog Modulation Analysis application using predefined standard settings. This allows for quick and easy configuration for commonly performed measurements.

Provided standard files

The instrument comes prepared with the following standard settings:

- AM Broadcast
- FM Narrowband
- FM Broadcast
- Frequency Settling
- None (default settings)

The default storage location for the settings files is:

```
C:\Users\Public\Documents\Rohde-Schwarz\Analyzer\user\predefined\AdemodPredefined.
```

Predefined settings

The following parameters can be stored in a standard settings file. Any parameters that are not included in the xml file are set to their default values when the standard is loaded.

Measurement settings:

- DBW
- AQT
- Demod Filter
- Sweep Points
- Squelch (State, Level)
- Units (Phase, THD)
- RF Span
- Settling Time (Time domain only)

Window display settings:

- Position
- State
- Window number
- Window type (all evaluation methods supported by the Analog Modulation Analysis application; see [Chapter 3, "Measurements and result displays"](#), on page 15)
- Scaling (Ref Position, Dev per Division)
- Time Domain Zoom (State, Start, Length)

AF specific settings:

- AF Center
- AF Span
- AF Filters (Lowpass, Highpass, Deemphasis, Weighting)
- Scaling for Spectrum (Ref Value, Deviation)
- Scaling for Time Domain (Ref Value, AF Coupling (FM/PM only))

Table A-1: List of predefined standards and settings

Setting	AM Broadcast	FM Narrowband	FM Broadcast	Frequency Settling *)	None (Default)
Demod. bandwidth	100 kHz	100 kHz	400 kHz	5 MHz	5 MHz
Aquisition time	100 ms	100 ms	100 ms	10 ms	62.5 µs
Input coupling	AC	AC	AC		AC
Squelch level				-30 dBm	-20 dBm
Windows	"RF Spectrum" "AM Time Domain" "AM Spectrum" "Result Summary"	"RF Spectrum" "FM Time Domain" "FM Spectrum" "Result Summary"	"RF Spectrum" "FM Time Domain" "FM Spectrum" "Result Summary"	"FM Time Domain" "RF Time Domain" "Result Summary"	"FM Time Domain" "Result Summary"
AF filter - High-pass	20 kHz	50 Hz			-
AF filter - Low-pass	15 kHz	3 kHz	150 kHz		-
RF Spectrum					
Span	50 kHz	25 kHz	400 kHz		
AM/FM Time Domain					
Time domain zoom	10 ms	10 ms	10 ms		-
Dev per division		1 kHz	20 kHz	100 kHz	50 kHz
Time domain					
Settling Time State				ON	
AM/FM Spectrum					
Start freq.	0 Hz	0 Hz	0 Hz		
Stop freq.	15 kHz	5 kHz	63.33 kHz		
Ref. value		5 kHz	75 kHz		
*) The Frequency Settling scenario requires a manually defined trigger					

List of commands (Analog Modulation Analysis)

[SENSe:][WINDow<n>:]DETEctor<t>[:FUNction].....	213
[SENSe:][WINDow<n>:]DETEctor<t>[:FUNction]:AUTO.....	214
[SENSe:]ADEMod:ACV:AFSPectrum:RESult?.....	188
[SENSe:]ADEMod:ACV[:TDOMain]:RESult?.....	188
[SENSe:]ADEMod:AF:CENter.....	157
[SENSe:]ADEMod:AF:SPAN.....	157
[SENSe:]ADEMod:AF:SPAN:FULL.....	157
[SENSe:]ADEMod:AF:STARt.....	158
[SENSe:]ADEMod:AF:STOP.....	158
[SENSe:]ADEMod:AM:RELative:AFSPectrum:RESult?.....	188
[SENSe:]ADEMod:AM:RELative:AFSPectrum[:TYPE].....	211
[SENSe:]ADEMod:AM:RELative[:TDOMain]:RESult?.....	188
[SENSe:]ADEMod:AM:RELative[:TDOMain][:TYPE].....	211
[SENSe:]ADEMod:AM[:ABSolute]:AFSPectrum:RESult?.....	188
[SENSe:]ADEMod:AM[:ABSolute]:AFSPectrum[:TYPE].....	211
[SENSe:]ADEMod:AM[:ABSolute][:TDOMain]:RESult?.....	188
[SENSe:]ADEMod:AM[:ABSolute][:TDOMain][:TYPE].....	211
[SENSe:]ADEMod:FM:AFSPectrum:RESult?.....	188
[SENSe:]ADEMod:FM:AFSPectrum[:TYPE].....	211
[SENSe:]ADEMod:FM[:TDOMain]:RESult?.....	188
[SENSe:]ADEMod:FM[:TDOMain][:TYPE].....	211
[SENSe:]ADEMod:MTIME.....	143
[SENSe:]ADEMod:PM:AFSPectrum:RESult?.....	188
[SENSe:]ADEMod:PM:AFSPectrum[:TYPE].....	211
[SENSe:]ADEMod:PM:RPOint[:X].....	152
[SENSe:]ADEMod:PM:RPOint[:X]:MODE.....	153
[SENSe:]ADEMod:PM[:TDOMain]:RESult?.....	188
[SENSe:]ADEMod:PM[:TDOMain][:TYPE].....	211
[SENSe:]ADEMod:PRESet:RESTore.....	128
[SENSe:]ADEMod:PRESet:STORe.....	128
[SENSe:]ADEMod:PRESet[:STANdard].....	128
[SENSe:]ADEMod:RLENgth.....	143
[SENSe:]ADEMod:SET.....	143
[SENSe:]ADEMod:SETTling:TIME:LIMit:LOWer.....	170
[SENSe:]ADEMod:SETTling:TIME:LIMit:UPPer.....	170
[SENSe:]ADEMod:SETTling:TIME:RESult<t>?.....	196
[SENSe:]ADEMod:SETTling:TIME:STATe.....	170
[SENSe:]ADEMod:SPEctrum:BWIDth[:RESolution].....	144
[SENSe:]ADEMod:SPEctrum:RESult?.....	188
[SENSe:]ADEMod:SPEctrum:SPAN:ZOOM.....	158
[SENSe:]ADEMod:SPEctrum:SPAN[:MAXimum].....	159
[SENSe:]ADEMod:SPEctrum[:TYPE].....	211
[SENSe:]ADEMod:SQUelch:LEVel.....	154
[SENSe:]ADEMod:SQUelch[:STATe].....	153
[SENSe:]ADEMod:SRATE.....	144

[SENSe:]ADEMod<n>:AF:COUPling.....	152
[SENSe:]ADEMod<n>:SPEctrum:BANDwidth[:RESolution].....	144
[SENSe:]ADEMod<n>:ZOOM:LENGth.....	155
[SENSe:]ADEMod<n>:ZOOM:LENGth:MODE.....	155
[SENSe:]ADEMod<n>:ZOOM:STARt.....	156
[SENSe:]ADEMod<n>:ZOOM[:STATe].....	156
[SENSe:]ADJust:ALL.....	171
[SENSe:]ADJust:CONFigure:HYSteresis:LOWer.....	173
[SENSe:]ADJust:CONFigure:HYSteresis:UPPer.....	173
[SENSe:]ADJust:CONFigure:LEVel:DURation.....	172
[SENSe:]ADJust:CONFigure:LEVel:DURation:MODE.....	172
[SENSe:]ADJust:CONFigure:SMODE.....	173
[SENSe:]ADJust:CONFigure:TRIGger.....	174
[SENSe:]ADJust:FREQuency.....	174
[SENSe:]ADJust:LEVel.....	174
[SENSe:]ADJust:SCALE[:Y]:AUTO[:CONTinuous].....	174
[SENSe:]AVERAge<n>:COUNT.....	212
[SENSe:]AVERAge<n>:TYPE.....	213
[SENSe:]AVERAge<n>[:STATe<t>].....	212
[SENSe:]BANDwidth:DEMod.....	144
[SENSe:]BANDwidth:DEMod:TYPE.....	145
[SENSe:]BANDwidth[:RESolution].....	145
[SENSe:]BWIDth:DEMod.....	144
[SENSe:]BWIDth:DEMod:TYPE.....	145
[SENSe:]FILTer<n>:AOFF.....	160
[SENSe:]FILTer<n>:AWEighted[:STATe].....	159
[SENSe:]FILTer<n>:CCIR:WEIGhted[:STATe].....	160
[SENSe:]FILTer<n>:CCIR[:UNWeighted][:STATe].....	160
[SENSe:]FILTer<n>:CCIT[:STATe].....	161
[SENSe:]FILTer<n>:DEMPHasis:TCONstant.....	161
[SENSe:]FILTer<n>:DEMPHasis[:STATe].....	161
[SENSe:]FILTer<n>:HPASs:FREQuency:MANual.....	162
[SENSe:]FILTer<n>:HPASs:FREQuency[:ABSolute].....	162
[SENSe:]FILTer<n>:HPASs[:STATe].....	163
[SENSe:]FILTer<n>:LPASs:FREQuency:MANual.....	163
[SENSe:]FILTer<n>:LPASs:FREQuency:RELative.....	164
[SENSe:]FILTer<n>:LPASs:FREQuency[:ABSolute].....	163
[SENSe:]FILTer<n>:LPASs[:STATe].....	164
[SENSe:]FREQuency:CENTer.....	134
[SENSe:]FREQuency:CENTer:STEP.....	134
[SENSe:]FREQuency:CENTer:STEP:LINK.....	135
[SENSe:]FREQuency:CENTer:STEP:LINK:FACTor.....	135
[SENSe:]SWEep:COUNT.....	145
[SENSe:]SWEep[:WINDow<n>]:POINts.....	146
ABORT.....	175
CALCulate<n>:DELTaMarker<m>:AOFF.....	217
CALCulate<n>:DELTaMarker<m>:FUNction:FIXed:RPOint:MAXimum[:PEAK].....	238
CALCulate<n>:DELTaMarker<m>:FUNction:FIXed:RPOint:X.....	238
CALCulate<n>:DELTaMarker<m>:FUNction:FIXed:RPOint:Y.....	239
CALCulate<n>:DELTaMarker<m>:FUNction:FIXed:RPOint:Y:OFFSet.....	239

CALCulate<n>:DELTamarker<m>:FUNction:FIXed[:STATE]	239
CALCulate<n>:DELTamarker<m>:LINK	217
CALCulate<n>:DELTamarker<m>:MAXimum:LEFT	236
CALCulate<n>:DELTamarker<m>:MAXimum:NEXT	236
CALCulate<n>:DELTamarker<m>:MAXimum:RIGHT	236
CALCulate<n>:DELTamarker<m>:MAXimum[:PEAK]	236
CALCulate<n>:DELTamarker<m>:MINimum:LEFT	237
CALCulate<n>:DELTamarker<m>:MINimum:NEXT	237
CALCulate<n>:DELTamarker<m>:MINimum:RIGHT	237
CALCulate<n>:DELTamarker<m>:MINimum[:PEAK]	237
CALCulate<n>:DELTamarker<m>:MODE	218
CALCulate<n>:DELTamarker<m>:MREFerence	219
CALCulate<n>:DELTamarker<m>:SGRam:FRAME	229
CALCulate<n>:DELTamarker<m>:SGRam:FRAME	254
CALCulate<n>:DELTamarker<m>:SGRam:SARea	229
CALCulate<n>:DELTamarker<m>:SGRam:SARea	254
CALCulate<n>:DELTamarker<m>:SGRam:XY:MAXimum[:PEAK]	230
CALCulate<n>:DELTamarker<m>:SGRam:XY:MAXimum[:PEAK]	255
CALCulate<n>:DELTamarker<m>:SGRam:XY:MINimum[:PEAK]	230
CALCulate<n>:DELTamarker<m>:SGRam:XY:MINimum[:PEAK]	255
CALCulate<n>:DELTamarker<m>:SGRam:Y:MAXimum:ABOVe	230
CALCulate<n>:DELTamarker<m>:SGRam:Y:MAXimum:ABOVe	255
CALCulate<n>:DELTamarker<m>:SGRam:Y:MAXimum:BELOW	230
CALCulate<n>:DELTamarker<m>:SGRam:Y:MAXimum:BELOW	256
CALCulate<n>:DELTamarker<m>:SGRam:Y:MAXimum:NEXT	231
CALCulate<n>:DELTamarker<m>:SGRam:Y:MAXimum:NEXT	256
CALCulate<n>:DELTamarker<m>:SGRam:Y:MAXimum[:PEAK]	231
CALCulate<n>:DELTamarker<m>:SGRam:Y:MAXimum[:PEAK]	256
CALCulate<n>:DELTamarker<m>:SGRam:Y:MINimum:ABOVe	231
CALCulate<n>:DELTamarker<m>:SGRam:Y:MINimum:ABOVe	256
CALCulate<n>:DELTamarker<m>:SGRam:Y:MINimum:BELOW	231
CALCulate<n>:DELTamarker<m>:SGRam:Y:MINimum:BELOW	257
CALCulate<n>:DELTamarker<m>:SGRam:Y:MINimum:NEXT	232
CALCulate<n>:DELTamarker<m>:SGRam:Y:MINimum:NEXT	257
CALCulate<n>:DELTamarker<m>:SGRam:Y:MINimum[:PEAK]	232
CALCulate<n>:DELTamarker<m>:SGRam:Y:MINimum[:PEAK]	257
CALCulate<n>:DELTamarker<m>:SPECTrogram:FRAMe	229
CALCulate<n>:DELTamarker<m>:SPECTrogram:FRAMe	254
CALCulate<n>:DELTamarker<m>:SPECTrogram:SARea	229
CALCulate<n>:DELTamarker<m>:SPECTrogram:SARea	254
CALCulate<n>:DELTamarker<m>:SPECTrogram:XY:MAXimum[:PEAK]	230
CALCulate<n>:DELTamarker<m>:SPECTrogram:XY:MAXimum[:PEAK]	255
CALCulate<n>:DELTamarker<m>:SPECTrogram:XY:MINimum[:PEAK]	230
CALCulate<n>:DELTamarker<m>:SPECTrogram:XY:MINimum[:PEAK]	255
CALCulate<n>:DELTamarker<m>:SPECTrogram:Y:MAXimum:ABOVe	230
CALCulate<n>:DELTamarker<m>:SPECTrogram:Y:MAXimum:ABOVe	255
CALCulate<n>:DELTamarker<m>:SPECTrogram:Y:MAXimum:BELOW	230
CALCulate<n>:DELTamarker<m>:SPECTrogram:Y:MAXimum:BELOW	256
CALCulate<n>:DELTamarker<m>:SPECTrogram:Y:MAXimum:NEXT	231
CALCulate<n>:DELTamarker<m>:SPECTrogram:Y:MAXimum:NEXT	256

CALCulate<n>:DELTamarker<m>:SPECtrogram:Y:MAXimum[:PEAK].....	231
CALCulate<n>:DELTamarker<m>:SPECtrogram:Y:MAXimum[:PEAK].....	256
CALCulate<n>:DELTamarker<m>:SPECtrogram:Y:MINimum:ABOVE.....	231
CALCulate<n>:DELTamarker<m>:SPECtrogram:Y:MINimum:ABOVE.....	256
CALCulate<n>:DELTamarker<m>:SPECtrogram:Y:MINimum:BELOW.....	231
CALCulate<n>:DELTamarker<m>:SPECtrogram:Y:MINimum:BELOW.....	257
CALCulate<n>:DELTamarker<m>:SPECtrogram:Y:MINimum:NEXT.....	232
CALCulate<n>:DELTamarker<m>:SPECtrogram:Y:MINimum:NEXT.....	257
CALCulate<n>:DELTamarker<m>:SPECtrogram:Y:MINimum[:PEAK].....	232
CALCulate<n>:DELTamarker<m>:SPECtrogram:Y:MINimum[:PEAK].....	257
CALCulate<n>:DELTamarker<m>:TRACe.....	220
CALCulate<n>:DELTamarker<m>:X.....	220
CALCulate<n>:DELTamarker<m>:X:RELative?.....	220
CALCulate<n>:DELTamarker<m>:Y?.....	221
CALCulate<n>:DELTamarker<m>[:STATe].....	219
CALCulate<n>:DELTamarker<ms>:LINK:TO:MARKer<md>.....	218
CALCulate<n>:FEED.....	275
CALCulate<n>:FORMat.....	154
CALCulate<n>:LIMit:ACTive?.....	267
CALCulate<n>:LIMit:CLEar[:IMMediate].....	270
CALCulate<n>:LIMit:COMMeNt.....	258
CALCulate<n>:LIMit:CONTRol:DOMain.....	259
CALCulate<n>:LIMit:CONTRol:MODE.....	259
CALCulate<n>:LIMit:CONTRol:OFFSet.....	260
CALCulate<n>:LIMit:CONTRol:SHIFt.....	260
CALCulate<n>:LIMit:CONTRol:SPACing.....	260
CALCulate<n>:LIMit:CONTRol[:DATA].....	259
CALCulate<n>:LIMit:COpy.....	267
CALCulate<n>:LIMit:DELeTe.....	268
CALCulate<n>:LIMit:FAIL?.....	270
CALCulate<n>:LIMit:LOWer:MARGin.....	261
CALCulate<n>:LIMit:LOWer:MODE.....	261
CALCulate<n>:LIMit:LOWer:OFFSet.....	262
CALCulate<n>:LIMit:LOWer:SHIFt.....	262
CALCulate<n>:LIMit:LOWer:SPACing.....	262
CALCulate<n>:LIMit:LOWer:STATe.....	263
CALCulate<n>:LIMit:LOWer:THReshold.....	263
CALCulate<n>:LIMit:LOWer[:DATA].....	261
CALCulate<n>:LIMit:NAME.....	263
CALCulate<n>:LIMit:STATe.....	268
CALCulate<n>:LIMit:TRACe<t>:CHECK.....	268
CALCulate<n>:LIMit:UNIT.....	264
CALCulate<n>:LIMit:UPPer:MARGin.....	264
CALCulate<n>:LIMit:UPPer:MODE.....	265
CALCulate<n>:LIMit:UPPer:OFFSet.....	265
CALCulate<n>:LIMit:UPPer:SHIFt.....	265
CALCulate<n>:LIMit:UPPer:SPACing.....	266
CALCulate<n>:LIMit:UPPer:STATe.....	266
CALCulate<n>:LIMit:UPPer:THReshold.....	266
CALCulate<n>:LIMit:UPPer[:DATA].....	264

CALCulate<n>:MARKer<m>:AOFF.....	215
CALCulate<n>:MARKer<m>:FUNCTION:ADEMod:AFREquency[:RESult<t>]?.....	193
CALCulate<n>:MARKer<m>:FUNCTION:ADEMod:AM[:RESult<t>]:RELative?.....	194
CALCulate<n>:MARKer<m>:FUNCTION:ADEMod:AM[:RESult<t>]?.....	193
CALCulate<n>:MARKer<m>:FUNCTION:ADEMod:CARRier[:RESult<t>]?.....	195
CALCulate<n>:MARKer<m>:FUNCTION:ADEMod:DISTortion[:WRITe]:RESult<t>?.....	195
CALCulate<n>:MARKer<m>:FUNCTION:ADEMod:FERRor[:RESult<t>]?.....	195
CALCulate<n>:MARKer<m>:FUNCTION:ADEMod:FM[:RESult<t>]:RELative?.....	194
CALCulate<n>:MARKer<m>:FUNCTION:ADEMod:FM[:RESult<t>]?.....	193
CALCulate<n>:MARKer<m>:FUNCTION:ADEMod:PM[:RESult<t>]:RELative?.....	194
CALCulate<n>:MARKer<m>:FUNCTION:ADEMod:PM[:RESult<t>]?.....	193
CALCulate<n>:MARKer<m>:FUNCTION:ADEMod:SINad:RESult<t>?.....	196
CALCulate<n>:MARKer<m>:FUNCTION:ADEMod:THD:RESult<t>?.....	196
CALCulate<n>:MARKer<m>:FUNCTION:FPEaks:ANNotation:LABel[:STATe].....	240
CALCulate<n>:MARKer<m>:FUNCTION:FPEaks:COUNt?.....	241
CALCulate<n>:MARKer<m>:FUNCTION:FPEaks:LIST:SIZE.....	242
CALCulate<n>:MARKer<m>:FUNCTION:FPEaks:SORT.....	242
CALCulate<n>:MARKer<m>:FUNCTION:FPEaks:STATe.....	242
CALCulate<n>:MARKer<m>:FUNCTION:FPEaks:X?.....	243
CALCulate<n>:MARKer<m>:FUNCTION:FPEaks:Y?.....	243
CALCulate<n>:MARKer<m>:FUNCTION:FPEaks[:IMMEdiate].....	241
CALCulate<n>:MARKer<m>:FUNCTION:NDBDown.....	244
CALCulate<n>:MARKer<m>:FUNCTION:NDBDown:FREQuency?.....	245
CALCulate<n>:MARKer<m>:FUNCTION:NDBDown:QFACtor?.....	245
CALCulate<n>:MARKer<m>:FUNCTION:NDBDown:RESult?.....	246
CALCulate<n>:MARKer<m>:FUNCTION:NDBDown:STATe.....	246
CALCulate<n>:MARKer<m>:FUNCTION:NDBDown:TIME?.....	247
CALCulate<n>:MARKer<m>:FUNCTION:PNOise:AOFF.....	247
CALCulate<n>:MARKer<m>:FUNCTION:PNOise:RESult?.....	248
CALCulate<n>:MARKer<m>:FUNCTION:PNOise[:STATe].....	248
CALCulate<n>:MARKer<m>:FUNCTION:REFerence.....	136
CALCulate<n>:MARKer<m>:LINK.....	222
CALCulate<n>:MARKer<m>:MAXimum:LEFT.....	233
CALCulate<n>:MARKer<m>:MAXimum:NEXT.....	234
CALCulate<n>:MARKer<m>:MAXimum:RIGHT.....	234
CALCulate<n>:MARKer<m>:MAXimum[:PEAK].....	234
CALCulate<n>:MARKer<m>:MINimum:LEFT.....	234
CALCulate<n>:MARKer<m>:MINimum:NEXT.....	235
CALCulate<n>:MARKer<m>:MINimum:RIGHT.....	235
CALCulate<n>:MARKer<m>:MINimum[:PEAK].....	235
CALCulate<n>:MARKer<m>:PEXCursion.....	232
CALCulate<n>:MARKer<m>:SGRam:FRAME.....	224
CALCulate<n>:MARKer<m>:SGRam:FRAME.....	249
CALCulate<n>:MARKer<m>:SGRam:SARea.....	225
CALCulate<n>:MARKer<m>:SGRam:SARea.....	250
CALCulate<n>:MARKer<m>:SGRam:XY:MAXimum[:PEAK].....	225
CALCulate<n>:MARKer<m>:SGRam:XY:MAXimum[:PEAK].....	250
CALCulate<n>:MARKer<m>:SGRam:XY:MINimum[:PEAK].....	225
CALCulate<n>:MARKer<m>:SGRam:XY:MINimum[:PEAK].....	251
CALCulate<n>:MARKer<m>:SGRam:Y:MAXimum:ABOVE.....	225

CALCulate<n>:MARKer<m>:SGRam:Y:MAXimum:ABOVE.....	251
CALCulate<n>:MARKer<m>:SGRam:Y:MAXimum:BELOW.....	226
CALCulate<n>:MARKer<m>:SGRam:Y:MAXimum:BELOW.....	251
CALCulate<n>:MARKer<m>:SGRam:Y:MAXimum:NEXT.....	226
CALCulate<n>:MARKer<m>:SGRam:Y:MAXimum:NEXT.....	251
CALCulate<n>:MARKer<m>:SGRam:Y:MAXimum[:PEAK].....	226
CALCulate<n>:MARKer<m>:SGRam:Y:MAXimum[:PEAK].....	252
CALCulate<n>:MARKer<m>:SGRam:Y:MINimum:ABOVE.....	227
CALCulate<n>:MARKer<m>:SGRam:Y:MINimum:ABOVE.....	252
CALCulate<n>:MARKer<m>:SGRam:Y:MINimum:BELOW.....	227
CALCulate<n>:MARKer<m>:SGRam:Y:MINimum:BELOW.....	252
CALCulate<n>:MARKer<m>:SGRam:Y:MINimum:NEXT.....	227
CALCulate<n>:MARKer<m>:SGRam:Y:MINimum:NEXT.....	252
CALCulate<n>:MARKer<m>:SGRam:Y:MINimum[:PEAK].....	227
CALCulate<n>:MARKer<m>:SGRam:Y:MINimum[:PEAK].....	253
CALCulate<n>:MARKer<m>:SPECTrogram:FRAME.....	224
CALCulate<n>:MARKer<m>:SPECTrogram:FRAME.....	249
CALCulate<n>:MARKer<m>:SPECTrogram:SARea.....	225
CALCulate<n>:MARKer<m>:SPECTrogram:SARea.....	250
CALCulate<n>:MARKer<m>:SPECTrogram:XY:MAXimum[:PEAK].....	225
CALCulate<n>:MARKer<m>:SPECTrogram:XY:MAXimum[:PEAK].....	250
CALCulate<n>:MARKer<m>:SPECTrogram:XY:MINimum[:PEAK].....	225
CALCulate<n>:MARKer<m>:SPECTrogram:XY:MINimum[:PEAK].....	251
CALCulate<n>:MARKer<m>:SPECTrogram:Y:MAXimum:ABOVE.....	225
CALCulate<n>:MARKer<m>:SPECTrogram:Y:MAXimum:ABOVE.....	251
CALCulate<n>:MARKer<m>:SPECTrogram:Y:MAXimum:BELOW.....	226
CALCulate<n>:MARKer<m>:SPECTrogram:Y:MAXimum:BELOW.....	251
CALCulate<n>:MARKer<m>:SPECTrogram:Y:MAXimum:NEXT.....	226
CALCulate<n>:MARKer<m>:SPECTrogram:Y:MAXimum:NEXT.....	251
CALCulate<n>:MARKer<m>:SPECTrogram:Y:MAXimum[:PEAK].....	226
CALCulate<n>:MARKer<m>:SPECTrogram:Y:MAXimum[:PEAK].....	252
CALCulate<n>:MARKer<m>:SPECTrogram:Y:MINimum:ABOVE.....	227
CALCulate<n>:MARKer<m>:SPECTrogram:Y:MINimum:ABOVE.....	252
CALCulate<n>:MARKer<m>:SPECTrogram:Y:MINimum:BELOW.....	227
CALCulate<n>:MARKer<m>:SPECTrogram:Y:MINimum:BELOW.....	252
CALCulate<n>:MARKer<m>:SPECTrogram:Y:MINimum:NEXT.....	227
CALCulate<n>:MARKer<m>:SPECTrogram:Y:MINimum:NEXT.....	252
CALCulate<n>:MARKer<m>:SPECTrogram:Y:MINimum[:PEAK].....	227
CALCulate<n>:MARKer<m>:SPECTrogram:Y:MINimum[:PEAK].....	253
CALCulate<n>:MARKer<m>:TRACe.....	216
CALCulate<n>:MARKer<m>:X.....	216
CALCulate<n>:MARKer<m>:X:SSIZe.....	221
CALCulate<n>:MARKer<m>:Y?.....	217
CALCulate<n>:MARKer<m>[:STATe].....	215
CALCulate<n>:MARKer<ms>:LINK:TO:MARKer<md>.....	215
CALCulate<n>:SGRam:CLEAr[:IMMediate].....	201
CALCulate<n>:SGRam:CONTInuous.....	201
CALCulate<n>:SGRam:FRAMe:COUNT.....	201
CALCulate<n>:SGRam:FRAMe:SELect.....	202
CALCulate<n>:SGRam:HDEPth.....	202

CALCulate<n>:SGRam:LAYout.....	203
CALCulate<n>:SGRam:THReedim[:STATe].....	204
CALCulate<n>:SGRam:TRACe.....	204
CALCulate<n>:SGRam:TSTamp:DATA?.....	204
CALCulate<n>:SGRam:TSTamp[:STATe].....	205
CALCulate<n>:SGRam[:STATe].....	203
CALCulate<n>:SPECtrogram:CLEar[:IMMediate].....	201
CALCulate<n>:SPECtrogram:CONTInuous.....	201
CALCulate<n>:SPECtrogram:FRAMe:COUNt.....	201
CALCulate<n>:SPECtrogram:FRAMe:SElect.....	202
CALCulate<n>:SPECtrogram:HDEPth.....	202
CALCulate<n>:SPECtrogram:LAYout.....	203
CALCulate<n>:SPECtrogram:THReedim[:STATe].....	204
CALCulate<n>:SPECtrogram:TRACe.....	204
CALCulate<n>:SPECtrogram:TSTamp:DATA?.....	204
CALCulate<n>:SPECtrogram:TSTamp[:STATe].....	205
CALCulate<n>:SPECtrogram[:STATe].....	203
CALCulate<n>:UNIT:ANGLE.....	166
CALCulate<n>:UNIT:POWER.....	136
CALCulate<n>:UNIT:THD.....	166
CONFigure:ADEMod:RESults:AM:DETEctor<det>:MODE.....	169
CONFigure:ADEMod:RESults:AM:DETEctor<det>:REFerence.....	167
CONFigure:ADEMod:RESults:AM:DETEctor<det>:REFerence:MEASStoref<t>.....	168
CONFigure:ADEMod:RESults:AM:DETEctor<det>:STATe.....	167
CONFigure:ADEMod:RESults:FM:DETEctor<det>:MODE.....	169
CONFigure:ADEMod:RESults:FM:DETEctor<det>:REFerence.....	167
CONFigure:ADEMod:RESults:FM:DETEctor<det>:REFerence:MEASStoref<t>.....	168
CONFigure:ADEMod:RESults:FM:DETEctor<det>:STATe.....	167
CONFigure:ADEMod:RESults:PM:DETEctor<det>:MODE.....	169
CONFigure:ADEMod:RESults:PM:DETEctor<det>:REFerence.....	167
CONFigure:ADEMod:RESults:PM:DETEctor<det>:REFerence:MEASStoref<t>.....	168
CONFigure:ADEMod:RESults:PM:DETEctor<det>:STATe.....	167
CONFigure:ADEMod:RESults:UNIT.....	169
DIAGnostic:SERVice:NSOurce.....	133
DISPlay[:WINDow<n>]:MINFo[:STATe].....	222
DISPlay[:WINDow<n>]:MTABLE.....	223
DISPlay[:WINDow<n>]:SGRam:COLor:DEFault.....	206
DISPlay[:WINDow<n>]:SGRam:COLor:LOWer.....	206
DISPlay[:WINDow<n>]:SGRam:COLor:SHAPE.....	206
DISPlay[:WINDow<n>]:SGRam:COLor:UPPer.....	207
DISPlay[:WINDow<n>]:SGRam:COLor[:STYLe].....	207
DISPlay[:WINDow<n>]:SIZE.....	179
DISPlay[:WINDow<n>]:SPECtrogram:COLor:DEFault.....	206
DISPlay[:WINDow<n>]:SPECtrogram:COLor:LOWer.....	206
DISPlay[:WINDow<n>]:SPECtrogram:COLor:SHAPE.....	206
DISPlay[:WINDow<n>]:SPECtrogram:COLor:UPPer.....	207
DISPlay[:WINDow<n>]:SPECtrogram:COLor[:STYLe].....	207
DISPlay[:WINDow<n>][:SUBWIndow<w>]:TRACe<t>:MODE.....	208
DISPlay[:WINDow<n>][:SUBWIndow<w>]:TRACe<t>:MODE:HCONTInuous.....	209
DISPlay[:WINDow<n>][:SUBWIndow<w>]:TRACe<t>:SElect.....	210

DISPlay[:WINDow<n>][:SUBWindow<w>]:TRACe<t>:Y:SPACing.....	142
DISPlay[:WINDow<n>][:SUBWindow<w>]:TRACe<t>:Y[:SCALE].....	139
DISPlay[:WINDow<n>][:SUBWindow<w>]:TRACe<t>:Y[:SCALE]:AUTO ONCE.....	140
DISPlay[:WINDow<n>][:SUBWindow<w>]:TRACe<t>:Y[:SCALE]:MODE.....	140
DISPlay[:WINDow<n>][:SUBWindow<w>]:TRACe<t>:Y[:SCALE]:PDIVision.....	140
DISPlay[:WINDow<n>][:SUBWindow<w>]:TRACe<t>:Y[:SCALE]:RLEVel.....	137
DISPlay[:WINDow<n>][:SUBWindow<w>]:TRACe<t>:Y[:SCALE]:RLEVel:OFFSet.....	137
DISPlay[:WINDow<n>][:SUBWindow<w>]:TRACe<t>:Y[:SCALE]:RPOSition.....	141
DISPlay[:WINDow<n>][:SUBWindow<w>]:TRACe<t>:Y[:SCALE]:RVALue.....	165
DISPlay[:WINDow<n>][:SUBWindow<w>]:TRACe<t>[:STATe].....	210
FORMat:DEXPort:DSEParator.....	191
FORMat:DEXPort:FORMat.....	190
FORMat:DEXPort:HEADer.....	191
FORMat:DEXPort:TRACes.....	191
FORMat[:DATA].....	189
INITiate:SEQuencer:ABORt.....	177
INITiate:SEQuencer:IMMediate.....	177
INITiate:SEQuencer:MODE.....	177
INITiate<n>:CONMeas.....	176
INITiate<n>:CONTinuous.....	176
INITiate<n>[:IMMediate].....	177
INPut:ATTenuation:PROTection:RESet.....	129
INPut<ip>:ATTenuation.....	138
INPut<ip>:ATTenuation:AUTO.....	138
INPut<ip>:EATT:AUTO.....	138
INPut<ip>:FILE:PATH.....	131
INPut<ip>:FILTer:SAW.....	129
INPut<ip>:FILTer:YIG[:STATe].....	129
INPut<ip>:GAIN:STATe.....	139
INPut<ip>:IMPedance.....	130
INPut<ip>:SElect.....	130
INSTrument:CREate:DUPLicate.....	124
INSTrument:CREate:REPLace.....	125
INSTrument:CREate[:NEW].....	125
INSTrument:DELeTe.....	125
INSTrument:LIST?.....	126
INSTrument:REName.....	126
INSTrument[:SElect].....	127
LAYout:ADD[:WINDow]?.....	180
LAYout:CATalog[:WINDow]?.....	181
LAYout:IDENtify[:WINDow]?.....	182
LAYout:MOVE[:WINDow].....	182
LAYout:REMOve[:WINDow].....	183
LAYout:REPLace[:WINDow].....	183
LAYout:SPLitter.....	183
LAYout:WINDow<n>:ADD?.....	185
LAYout:WINDow<n>:IDENtify?.....	185
LAYout:WINDow<n>:REMOve.....	186
LAYout:WINDow<n>:REPLace.....	186
LAYout:WINDow<n>:TYPE.....	187

MMEMory:LOAD:IQ:STATe.....	273
MMEMory:LOAD<n>:LIMit.....	269
MMEMory:STORe<n>:IQ:COMMeNt.....	273
MMEMory:STORe<n>:IQ:FORMat.....	274
MMEMory:STORe<n>:IQ:STATe.....	274
MMEMory:STORe<n>:LIMit.....	269
MMEMory:STORe<n>:LIST.....	243
MMEMory:STORe<n>:PEAK.....	244
MMEMory:STORe<n>:SPECTrogram.....	192
MMEMory:STORe<n>:TRACe.....	192
OUTPut<up>[:STATe].....	131
SOURce<si>:INTeRnal:FREQUency.....	132
SOURce<si>:POWeR[:LEVel][:IMMeDiate]:OFFSet.....	132
SOURce<si>:POWeR[:LEVel][:IMMeDiate][:AMPLitude].....	132
SYSTem:PRESet:CHANnel[:EXEC].....	127
SYSTem:SEQUencer.....	178
SYSTem:SPEaker:VOLume.....	134
SYSTem:SPEaker[:STATe].....	133
TRACe<n>[:DATA].....	190
TRIGger[:SEQUence]:DTIME.....	147
TRIGger[:SEQUence]:HOLDoff[:TIME].....	147
TRIGger[:SEQUence]:IFPower:HOLDoff.....	147
TRIGger[:SEQUence]:IFPower:HYSTeresis.....	148
TRIGger[:SEQUence]:LEVel:AM:RELative.....	149
TRIGger[:SEQUence]:LEVel:AM[:ABSolute].....	149
TRIGger[:SEQUence]:LEVel:FM.....	149
TRIGger[:SEQUence]:LEVel:IFPower.....	148
TRIGger[:SEQUence]:LEVel:PM.....	149
TRIGger[:SEQUence]:LEVel[:EXTeRnal<port>].....	148
TRIGger[:SEQUence]:SLOPe.....	150
TRIGger[:SEQUence]:SOURce.....	150
TRIGger[:SEQUence]:TIME:RINTeRval.....	151
UNIT<n>:ANGLE.....	166
UNIT<n>:POWeR.....	136
UNIT<n>:THD.....	166

Index

Symbols

*OPC 146

A

A weighted filter
 AF filters 62

Aborting
 Sweep 51, 52, 84

AC/DC coupling 28, 55, 65

Activating
 Analog Modulation Analysis (remote) 124

AF 15

AF Auto Scale
 Y-axis 66, 75

AF center
 Demodulation spectrum 58

AF CF 14

AF coupling 55, 65

AF filters 29
 A weighted 62
 CCIR 62
 CCITT 62
 Configuration 60
 Deactivating 63
 Deemphasis 63
 High pass 61
 Low pass 61
 Weighting 62

AF full span
 Demodulation spectrum 59

AF span
 Demodulation spectrum 59
 Displayed 14
 Remote control 157

AF spectrum 58

AF start
 Demodulation spectrum 58

AF stop
 Demodulation spectrum 58

AF trigger 29, 30

All Functions Off 108

AM (Offline)
 Softkey 47

AM Spectrum
 Evaluation method 18

AM Time Domain
 Evaluation method 15

Amplitude
 Configuration 40
 Scaling 67
 Settings 40

Analog Modulation Analysis
 Measurement examples 112

Analysis
 Marker functions 100
 Remote control 199
 Settings 77

Application cards 8

Application notes 8

AQT
 see Measurement time 13

ASCII trace export 197

Att (channel setup) 13

Attenuation
 Auto 43
 Displayed 13
 Manual 43
 Protective (remote) 129

Audio demodulation
 Volume (remote control) 133, 134

Audio frequency
 see AF 15

Auto adjustment
 Triggered measurement 174

Auto all 74

Auto frequency 75

Auto level
 Hysteresis 76
 Reference level 42, 75
 Softkey 42, 75

Auto scaling 66, 67, 75

Auto settings
 MeasTime Auto 75
 MeasTime Manual 75

Average count 52, 80

Average mode
 Traces 80

Averaging
 Traces (remote control) 213

B

Bandwidth settings 49

Basic Measurement Examples
 see User Manual 7

Brochures 8

C

Calibration certificate 9

Capturing
 I/Q data (remote) 175

Carrier
 Offset 24, 28
 Power 24

CCIR filter
 AF filters 62

CCITT filter
 AF filters 62

Center frequency 44, 59
 Automatic configuration 75
 Displayed 13, 14
 Softkey 44, 59
 Step size 45

Channel setup
 Creating (remote) 125
 Deleting (remote) 125
 Duplicating (remote) 124
 Querying (remote) 126
 Renaming (remote) 126
 Replacing (remote) 125

Closing
 Channel setups (remote) 125
 Windows (remote) 186

Color curve	
Shape	86
Color mapping	
Color curve	86
Color range	85, 86
Color scheme	86
Softkey	84
Spectrograms	84, 85
Color scheme	
Spectrogram	86
Conditions	
Measurement	26
Configuration	
Measurement (remote)	127
Procedure	34
Continue single sweep	
Softkey	52
Continuous sweep	
Softkey	51, 84
Conventions	
SCPI commands	119
Copying	
Channel setup (remote)	124
D	
Data acquisition	
Remote control	142
Settings	49
Data format	
ASCII	197
Binary	197
Remote	191
Data sheets	8
DB per division	
Scaling	64
DBW	
see Demodulation bandwidth	13
Decimal separator	
Trace export	88, 89
Deemphasis filter	
AF filters	63
Remote control	161
Deleting	
Settings files	37
Standards	37
Delta markers	91
Defining	91
Demodulation	
AF spectrum	58
Configuration	54
Display	54
Filter types	29, 49
Process	26
Relative (remote control)	169
Relative (remote)	167
RF spectrum	59
Scaling	60, 63
Settings	54
Spectrum	57
Spectrum (Result Summary)	59
Units	68
Demodulation bandwidth	49, 60
Conditions	28
Deemphasis filter	63
Displayed	13
Maximum	29

Remote control	144
Troubleshooting	117
Detectors	
Relative demodulation	169
Relative demodulation (remote)	167
Remote control	167, 213
Trace	79
Dev per division	
Scaling	64
Deviation	
Scaling	66
Diagram footer information	14
Display configuration	
Softkey	54
Drop-out time	
Trigger	48
Duplicating	
Channel setup (remote)	124
E	
Electronic input attenuation	43
Errors	
IF OVLD	41
Evaluation	
Data basis	15
Methods	15
Evaluation methods	
Remote	180
Examples	
Remote control	276
Export format	
Traces	197
Exporting	
I/Q data	109
I/Q data (remote)	273
Measurement settings	87
Peak list	108
Trace data	111
Traces	86, 88
External trigger	47
Level (remote)	148
F	
File format	
Export Files	197
Trace export	197
filename	
Settings	36
Files	
I/Q data input	39
Filters	
A weighted (AF)	62
AF	60
CCIR (AF)	62
CCITT (AF)	62
Demodulation	28, 29, 49
High pass (AF)	61
Low pass (AF)	61
Weighting (AF)	62
YIG (remote)	129
Fixed reference	
Defining	93
Remote control	238
FM (Offline)	
Softkey	47

FM Spectrum		
Evaluation method	19	
FM Time Domain		
Evaluation method	16	
Format		
Data	197	
Data (remote)	191	
see also File format	197	
Frame count		
Softkey	53	
Free Run		
Trigger	46	
Frequency		
Configuration	57	
Deemphasis filter	63	
Deviation	28	
Deviation, scaling	64	
Remote control	134	
Settings	44	
Span	60	
Frontend settings	37	
G		
Getting started	7	
H		
Hardware settings		
Displayed	13	
High pass filter		
AF filters	61	
History		
Spectrograms	83	
History Depth		
Softkey	83	
Hold		
Trace setting	80	
Hysteresis		
Lower (Auto level)	76	
Trigger	48	
Upper (Auto level)	76	
I		
I/Q data		
Exporting (remote)	273	
Importing (remote)	273	
Importing/Exporting	109	
Input file	40	
Input files	39	
IF Power		
Trigger	47	
Trigger level (remote)	148	
Impedance		
Setting	38, 44	
Importing		
I/Q data	109	
I/Q data (remote)	273	
Input		
I/Q data files	40	
Overload (remote)	129	
RF	38	
Settings	37	
Input sources	37	
I/Q data file	40	
I/Q data files	39	
Instrument security procedures	8	
K		
Keys		
MKR ->	95	
MKR FUNCT	99	
Peak Search	96	
RUN CONT	51, 84	
RUN SINGLE	52, 84	
L		
Limit check		
Remote control	258	
Limit lines		
Remote control	258	
Linking		
Markers	91, 94	
Loading		
Settings files	37	
Low pass filter		
AF filters	61	
Lower Level Hysteresis	76	
M		
Marker		
Search area (softkey)	99	
Search type (softkey)	98	
Marker functions		
Deactivating	108	
Remote control	238	
Marker peak list		
see Peak list	107	
Marker table		
Evaluation method	25	
Marker to Trace	92	
Markers		
Assigned trace	92	
Basic settings	89	
Configuration	89, 92	
Configuration (remote control)	214	
Deactivating	92	
Delta markers	91	
Fixed reference (remote control)	221, 238	
Function configuration	99	
Linked in AF spectrum display	94	
Linked in time domain	94	
Linking	91	
Minimum	96	
Minimum (remote control)	233	
n dB down	102	
n dB down (remote control)	244	
Next minimum	97	
Next minimum (remote control)	233	
Next peak	96	
Next peak (remote control)	233	
Peak	96	
Peak (remote control)	233	
Peak list (remote control)	240	
Phase noise measurement	102	
Phase noise measurement (remote control)	247	
Position	91	
Positioning	95	
Positioning (remote control)	214	
Remote control	214	

Search settings (remote)	232
Setting up (remote control)	214
Spectrograms (remote control)	223, 248
State	90
Step size	93
Step size (remote control)	221
Table	93
Table (evaluation method)	25
Table (remote control)	221
Type	91
X-value	91
Maximizing	
Windows (remote)	179, 204
Measurement examples	
Analog Modulation Analysis	112
Measurement time	50, 52
Auto settings	75
Displayed	13
Effects	30
Value range	29
Minimum	96
Marker positioning	96
Next	97
MKR ->	
Key	95
MKR FUNCT	
Key	99
Modulation	
Depth	24
Depth, scaling	64
Frequency	24, 28
Multiple	
Channel setups	12
N	
n dB down	
Delta value	102
Marker	102
Remote control	244
Next Minimum	97
Marker positioning	97
Next Mode X	
Softkey	98
Next Mode Y	
Softkey	98
Next Peak	96
Marker positioning	96
Noise	
Source	73
O	
Offset	
Reference level	42
Options	
Preamplifier	44
Output	
Noise source	73
Overload	
RF input (remote)	129
Overview	
Configuration K7	33
Softkey	33

P

Peak excursion	95, 99, 105, 108
Peak list	106
Configuring	105
Displaying	105
Evaluation method	25
Exporting	108
Marker numbers	108
Maximum number of peaks	108
Peak excursion	95, 99, 108
Remote control	240
Sort mode	107
State	107
Peak search	
Area (spectrograms)	99
Excursion	105
Key	96
Limits	105
List	106
Mode	98
Mode (spectrograms)	97, 98
Reference marker	93
Type (spectrograms)	98
Peaks	
Marker positioning	96
Next	96
Softkey	96
Performance	
Improving	30
Performing	
AM/FM/PM Modulation Analysis	110
Phase	
Deviation	28
Deviation, scaling	64
Unit	68
Phase noise measurement	
Activating/Deactivating	104
Deactivating	105
Marker	102
Remote control	247
Phase Wrap	
Activating	57
PM (Offline)	
Softkey	47
PM Spectrum	
Evaluation method	20
PM Time Domain	
Evaluation method	17
Preamplifier	
Setting	44
Softkey	44
Presetting	
Channels	35
Pretrigger	48
Programming examples	
Statistics	270, 272
Protection	
RF input (remote)	129
Q	
Quick Config	
Traces	80

R

Range	66
Scaling	67
RBW	50
Displayed	13
Remote control	144
Reference	
Fixed	93
Marker	93
Reference level	41
Auto level	42, 75
Displayed	13
Offset	42
Offset, displayed	13
Position	67
Unit	41, 42
Value	41
Reference marker	91
Reference value	65
Position	64
Release notes	8
Remote commands	
Basics on syntax	119
Boolean values	122
Capitalization	120
Character data	123
Data blocks	123
Deprecated	275
Numeric values	122
Optional keywords	121
Parameters	121
Strings	123
Suffixes	120
Repetition interval	48
Res BW	
see RBW	50
Resetting	
RF input protection	129
Residual FM	28
Resolution bandwidth	
see RBW	50
Restoring	
Channel settings	35
Standard files	37
Result Display	12
Result displays	
Marker table	25
Peak list	25
Result Summary	
Demodulation spectrum	59
Evaluation method	23
Retrieving values (remote)	192
Results	15
Analyzing	77
Data format (remote)	191
Exporting	87
Retrieving (remote control)	187
Stability	30
RF (Offline)	
Softkey	47
RF attenuation	
Auto	43
Manual	43
RF full span	60

RF input	
Overload protection (remote)	129
Remote	129
RF Spectrum	
Evaluation method	22
Troubleshooting	117
RF Time Domain	
Evaluation method	21
RUN CONT	
Key	51, 84
RUN SINGLE	
Key	52, 84
S	
Safety instructions	8
Sample rate	29
Samples	
Performance	30
Saving	
Settings	37
Scaling	
AF	63
Amplitude range, automatically	67
Automatic	66, 75
Configuration	63
Result Summary	66
RF	66
Y-axis	67
Y-axis (remote control)	142
Screen layout	12
Search Configuration (softkey)	95
Search Mode	
Spectrogram markers	97
Search settings	
Markers (remote)	232
Searching	
Configuration (softkey)	97
Security procedures	8
Select Frame	
Softkey	53, 83
Select Marker	95
Sequencer	12
Activating (remote)	177
Remote	176
Sequences	
Aborting (remote)	177
Mode (remote)	177
Service manual	7
Settings	
Displayed	33
filename	36
Restoring files	37
Storage location	36
Settings files	
Deleting	37
Loading	37
Predefined	278
Saving	37
Signal-to-noise ratio	28
Signal-to-noise-and-distortion	
see SINAD	24
SINAD	24
Querying (remote)	196
Troubleshooting	117
Single sweep	
Softkey	52, 84

- Slope
 - Trigger 48, 150
 - Softkeys
 - All Functions Off 108
 - AM (Offline) 47
 - Amplitude Config 40
 - Auto All 74
 - Auto Freq 75
 - Auto Level 42, 75
 - Center 44, 59
 - Clear Spectrogram 53, 84
 - Color Mapping 84
 - Continue Single Sweep 52
 - Continuous Sweep 51, 84
 - Display Config 54
 - External 47
 - FM (Offline) 47
 - Frame count 53
 - Free Run 46
 - History Depth 83
 - IF Power 47
 - Lower Level Hysteresis 76
 - Marker Search Area 99
 - Marker Search Type 98
 - Marker to Trace 92
 - Meastime Auto 75
 - Meastime Manual 75
 - Min 96
 - Next Min 97
 - Next Mode X 98
 - Next Mode Y 98
 - Next Peak 96
 - Norm/Delta 91
 - Overview 33
 - Peak 96
 - PM (Offline) 47
 - Preamp 44
 - Ref Level 41
 - Ref Level Offset 42
 - RF (Offline) 47
 - RF Atten Auto 43
 - RF Atten Manual 43
 - Search Config 95, 97
 - Select Frame 53, 83
 - Select Marker 95
 - Single Sweep 52, 84
 - Span Manual 60
 - Time 47
 - Timestamp 83
 - Trace 1/2/3/4 81
 - Trace Config 77
 - Trigger Offset 48
 - Upper Level Hysteresis 76
 - Sort mode
 - Peak list 107
 - Span 60
 - Displayed 14
 - Manual 60
 - Speaker
 - Remote control 133, 134
 - Specifics for
 - Configuration 35
 - Spectrograms
 - 3-dimensional 82, 83
 - Activating/Deactivating 82
 - Clearing 53, 84
 - Color curve 86
 - Color mapping 84, 85
 - Color mapping (remote control) 206
 - Color scheme 86
 - Configuring (remote control) 200
 - Display depth (3-D) 83
 - Frames (remote control) 200
 - History depth 83
 - Markers (remote control) 223, 248
 - Selecting frames 53, 83
 - Settings 81
 - Size 82
 - Timestamps 83
 - Spectrum
 - Demodulation 57
 - Squelch
 - AF 55
 - Level 55
 - Remote control 153
 - State 55
 - Standards
 - Configuration 35
 - Predefined 278
 - Presetting 36
 - VSA measurements 35
 - Statistics
 - Programming example 270, 272
 - Status registers
 - STAT:QUES:POW 129
 - Step size
 - Markers 93
 - Markers (remote control) 221
 - Storage location
 - Settings 36
 - Subwindows
 - Spectrogram 82
 - Suffixes
 - Common 124
 - Remote commands 120
 - Sweep
 - Aborting 51, 52, 84
 - Settings 50
 - Sweep Count 52
 - Sweep points
 - Displayed 14
 - Sweep Points 52
 - Sweeps
 - Performing (remote) 175
- ## T
- THD 24
 - Querying (remote) 196
 - Troubleshooting 117
 - Unit 68
 - Time domain zoom 31, 56
 - Length 57
 - Start 56
 - State 56
 - Time frames
 - Continuing 53
 - per sweep 53
 - Selecting 53, 83
 - Time per division
 - Displayed 14
 - Time trigger
 - Repetition interval 48
 - Softkey 47

Timestamps	
Softkey (Spectrogram)	83
Spectrograms	83
Total harmonic distortion	
see THD	24
Traces	81
Average mode	80
Averaging (remote control)	213
Configuration	77
Configuring (remote control)	208
Detector	79
Detector (remote control)	167, 213
Export format	88, 89
Exporting	86, 87, 88, 111
Hold	80
Mode	78
Mode (remote)	208
Remote control	187
Retrieving results (remote)	187
Settings (remote control)	208
Settings, predefined	80
Trigger	
Drop-out time	48
External (remote)	150
Holdoff	48
Hysteresis	48
Offset	48
Offset, value range	29
Remote control	146
Settings	45
Slope	48, 150
Trigger level	47
External trigger (remote)	148
IF Power (remote)	148
Trigger source	46
AF	30
AM (Offline)	47
External	47
FM (Offline)	47
Free Run	46
IF Power	47
PM (Offline)	47
RF (Offline)	47
Settings	46
Time	47
Troubleshooting	117
Demodulation bandwidth	117
Input overload	129
RF Spectrum	117
SINAD	117
THD	117
U	
Units	68
Reference level	41, 42
Upper Level Hysteresis	76
V	
Volume	
Remote control	133, 134
W	
Weighting filter	
AF filters	62
White papers	8
Window title bar information	13
Windows	
Adding (remote)	180
Closing (remote)	186
Configuring	35
Layout (remote)	183
Maximizing (remote)	179, 204
Querying (remote)	181, 182
Replacing (remote)	183
Splitting (remote)	179, 204
Types (remote)	180
X	
X-value	
Marker	91
Y	
Y-axis	
Scaling	67
YIG-preselector	
Activating/Deactivating	39
Activating/Deactivating (remote)	129
Z	
Zero Phase	
Reference Position	57
Reference Position (remote)	152
Zooming	
Time domain	31, 56