

# R&S®ZNL

## Analog Demodulation Mode (SA Option R&S®FPL1-K7) User Manual

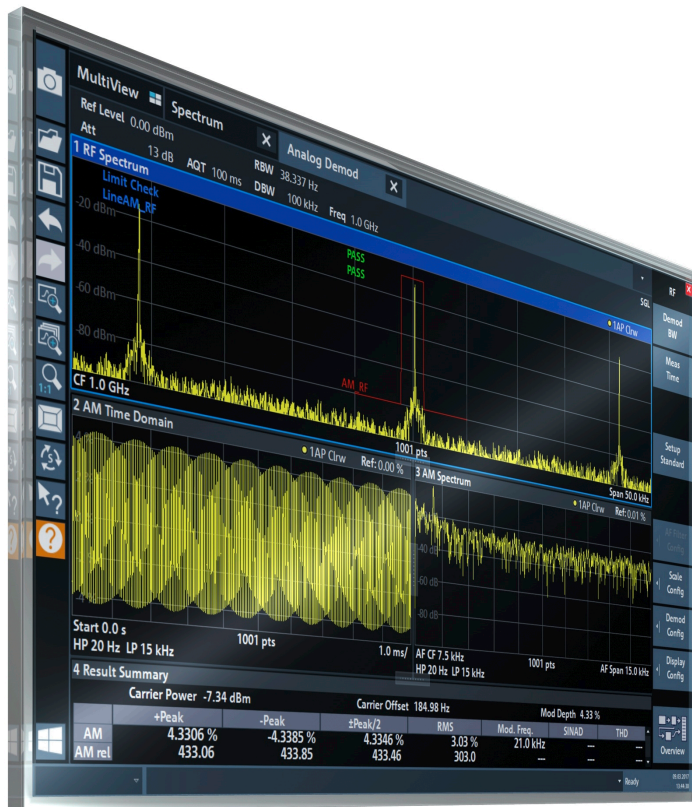

1178599502  
Version 13

**ROHDE & SCHWARZ**  
Make ideas real



This manual applies to the following R&S®ZNL models with firmware version 1.71 and higher:

- R&S®ZNL3, 5 kHz to 3 GHz, 2 ports, N(f) connectors, order no. 1323.0012K03
- R&S®ZNL4, 5 kHz to 4.5 GHz, 2 ports, N(f) connectors, order no. 1323.0012K04
- R&S®ZNL6, 5 kHz to 6 GHz, 2 ports, N(f) connectors, order no. 1323.0012K06
- R&S®ZNL14, 5 kHz to 14 GHz, 2 ports, N(f) connectors, order no. 1323.0012K14  
**Serial numbers 101200 and higher**
- R&S®ZNL20, 5 kHz to 20 GHz, 2 ports, 3.5 mm (m) connectors, order no. 1323.0012K20  
**Serial numbers 101200 and higher**

The following firmware options are described:

- R&S®ZNL3-B1 Spectrum Analysis (1323.1802.02)
- R&S®ZNL4-B1 Spectrum Analysis (1303.8099.02)
- R&S®ZNL6-B1 Spectrum Analysis (1323.2067.02)
- R&S®ZNL14-B1 Spectrum Analysis (1303.8082.02)
- R&S®ZNL20-B1 Spectrum Analysis (1303.8101.02)
- R&S FPL1-K7 Analog Demodulation AM/FM/PM (1323.1731.02)

© 2023 Rohde & Schwarz GmbH & Co. KG  
Muehldorfstr. 15, 81671 Muenchen, Germany  
Phone: +49 89 41 29 - 0  
Email: [info@rohde-schwarz.com](mailto:info@rohde-schwarz.com)  
Internet: [www.rohde-schwarz.com](http://www.rohde-schwarz.com)

Subject to change – data without tolerance limits is not binding.

R&S® is a registered trademark of Rohde & Schwarz GmbH & Co. KG.

All other trademarks are the properties of their respective owners.

1178.5995.02 | Version 13 | R&S®ZNL

Throughout this manual, products from Rohde & Schwarz are indicated without the ® symbol, e.g. R&S®ZNL is indicated as R&S ZNL.

# Contents

<b>1</b>	<b>Preface</b> .....	<b>5</b>
1.1	Documentation overview.....	5
1.2	Conventions used in the documentation.....	7
<b>2</b>	<b>Welcome to the R&amp;S FPL1-K7 AM/FM/PM Modulation Analysis application</b> .....	<b>9</b>
2.1	Starting AM/FM/PM Modulation Analysis.....	9
2.2	Understanding the display information.....	10
<b>3</b>	<b>Measurements and result displays</b> .....	<b>13</b>
<b>4</b>	<b>Measurement basics</b> .....	<b>24</b>
4.1	Demodulation process.....	24
4.2	Demodulation bandwidth.....	26
4.3	Sample rate and demodulation bandwidth.....	27
4.4	AF triggers.....	28
4.5	AF filters.....	29
4.6	Time domain zoom.....	29
<b>5</b>	<b>Configuration</b> .....	<b>31</b>
5.1	Configuration overview.....	31
5.2	Configuration according to standards.....	33
5.3	Input and frontend settings.....	35
5.4	Trigger configuration.....	42
5.5	Data acquisition.....	45
5.6	Demodulation display.....	50
5.7	Demodulation.....	50
5.8	Output settings.....	69
5.9	Adjusting settings automatically.....	69
<b>6</b>	<b>Analysis</b> .....	<b>73</b>
6.1	Trace settings.....	73
6.2	Spectrogram settings.....	76
6.3	Trace / data export configuration.....	81

6.4	Working with markers in the R&S FPL1-K7 AM/FM/PM Modulation Analysis application.....	84
7	I/Q data import and export.....	104
8	How to perform measurements in the R&S FPL1-K7 AM/FM/PM Modulation Analysis application.....	105
8.1	How to export trace data and numerical results.....	106
9	Measurement example: demodulating an FM signal.....	107
10	Optimizing and troubleshooting the measurement.....	112
11	Remote commands for AM/FM/PM Modulation Analysis.....	113
11.1	Introduction.....	114
11.2	Common suffixes.....	119
11.3	Activating analog modulation analysis.....	119
11.4	Configuring the measurement.....	122
11.5	Capturing data and performing sweeps.....	167
11.6	Configuring the result display.....	170
11.7	Retrieving results.....	178
11.8	Analyzing results.....	190
11.9	Importing and exporting I/Q data and results.....	264
11.10	Deprecated commands.....	265
11.11	Programming example.....	266
	<b>Annex.....</b>	<b>269</b>
A	<b>Predefined standards and settings.....</b>	<b>269</b>
	<b>List of commands (analog demodulation mode).....</b>	<b>271</b>
	<b>Index.....</b>	<b>280</b>

# 1 Preface

This chapter provides safety-related information, an overview of the user documentation and the conventions used in the documentation.

## 1.1 Documentation overview

This section provides an overview of the R&S ZNL user documentation. Unless specified otherwise, you find the documents at:

[www.rohde-schwarz.com/manual/ZNL](http://www.rohde-schwarz.com/manual/ZNL) or [www.rohde-schwarz.com/manual/ZNLE](http://www.rohde-schwarz.com/manual/ZNLE).

### 1.1.1 Getting started manual

Introduces the R&S ZNL and describes how to set up and start working with the product. Includes basic operations, typical measurement examples, and general information, e.g. safety instructions, etc.

A printed version is delivered with the instrument. A PDF version is available for download on the Internet.

### 1.1.2 User manuals and help

Separate user manuals are provided for the base unit and the firmware applications:

- **Base unit manual**  
Contains the description of all instrument modes and functions. It also provides an introduction to remote control, a complete description of the remote control commands with programming examples, and information on maintenance, instrument interfaces and error messages. Includes the contents of the getting started manual.
- **Firmware application manual**  
Contains the description of the specific functions of a firmware application, including remote control commands. Basic information on operating the R&S ZNL is not included.

The contents of the user manuals are available as help in the R&S ZNL. The help offers quick, context-sensitive access to the complete information for the base unit and the firmware applications.

All user manuals are also available for download or for immediate display on the Internet.

### 1.1.3 Service manual

Describes the performance test for checking compliance with rated specifications, firmware update, troubleshooting, adjustments, installing options and maintenance.

The service manual is available for registered users on the global Rohde & Schwarz information system (GLORIS):

<https://gloris.rohde-schwarz.com>

#### 1.1.4 Instrument security procedures

Deals with security issues when working with the R&S ZNL in secure areas. It is available for download on the Internet.

#### 1.1.5 Printed safety instructions

Provides safety information in many languages. The printed document is delivered with the product.

#### 1.1.6 Data sheets and brochures

The data sheet contains the technical specifications of the R&S ZNL. It also lists the firmware applications and their order numbers, and optional accessories.

The brochure provides an overview of the instrument and deals with the specific characteristics.

See [www.rohde-schwarz.com/brochure-datasheet/ZNL](http://www.rohde-schwarz.com/brochure-datasheet/ZNL) or [www.rohde-schwarz.com/brochure-datasheet/ZNLE](http://www.rohde-schwarz.com/brochure-datasheet/ZNLE).

#### 1.1.7 Release notes and open source acknowledgment (OSA)

The release notes list new features, improvements and known issues of the current firmware version, and describe the firmware installation.

The software makes use of several valuable open source software packages. An open source acknowledgment document provides verbatim license texts of the used open source software.

See [www.rohde-schwarz.com/firmware/ZNL](http://www.rohde-schwarz.com/firmware/ZNL) or [www.rohde-schwarz.com/firmware/ZNLE](http://www.rohde-schwarz.com/firmware/ZNLE).

#### 1.1.8 Application notes, application cards, white papers, etc.

These documents deal with special applications or background information on particular topics.

See [www.rohde-schwarz.com/application/ZNL](http://www.rohde-schwarz.com/application/ZNL) or [www.rohde-schwarz.com/application/ZNLE](http://www.rohde-schwarz.com/application/ZNLE).

### 1.1.9 Calibration certificate

The document is available on <https://gloris.rohde-schwarz.com/calcert>. You need the device ID of your instrument, which you can find on a label on the rear panel.

## 1.2 Conventions used in the documentation

### 1.2.1 Typographical conventions

The following text markers are used throughout this documentation:

Convention	Description
"Graphical user interface elements"	All names of graphical user interface elements on the screen, such as dialog boxes, menus, options, buttons, and softkeys are enclosed by quotation marks.
[Keys]	Key and knob names are enclosed by square brackets.
Filenames, commands, program code	Filenames, commands, coding samples and screen output are distinguished by their font.
<i>Input</i>	Input to be entered by the user is displayed in italics.
<a href="#">Links</a>	Links that you can click are displayed in blue font.
"References"	References to other parts of the documentation are enclosed by quotation marks.

### 1.2.2 Conventions for procedure descriptions

When operating the instrument, several alternative methods may be available to perform the same task. In this case, the procedure using the touchscreen is described. Any elements that can be activated by touching can also be clicked using an additionally connected mouse. The alternative procedure using the keys on the instrument or the on-screen keyboard is only described if it deviates from the standard operating procedures.

The term "select" may refer to any of the described methods, i.e. using a finger on the touchscreen, a mouse pointer in the display, or a key on the instrument or on a keyboard.

### 1.2.3 Notes on screenshots

When describing the functions of the product, we use sample screenshots. These screenshots are meant to illustrate as many as possible of the provided functions and possible interdependencies between parameters. The shown values may not represent realistic usage scenarios.

The screenshots usually show a fully equipped product, that is: with all options installed. Thus, some functions shown in the screenshots may not be available in your particular product configuration.



## 2 Welcome to the R&S FPL1-K7 AM/FM/PM Modulation Analysis application

The R&S FPL1-K7 AM/FM/PM Modulation Analysis application option converts the R&S ZNL into an analog modulation analyzer for amplitude-, frequency- or phase-modulated signals. It measures not only characteristics of the useful modulation, but also factors such as residual FM or synchronous modulation.

The R&S FPL1-K7 AM/FM/PM Modulation Analysis application features:

- AM, FM, and PM demodulation, with various result displays:
  - Modulation signal versus time
  - Spectrum of the modulation signal (FFT)
  - RF signal power versus time
  - Spectrum of the RF signal
- Determining maximum, minimum and average or current values in parallel over a selected number of measurements
- Maximum accuracy and temperature stability due to sampling (digitization) already at the IF and digital down-conversion to the baseband (I/Q)
- Error-free AM to FM conversion and vice versa, without deviation errors, frequency response or frequency drift at DC coupling
- Relative demodulation, in relation to a user-defined or measured reference value



### Availability of the R&S FPL1-K7 AM/FM/PM Modulation Analysis application

The R&S FPL1-K7 AM/FM/PM Modulation Analysis application becomes available when you equip the R&S ZNLxx with the optional spectrum analyzer hardware option R&S ZNLxx-B1 and the optional AM/FM/PM Modulation Analysis firmware (R&S FPL1-K7).

For the R&S ZNLE and for R&S ZNL14 and R&S ZNL20 with serial numbers below 101200, these options are **not available**.

This user manual contains a description of the functionality that the application provides, including remote control operation.

All functions not discussed in this manual are the same as in the base unit and are described in the R&S ZNL User Manual. The latest version is available for download at the product homepage <http://www.rohde-schwarz.com/product/ZNL>.

### 2.1 Starting AM/FM/PM Modulation Analysis

AM/FM/PM Modulation Analysis is a separate application on the R&S ZNL.

#### To activate AM/FM/PM Modulation Analysis

1. Select the [MODE] key.

A dialog box opens that contains all operating modes and applications currently available on your R&S ZNL.

2. Select the "Analog Demod" item.



The R&S ZNL opens a new channel setup for the application for analog modulation analysis.

The measurement is started immediately with the default settings. It can be configured in the analog modulation analysis "Overview" dialog box, which is displayed when you select the "Overview" softkey from any menu (see [Chapter 5.1, "Configuration overview"](#), on page 31).

### Multiple Channel Setups and Sequencer Function

When you activate an application, a new channel setup is created which determines the measurement settings for that application ("Channel"). The same application can be activated with different measurement settings by creating several "Channel"s for the same application.

The number of channel setups that can be configured at the same time depends on the available memory on the instrument.

Only one measurement can be performed at any time, namely the one in the currently active channel setup. However, to perform the configured measurements consecutively, a Sequencer function is provided.

If activated, the measurements configured in the currently defined "Channel"s are performed one after the other in the order of the tabs. The currently active measurement is indicated by a  symbol in the tab label.

The result displays of the individual channel setups are updated in the tabs (as well as the "MultiView" ) as the measurements are performed. Sequential operation itself is independent of the currently *displayed* tab.

For details on the Sequencer function, see the R&S ZNL User Manual.

## 2.2 Understanding the display information

The following figure shows a measurement diagram during analog modulation analysis. All different information areas are labeled. They are explained in more detail in the following sections.



- 1 = Channel Setup bar for firmware and measurement settings
- 2 = Diagram area
- 3 = Window title bar with diagram-specific (trace) information
- 4 = Instrument status bar with error messages and date/time display
- 5 = Diagram footer with diagram-specific information, depending on result display

### Channel Setup bar information

In the Analog Modulation Analysis application, the R&S ZNL shows the following settings:

**Table 2-1: Information displayed in the channel setup bar in the application for analog modulation analysis**

Ref Level	Reference level
Offset	Reference level offset
AQT	Measurement time for data acquisition.
RBW	Resolution bandwidth
DBW	Demodulation bandwidth
Freq	Center frequency for the RF signal

### Window title bar information

For each diagram, the header provides the following information:



**Figure 2-1: Window title bar information in the application for analog modulation analysis**

- 1 = Window number
- 2 = Window type
- 3 = Trace color
- 4 = Trace number
- 5 = Detector
- 6 = Trace mode
- 7 = Reference value (at the defined reference position)
- 8 = AF coupling (AC/DC), only in AF time domains, if applicable
- 9 = Results are selected for demodulation output

### Diagram footer information

The diagram footer (beneath the diagram) contains the following information, depending on the evaluation:

"RF Spectrum"		
CF: Center frequency of input signal	Sweep points	Span: measured span

RF Time domain		
CF: Center frequency of input signal	Sweep points	Time per division

AF Spectrum		
AF CF: center frequency of demodulated signal	Sweep points	AF Span: evaluated span

AF Time domain		
CF: Center frequency of input signal	Sweep points	Time per division

For most modes, the number of sweep points shown in the display are indicated in the diagram footer. In zoom mode, the (rounded) number of currently displayed points are indicated.

### Status bar information

Global instrument settings, the instrument status and any irregularities are indicated in the status bar beneath the diagram.

## 3 Measurements and result displays

**Access:** "Overview" > "Display Config"

**Or:** [MEAS] > "Display Config"

The data that was measured by the R&S ZNL can be evaluated using various different methods. In the Analog Modulation Analysis application, up to six evaluation methods can be displayed simultaneously in separate windows. The results can be displayed as absolute deviations or relative to a reference value or level.



The abbreviation "AF" (for Audio Frequency) refers to the demodulated AM, FM or PM signal.

### Basis for evaluation

All evaluations are based on the I/Q data set acquired during the measurement. The spectrum of the modulated signal to be evaluated is determined by the demodulation bandwidth. However, it can be restricted to a limited span ( "AF Span" ) if only part of the signal is of interest. Furthermore, the time base for evaluations in the time domain can be restricted to analyze a smaller extract in more detail, see [Chapter 4.6, "Time domain zoom"](#), on page 29.

<a href="#">AM Time Domain</a> .....	13
<a href="#">FM Time Domain</a> .....	14
<a href="#">PM Time Domain</a> .....	15
<a href="#">AM Spectrum</a> .....	16
<a href="#">FM Spectrum</a> .....	17
<a href="#">PM Spectrum</a> .....	18
<a href="#">RF Time Domain</a> .....	19
<a href="#">RF Spectrum</a> .....	20
<a href="#">Result Summary</a> .....	21
<a href="#">Marker Table</a> .....	23
<a href="#">Marker Peak List</a> .....	23

### AM Time Domain

Displays the modulation depth of the demodulated AM signal (in %) versus time.

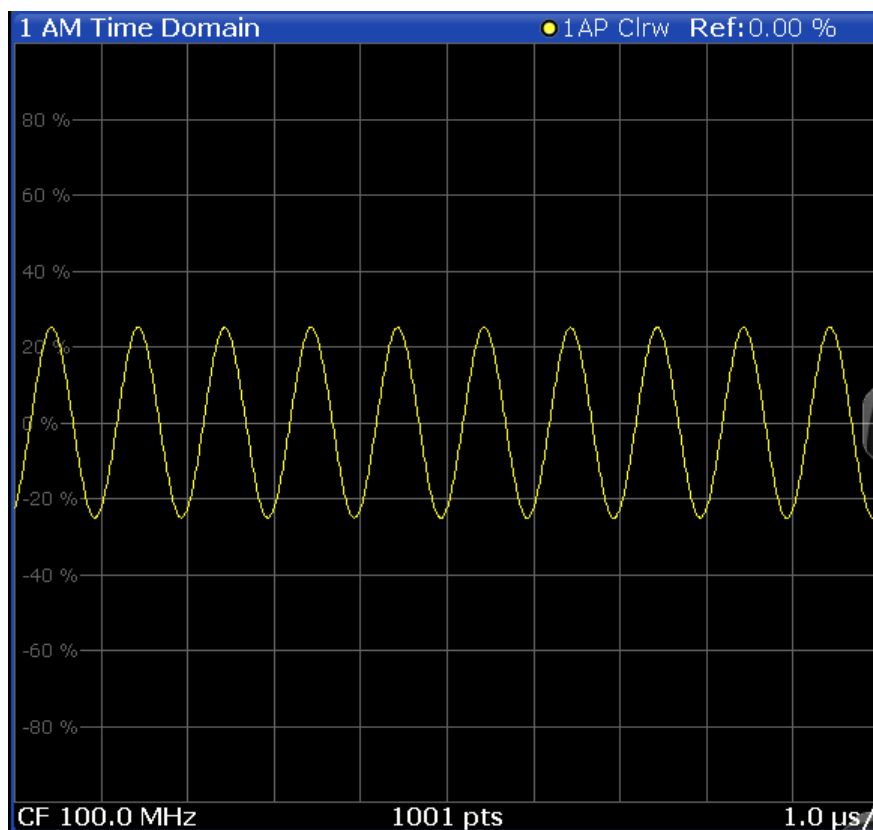

Optionally, the settling time can be evaluated and displayed, see [Chapter 5.7.7, "Settling time"](#), on page 67.

Remote command:

```
LAY:ADD? '1',RIGHT,'XTIM:AM:REL'
```

(See [LAYout:ADD\[:WINDow\]?](#) on page 171)

### FM Time Domain

Displays the frequency spectrum of the demodulated FM signal versus time.

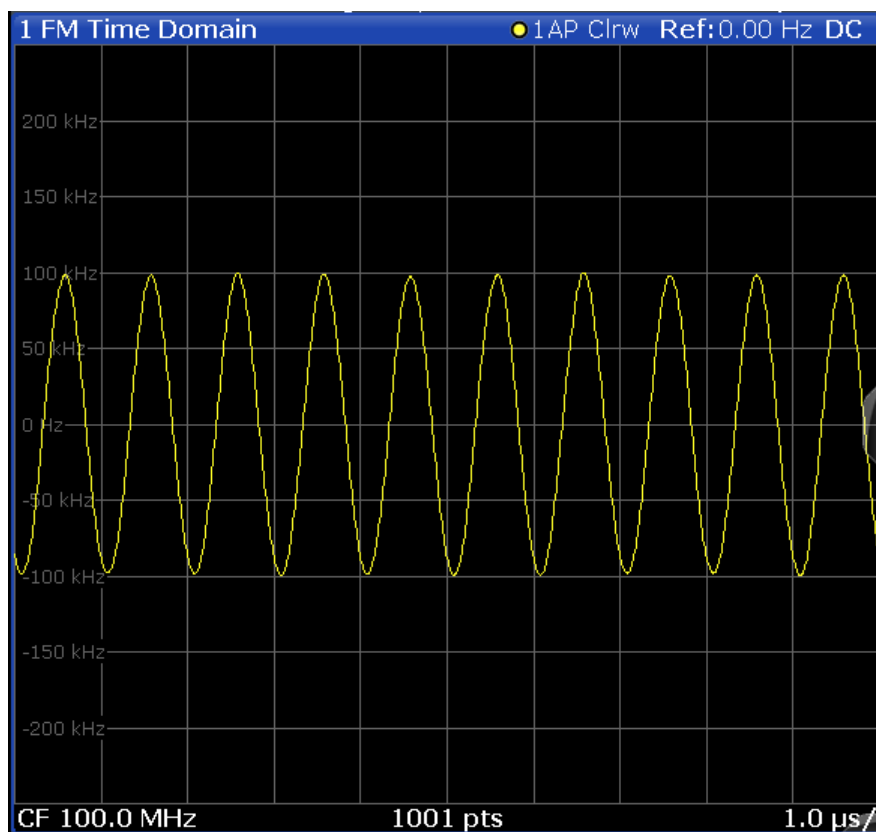

Optionally, the settling time can be evaluated and displayed, see [Chapter 5.7.7, "Settling time"](#), on page 67.

Remote command:

```
LAY:ADD? '1',RIGH,'XTIM:FM'
```

(See [LAYout:ADD\[:WINDow\]?](#) on page 171)

### PM Time Domain

Displays the phase deviations of the demodulated PM signal (in rad or °) versus time.

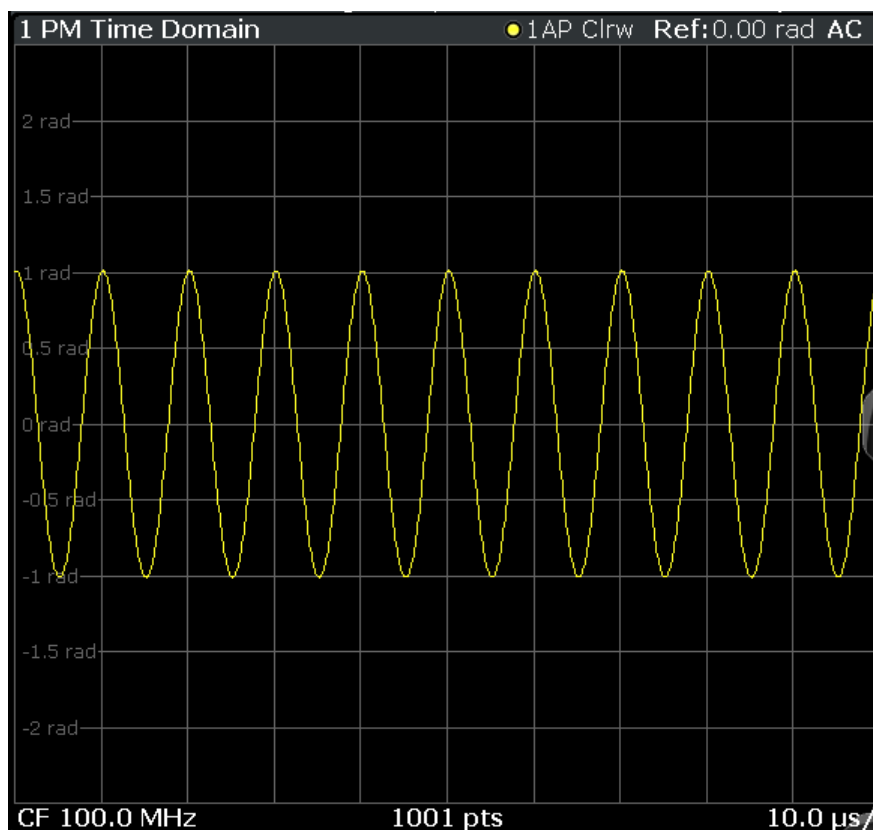

Optionally, the settling time can be evaluated and displayed, see [Chapter 5.7.7, "Settling time"](#), on page 67.

Remote command:

```
LAY:ADD? '1',RIGH,'XTIM:PM'
```

(See [LAYout:ADD\[:WINDow\]?](#) on page 171)

### AM Spectrum

Displays the modulation depth of the demodulated AM signal (in % or dB) versus AF span. The spectrum is calculated from the demodulated AM signal in the time domain via FFT.



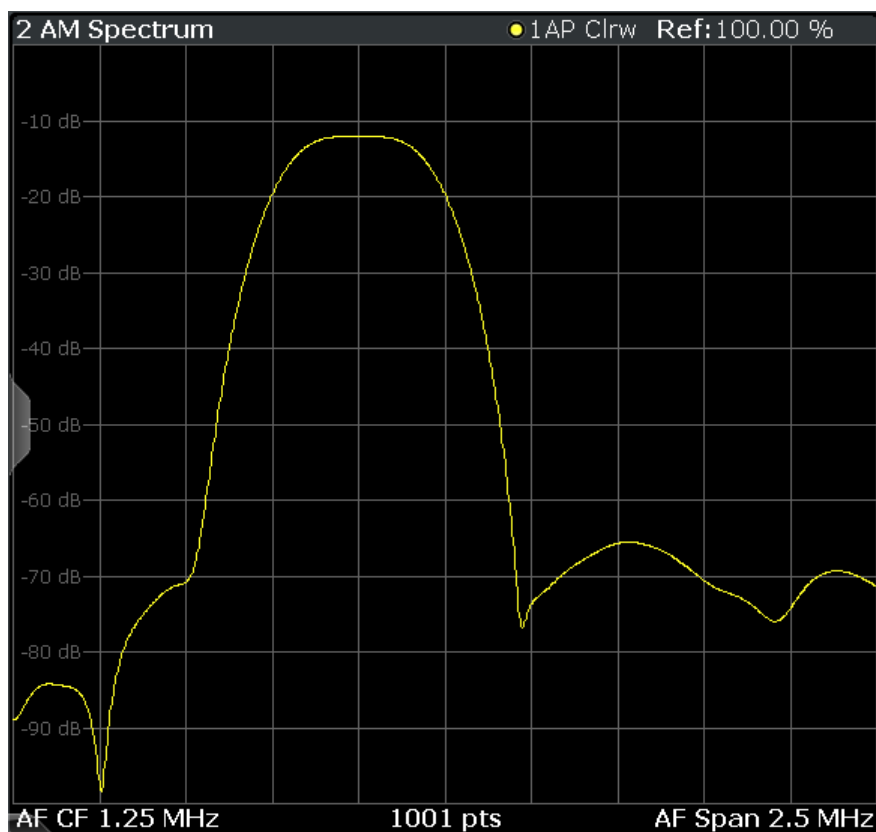

Remote command:

```
LAY:ADD? '1',RIGH,'XTIME:AM:REL:AFSPpectrum1'
```

(see [LAYout:ADD\[:WINDow\]?](#) on page 171)

### FM Spectrum

Displays the frequency deviations of the demodulated FM signal (in Hz or dB) versus AF span. The spectrum is calculated from the demodulated AM signal in the time domain via FFT.

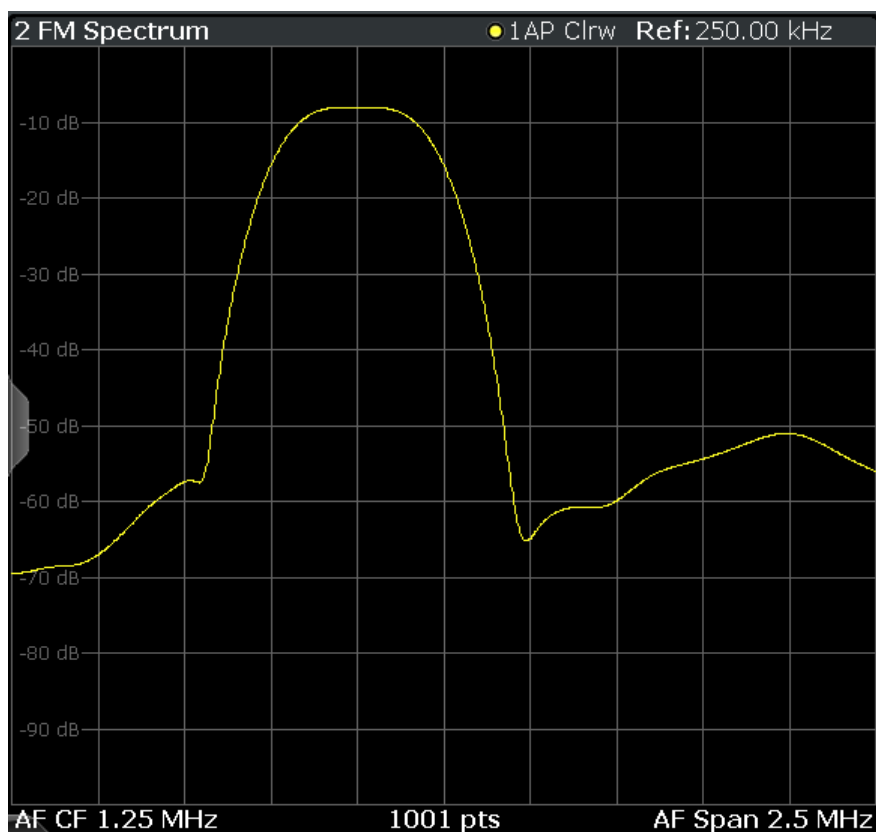

Remote command:

```
LAY:ADD? '1',RIGH,'XTIME:FM:AFSPpectrum1'
```

(see [LAYout:ADD\[:WINDow\]?](#) on page 171)

### PM Spectrum

Displays the phase deviations of the demodulated PM signal (in rad, ° or dB) versus AF span. The spectrum is calculated from the demodulated AM signal in the time domain via FFT.

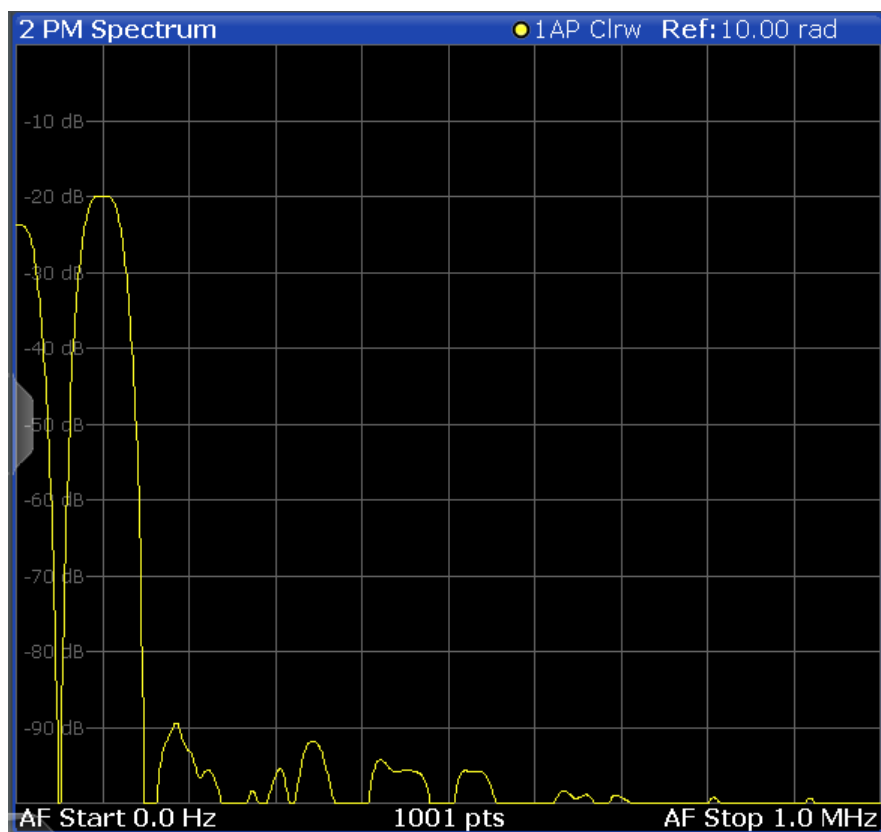

Remote command:

```
LAY:ADD? '1',RIGH,'XTIME:PM:AFSPpectrum1'
```

(see [LAYout:ADD\[:WINDow\]?](#) on page 171)

### RF Time Domain

Displays the RF power of the input signal versus time. The level values represent the magnitude of the I/Q data set.

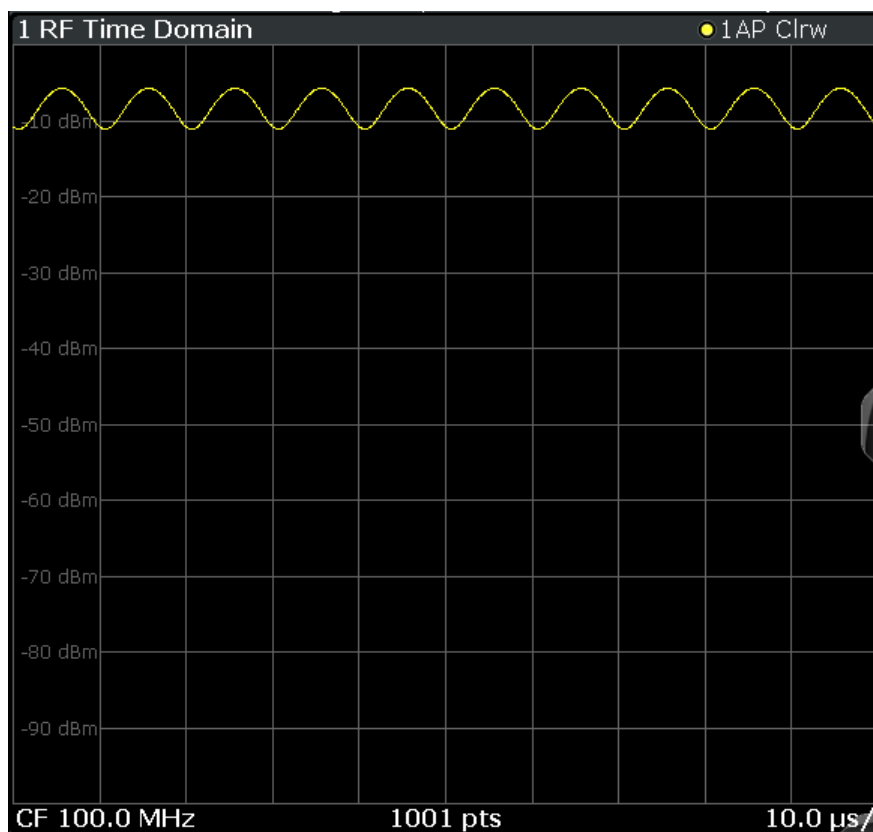

Optionally, the settling time can be evaluated and displayed, see [Chapter 5.7.7, "Settling time"](#), on page 67.

Remote command:

```
LAY:ADD? '1',RIGH,'XTIM:AM'
```

(see [LAYout:ADD\[:WINDow\]?](#) on page 171)

### RF Spectrum

Displays the spectrum of the input signal. In contrast to the Spectrum application, the frequency values are determined using FFT from the recorded I/Q data set.

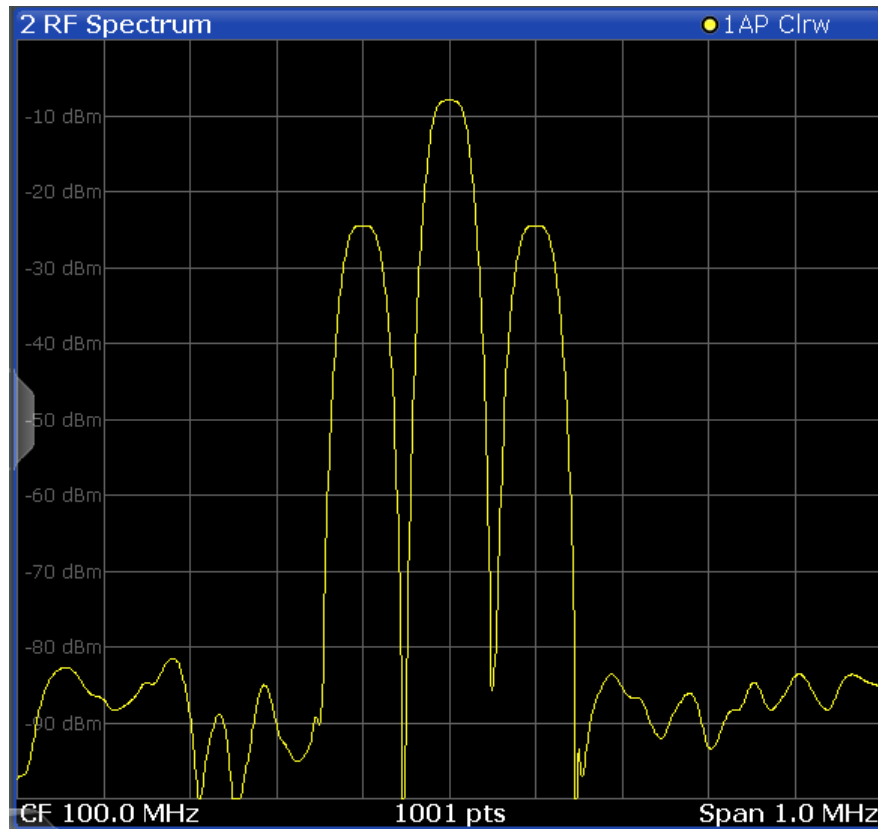

Remote command:

```
LAY:ADD? '1',RIGH,'XTIM:SPECTRUM'
```

(see [LAYout:ADD\[:WINDow\]?](#) on page 171)

### Result Summary

The "result summary" displays the results of the demodulation functions for all windows in a table.

4 Result Summary									
	Carrier Power -20.69 dBm				Carrier Offset 390.56 Hz				
	Settling Time	+Peak	-Peak	±Peak/2	RMS	Mod. Freq.	SINAD	DISTORT	THD
FM	1.022 µs	4.8423 MHz	-1.8343 MHz	3.3383 MHz	1.1283 MHz	---	---	---	---

The following general results are provided:

For each demodulation, the following results are provided:

Label	Description
"Carr Power"	Measured carrier power
"Carr Offset"	Carrier offset to nominal center frequency
"Mod. Depth"	Modulation depth

Table 3-1: Result summary description

Label	Description
"Settling Time"	Time after which signal remains in a specified value range. Only evaluated and displayed if enabled, see <a href="#">Chapter 5.7.7, "Settling time"</a> , on page 67.
"+Peak"	Positive peak (maximum)
"-Peak"	Negative peak (minimum)
" +/-Peak/2"	Average of positive and negative peaks
"RMS"	Root Mean Square value
"Mod Freq"	Modulation frequency
"SINAD"	Signal-to-noise-and-distortion (Calculated only if AF Spectrum is displayed) Measures the ratio of the total power to the power of noise and harmonic distortions. The noise and harmonic power is calculated inside the AF spectrum span. The DC offset is removed before the calculation. $SINAD[dB] = 20 \cdot \log \left[ \frac{P_{total}}{P_{Noise} + P_{distortion}} \right]$
"DISTORT"	Modulation distortion in % (Calculated only if "SINAD" is also calculated) Measures the distortion of the modulation in relation to the total power of the signal inside the AF spectrum span. Indicates the quality of the modulation. $Modulation\ distortion = \frac{\sqrt{P_{total} - P_{signal}}}{\sqrt{P_{total}}} * 100\%$
"THD"	Total harmonic distortion The ratio of the harmonics to the fundamental and harmonics. All harmonics inside the AF spectrum span are considered up to the tenth harmonic. (Calculated only if AF Spectrum is displayed) $THD[dB] = 20 \cdot \log \left[ \frac{\sqrt{\sum_{i=2}^{\infty} U_i^2}}{\sqrt{\sum_{i=1}^{\infty} U_i^2}} \right]$

**Note:** Relative demodulation results. Optionally, the demodulation results in relation to user-defined or measured reference values are determined. See [Chapter 5.7.6, "Result table settings"](#), on page 64.

In addition, the following general information for the input signal is provided:

- "Carrier Power": the power of the carrier without modulation
- "Carrier Offset": the deviation of the calculated carrier frequency to the ideal carrier frequency
- "Modulation Depth" (AM or "RF Time Domain" only): the difference in amplitude the carrier signal is modulated with

Remote command:

LAY:ADD? '1', RIGH, RSUM, see [LAYout:ADD\[:WINDow\]?](#) on page 171

Results:

[Chapter 11.7.3, "Retrieving result summary values"](#), on page 183

### Marker Table

Displays a table with the current marker values for the active markers.

This table is displayed automatically if configured accordingly.

(See "[Marker Table Display](#)" on page 88).

1 Marker Table						
Wnd	Type	Ref	Trc	X-Value	Y-Value	Function
2	M1		1	2.1725 ms	-6.80 dBm	
2	D2	M1	1	13.859 ms	-0.00 dB	
2	D3	M1	1	4.6259 ms	-0.00 dB	
2	D4	M1	1	9.2331 ms	-0.00 dB	

**Tip:** To navigate within long marker tables, simply scroll through the entries with your finger on the touchscreen.

Remote command:

LAY:ADD? '1', RIGH, MTAB, see [LAYout:ADD\[:WINDow\]?](#) on page 171

Results:

[CALCulate<n>:MARKer<m>:X](#) on page 207

[CALCulate<n>:MARKer<m>:Y?](#) on page 208

### Marker Peak List

The marker peak list determines the frequencies and levels of peaks in the spectrum or time domain. How many peaks are displayed can be defined, as well as the sort order. In addition, the detected peaks can be indicated in the diagram. The peak list can also be exported to a file for analysis in an external application.

3 Marker Peak List				
Wnd	No	X-Value	Y-Value	
2	1	1.086245 ms	-75.810 dBm	
2	2	2.172490 ms	-6.797 dBm	
2	3	3.258736 ms	-76.448 dBm	
2	4	4.831918 ms	-76.676 dBm	
2	5	6.255274 ms	-76.482 dBm	
2	6	6.798397 ms	-6.800 dBm	
2	7	9.233084 ms	-76.519 dBm	
2	8	10.075861 ms	-76.172 dBm	
2	9	11.405574 ms	-6.801 dBm	

Remote command:

LAY:ADD? '1', RIGH, PEAK, see [LAYout:ADD\[:WINDow\]?](#) on page 171

Results:

[CALCulate<n>:MARKer<m>:X](#) on page 207

[CALCulate<n>:MARKer<m>:Y?](#) on page 208

## 4 Measurement basics

Some background knowledge on basic terms and principles used in Analog Modulation Analysis measurements is provided here for a better understanding of the required configuration settings.

- [Demodulation process](#)..... 24
- [Demodulation bandwidth](#).....26
- [Sample rate and demodulation bandwidth](#).....27
- [AF triggers](#).....28
- [AF filters](#).....29
- [Time domain zoom](#).....29

### 4.1 Demodulation process

The demodulation process is shown in [Figure 4-1](#). All calculations are performed simultaneously with the same I/Q data set. Magnitude (= amplitude) and phase of the complex I/Q pairs are determined. The frequency result is obtained from the differential phase.

For details on general I/Q data processing in the R&S ZNL, refer to the reference part of the I/Q Analysis remote control description in the R&S ZNL User Manual.



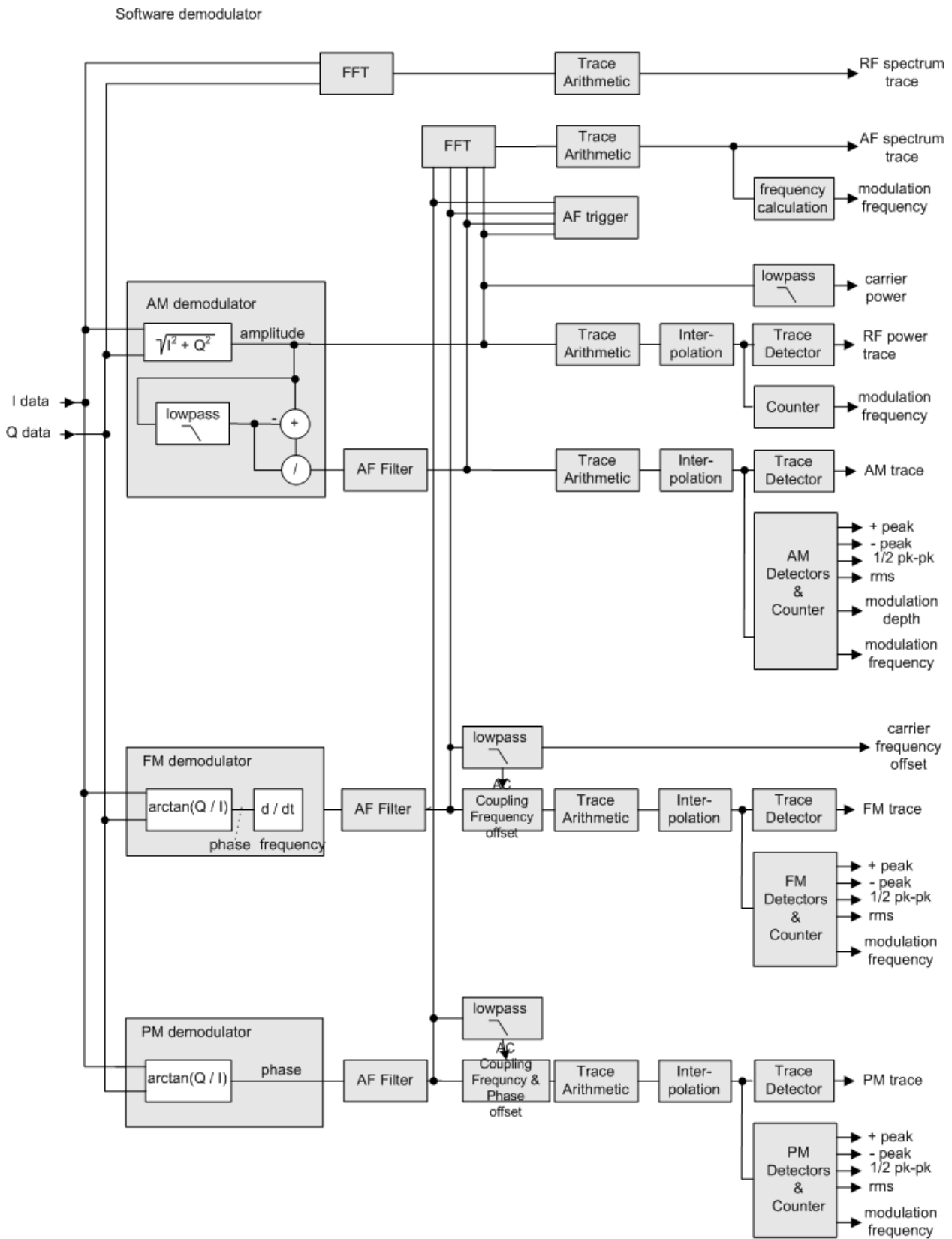

Figure 4-1: Block diagram of software demodulator

The AM DC, FM DC and PM DC raw data of the demodulators is fed into the "Trace Arithmetic" block that combines consecutive data sets. Possible trace modes are: Clear Write, Max Hold, Min Hold and Average. The output data of the "Trace Arithmetic" block can be read via remote control ([SENS:]ADEM:<evaluation>:RES?, see [SENSe:]ADEMod:AM[:ABSolute] [:TDOMain]:RESult? on page 179.

The collected measured values are evaluated by the selected detector. The result is displayed on the screen and can be read out via remote control.

In addition, important parameters are calculated:

- A counter determines the modulation frequency for AM, FM, and PM.
- average power = carrier power (RF power)
- average frequency = carrier frequency offset (FM)
- The modulation depth or the frequency or phase deviation; the deviations are determined from the trace data

AC coupling is possible with FM and PM display.

## 4.2 Demodulation bandwidth

The demodulation bandwidth determines the span of the signal that is demodulated. It is not the 3-dB bandwidth of the filter, but the useful bandwidth which is distortion-free regarding phase and amplitude.

Therefore the following formulas apply:

- AM: demodulation bandwidth  $\geq 2 \times$  modulation frequency
- FM: demodulation bandwidth  $\geq 2 \times$  (frequency deviation + modulation frequency)
- PM: demodulation bandwidth  $\geq 2 \times$  modulation frequency  $\times$  (1 + phase deviation)



If the center frequency of the analyzer is not set exactly to the signal frequency, the demodulation bandwidth must be increased by the carrier offset, in addition to the requirement described above. The bandwidth must also be increased if FM or PM AC coupling is selected.

In general, select the demodulation bandwidth as narrow as possible to improve the S/N ratio. The residual FM caused by noise floor and phase noise increases dramatically with the bandwidth, especially with FM.

For help on determining the adequate demodulation bandwidth, see ["Determining the demodulation bandwidth"](#) on page 112.

A practical example is described in [Chapter 9, "Measurement example: demodulating an FM signal"](#), on page 107.

### 4.3 Sample rate and demodulation bandwidth

The maximum demodulation bandwidths that can be obtained during the measurement, depending on the sample rate, are listed in the tables below for different demodulation filter types. The allowed value range of the measurement time and trigger offset depends on the selected demodulation bandwidth and demodulation filter. If the AF filter or the AF trigger are not active, the measurement time increases by 20 %.



A maximum of 24 million samples can be captured, assuming sufficient memory is available; thus the maximum measurement time can be determined according to the following formula:

$$\text{Meas.time}_{\text{max}} = \text{Sample count}_{\text{max}} / \text{sample rate}$$

The minimum trigger offset is  $(-\text{Meas.time}_{\text{max}})$

**Table 4-1: Available demodulation bandwidths and corresponding sample rates**

Demodulation BW	Sample Rate (Flat Top)	Sample Rate (Gaussian Top)
100 Hz	122.0703125 Hz	400 Hz
200 Hz	244.140625 Hz	800 Hz
400 Hz	488.28125 Hz	1.6 kHz
800 Hz	976.5625 Hz	3.2 kHz
1.6 kHz	1.953125 kHz	6.4 kHz
3.2 kHz	3.90625 kHz	12.8 kHz
6.4 kHz	7.8125 kHz	25.6 kHz
12.5 kHz	15.625 kHz	50 kHz
25 kHz	31.25 kHz	100 kHz
50 kHz	62.5 kHz	200 kHz
100 kHz	125 kHz	400 kHz
200 kHz	250 kHz	800 kHz
400 kHz	500 kHz	1.6 MHz
800 kHz	1 MHz	3.2 MHz
1.6 MHz	2 MHz	6.4 MHz
3 MHz	4 MHz	12 MHz
5 MHz	8 MHz	20 MHz
8 MHz	16 MHz	32 MHz**
10 MHz	32 MHz	40 MHz**
18 MHz*	32 MHz**	72 MHz**
* Gaussian filter curve is limited by I/Q bandwidth;		
**requires bandwidth extension option R&S FPL1-B40		

Demodulation BW	Sample Rate (Flat Top)	Sample Rate (Gaussian Top)
28 MHz*	64 MHz**	
40 MHz*	64 MHz**	
* Gaussian filter curve is limited by I/Q bandwidth; **requires bandwidth extension option R&S FPL1-B40		



Flat top filters require an I/Q bandwidth at least the size of the demodulation bandwidth on the R&S ZNL. Gauss filters require at least twice the size of the demodulation bandwidth on the R&S ZNL. If necessary, install optional bandwidth extensions on the R&S ZNL to use the required demodulation filter.

#### Large numbers of samples

Principally, the R&S ZNL can handle up to 24 million samples. However, when 480001 samples are exceeded, all traces that are not currently being displayed in a window are deactivated to improve performance. The traces can only be activated again when the samples are reduced.



#### Effects of measurement time on the stability of measurement results

Despite amplitude and frequency modulation, the display of carrier power and carrier frequency offset is stable.

Stability is achieved by a digital filter which sufficiently suppresses the modulation. As a prerequisite, the measurement time must be  $\geq 3 \times 1 / \text{modulation frequency}$ , i.e. at least three periods of the AF signal are recorded.

The mean carrier power for calculating the AM is also calculated with a digital filter. The filter returns stable results after a measurement time of  $\geq 3 \times 1 / \text{modulation frequency}$ , i.e. at least three cycles of the AF signal must be recorded before a stable AM can be shown.

## 4.4 AF triggers

The Analog Modulation Analysis application allows triggering to the demodulated signal. The display is stable if a minimum of five modulation periods are within the recording time.

Triggering is always DC-coupled. Therefore triggering is possible directly to the point where a specific carrier level, phase or frequency is exceeded or not attained.

## 4.5 AF filters

Additional filters applied after demodulation help filter out unwanted signals, or correct pre-emphasized input signals. A CCITT filter allows you to evaluate the signal by simulating the characteristics of human hearing.

## 4.6 Time domain zoom

For evaluations in the time domain, the demodulated data for a particular time span can be extracted and displayed in more detail using the "Time Domain Zoom" function. Zooming is useful if the measurement time is very large and thus each sweep point represents a large time span. The time domain zoom function distributes the available sweep points only among the time span defined by the zoom area length. The time span displayed per division of the diagram is decreased. Thus, the display of the extracted time span becomes more precise.

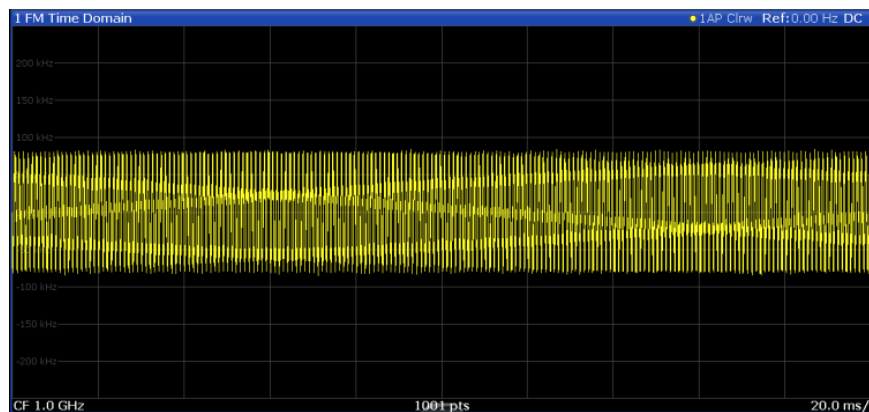

Figure 4-2: FM time domain measurement with a very long measurement time (200 ms)

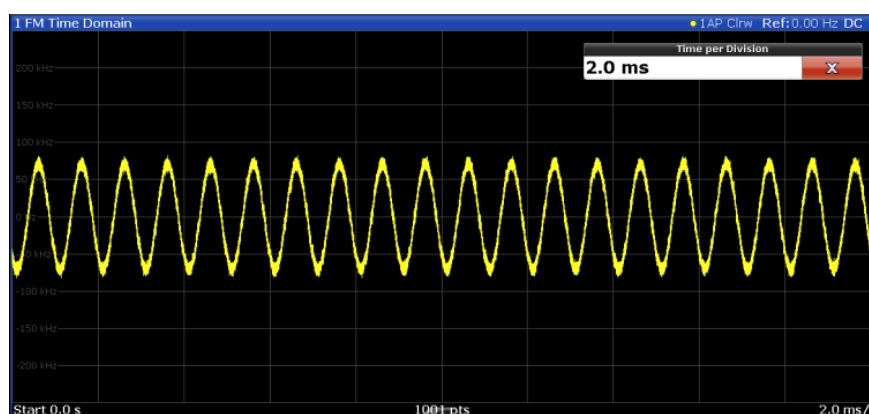
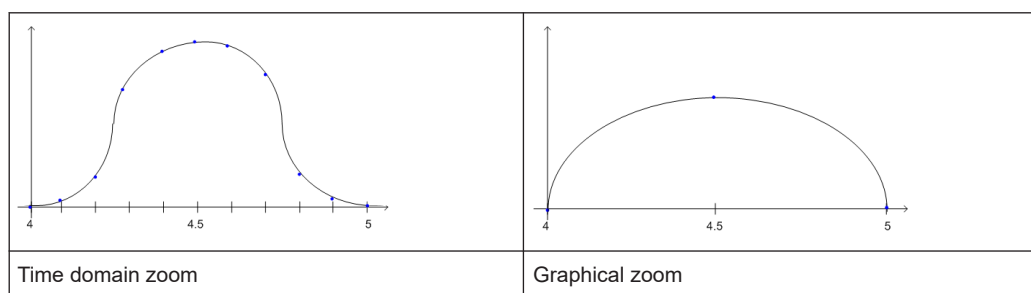
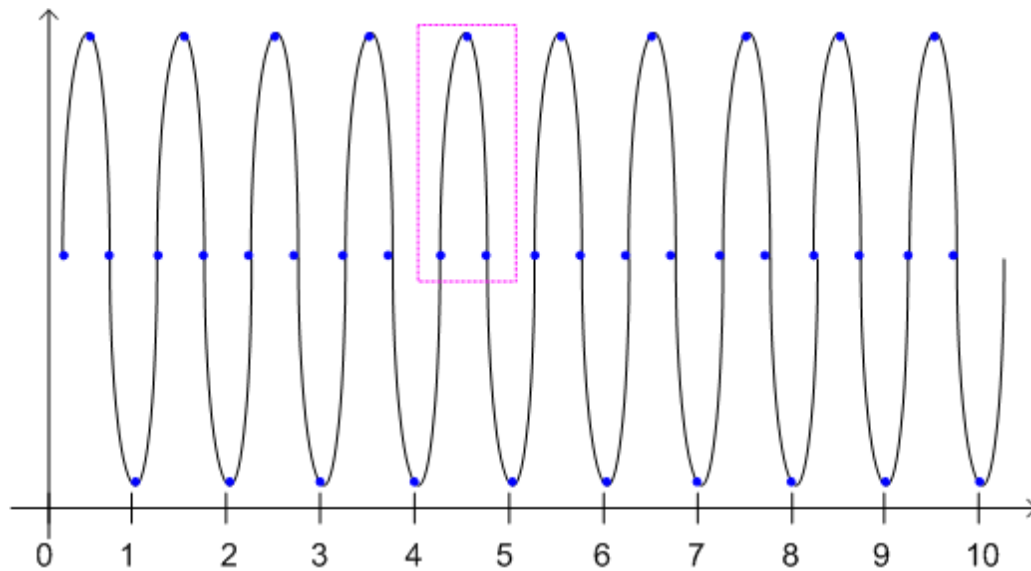

Figure 4-3: FM time domain measurement with time domain zoom (2.0 ms per division)

The time domain zoom area affects not only the diagram display, but the entire evaluation for the current window.

In contrast to the time domain zoom, the graphical zoom is available for all diagram evaluations. However, the graphical zoom is useful only if more measured values than trace points are available. The (time) span represented by each measurement point remains the same.



## 5 Configuration

**Access:** [MODE] > "Analog Demod"

Analog Modulation Analysis requires a special application on the R&S ZNL.

When you activate an R&S FPL1-K7 AM/FM/PM Modulation Analysis application the first time, a set of parameters is passed on from the currently active application. After initial setup, the parameters for the channel setup are stored upon exiting and restored upon re-entering the channel setup. Thus, you can switch between applications quickly and easily.

When you activate the R&S FPL1-K7 AM/FM/PM Modulation Analysis application, Analog Modulation Analysis for the input signal is started automatically with the default configuration. The "Analog Demod" menu is displayed and provides access to the most important configuration functions.

The remote commands required to perform these tasks are described in [Chapter 11, "Remote commands for AM/FM/PM Modulation Analysis"](#), on page 113.

### Predefined settings

For commonly performed measurements, standard setup files are provided for quick and easy configuration. Simply load an existing standard settings file and, if necessary, adapt the measurement settings to your specific requirements.

For an overview of predefined standards and settings see [Chapter A, "Predefined standards and settings"](#), on page 269.

- [Configuration overview](#).....31
- [Configuration according to standards](#)..... 33
- [Input and frontend settings](#).....35
- [Trigger configuration](#)..... 42
- [Data acquisition](#).....45
- [Demodulation display](#).....50
- [Demodulation](#)..... 50
- [Output settings](#)..... 69
- [Adjusting settings automatically](#)..... 69

### 5.1 Configuration overview



**Access:** "Meas Config" > "Overview"

Using the R&S FPL1-K7 AM/FM/PM Modulation Analysis application you can perform Analog Modulation Analysis using predefined standard setting files, or independently of standards using user-defined measurement settings. Such settings can be stored for recurrent use.

Thus, configuring AM/FM/PM Modulation Analysis measurements requires one of the following tasks:

- Selecting an existing standard settings file and, if necessary, adapting the measurement settings to your specific requirements.
- Configuring the measurement settings and, if necessary, storing the settings in a file.

### "Overview" window

Throughout the channel setup configuration, an overview of the most important currently defined settings is provided in the "Overview".

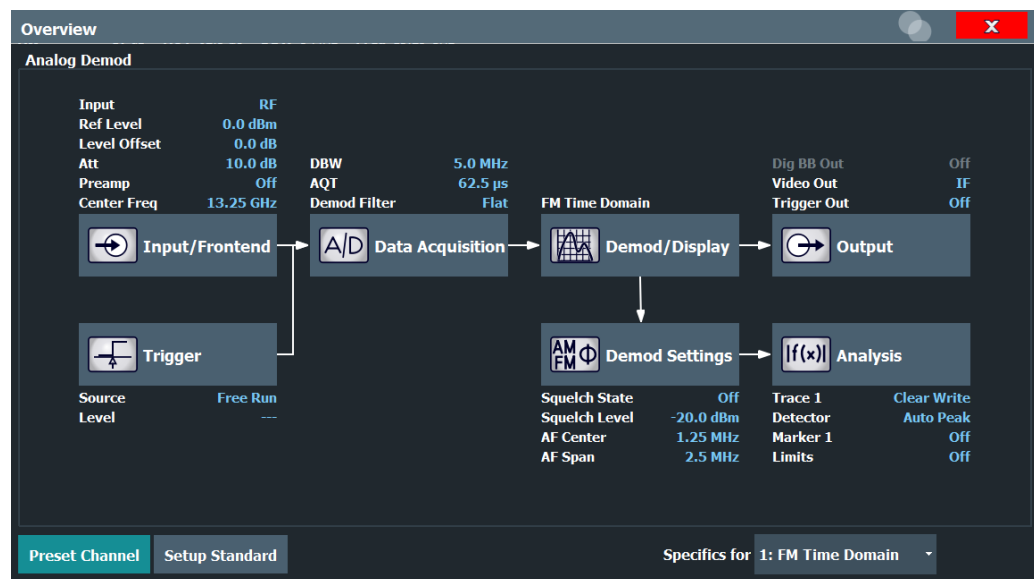

In addition to the main measurement settings, the "Overview" provides quick access to the main settings dialog boxes. The individual configuration steps are displayed in the order of the data flow. In particular, the "Overview" provides quick access to the following configuration dialog boxes (listed in the recommended order of processing):

1. Input/Frontend  
See [Chapter 5.3, "Input and frontend settings"](#), on page 35
2. Trigger  
See [Chapter 5.4, "Trigger configuration"](#), on page 42
3. Data Acquisition  
See [Chapter 5.5, "Data acquisition"](#), on page 45
4. Demod/Display  
See [Chapter 5.6, "Demodulation display"](#), on page 50
5. Demodulation Settings  
See [Chapter 5.7, "Demodulation"](#), on page 50
6. Analysis  
See [Chapter 6, "Analysis"](#), on page 73



## 7. (Optionally:) Outputs

See [Chapter 5.8, "Output settings"](#), on page 69

**To configure settings**

- ▶ Select any button in the "Overview" to open the corresponding dialog box.  
Select a setting in the channel setup bar (at the top of the channel setup tab) to change a specific setting.

**Preset Channel Setup**

Select the "Preset Channel" button in the lower left-hand corner of the "Overview" to restore all measurement settings *in the current channel setup* to their default values.

**Note:** Do not confuse the "Preset Channel" button with the [Preset] key, which restores the entire instrument to its default values and thus closes *all channel setups* on the R&S ZNL (except for the default channel setup)!

Remote command:

`SYSTem:PRESet:CHANnel [:EXEC]` on page 122

**Setup Standard**

Opens a file selection dialog box to select a predefined setup file. See "[Setup Standard](#)" on page 34.

**Specifics for**

The channel setup can contain several windows for different results. Thus, the settings indicated in the "Overview" and configured in the dialog boxes vary depending on the selected window.

Select an active window from the "Specifics for" selection list that is displayed in the "Overview" and in all window-specific configuration dialog boxes.

The "Overview" and dialog boxes are updated to indicate the settings for the selected window.

## 5.2 Configuration according to standards

**Access:** "Overview" > "Setup Standard"

Various predefined settings files for common standards are provided for use with the R&S FPL1-K7 AM/FM/PM Modulation Analysis application. In addition, you can create your own settings files for user-specific measurements.

For details on which settings are defined and an overview of predefined standards see [Chapter A, "Predefined standards and settings"](#), on page 269.

Setup Standard .....	34
L <a href="#">Selecting Storage Location - Drive/ Path/ Files</a> .....	34
L <a href="#">File name</a> .....	34
L <a href="#">Load Standard</a> .....	35

↳ <a href="#">Save Standard</a> .....	35
↳ <a href="#">Delete Standard</a> .....	35
↳ <a href="#">Restore Standard Files</a> .....	35

### Setup Standard

Opens a file selection dialog box to select a predefined setup file. The predefined settings are configured in the R&S FPL1-K7 AM/FM/PM Modulation Analysis application, which allows for quick and easy configuration for commonly performed measurements.

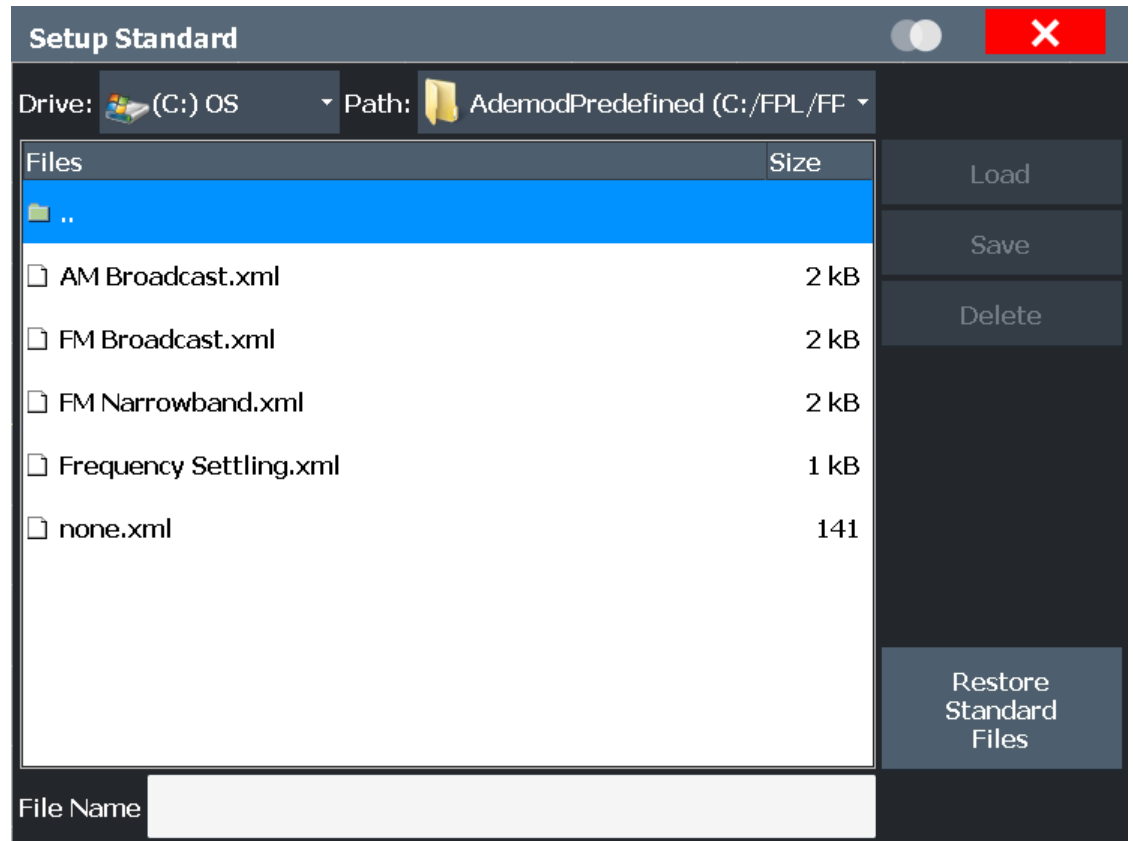

### Selecting Storage Location - Drive/ Path/ Files ← Setup Standard

Select the storage location of the file on the instrument or an external drive.

The default storage location for the settings files is:

C:\Users\Public\Documents\Rohde-Schwarz\ZNL\user\predefined\  
AdemodPredefined.

### File name ← Setup Standard

Contains the name of the data file without the path or extension.

File names must be compatible with the Windows conventions for file names. In particular, they must not contain special characters such as ":", "\*", "?".

For details on the filename and location, see the "Data Management" topic in the R&S ZNL User Manual.

**Load Standard ← Setup Standard**

Loads the selected measurement settings file.

Remote command:

[SENSe:]ADEMod:PRESet[:STANdard] on page 123

**Save Standard ← Setup Standard**

Saves the current measurement settings for a specific standard as a file with the defined name.

Remote command:

[SENSe:]ADEMod:PRESet:STORe on page 123

**Delete Standard ← Setup Standard**

Deletes the selected standard. Standards predefined by Rohde & Schwarz can also be deleted. A confirmation query is displayed to avoid unintentional deletion of the standard.

**Note:** Restoring predefined standard files. The standards predefined by Rohde & Schwarz available at the time of delivery can be restored using the "Restore Standard Files" function (see "Restore Standard Files" on page 35).

**Restore Standard Files ← Setup Standard**

Restores the standards predefined by Rohde & Schwarz available at the time of delivery.

Note that this function overwrites customized standards that have the same name as predefined standards.

Remote command:

[SENSe:]ADEMod:PRESet:RESTore on page 123

## 5.3 Input and frontend settings

**Access:** "Overview" > "Input/Frontend"

The source and characteristics of the input signal to be demodulated are configured in the "Input/Frontend Settings" dialog box.

Power sensor settings are described in the R&S ZNL User Manual.

- [Radio frequency input](#)..... 35
- [Amplitude settings](#)..... 37
- [Frequency](#)..... 41

### 5.3.1 Radio frequency input

**Access:** "Overview" > "Input" > "Input Source" > "RadioFrequency"

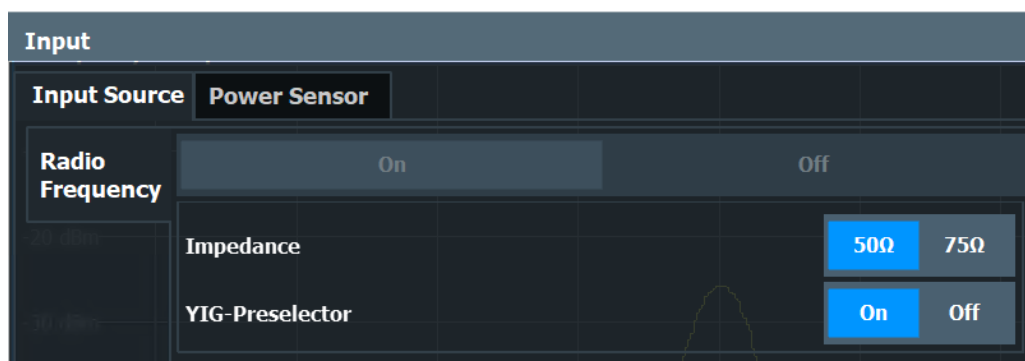

### RF Input Protection

The RF input connector of the R&S ZNL must be protected against signal levels that exceed the ranges specified in the data sheet. Therefore, the R&S ZNL is equipped with an overload protection mechanism. This mechanism becomes active as soon as the power at the input mixer exceeds the specified limit. It ensures that the connection between RF input and input mixer is cut off.

When the overload protection is activated, an error message is displayed in the status bar ( "INPUT OVLD" ), and a message box informs you that the RF input was disconnected. Furthermore, a status bit (bit 3) in the `STAT:QUES:POW` status register is set. In this case, you must decrease the level at the RF input connector and then close the message box. Then measurement is possible again. Reactivating the RF input is also possible via the remote command `INPut<ip>:ATTenuation:PROTection:RESet`.



The power sensor functions are described in the R&S ZNL User Manual.

<a href="#">Radio Frequency State</a> .....	36
<a href="#">Impedance</a> .....	36
<a href="#">YIG-Preselector</a> .....	37

### Radio Frequency State

Activates input from the "RF Input" connector.

Remote command:

`INPut<ip>:SELEct` on page 125

### Impedance

For some measurements, the reference impedance for the measured levels of the R&S ZNL can be set to 50 Ω or 75 Ω.

Select 75 Ω if the 50 Ω input impedance is transformed to a higher impedance using a 75 Ω adapter of the RAZ type. (That corresponds to 25Ω in series to the input impedance of the instrument.) The correction value in this case is 1.76 dB = 10 log (75Ω/50Ω).

This value also affects the unit conversion (see "Reference Level" on page 38).

Remote command:

`INPut<ip>:IMPedance` on page 124

### YIG-Preselector

Enables or disables the YIG-preselector.

This setting requires the option R&S FPL1-B11 on the R&S ZNL.

This option is only available for models R&S ZNL14 and R&S ZNL20.

An internal YIG-preselector at the input of the R&S ZNL ensures that image frequencies are rejected. However, image rejection is only possible for a restricted bandwidth. To use the maximum bandwidth for signal analysis you can disable the YIG-preselector at the input of the R&S ZNL. However, disabling the YIG-preselector can lead to image-frequency display.

**Note:** Note that the YIG-preselector is active only on frequencies greater than 6 GHz. Therefore, switching the YIG-preselector on or off has no effect if the frequency is below that value.

For measurements that require I/Q analysis in large bandwidths at frequencies higher than 6 GHz, it is strongly recommended that you disable the YIG-preselector.

Remote command:

`INPut<ip>:FILTer:YIG[:STATe]` on page 124

## 5.3.2 Amplitude settings

**Access:** "Overview" > "Input/Frontend" > "Amplitude"

Amplitude settings determine how the R&S ZNL must process or display the expected input power levels.

Configuring amplitude settings allows you to:

- Adapt the instrument hardware to the expected maximum signal level by setting the [Reference Level](#) to this maximum
- Consider an external attenuator or preamplifier (using the "Offset").
- Optimize the SNR of the measurement for low signal levels by configuring the [Reference Level](#) as high as possible without introducing compression, clipping or overload. Use early amplification by the preamplifier and a low attenuation.
- Optimize the SNR for high signal levels and ensure that the instrument hardware is not damaged, using high attenuation and AC coupling (for DC input voltage).
- Adapt the reference impedance for power results when measuring in a 75-Ohm system by connecting an external matching pad to the RF input.

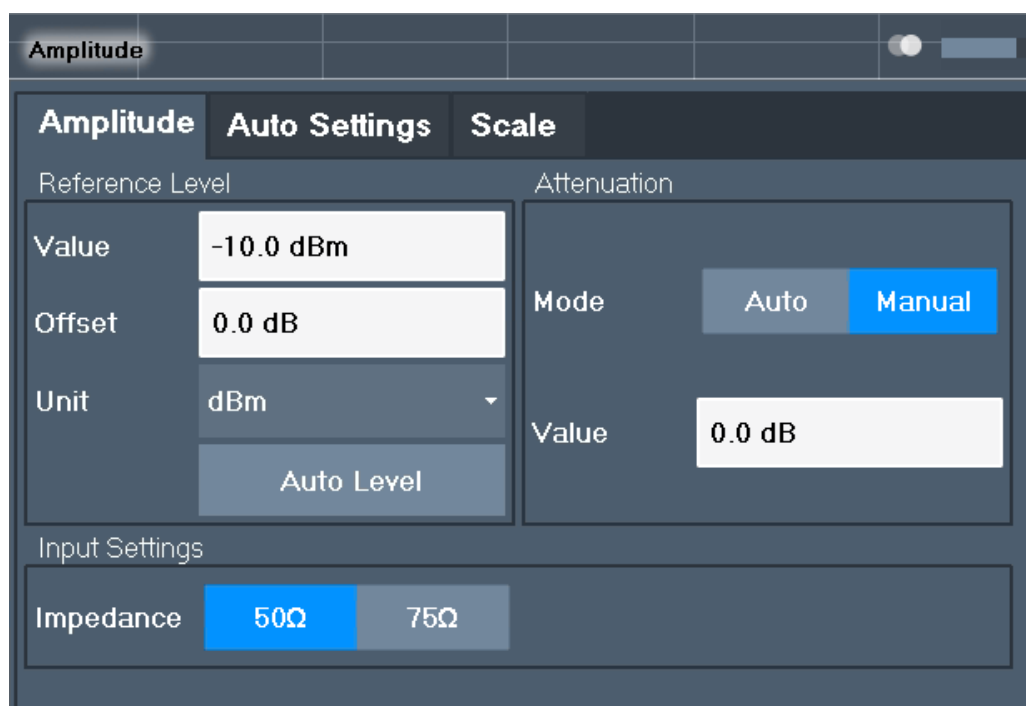

Reference Level .....	38
└ Shifting the Display (Offset).....	38
└ Unit.....	39
└ Setting the Reference Level Automatically ( Auto Level ).....	39
Attenuation Mode / Value .....	40
Attenuation Mode / Value .....	40
Impedance .....	40

### Reference Level

Defines the expected maximum reference level. Signal levels above this value are possibly not measured correctly. Signals above the reference level are indicated by an "IF Overload" status display.

The reference level can also be used to scale power diagrams; the reference level is then used for the calculation of the maximum on the y-axis.

Since the hardware of the R&S ZNL is adapted according to this value, it is recommended that you set the reference level close above the expected maximum signal level. Thus you ensure an optimal measurement (no compression, good signal-to-noise ratio).

Remote command:

`DISPlay[:WINDow<n>][:SUBWindow<w>]:TRACe<t>:Y[:SCALe]:RLEVel`  
on page 130

### Shifting the Display (Offset) ← Reference Level

Defines an arithmetic level offset. This offset is added to the measured level. In some result displays, the scaling of the y-axis is changed accordingly.

Define an offset if the signal is attenuated or amplified before it is fed into the R&S ZNL so the application shows correct power results. All displayed power level results are shifted by this value.

The setting range is  $\pm 200$  dB in 0.01 dB steps.

Note, however, that the *internal* reference level (used to adjust the hardware settings to the expected signal) ignores any "Reference Level Offset". Thus, it is important to keep in mind the actual power level the R&S ZNL must handle. Do not rely on the displayed reference level (internal reference level = displayed reference level - offset).

Remote command:

`DISPlay[:WINDow<n>][:SUBWindow<w>]:TRACe<t>:Y[:SCALe]:RLEVel:OFFSet` on page 130

### Unit ← Reference Level

The R&S ZNL measures the signal voltage at the RF input.

In the default state, the level is displayed at a power level of 1 mW (= dBm). Via the known input impedance (50  $\Omega$  or 75  $\Omega$ , see "[Impedance](#)" on page 36), conversion to other units is possible.

The following units are available and directly convertible:

- dBm
- dBmV
- dB $\mu$ V
- dB $\mu$ A
- dBpW
- Volt
- Ampere
- Watt

Remote command:

`INPut<ip>:IMPedance` on page 124

`CALCulate<n>:UNIT:POWer` on page 129

### Setting the Reference Level Automatically ( Auto Level ) ← Reference Level

Automatically determines a reference level which ensures that no overload occurs at the R&S ZNL for the current input data. At the same time, the internal attenuators are adjusted. As a result, the signal-to-noise ratio is optimized, while signal compression and clipping are minimized.

To determine the required reference level, a level measurement is performed on the R&S ZNL.

If necessary, you can optimize the reference level further. Decrease the attenuation level manually to the lowest possible value before an overload occurs, then decrease the reference level in the same way.

You can change the measurement time for the level measurement if necessary (see "[Changing the Automatic Measurement Time \( MeasTimeManual \)](#)" on page 71).

Remote command:

`[SENSe:]ADJust:LEVel` on page 166

**Attenuation Mode / Value**

Defines the attenuation applied to the RF input of the R&S ZNL.

The RF attenuation can be set automatically as a function of the selected reference level (Auto mode). Automatic attenuation ensures that no overload occurs at the RF Input connector for the current reference level. It is the default setting.

In "Manual" mode, you can set the RF attenuation in 10 dB steps down to 0 dB. Other entries are rounded to the next integer value. The range is specified in the data sheet. If the defined reference level cannot be set for the defined RF attenuation, the reference level is adjusted accordingly and the warning "limit reached" is displayed.

**NOTICE!** Risk of hardware damage due to high power levels. When decreasing the attenuation manually, ensure that the power level does not exceed the maximum level allowed at the RF input, as an overload can lead to hardware damage.

Remote command:

[INPut<ip>:ATTenuation](#) on page 131

[INPut<ip>:ATTenuation:AUTO](#) on page 131

**Attenuation Mode / Value**

Defines the attenuation applied to the RF input of the R&S ZNL.

The RF attenuation can be set automatically as a function of the selected reference level (Auto mode). Automatic attenuation ensures that no overload occurs at the RF Input connector for the current reference level. It is the default setting.

In "Manual" mode, you can set the RF attenuation in 10 dB steps down to 0 dB. Other entries are rounded to the next integer value. The range is specified in the data sheet. If the defined reference level cannot be set for the defined RF attenuation, the reference level is adjusted accordingly and the warning "limit reached" is displayed.

**NOTICE!** Risk of hardware damage due to high power levels. When decreasing the attenuation manually, ensure that the power level does not exceed the maximum level allowed at the RF input, as an overload can lead to hardware damage.

Remote command:

[INPut<ip>:ATTenuation](#) on page 131

[INPut<ip>:ATTenuation:AUTO](#) on page 131

**Impedance**

For some measurements, the reference impedance for the measured levels of the R&S ZNL can be set to 50  $\Omega$  or 75  $\Omega$ .

Select 75  $\Omega$  if the 50  $\Omega$  input impedance is transformed to a higher impedance using a 75  $\Omega$  adapter of the RAZ type. (That corresponds to 25 $\Omega$  in series to the input impedance of the instrument.) The correction value in this case is 1.76 dB = 10 log (75 $\Omega$ /50 $\Omega$ ).

This value also affects the unit conversion (see " [Reference Level](#) " on page 38).

Remote command:

[INPut<ip>:IMPedance](#) on page 124



### 5.3.3 Frequency

Access: "Overview" > "Input/Frontend" > "Frequency" tab

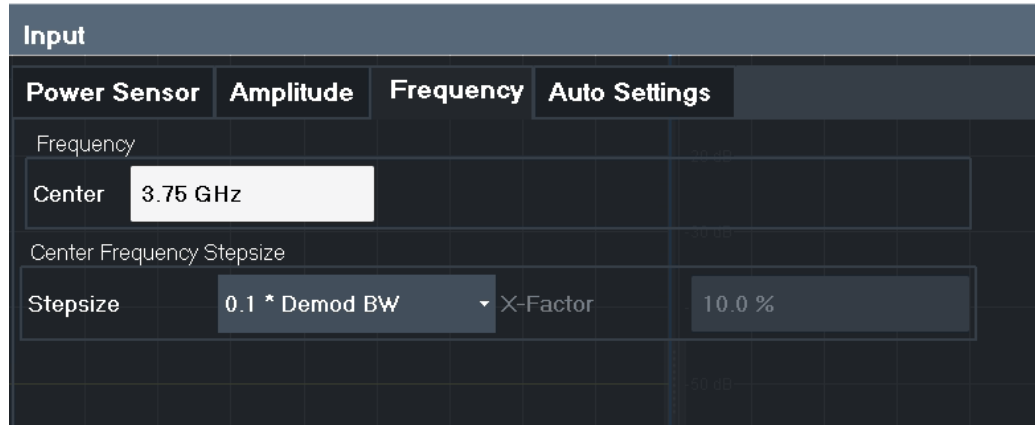

Center Frequency.....	41
Center Frequency Stepsize .....	41

#### Center Frequency

Defines the center frequency of the signal in Hertz.

The allowed range of values for the center frequency depends on the frequency span.

$$\text{span} > 0: \text{span}_{\min}/2 \leq f_{\text{center}} \leq f_{\text{max}} - \text{span}_{\min}/2$$

$f_{\text{max}}$  and  $\text{span}_{\min}$  depend on the instrument and are specified in the data sheet.

Remote command:

[SENSe:] FREQuency:CENTer on page 127

#### Center Frequency Stepsize

Defines the step size of the center frequency. The step size can be coupled to the demodulation bandwidth, or you can set it to a fixed value manually.

"0.1 * Demod BW"	(default:) Sets the step size for the center frequency to 10 % of the demodulation bandwidth.
"0.5 * Demod BW"	Sets the step size for the center frequency to 50 % of the demodulation bandwidth.
"X * Demod BW"	Sets the step size for the center frequency to a manually defined factor of the demodulation bandwidth. The "X-Factor" defines the percentage of the demodulation bandwidth. Values between 1 % and 100 % in steps of 1 % are allowed. The default setting is 10 %.
"= Center"	Sets the step size to the value of the center frequency and removes the coupling of the step size to the demodulation bandwidth. The used value is indicated in the "Value" field.
"Manual"	Defines a fixed step size for the center frequency. Enter the step size in the "Value" field.

Remote command:

[SENSe:] FREQuency:CENTer:STEP:LINK on page 128

[SENSe:] FREQuency:CENTer:STEP:LINK:FACTor on page 128

[SENSe:] FREQuency:CENTer:STEP on page 127

## 5.4 Trigger configuration

**Access:** "Overview" > "Trigger"

Triggering means to capture the interesting part of the signal. Choosing the right trigger type and configuring all trigger settings correctly allows you to detect various incidents in your demodulated signals.

Optionally, the trigger signal used by the R&S ZNL can be output to a connected device, and an external trigger signal from a connected device can be used by the R&S ZNL.

Trigger settings are identical to the base unit, except for the available trigger sources. Gating is not available for Analog Modulation Analysis.

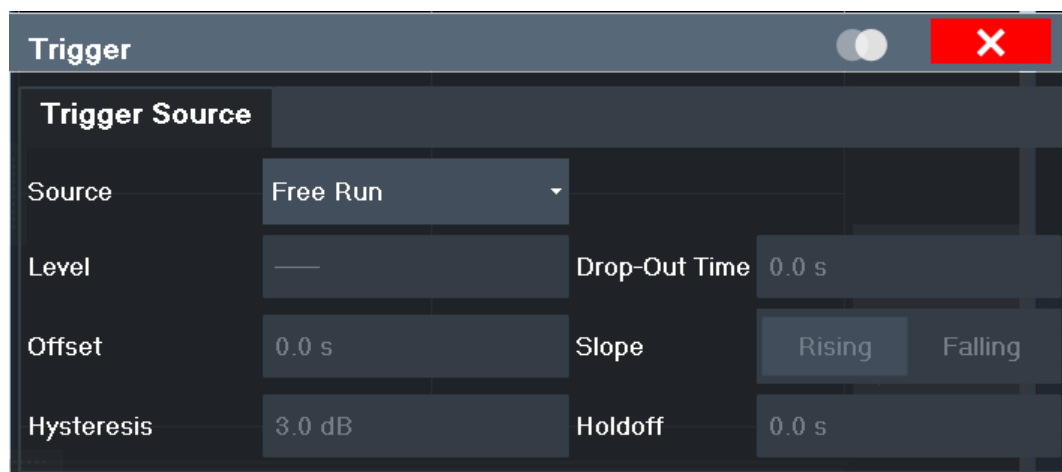

- [Trigger source settings](#).....42

### 5.4.1 Trigger source settings

**Access:** "Overview" > "Trigger" > "Trigger Source" tab

Trigger Source .....	43
L Free Run.....	43
L ExternalTrigger 1 .....	43
L IF Power .....	43
L FM(Offline) / AM(Offline) / PM(Offline) / RF(Offline) .....	43
L Time.....	44
Trigger Level .....	44
Repetition Interval .....	44

Trigger Offset .....	44
Hysteresis .....	44
Drop-Out Time .....	45
Slope .....	45
Trigger Holdoff .....	45

### Trigger Source

In the R&S FPL1-K7 AM/FM/PM Modulation Analysis application, the next measurement can be triggered if the selected input signal exceeds the threshold specified using the "Trigger Level" setting (see "Trigger Level" on page 44). Thus, a periodic signal modulated onto the carrier frequency can be displayed. It is recommended that the measurement time covers at least five periods of the audio signal.

Remote command:

TRIGger [:SEquence] :SOURce on page 142

### Free Run ← Trigger Source

No trigger source is considered. Data acquisition is started manually or automatically and continues until stopped explicitly.

Remote command:

TRIG:SOUR IMM, see TRIGger [:SEquence] :SOURce on page 142

### ExternalTrigger 1 ← Trigger Source

Data acquisition starts when the TTL signal fed into the trigger input connector of the R&S ZNL meets or exceeds the specified trigger level.

(See "Trigger Level" on page 44).

Remote command:

TRIG:SOUR EXT

See TRIGger [:SEquence] :SOURce on page 142

### IF Power ← Trigger Source

The R&S ZNL starts capturing data as soon as the trigger level is exceeded around the third intermediate frequency.

For frequency sweeps, the third IF represents the start frequency. The trigger threshold depends on the defined trigger level, as well as on the RF attenuation and preamplification. A reference level offset, if defined, is also considered. The trigger bandwidth at the intermediate frequency depends on the RBW and sweep type. For details on available trigger levels and trigger bandwidths, see the instrument data sheet.

For measurements on a fixed frequency (e.g. zero span or I/Q measurements), the third IF represents the center frequency.

This trigger source is only available for RF input.

For details on available trigger levels and trigger bandwidths, see the data sheet.

Remote command:

TRIG:SOUR IFP, see TRIGger [:SEquence] :SOURce on page 142

### FM(Offline) / AM(Offline) / PM(Offline) / RF(Offline) ← Trigger Source

Triggers when the demodulated input signal exceeds the trigger level.

Remote command:

[TRIGger\[:SEquence\]:SOURce](#) on page 142

### Time ← Trigger Source

Triggers in a specified repetition interval.

See "[Repetition Interval](#)" on page 44.

Remote command:

TRIG:SOUR TIME, see [TRIGger\[:SEquence\]:SOURce](#) on page 142

### Trigger Level

Defines the trigger level for the specified trigger source.

For details on supported trigger levels, see the instrument data sheet.

Remote command:

[TRIGger\[:SEquence\]:LEVel:IFPower](#) on page 140

[TRIGger\[:SEquence\]:LEVel:IQPower](#) on page 141

[TRIGger\[:SEquence\]:LEVel\[:EXternal<port>\]](#) on page 140

[TRIGger\[:SEquence\]:LEVel:AM:RELative](#) on page 141

[TRIGger\[:SEquence\]:LEVel:AM\[:ABSolute\]](#) on page 141

[TRIGger\[:SEquence\]:LEVel:FM](#) on page 141

[TRIGger\[:SEquence\]:LEVel:PM](#) on page 142

### Repetition Interval

Defines the repetition interval for a time trigger.

Set the repetition interval to the exact pulse period, burst length, frame length or other repetitive signal characteristic. If the required interval cannot be set with the available granularity, configure a multiple of the interval that can be set. Thus, the trigger remains synchronized to the signal.

Remote command:

[TRIGger\[:SEquence\]:TIME:RINTerval](#) on page 143

### Trigger Offset

Defines the time offset between the trigger event and the start of the sweep.

Offset > 0:	Start of the sweep is delayed
Offset < 0:	Sweep starts earlier (pretrigger)

For the "Time" trigger source, this function is not available.

Remote command:

[TRIGger\[:SEquence\]:HOLDoff\[:TIME\]](#) on page 139

### Hysteresis

Defines the distance in dB to the trigger level that the trigger source must exceed before a trigger event occurs. Setting a hysteresis avoids unwanted trigger events caused by noise oscillation around the trigger level.

This setting is only available for "IF Power" trigger sources. The range of the value is between 3 dB and 50 dB with a step width of 1 dB.

Remote command:

[TRIGger\[:SEQuence\]:IFPower:HYSteresis](#) on page 140

### Drop-Out Time

Defines the time that the input signal must stay below the trigger level before triggering again.

Remote command:

[TRIGger\[:SEQuence\]:DTIME](#) on page 139

### Slope

For all trigger sources except time, you can define whether triggering occurs when the signal rises to the trigger level or falls down to it.

Remote command:

[TRIGger\[:SEQuence\]:SLOPe](#) on page 142

### Trigger Holdoff

Defines the minimum time (in seconds) that must pass between two trigger events. Trigger events that occur during the holdoff time are ignored.

Remote command:

[TRIGger\[:SEQuence\]:IFPower:HOLDoff](#) on page 139

## 5.5 Data acquisition

**Access:** "Overview" > "Data Acquisition"

You configure how data is acquired and then demodulated in the "Data Acquisition" dialog box.

- [Bandwidth settings](#).....45
- [Sweep settings](#).....47

### 5.5.1 Bandwidth settings

**Access:** "Overview" > "Data Acquisition" > "Bandwidth" tab

The bandwidth settings define which parts of the input signal are acquired and then demodulated.

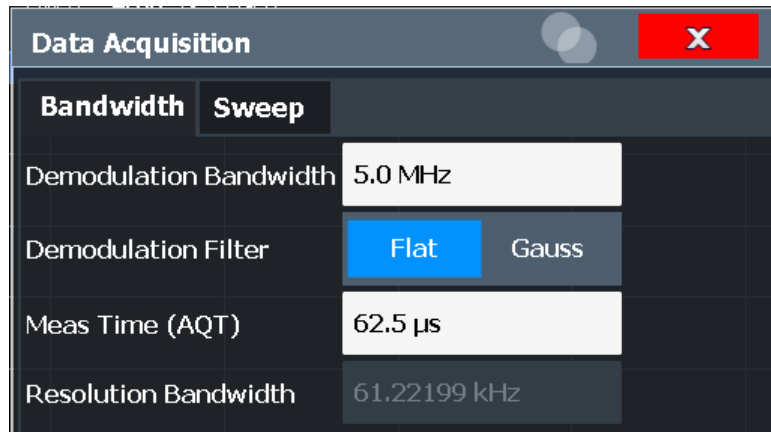

Demodulation Bandwidth .....	46
Demodulation Filter .....	46
Measurement Time (AQT).....	46
Resolution Bandwidth .....	46

### Demodulation Bandwidth

Defines the demodulation bandwidth of the measurement. The demodulation bandwidth determines the sample rate with which the input signal is captured and analyzed.

For recommendations on finding the correct demodulation bandwidth, see [Chapter 4.2, "Demodulation bandwidth"](#), on page 26.

Remote command:

`[SENSe:] BWIDth:DEMod` on page 136

### Demodulation Filter

Defines the filter to be used for demodulation.

For details on sample rates, measurement times and trigger offsets for various demodulation bandwidths when using a Gaussian filter, see [Chapter 4.3, "Sample rate and demodulation bandwidth"](#), on page 27.

"Flat"                    Default

"Gauss"                 Optimizes the settling behavior of the filter

Remote command:

`[SENSe:] BWIDth:DEMod:TYPE` on page 137

### Measurement Time (AQT)

Defines how long data is acquired for demodulation.

Remote command:

`[SENSe:] ADEMod:MTIME` on page 135

### Resolution Bandwidth

Defines the resolution bandwidth for data acquisition. The available range is specified in the data sheet.

Remote command:

`[SENSe:] BANDwidth[:RESolution]` on page 137

## 5.5.2 Sweep settings

**Access:** "Overview" > "Data Acquisition" > "Sweep" tab

The sweep settings define how often data from the input signal is acquired and then demodulated.

The screenshot shows the 'Data Acquisition' configuration window with the 'Sweep' tab selected. The settings are as follows:

- Meas Time (AQT): 62.5 µs
- Sweep Points: 1001
- Sweep Count: 0
- Select Frame: 0
- Continue Frame: Off (highlighted in blue)
- Frame Count: 1
- Spectrogram Clear button
- Specifics for: 1: FM Time Domain

Continuous Sweep / Run Cont .....	47
Single Sweep / Run Single .....	48
ContinueSingleSweep .....	48
Measurement Time (AQT).....	48
Sweep Points.....	48
Sweep/Average Count .....	49
Select Frame.....	49
Continue Frame .....	49
Frame Count .....	49
Clear Spectrogram .....	50

### Continuous Sweep / Run Cont

While the measurement is running, the "Continuous Sweep" softkey and the [RUN CONT] key are highlighted. The running measurement can be aborted by selecting the highlighted softkey or key again. The results are not deleted until a new measurement is started.

**Note:** Sequencer. If the Sequencer is active, the "Continuous Sweep" softkey only controls the sweep mode for the currently selected channel setup. However, the sweep

mode only takes effect the next time the Sequencer activates that channel setup, and only for a channel-defined sequence. In this case, a channel setup in continuous sweep mode is swept repeatedly.

Furthermore, the [RUN CONT] key controls the Sequencer, not individual sweeps. [RUN CONT] starts the Sequencer in continuous mode.

For details on the Sequencer, see the R&S ZNL User Manual.

Remote command:

`INITiate<n>:CONTInuous` on page 168

### Single Sweep / Run Single

After triggering, starts the number of sweeps set in "Sweep Count". The measurement stops after the defined number of sweeps has been performed.

While the measurement is running, the "Single Sweep" softkey and the [RUN SINGLE] key are highlighted. The running measurement can be aborted by selecting the highlighted softkey or key again.

**Note:** Sequencer. If the Sequencer is active, the "Single Sweep" softkey only controls the sweep mode for the currently selected channel setup. However, the sweep mode only takes effect the next time the Sequencer activates that channel setup, and only for a channel-defined sequence. In this case, the Sequencer sweeps a channel setup in single sweep mode only once.

Furthermore, the [RUN SINGLE] key controls the Sequencer, not individual sweeps. [RUN SINGLE] starts the Sequencer in single mode.

If the Sequencer is off, only the evaluation for the currently displayed channel setup is updated.

For details on the Sequencer, see the R&S ZNL User Manual.

Remote command:

`INITiate<n>[:IMMEDIATE]` on page 168

### ContinueSingleSweep

After triggering, repeats the number of sweeps set in "Sweep Count", without deleting the trace of the last measurement.

While the measurement is running, the "ContinueSingleSweep" softkey and the [RUN SINGLE] key are highlighted. The running measurement can be aborted by selecting the highlighted softkey or key again.

Remote command:

`INITiate<n>:CONMeas` on page 168

### Measurement Time (AQT)

Defines how long data is acquired for demodulation.

Remote command:

`[SENSe:]ADEMod:MTIME` on page 135

### Sweep Points

Defines the number of measured values to be collected during one sweep.

All values from 101 to 100001 can be set. The default value is 1001 sweep points.



Remote command:

[\[SENSe:\] SWEEp\[:WINDow<n>\]:POINTs](#) on page 138

### Sweep/Average Count

Defines the number of sweeps to be performed in the single sweep mode. Values from 0 to 200000 are allowed. If the values 0 or 1 are set, one sweep is performed.

The sweep count is applied to all the traces in all diagrams.

If the trace modes "Average", "Max Hold" or "Min Hold" are set, this value also determines the number of averaging or maximum search procedures.

In continuous sweep mode, if "Sweep Count" = 0 (default), averaging is performed over 10 sweeps. For "Sweep Count" = 1, no averaging, maxhold or minhold operations are performed.

Remote command:

[\[SENSe:\] SWEEp:COUNT](#) on page 137

[\[SENSe:\] AVERAge<n>:COUNT](#) on page 203

### Select Frame

Selects a specific frame, loads the corresponding trace from the memory, and displays it in the Spectrum window.

Note that activating a marker or changing the position of the active marker automatically selects the frame that belongs to that marker.

This function is only available in single sweep mode or if the sweep is stopped, and only if a spectrogram is selected.

The most recent frame is number 0, all previous frames have a negative number.

For more details, see the R&S ZNL User Manual.

Remote command:

[CALCulate<n>:SPECTrogram:FRAME:SElect](#) on page 193

### Continue Frame

Determines whether the results of the previous sweeps are included in the analysis of the next sweeps for trace modes "Max Hold", "Min Hold", and "Average".

This function is available in single sweep mode only.

- **On**  
When the average or peak values are determined for the new sweep, the results of the previous sweeps in the spectrogram are also considered.
- **Off**  
The average or peak values are determined from the results of the newly swept frames only.

Remote command:

[CALCulate<n>:SPECTrogram:CONTInuous](#) on page 192

### Frame Count

Determines how many frames are plotted during a single sweep (as opposed to a continuous sweep). The maximum number of possible frames depends on the history depth (see " [History Depth](#) " on page 78).

Remote command:

[CALCulate<n>:SPECTrogram:FRAMe:COUNT](#) on page 192

### Clear Spectrogram

Resets the spectrogram result display and clears the history buffer.

This function is only available if a spectrogram is selected.

Remote command:

[CALCulate<n>:SPECTrogram:CLEAr\[:IMMediate\]](#) on page 192

## 5.6 Demodulation display



**Access:** "Overview" > "Demod/Display"

The demodulated signal can be displayed using various evaluation methods. All evaluation methods available for the Analog Modulation Analysis application are displayed in the evaluation bar in SmartGrid mode when you do one of the following:

Up to six evaluation methods can be displayed simultaneously in separate windows. The Analog Modulation Analysis evaluation methods are described in [Chapter 3, "Measurements and result displays"](#), on page 13.

## 5.7 Demodulation

**Access:** "Overview" > "Demod Settings"

**Or:** "Meas Setup" > "Demod"

- [Basic demodulation measurement parameters \(Demod\)](#).....50
- [Demodulation spectrum](#)..... 53
- [AF filter](#).....56
- [Scaling](#)..... 59
- [Units](#)..... 64
- [Result table settings](#).....64
- [Settling time](#)..... 67

### 5.7.1 Basic demodulation measurement parameters (Demod)

**Access:** "Overview" > "Demod Settings" > "Demod"

**Or:** "Meas Setup" > "Demod" > "Demod" tab

The basic demodulation measurement parameters define how the measurement is performed.

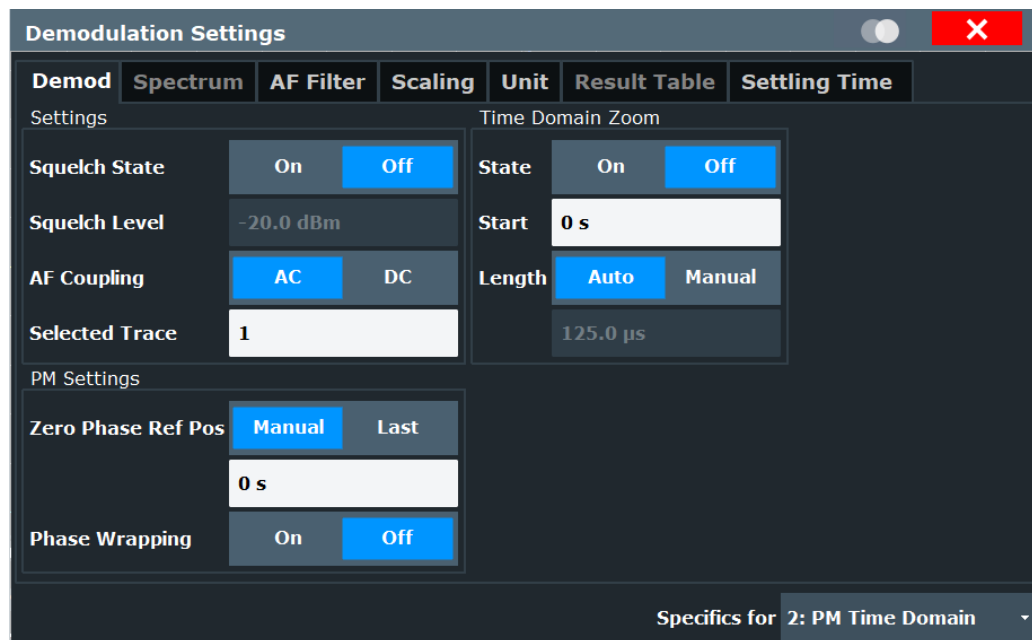

Squelch State .....	51
Squelch Level .....	51
AF Coupling .....	51
Selected Trace .....	52
Time Domain Zoom .....	52
L State .....	52
L Start .....	52
L Length .....	53
Zero Phase Reference Position (PM Time Domain only) .....	53
Phase Wrap On/Off (PM Time Domain only) .....	53

### Squelch State

Activates the squelch function, that is: if the signal falls below a defined threshold, the demodulated data is automatically set to 0. This is useful, for example, to avoid demodulation noise during transmission breaks.

This function is only available for FM demodulation.

Remote command:

[\[SENSe:\]ADEMod:SQUelch\[:STATe\]](#) on page 145

### Squelch Level

Defines the level threshold below which the demodulated data is set to 0 if squelching is enabled. The squelch level is an absolute value.

Remote command:

[\[SENSe:\]ADEMod:SQUelch:LEVel](#) on page 146

### AF Coupling

Controls the automatic correction of the frequency offset and phase offset of the input signal:

This function is only available for FM or PM time domain evaluations.

- **FM time evaluation**  
If DC is selected, the absolute frequency is displayed. That means, an input signal with an offset relative to the center frequency is not displayed symmetrically to the zero line.  
If AC is selected, the frequency offset is automatically corrected, i.e. the trace is always symmetric to the zero line.
- **PM time evaluation**  
If DC is selected, the phase runs according to the existing frequency offset. In addition, the DC signal contains a phase offset of  $\pm \pi$ .  
If AC is selected, the frequency offset and phase offset are automatically corrected, i.e. the trace is always symmetric to the zero line.

Remote command:

[\[SENSe:\]ADEMod<n>:AF:COUPling](#) on page 144

### Selected Trace

Defines the trace used to determine the results in the "Result Summary".

### Time Domain Zoom

Using the time domain zoom, the demodulated data for a particular time span is extracted and displayed in more detail. Time domain zoom is useful if the measurement time is very large and thus each sweep point represents a large time span. The time domain zoom function distributes the available sweep points only among the time span defined by the zoom area length. The time span displayed per division of the diagram is decreased. Thus, the display of the extracted time span becomes more precise. Note that the time domain zoom area affects not only the diagram display, but the entire evaluation for the current window.

This function is only available for evaluations in the time domain.

**Tip:** In addition to the Time Domain Zoom, a graphical zoom is available for all diagram evaluations. However, the graphical zoom is useful only if more measured values than trace points are available. The (time) span represented by each measurement point remains the same.

For details see the R&S ZNL User Manual.

### State ← Time Domain Zoom

Activates or deactivates the time domain zoom mode.

- |       |  |
|-------|--|
| "On"  | Activates the time domain zoom.  |
| "Off" | Deactivates the time domain zoom and restores the original display. If more measured values than measurement points are available, several measured values are combined in one measurement point according to the method of the selected trace detector. |

Remote command:

[\[SENSe:\]ADEMod<n>:ZOOM\[:STATe\]](#) on page 148

### Start ← Time Domain Zoom

Defines the start time for the time domain zoom area. For spectrum evaluations, the start time is always 0.

Remote command:

[SENSe:]ADEMod<n>:ZOOM:START on page 147

### Length ← Time Domain Zoom

Defines the length of the time domain zoom area. Enter the length as a time value manually, or use the "Auto" setting to set the length to the current number of sweep points automatically.

Remote command:

[SENSe:]ADEMod<n>:ZOOM:LENGTh on page 147

[SENSe:]ADEMod<n>:ZOOM:LENGTh:MODE on page 147

### Zero Phase Reference Position (PM Time Domain only)

Defines the position in time at which the phase of the PM-demodulated signal is set to 0 rad. In the default setting, the time of the first measured value is set to 0 rad. You can define a different position manually, or select the time of the last measured value as the reference position. The time of the last measured value corresponds to the acquisition time, considering the trigger event and trigger offset, if applicable. If the acquisition time or the trigger values are changed, the reference position is automatically adapted.

This setting is only available for PM time domain displays with DC coupling.

Remote command:

[SENSe:]ADEMod:PM:RPOint[:X] on page 144

[SENSe:]ADEMod:PM:RPOint[:X]:MODE on page 145

### Phase Wrap On/Off (PM Time Domain only)

Activates/deactivates the phase wrap.

On	The phase is displayed in the range $\pm 180^\circ$ ( $\pm \Pi$ ). For example, if the phase exceeds $+180^\circ$ , $360^\circ$ is subtracted from the phase value, with the display thus showing $>-180^\circ$ .
Off	The phase is not wrapped.

This setting is only available for PM time domain displays with DC coupling.

Remote command:

CALC:FORM PHAS/CALC:FORM UPH, see CALCulate<n>:FORMat on page 146

## 5.7.2 Demodulation spectrum

**Access:** "Overview" > "Demod Settings" > "Spectrum"

**Or:** "Meas Setup" > "Demod" > "Spectrum" tab

The demodulation spectrum defines which span of the demodulated data is evaluated.

Depending on the evaluation (AF or RF display), the settings vary.

- [AF evaluation](#)..... 54
- [RF evaluation](#)..... 55

### 5.7.2.1 AF evaluation

**Access:** "Overview" > "Demod Settings" > "Spectrum"

**Or:** "Meas Setup" > "Demod" > "Spectrum" tab

These settings are only available for AF Spectrum evaluations, not in the time domain.

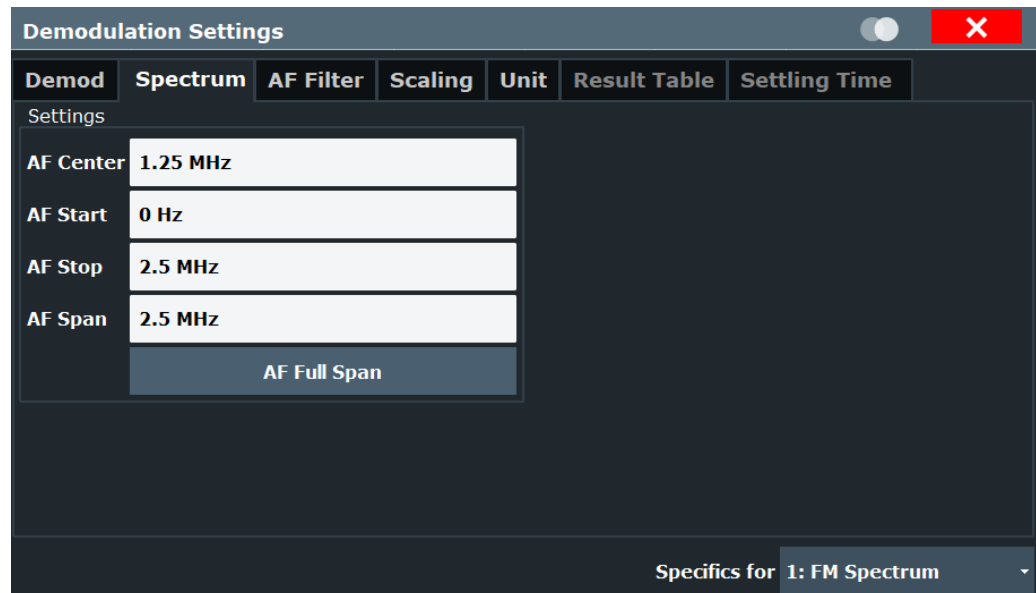

AF Center .....	54
AF Start .....	54
AF Stop .....	54
AF Span .....	55
AF Full Span .....	55

#### AF Center

Defines the center frequency of the demodulated data to evaluate.

Remote command:

[SENSe:]ADEMod:AF:CENTer on page 149

#### AF Start

Defines the start frequency of the demodulated data to evaluate.

Remote command:

[SENSe:]ADEMod:AF:START on page 149

#### AF Stop

Defines the stop frequency of the demodulated data to evaluate.

The maximum AF stop frequency corresponds to half the demodulation bandwidth.

Remote command:

[SENSe:]ADEMod:AF:STOP on page 150

**AF Span**

Defines the span (around the center frequency) of the demodulated data to evaluate. The maximum span is DBW/2.

Remote command:

[SENSe:]ADEMod:AF:SPAN on page 149

**AF Full Span**

Sets the span (around the center frequency) of the demodulated data to the maximum of DBW/2.

Remote command:

[SENSe:]ADEMod:AF:SPAN:FULL on page 149

**5.7.2.2 RF evaluation**

**Access:** "Overview" > "Demod Settings" > "Spectrum"

**Or:** "Meas Setup" > "Demod" > "Spectrum" tab

These settings are only available for RF evaluation, both in time and frequency domain. Note that for RF data the center frequency and demodulation bandwidth correspond to the settings defined in the "Input" and "Data Acquisition" configuration.

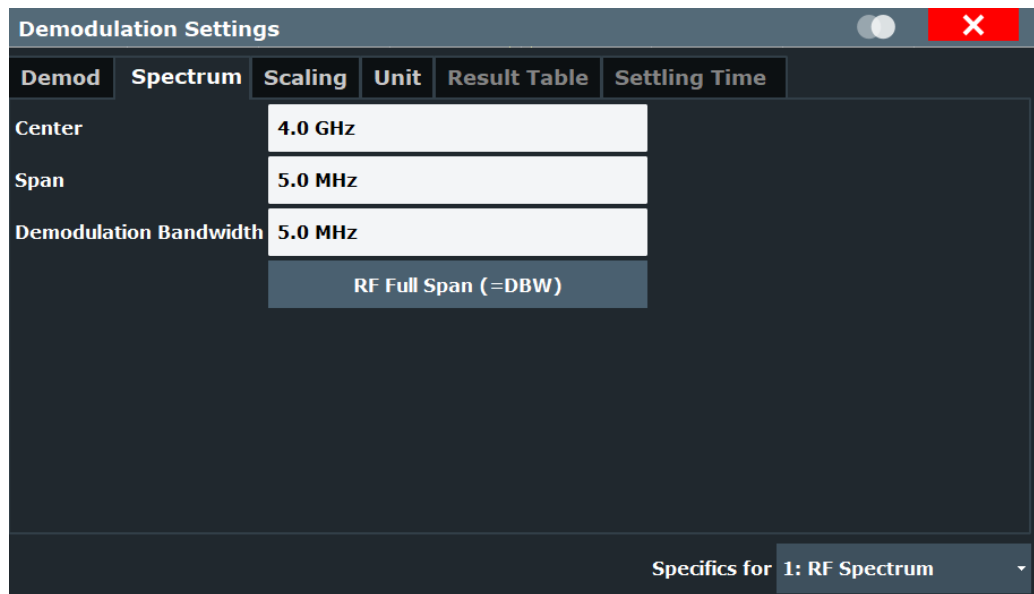

Center Frequency..... 55

Span.....56

Demodulation Bandwidth ..... 56

RF Full Span..... 56

**Center Frequency**

Defines the center frequency of the signal in Hertz.

The allowed range of values for the center frequency depends on the frequency span.

$$\text{span} > 0: \text{span}_{\text{min}}/2 \leq f_{\text{center}} \leq f_{\text{max}} - \text{span}_{\text{min}}/2$$

$f_{\max}$  and  $\text{span}_{\min}$  depend on the instrument and are specified in the data sheet.

Remote command:

[SENSe:] FREQuency:CENTer on page 127

### Span

Defines the frequency span. The center frequency is kept constant. The following range is allowed:

span = 0: 0 Hz

span >0:

$\text{span}_{\min} \leq f_{\text{span}} \leq f_{\max}$

and  $f_{\max} = \text{DBW}/2$

$f_{\max}$  and  $\text{span}_{\min}$  are specified in the data sheet.

Remote command:

[SENSe:] ADEMod:SPECTrum:SPAN[:MAXimum] on page 151

[SENSe:] ADEMod:SPECTrum:SPAN:ZOOM on page 150

### Demodulation Bandwidth

Defines the demodulation bandwidth of the measurement. The demodulation bandwidth determines the sample rate with which the input signal is captured and analyzed.

For recommendations on finding the correct demodulation bandwidth, see [Chapter 4.2, "Demodulation bandwidth"](#), on page 26.

Remote command:

[SENSe:] BWIDth:DEMod on page 136

### RF Full Span

Sets the span (around the center frequency) of the RF data to be evaluated to the demodulation bandwidth.

Remote command:

[SENSe:] ADEMod:SPECTrum:SPAN[:MAXimum] on page 151

## 5.7.3 AF filter

**Access:** "Overview" > "Demod Settings" > "AF Filter"

**Or:** "Meas Setup" > "Demod" > "AF Filter" tab

The AF filter reduces the evaluated bandwidth of the demodulated signal and can define a weighting function.



AF filters are only available for AF evaluations, not for RF evaluation.



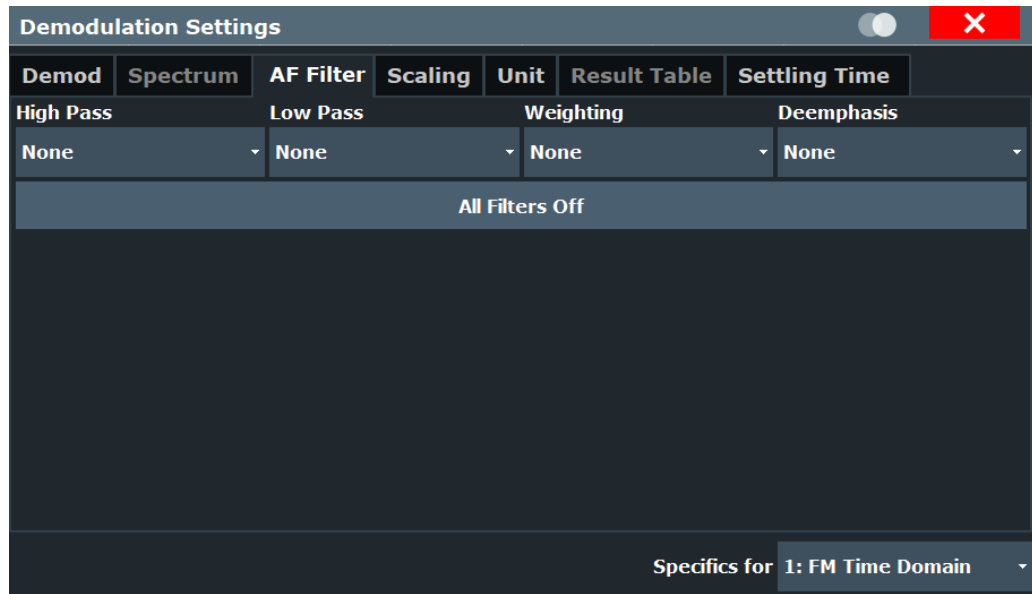

High Pass .....	57
Low Pass .....	57
Weighting .....	58
Deemphasis .....	59
Deactivating all AF Filters.....	59

### High Pass

Defines a high pass filter with the given limit to separate the DC component. The filters are indicated by the 3 dB cutoff frequency. The 50 Hz and 300 Hz filters are designed as 2nd-order Butterworth filter (12 dB/octave). The 20 Hz filter is designed as 3rd-order Butterworth filter (18 dB/octave).

The high pass filters are active in the following demodulation bandwidth range:

None	No AF Filter used (default)
20 Hz	$100 \text{ Hz} \leq \text{demodulation bandwidth} \leq 1.6 \text{ MHz}$
50 Hz:	$200 \text{ Hz} \leq \text{demodulation bandwidth} \leq 3 \text{ MHz}$
300 Hz:	$800 \text{ Hz} \leq \text{demodulation bandwidth} \leq 8 \text{ MHz}$
Manual:	A high pass filter with the manually defined frequency is used.

Remote command:

[SENSe:] FILTer<n>:HPASs[:STATe] on page 154

[SENSe:] FILTer<n>:HPASs:FREQuency[:ABSolute] on page 154

[SENSe:] FILTer<n>:HPASs:FREQuency:MANual on page 154

### Low Pass

Defines a low pass filter type. Relative and absolute low pass filter are available.

- Absolute low pass filters:

Absolute filters are indicated by the 3 dB cutoff frequency. The 3 kHz, 15 kHz and 23 kHz filters are designed as 5th-order Butterworth filters (30 dB/octave). The 150 kHz filter is designed as 8th-order Butterworth filter (48 dB/octave).

The absolute low pass filters are active in the following demodulation bandwidth range:

Filter type	Demodulation bandwidth
3 kHz:	$6.4 \text{ kHz} \leq \text{demodulation bandwidth} \leq 3 \text{ MHz}$
15 kHz:	$50 \text{ kHz} \leq \text{demodulation bandwidth} \leq 8 \text{ MHz}$
23 kHz	$50 \text{ kHz} \leq \text{demodulation bandwidth} \leq 18 \text{ MHz}$
150 kHz:	$400 \text{ kHz} \leq \text{demodulation bandwidth} \leq 8 \text{ MHz}$
Manual:	A low pass filter with the manually defined frequency is used.

- Relative low pass filters:  
Relative filters (3 dB) can be selected in % of the demodulation bandwidth. The filters are designed as 5th-order Butterworth filter (30 dB/octave) and active for all demodulation bandwidths.
- "NONE" deactivates the AF low pass filter (default).

Remote command:

[\[SENSe:\] FILTer<n>:LPASs\[:STATe\]](#) on page 156

[\[SENSe:\] FILTer<n>:LPASs:FREQuency\[:ABSolute\]](#) on page 155

[\[SENSe:\] FILTer<n>:LPASs:FREQuency:RELative](#) on page 155

[\[SENSe:\] FILTer<n>:LPASs:FREQuency:MANual](#) on page 155

### Weighting

Selects a weighting AF filter. By default, no weighting filter is active.

"A weighted"	Switches on the A weighted filter. The weighting filter is active in the following demodulation bandwidth range: $100 \text{ kHz} \leq \text{demodulation bandwidth} \leq 800 \text{ kHz}$
"CCITT"	Switches on a CCITT P.53 weighting filter. The weighting filter is active in the following demodulation bandwidth range: $20 \text{ kHz} \leq \text{demodulation bandwidth} \leq 3 \text{ MHz}$
"CCIR weighed"	Switches on the CCIR weighted filter. The weighting filter is active in the following demodulation bandwidth range: $100 \text{ kHz} \leq \text{demodulation bandwidth} \leq 3.0 \text{ MHz}$
"CCIR unweighted"	Switches on the CCIR unweighted filter, which is the combination of the 20 Hz highpass and 23 kHz low pass filter. The weighting filter is active in the following demodulation bandwidth range: $50 \text{ kHz} \leq \text{demodulation bandwidth} \leq 1.6 \text{ MHz}$

Remote command:

[\[SENSe:\] FILTer<n>:CCITt\[:STATe\]](#) on page 153

[\[SENSe:\] FILTer<n>:CCIR\[:UNWeighted\] \[:STATe\]](#) on page 152

[\[SENSe:\] FILTer<n>:CCIR:WEIGHTed\[:STATe\]](#) on page 152

[\[SENSe:\] FILTer<n>:AWEighted\[:STATe\]](#) on page 151

### Deemphasis

Activates a deemphasis filter with the given time constant.

Sometimes a modulated signal is extorted by a pre-emphasis filter before transmission, for example to eliminate frequencies that are more prone to interferences. In this case, the emphasis function must be reversed after demodulation, which is done by the deemphasis filter.

The deemphasis filter is active in the following demodulation bandwidth range:

25 $\mu$ s:	$25 \text{ kHz} \leq \text{demodulation bandwidth} \leq 40 \text{ MHz}$
50 $\mu$ s:	$6.4 \text{ kHz} \leq \text{demodulation bandwidth} \leq 18 \text{ MHz}$
75 $\mu$ s:	$6.4 \text{ kHz} \leq \text{demodulation bandwidth} \leq 18 \text{ MHz}$
750 $\mu$ s:	$800 \text{ Hz} \leq \text{demodulation bandwidth} \leq 3 \text{ MHz}$

Depending on the deemphasis filter, a minimum demodulation bandwidth is required for an error less than 0.5 dB, up to a maximum AF frequency. The following table shows the dependencies.

Deemphasis [ $\mu$ s]	25 $\mu$ s	50 $\mu$ s	75 $\mu$ s	750 $\mu$ s
Max. AF frequency	25 kHz	12 kHz	8 kHz	800 Hz
Required demodulation bandwidth	$\geq 200 \text{ kHz}$	$\geq 100 \text{ kHz}$	$\geq 50 \text{ kHz}$	$\geq 6.4 \text{ kHz}$

For higher AF frequencies, the demodulation bandwidth must be increased.

Remote command:

[\[SENSe:\] FILTer<n>:DEMPHasis\[:STATe\]](#) on page 153

[\[SENSe:\] FILTer<n>:DEMPHasis:TCONstant](#) on page 153

### Deactivating all AF Filters

The "All Filter Off" button deactivates all AF filters for the selected evaluation.

Remote command:

[\[SENSe:\] FILTer<n>:AOFF](#) on page 152

## 5.7.4 Scaling

**Access:** "Overview" > "Demod Settings" > "Scaling"

**Or:** "Meas Setup" > "Demod" > "Scaling" tab

The scaling parameters define the range of the demodulated data to be displayed.

- [AF evaluation](#)..... 59
- [RF evaluation](#)..... 62

### 5.7.4.1 AF evaluation

**Access:** "Overview" > "Demod Settings" > "Scaling"

**Or:** "Meas Setup" > "Demod" > "Scaling" tab

These settings are only available for AF evaluations.

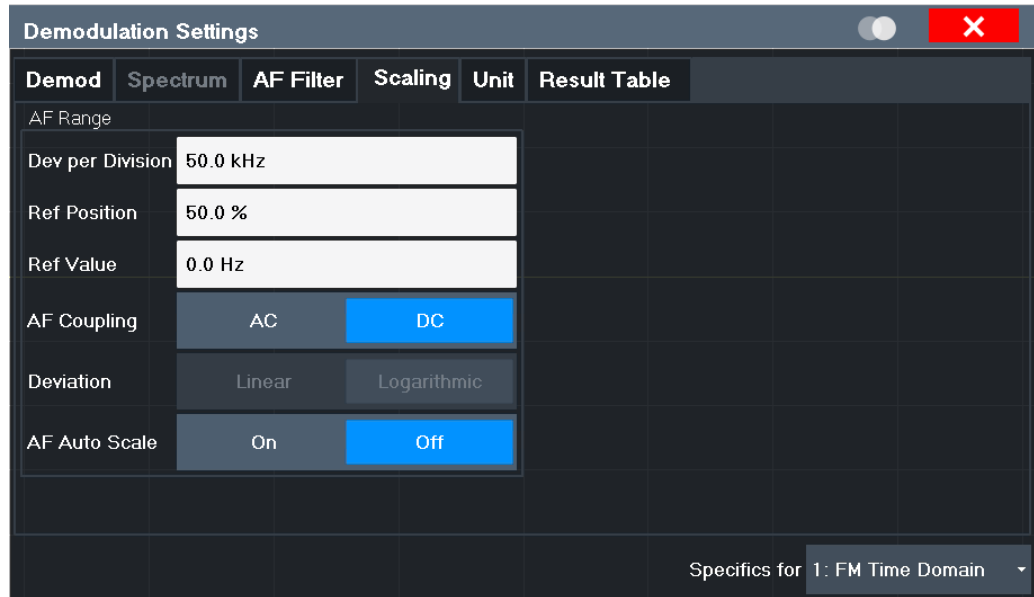

Dev per Division / dB per Division .....60  
 Reference Value Position.....60  
 Reference Value .....61  
 AF Coupling ..... 61  
 Deviation ..... 62  
 AF Auto Scale ..... 62

**Dev per Division / dB per Division**

Defines the modulation depth or the phase deviation or frequency deviation per division (logarithmic: 0.1 dB to 20 dB):

AM display:	0.0001 % to 1000 %
FM display:	
PM display:	0.0001 rad/div to 1000 rad/div

**Note:** The value defined per division refers to the default display of 10 divisions on the y-axis. If fewer divisions are displayed (e.g. because the window is reduced in height), the range per division is increased. Thus, the same result range is displayed in the smaller window. In this case, the per division value does not correspond to the actual display.

Remote command:

`DISPlay[:WINDow<n>] [:SUBWindow<w>]:TRACe<t>:Y[:SCALE]:PDIVision`  
 on page 133

**Reference Value Position**

Determines the position of the reference value for the modulation depth or the phase deviation or frequency deviation on the y-axis of the diagram.

The position is entered as a percentage of the diagram height with 100 % corresponding to the upper diagram border. The default setting is 50 % (diagram center) for the AF time evaluations and 100 % (upper diagram border) for the AF spectrum evaluations.

Remote command:

`DISPlay[:WINDow<n>][:SUBWindow<w>]:TRACe<t>:Y[:SCALe]:RPOSition`  
on page 133

### Reference Value

Determines the modulation depth or the phase deviation or the frequency deviation at the reference line of the y-axis. The reference value can be set specifically for each evaluation.

- AF time display  
The trace display takes individual frequency/phase offsets into account (in contrast, the **AF Coupling** setting permits automatic correction by the average frequency/phase offset of the signal, and therefore cannot be activated simultaneously).
- AF spectrum display  
In the default setting, the reference value defines the modulation depth or the FM/PM deviation at the upper diagram border.

Possible values:

- AM: 0 and  $\pm 10000$  %
- FM: 0 and  $\pm 10$  MHz
- PM: 0 and  $\pm 10000$  rad

**Note:** The reference value for the AF range in the **window title bar** is displayed with respect to the defined reference *position*. The position can vary for different windows. For time domain and frequency domain windows, for example, a different reference value can be displayed, although the same reference is actually used (but the positions vary).

Remote command:

`DISPlay[:WINDow<n>][:SUBWindow<w>]:TRACe<t>:Y[:SCALe]:RVALue`  
on page 157

### AF Coupling

Controls the automatic correction of the frequency offset and phase offset of the input signal:

This function is only available for FM or PM time domain evaluations.

- FM time evaluation  
If DC is selected, the absolute frequency is displayed. That means, an input signal with an offset relative to the center frequency is not displayed symmetrically to the zero line.  
If AC is selected, the frequency offset is automatically corrected, i.e. the trace is always symmetric to the zero line.
- PM time evaluation  
If DC is selected, the phase runs according to the existing frequency offset. In addition, the DC signal contains a phase offset of  $\pm \pi$ .  
If AC is selected, the frequency offset and phase offset are automatically corrected, i.e. the trace is always symmetric to the zero line.

Remote command:

[SENSe:]ADEMod<n>:AF:COUPling on page 144

**Deviation**

Switches between logarithmic and linear display of the modulation depth or the phase deviation or the frequency deviation.

Remote command:

DISPlay[:WINDow<n>][:SUBWindow<w>]:TRACe<t>:Y:SPACing on page 134

**AF Auto Scale**

Activates automatic scaling of the y-axis for AF measurements. RF power and RF spectrum measurements are not affected by the auto-scaling.

Remote command:

[SENSe:]ADJust:SCALE[:Y]:AUTO[:CONTinuous] on page 166

**5.7.4.2 RF evaluation**

**Access:** "Overview" > "Demod Settings" > "Scaling"

**Or:** "Meas Setup" > "Demod" > "Scaling" tab

These settings are only available for RF evaluations and the "result summary".

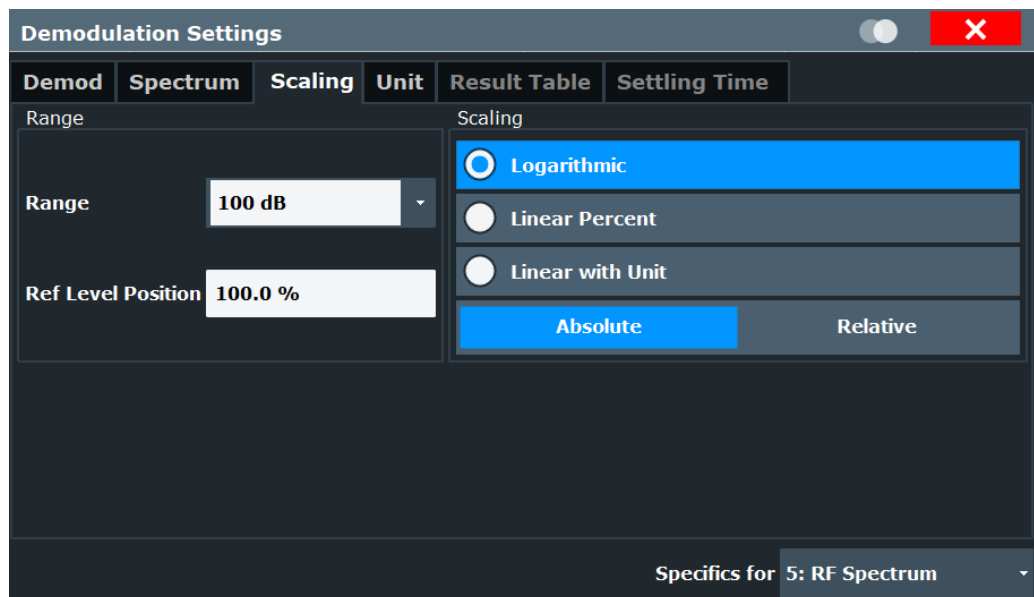

Range.....62  
 Ref Level Position ..... 63  
 Auto Scale Once ..... 63  
 Scaling..... 63

**Range**

Defines the displayed y-axis range in dB.

The default value is 100 dB.

For Analog Modulation Analysis measurements, time domain scaling is defined in Hz (default: 500 kHz).

Remote command:

`DISPlay[:WINDow<n>][:SUBWindow<w>]:TRACe<t>:Y[:SCALe]` on page 132

### Ref Level Position

Defines the reference level position, i.e. the position of the maximum AD converter value on the level axis in %.

0 % corresponds to the lower and 100 % to the upper limit of the diagram.

Values from -120 % to +600 % are available. Larger values are useful for small scales, such as a power range of 10 dB or 20 dB, and low signal levels, for example 60 dB below the reference level. In this case, large reference level position values allow you to see the trace again.

Only available for RF measurements.

Remote command:

`DISPlay[:WINDow<n>][:SUBWindow<w>]:TRACe<t>:Y[:SCALe]:RPOSition` on page 133

### Auto Scale Once

Automatically determines the optimal range and reference level position to be displayed for the current measurement settings.

The display is only set once; it is not adapted further if the measurement settings are changed again.

Remote command:

`DISPlay[:WINDow<n>][:SUBWindow<w>]:TRACe<t>:Y[:SCALe]:AUTO ONCE` on page 132

### Scaling

Defines the scaling method for the y-axis.

"Logarithmic"	Logarithmic scaling (only available for logarithmic units - dB..., and A, V, Watt)
"Linear with Unit"	Linear scaling in the unit of the measured signal
"Linear Percent"	Linear scaling in percentages from 0 to 100
"Absolute"	The labeling of the level lines refers to the absolute value of the reference level (not available for "Linear Percent" )
"Relative"	The scaling is in dB, relative to the reference level (only available for logarithmic units - dB...). The upper line of the grid (reference level) is always at 0 dB.

Remote command:

`DISPlay[:WINDow<n>][:SUBWindow<w>]:TRACe<t>:Y:SPACing` on page 134

`DISPlay[:WINDow<n>][:SUBWindow<w>]:TRACe<t>:Y[:SCALe]:MODE`

on page 132

### 5.7.5 Units

**Access:** "Overview" > "Demod Settings" > "Unit"

**Or:** "Meas Setup" > "Demod" > "Unit" tab

The units define how the demodulated data is displayed.

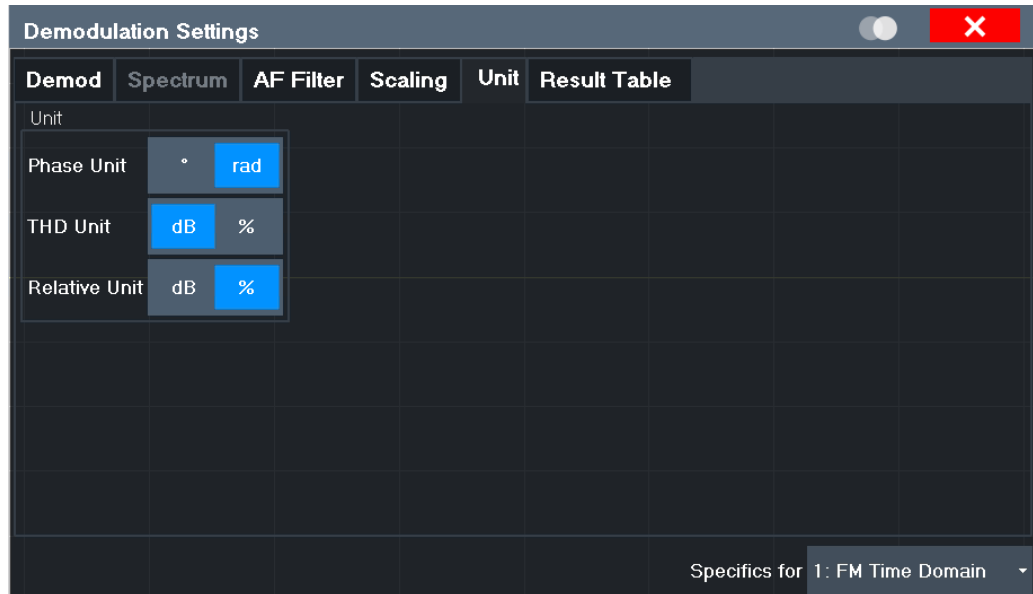

<a href="#">Phase Unit (Rad/Deg)</a> .....	64
<a href="#">THD Unit (%/ DB)</a> .....	64
<a href="#">Relative Unit</a> .....	64

#### Phase Unit (Rad/Deg)

Sets the phase unit to rad or deg for displaying PM signals.

Remote command:

[UNIT<n>:ANGLE](#) on page 158

#### THD Unit (%/ DB)

Sets the unit to percent or DB for the calculation of the THD (in the "Result Summary").

Remote command:

[UNIT<n>:THD](#) on page 158

#### Relative Unit

Defines the unit for relative demodulation results (see [Chapter 5.7.6, "Result table settings"](#), on page 64).

Remote command:

[CONFigure:ADEMod:RESults:UNIT](#) on page 161

### 5.7.6 Result table settings

**Access:** "Overview" > "Demod Settings" > "Result Table"



Or: "Meas Setup" > "Demod" > "Result Table" tab

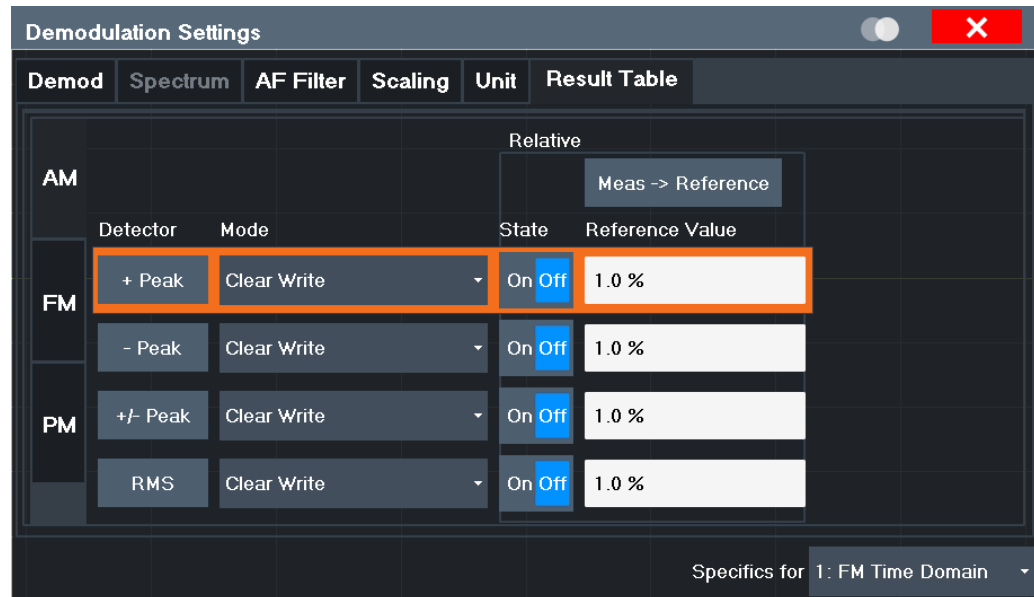

The demodulation results are displayed in the "Result Summary" table (see also "[Result Summary](#)" on page 21). The detectors used to determine the results can be configured.

In addition to common absolute demodulation, the R&S FPL1-K7 AM/FM/PM Modulation Analysis application also provides demodulation results relative to user-defined or measured reference values in the "Result Summary".

The settings for the "Result Summary" can be defined individually for the different modulation types (FM, AM, PM). For each modulation, a separate tab is provided in the dialog box.

Detector .....	65
Mode.....	65
State.....	66
Reference Value .....	66
Meas -> Reference .....	66

### Detector

Detector type for demodulation results

"+ Peak"	Positive peak
"- Peak"	Negative peak
"+/- Peak"	Autopick
"RMS"	Root mean square

Remote command:

The detector is specified by the DETector<det> suffix in

CONFigure:RELative:AM|FM|PM:DETector<det>... commands.

### Mode

Defines the mode with which the demodulation result is determined.

The modes are similar to those for the entire trace (see " [TraceMode](#) " on page 74).

- "Clear Write"      Overwrite mode: the detector value is overwritten by each sweep. This is the default setting.
- "Max Hold"        The maximum value is determined over several sweeps and displayed. The R&S ZNL saves each result only if the new value is greater than the previous one.
- "Average"         The average result is determined over all sweeps.

Remote command:

[CONFigure:ADEMod:RESults:AM:DETEctor<det>:MODE](#) on page 160

[CONFigure:ADEMod:RESults:FM:DETEctor<det>:MODE](#) on page 160

[CONFigure:ADEMod:RESults:PM:DETEctor<det>:MODE](#) on page 160

### State

Activates relative demodulation for the selected detector. If activated, the demodulated result is set in relation to the [Reference Value](#) .

Remote command:

[CONFigure:ADEMod:RESults:AM:DETEctor<det>:STATE](#) on page 159

[CONFigure:ADEMod:RESults:FM:DETEctor<det>:STATE](#) on page 159

[CONFigure:ADEMod:RESults:PM:DETEctor<det>:STATE](#) on page 159

### Reference Value

Defines the reference value to be used for relative demodulation results and recalculates the results. If necessary, the detector is activated.

**Note:** A reference value 0 would provide infinite results and is thus automatically corrected to 0.1.

Remote command:

[CONFigure:ADEMod:RESults:AM:DETEctor<det>:REFerence](#) on page 159

[CONFigure:ADEMod:RESults:FM:DETEctor<det>:REFerence](#) on page 159

[CONFigure:ADEMod:RESults:PM:DETEctor<det>:REFerence](#) on page 159

### Meas -> Reference

Sets the [Reference Value](#) to be used for relative demodulation results to the currently measured value *for all relative detectors*.

**Note:** A reference value 0 would provide infinite results and is thus automatically corrected to 0.1.

If necessary, the detectors are activated.

Remote command:

[CONFigure:ADEMod:RESults:AM:DETEctor<det>:REFerence:MEASStoref<t>](#)  
on page 160

[CONFigure:ADEMod:RESults:FM:DETEctor<det>:REFerence:MEASStoref<t>](#)  
on page 160

[CONFigure:ADEMod:RESults:PM:DETEctor<det>:REFerence:MEASStoref<t>](#)  
on page 160

### 5.7.7 Settling time

**Access:** "Overview" > "Demod Settings" > "Settling Time"

**Or:** "Meas Setup" > "Demod" > "Settling Time" tab

The settling time defines when the signal remains within a specified target corridor. The corridor is defined by the upper and lower settling limit. The function is available for all time domain displays.

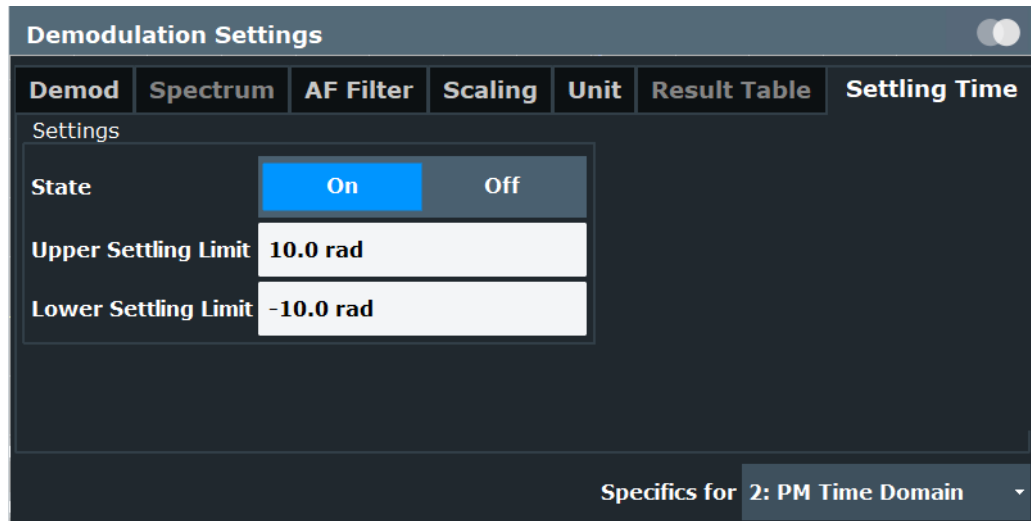

If enabled, the time is determined by evaluating the signal values from the end of the measurement. The last position at which the signal exceeds the corridor is the settling time. The settling time is defined with reference to the start of the data acquisition or the trigger event. A possible trigger offset is not considered.

The settling time is indicated by a temporary marker in the time domain diagram. The result is also indicated in the "result summary". The settling time is evaluated for each time domain window for the selected trace (see "[Selected Trace](#)" on page 52).

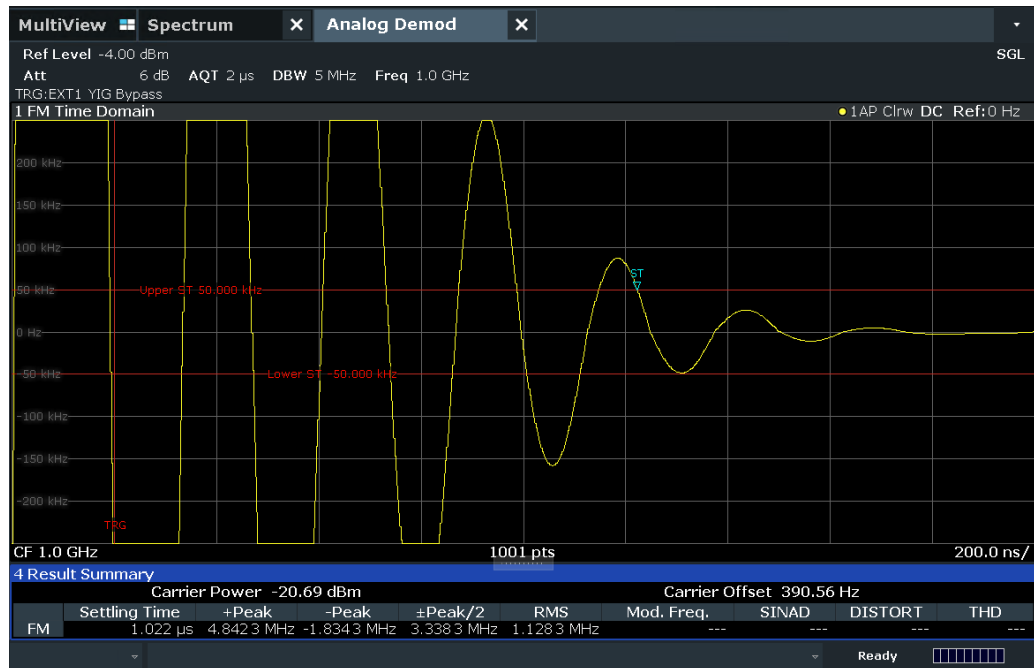

State.....68  
 Upper Settling Limit.....68  
 Lower Settling Limit.....68

**State**

Enables or disables the calculation and display of the settling time.

Remote command:

[SENSe:]ADEMod:SETTling:TIME:STATE on page 162

Result: [SENSe:]ADEMod:SETTling:TIME:RESult<t>? on page 187

**Upper Settling Limit**

Defines the upper limit of the settling time corridor. The value is defined with reference to the reference value, see also "Reference Value" on page 61 and "Zero Phase Reference Position (PM Time Domain only)" on page 53.

Remote command:

[SENSe:]ADEMod:SETTling:TIME:LIMit:UPPer on page 162

**Lower Settling Limit**

Defines the lower limit of the settling time corridor. The value is defined with reference to the reference value, see also "Reference Value" on page 61 and "Zero Phase Reference Position (PM Time Domain only)" on page 53.

Remote command:

[SENSe:]ADEMod:SETTling:TIME:LIMit:LOWer on page 161

## 5.8 Output settings

**Access:** "Overview" > "Output"

The R&S ZNL can provide signals to different output connectors.

For details on connectors, refer to the R&S ZNL Getting Started manual, "Front / Rear Panel View" chapters.

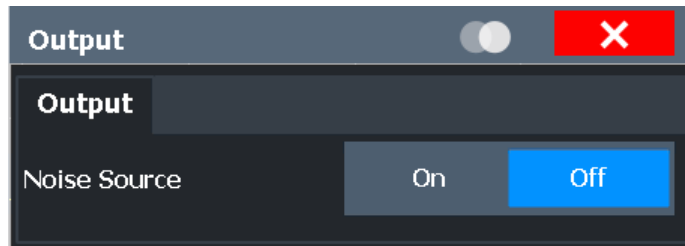

[Noise Source Control](#)..... 69

### Noise Source Control

Enables or disables the 28 V voltage supply for an external noise source connected to the "Noise source control / Power sensor") connector. By switching the supply voltage for an external noise source on or off in the firmware, you can enable or disable the device as required.

External noise sources are useful when you are measuring power levels that fall below the noise floor of the R&S ZNL itself, for example when measuring the noise level of an amplifier.

In this case, you can first connect an external noise source (whose noise power level is known in advance) to the R&S ZNL and measure the total noise power. From this value, you can determine the noise power of the R&S ZNL. Then when you measure the power level of the actual DUT, you can deduct the known noise level from the total power to obtain the power level of the DUT.

Remote command:

[DIAGnostic:SERVice:NSource](#) on page 126

## 5.9 Adjusting settings automatically

**Access:** "Overview" > "Amplitude"/"Frequency" > "Auto Settings"

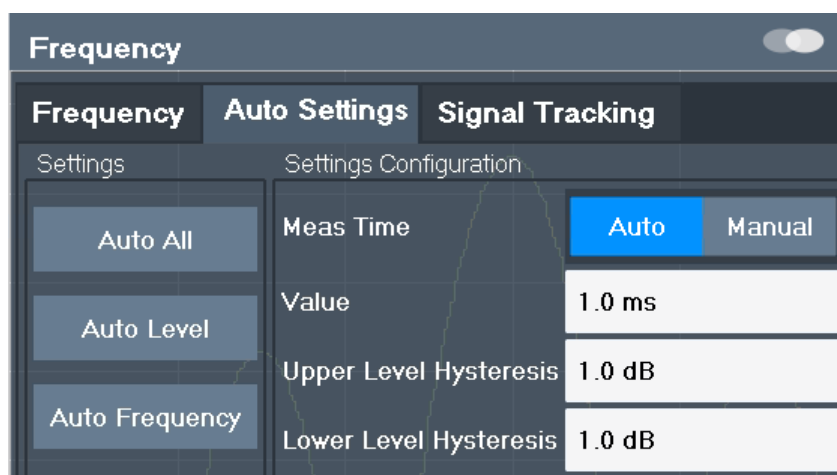

Some settings can be adjusted by the R&S ZNL automatically according to the current measurement settings. To do so, a measurement is performed. You can configure this measurement.



### Adjusting settings automatically during triggered measurements

When you select an auto adjust function, a measurement is performed to determine the optimal settings. If you select an auto adjust function for a triggered measurement, you are asked how you want the R&S ZNL to behave:

- (default:) The measurement for adjustment waits for the next trigger
- The measurement for adjustment is performed without waiting for a trigger. The trigger source is temporarily set to "Free Run". After the measurement is completed, the original trigger source is restored. The trigger level is adjusted as follows:
  - For IF Power and RF Power triggers:  
Trigger Level = Reference Level - 15 dB
  - For Video trigger:  
Trigger Level = 85 %

#### Remote command:

[\[SENSe:\]ADJust:CONFigure:TRIGger](#) on page 166

<a href="#">Adjusting all Determinable Settings Automatically ( Auto All )</a> .....	70
<a href="#">Adjusting the Center Frequency Automatically ( Auto Frequency )</a> .....	71
<a href="#">AF Auto Scale</a> .....	71
<a href="#">Setting the Reference Level Automatically ( Auto Level )</a> .....	71
<a href="#">Resetting the Automatic Measurement Time ( MeastimeAuto )</a> .....	71
<a href="#">Changing the Automatic Measurement Time ( MeastimeManual )</a> .....	71
<a href="#">Upper Level Hysteresis</a> .....	72
<a href="#">Lower Level Hysteresis</a> .....	72

### Adjusting all Determinable Settings Automatically ( Auto All )

Activates all automatic adjustment functions for the current measurement settings, including:

- [Auto Frequency](#)
- [Auto Level](#)
- [" AF Auto Scale "](#) on page 62

Remote command:

`[SENSe:]ADJust:ALL` on page 163

### **Adjusting the Center Frequency Automatically ( Auto Frequency )**

The R&S ZNL adjusts the center frequency automatically.

The optimum center frequency is the frequency with the highest S/N ratio in the frequency span. As this function uses the signal counter, it is intended for use with sinusoidal signals.

Remote command:

`[SENSe:]ADJust:FREQuency` on page 166

### **AF Auto Scale**

Activates automatic scaling of the y-axis for AF measurements. RF power and RF spectrum measurements are not affected by the auto-scaling.

Remote command:

`[SENSe:]ADJust:SCALe[:Y]:AUTO[:CONTInuous]` on page 166

### **Setting the Reference Level Automatically ( Auto Level )**

Automatically determines a reference level which ensures that no overload occurs at the R&S ZNL for the current input data. At the same time, the internal attenuators are adjusted. As a result, the signal-to-noise ratio is optimized, while signal compression and clipping are minimized.

To determine the required reference level, a level measurement is performed on the R&S ZNL.

If necessary, you can optimize the reference level further. Decrease the attenuation level manually to the lowest possible value before an overload occurs, then decrease the reference level in the same way.

You can change the measurement time for the level measurement if necessary (see "[Changing the Automatic Measurement Time \( MeastimeManual \)](#)" on page 71).

Remote command:

`[SENSe:]ADJust:LEVel` on page 166

### **Resetting the Automatic Measurement Time ( MeastimeAuto )**

Resets the measurement duration for automatic settings to the default value.

Remote command:

`[SENSe:]ADJust:CONFigure:LEVel:DURation:MODE` on page 164

### **Changing the Automatic Measurement Time ( MeastimeManual )**

This function allows you to change the measurement duration for automatic setting adjustments. Enter the value in seconds.

**Note:** The maximum measurement duration depends on the currently selected measurement and the installed (optional) hardware. Thus, the measurement duration

actually used to determine the automatic settings can be shorter than the value you define here.

Remote command:

[\[SENSe:\]ADJust:CONFigure:LEVel:DURation:MODE](#) on page 164

[\[SENSe:\]ADJust:CONFigure:LEVel:DURation](#) on page 164

### Upper Level Hysteresis

When the reference level is adjusted automatically using the [Auto Level](#) function, the internal attenuators are also adjusted. To avoid frequent adaptation due to small changes in the input signal, you can define a hysteresis. This setting defines an upper threshold that the signal must exceed (compared to the last measurement) before the reference level is adapted automatically.

Remote command:

[\[SENSe:\]ADJust:CONFigure:HYSTeresis:UPPer](#) on page 165

### Lower Level Hysteresis

When the reference level is adjusted automatically using the [Auto Level](#) function, the internal attenuators are also adjusted. To avoid frequent adaptation due to small changes in the input signal, you can define a hysteresis. This setting defines a lower threshold that the signal must fall below (compared to the last measurement) before the reference level is adapted automatically.

Remote command:

[\[SENSe:\]ADJust:CONFigure:HYSTeresis:LOWer](#) on page 165



## 6 Analysis

**Access:** "Overview" > "Analysis"

General result analysis settings concerning the trace, markers, lines etc. are identical to the analysis functions in the base unit except for the special marker functions.

For a description of the lines functionality, see the R&S ZNL User Manual.

The remote commands required to perform these tasks are described in [Chapter 11, "Remote commands for AM/FM/PM Modulation Analysis"](#), on page 113.

- [Trace settings](#).....73
- [Spectrogram settings](#).....76
- [Trace / data export configuration](#).....81
- [Working with markers in the R&S FPL1-K7 AM/FM/PM Modulation Analysis application](#).....84

### 6.1 Trace settings

**Access:** "Overview" > "Analysis" > "Traces"

Or: [TRACE] > Trace

You can configure the settings for up to 6 individual traces in the same result display. Each trace is displayed in a different color, indicated in the window title bar and the trace settings.



In the R&S FPL1-K7 AM/FM/PM Modulation Analysis application, when you configure the traces for a window with a specific evaluation (e.g. AM time domain), the traces in all windows with the same evaluation are configured identically.



Trace data can also be exported to an ASCII file for further analysis. For details see [Chapter 6.3, "Trace / data export configuration"](#), on page 81.

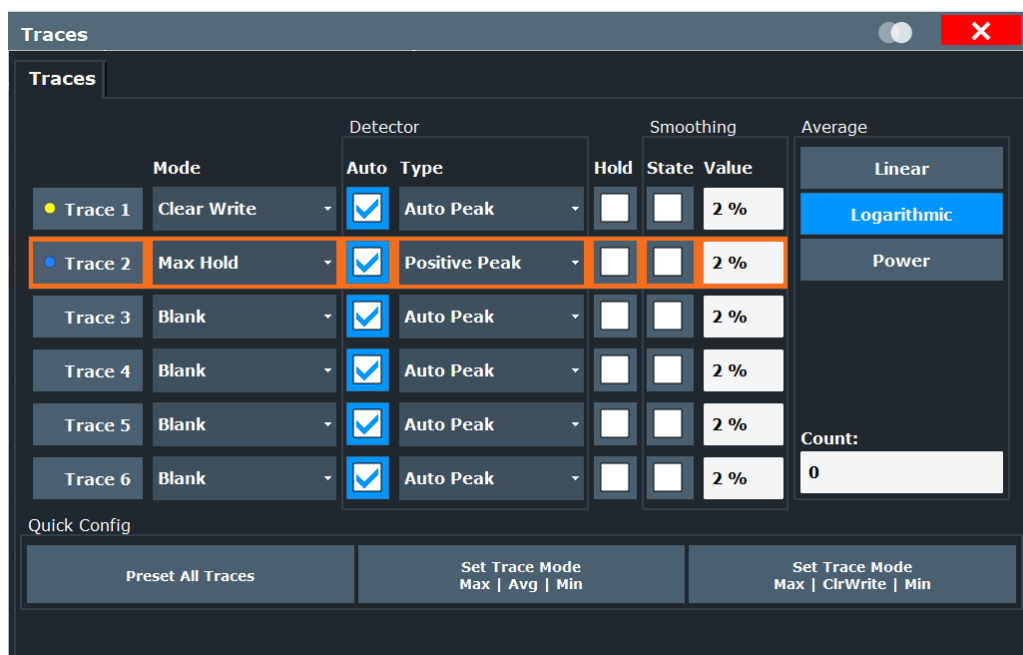

Trace 1 / Trace 2 / Trace 3 / Trace 4 / Trace 5 / Trace 6 .....74

TraceMode ..... 74

Detector .....75

Hold.....75

Average Mode .....75

Average Count ..... 76

Predefined Trace Settings - Quick Config .....76

Trace 1 / Trace 2 / Trace 3 / Trace 4 (Softkeys).....76

**Trace 1 / Trace 2 / Trace 3 / Trace 4 / Trace 5 / Trace 6**

Selects the corresponding trace for configuration. The currently selected trace is highlighted.

Remote command:

Selected via numeric suffix of:TRACe<1...6> commands

DISPlay[:WINDow<n>][:SUBWindow<w>]:TRACe<t>[:STATE] on page 201

**TraceMode**

Defines the update mode for subsequent traces.

- "Clear/ Write" Overwrite mode (default): the trace is overwritten by each sweep.
- "Max Hold" The maximum value is determined over several sweeps and displayed. The R&S ZNL saves each trace point in the trace memory only if the new value is greater than the previous one.
- "Min Hold" The minimum value is determined from several measurements and displayed. The R&S ZNL saves each trace point in the trace memory only if the new value is lower than the previous one.
- "Average" The average is formed over several sweeps. The Sweep/Average Count determines the number of averaging procedures.

"View" The current contents of the trace memory are frozen and displayed.

"Blank" Removes the selected trace from the display.

Remote command:

`DISPlay[:WINDow<n>][:SUBWindow<w>]:TRACe<t>:MODE` on page 199

### Detector

Defines the trace detector to be used for trace analysis.

"Auto" (default:) Selects the optimum detector for the selected trace and filter mode

"Type" Defines the selected detector type.

Remote command:

`[SENSe:] [WINDow<n>:] DETector<t> [:FUNction]` on page 204

`[SENSe:] [WINDow<n>:] DETector<t> [:FUNction]:AUTO` on page 205

### Hold

If activated, traces in "Min Hold", "Max Hold" and "Average" mode are not reset after specific parameter changes have been made.

Normally, the measurement is started again after parameter changes, before the measurement results are analyzed (e.g. using a marker). In all cases that require a new measurement after parameter changes, the trace is reset automatically to avoid false results (e.g. with span changes). For applications that require no reset after parameter changes, the automatic reset can be switched off.

The default setting is off.

Remote command:

`DISPlay[:WINDow<n>][:SUBWindow<w>]:TRACe<t>:MODE:HCONTinuous` on page 200

### Average Mode

Defines the mode with which the trace is averaged over several sweeps.

This setting is generally applicable if trace mode "Average" is selected.

For FFT sweeps, the setting also affects the VBW (regardless of whether the trace is averaged).

(See the chapter on ACLR power measurements in the R&S ZNL User Manual.)

"Linear" The power level values are converted into linear units before averaging. After the averaging, the data is converted back into its original unit.

"Logarithmic" For logarithmic scaling, the values are averaged in dBm. For linear scaling, the behavior is the same as with linear averaging.

"Power" Activates linear power averaging.  
The power level values are converted into unit Watt before averaging. After the averaging, the data is converted back into its original unit. Use this mode to average power values in Volts or Amperes correctly. In particular, for small VBW values (smaller than the RBW), use power averaging mode for correct power measurements in FFT sweep mode.

Remote command:

[SENSe:] AVERAge<n>:TYPE on page 204

### Average Count

Determines the number of averaging or maximum search procedures if the trace modes "Average", "Max Hold" or "Min Hold" are set.

In continuous sweep mode, if sweep count = 0 (default), averaging is performed over 10 sweeps. For sweep count = 1, no averaging, Max Hold or Min Hold operations are performed.

Remote command:

[SENSe:] AVERAge<n>:COUNT on page 203

### Predefined Trace Settings - Quick Config

Commonly required trace settings have been predefined and can be applied very quickly by selecting the appropriate button.

Function	Trace Settings	
Preset All Traces	Trace 1:	Clear Write
	Traces 2-6:	Blank
Set Trace Mode Max   Avg   Min	Trace 1:	Max Hold
	Trace 2:	Average
	Trace 3:	Min Hold
	Traces 4-6:	Blank
Set Trace Mode Max   ClrWrite   Min	Trace 1:	Max Hold
	Trace 2:	Clear Write
	Trace 3:	Min Hold
	Traces 4-6:	Blank

### Trace 1 / Trace 2 / Trace 3 / Trace 4 (Softkeys)

Displays the "Traces" settings and focuses the "Mode" list for the selected trace.

Remote command:

DISPlay[:WINDow<n>][:SUBWindow<w>]:TRACe<t>[:STATe] on page 201

## 6.2 Spectrogram settings

**Access:** [TRACE] > "Spectrogram Config"

The individual settings available for spectrogram display are described here. For settings on color mapping, see [Chapter 6.2.2, "Color map settings"](#), on page 80.

Settings concerning the frames and how they are handled during a sweep are provided as additional sweep settings for spectrogram display.

See [Chapter 5.5, "Data acquisition"](#), on page 45.

Search functions for spectrogram markers are described in [Chapter 6.4.3, "Marker search settings for spectrograms"](#), on page 92.

- [General spectrogram settings](#).....77
- [Color map settings](#).....80

### 6.2.1 General spectrogram settings

**Access:** [TRACE] > "Spectrogram Config"

This section describes general settings for spectrogram display.

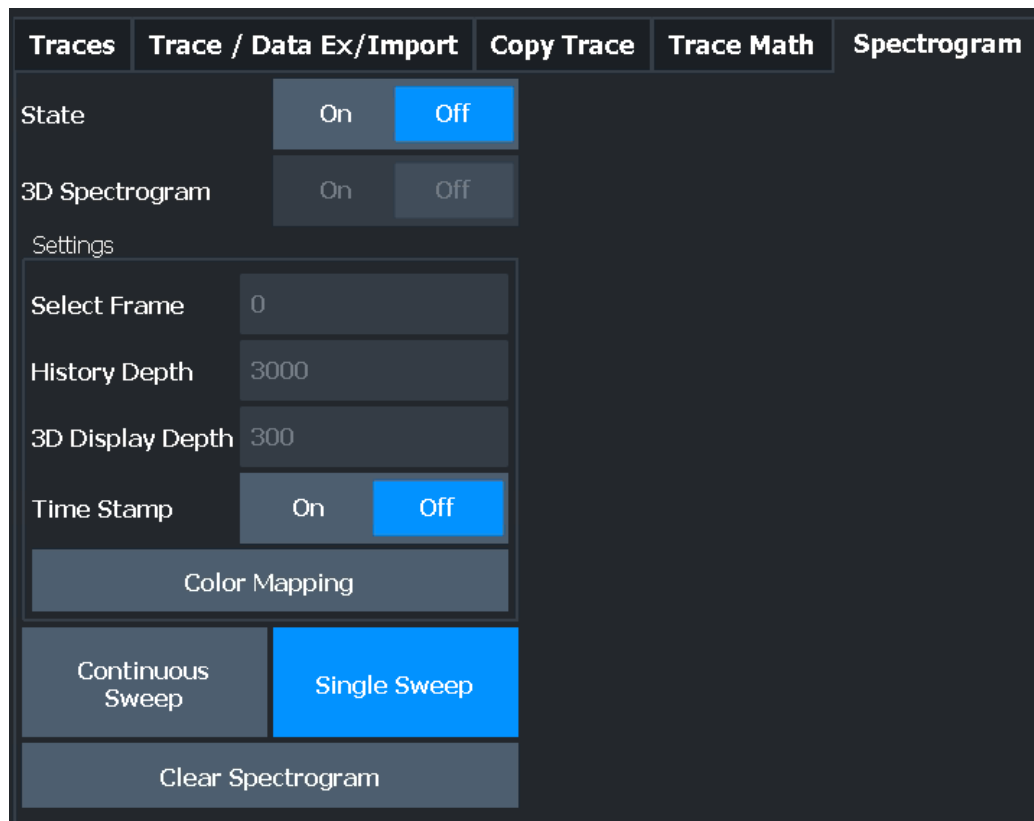

State.....	78
3D Spectrogram State.....	78
Select Frame.....	78
History Depth .....	78
3-D Display Depth.....	78
Trace.....	78
Time Stamp .....	79
Color Mapping .....	79
Continuous Sweep / Run Cont .....	79
Single Sweep / Run Single .....	79
Clear Spectrogram .....	80

**State**

Activates and deactivates a Spectrogram subwindow.

"On" Displays the Spectrogram as a subwindow in the original result display.

"Off" Closes the Spectrogram subwindow.

Remote command:

[CALCulate<n>:SPECTrogram:LAYout](#) on page 194

**3D Spectrogram State**

Activates and deactivates a 3-dimensional spectrogram. As opposed to the common 2-dimensional spectrogram, the power is not only indicated by a color mapping, but also in a third dimension, the z-axis.

For details see the R&S ZNL User Manual.

Remote command:

[CALCulate<n>:SPECTrogram:THReedim\[:STATe\]](#) on page 195

**Select Frame**

Selects a specific frame, loads the corresponding trace from the memory, and displays it in the Spectrum window.

Note that activating a marker or changing the position of the active marker automatically selects the frame that belongs to that marker.

This function is only available in single sweep mode or if the sweep is stopped, and only if a spectrogram is selected.

The most recent frame is number 0, all previous frames have a negative number.

For more details, see the R&S ZNL User Manual.

Remote command:

[CALCulate<n>:SPECTrogram:FRAMe:SElect](#) on page 193

**History Depth**

Sets the number of frames that the R&S ZNL stores in its memory.

The maximum number of frames depends on the [Sweep Points](#).

For an overview of the maximum number of frames depending on the number of sweep points, see the R&S ZNL User Manual.

If the memory is full, the R&S ZNL deletes the oldest frames stored in the memory and replaces them with the new data.

Remote command:

[CALCulate<n>:SPECTrogram:HDEPth](#) on page 193

**3-D Display Depth**

Defines the number of frames displayed in a 3-dimensional spectrogram.

For details see the R&S ZNL User Manual.

**Trace**

Selects the diagram trace on which the spectrogram is based.

Remote command:

[CALCulate<n>:SGRam:TRACe](#) on page 195

### Time Stamp

Activates and deactivates the timestamp. The timestamp shows the system time while the measurement is running. In single sweep mode or if the sweep is stopped, the timestamp shows the time and date of the end of the sweep.

When active, the timestamp replaces the display of the frame number.

Remote command:

[CALCulate<n>:SPECTrogram:TSTamp\[:STATe\]](#) on page 196

[CALCulate<n>:SPECTrogram:TSTamp:DATA?](#) on page 195

### Color Mapping

Opens the "Color Mapping" dialog.

For details see the R&S ZNL User Manual.

### Continuous Sweep / Run Cont

While the measurement is running, the "Continuous Sweep" softkey and the [RUN CONT] key are highlighted. The running measurement can be aborted by selecting the highlighted softkey or key again. The results are not deleted until a new measurement is started.

**Note:** Sequencer. If the Sequencer is active, the "Continuous Sweep" softkey only controls the sweep mode for the currently selected channel setup. However, the sweep mode only takes effect the next time the Sequencer activates that channel setup, and only for a channel-defined sequence. In this case, a channel setup in continuous sweep mode is swept repeatedly.

Furthermore, the [RUN CONT] key controls the Sequencer, not individual sweeps. [RUN CONT] starts the Sequencer in continuous mode.

For details on the Sequencer, see the R&S ZNL User Manual.

Remote command:

[INITiate<n>:CONTInuous](#) on page 168

### Single Sweep / Run Single

After triggering, starts the number of sweeps set in "Sweep Count". The measurement stops after the defined number of sweeps has been performed.

While the measurement is running, the "Single Sweep" softkey and the [RUN SINGLE] key are highlighted. The running measurement can be aborted by selecting the highlighted softkey or key again.

**Note:** Sequencer. If the Sequencer is active, the "Single Sweep" softkey only controls the sweep mode for the currently selected channel setup. However, the sweep mode only takes effect the next time the Sequencer activates that channel setup, and only for a channel-defined sequence. In this case, the Sequencer sweeps a channel setup in single sweep mode only once.

Furthermore, the [RUN SINGLE] key controls the Sequencer, not individual sweeps. [RUN SINGLE] starts the Sequencer in single mode.

If the Sequencer is off, only the evaluation for the currently displayed channel setup is updated.

For details on the Sequencer, see the R&S ZNL User Manual.

Remote command:

`INITiate<n>[:IMMEDIATE]` on page 168

### Clear Spectrogram

Resets the spectrogram result display and clears the history buffer.

This function is only available if a spectrogram is selected.

Remote command:

`CALCulate<n>:SPECTrogram:CLEar[:IMMEDIATE]` on page 192

## 6.2.2 Color map settings

**Access:** "Overview" > "Analysis" > "Traces" > "Spectrogram" > "Color Mapping"

or: [TRACE] > "Spectrogram Config" > "Color Mapping"

In addition to the available color settings, the dialog box displays the current color map and provides a preview of the display with the current settings.

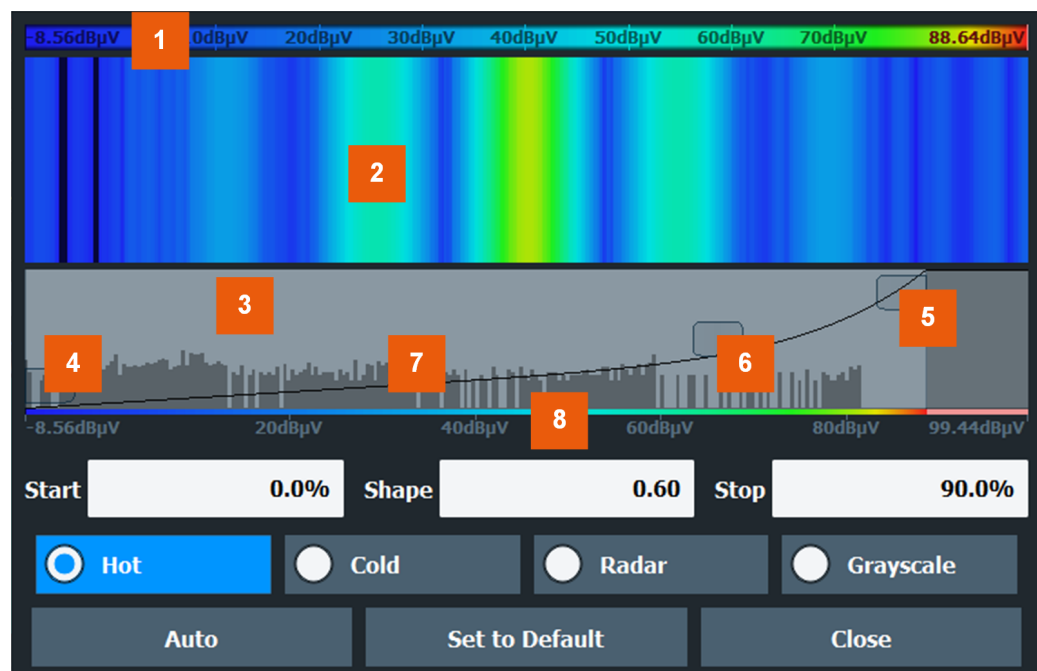

**Figure 6-1: Color Mapping dialog box**

- 1 = Color map: shows the current color distribution
- 2 = Preview pane: shows a preview of the spectrogram with any changes that you make to the color scheme
- 3 = Color curve pane: graphical representation of all settings available to customize the color scheme
- 4/5 = Color range start and stop sliders: define the range of the color map or amplitudes for the spectrogram
- 6 = Color curve slider: adjusts the focus of the color curve
- 7 = Histogram: shows the distribution of measured values
- 8 = Scale of the horizontal axis (value range)



Start / Stop .....	81
Shape.....	81
Hot / Cold / Radar / Grayscale .....	81
Auto.....	81
Set to Default.....	81
Close.....	81

**Start / Stop**

Defines the lower and upper boundaries of the value range of the spectrogram.

Remote command:

`DISPlay[:WINDow<n>]:SPECTrogram:COLor:LOWer` on page 197

`DISPlay[:WINDow<n>]:SPECTrogram:COLor:UPPer` on page 198

**Shape**

Defines the shape and focus of the color curve for the spectrogram result display.

"-1 to <0"      More colors are distributed among the lower values

"0"              Colors are distributed linearly among the values

">0 to 1"      More colors are distributed among the higher values

Remote command:

`DISPlay[:WINDow<n>]:SPECTrogram:COLor:SHApe` on page 197

**Hot / Cold / Radar / Grayscale**

Sets the color scheme for the spectrogram.

Remote command:

`DISPlay[:WINDow<n>]:SPECTrogram:COLor[:STYLE]` on page 198

**Auto**

Defines the color range automatically according to the existing measured values for optimized display.

**Set to Default**

Sets the color mapping to the default settings.

Remote command:

`DISPlay[:WINDow<n>]:SPECTrogram:COLor:DEFault` on page 197

**Close**

Saves the changes and closes the dialog box.

## 6.3 Trace / data export configuration



**Access:** "Save" > "Export" > "Trace Export Configuration"

**Or:** [TRACE] > Trace > "Trace / Data Export"



The standard data management functions (e.g. saving or loading instrument settings) that are available for all R&S ZNL applications are not described here.

See the R&S ZNL Spectrum Mode User Manual for a description of the standard functions.

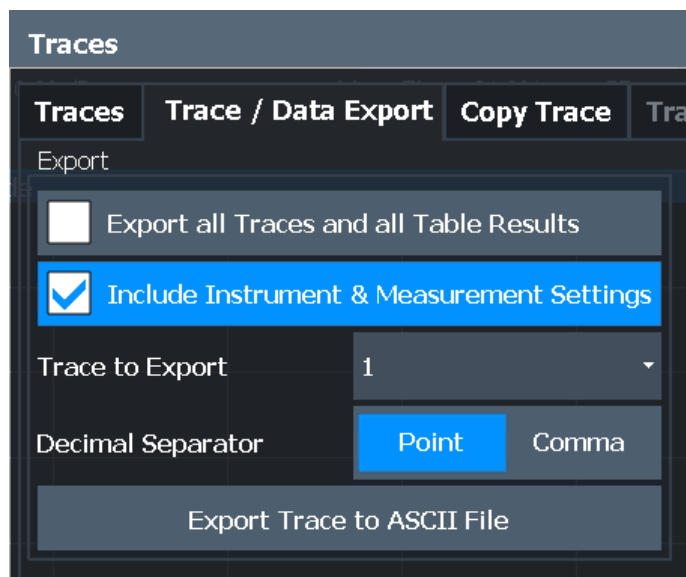

Export all Traces and all Table Results .....	82
Include Instrument & Measurement Settings .....	82
Trace to Export .....	83
Decimal Separator.....	83
Export Trace to ASCII File .....	83
└ File Type .....	84
└ Decimal Separator.....	84
└ File Explorer.....	84

### Export all Traces and all Table Results

Selects all displayed traces and result tables (e.g. "Result Summary", marker table etc.) in the current application for export to an ASCII file.

Alternatively, you can select one specific trace only for export (see [Trace to Export](#) ).

The results are output in the same order as they are displayed on the screen: window by window, trace by trace, and table row by table row.

Remote command:

`FORMat:DEXPort:TRACes` on page 182

### Include Instrument & Measurement Settings

Includes additional instrument and measurement settings in the header of the export file for result data.

See the R&S ZNL Spectrum Mode User Manual for details.

Remote command:

`FORMat:DEXPort:HEADer` on page 182

**Trace to Export**

Defines an individual trace to be exported to a file.

This setting is not available if [Export all Traces and all Table Results](#) is selected.

**Decimal Separator**

Defines the decimal separator for floating-point numerals for the data export/import files. Evaluation programs require different separators in different languages.

Remote command:

[FORMat:DEXPort:DSEPARATOR](#) on page 182

**Export Trace to ASCII File**

Saves the selected trace or all traces in the currently active result display to the specified file and directory in the selected ASCII format.

"File Explorer": Instead of using the file manager of the R&S ZNL firmware, you can also use the Microsoft Windows File Explorer to manage files.

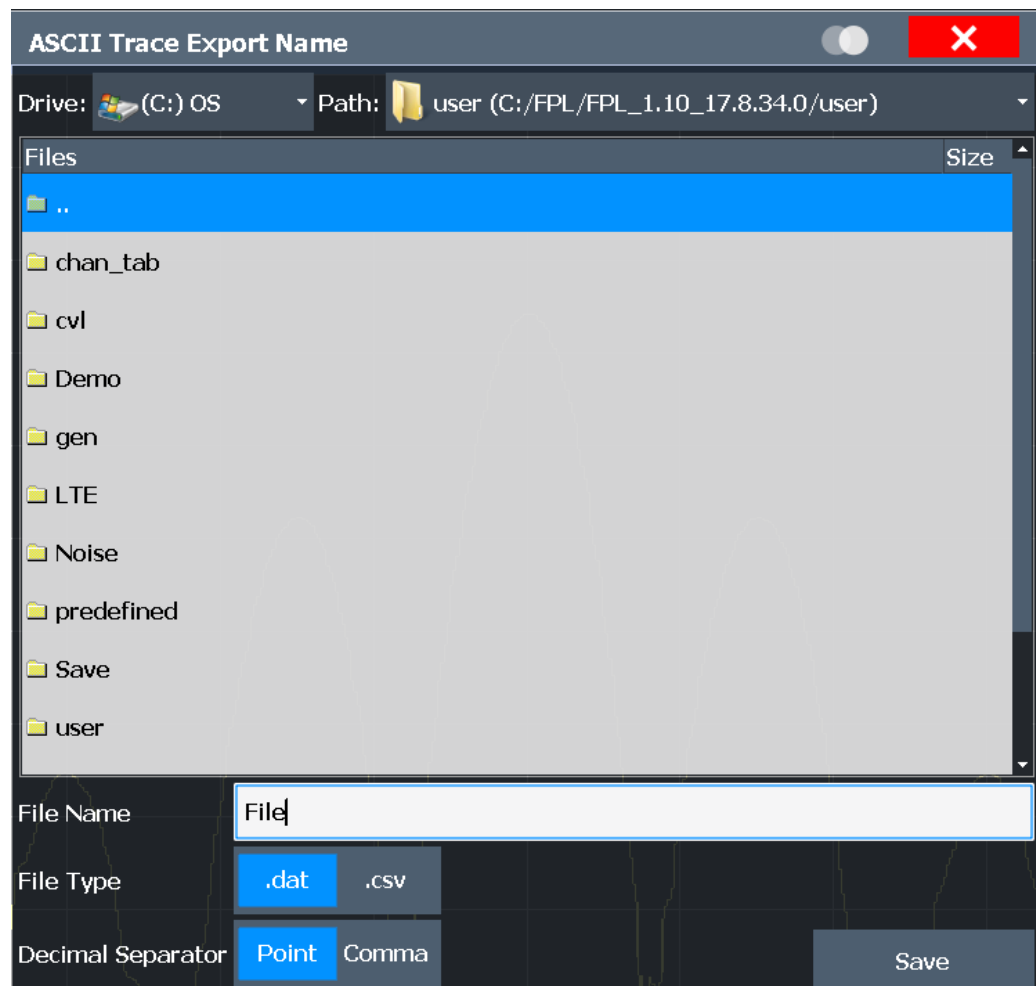

Remote command:

[MMEMory:STORe<n>:TRACe](#) on page 183

**File Type ← Export Trace to ASCII File**

Determines the format of the ASCII file to be imported or exported.

Depending on the external program in which the data file was created or is evaluated, a comma-separated list (CSV) or a plain data format (DAT) file is required.

Remote command:

`FORMat:DEXPort:FORMat` on page 181

**Decimal Separator ← Export Trace to ASCII File**

Defines the decimal separator for floating-point numerals for the data export/import files. Evaluation programs require different separators in different languages.

Remote command:

`FORMat:DEXPort:DSEPARATOR` on page 182

**File Explorer ← Export Trace to ASCII File**

Opens the Microsoft Windows File Explorer.

Remote command:

not supported

## 6.4 Working with markers in the R&S FPL1-K7 AM/FM/PM Modulation Analysis application

**Access:** "Overview" > "Analysis"

Basically, markers in the R&S FPL1-K7 AM/FM/PM Modulation Analysis application are very similar to those in the Spectrum application. However, some additional functions are available.

- [Marker settings](#).....84
- [Marker search settings and positioning functions](#)..... 89
- [Marker search settings for spectrograms](#).....92
- [Marker function configuration](#).....94

### 6.4.1 Marker settings

**Access:** "Overview" > "Analysis" > "Marker" > "Markers"

**Or:** "Marker" > "Markers"

The remote commands required to define these settings are described in [Chapter 11.8.3, "Working with markers remotely"](#), on page 205.

- [Individual marker setup](#).....84
- [General marker settings](#).....87

#### 6.4.1.1 Individual marker setup

**Access:** "Overview" > "Analysis" > "Marker" > "Markers"

Working with markers in the R&S FPL1-K7 AM/FM/PM Modulation Analysis application

Or: "Marker" > "Markers" tab

In the R&S FPL1-K7 AM/FM/PM Modulation Analysis application, up to 17 markers or delta markers can be activated for each window simultaneously.

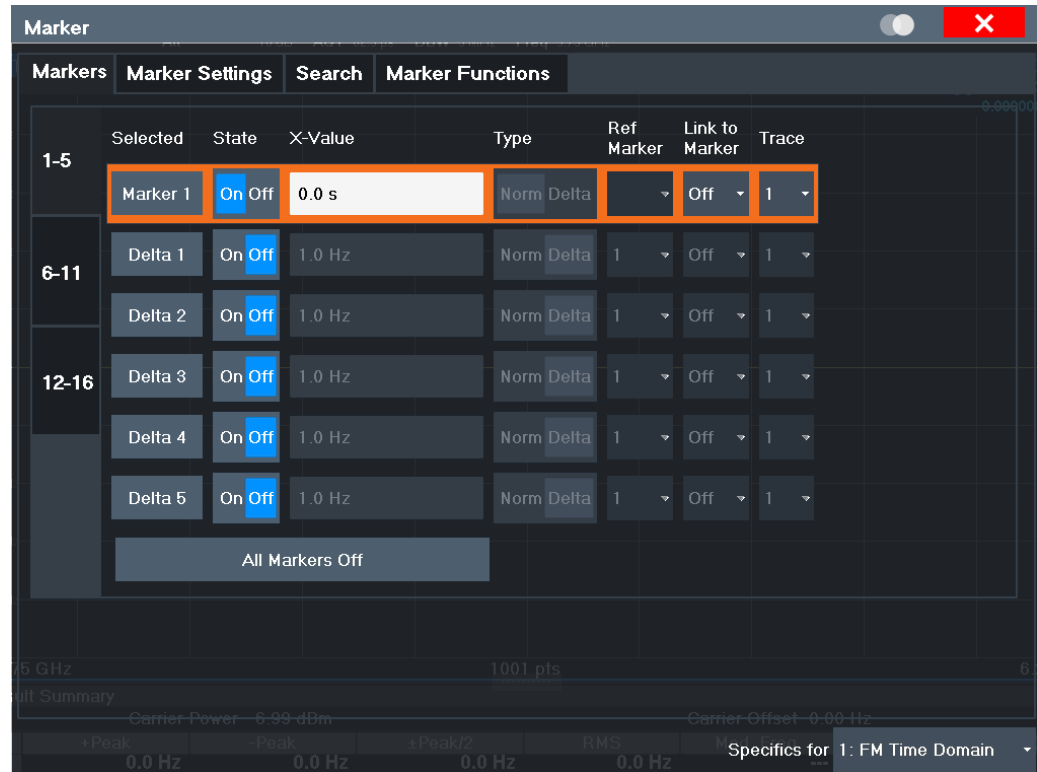

The markers are distributed among 3 tabs for a better overview. By default, the first marker is defined as a normal marker, whereas all others are defined as delta markers with reference to the first marker. All markers are assigned to trace 1, but only the first marker is active.

Selected Marker .....	85
Marker State .....	85
Marker Position X-value.....	86
Marker Type .....	86
Reference Marker .....	86
Linking to Another Marker .....	86
Assigning the Marker to a Trace .....	87
All Markers Off .....	87

### Selected Marker

Marker name. The marker which is currently selected for editing is highlighted orange.

Remote command:

Marker selected via suffix <m> in remote commands.

### Marker State

Activates or deactivates the marker in the diagram.

Remote command:

[CALCulate<n>:MARKer<m>\[:STATe\]](#) on page 206

[CALCulate<n>:DELTAmarker<m>\[:STATe\]](#) on page 210

### Marker Position X-value

Defines the position (x-value) of the marker in the diagram. For normal markers, the absolute position is indicated. For delta markers, the position relative to the reference marker is provided.

Remote command:

[CALCulate<n>:MARKer<m>:X](#) on page 207

[CALCulate<n>:DELTAmarker<m>:X](#) on page 211

### Marker Type

Toggles the marker type.

The type for marker 1 is always "Normal", the type for delta marker 1 is always "Delta". These types cannot be changed.

**Note:** If normal marker 1 is the active marker, switching the "Mkr Type" activates an additional delta marker 1. For any other marker, switching the marker type does not activate an additional marker, it only switches the type of the selected marker.

"Normal"            A normal marker indicates the absolute value at the defined position in the diagram.

"Delta "            A delta marker defines the value of the marker relative to the specified reference marker (marker 1 by default).

Remote command:

[CALCulate<n>:MARKer<m>\[:STATe\]](#) on page 206

[CALCulate<n>:DELTAmarker<m>\[:STATe\]](#) on page 210

### Reference Marker

Defines a marker as the reference marker which is used to determine relative analysis results (delta marker values).

If the reference marker is deactivated, the delta marker referring to it is also deactivated.

If a fixed reference point is configured (see "[Defining a Fixed Reference](#)" on page 89), the reference point ("FXD") can also be selected instead of another marker.

Remote command:

[CALCulate<n>:DELTAmarker<m>:MREference](#) on page 210

### Linking to Another Marker

Links the current marker to the marker selected from the list of active markers. If the x-axis value of the initial marker is changed, the linked marker follows to the same position on the x-axis. Linking is off by default.

Using this function you can set two markers on different traces to measure the difference (e.g. between a max hold trace and a min hold trace or between a measurement and a reference trace).

Working with markers in the R&S FPL1-K7 AM/FM/PM Modulation Analysis application

Remote command:

`CALCulate<n>:MARKer<ms>:LINK:TO:MARKer<md>` on page 206

`CALCulate<n>:DELTamarker<ms>:LINK:TO:MARKer<md>` on page 209

`CALCulate<n>:DELTamarker<m>:LINK` on page 208

### Assigning the Marker to a Trace

The "Trace" setting assigns the selected marker to an active trace. The trace determines which value the marker shows at the marker position. If the marker was previously assigned to a different trace, the marker remains on the previous frequency or time, but indicates the value of the new trace.

If a trace is turned off, the assigned markers and marker functions are also deactivated.

Remote command:

`CALCulate<n>:MARKer<m>:TRACe` on page 207

### All Markers Off

Deactivates all markers in one step.

Remote command:

`CALCulate<n>:MARKer<m>:AOFF` on page 206

## 6.4.1.2 General marker settings

**Access:** "Overview" > "Analysis" > "Marker" > "Marker Settings"

**Or:** "Marker" > "Marker Settings" tab

Some general marker settings allow you to influence the marker behavior for all markers.

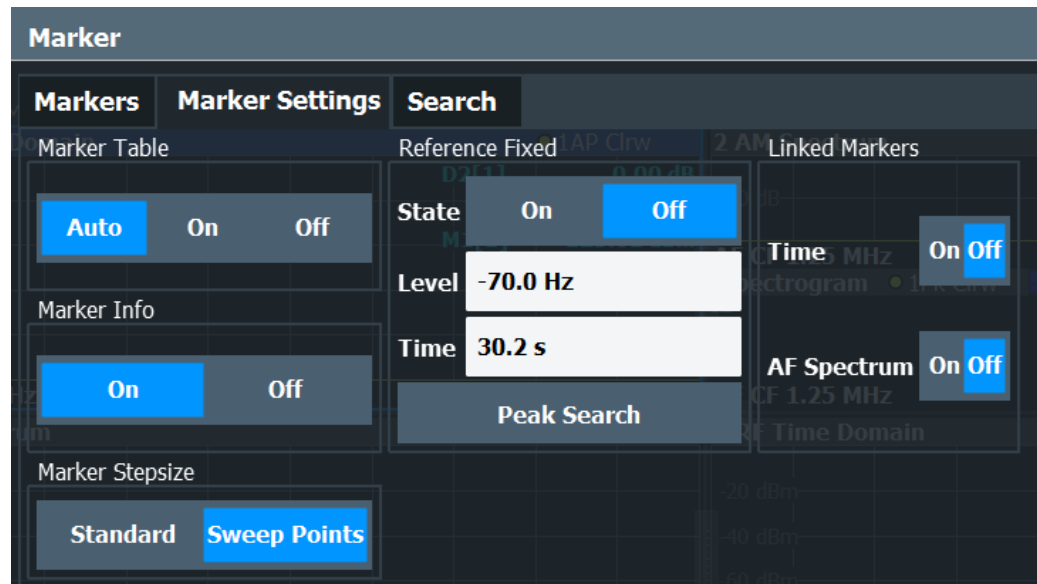

Working with markers in the R&S FPL1-K7 AM/FM/PM Modulation Analysis application

Marker Table Display .....	88
Marker Info .....	88
Marker Stepsize .....	88
Defining a Fixed Reference.....	89
Link Time Marker.....	89
Link AF Spectrum Marker.....	89

### Marker Table Display

Defines how the marker information is displayed.

"On"	Displays the marker information in a table in a separate area beneath the diagram.
"Off"	No separate marker table is displayed. If <a href="#">Marker Info</a> is active, the marker information is displayed within the diagram area.
"Auto"	(Default) If more than two markers are active, the marker table is displayed automatically. If <a href="#">Marker Info</a> is active, the marker information for up to two markers is displayed in the diagram area.

Remote command:

`DISPlay[:WINDow<n>]:MTABLE` on page 214

### Marker Info

Turns the marker information displayed in the diagram on and off.

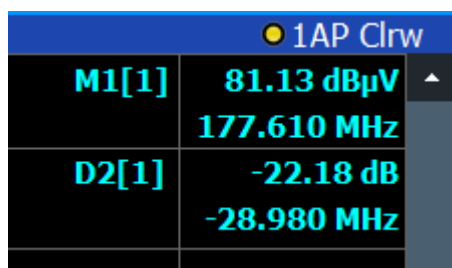

1AP Clrw	
M1[1]	81.13 dBµV 177.610 MHz
D2[1]	-22.18 dB -28.980 MHz

Remote command:

`DISPlay[:WINDow<n>]:MINFo[:STATe]` on page 213

### Marker Stepsize

Defines the size of the steps that the marker position is moved using the rotary knob.

"Standard"	The marker position is moved in steps of (Span/1000), which corresponds approximately to the number of pixels for the default display of 1001 sweep points. This setting is most suitable to move the marker over a larger distance.
"Sweep Points"	The marker position is moved from one sweep point to the next. This setting is required for a very precise positioning if more sweep points are collected than the number of pixels that can be displayed on the screen. It is the default mode.

Remote command:

`CALCulate<n>:MARKer<m>:X:SSIZE` on page 212



**Defining a Fixed Reference**

Instead of using a reference marker whose position can vary depending on the measurement results, you can define a fixed reference marker for trace analysis.

Note that this function is not available in all result displays.

For "State" = "On", a vertical and a horizontal red display line are displayed, marked as "FXD". The normal marker 1 is activated and set to the peak value of the trace assigned to marker 1, and a delta marker to the next peak. The fixed reference marker is set to the position of marker 1 at the peak value. The delta marker refers to the fixed reference marker.

The "Level" and "Frequency" or "Time" settings define the position and value of the reference marker. To move the fixed reference, move the red display lines marked "FXD" in the diagram, or change the position settings in the "Marker Settings" tab of the "Marker" dialog box.

**Peak Search** sets the fixed reference marker to the current maximum value of the trace assigned to marker 1.

If activated, the fixed reference marker ("FXD") can also be selected as a [Reference Marker](#) instead of another marker.

Remote command:

`CALCulate<n>:DELTAmarker<m>:FUNCTION:FIXed[:STATe]` on page 230

`CALCulate<n>:DELTAmarker<m>:FUNCTION:FIXed:RPOint:Y` on page 230

`CALCulate<n>:DELTAmarker<m>:FUNCTION:FIXed:RPOint:X` on page 229

`CALCulate<n>:DELTAmarker<m>:FUNCTION:FIXed:RPOint:MAXimum[:PEAK]` on page 229

**Link Time Marker**

Links the markers in all time domain diagrams.

Remote command:

`CALCulate<n>:MARKer<m>:LINK` on page 213

**Link AF Spectrum Marker**

Links the markers in all AF spectrum displays.

Remote command:

`CALCulate<n>:MARKer<m>:LINK` on page 213

**6.4.2 Marker search settings and positioning functions**

**Access:** "Overview" > "Analysis" > "Marker" > "Search"

**or:** "Marker" > "Search"

Several functions are available to set the marker to a specific position very quickly and easily, or to use the current marker position to define another characteristic value. To determine the required marker position, searches are performed. You can influence the search results using special settings.

Working with markers in the R&S FPL1-K7 AM/FM/PM Modulation Analysis application

The remote commands required to define these settings are described in [Chapter 11.8.3, "Working with markers remotely"](#), on page 205.

- [Marker search settings](#).....90
- [Positioning functions](#).....90

#### 6.4.2.1 Marker search settings

**Access:** "Overview" > "Analysis" > "Marker" > "Search"

**or:** "Marker" > "Search"

Markers are commonly used to determine peak values, i.e. maximum or minimum values, in the measured signal. Configuration settings allow you to influence the peak search results.

[Peak Excursion](#) ..... 90

##### Peak Excursion

Defines the minimum level value by which a signal must rise or fall so that it is identified as a maximum or a minimum by the search functions.

Entries from 0 dB to 80 dB are allowed; the resolution is 0.1 dB. The default setting for the peak excursion is 6 dB.

For Analog Modulation Analysis, the unit and value range depend on the selected result display type.

Remote command:

[CALCulate<n>:MARKer<m>:PEXCursion](#) on page 223

#### 6.4.2.2 Positioning functions

The following functions set the currently selected marker to the result of a peak search or set other characteristic values to the current marker value.

[Select Marker](#) ..... 90

[Peak Search](#) ..... 91

[Search Next Peak](#) ..... 91

[Search Minimum](#) ..... 91

[Search Next Minimum](#) ..... 92

##### Select Marker

The "Select Marker" function opens a dialog box to select and activate or deactivate one or more markers quickly.

Working with markers in the R&S FPL1-K7 AM/FM/PM Modulation Analysis application



Remote command:

`CALCulate<n>:MARKer<m>[:STATE]` on page 206

`CALCulate<n>:DELTamarker<m>[:STATE]` on page 210

### Peak Search

Sets the selected marker/delta marker to the maximum of the trace. If no marker is active, marker 1 is activated.

Remote command:

`CALCulate<n>:MARKer<m>:MAXimum[:PEAK]` on page 225

`CALCulate<n>:DELTamarker<m>:MAXimum[:PEAK]` on page 227

### Search Next Peak

Sets the selected marker/delta marker to the next (lower) maximum of the assigned trace. If no marker is active, marker 1 is activated.

Remote command:

`CALCulate<n>:MARKer<m>:MAXimum:NEXT` on page 225

`CALCulate<n>:MARKer<m>:MAXimum:RIGHT` on page 225

`CALCulate<n>:MARKer<m>:MAXimum:LEFT` on page 224

`CALCulate<n>:DELTamarker<m>:MAXimum:NEXT` on page 227

`CALCulate<n>:DELTamarker<m>:MAXimum:RIGHT` on page 227

`CALCulate<n>:DELTamarker<m>:MAXimum:LEFT` on page 227

### Search Minimum

Sets the selected marker/delta marker to the minimum of the trace. If no marker is active, marker 1 is activated.

Remote command:

`CALCulate<n>:MARKer<m>:MINimum[:PEAK]` on page 226

`CALCulate<n>:DELTamarker<m>:MINimum[:PEAK]` on page 228

### Search Next Minimum

Sets the selected marker/delta marker to the next (higher) minimum of the selected trace. If no marker is active, marker 1 is activated.

Remote command:

CALCulate<n>:MARKer<m>:MINimum:NEXT on page 226

CALCulate<n>:MARKer<m>:MINimum:LEFT on page 225

CALCulate<n>:MARKer<m>:MINimum:RIGHT on page 226

CALCulate<n>:DELTAmarker<m>:MINimum:NEXT on page 228

CALCulate<n>:DELTAmarker<m>:MINimum:LEFT on page 228

CALCulate<n>:DELTAmarker<m>:MINimum:RIGHT on page 228

## 6.4.3 Marker search settings for spectrograms

**Access:** "Overview" > "Analysis" > "Markers" > "Search"

or: [MKR TO] > "Search Config"

Spectrograms show not only the current sweep results, but also the sweep history. Thus, when searching for peaks, you must define the search settings within a single time frame (x-direction) and within several time frames (y-direction).

These settings are only available for spectrogram displays.

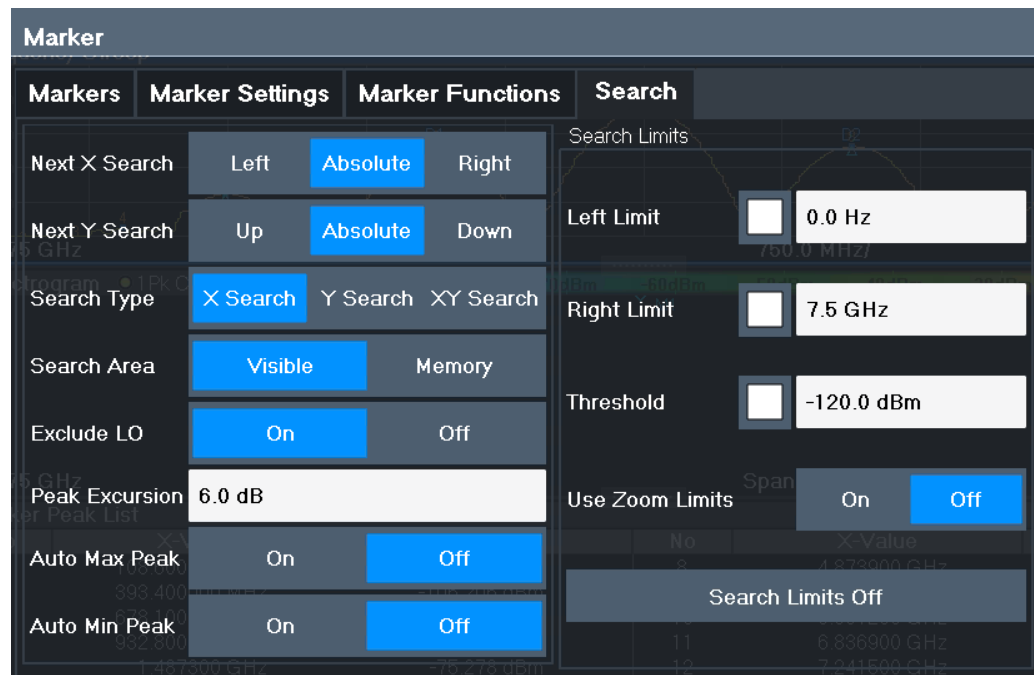

Search Mode for Next Peak in X-Direction .....	93
Search Mode for Next Peak in Y-Direction .....	93
Marker Search Type .....	93
Marker Search Area .....	94
Peak Excursion .....	94

Working with markers in the R&S FPL1-K7 AM/FM/PM Modulation Analysis application

### Search Mode for Next Peak in X-Direction

Selects the search mode for the next peak search within the currently selected frame.

"Left"	Determines the next maximum/minimum to the left of the current peak.
"Absolute"	Determines the next maximum/minimum to either side of the current peak.
"Right"	Determines the next maximum/minimum to the right of the current peak.

Remote command:

[Chapter 11.8.3.5, "Positioning the marker"](#), on page 224

### Search Mode for Next Peak in Y-Direction

Selects the search mode for the next peak search within all frames at the current marker position.

"Up"	Determines the next maximum/minimum above the current peak (in more recent frames).
"Absolute"	Determines the next maximum/minimum above or below the current peak (in all frames).
"Down"	Determines the next maximum/minimum below the current peak (in older frames).

Remote command:

[CALCulate<n>:MARKer<m>:SPECTrogram:Y:MAXimum:ABOVE](#) on page 216

[CALCulate<n>:DELTamarker<m>:SPECTrogram:Y:MAXimum:ABOVE](#)  
on page 221

[CALCulate<n>:MARKer<m>:SPECTrogram:Y:MAXimum:BELOW](#) on page 217

[CALCulate<n>:DELTamarker<m>:SPECTrogram:Y:MAXimum:BELOW](#)  
on page 221

[CALCulate<n>:MARKer<m>:SPECTrogram:Y:MAXimum:NEXT](#) on page 217

[CALCulate<n>:DELTamarker<m>:SPECTrogram:Y:MAXimum:NEXT](#) on page 222

[CALCulate<n>:MARKer<m>:SPECTrogram:Y:MINimum:ABOVE](#) on page 218

[CALCulate<n>:DELTamarker<m>:SPECTrogram:Y:MINimum:ABOVE](#)  
on page 222

[CALCulate<n>:MARKer<m>:SPECTrogram:Y:MINimum:BELOW](#) on page 218

[CALCulate<n>:DELTamarker<m>:SPECTrogram:Y:MINimum:BELOW](#)  
on page 222

[CALCulate<n>:MARKer<m>:SPECTrogram:Y:MINimum:NEXT](#) on page 218

[CALCulate<n>:DELTamarker<m>:SPECTrogram:Y:MINimum:NEXT](#) on page 223

### Marker Search Type

Defines the type of search to be performed in the spectrogram.

"X-Search"	Searches only within the currently selected frame.
"Y-Search"	Searches within all frames but only at the current frequency position.
"XY-Search"	Searches in all frames at all positions.

Working with markers in the R&S FPL1-K7 AM/FM/PM Modulation Analysis application

Remote command:

Defined by the search function, see [Chapter 11.8.3.3, "Marker search \(spectrograms\)"](#), on page 214

#### Marker Search Area

Defines which frames the search is performed in.

"Visible"            Only the visible frames are searched.

"Memory"           All frames stored in the memory are searched.

Remote command:

[CALCulate<n>:MARKer<m>:SPECTrogram:SARea](#) on page 216

[CALCulate<n>:DELTAmarker<m>:SPECTrogram:SARea](#) on page 220

#### Peak Excursion

Defines the minimum level value by which a signal must rise or fall so that it is identified as a maximum or a minimum by the search functions.

Entries from 0 dB to 80 dB are allowed; the resolution is 0.1 dB. The default setting for the peak excursion is 6 dB.

For Analog Modulation Analysis, the unit and value range depend on the selected result display type.

Remote command:

[CALCulate<n>:MARKer<m>:PEXCursion](#) on page 223

### 6.4.4 Marker function configuration

**Access:** "Overview" > "Analysis" > "Marker Functions" > "Phase Noise"

Special marker functions can be selected via the "Marker Function" dialog box.



The fixed reference marker is described under ["Defining a Fixed Reference"](#) on page 89.

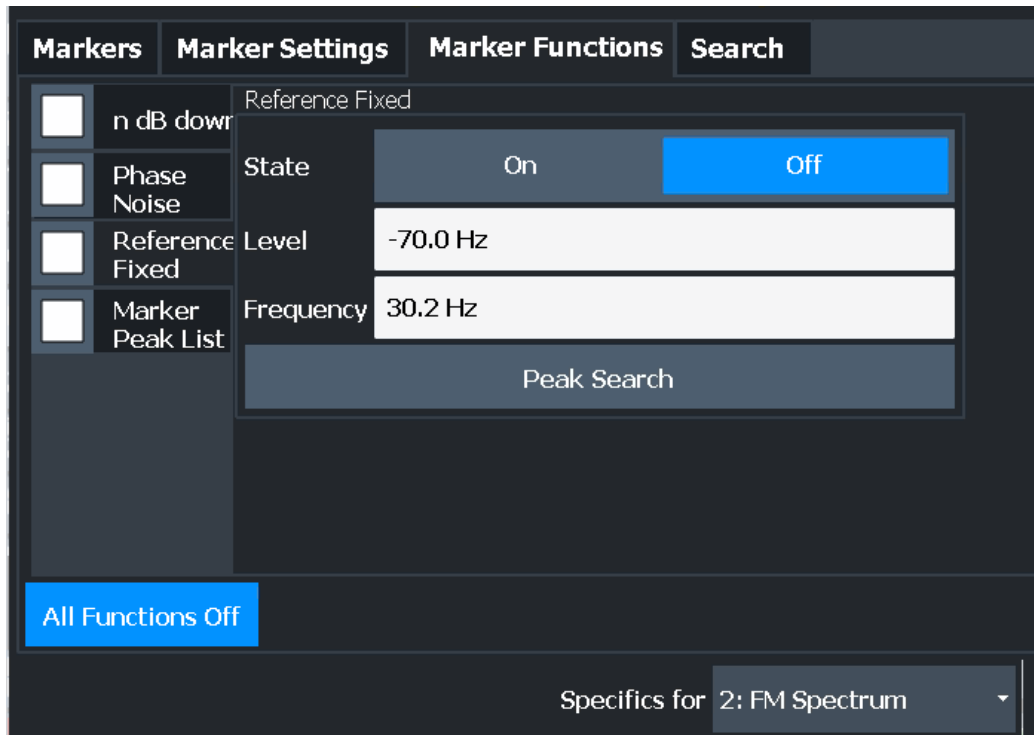

Not all marker functions are available for all evaluations. The following table indicates which functions are available for which evaluations.

Evaluation	n dB down	Phase Noise	Reference Fixed	"Marker Peak List"		
AM/FM/PM time	-	-	X	X		
AF/FM/PM spectrum	X	X	X	X		
RF time	X	-	X	X		
RF spectrum	X	X	X	X		

The remote commands required to define these settings are described in [Chapter 11.8.3.6, "Configuring special marker functions"](#), on page 229.



The Fixed Reference Marker settings are described in ["Defining a Fixed Reference"](#) on page 89.

- [Measuring characteristic bandwidths \(n db down marker\)](#).....96
- [Phase noise measurement marker](#)..... 97
- [Marker peak list](#).....100
- [Deactivating all marker functions](#)..... 103

#### 6.4.4.1 Measuring characteristic bandwidths (n dB down marker)

**Access:** "Overview" > "Analysis" > "Marker Functions" > "n dB down" > "n dB Down Config"

**Or:** [MKR] > "Select Marker Function" > "n dB down" > "n dB Down Config"

When characterizing the shape of a signal, the bandwidth at a specified offset from its peak level is often of interest. The offset is specified as a relative decrease in amplitude of n dB. To measure this bandwidth, you could use several markers and delta markers and determine the bandwidth manually. However, using the n dB down marker function makes the task very simple and quick.

The n dB down marker function uses the current value of marker 1 as the reference point. It activates two temporary markers T1 and T2 located on the signal, whose level is n dB below the level of the reference point. Marker T1 is placed to the left and marker T2 to the right of the reference marker. The default setting for n is 3 dB, but it can be changed.

If a positive offset is entered, the markers T1 and T2 are placed below the active reference point. If a negative value is entered (for example for notch filter measurements), the markers T1 and T2 are placed above the active reference point.

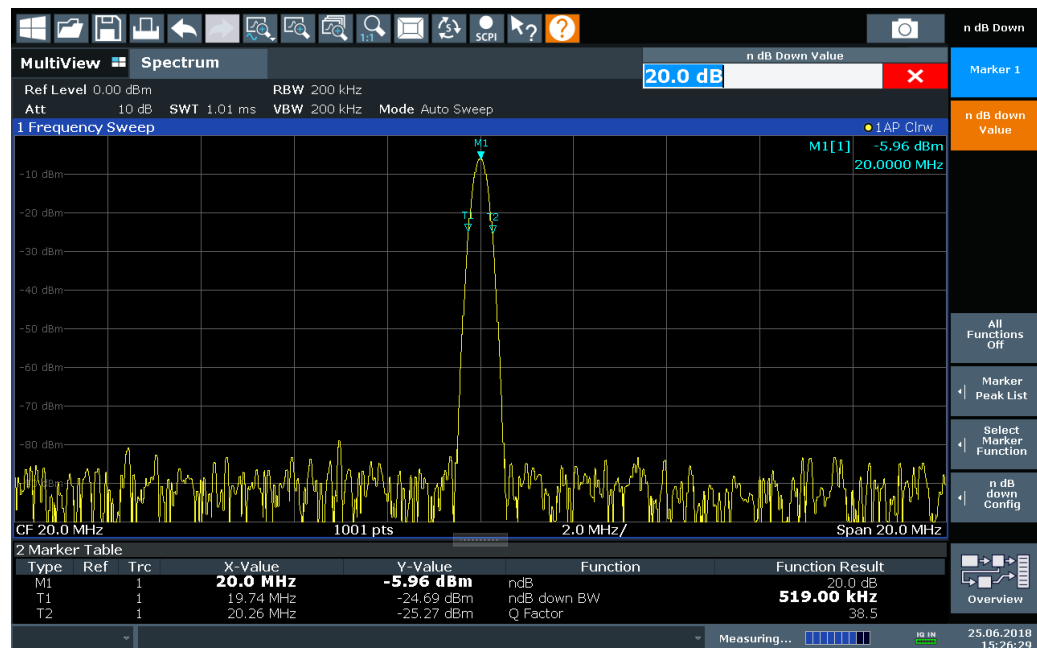

Figure 6-2: n dB down marker function

The following marker function results are displayed:

Table 6-1: n dB down marker function results

Label	Description
M1	Current position and level of marker 1
ndB	Offset value (n dB down)



Label	Description
ndB down Bw / PWid	Determined bandwidth or pulse width (zero span) at the offset
Q-factor	Center frequency / n-dB-down-bandwidth Quality factor of the determined bandwidth (characteristic of damping or resonance)
T1, T2	Current position and level of the temporary markers

If the required position for the temporary markers cannot be determined uniquely, for example due to noise, dashes are displayed as a result.

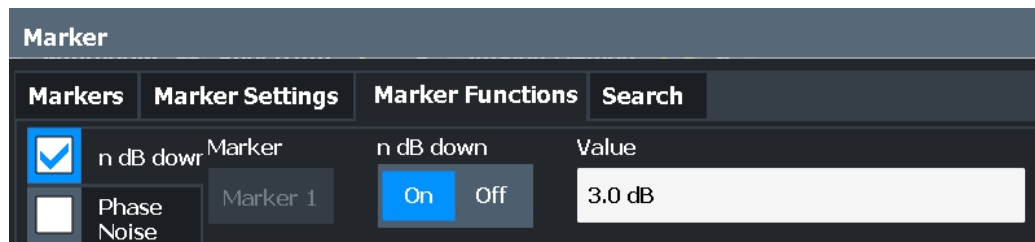

#### Remote commands:

[CALCulate<n>:MARKer<m>:FUNCTion:NDBDown:STATe](#) on page 237

[CALCulate<n>:MARKer<m>:FUNCTion:NDBDown:RESult?](#) on page 237

<a href="#">n dB down Marker State</a> .....	97
<a href="#">n dB down Value</a> .....	97

#### n dB down Marker State

Activates or deactivates the special n dB down marker function.

Remote command:

[CALCulate<n>:MARKer<m>:FUNCTion:NDBDown:STATe](#) on page 237

[CALCulate<n>:MARKer<m>:FUNCTion:NDBDown:RESult?](#) on page 237

#### n dB down Value

Defines the delta level from the reference marker 1 used to determine the bandwidth or time span.

Remote command:

[CALCulate<n>:MARKer<m>:FUNCTion:NDBDown:FREQuency?](#) on page 236

[CALCulate<n>:MARKer<m>:FUNCTion:NDBDown:TIME?](#) on page 238

#### 6.4.4.2 Phase noise measurement marker

**Access:** "Overview" > "Analysis" > "Marker Functions" > "Phase Noise" > "Phase Noise Config"

**Or:** [MKR] > "Select Marker Function" > "Phase Noise" > "Phase Noise Config"

For each of the 16 markers, you can activate a phase noise measurement.

Note that phase noise markers are available:

- for spectrum results
- for normal markers
- not for time domain results

Phase noise is unintentional modulation of a carrier; it creates frequencies next to the carrier frequency. A phase noise measurement consists of noise density measurements at defined offsets from the carrier; the results are given in relation to the carrier level (dBc). The phase noise marker function measures the noise power at the delta markers referred to 1 Hz bandwidth. Marker 1 is used as the reference for the phase noise measurement. By default, the current frequency and level of marker 1 are used as the fixed reference marker. However, you can start a peak search to use the current signal peak as the reference point, or you can define a reference point manually.

The reference point for the phase noise measurement is fixed. After phase noise measurement is started, you can set the reference level or the center frequency so that the carrier is outside the displayed frequency range. You can also activate a notch filter to suppress the carrier.

Alternatively, the reference point can be determined automatically by a peak search after each sweep. Use this function to track a drifting source during a phase noise measurement. The delta marker 2, which shows the phase noise measurement result, keeps the delta frequency value. Thus, the phase noise measurement leads to reliable results in a certain offset although the source is drifting. Only if the marker 2 reaches the border of the span, the delta marker value is adjusted to be within the span. In these cases, select a larger span.

The result of the phase noise measurement is the difference in level between the reference point and the noise power density. It is indicated as the function result of the phase noise marker in the "marker table".

The sample detector is automatically used and the video bandwidth set to 0.1 times the resolution bandwidth (RBW). The two settings are considered in the correction values used for the noise power measurement. To obtain stable results, two pixels on the right and the left of the delta marker position are taken for the measurement.

The individual marker settings correspond to those defined in the "Marker" dialog box. Any settings to the marker state or type changed in the "Marker Function" dialog box are also changed in the "Marker" dialog box and vice versa.

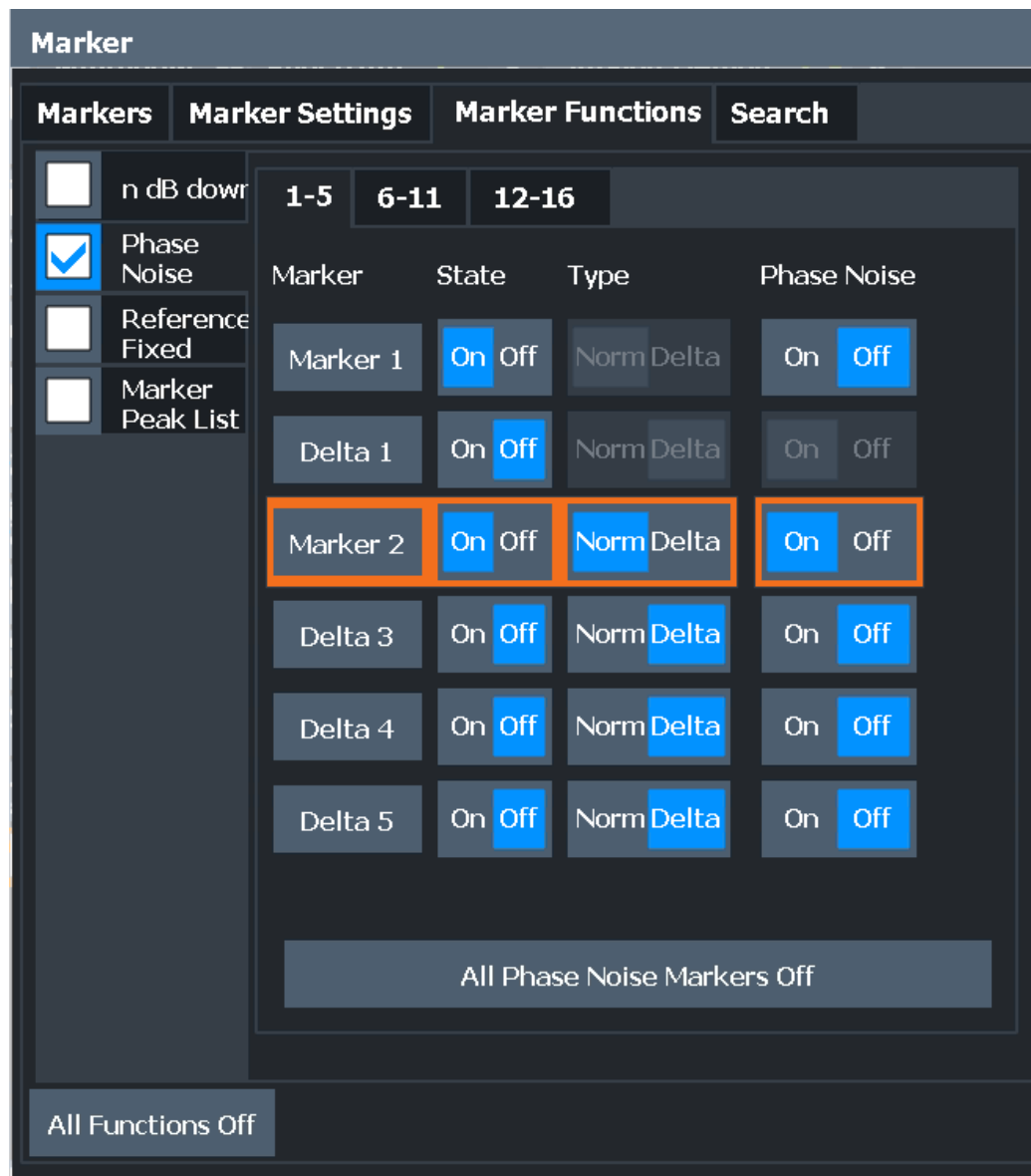
**Remote commands:**

[CALCulate<n>:MARKer<m>:FUNCTION:PNOise\[:STATE\]](#) on page 239

[CALCulate<n>:MARKer<m>:FUNCTION:PNOise:RESult?](#) on page 239

[Phase Noise Measurement State](#) ..... 99

[Switching All Phase Noise Measurements Off](#) ..... 100

**Phase Noise Measurement State**

Activates or deactivates phase noise measurement at the marker position in the diagram.

In the R&S FPL1-K7 AM/FM/PM Modulation Analysis application, this function is only available for normal markers.

Working with markers in the R&S FPL1-K7 AM/FM/PM Modulation Analysis application

If activated, the normal markers display the phase noise measured at their current position in the "marker table".

For details see [Chapter 6.4.4.2, "Phase noise measurement marker"](#), on page 97.

Remote command:

`CALCulate<n>:MARKer<m>:FUNction:PNOise[:STATe]` on page 239

`CALCulate<n>:MARKer<m>:FUNction:PNOise:RESult?` on page 239

### Switching All Phase Noise Measurements Off

Deactivates phase noise measurement for all markers.

Remote command:

`CALCulate<n>:MARKer<m>:FUNction:PNOise[:STATe]` on page 239

### 6.4.4.3 Marker peak list

**Access:** "Overview" > "Analysis" > "Marker Functions" > "Marker Peak List"

**Or:** [MKR] > "Select Marker Function" > "Marker Peak List"

A common measurement task is to determine peak values, i.e. maximum or minimum signal levels. The R&S ZNL provides various peak search functions and applications:

- Setting a marker to a peak value once (Peak Search)
- Searching for a peak value within a restricted search area (Search Limits)
- Creating a "marker table" with all or a defined number of peak values for one sweep ("Marker Peak List")
- Updating the marker position to the current peak value automatically after each sweep (Auto Peak Search)

#### Peak search limits

The peak search can be restricted to a search area. The search area is defined by limit lines which are also indicated in the diagram. In addition, a minimum value (threshold) can be defined as a further search condition.

#### When is a peak a peak? - Peak excursion

During a peak search, noise values are detected as a peak if the signal is very flat or does not contain many peaks. Therefore, you can define a relative threshold ("Peak Excursion"). The signal level must increase by the threshold value before falling again before a peak is detected. To avoid identifying noise peaks as maxima or minima, enter a peak excursion value that is higher than the difference between the highest and the lowest value measured for the displayed inherent noise.

#### Effect of peak excursion settings (example)

The following figure shows a trace to be analyzed.

## Working with markers in the R&amp;S FPL1-K7 AM/FM/PM Modulation Analysis application

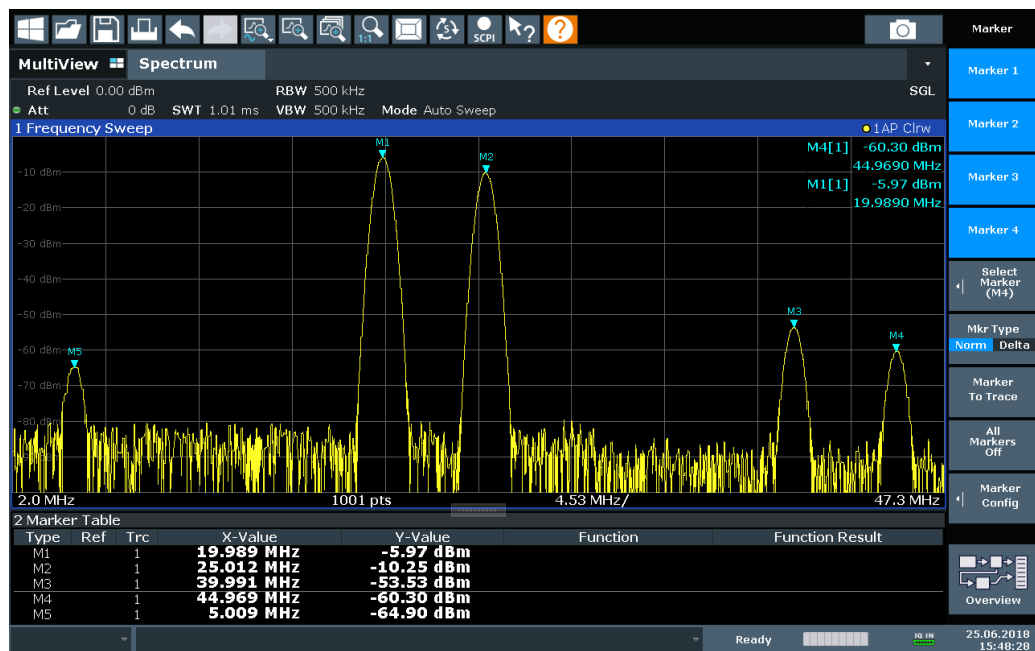

Figure 6-3: Trace example

The following table lists the peaks as indicated by the marker numbers in the diagram above, as well as the minimum decrease in amplitude to either side of the peak:

Marker #	Min. amplitude decrease to either side of the signal
1	80 dB
2	80 dB
3	55 dB
4	39 dB
5	32 dB

To eliminate the smaller peaks M3, M4 and M5 in the example above, a peak excursion of at least 60 dB is required. In this case, the amplitude must rise at least 60 dB before falling again before a peak is detected.

### Marker peak list

The marker peak list determines the frequencies and levels of peaks in the spectrum. It is updated automatically after each sweep. How many peaks are displayed can be defined, as well as the sort order. In addition, the detected peaks can be indicated in the diagram. The peak list can also be exported to a file for analysis in an external application.

In the R&S FPL1-K7 AM/FM/PM Modulation Analysis application, the search limits are not available.

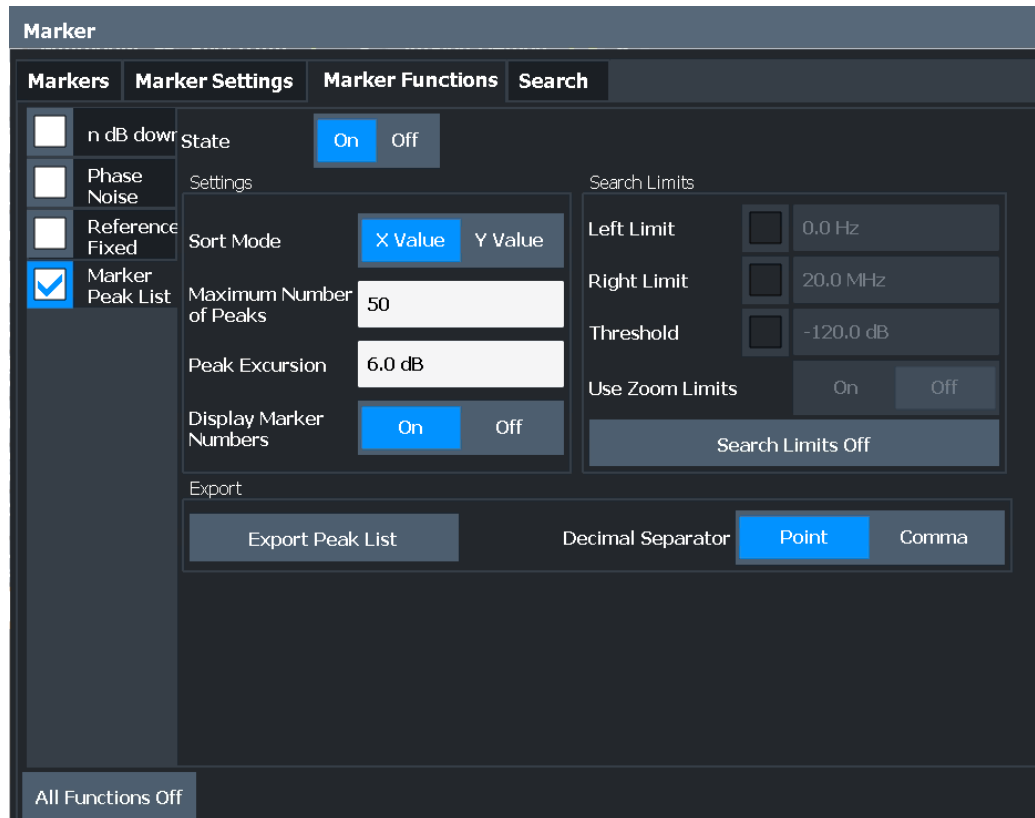

### Remote commands:

[CALCulate<n>:MARKer<m>:FUNCTION:FPEaks:STATE](#) on page 233

TRAC? LIST,

<a href="#">Peak List State</a> .....	102
<a href="#">Sort Mode</a> .....	102
<a href="#">Maximum Number of Peaks</a> .....	103
<a href="#">Peak Excursion</a> .....	103
<a href="#">Display Marker Numbers</a> .....	103
<a href="#">Export Peak List</a> .....	103

### Peak List State

Activates/deactivates the marker peak list. If activated, the peak list is displayed and the peaks are indicated in the trace display.

For each listed peak, the frequency/time ("X-value") and level ("Y-Value") values are given.

Remote command:

[CALCulate<n>:MARKer<m>:FUNCTION:FPEaks:STATE](#) on page 233

### Sort Mode

Defines whether the peak list is sorted according to the x-values or y-values. In either case, the values are sorted in ascending order.

Working with markers in the R&S FPL1-K7 AM/FM/PM Modulation Analysis application

Remote command:

[CALCulate<n>:MARKer<m>:FUNCTION:FPEaks:SORT](#) on page 233

#### Maximum Number of Peaks

Defines the maximum number of peaks to be determined and displayed.

Remote command:

[CALCulate<n>:MARKer<m>:FUNCTION:FPEaks:LIST:SIZE](#) on page 233

#### Peak Excursion

Defines the minimum level value by which a signal must rise or fall so that it is identified as a maximum or a minimum by the search functions.

Entries from 0 dB to 80 dB are allowed; the resolution is 0.1 dB. The default setting for the peak excursion is 6 dB.

For Analog Modulation Analysis, the unit and value range depend on the selected result display type.

Remote command:

[CALCulate<n>:MARKer<m>:PEXCursion](#) on page 223

#### Display Marker Numbers

By default, the marker numbers are indicated in the diagram so you can find the peaks from the list. However, for large numbers of peaks, the marker numbers can decrease readability; in this case, deactivate the marker number display.

Remote command:

[CALCulate<n>:MARKer<m>:FUNCTION:FPEaks:ANNOtation:LABel\[:STATe\]](#) on page 231

#### Export Peak List

The peak list can be exported to an ASCII file (.DAT) for analysis in an external application.

Remote command:

[MMEMory:STORe<n>:PEAK](#) on page 235

[FORMat:DEXPort:DSEParator](#) on page 182

#### 6.4.4.4 Deactivating all marker functions

**Access:** "Overview" > "Analysis" > "Marker Functions" > "All Functions Off"

**Or:** [MKR] > "All Functions Off"

All special marker functions can be deactivated in one step.

**Remote command:**

## 7 I/Q data import and export

Baseband signals mostly occur as so-called complex baseband signals, i.e. a signal representation that consists of two channels; the inphase (I) and the quadrature (Q) channel. Such signals are referred to as I/Q signals. The complete modulation information and even distortion that originates from the RF, IF or baseband domains can be analyzed in the I/Q baseband.

Importing and exporting I/Q signals is useful for various applications:

- Generating and saving I/Q signals in an RF or baseband signal generator or in external software tools to analyze them with the R&S ZNL later.
- Capturing and saving I/Q signals with the R&S ZNL to analyze them with the R&S ZNL or an external software tool later

As opposed to storing trace data, which can be averaged or restricted to peak values, I/Q data is stored as it was captured, without further processing. Multi-channel data is not supported.

The data is stored as complex values in 32-bit floating-point format. The I/Q data is stored in a format with the file extension `.iq.tar`.

For a detailed description, see the R&S ZNL I/Q Analyzer and I/Q Input User Manual.



An application note on converting Rohde & Schwarz I/Q data files is available from the Rohde & Schwarz website:

[1EF85: Converting R&S I/Q data files](#)



## 8 How to perform measurements in the R&S FPL1-K7 AM/FM/PM Modulation Analysis application

1. Press the [MODE] key.
2. Select the "AM/FM/PM Modulation Analysis" application.
3. Select "Overview" to display the "Overview" for AM/FM/PM Modulation Analysis.
4. Select "Input/Frontend" > "Frequency" tab to define the input signal's center frequency.
5. Select "Data Acquisition" and define the bandwidth parameters for the input signal:
  - "Demodulation Bandwidth" : the span of the input signal to demodulate
  - "Measurement Time": how long the input signal is measured
  - "Resolution Bandwidth" : how precise the signal is demodulated
  - "Capture Offset" (multistandard mode only): the offset of the analysis interval from the start of the capture buffer
6. Optionally, select "Trigger" and define a trigger for data acquisition, for example an offline demodulation trigger to start capturing data only when a useful signal is transmitted.
7. Select "Demod/Display" and select the demodulation displays that are of interest to you (up to 6).  
Arrange them on the display to suit your preferences.
8. Exit the SmartGrid mode and select "Overview" to display the "Overview" again.
9. Select "Demodulation Settings" to define demodulation parameters for each evaluation:
  - Configure the "Squelch" function (on the "Demod" tab) to suppress noise during demodulation.
  - For time domain evaluations, zoom into the areas of interest by defining a zoom area (on the "Demod" tab).
  - For AF evaluations, use special filters to eliminate certain effects of demodulation or to correct pre-emphasized modulated signals (on the "AF Filters" tab).
  - Adapt the diagram scaling to the displayed data (on the "Scaling" tab).
10. Select "Overview" > "Analysis" to use the advanced analysis functions in the demodulation displays.
  - Configure a trace to display the average over a series of sweeps (on the "Trace" tab. If necessary, increase the "Sweep Count" in the "Data Acquisition" settings).
  - Configure markers and delta markers to determine deviations and offsets within the demodulated signal (on the "Marker" tab).

- Use special marker functions to calculate phase noise or an n-dB-down bandwidth (on the "MarkerConfig" tab).
  - Configure a limit check to detect excessive deviations (on the "Lines" tab).
11. Start a new sweep with the defined settings.  
In multistandard mode, to stop the continuous measurement mode by the Sequencer and perform a single data acquisition:
    - a) Select the Sequencer (  ) from the toolbar.
    - b) Set the Sequencer state to "Off".
    - c) Press [RUN SINGLE].
  12. Optionally, export the trace data of the demodulated signal to a file.
    - a) In the "Traces" tab of the "Analysis" dialog box, switch to the "Trace Export" tab.
    - b) Select "Export Trace to ASCII File" .
    - c) Define a file name and storage location and select "OK".

## 8.1 How to export trace data and numerical results

The measured trace data and numerical measurement results in tables can be exported to an ASCII file. For each sweep point, the measured trace position and value are output.

The file is stored with a `.DAT` extension. For details on the storage format, see [Chapter 11.7.5, "Reference: ASCII file export format"](#), on page 188.

### To export trace data and table results

1. Select [TRACE] > Trace > "Trace / Data Export" tab.
2. Select "Export all Traces and all Table Results" to export all available measurement result data for the current application, or select a specific "Trace to Export" .
3. Optionally, select "Include Instrument & Measurement Settings" to insert additional information in the export file header.
4. If necessary, change the decimal separator for the ASCII export file.
5. Select "Export Trace to ASCII File" .
6. In the file selection dialog box, select the storage location and file name for the export file.
7. Select "Save" to close the dialog box and export the data to the file.

## 9 Measurement example: demodulating an FM signal

A practical example for a basic Analog Modulation Analysis measurement is provided here. It demonstrates how operating and measurement errors can be avoided using correct configuration settings.

The measurement is performed using the following devices:

- An R&S ZNL with the optional Spectrum application and the optional Analog Modulation Analysis application
- A vector signal generator, e.g. R&S SMW

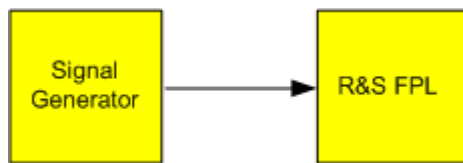

Figure 9-1: Test setup

### Signal generator settings (e.g. R&S SMW):

Frequency:	500 MHz
Level:	-10 dBm
Modulation:	FM
Modulation frequency:	10 kHz
Frequency deviation:	50 kHz

### Procedure:

1. Preset the R&S ZNL.
2. Set the center frequency to *500 MHz*.
3. Set the reference level to *0 dBm*.
4. Select the [MODE] key and then the "Analog Demod" button.

By default, the "FM Time Domain" result display and a "Result Summary" are shown.

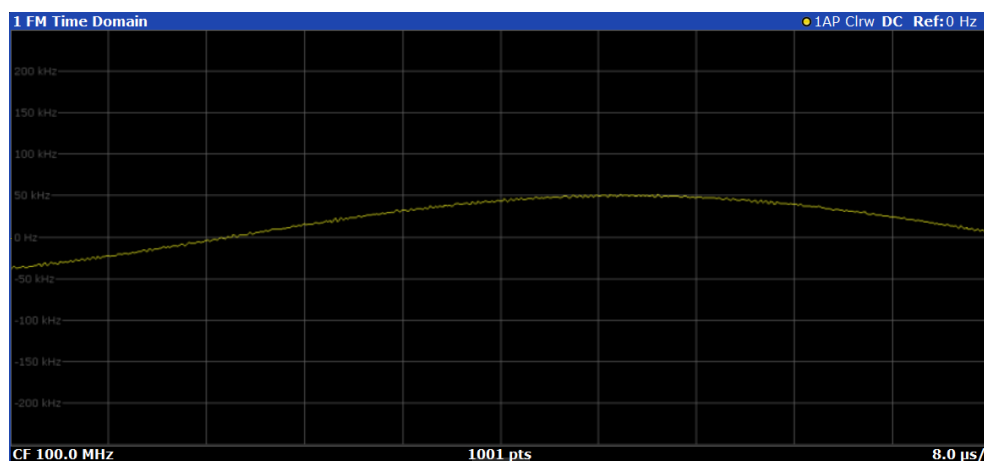

Figure 9-2: Default Analog Modulation Analysis measurement result display

5. Set the measurement time (AQT) to 1 ms to measure 10 periods of the signal.
6. Adjust the y-axis scaling to the measured frequency deviation automatically by selecting "ScaleConfig" > "Scaling" tab > "AF Auto Scale" : "On".

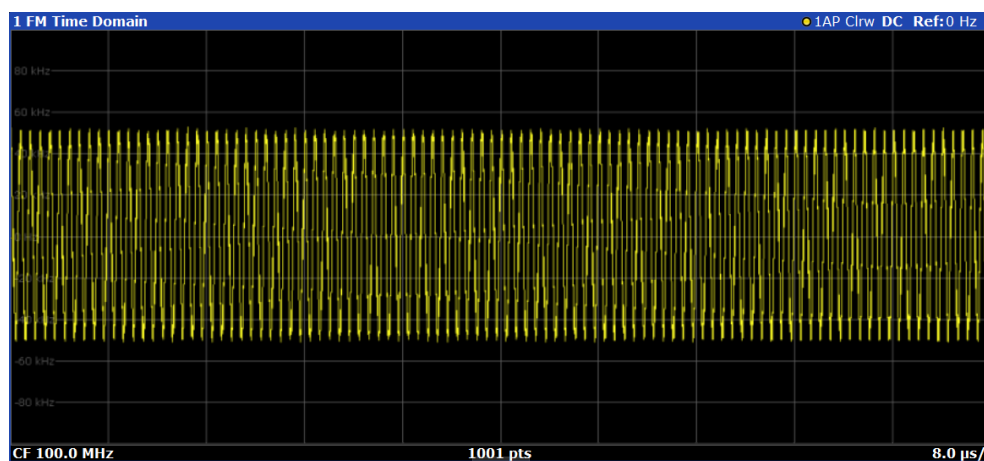

Figure 9-3: Auto-scaled measurement of 10 signal periods (continuous)

7. Display the RF spectrum of the measured signal to determine the required demodulation bandwidth. Select "Display Config" and add an "RF Spectrum" window to the display.

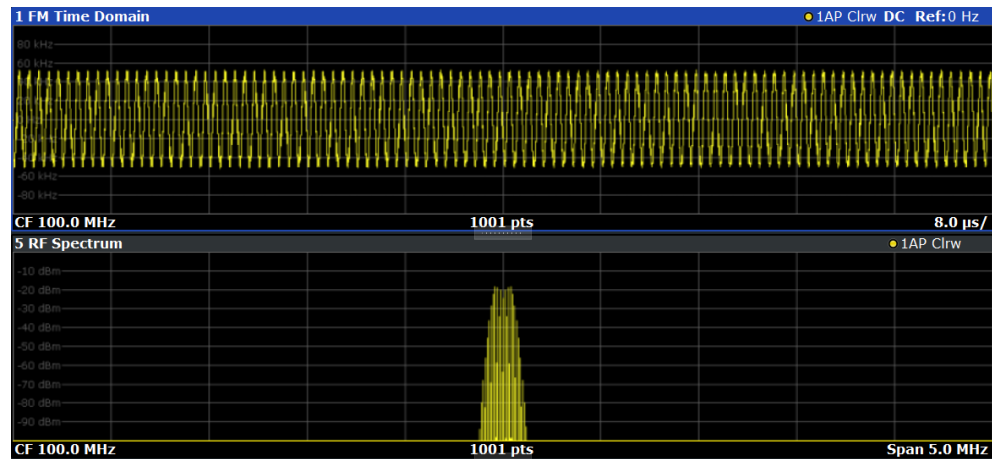

Figure 9-4: RF spectrum of FM signal with default demodulation bandwidth = 5 MHz

8. As you can see in Figure 9-4, the default demodulation bandwidth of 5 MHz is much too large - the actual signal takes up only a small part of the displayed range. That means that any noise or additional signals apart from the FM signal of interest may be included in the measured results. Select "Demod BW" and reduce the value to 200 kHz.

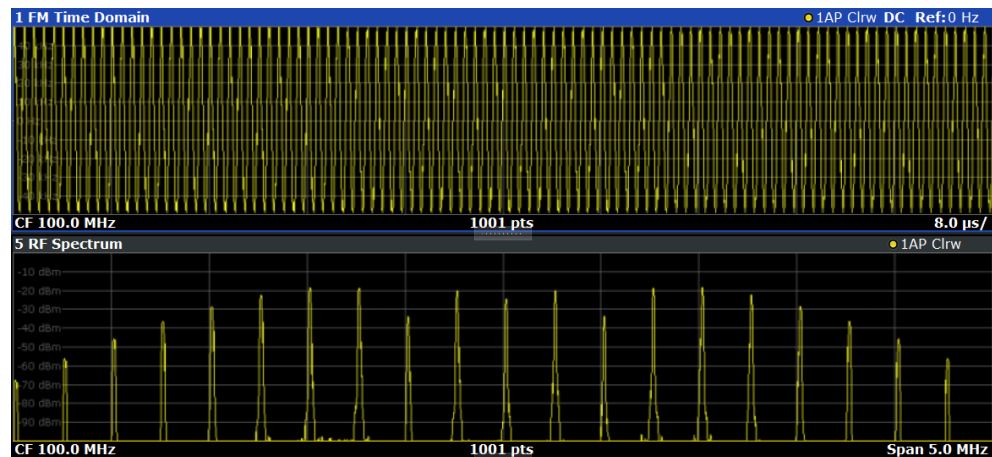

Figure 9-5: RF spectrum with demodulation bandwidth = 200 kHz

The span is automatically reduced to 200 kHz as well, as only the demodulated range can be displayed.

9. Now the RF spectrum shows that part of the FM signal is cut off. The missing signal parts are not included in the calculated results. Increase the demodulation bandwidth to 400 kHz to include the entire signal, but no interfering frequencies.

The span is not automatically increased for the wider DBW since it may be useful to display only a small range from the demodulated bandwidth. However, this means the RF spectrum will still not show the entire signal.

10. Increase the span manually to show the entire demodulated bandwidth:  
a) Select the "RF Spectrum" window.

- b) Press [SPAN].
- c) Select "Full Span".

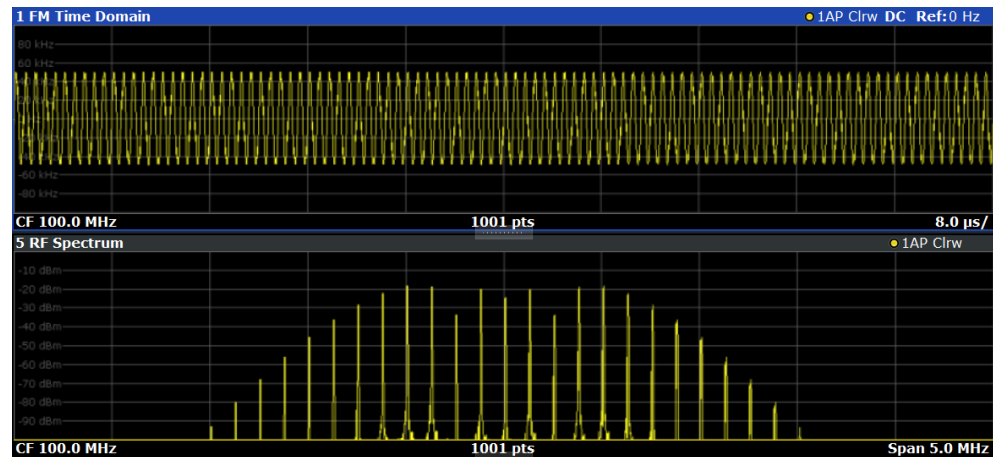

Figure 9-6: RF spectrum with demodulation bandwidth = 400 kHz

11. Once the correct DBW has been determined, you can replace the RF spectrum by the FM spectrum result display to analyze the spectrum of the FM signal. Select "Display Config" and move an "FM Spectrum" window over the "RF Spectrum" window in the display.

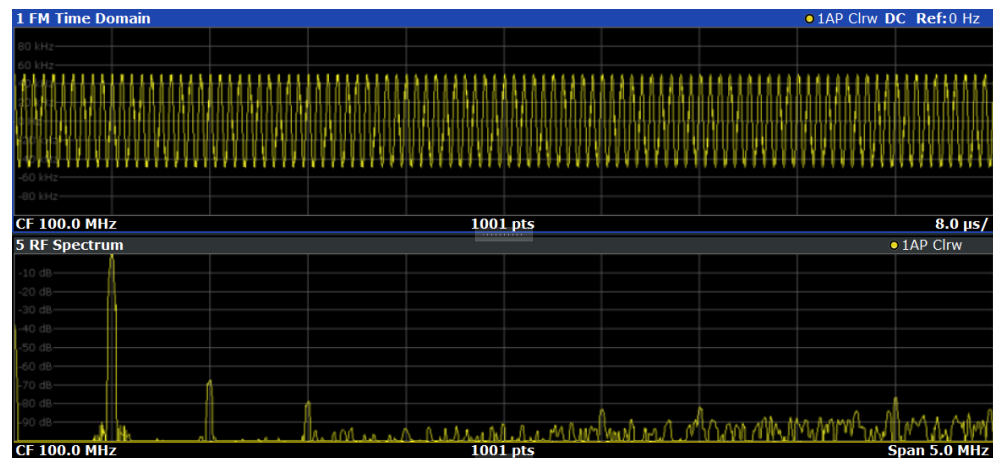
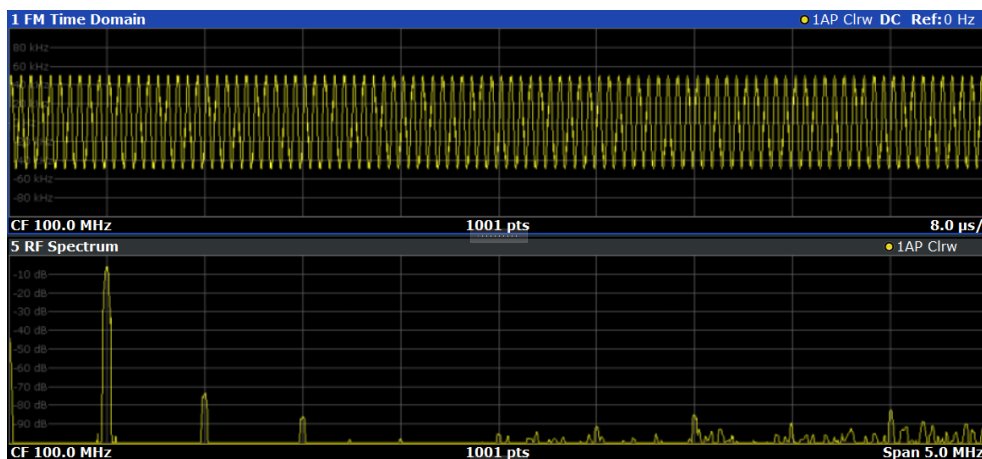

Figure 9-7: FM spectrum and Result Summary including SINAD and THD values

From the FM spectrum, the SINAD and THD are also calculated and displayed in the "Result Summary".

12. Since the "AF Auto Scale" function is enabled, the "FM Spectrum" diagram is scaled according to the current measurement automatically. Each diagram is scaled individually, so that the reference values at the top of the two diagrams can differ (100 kHz in the "FM Time Domain" versus 50 kHz in the "FM Spectrum" . However, you can adjust the values manually.
  - a) Select the "FM Spectrum" window to set the focus in it.
  - b) Press [AMPT].

- c) Select "ScaleConfig" .
- d) Disable the "AF Auto Scale" function.
- e) Define the new reference value (at 100% = top of the diagram) as *100 kHz*.



Note that while the reference values at the top of both y-axes are now identical, the reference values indicated in the window title bars are not. This is due to the fact that, by default, in AF time domain displays the reference value is defined at the reference position 50 % (=center of diagram), while in AF frequency domains it is defined at the position 100 % (= top of diagram).

# 10 Optimizing and troubleshooting the measurement

If the results do not meet your expectations, consider the following notes and tips to optimize the measurement.

## Determining the demodulation bandwidth

A frequent cause for measurement errors and false results is an **incorrectly defined demodulation bandwidth (DBW)**.

If the DBW is too large, the actual signal takes up only a small part of the demodulated range. That means that any noise or additional signal parts can be included in the measured results, which are then false.

On the other hand, if the DBW is too small, part of the signal is cut off and thus not included in the calculation of the results.

An easy way to determine the required DBW is to display the RF spectrum of the input signal. If the entire signal is displayed there and takes up most of the diagram width, the DBW is probably appropriate.

For further recommendations on finding the correct demodulation bandwidth, see [Chapter 4.2, "Demodulation bandwidth"](#), on page 26.

## Adjusting the displayed span

Be aware that the span of the "RF Spectrum" display is not automatically increased for a wider DBW. Sometimes, it can be useful to display only a small range from the demodulated bandwidth. Thus, if the RF spectrum does not show the entire demodulated bandwidth, you must increase the span manually to show the entire signal.

## Determining the SINAD and THD

The signal-to-noise-and-distortion ratio (SINAD) and the total harmonic distortion (THD) of the demodulated signal are a good indicator of the signal quality sent by the DUT. Both values are calculated inside the AF spectrum span and thus only if an AF spectrum window is displayed. If either value deviates strongly from the expected result, make sure that the demodulation bandwidth is defined correctly (see [Determining the demodulation bandwidth](#)).



# 11 Remote commands for AM/FM/PM Modulation Analysis

The commands required to perform measurements in the R&S FPL1-K7 AM/FM/PM Modulation Analysis application in a remote environment are described here.

It is assumed that the R&S ZNL has already been set up for remote control in a network as described in the R&S ZNL User Manual.

It is assumed that the R&S ZNL has already been set up for remote control in a network as described in the R&S ZNL User Manual.



A programming example at the end of the remote commands description demonstrates the most important commands in a typical application scenario, see [Chapter 11.11, "Programming example"](#), on page 266.



Note that basic tasks that are also performed in the base unit in the same way are not described here. For a description of such tasks, see the R&S ZNL User Manual.

In particular:

- Basic instrument configuration, e.g. checking the system configuration, customizing the screen layout, or configuring networks and remote operation
- Using the common status registers



## Status registers

The R&S FPL1-K7 option uses the status registers of the base unit (except for the `STATUS:QUESTIONABLE:ACPLimit` register).

For a description, see the R&S ZNL User Manual.

## General R&S ZNL Remote Commands

The application-independent remote commands for general tasks on the R&S ZNL are also available for AM/FM/PM Modulation Analysis and are described in the R&S ZNL User Manual. In particular:

- Managing settings and results
- Setting up the instrument
- Using the status register

## Channel Setup-specific commands

Apart from a few general commands on the R&S ZNL, most commands refer to the currently active channel setup. Thus, always remember to activate an Analog Modulation Analysis channel setup before starting a remote program for an Analog Modulation Analysis.

• Introduction.....	114
• Common suffixes.....	119
• Activating analog modulation analysis.....	119
• Configuring the measurement.....	122
• Capturing data and performing sweeps.....	167
• Configuring the result display.....	170
• Retrieving results.....	178
• Analyzing results.....	190
• Importing and exporting I/Q data and results.....	264
• Deprecated commands.....	265
• Programming example.....	266

## 11.1 Introduction

Commands are program messages that a controller (e.g. a PC) sends to the instrument or software. They operate its functions ('setting commands' or 'events') and request information ('query commands'). Some commands can only be used in one way, others work in two ways (setting and query). If not indicated otherwise, the commands can be used for settings and queries.

The syntax of a SCPI command consists of a header and, usually, one or more parameters. To use a command as a query, you have to append a question mark after the last header element, even if the command contains a parameter.

A header contains one or more keywords, separated by a colon. Header and parameters are separated by a "white space" (ASCII code 0 to 9, 11 to 32 decimal, e.g. blank). If there is more than one parameter for a command, they are separated by a comma from one another.

Only the most important characteristics that you need to know when working with SCPI commands are described here. For a more complete description, refer to the user manual of the R&S ZNL.



### Remote command examples

Note that some remote command examples mentioned in this general introduction are possibly not supported by this particular application.

### 11.1.1 Conventions used in descriptions

The following conventions are used in the remote command descriptions:

- **Command usage**  
If not specified otherwise, commands can be used both for setting and for querying parameters.  
If a command can be used for setting or querying only, or if it initiates an event, the usage is stated explicitly.
- **Parameter usage**

If not specified otherwise, a parameter can be used to set a value and it is the result of a query.

Parameters required only for setting are indicated as **Setting parameters**.

Parameters required only to refine a query are indicated as **Query parameters**.

Parameters that are only returned as the result of a query are indicated as **Return values**.

- **Conformity**

Commands that are taken from the SCPI standard are indicated as **SCPI confirmed**. All commands used by the R&S ZNL follow the SCPI syntax rules.

- **Asynchronous commands**

A command which does not automatically finish executing before the next command starts executing (overlapping command) is indicated as an **Asynchronous command**.

- **Reset values (\*RST)**

Default parameter values that are used directly after resetting the instrument (\*RST command) are indicated as \*RST values, if available.

- **Default unit**

The default unit is used for numeric values if no other unit is provided with the parameter.

### 11.1.2 Long and short form

The keywords have a long and a short form. You can use either the long or the short form, but no other abbreviations of the keywords.

The short form is emphasized in uppercase letters. Note however, that this emphasis only serves the purpose to distinguish the short from the long form in the manual. For the instrument, the case does not matter.

**Example:**

`SENSe:FREQuency:CENTer` is the same as `SENS:FREQ:CENT`.

### 11.1.3 Numeric suffixes

Some keywords have a numeric suffix if the command can be applied to multiple instances of an object. In that case, the suffix selects a particular instance (e.g. a measurement window).

Numeric suffixes are indicated by angular brackets (<n>) next to the keyword.

If you do not quote a suffix for keywords that support one, a 1 is assumed.

**Example:**

`DISPlay[:WINDow<1...4>]:ZOOM:STATe` enables the zoom in a particular measurement window, selected by the suffix at `WINDow`.

`DISPlay:WINDow4:ZOOM:STATe ON` refers to window 4.

### 11.1.4 Optional keywords

Some keywords are optional and are only part of the syntax because of SCPI compliance. You can include them in the header or not.



If an optional keyword has a numeric suffix and you need to use the suffix, you have to include the optional keyword. Otherwise, the suffix of the missing keyword is assumed to be the value 1.

Optional keywords are emphasized with square brackets.

**Example:**

Without a numeric suffix in the optional keyword:

```
[SENSe:]FREQuency:CENTer is the same as FREQuency:CENTer
```

With a numeric suffix in the optional keyword:

```
DISPlay[:WINDow<1...4>]:ZOOM:STATe
```

DISPlay:ZOOM:STATe ON enables the zoom in window 1 (no suffix).

DISPlay:WINDow4:ZOOM:STATe ON enables the zoom in window 4.

### 11.1.5 Alternative keywords

A vertical stroke indicates alternatives for a specific keyword. You can use both keywords to the same effect.

**Example:**

```
[SENSe:]BANDwidth|BWIDth[:RESolution]
```

In the short form without optional keywords, BAND 1MHZ would have the same effect as BWID 1MHZ.

### 11.1.6 SCPI parameters

Many commands feature one or more parameters.

If a command supports more than one parameter, they are separated by a comma.

**Example:**

```
LAYout:ADD:WINDow Spectrum,LEFT,MTABLE
```

Parameters can have different forms of values.

- [Numeric values](#)..... 117
- [Boolean](#)..... 117
- [Character data](#)..... 118
- [Character strings](#)..... 118
- [Block data](#)..... 118

### 11.1.6.1 Numeric values

Numeric values can be entered in any form, i.e. with sign, decimal point or exponent. For physical quantities, you can also add the unit. If the unit is missing, the command uses the basic unit.

**Example:**

With unit: `SENSe:FREQuency:CENTer 1GHZ`

Without unit: `SENSe:FREQuency:CENTer 1E9` would also set a frequency of 1 GHz.

Values exceeding the resolution of the instrument are rounded up or down.

If the number you have entered is not supported (e.g. for discrete steps), the command returns an error.

Instead of a number, you can also set numeric values with a text parameter in special cases.

- **MIN/MAX**  
Defines the minimum or maximum numeric value that is supported.
- **DEF**  
Defines the default value.
- **UP/DOWN**  
Increases or decreases the numeric value by one step. The step size depends on the setting. Sometimes, you can customize the step size with a corresponding command.

#### Querying numeric values

When you query numeric values, the system returns a number. For physical quantities, it applies the basic unit (e.g. Hz for frequencies). The number of digits after the decimal point depends on the type of numeric value.

**Example:**

Setting: `SENSe:FREQuency:CENTer 1GHZ`

Query: `SENSe:FREQuency:CENTer?` would return `1E9`

Sometimes, numeric values are returned as text.

- **INF/NINF**  
Infinity or negative infinity. Represents the numeric values 9.9E37 or -9.9E37.
- **NAN**  
Not a number. Represents the numeric value 9.91E37. NAN is returned if errors occur.

### 11.1.6.2 Boolean

Boolean parameters represent two states. The "on" state (logically true) is represented by "ON" or the numeric value 1. The "off" state (logically untrue) is represented by "OFF" or the numeric value 0.

### Querying Boolean parameters

When you query Boolean parameters, the system returns either the value 1 ("ON") or the value 0 ("OFF").

#### Example:

Setting: `DISPlay:WINDow:ZOOM:STATe ON`

Query: `DISPlay:WINDow:ZOOM:STATe?` would return 1

### 11.1.6.3 Character data

Character data follows the syntactic rules of keywords. You can enter text using a short or a long form. For more information, see [Chapter 11.1.2, "Long and short form"](#), on page 115.

### Querying text parameters

When you query text parameters, the system returns its short form.

#### Example:

Setting: `SENSe:BANDwidth:RESolution:TYPE NORMal`

Query: `SENSe:BANDwidth:RESolution:TYPE?` would return NORM

### 11.1.6.4 Character strings

Strings are alphanumeric characters. They have to be in straight quotation marks. You can use a single quotation mark ( ' ) or a double quotation mark ( " ).

#### Example:

`INSTRument:DELeTe 'Spectrum'`

### 11.1.6.5 Block data

Block data is a format which is suitable for the transmission of large amounts of data.

The ASCII character # introduces the data block. The next number indicates how many of the following digits describe the length of the data block. The data bytes follow. During the transmission of these data bytes, all end or other control signs are ignored until all bytes are transmitted. #0 specifies a data block of indefinite length. The use of the indefinite format requires an `NL^END` message to terminate the data block. This format is useful when the length of the transmission is not known or if speed or other considerations prevent segmentation of the data into blocks of definite length.

## 11.2 Common suffixes

In the R&S FPL1-K7 AM/FM/PM Modulation Analysis application, the following common suffixes are used in remote commands:

*Table 11-1: Common suffixes used in remote commands in the R&S FPL1-K7 AM/FM/PM Modulation Analysis application*

Suffix	Value range	Description
<m>	1 to 16	Marker
<n>	1 to 6	Window (in the currently selected channel setup)
<t>	1 to 6	Trace
<li>	1 to 8	Limit line

## 11.3 Activating analog modulation analysis

Analog Modulation Analysis require a special application on the R&S ZNL. The measurement is started immediately with the default settings.

<a href="#">INSTrument:CREate:DUPLicate</a> .....	119
<a href="#">INSTrument:CREate[:NEW]</a> .....	119
<a href="#">INSTrument:CREate:REPLace</a> .....	120
<a href="#">INSTrument:DELeTe</a> .....	120
<a href="#">INSTrument:LIST?</a> .....	120
<a href="#">INSTrument:REName</a> .....	121
<a href="#">INSTrument[:SELeCt]</a> .....	121
<a href="#">SYSTem:PRESet:CHANnel[:EXEC]</a> .....	122

---

### **INSTrument:CREate:DUPLicate**

This command duplicates the currently selected channel setup, i.e creates a new channel setup of the same type and with the identical measurement settings. The name of the new channel setup is the same as the copied channel setup, extended by a consecutive number (e.g. "IQAnalyzer" -> "IQAnalyzer 2").

The channel setup to be duplicated must be selected first using the `INST:SEL` command.

**Usage:**                      Event

---

### **INSTrument:CREate[:NEW] <ChannelType>, <ChannelName>**

This command adds a measurement channel. You can configure up to 10 measurement channels at the same time (depending on available memory).

**Parameters:**

- <ChannelType> Channel type of the new channel.  
For a list of available channel types, see [INSTrument:LIST?](#) on page 120.
- <ChannelName> String containing the name of the channel.  
Note that you cannot assign an existing channel name to a new channel. If you do, an error occurs.

**Example:**

```
INST:CRE SAN, 'Spectrum 2'
```

Adds a spectrum display named "Spectrum 2".

**INSTrument:CREate:REPLace** <ChannelName1>,<ChannelType>,<ChannelName2>

This command replaces a channel setup with another one.

**Setting parameters:**

- <ChannelName1> String containing the name of the channel setup you want to replace.
- <ChannelType> Channel type of the new channel setup.  
For a list of available channel setup types, see [INSTrument:LIST?](#) on page 120.
- <ChannelName2> String containing the name of the new channel setup.  
**Note:** If the specified name for a new channel setup already exists, the default name, extended by a sequential number, is used for the new channel setup (see [INSTrument:LIST?](#) on page 120).  
Channel names can have a maximum of 31 characters, and must be compatible with the Windows conventions for file names. In particular, they must not contain special characters such as ":", "\*", "?".

**Usage:** Setting only

**INSTrument:DELeTe** <ChannelName>

This command deletes a channel setup.

**Setting parameters:**

- <ChannelName> String containing the name of the channel setup you want to delete.  
A channel setup must exist to delete it.

**Usage:** Setting only

**INSTrument:LIST?**

This command queries all active channel setups. The query is useful to obtain the names of the existing channel setups, which are required to replace or delete the channel setups.



**Return values:**

<ChannelType>, For each channel setup, the command returns the channel setup type and channel setup name (see tables below).  
<ChannelName>

Tip: to change the channel setup name, use the [INSTrument:REName](#) command.

**Example:**

INST:LIST?

Result for 3 channel setups:

```
'ADEM', 'Analog Demod', 'IQ', 'IQ Analyzer', 'IQ', 'IQ Analyzer2'
```

**Usage:**

Query only

**Table 11-2: Available channel setup types and default channel setup names**

Application	<ChannelType> Parameter	Default Channel Setup Name*)
Spectrum	SANALYZER	Spectrum
AM/FM/PM Modulation Analysis	ADEM	Analog Demod
I/Q Analyzer	IQ	IQ Analyzer
Noise Figure Measurements	NOISE	Noise
Vector Signal Analysis (VSA)	DDEM	VSA
Network analysis	Vna	VNA

Note: the default channel setup name is also listed in the table. If the specified name for a new channel setup already exists, the default name, extended by a sequential number, is used for the new channel setup.

---

**INSTrument:REName** <ChannelName1>, <ChannelName2>

This command renames a channel setup.

**Setting parameters:**

<ChannelName1> String containing the name of the channel setup you want to rename.

<ChannelName2> String containing the new channel setup name.  
Note that you cannot assign an existing channel setup name to a new channel setup. If you do, an error occurs.  
Channel names can have a maximum of 31 characters, and must be compatible with the Windows conventions for file names. In particular, they must not contain special characters such as ":", "\*", "?".

**Usage:**

Setting only

---

**INSTrument[:SElect]** <ChannelType>

Selects the channel type for the current channel.

See also `INSTrument:CREate[:NEW]` on page 119.

For a list of available channel types, see `INSTrument:LIST?` on page 120.

**Parameters:**

<ChannelType>      **ADEMod**  
Optional Analog Modulation Analysis application.

---

**SYSTem:PRESet:CHANnel[:EXEC]**

This command restores the default instrument settings in the current channel setup.

Use `INST:SEL` to select the channel setup.

**Example:**            `INST:SEL 'Spectrum2'`  
Selects the channel setup for "Spectrum2".  
`SYST:PRESet:CHAN:EXEC`  
Restores the factory default settings to the "Spectrum2"channel setup.

**Usage:**              Event

**Manual operation:** See "[Preset Channel Setup](#)" on page 33

## 11.4 Configuring the measurement

The following remote commands are required to configure an Analog Modulation Analysis.

**Specific commands:**

- [Managing standard settings](#)..... 122
- [Configuring the input](#)..... 123
- [Configuring the output](#)..... 126
- [Frequency settings](#)..... 127
- [Configuring the vertical axis \(amplitude, scaling\)](#)..... 129
- [Configuring data acquisition](#)..... 134
- [Triggering](#)..... 138
- [Configuring demodulation](#)..... 143
- [Adjusting settings automatically](#)..... 163

### 11.4.1 Managing standard settings

You can configure the R&S FPL1-K7 AM/FM/PM Modulation Analysis application using predefined standard settings, allowing for quick and easy configuration for commonly performed measurements.

For details, see [Chapter 5.2, "Configuration according to standards"](#), on page 33.

For an overview of predefined standards and settings, see [Chapter A, "Predefined standards and settings"](#), on page 269.

<a href="#">[SENSe:]ADEMod:PRESet[:STANdard]</a> .....	123
<a href="#">[SENSe:]ADEMod:PRESet:RESTore</a> .....	123
<a href="#">[SENSe:]ADEMod:PRESet:STORE</a> .....	123

---

#### **[SENSe:]ADEMod:PRESet[:STANdard] <Standard>**

This command loads a measurement configuration.

Standard definitions are stored in an xml file. The default directory for Analog Modulation Analysis standards is C :

```
\Users\Public\Documents\Rohde-Schwarz\ZNL\user\predefined\AdemodPredefined
.
```

#### **Parameters:**

<Standard>                      String containing the file name.  
If you have stored the file in a subdirectory of the directory mentioned above, you have to include the relative path to the file.

**Manual operation:**    See "[Load Standard](#)" on page 35

---

#### **[SENSe:]ADEMod:PRESet:RESTore**

**Manual operation:**    See "[Restore Standard Files](#)" on page 35

---

#### **[SENSe:]ADEMod:PRESet:STORE <Standard>**

This command saves the current Analog Modulation Analysis measurement configuration.

Standard definitions are stored in an XML file. The default directory for Analog Modulation Analysis standards is C :

```
\Users\Public\Documents\Rohde-Schwarz\ZNL\user\predefined\AdemodPredefined
.
```

#### **Parameters:**

<Standard>                      String containing the file name.  
You can save the file in a subdirectory of the directory mentioned above. In that case, you have to include the relative path to the file.

**Manual operation:**    See "[Save Standard](#)" on page 35

## **11.4.2 Configuring the input**

• <a href="#">RF input</a> .....	124
• <a href="#">Configuring file input</a> .....	125

### 11.4.2.1 RF input

INPut<ip>:ATTenuation:PROTection:RESet.....	124
INPut<ip>:FILTer:YIG[:STATe].....	124
INPut<ip>:IMPedance.....	124
INPut<ip>:SELect.....	125

---

#### INPut<ip>:ATTenuation:PROTection:RESet

This command resets the attenuator and reconnects the RF input with the input mixer for the R&S ZNL after an overload condition occurred and the protection mechanism intervened. The error status bit (bit 3 in the `STAT:QUES:POW` status register) and the `INPUT OVLD` message in the status bar are cleared.

(For details on the status register see the R&S ZNL Spectrum Mode User Manual).

The command works only if the overload condition has been eliminated first.

#### Suffix:

<ip>                    1 | 2  
                          irrelevant

**Example:**            INP:ATT:PROT:RES

---

#### INPut<ip>:FILTer:YIG[:STATe] <State>

Enables or disables the YIG filter.

#### Suffix:

<ip>                    1 | 2  
                          irrelevant

**Example:**            INP:FILT:YIG OFF  
                          Deactivates the YIG-preselector.

**Manual operation:** See " [YIG-Preselector](#) " on page 37

---

#### INPut<ip>:IMPedance <Impedance>

This command selects the nominal input impedance of the RF input. In some applications, only 50  $\Omega$  are supported.

#### Suffix:

<ip>                    1 | 2  
                          irrelevant

#### Parameters:

<Impedance>        50 | 75  
                          \*RST:        50  $\Omega$   
                          Default unit: OHM

**Example:**            INP:IMP 75

**Manual operation:** See " [Impedance](#) " on page 36  
See " [Unit](#) " on page 39

---

### **INPut<ip>:SElect <Source>**

This command selects the signal source for measurements, i.e. it defines which connector is used to input data to the R&S ZNL.

Tip: The I/Q data to be analyzed for AM/FM/PM Modulation Analysis cannot only be measured by the R&S FPL1-K7 AM/FM/PM Modulation Analysis application itself, it can also be imported to the application, provided it has the correct format. Furthermore, the analyzed I/Q data from the R&S FPL1-K7 AM/FM/PM Modulation Analysis application can be exported for further analysis in external applications.

For details, see the R&S ZNL I/Q Analyzer and I/Q Input User Manual.

#### **Suffix:**

<ip>                    1 | 2  
                          irrelevant

#### **Parameters:**

<Source>                **RF**  
                             Radio Frequency ("RF INPUT" connector)  
\*RST:                    RF

**Manual operation:** See " [Radio Frequency State](#) " on page 36

## 11.4.2.2 **Configuring file input**

The following commands are required to define input from a file.

Useful commands for configuring file input described elsewhere:

- [INPut<ip>:SElect](#) on page 125

#### **Remote commands exclusive to configuring input from files:**

[INPut<ip>:FILE:PATH](#)..... 125

---

### **INPut<ip>:FILE:PATH <FileName>[, <AnalysisBW>]**

This command selects the I/Q data file to be used as input for further measurements.

The I/Q data must have a specific format as described in R&S ZNL I/Q Analyzer and I/Q Input User Manual.

#### **Suffix:**

<ip>                    1 | 2  
                          irrelevant

#### **Parameters:**

<FileName>             String containing the path and name of the source file.  
                             The file extension is \*.iq.tar.

<AnalysisBW>      Optionally: The analysis bandwidth to be used by the measurement. The bandwidth must be smaller than or equal to the bandwidth of the data that was stored in the file.

Default unit: HZ

**Example:**            INP:FILE:PATH 'C:\R\_S\Instr\user\data.iq.tar'  
Uses I/Q data from the specified file as input.

### 11.4.3 Configuring the output

The following commands configure signal output.

DIAGnostic:SERvice:NSOource.....	126
SYSTem:SPEaker[:STATe].....	126
SYSTem:SPEaker:VOLume.....	127

---

#### DIAGnostic:SERvice:NSOource <State>

This command turns the 28 V supply of the BNC connector labeled [noise source control] on the R&S ZNL on and off.

##### Parameters:

<State>            ON | OFF | 0 | 1  
**OFF | 0**  
 Switches the function off  
**ON | 1**  
 Switches the function on

**Example:**            DIAG:SERV:NSO ON

**Manual operation:** See "[Noise Source Control](#)" on page 69

---

#### SYSTem:SPEaker[:STATe] <State>

This command switches the built-in loudspeaker on or off for demodulated signals. This setting applies only to the current application.

The command is available in the time domain in Spectrum mode and in Analog Modulation Analysis mode.

To set the volume, use the `SYSTem:SPEaker:VOLume` command.

##### Parameters:

<State>            ON | OFF | 0 | 1  
**OFF | 0**  
 Switches the function off  
**ON | 1**  
 Switches the function on

**Example:**            SYST:SPE ON  
 SYST:SPE:VOL 0.5  
 Sets the loudspeaker to half the full volume.

**SYSTem:SPEaker:VOLume** <Volume>

This command defines the volume of the built-in loudspeaker for demodulated signals. This setting is maintained for all applications.

The command is available in the time domain in Spectrum mode and in Analog Modulation Analysis mode.

Note that you must switch the loudspeaker on first, using the [SYSTem:SPEaker \[ : STATE\]](#) command.

**Parameters:**

<Volume> Percentage of the maximum possible volume.  
 Range: 0 to 1  
 \*RST: 0.5

**Example:**

```
SYST:SPE:VOL 0
```

Switches the loudspeaker to mute.

**11.4.4 Frequency settings**

<a href="#">[SENSe:]FREQuency:CENTer</a> .....	127
<a href="#">[SENSe:]FREQuency:CENTer:STEP</a> .....	127
<a href="#">[SENSe:]FREQuency:CENTer:STEP:LINK</a> .....	128
<a href="#">[SENSe:]FREQuency:CENTer:STEP:LINK:FACTor</a> .....	128

**[SENSe:]FREQuency:CENTer** <Frequency>

This command defines the center frequency.

**Parameters:**

<Frequency> The allowed range and  $f_{max}$  is specified in the data sheet.  
 \*RST:  $f_{max}/2$   
 Default unit: Hz

**Example:**

```
FREQ:CENT 100 MHz
FREQ:CENT:STEP 10 MHz
FREQ:CENT UP
```

Sets the center frequency to 110 MHz.

**Manual operation:** See "[Center Frequency](#)" on page 41

**[SENSe:]FREQuency:CENTer:STEP** <StepSize>

This command defines the center frequency step size.

You can increase or decrease the center frequency quickly in fixed steps using the [SENS:FREQ UP](#) AND [SENS:FREQ DOWN](#) commands, see [\[SENSe:\]FREQuency:CENTer](#) on page 127.

**Parameters:**

<StepSize>  $f_{\max}$  is specified in the data sheet.  
 Range: 1 to fMAX  
 \*RST: 0.1 x span  
 Default unit: Hz

**Example:**

```
//Set the center frequency to 110 MHz.
FREQ:CENT 100 MHz
FREQ:CENT:STEP 10 MHz
FREQ:CENT UP
```

**Manual operation:** See "[Center Frequency Stepsize](#)" on page 41

**[SENSe:]FREQuency:CENTer:STEP:LINK <CouplingType>**

This command couples and decouples the center frequency step size to the span or the resolution bandwidth.

**Parameters:**

<CouplingType> SPAN | RBW | OFF

**SPAN**

Couples the step size to the span. Available for measurements in the frequency domain.  
 (for RF spectrum result display)

**RBW**

Couples the step size to the resolution bandwidth. Available for measurements in the time domain.  
 (for all result displays except RF spectrum)

**OFF**

Decouples the step size.

\*RST: SPAN

**Example:**

```
//Couple step size to span
FREQ:CENT:STEP:LINK SPAN
```

**Manual operation:** See "[Center Frequency Stepsize](#)" on page 41

**[SENSe:]FREQuency:CENTer:STEP:LINK:FACTor <Factor>**

This command defines a step size factor if the center frequency step size is coupled to the span or the resolution bandwidth.

**Parameters:**

<Factor> 1 to 100 PCT  
 \*RST: 10  
 Default unit: PCT

**Example:**

```
//Couple frequency step size to span and define a step size factor
FREQ:CENT:STEP:LINK SPAN
FREQ:CENT:STEP:LINK:FACT 20PCT
```



**Manual operation:** See " [Center Frequency Stepsize](#) " on page 41

## 11.4.5 Configuring the vertical axis (amplitude, scaling)

The following commands are required to configure the amplitude and vertical axis settings in a remote environment.

- [Amplitude settings](#)..... 129
- [Configuring the attenuation](#)..... 131
- [Scaling the Y-axis](#)..... 132

### 11.4.5.1 Amplitude settings

**Useful commands for amplitude configuration described elsewhere:**

- [\[SENSe:\]ADJust:LEVel](#) on page 166

**Remote commands exclusive to amplitude configuration:**

<a href="#">CALCulate&lt;n&gt;:MARKer&lt;m&gt;:FUNction:REFerence</a> .....	129
<a href="#">UNIT&lt;n&gt;:POWer</a> .....	129
<a href="#">CALCulate&lt;n&gt;:UNIT:POWer</a> .....	129
<a href="#">DISPlay[:WINDow&lt;n&gt;][:SUBWindow&lt;w&gt;]:TRACe&lt;t&gt;:Y[:SCALe]:RLEVel</a> .....	130
<a href="#">DISPlay[:WINDow&lt;n&gt;][:SUBWindow&lt;w&gt;]:TRACe&lt;t&gt;:Y[:SCALe]:RLEVel:OFFSet</a> .....	130

---

#### **CALCulate<n>:MARKer<m>:FUNction:REFerence**

This command matches the reference level to the power level of a marker.

If you use the command in combination with a delta marker, that delta marker is turned into a normal marker.

**Suffix:**

<n>                      [Window](#)

<m>                      [Marker](#)

**Example:**

`CALC:MARK2:FUNC:REF`

Sets the reference level to the level of marker 2.

---

#### **UNIT<n>:POWer <Unit>**

#### **CALCulate<n>:UNIT:POWer <Unit>**

This command selects the unit of the y-axis.

The unit applies to all power-based measurement windows with absolute values.

**Suffix:**

<n>                      irrelevant

**Parameters:**

<Unit> (Units based on 1 MHz require installed R&S FPL1-K54 (EMI measurements) option.)

\*RST: dBm

**Example:**

CALC:UNIT:POW DBM

Sets the power unit to dBm.

**Manual operation:** See "[Unit](#)" on page 39

**DISPlay[:WINDow<n>][:SUBWindow<w>]:TRACe<t>:Y[:SCALE]:RLEVel**  
<ReferenceLevel>

This command defines the reference level (for all traces in all windows).

With a reference level offset  $\neq 0$ , the value range of the reference level is modified by the offset.

**Suffix:**

<n> irrelevant

<w> subwindow  
Not supported by all applications

<t> irrelevant

**Parameters:**

<ReferenceLevel> The unit is variable.

Range: see datasheet

\*RST: 0 dBm

Default unit: DBM

**Example:**

DISP:TRAC:Y:RLEV -60dBm

**Manual operation:** See "[Reference Level](#)" on page 38

**DISPlay[:WINDow<n>][:SUBWindow<w>]:TRACe<t>:Y[:SCALE]:RLEVel:OFFSet**  
<Offset>

This command defines a reference level offset (for all traces in all windows).

**Suffix:**

<n> irrelevant

<w> subwindow  
Not supported by all applications

<t> irrelevant

**Parameters:**

<Offset> Range: -200 dB to 200 dB

\*RST: 0dB

Default unit: DB

**Example:**

DISP:TRAC:Y:RLEV:OFFS -10dB

**Manual operation:** See "[Shifting the Display \(Offset\)](#)" on page 38

#### 11.4.5.2 Configuring the attenuation

<a href="#">INPut&lt;ip&gt;:ATTenuation</a> .....	131
<a href="#">INPut&lt;ip&gt;:EATT:AUTO</a> .....	131
<a href="#">INPut&lt;ip&gt;:ATTenuation:AUTO</a> .....	131

---

##### INPut<ip>:ATTenuation <Attenuation>

This command defines the total attenuation for RF input.

If you set the attenuation manually, it is no longer coupled to the reference level, but the reference level is coupled to the attenuation. Thus, if the current reference level is not compatible with an attenuation that has been set manually, the command also adjusts the reference level.

**Suffix:**

<ip>                    1 | 2  
                          irrelevant

**Parameters:**

<Attenuation>        Range:        see data sheet  
                          Increment:  5 dB (with optional electr. attenuator: 1 dB)  
                          \*RST:        10 dB (AUTO is set to ON)  
                          Default unit: DB

**Example:**

INP:ATT 30dB  
Defines a 30 dB attenuation and decouples the attenuation from the reference level.

**Manual operation:** See "[Attenuation Mode / Value](#)" on page 40

---

##### INPut<ip>:EATT:AUTO <State>

##### INPut<ip>:ATTenuation:AUTO <State>

This command couples or decouples the attenuation to the reference level. Thus, when the reference level is changed, the R&S ZNL determines the signal level for optimal internal data processing and sets the required attenuation accordingly.

For the R&S ZNL, these commands are identical.

**Suffix:**

<ip>                    1 | 2  
                          irrelevant

**Parameters:**

<State>                ON | OFF | 0 | 1  
                          \*RST:        1

**Example:**

INP:ATT:AUTO ON  
Couples the attenuation to the reference level.

**Manual operation:** See "[Attenuation Mode / Value](#)" on page 40

### 11.4.5.3 Scaling the Y-axis

DISPlay[:WINDow<n>][:SUBWindow<w>]:TRACe<t>:Y[:SCALe].....	132
DISPlay[:WINDow<n>][:SUBWindow<w>]:TRACe<t>:Y[:SCALe]:AUTO ONCE.....	132
DISPlay[:WINDow<n>][:SUBWindow<w>]:TRACe<t>:Y[:SCALe]:MODE.....	132
DISPlay[:WINDow<n>][:SUBWindow<w>]:TRACe<t>:Y[:SCALe]:PDIVision.....	133
DISPlay[:WINDow<n>][:SUBWindow<w>]:TRACe<t>:Y[:SCALe]:RPOStion.....	133
DISPlay[:WINDow<n>][:SUBWindow<w>]:TRACe<t>:Y:SPACing.....	134

---

#### DISPlay[:WINDow<n>][:SUBWindow<w>]:TRACe<t>:Y[:SCALe] <Range>

This command defines the display range of the y-axis (for all traces).

##### Suffix:

<n>	Window
<w>	subwindow Not supported by all applications
<t>	irrelevant

##### Parameters:

<Range>	If the y-axis shows the power, the unit is dB with a range from 10 dB to 200 dB. If the y-axis shows the frequency, the unit is Hz with a variable range. *RST: 100 dB (frequency domain), 500 kHz (time domain)
---------	--

**Example:** DISP:TRAC:Y 110dB

**Manual operation:** See "Range" on page 62

---

#### DISPlay[:WINDow<n>][:SUBWindow<w>]:TRACe<t>:Y[:SCALe]:AUTO ONCE

Automatic scaling of the y-axis is performed once, then switched off again (for all traces).

##### Suffix:

<n>	Window
<t>	irrelevant

**Manual operation:** See "Auto Scale Once" on page 63

---

#### DISPlay[:WINDow<n>][:SUBWindow<w>]:TRACe<t>:Y[:SCALe]:MODE <Mode>

This command selects the type of scaling of the y-axis (for all traces).

When the display update during remote control is off, this command has no immediate effect.

##### Suffix:

<n>	Window
<w>	subwindow

<t> irrelevant

**Parameters:**

<Mode> **ABSolute**  
absolute scaling of the y-axis

**RELative**  
relative scaling of the y-axis

\*RST: ABSolute

**Example:** DISP:TRAC:Y:MODE REL

**Manual operation:** See "[Scaling](#)" on page 63

**DISPlay[:WINDow<n>][:SUBWindow<w>]:TRACe<t>:Y[:SCALE]:PDIVision**  
<Value>

This remote command determines the grid spacing on the Y-axis for all diagrams, where possible.

In spectrum displays, for example, this command is not available.

**Suffix:**

<n> [Window](#)

<w> subwindow  
Not supported by all applications

<t> irrelevant

**Parameters:**

<Value> numeric value WITHOUT UNIT (unit according to the result display)

Defines the range per division (total range = 10\*<Value>)

\*RST: depends on the result display

Default unit: DBM

**Example:** DISP:TRAC:Y:PDIV 10  
Sets the grid spacing to 10 units (e.g. dB) per division

**Manual operation:** See "[Dev per Division / dB per Division](#)" on page 60

**DISPlay[:WINDow<n>][:SUBWindow<w>]:TRACe<t>:Y[:SCALE]:RPOSITION**  
<Position>

This command defines the vertical position of the reference level on the display grid (for all traces).

The R&S ZNL adjusts the scaling of the y-axis accordingly.

**Suffix:**

<n> [Window](#)

<w> subwindow  
Not supported by all applications

<t> irrelevant

**Example:** DISP:TRAC:Y:RPOS 50PCT

**Manual operation:** See "Reference Value Position" on page 60  
See "Ref Level Position" on page 63

**DISPlay[:WINDow<n>][:SUBWindow<w>]:TRACe<t>:Y:SPACing <ScalingType>**

This command selects the scaling of the y-axis (for all traces, <t> is irrelevant).

For AF spectrum displays, only the parameters "LINear" and "LOGarithmic" are permitted.

**Suffix:**

<n> [Window](#)

<w> subwindow

<t> [Trace](#)

**Parameters:**

<ScalingType> **LOGarithmic**  
Logarithmic scaling.

**LINear**  
Linear scaling in %.

**LDB**  
Linear scaling in the specified unit.

**PERCent**  
Linear scaling in %.

\*RST: LOGarithmic

**Example:** DISP:TRAC:Y:SPAC LIN  
Selects linear scaling in %.

**Manual operation:** See "Deviation" on page 62  
See "Scaling" on page 63

## 11.4.6 Configuring data acquisition

The following remote commands are required to configure which data is to be acquired and then demodulated in a remote environment.

[SENSe:]ADEMod:MTIME.....	135
[SENSe:]ADEMod:RLENgth.....	135
[SENSe:]ADEMod:SET.....	135
[SENSe:]ADEMod<n>:SPECtrum:BANDwidth[:RESolution].....	136
[SENSe:]ADEMod:SPECtrum:BWIDth[:RESolution].....	136
[SENSe:]ADEMod:SRATe.....	136
[SENSe:]BANDwidth:DEMod.....	136
[SENSe:]BWIDth:DEMod.....	136
[SENSe:]BANDwidth:DEMod:TYPE.....	137

[SENSe:]BWIDth:DEMod:TYPE.....	137
[SENSe:]BANDwidth[:RESolution].....	137
[SENSe:]SWEep:COUnt.....	137
[SENSe:]SWEep[:WINDow<n>]:POINts.....	138

---

### [SENSe:]ADEMod:MTIME <Time>

This command defines the measurement time for Analog Modulation Analysis.

#### Parameters:

<Time>                    \*RST:        62.5us  
                               Default unit: S

**Example:**                ADEM:MTIM 62.5us  
                               Sets the measurement time to 62.5 µs.

**Manual operation:**    See "[Measurement Time \(AQT\)](#)" on page 46

---

### [SENSe:]ADEMod:RLENGth

---

[SENSe:]ADEMod:SET <SampleRate>, <RecordLength>, <TriggerSource>,  
                               <TriggerSlope>, <OffsetSamples>, <NoOfMeas>

This command configures the analog demodulator of the instrument.

#### Parameters:

<SampleRate>            **numeric value**  
                               The frequency at which measurement values are taken from the  
                               A/D-converter and stored in I/Q memory.  
                               \*RST:        8 MHz  
                               Default unit: HZ

<RecordLength>        Number of samples to be stored in I/Q memory.  
                               Range:        1 to 400001 with AF filter or AF trigger active, 1 to  
                               480001 with both AF filter and AF trigger deactive  
                               \*RST:        501)

<TriggerSource>        **IMMediate | EXTernal | EXT2 | EXT3 | IFPower | RFPower| AF  
                               | AM | AMRelative | FM | PM**  
                               **Note:** After selecting IF Power, the trigger threshold can be set  
                               with the [TRIGger\[:SEquence\]:LEVel:IFPower](#) command.  
                               \*RST:        IMMediate

<TriggerSlope>        POSitive | NEGative  
                               Used slope of the trigger signal.  
                               The value indicated here will be ignored for <trigger source> =  
                               IMMediate.  
                               \*RST:        POSitive

<OffsetSamples> Number of samples to be used as an offset to the trigger signal. The value indicated here is ignored for <trigger source> = "IMMEDIATE".

\*RST: 0

<NoOfMeas> Number of repetitions of the measurement to be executed. The value indicated here is especially necessary for the average/maxhold/minhold function.

Range: 0 to 32767

\*RST: 0

**Example:**

ADEM:SET 8MHz,32000,EXT,POS,-500,30

Performs a measurement at:

sample rate = 8 MHz

record length = 32000

trigger source = EXTERNAL

trigger slope = POSITIVE

offset samples = -500 (500 samples before trigger occurred)

# of meas = 30

---

**[SENSe:]ADEMod<n>:SPECtrum:BANDwidth[:RESolution] <Bandwidth>**

**[SENSe:]ADEMod:SPECtrum:BWIDth[:RESolution] <Bandwidth>**

Defines the resolution bandwidth for data acquisition.

From the specified RBW and the demodulation span set by [SENSe:]ADEMod:SPECtrum:SPAN[:MAXimum] on page 151 or [SENSe:]BWIDth:DEMod on page 136, the required measurement time is calculated. If the available measurement time is not sufficient for the given bandwidth, the measurement time is set to its maximum and the resolution bandwidth is increased to the resulting bandwidth.

This command is identical to SENS:BAND:RES, see the R&S ZNL User Manual.

**Parameters:**

<Bandwidth> refer to data sheet

\*RST: 61.2 kHz

Default unit: HZ

**Example:**

ADEM:SPEC:BAND 61.2kHz

Sets the resolution bandwidth to 61.2 kHz.

---

**[SENSe:]ADEMod:SRATe**

---

**[SENSe:]BANDwidth:DEMod <Bandwidth>**

**[SENSe:]BWIDth:DEMod <Bandwidth>**

This command sets the bandwidth for Analog Modulation Analysis. Depending on the selected demodulation bandwidth, the instrument selects the required sample rate.

This command is identical to SENS:ADEM:BAND:DEM.



**Parameters:**

<Bandwidth>            \*RST:        5 MHz  
                               Default unit: HZ

**Example:**

BAND:DEM 1MHz  
 Sets demodulation bandwidth to 1 MHz

**Manual operation:** See "[Demodulation Bandwidth](#)" on page 46

**[SENSe:]BANDwidth:DEMod:TYPE** <FilterType>

**[SENSe:]BWIDth:DEMod:TYPE** <FilterType>

This command defines the type of demodulation filter to be used.

This command is identical to SENS:ADEM:BAND:DEM:TYPE:

**Parameters:**

<FilterType>            **FLAT**  
                               Standard flat demodulation filter

**GAUSs**  
                               Gaussian filter for optimized settling behavior

\*RST:            FLAT

**Manual operation:** See "[Demodulation Filter](#)" on page 46

**[SENSe:]BANDwidth[:RESolution]** <Bandwidth>

This command defines the resolution bandwidth and decouples the resolution bandwidth from the span.

For statistics measurements, this command defines the **demodulation** bandwidth.

**Parameters:**

<Bandwidth>            refer to data sheet

\*RST:            RBW: AUTO is set to ON; DBW: 3MHz  
                               Default unit: Hz

**Example:**

BAND 1 MHz  
 Sets the resolution bandwidth to 1 MHz

**Manual operation:** See "[Resolution Bandwidth](#)" on page 46

**[SENSe:]SWEep:COUNT** <SweepCount>

This command defines the number of sweeps that the application uses to average traces.

In continuous sweep mode, the application calculates the moving average over the average count.

In single sweep mode, the application stops the measurement and calculates the average after the average count has been reached.

**Parameters:**

<SweepCount> When you set a sweep count of 0 or 1, the R&S ZNL performs one single sweep in single sweep mode. In continuous sweep mode, if the sweep count is set to 0, a moving average over 10 sweeps is performed.

Range: 0 to 200000  
\*RST: 0

**Example:**

```
SWE:COUN 64
Sets the number of sweeps to 64.
INIT:CONT OFF
Switches to single sweep mode.
INIT;*WAI
Starts a sweep and waits for its end.
```

**Manual operation:** See "[Sweep/Average Count](#)" on page 49

**[SENSe:]SWEep[:WINDow<n>]:POINTs** <SweepPoints>

This command defines the number of sweep points to analyze after a sweep.

**Suffix:**

<n>

**Parameters:**

<SweepPoints> Range: 101 to 100001  
\*RST: 1001

**Example:** SWE:POIN 251

**Manual operation:** See "[Sweep Points](#)" on page 48

## 11.4.7 Triggering

The following remote commands are required to configure a triggered measurement in a remote environment. More details are described for manual operation in [Chapter 5.4, "Trigger configuration"](#), on page 42.



\*OPC should be used after requesting data. This will hold off any subsequent changes to the selected trigger source, until after the sweep is completed and the data is returned.

- [Configuring the triggering conditions](#).....138

### 11.4.7.1 Configuring the triggering conditions

The following commands are required to configure a triggered measurement.

TRIGger[:SEQuence]:DTIME.....	139
TRIGger[:SEQuence]:HOLDoff[:TIME].....	139
TRIGger[:SEQuence]:IFPower:HOLDoff.....	139
TRIGger[:SEQuence]:IFPower:HYSteresis.....	140
TRIGger[:SEQuence]:LEVel[:EXternal<port>].....	140
TRIGger[:SEQuence]:LEVel:IFPower.....	140
TRIGger[:SEQuence]:LEVel:IQPower.....	141
TRIGger[:SEQuence]:LEVel:AM:RELative.....	141
TRIGger[:SEQuence]:LEVel:AM[:ABSolute].....	141
TRIGger[:SEQuence]:LEVel:FM.....	141
TRIGger[:SEQuence]:LEVel:PM.....	142
TRIGger[:SEQuence]:SLOPe.....	142
TRIGger[:SEQuence]:SOURce.....	142
TRIGger[:SEQuence]:TIME:RINTerval.....	143

---

### TRIGger[:SEQuence]:DTIME <DropoutTime>

Defines the time the input signal must stay below the trigger level before a trigger is detected again.

#### Parameters:

<DropoutTime> Dropout time of the trigger.  
 Range: 0 s to 10.0 s  
 \*RST: 0 s  
 Default unit: S

**Manual operation:** See " [Drop-Out Time](#) " on page 45

---

### TRIGger[:SEQuence]:HOLDoff[:TIME] <Offset>

Defines the time offset between the trigger event and the start of the sweep.

#### Parameters:

<Offset> \*RST: 0 s  
 Default unit: S

**Example:** TRIG:HOLD 500us

**Manual operation:** See " [Trigger Offset](#) " on page 44

---

### TRIGger[:SEQuence]:IFPower:HOLDoff <Period>

This command defines the holding time before the next trigger event.

Note that this command can be used for **any trigger source**, not just IF Power (despite the legacy keyword).

#### Parameters:

<Period> Range: 0 s to 10 s  
 \*RST: 0 s  
 Default unit: S

**Example:**           TRIG:SOUR EXT  
Sets an external trigger source.  
TRIG:IFP:HOLD 200 ns  
Sets the holding time to 200 ns.

**Manual operation:** See " [Trigger Holdoff](#) " on page 45

#### TRIGger[:SEQuence]:IFPower:HYSteresis <Hysteresis>

This command defines the trigger hysteresis, which is only available for "IF Power" trigger sources.

**Parameters:**

<Hysteresis>           Range:       3 dB to 50 dB  
                          \*RST:        3 dB  
                          Default unit: DB

**Example:**           TRIG:SOUR IFP  
Sets the IF power trigger source.  
TRIG:IFP:HYST 10DB  
Sets the hysteresis limit value.

**Manual operation:** See " [Hysteresis](#) " on page 44

#### TRIGger[:SEQuence]:LEVel[:EXTernal<port>] <TriggerLevel>

This command defines the level the external signal must exceed to cause a trigger event.

**Parameters:**

<TriggerLevel>       For the R&S ZNL, the external trigger level is always 1.4 V. It cannot be changed.  
                          \*RST:        1.4 V

**Manual operation:** See " [Trigger Level](#) " on page 44

#### TRIGger[:SEQuence]:LEVel:IFPower <TriggerLevel>

This command defines the power level at the third intermediate frequency that must be exceeded to cause a trigger event.

Note that any RF attenuation is considered when the trigger level is analyzed. If defined, a reference level offset is also considered.

**Parameters:**

<TriggerLevel>       For details on available trigger levels and trigger bandwidths, see the data sheet.  
                          \*RST:        -20 dBm  
                          Default unit: DBM

**Example:**           TRIG:LEV:IFP -30DBM

**Manual operation:** See " [Trigger Level](#) " on page 44

---

**TRIGger[:SEQuence]:LEVel:IQPower** <TriggerLevel>

This command defines the magnitude the I/Q data must exceed to cause a trigger event.

Note that any RF attenuation is considered when the trigger level is analyzed. If defined, a reference level offset is also considered.

**Parameters:**

<TriggerLevel>      Range:      -130 dBm to 30 dBm  
                          \*RST:      -20 dBm  
                          Default unit: DBM

**Example:**            TRIG:LEV:IQP -30DBM

**Manual operation:** See " [Trigger Level](#) " on page 44

---

**TRIGger[:SEQuence]:LEVel:AM:RELative** <Level>

The command sets the level when AM-modulated signals are used as trigger source.

For triggering to be successful, the measurement time must cover at least 5 periods of the audio signal.

**Parameters:**

<Level>                Range:      -100 to +100  
                          \*RST:      0 %  
                          Default unit: %

**Example:**            TRIG:LEV:AM:REL -20 %  
                          Sets the AM trigger threshold to -20 %

**Manual operation:** See " [Trigger Level](#) " on page 44

---

**TRIGger[:SEQuence]:LEVel:AM[:ABSolute]** <Level>

The command sets the level when RF power signals are used as trigger source.

For triggering to be successful, the measurement time must cover at least 5 periods of the audio signal.

**Parameters:**

<Level>                Range:      -100 to +30  
                          \*RST:      -20 dBm  
                          Default unit: dBm

**Example:**            TRIG:LEV:AM -30 dBm  
                          Sets the RF power signal trigger threshold to -30 dBm

**Manual operation:** See " [Trigger Level](#) " on page 44

---

**TRIGger[:SEQuence]:LEVel:FM** <Level>

The command sets the level when FM-modulated signals are used as trigger source.

For triggering to be successful, the measurement time must cover at least 5 periods of the audio signal.

**Parameters:**

<Level>                    Range:        -10 to +10  
                               \*RST:        0 Hz  
                               Default unit: MHz

**Example:**

TRIG:LEV:FM 10 kHz  
 Sets the FM trigger threshold to 10 kHz

**Manual operation:** See " [Trigger Level](#) " on page 44

**TRIGger[:SEQuence]:LEVel:PM <Level>**

The command sets the level when PM-modulated signals are used as trigger source.

For triggering to be successful, the measurement time must cover at least 5 periods of the audio signal.

**Parameters:**

<Level>                    Range:        -1000 to +1000  
                               \*RST:        0 RAD  
                               Default unit: RAD | DEG

**Example:**

TRIG:LEV:PM 1.2 RAD  
 Sets the PM trigger threshold to 1.2 rad

**Manual operation:** See " [Trigger Level](#) " on page 44

**TRIGger[:SEQuence]:SLOPe <Type>****Parameters:**

<Type>                    POSitive | NEGative

**POSitive**

Triggers when the signal rises to the trigger level (rising edge).

**NEGative**

Triggers when the signal drops to the trigger level (falling edge).

\*RST:                    POSitive

**Example:**

TRIG:SLOP NEG

**Manual operation:** See " [Slope](#) " on page 45

**TRIGger[:SEQuence]:SOURce <Source>**

This command selects the trigger source.

**Note on external triggers:**

If a measurement is configured to wait for an external trigger signal in a remote control program, remote control is blocked until the trigger is received and the program can continue. Make sure that this situation is avoided in your remote control programs.

**Parameters:**

<Source>	<b>IMMediate</b> Free Run
	<b>IFPower</b> Second intermediate frequency
	<b>IQPower</b> Magnitude of sampled I/Q data For applications that process I/Q data, such as the I/Q Analyzer or optional applications.
	<b>BBPower</b> Baseband power (for digital input via the optional "Digital Baseband" interface)
	*RST: IMMediate

**Example:** TRIG:SOUR EXT  
Selects the external trigger input as source of the trigger signal

**Manual operation:** See " [Trigger Source](#) " on page 43  
See " [Free Run](#) " on page 43  
See " [ExternalTrigger 1](#) " on page 43  
See " [IF Power](#) " on page 43  
See " [FM\(Offline\) / AM\(Offline\) / PM\(Offline\) / RF\(Offline\)](#) " on page 43  
See " [Time](#) " on page 44

---

**TRIGger[:SEQuence]:TIME:RINterval <Interval>**

This command defines the repetition interval for the time trigger.

**Example:** TRIG:SOUR TIME  
Selects the time trigger input for triggering.  
TRIG:TIME:RINT 5  
The sweep starts every 5 s.

**Manual operation:** See " [Repetition Interval](#) " on page 44

## 11.4.8 Configuring demodulation

The following remote commands are required to configure the demodulation parameters in a remote environment. The tasks for manual operation are described in [Chapter 5.7, "Demodulation"](#), on page 50.

- [Basic demodulation settings](#)..... 144
- [Time domain zoom settings](#)..... 146
- [Configuring the demodulation spectrum](#)..... 148
- [\(Post-processing\) AF filters](#)..... 151

• Defining the scaling and units.....	156
• Scaling for AF evaluation.....	156
• Scaling for RF evaluation.....	157
• Units.....	157
• Relative demodulation results.....	158
• Settling time.....	161

### 11.4.8.1 Basic demodulation settings

The basic demodulation measurement parameters define how the measurement is performed.

Useful commands described elsewhere:

- [Chapter 11.4.8.2, "Time domain zoom settings"](#), on page 146

#### Basic demodulation commands:

[SENSe:]ADEMod<n>:AF:COUPling.....	144
[SENSe:]ADEMod:PM:RPOint[:X].....	144
[SENSe:]ADEMod:PM:RPOint[:X]:MODE.....	145
[SENSe:]ADEMod:SQUelch[:STATE].....	145
[SENSe:]ADEMod:SQUelch:LEVel.....	146
CALCulate<n>:FORMat.....	146

---

#### [SENSe:]ADEMod<n>:AF:COUPling <Coupling>

This command selects the coupling of the AF path of the analyzer in the specified window.

##### Suffix:

<n>                      irrelevant

##### Parameters:

<Coupling>              AC | DC  
 \*RST:                    AC (PM); DC (FM)

##### Example:

ADEM:AF:COUP DC  
 Switches on DC coupling.

**Manual operation:** See "[AF Coupling](#)" on page 51

---

#### [SENSe:]ADEMod:PM:RPOint[:X] <Time>

This command determines the position where the phase of the PM-demodulated signal is set to 0 rad. The maximum value depends on the measurement time selected in the instrument; this value is output in response to the query ADEM:PM:RPO:X? MAX.

##### Parameters:

<Time>                    0 s to measurement time  
 \*RST:                    0 s  
 Default unit: S



**Example:** `ADEM:PM:RPO 500us`  
Sets the position where the phase to 0 rad setting to 500  $\mu$ s.

**Manual operation:** See ["Zero Phase Reference Position \(PM Time Domain only\)"](#) on page 53

**[SENSe:]ADEMod:PM:RPOint[:X]:MODE <Mode>**

Defines how the reference position in time for 0 rad is determined.

**Parameters:**

<Mode>                   MANual | RIGHT

**MANual**

The time is defined using `[SENSe:]ADEMod:PM:RPOint[:X]` on page 144.

**RIGHT**

The time of the last measured value is used as the reference position. The time of the last measured value corresponds to the acquisition time, regarding the trigger event and trigger offset, if applicable. If the acquisition time or the trigger values are changed, the reference position is automatically adapted.

\*RST:                   MANual

**Example:** `ADEM:MTIM 500us`  
`ADEM:PM:RPO:MODE RIGHT`  
Sets the position of the 0 rad phase setting to 500  $\mu$ s.

**Manual operation:** See ["Zero Phase Reference Position \(PM Time Domain only\)"](#) on page 53

**[SENSe:]ADEMod:SQUelch[:STATE] <State>**

This command activates the squelch function, i.e. if the signal falls below a defined threshold (see `[SENSe:]ADEMod:SQUelch:LEVel` on page 146), the demodulated data is automatically set to 0.

**Parameters:**

<State>                   ON | OFF | 0 | 1

**OFF | 0**

Switches the function off

**ON | 1**

Switches the function on

**Example:** `DEM:SQU ON`  
Signals below the level threshold are squelched.

**Manual operation:** See ["Squelch State"](#) on page 51

**[SENSe:]ADEMod:SQUelch:LEVel** <Threshold>

This command defines the level threshold below which the demodulated data is set to 0 if squelching is enabled (see [SENSe:]ADEMod:SQUelch[:STATe] on page 145).

**Parameters:**

<Threshold>            numeric value  
                           The absolute threshold level  
 Range:                -150 dBm to 30 dBm  
 \*RST:                -40 dBm

**Example:**

DEM:SQU:LEV -80  
 If the signal drops below -80 dBm, the demodulated data is set to 0.

**Manual operation:** See " [Squelch Level](#) " on page 51

**CALCulate<n>:FORMat** <Evaluation>

This command activates/deactivates the phase wrap for the specified PM time domain display with DC coupling.

**Suffix:**

<n>                    1..n

**Parameters:**

<Evaluation>        **PHAS**  
                           The phase is wrapped.  
                           **UPH**  
                           The phase is not wrapped.  
 \*RST:                UPH

**Example:**

LAY:ADD? '1',BEL,'XTIM:PM'  
 Activates PM time domain display. Result: window '2'  
 INP:COUP DC  
 Selects DC coupling.  
 CALC2:FORM PHAS  
 Selects a wrapped phase display in the PM time domain window.

**Manual operation:** See "[Phase Wrap On/Off \(PM Time Domain only\)](#)" on page 53

**11.4.8.2 Time domain zoom settings**

Using the time domain zoom, the demodulated data for a particular time span is extracted and displayed in more detail.

[SENSe:]ADEMod<n>:ZOOM:LENGth.....	147
[SENSe:]ADEMod<n>:ZOOM:LENGth:MODE.....	147
[SENSe:]ADEMod<n>:ZOOM:STARt.....	147
[SENSe:]ADEMod<n>:ZOOM[:STATe].....	148

**[SENSe:]ADEMod<n>:ZOOM:LENGth <Length>**

The command allows you to define the length of the time domain zoom area for the analog-demodulated measurement data in the specified window manually. If the length is defined manually using this command, the zoom mode is also set to manual.

**Suffix:**

<n> [Window](#)

**Parameters:**

<Length> \*RST: sweep time  
Default unit: S  
Length of the zoom area in seconds.

**Example:**

ADEM:ZOOM:LENG 2s  
Zoom mode is set to manual and the zoom length to 2 seconds.

**Manual operation:** See "[Length](#)" on page 53

**[SENSe:]ADEMod<n>:ZOOM:LENGth:MODE <Mode>**

The command defines whether the length of the zoom area for the analog-demodulated measurement data is defined automatically or manually in the specified window.

**Suffix:**

<n> [Window](#)

**Parameters:**

<Mode> AUTO | MAN  
**AUTO**  
(Default:) The number of sweep points is used as the zoom length.  
**MAN**  
The zoom length is defined manually using [\[SENSe:\]ADEMod<n>:ZOOM:LENGth](#).  
\*RST: AUTO

**Example:**

ADEM:ZOOM:LENG:MODE MAN  
Zoom function uses the length defined manually.

**Manual operation:** See "[Length](#)" on page 53

**[SENSe:]ADEMod<n>:ZOOM:STARt <Time>**

The command selects the start time for the zoomed display of analog-demodulated measurements in the specified window. The maximum value depends on the measurement time, which is set and can be queried with the [\[SENSe:\]ADEMod:MTIME](#) command.

If the zoom function is enabled, the defined number of sweep points are displayed from the start time specified with this command.

**Suffix:**<n> [Window](#)**Parameters:**

<Time>            Range:        0 s to (measurement time – zoom length)  
 \*RST:            0 s  
 Default unit: S

**Example:**

```
ADEM:ZOOM:STAT ON
Switches on the zoom function
ADEM:ZOOM:STAR 500us
Sets the starting point of the display to 500 µs.
```

**Manual operation:** See "[Start](#)" on page 52**[SENSe:]ADEMod<n>:ZOOM[:STATe] <State>**

The command enables or disables the time domain zoom function for the analog-demodulated measurement data in the specified window.

If the zoom function is enabled, the defined number of sweep points are displayed from the start time specified with [\[SENSe:\]ADEMod<n>:ZOOM:STARt](#) on page 147.

If the zoom function is disabled, data reduction is used to adapt the measurement points to the number of points available on the display.

**Suffix:**<n> [Window](#)**Parameters:**

<State>            ON | OFF | 0 | 1  
**OFF | 0**  
 Switches the function off  
**ON | 1**  
 Switches the function on

**Example:**

```
ADEM:ZOOM ON
Switches on the zoom function
```

**Manual operation:** See "[State](#)" on page 52**11.4.8.3 Configuring the demodulation spectrum**

The demodulation spectrum defines which span of the demodulated data is evaluated.

- [AF evaluation](#)..... 148
- [RF evaluation](#)..... 150

**AF evaluation**

These settings are only available for AF Spectrum evaluations, not in the time domain.

[SENSe:]ADEMod:AF:CENTer.....	149
[SENSe:]ADEMod:AF:SPAN.....	149
[SENSe:]ADEMod:AF:SPAN:FULL.....	149
[SENSe:]ADEMod:AF:START.....	149
[SENSe:]ADEMod:AF:STOP.....	150

---

#### [SENSe:]ADEMod:AF:CENTer <Frequency>

This command sets the center frequency for AF spectrum result display.

##### Parameters:

<Frequency>            \*RST:        1.25 MHz  
                               Default unit: HZ

**Manual operation:**    See " AF Center " on page 54

---

#### [SENSe:]ADEMod:AF:SPAN <Span>

This command sets the span (around the center frequency) for AF spectrum result display.

The span is limited to DBW/2 (see [SENSe:]BWIDth:DEMod on page 136).

##### Parameters:

<Span>                    \*RST:        9 MHz  
                               Default unit: HZ

**Example:**                ADEM:AF:SPAN 200 kHz  
                               Sets the AF span to 200 kHz

**Manual operation:**    See " AF Span " on page 55

---

#### [SENSe:]ADEMod:AF:SPAN:FULL

This command sets the maximum span for AF spectrum result display.

The maximum span corresponds to DBW/2 (see [SENSe:]BWIDth:DEMod on page 136).

**Example:**                ADEM:BAND 5 MHz  
                               Sets the demodulation bandwidth to 5 MHz  
                               ADEM:AF:SPAN:FULL  
                               Sets the AF span to 2.5 MHz

**Manual operation:**    See " AF Full Span " on page 55

---

#### [SENSe:]ADEMod:AF:START <Frequency>

This command sets the start frequency for AF spectrum result display.

##### Parameters:

<Frequency>            \*RST:        0 MHz  
                               Default unit: HZ

**Example:**           ADEM:AF:STAR 0 kHz  
                           Sets the AF start frequency to 0 kHz  
                           ADEM:AF:STOP 500 kHz  
                           Sets the AF stop frequency to 500 kHz

**Manual operation:** See " [AF Start](#) " on page 54

**[SENSe:]ADEMod:AF:STOP <Frequency>**

This command sets the stop frequency for AF spectrum result display.

**Parameters:**

<Frequency>           \*RST:        9 MHz  
                           Default unit: HZ

**Example:**           ADEM:AF:STAR 0 kHz  
                           Sets the AF start frequency to 0 kHz  
                           ADEM:AF:STOP 500 kHz  
                           Sets the AF stop frequency to 500 kHz

**Manual operation:** See " [AF Stop](#) " on page 54

### RF evaluation

These settings are only available for RF evaluation, both in time and frequency domain.

Useful commands described elsewhere

- [\[SENSe:\]FREQUENCY:CENTer](#) on page 127
- [\[SENSe:\]BWIDth:DEMod](#) on page 136

**Specific commands:**

[\[SENSe:\]ADEMod:SPECTrum:SPAN:ZOOM](#)..... 150  
[\[SENSe:\]ADEMod:SPECTrum:SPAN\[:MAXimum\]](#)..... 151

**[SENSe:]ADEMod:SPECTrum:SPAN:ZOOM <Span>**

This command sets the span (around the center frequency) for RF spectrum result display.

The span is limited to the demodulation bandwidth (see [\[SENSe:\]BWIDth:DEMod](#) on page 136).

**Parameters:**

<Span>                \*RST:        5 MHz  
                           Default unit: HZ

**Example:**           ADEM:SPEC:SPAN:ZOOM 200 kHz  
                           Sets the rF span to 200 kHz

**Manual operation:** See "[Span](#)" on page 56

---

**[SENSe:]ADEMod:SPECTrum:SPAN[:MAXimum] <FreqRange>**

Sets the DBW to the specified value and the span (around the center frequency) of the RF data to be evaluated to its new maximum (the demodulation bandwidth).

**Parameters:**

<FreqRange>            \*RST:        5 MHz  
                               Default unit: Hz

**Manual operation:**    See "Span" on page 56  
                               See "RF Full Span" on page 56

#### 11.4.8.4 (Post-processing) AF filters

The AF filter reduces the evaluated bandwidth of the demodulated signal and can define a weighting function. AF filters are only available for AM or FM time domain evaluations.

[SENSe:]FILTer<n>:AWEighted[:STATe].....	151
[SENSe:]FILTer<n>:AOFF.....	152
[SENSe:]FILTer<n>:CCIR:WEIGhted[:STATe].....	152
[SENSe:]FILTer<n>:CCIR[:UNWeighted][:STATe].....	152
[SENSe:]FILTer<n>:CCITt[:STATe].....	153
[SENSe:]FILTer<n>:DEMPHasis:TCONstant.....	153
[SENSe:]FILTer<n>:DEMPHasis[:STATe].....	153
[SENSe:]FILTer<n>:HPASs:FREQUency[:ABSolute].....	154
[SENSe:]FILTer<n>:HPASs:FREQUency:MANual.....	154
[SENSe:]FILTer<n>:HPASs[:STATe].....	154
[SENSe:]FILTer<n>:LPASs:FREQUency[:ABSolute].....	155
[SENSe:]FILTer<n>:LPASs:FREQUency:MANual.....	155
[SENSe:]FILTer<n>:LPASs:FREQUency:RELative.....	155
[SENSe:]FILTer<n>:LPASs[:STATe].....	156

---

**[SENSe:]FILTer<n>:AWEighted[:STATe] <State>**

This command activates/deactivates the "A" weighting filter for the specified evaluation.

For details on weighting filters, see " [Weighting](#) " on page 58.

**Suffix:**

<n>                            [Window](#)

**Parameters:**

<State>                    ON | OFF | 0 | 1  
                               **OFF | 0**  
                               Switches the function off  
                               **ON | 1**  
                               Switches the function on

**Example:**

FILT:AWE ON  
 Activates the A weighting filter.

**Manual operation:** See " [Weighting](#) " on page 58

---

**[SENSe:]FILTer<n>:AOFF**

**Suffix:**

<n> 1..n

**Manual operation:** See " [Deactivating all AF Filters](#) " on page 59

---

**[SENSe:]FILTer<n>:CCIR:WEIGhted[:STATE] <State>**

This command activates/deactivates the weighted CCIR filter for the specified evaluation.

For details on weighting filters, see " [Weighting](#) " on page 58.

**Suffix:**

<n> [Window](#)

**Parameters:**

<State> ON | OFF | 0 | 1  
**OFF | 0**  
 Switches the function off  
**ON | 1**  
 Switches the function on

**Example:**

FILT:CCIR:WEIG ON  
 Activates the weighted CCIR filter.

**Manual operation:** See " [Weighting](#) " on page 58

---

**[SENSe:]FILTer<n>:CCIR[:UNWeighted][:STATE] <State>**

This command activates/deactivates the unweighted CCIR filter in the specified window.

For details on weighting filters, see " [Weighting](#) " on page 58.

**Suffix:**

<n> [Window](#)

**Parameters:**

<State> ON | OFF | 0 | 1  
**OFF | 0**  
 Switches the function off  
**ON | 1**  
 Switches the function on

**Example:**

FILT:CCIR:UNW ON  
 Activates the unweighted CCIR filter.

**Manual operation:** See " [Weighting](#) " on page 58



---

**[SENSe:]FILTer<n>:CCITt[:STATe] <State>**

**Suffix:**

<n> 1..n

**Parameters:**

<State>

**Manual operation:** See " [Weighting](#) " on page 58

---

**[SENSe:]FILTer<n>:DEMPHasis:TCONstant <Value>**

This command selects the deemphasis for the specified evaluation.

For details on deemphasis refer to " [Deemphasis](#) " on page 59.

**Suffix:**

<n> [Window](#)

**Parameters:**

<Value> 25 us | 50 us | 75 us | 750 us  
 \*RST: 50 us  
 Default unit: S

**Example:**

`FILT:DEMP:TCON 750us`

Selects the deemphasis for the demodulation bandwidth range from 800 Hz to 4 MHz with a time constant of 750 μs.

**Manual operation:** See " [Deemphasis](#) " on page 59

---

**[SENSe:]FILTer<n>:DEMPHasis[:STATe] <State>**

This command activates/deactivates the selected deemphasis for the specified evaluation.

For details about deemphasis refer to " [Deemphasis](#) " on page 59.

**Suffix:**

<n> [Window](#)

**Parameters:**

<State> ON | OFF | 0 | 1  
**OFF | 0**  
 Switches the function off  
**ON | 1**  
 Switches the function on

**Example:**

`FILT:DEMP ON`

Activates the selected deemphasis.

**Manual operation:** See " [Deemphasis](#) " on page 59

**[SENSe:]FILTer<n>:HPASs:FREQuency[:ABSolute] <Frequency>**

This command selects the high pass filter type for the specified evaluation.

For details on the high pass filters, refer to " [High Pass](#) " on page 57.

**Suffix:**

<n> [Window](#)

**Parameters:**

<Frequency> 20 Hz | 50 Hz | 300 Hz  
 \*RST: 300Hz  
 Default unit: Hz

**Example:**

`FILT:HPAS:FREQ 300Hz`  
 Selects the high pass filter for the demodulation bandwidth range from 800 Hz to 8 MHz.

**Manual operation:** See " [High Pass](#) " on page 57

**[SENSe:]FILTer<n>:HPASs:FREQuency:MANual <Frequency>**

This command selects the cutoff frequency of the high pass filter for the specified evaluation.

For details on the high pass filters, refer to " [High Pass](#) " on page 57.

**Suffix:**

<n> [Window](#)

**Parameters:**

<Frequency> numeric value  
 Range: 0 to 3 MHz  
 \*RST: 15kHz  
 Default unit: HZ

**Example:**

`FILT:HPAS:FREQ:MAN 3MHz`  
 The AF results are restricted to frequencies lower than 3 MHz.

**Manual operation:** See " [High Pass](#) " on page 57

**[SENSe:]FILTer<n>:HPASs[:STATe] <State>**

This command activates/deactivates the selected high pass filter for the specified evaluation.

For details on the high pass filter, refer to " [High Pass](#) " on page 57.

**Suffix:**

<n> [Window](#)

**Parameters:**

<State> ON | OFF | 0 | 1  
**OFF | 0**  
 Switches the function off

**ON | 1**

Switches the function on

**Example:** `FILT:HPAS ON`  
Activates the selected high pass filter.

**Manual operation:** See " [High Pass](#) " on page 57

**[SENSe:]FILTer<n>:LPASs:FREQuency[:ABSolute] <Frequency>**

This command selects the absolute low pass filter type for the specified evaluation

For details on the low pass filter, refer to " [Low Pass](#) " on page 57.

**Suffix:**

<n> [Window](#)

**Parameters:**

<Frequency> 3kHz | 15kHz | 150kHz  
\*RST: 15kHz  
Default unit: HZ

**Example:** `FILT:LPAS:FREQ 150kHz`  
Selects the low pass filter for the demodulation bandwidth range from 400 kHz to 16 MHz.

**Manual operation:** See " [Low Pass](#) " on page 57

**[SENSe:]FILTer<n>:LPASs:FREQuency:MANual <Frequency>**

This command selects the cutoff frequency of the low pass filter for the specified evaluation.

For details on the low pass filter, refer to " [Low Pass](#) " on page 57.

**Suffix:**

<n> [Window](#)

**Parameters:**

<Frequency> numeric value  
Range: 0 to 3 MHz  
\*RST: 15kHz  
Default unit: HZ

**Example:** `FILT:LPAS:FREQ:MAN 150kHz`  
The AF results are restricted to frequencies lower than 150 kHz.

**Manual operation:** See " [Low Pass](#) " on page 57

**[SENSe:]FILTer<n>:LPASs:FREQuency:RELative <Frequency>**

This command selects the relative low pass filter type for the specified evaluation

For details on the low pass filter, refer to " [Low Pass](#) " on page 57.

**Suffix:**<n> [Window](#)**Parameters:**

<Frequency> 5PCT | 10PCT | 25PCT  
 \*RST: 25PCT  
 Default unit: PCT

**Example:**

```
FILT:LPAS:FREQ:REL 25PCT
```

Selects the low pass filter as 25 % of the demodulation bandwidth.

**Manual operation:** See "[Low Pass](#)" on page 57

**[SENSe:]FILTer<n>:LPASs[:STATe] <State>**

This command activates/deactivates the selected low pass filter for the specified evaluation.

For details on the low pass filter, refer to "[Low Pass](#)" on page 57.

**Suffix:**<n> [Window](#)**Parameters:**

<State> ON | OFF | 0 | 1  
**OFF | 0**  
 Switches the function off  
**ON | 1**  
 Switches the function on

**Example:**

```
FILT:LPAS ON
```

Activates the selected low pass filter.

**Manual operation:** See "[Low Pass](#)" on page 57

#### 11.4.8.5 Defining the scaling and units

The scaling parameters define the range of the demodulated data to be displayed.

#### 11.4.8.6 Scaling for AF evaluation

These settings are only available for AF evaluations.

Useful commands described elsewhere:

- [\[SENSe:\]ADJust:SCALe\[:Y\]:AUTO\[:CONTinuous\]](#) on page 166
- [\[SENSe:\]ADEMod<n>:AF:COUPling](#) on page 144
- [DISPlay\[:WINDow<n>\]\[:SUBWindow<w>\]:TRACe<t>:Y\[:SCALe\]:RPOsition](#) on page 133

- `DISPlay[:WINDow<n>][:SUBWindow<w>]:TRACe<t>:Y:SPACing`  
on page 134

#### Specific commands:

`DISPlay[:WINDow<n>][:SUBWindow<w>]:TRACe<t>:Y[:SCALe]:RVALue.....` 157

---

**DISPlay[:WINDow<n>][:SUBWindow<w>]:TRACe<t>:Y[:SCALe]:RVALue <Value>**

This command defines the reference value assigned to the reference position in the specified window. Separate reference values are maintained for the various displays.

#### Suffix:

<n>	Window
<w>	subwindow
<t>	irrelevant

#### Parameters:

<Value> Default unit: DB

#### Example:

`DISP:TRAC:Y:RVAL 0`

Sets the value assigned to the reference position to 0 Hz

**Manual operation:** See "Reference Value" on page 61

### 11.4.8.7 Scaling for RF evaluation

These commands are required for RF evaluations and the "result summary".

- `DISPlay[:WINDow<n>][:SUBWindow<w>]:TRACe<t>:Y[:SCALe]:RPOSITION` on page 133
- `DISPlay[:WINDow<n>][:SUBWindow<w>]:TRACe<t>:Y:SPACing`  
on page 134
- `DISPlay[:WINDow<n>][:SUBWindow<w>]:TRACe<t>:Y[:SCALe]`  
on page 132
- `DISPlay[:WINDow<n>][:SUBWindow<w>]:TRACe<t>:Y[:SCALe]:MODE`  
on page 132

### 11.4.8.8 Units

The units define how the demodulated data is displayed.

<code>CALCulate&lt;n&gt;:UNIT:ANGLE.....</code>	158
<code>UNIT&lt;n&gt;:ANGLE.....</code>	158
<code>CALCulate&lt;n&gt;:UNIT:THD.....</code>	158
<code>UNIT&lt;n&gt;:THD.....</code>	158

---

**CALCulate<n>:UNIT:ANGLE <Unit>**

**UNIT<n>:ANGLE <Unit>**

This command selects the unit for angles (for PM display, <n> is irrelevant).

This command is identical to `CALC:UNIT:ANGL`

**Suffix:**

<n> [Window](#)

**Parameters:**

<Unit> DEG | RAD  
\*RST: RAD

**Example:** UNIT:ANGL DEG

**Manual operation:** See "[Phase Unit \(Rad/Deg\)](#)" on page 64

---

**CALCulate<n>:UNIT:THD <Unit>**

**UNIT<n>:THD <Mode>**

Selects the unit for THD measurements (<n> is irrelevant).

This command is identical to `CALC:UNIT:THD`

**Suffix:**

<n> [Window](#)

**Parameters:**

<Mode> DB | PCT  
\*RST: DB

**Example:** UNIT:THD PCT

**Manual operation:** See "[THD Unit \(%/ DB\)](#)" on page 64

#### 11.4.8.9 Relative demodulation results

The following commands are required to obtain relative demodulation results.

<a href="#">CONFigure:ADEMod:RESults:AM:DETEctor&lt;det&gt;:REFerence</a> .....	159
<a href="#">CONFigure:ADEMod:RESults:FM:DETEctor&lt;det&gt;:REFerence</a> .....	159
<a href="#">CONFigure:ADEMod:RESults:PM:DETEctor&lt;det&gt;:REFerence</a> .....	159
<a href="#">CONFigure:ADEMod:RESults:AM:DETEctor&lt;det&gt;:STATE</a> .....	159
<a href="#">CONFigure:ADEMod:RESults:FM:DETEctor&lt;det&gt;:STATE</a> .....	159
<a href="#">CONFigure:ADEMod:RESults:PM:DETEctor&lt;det&gt;:STATE</a> .....	159
<a href="#">CONFigure:ADEMod:RESults:AM:DETEctor&lt;det&gt;:REFerence:MEASStoref&lt;t&gt;</a> .....	160
<a href="#">CONFigure:ADEMod:RESults:FM:DETEctor&lt;det&gt;:REFerence:MEASStoref&lt;t&gt;</a> .....	160
<a href="#">CONFigure:ADEMod:RESults:PM:DETEctor&lt;det&gt;:REFerence:MEASStoref&lt;t&gt;</a> .....	160
<a href="#">CONFigure:ADEMod:RESults:AM:DETEctor&lt;det&gt;:MODE</a> .....	160
<a href="#">CONFigure:ADEMod:RESults:FM:DETEctor&lt;det&gt;:MODE</a> .....	160
<a href="#">CONFigure:ADEMod:RESults:PM:DETEctor&lt;det&gt;:MODE</a> .....	160
<a href="#">CONFigure:ADEMod:RESults:UNIT</a> .....	161

---

**CONFigure:ADEMod:RESults:AM:DETEctor<det>:REFerence** <RefValue>

**CONFigure:ADEMod:RESults:FM:DETEctor<det>:REFerence** <RefValue>

**CONFigure:ADEMod:RESults:PM:DETEctor<det>:REFerence** <RefValue>

Defines the reference value to be used for relative demodulation results and recalculates the results. If necessary, the detector is activated.

A reference value 0 would provide infinite results and is thus automatically corrected to 0.1.

**Suffix:**

<det>                      Detector function used for relative demodulation

**Parameters:**

<RefValue>                double value  
 The unit depends on the demodulation type:  
 ACV: V  
 AM: %  
 FM: Hz  
 PM: depends on [UNIT<n>:ANGLE](#) setting  
 \*RST:            1.0  
 Default unit: RAD

**Example:**                See [CONFigure:ADEMod:RESults:PM:DETEctor<det>:STATE](#) on page 159

**Manual operation:**    See " [Reference Value](#) " on page 66

---

**CONFigure:ADEMod:RESults:AM:DETEctor<det>:STATE** <State>

**CONFigure:ADEMod:RESults:FM:DETEctor<det>:STATE** <State>

**CONFigure:ADEMod:RESults:PM:DETEctor<det>:STATE** <State>

Activates relative demodulation for the selected detector. If activated, the demodulated result is set in relation to the reference value defined by [CONFigure:ADEMod:RESults:PM:DETEctor<det>:REFerence](#).

**Suffix:**

<det>                      Detector function used for relative demodulation

**Parameters:**

<State>                    ON | OFF | 0 | 1  
**OFF | 0**  
 Switches the function off  
**ON | 1**  
 Switches the function on

**Example:**

```
CONF:ADEM:RES:PM:DET2:STAT ON
Activates relative demodulation for the negative peak detector.
CONF:ADEM:RES:UNIT PCT
Defines the unit for relative values as percent.
CONF:ADEM:RES:PM:DET2:REF 1.415%
Sets the reference value for the negative peak detector to
1.415 %.
CONF:ADEM:RES:PM:DET2:MODE AVER
Sets the negative peak detector to average mode.
CONF:ADEM:RES:PM:DET2:REF:MEAS2
Sets the reference value for the negative peak detector to the
average of the currently calculated value and the previous refer-
ence value on trace 2.
```

**Manual operation:** See ["State"](#) on page 66

**CONFigure:ADEMod:RESults:AM:DETEctor<det>:REFerence:MEASStoref<t>**  
**CONFigure:ADEMod:RESults:FM:DETEctor<det>:REFerence:MEASStoref<t>**  
**CONFigure:ADEMod:RESults:PM:DETEctor<det>:REFerence:MEASStoref<t>**

Sets the reference value to be used for relative demodulation results to the currently measured value on the specified trace *for all relative detectors*.

If necessary, the detectors are activated.

A reference value 0 would provide infinite results and is thus automatically corrected to 0.1.

**Suffix:**

<det>	irrelevant
<t>	1..n <a href="#">Trace</a>

**Example:** See [CONFigure:ADEMod:RESults:PM:DETEctor<det>:STATe](#) on page 159

**Manual operation:** See [" Meas -> Reference "](#) on page 66

**CONFigure:ADEMod:RESults:AM:DETEctor<det>:MODE <Mode>**  
**CONFigure:ADEMod:RESults:FM:DETEctor<det>:MODE <Mode>**  
**CONFigure:ADEMod:RESults:PM:DETEctor<det>:MODE <Mode>**

Defines the mode with which the demodulation result is determined.

**Suffix:**

<det>	Detector function used for relative demodulation
-------	--

**Parameters:**

<Mode>	<b>WRITE</b> Overwrite mode: the detector value is overwritten by each sweep. This is the default setting.
--------	---



**AVERage**

The average result is determined over all sweeps.

**MAXHold**

The maximum value is determined over several sweeps and displayed. The R&S ZNL saves each result only if the new value is greater than the previous one.

\*RST: WRITe

**Example:** See [CONFigure:ADEMod:RESults:PM:DETEctor<det>:STATe](#) on page 159

**Manual operation:** See "Mode" on page 65

**CONFigure:ADEMod:RESults:UNIT <Unit>**

This command selects the unit for relative demodulation results.

**Parameters:**

<Unit> PCT | DB  
\*RST: PCT

**Example:** `CONF:ADEM:RES:AM:DET2:STAT ON`  
Activates relative demodulation for the negative peak detector.  
`CONF:ADEM:RES:AM:DET2:MODE AVER`  
Sets the negative peak detector to average mode.  
`CONF:ADEM:RES:UNIT PCT`  
Defines the unit for relative values as percent.  
`CONF:ADEM:RES:AM:DET2:REF 1.415%`  
Sets the reference value for relative results to 1.415 %.

**Manual operation:** See "Relative Unit" on page 64

**11.4.8.10 Settling time**

Optionally, the settling time can be evaluated for time domain measurements.

Useful commands for the settling time described elsewhere:

- [\[SENSe:\]ADEMod:SETTling:TIME:RESult<t>?](#) on page 187

**Remote commands exclusive to configuring the settling time:**

[\[SENSe:\]ADEMod:SETTling:TIME:LIMit:LOWer](#)..... 161  
[\[SENSe:\]ADEMod:SETTling:TIME:LIMit:UPPer](#)..... 162  
[\[SENSe:\]ADEMod:SETTling:TIME:STATe](#)..... 162

**[SENSe:]ADEMod:SETTling:TIME:LIMit:LOWer <Position>**

Defines the upper limit of the settling time corridor. The value is defined with reference to the reference value, see also [DISPlay\[:WINDow<n>\]\[:SUBWindow<w>\]:TRACe<t>:Y\[:SCALE\]:RVALue](#) on page 157 and [\[SENSe:\]ADEMod:PM:RPOint\[:X\]](#) on page 144.

For details, see [Chapter 5.7.7, "Settling time"](#), on page 67.

**Parameters:**

<Position> Default unit: depends on result type

**Example:**

ADEM:SETT:TIME:LIM:LOW -10 RAD

**Manual operation:** See "[Lower Settling Limit](#)" on page 68

**[SENSe:]ADEMod:SETTling:TIME:LIMit:UPPer <Position>**

Defines the upper limit of the settling time corridor. The value is defined with reference to the reference value, see also [DISPlay\[:WINDow<n>\]\[:SUBWindow<w>\]:TRACe<t>:Y\[:SCALE\]:RVALue](#) on page 157 and [\[SENSe:\]ADEMod:PM:RPOint\[:X\]](#) on page 144.

For details, see [Chapter 5.7.7, "Settling time"](#), on page 67.

**Parameters:**

<Position> Default unit: depends on result type

**Example:**

ADEM:SETT:TIME:LIM:UPP 10 RAD

**Manual operation:** See "[Upper Settling Limit](#)" on page 68

**[SENSe:]ADEMod:SETTling:TIME:STATe <State>**

Enables or disables the calculation and display of the settling time. The function is available for all time domain displays.

For details, see [Chapter 5.7.7, "Settling time"](#), on page 67.

**Parameters:**

<State> ON | OFF | 0 | 1

**OFF | 0**

Switches the function off

**ON | 1**

Switches the function on

\*RST: 0

**Example:**

```
//Define a PM time domain result display
LAY:ADD? '1',RIGH,'XTIM:PM'
//Define a second maxhold trace
DISP:WIND2:TRAC2:MODE MAXH
//Enable settling time calculation
ADEM:SETT:TIME:STAT ON
//Define the settling limit corridor as +/-10 RAD
ADEM:SETT:TIME:LIM:UPP 10 RAD
ADEM:SETT:TIME:LIM:LOW -10 RAD
//Set the zero RAD reference to the last measurement value
ADEM:PM:RPO:MODE LAST
//Perform the measurement
INIT;*WAI
//Query the settling time
ADEM:SETT:TIME:RES2?
//Result: 29.950000us
//After 29.95 us the signal is settled.
```

**Manual operation:** See "State" on page 68

### 11.4.9 Adjusting settings automatically

The following remote commands are required to adjust settings automatically in a remote environment. The tasks for manual operation are described in [Chapter 5.9, "Adjusting settings automatically"](#), on page 69.

[SENSe:]ADJust:ALL.....	163
[SENSe:]ADJust:CONFigure:LEVel:DURation.....	164
[SENSe:]ADJust:CONFigure:LEVel:DURation:MODE.....	164
[SENSe:]ADJust:CONFigure:HYSTeresis:LOWer.....	165
[SENSe:]ADJust:CONFigure:HYSTeresis:UPPer.....	165
[SENSe:]ADJust:CONFigure:SMODE.....	165
[SENSe:]ADJust:CONFigure:TRIGger.....	166
[SENSe:]ADJust:FREQuency.....	166
[SENSe:]ADJust:LEVel.....	166
[SENSe:]ADJust:SCALe[:Y]:AUTO[:CONTInuous].....	166

---

#### [SENSe:]ADJust:ALL

This command initiates a measurement to determine and set the ideal settings for the current task automatically (only once for the current measurement).

This includes:

- Center frequency
- Reference level
- Scaling

**Example:** ADJ:ALL

**Manual operation:** See "[Adjusting all Determinable Settings Automatically \( Auto All \)](#)" on page 70

---

**[SENSe:]ADJust:CONFigure:LEVel:DURation <Duration>**

To determine the ideal reference level, the R&S ZNL performs a measurement on the current input data. This command defines the length of the measurement if [\[SENSe:\]ADJust:CONFigure:LEVel:DURation:MODE](#) is set to `MANual`.

**Parameters:**

<Duration>            Numeric value in seconds  
 Range:            0.001 to 16000.0  
 \*RST:            0.001  
 Default unit: s

**Example:**

`ADJ:CONF:DUR:MODE MAN`  
 Selects manual definition of the measurement length.  
`ADJ:CONF:LEV:DUR 5ms`  
 Length of the measurement is 5 ms.

**Manual operation:** See "[Changing the Automatic Measurement Time \( Meastime-Manual \)](#)" on page 71

---

**[SENSe:]ADJust:CONFigure:LEVel:DURation:MODE <Mode>**

To determine the ideal reference level, the R&S ZNL performs a measurement on the current input data. This command selects the way the R&S ZNL determines the length of the measurement .

**Parameters:**

<Mode>            **AUTO**  
 The R&S ZNL determines the measurement length automatically according to the current input data.

**MANual**  
 The R&S ZNL uses the measurement length defined by [\[SENSe:\]ADJust:CONFigure:LEVel:DURation](#) on page 164.

\*RST:            AUTO

**Manual operation:** See "[Resetting the Automatic Measurement Time \( MeastimeAuto \)](#)" on page 71  
 See "[Changing the Automatic Measurement Time \( Meastime-Manual \)](#)" on page 71

**[SENSe:]ADJJust:CONFigure:HYSTeresis:LOWer** <Threshold>

When the reference level is adjusted automatically using the [\[SENSe:\]ADJJust:LEVEl](#) on page 166 command, the internal attenuators are also adjusted. To avoid frequent adaptation due to small changes in the input signal, you can define a hysteresis. This setting defines a lower threshold the signal must fall below (compared to the last measurement) before the reference level is adapted automatically.

**Parameters:**

<Threshold>            Range:        0 dB to 200 dB  
                          \*RST:        +1 dB  
                          Default unit: dB

**Example:**

```
SENS:ADJ:CONF:HYST:LOW 2
```

For an input signal level of currently 20 dBm, the reference level is only adjusted when the signal level falls below 18 dBm.

**Manual operation:** See "[Lower Level Hysteresis](#)" on page 72

**[SENSe:]ADJJust:CONFigure:HYSTeresis:UPPer** <Threshold>

When the reference level is adjusted automatically using the [\[SENSe:\]ADJJust:LEVEl](#) on page 166 command, the internal attenuators are also adjusted. To avoid frequent adaptation due to small changes in the input signal, you can define a hysteresis. This setting defines an upper threshold the signal must exceed (compared to the last measurement) before the reference level is adapted automatically.

**Parameters:**

<Threshold>            Range:        0 dB to 200 dB  
                          \*RST:        +1 dB  
                          Default unit: dB

**Example:**

```
SENS:ADJ:CONF:HYST:UPP 2
```

**Example:**

For an input signal level of currently 20 dBm, the reference level is only adjusted when the signal level rises above 22 dBm.

**Manual operation:** See "[Upper Level Hysteresis](#)" on page 72

**[SENSe:]ADJJust:CONFigure:SMODE** <Search Mode>

Determines the search mode for the automatic measurement performed to determine the optimal measurement configuration.

**Parameters:**

<Search Mode>        FAST | POPTimized

**FAST**

The measurement is optimized for speed.

**POPTimized**

The measurement is optimized to analyze pulse signals adequately.

**Example:**

```
ADJ:CONF:SMOD POPT
```

**[SENSe:]ADJust:CONFigure:TRIGger <State>**

Defines the behavior of the measurement when adjusting a setting automatically (using `SENS:ADJ:LEV ON`, for example).

**Parameters:**

<State>                    `ON | OFF | 0 | 1`  
                               **OFF | 0**  
                               Switches the function off  
                               **ON | 1**  
                               Switches the function on

**[SENSe:]ADJust:FREQuency**

This command sets the center frequency to the frequency with the highest signal level in the current frequency range.

**Example:**                    `ADJ:FREQ`

**Manual operation:**    See "[Adjusting the Center Frequency Automatically \( Auto Frequency \)](#)" on page 71

**[SENSe:]ADJust:LEVel**

Initiates a single (internal) measurement that evaluates and sets the ideal reference level for the current input data and measurement settings. Thus, the settings of the RF attenuation and the reference level are optimized for the signal level. The R&S ZNL is not overloaded and the dynamic range is not limited by an S/N ratio that is too small.

**Example:**                    `ADJ:LEV`

**Manual operation:**    See "[Setting the Reference Level Automatically \( Auto Level \)](#)" on page 39

**[SENSe:]ADJust:SCALe[:Y]:AUTO[:CONTInuous] <State>**

Activates automatic scaling of the y-axis in all diagrams according to the current measurement results. Currently auto-scaling is only available for AF measurements. RF power and RF spectrum measurements are not affected by the auto-scaling.

**Parameters:**

<State>                    `ON | OFF | 0 | 1`  
                               **OFF | 0**  
                               Switches the function off  
                               **ON | 1**  
                               Switches the function on

**Example:**                    `SENS:ADJ:SCAL:Y:AUTO ON`

**Manual operation:**    See "[AF Auto Scale](#)" on page 62

## 11.5 Capturing data and performing sweeps

The following commands are required to capture data.

ABORt.....	167
INITiate<n>:CONMeas.....	168
INITiate<n>:CONTinuous.....	168
INITiate<n>[:IMMediate].....	168
INITiate:SEQuencer:ABORt.....	168
INITiate:SEQuencer:IMMediate.....	169
INITiate:SEQuencer:MODE.....	169
SYSTem:SEQuencer.....	169

---

### ABORt

This command aborts the measurement in the current channel setup and resets the trigger system.

To prevent overlapping execution of the subsequent command before the measurement has been aborted successfully, use the \*OPC? or \*WAI command after ABOR and before the next command.

For details on overlapping execution see [Remote control via SCPI](#).

#### Note on blocked remote control programs:

If a sequential command cannot be completed, for example because a triggered sweep never receives a trigger, the remote control program will never finish and the remote channel to the R&S ZNL is blocked for further commands. In this case, you must interrupt processing on the remote channel first in order to abort the measurement.

To do so, send a "Device Clear" command from the control instrument to the R&S ZNL on a parallel channel to clear all currently active remote channels. Depending on the used interface and protocol, send the following commands:

- **Visa:** viClear()

Now you can send the ABORt command on the remote channel performing the measurement.

**Example:**            ABOR; :INIT:IMM  
Aborts the current measurement and immediately starts a new one.

**Example:**            ABOR; \*WAI  
                          INIT:IMM  
Aborts the current measurement and starts a new one once abortion has been completed.

**Usage:**              Event

---

**INITiate<n>:CONMeas**

This command restarts a (single) measurement that has been stopped (using `ABORT`) or finished in single sweep mode.

The measurement is restarted at the beginning, not where the previous measurement was stopped.

**Suffix:**

<n> irrelevant

**Manual operation:** See "[ContinueSingleSweep](#)" on page 48

---

**INITiate<n>:CONTinuous <State>**

This command controls the sweep mode for an individual channel setup.

Note that in single sweep mode, you can synchronize to the end of the measurement with `*OPC`, `*OPC?` or `*WAI`. In continuous sweep mode, synchronization to the end of the measurement is not possible. Thus, it is not recommended that you use continuous sweep mode in remote control, as results like trace data or markers are only valid after a single sweep end synchronization.

For details on synchronization see [Remote control via SCPI](#).

**Example:**

```
INIT:CONT OFF
```

Switches the sweep mode to single sweep.

```
INIT:CONT ON
```

Switches the sweep mode to continuous sweep.

**Manual operation:** See "[Continuous Sweep / Run Cont](#)" on page 47

---

**INITiate<n>:[IMMEDIATE]**

This command starts a (single) new measurement.

With sweep count or average count > 0, this means a restart of the corresponding number of measurements. With trace mode `MAXHold`, `MINHold` and `AVERage`, the previous results are reset on restarting the measurement.

You can synchronize to the end of the measurement with `*OPC`, `*OPC?` or `*WAI`.

For details on synchronization see [Remote control via SCPI](#).

**Suffix:**

<n> irrelevant

**Manual operation:** See "[Single Sweep / Run Single](#)" on page 48

---

**INITiate:SEQuencer:ABORT**

This command stops the currently active sequence of measurements.

You can start a new sequence any time using `INITiate:SEQuencer:IMMEDIATE` on page 169.



**Usage:** Event

---

### INITiate:SEQuencer:IMMediate

This command starts a new sequence of measurements by the Sequencer.

Before this command can be executed, the Sequencer must be activated (see [SYSTem:SEQuencer](#) on page 169).

**Example:**

```

SYST:SEQ ON
Activates the Sequencer.
INIT:SEQ:MODE SING
Sets single sequence mode so each active measurement is per-
formed once.
INIT:SEQ:IMM
Starts the sequential measurements.

```

---

### INITiate:SEQuencer:MODE <Mode>

Defines the capture mode for the entire measurement sequence and all measurement groups and channels it contains.

**Note:** To synchronize to the end of a measurement sequence using \*OPC, \*OPC? or \*WAI, use SINGle Sequencer mode.

#### Parameters:

<Mode>

#### SINGle

Each measurement group is started one after the other in the order of definition. All measurement channels in a group are started simultaneously and performed once. After *all* measurements are completed, the next group is started. After the last group, the measurement sequence is finished.

#### CONTInuous

Each measurement group is started one after the other in the order of definition. All measurement channels in a group are started simultaneously and performed once. After *all* measurements are completed, the next group is started. After the last group, the measurement sequence restarts with the first one and continues until it is stopped explicitly.

```
*RST: CONTInuous
```

---

### SYSTem:SEQuencer <State>

This command turns the Sequencer on and off. The Sequencer must be active before any other Sequencer commands (INIT:SEQ...) are executed, otherwise an error occurs.

A detailed programming example is provided in the "Operating Modes" chapter in the R&S ZNL User Manual.

**Parameters:**

<State> ON | OFF | 0 | 1

**ON | 1**

The Sequencer is activated and a sequential measurement is started immediately.

**OFF | 0**

The Sequencer is deactivated. Any running sequential measurements are stopped. Further Sequencer commands (INIT:SEQ...) are not available.

\*RST: 0

**Example:**

SYST:SEQ ON

Activates the Sequencer.

INIT:SEQ:MODE SING

Sets single Sequencer mode so each active measurement is performed once.

INIT:SEQ:IMM

Starts the sequential measurements.

SYST:SEQ OFF

## 11.6 Configuring the result display

The following remote commands are required to configure the screen display in a remote environment.

- [General window commands](#)..... 170
- [Working with windows in the display](#)..... 171

### 11.6.1 General window commands

The following commands are required to configure general window layout, independent of the application.

Note that the suffix <n> always refers to the window *in the currently selected channel setup* (see [INSTrument\[:SElect\]](#) on page 121).

[DISPlay\[:WINDow<n>\]:SIZE](#)..... 170

---

**DISPlay[:WINDow<n>]:SIZE <Size>**

This command maximizes the size of the selected result display window *temporarily*. To change the size of several windows on the screen permanently, use the [LAYout:SPLitter](#) on page 174).

**Suffix:**<n> [Window](#)**Parameters:**

&lt;Size&gt;

**LARGE**

Maximizes the selected window to full screen.  
Other windows are still active in the background.

**SMALI**

Reduces the size of the selected window to its original size.  
If more than one measurement window was displayed originally, these are visible again.

\*RST: [SMALI](#)**Example:**

DISP:WIND2:SIZE LARG

## 11.6.2 Working with windows in the display

The following commands are required to change the evaluation type and rearrange the screen layout for a channel setup as you do using the SmartGrid in manual operation. Since the available evaluation types depend on the selected application, some parameters for the following commands also depend on the selected channel setup.

Note that the suffix <n> always refers to the window *in the currently selected channel setup*.

(See [INSTrument\[:SElect\]](#) on page 121).

<a href="#">LAYout:ADD[:WINDow]?</a> .....	171
<a href="#">LAYout:CATalog[:WINDow]?</a> .....	173
<a href="#">LAYout:IDENtify[:WINDow]?</a> .....	173
<a href="#">LAYout:REMOve[:WINDow]</a> .....	174
<a href="#">LAYout:REPLace[:WINDow]</a> .....	174
<a href="#">LAYout:SPLitter</a> .....	174
<a href="#">LAYout:WINDow&lt;n&gt;:ADD?</a> .....	176
<a href="#">LAYout:WINDow&lt;n&gt;:IDENtify?</a> .....	176
<a href="#">LAYout:WINDow&lt;n&gt;:REMOve</a> .....	177
<a href="#">LAYout:WINDow&lt;n&gt;:REPLace</a> .....	177
<a href="#">LAYout:WINDow&lt;n&gt;:TYPE</a> .....	178

---

**LAYout:ADD[:WINDow]?** <WindowName>, <Direction>, <WindowType>

This command adds a window to the display in the active channel setup.

This command is always used as a query so that you immediately obtain the name of the new window as a result.

To replace an existing window, use the [LAYout:REPLace\[:WINDow\]](#) command.

**Query parameters:**

- <WindowName> String containing the name of the existing window the new window is inserted next to.  
By default, the name of a window is the same as its index. To determine the name and index of all active windows, use the [LAYout:CATalog\[:WINDow\]? query](#).
- <Direction> LEFT | RIGHT | ABOVE | BELOW  
Direction the new window is added relative to the existing window.
- <WindowType> text value  
Type of result display (evaluation method) you want to add. See the table below for available parameter values.

**Return values:**

- <NewWindowName> When adding a new window, the command returns its name (by default the same as its number) as a result.

**Example:**

```
LAY:ADD? '1',BEL,'XTIM:AM:RElative[:TDOMain]'
```

Adds an "AM Time Domain" display below window 1.

**Usage:**

Query only

**Manual operation:**

See " [AM Time Domain](#) " on page 13  
 See " [FM Time Domain](#) " on page 14  
 See " [PM Time Domain](#) " on page 15  
 See " [AM Spectrum](#) " on page 16  
 See " [FM Spectrum](#) " on page 17  
 See " [PM Spectrum](#) " on page 18  
 See " [RF Time Domain](#) " on page 19  
 See " [RF Spectrum](#) " on page 20  
 See " [Result Summary](#) " on page 21  
 See " [Marker Table](#) " on page 23  
 See " [Marker Peak List](#) " on page 23

**Table 11-3: <WindowType> parameter values for AnalogDemod application**

Parameter value	Window type
MTABLE	"Marker table"
PEAKlist	"Marker peak list"
RSUMmary	"Result summary"
'XTIM:AM'	"RF Time Domain" (= RF power)
'XTIM:AM:RElative'	"AM Time Domain"
'XTIM:AM:RElative:AFSPec-trum'	"AM Spectrum"
'XTIM:FM'	"FM Time Domain"
'XTIM:FM:AFSPpectrum'	"FM Spectrum"

Parameter value	Window type
'XTIM:PM'	"PM Time Domain"
'XTIM:PM:AFSPpectrum'	"PM Spectrum"
'XTIM:SPECTrum'	"RF Spectrum"

---

### LAYout:CATalog[:WINDow]?

This command queries the name and index of all active windows in the active channel setup from top left to bottom right. The result is a comma-separated list of values for each window, with the syntax:

<WindowName\_1>,<WindowIndex\_1>..<WindowName\_n>,<WindowIndex\_n>

#### Return values:

<WindowName>      string  
Name of the window.  
In the default state, the name of the window is its index.

<WindowIndex>    **numeric value**  
Index of the window.

**Example:**            LAY:CAT?  
Result:  
'2',2,'1',1  
Two windows are displayed, named '2' (at the top or left), and '1' (at the bottom or right).

**Usage:**              Query only

---

### LAYout:IDENTify[:WINDow]? <WindowName>

This command queries the **index** of a particular display window in the active channel setup.

**Note:** to query the **name** of a particular window, use the [LAYout:WINDow<n>:IDENTify?](#) query.

#### Query parameters:

<WindowName>      String containing the name of a window.

#### Return values:

<WindowIndex>    Index number of the window.

**Example:**            LAY:IDEN:WIND? '2'  
Queries the index of the result display named '2'.  
Response:  
2

**Usage:**              Query only

---

**LAYout:REMove[:WINDow]** <WindowName>

This command removes a window from the display in the active channel.

**Setting parameters:**

<WindowName> String containing the name of the window. In the default state, the name of the window is its index.

**Example:** `LAY:REM '2'`  
Removes the result display in the window named '2'.

**Usage:** Setting only

---

**LAYout:REPLace[:WINDow]** <WindowName>, <WindowType>

This command replaces the window type (for example from "Diagram" to "Result Summary") of an already existing window in the active channel setup while keeping its position, index and window name.

To add a new window, use the `LAYout:ADD[:WINDow]?` command.

**Setting parameters:**

<WindowName> String containing the name of the existing window.  
By default, the name of a window is the same as its index. To determine the name and index of all active windows in the active channel setup, use the `LAYout:CATalog[:WINDow]?` query.

<WindowType> Type of result display you want to use in the existing window.  
See `LAYout:ADD[:WINDow]?` on page 171 for a list of available window types.

**Example:** `LAY:REPL:WIND '1',MTAB`  
Replaces the result display in window 1 with a marker table.

**Usage:** Setting only

---

**LAYout:SPLitter** <Index1>, <Index2>, <Position>

This command changes the position of a splitter and thus controls the size of the windows on each side of the splitter.

Note that windows must have a certain minimum size. If the position you define conflicts with the minimum size of any of the affected windows, the command does not work, but does not return an error.

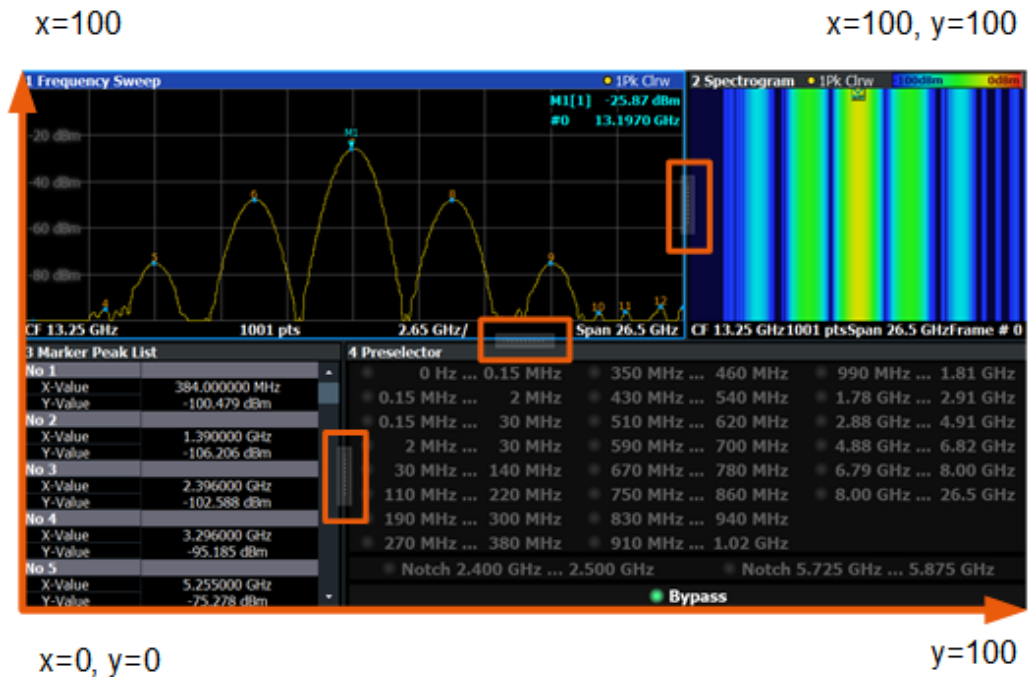

Figure 11-1: SmartGrid coordinates for remote control of the splitters

#### Setting parameters:

- <Index1> The index of one window the splitter controls.
- <Index2> The index of a window on the other side of the splitter.
- <Position> New vertical or horizontal position of the splitter as a fraction of the screen area (without channel and status bar and softkey menu).  
The point of origin (x = 0, y = 0) is in the lower left corner of the screen. The end point (x = 100, y = 100) is in the upper right corner of the screen. (See Figure 11-1.)  
The direction in which the splitter is moved depends on the screen layout. If the windows are positioned horizontally, the splitter also moves horizontally. If the windows are positioned vertically, the splitter also moves vertically.

Range: 0 to 100

#### Example:

LAY:SPL 1,3,50

Moves the splitter between window 1 ("Frequency Sweep") and 3 ("Marker Table") to the center (50%) of the screen, i.e. in the figure above, to the left.

**Example:** `LAY:SPL 1,4,70`  
 Moves the splitter between window 1 ('Frequency Sweep') and 3 ('Marker Peak List') towards the top (70%) of the screen. The following commands have the exact same effect, as any combination of windows above and below the splitter moves the splitter vertically.  
`LAY:SPL 3,2,70`  
`LAY:SPL 4,1,70`  
`LAY:SPL 2,1,70`

**Usage:** Setting only

---

#### **LAYout:WINDow<n>:ADD? <Direction>,<WindowType>**

This command adds a measurement window to the display. Note that with this command, the suffix <n> determines the existing window next to which the new window is added. Unlike `LAYout:ADD[:WINDow]?`, for which the existing window is defined by a parameter.

To replace an existing window, use the `LAYout:WINDow<n>:REPLace` command.

This command is always used as a query so that you immediately obtain the name of the new window as a result.

#### **Suffix:**

<n> [Window](#)

#### **Query parameters:**

<Direction> LEFT | RIGHT | ABOVE | BELOW

<WindowType> Type of measurement window you want to add.  
 See `LAYout:ADD[:WINDow]?` on page 171 for a list of available window types.

#### **Return values:**

<NewWindowName> When adding a new window, the command returns its name (by default the same as its number) as a result.

**Example:** `LAY:WIND1:ADD? LEFT,MTAB`  
**Result:**  
 '2'  
 Adds a new window named '2' with a marker table to the left of window 1.

**Usage:** Query only

---

#### **LAYout:WINDow<n>:IDENTify?**

This command queries the **name** of a particular display window (indicated by the <n> suffix) in the active channel setup.

**Note:** to query the **index** of a particular window, use the `LAYout:IDENTify[:WINDow]?` command.



<b>Suffix:</b>	
<n>	Window
<b>Return values:</b>	
<WindowName>	String containing the name of a window. In the default state, the name of the window is its index.
<b>Example:</b>	LAY:WIND2:IDEN? Queries the name of the result display in window 2. Response: '2'
<b>Usage:</b>	Query only

---

#### LAYout:WINDow<n>:REMove

This command removes the window specified by the suffix <n> from the display in the active channel setup.

The result of this command is identical to the [LAYout:REMove\[:WINDow\]](#) command.

<b>Suffix:</b>	
<n>	Window
<b>Example:</b>	LAY:WIND2:REM Removes the result display in window 2.
<b>Usage:</b>	Event

---

#### LAYout:WINDow<n>:REPLace <WindowType>

This command changes the window type of an existing window (specified by the suffix <n>) in the active channel setup.

The effect of this command is identical to the [LAYout:REPLace\[:WINDow\]](#) command.

To add a new window, use the [LAYout:WINDow<n>:ADD?](#) command.

<b>Suffix:</b>	
<n>	Window
<b>Setting parameters:</b>	
<WindowType>	Type of measurement window you want to replace another one with. See <a href="#">LAYout:ADD[:WINDow]?</a> on page 171 for a list of available window types.
<b>Example:</b>	LAY:WIND2:REPL MTAB Replaces the result display in window 2 with a marker table.
<b>Usage:</b>	Setting only

**LAYout:WINDow<n>:TYPE <WindowType>**

Queries or defines the window type of the window specified by the index <n>. The window type determines which results are displayed. For a list of possible window types, see [LAYout:ADD\[:WINDow\]?](#) on page 171.

Note that this command is not available in all applications and measurements.

**Suffix:**

<n> 1..n  
Window

**Parameters:**

<WindowType>

**Example:** LAY:WIND2:TYPE?

## 11.7 Retrieving results

The following remote commands are required to retrieve the results from an Analog Modulation Analysis in a remote environment.



In the Analog Modulation Analysis when you configure the traces for a window with a specific evaluation (e.g. AM time domain), the traces in all windows with the same evaluation are configured identically.

**Specific commands:**

- [Retrieving trace results](#)..... 178
- [Exporting trace results](#)..... 181
- [Retrieving result summary values](#)..... 183
- [Formats for returned values: ASCII format and binary format](#)..... 188
- [Reference: ASCII file export format](#)..... 188

### 11.7.1 Retrieving trace results

The following remote commands are required to retrieve the trace results in a remote environment.

<a href="#">[SENSe:]ADEMod:ACV:AFSPectrum:RESult?</a> .....	179
<a href="#">[SENSe:]ADEMod:ACV[:TDOMain]:RESult?</a> .....	179
<a href="#">[SENSe:]ADEMod:AM[:ABSolute]:AFSPectrum:RESult?</a> .....	179
<a href="#">[SENSe:]ADEMod:AM[:ABSolute][:TDOMain]:RESult?</a> .....	179
<a href="#">[SENSe:]ADEMod:AM:RELative:AFSPectrum:RESult?</a> .....	179
<a href="#">[SENSe:]ADEMod:AM:RELative[:TDOMain]:RESult?</a> .....	179
<a href="#">[SENSe:]ADEMod:FM:AFSPectrum:RESult?</a> .....	179
<a href="#">[SENSe:]ADEMod:FM[:TDOMain]:RESult?</a> .....	179
<a href="#">[SENSe:]ADEMod:PM:AFSPectrum:RESult?</a> .....	179
<a href="#">[SENSe:]ADEMod:PM[:TDOMain]:RESult?</a> .....	179

[SENSe:]ADEMod:SPECTrum:RESult?.....	179
FORMat[:DATA].....	180
FORMat:DEXPort:FORMat.....	181
TRACe<n>[:DATA].....	181

**[SENSe:]ADEMod:ACV:AFSPectrum:RESult? <TraceMode>**  
**[SENSe:]ADEMod:ACV[:TDOMain]:RESult? <TraceMode>**  
**[SENSe:]ADEMod:AM[:ABSolute]:AFSPectrum:RESult? <TraceMode>**  
**[SENSe:]ADEMod:AM[:ABSolute][:TDOMain]:RESult? <TraceMode>**  
**[SENSe:]ADEMod:AM:RELative:AFSPectrum:RESult? <TraceMode>**  
**[SENSe:]ADEMod:AM:RELative[:TDOMain]:RESult? <TraceMode>**  
**[SENSe:]ADEMod:FM:AFSPectrum:RESult? <TraceMode>**  
**[SENSe:]ADEMod:FM[:TDOMain]:RESult? <TraceMode>**  
**[SENSe:]ADEMod:PM:AFSPectrum:RESult? <TraceMode>**  
**[SENSe:]ADEMod:PM[:TDOMain]:RESult? <TraceMode>**  
**[SENSe:]ADEMod:SPECTrum:RESult? <TraceMode>**

This command reads the result data of the evaluated signal in the specified trace mode. The data format of the output data block is defined by the FORMat command (see FORMat [: DATA] on page 180).

The trace results are configured for a specific evaluation. The following table indicates which command syntax refers to which evaluation method, as well as the output unit of the results.

Command syntax	Evaluation method	Output unit
ACV[:TDOMain]	AC-Video time domain	V
ACV:AFSPectrum	AC-Video spectrum	V
AM[:ABSolute][:TDOMain]	RF time domain	dBm
AM:RELative[:TDOMain]	AM time domain	%
AM:RELative:AFSPectrum	AM spectrum	%
FM[:TDOMain]	FM time domain	kHz
FM:AFSPectrum	FM spectrum	kHz
PM[:TDOMain]	PM time domain	rad or °
PM:AFSPectrum	PM spectrum	rad or °
SPECTrum	RF spectrum	dBm (logarithmic display) or V (linear display).

#### Query parameters:

<TraceMode> WRITe | AVERage | MAXHold | MINHold

#### Return values:

<TraceModeResult> The specified trace mode must be one of those configured by SENS:ADEM:<Evaluation>:TYPE, see [SENSe:]ADEMod:SPECTrum[:TYPE] on page 202. Otherwise a query error is generated.

**Example:**

```

ADEM:AM AVER,MAXH,MINH
Sets up RF time domain results to be measured
INIT; *WAI
Starts measurement and waits for sync
FORM ASC
Selects output format
ADEM:AM:RES? AVER
Reads RF time domain average results
ADEM:AM:RES? MAXH
Reads RF time domain max hold results
ADEM:AM:RES? MINH
Reads RF time domain min hold results

```

**Usage:** Query only

---

### FORMat[:DATA] <Format>[, <BitLength>]

This command selects the data format that is used for transmission of trace data from the R&S ZNL to the controlling computer.

Note that the command has no effect for data that you send to the R&S ZNL. The R&S ZNL automatically recognizes the data it receives, regardless of the format.

#### Parameters:

<Format>

##### ASCii

ASCII format, separated by commas.

This format is almost always suitable, regardless of the actual data format. However, the data is not as compact as other formats can be.

##### REAL

Floating-point numbers (according to IEEE 754) in the "definite length block format".

In the Spectrum application, the format setting `REAL` is used for the binary transmission of trace data.

<BitLength>

Length in bits for floating-point results

##### 16

16-bit floating-point numbers.

Compared to `REAL, 32` format, half as many numbers are returned.

##### 32

32-bit floating-point numbers

For I/Q data, 8 bytes per sample are returned for this format setting.

##### 64

64-bit floating-point numbers

Compared to `REAL, 32` format, twice as many numbers are returned.

**Example:**

```
FORM REAL, 32
```

**FORMat:DEXPort:FORMat** <FileFormat>

Determines the format of the ASCII file to be imported or exported. Depending on the external program that creates the data file or evaluates it, a comma-separated list (CSV) or a plain data format (DAT) file is required.

**Parameters:**

<FileFormat>            CSV | DAT  
                           \*RST:        DAT

**Example:**                FORM:DEXP:FORM CSV

**Manual operation:**    See " [File Type](#) " on page 84

**TRACe<n>[:DATA]**

This command queries current trace data and measurement results.

The data format depends on [FORMat \[:DATA\]](#) on page 180.

**Suffix:**

<n>                        [Window](#)

**Query parameters:**

<ResultType>            Selects the type of result to be returned.

**TRACE1 | ... | TRACE6**

Returns the trace data for the corresponding trace.

The trace data consists of a list of measured power levels. The number of power levels in the list depends on the currently selected number of sweep points. The unit depends on the measurement and on the configured unit.

For the auto peak detector, the command returns positive peak values only. (To retrieve negative peak values, define a second trace with a negative peak detector.)

**Example:**                TRAC? TRACE3  
                               Queries the data of trace 3.

## 11.7.2 Exporting trace results

Trace results can be exported to a file.

For more commands concerning data and results storage, see the R&S ZNL User Manual.

<a href="#">FORMat:DEXPort:DSEParator</a> .....	182
<a href="#">FORMat:DEXPort:HEADer</a> .....	182
<a href="#">FORMat:DEXPort:TRACes</a> .....	182
<a href="#">MMEMory:STORe&lt;n&gt;:SPECtrogram</a> .....	183
<a href="#">MMEMory:STORe&lt;n&gt;:TRACe</a> .....	183

**FORMat:DEXPort:DSEParator** <Separator>

This command selects the decimal separator for data exported in ASCII format.

**Parameters:**

<Separator>            POINT | COMMa

**COMMa**

Uses a comma as decimal separator, e.g. 4,05.

**POINT**

Uses a point as decimal separator, e.g. 4.05.

\*RST:            \*RST has no effect on the decimal separator.  
Default is POINT.

**Example:**

FORM:DEXP:DSEP POIN

Sets the decimal point as separator.

**Manual operation:** See "[Decimal Separator](#)" on page 83  
See "[Export Peak List](#)" on page 103

**FORMat:DEXPort:HEADer** <State>

If enabled, additional instrument and measurement settings are included in the header of the export file for result data. If disabled, only the pure result data from the selected traces and tables is exported.

See [Chapter 11.7.5, "Reference: ASCII file export format"](#), on page 188 for details.

**Parameters:**

<State>                ON | OFF | 0 | 1

\*RST:                1

**Manual operation:** See "[Include Instrument & Measurement Settings](#)" on page 82

**FORMat:DEXPort:TRACes** <Selection>

This command selects the data to be included in a data export file (see [MMEMory:STORe<n>:TRACe](#) on page 183).

**Parameters:**

<Selection>            SINGle | ALL

**SINGle**

Only a single trace is selected for export, namely the one specified by the [MMEMory:STORe<n>:TRACe](#) command.

**ALL**

Selects all active traces and result tables (e.g. "Result Summary", marker peak list etc.) in the current application for export to an ASCII file.

The <trace> parameter for the [MMEMory:STORe<n>:TRACe](#) command is ignored.

\*RST:                SINGle

**Manual operation:** See " [Export all Traces and all Table Results](#) " on page 82

---

### **MMEMory:STORe<n>:SPECTrogram <FileName>**

This command exports spectrogram data to an ASCII file.

The file contains the data for every frame in the history buffer. The data corresponding to a particular frame begins with information about the frame number and the time that frame was recorded.

Note that, depending on the size of the history buffer, the process of exporting the data can take a while.

**Suffix:**

<n> [Window](#)

**Parameters:**

<FileName> String containing the path and name of the target file.

**Example:**

MMEM:STOR:SGR 'Spectrogram'  
Copies the spectrogram data to a file.

---

### **MMEMory:STORe<n>:TRACe <Trace>, <FileName>**

This command exports trace data from the specified window to an ASCII file.

**Suffix:**

<n> [Window](#)

**Parameters:**

<Trace> Number of the trace to be stored  
(This parameter is ignored if the option "Export all Traces and all Table Results" is activated in the Export configuration settings, see [FORMat:DEXPort:TRACes](#) on page 182).

<FileName> String containing the path and name of the target file.

**Example:**

MMEM:STOR1:TRAC 1, 'C:\TEST.ASC'  
Stores trace 1 from window 1 in the file TEST.ASC.

**Manual operation:** See " [Export Trace to ASCII File](#) " on page 83

## 11.7.3 Retrieving result summary values

The result summary contains measurement values that are calculated from the trace data.

For details see " [Result Summary](#) " on page 21.

<a href="#">CALCulate&lt;n&gt;:MARKer&lt;m&gt;:FUNCTion:ADEMod:AFRequency[:RESult&lt;t&gt;]?</a> .....	184
<a href="#">CALCulate&lt;n&gt;:MARKer&lt;m&gt;:FUNCTion:ADEMod:AM[:RESult&lt;t&gt;]?</a> .....	184
<a href="#">CALCulate&lt;n&gt;:MARKer&lt;m&gt;:FUNCTion:ADEMod:FM[:RESult&lt;t&gt;]?</a> .....	184
<a href="#">CALCulate&lt;n&gt;:MARKer&lt;m&gt;:FUNCTion:ADEMod:PM[:RESult&lt;t&gt;]?</a> .....	184
<a href="#">CALCulate&lt;n&gt;:MARKer&lt;m&gt;:FUNCTion:ADEMod:AM[:RESult&lt;t&gt;]:RELative?</a> .....	185

CALCulate<n>:MARKer<m>:FUNction:ADEMod:FM[:RESult<t>]:RELative?.....	185
CALCulate<n>:MARKer<m>:FUNction:ADEMod:PM[:RESult<t>]:RELative?.....	185
CALCulate<n>:MARKer<m>:FUNction:ADEMod:CARRier[:RESult<t>]?.....	186
CALCulate<n>:MARKer<m>:FUNction:ADEMod:DISTortion[:WRITe]:RESult<t>?.....	186
CALCulate<n>:MARKer<m>:FUNction:ADEMod:FERRor[:RESult<t>]?.....	186
CALCulate<n>:MARKer<m>:FUNction:ADEMod:SINad:RESult<t>?.....	187
CALCulate<n>:MARKer<m>:FUNction:ADEMod:THD:RESult<t>?.....	187
[SENSe:]ADEMod:SETTling:TIME:RESult<t>?.....	187

---

### CALCulate<n>:MARKer<m>:FUNction:ADEMod:AFRequency[:RESult<t>]?

This command queries the modulation (audio) frequency for the demodulation method in the specified window.

**Suffix:**

<n>	Window
<m>	irrelevant
<t>	Trace

**Return values:**

<ModFreq>	Modulation frequency in Hz.
-----------	-----------------------------

**Usage:** Query only

---

### CALCulate<n>:MARKer<m>:FUNction:ADEMod:AM[:RESult<t>]?

<MeasType>

CALCulate<n>:MARKer<m>:FUNction:ADEMod:FM[:RESult<t>]?

<MeasType>

CALCulate<n>:MARKer<m>:FUNction:ADEMod:PM[:RESult<t>]?

<MeasType>

This command queries the current value of the demodulated signal for the specified trace (as displayed in the "Result Summary" in manual operation).

Note that all windows with the same evaluation method have the same traces, thus the window is irrelevant.

**Suffix:**

<n>	Window
<m>	irrelevant
<t>	Trace

**Query parameters:**

<MeasType> PPEak | MPEak | MIDDLE | RMS

**PPEak**

Positive peak (+PK)

**MPEak | NPEak**

Negative peak (-PK)

**MIDDLE**

Average of positive and negative peaks  $\pm PK/2$

**RMS**

Root mean square value



**Return values:**

&lt;MeasTypeResult&gt;

**Example:**

```
CALC:FEED 'XTIM:PM:TDOM'
```

Switches on the PM time domain result display.

```
DISP:TRAC ON
```

Switches on the trace.

```
CALC:MARK:FUNC:ADEM:PM? PPE
```

Queries the peak value of the demodulated PM trace.

**Usage:**

Query only

```
CALCulate<n>:MARKer<m>:FUNCTION:ADEMod:AM[:RESult<t>]:RELative?
<MeasType>
```

```
CALCulate<n>:MARKer<m>:FUNCTION:ADEMod:FM[:RESult<t>]:RELative?
<MeasType>
```

```
CALCulate<n>:MARKer<m>:FUNCTION:ADEMod:PM[:RESult<t>]:RELative?
<MeasType>
```

This command queries the current *relative* value of the demodulated signal for the specified trace (as displayed in the "Result Summary" in manual operation).

Note that all windows with the same evaluation method have the same traces.

The unit of the results depends on the `CONFigure:ADEMod:RESults:UNIT` setting.

**Suffix:**

<n> irrelevant

<m> irrelevant

<t> [Trace](#)

**Query parameters:**

&lt;MeasType&gt;

**PPEak**

Positive peak (+PK)

**MPEak | NPEak**

Negative peak (-PK)

**MIDDLE**Average of positive and negative peaks  $\pm PK/2$ **RMS**

Root mean square value

**Return values:**

&lt;MeasTypeResult&gt;

**Example:**

```
CALC:FEED 'XTIM:PM:TDOM'
```

Switches on the PM time domain result display.

```
DISP:TRAC ON
```

Switches on the trace.

```
CALC:MARK:FUNC:ADEM:PM? PPE
```

Queries the peak value of the demodulated PM trace.

**Usage:**

Query only

**CALCulate<n>:MARKer<m>:FUNCTION:ADEMod:CARRier[:RESult<t>]?**

This command queries the carrier power, which is determined from the Clr/Write data.

**Suffix:**

<n>	Window
<m>	irrelevant
<t>	Trace

**Return values:**

<CPower> Power of the carrier without modulation in dBm.

**Usage:** Query only

**CALCulate<n>:MARKer<m>:FUNCTION:ADEMod:DISToRTion[:WRITe]:RESult<t>?**

This command queries the result of the modulation distortion measurement in the specified window for the specified trace.

Note that this value is only calculated if an AF Spectrum window is displayed.

**Suffix:**

<n>	Window
<m>	irrelevant
<t>	Trace

**Return values:**

<DISTORT> numeric value  
Modulation distortion in percent.  
Default unit: %

**Usage:** Query only

**CALCulate<n>:MARKer<m>:FUNCTION:ADEMod:FERRor[:RESult<t>]?**

This command queries the carrier offset (= frequency error) for FM and PM demodulation. The carrier offset is determined from the current measurement data (CLR/ WRITE). The modulation is removed using low pass filtering.

**Suffix:**

<n>	Window
<m>	irrelevant
<t>	Trace

**Return values:**

<CarrOffset> The deviation of the calculated carrier frequency to the ideal carrier frequency in Hz.

**Usage:** Query only

**CALCulate<n>:MARKer<m>:FUNction:ADEMod:SINad:RESult<t>?**

This command queries the result of the signal-to-noise-and-distortion (SINAD) measurement in the specified window for the specified trace.

Note that this value is only calculated if an AF Spectrum window is displayed.

**Suffix:**

<n>	Window
<m>	irrelevant
<t>	Trace

**Return values:**

<SINAD> The signal-to-noise-and-distortion ratio in dB.

**Usage:** Query only

**CALCulate<n>:MARKer<m>:FUNction:ADEMod:THD:RESult<t>?**

This command queries the result of the total harmonic distortion (THD) measurement in the specified window.

Note that this value is only calculated if an AF Spectrum window is displayed.

**Suffix:**

<n>	Window
<m>	irrelevant
<t>	Trace

**Return values:**

<THD> Total harmonic distortion of the demodulated signal in dB.

**Usage:** Query only

**[SENSe:]ADEMod:SETTling:TIME:RESult<t>?**

Returns the settling time after which the signal remains within a specified target corridor. The settling time is evaluated for the selected trace in each time domain window. The value is only determined for [SENSe:]ADEMod:SETTling:TIME:STATeON.

For details, see [Chapter 5.7.7, "Settling time"](#), on page 67.

**Suffix:**

<t>	1..n Trace
-----	---------------

**Return values:**

<Time> Default unit: s

**Example:**

```
ADEM:SETT:TIME:RES2?
//Result: 29.950000us
After 29.95 us, the signal is settled.
```

- Usage:** Query only
- Manual operation:** See "State" on page 68

#### 11.7.4 Formats for returned values: ASCII format and binary format

When trace data is retrieved using the `TRAC:DATA` or `TRAC:IQ:DATA` command, the data is returned in the format defined using the `FORMat[:DATA]` on page 180. The possible formats are described here.

- **ASCII Format (FORMat ASCII):**  
The data is stored as a list of comma-separated values (CSV) of the measured values in floating point format.
- **Binary Format (FORMat REAL,16/32/64):**  
The data is stored as binary data (definite length block data according to IEEE 488.2), each measurement value being formatted in 16-bit/32-bit/64-bit IEEE 754 floating-point-format.  
The schema of the result string is as follows:  
#<Length of length><Length of data><value1><value2>...<value n>  
with:

<Length of length>	Number of digits of the following number of data bytes
<Length of data>	Number of following data bytes
<Value>	2-byte/4-byte/8-byte floating point value

**Example:** #41024<Data>... contains 1024 data bytes

##### Data blocks larger than 999,999,999 bytes

According to SCPI, the header of the block data format allows for a maximum of 9 characters to describe the data length. Thus, the maximum REAL 32 data that can be represented is 999,999,999 bytes. However, the R&S ZNL is able to send larger data blocks. In this case, the length of the data block is placed in brackets, e.g.  
#(1234567890) <value1><value2>...



Reading out data in binary format is quicker than in ASCII format. Thus, binary format is recommended for large amounts of data.

#### 11.7.5 Reference: ASCII file export format

Trace data can be exported to a file in ASCII format for further evaluation in other applications. This reference describes in detail the format of the export files for result data.

The file consists of the header containing important scaling parameters and a data section containing the trace data. Optionally, the header can be excluded from the file (see "Include Instrument & Measurement Settings" on page 82).

The data of the file header consist of three columns, each separated by a semicolon: parameter name; numeric value; basic unit. The data section starts with the keyword "Trace <n>" (<n> = number of stored trace). The measured data follows in one or several columns (depending on the measurement), which are also separated by a semicolon.

The results are output in the same order as they are displayed on the screen: window by window, trace by trace, and table row by table row.

Generally, the format of this ASCII file can be processed by spreadsheet calculation programs, e.g. MS-Excel. Different language versions of evaluation programs can require a different handling of the decimal point. Thus, you can define the decimal separator to use (decimal point or comma, see "[Decimal Separator](#)" on page 83).

**Table 11-4: ASCII file format for trace export in the Spectrum application**

File contents	Description
<b>Header data</b>	
Type;R&S ZNL;	Instrument model
Version;1.00;	Firmware version
Date;01.Oct 2006;	Date of data set storage
Mode;ANALYZER;	Operating mode
Preamplifier;OFF	Preamplifier status
Transducer; OFF	Transducer status
Center Freq;55000;Hz	Center frequency
Freq Offset;0;Hz	Frequency offset
Start;10000;Hz Stop;100000;Hz	Start/stop of the display range. Unit: Hz for span > 0, s for span = 0, dBm/dB for statistics measurements
Span;90000;Hz	Frequency range (0 Hz in zero span and statistics measurements)
Ref Level;-30;dBm	Reference level
Level Offset;0;dB	Level offset
Rf Att;20;dB	Input attenuation
EI Att;2.0;dB	Electrical attenuation
RBW;100000;Hz	Resolution bandwidth
VBW;30000;Hz	Video bandwidth
SWT;0.005;s	Sweep time
Sweep Count;20;	Number of sweeps set
Ref Position;75;%	Position of reference level referred to diagram limits (0 % = lower edge)
Level Range;100;dB	Display range in y direction. Unit: dB with x-axis LOG, % with x-axis LIN

File contents	Description
x-Axis;LIN;	Scaling of x-axis linear (LIN) or logarithmic (LOG)
y-Axis;LOG;	Scaling of y-axis linear (LIN) or logarithmic (LOG)
x-Unit;Hz;	Unit of x values: Hz with span > 0; s with span = 0; dBm/dB with statistics measurements
y-Unit;dBm;	Unit of y values: dB*/V/A/W depending on the selected unit with y-axis LOG or % with y-axis LIN
<b>Data section for individual window</b>	
Window;1;Frequency Sweep	Window number and name
Trace 1;;	Selected trace
Trace Mode;AVERAGE;	Display mode of trace: CLR/WRITE,AVERAGE,MAXHOLD,MINHOLD
Detector;AUTOPEAK;	Selected detector
Values; 1001;	Number of measurement points
10000;-10.3;-15.7 10130;-11.5;-16.9 10360;-12.0;-17.4 ...;...;	Measured values: <x value>, <y1>, <y2>; <y2> being available only with detector AUTOPEAK and containing in this case the smallest of the two measured values for a measurement point.
<b>Data section for individual trace</b>	
Trace 2;;	Next trace in same window
...	
<b>Data section for individual window</b>	
Window;2 ..;	Name of next window
<b>Data section for individual trace</b>	
Trace 1;;	First trace
...	

## 11.8 Analyzing results

The following remote commands are required to configure general result analysis settings concerning the trace, markers, lines etc. in a remote environment. They are identical to the analysis functions in the base unit except for some special marker functions and spectrograms, which are not available in the R&S FPL1-K7 AM/FM/PM Modulation Analysis application.

More details are described for manual operation in [Chapter 6, "Analysis"](#), on page 73.

• Configuring spectrograms.....	191
• Configuring standard traces.....	199
• Working with markers remotely.....	205
• Marker search (spectrograms).....	239
• Defining limit checks.....	249

### 11.8.1 Configuring spectrograms

In addition to the standard "level versus frequency" or "level versus time" spectrum traces, the R&S ZNL also provides a spectrogram display of the measured data. A spectrogram shows how the spectral density of a signal varies over time. The x-axis shows the frequency, the y-axis shows the time. The commands required to configure spectrograms in a remote environment are described here. For details and manual operation see [Chapter 6.2, "Spectrogram settings"](#), on page 76.



When configuring spectrograms, the window suffix is irrelevant. The settings are always applied to the spectrogram window, or to all spectrogram windows, if several are active for the same channel setup.

For commands to set markers in spectrograms, see [Chapter 11.8.3.3, "Marker search \(spectrograms\)"](#), on page 214.

11.8.1.1 Configuring a spectrogram measurement.....	191
11.8.1.2 Configuring the color map.....	197

#### 11.8.1.1 Configuring a spectrogram measurement

CALCulate<n>:SGRam:CLEAr[:IMMediate].....	192
CALCulate<n>:SPECTrogram:CLEAr[:IMMediate].....	192
CALCulate<n>:SGRam:CONTInuous.....	192
CALCulate<n>:SPECTrogram:CONTInuous.....	192
CALCulate<n>:SGRam:FRAMe:COUNT.....	192
CALCulate<n>:SPECTrogram:FRAMe:COUNT.....	192
CALCulate<n>:SGRam:FRAMe:SELEct.....	193
CALCulate<n>:SPECTrogram:FRAMe:SELEct.....	193
CALCulate<n>:SGRam:HDEPth.....	193
CALCulate<n>:SPECTrogram:HDEPth.....	193
CALCulate<n>:SGRam:LAYout.....	194
CALCulate<n>:SPECTrogram:LAYout.....	194
CALCulate<n>:SGRam[:STATe].....	194
CALCulate<n>:SPECTrogram[:STATe].....	194
CALCulate<n>:SGRam:THReedim[:STATe].....	195
CALCulate<n>:SPECTrogram:THReedim[:STATe].....	195
CALCulate<n>:SGRam:TRACe.....	195
CALCulate<n>:SPECTrogram:TRACe.....	195
CALCulate<n>:SGRam:TSTamp:DATA?.....	195
CALCulate<n>:SPECTrogram:TSTamp:DATA?.....	195

CALCulate<n>:SGRam:TSTamp[:STATE].....	196
CALCulate<n>:SPECtrogram:TSTamp[:STATE].....	196

**CALCulate<n>:SGRam:CLEAr[:IMMediate]****CALCulate<n>:SPECtrogram:CLEAr[:IMMediate]**

This command resets the spectrogram and clears the history buffer.

**Suffix:**

<n> [Window](#)

**Example:**

```
//Reset the result display and clear the memory
CALC:SGR:CLE
```

**Manual operation:** See "[Clear Spectrogram](#)" on page 50

**CALCulate<n>:SGRam:CONTInuous <State>****CALCulate<n>:SPECtrogram:CONTInuous <State>**

This command determines whether the results of the last measurement are deleted before starting a new measurement in single sweep mode.

This setting applies to all spectrograms in the channel setup.

**Suffix:**

<n> [Window](#)

**Parameters:**

<State> ON | OFF | 0 | 1

**OFF | 0**

Switches the function off

**ON | 1**

Switches the function on

**Example:**

```
INIT:CONT OFF
```

Selects single sweep mode.

```
INIT;*WAI
```

Starts the sweep and waits for the end of the sweep.

```
CALC:SGR:CONT ON
```

Repeats the single sweep measurement without deleting the results of the last measurement.

**Manual operation:** See "[Continue Frame](#)" on page 49

**CALCulate<n>:SGRam:FRAME:COUNT <Frames>****CALCulate<n>:SPECtrogram:FRAME:COUNT <Frames>**

This command defines the number of frames to be recorded in a single sweep.

This value applies to all spectrograms in the channel setup.

**Suffix:**

<n> [Window](#)



**Parameters:**

<Frames> The maximum number of frames depends on the history depth.  
 Range: 1 to history depth  
 Increment: 1  
 \*RST: 1

**Example:**

```
//Select single sweep mode
INIT:CONT OFF
//Set the number of frames to 200
CALC:SGR:FRAM:COUN 200
```

**Manual operation:** See "[Frame Count](#)" on page 49

**CALCulate<n>:SGRam:FRAMe:SElect <Frame> | <Time>**

**CALCulate<n>:SPECTrogram:FRAMe:SElect <Frame> | <Time>**

This command selects a specific frame for further analysis.

The command is available if no measurement is running or after a single sweep has ended.

**Suffix:**

<n> [Window](#)

**Parameters:**

<Frame> Selects a frame directly by the frame number. Valid if the time stamp is off.  
 The range depends on the history depth.  
 Default unit: S

<Time> Selects a frame via its time stamp. Valid if the time stamp is on.  
 The number is the distance to frame 0 in seconds. The range depends on the history depth.

**Example:**

```
INIT:CONT OFF
Stop the continuous sweep.
CALC:SGR:FRAM:SEL -25
Selects frame number -25.
```

**Manual operation:** See "[Select Frame](#)" on page 49

**CALCulate<n>:SGRam:HDEPth <History>**

**CALCulate<n>:SPECTrogram:HDEPth <History>**

This command defines the number of frames to be stored in the R&S ZNL memory.

**Suffix:**

<n> [Window](#)

**Parameters:**

<History> The maximum number of frames depends on the number of sweep points.

Range: 781 to 20000

Increment: 1

\*RST: 3000

**Example:**

```
//Set the history depth to 1500
```

```
CALC:SGR:SPEC 1500
```

**Manual operation:** See "[History Depth](#)" on page 78

**CALCulate<n>:SGRam:LAYout <State>**

**CALCulate<n>:SPECtrogram:LAYout <State>**

This command selects the state and size of spectrograms.

The command is available for result displays that support spectrograms.

**Suffix:**

<n> [Window](#)

**Parameters:**

<State>

**ON**

Spectrogram and trace diagram share a window.

**OFF**

Only the trace diagram is displayed, the spectrogram is not.

\*RST: OFF

**Example:**

```
CALC4:SPEC:LAY FULL
```

Shows the spectrogram in window 4. The corresponding trace diagram is hidden.

**Manual operation:** See "[State](#)" on page 78

**CALCulate<n>:SGRam[:STATe] <State>**

**CALCulate<n>:SPECtrogram[:STATe] <State>**

This command turns the spectrogram on and off.

**Parameters:**

<State>

ON | OFF | 0 | 1

**OFF | 0**

Switches the function off

**ON | 1**

Switches the function on

**Example:**

```
CALC:SGR ON
```

Activates the Spectrogram result display.

---

**CALCulate<n>:SGRam:THReedim[:STATe] <State>**

**CALCulate<n>:SPECtrogram:THReedim[:STATe] <State>**

Activates or deactivates a 3-dimensional spectrogram for the selected result display.

**Suffix:**

<n> [Window](#)

**Parameters:**

<State> ON | OFF | 0 | 1

**OFF | 0**

Switches the function off

**ON | 1**

Switches the function on

\*RST: 0

**Example:** `CALC:SPEC:THR:STAT ON`

**Manual operation:** See "[3D Spectrogram State](#)" on page 78

---

**CALCulate<n>:SGRam:TRACe <Trace>**

**CALCulate<n>:SPECtrogram:TRACe <Trace>**

This command determines the trace in the result display the Spectrogram is based on.

**Suffix:**

<n> [Window](#)

**Parameters:**

<Trace> TRACE1 | TRACE2 | TRACE3 | TRACE4 | TRACE5 | TRACE6

How many traces are available depends on the selected result display.

**Example:** `CALC2:SPEC:TRAC TRACE3`

---

**CALCulate<n>:SGRam:TSTamp:DATA? <Frames>**

**CALCulate<n>:SPECtrogram:TSTamp:DATA? <Frames>**

This command queries the starting time of the frames.

The return values consist of four values for each frame. If the "Spectrogram" is empty, the command returns '0,0,0,0'. The times are given as delta values, which simplifies evaluating relative results; however, you can also calculate the absolute date and time as displayed on the screen.

The frame results themselves are returned with `TRAC:DATA? SGR`

**Suffix:**

<n> [Window](#)

**Query parameters:**

<Frames> **CURRent**

Returns the starting time of the current frame.

**ALL**

Returns the starting time for all frames. The results are sorted in descending order, beginning with the current frame.

**Return values:**

<Seconds>	Number of seconds that have passed since 01.01.1970 until the frame start
<Nanoseconds>	Number of nanoseconds that have passed <i>in addition to the</i> <Seconds> since 01.01.1970 until the frame start.
<Reserved>	The third value is reserved for future uses.
<Reserved>	The fourth value is reserved for future uses.

**Example:**

```
CALC:SGR:TST:DATA? ALL
```

Returns the starting times of all frames sorted in a descending order.

**Usage:**

Query only

**Manual operation:** See "[Time Stamp](#)" on page 79

**CALCulate<n>:SGRam:TSTamp[:STATE] <State>**

**CALCulate<n>:SPECTrogram:TSTamp[:STATE] <State>**

This command activates and deactivates the time stamp.

If the time stamp is active, some commands do not address frames as numbers, but as (relative) time values:

- [CALCulate<n>:DELTaMarker<m>:SPECTrogram:FRAME](#) on page 220
- [CALCulate<n>:MARKer<m>:SPECTrogram:FRAME](#) on page 215
- [CALCulate<n>:SPECTrogram:FRAME:SElect](#) on page 193

**Suffix:**

<n> 1..n  
[Window](#)

**Parameters:**

<State> ON | OFF | 0 | 1  
**OFF | 0**  
Switches the function off  
**ON | 1**  
Switches the function on

**Example:**

```
//Activates the time stamp
CALC:SGR:TST ON
```

**Manual operation:** See "[Time Stamp](#)" on page 79

### 11.8.1.2 Configuring the color map

DISPlay[:WINDow<n>]:SGRam:COLor:DEFault.....	197
DISPlay[:WINDow<n>]:SPECTrogram:COLor:DEFault.....	197
DISPlay[:WINDow<n>]:SGRam:COLor:LOWer.....	197
DISPlay[:WINDow<n>]:SPECTrogram:COLor:LOWer.....	197
DISPlay[:WINDow<n>]:SGRam:COLor:SHAPE.....	197
DISPlay[:WINDow<n>]:SPECTrogram:COLor:SHAPE.....	197
DISPlay[:WINDow<n>]:SGRam:COLor:UPPer.....	198
DISPlay[:WINDow<n>]:SPECTrogram:COLor:UPPer.....	198
DISPlay[:WINDow<n>]:SGRam:COLor[:STYLe].....	198
DISPlay[:WINDow<n>]:SPECTrogram:COLor[:STYLe].....	198

---

#### DISPlay[:WINDow<n>]:SGRam:COLor:DEFault DISPlay[:WINDow<n>]:SPECTrogram:COLor:DEFault

This command restores the original color map.

##### Suffix:

<n>                      Window

**Manual operation:**    See "Set to Default" on page 81

---

#### DISPlay[:WINDow<n>]:SGRam:COLor:LOWer <Percentage> DISPlay[:WINDow<n>]:SPECTrogram:COLor:LOWer <Percentage>

This command defines the starting point of the color map.

##### Suffix:

<n>                      Window

##### Parameters:

<Percentage>            Statistical frequency percentage.  
Range:            0 to 66  
\*RST:            0  
Default unit: %

**Example:**            DISP:WIND:SGR:COL:LOW 10  
Sets the start of the color map to 10%.

**Manual operation:**    See " Start / Stop " on page 81

---

#### DISPlay[:WINDow<n>]:SGRam:COLor:SHAPE <Shape> DISPlay[:WINDow<n>]:SPECTrogram:COLor:SHAPE <Shape>

This command defines the shape and focus of the color curve for the spectrogram result display.

##### Suffix:

<n>                      Window

**Parameters:**

<Shape> Shape of the color curve.  
 Range: -1 to 1  
 \*RST: 0

**Manual operation:** See "[Shape](#)" on page 81

**DISPlay[:WINDow<n>]:SGRam:COLor:UPPer** <Percentage>

**DISPlay[:WINDow<n>]:SPECtrogram:COLor:UPPer** <Percentage>

This command defines the end point of the color map.

**Suffix:**

<n> [Window](#)

**Parameters:**

<Percentage> Statistical frequency percentage.  
 Range: 0 to 66  
 \*RST: 0  
 Default unit: %

**Example:**

DISP:WIND:SGR:COL:UPP 95

Sets the start of the color map to 95%.

**Manual operation:** See "[Start / Stop](#)" on page 81

**DISPlay[:WINDow<n>]:SGRam:COLor[:STYLE]** <ColorScheme>

**DISPlay[:WINDow<n>]:SPECtrogram:COLor[:STYLE]** <ColorScheme>

This command selects the color scheme.

**Parameters:**

<ColorScheme>

**HOT**

Uses a color range from blue to red. Blue colors indicate low levels, red colors indicate high ones.

**COLD**

Uses a color range from red to blue. Red colors indicate low levels, blue colors indicate high ones.

**RADar**

Uses a color range from black over green to light turquoise with shades of green in between.

**GRAYscale**

Shows the results in shades of gray.

\*RST: HOT

**Example:**

DISP:WIND:SPEC:COL GRAY

Changes the color scheme of the spectrogram to black and white.

**Manual operation:** See "[Hot / Cold / Radar / Grayscale](#)" on page 81

## 11.8.2 Configuring standard traces

### Useful commands for trace configuration described elsewhere

- `DISPlay[:WINDow<n>][:SUBWindow<w>]:TRACe<t>:Y:SPACing`  
on page 134
- `DISPlay[:WINDow<n>][:SUBWindow<w>]:TRACe<t>:Y[:SCALe]`  
on page 132

### Remote commands exclusive to trace configuration

<code>DISPlay[:WINDow&lt;n&gt;][:SUBWindow&lt;w&gt;]:TRACe&lt;t&gt;:MODE</code> .....	199
<code>DISPlay[:WINDow&lt;n&gt;][:SUBWindow&lt;w&gt;]:TRACe&lt;t&gt;:MODE:HCONTinuous</code> .....	200
<code>DISPlay[:WINDow&lt;n&gt;][:SUBWindow&lt;w&gt;]:TRACe&lt;t&gt;:SELect</code> .....	201
<code>DISPlay[:WINDow&lt;n&gt;][:SUBWindow&lt;w&gt;]:TRACe&lt;t&gt;[:STATe]</code> .....	201
<code>[SENSe:]ADEMod:AM:RELative:AFSPectrum[:TYPE]</code> .....	202
<code>[SENSe:]ADEMod:AM:RELative:TDOMain[:TYPE]</code> .....	202
<code>[SENSe:]ADEMod:AM[:ABSolute]:AFSPectrum[:TYPE]</code> .....	202
<code>[SENSe:]ADEMod:AM[:ABSolute][:TDOMain][:TYPE]</code> .....	202
<code>[SENSe:]ADEMod:FM:AFSPectrum[:TYPE]</code> .....	202
<code>[SENSe:]ADEMod:FM[:TDOMain][:TYPE]</code> .....	202
<code>[SENSe:]ADEMod:PM:AFSPectrum[:TYPE]</code> .....	202
<code>[SENSe:]ADEMod:PM[:TDOMain][:TYPE]</code> .....	202
<code>[SENSe:]ADEMod:SPECtrum[:TYPE]</code> .....	202
<code>[SENSe:]AVERAge&lt;n&gt;:COUNT</code> .....	203
<code>[SENSe:]AVERAge&lt;n&gt;[:STATe&lt;t&gt;]</code> .....	203
<code>[SENSe:]AVERAge&lt;n&gt;:TYPE</code> .....	204
<code>[SENSe:][:WINDow&lt;n&gt;]:DETector&lt;t&gt;[:FUNction]</code> .....	204
<code>[SENSe:][:WINDow&lt;n&gt;]:DETector&lt;t&gt;[:FUNction]:AUTO</code> .....	205

---

### `DISPlay[:WINDow<n>][:SUBWindow<w>]:TRACe<t>:MODE <Mode>`

This command selects the trace mode. If necessary, the selected trace is also activated.

For max hold, min hold or average trace mode, you can set the number of single measurements with `[SENSe:]SWEep:COUNT`. Note that synchronization to the end of the measurement is possible only in single sweep mode.

In the R&S FPL1-K7 AM/FM/PM Modulation Analysis application, when you configure the traces for a window with a specific evaluation (e.g. AM time domain), the traces in all windows with the same evaluation are configured identically.

#### Suffix:

<n>	Window
<w>	subwindow
	Not supported by all applications

&lt;t&gt;

Trace

**Parameters:**

&lt;Mode&gt;

**WRITe**

(default:) Overwrite mode: the trace is overwritten by each sweep.

**AVERage**

The average is formed over several sweeps. The "Sweep/Average Count" determines the number of averaging procedures.

**MAXHold**

The maximum value is determined over several sweeps and displayed. The R&S ZNL saves the sweep result in the trace memory only if the new value is greater than the previous one.

**MINHold**

The minimum value is determined from several measurements and displayed. The R&S ZNL saves the sweep result in the trace memory only if the new value is lower than the previous one.

**VIEW**

The current contents of the trace memory are frozen and displayed.

**BLANK**

Hides the selected trace.

\*RST: Trace 1: WRITe, Trace 2-6: BLANK

**Example:**

```
INIT:CONT OFF
```

Switching to single sweep mode.

```
SWE:COUN 16
```

Sets the number of measurements to 16.

```
DISP:TRAC3:MODE WRIT
```

Selects clear/write mode for trace 3.

```
INIT;*WAI
```

Starts the measurement and waits for the end of the measurement.

**Manual operation:** See " [TraceMode](#) " on page 74

---

**DISPlay[:WINDow<n>][:SUBWindow<w>]:TRACe<t>:MODE:HCONtinuous**  
<State>

This command turns an automatic reset of a trace on and off after a parameter has changed.

The reset works for trace modes min hold, max hold and average.

Note that the command has no effect if critical parameters like the span have been changed to avoid invalid measurement results

**Suffix:**

&lt;n&gt;

Window

&lt;w&gt;

subwindow



<t> [Trace](#)

**Parameters:**

<State> ON | OFF | 0 | 1  
**OFF | 0**  
 Switches the function off  
**ON | 1**  
 Switches the function on

**Example:** DISP:WIND:TRAC3:MODE:HCON ON  
 Switches off the reset function.

**Manual operation:** See "[Hold](#)" on page 75

**DISPlay[:WINDow<n>][:SUBWindow<w>]:TRACe<t>:SELEct**

This command selects the trace specified by the index <t> in the window specified by the index <n>. Only traces that are active in the specified result display can be selected. The selected trace is used to determine the "Result Summary" for the corresponding result display.

The query returns the number of the currently selected trace in the window specified by the index <n> (trace index is ignored). Traces can only be queried for graphical result displays (not "Result Summary", "Marker Table" or Peak Marker List).

**Suffix:**

<n> [Window](#)  
 <w> subwindow  
 <t> irrelevant

**Example:** DISP:TRAC3:SEL

**DISPlay[:WINDow<n>][:SUBWindow<w>]:TRACe<t>[:STATE] <State>**

This command turns a trace on and off.

The measurement continues in the background.

**Suffix:**

<n> [Window](#)  
 <w> subwindow  
 Not supported by all applications  
 <t> [Trace](#)

**Parameters:**

<State> ON | OFF | 0 | 1  
**OFF | 0**  
 Switches the function off  
**ON | 1**  
 Switches the function on

**Example:** DISP:TRAC3 ON

**Manual operation:** See " [Trace 1 / Trace 2 / Trace 3 / Trace 4 / Trace 5 / Trace 6](#) " on page 74  
See " [Trace 1 / Trace 2 / Trace 3 / Trace 4 \(Softkeys\)](#) " on page 76

---

```
[SENSe:]ADEMod:AM:RELative:AFSPectrum[:TYPE] <TraceMode>...
[SENSe:]ADEMod:AM:RELative[:TDOMain][:TYPE] <TraceMode>...
[SENSe:]ADEMod:AM[:ABSolute]:AFSPectrum[:TYPE] <TraceMode>...
[SENSe:]ADEMod:AM[:ABSolute][:TDOMain][:TYPE] <TraceMode>...
[SENSe:]ADEMod:FM:AFSPectrum[:TYPE] <TraceMode>...
[SENSe:]ADEMod:FM[:TDOMain][:TYPE] <TraceMode>...
[SENSe:]ADEMod:PM:AFSPectrum[:TYPE] <TraceMode>...
[SENSe:]ADEMod:PM[:TDOMain][:TYPE] <TraceMode>...
[SENSe:]ADEMod:SPECTrum[:TYPE] <TraceMode>...
```

This command selects the trace modes of the evaluated signal to be measured simultaneously. For each of the six available traces a mode can be defined.

The trace modes are configured identically for all windows with a specific evaluation. The following table indicates which command syntax refers to which evaluation method.

Command syntax	Evaluation method
AM[:ABSolute][:TDOMain]	RF time domain
AM:RELative[:TDOMain]	AM time domain
AM:RELative:AFSPectrum	AM spectrum (relative)
FM[:TDOMain]	FM time domain
FM:AFSPectrum	FM spectrum
PM[:TDOMain]	PM time domain
PM:AFSPectrum	PM spectrum
SPECTrum	RF spectrum

**Parameters:**

<TraceMode>

WRITe | AVERAge | MAXHold | MINHold | VIEW | OFF

**WRITe**

Overwrite mode: the trace is overwritten by each sweep. This is the default setting.

**AVERAge**

The average is formed over several sweeps.

**MAXHold**

The maximum value is determined over several sweeps and displayed. The R&S ZNL saves the sweep result in the trace memory only if the new value is greater than the previous one.

**MINHold**

The minimum value is determined from several measurements and displayed. The R&S ZNL saves the sweep result in the trace memory only if the new value is lower than the previous one.

**VIEW**

The current contents of the trace memory are frozen and displayed.

**OFF**

Hides the selected trace.

\*RST: WRITe,OFF,OFF,OFF,OFF,OFF

**Example:**

ADEM:AM AVER,MAXH,MINH,OFF,OFF,OFF

Determines average, max hold and min hold values simultaneously for the traces 1-3 of the RF time domain evaluation.

ADEM:AM WRIT,OFF,OFF,OFF,OFF,OFF

Determines only the current measurement values for trace 1.

ADEM:AM OFF,OFF,OFF,OFF,OFF,OFF

Switches AM demodulation off.

**[SENSe:]AVERage<n>:COUNT <AverageCount>**

This command defines the number of sweeps that the application uses to average traces.

In case of continuous sweep mode, the application calculates the moving average over the average count.

In case of single sweep mode, the application stops the measurement and calculates the average after the average count has been reached.

**Suffix:**

<n> irrelevant

**Parameters:**

<AverageCount> If you set an average count of 0 or 1, the application performs one single sweep in single sweep mode.  
In continuous sweep mode, if the average count is set to 0, a moving average over 10 sweeps is performed.

Range: 0 to 200000

\*RST: 0

**Manual operation:** See "[Sweep/Average Count](#)" on page 49  
See "[Average Count](#)" on page 76

**[SENSe:]AVERage<n>[:STATe<t>] <State>**

This command turns averaging for a particular trace in a particular window on and off.

**Suffix:**

<n> [Window](#)

<t> [Trace](#)

**Parameters:**

<State> ON | OFF | 1 | 0

**[SENSe:]AVERAge<n>:TYPE <Mode>**

This command selects the trace averaging mode.

**Suffix:**

<n> 1..n  
Window

**Parameters:**

<Mode> **LOGarithmic**  
The logarithmic power values are averaged.

**LINear**  
The power values are averaged before they are converted to logarithmic values.

**POWER**  
The power level values are converted into unit Watt prior to averaging. After the averaging, the data is converted back into its original unit.

**Example:**

AVER:TYPE LIN  
Switches to linear average calculation.

**Manual operation:** See " [Average Mode](#) " on page 75

**[SENSe:][WINDow<n>:]DETEctor<t>[:FUNCTion] <Detector>**

Defines the trace detector to be used for trace analysis.

**Suffix:**

<n> Window  
<t> Trace

**Parameters:**

<Detector> **APEak**  
Autoppeak

**NEGative**  
Negative peak

**POSitive**  
Positive peak

**SAMPIe**  
First value detected per trace point

**RMS**  
RMS value

**AVERAge**  
Average

\*RST: APEak

**Example:**           DET POS  
Sets the detector to "positive peak".

**Manual operation:** See " [Detector](#) " on page 75

**[SENSe:][WINDow<n>:]DETEctor<t>[:FUNction]:AUTO <State>**

This command couples and decouples the detector to the trace mode.

**Suffix:**

<n>                   Window

<t>                   Trace

**Parameters:**

<State>           ON | OFF | 0 | 1

\*RST:           1

**Example:**           DET:AUTO OFF  
The selection of the detector is not coupled to the trace mode.

**Manual operation:** See " [Detector](#) " on page 75

### 11.8.3 Working with markers remotely

In the R&S FPL1-K7 AM/FM/PM Modulation Analysis application, up to 16 markers or delta markers can be activated for each window simultaneously.

More details are described for manual operation in [Chapter 6.4.4, "Marker function configuration"](#), on page 94.

- [Setting up individual markers](#).....205
- [General marker settings](#).....212
- [Marker search \(spectrograms\)](#).....214
- [Marker search settings](#).....223
- [Positioning the marker](#).....224
- [Configuring special marker functions](#).....229

#### 11.8.3.1 Setting up individual markers

The following commands define the position of markers in the diagram.

<a href="#">CALCulate&lt;n&gt;:MARKer&lt;m&gt;:AOFF</a> .....	206
<a href="#">CALCulate&lt;n&gt;:MARKer&lt;ms&gt;:LINK:TO:MARKer&lt;md&gt;</a> .....	206
<a href="#">CALCulate&lt;n&gt;:MARKer&lt;m&gt;[:STATE]</a> .....	206
<a href="#">CALCulate&lt;n&gt;:MARKer&lt;m&gt;:TRACe</a> .....	207
<a href="#">CALCulate&lt;n&gt;:MARKer&lt;m&gt;:X</a> .....	207
<a href="#">CALCulate&lt;n&gt;:MARKer&lt;m&gt;:Y?</a> .....	208
<a href="#">CALCulate&lt;n&gt;:DELTamarker&lt;m&gt;:AOFF</a> .....	208
<a href="#">CALCulate&lt;n&gt;:DELTamarker&lt;m&gt;:LINK</a> .....	208
<a href="#">CALCulate&lt;n&gt;:DELTamarker&lt;ms&gt;:LINK:TO:MARKer&lt;md&gt;</a> .....	209
<a href="#">CALCulate&lt;n&gt;:DELTamarker&lt;m&gt;:MODE</a> .....	209

CALCulate<n>:DELTaMarker<m>:MREFerence.....	210
CALCulate<n>:DELTaMarker<m>[:STATe].....	210
CALCulate<n>:DELTaMarker<m>:TRACe.....	211
CALCulate<n>:DELTaMarker<m>:X.....	211
CALCulate<n>:DELTaMarker<m>:X:RELative?.....	211
CALCulate<n>:DELTaMarker<m>:Y?.....	212

---

### CALCulate<n>:MARKer<m>:AOFF

This command turns off all markers.

#### Suffix:

<n>                    Window

<m>                    Marker

#### Example:

CALC:MARK:AOFF  
Switches off all markers.

**Manual operation:** See " [All Markers Off](#) " on page 87

---

### CALCulate<n>:MARKer<ms>:LINK:TO:MARKer<md> <State>

This command links the normal source marker <ms> to any active destination marker <md> (normal or delta marker).

If you change the horizontal position of marker <md>, marker <ms> changes its horizontal position to the same value.

#### Suffix:

<n>                    Window

<ms>                  source marker, see [Marker](#)

<md>                  destination marker, see [Marker](#)

#### Parameters:

<State>              ON | OFF | 0 | 1  
**OFF | 0**  
Switches the function off

**ON | 1**  
Switches the function on

#### Example:

CALC:MARK4:LINK:TO:MARK2 ON  
Links marker 4 to marker 2.

**Manual operation:** See " [Linking to Another Marker](#) " on page 86

---

### CALCulate<n>:MARKer<m>[:STATe] <State>

This command turns markers on and off. If the corresponding marker number is currently active as a delta marker, it is turned into a normal marker.

**Suffix:**<n> [Window](#)<m> [Marker](#)**Parameters:**

&lt;State&gt; ON | OFF | 0 | 1

**OFF | 0**

Switches the function off

**ON | 1**

Switches the function on

**Example:**

CALC:MARK3 ON

Switches on marker 3.

**Manual operation:**See "[Marker State](#)" on page 85See "[Marker Type](#)" on page 86See "[Select Marker](#)" on page 90**CALCulate<n>:MARKer<m>:TRACe <Trace>**

This command selects the trace the marker is positioned on.

Note that the corresponding trace must have a trace mode other than "Blank".

If necessary, the command activates the marker first.

**Suffix:**<n> [Window](#)<m> [Marker](#)**Parameters:**<Trace> **1 to 6**

Trace number the marker is assigned to.

**Example:**

//Assign marker to trace 1

CALC:MARK3:TRAC 2

**Manual operation:**See "[Assigning the Marker to a Trace](#)" on page 87**CALCulate<n>:MARKer<m>:X <Position>**

This command moves a marker to a specific coordinate on the x-axis.

If necessary, the command activates the marker.

If the marker has been used as a delta marker, the command turns it into a normal marker.

**Suffix:**<n> [Window](#)<m> [Marker](#)

**Parameters:**

<Position> Numeric value that defines the marker position on the x-axis.  
The unit depends on the result display.

Range: The range depends on the current x-axis range.  
Default unit: Hz

**Example:**

CALC:MARK2:X 1.7MHz

Positions marker 2 to frequency 1.7 MHz.

**Manual operation:**

See " [Marker Table](#) " on page 23

See " [Marker Peak List](#) " on page 23

See " [Marker Position X-value](#) " on page 86

**CALCulate<n>:MARKer<m>:Y?**

Queries the result at the position of the specified marker.

**Suffix:**

<n> 1..n

<m> 1..n

**Return values:**

<Result> Default unit: DBM

**Usage:**

Query only

**Manual operation:**

See " [Marker Table](#) " on page 23

See " [Marker Peak List](#) " on page 23

**CALCulate<n>:DELTamarker<m>:AOFF**

This command turns off *all* delta markers.

**Suffix:**

<n> [Window](#)

<m> irrelevant

**Example:**

CALC:DELT:AOFF

Turns off all delta markers.

**CALCulate<n>:DELTamarker<m>:LINK <State>**

This command links delta marker <m> to marker 1.

If you change the horizontal position (x-value) of marker 1, delta marker <m> changes its horizontal position to the same value.

**Suffix:**

<n> [Window](#)



<m> [Marker](#)

**Parameters:**

<State> ON | OFF | 0 | 1  
**OFF | 0**  
 Switches the function off  
**ON | 1**  
 Switches the function on

**Example:** CALC:DELT2:LINK ON

**Manual operation:** See "[Linking to Another Marker](#)" on page 86

**CALCulate<n>:DELTamarker<ms>:LINK:TO:MARKer<md>** <State>

This command links the delta source marker <ms> to any active destination marker <md> (normal or delta marker).

**Suffix:**

<n> [Window](#)  
 <ms> source marker, see [Marker](#)  
 <md> destination marker, see [Marker](#)

**Parameters:**

<State> ON | OFF | 0 | 1  
**OFF | 0**  
 Switches the function off  
**ON | 1**  
 Switches the function on

**Example:** CALC:DELT4:LINK:TO:MARK2 ON  
 Links the delta marker 4 to the marker 2.

**Manual operation:** See "[Linking to Another Marker](#)" on page 86

**CALCulate<n>:DELTamarker<m>:MODE** <Mode>

This command defines whether the position of a delta marker is provided as an absolute value or relative to a reference marker. Note that this setting applies to *all* windows.

Note that when the position of a delta marker is *queried*, the result is always an absolute value (see [CALCulate<n>:DELTamarker<m>:X](#) on page 211)!

**Suffix:**

<n> irrelevant  
 <m> irrelevant

**Parameters:**

<Mode> **ABSolute**  
 Delta marker position in absolute terms.

**RELative**

Delta marker position in relation to a reference marker.

\*RST: RELative

**Example:**

CALC:DELT:MODE ABS

Absolute delta marker position.

**CALCulate<n>:DELTamarker<m>:MREFerence <Reference>**

This command selects a reference marker for a delta marker other than marker 1.

The reference may be another marker or the fixed reference.

**Suffix:**

<n> [Window](#)

<m> [Marker](#)

**Parameters:**

<Reference> **1 to 16**

Selects markers 1 to 16 as the reference.

**FIXed**

Selects the fixed reference as the reference.

**Example:**

CALC:DELT3:MREF 2

Specifies that the values of delta marker 3 are relative to marker 2.

**Manual operation:** See "[Reference Marker](#)" on page 86

**CALCulate<n>:DELTamarker<m>[:STATE] <State>**

This command turns delta markers on and off.

If necessary, the command activates the delta marker first.

No suffix at DELTmarker turns on delta marker 1.

**Suffix:**

<n> [Window](#)

<m> [Marker](#)

**Parameters:**

<State> ON | OFF | 0 | 1

**OFF | 0**

Switches the function off

**ON | 1**

Switches the function on

**Example:**

CALC:DELT2 ON

Turns on delta marker 2.

**Manual operation:** See " [Marker State](#) " on page 85  
 See " [Marker Type](#) " on page 86  
 See " [Select Marker](#) " on page 90

---

#### **CALCulate<n>:DELTamarker<m>:TRACe <Trace>**

This command selects the trace a delta marker is positioned on.

Note that the corresponding trace must have a trace mode other than "Blank".

If necessary, the command activates the marker first.

#### **Suffix:**

<n> [Window](#)

<m> [Marker](#)

#### **Parameters:**

<Trace> Trace number the marker is assigned to.

#### **Example:**

`CALC:DELT2:TRAC 2`  
 Positions delta marker 2 on trace 2.

---

#### **CALCulate<n>:DELTamarker<m>:X <Position>**

This command moves a delta marker to a particular coordinate on the x-axis.

If necessary, the command activates the delta marker and positions a reference marker to the peak power.

#### **Suffix:**

<n> [Window](#)

<m> [Marker](#)

#### **Parameters:**

<Position> Numeric value that defines the marker position on the x-axis. The position is relative to the reference marker. To select an absolute position you have to change the delta marker mode with `CALCulate<n>:DELTamarker<m>:MODE` on page 209. A query returns the absolute position of the delta marker.  
 Range: The value range and unit depend on the measurement and scale of the x-axis.  
 Default unit: HZ

#### **Example:**

`CALC:DELT:X?`  
 Outputs the absolute x-value of delta marker 1.

**Manual operation:** See "[Marker Position X-value](#)" on page 86

---

#### **CALCulate<n>:DELTamarker<m>:X:RELative?**

This command queries the relative position of a delta marker on the x-axis.

If necessary, the command activates the delta marker first.

**Suffix:**

<n> [Window](#)

<m> [Marker](#)

**Return values:**

<Position> Position of the delta marker in relation to the reference marker.

**Example:**

`CALC:DELT3:X:REL?`

Outputs the frequency of delta marker 3 relative to marker 1 or relative to the reference position.

**Usage:**

Query only

**CALCulate<n>:DELTaMarker<m>:Y?**

Queries the result at the position of the specified delta marker.

**Suffix:**

<n> 1..n

<m> 1..n

**Return values:**

<Result> Result at the position of the delta marker.  
The unit is variable and depends on the one you have currently set.

Default unit: DBM

**Usage:**

Query only

**11.8.3.2 General marker settings**

The following commands control general marker functionality.

See also "[Fixed reference marker settings](#)" on page 229

<a href="#">CALCulate&lt;n&gt;:MARKer&lt;m&gt;:X:SSIZE</a> .....	212
<a href="#">CALCulate&lt;n&gt;:MARKer&lt;m&gt;:LINK</a> .....	213
<a href="#">DISPlay[:WINDow&lt;n&gt;]:MINFo[:STATe]</a> .....	213
<a href="#">DISPlay[:WINDow&lt;n&gt;]:MTABLE</a> .....	214

**CALCulate<n>:MARKer<m>:X:SSIZE <StepSize>**

This command selects the marker step size mode for *all* markers in *all* windows.

The step size defines the distance the marker moves when you move it with the rotary knob.

It therefore takes effect in manual operation only.

**Suffix:**

<n> irrelevant

<m> irrelevant

**Parameters:**

<StepSize>

**STANDARD**

the marker moves from one pixel to the next

**POINTS**

the marker moves from one sweep point to the next

\*RST: POINTs

**Example:**

CALC:MARK:X:SSIZ STAN

Sets the marker step size to one pixel.

**Manual operation:** See " [Marker Stepsize](#) " on page 88

**CALCulate<n>:MARKer<m>:LINK <DisplayType>**

Links the specified marker in all displays of the specified type.

**Suffix:**

<n> irrelevant

<m> [Marker](#)

**Parameters:**

<DisplayType>

TIME | SPECTrum | BOTH | NONE

**TIME**

Links the markers in all time domain diagrams

**SPECTrum**

Links the markers in all AF Spectrum displays

**BOTH**

Links the markers both in the time domain diagrams and in the AF Spectrum displays

**NONE**

Markers are not linked.

\*RST: NONE

**Manual operation:** See "[Link Time Marker](#)" on page 89  
See "[Link AF Spectrum Marker](#)" on page 89

**DISPlay[:WINDow<n>]:MINFo[:STATE] <State>**

This command turns the marker information in all diagrams on and off.

**Suffix:**

<n> irrelevant

**Parameters:**

<State>

**ON | 1**

Displays the marker information in the diagrams.

**OFF | 0**

Hides the marker information in the diagrams.

\*RST: 1

**Example:** DISP:MINF OFF  
Hides the marker information.

**Manual operation:** See " [Marker Info](#) " on page 88

**DISPlay[:WINDow<n>]:MTABLE <DisplayMode>**

This command turns the marker table on and off.

**Suffix:**

<n> irrelevant

**Parameters:**

<DisplayMode> **ON | 1**  
Turns on the marker table.

**OFF | 0**  
Turns off the marker table.

**AUTO**  
Turns on the marker table if 3 or more markers are active.

\*RST: AUTO

**Example:** DISP:MTAB ON  
Activates the marker table.

**Manual operation:** See " [Marker Table Display](#) " on page 88

### 11.8.3.3 Marker search (spectrograms)

The following commands automatically define the marker and delta marker position in the spectrogram.

#### Using markers

The following commands control spectrogram markers.

#### Useful commands for spectrogram markers described elsewhere

The following commands define the horizontal position of the markers.

- [CALCulate<n>:MARKer<m>:MAXimum:LEFT](#) on page 224
- [CALCulate<n>:MARKer<m>:MAXimum:NEXT](#) on page 225
- [CALCulate<n>:MARKer<m>:MAXimum\[:PEAK\]](#) on page 225
- [CALCulate<n>:MARKer<m>:MAXimum:RIGHT](#) on page 225
- [CALCulate<n>:MARKer<m>:MINimum:LEFT](#) on page 225
- [CALCulate<n>:MARKer<m>:MINimum:NEXT](#) on page 226
- [CALCulate<n>:MARKer<m>:MINimum\[:PEAK\]](#) on page 226
- [CALCulate<n>:MARKer<m>:MINimum:RIGHT](#) on page 226

**Remote commands exclusive to spectrogram markers**

CALCulate<n>:MARKer<m>:SGRam:FRAMe.....	215
CALCulate<n>:MARKer<m>:SPEctrogram:FRAMe.....	215
CALCulate<n>:MARKer<m>:SGRam:SARea.....	216
CALCulate<n>:MARKer<m>:SPEctrogram:SARea.....	216
CALCulate<n>:MARKer<m>:SGRam:XY:MAXimum[:PEAK].....	216
CALCulate<n>:MARKer<m>:SPEctrogram:XY:MAXimum[:PEAK].....	216
CALCulate<n>:MARKer<m>:SGRam:XY:MINimum[:PEAK].....	216
CALCulate<n>:MARKer<m>:SPEctrogram:XY:MINimum[:PEAK].....	216
CALCulate<n>:MARKer<m>:SGRam:Y:MAXimum:ABOVe.....	216
CALCulate<n>:MARKer<m>:SPEctrogram:Y:MAXimum:ABOVe.....	216
CALCulate<n>:MARKer<m>:SGRam:Y:MAXimum:BELow.....	217
CALCulate<n>:MARKer<m>:SPEctrogram:Y:MAXimum:BELow.....	217
CALCulate<n>:MARKer<m>:SGRam:Y:MAXimum:NEXT.....	217
CALCulate<n>:MARKer<m>:SPEctrogram:Y:MAXimum:NEXT.....	217
CALCulate<n>:MARKer<m>:SGRam:Y:MAXimum[:PEAK].....	217
CALCulate<n>:MARKer<m>:SPEctrogram:Y:MAXimum[:PEAK].....	217
CALCulate<n>:MARKer<m>:SGRam:Y:MINimum:ABOVe.....	218
CALCulate<n>:MARKer<m>:SPEctrogram:Y:MINimum:ABOVe.....	218
CALCulate<n>:MARKer<m>:SGRam:Y:MINimum:BELow.....	218
CALCulate<n>:MARKer<m>:SPEctrogram:Y:MINimum:BELow.....	218
CALCulate<n>:MARKer<m>:SGRam:Y:MINimum:NEXT.....	218
CALCulate<n>:MARKer<m>:SPEctrogram:Y:MINimum:NEXT.....	218
CALCulate<n>:MARKer<m>:SGRam:Y:MINimum[:PEAK].....	218
CALCulate<n>:MARKer<m>:SPEctrogram:Y:MINimum[:PEAK].....	218

---

**CALCulate<n>:MARKer<m>:SGRam:FRAMe <Frame>**

**CALCulate<n>:MARKer<m>:SPEctrogram:FRAMe <Frame> | <Time>**

This command positions a marker on a particular frame.

**Suffix:**

<n>                      Window

<m>                      Marker

**Parameters:**

<Frame>                Selects a frame directly by the frame number. Valid if the time stamp is off.

The range depends on the history depth.

Default unit: S

<Time>                Selects a frame via its time stamp. Valid if the time stamp is on.

The number is the (negative) distance to frame 0 in seconds.

The range depends on the history depth.

**Example:**

CALC:MARK:SGR:FRAM -20

Sets the marker on the 20th frame before the present.

CALC:MARK2:SGR:FRAM -2s

Sets second marker on the frame 2 seconds ago.

---

**CALCulate<n>:MARKer<m>:SGRam:SARea <SearchArea>**

**CALCulate<n>:MARKer<m>:SPECTrogram:SARea <SearchArea>**

This command defines the marker search area for all spectrogram markers in the channel setup.

**Suffix:**

<n> irrelevant

<m> irrelevant

**Parameters:**

<SearchArea>

**VISible**

Performs a search within the visible frames.

Note that the command does not work if the spectrogram is not visible for any reason (e.g. if the display update is off).

**MEMory**

Performs a search within all frames in the memory.

\*RST: VISible

**Manual operation:** See "[Marker Search Area](#)" on page 94

---

**CALCulate<n>:MARKer<m>:SGRam:XY:MAXimum[:PEAK]**

**CALCulate<n>:MARKer<m>:SPECTrogram:XY:MAXimum[:PEAK]**

This command moves a marker to the highest level of the spectrogram.

**Suffix:**

<n> [Window](#)

<m> [Marker](#)

---

**CALCulate<n>:MARKer<m>:SGRam:XY:MINimum[:PEAK]**

**CALCulate<n>:MARKer<m>:SPECTrogram:XY:MINimum[:PEAK]**

This command moves a marker to the minimum level of the spectrogram.

**Suffix:**

<n> [Window](#)

<m> [Marker](#)

---

**CALCulate<n>:MARKer<m>:SGRam:Y:MAXimum:ABOVE**

**CALCulate<n>:MARKer<m>:SPECTrogram:Y:MAXimum:ABOVE**

This command moves a marker vertically to the next lower peak level for the current frequency.

The search includes only frames above the current marker position. It does not change the horizontal position of the marker.

**Suffix:**

<n> [Window](#)



<m> [Marker](#)

**Manual operation:** See "[Search Mode for Next Peak in Y-Direction](#)" on page 93

**CALCulate<n>:MARKer<m>:SGRam:Y:MAXimum:BELOW**

**CALCulate<n>:MARKer<m>:SPECTrogram:Y:MAXimum:BELOW**

This command moves a marker vertically to the next lower peak level for the current frequency.

The search includes only frames below the current marker position. It does not change the horizontal position of the marker.

**Suffix:**

<n> [Window](#)

<m> [Marker](#)

**Manual operation:** See "[Search Mode for Next Peak in Y-Direction](#)" on page 93

**CALCulate<n>:MARKer<m>:SGRam:Y:MAXimum:NEXT**

**CALCulate<n>:MARKer<m>:SPECTrogram:Y:MAXimum:NEXT**

This command moves a marker vertically to the next lower peak level for the current frequency.

The search includes all frames. It does not change the horizontal position of the marker.

**Suffix:**

<n> [Window](#)

<m> [Marker](#)

**Manual operation:** See "[Search Mode for Next Peak in Y-Direction](#)" on page 93

**CALCulate<n>:MARKer<m>:SGRam:Y:MAXimum[:PEAK]**

**CALCulate<n>:MARKer<m>:SPECTrogram:Y:MAXimum[:PEAK]**

This command moves a marker vertically to the highest level for the current frequency.

The search includes all frames. It does not change the horizontal position of the marker.

If the marker hasn't been active yet, the command looks for the peak level in the whole spectrogram.

**Suffix:**

<n> [Window](#)

<m> [Marker](#)

**CALCulate<n>:MARKer<m>:SGRam:Y:MINimum:ABOVE****CALCulate<n>:MARKer<m>:SPECTrogram:Y:MINimum:ABOVE**

This command moves a marker vertically to the next higher minimum level for the current frequency.

The search includes only frames above the current marker position. It does not change the horizontal position of the marker.

**Suffix:**

<n> [Window](#)

<m> [Marker](#)

**Manual operation:** See "[Search Mode for Next Peak in Y-Direction](#)" on page 93

**CALCulate<n>:MARKer<m>:SGRam:Y:MINimum:BELOW****CALCulate<n>:MARKer<m>:SPECTrogram:Y:MINimum:BELOW**

This command moves a marker vertically to the next higher minimum level for the current frequency.

The search includes only frames below the current marker position. It does not change the horizontal position of the marker.

**Suffix:**

<n> [Window](#)

<m> [Marker](#)

**Manual operation:** See "[Search Mode for Next Peak in Y-Direction](#)" on page 93

**CALCulate<n>:MARKer<m>:SGRam:Y:MINimum:NEXT****CALCulate<n>:MARKer<m>:SPECTrogram:Y:MINimum:NEXT**

This command moves a marker vertically to the next higher minimum level for the current frequency.

The search includes all frames. It does not change the horizontal position of the marker.

**Suffix:**

<n> [Window](#)

<m> [Marker](#)

**Manual operation:** See "[Search Mode for Next Peak in Y-Direction](#)" on page 93

**CALCulate<n>:MARKer<m>:SGRam:Y:MINimum[:PEAK]****CALCulate<n>:MARKer<m>:SPECTrogram:Y:MINimum[:PEAK]**

This command moves a marker vertically to the minimum level for the current frequency.

The search includes all frames. It does not change the horizontal position of the marker.

If the marker hasn't been active yet, the command first looks for the peak level for all frequencies and moves the marker vertically to the minimum level.

**Suffix:**

<n> [Window](#)

<m> [Marker](#)

**Using delta markers**

The following commands control spectrogram delta markers.

**Useful commands for spectrogram markers described elsewhere**

The following commands define the horizontal position of the delta markers.

- [CALCulate<n>:DELTaMarker<m>:MAXimum:LEFT](#) on page 227
- [CALCulate<n>:DELTaMarker<m>:MAXimum:NEXT](#) on page 227
- [CALCulate<n>:DELTaMarker<m>:MAXimum\[:PEAK\]](#) on page 227
- [CALCulate<n>:DELTaMarker<m>:MAXimum:RIGHT](#) on page 227
- [CALCulate<n>:DELTaMarker<m>:MINimum:LEFT](#) on page 228
- [CALCulate<n>:DELTaMarker<m>:MINimum:NEXT](#) on page 228
- [CALCulate<n>:DELTaMarker<m>:MINimum\[:PEAK\]](#) on page 228
- [CALCulate<n>:DELTaMarker<m>:MINimum:RIGHT](#) on page 228

**Remote commands exclusive to spectrogram markers**

<a href="#">CALCulate&lt;n&gt;:DELTaMarker&lt;m&gt;:SGRam:FRaMe</a> .....	220
<a href="#">CALCulate&lt;n&gt;:DELTaMarker&lt;m&gt;:SPECTrogram:FRaMe</a> .....	220
<a href="#">CALCulate&lt;n&gt;:DELTaMarker&lt;m&gt;:SGRam:SARea</a> .....	220
<a href="#">CALCulate&lt;n&gt;:DELTaMarker&lt;m&gt;:SPECTrogram:SARea</a> .....	220
<a href="#">CALCulate&lt;n&gt;:DELTaMarker&lt;m&gt;:SGRam:XY:MAXimum[:PEAK]</a> .....	221
<a href="#">CALCulate&lt;n&gt;:DELTaMarker&lt;m&gt;:SPECTrogram:XY:MAXimum[:PEAK]</a> .....	221
<a href="#">CALCulate&lt;n&gt;:DELTaMarker&lt;m&gt;:SGRam:XY:MINimum[:PEAK]</a> .....	221
<a href="#">CALCulate&lt;n&gt;:DELTaMarker&lt;m&gt;:SPECTrogram:XY:MINimum[:PEAK]</a> .....	221
<a href="#">CALCulate&lt;n&gt;:DELTaMarker&lt;m&gt;:SGRam:Y:MAXimum:ABOVe</a> .....	221
<a href="#">CALCulate&lt;n&gt;:DELTaMarker&lt;m&gt;:SPECTrogram:Y:MAXimum:ABOVe</a> .....	221
<a href="#">CALCulate&lt;n&gt;:DELTaMarker&lt;m&gt;:SGRam:Y:MAXimum:BELOW</a> .....	221
<a href="#">CALCulate&lt;n&gt;:DELTaMarker&lt;m&gt;:SPECTrogram:Y:MAXimum:BELOW</a> .....	221
<a href="#">CALCulate&lt;n&gt;:DELTaMarker&lt;m&gt;:SGRam:Y:MAXimum:NEXT</a> .....	222
<a href="#">CALCulate&lt;n&gt;:DELTaMarker&lt;m&gt;:SPECTrogram:Y:MAXimum:NEXT</a> .....	222
<a href="#">CALCulate&lt;n&gt;:DELTaMarker&lt;m&gt;:SGRam:Y:MAXimum[:PEAK]</a> .....	222
<a href="#">CALCulate&lt;n&gt;:DELTaMarker&lt;m&gt;:SPECTrogram:Y:MAXimum[:PEAK]</a> .....	222
<a href="#">CALCulate&lt;n&gt;:DELTaMarker&lt;m&gt;:SGRam:Y:MINimum:ABOVe</a> .....	222
<a href="#">CALCulate&lt;n&gt;:DELTaMarker&lt;m&gt;:SPECTrogram:Y:MINimum:ABOVe</a> .....	222
<a href="#">CALCulate&lt;n&gt;:DELTaMarker&lt;m&gt;:SGRam:Y:MINimum:BELOW</a> .....	222
<a href="#">CALCulate&lt;n&gt;:DELTaMarker&lt;m&gt;:SPECTrogram:Y:MINimum:BELOW</a> .....	222
<a href="#">CALCulate&lt;n&gt;:DELTaMarker&lt;m&gt;:SGRam:Y:MINimum:NEXT</a> .....	223
<a href="#">CALCulate&lt;n&gt;:DELTaMarker&lt;m&gt;:SPECTrogram:Y:MINimum:NEXT</a> .....	223

<a href="#">CALCulate&lt;n&gt;:DELTamarker&lt;m&gt;:SGRam:Y:MINimum[:PEAK]</a> .....	223
<a href="#">CALCulate&lt;n&gt;:DELTamarker&lt;m&gt;:SPECTrogram:Y:MINimum[:PEAK]</a> .....	223

---

**CALCulate<n>:DELTamarker<m>:SGRam:FRAMe <Frame>**

**CALCulate<n>:DELTamarker<m>:SPECTrogram:FRAMe <Frame>**

This command positions a delta marker on a particular frame. The frame is relative to the position of marker 1.

The command is available for the spectrogram.

**Suffix:**

<n>                      [Window](#)

<m>                      [Marker](#)

**Parameters:**

<Frame>                      Selects a frame either by its frame number or time stamp.  
 The frame number is available if the time stamp is off. The range depends on the history depth.  
 The time stamp is available if the time stamp is on. The number is the distance to frame 0 in seconds. The range depends on the history depth.  
 Default unit: S

**Example:**

`CALC:DELT4:SGR:FRAM -20`

Sets fourth deltamarker 20 frames below marker 1.

`CALC:DELT4:SGR:FRAM 2 s`

Sets fourth deltamarker 2 seconds above the position of marker 1.

---

**CALCulate<n>:DELTamarker<m>:SGRam:SARea <SearchArea>**

**CALCulate<n>:DELTamarker<m>:SPECTrogram:SARea <SearchArea>**

This command defines the marker search area for *all* spectrogram markers in the channel setup.

**Suffix:**

<n>                      irrelevant

<m>                      irrelevant

**Parameters:**

<SearchArea>                      **VISible**  
 Performs a search within the visible frames.  
 Note that the command does not work if the spectrogram is not visible for any reason (e.g. if the display update is off).

**MEMory**

Performs a search within all frames in the memory.

\*RST:                      VISible

**Manual operation:**    See "[Marker Search Area](#)" on page 94

---

**CALCulate<n>:DELTaMarker<m>:SGRam:XY:MAXimum[:PEAK]**

**CALCulate<n>:DELTaMarker<m>:SPECTrogram:XY:MAXimum[:PEAK]**

This command moves a marker to the highest level of the spectrogram over all frequencies.

**Suffix:**

<n> [Window](#)

<m> [Marker](#)

---

**CALCulate<n>:DELTaMarker<m>:SGRam:XY:MINimum[:PEAK]**

**CALCulate<n>:DELTaMarker<m>:SPECTrogram:XY:MINimum[:PEAK]**

This command moves a delta marker to the minimum level of the spectrogram over all frequencies.

**Suffix:**

<n> [Window](#)

<m> [Marker](#)

---

**CALCulate<n>:DELTaMarker<m>:SGRam:Y:MAXimum:ABOVE**

**CALCulate<n>:DELTaMarker<m>:SPECTrogram:Y:MAXimum:ABOVE**

This command moves a marker vertically to the next higher level for the current frequency.

The search includes only frames above the current marker position. It does not change the horizontal position of the marker.

**Suffix:**

<n> [Window](#)

<m> [Marker](#)

**Manual operation:** See "[Search Mode for Next Peak in Y-Direction](#)" on page 93

---

**CALCulate<n>:DELTaMarker<m>:SGRam:Y:MAXimum:BELOW**

**CALCulate<n>:DELTaMarker<m>:SPECTrogram:Y:MAXimum:BELOW**

This command moves a marker vertically to the next higher level for the current frequency.

The search includes only frames below the current marker position. It does not change the horizontal position of the marker.

**Suffix:**

<n> [Window](#)

<m> [Marker](#)

**Manual operation:** See "[Search Mode for Next Peak in Y-Direction](#)" on page 93

---

**CALCulate<n>:DELTamarker<m>:SGRam:Y:MAXimum:NEXT**

**CALCulate<n>:DELTamarker<m>:SPECTrogram:Y:MAXimum:NEXT**

This command moves a delta marker vertically to the next higher level for the current frequency.

The search includes all frames. It does not change the horizontal position of the marker.

**Suffix:**

<n> [Window](#)

<m> [Marker](#)

**Manual operation:** See "[Search Mode for Next Peak in Y-Direction](#)" on page 93

---

**CALCulate<n>:DELTamarker<m>:SGRam:Y:MAXimum[:PEAK]**

**CALCulate<n>:DELTamarker<m>:SPECTrogram:Y:MAXimum[:PEAK]**

This command moves a delta marker vertically to the highest level for the current frequency.

The search includes all frames. It does not change the horizontal position of the marker.

If the marker hasn't been active yet, the command looks for the peak level in the whole spectrogram.

**Suffix:**

<n> [Window](#)

<m> [Marker](#)

---

**CALCulate<n>:DELTamarker<m>:SGRam:Y:MINimum:ABOVE**

**CALCulate<n>:DELTamarker<m>:SPECTrogram:Y:MINimum:ABOVE**

This command moves a delta marker vertically to the next minimum level for the current frequency.

The search includes only frames above the current marker position. It does not change the horizontal position of the marker.

**Suffix:**

<n> [Window](#)

<m> [Marker](#)

**Manual operation:** See "[Search Mode for Next Peak in Y-Direction](#)" on page 93

---

**CALCulate<n>:DELTamarker<m>:SGRam:Y:MINimum:BELOW**

**CALCulate<n>:DELTamarker<m>:SPECTrogram:Y:MINimum:BELOW**

This command moves a delta marker vertically to the next minimum level for the current frequency.

The search includes only frames below the current marker position. It does not change the horizontal position of the marker.

**Suffix:**

<n> [Window](#)

<m> [Marker](#)

**Manual operation:** See "[Search Mode for Next Peak in Y-Direction](#)" on page 93

**CALCulate<n>:DELTaMarker<m>:SGRam:Y:MINimum:NEXT**

**CALCulate<n>:DELTaMarker<m>:SPECTrogram:Y:MINimum:NEXT**

This command moves a delta marker vertically to the next minimum level for the current frequency.

The search includes all frames. It does not change the horizontal position of the marker.

**Suffix:**

<n> [Window](#)

<m> [Marker](#)

**Manual operation:** See "[Search Mode for Next Peak in Y-Direction](#)" on page 93

**CALCulate<n>:DELTaMarker<m>:SGRam:Y:MINimum[:PEAK]**

**CALCulate<n>:DELTaMarker<m>:SPECTrogram:Y:MINimum[:PEAK]**

This command moves a delta marker vertically to the minimum level for the current frequency.

The search includes all frames. It does not change the horizontal position of the marker.

If the marker hasn't been active yet, the command first looks for the peak level in the whole spectrogram and moves the marker vertically to the minimum level.

**Suffix:**

<n> [Window](#)

<m> [Marker](#)

#### 11.8.3.4 Marker search settings

The following commands define criteria for searches.

[CALCulate<n>:MARKer<m>:PEXCursion](#).....223

**CALCulate<n>:MARKer<m>:PEXCursion <Excursion>**

This command defines the peak excursion (for *all* markers in *all* windows).

The peak excursion sets the requirements for a peak to be detected during a peak search.

The unit depends on the measurement.

Application/Result display	Unit
Spectrum	dB
ADEMOD, RF	dB
ADEMOD, AM	PCT
ADEMOD, FM	kHz
ADEMOD, PM	RAD

**Suffix:**

<n> irrelevant  
 <m> irrelevant

**Parameters:**

<Excursion> The excursion is the distance to a trace maximum that must be attained before a new maximum is recognized, or the distance to a trace minimum that must be attained before a new minimum is recognized

\*RST: 5 PCT in AM displays, 50 kHz in FM displays, (0.5 RAD in PM displays)

**Example:**

CALC:MARK:PEXC 10dB  
 Defines peak excursion as 10 dB.

**Manual operation:** See " [Peak Excursion](#) " on page 90

### 11.8.3.5 Positioning the marker

This chapter contains remote commands necessary to position the marker on a trace.

- [Positioning normal markers](#).....224
- [Positioning delta markers](#).....226

#### Positioning normal markers

The following commands position markers on the trace.

CALCulate<n>:MARKer<m>:MAXimum:LEFT.....	224
CALCulate<n>:MARKer<m>:MAXimum:NEXT.....	225
CALCulate<n>:MARKer<m>:MAXimum[:PEAK].....	225
CALCulate<n>:MARKer<m>:MAXimum:RIGHT.....	225
CALCulate<n>:MARKer<m>:MINimum:LEFT.....	225
CALCulate<n>:MARKer<m>:MINimum:NEXT.....	226
CALCulate<n>:MARKer<m>:MINimum[:PEAK].....	226
CALCulate<n>:MARKer<m>:MINimum:RIGHT.....	226

---

#### CALCulate<n>:MARKer<m>:MAXimum:LEFT

This command moves a marker to the next positive peak.



The search includes only measurement values to the left of the current marker position.

**Suffix:**

<n> [Window](#)

<m> [Marker](#)

**Manual operation:** See "[Search Next Peak](#)" on page 91

---

**CALCulate<n>:MARKer<m>:MAXimum:NEXT**

This command moves a marker to the next positive peak.

**Suffix:**

<n> [Window](#)

<m> [Marker](#)

**Manual operation:** See "[Search Next Peak](#)" on page 91

---

**CALCulate<n>:MARKer<m>:MAXimum[:PEAK]**

This command moves a marker to the highest level.

If the marker is not yet active, the command first activates the marker.

**Suffix:**

<n> [Window](#)

<m> [Marker](#)

**Manual operation:** See "[Peak Search](#)" on page 91

---

**CALCulate<n>:MARKer<m>:MAXimum:RIGHT**

This command moves a marker to the next positive peak.

The search includes only measurement values to the right of the current marker position.

**Suffix:**

<n> [Window](#)

<m> [Marker](#)

**Manual operation:** See "[Search Next Peak](#)" on page 91

---

**CALCulate<n>:MARKer<m>:MINimum:LEFT**

This command moves a marker to the next minimum peak value.

The search includes only measurement values to the right of the current marker position.

**Suffix:**<n> [Window](#)<m> [Marker](#)**Manual operation:** See "[Search Next Minimum](#)" on page 92**CALCulate<n>:MARKer<m>:MINimum:NEXT**

This command moves a marker to the next minimum peak value.

**Suffix:**<n> [Window](#)<m> [Marker](#)**Manual operation:** See "[Search Next Minimum](#)" on page 92**CALCulate<n>:MARKer<m>:MINimum[:PEAK]**

This command moves a marker to the minimum level.

If the marker is not yet active, the command first activates the marker.

**Suffix:**<n> [Window](#)<m> [Marker](#)**Manual operation:** See "[Search Minimum](#)" on page 91**CALCulate<n>:MARKer<m>:MINimum:RIGHT**

This command moves a marker to the next minimum peak value.

The search includes only measurement values to the right of the current marker position.

**Suffix:**<n> [Window](#)<m> [Marker](#)**Manual operation:** See "[Search Next Minimum](#)" on page 92**Positioning delta markers**

The following commands position delta markers on the trace.

<a href="#">CALCulate&lt;n&gt;:DELTamarker&lt;m&gt;:MAXimum:LEFT</a> .....	227
<a href="#">CALCulate&lt;n&gt;:DELTamarker&lt;m&gt;:MAXimum:NEXT</a> .....	227
<a href="#">CALCulate&lt;n&gt;:DELTamarker&lt;m&gt;:MAXimum[:PEAK]</a> .....	227
<a href="#">CALCulate&lt;n&gt;:DELTamarker&lt;m&gt;:MAXimum:RIGHT</a> .....	227
<a href="#">CALCulate&lt;n&gt;:DELTamarker&lt;m&gt;:MINimum:LEFT</a> .....	228

CALCulate<n>:DELTamarker<m>:MINimum:NEXT.....	228
CALCulate<n>:DELTamarker<m>:MINimum[:PEAK].....	228
CALCulate<n>:DELTamarker<m>:MINimum:RIGHT.....	228

---

#### CALCulate<n>:DELTamarker<m>:MAXimum:LEFT

This command moves a delta marker to the next positive peak value.

The search includes only measurement values to the left of the current marker position.

##### Suffix:

<n>                      Window

<m>                      Marker

**Manual operation:**    See " [Search Next Peak](#) " on page 91

---

#### CALCulate<n>:DELTamarker<m>:MAXimum:NEXT

This command moves a marker to the next positive peak value.

##### Suffix:

<n>                      1..n  
                            Window

<m>                      1..n  
                            Marker

**Manual operation:**    See " [Search Next Peak](#) " on page 91

---

#### CALCulate<n>:DELTamarker<m>:MAXimum[:PEAK]

This command moves a delta marker to the highest level.

If the marker is not yet active, the command first activates the marker.

##### Suffix:

<n>                      Window

<m>                      Marker

**Manual operation:**    See " [Peak Search](#) " on page 91

---

#### CALCulate<n>:DELTamarker<m>:MAXimum:RIGHT

This command moves a delta marker to the next positive peak value on the trace.

The search includes only measurement values to the right of the current marker position.

##### Suffix:

<n>                      Window

<m>                      Marker

**Manual operation:** See " [Search Next Peak](#) " on page 91

---

#### **CALCulate<n>:DELTamarker<m>:MINimum:LEFT**

This command moves a delta marker to the next minimum peak value.

The search includes only measurement values to the right of the current marker position.

**Suffix:**

<n> [Window](#)

<m> [Marker](#)

**Manual operation:** See " [Search Next Minimum](#) " on page 92

---

#### **CALCulate<n>:DELTamarker<m>:MINimum:NEXT**

This command moves a marker to the next minimum peak value.

**Suffix:**

<n> [Window](#)

<m> [Marker](#)

**Manual operation:** See " [Search Next Minimum](#) " on page 92

---

#### **CALCulate<n>:DELTamarker<m>:MINimum[:PEAK]**

This command moves a delta marker to the minimum level.

If the marker is not yet active, the command first activates the marker.

**Suffix:**

<n> [Window](#)

<m> [Marker](#)

**Manual operation:** See " [Search Minimum](#) " on page 91

---

#### **CALCulate<n>:DELTamarker<m>:MINimum:RIGHT**

This command moves a delta marker to the next minimum peak value.

The search includes only measurement values to the right of the current marker position.

**Suffix:**

<n> [Window](#)

<m> [Marker](#)

**Manual operation:** See " [Search Next Minimum](#) " on page 92

### 11.8.3.6 Configuring special marker functions

The following commands are required to configure the special marker functions that are available in the R&S FPL1-K7 AM/FM/PM Modulation Analysis application.

- [Fixed reference marker settings](#).....229
- [Marker peak lists](#).....231
- [N db down marker](#).....235
- [Phase noise measurement marker](#).....238

#### Fixed reference marker settings

The following commands configure a fixed reference marker.

<a href="#">CALCulate&lt;n&gt;:DELTamarker&lt;m&gt;:FUNCTION:FIXed:RPOint:MAXimum[:PEAK]</a> .....	229
<a href="#">CALCulate&lt;n&gt;:DELTamarker&lt;m&gt;:FUNCTION:FIXed:RPOint:X</a> .....	229
<a href="#">CALCulate&lt;n&gt;:DELTamarker&lt;m&gt;:FUNCTION:FIXed:RPOint:Y</a> .....	230
<a href="#">CALCulate&lt;n&gt;:DELTamarker&lt;m&gt;:FUNCTION:FIXed:RPOint:Y:OFFSet</a> .....	230
<a href="#">CALCulate&lt;n&gt;:DELTamarker&lt;m&gt;:FUNCTION:FIXed[:STATE]</a> .....	230

---

#### **CALCulate<n>:DELTamarker<m>:FUNCTION:FIXed:RPOint:MAXimum[:PEAK]**

This command moves the fixed reference marker to the peak power.

##### Suffix:

<n> [Window](#)

<m> [Marker](#)

##### Example:

`CALC:DELT:FUNC:FIX:RPO:MAX`

Sets the reference point level for delta markers to the peak of the selected trace.

**Manual operation:** See "[Defining a Fixed Reference](#)" on page 89

---

#### **CALCulate<n>:DELTamarker<m>:FUNCTION:FIXed:RPOint:X <RefPoint>**

This command defines the horizontal position of the fixed delta marker reference point. The coordinates of the reference may be anywhere in the diagram.

##### Suffix:

<n> [Window](#)

<m> [Marker](#)

##### Parameters:

<RefPoint> Numeric value that defines the horizontal position of the reference.  
 For frequency domain measurements, it is a frequency in Hz.  
 For time domain measurements, it is a point in time in s.  
 \*RST: Fixed Reference: OFF  
 Default unit: HZ

**Example:** `CALC:DELTA:FUNC:FIX:RPO:X 128 MHz`  
Sets the frequency reference to 128 MHz.

**Manual operation:** See ["Defining a Fixed Reference"](#) on page 89

**CALCulate<n>:DELTamarker<m>:FUNctioN:FIXed:RPOint:Y <RefPointLevel>**

This command defines the vertical position of the fixed delta marker reference point. The coordinates of the reference may be anywhere in the diagram.

**Suffix:**

<n> [Window](#)

<m> [Marker](#)

**Parameters:**

<RefPoint> Numeric value that defines the vertical position of the reference. The unit and value range is variable.

\*RST: Fixed Reference: OFF

Default unit: DBM

**Example:** `CALC:DELTA:FUNC:FIX:RPO:Y -10dBm`  
Sets the reference point level for delta markers to -10 dBm.

**Manual operation:** See ["Defining a Fixed Reference"](#) on page 89

**CALCulate<n>:DELTamarker<m>:FUNctioN:FIXed:RPOint:Y:OFFSet <Offset>**

This command defines a level offset for the fixed delta marker reference point.

**Suffix:**

<n> [Window](#)

<m> [Marker](#)

**Parameters:**

<Offset> Numeric value

\*RST: 0

Default unit: dB

**CALCulate<n>:DELTamarker<m>:FUNctioN:FIXed[:STATe] <State>**

This command activates or deactivates a marker that defines a fixed reference point for relative marker analysis.

If necessary, the command activates a marker and positions it on the peak power.

Subsequently, you can change the coordinates of the fixed reference independent of the marker. The fixed reference is independent of the trace and is applied to all active delta markers.

**Suffix:**

<n> [Window](#)

<m> [Marker](#)

**Parameters:**

<State> ON | OFF | 0 | 1  
**OFF | 0**  
 Switches the function off  
**ON | 1**  
 Switches the function on

**Example:**

CALC:DELT:FUNC:FIX ON  
 Switches on the measurement with fixed reference value for all delta markers.  
 CALC:DELT:FUNC:FIX:RPO:X 128 MHZ  
 Sets the frequency reference to 128 MHz.  
 CALC:DELT:FUNC:FIX:RPO:Y 30 DBM  
 Sets the reference level to +30 dBm.

**Manual operation:** See ["Defining a Fixed Reference"](#) on page 89

### Marker peak lists

#### Useful commands for peak lists described elsewhere

- [CALCulate<n>:MARKer<m>:PEXCursion](#) on page 223
- [MMEMy:STORe<n>:PEAK](#) on page 235
- [Chapter 11.8.3.4, "Marker search settings"](#), on page 223

#### Remote commands exclusive to peak lists

<a href="#">CALCulate&lt;n&gt;:MARKer&lt;m&gt;:FUNCTION:FPEaks:ANNOtation:LABel[:STATe]</a> .....	231
<a href="#">CALCulate&lt;n&gt;:MARKer&lt;m&gt;:FUNCTION:FPEaks:COUNT?</a> .....	232
<a href="#">CALCulate&lt;n&gt;:MARKer&lt;m&gt;:FUNCTION:FPEaks[:IMMEDIATE]</a> .....	232
<a href="#">CALCulate&lt;n&gt;:MARKer&lt;m&gt;:FUNCTION:FPEaks:LIST:SIZE</a> .....	233
<a href="#">CALCulate&lt;n&gt;:MARKer&lt;m&gt;:FUNCTION:FPEaks:SORT</a> .....	233
<a href="#">CALCulate&lt;n&gt;:MARKer&lt;m&gt;:FUNCTION:FPEaks:STATe</a> .....	233
<a href="#">CALCulate&lt;n&gt;:MARKer&lt;m&gt;:FUNCTION:FPEaks:X?</a> .....	234
<a href="#">CALCulate&lt;n&gt;:MARKer&lt;m&gt;:FUNCTION:FPEaks:Y?</a> .....	234
<a href="#">MMEMy:STORe&lt;n&gt;:LIST</a> .....	234
<a href="#">MMEMy:STORe&lt;n&gt;:PEAK</a> .....	235

---

**CALCulate<n>:MARKer<m>:FUNCTION:FPEaks:ANNOtation:LABel[:STATe]**  
 <State>

This command turns labels for peaks found during a peak search on and off.

The labels correspond to the marker number in the marker peak list.

**Suffix:**

<n> [Window](#)  
 <m> [Marker](#)

**Parameters:**

<State> ON | OFF | 0 | 1  
 \*RST: 1

**Example:**

CALC:MARK:FUNC:FPE:ANN:LAB:STAT OFF  
 Removes the peak labels from the diagram

**Manual operation:** See "[Display MarkerNumbers](#)" on page 103

**CALCulate<n>:MARKer<m>:FUNCTION:FPEaks:COUNT?**

This command queries the number of peaks that have been found during a peak search.

The actual number of peaks that have been found may differ from the number of peaks you have set to be found because of the peak excursion.

**Suffix:**

<n> irrelevant  
 <m> irrelevant

**Return values:**

<NumberOfPeaks>

**Example:**

CALC:MARK:FUNC:FPE:COUN?  
 Queries the number of peaks.

**Usage:**

Query only

**CALCulate<n>:MARKer<m>:FUNCTION:FPEaks[:IMMEDIATE] <Peaks>**

This command initiates a peak search.

**Suffix:**

<n> [Window](#)  
 <m> [Marker](#)

**Parameters:**

<Peaks> This parameter defines the number of peaks to find during the search.  
 Note that the actual number of peaks found during the search also depends on the peak excursion you have set with [CALCulate<n>:MARKer<m>:PEXCursion](#).  
 Range: 1 to 200

**Example:**

CALC:MARK:PEXC 5  
 Defines a peak excursion of 5 dB, i.e. peaks must be at least 5 dB apart to be detected as a peak.  
 CALC:MARK:FUNC:FPE 10  
 Initiates a search for 10 peaks on the current trace.



---

**CALCulate<n>:MARKer<m>:FUNction:FPEaks:LIST:SIZE <MaxNoPeaks>**

This command defines the maximum number of peaks that the R&S ZNL looks for during a peak search.

**Suffix:**

<n> [Window](#)

<m> [Marker](#)

**Parameters:**

<MaxNoPeaks> Maximum number of peaks to be determined.

Range: 1 to 500

\*RST: 50

**Example:**

CALC:MARK:FUNC:FPE:LIST:SIZE 10

The marker peak list will contain a maximum of 10 peaks.

**Manual operation:** See "[Maximum Number of Peaks](#)" on page 103

---

**CALCulate<n>:MARKer<m>:FUNction:FPEaks:SORT <SortMode>**

This command selects the order in which the results of a peak search are returned.

**Suffix:**

<n> [Window](#)

<m> [Marker](#)

**Parameters:**

<SortMode> **X**

Sorts the peaks according to increasing position on the x-axis.

**Y**

Sorts the peaks according to decreasing position on the y-axis.

\*RST: X

**Example:**

CALC:MARK:FUNC:FPE:SORT Y

Sets the sort mode to decreasing y values

**Manual operation:** See "[Sort Mode](#)" on page 102

---

**CALCulate<n>:MARKer<m>:FUNction:FPEaks:STATe <State>**

This command turns a peak search on and off.

**Suffix:**

<n> [Window](#)

<m> [Marker](#)

**Parameters:**

<State> ON | OFF | 0 | 1

**OFF | 0**

Switches the function off

**ON | 1**

Switches the function on

**Example:** `CALC:MARK:FUNC:FPE:STAT ON`  
Activates marker peak search

**Manual operation:** See " [Peak List State](#) " on page 102

**CALCulate<n>:MARKer<m>:FUNCTion:FPEaks:X?**

This command queries the position of the peaks on the x-axis.

The order depends on the sort order that has been set with `CALCulate<n>:MARKer<m>:FUNCTion:FPEaks:SORT`.

**Suffix:**

<n> irrelevant

<m> irrelevant

**Return values:**

<PeakPosition> Position of the peaks on the x-axis. The unit depends on the measurement.

**Usage:** Query only

**CALCulate<n>:MARKer<m>:FUNCTion:FPEaks:Y?**

This command queries the position of the peaks on the y-axis.

The order depends on the sort order that has been set with `CALCulate<n>:MARKer<m>:FUNCTion:FPEaks:SORT`.

**Suffix:**

<n> irrelevant

<m> irrelevant

**Return values:**

<PeakPosition> Position of the peaks on the y-axis. The unit depends on the measurement.

**Usage:** Query only

**MMEMory:STORe<n>:LIST <FileName>**

This command exports the SEM and spurious emission list evaluation to a file.

The file format is \*.dat.

**Suffix:**

<n> [Window](#)

**Parameters:**

<FileName> String containing the path and name of the target file.

**Example:** `MMEM:STOR:LIST 'test'`  
Stores the current list evaluation results in the `test.dat` file.

---

### MMEMory:STORe<n>:PEAK <FileName>

This command exports the marker peak list to a file.

**Suffix:**

<n> [Window](#)

**Parameters:**

<FileName> String containing the path, name and extension of the target file.

**Example:** `MMEM:STOR:PEAK 'test.dat'`  
Saves the current marker peak list in the file `test.dat`.

**Manual operation:** See "[Export Peak List](#)" on page 103

### N db down marker

The following commands control the n dB down markers.

<a href="#">CALCulate&lt;n&gt;:MARKer&lt;m&gt;:FUNCTion:NDBDown</a> .....	235
<a href="#">CALCulate&lt;n&gt;:MARKer&lt;m&gt;:FUNCTion:NDBDown:FREQuency?</a> .....	236
<a href="#">CALCulate&lt;n&gt;:MARKer&lt;m&gt;:FUNCTion:NDBDown:QFACtor?</a> .....	236
<a href="#">CALCulate&lt;n&gt;:MARKer&lt;m&gt;:FUNCTion:NDBDown:RESult?</a> .....	237
<a href="#">CALCulate&lt;n&gt;:MARKer&lt;m&gt;:FUNCTion:NDBDown:STATe</a> .....	237
<a href="#">CALCulate&lt;n&gt;:MARKer&lt;m&gt;:FUNCTion:NDBDown:TIME?</a> .....	238

---

### CALCulate<n>:MARKer<m>:FUNCTion:NDBDown <Distance>

This command defines the distance of the n dB down markers to the reference marker.

**Suffix:**

<n> [Window](#)

<m> [Marker](#)

**Parameters:**

<Distance> Distance of the temporary markers to the reference marker in dB.  
For a positive offset, the markers T1 and T2 are placed *below* the active reference point.  
For a negative offset (for example for notch filter measurements), the markers T1 and T2 are placed *above* the active reference point.

\*RST: 6dB  
Default unit: DB

**Example:** `CALC:MARK:FUNC:NDBD 3dB`  
Sets the distance to the reference marker to 3 dB.

**CALCulate<n>:MARKer<m>:FUNCtion:NDBDown:FREQuency?**

This command queries the position of the n dB down markers on the x-axis when measuring in the frequency domain.

To get a valid result, you have to perform a complete measurement with synchronization to the end of the measurement before reading out the result. This is only possible for single sweep mode.

See also [INITiate<n>:CONTinuous](#) on page 168.

**Suffix:**

<n> irrelevant

<m> irrelevant

**Return values:**

<Frequency>

**<frequency 1>**

absolute frequency of the n dB marker to the left of the reference marker in Hz

**<frequency 2>**

absolute frequency of the n dB marker to the right of the reference marker in Hz.

**Example:**

```
INIT:CONT OFF
```

Switches to single sweep mode.

```
CALC:MARK:FUNC:NDBD ON
```

Switches on the n dB down function.

```
INIT;*WAI
```

Starts a sweep and waits for the end.

```
CALC:MARK:FUNC:NDBD:FREQ?
```

This command would return, for example, 100000000, 200000000, meaning that the first marker position is at 100 MHz, the second marker position is at 200 MHz

**Usage:** Query only

**Manual operation:** See "[n dB down Value](#)" on page 97

**CALCulate<n>:MARKer<m>:FUNCtion:NDBDown:QFACtor?**

This command queries the Q factor of n dB down measurements.

**Suffix:**

<n> irrelevant

<m> irrelevant

**Return values:**

<QFactor>

**Usage:** Query only

**CALCulate<n>:MARKer<m>:FUNCtion:NDBDown:RESult?**

This command queries the distance of the n dB down markers from each other.

To get a valid result, you have to perform a complete measurement with synchronization to the end of the measurement before reading out the result. This is only possible for single sweep mode.

See also [INITiate<n>:CONTinuous](#) on page 168.

**Suffix:**

<n> irrelevant

<m> irrelevant

**Return values:**

<Distance> The result depends on the span.  
 In case of frequency domain measurements, the command returns the bandwidth between the two n dB down markers in Hz.  
 In case of time domain measurements, the command returns the pulse width between the two n dB down markers in seconds.

**Example:**

```
INIT:CONT OFF
Switches to single sweep mode.
CALC:MARK:FUNC:NDBD ON
Switches on the n dB down function.
INIT;*WAI
Starts a sweep and waits for the end.
CALC:MARK:FUNC:NDBD:RES?
Outputs the measured value.
```

**Usage:** Query only

**Manual operation:** See "[n dB down Marker State](#)" on page 97

**CALCulate<n>:MARKer<m>:FUNCtion:NDBDown:STATe <State>**

This command turns the n dB Down marker function on and off.

**Suffix:**

<n> irrelevant

<m> irrelevant

**Parameters:**

<State> ON | OFF | 0 | 1  
**OFF | 0**  
 Switches the function off  
**ON | 1**  
 Switches the function on

**Example:**

```
CALC:MARK:FUNC:NDBD:STAT ON
Turns the n dB Down marker on.
```

**Manual operation:** See "[n dB down Marker State](#)" on page 97

---

### CALCulate<n>:MARKer<m>:FUNCtion:NDBDown:TIME?

This command queries the position of the n dB down markers on the x-axis when measuring in the time domain.

To get a valid result, you have to perform a complete measurement with synchronization to the end of the measurement before reading out the result. This is only possible for single sweep mode.

See also [INITiate<n>:CONTinuous](#) on page 168.

**Suffix:**

<n> irrelevant

<m> irrelevant

**Return values:**

<TimeX1> absolute position in time of the n dB marker to the left of the reference marker in seconds

<TimeX2> absolute position in time of the n dB marker to the right of the reference marker in seconds

**Example:**

```
INIT:CONT OFF
Switches to single sweep mode
CALC:MARK:FUNC:NDBD ON
Switches on the n dB down function.
INIT;*WAI
Starts a sweep and waits for the end.
CALC:MARK:FUNC:NDBD:TIME?
Outputs the time values of the temporary markers.
```

**Usage:** Query only

**Manual operation:** See "[n dB down Value](#)" on page 97

### Phase noise measurement marker

The following commands control the phase noise measurement marker function.

<a href="#">CALCulate&lt;n&gt;:MARKer&lt;m&gt;:FUNCtion:PNOise:AOff</a> .....	238
<a href="#">CALCulate&lt;n&gt;:MARKer&lt;m&gt;:FUNCtion:PNOise[:STATe]</a> .....	239
<a href="#">CALCulate&lt;n&gt;:MARKer&lt;m&gt;:FUNCtion:PNOise:RESult?</a> .....	239

---

### CALCulate<n>:MARKer<m>:FUNCtion:PNOise:AOff

Removes all phase noise markers in the specified window.

**Suffix:**

<n> [Window](#)

<m> irrelevant

**Example:** CALC:MARK:FUNC:PNO:AOff

**CALCulate<n>:MARKer<m>:FUNcTion:PNOise[:STATe] <State>**

This command turns the phase noise measurement at the marker position on and off.

**Suffix:**

<n> [Window](#)

<m> [Marker](#)

**Parameters:**

<State> ON | OFF | 0 | 1

**OFF | 0**

Switches the function off

**ON | 1**

Switches the function on

**Example:**

CALC:MARK2:FUNC:PNO ON

Switches on the phase-noise measurement for the marker 2.

**Manual operation:**

See "[Phase Noise Measurement State](#)" on page 99

See "[Switching All Phase Noise Measurements Off](#)" on page 100

**CALCulate<n>:MARKer<m>:FUNcTion:PNOise:RESult?**

This command queries the result of a phase noise measurement.

If necessary, the command activates the measurement first.

**Suffix:**

<n> [Window](#)

<m> [Marker](#)

**Return values:**

<PhaseNoise> numeric value

The difference between the measured carrier power and the noise power at the position of the specified (normal) marker.

**Example:**

CALC:MARK2:FUNC:PNO:RES?

Outputs the result of phase-noise measurement of the marker 2.

**Usage:**

Query only

**Manual operation:**

See "[Phase Noise Measurement State](#)" on page 99

### 11.8.4 Marker search (spectrograms)

The following commands automatically define the marker and delta marker position in the spectrogram.

### 11.8.4.1 Using markers

The following commands control spectrogram markers.

#### Useful commands for spectrogram markers described elsewhere

The following commands define the horizontal position of the markers.

- `CALCulate<n>:MARKer<m>:MAXimum:LEFT` on page 224
- `CALCulate<n>:MARKer<m>:MAXimum:NEXT` on page 225
- `CALCulate<n>:MARKer<m>:MAXimum[:PEAK]` on page 225
- `CALCulate<n>:MARKer<m>:MAXimum:RIGHT` on page 225
- `CALCulate<n>:MARKer<m>:MINimum:LEFT` on page 225
- `CALCulate<n>:MARKer<m>:MINimum:NEXT` on page 226
- `CALCulate<n>:MARKer<m>:MINimum[:PEAK]` on page 226
- `CALCulate<n>:MARKer<m>:MINimum:RIGHT` on page 226

#### Remote commands exclusive to spectrogram markers

<code>CALCulate&lt;n&gt;:MARKer&lt;m&gt;:SGRam:FRAME</code> .....	240
<code>CALCulate&lt;n&gt;:MARKer&lt;m&gt;:SPEctrogram:FRAME</code> .....	240
<code>CALCulate&lt;n&gt;:MARKer&lt;m&gt;:SGRam:SARea</code> .....	241
<code>CALCulate&lt;n&gt;:MARKer&lt;m&gt;:SPEctrogram:SARea</code> .....	241
<code>CALCulate&lt;n&gt;:MARKer&lt;m&gt;:SGRam:XY:MAXimum[:PEAK]</code> .....	241
<code>CALCulate&lt;n&gt;:MARKer&lt;m&gt;:SPEctrogram:XY:MAXimum[:PEAK]</code> .....	241
<code>CALCulate&lt;n&gt;:MARKer&lt;m&gt;:SGRam:XY:MINimum[:PEAK]</code> .....	242
<code>CALCulate&lt;n&gt;:MARKer&lt;m&gt;:SPEctrogram:XY:MINimum[:PEAK]</code> .....	242
<code>CALCulate&lt;n&gt;:MARKer&lt;m&gt;:SGRam:Y:MAXimum:ABOVE</code> .....	242
<code>CALCulate&lt;n&gt;:MARKer&lt;m&gt;:SPEctrogram:Y:MAXimum:ABOVE</code> .....	242
<code>CALCulate&lt;n&gt;:MARKer&lt;m&gt;:SGRam:Y:MAXimum:BELOW</code> .....	242
<code>CALCulate&lt;n&gt;:MARKer&lt;m&gt;:SPEctrogram:Y:MAXimum:BELOW</code> .....	242
<code>CALCulate&lt;n&gt;:MARKer&lt;m&gt;:SGRam:Y:MAXimum:NEXT</code> .....	242
<code>CALCulate&lt;n&gt;:MARKer&lt;m&gt;:SPEctrogram:Y:MAXimum:NEXT</code> .....	242
<code>CALCulate&lt;n&gt;:MARKer&lt;m&gt;:SGRam:Y:MAXimum[:PEAK]</code> .....	243
<code>CALCulate&lt;n&gt;:MARKer&lt;m&gt;:SPEctrogram:Y:MAXimum[:PEAK]</code> .....	243
<code>CALCulate&lt;n&gt;:MARKer&lt;m&gt;:SGRam:Y:MINimum:ABOVE</code> .....	243
<code>CALCulate&lt;n&gt;:MARKer&lt;m&gt;:SPEctrogram:Y:MINimum:ABOVE</code> .....	243
<code>CALCulate&lt;n&gt;:MARKer&lt;m&gt;:SGRam:Y:MINimum:BELOW</code> .....	243
<code>CALCulate&lt;n&gt;:MARKer&lt;m&gt;:SPEctrogram:Y:MINimum:BELOW</code> .....	243
<code>CALCulate&lt;n&gt;:MARKer&lt;m&gt;:SGRam:Y:MINimum:NEXT</code> .....	243
<code>CALCulate&lt;n&gt;:MARKer&lt;m&gt;:SPEctrogram:Y:MINimum:NEXT</code> .....	243
<code>CALCulate&lt;n&gt;:MARKer&lt;m&gt;:SGRam:Y:MINimum[:PEAK]</code> .....	244
<code>CALCulate&lt;n&gt;:MARKer&lt;m&gt;:SPEctrogram:Y:MINimum[:PEAK]</code> .....	244

---

**`CALCulate<n>:MARKer<m>:SGRam:FRAME`** <Frame>

**`CALCulate<n>:MARKer<m>:SPEctrogram:FRAME`** <Frame> | <Time>

This command positions a marker on a particular frame.



**Suffix:**<n> [Window](#)<m> [Marker](#)**Parameters:**

<Frame> Selects a frame directly by the frame number. Valid if the time stamp is off.  
The range depends on the history depth.  
Default unit: S

<Time> Selects a frame via its time stamp. Valid if the time stamp is on.  
The number is the (negative) distance to frame 0 in seconds.  
The range depends on the history depth.

**Example:**

```
CALC:MARK:SGR:FRAM -20
```

Sets the marker on the 20th frame before the present.

```
CALC:MARK2:SGR:FRAM -2s
```

Sets second marker on the frame 2 seconds ago.

```
CALCulate<n>:MARKer<m>:SGRam:SARea <SearchArea>
```

```
CALCulate<n>:MARKer<m>:SPECTrogram:SARea <SearchArea>
```

This command defines the marker search area for all spectrogram markers in the channel setup.

**Suffix:**

&lt;n&gt; irrelevant

&lt;m&gt; irrelevant

**Parameters:**

&lt;SearchArea&gt;

**VISible**

Performs a search within the visible frames.

Note that the command does not work if the spectrogram is not visible for any reason (e.g. if the display update is off).

**MEMory**

Performs a search within all frames in the memory.

```
*RST: VISible
```

**Manual operation:** See "[Marker Search Area](#)" on page 94

```
CALCulate<n>:MARKer<m>:SGRam:XY:MAXimum[:PEAK]
```

```
CALCulate<n>:MARKer<m>:SPECTrogram:XY:MAXimum[:PEAK]
```

This command moves a marker to the highest level of the spectrogram.

**Suffix:**<n> [Window](#)<m> [Marker](#)

---

**CALCulate<n>:MARKer<m>:SGRam:XY:MINimum[:PEAK]**  
**CALCulate<n>:MARKer<m>:SPECTrogram:XY:MINimum[:PEAK]**

This command moves a marker to the minimum level of the spectrogram.

**Suffix:**

<n> [Window](#)

<m> [Marker](#)

---

**CALCulate<n>:MARKer<m>:SGRam:Y:MAXimum:ABOVE**  
**CALCulate<n>:MARKer<m>:SPECTrogram:Y:MAXimum:ABOVE**

This command moves a marker vertically to the next lower peak level for the current frequency.

The search includes only frames above the current marker position. It does not change the horizontal position of the marker.

**Suffix:**

<n> [Window](#)

<m> [Marker](#)

**Manual operation:** See "[Search Mode for Next Peak in Y-Direction](#)" on page 93

---

**CALCulate<n>:MARKer<m>:SGRam:Y:MAXimum:BELOW**  
**CALCulate<n>:MARKer<m>:SPECTrogram:Y:MAXimum:BELOW**

This command moves a marker vertically to the next lower peak level for the current frequency.

The search includes only frames below the current marker position. It does not change the horizontal position of the marker.

**Suffix:**

<n> [Window](#)

<m> [Marker](#)

**Manual operation:** See "[Search Mode for Next Peak in Y-Direction](#)" on page 93

---

**CALCulate<n>:MARKer<m>:SGRam:Y:MAXimum:NEXT**  
**CALCulate<n>:MARKer<m>:SPECTrogram:Y:MAXimum:NEXT**

This command moves a marker vertically to the next lower peak level for the current frequency.

The search includes all frames. It does not change the horizontal position of the marker.

**Suffix:**

<n> [Window](#)

<m> [Marker](#)

**Manual operation:** See "[Search Mode for Next Peak in Y-Direction](#)" on page 93

---

**CALCulate<n>:MARKer<m>:SGRam:Y:MAXimum[:PEAK]  
CALCulate<n>:MARKer<m>:SPECTrogram:Y:MAXimum[:PEAK]**

This command moves a marker vertically to the highest level for the current frequency.

The search includes all frames. It does not change the horizontal position of the marker.

If the marker hasn't been active yet, the command looks for the peak level in the whole spectrogram.

**Suffix:**

<n> [Window](#)

<m> [Marker](#)

---

**CALCulate<n>:MARKer<m>:SGRam:Y:MINimum:ABOVE  
CALCulate<n>:MARKer<m>:SPECTrogram:Y:MINimum:ABOVE**

This command moves a marker vertically to the next higher minimum level for the current frequency.

The search includes only frames above the current marker position. It does not change the horizontal position of the marker.

**Suffix:**

<n> [Window](#)

<m> [Marker](#)

**Manual operation:** See "[Search Mode for Next Peak in Y-Direction](#)" on page 93

---

**CALCulate<n>:MARKer<m>:SGRam:Y:MINimum:BELOW  
CALCulate<n>:MARKer<m>:SPECTrogram:Y:MINimum:BELOW**

This command moves a marker vertically to the next higher minimum level for the current frequency.

The search includes only frames below the current marker position. It does not change the horizontal position of the marker.

**Suffix:**

<n> [Window](#)

<m> [Marker](#)

**Manual operation:** See "[Search Mode for Next Peak in Y-Direction](#)" on page 93

---

**CALCulate<n>:MARKer<m>:SGRam:Y:MINimum:NEXT  
CALCulate<n>:MARKer<m>:SPECTrogram:Y:MINimum:NEXT**

This command moves a marker vertically to the next higher minimum level for the current frequency.

The search includes all frames. It does not change the horizontal position of the marker.

**Suffix:**

<n> [Window](#)

<m> [Marker](#)

**Manual operation:** See "[Search Mode for Next Peak in Y-Direction](#)" on page 93

**CALCulate<n>:MARKer<m>:SGRam:Y:MINimum[:PEAK]**

**CALCulate<n>:MARKer<m>:SPECTrogram:Y:MINimum[:PEAK]**

This command moves a marker vertically to the minimum level for the current frequency.

The search includes all frames. It does not change the horizontal position of the marker.

If the marker hasn't been active yet, the command first looks for the peak level for all frequencies and moves the marker vertically to the minimum level.

**Suffix:**

<n> [Window](#)

<m> [Marker](#)

#### 11.8.4.2 Using delta markers

The following commands control spectrogram delta markers.

##### Useful commands for spectrogram markers described elsewhere

The following commands define the horizontal position of the delta markers.

- [CALCulate<n>:DELTamarker<m>:MAXimum:LEFT](#) on page 227
- [CALCulate<n>:DELTamarker<m>:MAXimum:NEXT](#) on page 227
- [CALCulate<n>:DELTamarker<m>:MAXimum\[:PEAK\]](#) on page 227
- [CALCulate<n>:DELTamarker<m>:MAXimum:RIGHT](#) on page 227
- [CALCulate<n>:DELTamarker<m>:MINimum:LEFT](#) on page 228
- [CALCulate<n>:DELTamarker<m>:MINimum:NEXT](#) on page 228
- [CALCulate<n>:DELTamarker<m>:MINimum\[:PEAK\]](#) on page 228
- [CALCulate<n>:DELTamarker<m>:MINimum:RIGHT](#) on page 228

##### Remote commands exclusive to spectrogram markers

<a href="#">CALCulate&lt;n&gt;:DELTamarker&lt;m&gt;:SGRam:FRAMe</a> .....	245
<a href="#">CALCulate&lt;n&gt;:DELTamarker&lt;m&gt;:SPECTrogram:FRAMe</a> .....	245
<a href="#">CALCulate&lt;n&gt;:DELTamarker&lt;m&gt;:SGRam:SARea</a> .....	245
<a href="#">CALCulate&lt;n&gt;:DELTamarker&lt;m&gt;:SPECTrogram:SARea</a> .....	245
<a href="#">CALCulate&lt;n&gt;:DELTamarker&lt;m&gt;:SGRam:XY:MAXimum[:PEAK]</a> .....	246
<a href="#">CALCulate&lt;n&gt;:DELTamarker&lt;m&gt;:SPECTrogram:XY:MAXimum[:PEAK]</a> .....	246

CALCulate<n>:DELTamarker<m>:SGRam:XY:MINimum[:PEAK].....	246
CALCulate<n>:DELTamarker<m>:SPECTrogram:XY:MINimum[:PEAK].....	246
CALCulate<n>:DELTamarker<m>:SGRam:Y:MAXimum:ABOVe.....	246
CALCulate<n>:DELTamarker<m>:SPECTrogram:Y:MAXimum:ABOVe.....	246
CALCulate<n>:DELTamarker<m>:SGRam:Y:MAXimum:BELow.....	247
CALCulate<n>:DELTamarker<m>:SPECTrogram:Y:MAXimum:BELow.....	247
CALCulate<n>:DELTamarker<m>:SGRam:Y:MAXimum:NEXT.....	247
CALCulate<n>:DELTamarker<m>:SPECTrogram:Y:MAXimum:NEXT.....	247
CALCulate<n>:DELTamarker<m>:SGRam:Y:MAXimum[:PEAK].....	247
CALCulate<n>:DELTamarker<m>:SPECTrogram:Y:MAXimum[:PEAK].....	247
CALCulate<n>:DELTamarker<m>:SGRam:Y:MINimum:ABOVe.....	247
CALCulate<n>:DELTamarker<m>:SPECTrogram:Y:MINimum:ABOVe.....	247
CALCulate<n>:DELTamarker<m>:SGRam:Y:MINimum:BELow.....	248
CALCulate<n>:DELTamarker<m>:SPECTrogram:Y:MINimum:BELow.....	248
CALCulate<n>:DELTamarker<m>:SGRam:Y:MINimum:NEXT.....	248
CALCulate<n>:DELTamarker<m>:SPECTrogram:Y:MINimum:NEXT.....	248
CALCulate<n>:DELTamarker<m>:SGRam:Y:MINimum[:PEAK].....	248
CALCulate<n>:DELTamarker<m>:SPECTrogram:Y:MINimum[:PEAK].....	248

---

**CALCulate<n>:DELTamarker<m>:SGRam:FRAMe <Frame>**

**CALCulate<n>:DELTamarker<m>:SPECTrogram:FRAMe <Frame>**

This command positions a delta marker on a particular frame. The frame is relative to the position of marker 1.

The command is available for the spectrogram.

**Suffix:**

<n>                      Window

<m>                      Marker

**Parameters:**

<Frame>                Selects a frame either by its frame number or time stamp.  
 The frame number is available if the time stamp is off. The range depends on the history depth.  
 The time stamp is available if the time stamp is on. The number is the distance to frame 0 in seconds. The range depends on the history depth.  
 Default unit: S

**Example:**

CALC:DELT4:SGR:FRAM -20

Sets fourth deltamarker 20 frames below marker 1.

CALC:DELT4:SGR:FRAM 2 s

Sets fourth deltamarker 2 seconds above the position of marker 1.

---

**CALCulate<n>:DELTamarker<m>:SGRam:SARea <SearchArea>**

**CALCulate<n>:DELTamarker<m>:SPECTrogram:SARea <SearchArea>**

This command defines the marker search area for *all* spectrogram markers in the channel setup.

**Suffix:**

<n> irrelevant

<m> irrelevant

**Parameters:**

<SearchArea>

**VISible**

Performs a search within the visible frames.

Note that the command does not work if the spectrogram is not visible for any reason (e.g. if the display update is off).

**MEMory**

Performs a search within all frames in the memory.

\*RST: VISible

**Manual operation:** See " [Marker Search Area](#) " on page 94

**CALCulate<n>:DELTamarker<m>:SGRam:XY:MAXimum[:PEAK]**

**CALCulate<n>:DELTamarker<m>:SPECTrogram:XY:MAXimum[:PEAK]**

This command moves a marker to the highest level of the spectrogram over all frequencies.

**Suffix:**

<n> [Window](#)

<m> [Marker](#)

**CALCulate<n>:DELTamarker<m>:SGRam:XY:MINimum[:PEAK]**

**CALCulate<n>:DELTamarker<m>:SPECTrogram:XY:MINimum[:PEAK]**

This command moves a delta marker to the minimum level of the spectrogram over all frequencies.

**Suffix:**

<n> [Window](#)

<m> [Marker](#)

**CALCulate<n>:DELTamarker<m>:SGRam:Y:MAXimum:ABOVE**

**CALCulate<n>:DELTamarker<m>:SPECTrogram:Y:MAXimum:ABOVE**

This command moves a marker vertically to the next higher level for the current frequency.

The search includes only frames above the current marker position. It does not change the horizontal position of the marker.

**Suffix:**

<n> [Window](#)

<m> [Marker](#)

**Manual operation:** See " [Search Mode for Next Peak in Y-Direction](#) " on page 93

---

**CALCulate<n>:DELTamarker<m>:SGRam:Y:MAXimum:BELOW**  
**CALCulate<n>:DELTamarker<m>:SPECTrogram:Y:MAXimum:BELOW**

This command moves a marker vertically to the next higher level for the current frequency.

The search includes only frames below the current marker position. It does not change the horizontal position of the marker.

**Suffix:**

<n> [Window](#)

<m> [Marker](#)

**Manual operation:** See "[Search Mode for Next Peak in Y-Direction](#)" on page 93

---

**CALCulate<n>:DELTamarker<m>:SGRam:Y:MAXimum:NEXT**  
**CALCulate<n>:DELTamarker<m>:SPECTrogram:Y:MAXimum:NEXT**

This command moves a delta marker vertically to the next higher level for the current frequency.

The search includes all frames. It does not change the horizontal position of the marker.

**Suffix:**

<n> [Window](#)

<m> [Marker](#)

**Manual operation:** See "[Search Mode for Next Peak in Y-Direction](#)" on page 93

---

**CALCulate<n>:DELTamarker<m>:SGRam:Y:MAXimum[:PEAK]**  
**CALCulate<n>:DELTamarker<m>:SPECTrogram:Y:MAXimum[:PEAK]**

This command moves a delta marker vertically to the highest level for the current frequency.

The search includes all frames. It does not change the horizontal position of the marker.

If the marker hasn't been active yet, the command looks for the peak level in the whole spectrogram.

**Suffix:**

<n> [Window](#)

<m> [Marker](#)

---

**CALCulate<n>:DELTamarker<m>:SGRam:Y:MINimum:ABOVE**  
**CALCulate<n>:DELTamarker<m>:SPECTrogram:Y:MINimum:ABOVE**

This command moves a delta marker vertically to the next minimum level for the current frequency.

The search includes only frames above the current marker position. It does not change the horizontal position of the marker.

**Suffix:**

<n> [Window](#)

<m> [Marker](#)

**Manual operation:** See "[Search Mode for Next Peak in Y-Direction](#)" on page 93

**CALCulate<n>:DELTamarker<m>:SGRam:Y:MINimum:BELOW**

**CALCulate<n>:DELTamarker<m>:SPECTrogram:Y:MINimum:BELOW**

This command moves a delta marker vertically to the next minimum level for the current frequency.

The search includes only frames below the current marker position. It does not change the horizontal position of the marker.

**Suffix:**

<n> [Window](#)

<m> [Marker](#)

**Manual operation:** See "[Search Mode for Next Peak in Y-Direction](#)" on page 93

**CALCulate<n>:DELTamarker<m>:SGRam:Y:MINimum:NEXT**

**CALCulate<n>:DELTamarker<m>:SPECTrogram:Y:MINimum:NEXT**

This command moves a delta marker vertically to the next minimum level for the current frequency.

The search includes all frames. It does not change the horizontal position of the marker.

**Suffix:**

<n> [Window](#)

<m> [Marker](#)

**Manual operation:** See "[Search Mode for Next Peak in Y-Direction](#)" on page 93

**CALCulate<n>:DELTamarker<m>:SGRam:Y:MINimum[:PEAK]**

**CALCulate<n>:DELTamarker<m>:SPECTrogram:Y:MINimum[:PEAK]**

This command moves a delta marker vertically to the minimum level for the current frequency.

The search includes all frames. It does not change the horizontal position of the marker.

If the marker hasn't been active yet, the command first looks for the peak level in the whole spectrogram and moves the marker vertically to the minimum level.

**Suffix:**

<n> [Window](#)



<m> Marker

### 11.8.5 Defining limit checks

Note that in remote control, upper and lower limit lines are configured using separate commands. Thus, you must decide in advance which you want to configure. The x-values for both upper and lower limit lines are defined as a common control line. This control line is the reference for the y-values for both upper and lower limit lines.

- [Configuring limit lines](#)..... 249
- [Managing limit lines](#)..... 258
- [Checking the results of a limit check](#)..... 260
- [Programming example: using limit lines](#)..... 261

#### 11.8.5.1 Configuring limit lines

<a href="#">CALCulate&lt;n&gt;:LIMit&lt;li&gt;:COMMENT</a> .....	249
<a href="#">CALCulate&lt;n&gt;:LIMit&lt;li&gt;:CONTRol[:DATA]</a> .....	250
<a href="#">CALCulate&lt;n&gt;:LIMit&lt;li&gt;:CONTRol:DOMain</a> .....	250
<a href="#">CALCulate&lt;n&gt;:LIMit&lt;li&gt;:CONTRol:MODE</a> .....	250
<a href="#">CALCulate&lt;n&gt;:LIMit&lt;li&gt;:CONTRol:OFFSet</a> .....	251
<a href="#">CALCulate&lt;n&gt;:LIMit&lt;li&gt;:CONTRol:SHIFt</a> .....	251
<a href="#">CALCulate&lt;n&gt;:LIMit&lt;li&gt;:CONTRol:SPACing</a> .....	251
<a href="#">CALCulate&lt;n&gt;:LIMit&lt;li&gt;:LOWer[:DATA]</a> .....	252
<a href="#">CALCulate&lt;n&gt;:LIMit&lt;li&gt;:LOWer:MARGin</a> .....	252
<a href="#">CALCulate&lt;n&gt;:LIMit&lt;li&gt;:LOWer:MODE</a> .....	252
<a href="#">CALCulate&lt;n&gt;:LIMit&lt;li&gt;:LOWer:OFFSet</a> .....	253
<a href="#">CALCulate&lt;n&gt;:LIMit&lt;li&gt;:LOWer:SHIFt</a> .....	253
<a href="#">CALCulate&lt;n&gt;:LIMit&lt;li&gt;:LOWer:SPACing</a> .....	253
<a href="#">CALCulate&lt;n&gt;:LIMit&lt;li&gt;:LOWer:STATe</a> .....	254
<a href="#">CALCulate&lt;n&gt;:LIMit&lt;li&gt;:LOWer:THReshold</a> .....	254
<a href="#">CALCulate&lt;n&gt;:LIMit&lt;li&gt;:NAME</a> .....	254
<a href="#">CALCulate&lt;n&gt;:LIMit&lt;li&gt;:UNIT</a> .....	255
<a href="#">CALCulate&lt;n&gt;:LIMit&lt;li&gt;:UPPer[:DATA]</a> .....	255
<a href="#">CALCulate&lt;n&gt;:LIMit&lt;li&gt;:UPPer:MARGin</a> .....	255
<a href="#">CALCulate&lt;n&gt;:LIMit&lt;li&gt;:UPPer:MODE</a> .....	256
<a href="#">CALCulate&lt;n&gt;:LIMit&lt;li&gt;:UPPer:OFFSet</a> .....	256
<a href="#">CALCulate&lt;n&gt;:LIMit&lt;li&gt;:UPPer:SHIFt</a> .....	256
<a href="#">CALCulate&lt;n&gt;:LIMit&lt;li&gt;:UPPer:SPACing</a> .....	257
<a href="#">CALCulate&lt;n&gt;:LIMit&lt;li&gt;:UPPer:STATe</a> .....	257
<a href="#">CALCulate&lt;n&gt;:LIMit&lt;li&gt;:UPPer:THReshold</a> .....	257

---

**CALCulate<n>:LIMit<li>:COMMENT** <Comment>

This command defines a comment for a limit line.

**Suffix:**

<n>	irrelevant
<li>	Limit line

**Parameters:**

<Comment> String containing the description of the limit line.

**CALCulate<n>:LIMit<li>:CONTrol[:DATA] <LimitLinePoints>**

This command defines the horizontal definition points of a limit line.

**Suffix:**

<n> irrelevant

<li> [Limit line](#)

**Parameters:**

<LimitLinePoints> Variable number of x-axis values.  
 Note that the number of horizontal values has to be the same as the number of vertical values set with [CALCulate<n>:LIMit<li>:LOWer\[:DATA\]](#) or [CALCulate<n>:LIMit<li>:UPPer\[:DATA\]](#). If not, the R&S ZNL either adds missing values or ignores surplus values.  
 The unit is Hz or s.

\*RST: -

Default unit: HZ

**CALCulate<n>:LIMit<li>:CONTrol:DOMain <SpanSetting>**

This command selects the domain of the limit line.

**Suffix:**

<n> irrelevant

<li> [Limit line](#)

**Parameters:**

<SpanSetting> FREQUENCY | TIME

**FREQUENCY**

For limit lines that apply to a range of frequencies.

**TIME**

For limit lines that apply to a period of time.

\*RST: FREQUENCY

**Example:**

CALC:LIM:CONT:DOM FREQ

Select a limit line in the frequency domain.

**CALCulate<n>:LIMit<li>:CONTrol:MODE <Mode>**

This command selects the horizontal limit line scaling.

**Suffix:**

<n> irrelevant

<li> [Limit line](#)

**Parameters:**

<Mode>

**ABSolute**

Limit line is defined by absolute physical values (Hz or s).

**RELative**

Limit line is defined by relative values related to the center frequency (frequency domain) or the left diagram border (time domain).

\*RST: ABSolute

**CALCulate<n>:LIMit<li>:CONTrol:OFFSet <Offset>**

This command defines an offset for a complete limit line.

Compared to shifting the limit line, an offset does not actually change the limit line definition points.

**Suffix:**

<n> irrelevant

<li> [Limit line](#)

**Parameters:**

<Offset>

Numeric value.

The unit depends on the scale of the x-axis.

\*RST: 0

Default unit: HZ

**CALCulate<n>:LIMit<li>:CONTrol:SHIFt <Distance>**

This command moves a complete limit line horizontally.

Compared to defining an offset, this command actually changes the limit line definition points by the value you define.

**Suffix:**

<n> irrelevant

<li> [Limit line](#)

**Parameters:**

<Distance>

Numeric value.

The unit depends on the scale of the x-axis.

Default unit: HZ

**CALCulate<n>:LIMit<li>:CONTrol:SPACing <InterpolMode>**

This command selects linear or logarithmic interpolation for the calculation of limit lines from one horizontal point to the next.

**Suffix:**<n> [Window](#)<li> [Limit line](#)**Parameters:**

&lt;InterpolMode&gt; LINear | LOGarithmic

\*RST: LIN

**Example:**

CALC:LIM:CONT:SPAC LIN

**CALCulate<n>:LIMit<li>:LOWer[:DATA] <LimitLinePoints>**

This command defines the vertical definition points of a lower limit line.

**Suffix:**

&lt;n&gt; irrelevant

<li> [Limit line](#)**Parameters:**

&lt;LimitLinePoints&gt; Variable number of level values.

Note that the number of vertical values has to be the same as the number of horizontal values set with [CALCulate<n>:LIMit<li>:CONTrol\[:DATA\]](#). If not, the R&S ZNL either adds missing values or ignores surplus values.

The unit depends on [CALCulate<n>:LIMit<li>:UNIT](#) on page 255.

\*RST: Limit line state is OFF

Default unit: DBM

**CALCulate<n>:LIMit<li>:LOWer:MARGin <Margin>**

This command defines an area around a lower limit line where limit check violations are still tolerated.

**Suffix:**

&lt;n&gt; irrelevant

<li> [Limit line](#)**Parameters:**<Margin> **numeric value**

\*RST: 0

Default unit: dB

**CALCulate<n>:LIMit<li>:LOWer:MODE <Mode>**

This command selects the vertical limit line scaling.

**Suffix:**<n> [Window](#)

<li> [Limit line](#)

**Parameters:**

<Mode>

**ABSolute**

Limit line is defined by absolute physical values.

The unit is variable.

**RELative**

Limit line is defined by relative values related to the reference level (dB).

\*RST: ABSolute

**CALCulate<n>:LIMit<li>:LOWer:OFFSet <Offset>**

This command defines an offset for a complete lower limit line.

Compared to shifting the limit line, an offset does not actually change the limit line definition points.

**Suffix:**

<n> [Window](#)

<li> [Limit line](#)

**Parameters:**

<Offset>

Numeric value.

\*RST: 0

Default unit: dB

**CALCulate<n>:LIMit<li>:LOWer:SHIFt <Distance>**

This command moves a complete lower limit line vertically.

Compared to defining an offset, this command actually changes the limit line definition points by the value you define.

**Suffix:**

<n> [Window](#)

<li> [Limit line](#)

**Parameters:**

<Distance>

Defines the distance that the limit line moves.

The unit depends on [CALCulate<n>:LIMit<li>:UNIT](#) on page 255.

Default unit: DB

**CALCulate<n>:LIMit<li>:LOWer:SPACing <InterpolType>**

This command selects linear or logarithmic interpolation for the calculation of a lower limit line from one horizontal point to the next.

**Suffix:**<n> [Window](#)<li> [Limit line](#)**Parameters:**

&lt;InterpolType&gt; LINear | LOGarithmic

\*RST: LIN

**CALCulate<n>:LIMit<li>:LOWer:STate** <State>

This command turns a lower limit line on and off.

Before you can use the command, you have to select a limit line with [CALCulate<n>:LIMit<li>:NAME](#) on page 254.

**Suffix:**

&lt;n&gt; irrelevant

<li> [Limit line](#)**Parameters:**

&lt;State&gt; ON | OFF | 0 | 1

**OFF | 0**

Switches the function off

**ON | 1**

Switches the function on

**CALCulate<n>:LIMit<li>:LOWer:THReshold** <Threshold>

This command defines a threshold for relative limit lines.

The R&S ZNL uses the threshold for the limit check, if the limit line violates the threshold.

**Suffix:**

&lt;n&gt; irrelevant

<li> [Limit line](#)**Parameters:**

&lt;Threshold&gt; Numeric value.

The unit depends on [CALCulate<n>:LIMit<li>:UNIT](#) on page 255.

\*RST: -200 dBm

Default unit: DBM

**CALCulate<n>:LIMit<li>:NAME** <Name>

This command selects a limit line that already exists or defines a name for a new limit line.

**Suffix:**<n> [Window](#)<li> [Limit line](#)**Parameters:**

&lt;Name&gt; String containing the limit line name.

\*RST: REM1 to REM8 for lines 1 to 8

**CALCulate<n>:LIMit<li>:UNIT <Unit>**

This command defines the unit of a limit line.

**Suffix:**

&lt;n&gt; irrelevant

<li> [Limit line](#)**Parameters:**

&lt;Unit&gt; If you select a dB-based unit for the limit line, the command automatically turns the limit line into a relative limit line.

\*RST: DBM

**CALCulate<n>:LIMit<li>:UPPer[:DATA] <LimitLinePoints>**

This command defines the vertical definition points of an upper limit line.

**Suffix:**

&lt;n&gt; irrelevant

<li> [Limit line](#)**Parameters:**

&lt;LimitLinePoints&gt; Variable number of level values.

Note that the number of vertical values has to be the same as the number of horizontal values set with [CALCulate<n>:LIMit<li>:CONTRol\[:DATA\]](#). If not, the R&S ZNL either adds missing values or ignores surplus values.

The unit depends on [CALCulate<n>:LIMit<li>:UNIT](#) on page 255.

\*RST: Limit line state is OFF

Default unit: DBM

**CALCulate<n>:LIMit<li>:UPPer:MARGin <Margin>**

This command defines an area around an upper limit line where limit check violations are still tolerated.

**Suffix:**

&lt;n&gt; irrelevant

<li> [Limit line](#)

**Parameters:**

<Margin>                    **numeric value**  
 \*RST:                    0  
 Default unit: dB

**CALCulate<n>:LIMit<li>:UPPer:MODE <Mode>**

This command selects the vertical limit line scaling.

**Suffix:**

<n>                            [Window](#)

<li>                           [Limit line](#)

**Parameters:**

<Mode>                    **ABSolute**  
 Limit line is defined by absolute physical values.  
 The unit is variable.

**RELative**  
 Limit line is defined by relative values related to the reference  
 level (dB).

\*RST:                    ABSolute

**CALCulate<n>:LIMit<li>:UPPer:OFFSet <Offset>**

This command defines an offset for a complete upper limit line.

Compared to shifting the limit line, an offset does not actually change the limit line definition points.

**Suffix:**

<n>                            irrelevant

<li>                           [Limit line](#)

**Parameters:**

<Offset>                    Numeric value.  
 \*RST:                    0  
 Default unit: dB

**CALCulate<n>:LIMit<li>:UPPer:SHIFt <Distance>**

This command moves a complete upper limit line vertically.

Compared to defining an offset, this command actually changes the limit line definition points by the value you define.

**Suffix:**

<n>                            irrelevant

<li>                           [Limit line](#)



**Parameters:**

<Distance> Defines the distance that the limit line moves.  
The unit depends on [CALCulate<n>:LIMit<li>:UNIT](#) on page 255.

**CALCulate<n>:LIMit<li>:UPPer:SPACing** <InterpolType>

This command selects linear or logarithmic interpolation for the calculation of an upper limit line from one horizontal point to the next.

**Suffix:**

<n> [Window](#)

<li> [Limit line](#)

**Parameters:**

<InterpolType> LINear | LOGarithmic  
\*RST: LIN

**CALCulate<n>:LIMit<li>:UPPer:STATe** <State>

This command turns an upper limit line on and off.

Before you can use the command, you have to select a limit line with [CALCulate<n>:LIMit<li>:NAME](#) on page 254.

**Suffix:**

<n> irrelevant

<li> [Limit line](#)

**Parameters:**

<State> ON | OFF | 0 | 1  
**OFF | 0**  
Switches the function off  
**ON | 1**  
Switches the function on

**CALCulate<n>:LIMit<li>:UPPer:THReshold** <Limit>

This command defines an absolute limit for limit lines with a relative scale.

The R&S ZNL uses the threshold for the limit check, if the limit line violates the threshold.

**Suffix:**

<n> irrelevant

<li> [Limit line](#)

**Parameters:**

<Limit>                    Numeric value.  
 The unit depends on `CALCulate<n>:LIMit<li>:UNIT`  
 on page 255.

\*RST:                    -200  
 Default unit: dBm

**11.8.5.2 Managing limit lines**

Useful commands for managing limit lines described in the R&S ZNL User Manual:

- `MMEM:SEL[:ITEM]:LIN:ALL`
- `MMEM:STOR:TYPE`

**Remote commands exclusive to managing limit lines:**

<code>CALCulate&lt;n&gt;:LIMit&lt;li&gt;:ACTive?</code> .....	258
<code>CALCulate&lt;n&gt;:LIMit&lt;li&gt;:COPY</code> .....	258
<code>CALCulate&lt;n&gt;:LIMit&lt;li&gt;:DELeTe</code> .....	259
<code>CALCulate&lt;n&gt;:LIMit&lt;li&gt;:STATe</code> .....	259
<code>CALCulate&lt;n&gt;:LIMit&lt;li&gt;:TRACe&lt;t&gt;:CHECK</code> .....	259
<code>MMEMory:LOAD&lt;n&gt;:LIMit</code> .....	260
<code>MMEMory:STORe&lt;n&gt;:LIMit</code> .....	260

**CALCulate<n>:LIMit<li>:ACTive?**

This command queries the names of *all* active limit lines.

**Suffix:**

<n>                    irrelevant  
 <li>                    irrelevant

**Return values:**

<LimitLines>                    String containing the names of all active limit lines in alphabetical order.

**Example:**

`CALC:LIM:ACT?`  
 Queries the names of all active limit lines.

**Usage:**

Query only

**CALCulate<n>:LIMit<li>:COPY <Line>**

This command copies a limit line.

**Suffix:**

<n>                    [Window](#)  
 <li>                    [Limit line](#)

**Parameters:**

<Line>                    **1 to 8**  
 number of the new limit line

**<name>**

String containing the name of the limit line.

**Example:**

```
CALC:LIM1:COPY 2
Copies limit line 1 to line 2.
CALC:LIM1:COPY 'FM2'
Copies limit line 1 to a new line named FM2.
```

**CALCulate<n>:LIMit<li>:DELete**

This command deletes a limit line.

**Suffix:**

<n> [Window](#)  
<li> [Limit line](#)

**CALCulate<n>:LIMit<li>:STATe <State>**

This command turns the limit check for a specific limit line on and off.

To query the limit check result, use [CALCulate<n>:LIMit<li>:FAIL?](#).

Note that a new command exists to activate the limit check and define the trace to be checked in one step (see [CALCulate<n>:LIMit<li>:TRACe<t>:CHECK](#) on page 259).

**Suffix:**

<n> irrelevant  
<li> [Limit line](#)

**Parameters:**

<State> ON | OFF | 0 | 1  
**OFF | 0**  
Switches the function off  
**ON | 1**  
Switches the function on

**Example:**

```
CALC:LIM:STAT ON
Switches on the limit check for limit line 1.
```

**CALCulate<n>:LIMit<li>:TRACe<t>:CHECK <State>**

This command turns the limit check for a specific trace on and off.

To query the limit check result, use [CALCulate<n>:LIMit<li>:FAIL?](#).

**Suffix:**

<n> [Window](#)  
<li> [Limit line](#)

<t> Trace

**Parameters:**

<State> ON | OFF | 0 | 1  
**OFF | 0**  
 Switches the function off  
**ON | 1**  
 Switches the function on

**Example:** CALC:LIM3:TRAC2:CHEC ON  
 Switches on the limit check for limit line 3 on trace 2.

**MMEMory:LOAD<n>:LIMit <FileName>**

Loads the limit line from the selected file in .CSV format.

**Suffix:**

<n> irrelevant

**Parameters:**

<FileName> String containing the path and name of the CSV import file.

**Example:** MMEM:LOAD:LIM 'C:\TEST.CSV'

**MMEMory:STORe<n>:LIMit <FileName>, <LimitLineName>**

This command exports limit line data to an ASCII (CSV) file.

For details on the file format see the R&S ZNL User Manual.

**Suffix:**

<n> irrelevant

**Parameters:**

<FileName> String containing the path and name of the target file.

<LimitLineName> Name of the limit line to be exported.

**Example:** MMEM:STOR:LIM 'C:\TEST', 'UpperLimitLine'  
 Stores the limit line named "UpperLimitLine" in the file TEST.CSV.

### 11.8.5.3 Checking the results of a limit check

CALCulate<n>:LIMit<li>:CLEar[:IMMEDIATE].....	260
CALCulate<n>:LIMit<li>:FAIL?.....	261

**CALCulate<n>:LIMit<li>:CLEar[:IMMEDIATE]**

This command deletes the result of the current limit check.

The command works on *all* limit lines in *all* measurement windows at the same time.

<b>Suffix:</b>	
<n>	Window
<li>	irrelevant
<b>Example:</b>	CALC:LIM:CLE Deletes the result of the limit check.

### CALCulate<n>:LIMit<li>:FAIL?

This command queries the result of a limit check in the specified window.

To get a valid result, you have to perform a complete measurement with synchronization to the end of the measurement before reading out the result. This is only possible for single sweep mode.

See also [INITiate<n>:CONTinuous](#) on page 168.

<b>Suffix:</b>	
<n>	Window
<li>	Limit line
<b>Return values:</b>	
<Result>	0 PASS
	1 FAIL
<b>Example:</b>	INIT;*WAI Starts a new sweep and waits for its end. CALC2:LIM3:FAIL? Queries the result of the check for limit line 3 in window 2.
<b>Usage:</b>	Query only

#### 11.8.5.4 Programming example: using limit lines

The following examples demonstrate how to work with limit lines in a remote environment.

- [Example: configuring limit lines](#).....261
- [Example: performing a limit check](#)..... 263

#### Example: configuring limit lines

This example demonstrates how to configure 2 limit lines - an upper and a lower limit - for a measurement in a remote environment.

```
//----- Configuing the limit lines -----
CALC:LIM1:NAME 'FM1'
//Names limit line 1 'FM1'.

CALC:LIM1:CONT:MODE ABS
//Selects absolute scaling for the horizontal axis.
```

```
CALC:LIM1:CONT 1 MHz,50MHz,100 MHz,150MHz,200MHz
//Defines 5 horizontal definition points for limit line 1.
CALC:LIM1:UPP:MODE ABS
//Selects an absolute vertical scale for limit line 1.
CALC:LIM1:UNIT DBM
//Selects the unit dBm for limit line 1.
CALC:LIM1:UPP -10,-5,0,-5,-10
//Defines 5 definition points for limit line 1.

CALC:LIM1:UPP:MARG 5dB
//Defines an area of 5 dB around limit line 1 where limit check violations
//are still tolerated.

CALC:LIM1:UPP:SHIF -10DB
//Shifts the limit line 1 by -10 dB.
CALC:LIM1:UPP:OFFS -3dB
//Defines an additional -3 dB offset for limit line 1.

CALC:LIM3:NAME 'FM3'
//Names limit line 3 'FM3'.

CALC:LIM3:LOW:MODE REL
//Selects a relative vertical scale for limit line 3.
CALC:LIM3:UNIT DB

CALC:LIM3:CONT 1 MHz,50MHz,100 MHz,150MHz,200MHz
//Defines 5 horizontal definition points for limit line 3.
CALC:LIM3:LOW -90,-60,-40,-60,-90
//Defines 5 definition points relative to the reference level for limit line 3.

CALC:LIM3:LOW:SHIF 2
//Shifts the limit line 3 by 2dB.
CALC:LIM3:LOW:OFFS 3
//Defines an additional 3 dB offset for limit line 3.

CALC:LIM3:LOW:THR -200DBM
//Defines a power threshold of -200dBm that must be exceeded for limit to be checked

CALC:LIM3:LOW:MARG 5dB
//Defines an area of 5dB around limit line 3 where limit check violations
//are still tolerated.

//----- Storing the limit lines -----
MMEM:SEL:CHAN:LIN:ALL ON
MMEM:STOR:TYPE CHAN
MMEM:STOR:STAT 1,'LimitLines_FM1_FM3'
```

**Example: performing a limit check**

This example demonstrates how to perform a limit check during a basic frequency sweep measurement in a remote environment. The limit lines configured in ["Example: configuring limit lines"](#) on page 261 are assumed to exist and be active.

```
//-----Preparing the instrument -----
*RST
//Resets the instrument
INIT:CONT OFF
//Selects single sweep mode.

//-----Configuring the measurement -----
FREQ:CENT 100MHz
//Defines the center frequency
FREQ:SPAN 200MHz
//Sets the span to 100 MHz on either side of the center frequency.
SENS:SWE:COUN 10
//Defines 10 sweeps to be performed in each measurement.
DISP:TRAC1:Y:RLEV 0dBm
//Sets the reference level to 0 dBm.
TRIG:SOUR IFP
TRIG:LEV:IFP -10dBm
//Defines triggering when the second intermediate frequency rises to a level
//of -10 dBm.

//-----Configuring the Trace-----
DISP:TRAC2 ON
DISP:TRAC2:MODE AVER
DISP:TRAC3 ON
DISP:TRAC3:MODE MAXH
//Configures 3 traces: 1 (default): clear/write; 2: average; 3: max hold

//----- Configuring the limit check -----
MMEM:LOAD:TYPE REPL
MMEM:LOAD:STAT 1,'LimitLines_FM1_FM3'
//Loads the limit lines stored in 'LimitLines_FM1_FM3'
CALC:LIM1:NAME 'FM1'
CALC:LIM1:UPP:STAT ON
//Activates upper limit FM1 as line 1.
CALC:LIM3:NAME 'FM3'
CALC:LIM3:LOW:STAT ON
//Activates lower limit line FM3 as line 3.
CALC:LIM:ACT?
//Queries the names of all active limit lines
//Result: 'FM1,FM3'
CALC:LIM1:TRAC3:CHEC ON
//Activates the upper limit to be checked against trace3 (maxhold trace)
CALC:LIM3:TRAC2:CHEC ON
//Activates the upper limit to be checked against trace2 (average trace)
CALC:LIM:CLE
```

```
//Clears the previous limit check results

//----- Performing the measurement-----
INIT;*WAI
//Initiates a new measurement and waits until the last sweep has finished.

//----- Retrieving limit check results-----

CALC:LIM1:FAIL?
//Queries the result of the upper limit line check
CALC:LIM3:FAIL?
//Queries the result of the lower limit line check
```

## 11.9 Importing and exporting I/Q data and results

The I/Q data to be evaluated in the AM/FM/PM Modulation Analysis application can not only be measured by the AM/FM/PM Modulation Analysis application itself, it can also be imported to the application, provided it has the correct format. Furthermore, the evaluated I/Q data from the AM/FM/PM Modulation Analysis application can be exported for further analysis in external applications.

For details see [Chapter 7, "I/Q data import and export"](#), on page 104.

<a href="#">MMEMory:STORe&lt;n&gt;:IQ:COMMeNt.....</a>	264
<a href="#">MMEMory:STORe&lt;n&gt;:IQ:FORMat.....</a>	264
<a href="#">MMEMory:STORe&lt;n&gt;:IQ:STATe.....</a>	265

---

### MMEMory:STORe<n>:IQ:COMMeNt <Comment>

This command adds a comment to a file that contains I/Q data.

#### Suffix:

<n> irrelevant

#### Parameters:

<Comment> String containing the comment.

#### Example:

```
MMEM:STOR:IQ:COMM 'Device test 1b'
Creates a description for the export file.
MMEM:STOR:IQ:STAT 1, 'C:
\R_S\Instr\user\data.iq.tar'
Stores I/Q data and the comment to the specified file.
```

---

### MMEMory:STORe<n>:IQ:FORMat <Format>,<DataFormat>

This command sets or queries the format of the I/Q data to be stored.



<b>Suffix:</b>	
<n>	irrelevant
<b>Parameters:</b>	
<Format>	<b>FLOat32</b> 32-bit floating point format.
	<b>INT32</b> 32-bit integer format.
	*RST: FLOat32
<DataFormat>	<b>COMPLex</b> Exports complex data.
	<b>REAL</b> Exports real data.
	*RST: COMPLex
<b>Example:</b>	MMEM:STOR:IQ:FORM INT32,REAL

---

#### MMEMory:STORe<n>:IQ:STATe <1>, <FileName>

This command writes the captured I/Q data to a file.

The file extension is \*.iq.tar. By default, the contents of the file are in 32-bit floating point format.

<b>Suffix:</b>	
<n>	1..n
<b>Parameters:</b>	
<1>	
<FileName>	String containing the path and name of the target file.
<b>Example:</b>	MMEM:STOR:IQ:STAT 1, 'C: \R_S\Instr\user\data.iq.tar' Stores the captured I/Q data to the specified file.

## 11.10 Deprecated commands

The following commands are provided for compatibility to other signal analyzers only. For new remote control programs use the specified alternative commands.

[CALCulate<n>:FEED.....](#) 265

---

#### CALCulate<n>:FEED <Evaluation>

This command selects the evaluation method of the measured data that is to be displayed in the specified window.

<b>Suffix:</b>	
<n>	Window

**Parameters:**

<Evaluation> Type of evaluation you want to display.  
See the table below for available parameter values.

**Example:**

```
INST:SEL ADEM
Activates Analog Modulation Analysis.
CALC:FEED 'XTIM:FM'
Selects the display of the FM signal.
```

**Table 11-5: <Evaluation> parameter values for the R&S FPL1-K7 AM/FM/PM Modulation Analysis application**

Parameter	Evaluation
'XTIM:AM:RELative'	"AM Time Domain"
'XTIM:AM:RELative:AFSPectrum'	"AM Spectrum"
'XTIM:FM'	"FM Time Domain"
'XTIM:FM:AFSPectrum'	"FM Spectrum"
'XTIM:PM'	"PM Time Domain"
'XTIM:PM:AFSPectrum'	"PM Spectrum"
'XTIM:SPECTrum'	"RF Spectrum"
'XTIM:AM'	"RF Time Domain" (= RF power)
'XTIM:RFPower'	
'XTIM:AMSummary'	Result summary
'XTIM:AMSummary:RELative'	
'XTIM:FMSummary'	
'XTIM:FMSummary:RELative'	
'XTIM:PMSummary'	
'XTIM:PMSummary:RELative'	
'XTIM:SUMMary'	

## 11.11 Programming example

In this example we will configure and perform an Analog Modulation Analysis measurement to demonstrate the remote control commands.

### Signal generator settings (e.g. R&S SMW):

Frequency:	500 MHz
Level:	-10 dBm
Modulation:	FM
Modulation frequency:	10 kHz
Frequency deviation:	50 kHz

```

//-----Preparing the measurement -----
//Reset the instrument
*RST

//Set the center frequency to 500 MHz
FREQ:CENT 500 MHz
//Set the reference level to 0 dBm
DISP:TRAC:Y:SCAL:RLEV 0

//----- Activating an Analog Modulation Analysis measurement channel -----
//Activate an Analog Modulation Analysis measurement channel named "FMDemodulation"
INST:CRE:NEW ADEM,'FMDemodulation'

//----- Configuring data acquisition -----
//Set the measurement time to 1 ms (=10 periods)
ADEM:MTIM 1ms
//Optimize the scaling of the y-axis for the current measurement (continuously)
SENS:ADJ:SCAL:Y:AUTO ON
//Set the demodulation bandwidth to 400 kHz
BAND:DEM 400 kHz
//Trigger when magnitude of I/Q data reaches -50dBm
TRIG:SOUR IQP
TRIG:LEV:IQP -50

//----- Configuring the result display -----

//Add an FM Spectrum result display below FM Time Domain
LAY:ADD:WIND? '1',BEL,'XTIM:FM:AFSP'
//Define two traces in the FM Spectrum: 1: Clear/write, 2: average
ADEM:FM:AFSP WRIT,AVER,OFF,OFF,OFF,OFF
//Set analog demodulator to execute 30 sweeps with 32000 samples each
//at a sample rate of 8 MHz; use IQ trigger, trigger on positive slope
//with a pretrigger offset of 500 samples
ADEM:SET 8MHz,32000,IQP,POS,-500,30

//-----Performing the Measurement-----

//Stop continuous sweep
INIT:CONT OFF

//Start a new measurement with 30 sweeps and wait for the end
INIT;*WAI

//-----Retrieving Results-----
//Query the carrier power

```

```
CALC:MARK:FUNC:ADEM:CARR?
//Result: -10.37 [dBm]

//Query the signal-to-noise-and-distortion ratio from the FM Spectrum
CALC2:MARK:FUNC:ADEM:SIN:RES?
//Result: 65.026 [dB]

//Query the total harmonic distortion of the demodulated signal
//from the FM Spectrum
CALC2:MARK:FUNC:ADEM:THD:RES?
//Result: -66.413 [dB]

//Query the FM carrier offset (=frequency error) for the most recent
//measurement (trace 1)
CALC:MARK:FUNC:ADEM:FERR?
//Result: 649.07 [Hz]

//Query FM carrier offset averaged over 30 measurements
ADEM:FM:OFFS? AVER
//Result: 600 [Hz]

//Retrieve the trace data of the most recent measurement (trace 1)
TRAC:DATA? TRACE1
//Result: -1.201362252,-1.173495054,-1.187217355,-1.186594367,-1.171583891,
//-1.188250422,-1.204138160,-1.181404829,-1.186317205,-1.197872400, [...]

//Retrieve the averaged trace data for all 30 measurements (trace 2)
TRAC:DATA? TRACE2//Result: -1.201362252,-1.173495054,-1.187217355,-1.186594367,-1.171583891,
//-1.188250422,-1.204138160,-1.181404829,-1.186317205,-1.197872400, [...]
```

# Annex

## A Predefined standards and settings

You can configure the Analog Modulation Analysis application using predefined standard settings. This allows for quick and easy configuration for commonly performed measurements.

### Provided standard files

The instrument comes prepared with the following standard settings:

- AM Broadcast
- FM Narrowband
- FM Broadcast
- Frequency Settling
- None (default settings)

The default storage location for the settings files is:

```
C:\Users\Public\Documents\Rohde-Schwarz\ZNL\user\predefined\AdemodPredefined.
```

### Predefined settings

The following parameters can be stored in a standard settings file. Any parameters that are not included in the xml file are set to their default values when the standard is loaded.

#### Measurement settings:

- DBW
- AQT
- Demod Filter
- Sweep Points
- Squelch (State, Level)
- Units (Phase, THD)
- RF Span
- Settling Time (Time domain only)

#### Window display settings:

- Position
- State
- Window number
- Window type (all evaluation methods supported by the Analog Modulation Analysis application; see [Chapter 3, "Measurements and result displays"](#), on page 13)
- Scaling (Ref Position, Dev per Division)
- Time Domain Zoom (State, Start, Length)

**AF specific settings:**

- AF Center
- AF Span
- AF Filters (Lowpass, Highpass, Deemphasis, Weighting)
- Scaling for Spectrum (Ref Value, Deviation)
- Scaling for Time Domain (Ref Value, AF Coupling (FM/PM only))

**Table A-1: List of predefined standards and settings**

Setting	AM Broadcast	FM Narrowband	FM Broadcast	Frequency Settling *)	None (Default)
<b>Demod. bandwidth</b>	100 kHz	100 kHz	400 kHz	5 MHz	5 MHz
<b>Aquisition time</b>	100 ms	100 ms	100 ms	10 ms	62.5 µs
<b>Input coupling</b>	AC	AC	AC		AC
<b>Squelch level</b>				-30 dBm	-20 dBm
<b>Windows</b>	"RF Spectrum" "AM Time Domain" "AM Spectrum" "Result Summary"	"RF Spectrum" "FM Time Domain" "FM Spectrum" "Result Summary"	"RF Spectrum" "FM Time Domain" "FM Spectrum" "Result Summary"	"FM Time Domain" "RF Time Domain" "Result Summary"	"FM Time Domain" "Result Summary"
<b>AF filter - High-pass</b>	20 kHz	50 Hz			-
<b>AF filter - Low-pass</b>	15 kHz	3 kHz	150 kHz		-
<b>RF Spectrum</b>					
<b>Span</b>	50 kHz	25 kHz	400 kHz		
<b>AM/FM Time Domain</b>					
<b>Time domain zoom</b>	10 ms	10 ms	10 ms		-
<b>Dev per division</b>		1 kHz	20 kHz	100 kHz	50 kHz
<b>Time domain</b>					
<b>Settling Time State</b>				ON	
<b>AM/FM Spectrum</b>					
<b>Start freq.</b>	0 Hz	0 Hz	0 Hz		
<b>Stop freq.</b>	15 kHz	5 kHz	63.33 kHz		
<b>Ref. value</b>		5 kHz	75 kHz		
*) The Frequency Settling scenario requires a manually defined trigger					

# List of commands (analog demodulation mode)

[SENSe:] [WINDow<n>:] DETector<t>[:FUNCTION]	204
[SENSe:] [WINDow<n>:] DETector<t>[:FUNCTION]:AUTO	205
[SENSe:] ADEMod:ACV:AFSPectrum:RESult?	179
[SENSe:] ADEMod:ACV[:TDOMain]:RESult?	179
[SENSe:] ADEMod:AF:CENter	149
[SENSe:] ADEMod:AF:SPAN	149
[SENSe:] ADEMod:AF:SPAN:FULL	149
[SENSe:] ADEMod:AF:STARt	149
[SENSe:] ADEMod:AF:STOP	150
[SENSe:] ADEMod:AM:RELative:AFSPectrum:RESult?	179
[SENSe:] ADEMod:AM:RELative:AFSPectrum[:TYPE]	202
[SENSe:] ADEMod:AM:RELative[:TDOMain]:RESult?	179
[SENSe:] ADEMod:AM:RELative[:TDOMain][:TYPE]	202
[SENSe:] ADEMod:AM[:ABSolute]:AFSPectrum:RESult?	179
[SENSe:] ADEMod:AM[:ABSolute]:AFSPectrum[:TYPE]	202
[SENSe:] ADEMod:AM[:ABSolute][:TDOMain]:RESult?	179
[SENSe:] ADEMod:AM[:ABSolute][:TDOMain][:TYPE]	202
[SENSe:] ADEMod:FM:AFSPectrum:RESult?	179
[SENSe:] ADEMod:FM:AFSPectrum[:TYPE]	202
[SENSe:] ADEMod:FM[:TDOMain]:RESult?	179
[SENSe:] ADEMod:FM[:TDOMain][:TYPE]	202
[SENSe:] ADEMod:MTIME	135
[SENSe:] ADEMod:PM:AFSPectrum:RESult?	179
[SENSe:] ADEMod:PM:AFSPectrum[:TYPE]	202
[SENSe:] ADEMod:PM:RPOint[:X]	144
[SENSe:] ADEMod:PM:RPOint[:X]:MODE	145
[SENSe:] ADEMod:PM[:TDOMain]:RESult?	179
[SENSe:] ADEMod:PM[:TDOMain][:TYPE]	202
[SENSe:] ADEMod:PRESet:REStore	123
[SENSe:] ADEMod:PRESet:StORe	123
[SENSe:] ADEMod:PRESet[:STANdard]	123
[SENSe:] ADEMod:RLENgth	135
[SENSe:] ADEMod:SET	135
[SENSe:] ADEMod:SETTling:TIME:LIMit:LOWer	161
[SENSe:] ADEMod:SETTling:TIME:LIMit:UPPer	162
[SENSe:] ADEMod:SETTling:TIME:RESult<t>?	187
[SENSe:] ADEMod:SETTling:TIME:STATe	162
[SENSe:] ADEMod:SPEctrum:BWIDth[:RESolution]	136
[SENSe:] ADEMod:SPEctrum:RESult?	179
[SENSe:] ADEMod:SPEctrum:SPAN:ZOOM	150
[SENSe:] ADEMod:SPEctrum:SPAN[:MAXimum]	151
[SENSe:] ADEMod:SPEctrum[:TYPE]	202
[SENSe:] ADEMod:SQUelch:LEVel	146
[SENSe:] ADEMod:SQUelch[:STATe]	145
[SENSe:] ADEMod:SRATe	136

[SENSe:]ADEMod<n>:AF:COUPling.....	144
[SENSe:]ADEMod<n>:SPEctrum:BANDwidth[:RESolution].....	136
[SENSe:]ADEMod<n>:ZOOM:LENGth.....	147
[SENSe:]ADEMod<n>:ZOOM:LENGth:MODE.....	147
[SENSe:]ADEMod<n>:ZOOM:STARt.....	147
[SENSe:]ADEMod<n>:ZOOM[:STATe].....	148
[SENSe:]ADJust:ALL.....	163
[SENSe:]ADJust:CONFigure:HYSteresis:LOWer.....	165
[SENSe:]ADJust:CONFigure:HYSteresis:UPPer.....	165
[SENSe:]ADJust:CONFigure:LEVel:DURation.....	164
[SENSe:]ADJust:CONFigure:LEVel:DURation:MODE.....	164
[SENSe:]ADJust:CONFigure:SMODE.....	165
[SENSe:]ADJust:CONFigure:TRIGger.....	166
[SENSe:]ADJust:FREQuency.....	166
[SENSe:]ADJust:LEVel.....	166
[SENSe:]ADJust:SCALE[:Y]:AUTO[:CONTInuous].....	166
[SENSe:]AVERAge<n>:COUNT.....	203
[SENSe:]AVERAge<n>:TYPE.....	204
[SENSe:]AVERAge<n>[:STATe<t>].....	203
[SENSe:]BANDwidth:DEMod.....	136
[SENSe:]BANDwidth:DEMod:TYPE.....	137
[SENSe:]BANDwidth[:RESolution].....	137
[SENSe:]BWIDth:DEMod.....	136
[SENSe:]BWIDth:DEMod:TYPE.....	137
[SENSe:]FILTer<n>:AOFF.....	152
[SENSe:]FILTer<n>:AWEighted[:STATe].....	151
[SENSe:]FILTer<n>:CCIR:WEIGhted[:STATe].....	152
[SENSe:]FILTer<n>:CCIR[:UNWeighted][:STATe].....	152
[SENSe:]FILTer<n>:CCIT[:STATe].....	153
[SENSe:]FILTer<n>:DEMPHasis:TCONstant.....	153
[SENSe:]FILTer<n>:DEMPHasis[:STATe].....	153
[SENSe:]FILTer<n>:HPASs:FREQuency:MANual.....	154
[SENSe:]FILTer<n>:HPASs:FREQuency[:ABSolute].....	154
[SENSe:]FILTer<n>:HPASs[:STATe].....	154
[SENSe:]FILTer<n>:LPASs:FREQuency:MANual.....	155
[SENSe:]FILTer<n>:LPASs:FREQuency:RELative.....	155
[SENSe:]FILTer<n>:LPASs:FREQuency[:ABSolute].....	155
[SENSe:]FILTer<n>:LPASs[:STATe].....	156
[SENSe:]FREQuency:CENTer.....	127
[SENSe:]FREQuency:CENTer:STEP.....	127
[SENSe:]FREQuency:CENTer:STEP:LINK.....	128
[SENSe:]FREQuency:CENTer:STEP:LINK:FACTor.....	128
[SENSe:]SWEep:COUNT.....	137
[SENSe:]SWEep[:WINDow<n>]:POINts.....	138
ABORT.....	167
CALCulate<n>:DELTaMarker<m>:AOFF.....	208
CALCulate<n>:DELTaMarker<m>:FUNctIon:FIXed:RPOint:MAXimum[:PEAK].....	229
CALCulate<n>:DELTaMarker<m>:FUNctIon:FIXed:RPOint:X.....	229
CALCulate<n>:DELTaMarker<m>:FUNctIon:FIXed:RPOint:Y.....	230
CALCulate<n>:DELTaMarker<m>:FUNctIon:FIXed:RPOint:Y:OFFSet.....	230



CALCulate<n>:DELTamarker<m>:FUNction:FIXed[:STATE]	230
CALCulate<n>:DELTamarker<m>:LINK	208
CALCulate<n>:DELTamarker<m>:MAXimum:LEFT	227
CALCulate<n>:DELTamarker<m>:MAXimum:NEXT	227
CALCulate<n>:DELTamarker<m>:MAXimum:RIGHT	227
CALCulate<n>:DELTamarker<m>:MAXimum[:PEAK]	227
CALCulate<n>:DELTamarker<m>:MINimum:LEFT	228
CALCulate<n>:DELTamarker<m>:MINimum:NEXT	228
CALCulate<n>:DELTamarker<m>:MINimum:RIGHT	228
CALCulate<n>:DELTamarker<m>:MINimum[:PEAK]	228
CALCulate<n>:DELTamarker<m>:MODE	209
CALCulate<n>:DELTamarker<m>:MREFerence	210
CALCulate<n>:DELTamarker<m>:SGRam:FRAME	220
CALCulate<n>:DELTamarker<m>:SGRam:FRAME	245
CALCulate<n>:DELTamarker<m>:SGRam:SARea	220
CALCulate<n>:DELTamarker<m>:SGRam:SARea	245
CALCulate<n>:DELTamarker<m>:SGRam:XY:MAXimum[:PEAK]	221
CALCulate<n>:DELTamarker<m>:SGRam:XY:MAXimum[:PEAK]	246
CALCulate<n>:DELTamarker<m>:SGRam:XY:MINimum[:PEAK]	221
CALCulate<n>:DELTamarker<m>:SGRam:XY:MINimum[:PEAK]	246
CALCulate<n>:DELTamarker<m>:SGRam:Y:MAXimum:ABOVe	221
CALCulate<n>:DELTamarker<m>:SGRam:Y:MAXimum:ABOVe	246
CALCulate<n>:DELTamarker<m>:SGRam:Y:MAXimum:BELOW	221
CALCulate<n>:DELTamarker<m>:SGRam:Y:MAXimum:BELOW	247
CALCulate<n>:DELTamarker<m>:SGRam:Y:MAXimum:NEXT	222
CALCulate<n>:DELTamarker<m>:SGRam:Y:MAXimum:NEXT	247
CALCulate<n>:DELTamarker<m>:SGRam:Y:MAXimum[:PEAK]	222
CALCulate<n>:DELTamarker<m>:SGRam:Y:MAXimum[:PEAK]	247
CALCulate<n>:DELTamarker<m>:SGRam:Y:MINimum:ABOVe	222
CALCulate<n>:DELTamarker<m>:SGRam:Y:MINimum:ABOVe	247
CALCulate<n>:DELTamarker<m>:SGRam:Y:MINimum:BELOW	222
CALCulate<n>:DELTamarker<m>:SGRam:Y:MINimum:BELOW	248
CALCulate<n>:DELTamarker<m>:SGRam:Y:MINimum:NEXT	223
CALCulate<n>:DELTamarker<m>:SGRam:Y:MINimum:NEXT	248
CALCulate<n>:DELTamarker<m>:SGRam:Y:MINimum[:PEAK]	223
CALCulate<n>:DELTamarker<m>:SGRam:Y:MINimum[:PEAK]	248
CALCulate<n>:DELTamarker<m>:SPECTrogram:FRAME	220
CALCulate<n>:DELTamarker<m>:SPECTrogram:FRAME	245
CALCulate<n>:DELTamarker<m>:SPECTrogram:SARea	220
CALCulate<n>:DELTamarker<m>:SPECTrogram:SARea	245
CALCulate<n>:DELTamarker<m>:SPECTrogram:XY:MAXimum[:PEAK]	221
CALCulate<n>:DELTamarker<m>:SPECTrogram:XY:MAXimum[:PEAK]	246
CALCulate<n>:DELTamarker<m>:SPECTrogram:XY:MINimum[:PEAK]	221
CALCulate<n>:DELTamarker<m>:SPECTrogram:XY:MINimum[:PEAK]	246
CALCulate<n>:DELTamarker<m>:SPECTrogram:Y:MAXimum:ABOVe	221
CALCulate<n>:DELTamarker<m>:SPECTrogram:Y:MAXimum:ABOVe	246
CALCulate<n>:DELTamarker<m>:SPECTrogram:Y:MAXimum:BELOW	221
CALCulate<n>:DELTamarker<m>:SPECTrogram:Y:MAXimum:BELOW	247
CALCulate<n>:DELTamarker<m>:SPECTrogram:Y:MAXimum:NEXT	222
CALCulate<n>:DELTamarker<m>:SPECTrogram:Y:MAXimum:NEXT	247

CALCulate<n>:DELTamarker<m>:SPECtrogram:Y:MAXimum[:PEAK].....	222
CALCulate<n>:DELTamarker<m>:SPECtrogram:Y:MAXimum[:PEAK].....	247
CALCulate<n>:DELTamarker<m>:SPECtrogram:Y:MINimum:ABOVE.....	222
CALCulate<n>:DELTamarker<m>:SPECtrogram:Y:MINimum:ABOVE.....	247
CALCulate<n>:DELTamarker<m>:SPECtrogram:Y:MINimum:BELOW.....	222
CALCulate<n>:DELTamarker<m>:SPECtrogram:Y:MINimum:BELOW.....	248
CALCulate<n>:DELTamarker<m>:SPECtrogram:Y:MINimum:NEXT.....	223
CALCulate<n>:DELTamarker<m>:SPECtrogram:Y:MINimum:NEXT.....	248
CALCulate<n>:DELTamarker<m>:SPECtrogram:Y:MINimum[:PEAK].....	223
CALCulate<n>:DELTamarker<m>:SPECtrogram:Y:MINimum[:PEAK].....	248
CALCulate<n>:DELTamarker<m>:TRACe.....	211
CALCulate<n>:DELTamarker<m>:X.....	211
CALCulate<n>:DELTamarker<m>:X:RELative?.....	211
CALCulate<n>:DELTamarker<m>:Y?.....	212
CALCulate<n>:DELTamarker<m>[:STATe].....	210
CALCulate<n>:DELTamarker<ms>:LINK:TO:MARKer<md>.....	209
CALCulate<n>:FEED.....	265
CALCulate<n>:FORMat.....	146
CALCulate<n>:LIMit<li>:ACTive?.....	258
CALCulate<n>:LIMit<li>:CLEar[:IMMediate].....	260
CALCulate<n>:LIMit<li>:COMment.....	249
CALCulate<n>:LIMit<li>:CONTRol:DOMain.....	250
CALCulate<n>:LIMit<li>:CONTRol:MODE.....	250
CALCulate<n>:LIMit<li>:CONTRol:OFFSet.....	251
CALCulate<n>:LIMit<li>:CONTRol:SHIFt.....	251
CALCulate<n>:LIMit<li>:CONTRol:SPACing.....	251
CALCulate<n>:LIMit<li>:CONTRol[:DATA].....	250
CALCulate<n>:LIMit<li>:COPY.....	258
CALCulate<n>:LIMit<li>:DELeTe.....	259
CALCulate<n>:LIMit<li>:FAIL?.....	261
CALCulate<n>:LIMit<li>:LOWer:MARGin.....	252
CALCulate<n>:LIMit<li>:LOWer:MODE.....	252
CALCulate<n>:LIMit<li>:LOWer:OFFSet.....	253
CALCulate<n>:LIMit<li>:LOWer:SHIFt.....	253
CALCulate<n>:LIMit<li>:LOWer:SPACing.....	253
CALCulate<n>:LIMit<li>:LOWer:STATe.....	254
CALCulate<n>:LIMit<li>:LOWer:THReshold.....	254
CALCulate<n>:LIMit<li>:LOWer[:DATA].....	252
CALCulate<n>:LIMit<li>:NAME.....	254
CALCulate<n>:LIMit<li>:STATe.....	259
CALCulate<n>:LIMit<li>:TRACe<t>:CHECK.....	259
CALCulate<n>:LIMit<li>:UNIT.....	255
CALCulate<n>:LIMit<li>:UPPer:MARGin.....	255
CALCulate<n>:LIMit<li>:UPPer:MODE.....	256
CALCulate<n>:LIMit<li>:UPPer:OFFSet.....	256
CALCulate<n>:LIMit<li>:UPPer:SHIFt.....	256
CALCulate<n>:LIMit<li>:UPPer:SPACing.....	257
CALCulate<n>:LIMit<li>:UPPer:STATe.....	257
CALCulate<n>:LIMit<li>:UPPer:THReshold.....	257
CALCulate<n>:LIMit<li>:UPPer[:DATA].....	255

CALCulate<n>:MARKer<m>:AOFF.....	206
CALCulate<n>:MARKer<m>:FUNCTION:ADEMod:AFREquency[:RESult<t>]?.....	184
CALCulate<n>:MARKer<m>:FUNCTION:ADEMod:AM[:RESult<t>]:RELative?.....	185
CALCulate<n>:MARKer<m>:FUNCTION:ADEMod:AM[:RESult<t>]?.....	184
CALCulate<n>:MARKer<m>:FUNCTION:ADEMod:CARRier[:RESult<t>]?.....	186
CALCulate<n>:MARKer<m>:FUNCTION:ADEMod:DISTortion[:WRITe]:RESult<t>?.....	186
CALCulate<n>:MARKer<m>:FUNCTION:ADEMod:FERRor[:RESult<t>]?.....	186
CALCulate<n>:MARKer<m>:FUNCTION:ADEMod:FM[:RESult<t>]:RELative?.....	185
CALCulate<n>:MARKer<m>:FUNCTION:ADEMod:FM[:RESult<t>]?.....	184
CALCulate<n>:MARKer<m>:FUNCTION:ADEMod:PM[:RESult<t>]:RELative?.....	185
CALCulate<n>:MARKer<m>:FUNCTION:ADEMod:PM[:RESult<t>]?.....	184
CALCulate<n>:MARKer<m>:FUNCTION:ADEMod:SINad:RESult<t>?.....	187
CALCulate<n>:MARKer<m>:FUNCTION:ADEMod:THD:RESult<t>?.....	187
CALCulate<n>:MARKer<m>:FUNCTION:FPEaks:ANNotation:LABel[:STATe].....	231
CALCulate<n>:MARKer<m>:FUNCTION:FPEaks:COUNT?.....	232
CALCulate<n>:MARKer<m>:FUNCTION:FPEaks:LIST:SIZE.....	233
CALCulate<n>:MARKer<m>:FUNCTION:FPEaks:SORT.....	233
CALCulate<n>:MARKer<m>:FUNCTION:FPEaks:STATe.....	233
CALCulate<n>:MARKer<m>:FUNCTION:FPEaks:X?.....	234
CALCulate<n>:MARKer<m>:FUNCTION:FPEaks:Y?.....	234
CALCulate<n>:MARKer<m>:FUNCTION:FPEaks[:IMMEdiate].....	232
CALCulate<n>:MARKer<m>:FUNCTION:NDBDown.....	235
CALCulate<n>:MARKer<m>:FUNCTION:NDBDown:FREQuency?.....	236
CALCulate<n>:MARKer<m>:FUNCTION:NDBDown:QFACtor?.....	236
CALCulate<n>:MARKer<m>:FUNCTION:NDBDown:RESult?.....	237
CALCulate<n>:MARKer<m>:FUNCTION:NDBDown:STATe.....	237
CALCulate<n>:MARKer<m>:FUNCTION:NDBDown:TIME?.....	238
CALCulate<n>:MARKer<m>:FUNCTION:PNOise:AOFF.....	238
CALCulate<n>:MARKer<m>:FUNCTION:PNOise:RESult?.....	239
CALCulate<n>:MARKer<m>:FUNCTION:PNOise[:STATe].....	239
CALCulate<n>:MARKer<m>:FUNCTION:REFerence.....	129
CALCulate<n>:MARKer<m>:LINK.....	213
CALCulate<n>:MARKer<m>:MAXimum:LEFT.....	224
CALCulate<n>:MARKer<m>:MAXimum:NEXT.....	225
CALCulate<n>:MARKer<m>:MAXimum:RIGHT.....	225
CALCulate<n>:MARKer<m>:MAXimum[:PEAK].....	225
CALCulate<n>:MARKer<m>:MINimum:LEFT.....	225
CALCulate<n>:MARKer<m>:MINimum:NEXT.....	226
CALCulate<n>:MARKer<m>:MINimum:RIGHT.....	226
CALCulate<n>:MARKer<m>:MINimum[:PEAK].....	226
CALCulate<n>:MARKer<m>:PEXCursion.....	223
CALCulate<n>:MARKer<m>:SGRam:FRAME.....	215
CALCulate<n>:MARKer<m>:SGRam:FRAME.....	240
CALCulate<n>:MARKer<m>:SGRam:SARea.....	216
CALCulate<n>:MARKer<m>:SGRam:SARea.....	241
CALCulate<n>:MARKer<m>:SGRam:XY:MAXimum[:PEAK].....	216
CALCulate<n>:MARKer<m>:SGRam:XY:MAXimum[:PEAK].....	241
CALCulate<n>:MARKer<m>:SGRam:XY:MINimum[:PEAK].....	216
CALCulate<n>:MARKer<m>:SGRam:XY:MINimum[:PEAK].....	242
CALCulate<n>:MARKer<m>:SGRam:Y:MAXimum:ABOVE.....	216

CALCulate<n>:MARKer<m>:SGRam:Y:MAXimum:ABOVE.....	242
CALCulate<n>:MARKer<m>:SGRam:Y:MAXimum:BELOW.....	217
CALCulate<n>:MARKer<m>:SGRam:Y:MAXimum:BELOW.....	242
CALCulate<n>:MARKer<m>:SGRam:Y:MAXimum:NEXT.....	217
CALCulate<n>:MARKer<m>:SGRam:Y:MAXimum:NEXT.....	242
CALCulate<n>:MARKer<m>:SGRam:Y:MAXimum[:PEAK].....	217
CALCulate<n>:MARKer<m>:SGRam:Y:MAXimum[:PEAK].....	243
CALCulate<n>:MARKer<m>:SGRam:Y:MINimum:ABOVE.....	218
CALCulate<n>:MARKer<m>:SGRam:Y:MINimum:ABOVE.....	243
CALCulate<n>:MARKer<m>:SGRam:Y:MINimum:BELOW.....	218
CALCulate<n>:MARKer<m>:SGRam:Y:MINimum:BELOW.....	243
CALCulate<n>:MARKer<m>:SGRam:Y:MINimum:NEXT.....	218
CALCulate<n>:MARKer<m>:SGRam:Y:MINimum:NEXT.....	243
CALCulate<n>:MARKer<m>:SGRam:Y:MINimum[:PEAK].....	218
CALCulate<n>:MARKer<m>:SGRam:Y:MINimum[:PEAK].....	244
CALCulate<n>:MARKer<m>:SPECTrogram:FRAME.....	215
CALCulate<n>:MARKer<m>:SPECTrogram:FRAME.....	240
CALCulate<n>:MARKer<m>:SPECTrogram:SAREa.....	216
CALCulate<n>:MARKer<m>:SPECTrogram:SAREa.....	241
CALCulate<n>:MARKer<m>:SPECTrogram:XY:MAXimum[:PEAK].....	216
CALCulate<n>:MARKer<m>:SPECTrogram:XY:MAXimum[:PEAK].....	241
CALCulate<n>:MARKer<m>:SPECTrogram:XY:MINimum[:PEAK].....	216
CALCulate<n>:MARKer<m>:SPECTrogram:XY:MINimum[:PEAK].....	242
CALCulate<n>:MARKer<m>:SPECTrogram:Y:MAXimum:ABOVE.....	216
CALCulate<n>:MARKer<m>:SPECTrogram:Y:MAXimum:ABOVE.....	242
CALCulate<n>:MARKer<m>:SPECTrogram:Y:MAXimum:BELOW.....	217
CALCulate<n>:MARKer<m>:SPECTrogram:Y:MAXimum:BELOW.....	242
CALCulate<n>:MARKer<m>:SPECTrogram:Y:MAXimum:NEXT.....	217
CALCulate<n>:MARKer<m>:SPECTrogram:Y:MAXimum:NEXT.....	242
CALCulate<n>:MARKer<m>:SPECTrogram:Y:MAXimum[:PEAK].....	217
CALCulate<n>:MARKer<m>:SPECTrogram:Y:MAXimum[:PEAK].....	243
CALCulate<n>:MARKer<m>:SPECTrogram:Y:MINimum:ABOVE.....	218
CALCulate<n>:MARKer<m>:SPECTrogram:Y:MINimum:ABOVE.....	243
CALCulate<n>:MARKer<m>:SPECTrogram:Y:MINimum:BELOW.....	218
CALCulate<n>:MARKer<m>:SPECTrogram:Y:MINimum:BELOW.....	243
CALCulate<n>:MARKer<m>:SPECTrogram:Y:MINimum:NEXT.....	218
CALCulate<n>:MARKer<m>:SPECTrogram:Y:MINimum:NEXT.....	243
CALCulate<n>:MARKer<m>:SPECTrogram:Y:MINimum[:PEAK].....	218
CALCulate<n>:MARKer<m>:SPECTrogram:Y:MINimum[:PEAK].....	244
CALCulate<n>:MARKer<m>:TRACe.....	207
CALCulate<n>:MARKer<m>:X.....	207
CALCulate<n>:MARKer<m>:X:SSIZe.....	212
CALCulate<n>:MARKer<m>:Y?.....	208
CALCulate<n>:MARKer<m>[:STATe].....	206
CALCulate<n>:MARKer<ms>:LINK:TO:MARKer<md>.....	206
CALCulate<n>:SGRam:CLEAr[:IMMediate].....	192
CALCulate<n>:SGRam:CONTInuous.....	192
CALCulate<n>:SGRam:FRAMe:COUNT.....	192
CALCulate<n>:SGRam:FRAMe:SELect.....	193
CALCulate<n>:SGRam:HDEPth.....	193

CALCulate<n>:SGRam:LAYout.....	194
CALCulate<n>:SGRam:THReedim[:STATe].....	195
CALCulate<n>:SGRam:TRACe.....	195
CALCulate<n>:SGRam:TSTamp:DATA?.....	195
CALCulate<n>:SGRam:TSTamp[:STATe].....	196
CALCulate<n>:SGRam[:STATe].....	194
CALCulate<n>:SPECtrogram:CLEar[:IMMediate].....	192
CALCulate<n>:SPECtrogram:CONTInuous.....	192
CALCulate<n>:SPECtrogram:FRAMe:COUNt.....	192
CALCulate<n>:SPECtrogram:FRAMe:SElect.....	193
CALCulate<n>:SPECtrogram:HDEPth.....	193
CALCulate<n>:SPECtrogram:LAYout.....	194
CALCulate<n>:SPECtrogram:THReedim[:STATe].....	195
CALCulate<n>:SPECtrogram:TRACe.....	195
CALCulate<n>:SPECtrogram:TSTamp:DATA?.....	195
CALCulate<n>:SPECtrogram:TSTamp[:STATe].....	196
CALCulate<n>:SPECtrogram[:STATe].....	194
CALCulate<n>:UNIT:ANGLE.....	158
CALCulate<n>:UNIT:POWEr.....	129
CALCulate<n>:UNIT:THD.....	158
CONFigure:ADEMod:RESults:AM:DETEctor<det>:MODE.....	160
CONFigure:ADEMod:RESults:AM:DETEctor<det>:REFerence.....	159
CONFigure:ADEMod:RESults:AM:DETEctor<det>:REFerence:MEASStoref<t>.....	160
CONFigure:ADEMod:RESults:AM:DETEctor<det>:STATe.....	159
CONFigure:ADEMod:RESults:FM:DETEctor<det>:MODE.....	160
CONFigure:ADEMod:RESults:FM:DETEctor<det>:REFerence.....	159
CONFigure:ADEMod:RESults:FM:DETEctor<det>:REFerence:MEASStoref<t>.....	160
CONFigure:ADEMod:RESults:FM:DETEctor<det>:STATe.....	159
CONFigure:ADEMod:RESults:PM:DETEctor<det>:MODE.....	160
CONFigure:ADEMod:RESults:PM:DETEctor<det>:REFerence.....	159
CONFigure:ADEMod:RESults:PM:DETEctor<det>:REFerence:MEASStoref<t>.....	160
CONFigure:ADEMod:RESults:PM:DETEctor<det>:STATe.....	159
CONFigure:ADEMod:RESults:UNIT.....	161
DIAGnostic:SERVice:NSOURce.....	126
DISPlay[:WINDow<n>]:MINFo[:STATe].....	213
DISPlay[:WINDow<n>]:MTABLE.....	214
DISPlay[:WINDow<n>]:SGRam:COLor:DEFault.....	197
DISPlay[:WINDow<n>]:SGRam:COLor:LOWer.....	197
DISPlay[:WINDow<n>]:SGRam:COLor:SHAPE.....	197
DISPlay[:WINDow<n>]:SGRam:COLor:UPPer.....	198
DISPlay[:WINDow<n>]:SGRam:COLor[:STYLe].....	198
DISPlay[:WINDow<n>]:SIZE.....	170
DISPlay[:WINDow<n>]:SPECtrogram:COLor:DEFault.....	197
DISPlay[:WINDow<n>]:SPECtrogram:COLor:LOWer.....	197
DISPlay[:WINDow<n>]:SPECtrogram:COLor:SHAPE.....	197
DISPlay[:WINDow<n>]:SPECtrogram:COLor:UPPer.....	198
DISPlay[:WINDow<n>]:SPECtrogram:COLor[:STYLe].....	198
DISPlay[:WINDow<n>][:SUBWIndow<w>]:TRACe<t>:MODE.....	199
DISPlay[:WINDow<n>][:SUBWIndow<w>]:TRACe<t>:MODE:HCONTInuous.....	200
DISPlay[:WINDow<n>][:SUBWIndow<w>]:TRACe<t>:SElect.....	201

DISPlay[:WINDow<n>][:SUBWindow<w>]:TRACe<t>:Y:SPACing.....	134
DISPlay[:WINDow<n>][:SUBWindow<w>]:TRACe<t>:Y[:SCALe].....	132
DISPlay[:WINDow<n>][:SUBWindow<w>]:TRACe<t>:Y[:SCALe]:AUTO ONCE.....	132
DISPlay[:WINDow<n>][:SUBWindow<w>]:TRACe<t>:Y[:SCALe]:MODE.....	132
DISPlay[:WINDow<n>][:SUBWindow<w>]:TRACe<t>:Y[:SCALe]:PDIVision.....	133
DISPlay[:WINDow<n>][:SUBWindow<w>]:TRACe<t>:Y[:SCALe]:RLEVel.....	130
DISPlay[:WINDow<n>][:SUBWindow<w>]:TRACe<t>:Y[:SCALe]:RLEVel:OFFSet.....	130
DISPlay[:WINDow<n>][:SUBWindow<w>]:TRACe<t>:Y[:SCALe]:RPOSition.....	133
DISPlay[:WINDow<n>][:SUBWindow<w>]:TRACe<t>:Y[:SCALe]:RVALue.....	157
DISPlay[:WINDow<n>][:SUBWindow<w>]:TRACe<t>[:STATe].....	201
FORMat:DEXPort:DSEParator.....	182
FORMat:DEXPort:FORMat.....	181
FORMat:DEXPort:HEADer.....	182
FORMat:DEXPort:TRACes.....	182
FORMat[:DATA].....	180
INITiate:SEQuencer:ABORT.....	168
INITiate:SEQuencer:IMMediate.....	169
INITiate:SEQuencer:MODE.....	169
INITiate<n>:CONMeas.....	168
INITiate<n>:CONTinuous.....	168
INITiate<n>[:IMMediate].....	168
INPut<ip>:ATTenuation.....	131
INPut<ip>:ATTenuation:AUTO.....	131
INPut<ip>:ATTenuation:PROTection:RESet.....	124
INPut<ip>:EATT:AUTO.....	131
INPut<ip>:FILE:PATH.....	125
INPut<ip>:FILTer:YIG[:STATe].....	124
INPut<ip>:IMPedance.....	124
INPut<ip>:SELEct.....	125
INSTrument:CREate:DUPLicate.....	119
INSTrument:CREate:REPLace.....	120
INSTrument:CREate[:NEW].....	119
INSTrument:DELeTe.....	120
INSTrument:LIST?.....	120
INSTrument:REName.....	121
INSTrument[:SELEct].....	121
LAYout:ADD[:WINDow]?.....	171
LAYout:CATalog[:WINDow]?.....	173
LAYout:IDENtify[:WINDow]?.....	173
LAYout:REMove[:WINDow].....	174
LAYout:REPLace[:WINDow].....	174
LAYout:SPLitter.....	174
LAYout:WINDow<n>:ADD?.....	176
LAYout:WINDow<n>:IDENtify?.....	176
LAYout:WINDow<n>:REMove.....	177
LAYout:WINDow<n>:REPLace.....	177
LAYout:WINDow<n>:TYPE.....	178
MMEMory:LOAD<n>:LIMit.....	260
MMEMory:STORe<n>:IQ:COMMeNt.....	264
MMEMory:STORe<n>:IQ:FORMat.....	264

MMEMory:STORe<n>:IQ:STATe.....	265
MMEMory:STORe<n>:LIMit.....	260
MMEMory:STORe<n>:LIST.....	234
MMEMory:STORe<n>:PEAK.....	235
MMEMory:STORe<n>:SPECTrogram.....	183
MMEMory:STORe<n>:TRACe.....	183
SYSTem:PRESet:CHANnel[:EXEC].....	122
SYSTem:SEQuencer.....	169
SYSTem:SPEaker:VOLume.....	127
SYSTem:SPEaker[:STATe].....	126
TRACe<n>[:DATA].....	181
TRIGger[:SEQuence]:DTIME.....	139
TRIGger[:SEQuence]:HOLDoff[:TIME].....	139
TRIGger[:SEQuence]:IFPower:HOLDoff.....	139
TRIGger[:SEQuence]:IFPower:HYSTeresis.....	140
TRIGger[:SEQuence]:LEVel:AM:RELative.....	141
TRIGger[:SEQuence]:LEVel:AM[:ABSolute].....	141
TRIGger[:SEQuence]:LEVel:FM.....	141
TRIGger[:SEQuence]:LEVel:IFPower.....	140
TRIGger[:SEQuence]:LEVel:IQPower.....	141
TRIGger[:SEQuence]:LEVel:PM.....	142
TRIGger[:SEQuence]:LEVel[:EXTernal<port>].....	140
TRIGger[:SEQuence]:SLOPe.....	142
TRIGger[:SEQuence]:SOURce.....	142
TRIGger[:SEQuence]:TIME:RINTerval.....	143
UNIT<n>:ANGLE.....	158
UNIT<n>:POWer.....	129
UNIT<n>:THD.....	158

# Index

## Symbols

\*OPC ..... 138

## A

A weighted filter  
 AF filters ..... 58

Aborting  
 Sweep ..... 47, 48, 79

AC/DC coupling ..... 26, 51, 61

Activating  
 Analog Modulation Analysis (remote) ..... 119

AF ..... 13

AF Auto Scale  
 Y-axis ..... 62, 71

AF center  
 Demodulation spectrum ..... 54

AF CF ..... 12

AF coupling ..... 51, 61

AF filters ..... 27  
 A weighted ..... 58  
 CCIR ..... 58  
 CCITT ..... 58  
 Configuration ..... 56  
 Deactivating ..... 59  
 Deemphasis ..... 59  
 High pass ..... 57  
 Low pass ..... 57  
 Weighting ..... 58

AF full span  
 Demodulation spectrum ..... 55

AF span  
 Demodulation spectrum ..... 55  
 Displayed ..... 12  
 Remote control ..... 149

AF spectrum ..... 54

AF start  
 Demodulation spectrum ..... 54

AF stop  
 Demodulation spectrum ..... 54

AF trigger ..... 27, 28

All Functions Off ..... 103

AM (Offline)  
 Softkey ..... 43

AM Spectrum  
 Evaluation method ..... 16

AM Time Domain  
 Evaluation method ..... 13

Amplitude  
 Configuration ..... 37  
 Scaling ..... 63  
 Settings ..... 37

Analog Modulation Analysis  
 Measurement examples ..... 107

Analysis  
 Marker functions ..... 95  
 Remote control ..... 190  
 Settings ..... 73

Application cards ..... 6

Application notes ..... 6

AQT  
 see Measurement time ..... 11

ASCII trace export ..... 188

Attenuation  
 Auto ..... 40  
 Displayed ..... 11  
 Manual ..... 40  
 Protective (remote) ..... 124

Audio demodulation  
 Volume (remote control) ..... 126, 127

Audio frequency  
 see AF ..... 13

Auto adjustment  
 Triggered measurement ..... 166

Auto all ..... 70

Auto frequency ..... 71

Auto level  
 Hysteresis ..... 72  
 Reference level ..... 39, 71  
 Softkey ..... 39, 71

Auto scaling ..... 62, 63, 71

Auto settings  
 MeasTime Auto ..... 71  
 MeasTime Manual ..... 71

Average count ..... 49, 76

Average mode  
 Traces ..... 75

Averaging  
 Traces (remote control) ..... 204

## B

Bandwidth settings ..... 45

Basic Measurement Examples  
 see User Manual ..... 5

Brochures ..... 6

## C

Calibration certificate ..... 7

Capturing  
 I/Q data (remote) ..... 167

Carrier  
 Offset ..... 22, 26  
 Power ..... 22

CCIR filter  
 AF filters ..... 58

CCITT filter  
 AF filters ..... 58

Center frequency ..... 41, 55  
 Automatic configuration ..... 71  
 Displayed ..... 11, 12  
 Softkey ..... 41, 55  
 Step size ..... 41

Channel Setup  
 Creating (remote) ..... 120  
 Deleting (remote) ..... 120  
 Duplicating (remote) ..... 119  
 Querying (remote) ..... 120  
 Renaming (remote) ..... 121  
 Replacing (remote) ..... 120

Closing  
 Channel Setups (remote) ..... 120  
 Windows (remote) ..... 177



- Color curve
  - Shape ..... 81
- Color mapping
  - Color curve ..... 81
  - Color range ..... 81
  - Color scheme ..... 81
  - Softkey ..... 79
  - Spectrograms ..... 79, 80
- Color scheme
  - Spectrogram ..... 81
- Conditions
  - Measurement ..... 24
- Configuration
  - Measurement (remote) ..... 122
  - Procedure ..... 32
- Continue single sweep
  - Softkey ..... 48
- Continuous sweep
  - Softkey ..... 47, 79
- Conventions
  - SCPI commands ..... 114
- Copying
  - Channel Setup (remote) ..... 119
- D**
- Data acquisition
  - Remote control ..... 134
  - Settings ..... 45
- Data format
  - ASCII ..... 188
  - Binary ..... 188
  - Remote ..... 182
- Data sheets ..... 6
- DB per division
  - Scaling ..... 60
- DBW
  - see Demodulation bandwidth ..... 11
- Decimal separator
  - Trace export ..... 83, 84
- Deemphasis filter
  - AF filters ..... 59
  - Remote control ..... 153
- Deleting
  - Settings files ..... 35
  - Standards ..... 35
- Delta markers
  - Defining ..... 86
- Demodulation
  - AF spectrum ..... 54
  - Configuration ..... 50
  - Display ..... 50
  - Filter types ..... 27, 46
  - Process ..... 24
  - Relative (remote control) ..... 160
  - Relative (remote) ..... 159
  - RF spectrum ..... 55
  - Scaling ..... 56, 59
  - Settings ..... 50
  - Spectrum ..... 53
  - Spectrum (Result Summary) ..... 55
  - Units ..... 64
- Demodulation bandwidth ..... 46, 56
  - Conditions ..... 26
  - Deemphasis filter ..... 59
  - Displayed ..... 11
  - Maximum ..... 27
  - Remote control ..... 136
  - Troubleshooting ..... 112
- Detectors
  - Relative demodulation ..... 160
  - Relative demodulation (remote) ..... 159
  - Remote control ..... 159, 204
  - Trace ..... 75
- Dev per division
  - Scaling ..... 60
- Deviation
  - Scaling ..... 62
- Diagram footer information ..... 12
- Display configuration
  - Softkey ..... 50
- Drop-out time
  - Trigger ..... 45
- Duplicating
  - Channel Setup (remote) ..... 119
- E**
- Errors
  - IF OVLD ..... 38
- Evaluation
  - Data basis ..... 13
  - Methods ..... 13
- Evaluation methods
  - Remote ..... 171
- Examples
  - Remote control ..... 266
- Export format
  - Traces ..... 188
- Exporting
  - I/Q data ..... 104
  - I/Q data (remote) ..... 264
  - Measurement settings ..... 82
  - Peak list ..... 103
  - Trace data ..... 106
  - Traces ..... 81, 83
- External trigger
  - Level (remote) ..... 140
- F**
- File format
  - Export Files ..... 188
  - Trace export ..... 188
- filename
  - Settings ..... 34
- Filters
  - A weighted (AF) ..... 58
  - AF ..... 56
  - CCIR (AF) ..... 58
  - CCITT (AF) ..... 58
  - Demodulation ..... 26, 27, 46
  - High pass (AF) ..... 57
  - Low pass (AF) ..... 57
  - Weighting (AF) ..... 58
  - YIG (remote) ..... 124
- Fixed reference
  - Defining ..... 89
  - Remote control ..... 229
- FM (Offline)
  - Softkey ..... 43
- FM Spectrum
  - Evaluation method ..... 17

FM Time Domain	
Evaluation method .....	14
Format	
Data .....	188
Data (remote) .....	182
see also File format .....	188
Frame count	
Softkey .....	49
Free Run	
Trigger .....	43
Frequency	
Configuration .....	53
Deemphasis filter .....	59
Deviation .....	26
Deviation, scaling .....	60
Remote control .....	127
Settings .....	41
Span .....	56
Frontend settings .....	35

**G**

Getting started .....	5
-----------------------	---

**H**

Hardware settings	
Displayed .....	11
High pass filter	
AF filters .....	57
History	
Spectrograms .....	78
History Depth	
Softkey .....	78
Hold	
Trace setting .....	75
Hysteresis	
Lower (Auto level) .....	72
Trigger .....	44
Upper (Auto level) .....	72

**I**

I/Q data	
Exporting (remote) .....	264
Importing (remote) .....	264
Importing/Exporting .....	104
I/Q Power	
Trigger level (remote) .....	141
IF Power	
Trigger .....	43
Trigger level (remote) .....	140
Impedance	
Setting .....	36, 40
Importing	
I/Q data .....	104
I/Q data (remote) .....	264
Input	
Overload (remote) .....	124
RF .....	36
Settings .....	35
Input sources .....	35
Instrument security procedures .....	6

**K**

Keys	
MKR -> .....	90
MKR FUNCT .....	94
RUN CONT .....	47, 79
RUN SINGLE .....	48, 79

**L**

Limit check	
Remote control .....	249
Limit lines	
Remote control .....	249
Linking	
Markers .....	86, 89
Loading	
Settings files .....	35
Low pass filter	
AF filters .....	57
Lower Level Hysteresis .....	72

**M**

Marker	
Search area (softkey) .....	94
Search type (softkey) .....	93
Marker functions	
Deactivating .....	103
Remote control .....	229
Marker peak list	
see Peak list .....	102
Marker table	
Evaluation method .....	23
Marker to Trace .....	87
Markers	
Assigned trace .....	87
Basic settings .....	84
Configuration .....	84, 87
Configuration (remote control) .....	205
Deactivating .....	87
Delta markers .....	86
Fixed reference (remote control) .....	212, 229
Function configuration .....	94
Linked in AF spectrum display .....	89
Linked in time domain .....	89
Linking .....	86
Minimum .....	91
Minimum (remote control) .....	224
n dB down .....	97
n dB down (remote control) .....	235
Next minimum .....	92
Next minimum (remote control) .....	224
Next peak .....	91
Next peak (remote control) .....	224
Peak .....	91
Peak (remote control) .....	224
Peak list (remote control) .....	231
Phase noise measurement .....	97
Phase noise measurement (remote control) .....	238
Position .....	86
Positioning .....	90
Positioning (remote control) .....	205
Remote control .....	205
Search settings (remote) .....	223
Setting up (remote control) .....	205
Spectrograms (remote control) .....	214, 239

- State ..... 85
- Step size ..... 88
- Step size (remote control) ..... 212
- Table ..... 88
- Table (evaluation method) ..... 23
- Table (remote control) ..... 212
- Type ..... 86
- X-value ..... 86
- Maximizing
  - Windows (remote) ..... 170, 195
- Measurement examples
  - Analog Modulation Analysis ..... 107
- Measurement time ..... 46, 48
  - Auto settings ..... 71
  - Displayed ..... 11
  - Effects ..... 28
  - Value range ..... 27
- Minimum ..... 91
  - Marker positioning ..... 91
  - Next ..... 92
- MKR ->
  - Key ..... 90
- MKR FUNCT
  - Key ..... 94
- Modulation
  - Depth ..... 22
  - Depth, scaling ..... 60
  - Frequency ..... 22, 26
- Multiple
  - Channel Setups ..... 10
- N**
- n dB down
  - Delta value ..... 97
  - Marker ..... 97
  - Remote control ..... 235
- Next Minimum ..... 92
  - Marker positioning ..... 92
- Next Mode X
  - Softkey ..... 93
- Next Mode Y
  - Softkey ..... 93
- Next Peak ..... 91
  - Marker positioning ..... 91
- Noise
  - Source ..... 69
- O**
- Offset
  - Reference level ..... 38
- Output
  - Noise source ..... 69
- Overload
  - RF input (remote) ..... 124
- Overview
  - Configuration K7 ..... 31
  - Softkey ..... 31
- P**
- Peak excursion ..... 90, 94, 100, 103
- Peak list ..... 101
  - Configuring ..... 100
  - Displaying ..... 100
  - Evaluation method ..... 23
- Exporting ..... 103
- Marker numbers ..... 103
- Maximum number of peaks ..... 103
- Peak excursion ..... 90, 94, 103
- Remote control ..... 231
- Sort mode ..... 102
- State ..... 102
- Peak search
  - Area (spectrograms) ..... 94
  - Excursion ..... 100
  - Limits ..... 100
  - List ..... 101
  - Mode ..... 93
  - Mode (spectrograms) ..... 92, 93
  - Reference marker ..... 89
  - Type (spectrograms) ..... 93
- Peaks
  - Marker positioning ..... 91
  - Next ..... 91
- Performance
  - Improving ..... 28
- Performing
  - AM/FM/PM Modulation Analysis ..... 105
- Phase
  - Deviation ..... 26
  - Deviation, scaling ..... 60
  - Unit ..... 64
- Phase noise measurement
  - Activating/Deactivating ..... 99
  - Deactivating ..... 100
  - Marker ..... 97
  - Remote control ..... 238
- Phase Wrap
  - Activating ..... 53
- PM (Offline)
  - Softkey ..... 43
- PM Spectrum
  - Evaluation method ..... 18
- PM Time Domain
  - Evaluation method ..... 15
- Presetting
  - Channels ..... 33
- Pretrigger ..... 44
- Programming examples
  - Statistics ..... 261, 263
- Protection
  - RF input (remote) ..... 124
- Q**
- Quick Config
  - Traces ..... 76
- R**
- Range ..... 62
  - Scaling ..... 63
- RBW ..... 46
  - Displayed ..... 11
  - Remote control ..... 136
- Reference
  - Fixed ..... 89
  - Marker ..... 89
- Reference level ..... 38
  - Auto level ..... 39, 71
  - Displayed ..... 11
  - Offset ..... 38

- Offset, displayed ..... 11
- Position ..... 63
- Unit ..... 38, 39
- Value ..... 38
- Reference marker ..... 86
- Reference value ..... 61
  - Position ..... 60
- Release notes ..... 6
- Remote commands
  - Basics on syntax ..... 114
  - Boolean values ..... 117
  - Capitalization ..... 115
  - Character data ..... 118
  - Data blocks ..... 118
  - Deprecated ..... 265
  - Numeric values ..... 117
  - Optional keywords ..... 116
  - Parameters ..... 116
  - Strings ..... 118
  - Suffixes ..... 115
- Repetition interval ..... 44
- Res BW
  - see RBW ..... 46
- Resetting
  - RF input protection ..... 124
- Residual FM ..... 26
- Resolution bandwidth
  - see RBW ..... 46
- Restoring
  - Channel settings ..... 33
  - Standard files ..... 35
- Result Display ..... 10
- Result displays
  - Marker table ..... 23
  - Peak list ..... 23
- Result Summary
  - Demodulation spectrum ..... 55
  - Evaluation method ..... 21
  - Retrieving values (remote) ..... 183
- Results ..... 13
  - Analyzing ..... 73
  - Data format (remote) ..... 182
  - Exporting ..... 82
  - Retrieving (remote control) ..... 178
  - Stability ..... 28
- RF (Offline)
  - Softkey ..... 43
- RF attenuation
  - Auto ..... 40
  - Manual ..... 40
- RF full span ..... 56
- RF input
  - Overload protection (remote) ..... 124
  - Remote ..... 124
- RF Spectrum
  - Evaluation method ..... 20
  - Troubleshooting ..... 112
- RF Time Domain
  - Evaluation method ..... 19
- RUN CONT
  - Key ..... 47, 79
- RUN SINGLE
  - Key ..... 48, 79
- S**
- Safety instructions ..... 6
- Sample rate ..... 27
- Samples
  - Performance ..... 28
- Saving
  - Settings ..... 35
- Scaling
  - AF ..... 59
  - Amplitude range, automatically ..... 63
  - Automatic ..... 62, 71
  - Configuration ..... 59
  - Result Summary ..... 62
  - RF ..... 62
  - Y-axis ..... 63
  - Y-axis (remote control) ..... 134
- Screen layout ..... 10
- Search Configuration (softkey) ..... 90
- Search Mode
  - Spectrogram markers ..... 92
- Search settings
  - Markers (remote) ..... 223
- Searching
  - Configuration (softkey) ..... 92
- Security procedures ..... 6
- Select Frame
  - Softkey ..... 49, 78
- Select Marker ..... 90
- Sequencer ..... 10
  - Activating (remote) ..... 169
- Sequences
  - Aborting (remote) ..... 168
  - Mode (remote) ..... 169
- Service manual ..... 5
- Settings
  - Displayed ..... 31
  - filename ..... 34
  - Restoring files ..... 35
  - Storage location ..... 34
- Settings files
  - Deleting ..... 35
  - Loading ..... 35
  - Predefined ..... 269
  - Saving ..... 35
- Signal-to-noise ratio ..... 26
- Signal-to-noise-and-distortion
  - see SINAD ..... 22
- SINAD ..... 22
  - Querying (remote) ..... 187
  - Troubleshooting ..... 112
- Single sweep
  - Softkey ..... 48, 79
- Slope
  - Trigger ..... 45, 142
- Softkeys
  - All Functions Off ..... 103
  - AM (Offline) ..... 43
  - Amplitude Config ..... 37
  - Auto Level ..... 39, 71
  - Center ..... 41, 55
  - Clear Spectrogram ..... 50, 80
  - Color Mapping ..... 79
  - Continue Single Sweep ..... 48
  - Continuous Sweep ..... 47, 79
  - Display Config ..... 50
  - External ..... 43
  - FM (Offline) ..... 43
  - Frame count ..... 49
  - Free Run ..... 43

- History Depth ..... 78
- Marker Search Area ..... 94
- Marker Search Type ..... 93
- Next Mode X ..... 93
- Next Mode Y ..... 93
- Next Peak ..... 91
- Overview ..... 31
- PM (Offline) ..... 43
- Ref Level ..... 38
- RF (Offline) ..... 43
- Search Config ..... 90, 92
- Select Frame ..... 49, 78
- Select Marker ..... 90
- Single Sweep ..... 48, 79
- Span Manual ..... 56
- Time ..... 44
- Timestamp ..... 79
- Trace 1/2/3/4 ..... 76
- Trace Config ..... 73
- Sort mode
  - Peak list ..... 102
- Span ..... 56
  - Displayed ..... 12
  - Manual ..... 56
- Speaker
  - Remote control ..... 126, 127
- Specifics for
  - Configuration ..... 33
- Spectrograms
  - 3-dimensional ..... 78
  - Activating/Deactivating ..... 78
  - Clearing ..... 50, 80
  - Color curve ..... 81
  - Color mapping ..... 79, 80
  - Color mapping (remote control) ..... 197
  - Color scheme ..... 81
  - Configuring (remote control) ..... 191
  - Display depth (3-D) ..... 78
  - Frames (remote control) ..... 191
  - History depth ..... 78
  - Markers (remote control) ..... 214, 239
  - Selecting frames ..... 49, 78
  - Settings ..... 76
  - Size ..... 78
  - Timestamps ..... 79
- Spectrum
  - Demodulation ..... 53
- Squelch
  - AF ..... 51
  - Level ..... 51
  - Remote control ..... 145
  - State ..... 51
- Standards
  - Configuration ..... 33
  - Predefined ..... 269
  - Presetting ..... 34
  - VSA measurements ..... 33
- Statistics
  - Programming example ..... 261, 263
- Status registers
  - STAT:QUES:POW ..... 124
- Step size
  - Markers ..... 88
  - Markers (remote control) ..... 212
- Storage location
  - Settings ..... 34
- Subwindows
  - Spectrogram ..... 78
- Suffixes
  - Common ..... 119
  - Remote commands ..... 115
- Sweep
  - Aborting ..... 47, 48, 79
  - Settings ..... 47
- Sweep Count ..... 49
- Sweep points
  - Displayed ..... 12
- Sweep Points ..... 48
- Sweeps
  - Performing (remote) ..... 167
- T**
- THD ..... 22
  - Querying (remote) ..... 187
  - Troubleshooting ..... 112
  - Unit ..... 64
- Time domain zoom ..... 29, 52
  - Length ..... 53
  - Start ..... 52
  - State ..... 52
- Time frames
  - Continuing ..... 49
  - per sweep ..... 49
  - Selecting ..... 49, 78
- Time per division
  - Displayed ..... 12
- Time trigger
  - Repetition interval ..... 44
  - Softkey ..... 44
- Timestamps
  - Softkey (Spectrogram) ..... 79
  - Spectrograms ..... 79
- Total harmonic distortion
  - see THD ..... 22
- Traces ..... 76
  - Average mode ..... 75
  - Averaging (remote control) ..... 204
  - Configuration ..... 73
  - Configuring (remote control) ..... 199
  - Detector ..... 75
  - Detector (remote control) ..... 159, 204
  - Export format ..... 83, 84
  - Exporting ..... 81, 82, 83, 106
  - Hold ..... 75
  - Mode ..... 74
  - Mode (remote) ..... 199
  - Remote control ..... 178
  - Retrieving results (remote) ..... 178
  - Settings (remote control) ..... 199
  - Settings, predefined ..... 76
- Trigger
  - Drop-out time ..... 45
  - External (remote) ..... 142
  - Holdoff ..... 45
  - Hysteresis ..... 44
  - Offset ..... 44
  - Offset, value range ..... 27
  - Remote control ..... 138
  - Settings ..... 42
  - Slope ..... 45, 142

Trigger level .....	44		
External trigger (remote) .....	140		
I/Q Power (remote) .....	141		
IF Power (remote) .....	140		
Trigger source .....	43		
AF .....	28		
AM (Offline) .....	43		
External .....	43		
FM (Offline) .....	43		
Free Run .....	43		
IF Power .....	43		
PM (Offline) .....	43		
RF (Offline) .....	43		
Settings .....	42		
Time .....	44		
Troubleshooting .....	112		
Demodulation bandwidth .....	112		
Input overload .....	124		
RF Spectrum .....	112		
SINAD .....	112		
THD .....	112		
<b>U</b>			
Units .....	64		
Reference level .....	38, 39		
Upper Level Hysteresis .....	72		
<b>V</b>			
Volume			
Remote control .....	126, 127		
<b>W</b>			
Weighting filter			
AF filters .....	58		
White papers .....	6		
Window title bar information .....	11		
Windows			
Adding (remote) .....	171		
Closing (remote) .....	177		
Configuring .....	33		
Layout (remote) .....	174		
Maximizing (remote) .....	170, 195		
Querying (remote) .....	173		
Replacing (remote) .....	174		
Splitting (remote) .....	170, 195		
Types (remote) .....	171		
<b>X</b>			
X-value			
Marker .....	86		
<b>Y</b>			
Y-axis			
Scaling .....	63		
YIG-preselector			
Activating/Deactivating .....	37		
Activating/Deactivating (remote) .....	124		
<b>Z</b>			
Zero Phase			
Reference Position .....	53		
Reference Position (remote) .....	144		
Zooming			
Time domain .....	29, 52		