

R&S[®]SMW-K81

Log File Generation

User Manual



1178896502
Version 08

ROHDE & SCHWARZ
Make ideas real



This document describes the following software options:

- R&S®SMW-K81 Log File Generation (1413.4539.0x)

This manual describes firmware version FW 5.20.043.xx and later of the R&S®SMW200A.

© 2023 Rohde & Schwarz GmbH & Co. KG
Muehldorfstr. 15, 81671 Muenchen, Germany
Phone: +49 89 41 29 - 0
Email: info@rohde-schwarz.com
Internet: www.rohde-schwarz.com

Subject to change – data without tolerance limits is not binding.

R&S® is a registered trademark of Rohde & Schwarz GmbH & Co. KG.

Trade names are trademarks of the owners.

1178.8965.02 | Version 08 | R&S®SMW-K81

The following abbreviations are used throughout this manual: R&S®SMW200A is abbreviated as R&S SMW, R&S®WinIQSIM2 is abbreviated as R&S WinIQSIM2; the license types 02/03 are abbreviated as 0x.

Contents

1	Welcome to the logfile generation option.....	5
1.1	What's new.....	5
1.2	Documentation overview.....	5
1.2.1	Getting started manual.....	6
1.2.2	User manuals and help.....	6
1.2.3	Tutorials.....	6
1.2.4	Service manual.....	6
1.2.5	Instrument security procedures.....	6
1.2.6	Printed safety instructions.....	7
1.2.7	Data sheets and brochures.....	7
1.2.8	Release notes and open source acknowledgment (OSA).....	7
1.2.9	Application notes, application cards, white papers, etc.....	7
1.2.10	Videos.....	7
1.3	Notes on screenshots.....	8
2	LTE/IoT logfile generation.....	9
2.1	Required options.....	9
2.2	Output files.....	9
2.2.1	Filenames.....	9
2.2.2	Extended logfiles contents.....	14
2.2.3	Summary logfiles contents.....	18
2.3	Signal processing chains and logging points.....	18
2.4	How to use the logfile generation functionality.....	23
2.5	Logfile generation settings.....	24
2.6	Remote-control commands.....	28
3	5G NR logfile generation.....	33
3.1	Required options.....	33
3.2	Output files.....	33
3.3	How to generate logfiles.....	34
3.4	Logfile generation settings.....	34

3.5	Logging commands.....	35
	List of commands.....	37
	Index.....	38

1 Welcome to the logfile generation option

Generating logfiles for design cross-verification

If equipped with the option R&S SMW-K81, your R&S SMW can create logfiles for exchanging intermediate results of different logging points in the signal processing chain.

Analyzing the content of the logfiles can help you to verify the signal processing chain in both the DL and UL direction. The intermediate results provide a basis for enhanced debugging. By loading the coded bitstream from the instrument into an Rx software module for offline analysis in a simulation environment, the FEC implementation in DUT is verified. You can also compare the coded stream to the bitstreams from a Tx software module. The logfiles generation functionality can also be remote controlled, so that the design flow can be optimized and the process automated.

This user manual contains a description of the functionality that the application provides, including remote control operation.

All functions not discussed in this manual are the same as in the base unit and are described in the R&S SMW user manual. The latest version is available at:

www.rohde-schwarz.com/manual/SMW200A

Installation

You can find detailed installation instructions in the delivery of the option or in the R&S SMW service manual.

1.1 What's new

This manual describes firmware version FW 5.20.043.xx and later of the R&S®SMW200A.

Compared to the previous version there are editorial changes only.

1.2 Documentation overview

This section provides an overview of the R&S SMW user documentation. Unless specified otherwise, you find the documents at:

www.rohde-schwarz.com/manual/smw200a

1.2.1 Getting started manual

Introduces the R&S SMW and describes how to set up and start working with the product. Includes basic operations, typical measurement examples, and general information, e.g. safety instructions, etc. A printed version is delivered with the instrument.

1.2.2 User manuals and help

Separate manuals for the base unit and the software options are provided for download:

- **Base unit manual**
Contains the description of all instrument modes and functions. It also provides an introduction to remote control, a complete description of the remote control commands with programming examples, and information on maintenance, instrument interfaces and error messages. Includes the contents of the getting started manual.
- **Software option manual**
Contains the description of the specific functions of an option. Basic information on operating the R&S SMW is not included.

The contents of the user manuals are available as help in the R&S SMW. The help offers quick, context-sensitive access to the complete information for the base unit and the software options.

All user manuals are also available for download or for immediate display on the Internet.

1.2.3 Tutorials

The R&S SMW provides interactive examples and demonstrations on operating the instrument in form of tutorials. A set of tutorials is available directly on the instrument.

1.2.4 Service manual

Describes the performance test for checking compliance with rated specifications, firmware update, troubleshooting, adjustments, installing options and maintenance.

The service manual is available for registered users on the global Rohde & Schwarz information system (GLORIS):

<https://gloris.rohde-schwarz.com>

1.2.5 Instrument security procedures

Deals with security issues when working with the R&S SMW in secure areas. It is available for download on the internet.

1.2.6 Printed safety instructions

Provides safety information in many languages. The printed document is delivered with the product.

1.2.7 Data sheets and brochures

The data sheet contains the technical specifications of the R&S SMW. It also lists the options and their order numbers and optional accessories.

The brochure provides an overview of the instrument and deals with the specific characteristics.

See www.rohde-schwarz.com/brochure-datasheet/smw200a

1.2.8 Release notes and open source acknowledgment (OSA)

The release notes list new features, improvements and known issues of the current firmware version, and describe the firmware installation.

The software makes use of several valuable open source software packages. An open-source acknowledgment document provides verbatim license texts of the used open source software.

See www.rohde-schwarz.com/firmware/smw200a

1.2.9 Application notes, application cards, white papers, etc.

These documents deal with special applications or background information on particular topics.

See www.rohde-schwarz.com/application/smw200a and www.rohde-schwarz.com/manual/smw200a

1.2.10 Videos

Find various videos on Rohde & Schwarz products and test and measurement topics on YouTube: <https://www.youtube.com/@RohdeundSchwarz>



On the menu bar, search for your product to find related videos.

HOME VIDEOS SHORTS PLAYLISTS COMMUNITY CHANNELS ABOUT

Figure 1-1: Product search on YouTube

1.3 Notes on screenshots

When describing the functions of the product, we use sample screenshots. These screenshots are meant to illustrate as many as possible of the provided functions and possible interdependencies between parameters. The shown values may not represent realistic usage scenarios.

The screenshots usually show a fully equipped product, that is: with all options installed. Thus, some functions shown in the screenshots may not be available in your particular product configuration.

2 LTE/LoT logfile generation

2.1 Required options

The generation of logfiles requires:

- Standard or wideband baseband generator (R&S SMW-B10/-B9)
- Option EUTRA/LTE (R&S SMW-K55)
- Option Cellular IoT (R&S SMW-K115)
- Option log files generation (R&S SMW-K81)

Two options R&S SMW-K81 are required in the following cases:

- For generating logfiles for more than one transmission antenna simultaneously.
- If coupled baseband sources are used.

2.2 Output files

The instrument stores the output logfiles in a user-defined network directory, selected with the parameter [Output Path](#). The logfiles are named according to the naming conventions described in [Chapter 2.2.1, "Filenames"](#), on page 9. Description of the available file formats is listed in ["File formats"](#) on page 9.

File formats

Generally, the logfiles are generated in two file formats:

- Bitstream
The logfile contains a sequence of "1" and "0"; one value per line
The logfile of the PHICH contains also the entry "-" that corresponds to DTX.
- IQ samples
The logfile contains pairs of I and Q samples; the I and Q components alternate at each line

File format "IQ samples" is used for the logfiles generated for the logging points after "Modulation Mapping". The other logfiles are output in a Bitstream format.

Exceptions are the extended DCI/UCI logfiles, and the summary logfile (see [Chapter 2.2.2.1, "Extended DCI logfile"](#), on page 14 and [Chapter 2.2.2.2, "Extended UCI logfile"](#), on page 17).

2.2.1 Filenames

The generated logging files are named according to the following naming structure:

```
[<Preamble>_]<Frame#>_<Subframe#>|<TRANSM#>_<Channel>[-<Format>]
[_<User/Allocation#>|<DCI#>|<Group#>]_<Point#>[_<CW#>|<LAY#>|
<ANT#>] [_<RV#>]_<PointName>[_<CodeBlock#>].dat
```

Exceptions are the extended DCI/UCI logfiles, and the summary logfile. The filenames of these logfiles are as follows:

- [<Preamble>_]ExtendedDciLog_<BB#>.txt
- [<Preamble>_]ExtendedUciLog_<BB#>.txt
- [<Preamble>_]SummaryLogfile_<BB#>.txt

Table 2-1: Filename structure

	Description	Value range
<Preamble>	Preamble with default syntax EUtraLog_<Entity#>	Entity#: 0 to 7
<Frame#>	Frame number	F000 to F873 NPBCH ^{*)} : F000, F064, F128, etc.
<Subframe#>	Subframe number Starting subframe number (NPBCH/ NPDSCH/NPDCCH)	SF0 to SF9
<TRANSM#>	eMTC/NB-LoT transmission	TRANSM01 to TRANSM20
<Channel>	Channel name	DL: PBCH PCFICH PHICH PDCCH PDSCH PMCH DL: NPBCH NPDSCH NPDCCH NPDSCH-SIB1 PDSCH-SIB1BR UL: PUSCH PUCCH PUSCHDRS PUCCHDRS SRS UL: NPUSCH
<User>	PDSCH, PUSCH, PUCCH, PUSCH DRS, PUCCH DRS NPUSCH, NPUSCH DRS	USER1 to USER4
<Allocation#>	PDSCH allocation only	ALL000 to ALL101
<DCI#>	PDCCH allocation only Each PDCCH DCI is logged individu- ally	DCI00 to DCI19
<Group#>	PHICH group An individual file is generated for each PHICH group	Group00 Group01
<Format>	PUCCH format	F1 F1A F1B F2 F2A F2B F3 F4 F5
<Point#>	Logging point number	See Table 2-2 .
<CW#>	PDSCH, PUSCH/NPUSCH allocations only Codeword	CW0 CW1 (PDSCH, PUSCH) CW0 (NPUSCH, PDSCH-SIB1BR)

	Description	Value range
<LAY#>	PDSCH, PUSCH, and PUSCH DRS allocations only PDSCH-SIB1BR, NPBCH, NPDSCH, NPUSCH and NPUSCH DRS allocations only Layer number	DL: LAY0 to LAY7 DL: LAY0 to LAY1 (NPBCH/NPDCCH/NPDSCH/NPDSCH-SIB1/PDSCH-SIB1BR) UL: LAY0 to LAY3 (PUSCH and PSUCH DRS) UL: LAY0 (NPUSCH and NPUSCH DRS)
<ANT#> <AP#>	Antenna port number	DL: ANT1 to ANT4 DL NB-IoT: ANT1 ANT2 UL: AP10 AP100 AP20 AP21 AP40 AP41 AP42 AP43 AP200 AP201
<RV#>	NPUSCH allocations only Redundancy version	RV00 to RV02
<PointName>	Logging point designation	See Table 2-2
<CodeBlock#>	PDSCH and PUSCH allocations only	CB00 to CB20
<BB#>	Baseband	BBA to BBH

*) NPBCH lasts 640 ms. One logfile contains 64 frames, starting from the frame number indicated as <Frame#>.

There is a fixed cross-reference between the logging point number and the logging point designation:

- See [Table 2-2](#).
- The PUCCH logging points depend on the PUCCH format, see [Table 2-3](#).
- See [Table 2-4](#).

Table 2-2: Logging points overview (DL and PUSCH/NPUSCH)

<Point#>	<PointName>	DL)	PUSCH	NPUSCH	Description
PT00	TB	X	X	X	Bits of the transport block
PT01	TBCRC	X	X	X	Bits after transport block CRC
PT02	CBCRC	X	X	-	Bits after code block CRC One file per code block is generated
PT03	Bits after channel coding (one file per code block)				
	CCSys	X	X	X	Systematic bits
	CCPar1	X	X	X	Parity 1 bits
	CCPar2	X	X	X	Parity 2 bits
	CCTotal	X	X	X	(N)PDSCH and PUSCH allocation only Complete bitstream after channel coding, incl. systematic, parity 1 and parity 2 bits
PT04	RM	X	X	X	Bits after rate matcher (one file per code block)

<Point#>	<PointName>	DL *)	PUSCH	NPUSCH	Description
PT05	CBCON	X	X	-	Bits after code block concatenation
PT06	DL: SCR	X	-	-	Bits after scrambling
	UL: MUX	-	X	-	Bits after data and control multiplexing
PT07	DL: MOD	X	-	-	IQ-Samples after modulation
	UL: CHI	-	X	X	Bits after channel interleaver
PT08	DL: MAP	X	-	-	IQ-Samples after layer mapping (one file per layer)
	UL: SCR	-	X	X	Bits after Scrambling
PT09	DL: PREC	X	-	-	IQ-Samples after precoding (one file per antenna)
	UL: MOD	-	X	X	IQ-Samples after modulation
PT10	UL: MAP	-	X	-	IQ-Samples after layer mapping (one file per layer)
PT11	UL: DFT	-	X	X	IQ-Samples after DFT
PT12	UL: PREC	-	X	-	IQ-Samples after precoding (one file per antenna)

*) PT02 and PT05 not available for NPBCH, NPDSCH and NPDCCH

Table 2-3: PUCCH logging points overview per PUCCH format

PUCCH format	<Point#>	<PointName>	Description
F1/F1a/F1b	PT00	SCR-BLOCK-WISE-SPREAD	Bits after scrambled block-wise spread operation
F2/F2a/F2b	PT00	UNCODED	Uncoded bits
	PT01	SCR	Scrambled bits
	PT02	CYCLIC-SHIFTED	Bits after cyclic-shift operation
F3	PT00	UNCODED	Uncoded bits
	PT01	CODED	Coded bits
	PT02	SCR	Scrambled bits
	PT03	MOD	IQ-Samples after modulation
	PT04	BLOCK-WISE-SPREAD	Bits after block-wise spread operation
	PT05	CYCLIC-SHIFTED	Bits after cyclic-shift operation
	PT06	DFT-PREC	IQ-Samples after DFT transform precoding
F4/F5	PT00	UNCODED	Uncoded bits
	PT01	CRC	Bits after block CRC

PUCCH format	<Point#>	<PointName>	Description
	PT02	CCSys CCPar1/CCPar2	Systematic bits Parity 1 bits/Parity 2 bits
	PT03	RM	Bits after rate matcher
	PT04	SCR	Scrambled bits
	PT05	MOD	IQ-Samples after modulation

Table 2-4: PUCCHDRS and PUSCHDRS logging points overview

DRS	<Point#>	<PointName>	Description
PUCCHDRS	PT00	CYCLIC-SHIF- TED	Bits after cyclic-shift operation
PUSCHDRS	PT00	CAZAC	IQ-Samples after CAZAC sequence generation
	PT01	OCC	IQ-Samples of OCC (orthogonal cover code) sequence
	PT02	PREC	IQ-Samples after precoding

Example: List of the output logfiles for PDSCH

The following output files are generated for one PDSCH channel, configured on an allocation with index ALL002 in the third subframe (SF2) of the first frame (F000). The instrument is configured to generate a MIMO signal with two antennas (PREC_ANT1 and PREC_ANT2). Channel coding and scrambling are enabled (CCPar1, CCPar2, CCSys, CCTotal and SCR). Two codewords (CW0 and CW1) and two layers (LAY0 and LAY1) are used; three code blocks per code (CB00, CB01, CB02) are generated.

All logging points are enabled and a preamble (EUtraLog_0) is selected.

<User/

Allocation#>_<Point#>[_<CW#>|<LAY#>|<ANT#>]_<PointName>[_<CodeBlock#>].dat

```
EUtraLog_0_F000_SF2_PDSCH_ALL002_PT00_CW0_TB.dat
EUtraLog_0_F000_SF2_PDSCH_ALL002_PT00_CW1_TB.dat
EUtraLog_0_F000_SF2_PDSCH_ALL002_PT01_CW0_TBCRC.dat
EUtraLog_0_F000_SF2_PDSCH_ALL002_PT01_CW1_TBCRC.dat
EUtraLog_0_F000_SF2_PDSCH_ALL002_PT02_CW0_CBCRC_CB00.dat
EUtraLog_0_F000_SF2_PDSCH_ALL002_PT02_CW1_CBCRC_CB00.dat
EUtraLog_0_F000_SF2_PDSCH_ALL002_PT02_CW0_CBCRC_CB01.dat
EUtraLog_0_F000_SF2_PDSCH_ALL002_PT02_CW1_CBCRC_CB01.dat
EUtraLog_0_F000_SF2_PDSCH_ALL002_PT02_CW0_CBCRC_CB02.dat
EUtraLog_0_F000_SF2_PDSCH_ALL002_PT02_CW1_CBCRC_CB02.dat
EUtraLog_0_F000_SF2_PDSCH_ALL002_PT03_CW0_CCPar1_CB00.dat
EUtraLog_0_F000_SF2_PDSCH_ALL002_PT03_CW1_CCPar1_CB00.dat
EUtraLog_0_F000_SF2_PDSCH_ALL002_PT03_CW0_CCPar1_CB01.dat
EUtraLog_0_F000_SF2_PDSCH_ALL002_PT03_CW1_CCPar1_CB01.dat
EUtraLog_0_F000_SF2_PDSCH_ALL002_PT03_CW0_CCPar1_CB02.dat
EUtraLog_0_F000_SF2_PDSCH_ALL002_PT03_CW1_CCPar1_CB02.dat
EUtraLog_0_F000_SF2_PDSCH_ALL002_PT03_CW0_CCPar2_CB00.dat
EUtraLog_0_F000_SF2_PDSCH_ALL002_PT03_CW1_CCPar2_CB00.dat
```

```

EUltraLog_0_F000_SF2_PDSCH_ALL002_PT03_CW0_CCPAr2_CB01.dat
EUltraLog_0_F000_SF2_PDSCH_ALL002_PT03_CW1_CCPAr2_CB01.dat
EUltraLog_0_F000_SF2_PDSCH_ALL002_PT03_CW0_CCPAr2_CB02.dat
EUltraLog_0_F000_SF2_PDSCH_ALL002_PT03_CW1_CCPAr2_CB02.dat
EUltraLog_0_F000_SF2_PDSCH_ALL002_PT03_CW0_CCSys_CB00.dat
EUltraLog_0_F000_SF2_PDSCH_ALL002_PT03_CW1_CCSys_CB00.dat
EUltraLog_0_F000_SF2_PDSCH_ALL002_PT03_CW0_CCSys_CB01.dat
EUltraLog_0_F000_SF2_PDSCH_ALL002_PT03_CW1_CCSys_CB01.dat
EUltraLog_0_F000_SF2_PDSCH_ALL002_PT03_CW0_CCSys_CB02.dat
EUltraLog_0_F000_SF2_PDSCH_ALL002_PT03_CW1_CCSys_CB02.dat
EUltraLog_0_F000_SF2_PDSCH_ALL002_PT03_CW0_CCTotal_CB00.dat
EUltraLog_0_F000_SF2_PDSCH_ALL002_PT03_CW1_CCTotal_CB00.dat
EUltraLog_0_F000_SF2_PDSCH_ALL002_PT03_CW0_CCTotal_CB01.dat
EUltraLog_0_F000_SF2_PDSCH_ALL002_PT03_CW1_CCTotal_CB01.dat
EUltraLog_0_F000_SF2_PDSCH_ALL002_PT03_CW0_CCTotal_CB02.dat
EUltraLog_0_F000_SF2_PDSCH_ALL002_PT03_CW1_CCTotal_CB02.dat
EUltraLog_0_F000_SF2_PDSCH_ALL002_PT04_CW0_RM_CB00.dat
EUltraLog_0_F000_SF2_PDSCH_ALL002_PT04_CW1_RM_CB00.dat
EUltraLog_0_F000_SF2_PDSCH_ALL002_PT04_CW0_RM_CB01.dat
EUltraLog_0_F000_SF2_PDSCH_ALL002_PT04_CW1_RM_CB01.dat
EUltraLog_0_F000_SF2_PDSCH_ALL002_PT04_CW0_RM_CB02.dat
EUltraLog_0_F000_SF2_PDSCH_ALL002_PT04_CW1_RM_CB02.dat
EUltraLog_0_F000_SF2_PDSCH_ALL002_PT05_CW0_CBCON.dat
EUltraLog_0_F000_SF2_PDSCH_ALL002_PT05_CW1_CBCON.dat
EUltraLog_0_F000_SF2_PDSCH_ALL002_PT06_CW0_SCR.dat
EUltraLog_0_F000_SF2_PDSCH_ALL002_PT06_CW1_SCR.dat
EUltraLog_0_F000_SF2_PDSCH_ALL002_PT07_CW0_MOD.dat
EUltraLog_0_F000_SF2_PDSCH_ALL002_PT07_CW1_MOD.dat
EUltraLog_0_F000_SF2_PDSCH_ALL002_PT08_LAY0_MAP.dat
EUltraLog_0_F000_SF2_PDSCH_ALL002_PT08_LAY1_MAP.dat
EUltraLog_0_F000_SF2_PDSCH_ALL002_PT09_ANT1_PREC.dat
EUltraLog_0_F000_SF2_PDSCH_ALL002_PT09_ANT2_PREC.dat

```

2.2.2 Extended logfiles contents

The instrument generates only one logfile with extended information regarding the DCI/UCI mapping.

DCI mapping to the NB-IoT channels is not logged.

2.2.2.1 Extended DCI logfile

An extended DCI logfile summarizes the information for the whole generated signal. It can contain information for more than one frame. The information is grouped in rows with different syntax.

- PCFICH mapping, i.e. the resource elements the PCFICH REGs are mapped to

```
<Frame#>_<Subframe#>_
```

```
PCFICH: REG-Idx=<REG#>: Subcarrier=<Subcarrier#>,
Symbol=<OFDMSymbol#>
```

- PHICH mapping, i.e the resource elements the PHICH REGs of the individual PHICH groups are mapped to

```
<Frame#>_<Subframe#>_
```

```
PHICH: Group=<Group#>: REG-Idx=<REG#>: Subcarrier=<Subcarrier#>,
Symbol=<OFDMSymbol#>
```

- PDCCH number of useful REGs

```
<Frame#>_<Subframe#>_PDCCH: Columns:<Columns#>, Rows:<Rows#>,
Useful REGs:<REG#>
```

The number of useful REGs corresponds to the value displayed with the parameter "LTE > PDCCH > Number of PDCCH REGs".

- The start CCE-Index of the individual DCIs

```
<Frame#>_<Subframe#>_DCI: DCI Idx=<DCI#>, Start CCE-Idx=<CCE#>
```

The DCI Idx corresponds to the row in the DCI table and the start CCE-Idx is the "CCE Index" for the corresponding DCI.

- PDCCH mapping, i.e the resource elements the PDCCH REGs of the individual PDCCHs are mapped to.

```
<Frame#>_<Subframe#>_
```

```
PDCCH: Idx=<Symbol#>: REG-Idx=<REG#>: Subcarrier=<Subcarrier#>,
Symbol=<OFDMSymbol#> [--- DTX REG]
```

The additional information DTX REG is assigned to all dummy PDCCH REGs.



Subcarrier with index 0 is the most left subcarrier, i.e. the one belonging to the resource block 0.

Example: Content of an extended DCI logfile

The instrument is configured to generate a DL LTE signal with the following configuration:

- 1.4 MHz bandwidth (6 RBs)
- Normal cyclic prefix
- Extended PHICH duration
- Control region for PDCCH of 3 OFDM symbols
- Two antennas, path A generates the signal of antenna 1 and path B, the signal of antenna 2
- PDCCH format variable
- PDCCH is configured as given on the figure bellow.

	User	UE_ID n_RNTI	Cell Index	DCI Format	Search Space	Content	PDCCH Format	Number CCEs	CCE Index	No.Dummy CCEs	Conflict
0	User1	0	0	0	Off	Config...	1	2	0	0	
1	SI-RNTI	65535	0	1A	Off	Config...	0	1	2	1	

Generation of extended DCI logfile is enabled and the file contains the following information (only the beginning of the file is listed):

```

F00,SF0,PCFICH: REG-Idx=0: Subcarrier=1, Symbol=0
F00,SF0,PCFICH: REG-Idx=0: Subcarrier=2, Symbol=0
F00,SF0,PCFICH: REG-Idx=0: Subcarrier=4, Symbol=0
F00,SF0,PCFICH: REG-Idx=0: Subcarrier=5, Symbol=0
F00,SF0,PCFICH: REG-Idx=1: Subcarrier=19, Symbol=0
F00,SF0,PCFICH: REG-Idx=1: Subcarrier=20, Symbol=0
F00,SF0,PCFICH: REG-Idx=1: Subcarrier=22, Symbol=0
F00,SF0,PCFICH: REG-Idx=1: Subcarrier=23, Symbol=0
F00,SF0,PCFICH: REG-Idx=2: Subcarrier=37, Symbol=0
F00,SF0,PCFICH: REG-Idx=2: Subcarrier=38, Symbol=0
F00,SF0,PCFICH: REG-Idx=2: Subcarrier=40, Symbol=0
F00,SF0,PCFICH: REG-Idx=2: Subcarrier=41, Symbol=0
F00,SF0,PCFICH: REG-Idx=3: Subcarrier=55, Symbol=0
F00,SF0,PCFICH: REG-Idx=3: Subcarrier=56, Symbol=0
F00,SF0,PCFICH: REG-Idx=3: Subcarrier=58, Symbol=0
F00,SF0,PCFICH: REG-Idx=3: Subcarrier=59, Symbol=0

F00,SF0,PHICH: Group=0: REG-Idx=0: Subcarrier=7, Symbol=0
F00,SF0,PHICH: Group=0: REG-Idx=0: Subcarrier=8, Symbol=0
F00,SF0,PHICH: Group=0: REG-Idx=0: Subcarrier=10, Symbol=0
F00,SF0,PHICH: Group=0: REG-Idx=0: Subcarrier=11, Symbol=0
F00,SF0,PHICH: Group=0: REG-Idx=1: Subcarrier=24, Symbol=1
F00,SF0,PHICH: Group=0: REG-Idx=1: Subcarrier=25, Symbol=1
F00,SF0,PHICH: Group=0: REG-Idx=1: Subcarrier=26, Symbol=1
F00,SF0,PHICH: Group=0: REG-Idx=1: Subcarrier=27, Symbol=1
F00,SF0,PHICH: Group=0: REG-Idx=2: Subcarrier=48, Symbol=2
F00,SF0,PHICH: Group=0: REG-Idx=2: Subcarrier=49, Symbol=2
F00,SF0,PHICH: Group=0: REG-Idx=2: Subcarrier=50, Symbol=2
F00,SF0,PHICH: Group=0: REG-Idx=2: Subcarrier=51, Symbol=2

F00,SF0,PDCCH: Columns:32, Rows:2, Useful REGs:41
F00,SF0,DCI: DCI Idx=0: Start CCE-Idx=0
F00,SF0,DCI: DCI Idx=1: Start CCE-Idx=2
F00,SF0,PDCCH: Idx=0: REG-Idx=10: Subcarrier=0, Symbol=1
F00,SF0,PDCCH: Idx=0: REG-Idx=10: Subcarrier=1, Symbol=1
F00,SF0,PDCCH: Idx=0: REG-Idx=10: Subcarrier=2, Symbol=1
F00,SF0,PDCCH: Idx=0: REG-Idx=10: Subcarrier=3, Symbol=1
F00,SF0,PDCCH: Idx=1: REG-Idx=26: Subcarrier=0, Symbol=2
F00,SF0,PDCCH: Idx=1: REG-Idx=26: Subcarrier=1, Symbol=2
F00,SF0,PDCCH: Idx=1: REG-Idx=26: Subcarrier=2, Symbol=2
F00,SF0,PDCCH: Idx=1: REG-Idx=26: Subcarrier=3, Symbol=2
.....

```

The [Figure 2-1](#) shows the resource allocation for this example.

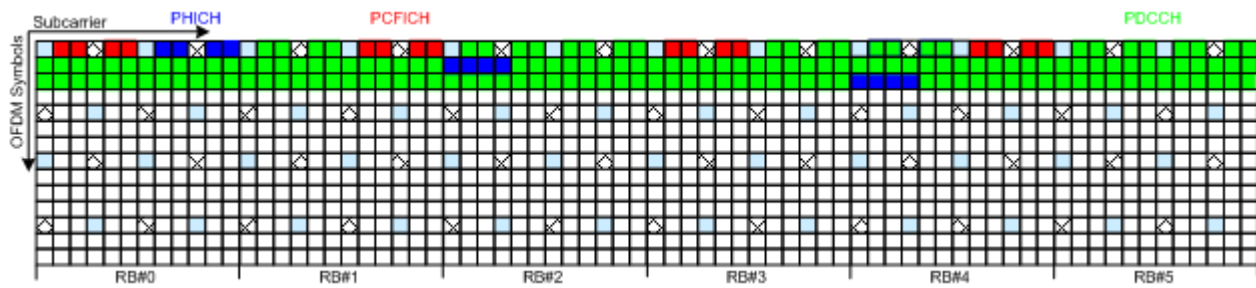

Figure 2-1: Example of DL control information mapping

2.2.2.2 Extended UCI logfile

The extended UCI logfile summarizes the information for the whole generated signal and can contain information for more than one frame. The information is grouped in rows with the following syntax:

```
PUSCH_<Frame#>_<Subframe#>: <CW#>:
```

```
No.HARQ Bits=<HARQ#>,No.RI Bits=<RI#>,No.CQI Bits=<CQI#>,
```

```
No.coded A/
```

```
N Bits=<CodedHARQ#>,No.coded RI Bits=<CodedRI#>,
```

```
No.coded CQI Bits=<CodedCQI#>,No.coded UL-SCH Bits=<UL-SCH#>
```

In case of NB-LoT, extended UCI logfile contains the number of bits per transmission, where transmissions are indicated with their starting frame and subframe indexes. The logfile has the following format:

```
NPUSCH_<Frame#>_<Subframe#>: <CW#>:
```

```
No.HARQ Bits=<HARQ#>,No.coded UL-SCH Bits=<UL-SCH#>
```

Example:

The PUSCH of a release 8/9 UE carries multiplexed control information and data (UCI+UL-SCH) and the channel is configured as follows:

EUTRA/LTE A: Enhanced Sett. (PCell, SF 0, UE 1)					
Common	DRS	HARQ ACK	Rank Indication (RI)	Channel Quality Indication (CQI)	UL-SCH
ACK/NACK Mode					
Multiplexing					
Number of A/N Bits				3	ACK/NACK Pattern
Number of Coded A/N Bits				28	0...

- | EUTRA/LTE A: Enhanced Sett. (PCell, SF 0, UE 1) | | | | | | |
|---|-----|----------|----------------------|----------------------------------|--------|--|
| Common | DRS | HARQ ACK | Rank Indication (RI) | Channel Quality Indication (CQI) | UL-SCH | |
| Number of RI Bits | | | 2 | RI Pattern | | |
| Number of Coded RI Bits | | | 12 | 0... | | |
- | EUTRA/LTE A: Enhanced Sett. (PCell, SF 0, UE 1) | | | | | | |
|---|-----|----------|----------------------|----------------------------------|--------|--|
| Common | DRS | HARQ ACK | Rank Indication (RI) | Channel Quality Indication (CQI) | UL-SCH | |
| Number of CQI Bits | | | 1 | CQI Pattern | | |
| Number of Coded CQI Bits | | | 6 | 0... | | |
- | EUTRA/LTE A: Enhanced Sett. (PCell, SF 0, UE 1) | | | | | | |
|---|-----|----------|----------------------|----------------------------------|-----------------------------|---|
| Common | DRS | HARQ ACK | Rank Indication (RI) | Channel Quality Indication (CQI) | UL-SCH | |
| UL-SCH Codeword 1 | | | | | | |
| Total Number Of Physical Bits | | | | 2 880 | Number Of Coded UL-SCH Bits | |
| Transport Block Size/Payload | | | | 600 | Redundancy Version Index | |
| | | | | | 2 862 | 0 |

The first line of the logfile is:

```
F00, SF0,
PUSCH UCI+UL-SCH Number of Bits: No.HARQ Bits=3, No.RI Bits=2,
No.CQI Bits=1, No.coded HARQ Bits=28, No.coded RI Bits=12,
No.coded CQI Bits=6, No.coded UL-SCH Bits=2862
```

2.2.3 Summary logfiles contents

The summary logfiles contain general information on the individual signal processing blocks, like the used rate matching parameters or allocation mapping.

In case of NB-IoT, the summary logfile contains also the base sequence index u and, if group hopping is used, the group hopping pattern f_{gh} and the sequence shift f_{ss} . The base sequence shift u is logged per slot; the f_{gh} and f_{ss} are logged on recalculation.

2.3 Signal processing chains and logging points

Logfile generation can be enabled after at the so called logging point. Logging points (PTxx) are available after each completed processing stage up to the "Precoding". Not logged are the results of the "Resource Element Mapping/OFDM Mapper".



For detailed information about the signal processing of all channels, refer to TS 36.212 and TS 36.211.

Signal processing in downlink

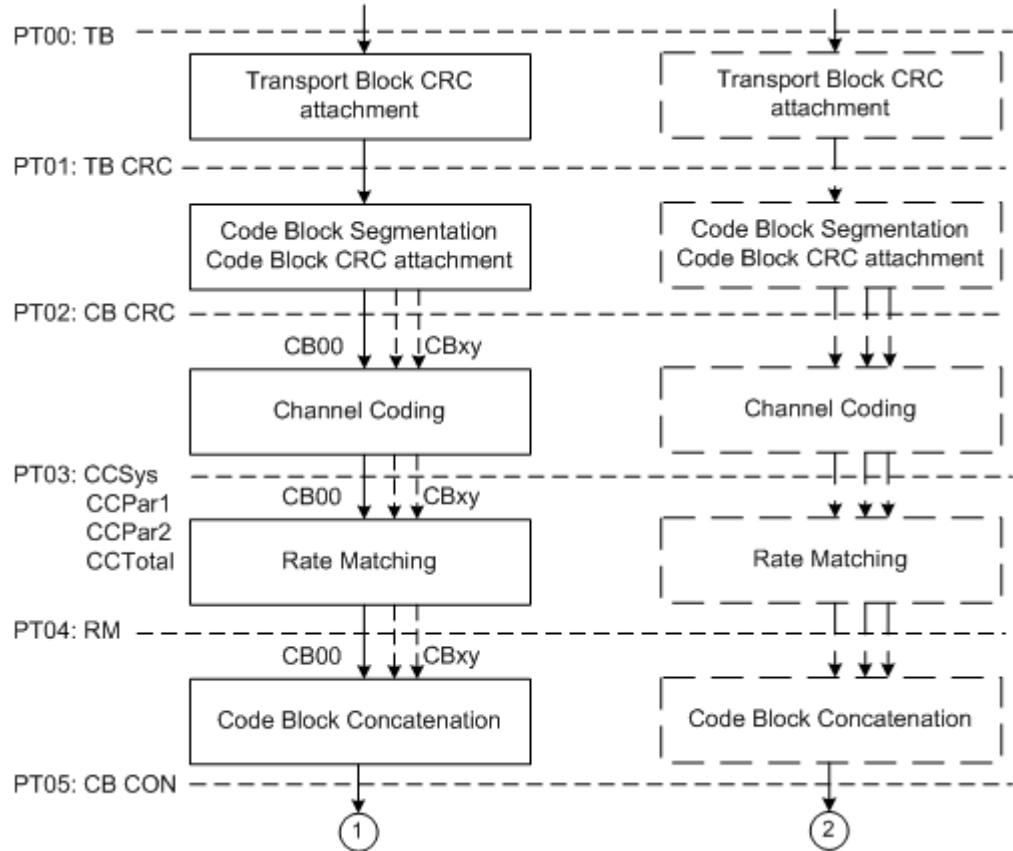

Figure 2-2: Transport channel processing for DL-SCH

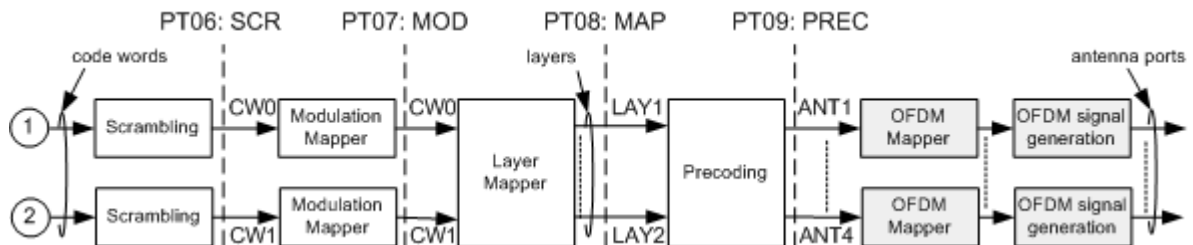

Figure 2-3: Overview of physical channel processing

The [Table 2-5](#) gives an overview of the logging point available for the DL channels.

Table 2-5: Available logging points per DL channel

Point/ Channel	PT00 TB	PT01 TBCRC	PT02 CBCRC	PT03 CC	PT04 RM	PT05 CBCON	PT06 SCR	PT07 MOD	PT08 MAP	PT09 PREC
PDSCH	X	X	X	X	X	X	X	X	X	X
NPDSCH NPDSCH- SIB1	X	X		X	X		X	X	X	X

Point/ Channel	PT00 TB	PT01 TBCRC	PT02 CBCRC	PT03 CC	PT04 RM	PT05 CBCON	PT06 SCR	PT07 MOD	PT08 MAP	PT09 PREC
PDSCH- SIB1	X	X	X	X	X	X	X	X	X	X
PBCH ¹⁾	X	X		X	X		X	X	X	X
NPBCH	X	X		X	X		X	X	X	X
PCFICH ¹⁾	X						X	X	X	X
PHICH ¹⁾	X							X ²⁾	X ²⁾	X ²⁾
PDCCH ¹⁾	X ³⁾	X ³⁾		X ³⁾	X ³⁾	X	X	X	X	X
PMCH ¹⁾	X	X		X	X		X	X	X	X
NPDCCH	X	X		X	X		X	X	X	X

¹⁾ The channel has one codeword and one code block.

²⁾ An individual file is generated per PHICH group.

³⁾ An individual file is generated per DCI

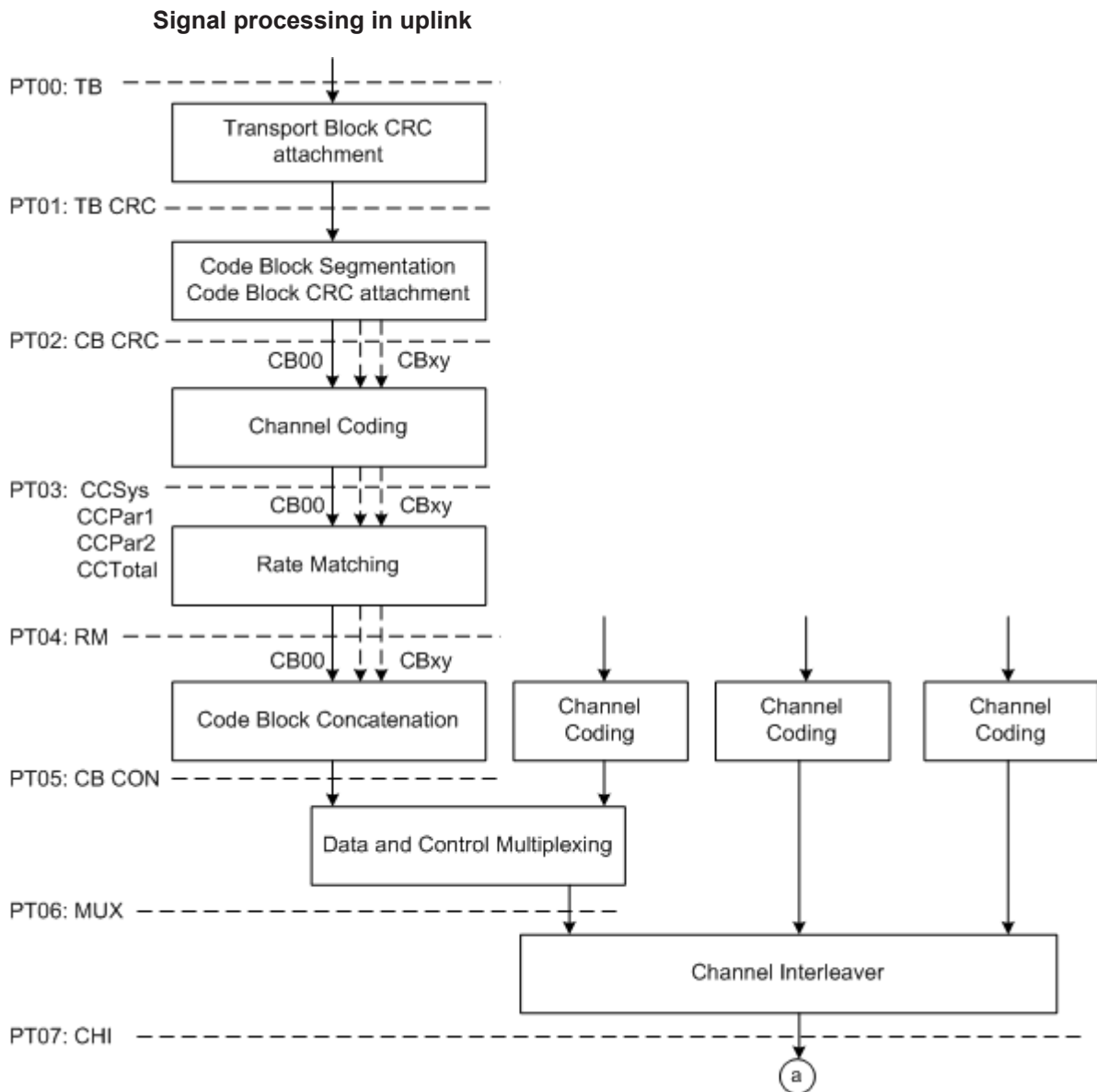

Figure 2-4: Transport channel processing for UL-SCH [TS 36.212]

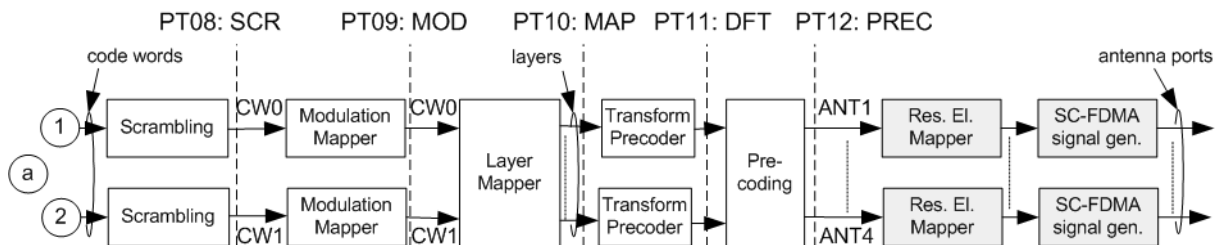

Figure 2-5: Overview of uplink physical shared channel processing [TS 36.211]

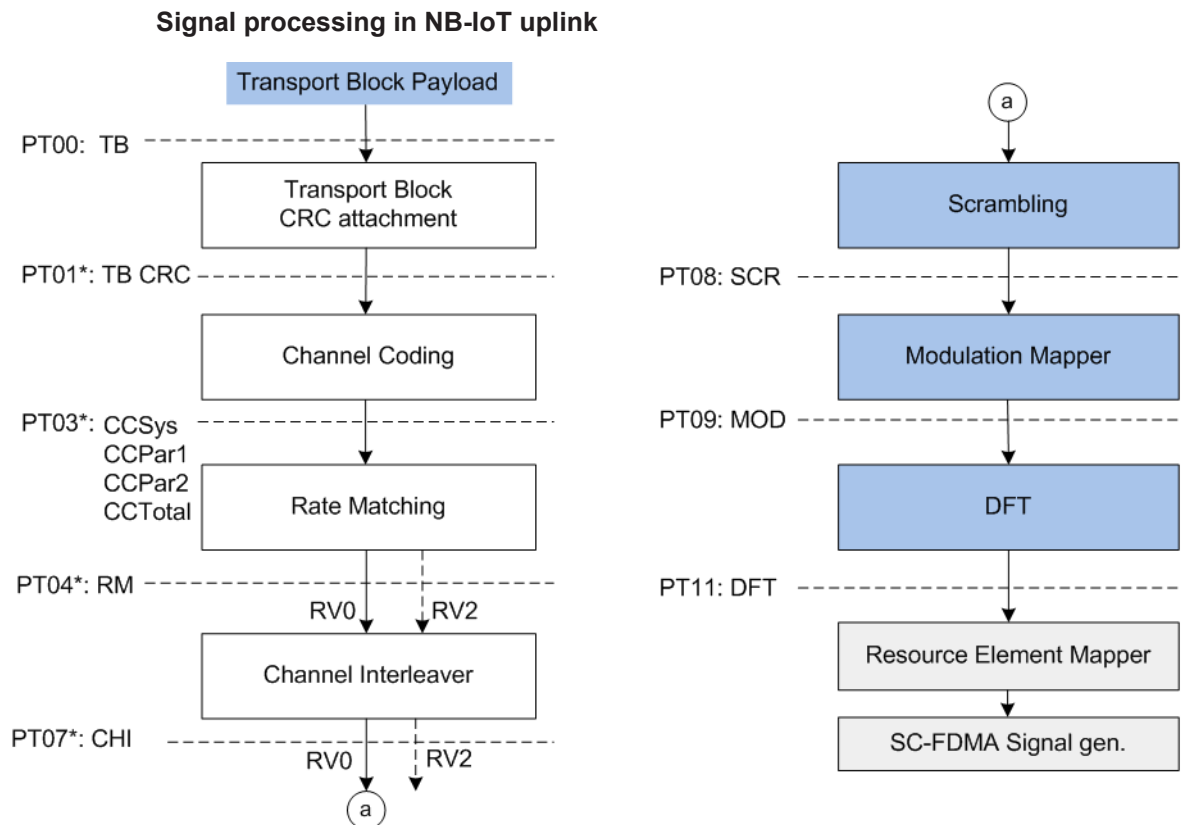

Figure 2-6: Narrowband uplink physical shared channel NPUSCH processing [TS 36.212]

* = Logging points that are available only for NPUSCH Format 1
 RV = Redundancy version
 Transport block payload = For PUSCH format 2, it the payload is 16 zero or 16 one bits

For an overview of logging points available for the UL channels, see:

- [Table 2-6](#)
- [Table 2-3](#)
- [Table 2-4](#)
- There are no specific logging points for the SRS; a logfile with SRS information is always created.

Table 2-6: Available logging points per PUSCH channel

Point/ Channel	PT00 TB	PT01 TBCRC	PT02 CBCRC	PT03 CC	PT04 RM	PT05 CBCON	PT06 MUX	PT07 CHI	PT08 SCR	PT09 MOD	PT10 MAP	PT11 DFT	PT12 PRE C
PUSCH	X	X	X	X	X	X	X	X	X	X	X	X	X
NPUSCH	X	X	-	X	X	-	-	X	X	X	-	X	-

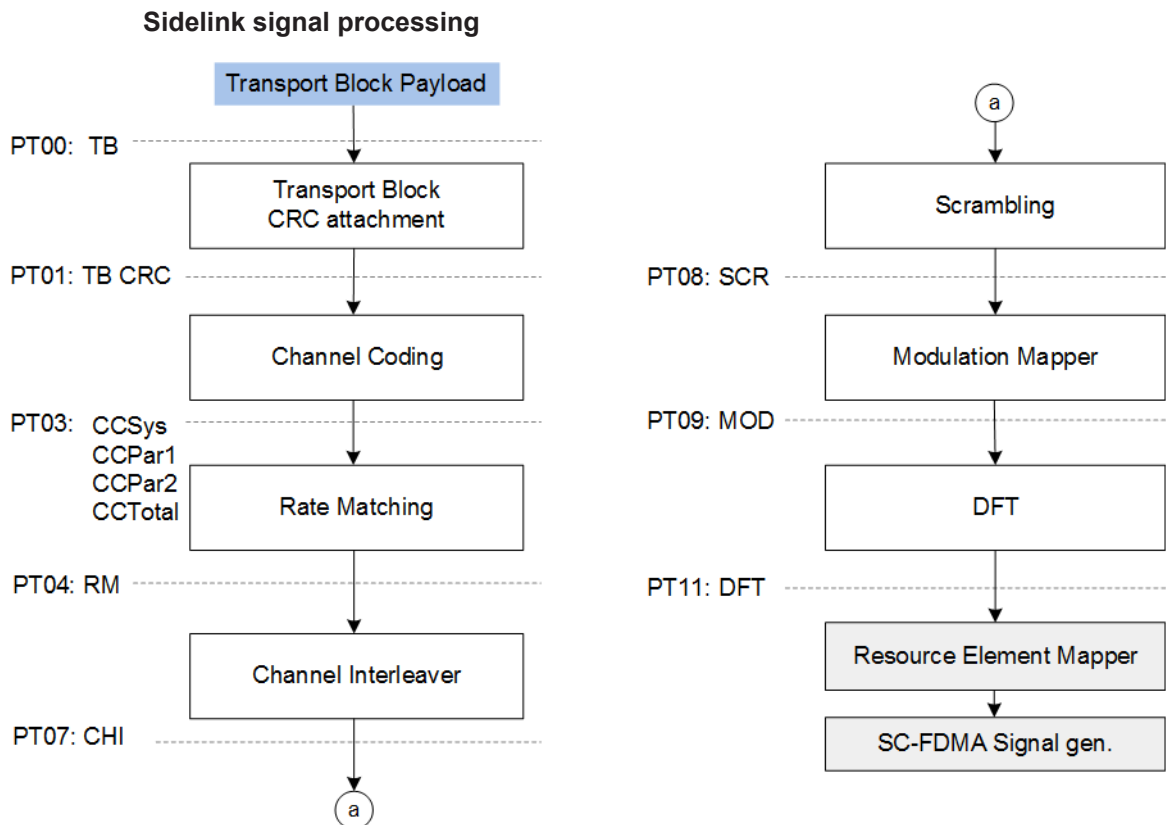

Figure 2-7: Sidelink processing [TS 36.212]

2.4 How to use the logfile generation functionality

The R&S SMW generates logfiles only if the logging state is enabled. Adjusting the settings in the "Logfile Generation" dialog does not affect the content of the generated LTE/loT signal and does not cause a recalculation of the signal. The generation of new logfiles is triggered by changing of a signal relevant LTE/loT parameter or by enabling/disabling the generation of LTE/loT signal.



Activation of logfile generation slows down the calculation speed of the instrument. Enable this function only if logfiles are explicitly requested.

General workflow

To enable the generation of logfiles, proceed as follows:

1. In the "EUTRA/LTE > Logfile Generation > Output Path" dialog, select the network directory the logfiles are saved to, e.g. `/var/user/logfiles`.

Note: Select an empty directory. Existing logfiles are overwritten. Use different preambles to assure that previous logfiles are not lost.

2. If necessary, enable "Extended DCI/UCI Logging".
3. Select the processing chain points for that logfiles are generated, e.g. "Point 3: Channel Coding".

Tip: Not all the available logging points are relevant for all channels. The processing of the PBCH for instance does not include the step "Code block segmentation / CRC", i.e. even if the logging point "Point 2: Code block segmentation / CRC" is enabled, no logfile is generated.

No logfiles are generated also in case that the corresponding processing step is disabled in the EUTRA/LTE dialog. For example, if for a particular channel coding or scrambling are disabled, no logfiles for points 3, 6 and 8 are available for this channel. Logfiles are created after coding and scrambling are enabled for this particular channel.

4. To enable logfile generation, select "Logging State > On".
5. Adjust the EUTRA/LTE settings as required.
6. Set "EUTRA/LTE > State > On".

2.5 Logfile generation settings

Access:

- ▶ Select "EUTRA/LTE > General > Logfile Generation".

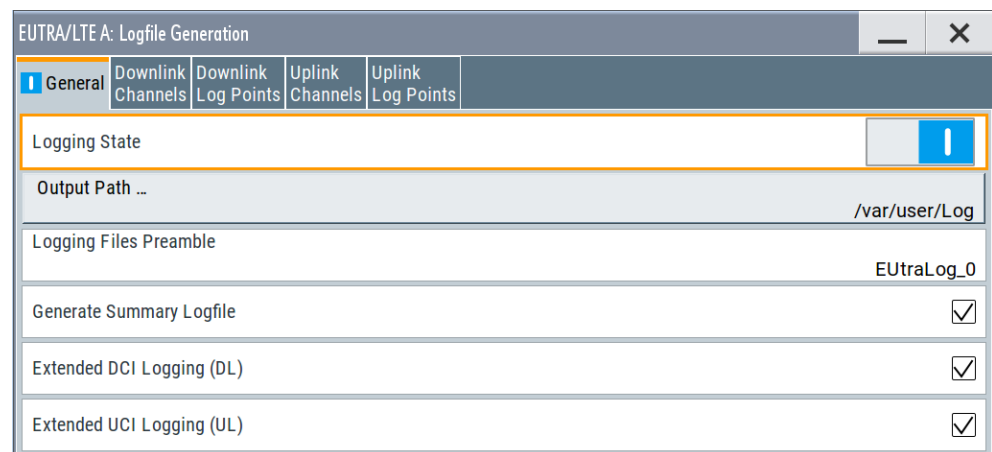

The dialog is divided into several tabs. The general tab comprises the settings necessary to enable the logfile generation and configure the output file. The further tabs group the settings to define the different channels to be logged and the logging points for which logfiles are generated.

- Downlink Channels

EUTRA/LTE A: Logfile Generation				
General	Downlink Channels	Downlink Log Points	Uplink Channels	Uplink Log Points
	PDSCH			<input checked="" type="checkbox"/>
	PBCH			<input checked="" type="checkbox"/>
	PMCH			<input checked="" type="checkbox"/>
	PCFICH/PHICH/PDCCH			<input checked="" type="checkbox"/>
	Narrowband Wakeup Signal			<input checked="" type="checkbox"/>

- Uplink Channels

EUTRA/LTE A: Logfile Generation				
General	Downlink Channels	Downlink Log Points	Uplink Channels	Uplink Log Points
			PUSCH	<input checked="" type="checkbox"/>
			PUCCH	<input checked="" type="checkbox"/>
			PUSCHDRS	<input checked="" type="checkbox"/>
			PUCCHDRS	<input checked="" type="checkbox"/>
			SRS	<input checked="" type="checkbox"/>
			Sidelink	<input checked="" type="checkbox"/>
			Sidelink DRS	<input checked="" type="checkbox"/>

- Downlink Log Pints

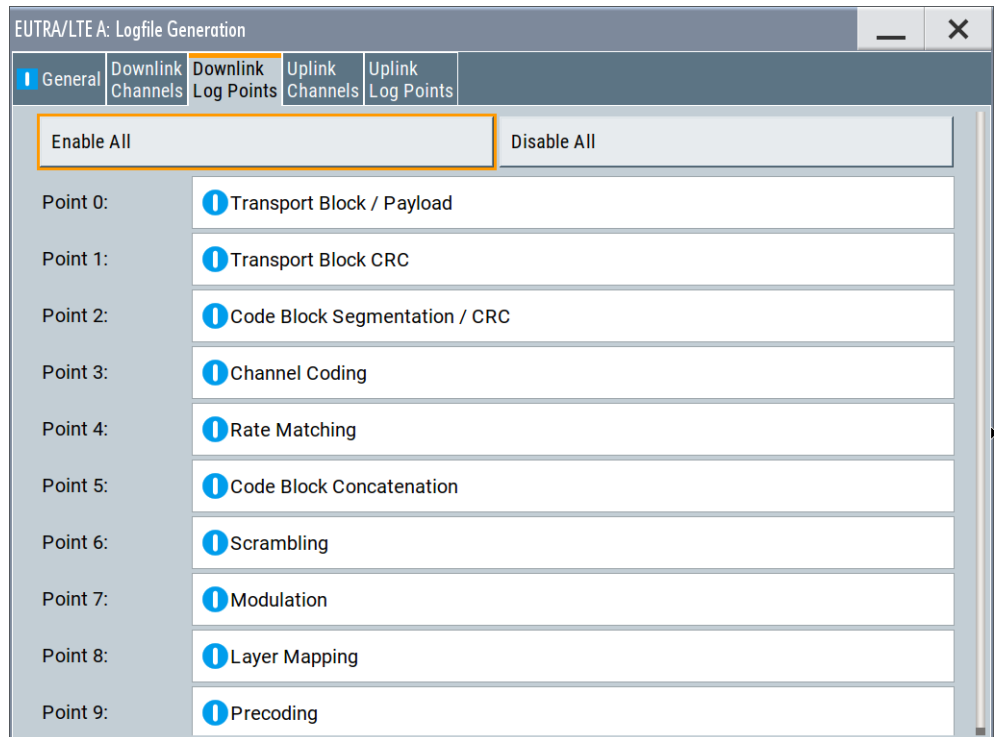

- Uplink Log Points

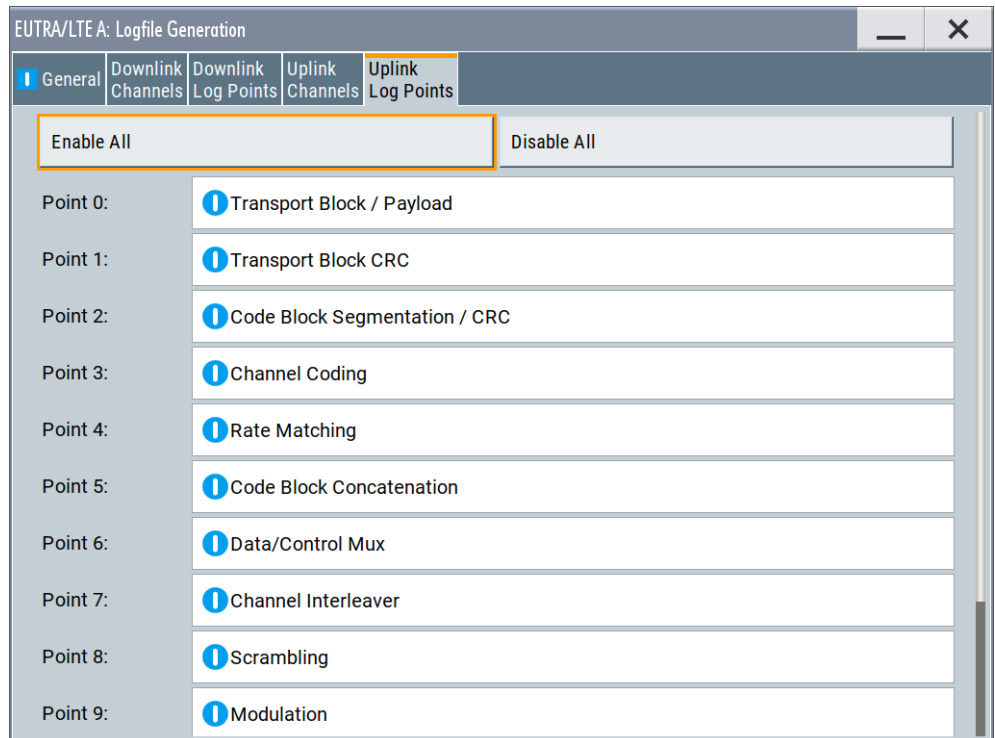

The remote commands required to define these settings are described in [Chapter 2.6, "Remote-control commands"](#), on page 28.

Logging State.....	27
Output Path.....	27
Logging Files Preamble.....	27
Generate Summary Log.....	27
Extended DCI/UCI Logging.....	27
Physical Channels.....	28
Enable/Disable All.....	28
Logging Point.....	28

Logging State

Enables/disables logfile generation.

Note: Activation of logfile generation slows down the calculation speed of the instrument.

Enable this function only if logfiles are explicitly requested.

See also [Chapter 2.4, "How to use the logfile generation functionality"](#), on page 23.

Remote command:

`[:SOURCE<hw>] :BB:EUTRa:LOGGen:STATe` on page 30

Output Path

Selects the network directory the logged files are stored in.

Remote command:

`[:SOURCE<hw>] :BB:EUTRa:LOGGen:OUTPut` on page 30

Logging Files Preamble

Adds a preamble to the filename.

Refer to [Chapter 2.2.1, "Filenames"](#), on page 9 for a description of the file naming convention used.

Remote command:

`[:SOURCE<hw>] :BB:EUTRa:LOGGen:LFP` on page 31

Generate Summary Log

Enables the generation of a summary logfile.

The summary logfiles contain general information on the individual signal processing blocks, like the used rate matching parameters or allocation mapping.

In case of NB-IoT, the summary logfile contains also the base sequence index u and, if group hopping is used, the group hopping pattern f_{gh} and the sequence shift f_{ss} . The base sequence shift u is logged per slot; the f_{gh} and f_{ss} are logged on recalculation.

Remote command:

`[:SOURCE<hw>] :BB:EUTRa:LOGGen:GSLogfile` on page 31

Extended DCI/UCI Logging

Enables the generation of a logfile with extended information regarding the DCI/UCI mapping.

For description of the content of the generated file, see:

- [Chapter 2.2.2.1, "Extended DCI logfile"](#), on page 14

- [Chapter 2.2.2.2, "Extended UCI logfile"](#), on page 17.

Remote command:

[\[:SOURCE<hw>\]:BB:EUTRa:LOGGen:DL:EDLogging](#) on page 31

[\[:SOURCE<hw>\]:BB:EUTRa:LOGGen:UL:EULogging](#) on page 31

Physical Channels

Selects the channel for which logfiles are generated.

Remote command:

[\[:SOURCE<hw>\]:BB:EUTRa:LOGGen:DL:ENCC](#) on page 32

[\[:SOURCE<hw>\]:BB:EUTRa:LOGGen:DL:PBCH](#) on page 32

[\[:SOURCE<hw>\]:BB:EUTRa:LOGGen:DL:PDSCh](#) on page 32

[\[:SOURCE<hw>\]:BB:EUTRa:LOGGen:DL:PMCH](#) on page 32

[\[:SOURCE<hw>\]:BB:EUTRa:LOGGen:UL:PUSCh](#) on page 32

[\[:SOURCE<hw>\]:BB:EUTRa:LOGGen:UL:PUS Drs](#) on page 32

[\[:SOURCE<hw>\]:BB:EUTRa:LOGGen:UL:PUCCh](#) on page 32

[\[:SOURCE<hw>\]:BB:EUTRa:LOGGen:UL:PUC Drs](#) on page 32

[\[:SOURCE<hw>\]:BB:EUTRa:LOGGen:UL:SRS](#) on page 32

[\[:SOURCE<hw>\]:BB:EUTRa:LOGGen:UL:SL](#) on page 32

[\[:SOURCE<hw>\]:BB:EUTRa:LOGGen:UL:SLD](#) on page 32

Enable/Disable All

Enables/disables all logging points.

Remote command:

[\[:SOURCE<hw>\]:BB:EUTRa:LOGGen:DL:EALL](#) on page 31

[\[:SOURCE<hw>\]:BB:EUTRa:LOGGen:DL:DALL](#) on page 31

[\[:SOURCE<hw>\]:BB:EUTRa:LOGGen:UL:EALL](#) on page 31

[\[:SOURCE<hw>\]:BB:EUTRa:LOGGen:UL:DALL](#) on page 31

Logging Point

Enables/disables one particular logging point.

Refer to [Chapter 2.3, "Signal processing chains and logging points"](#), on page 18 for description on the available logging points.

Remote command:

[\[:SOURCE<hw>\]:BB:EUTRa:LOGGen:DL:LOGPoint<ch0>](#) on page 32

[\[:SOURCE<hw>\]:BB:EUTRa:LOGGen:UL:LOGPoint<ch0>](#) on page 32

2.6 Remote-control commands

The following commands are required to generate logfiles with the **Log file generation option R&S SMW-K81** in a remote environment. We assume that the R&S SMW has already been set up for remote operation in a network as described in the R&S SMW documentation. A knowledge about the remote control operation and the SCPI command syntax are assumed.



Conventions used in SCPI command descriptions

For a description of the conventions used in the remote command descriptions, see section "Remote Control Commands" in the R&S SMW user manual.

Common Suffixes

The following common suffixes are used in remote commands:

Suffix	Value range	Description
ENTity<ch>	1 to 4	Entity in a multiple entity configuration ENTity3 4 require option R&S SMW-K76
SOURce<hw>	[1] to 4	Available baseband signals
OUTPut<ch>	1 to 3	Available markers



Using SCPI command aliases for advanced mode with multiple entities

You can address multiple entities configurations by using the SCPI commands starting with the keyword `SOURce` or the alias commands starting with the keyword `ENTity`.

Note that the meaning of the keyword `SOURce<hw>` changes in the second case.

For details, see section "SCPI Command Aliases for Advanced Mode with Multiple Entities" in the R&S SMW user manual.

Programming example

This description provides a simple programming example. The purpose of the example is to present **all** commands for a given task. In real applications, one would rather reduce the examples to an appropriate subset of commands.

The programming examples have been tested with a software tool which provides an environment for the development and execution of remote tests. To keep the example as simple as possible, only the "clean" SCPI syntax elements are reported. Non-executable command lines (e.g. comments) start with two // characters.

At the beginning of the most remote control program, an instrument (p)reset is recommended to set the instrument to a definite state. The commands `*RST` and `SYSTem:PRESet` are equivalent for this purpose. `*CLS` also resets the status registers and clears the output buffer.

Example: Logfiles generation

```

SOURce1:BB:EUTRa:LOGGen:OUTPut '/var/user/logfiles'
SOURce1:BB:EUTRa:LOGGen:LFP "EUtraLog_0"
SOURce1:BB:EUTRa:LOGGen:DL:EDLoggong ON
SOURce1:BB:EUTRa:LOGGen:DL:PBCH ON
SOURce1:BB:EUTRa:LOGGen:DL:LOGP9 ON
SOURce1:BB:EUTRa:LOGGen:STATe ON
SOURce1:BB:EUTRa:STATe ON

```

The following commands specific to the **Log file generation option R&S SMW-K81** are described here:

<code>[:SOURce<hw>]:BB:EUTRa:LOGGen:STATe</code>	30
<code>[:SOURce<hw>]:BB:EUTRa:LOGGen:OUTPut</code>	30
<code>[:SOURce<hw>]:BB:EUTRa:LOGGen:LFP</code>	31
<code>[:SOURce<hw>]:BB:EUTRa:LOGGen:GSLogfile</code>	31
<code>[:SOURce<hw>]:BB:EUTRa:LOGGen:DL:EDLogging</code>	31
<code>[:SOURce<hw>]:BB:EUTRa:LOGGen:UL:EULogging</code>	31
<code>[:SOURce<hw>]:BB:EUTRa:LOGGen:DL:EALL</code>	31
<code>[:SOURce<hw>]:BB:EUTRa:LOGGen:UL:EALL</code>	31
<code>[:SOURce<hw>]:BB:EUTRa:LOGGen:DL:DALL</code>	31
<code>[:SOURce<hw>]:BB:EUTRa:LOGGen:UL:DALL</code>	31
<code>[:SOURce<hw>]:BB:EUTRa:LOGGen:DL:LOGPoint<ch0></code>	32
<code>[:SOURce<hw>]:BB:EUTRa:LOGGen:UL:LOGPoint<ch0></code>	32
<code>[:SOURce<hw>]:BB:EUTRa:LOGGen:DL:ENCC</code>	32
<code>[:SOURce<hw>]:BB:EUTRa:LOGGen:DL:PBCH</code>	32
<code>[:SOURce<hw>]:BB:EUTRa:LOGGen:DL:PDSCCh</code>	32
<code>[:SOURce<hw>]:BB:EUTRa:LOGGen:DL:PMCH</code>	32
<code>[:SOURce<hw>]:BB:EUTRa:LOGGen:UL:PUSDRs</code>	32
<code>[:SOURce<hw>]:BB:EUTRa:LOGGen:UL:PUCDRs</code>	32
<code>[:SOURce<hw>]:BB:EUTRa:LOGGen:UL:SL</code>	32
<code>[:SOURce<hw>]:BB:EUTRa:LOGGen:UL:SLD</code>	32
<code>[:SOURce<hw>]:BB:EUTRa:LOGGen:UL:SRS</code>	32
<code>[:SOURce<hw>]:BB:EUTRa:LOGGen:UL:PUCCh</code>	32
<code>[:SOURce<hw>]:BB:EUTRa:LOGGen:UL:PUSCh</code>	32

`[:SOURce<hw>]:BB:EUTRa:LOGGen:STATe` <LoggingState>

Enables/disables logfile generation.

Parameters:

<LoggingState> 1 | ON | 0 | OFF
 *RST: OFF

Example: See [Example"Logfiles generation"](#) on page 29.

Options: R&S SMW-K81

Manual operation: See ["Logging State"](#) on page 27

`[:SOURce<hw>]:BB:EUTRa:LOGGen:OUTPut` <OutputPath>

Selects the network directory the logged files are stored in.

Example: See [Example"Logfiles generation"](#) on page 29.

Options: R&S SMW-K81

Manual operation: See ["Output Path"](#) on page 27

[[:SOURce<hw>]:BB:EUTRa:LOGGen:LFP <Preamble>

Sets the preamble added to the file name.

See [Chapter 2.2.1, "Filenames"](#), on page 9 for a description of the file naming conventions.

Parameters:

<Preamble> string
 *RST: K55Log

Example: See [Example "Logfiles generation"](#) on page 29.

Options: R&S SMW-K81

Manual operation: See ["Logging Files Preamble"](#) on page 27

[[:SOURce<hw>]:BB:EUTRa:LOGGen:GSLogfile <GenSumLog>

Enables the generation of a summary logfile.

Parameters:

<GenSumLog> 1 | ON | 0 | OFF
 *RST: 0

Example: See [Example "Logfiles generation"](#) on page 29.

Options: R&S SMW-K81

Manual operation: See ["Generate Summary Log"](#) on page 27

[[:SOURce<hw>]:BB:EUTRa:LOGGen:DL:EDLogging <ExtDciLog>

[[:SOURce<hw>]:BB:EUTRa:LOGGen:UL:EULogging <ExtUciLog>

Enables the generation of a logfile with extended information regarding the DCI/UCI mapping.

Parameters:

<ExtUciLog> 1 | ON | 0 | OFF
 *RST: OFF

Example: See [Example "Logfiles generation"](#) on page 29.

Options: R&S SMW-K81

Manual operation: See ["Extended DCI/UCI Logging"](#) on page 27

[[:SOURce<hw>]:BB:EUTRa:LOGGen:DL:EALL

[[:SOURce<hw>]:BB:EUTRa:LOGGen:UL:EALL

[[:SOURce<hw>]:BB:EUTRa:LOGGen:DL:DALL

[[:SOURce<hw>]:BB:EUTRa:LOGGen:UL:DALL

Enables/disables all logging points.

Example: See [Example "Logfiles generation"](#) on page 29.

Options: R&S SMW-K81

Manual operation: See ["Enable/Disable All"](#) on page 28

```
[ :SOURce<hw>]:BB:EUTRa:LOGGen:DL:LOGPoint<ch0> <LogPointState>
[:SOURce<hw>]:BB:EUTRa:LOGGen:UL:LOGPoint<ch0> <LogPointState>
```

Enables/disables one particular logging point.

Refer to [Chapter 2.3, "Signal processing chains and logging points"](#), on page 18 for description on the available logging points.

Parameters:

```
<LogPointState> 1 | ON | 0 | OFF
*RST:           OFF
```

Example: See [Example "Logfiles generation"](#) on page 29.

Options: R&S SMW-K81

Manual operation: See ["Logging Point"](#) on page 28

```
[ :SOURce<hw>]:BB:EUTRa:LOGGen:DL:ENCC <EnccLogState>
[:SOURce<hw>]:BB:EUTRa:LOGGen:DL:PBCH <PbchLogState>
[:SOURce<hw>]:BB:EUTRa:LOGGen:DL:PDSCh <PdschLogState>
[:SOURce<hw>]:BB:EUTRa:LOGGen:DL:PMCH <State>
[:SOURce<hw>]:BB:EUTRa:LOGGen:UL:PUS Drs <PuschDrsLog>
[:SOURce<hw>]:BB:EUTRa:LOGGen:UL:PUC Drs <PuschDrsLog>
[:SOURce<hw>]:BB:EUTRa:LOGGen:UL:SL <LogSidelink>
[:SOURce<hw>]:BB:EUTRa:LOGGen:UL:SLD <LogSidelinkDrs>
[:SOURce<hw>]:BB:EUTRa:LOGGen:UL:SRS <SrsState>
[:SOURce<hw>]:BB:EUTRa:LOGGen:UL:PUC Ch <PucchLogState>
[:SOURce<hw>]:BB:EUTRa:LOGGen:UL:PUS Ch <PuschLogState>
```

Enables the channel or reference signal for that logfiles are generated.

Parameters:

```
<PuschLogState> 1 | ON | 0 | OFF
*RST:           ON
```

Example: See [Example "Logfiles generation"](#) on page 29.

Options: R&S SMW-K81

Manual operation: See ["Physical Channels"](#) on page 28

3 5G NR logfile generation

3.1 Required options

The generation of logfiles requires:

- Standard or wideband baseband generator (R&S SMW-B10/-B9)
- Baseband main module (R&S SMW-B13) or wideband baseband main module (R&S SMW-B13XT)
- Option 5G New Radio (R&S SMW-K144)
(per signal path)
- Option log files generation (R&S SMW-K81)
Two options R&S SMW-K81 are required if system configuration with baseband blocks with more that one output is used.
For example, as it is in configuration with coupled or coupled per entity baseband sources.

3.2 Output files

Logfiles are generated after each step of signal processing chain defined in TS 38.212.

The R&S SMW saves the output logfiles in a user-defined network directory, selected with the parameter [Output Path](#). A folder structure is automatically created according to the number of configured users, BWPs, channels, etc. The logfiles are named according to the naming convention described in ["File format and filenames"](#) on page 33.

File format and filenames

The log files are files in json format and are named according to the following naming structure `after_<SignalProcessingStep>.json`. See [Table 3-1](#) for an overview of the signal processing steps and the filenames per channel.

Table 3-1: Log files

File name (signal processing step)	PxSCH (per codeword)	CORESET (PDCCH/DCI)	PUCCH (Format 2, 3, 4)	PRACH	SSPBCH (MIB)
transport_block	x	-	-	-	-
after_block_segmentation	-	0*	-	-	-
after_code_block_crc_attachment	-	0*	-	-	-
after_interleaving	-	0*	-	-	-
after_crc_attachment	0*	-	-	-	-
after_code_block_segmentation	0*	-	-	-	-
after_channel_coding	0*	0*	-	-	-

File name (signal processing step)	PxSCH (per codeword)	CORESET (PDCCH/DCI)	PUCCH (Format 2, 3, 4)	PRACH	SSPBCH (MIB)
after_rate_matching	0*	0*	-	-	-
after_code_block_concatenation	x	0*	-	-	-
after_encoding	x	x	x		x
after_scrambling	x	x	x		x

0* = if channel coding is enabled.

3.3 How to generate logfiles

The R&S SMW generates logfiles depending on the current configuration, like active channels, users, BWPs, codewords, channel coding.

Activating the logfile generation does not affect the content of the generated 5G NR signal and does not cause a recalculation of the signal. The generation of new logfiles is triggered by changing of a relevant 5G NR parameter or by enabling/disabling the generation of 5G NR signal.



Activation of logfile generation slows down the calculation speed of the instrument. Enable this function only if logfiles are explicitly requested.

General workflow

To enable the generation of logfiles, proceed as follows:

1. Select "5G New Radio > Logfile Generation > Output Path".
Set the logfile storage path to, e.g. `/var/user/logfiles`.
Note: Select an empty directory. Existing logfiles are overwritten.
2. Select "Logging State > On".
3. Adjust the 5G NR settings as required.
4. Set "5G New Radio > State > On".

3.4 Logfile generation settings

Access:

1. Select "5G New Radio > General > Logfile Generation".
2. To enable log file generations, set "Logging State > On".

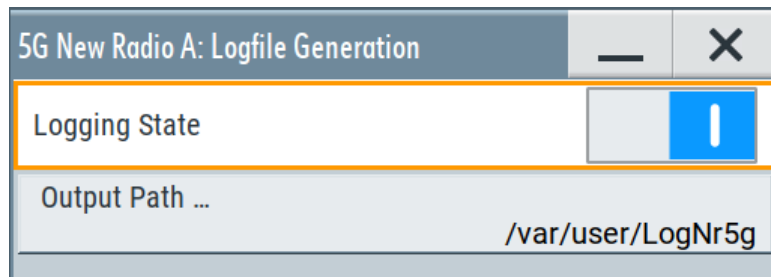

- To start generation and logging, set "5G New Radio > State > On".

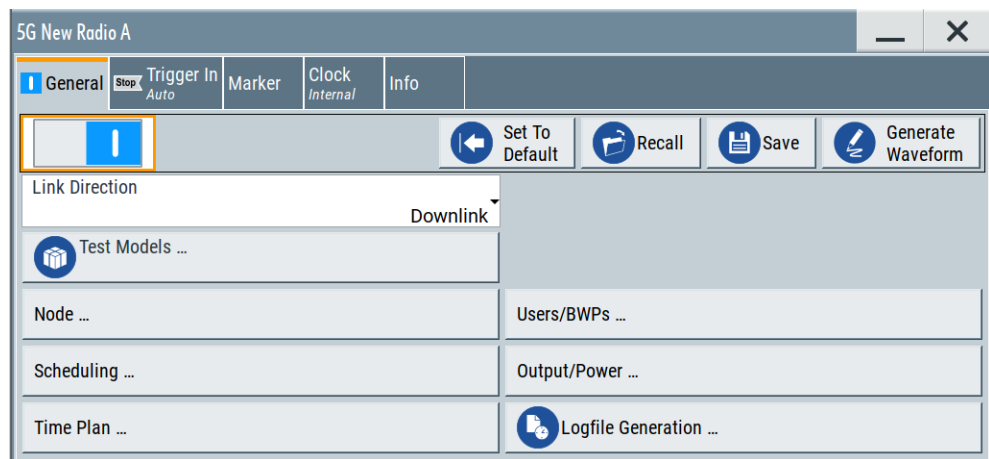

Logging State.....	35
Output Path.....	35

Logging State

Enables/disables logfile generation.

Note: Activation of logfile generation slows down the calculation speed of the instrument.

Enable this function only if logfiles are explicitly requested.

See also [Chapter 3.3, "How to generate logfiles"](#), on page 34.

Remote command:

[:SOURce<hw>] :BB:NR5G:LOGGen:STATe on page 36

Output Path

Selects the network directory the logged files are saved in.

Per default, files are saved in the user directory of the instrument.

Remote command:

[:SOURce<hw>] :BB:NR5G:LOGGen:OUTPut on page 36

3.5 Logging commands

Option: R&S SMW-K81

Example: Activating logfile generation

To start logfile generation with the default settings:

```
SOURce1:BB:NR5G:PRESet
SOURce1:BB:NR5G:STATe 1
SOURce1:BB:NR5G:LOGGen:OUTPut "/var/user/"
SOURce1:BB:NR5G:LOGGen:STATe 1
```

[\[:SOURce<hw>\]:BB:NR5G:LOGGen:STATe](#).....36
[\[:SOURce<hw>\]:BB:NR5G:LOGGen:OUTPut](#)..... 36

[[:SOURce<hw>]:BB:NR5G:LOGGen:STATe <LogGenState>

Activates the logfile generation.

Parameters:

<LogGenState> 1 | ON | 0 | OFF
 *RST: 0

Example: See [Example"Activating logfile generation"](#) on page 36.

Manual operation: See "[Logging State](#)" on page 35

[[:SOURce<hw>]:BB:NR5G:LOGGen:OUTPut <LogGenOutPath>

Sets the directory the files are saved in.

Parameters:

<LogGenOutPath> string

Example: See [Example"Activating logfile generation"](#) on page 36.

Manual operation: See "[Output Path](#)" on page 35

List of commands

[:SOURce<hw>]:BB:EUTRa:LOGGen:DL:DALL.....	31
[:SOURce<hw>]:BB:EUTRa:LOGGen:DL:EALL.....	31
[:SOURce<hw>]:BB:EUTRa:LOGGen:DL:EDLogging.....	31
[:SOURce<hw>]:BB:EUTRa:LOGGen:DL:ENCC.....	32
[:SOURce<hw>]:BB:EUTRa:LOGGen:DL:LOGPoint<ch0>.....	32
[:SOURce<hw>]:BB:EUTRa:LOGGen:DL:PBCH.....	32
[:SOURce<hw>]:BB:EUTRa:LOGGen:DL:PDSCh.....	32
[:SOURce<hw>]:BB:EUTRa:LOGGen:DL:PMCH.....	32
[:SOURce<hw>]:BB:EUTRa:LOGGen:GSLogfile.....	31
[:SOURce<hw>]:BB:EUTRa:LOGGen:LFP.....	31
[:SOURce<hw>]:BB:EUTRa:LOGGen:OUTPut.....	30
[:SOURce<hw>]:BB:EUTRa:LOGGen:STATe.....	30
[:SOURce<hw>]:BB:EUTRa:LOGGen:UL:DALL.....	31
[:SOURce<hw>]:BB:EUTRa:LOGGen:UL:EALL.....	31
[:SOURce<hw>]:BB:EUTRa:LOGGen:UL:EULogging.....	31
[:SOURce<hw>]:BB:EUTRa:LOGGen:UL:LOGPoint<ch0>.....	32
[:SOURce<hw>]:BB:EUTRa:LOGGen:UL:PUCCh.....	32
[:SOURce<hw>]:BB:EUTRa:LOGGen:UL:PUC Drs.....	32
[:SOURce<hw>]:BB:EUTRa:LOGGen:UL:PUSCh.....	32
[:SOURce<hw>]:BB:EUTRa:LOGGen:UL:PUS Drs.....	32
[:SOURce<hw>]:BB:EUTRa:LOGGen:UL:SL.....	32
[:SOURce<hw>]:BB:EUTRa:LOGGen:UL:SLD.....	32
[:SOURce<hw>]:BB:EUTRa:LOGGen:UL:SRS.....	32
[:SOURce<hw>]:BB:NR5G:LOGGen:OUTPut.....	36
[:SOURce<hw>]:BB:NR5G:LOGGen:STATe.....	36

Index

A

Application cards	7
Application notes	7

B

Brochures	7
-----------------	---

C

Conventions	
SCPI commands	29

D

Data sheets	7
Documentation overview	5

E

Extended logfiles	14
-------------------------	----

G

Getting started	6
-----------------------	---

H

Help	6
------------	---

I

Installation	5
Instrument help	6
Instrument security procedures	6

L

Logfile generation	
Extended logfiles	14
File formats	9, 33
File names	9, 33
Output files	9, 33
Logging point	18

O

Open source acknowledgment (OSA)	7
--	---

R

Release notes	7
---------------------	---

S

Safety instructions	7
Security procedures	6
Service manual	6

T

Tutorials	6
-----------------	---

U

User manual	6
-------------------	---

V

Videos	7
--------------	---

W

White papers	7
--------------------	---