

R&S®FSV3-K144

3GPP 5G NR Downlink Measurement Application User Manual



1178924902
Version 11

ROHDE & SCHWARZ
Make ideas real



This manual applies to the following R&S®FSV3000 and R&S®FSVA3000 models with firmware version 2.10 and higher:

- R&S®FSV3004 (1330.5000K04) / R&S®FSVA3004 (1330.5000K05)
- R&S®FSV3007 (1330.5000K07) / R&S®FSVA3007 (1330.5000K08)
- R&S®FSV3013 (1330.5000K13) / R&S®FSVA3013 (1330.5000K14)
- R&S®FSV3030 (1330.5000K30) / R&S®FSVA3030 (1330.5000K31)
- R&S®FSV3044 (1330.5000K43) / R&S®FSVA3044 (1330.5000K44)
- R&S®FSV3050 (1330.5000K50) / R&S®FSVA3050 (1330.5000K51)

The following firmware options are described:

- R&S®FSV3-K144 (5G NR R15 Downlink Measurements) (1330.7219.02)
- R&S®FSV3-K147 (5G NR Combined EVM / ACLR / SEM Measurements) (1346.4250.02)
- R&S®FSV3-K148 (5G NR R16 Downlink / Uplink Measurements) (1346.4914.02)
- R&S®FSV3-K171 (5G NR R17 Downlink / Uplink Measurements) (1346.5362.02)

© 2023 Rohde & Schwarz GmbH & Co. KG
Muehldorfstr. 15, 81671 Muenchen, Germany
Phone: +49 89 41 29 - 0
Email: info@rohde-schwarz.com
Internet: www.rohde-schwarz.com

Subject to change – data without tolerance limits is not binding.

R&S® is a registered trademark of Rohde & Schwarz GmbH & Co. KG.

Trade names are trademarks of the owners.

1178.9249.02 | Version 11 | R&S®FSV3-K144

Throughout this manual, products from Rohde & Schwarz are indicated without the ® symbol, e.g. R&S®FSV3000 is indicated as R&S FSV3000.

Contents

1	Documentation overview.....	9
1.1	Getting started manual.....	9
1.2	User manuals and help.....	9
1.3	Service manual.....	10
1.4	Instrument security procedures.....	10
1.5	Printed safety instructions.....	10
1.6	Data sheets and brochures.....	10
1.7	Release notes and open-source acknowledgment (OSA).....	10
1.8	Application notes, application cards, white papers, etc.....	11
1.9	Videos.....	11
2	Welcome to the 5G NR measurement application.....	12
2.1	Overview of the 5G NR applications.....	12
2.2	Installation.....	15
2.3	5G NR measurement application selection.....	15
2.4	Display information.....	15
3	Measurements and result displays.....	18
3.1	Selecting measurements.....	18
3.2	Selecting result displays.....	20
3.3	Performing measurements.....	20
3.4	Result summary.....	21
3.5	I/Q measurements.....	28
3.6	Time alignment error.....	44
3.7	Transmit on / off power measurement.....	47
3.8	Frequency sweep measurements.....	52
3.9	Combined measurements.....	60
3.10	Reference: custom limits.....	63
3.11	Reference: 3GPP test scenarios.....	64
4	Configuration.....	67
4.1	I/Q Measurement.....	67
4.1.1	Configuration overview.....	68

4.1.2	Automatic measurement configuration.....	70
4.1.3	Physical signal description.....	73
4.1.4	Test scenarios.....	76
4.1.5	Component carrier configuration.....	77
4.1.6	Radio frame configuration.....	82
4.1.7	Synchronization signal configuration.....	86
4.1.8	Bandwidth part configuration.....	92
4.1.9	Slot configuration.....	97
4.1.10	PDSCH and PDCCH configuration.....	109
4.1.11	Antenna port configuration.....	129
4.1.12	Advanced settings.....	131
4.1.13	Generator control.....	137
4.1.14	Input source configuration.....	141
4.1.15	Frequency configuration.....	143
4.1.16	Amplitude configuration.....	144
4.1.17	Trigger configuration.....	147
4.1.18	Data capture.....	149
4.1.19	Tracking.....	152
4.1.20	Demodulation.....	155
4.2	Time Alignment Error Configuration.....	158
4.3	Transmit On / Off Power Configuration.....	159
4.4	Frequency Sweep Measurement Configuration.....	160
4.5	Combined measurement configuration.....	163
4.5.1	Signal description.....	164
4.5.2	Signal capture.....	165
4.5.3	Trigger configuration.....	167
4.6	Combined measurement guide.....	169
4.6.1	General configuration.....	170
4.6.2	Trigger configuration.....	171
4.7	Time trigger measurement guide.....	180
4.8	Microservice export.....	181
4.9	O-RAN measurement guide.....	182
4.10	Reference: structure of .allocation files.....	182

4.11	Basics on input from I/Q data files.....	191
5	Analysis.....	193
5.1	General analysis tools.....	193
5.1.1	Data export.....	193
5.1.2	Diagram scale.....	194
5.1.3	Zoom.....	195
5.1.4	Markers.....	196
5.2	Analysis tools for I/Q measurements.....	196
5.2.1	Layout of numerical results.....	197
5.2.2	Result settings.....	197
5.2.3	Table configuration.....	200
5.2.4	Result views.....	201
5.2.5	Evaluation range.....	203
5.2.6	Beamforming selection.....	206
5.3	Analysis tools for combined measurements.....	206
5.3.1	Event filter.....	207
5.3.2	General analysis tools.....	208
5.4	Analysis tools for frequency sweep measurements.....	208
6	Remote control.....	209
6.1	Common suffixes.....	209
6.2	Introduction.....	210
6.2.1	Conventions used in descriptions.....	211
6.2.2	Long and short form.....	211
6.2.3	Numeric suffixes.....	212
6.2.4	Optional keywords.....	212
6.2.5	Alternative keywords.....	212
6.2.6	SCPI parameters.....	213
6.3	5G NR application selection.....	215
6.4	Screen layout.....	218
6.4.1	General layout.....	218
6.4.2	Layout of a single channel.....	220
6.5	Measurement control.....	228
6.5.1	Measurements.....	228

6.5.2	Measurement sequences.....	230
6.6	Remote commands to retrieve numeric results.....	232
6.6.1	Result summary.....	232
6.6.2	Time alignment error.....	252
6.6.3	Marker table.....	253
6.6.4	CCDF table.....	256
6.7	Limit check results.....	257
6.7.1	EVM limits.....	257
6.7.2	Transmit power on / off limits.....	262
6.7.3	Frequency sweep limits.....	263
6.8	Retrieve trace data.....	271
6.8.1	Using the TRACe[:DATA] command.....	271
6.8.2	Read measurement results.....	289
6.9	Configuration.....	294
6.9.1	General configuration.....	295
6.9.2	Automatic configuration.....	297
6.9.3	Physical settings.....	302
6.9.4	Component carrier configuration.....	306
6.9.5	General radio frame configuration.....	311
6.9.6	Synchronization signal configuration.....	312
6.9.7	Bandwidth part configuration.....	319
6.9.8	Slot configuration.....	323
6.9.9	CSI reference signal configuration.....	330
6.9.10	Positioning reference signal.....	339
6.9.11	CORESET allocation configuration.....	343
6.9.12	PDSCH allocation configuration.....	349
6.9.13	Enhanced CORESET allocation configuration.....	357
6.9.14	Enhanced PDSCH settings: DMRS.....	373
6.9.15	Enhanced PDSCH settings: PTRS.....	383
6.9.16	Enhanced PDSCH settings: scrambling / coding.....	386
6.9.17	Antenna port configuration.....	390
6.9.18	Advanced settings: global.....	392
6.9.19	Advanced settings: reference point A.....	396

6.9.20	Advanced settings: LTE-CRS coexistence.....	399
6.9.21	Generator control.....	401
6.9.22	Input configuration.....	407
6.9.23	Frequency configuration.....	410
6.9.24	Amplitude configuration.....	412
6.9.25	Data capture.....	417
6.9.26	Trigger.....	420
6.9.27	Tracking.....	425
6.9.28	Demodulation.....	427
6.9.29	Time alignment measurement.....	431
6.9.30	Transmit on/off power measurements.....	431
6.9.31	Frequency sweep measurements.....	434
6.9.32	Combined measurements.....	438
6.10	Analysis.....	444
6.10.1	General analysis tools.....	444
6.10.2	Analysis tools for I/Q measurements.....	456
6.10.3	Analysis tools for combined measurements.....	467
	List of Commands (5G NR Downlink).....	470
	Index.....	482

1 Documentation overview

This section provides an overview of the R&S FSV/A user documentation. Unless specified otherwise, you find the documents at:

www.rohde-schwarz.com/manual/FSVA3000

www.rohde-schwarz.com/manual/FSV3000

Further documents are available at:

www.rohde-schwarz.com/product/FSVA3000

www.rohde-schwarz.com/product/FSV3000

1.1 Getting started manual

Introduces the R&S FSV/A and describes how to set up and start working with the product. Includes basic operations, typical measurement examples, and general information, e.g. safety instructions, etc.

A printed version is delivered with the instrument. A PDF version is available for download on the Internet.

1.2 User manuals and help

Separate user manuals are provided for the base unit and the firmware applications:

- **Base unit manual**
Contains the description of all instrument modes and functions. It also provides an introduction to remote control, a complete description of the remote control commands with programming examples, and information on maintenance, instrument interfaces and error messages. Includes the contents of the getting started manual.
- **Firmware application manual**
Contains the description of the specific functions of a firmware application, including remote control commands. Basic information on operating the R&S FSV/A is not included.

The contents of the user manuals are available as help in the R&S FSV/A. The help offers quick, context-sensitive access to the complete information for the base unit and the firmware applications.

All user manuals are also available for download or for immediate display on the Internet.

1.3 Service manual

Describes the performance test for checking the rated specifications, module replacement and repair, firmware update, troubleshooting and fault elimination, and contains mechanical drawings and spare part lists.

The service manual is available for registered users on the global Rohde & Schwarz information system (GLORIS):

[R&S®FSVA3000/FSV3000 Service manual](#)

1.4 Instrument security procedures

Deals with security issues when working with the R&S FSV/A in secure areas. It is available for download on the internet.

1.5 Printed safety instructions

Provides safety information in many languages. The printed document is delivered with the product.

1.6 Data sheets and brochures

The data sheet contains the technical specifications of the R&S FSV/A. It also lists the firmware applications and their order numbers, and optional accessories.

The brochure provides an overview of the instrument and deals with the specific characteristics.

See www.rohde-schwarz.com/brochure-datasheet/FSV3000/

www.rohde-schwarz.com/brochure-datasheet/FSVA3000

1.7 Release notes and open-source acknowledgment (OSA)

The release notes list new features, improvements and known issues of the current firmware version, and describe the firmware installation.

The software makes use of several valuable open source software packages. An open-source acknowledgment document provides verbatim license texts of the used open source software.

See www.rohde-schwarz.com/firmware/FSV3000/

www.rohde-schwarz.com/firmware/FSVA3000

1.8 Application notes, application cards, white papers, etc.

These documents deal with special applications or background information on particular topics.

See www.rohde-schwarz.com/application/FSV3000/ /

www.rohde-schwarz.com/application/FSVA3000

1.9 Videos

Find various videos on Rohde & Schwarz products and test and measurement topics on YouTube: <https://www.youtube.com/@RohdeundSchwarz>

2 Welcome to the 5G NR measurement application

The 5G NR application is a firmware application that adds functionality to measure signals according to the 3GPP 5G NR (new radio) standard on the downlink to the R&S FSV/A.



Bandwidth of 5G NR signals

5G NR signals have a bandwidth between 5 MHz and 400 MHz.

Measuring signals greater than 10 MHz requires an R&S FSV/A with one of the optional bandwidth extensions (28 MHz or more).

This user manual contains a description of the functionality that the application provides, including remote control operation. Functions that are not discussed in this manual are the same as in the spectrum application and are described in the R&S FSV/A user manual. The latest versions of the manuals are available for download at the product homepage.

<https://www.rohde-schwarz.com/manual/fsv3000>

- [Overview of the 5G NR applications](#)..... 12
- [Installation](#)..... 15
- [5G NR measurement application selection](#)..... 15
- [Display information](#)..... 15

2.1 Overview of the 5G NR applications

You can equip the R&S FSV/A with one or more NR 5G applications. Each of the applications provides functionality for specific measurement tasks.

R&S FSV3-K144

The R&S FSV3-K144 is designed to measure NR 5G signals on the downlink.

The application supports features up to 3GPP release 15.

- Basic signal characteristics (like multiple component carriers, frequency ranges and channel bandwidths).
- (Automatic) demodulation and configuration of the PDSCH and synchronization signal (SS/PBCH).
- Configuration and analysis of multiple frames and bandwidth parts (multi-numerology).
- Configuration and analysis of special downlink channels and reference signals (like the PDCCH, the CSI-RS or the PT-RS).
- Configuration and analysis of various demodulation reference signals.
- Mapping of channels to different antenna ports.

- LTE coexistence analysis.
- Synchronization of the configuration with a connected Rohde & Schwarz signal generator.
- Tools to refine and filter the measurement results.
- Various result displays that show the measured signal characteristics in a diagram or a numeric result table.
- Available measurements: EVM, ACLR, SEM, time alignment and on / off power.

R&S FSV3-K145

The R&S FSV3-K145 is designed to measure NR 5G signals on the uplink.

The application supports features up to 3GPP release 15.

- Basic signal characteristics (like multiple component carriers, frequency ranges and channel bandwidths).
- (Automatic) demodulation and configuration of the PUSCH.
- Configuration and analysis of multiple frames and bandwidth parts (multi-numerology).
- Configuration and analysis of special uplink channels and reference signals (like the PUCCH, the PRACH, the SRS or the PT-RS).
- Configuration and analysis of various demodulation reference signals.
- Mapping of channels to different antenna ports.
- Synchronization of the configuration with a connected Rohde & Schwarz signal generator.
- Tools to refine and filter the measurement results.
- Various result displays that show the measured signal characteristics in a diagram or a numeric result table.
- Available measurements: EVM, ACLR and SEM.

R&S FSV3-K147

The R&S FSV3-K147 is designed to combine different 5G NR measurements in a single measurement sequence, either on the downlink or on the uplink.

Note that this application requires the R&S FSV3-K144 or -K145.

The application supports the following features.

- Combined analysis of EVM, ACLR and SEM in a single application.
- Automatic measurement of multiple, subsequent events with a single analyzer.
- Increased measurement speed due to optimized measurement methods.
- Advanced trigger configuration.
- Extended functionality of the result displays that reflect the measurement sequence.

R&S FSV3-K148

The R&S FSV3-K148 extends the functionality of the base application with features introduced with 3GPP release 16.

Note that this application requires the R&S FSV3-K144 or -K145.

Release 16 features include:

- Configuration of DCI parameters.
- Configuration and analysis of the PRS.
- New operating bands, slot formats (for IAB) and test models introduced with release 16.
- New channel bandwidth introduced with release 16 (70 MHz).
- Increased PDSCH DMRS length.
- Increased number of SS/PBCH blocks to support shared spectrum access.

R&S FSV3-K171

The R&S FSV3-K171 extends the functionality of the base application with features introduced with 3GPP release 17.

Note that this application requires the R&S FSV3-K144 or -K145 and the R&S FSV3-K148.

Release 17 features include:

- New deployment frequency range (FR2-2, up to 71 GHz).
- New channel bandwidths introduced with FR2-2 (800 MHz, 1600 MHz and 2000 MHz).
- New subcarrier spacings for various channels (user allocations, SS/PBCH, PRACH etc.) introduced with FR2-2.
- New channel bandwidths introduced with release 17 (35 MHz and 45 MHz).
- Support of 1024QAM modulation in FR1.
- New operating bands, test models and limits for ACLR and SEM measurements introduced with release 17.

R&S FSV3-K175

The R&S FSV3-K175 extends the functionality of the base application with features that allow measurements based on the O-RAN standard.

Note that this application requires the R&S FSV3-K144 or -K145.

The application supports the following features.

- Support of O-RAN test cases.
- Extended features in selected result displays that allow evaluation of O-RAN test cases.
- Automatic configuration of the NR 5G application upon selection of an O-RAN test case.

2.2 Installation

Find detailed installation instructions in the getting started or the release notes of the R&S FSV/A.

2.3 5G NR measurement application selection

The 5G NR measurement application adds a new application to the R&S FSV/A.

Starting the application

1. Press the [MODE] key on the front panel of the R&S FSV/A.

A dialog box opens that contains all operating modes and applications currently available on your R&S FSV/A.

2. Select the "5G NR" item.



The R&S FSV/A opens a new measurement channel for the 5G NR measurement application.

The measurement is started immediately with the default settings. It can be configured in the "Overview" dialog box, which is displayed when you select the "Overview" soft-key from any menu.

2.4 Display information

The following figure shows a measurement diagram during analyzer operation. All different information areas are labeled. They are explained in more detail in the following sections.

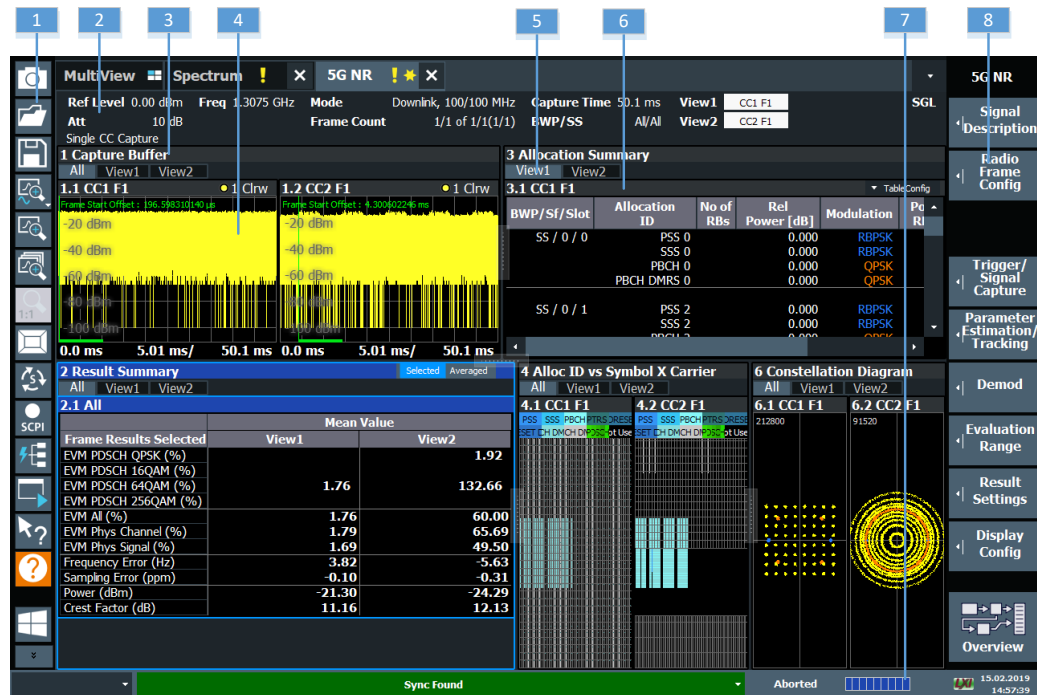

- 1 = Toolbar
- 2 = Channel bar
- 3 = Diagram header
- 4 = Result display
- 5 = Subwindows (Views)
- 6 = Subwindow header
- 7 = Status bar
- 8 = Softkeys

Channel bar information

In the 5G NR measurement application, the R&S FSV/A shows the following settings:

Table 2-1: Information displayed in the channel bar in the 5G NR measurement application

Ref Level	Reference level.
Att	Mechanical and electronic RF attenuation.
Inp: File Freq	Frequency for I/Q file input.
Freq	Frequency for other input sources (RF etc.).
Mode*	5G NR mode (link direction and channel bandwidth).
Frame Count*	The first number represents the number of frames that have already been captured. The second number represents the total number of frames that will be captured. The third number in brackets represents the number of frames currently in the capture buffer.
Capture Time	Signal length that has been captured.
Frame	Selected frame number.

BWP/SS*	Shows the signal part for which results are displayed (evaluation range). SS = synchronization signal BWP = bandwidth part
View<x>	Information about the contents of View 1 and View 2. Select the button for access to the dialog box for view configuration.
SGL	Indicates that single sweep measurement is active.
Auto Demod Once	Select the button to start automatic signal demodulation.
Consecutive CC Meas	Number of component carriers that are measured; the numbers in parentheses indicate the number of component carriers that are analyzed in a single capture. Example: 8 (3 / 3 / 2) means that 8 component carriers are analyzed in three consecutive data captures. The first two data captures analyze the first 6 component carriers (3 CCs each), while the last data capture analyzes the last 2 component carriers.

*If you capture more than one data stream (for example several component carriers), the R&S FSV/A shows two values separated by a slash. The first number corresponds to the first analyzed data stream, the second number to the second analyzed data stream.

The channel bar also displays information on instrument settings that affect the measurement results even though this is not immediately apparent from the display of the measured values (for example transducer or trigger settings). This information is displayed only when applicable for the current measurement. For details, see the R&S FSV/A getting started manual.

Diagram header

The information in the diagram header depends on the result display.

- All diagrams show the window number and type of result display.
- Most diagrams contain trace information.
- Some diagrams contain controls to customize the diagram contents. The diagram header of the "Allocation Summary", for example, contains a control to select which columns are displayed.
- If you analyze multiple component carriers or frames, the diagram header shows which CC or frame is analyzed.

Status bar information

Global instrument settings, the instrument status and any irregularities are indicated in the status bar beneath the diagram. Furthermore, the progress of the current operation is displayed in the status bar.

Regarding the synchronization state, the application shows the following labels.

- "Sync OK"
The synchronization was successful. The status bar is green.
- "Sync Failed"
The synchronization was not successful. The status bar is red.
If you are measuring several component carriers, the message also indicates which component carrier could not be synchronized.

3 Measurements and result displays

The 5G NR measurement application measures and analyzes various aspects of a 5G NR signal.

The application provides several measurements and result displays.

- Measurements capture and analyze the signal in a different way.
- Result displays are different representations of the measurement results. They are either diagrams that show the results as a graph or tables that show the results as numbers.

Remote command:

Measurement selection: `CONFigure[:NR5G]:MEASurement` on page 295

Result display selection: `LAYout:ADD[:WINDow]?` on page 220

• Selecting measurements	18
• Selecting result displays	20
• Performing measurements	20
• Result summary	21
• I/Q measurements	28
• Time alignment error	44
• Transmit on / off power measurement	47
• Frequency sweep measurements	52
• Combined measurements	60
• Reference: custom limits	63
• Reference: 3GPP test scenarios	64

3.1 Selecting measurements

Access: "Overview" > "Select Measurement"

The "Select Measurement" dialog box contains several buttons. Each button represents a measurement. A measurement in turn is a set of result displays that thematically belong together and that have a particular display configuration. If these predefined display configurations do not suit your requirements, you can add or remove result displays as you like. For more information about selecting result displays, see [Chapter 3.2, "Selecting result displays"](#), on page 20.

Depending on the measurement, the R&S FSV/A changes the way it captures and processes the raw signal data.

EVM

EVM measurements record, process and demodulate the signal's I/Q data. The result displays available for EVM measurements show various aspects of the 5G NR signal quality.

For EVM measurements, you can combine the result displays in any way.

For more information on the result displays, see [Chapter 3.5, "I/Q measurements"](#), on page 28.

Remote command:

[CONFigure\[:NR5G\]:MEASurement](#) on page 295

Time alignment error

Time alignment error (TAE) measurements record, process and demodulate the signal's I/Q data. The result displays available for TAE measurements indicate how well the antennas in a multi-antenna system are aligned.

For TAE measurements, you can combine the result displays in any way.

For more information on the result displays, see [Chapter 3.6, "Time alignment error"](#), on page 44.

Remote command:

[CONFigure\[:NR5G\]:MEASurement](#) on page 295

Transmit on / off power

Transmit on / off power measurements record and process the signal's I/Q data without demodulating the data. The result displays available for transmit on / off power measurements show various aspects of the transition from on to off power.

For transmit on / off power measurements, you can combine the result displays in any way.

For more information on the result displays, see [Chapter 3.7, "Transmit on / off power measurement"](#), on page 47.

Remote command:

[CONFigure\[:NR5G\]:MEASurement](#) on page 295

Combined EVM / ACLR / SEM

Combined measurements are a sequence of individual measurements that evaluate the EVM, ACLR and / or SEM of a DUT.

For more information on the result displays, see [Chapter 3.9, "Combined measurements"](#), on page 60.

Channel power ACLR

(includes multi carrier ACLR and cumulative ACLR measurements)

ACLR measurements sweep the frequency spectrum instead of processing I/Q data.

The ACLR measurements evaluates the leakage ratio of neighboring channels and evaluates if the signal is within the defined limits. The measurement provides several result displays. You can combine the result displays in any way.

For more information on the result displays, see [Chapter 3.8, "Frequency sweep measurements"](#), on page 52.

Remote command:

[CONFigure\[:NR5G\]:MEASurement](#) on page 295

SEM

(includes multi carrier SEM measurements)

SEM measurements sweep the frequency spectrum instead of processing I/Q data.

The SEM measurements tests the signal against a spectrum emission mask and evaluates if the signal is within the defined limits. The measurement provides several result displays. You can combine the result displays in any way.

For more information on the result displays, see [Chapter 3.8, "Frequency sweep measurements"](#), on page 52.

Remote command:

[CONFigure\[:NR5G\]:MEASurement](#) on page 295

3.2 Selecting result displays

Access: 

The R&S FSV/A opens a menu (the SmartGrid) to select result displays. For more information on the SmartGrid functionality, see the R&S FSV/A Getting Started.

In the default state of the application, it shows several conventional result displays.

- Capture Buffer
- EVM vs Carrier
- Power Spectrum
- Result Summary
- Alloc ID vs Symbol x Carrier
- Constellation Diagram

From that predefined state, add and remove result displays as you like from the SmartGrid menu.

Remote command: [LAYout:ADD\[:WINDow\]?](#) on page 220

3.3 Performing measurements

By default, the application measures the signal continuously. In "Continuous Sweep" mode, the R&S FSV/A captures and analyzes the data again and again.

- For I/Q measurements, the amount of captured data depends on the [capture time](#).
- For frequency sweep measurement, the amount of captured data depends on the sweep time.

In "Single Sweep" mode, the R&S FSV/A stops measuring after it has captured the data once. The amount of data again depends on the capture time.

Refreshing captured data

You can also repeat a measurement based on the data that has already been captured with the "Refresh" function. Repeating a measurement with the same data can be useful, for example, if you want to apply different modulation settings to the same I/Q data.

For more information, see the documentation of the R&S FSV/A.

3.4 Result summary

In addition to various graphical results, the R&S FSV/A provides a numerical result summary for I/Q measurements. The result summary shows a multitude of results that indicate the signal quality, combined in one table.

The result summary is split into several parts.

- Frame statistics, which evaluate the metrics of the resource elements in a complete frame.
Results are averaged over frames.
- Slot and subframe statistics, which evaluate metrics of the resource elements in a single slot or subframe.
Results are averaged over slots / subframes.

If you are using different [numerologies](#), the R&S FSV/A first averages all slots with the same numerology, before calculating the overall mean value.

Each row in the table corresponds to a certain metric or result parameter. You can [add](#) or [remove](#) results you want to display as necessary.

By default, the R&S FSV/A evaluates the results over all captured frames, bandwidth parts, subframes and slots. For most results, the result summary therefore contains a mean (average), maximum and minimum value.

2 Result Summary				
Frame Results Selected	Mean	Limit	Max	Min
EVM PDSCH QPSK (%)	0.00	0.00	0.00	0.00
EVM PDSCH 16QAM (%)	0.00	0.00	0.00	0.00
EVM PDSCH 64QAM (%)	0.00	0.00	0.00	0.00
EVM PDSCH 256QAM (%)	0.00	0.00	0.00	0.00
Results for Selection BWP/SS All, Subframe All, Slot All				
EVM All (%)	0.00		0.00	0.00
EVM Peak (%)	0.00		0.00	0.00
EVM Phys Channel (%)	0.00		0.00	0.00
EVM Phys Signal (%)	0.00		0.00	0.00
Frequency Error (Hz)	0.00		0.00	0.00
Sampling Error (ppm)	0.00		0.00	0.00
I/Q Offset (dB)	0.00		0.00	0.00
I/Q Gain Imbalance (dB)	-		-	-
I/Q Quadrature Error (°)	-		-	-

Limit check

The R&S FSV/A also tests several results against limits, if 3GPP has defined limits for a result. Limits are only evaluated if the signal complies to the 3GPP specification regarding the [number of analyzed frames](#) and the results are averaged over all frames.

Depending on the limit test, the results are highlighted.

- If one of the results passes the limit, the value is highlighted green.
- If one of the results violates the limit, the value is highlighted red.
- Results that are not evaluated are not highlighted in a color.

For some results you can define custom limits. For more information, see [Chapter 3.10, "Reference: custom limits"](#), on page 63.

You can check if a result supports limit evaluation in the result descriptions below. The result descriptions also indicate special behavior of the limit check.

Evaluation range and multiple frame analysis

The **evaluation range** selects the way the results are evaluated and which values are displayed.

For the **frame statistics**, the evaluation range is irrelevant. However, you can select a specific frame that you want to analyze.

- Select "Frame Averaged" in the result summary header to display the average result over all analyzed frames. The average results relate to all frames, not just those in the capture buffer.
The table also shows the minimum and maximum values over the analyzed frames.
- Select "Selected Frame" in the result summary header to display the results for a **single frame**.
If you analyze a single frame, the mean, minimum and maximum values are the same.

2 Result Summary

Selected Frame **Frame Averaged**

For the **slot statistics** and subframe statistics, the effects of the evaluation range are as follows.

- Select "Frame Averaged" in the result summary header to display the average results over all analyzed slots in all analyzed frames. The average results relate to all frames, not just those in the capture buffer. The table also shows the minimum and maximum values found in the analyzed frames.
When you select a specific BWP, subframe or slot while in "Frame Averaged" mode, the R&S FSV/A automatically selects "Selected Frame" mode.
- Select "Selected Frame" in the result summary header to display the results over all analyzed slots in a single frame. The analyzed frame depends on the frame you have selected. In this case, you can filter the evaluation range as you like.

Examples:

- If you select a specific BWP: the R&S FSV/A takes the average over all slots in the selected BWP.
- If you select a specific subframe: the R&S FSV/A takes the average over all slots in the selected subframe.
- If you select a specific slot: the R&S FSV/A shows the result for that slot.
Note that selecting a specific slot for the subframe results (frequency and sampling error) will not make a difference, because those results are always calculated over a complete subframe.

The current evaluation range is indicated in the header row of the slot statistics.

Multiple carrier analysis

For measurements on [multiple carriers](#), the contents of the result summary depend on your configuration, especially the [CC result](#) setting.

- Select "CC Result" = "All" to display information about all component carriers, regardless of the number of component carriers.
 - The "All" tab shows the average results for all component carriers. Each column in the table corresponds to one component carrier.
 - The "View <x>" tabs show the detailed results for the component carriers assigned to the two [views](#).
- Select "CC Result" = "Viewed" to display information about the component carriers assigned to the two views.
 - The "All" tab shows the average results for the two selected component carriers. Depending on your selection in the result summary header, the results are either averaged over all frames, or relate to a single frame.
 - The "View <x>" tabs show the detailed results for the component carriers assigned to the two views. Depending on your selection in the result summary header, the results are either averaged over all frames, or relate to a single, selected frame.
If you analyze only one frame, the results are the same in both cases.

Note that analyzing all component carriers is slower compared analyzing the viewed component carriers, because of the post-processing that occurs during the analysis. Thus, if time is an issue, you can select two component carriers to analyze, and, if you are later interested in the characteristics of another component carrier, analyze that component carrier later (the data of the other carriers is available, just not analyzed).

Units

Most of the units of the results are fixed.

The unit of the EVM results depends on the selected [EVM unit](#).

Remote queries	24
EVM PDSCH	24
BLER (%)	24
TPUT (%)	25
Frame Start Offset	25
EVM All	25
EVM Peak	25
EVM Phys Channel	25
EVM Phys Signal	26
Frequency Error	26
Sampling Error	26
Power	26
I/Q Offset	26
I/Q Gain Imbalance	26
I/Q Quadrature Error	27
Crest Factor	27

OSTP.....	27
RSTP.....	27
RSRP.....	27

Remote queries

The remote commands to query individual results and limit check results are indicated in the description of the respective result.

Alternatively, you can query all results or limit check results at the same time using a single command.

Remote command:

Results: `FETCh[:CC<cc>][:ISRC<ant>][:FRAMe<fr>]:SUMMary:ALL?`
on page 233

Limit check: `CALCulate<n>:LIMit[:CC<cc>][:ISRC<ant>][:FRAMe<fr>]:SUMMary:ALL:RESult?` on page 258

EVM PDSCH

Shows the EVM for all PDSCH resource elements with a certain modulation in the analyzed frame (QPSK, 16QAM, 64QAM, 256QAM).

[Limit](#) evaluation supported.

Remote command:

QPSK: `FETCh[:CC<cc>][:ISRC<ant>][:FRAMe<fr>]:SUMMary:EVM:DSQP[:AVERage]?` on page 238

16QAM: `FETCh[:CC<cc>][:ISRC<ant>][:FRAMe<fr>]:SUMMary:EVM:DSST[:AVERage]?` on page 239

64QAM: `FETCh[:CC<cc>][:ISRC<ant>][:FRAMe<fr>]:SUMMary:EVM:DSSF[:AVERage]?` on page 239

256QAM: `FETCh[:CC<cc>][:ISRC<ant>][:FRAMe<fr>]:SUMMary:EVM:DSTS[:AVERage]?` on page 240

Limit check QPSK: `CALCulate<n>:LIMit[:CC<cc>][:ISRC<ant>][:FRAMe<fr>]:SUMMary:EVM:DSQP[:AVERage]:RESult?` on page 259

Limit check 16QAM: `CALCulate<n>:LIMit[:CC<cc>][:ISRC<ant>][:FRAMe<fr>]:SUMMary:EVM:DSST[:AVERage]:RESult?` on page 260

Limit check 64QAM: `CALCulate<n>:LIMit[:CC<cc>][:ISRC<ant>][:FRAMe<fr>]:SUMMary:EVM:DSSF[:AVERage]:RESult?` on page 259

Limit check 256QAM: `CALCulate<n>:LIMit[:CC<cc>][:ISRC<ant>][:FRAMe<fr>]:SUMMary:EVM:DSTS[:AVERage]:RESult?` on page 261

BLER (%)

Shows the block error rate (BLER) for all code blocks used by the PDSCH as a percentage. The BLER is the ratio of the number of erroneously transmitted code blocks to all code blocks in the analyzed frame.

Note that the result is only calculated if the number of bits per code block is identical for all allocations.

To see the BLER results, you have turn on the [throughput measurement](#).

Remote command:

`FETCh[:CC<cc>][:ISRC<ant>][:FRAMe<fr>]:SUMMary:BLER[:AVERage]?`
on page 236

TPUT (%)

Shows the throughput for all code blocks used by the PDSCH. The BLER is the ratio of the number of successfully transmitted code blocks to all code blocks in the analyzed frame.

Note that the result is only calculated if the number of bits per code block is identical for all allocations.

To see the throughput results, you have to turn on the [throughput measurement](#).

Remote command:

`FETCh[:CC<cc>][:ISRC<ant>][:FRAME<fr>]:SUMMARY:TPUT[:AVERAGE]?`
on page 250

Frame Start Offset

Shows the start of the frame relative to the start of the capture buffer.

Unavailable for "Frame Averaged" results, otherwise refers to the selected frame.

Remote command:

`FETCh[:CC<cc>][:ISRC<ant>]:SUMMARY:TFrame?` on page 252

EVM All

Shows the EVM for all resource elements in the selected evaluation range.

The result is a weighted average over all resource elements (PDSCH, DMRS etc.). The number of occupied resource blocks and the number of used symbols of each allocation is taken into account in the calculation of the mean EVM. Therefore, a fully loaded PDSCH across multiple symbols gets a much higher weight than a single symbol DMRS.

Remote command:

`FETCh[:CC<cc>][:ISRC<ant>][:FRAME<fr>]:SUMMARY:EVM[:ALL][:AVERAGE]?` on page 237

EVM Peak

Shows the EVM of the resource element with the highest EVM value in the selected evaluation range.

Unavailable for combined measurements.

Remote command:

`FETCh[:CC<cc>][:ISRC<ant>][:FRAME<fr>]:SUMMARY:EVM:PEAK[:AVERAGE]?` on page 241

EVM Phys Channel

Shows the EVM for all physical channel resource elements in the selected evaluation range.

A physical channel corresponds to a set of resource elements carrying information from higher layers. PDSCH, PUSCH, PBCH or PDCCH, for example, are physical channels.

Remote command:

`FETCh[:CC<cc>][:ISRC<ant>][:FRAME<fr>]:SUMMARY:EVM:PChannel[:AVERAGE]?` on page 241

EVM Phys Signal

Shows the EVM for all physical signal resource elements in the selected evaluation range.

The reference signal is a physical signal, for example.

Frequency Error

Shows the difference in the measured center frequency and the reference center frequency.

The frequency error is calculated over a subframe.

[Limits](#) are evaluated if you [turn on the limit check](#).

The R&S FSV/A checks the measured frequency error against the limits defined by 3GPP. The values are highlighted green (pass) or red (fail) respectively. The color of the mean value indicates the overall limit check passes or fails. Note that if you evaluate a single subframe only, the minimum, maximum and mean values are the same.

The limit values depend on the [base station category](#).

Remote command:

Result: `FETCh[:CC<cc>][:ISRC<ant>][:FRAME<fr>]:SUMMARY:FERRor[:AVERAge]?` on page 243

Limit check: `CALCulate<n>:LIMit[:CC<cc>][:ISRC<ant>][:FRAME<fr>]:SUMMARY:EVM:FERRor[:AVERAge]:RESult?` on page 261

Sampling Error

Shows the difference in measured symbol clock and reference symbol clock relative to the system sampling rate.

The sampling error is calculated over a subframe.

Remote command:

`FETCh[:CC<cc>][:ISRC<ant>][:FRAME<fr>]:SUMMARY:SERRor[:AVERAge]?` on page 248

Power

Shows the average time domain power for all resource elements in the selected evaluation range.

Remote command:

`FETCh[:CC<cc>][:ISRC<ant>][:FRAME<fr>]:SUMMARY:POWer[:AVERAge]?` on page 245

I/Q Offset

Shows the power at spectral line 0 normalized to the total transmitted power.

Not available for multiple BWPs.

Remote command:

`FETCh[:CC<cc>][:ISRC<ant>][:FRAME<fr>]:SUMMARY:IQOFFset[:AVERAge]?` on page 244

I/Q Gain Imbalance

Shows the logarithm of the gain ratio between the Q-channel and the I-channel.

Not available for multiple BWPs and only calculated if you [turn on the calculation](#).

Remote command:

`FETCh[:CC<cc>][:ISRC<ant>][:FRAME<fr>]:SUMMARY:GIMBalance[:AVERage]?` on page 243

I/Q Quadrature Error

Shows the measure of the phase angle between Q-channel and I-channel deviating from the ideal 90 degrees.

Not available for multiple BWPs and only calculated if you [turn on the calculation](#).

Crest Factor

Shows the peak-to-average power ratio of the captured signal.

The peak power is determined over multiple frames.

Remote command:

`FETCh[:CC<cc>][:ISRC<ant>]:SUMMARY:CRESt[:AVERage]?` on page 234

OSTP

Shows the OFDM symbol transmit power.

The result is the average power of all OFDM symbols that carry PDSCH and not containing PDCCH, RS or SSB within a slot.

Not available for multiple BWPs.

Remote command:

`FETCh[:CC<cc>][:ISRC<ant>][:FRAME<fr>]:SUMMARY:OSTP[:AVERage]?` on page 244

RSTP

Shows the reference signal transmit power.

The result is an average over all PDSCH DMRS within a frame. For the calculation, the R&S FSV/A first averages all DMRS in each slot, and then averages this value over all slots in a frame.

Remote command:

`FETCh[:CC<cc>][:ISRC<ant>][:FRAME<fr>]:SUMMARY:RSTP[:AVERage]?` on page 247

RSRP

Shows the reference signal receive power for the CSI reference signal (CSI-RSRP) and the second synchronization reference signal (SS-RSRP) as defined in 3GPP 38.215.

It is an average power over all resource elements that carry the CSI or SS reference signal.

Remote command:

CSI-RSRP: `FETCh[:CC<cc>][:ISRC<ant>][:FRAME<fr>]:SUMMARY:RSRP:CSI[:AVERage]?` on page 246

SS-RSRP: `FETCh[:CC<cc>][:ISRC<ant>][:FRAME<fr>]:SUMMARY:RSRP:SS[:AVERage]?` on page 247

3.5 I/Q measurements

Access: [MEAS] > "EVM/Frequency Err/Power"

For I/Q measurements, the R&S FSV/A captures and then analyzes the demodulated I/Q data. I/Q measurements provide various result displays that show different aspects and characteristics of the captured signal.

You can select the result displays from the evaluation bar and arrange them as you like with the SmartGrid functionality.

Remote command:

Measurement selection: `CONFigure[:NR5G]:MEASurement` on page 295

Result display selection: `LAYout:ADD[:WINDow]?` on page 220

Capture Buffer.....	28
EVM vs Carrier.....	29
EVM vs Symbol.....	30
EVM vs RB.....	31
Frequency Error vs Symbol.....	31
Frequency Error vs Subframe.....	32
Power Spectrum.....	33
Flatness.....	33
CCDF.....	34
Constellation Diagram.....	35
Allocation Summary.....	36
Channel Decoder Results.....	36
Bitstream.....	37
EVM vs Symbol x Carrier.....	39
Power vs Symbol x Carrier.....	39
Allocation ID vs Symbol x Carrier.....	40
RS Magnitude.....	40
RS Phase.....	41
RS Phase Difference.....	42
Beamforming Summary.....	43
Marker Table.....	43

Capture Buffer

The "Capture Buffer" shows the complete range of captured data for the last data capture.

The x-axis represents time. The maximum value of the x-axis is equal to the [Capture Time](#).

The y-axis represents the amplitude of the captured I/Q data in dBm (for RF input).

The capture buffer uses the auto peak detector to evaluate the measurement data. The auto peak detector determines the maximum and the minimum value of the measured levels for each measurement point and combines both values in one sample point.

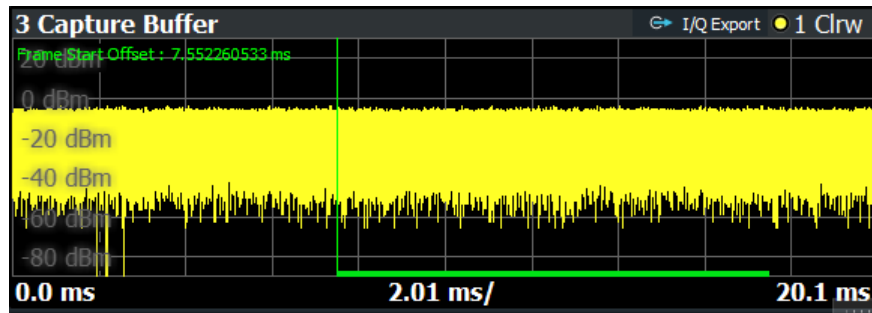

Figure 3-1: Capture buffer without zoom

A green bar at the bottom of the diagram represents the frame that is currently analyzed.

A green vertical line at the beginning of the green bar in the capture buffer represents the frame start. The diagram also contains the "Start Offset" value. This value is the time difference between the frame start and capture buffer start.

The header of the "Capture Buffer" result display contains an "I/Q Export" button that allows you to export I/Q data easily.

Remote command:

Selection: `LAY:ADD ? '1',LEFT,CBUF`

Query (y-axis): `TRACe:DATA?`

Query (x-axis): `TRACe<n>[:DATA]:X?` on page 293

Frame start offset: `FETCh[:CC<cc>][:ISRC<ant>]:SUMMary:TFRame?` on page 252

EVM vs Carrier

The "EVM vs Carrier" result display shows the error vector magnitude (EVM) of the subcarriers. With the help of a marker, you can use it as a debugging technique to identify any subcarriers whose EVM is too high.

The results are based on an average EVM that is calculated over the resource elements for each subcarrier. This average subcarrier EVM is determined for each analyzed slot in the capture buffer.

The contents of the result display depend on the [evaluation range](#).

- If you analyze all synchronization signals (SS) and bandwidth parts (BWP), the result display contains one trace for the [synchronization signal](#) and a variable number of traces that represent the [bandwidth parts](#). The traces show the average EVM of the corresponding signal part. The diagram header contains a legend that shows the information that each trace carries.
- If you analyze only the synchronization signal, one specific bandwidth part, or a single subframe, the diagram contains three traces. The traces show the following information.
 - The average subcarrier EVM over all slots in the selected signal part.
 - The lowest subcarrier EVM over all slots in the selected signal part.
 - The highest subcarrier EVM over all slots in the selected signal part.
- If you analyze only a single slot, the diagram contains one trace. That trace shows the subcarrier EVM for that slot only. Average, minimum and maximum values in that case are the same.

The x-axis represents the center frequencies of the subcarriers. The y-axis shows the EVM in % or in dB, depending on the [EVM Unit](#).

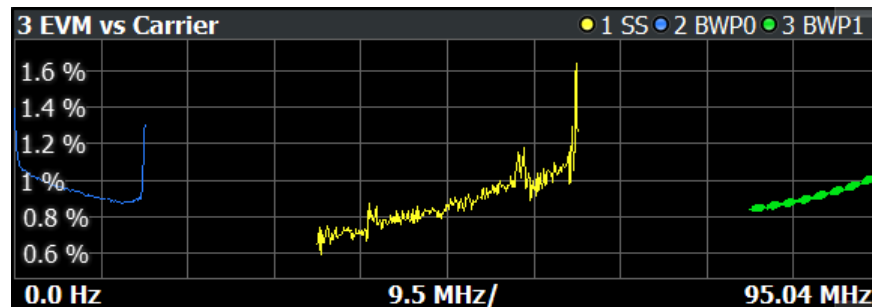

Remote command:

Selection `LAY:ADD ? '1',LEFT,EVCA`

Query (y-axis): `TRACe:DATA?`

Query (x-axis): `TRACe<n>[:DATA]:X?` on page 293

EVM vs Symbol

The "EVM vs Symbol" result display shows the error vector magnitude (EVM) of the OFDM symbols. You can use it as a debugging technique to identify any symbols whose EVM is too high.

The results are based on an average EVM that is calculated over the resource elements for each subcarrier. This average subcarrier EVM is determined for each analyzed slot in the capture buffer.

The contents of the result display depend on the [evaluation range](#).

- If you analyze all synchronization signals (SS) and bandwidth parts (BWP), the result display contains one trace for the [synchronization signal](#) and a variable number of traces that represent the [bandwidth parts](#). The diagram header contains a legend that shows the information that each trace carries.
- If you analyze only the synchronization signal, one specific bandwidth part, a single subframe or a single slot, the diagram contains one trace. That trace shows the average EVM of the symbols in the selected signal part.

The x-axis represents the OFDM symbols, with each symbol represented by a dot on the line. Any missing connections from one dot to another mean that the R&S FSV/A could not determine the EVM for that symbol.

On the y-axis, the EVM is plotted either in % or in dB, depending on the [EVM Unit](#).

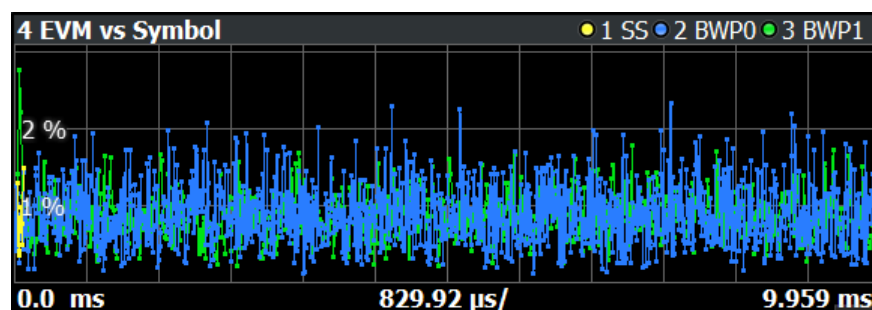

Remote command:

Selection: `LAY:ADD ? '1',LEFT,EVSY`

Query (y-axis): `TRACe:DATA?`

Query (x-axis): `TRACe<n>[:DATA]:X?` on page 293

EVM vs RB

The "EVM vs RB" result display shows the Error Vector Magnitude (EVM) for all resource blocks that can be occupied by the PDSCH.

The contents of the result display depend on the [evaluation range](#).

- If you analyze all synchronization signals (SS) and bandwidth parts (BWP), the result display contains one trace for the [synchronization signal](#) and a variable number of traces that represent the [bandwidth parts](#). The traces show the average EVM of the corresponding signal part. The diagram header contains a legend that shows the information that each trace carries.
- If you analyze only the synchronization signal, one specific bandwidth part, or a single subframe, the diagram contains three traces. The traces show the following information.
 - The average subcarrier EVM over all slots in the selected signal part.
 - The lowest subcarrier EVM over all slots in the selected signal part.
 - The highest subcarrier EVM over all slots in the selected signal part.
- If you analyze only a single slot, the diagram contains one trace. That trace shows the subcarrier EVM for that slot only. Average, minimum and maximum values in that case are the same.

If you select and analyze one subframe only, the result display contains one trace that shows the resource block EVM for that subframe only. Average, minimum and maximum values in that case are the same. For more information, see "[Subframe Selection](#)" on page 204.

The x-axis represents the PDSCH resource blocks. On the y-axis, the EVM is plotted either in % or in dB, depending on the [EVM Unit](#).

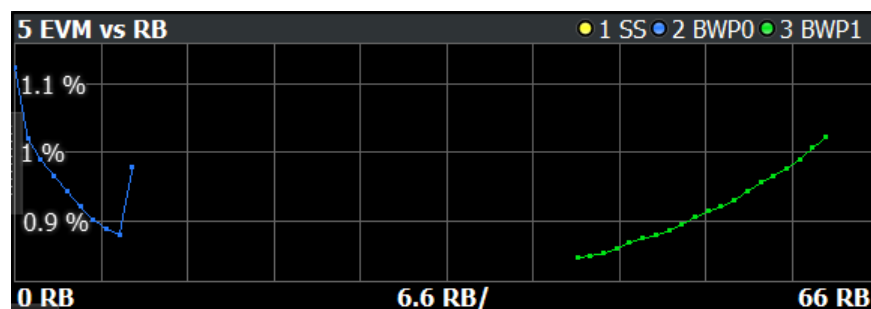

Remote command:

Selection: `LAY:ADD ? '1',LEFT,EVRB`

Query (y-axis): `TRACe:DATA?`

Query (x-axis): `TRACe<n>[:DATA]:X?` on page 293

Frequency Error vs Symbol

The "Frequency Error vs Symbol" result display shows the frequency error of each symbol. You can use it as a debugging technique to identify any frequency errors within symbols.

The result is an average over all subcarriers in the symbol.

The contents of the result display depend on the [evaluation range](#).

- If you analyze all synchronization signals (SS) and bandwidth parts (BWP), the result display contains one trace for the [synchronization signal](#) and a variable number of traces that represent the [bandwidth parts](#). The diagram header contains a legend that shows the information that each trace carries.
- If you analyze only the synchronization signal, one specific bandwidth part, a single subframe or a single slot, the diagram contains one trace. That trace shows the average frequency error of the symbols in the selected signal part.

The x-axis represents the OFDM symbols, with each symbol represented by a dot on the line. The number of displayed symbols depends on the [subframe selection](#). Any missing connections from one dot to another mean that the R&S FSV/A could not determine the frequency error for that symbol.

On the y-axis, the frequency error is plotted in Hz.

Note that the variance of the measurement results in this result display can be much higher compared to the frequency error display in the numerical result summary, depending on the PDSCH and control channel configuration. The potential difference is caused by the number of available resource elements for the measurement on symbol level.

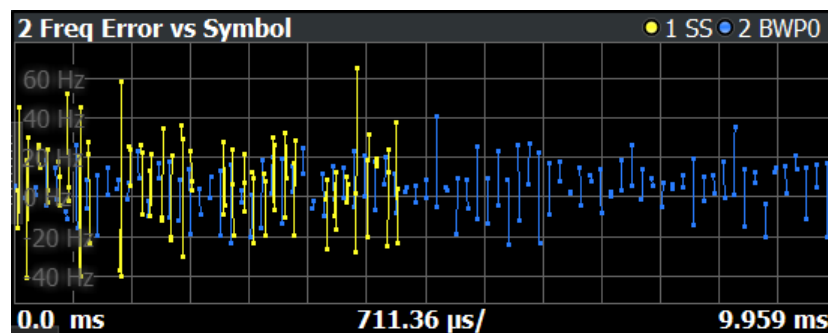

Remote command:

Selection: `LAY:ADD ? '1',LEFT,FEVS`

Query (y-axis): `TRACe:DATA?`

Query (x-axis): `TRACe<n> [:DATA] :X?` on page 293

Frequency Error vs Subframe

The "Frequency Error vs Subframe" result display shows the frequency error of each subframe. You can use it as a debugging technique to identify any frequency errors among subframes.

The result is an average over all subcarriers and symbols of each subframe.

The contents of the result display depend on the [evaluation range](#).

- If you analyze all synchronization signals (SS) and bandwidth parts (BWP), the result display contains one trace for the [synchronization signal](#) and a variable number of traces that represent the [bandwidth parts](#). The diagram header contains a legend that shows the information that each trace carries.
- If you analyze only the synchronization signal or one specific bandwidth part, the diagram contains one trace. That trace shows the average frequency error of the

subframes in the selected signal part. Selecting a specific subframe or slot from the evaluation range has no effects on the contents of the diagram.

The x-axis represents the subframes, with each of the nine subframes represented by a dot on the line.

On the y-axis, the frequency error is plotted in Hz.

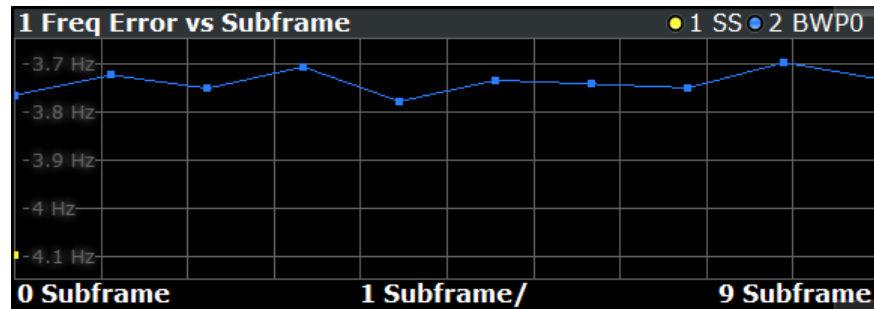

Remote command:

Selection: `LAY:ADD ? '1', LEFT, FEVS`

Query (y-axis): `TRACe:DATA?`

Query (x-axis): `TRACe<n>[:DATA]:X?` on page 293

Power Spectrum

The "Power Spectrum" shows the power density of the complete capture buffer in dBm/Hz.

The displayed bandwidth depends on the [channel bandwidth](#).

The x-axis represents the frequency. On the y-axis, the power level is plotted.

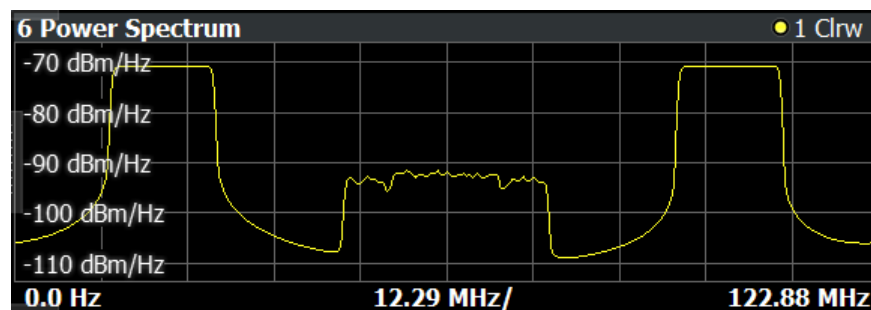

Remote command:

Selection: `LAY:ADD ? '1', LEFT, PSPE`

Query (y-axis): `TRACe:DATA?`

Query (x-axis): `TRACe<n>[:DATA]:X?` on page 293

Flatness

The "Channel Flatness" result shows the relative power offset caused by the transmit channel for each subcarrier.

The contents of the result display depend on the [evaluation range](#).

- If you analyze all synchronization signals (SS) and bandwidth parts (BWP), the result display contains one trace for the [synchronization signal](#) and a variable number of traces that represent the [bandwidth parts](#). The traces show the average flat-

ness of the corresponding signal part. The diagram header contains a legend that shows the information that each trace carries.

- If you analyze only the synchronization signal, one specific bandwidth part, a specific frame or a single subframe, the diagram contains three traces. The traces show the following information.
 - The average subcarrier flatness over all slots in the selected signal part.
 - The lowest subcarrier flatness over all slots in the selected signal part.
 - The highest subcarrier flatness over all slots in the selected signal part.
- If you analyze only a single slot, the diagram contains one trace. That trace shows the subcarrier flatness for that slot only. Average, minimum and maximum values in that case are the same.

The x-axis represents the frequency. On the y-axis, the channel flatness is plotted in dB.

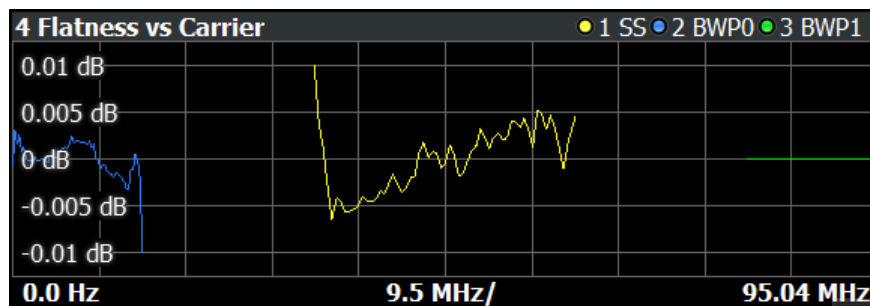

Remote command:

Selecting the result display: `LAY:ADD ? '1', LEFT, FLAT`

Querying results:

`TRACe:DATA?`

`TRACe<n>[:DATA]:X?` on page 293

CCDF

The "Complementary Cumulative Distribution Function (CCDF)" shows the probability of an amplitude exceeding the mean power. For the measurement, the complete capture buffer is used.

The x-axis represents the power relative to the measured mean power. On the y-axis, the probability is plotted in %.

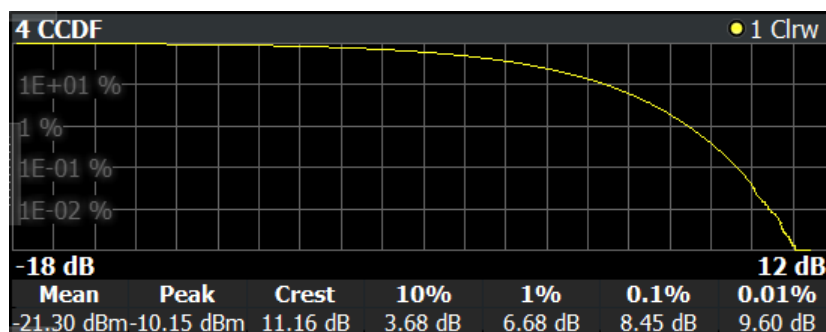

In addition to the diagram, the results for the CCDF measurement are summarized in the CCDF table.

Mean	Mean power
Peak	Peak power
Crest	Crest factor (peak power – mean power)
10 %	10 % probability that the level exceeds mean power + [x] dB
1 %	1 % probability that the level exceeds mean power + [x] dB
0.1 %	0.1 % probability that the level exceeds mean power + [x] dB
0.01 %	0.01 % probability that the level exceeds mean power + [x] dB

Remote command:

Selection: `LAY:ADD ? '1',LEFT,CCDF`

Query (y-axis): `TRACe:DATA?`

Numerical results: `CALCulate<n>:STATistics:CCDF:X<t>?` on page 256

Numerical results: `CALCulate<n>:STATistics:RESult<res>?` on page 256

Constellation Diagram

The "Constellation Diagram" shows the in-phase and quadrature phase results and is an indicator of the quality of the modulation of the signal.

In the default state, the result display evaluates the full range of the measured input data.

If you apply a boosting factor to resources as required by 3GPP for certain test models, the constellation diagram excludes that boosting factor to display the constellation diagram points by default. To consider the boosting factor for the calculation of the constellation points, turn on the [corresponding parameter](#).

The color represent either the modulation type or the allocation type, depending on your selection. The color mapping for modulation is as follows. The color mapping for allocations is the same as in the [allocation ID vs symbol vs carrier](#) result display.

- : RBPSK
- : QPSK
- : 16QAM
- : 64QAM
- : 256QAM
- : 1024QAM

You can filter the results by changing the [evaluation range](#).

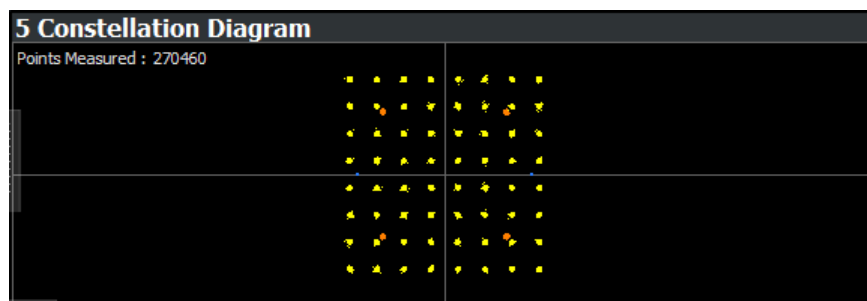

The constellation diagram shows the number of points that are displayed in the diagram.

Remote command:

Selection: `LAY:ADD ? '1', LEFT, CONS`

Query: `TRACe:DATA?`

Allocation Summary

The "Allocation Summary" shows various parameters of the measured allocations in a table.

Each row in the allocation table corresponds to an allocation. A set of several allocations make up a slot. A horizontal line indicates the beginning of a new slot. Special allocations summarize the characteristics of all allocations in a bandwidth part ("BWP ALL") and the radio frame ("TOTAL ALL").

The "BWP ALL" and "TOTAL ALL" values are an average of all EVM values in the table. For example: $(\text{EVM PDSCH 1} + \text{EVM PDSCH 2} + \text{EVM PDSCH 3} + \text{EVM DMRS}) / 4$. Each value has the same weight. Therefore, a fully loaded PDSCH across multiple symbols has the same weight a single symbol DMRS.

1 Allocation Summary						
BWP/SF/Slot	Allocation ID	No of RBs	Rel Power [dB]	Modulation	Power per RE [dBm]	EVM [%]
SS / 1 / 3	PSS 6		0.000	RBPSK	-23.113	0.003
	SSS 6		0.000	RBPSK	-23.113	0.003
	PBCH 6		0.000	QPSK	-23.113	0.003
	PBCH DMRS 6		0.000	QPSK	-23.113	0.003
	PSS 7		0.000	RBPSK	-23.113	0.003
	SSS 7		0.000	RBPSK	-23.113	0.003
	PBCH 7		0.000	QPSK	-23.113	0.003
	PBCH DMRS 7		0.000	QPSK	-23.113	0.003
	BWP ALL	273				0.003
	0 / 0 / 0	CORESET 0	270	0.000	QPSK	-23.113

The columns of the table show the following properties for each allocation.

- The location of the allocation (slot, subframe, bandwidth part number).
- The ID of the allocation (channel type).
- Number of resource blocks used by the allocation.
- The relative power of the allocation in dB.
- The modulation of the allocation.
- The power of each resource element in the allocation in dBm.
- The EVM of the allocation.

The unit depends on the [EVM unit](#)

Select "TableConfig" to open a dialog box that allows you to add and remove columns.

Remote command:

Selection: `LAY:ADD ? '1', LEFT, ASUM`

Query: `TRACe:DATA?`

Channel Decoder Results

The "Channel Decoder" result display shows the characteristics of various channels in a specific subframe.

The size of the table thus depends on the number of subframes and the number of channels that were decoded.

The R&S FSV/A can decode the following channels, if they are present.

- Protocol information of the PBCH.

2 Channel Decoder Results					
SUBF / SSB	Allocation ID	Data			
SUBF 0 / SSB 0	PBCH	SSBIndexExplicitFR2	1		
		HalfFrameIndex	secondHalf	systemFrameNumber	922
		sub-carrierOffset	8	dmrs-TypeA-Position	pos3
		cellBarred	not barred	intraFreqReselection	not allowe
SUBF 0 / SSB 1	PBCH	SSBIndexExplicitFR2	0		
		HalfFrameIndex	secondHalf	systemFrameNumber	403
		sub-carrierOffset	6	dmrs-TypeA-Position	pos2
		cellBarred	not barred	intraFreqReselection	not allowe

For each channel type, the table contains a different set of values.

- PBCH

Information as defined in 3GPP 38.331, for example:

- The half frame index
- The system frame number
- The [subcarrier spacing](#)
- The [subcarrier offset](#)
- The [DMRS Type A position](#)

If the CRC is not valid, the R&S FSV/A shows a corresponding message instead of the results.

- PDCCH

Information about the [DCI fields](#) in the signal as defined by 3GPP. This includes the field name and transmitted field values.

To decode the PDCCH, you have to demodulate the [decoded payload data](#).

Remote command:

Selecting the result display: `LAY:ADD ? '1', LEFT, CDEC`

Querying results: `TRACe:DATA?`

Bitstream

The "Bitstream" shows the demodulated data stream for the data allocations.

Each row in the table corresponds to an allocation (PDSCH or CORESET). A set of several allocations make up a slot.

At the end of the table is a summary of the bitstream for certain configurations.

- Total number of bits or symbols
- Total number of coded bits
- Total number of bit errors
- Bit error rate (BER) in percent
- Bits per second (= coded bits - bit errors)

The totals are calculated over all PDSCH allocations that contribute to the bitstream. If the crc fails for one of the allocations, the R&S FSV/A returns NAN for the total numbers.

The bitstream summary is displayed under the following conditions.

- Select an ORAN test case.
The PDSCH [reference data](#) must be "ORAN PN23".
- Outside of ORAN test cases:

Select PDSCH [reference data](#) = "All 0" or "PN23" or [demodulation data](#) = "Decoded Payload Data".

Depending on the [bitstream format](#), the numbers represent either bits (bit order) or symbols (symbol order).

- For the bit format, each number represents one raw bit.
- For the symbol format, the bits that belong to one symbol are shown as hexadecimal numbers with two digits.
(1024QAM: hexadecimal number with three digits)

Resource elements that do not contain data or are not part of the transmission are represented by a "-".

BWP/Sf/Slot	Allocation ID	Code-word	Modulation	# Symbols	Bitstream
SS / 0 / 0	PBCH 0	1/1	QPSK	432	02 01 03 00 03 02 00 02 02
SS / 0 / 0	PBCH 1	1/1	QPSK	432	02 01 01 03 03 00 03 03 00
0 / 0 / 0	PDSCH 0	1/1	QPSK	39990	00 02 03 01 00 00 01 00 02
0 / 0 / 1	PDSCH 0	1/1	QPSK	40050	02 03 01 00 02 03 01 00 02

The table contains the following information:

- **BWP / Sf / Slot**
Number of the bandwidth part, subframe and slot the bits belong to.
- **Allocation ID**
Channel the bits belong to.
This is either a PDSCH, PDCCH or PBCH allocation.
If you [bundle PDSCH allocations](#), a row combines the information for all allocations with the same user ID.
- **Codeword**
Code word of the allocation.
- **Modulation**
Modulation type of the channels.
- **# Symbols / # Bits**
Number of symbols in the allocation.
- **Bit Stream**
The actual bit stream.
The table only shows the first few bits for each slot. If you want to see the complete bitstream, you have to select a certain bandwidth part, subframe and slot from the [evaluation range](#). When you have done that, you can select "Extended" bitstream from the header row.

# Symbols	Bitstream Extended [Compact]
3756	00 00 00 00 00 00 00 00 00 00 00 00 00 00 00 00 ...

Symbol Index	Bitstream [Extended] Compact
0	00 00 00 00 00 00 00 00 00 00 00 00 00 00 00 00
16	00 00 00 00 00 00 00 00 00 00 00 00 00 00 00 00
32	00 00 00 00 00 00 00 00 00 00 00 00 00 00 00 00
48	00 00 00 00 00 00 00 00 00 00 00 00 00 00 00 00
64	00 00 00 00 00 00 00 00 00 00 00 00 00 00 03 00
80	00 00 00 00 00 00 00 00 00 00 00 00 00 00 00 00
96	00 00 00 00 00 00 00 00 00 00 00 00 00 00 00 00

Figure 3-2: Compact vs extended bitstream (symbol format for coded data)

In the extended display, the "# Symbols" / "# Bits" column turns into the "Bit Index" or "Symbol Index" column, which indicates the position of the table row's first bit or symbol within the complete stream.

If you decode the payload data, the R&S FSV/A shows the number of coded bits (# symbols * Number of bits per symbol) and the number of bit errors at the end of the bitstream. The number of info bits transmitted by the PDCCH is displayed in a dedicated column ("# Bits").

Remote command:

Selection: `LAY:ADD ? '1',LEFT,BSTR`

Query: `TRACe:DATA?`

EVM vs Symbol x Carrier

The "EVM vs Symbol x Carrier" result display shows the EVM for each carrier in each symbol.

The x-axis represents the symbols. The y-axis represents the subcarriers. Different colors in the diagram area represent the EVM. A color map in the diagram header indicates the corresponding power levels.

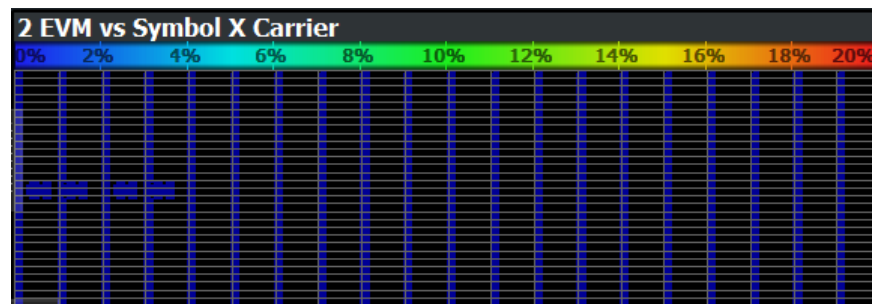

Remote command:

Selection: `LAY:ADD ? '1',LEFT,EVSC`

Query: `TRACe:DATA?`

Power vs Symbol x Carrier

The "Power vs Symbol x Carrier" result display shows the power for each carrier in each symbol.

The x-axis represents the symbols. The y-axis represents the subcarriers. Different colors in the diagram area represent the power. A color map in the diagram header indicates the corresponding power levels.

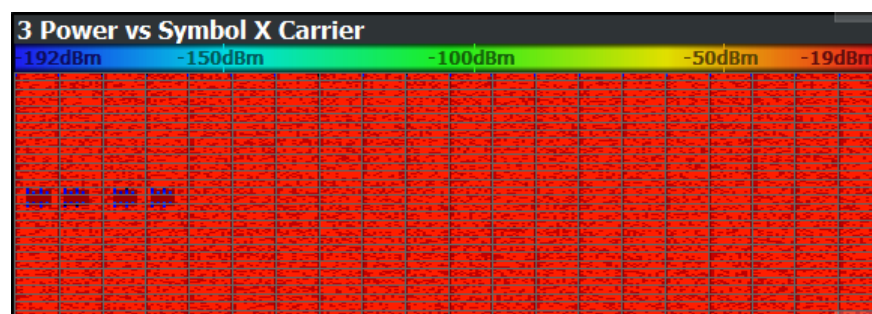

Remote command:

Selection: `LAY:ADD ? '1',LEFT,PVSC`

Query: `TRACe:DATA?`

Allocation ID vs Symbol x Carrier

The "Allocation ID vs Symbol x Carrier" result display is a graphical representation of the structure of the analyzed frame. It shows the allocation type of each subcarrier in each symbol of the received signal.

The x-axis represents the OFDM symbols. The y-axis represents the subcarriers.

Each type of allocation is represented by a different color. The legend above the diagram indicates the colors used for each allocation. You can also use a marker to get more information about the type of allocation.

The color mapping is as follows.

- █: PDSCH allocations
- █: CORESET allocations
- █: DMRS allocations (PBCH, CORESET, PDSCH)
- █: PTRS allocations
- █: CSI-RS and PRS allocations
- █: Synchronization signal allocations (PSS, SSS, PBCH)

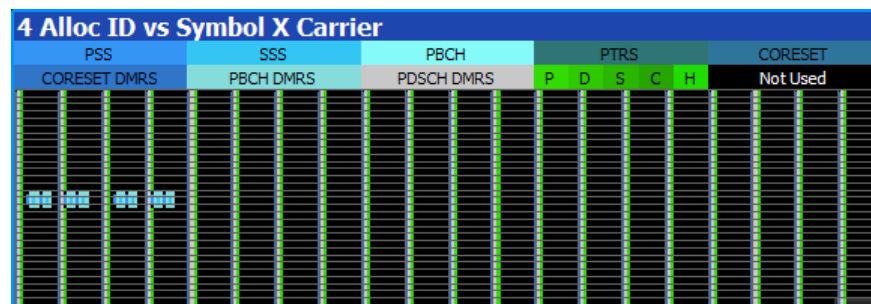

Remote command:

Selection: `LAY:ADD ? '1',LEFT,AISC`

Query: `TRACe:DATA?`

RS Magnitude

The "RS Magnitude" result display shows the magnitude of the carriers occupied by various reference signals (PDSCH, PDCCH etc.) on different antenna ports (AP).

The contents of the result display depend on the [evaluation range](#).

- If you analyze all antenna ports, the result display contains one trace for each antenna port. The traces show the average magnitude of the corresponding antenna port. The diagram header contains a legend that shows the information that each trace carries.
- If you analyze a specific antenna port, the diagram contains three traces.
 - The average magnitude over all slots on the selected antenna port.
 - The lowest magnitude over all slots on the selected antenna port.
 - The highest magnitude over all slots on the selected antenna port.
- If you analyze only a single slot, the diagram contains one trace. That trace shows the magnitude for that slot only. Average, minimum and maximum values in that case are the same.

The x-axis represents the frequency, with the unit depending on your [selection](#). The y-axis shows the magnitude of each antenna port in dB.

Because the beamforming configuration can change between the slots of one frame, the contents of this result display for [Slot Selection](#) = 'All' might be invalid. Thus, it is recommended to select the precise slot to be evaluated in order to get valid results.

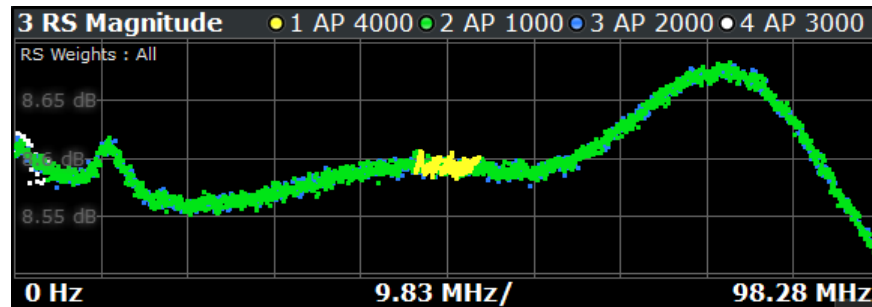

Remote command:

Selection: `LAY:ADD ? '1',LEFT,RSMA`

Query: `TRACe:DATA?`

RS Phase

The "RS Phase" result display shows the phase of the carriers occupied by various reference signals (PDSCH, PDCCH etc.) on different antenna ports (AP).

The contents of the result display depend on the [evaluation range](#).

- If you analyze all antenna ports, the result display contains one trace for each antenna port. The traces show the average phase of the corresponding antenna port. The diagram header contains a legend that shows the information that each trace carries.
- If you analyze a specific antenna port, the diagram contains three traces.
 - The average phase over all slots on the selected antenna port.
 - The lowest phase over all slots on the selected antenna port.
 - The highest phase over all slots on the selected antenna port.
- If you analyze only a single slot, the diagram contains one trace. That trace shows the phase for that slot only. Average, minimum and maximum values in that case are the same.

The x-axis represents the frequency, with the unit depending on your [selection](#). The y-axis shows the phase of each antenna port in degrees.

Because the beamforming configuration can change between the slots of one frame, the contents of this result display for [Slot Selection](#) = 'All' might be invalid. Thus, it is recommended to select the precise slot to be evaluated in order to get valid results.

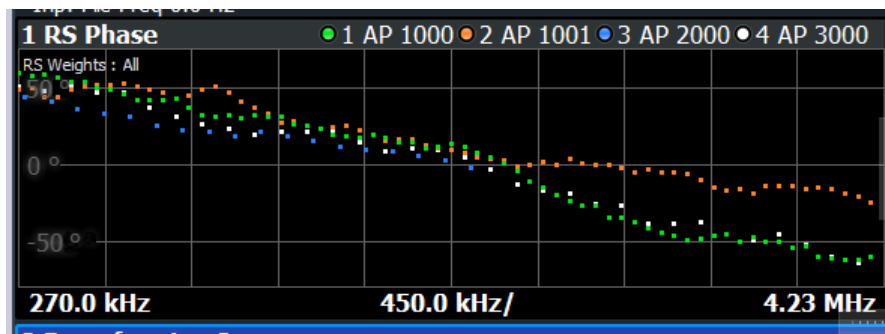

Remote command:

Selection: `LAY:ADD ? '1',LEFT,RSWP`

Query: `TRACe:DATA?`

RS Phase Difference

The "RS Phase Difference" result display shows the phase difference of different antenna ports (AP) relative to a [reference antenna port](#).

The contents of the result display depend on the [evaluation range](#).

- If you analyze all antenna ports, the result display contains one trace for each antenna port (but not the reference antenna port). The traces show the average phase deviation of the corresponding antenna port to the reference antenna port. The diagram header contains a legend that shows the information that each trace carries.
- If you analyze a specific antenna port, the diagram contains three traces.
 - The average phase deviation over all slots on the selected antenna port.
 - The lowest phase deviation over all slots on the selected antenna port.
 - The highest phase deviation over all slots on the selected antenna port.
- If you analyze only a single slot, the diagram contains one trace. That trace shows the phase deviation for that slot only. Average, minimum and maximum values in that case are the same.

The x-axis represents the frequency, with the unit depending on your [selection](#). The y-axis shows the phase deviation of each evaluated antenna port in degrees.

Because the beamforming configuration can change between the slots of one frame, the contents of this result display for [Slot Selection](#) = 'All' might be invalid. Thus, it is recommended to select the precise slot to be evaluated in order to get valid results.

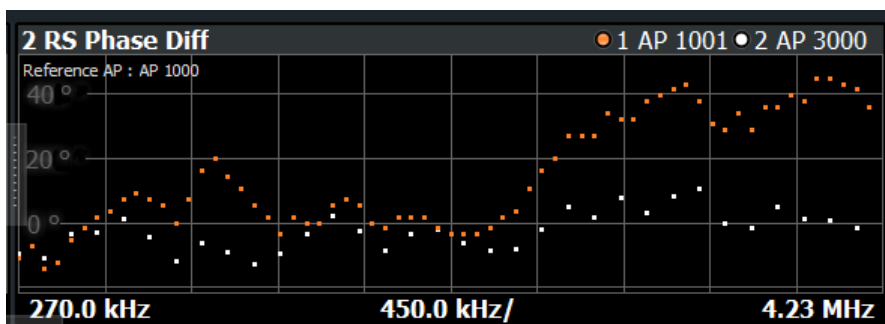

Remote command:

Selection: `LAY:ADD ? '1',LEFT,RSWP`

Query: `TRACe:DATA?`

Beamforming Summary

The "Beamforming Summary" shows the phase characteristics for each allocation used by the UE-specific reference signals (PDSCH, CORESET, CSI-RS etc.) in numerical form.

2 Beamforming Summary				
BWP/Sf/Slot	Allocation Type	Antenna Port	Phase [°]	Phase Diff [°]
0 / 0 / 0	PDSCH	AP 1000	0.000	
	CORESET	AP 2000	-134.124	-134.124
0 / 0 / 1	PDSCH	AP 1000	-0.000	
	CORESET	AP 2000	59.630	59.630
0 / 1 / 2	PDSCH	AP 1000	0.000	
	CORESET	AP 2000	-1068.054	-708.054

The rows in the table represent the allocation types. A set of allocations forms a slot. The slots are separated by a line. The columns of the table contain the following information:

- **BWP / SF / Slot**
Shows the location of the allocation (bandwidth part - subframe - slot).
- **Allocation Type**
Shows the type of the allocation.
- **Antenna Port**
Shows the antenna port used by the allocation.
- **Phase**
Shows the phase of the allocation in degrees.
- **Phase Diff(ference)**
Shows the phase difference of the allocation relative to the [reference antenna port](#).
- **Average RS Weights**
Shows the average [magnitude](#) of the weighted reference signal carriers in dB.
- **Rel Power**
Shows the power of each antenna port relative to the [reference AP](#) defined for the corresponding slot.
The relative power in combination with the phase difference allows you to calculate the beamforming.

Remote command:

Selection: `LAY:ADD ? '1', LEFT, BSUM`

Query: `TRACe:DATA?`

Marker Table

Displays a table with the current marker values for the active markers.

This table is displayed automatically if configured accordingly.

Wnd	Shows the window the marker is in.
Type	Shows the marker type and number ("M" for a normal marker, "D" for a delta marker).
Trc	Shows the trace that the marker is positioned on.

Ref	Shows the reference marker that a delta marker refers to.
X- / Y-Value	Shows the marker coordinates (usually frequency and level).
Z-EVM	Shows the "EVM", power and allocation type at the marker position. Only in 3D result displays (for example "EVM vs Symbol x Carrier").
Z-Power	
Z-Alloc ID	

5 Marker Table	
2 - M1	
Trace	1
X-value	Symbol 84
Y-value	Carrier 14
Z-EVM	772.99 %
Z-Power	-47.12 dBm
Z-Alloc ID	PHICH
4 - M1	
Trace	1
X-value	-495.000 kHz
Y-value	0.32 dB

Tip: To navigate within long marker tables, simply scroll through the entries with your finger on the touchscreen.

Remote command:

LAY:ADD? '1',RIGH, MTAB, see [LAYout:ADD\[:WINDow\]?](#) on page 220

Results:

[CALCulate<n>:MARKer<m>:X](#) on page 254

[CALCulate<n>:MARKer<m>:Y](#) on page 254

[CALCulate<n>:MARKer<m>:Z?](#) on page 255

[CALCulate<n>:MARKer<m>:Z:ALL?](#) on page 255

3.6 Time alignment error

Access: [MEAS] > "Time Alignment Error"

The time alignment error measurement captures the signal from different antenna ports and calculates the time offset between a reference antenna port and another antenna port(s).

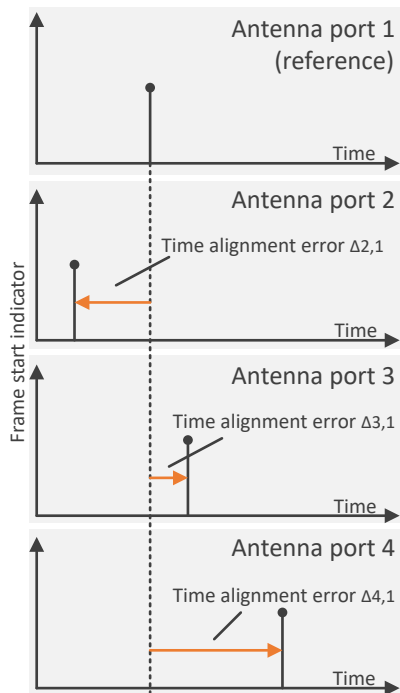

Figure 3-3: Time alignment error measurement (4 antenna ports)

Note that the measurement only works if you are analyzing [multiple layers](#) (antenna ports). Therefore, you have to mix the signals into one cable that you can connect to the R&S FSV/A.

Test setup

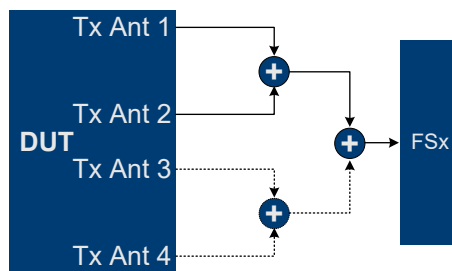

Figure 3-4: Hardware setup

The dashed lines are optional connections, and only necessary if you measure more than two antenna ports. For most accurate measurement results, we recommend to use cables of the same length and identical combiners as adders.

In addition to the result displays mentioned in this section, the time alignment error measurement also supports the following result displays described elsewhere.

- ["Capture Buffer"](#) on page 28
- ["Power Spectrum"](#) on page 33
- ["Marker Table"](#) on page 43

In the default layout, the application shows the "Time Alignment Error", "Capture Buffer" and "Power Spectrum" result displays.

The remote commands required to configure the time alignment error measurement are described in [Chapter 6.9.29, "Time alignment measurement"](#), on page 431.

Remote command:

Measurement selection: `CONFigure[:NR5G]:MEASurement` on page 295

Result display selection: `LAYout:ADD[:WINDow]?` on page 220

[Time Alignment Error](#)..... 46

Time Alignment Error

The time alignment is an indicator of how well the transmission antennas or antenna ports in a MIMO system and between component carriers are synchronized. The time alignment error is the time delay between a reference antenna port and another antenna port. The reference is [antenna port 1000](#). For measurements on multiple carriers, the reference is antenna port 1000 of the first component carrier.

As AP1000 is the reference antenna port, it must be sent. Otherwise result are invalid.

The application shows the results in a table.

- For single carrier MIMO measurements, each row in the table represents one antenna port.
- For multi carrier measurements, each row in the table represents one antenna port for each carrier.

The number of rows therefore depends on the [number of carriers](#) and the [PDSCH antenna port configuration](#).

The reference antenna port is not shown in the table (all results would be "0").

For each antenna, the maximum, minimum and average time delay that has been measured is shown. The minimum and maximum results are calculated only if the measurement covers more than one frame.

In any case, results are only displayed if the transmission power of both antennas ports is within 15 dB of each other. Likewise, if only one antenna transmits a signal, results will not be displayed (for example if the cabling on one antenna is faulty).

The "Limit" value shown in the result display is the maximum time delay that may occur for each antenna (only displayed for systems without carrier aggregation).

You can define a custom limit for the time alignment error. For more information, see [Chapter 3.10, "Reference: custom limits"](#), on page 63.

2 Time Alignment Error			
Limit : 90 ns			
Time Alignment Error to Antenna Port 1000			
Antenna Port	Min	Mean	Max
AP 1001	2.60 ns	2.60 ns	2.60 ns
AP 1002	5.21 ns	5.21 ns	5.21 ns
AP 1003	7.81 ns	7.81 ns	7.81 ns
AP 1006	15.63 ns	15.63 ns	15.63 ns

Remote command:

Measurement selection: `LAY:ADD ? '1',LEFT,TAL`

Result query: `FETCh:TAERror[:CC<cc>]:AP<ap>[:AVERage]?` on page 252

3.7 Transmit on / off power measurement

The technical specification in 3GPP 38.141-1 / -2 describes the measurement of the transmitter "off" power and the transmitter transient period of a base transceiver station (BTS) transmitting a TDD signal and operating at its rated output power.

This measurement requires a special hardware setup. During the "off" periods (the interesting parts of the signal for this measurement), the signal power is very low - measuring such low powers requires a low attenuation at the RF input. On the other hand, the signal power is very high during the transmitter "on" periods - in fact the signal power is usually higher than the maximum allowed RF input level. Measuring high signal levels requires an appropriate test setup as described below.

NOTICE

Risk of instrument damage

The signal power during the "on" periods in this test scenario is usually higher than the maximum power allowed at the RF input of a spectrum analyzer.

Make sure to set up the measurement appropriately. Not doing so can cause severe damage to the spectrum analyzer.

Test setup

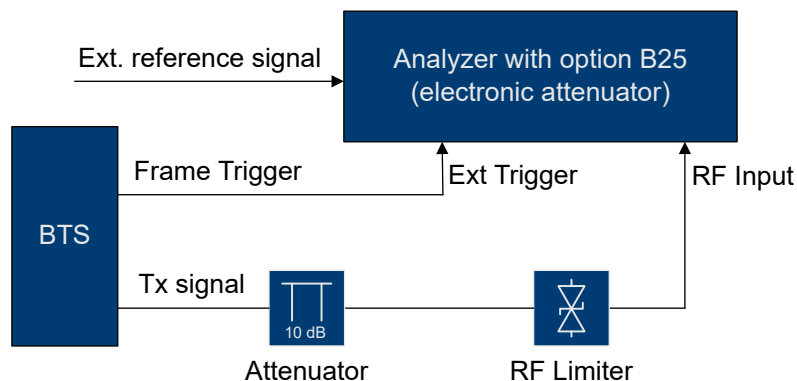

Figure 3-5: Test setup for transmit on / off power measurement

- Connect an RF limiter to the RF input to protect the RF input from damage. [Table 3-1](#) shows the specifications that the limiter has to fulfill.
- Insert an additional 10 dB attenuator in front of the RF limiter to absorb possible reflected waves (because of the high VSWR of the limiter). The maximum allowed CW input power of the attenuator must be higher than the maximum output power of the BTS.

Table 3-1: Specifications of the RF limiter in the test setup

Min. acceptable CW input power	BTS output power minus 10 dB
Min. acceptable peak input power	BTS peak output power minus 10 dB
Max. output leakage	20 dBm
Max. response time	1 µs
Max. recovery time	1 µs

Measuring the on / off power

If you are using an external trigger, you have to [adjust the timing](#) before you can start the actual measurement.

The status message in the diagram header shows if timing adjustment is required or not. After timing was successfully adjusted, you can start the measurement. Note that relevant changes of settings might require another timing adjustment.

If timing adjustment fails for any reason, the application shows a corresponding message in the diagram header. To find out what causes the synchronization failure, we recommend to perform a regular [EVM measurement](#). Then you can use all the measurement results like "EVM vs Carrier" to get more detailed information about the failure. The timing adjustment will succeed if the synchronization state in the header is OK.

Select "Run Single" to start the measurement. The number of measurements that trace averaging is based on depends on the [number of frames](#) you have defined. When all measurements are done, the R&S FSV/A indicates if the measurement has failed or passed.

The remote commands required to measure the transmit on / off power are described in [Chapter 6.9.30, "Transmit on/off power measurements"](#), on page 431.

Remote command:

Measurement selection: `CONFigure[:NR5G]:MEASurement` on page 295

Result display selection: `LAYout:ADD[:WINDow]?` on page 220

Transmit On / Off Power	48
L Numerical results	49
L Transmit power on / off diagram	50
L Transition diagram	51
L Adjust Timing	51
L Noise Cancellation	51

Transmit On / Off Power

The transmit on / off power measurement analyzes the transition from transmission ("on" periods) to reception ("off" periods) of an 5G NR TDD signal over time. Because this transition must happen very fast to use resources efficiently, it can be an issue in TDD systems.

During the transmit power on / off measurement, the R&S FSV/A verifies if the "off" periods (= no signal transmission) comply to the limits defined by 3GPP. Note that you have to apply a signal to the RF input for this measurement, because the R&S FSV/A has to capture new I/Q data instead of using the data other I/Q measurements are based on.

The results for the transmit on / off power measurement are available in the following displays.

- "Numerical results" on page 49
- "Transmit power on / off diagram" on page 50
- "Transition diagram" on page 51

Remote command:

Selection: `CONFigure[:NR5G]:MEASurement` on page 295

Selection (transition period): `DISPlay[:WINDow<n>]:TPOO:PERiod:SElect` on page 433

Query: `TRACe:DATA?`

Unit: `UNIT:OPower` on page 434

Numerical results ← Transmit On / Off Power

The result summary shows the measurement results in a table. Each line in the table corresponds to one "off" period.

The result summary shows the following information for each "off" period.

- "Start Off Period Limit"
Shows the beginning of the "off" period relative to the frame start (0 seconds).
- "Stop Off Period Limit"
Shows the end of the "off" period relative to the frame start (0 seconds).
The time from the start to the stop of the "off" period is the period over which the limits are checked. It corresponds to the yellow trace in the diagram.
- "Time at Δ to Limit"
Shows the trace point at which the lowest distance between trace and limit line has been detected. The result is a time relative to the frame start.
- "OFF Power"
Shows the absolute power of the signal at the trace point with the lowest distance to the limit line.
You can display the "OFF Power" either as an absolute value in dBm or a relative value in dBm/MHz. To select the unit, use the "Power Unit (dBm/MHz)" softkey available in the "Meas Config" menu.
- "OFF Power Δ to Limit"
Shows the distance between the trace and the limit line of the trace point with the lowest distance to the limit line in dB.
- "Falling Transition Period"
Shows the length of the falling transient.
- "Rising Transition Period"
Shows the length of the rising transient.

Results that comply with the limits are displayed in green. Any results that violate the limits defined by 3GPP are displayed in red.

6 Transmit ON/OFF Power List						
Start OFF Period Limit	Stop OFF Period Limit	Time at Δ to Limit	OFF Power Abs [dBm]	OFF Power Δ to Limit	Falling Trans Period	Rising Trans Period
1.267 ms	4.948 ms	4.786523 ms	-92.41 dBm	17.41 dB	2.73 μ s	2.80 μ s
6.267 ms	9.948 ms	8.799381 ms	-92.32 dBm	17.32 dB	2.73 μ s	2.77 μ s

Note that the beginning and end of a transition period is determined based on the "Off Power Density Limit". This limit is defined in 3GPP 38.141-1 / -2 as the maximum allowed mean power spectral density. The length of the transient from "on" to "off" period is, for example, the distance from the detected end of the subframe to the last time that the signal power is above the measured mean power spectral density.

You can define a custom limit for the off power density. For more information, see [Chapter 3.10, "Reference: custom limits"](#), on page 63.

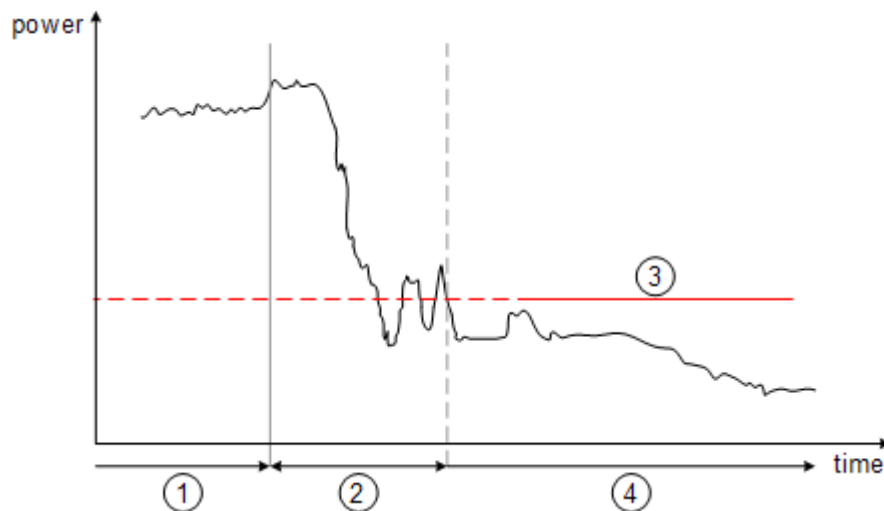

Figure 3-6: Power profile of a TD-LTE On-to-Off transition. The transition lasts from the end of the ON period until the signal is completely below the off power density limit.

- 1 = subframe ("on" power period)
- 2 = transient (transition length)
- 3 = "off" power density limit
- 4 = "off" power period

Transmit power on / off diagram ← Transmit On / Off Power

The diagram shows all TDD frames that were captured and analyzed and contains several elements.

- Yellow trace
 - The yellow trace represents the signal power during the "off" periods. The calculation of the trace also accounts for filtering as defined in 3GPP 38.141-1 / -2.
- Blue trace
 - The blue trace represents the transition periods (falling and rising).
 - Note that the blue trace might not be visible in the diagram because of its steep flank and small horizontal dimensions. You can see the falling and rising transitions in [separate diagrams](#).
- Blue rectangles
 - The blue rectangles represent the "on" periods. Because of the overload during the "on" periods, the actual signal power is only hinted at, not shown.
- Red lines
 - Limits as defined by 3GPP.
- Other information

In addition to these elements, the diagram also shows the overall limit check, the average count and the limit for the mean power spectral density ("Off Power Density Limit").

The overall limit check only passes if all "off" periods (including the transients) comply with the limits.

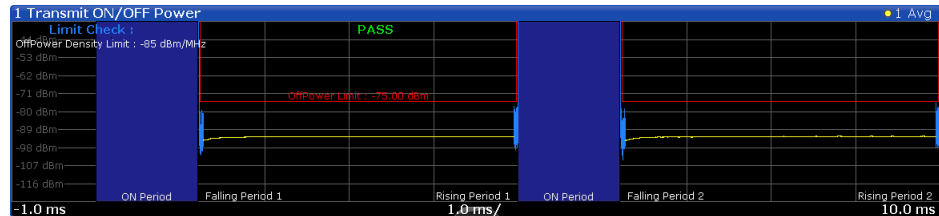

Transition diagram ← Transmit On / Off Power

The transition diagrams show the rising and falling periods for each TDD frame in more detail.

The maximum number of transitions you can display depends on the slot configuration. When you add a "Falling Period" or "Rising Period" to the diagram area, you can select the period you want to analyze from a dropdown menu in the header of the result display. By default, the R&S FSV/A shows two periods.

Alternatively, you can configure these diagrams via the "Evaluation Range" dialog box.

The diagrams contain the following elements.

- Blue trace
The blue trace represents the transition periods (falling and rising).
- Red lines
Limits as defined by 3GPP.

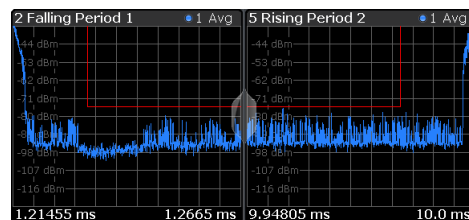

Adjust Timing ← Transmit On / Off Power

Access: [Sweep] > "Adjust Timing"

If you are using an external trigger for the on / off power measurement, you have to determine the offset of the trigger time to the time the 5G NR frame starts. You can do this with the "Adjust Timing" function. When the application has determined the offset, it corrects the results of the on / off power measurement accordingly.

Adjust timing also captures data with a reference level optimized for the "on" period to increase the probability for successful synchronization.

Remote command:

[SENSe:]NR5G:OOPower:ATIMing on page 433

Noise Cancellation ← Transmit On / Off Power

Access: [Meas Config] > "Noise Cancellation"

Noise cancellation corrects the results by removing the inherent noise of the analyzer, which increases the dynamic range. To do this, the R&S FSV/A measures its inherent noise and subtracts the measured noise power from the power in the channel that is being analyzed.

Noise cancellation is valid for the current measurement configuration. If you change the measurement configuration in any way, you have to repeat noise cancellation.

Remote command:

[\[SENSe:\]NR5G:OOPower:NCORrection](#) on page 434

3.8 Frequency sweep measurements

Access (ACLR): [MEAS] > "Channel Power ACLR"

Access (MC ACLR): [MEAS] > "Multi Carrier ACLR"

Access (Cumulative ACLR): [MEAS] > "Cumulative ACLR"

Access (SEM): [MEAS] > "Spectrum Emission Mask"

Access (Multi Carrier SEM): [MEAS] > "Multi Carrier SEM"

The 5G NR application supports the following frequency sweep measurements.

- Adjacent channel leakage ratio (ACLR)
- Spectrum emission mask (SEM)

Instead of using I/Q data, the frequency sweep measurements sweep the spectrum every time you run a new measurement. Therefore, it is mandatory to feed a signal into the RF input for these measurements. Using previously acquired I/Q data for the frequency sweep measurements is not possible (and vice-versa).

Because each of the frequency sweep measurements uses different settings to obtain signal data it is also not possible to run a frequency sweep measurement and view the results in another frequency sweep measurement.

Make sure to have sufficient bandwidth to be able to capture the whole signal, including neighboring channels.

Features of the frequency sweep measurements:

- SEM measurements use the FFT sweep type by default. For more information, see the R&S FSV/A user manual.

In addition to the specific diagrams and table (see description below), frequency sweep measurements support the following result displays.

- ["Marker Table"](#) on page 43
 - Marker peak list
- Both result displays have the same contents as the spectrum application.

Remote command:

Measurement selection: [CONFigure\[:NR5G\]:MEASurement](#) on page 295

Result display selection: [LAYout:ADD\[:WINDow\]?](#) on page 220

Adjacent Channel Leakage Ratio (ACLR).....	53
└ Result diagram.....	53
└ Result summary.....	54
Multi Carrier ACLR (MC ACLR).....	54
└ Result diagram.....	55
└ Result summary.....	55
Cumulative ACLR.....	56
└ Result diagram.....	57
└ Result summary.....	57
Spectrum Emission Mask (SEM).....	58
└ Result diagram.....	59
└ Result summary.....	59
Marker Peak List.....	59

Adjacent Channel Leakage Ratio (ACLR)

The adjacent channel leakage ratio (ACLR) measurement is designed to analyze signals that contain multiple signals for different radio standards. Using the ACLR measurement, you can determine the power of the transmit (Tx) channel and the power of the neighboring (adjacent) channels to the left and right of the Tx channel. Thus, the ACLR measurement provides information about the power in the adjacent channels as well as the leakage into these adjacent channels.

When you measure the ACLR in the 5G NR application, the R&S FSV/A automatically selects appropriate ACLR settings based on the selected channel bandwidth.

For a comprehensive description of the ACLR measurement, refer to the user manual of the R&S FSV/A.

Remote command:

Selection: [CONFigure \[:NR5G\] :MEASurement](#) on page 295

Result diagram ← Adjacent Channel Leakage Ratio (ACLR)

The result diagram is a graphic representation of the signals with a trace that shows the measured signal. Individual channels (Tx and adjacent channels) are indicated by vertical lines and corresponding labels.

In addition, the R&S FSV/A highlights the channels (blue: Tx channel, green: adjacent channels).

The x-axis represents the frequency with a frequency span that relates to the specified 5G NR channel and adjacent channel bandwidths. On the y-axis, the power is plotted in dBm.

The power for the Tx channel is an absolute value in dBm. The power of the adjacent channels is relative to the power of the Tx channel.

In addition, the R&S FSV/A tests the ACLR measurement results against the limits defined by 3GPP.

Remote command:

Result query: [TRACe:DATA?](#)

Result summary ← Adjacent Channel Leakage Ratio (ACLR)

The result summary shows the signal characteristics in numerical form. Each row in the table corresponds to a certain channel type (Tx, adjacent channel). The columns contain the channel characteristics.

- **Channel**
Shows the channel type (Tx, adjacent or alternate channel).
- **Bandwidth**
Shows the channel bandwidth.
- **Offset**
Shows the channel spacing.
- **Power**
Shows the power of the Tx channel.
- **Lower / Upper**
Shows the relative power of the lower and upper adjacent and alternate channels. The values turn red if the power violates the limits. Depending on the [evaluation logic](#), the R&S FSV/A shows either the absolute power in dBm, the relative power in dBc or both power values. The overall limit check passes or fails depending on your selected evaluation logic. The end result of the limit check is displayed in the table header.

Remote command:

Result query: `CALCulate<n>:MARKer<m>:FUNction:POWer<sb>:RESult[:CURRent]?`

Result query details: `CALCulate<n>:MARKer<m>:FUNction:POWer<sb>:RESult:DEtails` on page 291

Limit check: `CALCulate<n>:LIMit:FAIL?` on page 270

Limit check absolute: `CALCulate<n>:LIMit:ACPower:ACHannel:RESult:ABSolute` on page 264

Limit check relative: `CALCulate<n>:LIMit:ACPower:ACHannel:RESult:RELative` on page 264

Multi Carrier ACLR (MC ACLR)

The MC ACLR measurement is basically the same as the [Adjacent Channel Leakage Ratio \(ACLR\)](#) measurement: it measures the power of the transmission channels and neighboring channels and their effect on each other. Instead of measuring a single carrier, the MC ACLR measures several component carriers and the gaps in between. The component carriers do not necessarily have to be next to each other.

In its default state, the MC ACLR measurement measures two neighboring channels above and below the carrier.

Note that you can configure a different neighboring channel setup with the tools provided by the measurement. These tools are the same as those in the spectrum application. For more information, refer to the documentation of the R&S FSV/A.

The configuration in its default state complies with the test specifications defined in 38.141-1 / -2.

Remote command:

Selection: `CONF:MEAS MCAC`

Result diagram ← Multi Carrier ACLR (MC ACLR)

The result diagram is a graphic representation of the signals with a trace that shows the measured signal. Individual channels (Tx and adjacent channels) are indicated by vertical lines and corresponding labels.

In addition, the R&S FSV/A highlights the channels (blue: Tx channel, green: adjacent channels).

The x-axis represents the frequency with a frequency span that relates to the 5G NR channel characteristics and adjacent channel bandwidths. Note that the application automatically determines the center frequency of the measurement according to the frequencies of the carriers.

On the y-axis, the power is plotted in dBm. The power for the TX channels is an absolute value in dBm. The powers of the adjacent channels are values relative to the power of the TX channel. The power of the channels is automatically tested against the limits defined by 3GPP.

The result display contains several additional elements.

- **Blue and green lines:**
Represent the bandwidths of the carriers (blue lines) and those of the neighboring channels (green lines). Note that the channels can overlap each other.
- **Blue and green bars:**
Represent the integrated power of the transmission channels (blue bars) and neighboring channels (green bars).

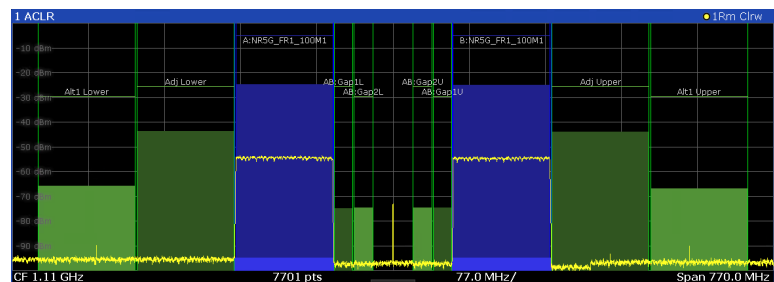

Remote command:

[TRACe:DATA?](#)

Result summary ← Multi Carrier ACLR (MC ACLR)

The result summary shows the signal characteristics in numerical form. Each row in the table corresponds to a certain channel type (Tx, adjacent channel). The columns contain the channel characteristics.

A table above the result display contains information about the measurement in numerical form:

- **Channel**
Shows the type of channel.
The first rows represent the characteristics of the component carriers. The label also indicates their respective bandwidths (for example: NR5G_FR1_100M1 means the first NR channel ("_100M1") with a 100 MHz bandwidth ("_100M1")).
The information also includes the total power of all component carriers.
The other rows represent the neighboring channels (Adj Lower / Upper and Alt1 Lower / Upper).
- **Bandwidth**

Shows the bandwidth of the channel.

The bandwidth of the carrier is the sum of the two component carriers.

- **Frequency**
Shows the center frequency of the component carriers.
- **Offset**
Frequency offset relative to the center frequency of the aggregated carrier.
- **Power / Lower / Upper / Gap**
Shows the power of the carrier and the power of the lower and upper neighboring channels relative to the power of the aggregated carrier.
Depending on the [evaluation logic](#), the R&S FSV/A shows either the absolute power in dBm, the relative power in dBc or both power values. The overall limit check passes or fails depending on your selected evaluation logic. The end result of the limit check is displayed in the table header.

2 Result Summary		Multi-Standard Radio	
Channel	Bandwidth	Frequency	Power
A:NR5G_FR1_100M1 (Ref)	98,280 MHz	1,000 GHz	-24.79 dBm
Sub Block A Total			-24.79 dBm
Channel	Bandwidth	Frequency	Power
B:NR5G_FR1_100M1	98,280 MHz	1,220 GHz	-25.01 dBm
Sub Block B Total			-25.01 dBm
Adj Channels	Bandwidth	Offset	ACLR Power
Adj Lower*	98,280 MHz	100,000 MHz	-19.01 dBc *
Adj Upper*	98,280 MHz	100,000 MHz	-19.28 dBc *
Ref Power	98,280 MHz	100,000 MHz	-24.79 dBc *

Note that the font of the results turns red if the signal violates the limits defined by 3GPP.

Remote command:

Result query: `CALCulate<n>:MARKer<m>:FUNction:POWer<sb>:RESult[:CURRent]?` on page 290

Limit check adjacent: `CALCulate<n>:LIMit:ACPowEr:ACHannel:RESult?` on page 263

Limit check adjacent absolute: `CALCulate<n>:LIMit:ACPowEr:ACHannel:RESult:ABSolute` on page 264

Limit check adjacent relative: `CALCulate<n>:LIMit:ACPowEr:ACHannel:RESult:RELative` on page 264

Limit check alternate: `CALCulate<n>:LIMit:ACPowEr:ALTernate<alt>:RESult?` on page 265

Limit check alternate absolute: `CALCulate<n>:LIMit:ACPowEr:ALTernate<ch>:RESult:ABSolute` on page 266

Limit check alternate relative: `CALCulate<n>:LIMit:ACPowEr:ALTernate<ch>:RESult:RELative` on page 266

Cumulative ACLR

The cumulative ACLR measurement is designed to measure the cumulative ACLR test requirement for non-contiguous spectrum in 38.141-1 / -2. It calculates the cumulative ACLR of the gaps as defined in 38.141-1 / -2. Note that this measurement is only useful for two non-contiguous carriers.

The gap channels are labeled "Gap<x>U" or "Gap<x>L", with <x> representing the number of the gap channels and "U" and "L" standing for "Upper" and "Lower". The number of analyzed gap channels depends on the channel spacing between the carriers as defined in the test specification.

Remote command:

Selection: `CONF:MEAS MCAC`

Result diagram ← Cumulative ACLR

The result diagram is a graphic representation of the signals with a trace that shows the measured signal. Individual channels (Tx and adjacent channels) are indicated by vertical lines and corresponding labels.

In addition, the R&S FSV/A highlights the channels (blue: Tx channel, green: adjacent channels).

The x-axis represents the frequency. Note that the application automatically determines the center frequency and span of the measurement according to the frequencies of the carriers.

On the y-axis, the power is plotted in dBm. The power for the Tx channels is an absolute value in dBm. The power of the gap channels is an absolute value relative to the cumulative power of the Tx channels. The power of the channels is automatically tested against the limits defined by 3GPP.

The result display contains several additional elements.

- **Blue and green lines:**
Represent the bandwidths of the carriers (blue lines) and those of the gap channels (green lines). Note that the channels can overlap each other.
- **Blue and green bars:**
Represent the integrated power of the transmission channels (blue bars) and gap channels (green bars).

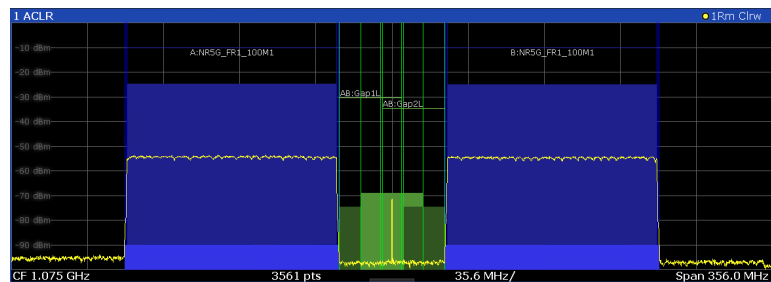

Remote command:

[TRACe:DATA?](#)

Result summary ← Cumulative ACLR

The result summary shows the signal characteristics in numerical form. Each row in the table corresponds to a certain channel type (Tx, adjacent channel). The columns contain the channel characteristics.

A table in the result display contains information about the measurement in numerical form:

- **Channel**
Shows the type of channel.
Channel "A" and "B" represent the component carriers. For each of the channels, the application also shows the "Total", which should be the same as that for the channel.
The other rows ("AB:Gap") represent the gap channels.
- **Bandwidth**
Shows the bandwidth of the channel.
The bandwidth of the carrier is the sum of the two component carriers.
- **Frequency**

Shows the frequency of the carrier.
Available for the aggregated carriers.

- **Offset**

Frequency offset relative to the center frequency of the aggregated carrier.
Available for the gap channels.

- **Power / Lower / Upper**

Shows the power of the carrier and the power of the lower and upper gap channels relative to the power of the aggregated carrier.

Depending on the [evaluation logic](#), the R&S FSV/A shows either the absolute power in dBm, the relative power in dBc or both power values. The overall limit check passes or fails depending on your selected evaluation logic. The end result of the limit check is displayed in the table header.

2 Result Summary		Multi-Standard Radio		
Channel	Bandwidth	Frequency	Power	
A:NR5G_FR1_100M1 (Ref)	98.280 MHz	1.000 GHz	-24.77 dBm	
Sub Block A Total				
Channel	Bandwidth	Frequency	Power	
B:NR5G_FR1_100M1	98.280 MHz	1.150 GHz	-25.09 dBm	
Sub Block B Total				
Gap Channels		Offset	ACL/R Power	CACLR Power
AB:GapL	19.080 MHz	10.000 MHz	-49.98 dBc	-52.83 dBc
AB:GapU	19.080 MHz	10.000 MHz	-49.53 dBc	-52.70 dBc

Remote command:

Result query: `CALCulate<n>:MARKer<m>:FUNction:POWer<sb>:RESult[:CURRent]?` on page 290

Limit check adjacent: `CALCulate<n>:LIMit:ACPowEr:ACHannel:RESult?` on page 263

Limit check adjacent absolute: `CALCulate<n>:LIMit:ACPowEr:ACHannel:RESult:ABSolute` on page 264

Limit check adjacent relative: `CALCulate<n>:LIMit:ACPowEr:ACHannel:RESult:RELative` on page 264

Limit check alternate: `CALCulate<n>:LIMit:ACPowEr:ALTernate<alt>:RESult?` on page 265

Limit check alternate absolute: `CALCulate<n>:LIMit:ACPowEr:ALTernate<ch>:RESult:ABSolute` on page 266

Limit check alternate relative: `CALCulate<n>:LIMit:ACPowEr:ALTernate<ch>:RESult:RELative` on page 266

Spectrum Emission Mask (SEM)

Note: The application also provides multi-SEM measurements as a separate measurement. This measurement is basically the same as the SEM measurement, with the difference that it analyzes several sub blocks. The limits between the carriers are a sum of the individual limits according to 3GPP.38.141-1 / -2 The multi-SEM measurement also supports carrier aggregation.

The "Spectrum Emission Mask" (SEM) measurement shows the quality of the measured signal by comparing the power values in the frequency range near the carrier against a spectral mask that is defined by the 3GPP specifications. In this way, you can test the performance of the DUT and identify the emissions and their distance to the limit.

For a comprehensive description of the SEM measurement, refer to the user manual of the R&S FSV/A.

Remote command:

Selection: `CONFigure[:NR5G]:MEASurement` on page 295

Result diagram ← Spectrum Emission Mask (SEM)

The result diagram is a graphic representation of the signal with a trace that shows the measured signal. The SEM is represented by a red line.

If any measured power levels are above that limit line, the test fails. If all power levels are inside the specified limits, the test passes. The application labels the limit line to indicate whether the limit check has passed or failed.

The x-axis represents the frequency with a frequency span that relates to the specified 5G NR channel bandwidths. The y-axis shows the signal power in dBm.

Remote command:

Result query: [TRACe:DATA?](#)

Result summary ← Spectrum Emission Mask (SEM)

The result summary shows the signal characteristics in numerical form. Each row in the table corresponds to a certain SEM range. The columns contain the range characteristics. If a limit fails, the range characteristics turn red.

- **Start / Stop Freq Rel**
Shows the start and stop frequency of each section of the spectrum emission mask relative to the center frequency.
- **RBW**
Shows the resolution bandwidth of each section of the spectrum emission mask.
- **Freq at Δ to Limit**
Shows the absolute frequency whose power measurement being closest to the limit line for the corresponding frequency segment.
- **Power Abs**
Shows the absolute measured power of the frequency whose power is closest to the limit. The application evaluates this value for each frequency segment.
- **Power Rel**
Shows the distance from the measured power to the limit line at the frequency whose power is closest to the limit. The application evaluates this value for each frequency segment.
- **Δ to Limit**
Shows the minimal distance of the tolerance limit to the SEM trace for the corresponding frequency segment. Negative distances indicate that the trace is below the tolerance limit, positive distances indicate that the trace is above the tolerance limit.

Marker Peak List

The marker peak list determines the frequencies and levels of peaks in the spectrum or time domain. How many peaks are displayed can be defined, as well as the sort order. In addition, the detected peaks can be indicated in the diagram. The peak list can also be exported to a file for analysis in an external application.

3 Marker Peak List			
Wnd	No	X-Value	Y-Value
2	1	1.086245 ms	-75.810 dBm
2	2	2.172490 ms	-6.797 dBm
2	3	3.258736 ms	-76.448 dBm
2	4	4.831918 ms	-76.676 dBm
2	5	6.255274 ms	-76.482 dBm
2	6	6.798397 ms	-6.800 dBm
2	7	9.233084 ms	-76.519 dBm
2	8	10.075861 ms	-76.172 dBm
2	9	11.405574 ms	-6.801 dBm

Tip: To navigate within long marker peak lists, simply scroll through the entries with your finger on the touchscreen.

Remote command:

LAY:ADD? '1',RIGH, PEAK, see [LAYout:ADD\[:WINDow\]?](#) on page 220

Results:

[CALCulate<n>:MARKer<m>:X](#) on page 254

[CALCulate<n>:MARKer<m>:Y](#) on page 254

3.9 Combined measurements

Access (ACLR): [MEAS] > "Channel Power ACLR"

For an introduction on combined measurements and their application, see [Chapter 4.6, "Combined measurement guide"](#), on page 169.

The measurements (EVM, ACLR and SEM) themselves are the same as in their respective mode. The combined mode supports all result displays that are available for the corresponding measurements (diagrams, tables etc.).

Note that combined measurements are not available for FR2-2 frequency deployment.

For a comprehensive description of the measurements and their result displays, refer to:

- [EVM measurements](#)
- [ACLR measurements](#)
- [SEM measurements](#)

Using the combined EVM / ACLR / SEM results table

Combined measurements show the results of the measurement sequence in a big numerical result summary. This result summary contains a list of all single measurements ([events](#)) in the measurement sequence.

Each line in the result summary corresponds to an event (aka "Meas ID"). Each column shows a certain aspect about the events. By default, the table contains the results of all measurements.

You have several options to work with the table.

1. Filter the results by certain aspects.
2. Add columns (= other results) to the tables.
3. Select a line to view the results for the captured I/Q data of the corresponding event.
When you select a single event, you can view the usual result displays (tables and diagrams) available for the EVM, ACLR and SEM measurements. By default, the R&S FSV/A only shows the result summaries, but you can add other result displays as well.

4. Select another line to compare the results of different events.

5. Apply different settings to the captured data.
You can apply different settings to all events or the selected event only.
All events: "Sweep" > "Refresh"
Selected event: "Sweep" > "Refresh Current"
The result summary displays a yellow star for all events whose settings deviate from the current setting - if you select a measurement, change the signal configuration, all other measurements get a yellow star.
Yellow stars disappear if you also apply the current signal configuration to other events. To do so, select an event and apply the current configuration.
You can restore the initial settings with "Restore Settings" available in the "Meas Config" softkey menu.

In addition to the results available for EVM, ACLR and SEM measurements, the combined measurements result summary contains the following events aspects.

Meas ID

Shows an index number that identifies each measurement in the measurement sequence.

Remote command:

[TRACe:DATA?](#)

Time Stamp

Shows the beginning time of the I/Q data capture for the corresponding measurement (= time when the event has occurred).

The time stamp is a value relative to the first event. The first event has a time stamp = 0 seconds.

Remote command:

[FETCh\[:CC<cc>\]\[:ISRC<ant>\]\[:FRAME<fr>\]:SUMMARY:TSTamp?](#) on page 251
[TRACe:DATA?](#)

Time Stamp Delta

Shows the time that has passed between events.

The delta is therefore the difference between the time stamp of two consecutive measurements.

Remote command:

[FETCh\[:CC<cc>\]\[:ISRC<ant>\]\[:FRAMe<fr>\]:SUMMARY:TSDelta?](#)

on page 251

Sync State

Shows the synchronization state for the corresponding measurement.

Remote command:

[FETCh\[:CC<cc>\]\[:ISRC<ant>\]\[:FRAMe<fr>\]:SUMMARY:SState?](#) on page 250

[TRACe:DATA?](#)

ACLR Pass / Fail

Shows the limit check results for the ACLR of the corresponding measurement.

You can check the ACLR against the [absolute or relative limits](#) defined by 3GPP. The result summary shows the limit check results that you have selected.

"ACLR Pass / Fail" Shows the overall limit check result.

"ACLR Abs Pass / Fail" Shows the absolute limit check result.

"ACLR Rel Pass / Fail" Shows the relative limit check result.

Remote command:

Absolute or relative: [FETCh\[:CC<cc>\]\[:ISRC<ant>\]\[:FRAMe<fr>\]:SUMMARY:APFail?](#) on page 235

Absolute: [FETCh\[:CC<cc>\]\[:ISRC<ant>\]\[:FRAMe<fr>\]:SUMMARY:AAPFail?](#) on page 234

Relative: [FETCh\[:CC<cc>\]\[:ISRC<ant>\]\[:FRAMe<fr>\]:SUMMARY:ARPFail?](#) on page 235

[TRACe:DATA?](#)

SEM Pass / Fail

Shows the overall limit check result for the SEM of the corresponding measurement.

Remote command:

[FETCh\[:CC<cc>\]\[:ISRC<ant>\]\[:FRAMe<fr>\]:SUMMARY:SPFail?](#) on page 249

[TRACe:DATA?](#)

OVLD

Shows a message if an overload status was detected (RF overload, RF input overload, IF overload).

For details about the overload states and what to do about them, see the R&S FSV/A user manual.

Remote command:

[FETCh\[:CC<cc>\]\[:ISRC<ant>\]\[:FRAMe<fr>\]:SUMMARY:OVLD?](#) on page 248

[TRACe:DATA?](#)

3.10 Reference: custom limits

The R&S FSV/A checks various results against the limits defined by 3GPP. For some of those limits, you can define custom limits.

I/Q measurement [result summary](#)

- EVM PDSCH QPSK / 16QAM / 64QAM / 256QAM
- EVM PUSCH PI/2 BPSK / QPSK / 16QAM / 64QAM
- EVM PUSCH DMRS PI/2 BPSK / QPSK / 16QAM / 64QAM
- EVM PUCCH

[Time alignment error measurements](#)

- Time alignment error

[Transmit on / off power](#)

- Off power spectral density

Limit values are stored in an xml file that combines the limits for downlink and uplink. The file name must be `Default.nr5g_limits` and is located in the following directory:

```
C:\R_S\instr\user\NR5G\
```

The R&S FSV/A automatically applies the custom limits after you have copied the file and restarted the R&S FSV/A

The structure of the file is as follows. You can omit any xml elements you do not want to define, either by making no entry or by deleting the corresponding element.

```
<Limits>
  <DL>
    <EVM>
      <PDSCHQPSK Mean="0.185"></PDSCHQPSK>
      <!--Unit: linear (1 = 0 dB, 0.1 = -20 dB)-->
      <PDSCH16QAM Mean="0.135"></PDSCH16QAM>
      <!--Unit: linear (1 = 0 dB, 0.1 = -20 dB)-->
      <PDSCH64QAM Mean="0.09"></PDSCH64QAM>
      <!--Unit: linear (1 = 0 dB, 0.1 = -20 dB)-->
      <PDSCH256QAM Mean="0.045"></PDSCH256QAM>
      <!--Unit: linear (1 = 0 dB, 0.1 = -20 dB)-->
    </EVM>
    <TimeAlignmentError Limit="90"></TimeAlignmentError>
    <!--Unit [ns]-->
    <OffPowSpectralDensity Limit="-82.5"></OffPowSpectralDensity>
    <!--Unit: [dBm/MHz]-->
  </DL>
  <UL>
    <EVM>
      <PUSCHPI_2BPSK Max="0.3"></PUSCHPI_2BPSK>
      <!--Unit: linear (1 = 0 dB, 0.1 = -20 dB)-->
      <PUSCHQPSK Max="0.175"></PUSCHQPSK>
      <!--Unit: linear (1 = 0 dB, 0.1 = -20 dB)-->
    </EVM>
  </UL>
</Limits>
```

```

<PUSCH16QAM Max="0.125"></PUSCH16QAM>
<!--Unit: linear (1 = 0 dB, 0.1 = -20 dB)-->
<PUSCH64QAM Max="0.08"></PUSCH64QAM>
<!--Unit: linear (1 = 0 dB, 0.1 = -20 dB)-->
<DMRSPUSCHPI_2BPSK Mean="0.3"></DMRSPUSCHPI_2BPSK>
<!--Unit: linear (1 = 0 dB, 0.1 = -20 dB)-->
<DMRSPUSCHQPSK Mean="0.175"></DMRSPUSCHQPSK>
<!--Unit: linear (1 = 0 dB, 0.1 = -20 dB)-->
<DMRSPUSCH16QAM Mean="0.125"></DMRSPUSCH16QAM>
<!--Unit: linear (1 = 0 dB, 0.1 = -20 dB)-->
<DMRSPUSCH64QAM Mean="0.08"></DMRSPUSCH64QAM>
<!--Unit: linear (1 = 0 dB, 0.1 = -20 dB)-->
<PUCCH Max="0.175"></PUCCH>
<!--Unit: linear (1 = 0 dB, 0.1 = -20 dB)-->
</EVM>
</UL>
</Limits>

```

3.11 Reference: 3GPP test scenarios

3GPP defines several test scenarios for measuring base stations. These test scenarios are described in detail in 3GPP TS 38.141-1 (conducted measurements) and 38.141-2 (radiated measurements).

For radiated measurements, 3GPP only supports test models 1.1, 2, and 3.1. Release 16 also supports test models 2a and 3.1a.

The following table provides an overview which measurements available in the 5G NR application are suited to use for the test scenarios in the 3GPP documents.

Table 3-2: Test scenarios for NR-FR<x>-TMs as defined by 3GPP (38.141-1 / -2)

Test Model	Test scenario	FR1 test described in	FR2 test described in	Measurement
NR-FR-TM1.1	Radiated transmit power	n/a	chapter 6.2	Transmit on / off power
	Base station output power	chapter 6.2	chapter 6.3	Power (→ "Result Summary")
	Transmit on / off power	chapter 6.4	chapter 6.5	Transmit on / off power
	TAE	chapter 6.5.4	chapter 6.6.4	Time alignment error
	Transmitter intermodulation	chapter 6.7	chapter 6.8	ACLR
	Occupied bandwidth	chapter 6.6.1	chapter 6.7.2	Occupied bandwidth ¹
	ACLR	chapter 6.6.2	chapter 6.7.3	ACLR
	Operating band unwanted emissions	chapter 6.6.3	chapter 6.7.4	Spectrum emission mask

Test Model	Test scenario	FR1 test described in	FR2 test described in	Measurement
	Transmitter spurious emissions	chapter 6.6.4	chapter 6.7.5	Spurious emissions ¹
NR-FR-TM1.2	ACLR	chapter 6.6.2	n/a	ACLR
	Operating band unwanted emissions	chapter 6.6.2	n/a	Spectrum emission mask
NR-FR-TM2	Total power dynamic range	chapter 6.3.2	chapter 6.4.3	OSTP (→ "Result Summary")
	Frequency error	chapter 6.5.1	chapter 6.6.2	Frequency Error (→ "Result Summary")
	Error vector magnitude	chapter 6.5.2	chapter 6.6.3	EVM results
NR-FR-TM2a	Total power dynamic range	chapter 6.3.2	n/a	OSTP (→ "Result Summary")
	Error vector magnitude	chapter 6.5.2	n/a	EVM results
	Frequency error	chapter 6.5.1	n/a	Frequency error (→ "Result Summary")
NR-FR-TM2b	Total power dynamic range	chapter 6.3.2	n/a	OSTP (→ "Result Summary")
	Error vector magnitude	chapter 6.5.2	n/a	EVM results
	Frequency error	chapter 6.5.1	n/a	Frequency error (→ "Result Summary")
NR-FR-TM3.1	Total power dynamic range	chapter 6.3.2	chapter 6.4.3	OSTP (→ "Result Summary")
	Frequency error	chapter 6.5.1	chapter 6.6.2	Frequency error (→ "Result Summary")
	Error vector magnitude	chapter 6.5.2	chapter 6.6.3	EVM results
NR-FR-TM3.1a	Total power dynamic range	chapter 6.3.2	n/a	OSTP (→ "Result Summary")
	Error vector magnitude	chapter 6.5.2	n/a	EVM results
	Frequency error	chapter 6.5.1	n/a	Frequency error (→ "Result Summary")
NR-FR-TM3.1b	Total power dynamic range	chapter 6.3.2	n/a	OSTP (→ "Result Summary")
	Error vector magnitude	chapter 6.5.2	n/a	EVM results
	Frequency error	chapter 6.5.1	n/a	Frequency error (→ "Result Summary")

Reference: 3GPP test scenarios

Test Model	Test scenario	FR1 test described in	FR2 test described in	Measurement
NR-FR-TM3.2	Frequency error	chapter 6.5.1	n/a	Frequency error (→ "Result Summary")
	Error vector magnitude	chapter 6.5.2	n/a	EVM results
NR-FR-TM3.3	Frequency error	chapter 6.5.1	n/a	Frequency error (→ "Result Summary")
	Error vector magnitude	chapter 6.5.2	n/a	EVM results

¹These measurements are available in the spectrum application of the Rohde & Schwarz signal and spectrum analyzers (for example the R&S FSW)

4 Configuration

3GPP 5G NR measurements require a special application on the R&S FSV/A, which you activate using the [MODE] key on the front panel.

When you start the 5G NR application, the R&S FSV/A starts to measure the input signal with the default configuration or the configuration of the last measurement (when you have not performed a preset since then). After you have started an instance of the 5G NR application, the application displays the "Meas Config" menu which contains functions to define the characteristics of the signal you are measuring.



Unavailable hardkeys

Note that the [SPAN], [BW], [TRACE], [LINES] and [MKR FUNC] keys have no contents and no function in the 5G NR application.

• I/Q Measurement.....	67
• Time Alignment Error Configuration.....	158
• Transmit On / Off Power Configuration.....	159
• Frequency Sweep Measurement Configuration.....	160
• Combined measurement configuration.....	163
• Combined measurement guide.....	169
• Time trigger measurement guide.....	180
• Microservice export.....	181
• O-RAN measurement guide.....	182
• Reference: structure of .allocation files.....	182
• Basics on input from I/Q data files.....	191

4.1 I/Q Measurement

• Configuration overview.....	68
• Automatic measurement configuration.....	70
• Physical signal description.....	73
• Test scenarios.....	76
• Component carrier configuration.....	77
• Radio frame configuration.....	82
• Synchronization signal configuration.....	86
• Bandwidth part configuration.....	92
• Slot configuration.....	97
• PDSCH and PDCCH configuration.....	109
• Antenna port configuration.....	129
• Advanced settings.....	131
• Generator control.....	137
• Input source configuration.....	141
• Frequency configuration.....	143
• Amplitude configuration.....	144
• Trigger configuration.....	147

- [Data capture](#).....149
- [Tracking](#)..... 152
- [Demodulation](#)..... 155

4.1.1 Configuration overview

Throughout the measurement channel configuration, an overview of the most important currently defined settings is provided in the "Overview". The "Overview" is displayed when you select the "Overview" menu item from the "Meas Setup" menu.

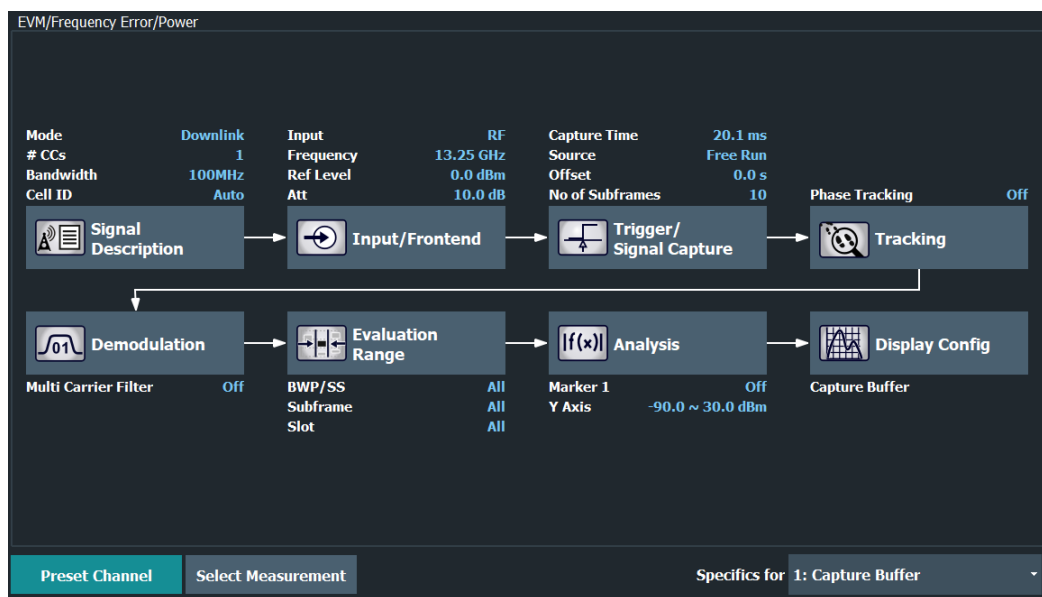

In addition to the main measurement settings, the "Overview" provides quick access to the main settings dialog boxes. The individual configuration steps are displayed in the order of the data flow. Thus, you can easily configure an entire measurement channel from input over processing to output and analysis by stepping through the dialog boxes as indicated in the "Overview".

In particular, the "Overview" provides quick access to the following configuration dialog boxes (listed in the recommended order of processing):

1. Signal Description
See [Chapter 4.1.3, "Physical signal description"](#), on page 73.
2. Input / Frontend
See [Chapter 4.1.14, "Input source configuration"](#), on page 141.
3. Trigger / Signal Capture
See [Chapter 4.1.17, "Trigger configuration"](#), on page 147.
See [Chapter 4.1.18, "Data capture"](#), on page 149.
4. Tracking
See [Chapter 4.1.19, "Tracking"](#), on page 152.
5. Demodulation

See [Chapter 4.1.20, "Demodulation"](#), on page 155.

6. Analysis
See [Chapter 5, "Analysis"](#), on page 193.
7. Display Configuration
See [Chapter 3, "Measurements and result displays"](#), on page 18

In addition, the dialog box provides the "Select Measurement" button that serves as a shortcut to select the measurement type.

Configuring the measurement

- ▶ Select any button in the "Overview" to open the corresponding dialog box.
Select a setting in the channel bar (at the top of the measurement channel tab) to change a specific setting.

Preset Channel	69
Select Measurement	69
Specific Settings for	69

Preset Channel

Select the "Preset Channel" button in the lower left-hand corner of the "Overview" to restore all measurement settings *in the current channel* to their default values.

Note: Do not confuse the "Preset Channel" button with the [Preset] key, which restores the entire instrument to its default values and thus closes *all channels* on the R&S FSV/A (except for the default channel)!

Remote command:

`SYSTem:PRESet:CHANnel [:EXEC]` on page 297

Select Measurement

Opens a dialog box to select the type of measurement.

For more information about selecting measurements, see [Chapter 3.1, "Selecting measurements"](#), on page 18.

Remote command:

`CONFigure[:NR5G]:MEASurement` on page 295

Specific Settings for

The channel can contain several windows for different results. Thus, the settings indicated in the "Overview" and configured in the dialog boxes vary depending on the selected window.

Select an active window from the "Specific Settings for" selection list that is displayed in the "Overview" and in all window-specific configuration dialog boxes.

The "Overview" and dialog boxes are updated to indicate the settings for the selected window.

4.1.2 Automatic measurement configuration

The R&S FSV/A provides various functions to automatically configure measurements based on the signal you are measuring and thus makes these measurements as easy as possible.

Automatic configuration functions are available in different dialog boxes and softkey menus.

Access (auto configuration): [AUTO SET]

Access (auto demodulation): "Overview" > "Signal Description" > "Signal Description"

Automatic measurement configuration

The automatic measurement configuration functions adjust various general measurement settings to achieve the optimal display of the measurement results.

Automatic signal demodulation

The automatic signal demodulation functions determine the characteristics of the signal you are measuring. Based on the signal characteristics, the R&S FSV/A is then able to demodulate and analyze the signal.

Signal demodulation is available on several levels.

- Detection of all signal characteristics.
- Detection of the bandwidth part configuration, incl. antenna port configuration.
- Detection of the synchronization signal configuration.

For an automatic signal demodulation, all frames must have the same configuration.

Auto Level	70
Auto EVM	70
Auto Scale	71
Complete Signal Demodulation	71
Bandwidth Parts Demodulation	72
Synchronization Signal Demodulation	73

Auto Level

You can use the auto leveling routine for a quick determination of preliminary amplitude settings for the current 5G NR input signal.

For additional information, see "[Auto Level](#)" on page 145.

Remote command:

[\[SENSe:\]ADJust:LEVel](#) on page 299

Auto EVM

Adjusts the amplitude settings to achieve the optimal EVM using the maximum dynamic range.

This routine measures the signal several times at various levels to achieve the best results.

If you measure several component carriers, this routine can take several minutes to finish (depending on the number of component carriers).

You can speed up the auto EVM routine by performing it across a certain number of slots only ("Auto EVM # Of Slots To Analyze").

Select "Auto Set" > "Auto Level Config" > "Meas Time Mode" = "Manual" to access this method.

If you are using this method, make sure to:

- Define an appropriate measurement time that corresponds to the number of selected slots. The minimum measurement time is 1 ms.
- Perform a triggered measurement to reliably capture at least one complete slot.

Remote command:

Run measurement: `[SENSe:]ADJust:EVM` on page 299

Slots used: `[SENSe:]ADJust:EVM:SLOTs` on page 299

Auto Scale

Scales the y-axis for best viewing results based on the results.

For more information about y-axis scaling, see ["Automatic scaling of the y-axis"](#) on page 195.

Remote command:

`DISPlay[:WINDow<n>][:SUBWindow<w>]:TRACe<t>:Y[:SCALE]:AUTO`
on page 446

Complete Signal Demodulation

Automatic signal demodulation determines the complete signal configuration.

Complete signal demodulation includes:

- Detection of the synchronization signal configuration, including the SS/PBCH block state.
You can still define the relative powers of the PSS, SSS, PBCH and PBCH DMRS.
- Detection of the cell ID.
- Detection of the bandwidth part configuration.
- Detection of the slot configuration.
- Detection of the PDSCH and CORESET configuration, including the enhanced settings.
- Detection of the antenna port configuration.

It is not possible to edit any properties that are automatically detected.

When you turn on complete signal detection, you only have to define the basic signal characteristics like the deployment frequency range, the channel bandwidth or the number of component carriers.

To turn on complete and continuous signal demodulation, select "All On". "All On" automatically turns on automatic demodulation of the synchronization signal, the cell ID and the bandwidth parts.

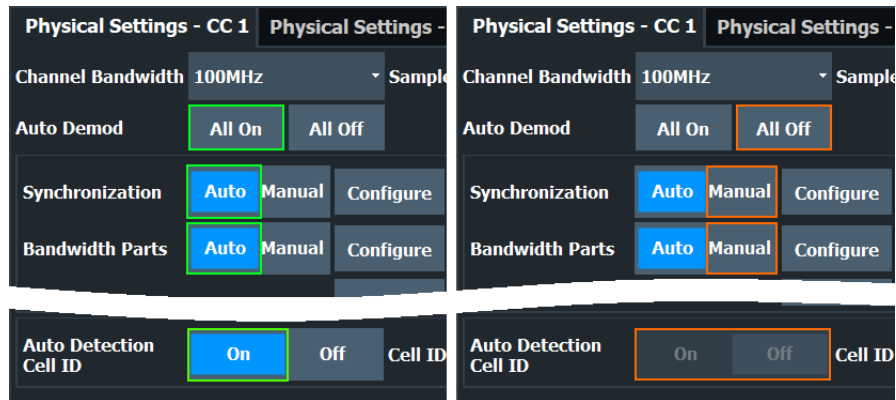

Instead of continuous automatic demodulation, you can demodulate the signal once for a single capture. This method is useful if you want to change individual parameters like the bandwidth part configuration later on without subsequent automatic demodulation. In addition, it increases the measurement speed, because automatic demodulation occurs only once.

To demodulate the signal once, select the corresponding button in the channel bar.

For a one-off demodulation, all properties remain available to edit.

Similarly, you can turn off automatic signal demodulation with a single step with "All Off". All automatic signal demodulation routines are turned off in that case.

Note that if the signal contains no synchronization signal, you have to define the cell ID manually ("Auto Detection Cell ID" = Off).

For FR2-2 frequency deployment, only auto demodulation of the synchronization signal is supported.

Remote command:

State: `CONFigure[:NR5G]:DL[:CC<cc>]:DEMod:AUTO` on page 300

Demodulate once: `[SENSe:]ADJust:DEMod` on page 298

Bandwidth Parts Demodulation

Determines the configuration of the bandwidth parts.

Bandwidth part demodulation includes:

- Detection of the bandwidth part configuration.
- Detection of the slot configuration.
- Detection of the PDSCH and CORESET configuration, including the enhanced settings.
- Detection of the cell ID in the range of 0 to 10.

If you are using a different cell ID, you have to enter the cell ID manually.

It is not possible to edit any properties that are automatically detected.

When you turn on bandwidth part detection, you only have to define the basic signal characteristics like the deployment, the channel bandwidth or the number of component carriers and the synchronization signal.

Note that auto demodulation is not available for FR2-2 frequency deployment.

Remote command:

`CONFigure[:NR5G]:DL[:CC<cc>]:FRAME<fr>:BWPart<bwp>:DETection`
on page 301

Synchronization Signal Demodulation

Determines the configuration of the synchronization signal.

Synchronization signal demodulation includes:

- Detection of the synchronization signal configuration, including the SS/PBCH block state.
You can still define the relative powers of the PSS, SSS, PBCH and PBCH DMRS.
- Detection of the cell ID.

It is not possible to edit any properties that are automatically detected.

When you turn on synchronization signal detection, you can still define the basic signal characteristics like the deployment or the channel bandwidth and the complete bandwidth part configuration, including the PDSCH and CORESET allocations.

Note that if the signal contains no synchronization signal, you have to define the cell ID manually ("Auto Detection Cell ID" = Off).

Remote command:

[CONFigure\[:NR5G\]:DL\[:CC<cc>\]:SSBLock<ssb>:DETection](#) on page 301

4.1.3 Physical signal description

Access: "Overview" > "Signal Description" > "Signal Description"

The "Signal Description" dialog box contains general signal characteristics.

Signal Description	Radio Frame Config	Ant Port Mapping	Advanced Settings
Mode	Downlink	(CC1)User Defined Set: Settings.allocation	
Number of Component Carriers	2	CC Signal Capture	Auto Single
Deploy Frequency Range	FR1 > 3GHz	Operating Band	n1
Physical Settings - CC 1		Physical Settings - CC 2	Carrier Configuration
Channel Bandwidth	100MHz	Sample Rate 122.88 MHz	
Auto Demod	All On	All Off	
Synchronization	Auto Manual	Configure	SCS --- Delta to CF ---
Bandwidth Parts	Auto Manual	Configure	1 BWPs SCS 30kHz
Slot		Configure	Slot Format 0
PDSCH/PDCCH		Configure	QPSK
Auto Detection Cell ID	On Off	Cell ID	1



Configuring component carriers

When you are doing measurements on [aggregated carriers](#), you can configure each carrier separately.

When available, each carrier in the dialog boxes is represented by an additional tab labeled "CC<x>", with <x> indicating the number of the component carrier.

Note that the additional tabs are only added to the user interface after you have selected more than "1" component carrier.

The remote commands required to configure the physical signal characteristics are described in [Chapter 6.9.3, "Physical settings"](#), on page 302.

The remote commands required to query measurement results are described in:

- [Chapter 6.8, "Retrieve trace data"](#), on page 271
- [Chapter 6.6, "Remote commands to retrieve numeric results"](#), on page 232

Selecting the 5G NR mode	74
Deployment Frequency Range	74
Operating Band	75
Physical settings of the signal	75

Selecting the 5G NR mode

The "Mode" selects the 5G NR link direction you are testing.

The choices you have depend on the set of options you have installed.

- Option R&S FSV/A-K144 enables testing of 3GPP 5G NR signals on the downlink.
- Option R&S FSV/A-K145 enables testing of 3GPP 5G NR signals on the uplink.

Downlink (DL) and Uplink (UL) describe the **transmission path**.

- Downlink is the transmission path from the base station to the user equipment.
The physical layer mode for the downlink is always OFDMA.
- Uplink is the transmission path from the user equipment to the base station.

The application shows the currently selected 5G NR mode (including the bandwidth) in the channel bar.

Remote command:

Link direction: `CONFigure[:NR5G]:LDIRection` on page 304
not supported

Deployment Frequency Range

A 5G NR signal can be transmitted in several different frequency ranges ("FR").

3GPP release 17 extends the deployment frequency range (FR2-2).

- "FR1 <= 3 GHz": Deployment in frequency range 1 ≤ 3 GHz.
- "FR1 > 3 GHz": Deployment in frequency range 1 above 3 GHz.
- "FR2-1": Deployment in frequency range 2 (high frequencies up to 52.60 GHz).
- "FR2-2": Deployment in frequency range 2 (extra high frequencies up to 71 GHz).

The frequencies that FR1 and FR2 cover are defined by 3GPP.

The selected frequency range has an effect on the following settings.

- Different [channel bandwidths](#) are available in each frequency range.
- Different [subcarrier spacings](#) are available in each frequency range.
- Different [synchronization signal patterns](#) are available in each frequency range.

Remote command:

[CONFigure \[:NR5G\] :DL\[:CC<cc>\] :DFRange](#) on page 303

Operating Band

Selects the operating band that the carriers are in. The operating bands are defined in 3GPP 38.104: 5.2 "Operating Bands".

Depending on the operating band you select for the transmission, the R&S FSV/A automatically adjusts the minimum requirements for channel spacing between component carriers, especially the [frequency offset to CC1](#).

If the center frequency of the carriers is not within the selected operating band, the R&S FSV/A shows a corresponding message in the [carrier configuration](#) dialog box.

For a selected set of operating bands, you can select the [channel raster](#) within the component carrier.

3GPP release 16 unlocks additional operating bands.

3GPP release 17 unlocks additional operating bands.

Remote command:

[CONFigure \[:NR5G\] :OBANd](#) on page 302

Physical settings of the signal

Physical settings describe the basic structure of the signal you are measuring.

The "Channel Bandwidth" is variable with fixed values in the range from 5 MHz to 400 MHz. The numbers next to the dropdown box show the sample rate of the signal. The sample rate depends on the selected channel bandwidth.

3GPP release 17 extends the channel bandwidths up to 2000 MHz in FR2 and adds additional bandwidths in FR1 (35 MHz and 45 MHz).

The available channel bandwidths depend on the [frequency range](#) you have selected.

Selecting one of the "Configure" buttons opens the [radio frame configuration](#) tab where you can customize the radio frame structure according to your needs.

- "Synchronization": Configuration of [synchronization signal](#) (SS).
The numbers next to the button indicate the subcarrier spacing of the SS and the frequency offset relative to the center of the channel bandwidth.
- "Bandwidth Parts": Configuration of [bandwidth parts](#) (BWP).
The numbers next to the button indicate the number of configured BWPs and their subcarrier spacings.
- "Slot Config": Configuration of individual [slots](#).
The numbers next to the button indicate the slot format used in the BWPs and if a CSI reference signal is present or not.
The slot format determines the usage of the OFDM symbols (UL, DL or flexible).
The slot formats are defined in 3GPP 38.211, table 4.3.2-3.
- "PDSCH / PDCCH Config": Configuration of the [data channel \(PDSCH\)](#) and the control channel (PDCCH)
The numbers next to the button indicate the modulation types used for the allocations in all slots and if a SMUX or phase-tracking reference signal (PT-RS) is present or not.

The physical layer cell ID is responsible for synchronization between network and user equipment. It identifies a specific radio cell in the 5G NR network. The cell ID is a value between 0 and 503.

For automatic detection of the cell ID, turn on the "Auto" function. However, auto detection only works if at least one [SS/PBCH block](#) is included in the signal.

Remote command:

Channel bandwidth: [CONFigure\[:NR5G\]:DL\[:CC<cc>\]:BW](#) on page 302

Cell ID: [CONFigure\[:NR5G\]:DL\[:CC<cc>\]:PLC:CID](#) on page 303

4.1.4 Test scenarios

Access: "Overview" > "Signal Description" > "Test Models"

Test scenarios are descriptions of specific 5G NR signals for standardized testing of DUTs. These test scenarios are stored in `.allocation` files. You can select, manage and create test scenarios in the "Test Models" dialog box.

3GPP test models

Test models are certain signal descriptions defined by 3GPP for various test scenarios. 3GPP calls them NR-TM. These NR-TM are defined in 3GPP 38.141-1 / -2.

There are three main test model groups NR-TM1, NR-TM2 and NR-TM3). Each of these main groups in turn contain signal descriptions for specific signal configurations (different transmission type, different bandwidth etc.).

Because the complete list of test scenarios is long, you can filter the list by the following criteria.

- "Test Model": Filters by test model group (NR-TM1, NR-TM2 etc.).
- "Transmission": Filters by transmission technology (radiated or conducted).
- "Duplexing": Filters by duplexing mode (FDD or TDD).
- "Bandwidth": Filters by [channel bandwidth](#).
- "Subcarrier Spacing": Filters by [subcarrier spacing](#).

For an overview of the test scenarios, see [Chapter 3.11, "Reference: 3GPP test scenarios"](#), on page 64.

3GPP release 17 adds additional test models.

Remote command:

[MMEMory:LOAD:TMODe1\[:CC<cc>\]](#) on page 304

ORAN test cases

In addition to the 3GPP test models, you can also use O-RAN test cases. O-RAN test cases are defined by the O-RAN alliance for standardized measurements.

The test cases comply with O-RAN specification O-RAN.WG4.CONF.0-v05.00.

The O-RAN test cases are based on the 3GPP test models (downlink) and fixed reference channels (uplink) and are customized for the O-RAN applications.

For more information about the test cases themselves, see the O-RAN specifications available on the O-RAN website.

For more information about using O-RAN test cases in measurements with the R&S FSV/A, see [Chapter 4.9, "O-RAN measurement guide"](#), on page 182.

Remote command:

`MMEemory:LOAD:TMODEl[:CC<cc>]` on page 304

User defined test scenarios

User defined test scenarios are custom signal descriptions for standardized measurements that you can save and restore as you like. To create a custom test scenario, describe a signal as required and then save it with the corresponding button. The R&S FSV/A stores custom scenarios in `.allocation` files.

If you do not need test scenarios any longer, you can also delete them.

For a description of the `.allocation` files, see [Chapter 4.10, "Reference: structure of .allocation files"](#), on page 182.

Remote command:

Save: `MMEemory:STORe<n>:DEModsetting[:CC<cc>]` on page 306

Restore: `MMEemory:LOAD:DEModsetting[:CC<cc>]` on page 305

Test scenarios for carrier aggregation

When you measure component carriers, you can describe each component carrier separately and save or restore the scenario for each carrier in the corresponding tab ("CC<x>"). Single carrier scenarios are stored in `.allocation` files.

For easier handling of multiple carriers, however, you can also store the descriptions of all carriers in a single file. To do so, configure all component carriers as required and save the test scenario in "All CCs" tab. Multiple carrier test scenarios are stored in `.ccallocation` files. The advantage of this method is, that you do not have to restore a scenario for each component carrier, but can do so in a single step.

The `.ccallocation` files contain the frequency information of the signal.

Remote command:

Save: `MMEemory:STORe<n>:DEModsetting:ALL` on page 306

Restore: `MMEemory:LOAD:DEModsetting:ALL` on page 305

4.1.5 Component carrier configuration

Access: "Overview" > "Signal Description"

Carrier aggregation has been introduced in the 5G NR standard to increase the bandwidth. In those systems, you can use several carriers to transmit a signal.

The 5G NR measurement application supports up to 16 component carriers for measurements on contiguous and non-contiguous intra-band carrier aggregation (the carriers are in the same frequency band).

Each carrier has one of the [channel bandwidths](#) defined by 3GPP. You can deploy the component carriers in different [frequency ranges](#).

The radio frame can be different for each component carrier. For more information about configuring 5G NR radio frames, see [Chapter 4.1.6, "Radio frame configuration"](#), on page 82.

Several measurements support contiguous and non-contiguous intra-band carrier aggregation (the carriers are in the same frequency band).

- I/Q Based Measurements (EVM, Frequency Error, etc.)
- Frequency sweep measurements (multi-carrier ACLR, cumulative ACLR and multi SEM)

The screenshot shows the 'Carrier Configuration' interface. It has three tabs: 'Physical Settings - CC 1', 'Physical Settings - CC 2', and 'Carrier Configuration'. The 'Carrier Configuration' tab is active, showing a table of carrier settings and a frequency diagram.

CC	Center Frequency	Frequency Offset	Bandwidth
1	850 MHz	0 Hz	100MHz
2	1 GHz	150 MHz	100MHz

Below the table, the 'MC Setup' section includes:

- Global MC Frequency: 850.0 MHz (Center)
- Frequency Offset rel. to: CC1
- Frequency Offset Mode: Arbitrary
- Carrier Spacing: 0 Hz
- Fixed CC Offset: On/Off

The frequency diagram at the bottom shows two trapezoidal carriers, CC1 and CC2, on a frequency axis. CC1 is centered at 850 MHz with a 100 MHz bandwidth. CC2 is centered at 1 GHz with a 100 MHz bandwidth. There is a 30 MHz gap between the two carriers. The total span from the start of CC1 to the end of CC2 is 250 MHz.

The remote commands required to configure component carriers are described in [Chapter 6.9.4, "Component carrier configuration"](#), on page 306.

Number of component carriers.....	78
Component carrier data capture.....	78
Views.....	79
Basic component carrier configuration.....	79
L Frequency configuration.....	79
L Bandwidth configuration.....	80
L Channel Raster.....	80
Nominal Channel Spacing.....	81
Additional tools for frequency configuration.....	81
L Center frequency configuration.....	82
L Frequency offset configuration.....	82

Number of component carriers

The supported "Number Of Component Carriers" you can measure is in the range from 1 to 16. When you select more than one component carrier, the R&S FSV/A expands the "Signal Description" dialog box by several tabs.

One tab for each component carrier you can configure and one tab to define [general properties](#) of the component carrier configuration.

Remote command:

`CONFigure[:NR5G]:NOCC` on page 309

Component carrier data capture

Capturing signals with several component carriers can generate big amounts of data.

The 5G NR application thus provides different "CC Signal Capture" modes that allow you to capture even several component carriers with a large bandwidth.

- "Single": Each configured component carrier is captured consecutively by an individual data capture buffer.

- "Auto": The R&S FSV/A determines how many component carriers it can capture in a single measurement.

If you select "Auto" mode, the R&S FSV/A captures as many component carriers as it can in a single measurement and captures the rest in subsequent measurements. The maximum number of component carriers the R&S FSV/A can analyze in a single capture depends on the available bandwidth.

With the optional 400 MHz bandwidth, for example, it can analyze up to 4 100 MHz carriers in a single capture.

When all required measurements are done, the R&S FSV/A shows the results for all component carriers.

Remote command:

`CONFigure[:NR5G]:CSCapture` on page 308

Views

Results of component carrier measurements are shown for each component carrier separately. When you measure more than one carrier, each result display shows the information of up to two component carriers. For more than two component carriers, you can select which component carriers are displayed in the [two views](#).

Remote command:

`DISPlay[:WINDow<n>][:SUBWindow<w>]:CCNumber` on page 456

Basic component carrier configuration

Access: "Overview" > "Signal Description" > "Carrier Configuration"

The number of component carriers (CCs) you can select depends on the measurement.

- I/Q based measurements (EVM etc.): up to 16 CCs
- Frequency sweep measurements (ACLR etc.): up to 8 CCs

You can define the characteristics of the CCs in the carrier configuration table.

Depending on the "Number of Component Carriers", the application adjusts the size of the table. Each line corresponds to a component carrier.

The R&S FSV/A shows a preview of the current carrier configuration in a diagram at the bottom of the dialog.

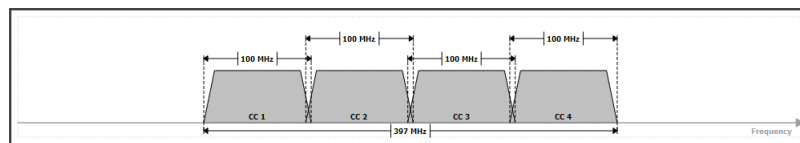

Frequency configuration ← Basic component carrier configuration

The location of each component carrier in the spectrum is defined by a center frequency. The frequencies of the carriers must be in an ascending order.

The R&S FSV/A indicates if the location of the carriers is compatible to the selected [operating band](#).

- "Carrier within selected NR band"
- "Carrier outside of selected NR band"

The actual measurement frequency differs from the carrier frequencies: the application calculates that frequency based on the carrier frequencies. It is somewhere in between the carrier frequencies.

Note that the measurement frequency can change during a capture. If the signal bandwidth is larger than the available analysis bandwidth, the captured data consists of several captures with a smaller bandwidth, each with a different measurement frequency.

The R&S FSV/A indicates the actual measurement frequency in the channel bar.

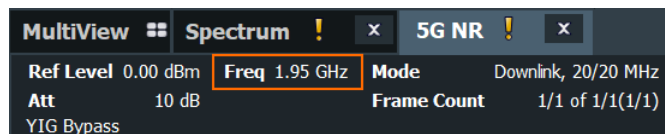

In addition to the carrier's center frequency, you have to define a frequency offset. By default, the frequency offset is an offset relative to the first component carrier and an arbitrary value.

- When you change the offset of a carrier in the table, the R&S FSV/A adjusts its center frequency.
- When you change the frequency of one of the carriers in the table, the R&S FSV/A adjusts the offset.

You can use [additional tools](#) to define the frequency characteristics of the component carriers.

Remote command:

Frequency: `[SENSe:]FREQuency:CENTer[:CC<cc>]` on page 411

Offset (ref. point = CC1): `[SENSe:]FREQuency:CENTer[:CC<cc>]:OFFSet` on page 411

Offset (ref. point = global MC freq.): `[SENSe:]FREQuency:CENTer[:CC<cc>]:MCOFFset` on page 310

Bandwidth configuration ← Basic component carrier configuration

For each carrier, select the "Bandwidth" from the corresponding dropdown menu.

The combination of bandwidths is arbitrary. If the total bandwidth of all component carriers is too large, the R&S FSV/A displays a corresponding message.

The R&S FSV/A also shows the "Occupied Bandwidth" of the aggregated carriers and the "Sample Rate" in a read-only field next to the carrier configuration.

Remote command:

`CONFigure[:NR5G]:DL[:CC<cc>]:BW` on page 302

Channel Raster ← Basic component carrier configuration

Access: "Overview" > "Signal Description" > "Carrier Configuration" > "Global"

Shows the distance between the RF reference frequencies in the selected [operating band](#). The distance between frequencies depends on the channel raster the operating band belongs to (channel raster are defined by 3GPP).

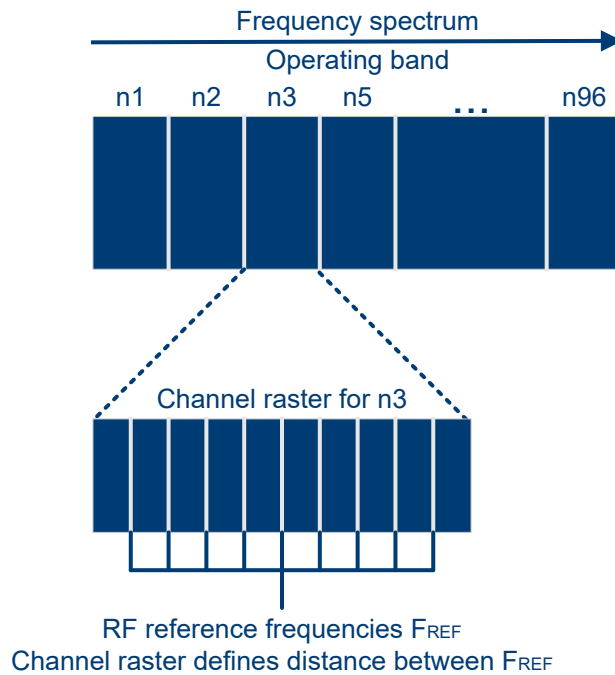

For most operating bands, the channel raster is a fix value of 15 kHz, 60 kHz or 100 kHz.

A few selected operating bands support multiple channel raster.

The channel raster is the basis for the calculation of the channel spacing (distance between component carriers) for intra-band contiguous carrier aggregation.

For details about the channel raster and its effects, see 3GPP 38.104, chapter 5.4.2.

Remote command:

[CONFigure\[:NR5G\]:CRASter](#) on page 307

Nominal Channel Spacing

Resets the channel spacing between component carriers to its default value according to the channel spacings defined by 3GPP.

This setting has an effect if you change the distance (frequency offset) between the component carriers, for example by changing the frequency of one of the carriers.

Remote command:

[CONFigure\[:NR5G\]:NCSPacing](#) on page 309

Additional tools for frequency configuration

Access: "Overview" > "Signal Description" > "Carrier Configuration" > "MC Setup"

You can either define the frequency characteristics of each component carrier separately in the [component carrier table](#), or use the following tools. These tools allow you to change the frequency characteristics of all component carriers at the same time according to a certain logic.

Note that regardless of the changes you make with these tools, the [carrier bandwidth](#) of each carrier remains the same.

Center frequency configuration ← Additional tools for frequency configuration

The global multicarrier frequency is a tool you can use to change the center frequency of all carriers at the same time.

Center frequencies of the component carriers remain the same, as long as you do not change the global MC frequency. When you change the global MC frequency, the center frequencies change and the frequency offset for each carrier remains the same.

You can also synchronize the global MC frequency to the center frequency of all carriers.

Remote command:

Define global MC frequency: [CONFigure\[:NR5G\]:GMCFreq](#) on page 309

Synchronize to center frequency: [CONFigure\[:NR5G\]:CENTer](#) on page 307

Frequency offset configuration ← Additional tools for frequency configuration

The frequency offset configuration tools allow you to change the frequency offset between carriers.

By default, the frequency offset of each component carrier is a frequency relative to the first component carrier (CC1). In that case, the offset of the first carrier is always 0 Hz.

Alternatively, you can set a frequency offset that is relative to the [global multicarrier frequency](#). In that case, the offset can take on negative values if a carrier is on a frequency below the global MC frequency.

For both methods, the offsets are arbitrary values - the spacing between carriers is not equidistant.

If you have a setup in which the distance between carriers is the same, you can use the equidistant frequency offset mode. In this mode, you can define a carrier spacing that is applied to all component carriers. Changing the component carrier's offset separately is no longer possible. Center frequencies of the component carriers are automatically adjusted depending on the carrier spacing you enter.

You can change this logic by turning on a fixed CC offset. When you do, the offset becomes a fixed value (but not necessarily equidistant). Changing the frequency of one carrier adjusts the frequencies of the other carriers. The offset remains the same.

Remote command:

Reference point: [CONFigure\[:NR5G\]:OREL](#) on page 310

Offset mode: [CONFigure\[:NR5G\]:OMODE](#) on page 309

Carrier spacing: [CONFigure\[:NR5G\]:CSPacing](#) on page 308

Fixed offset: [CONFigure\[:NR5G\]:FCOFFset](#) on page 308

4.1.6 Radio frame configuration

Access: "Overview" > "Signal Description" > "Radio Frame Config"

Basic frame structure

A radio frame in the 5G NR standard has a length of 10 ms (same as in LTE). It consists of 10 subframes, each with a length of 1 ms.

A subframe contains a variable number of [slots](#), depending on the [subcarrier spacing](#). A subframe can have different subcarrier spacings in different [bandwidth parts](#).

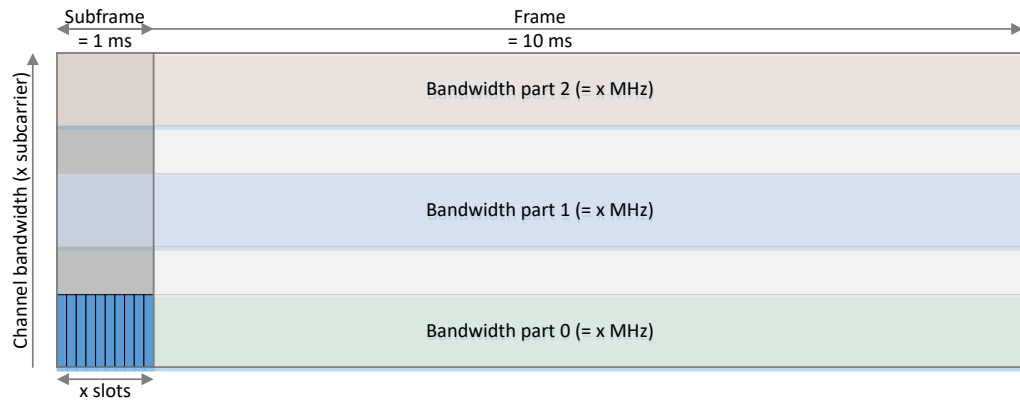

Figure 4-1: Basic frame structure of a 5G NR frame

Slot structure

A slot contains 14 OFDM symbols and has a bandwidth the size of the bandwidth part it is in. A slot can have one of many slot formats, with each slot format representing a different symbol usage. Most of the symbols are usually used by the PDSCH for transmission of user data (payload).

Resource blocks

One symbol with a bandwidth of 12 subcarriers makes up a resource block (the size of the subcarrier is variable). One symbol over one subcarrier makes up a resource element, which is the basic quantity in a 5G NR radio frame.

The 5G NR standard differentiates between virtual resource blocks (VRB) and physical resource blocks (PRB). VRBs are all resource blocks that are allocated to the resource grid. PRBs have the same size and number as VRBs, but can be mapped to different subcarriers to according to certain rules defined by 3GPP. Mapping to different subcarriers can be useful to use the resource grid more efficiently.

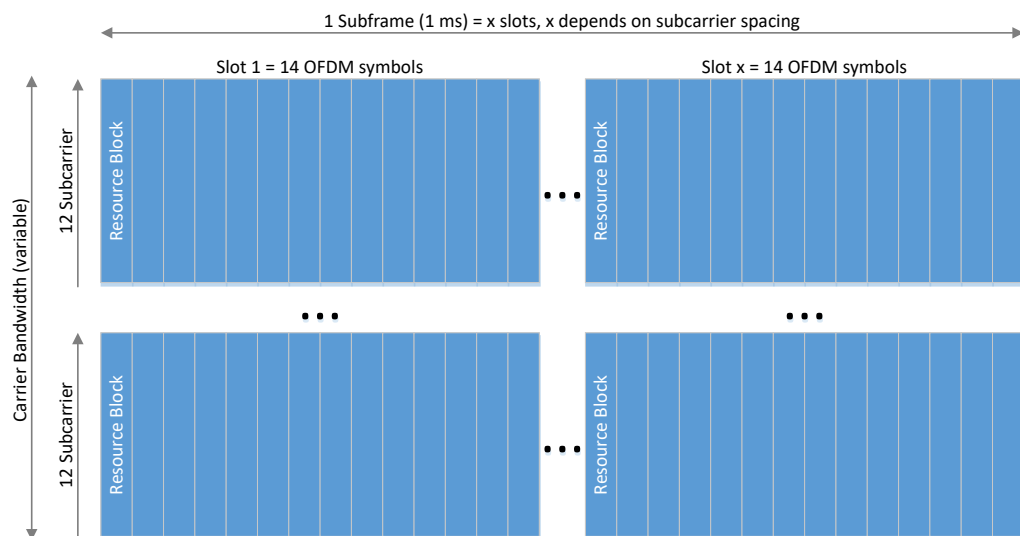

Figure 4-2: Basic slot structure of a 5G NR slot

The radio frame in a 5G NR signal is highly flexible. The location of the synchronization signal is just as variable as the size and number of bandwidth parts and the configuration of each slot in the radio frame.

For more information about configuring the radio frame structure, refer to the following topics.

- [Synchronization Signal](#)
- [Bandwidth parts](#)
- [Slots](#)
- [PDSCH](#)

Measuring multiple radio frames

You can capture and analyze multiple radio frames. Each radio frame can have a different configuration.



Configuring component carriers

When you are doing measurements on [aggregated carriers](#), you can configure each carrier separately.

When available, each carrier in the dialog boxes is represented by an additional tab labeled "CC<x>", with <x> indicating the number of the component carrier.

Note that the additional tabs are only added to the user interface after you have selected more than "1" component carrier.

Frame Configuration	84
Effects of capturing multiple frames on results	85
Frame Configuration Management	86

Frame Configuration

The "# Frames To Configure" input field defines the number of radio frames with a different configuration. If you select more than one frame to configure, you can assign a different slot configuration and PDSCH configuration for the frames. The synchronization signal and bandwidth part configuration is the same for all frames.

To configure a specific frame, enter the corresponding number in the "Selected Frame" field. If you configure only one frame ("# Frames To Configure" = 1), all frames have the same configuration.

After you have configured several frames, you can also select how many frames the R&S FSV/A actually captures and analyzes with the ["Number of Frames to Analyze"](#) property. If you capture more than the number of configurable frames, the frame configuration is repeated for the surplus frames.

Example:

The number of configurable frames is 2. The number of frames you have captured is 5. In that case, the BWP configuration of frame 0 and 1 is repeated for frames 2 to 4.

If you capture less than the number of configurable frames, only the first frame configurations are applied.

Example:

The number of configurable frames is 3. The number of frames you have captured is 1. In that case, the BWP configuration of frame 0 is used for analysis.

In addition, if the R&S FSV/A needs more than one capture to analyze all frames, for example if the capture time is too small, the capture always starts with the configuration of the first frame.

Example:

The number of configurable frames is 3. The capture time is 20.1 ms. The number of frames you have captured is 3.

The first capture contains 2 full frames with configuration of frame 0 and 1.

The second capture contains 1 frame, again with configuration of frame 0.

(If you want to capture a frame with the third configuration, you would have to define a capture time of at least 30.1 ms.)

Remote command:

Configurable frames: `CONFigure[:NR5G]:DL[:CC<cc>]:FTConfig` on page 312

Frame selection: via suffix at `FRAMe<fr>`

Effects of capturing multiple frames on results

Analyzing multiple frames has the following effects on results.

- Results in the [result summary](#) are either averaged over all frames or refer to a single frame, depending on your selection.
- All graphical results refer to a single frame.
If there is more than one frame in the capture buffer, you can [select the frame](#) you want to display.
- The R&S FSV/A can only display graphical results of the last data capture.
If the [capture time](#) is too small to capture all [frames to analyze](#), the R&S FSV/A captures the signal in multiple capture buffers.
Note that this only applies to graphical results like EVM vs Carrier or the constellation diagram. The result summary still averages over all analyzed frames.

Example:

The capture time is 20.1 ms. The number of frames to analyze is 3. Two data captures are required to analyze all frames.

In that case, the first data capture analyzes the first two frames. The second data capture analyzes the third frame. However, you can only display the results for the third frame in the graphical result displays.

If you analyze multiple component carriers, you can also display the results for a specific frame by assigning a frame to a [view](#).

Remote command:

Select a frame: `[SENSe:]NR5G[:CC<cc>]:FRAMe:SElect` on page 464

Assign frame to a view: `DISPlay[:WINDow<n>][:SUBWindow<w>]:FNUMber` on page 457

Frame Configuration Management

The R&S FSV/A provides some tools to make frame configuration easier.

- "Copy Frame": Copies the bandwidth part configuration of the selected frame. Note that this includes the [slot configuration](#) and [PDSCH/PDCCH configuration](#) of that frame.
- "Paste Frame": Applies the bandwidth part configuration in the cache to the selected frame.
- "Paste To All": Applies the bandwidth part configuration in the cache to all configurable frames.

Remote command:

Copy: `CONFigure[:NR5G]:DL[:CC<cc>]:FRAME<fr>:COPY` on page 311

Paste: `CONFigure[:NR5G]:DL[:CC<cc>]:FRAME<fr>:PASTE[:FRAME]` on page 312

Paste to all: `CONFigure[:NR5G]:DL[:CC<cc>]:FRAME<fr>:PASTE:ALL` on page 311

4.1.7 Synchronization signal configuration

Access: "Overview" > "Signal Description" > "Radio Frame Config" > "Synchronization"

The 3GPP 5G NR standard defines two synchronization signals (SS), the primary synchronization signal (PSS) and the secondary synchronization signal (SSS). They are bundled in a synchronization signal block (SS/PBCH block). Both synchronization signals are used for radio frame synchronization. The UE also uses the synchronization signals to detect the [physical layer cell ID](#).

In addition to the two synchronization signals, the SS/PBCH block also includes the physical broadcast channel (PBCH). The PBCH carries general system information.

An SS/PBCH block is transmitted on a fixed schedule. Each half frame contains either 4, 8 or 64 SS/PBCH blocks, depending on the subcarrier spacing and the deployment frequency range.

The synchronization signals are assigned to fixed symbols as defined by 3GPP, but you can adjust the subcarriers on which they are transmitted.



Figure 4-3: Location of synchronization signals in a succession of several slots

Detection of synchronization signal

The R&S FSV/A supports automatic detection of the synchronization signal characteristics. When you select "Auto" detection mode, the R&S FSV/A detects various synchronization signal properties like the subcarrier spacing, block pattern and the frequency offset (in terms of resource blocks and subcarriers).

When you select "Manual" mode, you can describe the synchronization signals manually with various characteristics.

If you measure a signal with a bad signal-to-noise ratio, for example due to a low signal level, manual configuration of the synchronization signals can increase the synchronization probability.

When you turn on automatic signal detection, the settings in this dialog box are unavailable.

Synchronization signal in multiple frame analysis

If you measure [multiple frames](#), the configuration of the synchronization signal is the same for all frames. Therefore, the synchronization signal configuration is only available for the first frame.

Signal Description		Radio Frame Config		Ant Port Mapping		Advanced Settings	
CC 1							
Synchronization		BWP Config		Slot Config		PDSCH/PDCCH Config	
Detection		Auto		Manual			
Subcarrier Spacing		30kHz		SS/PBCH Block Pattern		CASE C	
SS/PBCH Block Offset							
Offset rel to		Ref Point A		Delta: SS/PBCH Block Center to CF		-36.54 MHz	
RB Offset (15kHz SCS)		50		Additional Subcarrier Offset (15kHz SCS)		0	
Burst Set Periodicity		10ms		SS/PBCH Block State		Configure	
Half Frame Offset		0		L Selection		4	
PSS Rel Power		0.0 dB		SSS Rel Power		0.0 dB	
PBCH Rel Power		0.0 dB		PBCH DMRS Rel Power (to PBCH)		0.0 dB	



Configuring component carriers

When you are doing measurements on [aggregated carriers](#), you can configure each carrier separately.

When available, each carrier in the dialog boxes is represented by an additional tab labeled "CC<x>", with <x> indicating the number of the component carrier.

Note that the additional tabs are only added to the user interface after you have selected more than "1" component carrier.

The remote commands required to configure the synchronization signals are described in [Chapter 6.9.6, "Synchronization signal configuration"](#), on page 312.

Subcarrier Spacing (synchronization signal)	88
SS/PBCH Block Pattern	89
Synchronization Signal Offset	89
Burst Set Periodicity	91
SS/PBCH Block State	91
Half Frame Offset	91
Relative Power	92

Subcarrier Spacing (synchronization signal)

The "Subcarrier Spacing" selects the subcarrier spacing for the synchronization signals.

The available subcarrier spacings depend on the [frequency range](#) you have selected.

- FR1: 15 kHz, 30 kHz
(30 kHz unavailable for a 5 MHz [channel bandwidth](#).)
- FR2-1: 120 kHz, 240 kHz
(240 kHz unavailable for a 50 MHz channel bandwidth.)
- FR2-2: 120 kHz, 480 kHz, 960 kHz

Note that a 60 kHz subcarrier spacing is only supported for the [user data](#) transmission.

Subcarrier spacings for FR2-2 have been introduced in 3GPP release 17.

Remote command:

[CONFigure\[:NR5G\]:DL\[:CC<cc>\]:SSBLock<ssb>:SSPacing](#) on page 317

SS/PBCH Block Pattern

The "SS Block Pattern" defines which symbols in a slot carry the synchronization signals.

- "Case A": Used for subcarrier spacing of 15 kHz and a carrier frequency in FR1.
- "Case B": Used for subcarrier spacing of 30 kHz and a carrier frequency in FR1.
- "Case C": Used for subcarrier spacing of 30 kHz and a carrier frequency in FR1.
The start symbol index for the SS/PBCH blocks is different than "Case B".
- "Case D": Used for subcarrier spacing of 120 kHz and a carrier frequency in FR2.
- "Case E": Used for subcarrier spacing of 240 kHz and a carrier frequency in FR2.
- "Case F": Used for subcarrier spacing of 480 kHz and carrier frequency in FR2-2.
- "Case G": Used for subcarrier spacing of 960 kHz and carrier frequency in FR2-2.

For cases A, B and C, the symbols occupied by the SS further depend on if the carrier frequency is below or above 3 GHz.

For a comprehensive description of the block patterns, refer to 3GPP 38.213, chapter 4.1.

The R&S FSV/A automatically selects the valid case, depending on the selected [frequency range](#) and [subcarrier spacing](#) - you only have to select the case for a subcarrier spacing of 30 kHz.

Remote command:

[CONFigure\[:NR5G\]:DL\[:CC<cc>\]:SSBLock<ssb>:PATtern](#) on page 315

Synchronization Signal Offset

The "RB Offset" and "Additional Subcarrier Offset" parameters define the location of the synchronization signals in the frequency domain in terms of resource blocks (RB) and subcarrier.

Both values are either relative to the first subcarrier of the channel or the [reference point A](#), depending on the "Offset Rel To" property.

- If you select "TxBW", the offset refers to a resource grid with the subcarrier spacing of the bandwidth part.
- If you select "Reference Point A", the offset refers to a resource grid with a 15 kHz subcarrier spacing (deployment in FR1) or a 60 kHz subcarrier spacing (deployment in FR2).

Note that an offset relative to the "TxBW" is only supported if one of the [bandwidth parts](#) has the same subcarrier spacing as the synchronization signal. Therefore, for a SS/PBCH subcarrier spacing = 240 kHz, the reference is always the reference point A.

The read-only field next to the input fields indicates the frequency offset of the SS/PBCH block in Hz, relative to the center of the channel bandwidth.

Example:

For "Offset Rel To" = "TXBW":

An RB offset = 0 would position the first subcarrier of the SS/PBCH block on the first subcarrier of the channel.

An RB offset = 12 would position the first subcarrier of the SS/PBCH block on the 144th subcarrier of the channel.

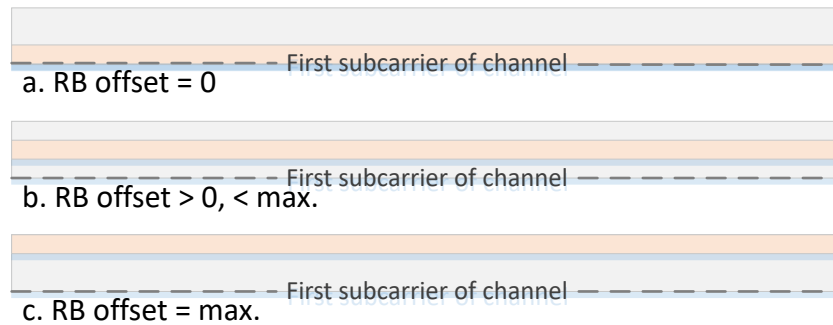

Figure 4-4: Synchronization signal block offset relative to the first subcarrier

For "Offset Rel To" = "Ref Point A":

The RB offset must consider the distance between reference point A and the first subcarrier of the channel (min. offset).

The min. offset would position the first subcarrier of the SS/PBCH block on the first subcarrier of the channel.

An RB offset greater than the minimum RB offset would place the SS/PBCH block on the nth subcarrier of the channel.

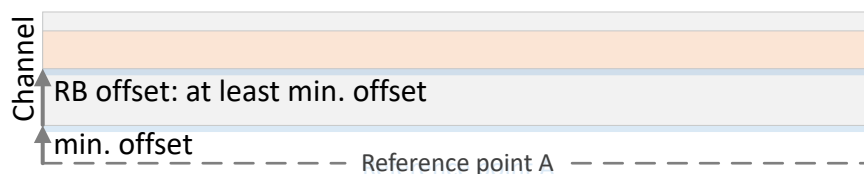

Figure 4-5: Synchronization signal block offset relative to the reference point A

You can fine-tune the location by defining an "Additional Subcarrier Offset".

Example:

An SS block offset = 12 and an additional subcarrier offset = 6 would position the first subcarrier of the SS/PBCH block on the 150th subcarrier of the channel or above the reference point A (provided that the minimum offset is lower than 150 subcarriers).

Remote command:

Resource blocks: `CONFigure[:NR5G]:DL[:CC<cc>]:SSBLock<ssb>:OFFSet`
on page 315

Subcarrier: `CONFigure[:NR5G]:DL[:CC<cc>]:SSBLock<ssb>:ASOFFset`
on page 313

Offset reference: `CONFigure[:NR5G]:DL[:CC<cc>]:SSBLock<ssb>:RTO`
on page 317

Burst Set Periodicity

The "Burst Set Periodicity" determines how often a block of synchronization signals is transmitted.

Currently, the R&S FSV/A supports a burst set periodicity of 10 ms which corresponds to a transmission in every frame.

The following periodicities are supported.

- 5 ms: transmission in every half frame.
- 10 ms: transmission in every frame.
- 20 ms: transmission in every second frame.
- 40 ms: transmission in every fourth frame.

Burst set periodicities greater than 10 ms are useful for the analysis of [multiple frames](#).

Remote command:

`CONFigure[:NR5G]:DL[:CC<cc>]:SSBLock<ssb>:BSPeriod` on page 313

SS/PBCH Block State

A half frame can contain up to 4, 8 or 64 SS/PBCH blocks, depending on the selected subcarrier spacing and the deploy frequency range. However, you can exclude individual SS/PBCH blocks from the signal description if you measure a signal that contains less than the supported number of SS/PBCH blocks.

When you select the "Configure" button, the R&S FSV/A opens a dialog box to turn individual SS/PBCH blocks on and off.

The number of SS/PBCH blocks that you can turn on and off (4, 8 or 64) depends on the deployment.

- 4 SS/PBCH blocks for a deployment in FR1 \leq 3 GHz.*
- 8 SS/PBCH blocks for a deployment in FR1 above 3 GHz.
- 64 SS/PBCH blocks for a deployment in FR2.

*A special scenario also allows you to use 8 SS/PBCH blocks for a deployment < 3 GHz:

- Select a 30 kHz [subcarrier spacing](#).
- Select a "Case C" [block pattern](#).
- The "L Selection" parameter becomes available. Select the number of resource blocks to use (4 or 8).

Remote command:

SS/PBCH block state: `CONFigure[:NR5G]:DL[:CC<cc>]:SSBLock<ssb>[:STATE<ss>]` on page 319

L selection: `CONFigure[:NR5G]:DL[:CC<cc>]:SSBLock<ssb>:L` on page 314

Half Frame Offset

Selects the half frame in which the synchronization signal is in.

Select "0" if your SSB is in the first half frame, and "1" if it is in the second.

This selection only has an effect for synchronization signals with a [periodicity](#) greater than 5 ms.

Remote command:

[CONFigure\[:NR5G\]:DL\[:CC<cc>\]:SSBLock<ssb>:HFOffset](#) on page 313

Relative Power

You can define an additional boosting for each synchronization signal.

The "PSS Rel Power" defines the relative power of the PSS.

The "SSS Rel Power" defines the relative power of the SSS.

The "PBCH Rel Power" defines the relative power of the PBCH.

The "PBCH DMRS Power" defines the power of the PBCH demodulation reference signal (DMRS) relative to the PBCH power.

Remote command:

PSS: [CONFigure\[:NR5G\]:DL\[:CC<cc>\]:SSBLock<ssb>:PSS:POWer](#)
on page 317

SSS: [CONFigure\[:NR5G\]:DL\[:CC<cc>\]:SSBLock<ssb>:SSS:POWer](#)
on page 318

PBCH: [CONFigure\[:NR5G\]:DL\[:CC<cc>\]:SSBLock<ssb>:PBCH:POWer](#)
on page 316

PBCH DMRS: [CONFigure\[:NR5G\]:DL\[:CC<cc>\]:SSBLock<ssb>:PDMRs:POWer](#)
on page 316

4.1.8 Bandwidth part configuration

Access: "Overview" > "Signal Description" > "Radio Frame Config" > "BWP Config"

One of the defining features of the 5G NR standard is bandwidth parts (BWP). Using bandwidth parts, you can split the complete channel bandwidth into several smaller slices. A bandwidth part is defined as a contiguous set of physical resource blocks that have the same subcarrier spacing (or numerology as the 3GPP standard calls it).

The numerology has several effects on the signal, like the symbol length and the number of slots in a subframe.

Table 4-1: Numerology in 5G NR

Numerology	0	1	2	3	4
Subcarrier spacing	15 kHz	30 kHz	60 kHz	120 kHz	240 kHz
Slot length	1 ms	0.5 ms	0.25 ms	0.125 ms	0.0625 ms
Number of slots in subframe	1	2	4	8	16

Table 4-2: Additional numerology introduced with 3GPP release 17

Numerology	5	6
Subcarrier spacing	480 kHz	960 kHz
Slot length	0.03125 ms	0.015625 ms
Number of slots in subframe	32	64

The number of bandwidth parts you can configure with the R&S FSV/A is limited to 12. During transmission, each bandwidth part can be assigned to a specific user equipment (UE). Bandwidth parts can overlap, in which case UEs share the resource elements of a bandwidth part.

For measurements on signals with multiple bandwidth parts, it is sufficient to configure only the active bandwidth part.

You can configure bandwidth parts in the bandwidth part configuration table. This table contains the characteristics of all bandwidth parts in the currently selected frame. You can add or remove bandwidth parts and configure them as you like.

Each row in the table corresponds to a bandwidth part.

Detection of bandwidth part configuration

The R&S FSV/A supports [automatic detection](#) of the bandwidth part configuration. When you select "Auto" detection mode, the R&S FSV/A detects the bandwidth part configuration, slot configuration and PDSCH and CORESET allocations.

When you select "Manual" mode, you can describe the bandwidth part manually with various characteristics.

If you measure a signal with a bad signal-to-noise ratio, for example due to a low signal level, manual configuration of the bandwidth parts can increase the synchronization probability.

When you turn on automatic signal detection, the settings in this dialog box are unavailable.

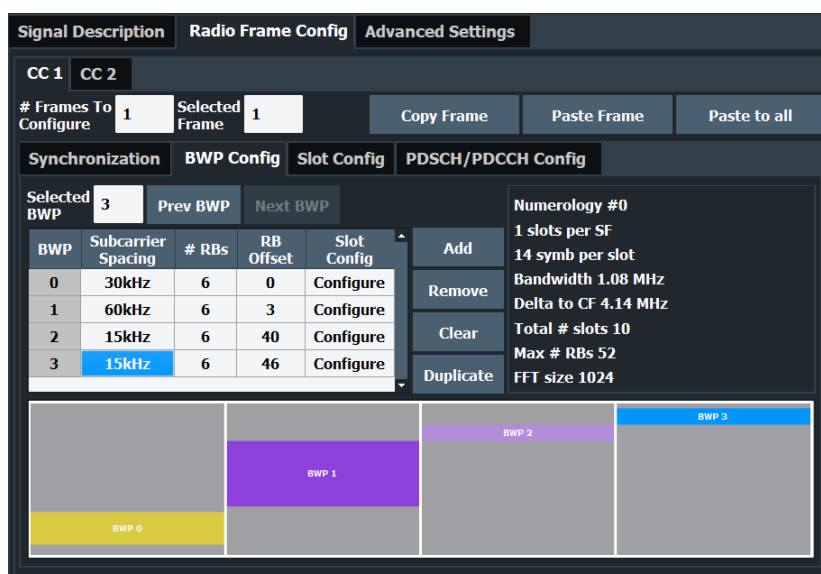

Configuring component carriers

When you are doing measurements on [aggregated carriers](#), you can configure each carrier separately.

When available, each carrier in the dialog boxes is represented by an additional tab labeled "CC<x>", with <x> indicating the number of the component carrier.

Note that the additional tabs are only added to the user interface after you have selected more than "1" component carrier.

The remote commands required to configure the bandwidth parts are described in [Chapter 6.9.7, "Bandwidth part configuration"](#), on page 319.

- [BWP configuration table management](#).....94
- [BWP configuration table](#).....95

4.1.8.1 BWP configuration table management

The R&S FSV/A provides several tools to manage the configuration table and make the configuration of bandwidth parts easier.

- [Bandwidth Part Selection](#)..... 94
- [BWP Configuration Tools](#)..... 95

Bandwidth Part Selection

You can select the bandwidth part you want to configure by entering its number in the "Selected BWP" input field. In the configuration table, the selected bandwidth part is highlighted blue.

You can also select bandwidth parts with the "Prev BWP" and "Next BWP" buttons.

Note that when you select a bandwidth part, the R&S FSV/A also selects that bandwidth part in the [Slot Config](#) and [PDSCH / PDCCH Config](#) tabs and vice versa.

Remote command:
via suffix at `BWPart<bwp>`

BWP Configuration Tools

The BWP configuration table provides several management tools.

- "Add": Adds a bandwidth part to the table.
- "Remove": Deletes the selected (highlighted) bandwidth part.
- "Clear": Removes all entries from the table.
- "Duplicate": Copies the configuration of the selected bandwidth part to a new bandwidth part.

Note that this includes the [Slot Config](#) and [PDSCH / PDCCH](#).

Remote command:

Add BWP: `CONFigure[:NR5G]:DL[:CC<cc>]:FRAME<fr>:BWPart<bwp>:ADD`
on page 319

Remove BWP: `CONFigure[:NR5G]:DL[:CC<cc>]:FRAME<fr>:BWPart<bwp>:REMove`
on page 321

Clear table: `CONFigure[:NR5G]:DL[:CC<cc>]:FRAME<fr>:BWPart<bwp>:CLEar`
on page 320

Duplicate BWP: `CONFigure[:NR5G]:DL[:CC<cc>]:FRAME<fr>:BWPart<bwp>:DUPLicate`
on page 320

4.1.8.2 BWP configuration table

The bandwidth part configuration table consists of several rows, each of which corresponds to a bandwidth part. The size of the table therefore depends on the number of bandwidth parts you have added to the table.

Preview diagram

The preview diagram shows the distribution and location of the bandwidth parts. The x-axis represents the bandwidth part, the y-axis represent the frequency, with the point of origin of the diagram being the first subcarrier. The color depends on the subcarrier spacing selected for the corresponding bandwidth part.

The width of the bandwidth parts depends on the number of resource blocks it occupies. The location of the bandwidth part on the y-axis depends on the resource block offset.

If two or more bandwidth parts overlap (share the same resource blocks), the corresponding parts of the bandwidth part are highlighted by black lines.

Unused parts of the spectrum remain gray.

Numerology

Next to the bandwidth part configuration table, the R&S FSV/A displays various information about the numerology in the currently selected bandwidth part.

- "Numerology": Shows the [numerology](#) of the bandwidth part as defined by 3GPP.
- "Slots per SF": Shows the number of slots in a subframe in the selected BWP. The number of slots depends on the selected subcarrier spacing.

- "Symbols Per Slot": Shows the number of symbols in a slot in the selected BWP.
- "Bandwidth": Shows the width of the selected BWP in Hz.
- "Delta To CF": Shows the frequency offset of the BWP relative to the center frequency of the complete signal.
- "Total # Slots": Shows the complete number of slots in the BWP over all subframes. The number of slots depends on the selected subcarrier spacing.
- "Max # RBs": Shows the maximum number of resource blocks that the bandwidth part can have.
- "FFT Size": Shows the FFT size in the selected BWP. The FFT size depends on the selected subcarrier spacing.

BWP Number.....	96
Subcarrier Spacing (user data).....	96
# RBs.....	97
RB Offset.....	97
Slot Config.....	97

BWP Number

The "BWP Number" shows the index number of the corresponding BWP.

The bandwidth part number is a consecutive index number that allows you to identify each bandwidth part. The first bandwidth part has the index number 0.

Remote command:
not supported

Subcarrier Spacing (user data)







The "Subcarrier Spacing" selects the subcarrier spacing for the corresponding BWP.

The available subcarrier spacings depend on the [frequency range](#) you have selected.

- FR1: 15 kHz, 30 kHz, 60 kHz
Note that 15 kHz is only available for channel bandwidths < 60 MHz.
- FR2-1: 60 kHz, 120 kHz
- FR2-2: 120 kHz, 480 kHz, 960 kHz
The following restrictions apply:
 - Channel bandwidth = 100 MHz: 120 kHz
 - Channel bandwidth = 400 MHz: 120 kHz, 480 kHz and 960 kHz
 - Channel bandwidth = 800 MHz and 1600 MHz: 480 kHz and 960 kHz
 - Channel bandwidth = 2000 MHz: 960 kHz

Note that a 240 kHz subcarrier spacing is only supported for the [synchronization signal](#).

Subcarrier spacings are indicated by different colors in the preview diagram.

- : 15 kHz
- : 30 kHz
- : 60 kHz
- : 120 kHz
- : 480 kHz
- : 960 kHz

For bandwidth parts with a 60 kHz subcarrier spacing, you can select if it has a normal cyclic prefix (NCP) or an extended cyclic prefix (ECP). Note that the diagrams only show results if you select the BWP with the extended cyclic prefix from the [evaluation range](#).

Remote command:

`CONFigure[:NR5G]:DL[:CC<cc>]:FRAMe<fr>:BWPart<bwp>:SSPacing`
on page 322

RBs

The "# RBs" defines the number of physical resource blocks (PRB) the bandwidth part occupies. The number of physical resource blocks also defines the frequency width of the bandwidth part.

The maximum number of physical resource blocks for a bandwidth part depends on the selected [subcarrier spacing](#) and the overall [channel bandwidth](#), which in turn depend on the selected [frequency range](#). For a detailed overview, see 3GPP 38.104, tables 5.3.2-1 and 5.3.2-2.

Bandwidth parts can share resource blocks.

Remote command:

`CONFigure[:NR5G]:DL[:CC<cc>]:FRAMe<fr>:BWPart<bwp>:RBCount`
on page 320

RB Offset

The "RB Offset" defines an offset of the first resource block that the bandwidth part uses relative to the first resource block of the channel.

The resource block offset therefore defines the location (frequency) of the bandwidth part in the NR channel.

Remote command:

`CONFigure[:NR5G]:DL[:CC<cc>]:FRAMe<fr>:BWPart<bwp>:RBOffset`
on page 321

Slot Config

The "Configure" button opens the dialog box to configure the slots in the corresponding bandwidth part.

For details, see [Slot Config](#).

Remote command:

not supported

4.1.9 Slot configuration

Access: "Overview" > "Signal Description" > "Radio Frame Config" > "Slot Config"

Slots

Slots are flexible entities in the 5G NR radio frame, whose characteristics depend on a number of factors.

In the time domain, the length of a slot and the number of slots in a subframe depends on the numerology.

Each slot contains 14 OFDM symbols. Each symbol can have a different scheduling type to make scheduling during transmission as flexible as possible.

Slot configuration table

The slot configuration table represents the frame structure in the time domain. Each row corresponds to one slot, and each slot can have a different configuration.

When you turn on automatic signal detection, the settings in this dialog box are unavailable.

Selecting the bandwidth part to configure

- ▶ Enter the number of the bandwidth part you want to configure in the "Bandwidth Part Number" field.

The R&S FSV/A selects the corresponding bandwidth part.

Note that when you select bandwidth part here, the R&S FSV/A also selects that bandwidth part in the [BWP Config](#) tab and vice versa.



Configuring component carriers

When you are doing measurements on [aggregated carriers](#), you can configure each carrier separately.

When available, each carrier in the dialog boxes is represented by an additional tab labeled "CC<x>", with <x> indicating the number of the component carrier.

Note that the additional tabs are only added to the user interface after you have selected more than "1" component carrier.

The remote commands required to configure the slots are described in [Chapter 6.9.8, "Slot configuration"](#), on page 323.

• General slot configuration	99
• Slot configuration table	100
• CSI reference signal	102
• Positioning reference signal	106

4.1.9.1 General slot configuration

The slot configuration table contains a variable number of rows, depending on the bandwidth parts configuration.

Selected Slot	99
Number of Configurable Slots	99
Slot Configuration Tools	100

Selected Slot

You can select the slot you want to configure by entering its number in the "Selected Slot" input field. In the configuration table, the selected slot is highlighted blue.

You can also select slots with the "Prev Slot" and "Next Slot" buttons.

Note that when you select a slot, the R&S FSV/A also selects that slot in the [PDSCH / PDCCH Config](#) tab and vice versa.

Remote command:

via suffix at `SLOT<sl>`

Number of Configurable Slots

You can configure each slot in the radio frame individually, but when more slots have the same configuration (for example each subframe has the same slot configurations), you can configure just a certain number of slots and repeat this configuration on other slots.

The slots you can edit ("# User Configurable Slots") are always the first slots in the table. For example, if the number of configurable slots is "4", you can edit the first four rows in the table. The cells of slots you can edit are white.

The slot configuration is repeated for all other slots. For example, if you can edit the first four slots, the subsequent four slots have the same configuration and so on. The configuration that a specific slot uses is indicated in the last column of the slot configuration table.

The "Periodicity" shown next to the slot configuration table indicates the length of all customized slots. For example, a periodicity of 1 ms in a BWP with a 30 kHz subcarrier spacing indicates that the first two slots have a custom configuration which is repeated every 1 ms.

Remote command:

[CONFigure\[:NR5G\]:DL\[:CC<cc>\]:FRAME<fr>:BWPart<bwp>:CSLot](#)
on page 323

Slot Configuration Tools

The R&S FSV/A provides some tools to make slot configuration easier.

- "Copy Slot": Copies the slot configuration of the selected slot.
Note that this includes the [PDSCH/PDCCH configuration](#) of that slot.
- "Paste Slot": Applies the slot configuration in the cache to the selected slot.
- "Paste To": Applies the slot configuration to a set of configurable slots.
 - Paste to "Slots": Paste to specific slots or range of slots (e.g. 1,2,5-8)
 - Paste to "Data": Paste to all data slots.
 - Paste to "Unused": Paste to all unused slots (they will turn into data slots).
 - Paste to "Custom": Paste to selected slots according to a certain [logic](#) (period / duration).
- "Paste To All": Applies the slot configuration in the cache to all configurable slots.
- "Reset Slot Config": Restores the default slot configuration (including the PDSCH/PDCCH configuration).

Remote command:

Copy: `CONFigure[:NR5G]:DL[:CC<cc>]:FRAMe<fr>:BWPART<bwp>:SLOT<sl>:COPY` on page 324

Paste: `CONFigure[:NR5G]:DL[:CC<cc>]:FRAMe<fr>:BWPART<bwp>:SLOT<sl>:PASTe[:SLOT]` on page 329

Paste to all: `CONFigure[:NR5G]:DL[:CC<cc>]:FRAMe<fr>:BWPART<bwp>:SLOT<sl>:PASTe:ALL` on page 325

Paste to selected: `CONFigure[:NR5G]:DL[:CC<cc>]:FRAMe<fr>:BWPART<bwp>:SLOT<sl>:PASTe:TO` on page 327

Reset: `CONFigure[:NR5G]:DL[:CC<cc>]:FRAMe<fr>:BWPART<bwp>:SLOT<sl>:PRESet` on page 329

4.1.9.2 Slot configuration table

The slot configuration table contains the configuration of all slots in the currently selected bandwidth part. The number of rows (slots) depends on the [subcarrier spacing](#) in the selected bandwidth part.

The complete number of slots in the selected bandwidth part is indicated next to the table ("n Slots in BWP x").

SF Number	Slot Number	Slot Allocation	Slot Format	PDSCH Allocations	Repeated Slot No	Ref Signals
0	0	Data	0	Configure	User	CSI-RS
	1	Data	0		0	None
1	2	Data	0		0	None
	3	Data	0		0	None
2	4	Data	0		0	CSI-RS
	5	Data	0		0	None
3	6	Data	0		0	None
	7	Data	0		0	None

Slot preview

The slot preview shows the scheduling of the OFDM symbols in the selected slot.



Figure 4-6: Preview of symbol usage for slot format 38 as defined in 3GPP 38.211, table 4.3.2-3

The scheduling depends on the selected [slot format](#).

Subframe Number.....	101
Slot Number.....	101
Slot Allocation.....	101
Slot Format.....	101
PDSCH Allocations.....	102
Repeated Slot No.....	102
Ref Signals.....	102

Subframe Number

The "Subframe Number" shows the index number (0 to 9) of the subframe that the slot belongs to.

The number of subframes is always 10, the number of slots in a subframe varies, depending on the subcarrier spacing / [numerology](#). The first subframe always has the index 0.

Remote command:
not supported

Slot Number

The "Slot Number" shows the index number (0 to n) of the corresponding slot.

The selected slot is highlighted blue.

The number of slots in the frame varies, depending on the subcarrier spacing / [numerology](#). The first slot always has the index 0.

Remote command:
not supported

Slot Allocation

The "Slot Allocation" selects the usage of the corresponding slot.

- "Data": Slot is used for user data transmission.
- "Unused": Slot is not used.

Remote command:

`CONFigure[:NR5G]:DL[:CC<cc>]:FRAME<fr>:BWPart<bwp>:SLOT<sl>:`
[ATYPe](#) on page 324

Slot Format

The "Slot Format" selects one of the slot formats defined by 3GPP for the corresponding slot.

The slot format defines the usage of the OFDM symbols in a slot. Possible symbol usages are:

- Uplink: Symbol carries uplink information.
- Downlink: Symbol carries downlink information.
- Flexible: Symbol usage is undefined and can carry uplink or downlink information.

The symbol usage of the selected slot format is indicated in the [slot preview](#).

For a comprehensive list of all supported slot formats, see 3GPP 38.211, table 4.3.2-3: "Slot formats".

3GPP release 16 unlocks additional slot formats.

Remote command:

`CONFigure[:NR5G]:DL[:CC<cc>]:FRAMe<fr>:BWPart<bwp>:SLOT<sl>:FORMat` on page 325

PDSCH Allocations

The "Configure" button opens the dialog box to configure the PDSCH or CORESET allocations in the corresponding slot.

For details, see [Chapter 4.1.10, "PDSCH and PDCCH configuration"](#), on page 109.

Remote command:

not supported

Repeated Slot No

The "Repeated Slot No" shows the slot number on which the configuration of a slot is based on.

If the table cell says "User", the slot is configured manually.

If the table cell contains a number, the slot configuration is the same as the slot indicated by that number. For example, if the cell contains the number "1", the slot configuration is the same as the slot with the index number 1.

Remote command:

not supported

Ref Signals

Opens a dialog box to configure reference signals transmitted in the corresponding slot.

For details, see [Chapter 4.1.9.3, "CSI reference signal"](#), on page 102.

Remote command:

not supported

4.1.9.3 CSI reference signal

The channel state information reference signal (CSI-RS) is used to estimate the properties of the signal propagation channel from the base station to the user equipment. This information is quantized and fed back to the base station. The base station makes use of this information for example to calculate the channel quality or to adjust the beamforming parameters.

You can define various parameters to describe the physical attributes and structure of the CSI-RS, for example where it is located in the resource grid or how often it occurs in the signal.

The CSI-RS configuration is specific to a bandwidth part.

Within a bandwidth part, the CSI-RS configuration depends on the number of resources you define. Each resource of the CSI-RS can have a different configuration. You

can allocate the CSI-RS to more than one slot (periodic or aperiodic [transmission method](#)).

Note that the CSI-RS is only analyzed if you assign it to an [antenna port](#).

Channel-State Information RS												
State	On	Off	Resources	3								
Slot Config	Zero Power	Number of RBs	Start RB	Row	Ports	Density	CDM Type	Bitmap	I0	I1	Scrambling ID	Rel. Power / dB
Periodic	Off	273	0	1	1	3	No CDM	1111	9	11	0	0 dB
Periodic	Off	273	0	1	1	3	No CDM	1111	9	11	0	0 dB
Periodic	Off	273	0	1	1	3	No CDM	1111	9	11	0	0 dB

The remote commands required to configure the CSI reference signal are described in [Chapter 6.9.9, "CSI reference signal configuration"](#), on page 330.

State.....	103
Resources.....	103
Slot Config.....	104
└ Periodic transmission.....	104
└ Aperiodic transmission.....	104
Zero Power.....	104
No. RBs.....	105
Start RB.....	105
Row.....	105
Density.....	105
Bitmap.....	106
I0 / I1.....	106
Scrambling ID.....	106
Rel Power.....	106

State

Turns the CSI reference signal on and off.

Remote command:

```
CONFigure[:NR5G]:DL[:CC<cc>]:FRAME<fr>:BWPart<bwp>:CSI<csi>:
STATE on page 338
```

Resources

Defines the number of CSI-RS resources that make up the CSI-RS. Each resource can have a different configuration

Each line in the CSI-RS configuration table corresponds to a resource. Changing the number of resources adjusts the number of rows accordingly.

Remote command:

```
CONFigure[:NR5G]:DL[:CC<cc>]:FRAME<fr>:BWPart<bwp>:CSI<csi>:
RESources on page 334
```

Slot Config

Opens a dialog box to configure in which slots the CSI reference signal appears.

You can select "Periodic" or "Aperiodic" transmission.

Remote command:

Method: `CONFigure[:NR5G]:DL[:CC<cc>]:FRAMe<fr>:BWPart<bwp>:CSI<csi>:SLOT:MODE` on page 336

Periodic transmission ← Slot Config

Periodic transmission transmits the CSI-RS every <x> slots ("Periodicity"). You can also define an "Offset" if you do not want the first occurrence of the CSI-RS in the first slot - for an offset of 2, for example, the first slot that carries the CSI-RS is slot 2.

If you configure and analyze multiple frames, the sequence of CSI-RS is applied in subsequent frames. For example, if you define a periodicity of "4" in 2 frames with 10 slots each, the following slots contain a CSI-RS (assuming, there is no offset):

- First frame: 0 - 4 - 8
- Second frame: 2 - 6 - 10

You can check the distribution of CSI-RS in the "Ref Signals" column of the [slot configuration table](#) when you [select different frames](#).

For a correct analysis of the CSI-RS over multiple frames, you have to define the starting frame. You can do this in different ways.

- Trigger on a fixed system frame number (recommended).
- Select the received frame with the [frame number n_f](#) parameter. You can find out the system frame n_f in the [channel decoder results](#) (an SSB must be available for this to work). After you change n_f, you have to [refresh](#) the results.

Remote command:

Periodicity: `CONFigure[:NR5G]:DL[:CC<cc>]:FRAMe<fr>:BWPart<bwp>:CSI<csi>:SLOT:PERiodicity` on page 336

Offset: `CONFigure[:NR5G]:DL[:CC<cc>]:FRAMe<fr>:BWPart<bwp>:CSI<csi>:SLOT:POFFset` on page 337

Aperiodic transmission ← Slot Config

Aperiodic transmission transmits the CSI-RS in arbitrary slots. Enter the slot numbers that should carry the CSI-RS in the "Slots" input field. For example: 1-3,5,7 to transmit the CSI-RS in slots 1,2,3,5 and 7.

Available slots depend on the subcarrier spacing in the bandwidth part.

For aperiodic transmission over multiple frames, you can define the location of the CSI-RS in each frame manually. If you only define the CSI-RS location for one frame, the R&S FSV/A assumes that the location is the same in all frames.

Remote command:

Slots: `CONFigure[:NR5G]:DL[:CC<cc>]:FRAMe<fr>:BWPart<bwp>:CSI<csi>:SLOT:APERiodic` on page 335

Zero Power

Turns zero power transmission of the CSI reference signal on and off.

If you turn on zero power transmission, the resource elements are allocated to the CSI-RS as if it were there, but it is not actually transmitted. Results for the CSI-RS, like the EVM, are also not calculated. You can no longer define a scrambling ID or relative power for the CSI-RS.

Remote command:

`CONFigure[:NR5G]:DL[:CC<cc>]:FRAMe<fr>:BWPart<bwp>:CSI<csi>:
ZPOWer` on page 338

No. RBs

Selects the number of resource blocks the CSI reference signal uses.

Remote command:

`CONFigure[:NR5G]:DL[:CC<cc>]:FRAMe<fr>:BWPart<bwp>:CSI<csi>:
NORBs` on page 333

Start RB

Selects the first resource block in the bandwidth part that the CSI reference signal uses.

Remote command:

`CONFigure[:NR5G]:DL[:CC<cc>]:FRAMe<fr>:BWPart<bwp>:CSI<csi>:SRB`
on page 337

Row

Selects one of the CSI-RS location settings defined in 3GPP 38.211, table 7.4.1.5.3-1. The location settings correspond to the rows in this table.

The selection has an effect on the ranges of the following CSI-RS settings:

- [Density](#)
- [Bitmap](#)
(Note that the bitmap has a fixed configuration for some rows.)
- [I0 / I1](#)
(Some location settings reserve two symbols for the CSI-RS transmission.)

The row selection also defines the values for the "Ports" and the "CDM Type" (code domain multiplexing type) parameters. These two values are fixed for each row and therefore read only parameters.

Remote command:

Row selection: `CONFigure[:NR5G]:DL[:CC<cc>]:FRAMe<fr>:BWPart<bwp>:
CSI<csi>:ROW` on page 334

Ports (query): `CONFigure[:NR5G]:DL[:CC<cc>]:FRAMe<fr>:BWPart<bwp>:
CSI<csi>:PORT?` on page 333

CDM type (query): `CONFigure[:NR5G]:DL[:CC<cc>]:FRAMe<fr>:
BWPart<bwp>:CSI<csi>:CTYPe?` on page 331

Density

Defines how many subcarriers are allocated to the CSI-RS.

The available values depend on the [location settings](#) parameter.

If you select 0.5 density, you can define if the CSI-RS is located on even or odd resource blocks.

Remote command:

CONFigure[:NR5G]:DL[:CC<cc>]:FRAMe<fr>:BWPart<bwp>:CSI<csi>:
DENSIty on page 331

Bitmap

Defines the subcarriers on which the CSI-RS is transmitted (location of the CSI-RS in the frequency domain).

For more information about supported bitmap values, see 3GPP 38.211, chapter 7.4.1.5.

Note that the bitmap setting is not available for all [location settings](#).

Remote command:

CONFigure[:NR5G]:DL[:CC<cc>]:FRAMe<fr>:BWPart<bwp>:CSI<csi>:
BITMap on page 330

I0 / I1

Parameters I_0 and I_1 define the location of the CSI-RS in the time domain.

"I0" defines the position of the first symbol of the first CSI-RS in the resource grid.

"I1" becomes available for [location settings](#) that support a two-symbol transmission of the CSI-RS. It defines the resource grid position of the second symbol allocated to the CSI-RS.

Note that I_0 must be smaller than I_1 . I_0 is automatically adjusted if this is not the case.

Remote command:

I_0 : CONFigure[:NR5G]:DL[:CC<cc>]:FRAMe<fr>:BWPart<bwp>:CSI<csi>:
LZERo
 I_1 : CONFigure[:NR5G]:DL[:CC<cc>]:FRAMe<fr>:BWPart<bwp>:CSI<csi>:
LONE on page 331

Scrambling ID

Defines the pseudo-random seed value for the CSI-RS sequence generation.

Remote command:

CONFigure[:NR5G]:DL[:CC<cc>]:FRAMe<fr>:BWPart<bwp>:CSI<csi>:SID
on page 335

Rel Power

Defines the relative power of the CSI-RS in dB.

Remote command:

CONFigure[:NR5G]:DL[:CC<cc>]:FRAMe<fr>:BWPart<bwp>:CSI<csi>:
POWer on page 333

4.1.9.4 Positioning reference signal

The positioning reference signal (PRS) is used to locate user equipment using timing based methods. Compared to other positioning systems like GPS, using the PRS is highly accurate and provides a greater coverage, even indoors. PRS is useful for any type of location based services, for example emergency calls.

You can define various parameters to describe the physical attributes and structure of the PRS, for example where it is located in the resource grid or how often it occurs in the signal.

The PRS configuration is specific to a bandwidth part.

Within a bandwidth part, you can configure a single PRS. You can allocate the PRS to more than one slot (aperiodic [transmission method](#)).

The positioning reference signal is available with 3GPP release 16.

Positioning RS								
State	<input checked="" type="radio"/> On <input type="radio"/> Off							
Slot Config	Number of RBs	Start RB	l [^] PRS_start	L_PRS	n [^] PRS_ID,Seq	K [^] PRS_comb	k [^] PRS_offset	Rel. Power/dB
Aperiodic	272	0	0	2	0	2	0	0 dB

The remote commands required to configure the positioning reference signal are described in [Chapter 6.9.10, "Positioning reference signal"](#), on page 339.

State.....	107
Slot Config.....	107
No. RBs.....	107
Start RB.....	108
l [^] PRS_Start.....	108
L_PRS.....	108
n [^] PRS_ID,Seq.....	108
K [^] PRS_comb.....	108
K [^] PRS_Offset.....	108
Rel Power.....	109

State

Turns the positioning reference signal on and off.

Remote command:

`CONFigure[:NR5G]:DL[:CC<cc>]:FRAME<fr>:BWPart<bw>:PRS:STATE`
on page 342

Slot Config

Opens a dialog box to configure in which slots the positioning reference signal appears.

You can assign the PRS to arbitrary slots. Enter the slot numbers that should carry the PRS in the "Slots" input field. For example: 1-3,5,7 to transmit the PRS in slots 1,2,3,5 and 7.

Available slots depend on the subcarrier spacing in the bandwidth part.

Remote command:

`CONFigure[:NR5G]:DL[:CC<cc>]:FRAME<fr>:BWPart<bw>:PRS:SLOT:APERiodic` on page 341

No. RBs

Selects the number of resource blocks the positioning reference signal uses.

Remote command:

`CONFigure[:NR5G]:DL[:CC<cc>]:FRAMe<fr>:BWPart<bwp>:PRS:NORBs`
on page 340

Start RB

Selects the first resource block in the bandwidth part that the positioning reference signal uses.

Remote command:

`CONFigure[:NR5G]:DL[:CC<cc>]:FRAMe<fr>:BWPart<bwp>:PRS:SRB`
on page 342

I^PRS_Start

Defines the first symbol in a slot allocated to the positioning reference signal.

Note that the selection of the start symbol has an effect on the number of symbols [number of symbols](#) the PRS can use. The higher the start symbol, the less symbols the PRS can use.

Remote command:

`CONFigure[:NR5G]:DL[:CC<cc>]:FRAMe<fr>:BWPart<bwp>:PRS:LPStart`
on page 340

L_PRS

Defines the number of symbols allocated to the positioning reference signal.

Note that the selection of the [start symbol](#) has an effect on the number of symbols the PRS can use. The higher the start symbol, the less symbols the PRS can use.

Remote command:

`CONFigure[:NR5G]:DL[:CC<cc>]:FRAMe<fr>:BWPart<bwp>:PRS:LPRS`
on page 340

n^PRS_ID,Seq

Defines the pseudo-random seed value for the PRS sequence generation.

Remote command:

`CONFigure[:NR5G]:DL[:CC<cc>]:FRAMe<fr>:BWPart<bwp>:PRS:NPID`
on page 341

K^PRS_comb

Defines the number of subcarriers allocated to the positioning reference signal.

The number of subcarriers you can use depends on the [size of the PRS](#).

Remote command:

`CONFigure[:NR5G]:DL[:CC<cc>]:FRAMe<fr>:BWPart<bwp>:PRS:KPComb`
on page 339

K^PRS_Offset

Defines an offset for the positioning reference signal in the frequency domain relative to the first subcarrier.

Possible offsets depend on the [number of subcarriers](#) the PRS uses.

Remote command:

`CONFigure [:NR5G] :DL[:CC<cc>] :FRAMe<fr>:BWPart<bwp>:PRS:KPOffset`
on page 339

Rel Power

Defines the relative power of the positioning reference signal in dB.

Remote command:

`CONFigure [:NR5G] :DL[:CC<cc>] :FRAMe<fr>:BWPart<bwp>:PRS:POWer`
on page 341

4.1.10 PDSCH and PDCCH configuration

Access: "Overview" > "Signal Description" > "Radio Frame Config" > "PDSCH / PDCCH Config"

Each slot assigned to carry user data contains one or more resource allocations. Resource allocations are the physical channels that carry user data or information about it. The size of an allocation in the resource grid is variable. An allocation covers one or more physical resource blocks.

PDSCH

The physical downlink shared channel (PDSCH) carries the general user data and is therefore the most prominent channel in a radio frame that occupies the most resources. PDSCH allocations have a variable number of resource blocks and OFDM symbols. Each slot can have one or more PDSCHs. The PDSCH has a dedicated demodulation reference signal (DMRS).

Interleaving means that virtual resource block bundles are mapped to different physical resource block bundles in the physical resource grid. If you do not apply interleaving, the physical resource grid is the same as the virtual resource grid.

The RB bundle size in the frequency domain is variable, in the time domain it still consists of a single OFDM symbol.

CORESET

The physical downlink control channel (PDCCH) carries the downlink control information. The PDCCH is transmitted in a control resource set (CORESET) that has a dedicated demodulation reference signal (DMRS). A CORESET contains the control information for one or more UEs. Each slot can contain one or more CORESETs.

In terms of the resource allocation, a PDCCH consists of several control channel elements (CCEs), depending on the aggregation level. A CCE is a cluster of several REG bundles, which in turn consist of one or more resource element groups (REG). In the resource grid, the REG bundles can be grouped, but can also be distributed over non-contiguous resource blocks (interleaving). A REG corresponds to one resource block (12 resource elements in the frequency domain and one OFDM symbol in the time domain).

The PDCCH also contains the [downlink control information](#) (DCI).

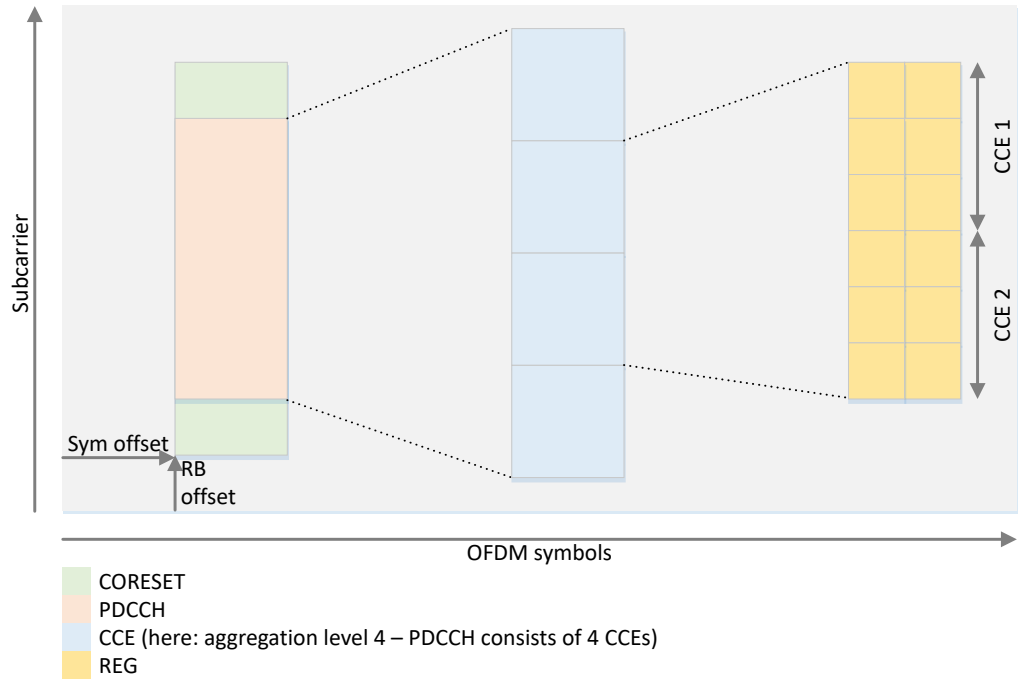

Figure 4-7: PDCCH structure

When you turn on automatic signal detection, the settings in this dialog box are unavailable.

Signal Description Radio Frame Config Ant Port Mapping Advanced Settings

CC 1 CC 2

Frames To Configure: 1 Selected Frame: 1 Copy Frame Paste Frame Paste to all

Synchronization BWP Config Slot Config PDSCH/PDCCH Config

Bandwidth Part Number: 0 Slot Number: 0

PDSCH Allocations: 2 # CORESETs: 2

ID	User ID	Allocation	Code Word	Modulation	Enhanced Settings	Number of RBs	Offset RB	Number of Symb	Offset Symb	Rel. Power /dB	Conflict
0		CORESET		QPSK	...	6	0	1	0	0 dB	
1		CORESET		QPSK	...	6	6	1	0	0 dB	
0	0	PDSCH	1/1	QPSK	...	20	20	10	1	0 dB	
1	0	PDSCH	1/1	QPSK	...	20	0	10	1	0 dB	

Combine PDSCH Allocations with Same User ID: On Off



Configuring component carriers

When you are doing measurements on [aggregated carriers](#), you can configure each carrier separately.

When available, each carrier in the dialog boxes is represented by an additional tab labeled "CC<x>", with <x> indicating the number of the component carrier.

Note that the additional tabs are only added to the user interface after you have selected more than "1" component carrier.

- [General PDSCH / PDCCH configuration](#)..... 111
- [PDSCH / PDCCH configuration table](#)..... 112
- [Enhanced CORESET settings: allocation configuration](#)..... 116
- [Enhanced CORESET settings: PDCCH](#)..... 118
- [Enhanced PDSCH settings: DMRS](#)..... 122
- [Enhanced PDSCH settings: PTRS](#)..... 126
- [Enhanced PDSCH settings: scrambling / coding](#)..... 127

4.1.10.1 General PDSCH / PDCCH configuration

The allocations in the table refer to a specific bandwidth part and slot.

Selecting the bandwidth part to configure

- ▶ Enter the number of the bandwidth part you want to configure in the "Bandwidth Part Number" field.

The R&S FSV/A selects the corresponding bandwidth part.

Note that when you select bandwidth part here, the R&S FSV/A also selects that bandwidth part in the [BWP Config](#) tab and vice versa.

Selecting the slot to configure

- ▶ Enter the number of the slot you want to configure in the "Selected Slot" field.

Note that when you select a slot here, the R&S FSV/A also selects that slot in the [Slot Config](#) tab and vice versa.

Defining the number of PDSCH and CORESET allocations

The R&S FSV/A allows you to allocate up to 100 individual CORESETs and PDSCH allocations to a slot.

- ▶ Enter the number of allocations in the "# CORESETs" or "# PDSCH Allocations" field.

The R&S FSV/A expands the PDSCH configuration table accordingly.

When you add a CORESET, the new CORESET is added after the last existing CORESET and before the first PDSCH allocation. New PDSCH allocations are always added at the end of the table.

Combining PDSCH allocations with the same user ID

Instead of decoding each PDSCH separately, you can bundle PDSCH allocations and decode them as one (PRB bundling), even if they have a different location in the resource grid. You can bundle PDSCH allocations by giving them the same user ID.

1. Assign [user IDs](#) to PDSCH allocations as required.
You can define the user ID for a specific allocation in the "Enhanced Settings" or in the corresponding column in the allocation table.
2. Turn on "Combine PDSCH Allocations With Same User ID".

When you combine allocations, you can change the allocation settings (modulation, number of symbols, enhanced settings etc.) only for the first allocation in the bundle. Number of resource blocks and the resource block offset remain available for all allocations.

Bundling PDSCH allocations has an effect on result displays that show the decoded signal, like the bit stream. Instead of showing the decoded results for each PDSCH allocation, these result display combine the results for bundled allocations.

# PDSCH Allocations.....	112
# CORESETs.....	112
Combine PDSCH Allocations With Same User ID.....	112

PDSCH Allocations

Defines the [number of PDSCH allocations](#) in the slot.

Remote command:

```
CONFigure[:NR5G]:DL[:CC<cc>]:FRAMe<fr>:BWPart<bwp>:SLOT<sl>:ALCount on page 350
```

CORESETs

Defines the [number of CORESET allocations](#) in the slot.

Remote command:

```
CONFigure[:NR5G]:DL[:CC<cc>]:FRAMe<fr>:BWPart<bwp>:SLOT<sl>:CRSCount on page 349
```

Combine PDSCH Allocations With Same User ID

Turns [PRB bundling](#) on and off.

Remote command:

```
CONFigure[:NR5G]:DL[:CC<cc>]:FRAMe<fr>:BWPart<bwp>:SLOT<sl>:CUID on page 356
```

4.1.10.2 PDSCH / PDCCH configuration table

The configuration table contains the PDSCH and PDCCH (CORESET) allocations. Each row corresponds to an allocation. The first part of the table shows the CORESETs, the second part of the table the PDSCH allocations.

Reusing PDSCH allocations

If you are measuring multiple slots with a different configuration, you can copy allocations to other slots once you have defined them in the first slot.

Prerequisite: [# of configurable slots](#) > 1

1. Select "Copy To" to copy the allocation configuration to the clipboard.
The R&S FSV/A opens a dialog to select the target slots.
2. From the "Copy To" menu, select:
 - "Slots" to copy the allocation to a number of selected slots.
 - "Custom" to copy the allocation to slots based on a certain logic.
3. "Copy To": "Slots":
Select the slots you want to copy the allocation to.
 - Enter a comma-separated list of slots (for example: 1,4,5,7)
 - Enter a range of slots (for example: 3-6)
 - Enter a combination of both (for example: 1,3-5,8)
4. "Copy To": "Custom":
Select the copy logic.
 - "Period": Copy the allocation to every n^{th} slot.
Example: Period = 3 copies the allocation to every 3rd slot, beginning with slot 0 (if selected slot = 0, the copy appears in slots 3,6,9, etc.).
 - "Duration": Copy the allocation to n slots in a row.
Example: Period = 3 and duration = 2 copies the allocation to two slots in a row, every 3rd slot, beginning with slot 0 (if selected slot = 0, the copy appears in slots 1,3,4,6,7,9,10 etc.)

The R&S FSV/A only copies the allocation to a slot if the slot configuration accepts a [manual configuration](#) (and is not based on the configuration of another slot).



Allocations in the time alignment measurements

For time alignment measurements, you can only configure PDSCH allocations.

In addition, enhanced settings are only available for the PDSCH DMRS. Because the enhanced PDSCH settings are the same for all PDSCH allocations in the entire frame, you can configure them centrally with the corresponding button in the "Slot" configuration tab.

ID	User ID	Allocation	Code Word	Modulation	Enhanced Settings	Number of RBs	Offset RB	Number of Symb	Offset Symb	Rel. Power /dB	Conflict
0		CORESET		QPSK	...	6	0	1	0	0 dB	
1		CORESET		QPSK	...	6	6	1	0	0 dB	
0	0	PDSCH	1/1	QPSK	...	10	16	13	1	0 dB	
1	0	PDSCH	1/1	QPSK	...	10	0	13	1	0 dB	

The remote commands required to configure the PDSCH and CORESET allocations are described in [Chapter 6.9.11, "CORESET allocation configuration"](#), on page 343 and [Chapter 6.9.12, "PDSCH allocation configuration"](#), on page 349.

ID.....	114
Allocation.....	114
Modulation.....	114
Enhanced Settings.....	114
Number of RBs.....	115
Offset RB.....	115
Number of Symbols.....	115
Offset Symbols.....	115
Rel Power / dB.....	115
Copy to.....	116
Conflicts.....	116

ID

The "ID" column shows the unique identifier for the corresponding CORESET or PDSCH allocation.

The counter starts at 0.

Remote command:

```
CONFigure[:NR5G]:DL[:CC<cc>]:FRAMe<fr>:BWPart<bwp>:SLOT<sl>:
ALLocation<al>:UEID on page 382
```

Allocation

The "Allocation" column shows the allocation's channel type (CORESET or PDSCH).

Remote command:

not supported

Modulation

The "Modulation" selects the modulation type for the corresponding allocation (channel).

"DMRS Only" analyzes the DMRS and ignores the payload data in the allocation.

The CORESET modulation is always QPSK.

The PDSCH modulation is either QPSK, 16QAM, 64QAM, 256QAM.

3GPP release 17 adds 1024QAM modulation.

Remote command:

CORESET: not supported

```
PDSCH allocations: CONFigure[:NR5G]:DL[:CC<cc>]:FRAMe<fr>:
BWPart<bwp>:SLOT<sl>:ALLocation<al>[:CW<cw>]:MODulation
on page 353
```

Enhanced Settings

Opens the "Enhanced Settings" dialog box.

Enhanced settings for CORESET allocations:

- [CORESET DMRS](#)
- [PDCCH and DCI](#)

Enhanced settings for PDSCH allocations:

- [PDSCH DMRS](#)
- [PTRS](#)
- [Channel coding and PDSCH scrambling](#)

Remote command:
not supported

Number of RBs

The "Number of RBs" defines the number of physical resource blocks that the allocation occupies in the resource grid.

Remote command:

CORESET: `CONFigure[:NR5G]:DL[:CC<cc>]:FRAMe<fr>:BWPart<bwp>:SLOT<sl>:COReset<cr>:RBCount` on page 347

PDSCH allocation: `CONFigure[:NR5G]:DL[:CC<cc>]:FRAMe<fr>:BWPart<bwp>:SLOT<sl>:ALLocation<al>:RBCount` on page 354

Offset RB

The "Offset RB" defines the first physical resource block that the allocation uses. The offset is a value relative to the first resource block used by the bandwidth part the allocation is in.

Remote command:

CORESET: `CONFigure[:NR5G]:DL[:CC<cc>]:FRAMe<fr>:BWPart<bwp>:SLOT<sl>:COReset<cr>:RBOffset` on page 347

PDSCH allocation: `CONFigure[:NR5G]:DL[:CC<cc>]:FRAMe<fr>:BWPart<bwp>:SLOT<sl>:ALLocation<al>:RBOffset` on page 355

Number of Symbols

The "Number of Symbols" defines the number of symbols that the allocation uses.

The number of symbols a CORESET can use is limited to 3.

3GPP release 16 unlocks additional numbers of symbols a PDSCH can use.

Remote command:

CORESET: `CONFigure[:NR5G]:DL[:CC<cc>]:FRAMe<fr>:BWPart<bwp>:SLOT<sl>:COReset<cr>:SCOunt` on page 348

PDSCH allocation: `CONFigure[:NR5G]:DL[:CC<cc>]:FRAMe<fr>:BWPart<bwp>:SLOT<sl>:ALLocation<al>:SCOunt` on page 355

Offset Symbols

The "Offset Symbols" defines the first symbol that the allocation uses. The offset is a value relative to the first symbol in the slot.

Remote command:

CORESET: `CONFigure[:NR5G]:DL[:CC<cc>]:FRAMe<fr>:BWPart<bwp>:SLOT<sl>:COReset<cr>:SOFFset` on page 348

PDSCH allocation: `CONFigure[:NR5G]:DL[:CC<cc>]:FRAMe<fr>:BWPart<bwp>:SLOT<sl>:ALLocation<al>:SOFFset` on page 356

Rel Power / dB

The "Rel Power / dB" defines the relative power of the corresponding allocation.

Remote command:

CORESET: CONFigure [:NR5G] : DL [:CC<cc>] : FRAME<fr> : BWPart<bwp> :
SLOT<sl> : COREset<cr> : POWer on page 346

PDSCH allocation: CONFigure [:NR5G] : DL [:CC<cc>] : FRAME<fr> :
BWPart<bwp> : SLOT<sl> : ALLocation<al> : POWer on page 354

Copy to

Opens a dialog to copy the allocation configuration to other slots.

For details, see ["Reusing PDSCH allocations"](#) on page 113.

Remote command:

PDSCH: CONFigure [:NR5G] : DL [:CC<cc>] : FRAME<fr> : BWPart<bwp> :
SLOT<sl> : ALLocation<al> : COPY on page 351

CORESET: CONFigure [:NR5G] : DL [:CC<cc>] : FRAME<fr> : BWPart<bwp> :
SLOT<sl> : COREset<cr> : COPY on page 344

Conflicts

The R&S FSV/A indicates a conflict in the following cases.

- If the allocation is located in a symbol reserved for uplink.
- If two or more allocations use the same resource blocks (overlapping allocations).
- If the total number of resource blocks over all allocations is greater than 273.

To remove a conflict, try to reduce the total number of resource blocks or change the RB offset.

Remote command:

not supported

4.1.10.3 Enhanced CORESET settings: allocation configuration

The enhanced CORESET settings contain settings to configure the CORESET demodulation reference signal (CORESET DMRS) and the characteristics (like the location and [DCI content](#)) of the PDCCH within the CORESET.

General		CORESET DMRS Config				
Precoder Granularity	REG Bundle	Rel Power (to CORESET)	0.0 dB			
Use DMRS Scrambling ID	On Off 0	Reference Point	Ref Point A			
Allow PDSCH	On Off					
Interleaving						
State	On Off	Bundle Size	6			
Shift Index	n_shift 0	Interleaver Size	2			
PDCCH Config						
Usage	RNTI	DCI Format	Aggregation Level	CCE Index	Pattern Length	Content
C-RNTI	0	0_0	1	0	44	...

The remote commands required to configure CORESET allocations are described in [Chapter 6.9.13, "Enhanced CORESET allocation configuration"](#), on page 357.

Precoder Granularity.....	117
CORESET DMRS Sequence Generation.....	117
Allow PDSCH.....	117
CORESET DMRS Rel Power.....	117
CORESET DMRS Reference Point.....	118
Interleaving.....	118

Precoder Granularity

Defines which resource elements are used by the PDCCH DMRS.

"All Contiguous PDCCH DMRS expected on all resource blocks of the CORESET RBs"

"REG Bundle" PDCCH DMRS expected on the resource blocks allocated to the PDCCH.

Remote command:

`CONFigure[:NR5G]:DL[:CC<cc>]:FRAMe<fr>:BWPart<bwp>:SLOT<sl>:COREset<cr>:PGRanularity` on page 373

CORESET DMRS Sequence Generation

3GPP (38.211) defines two methods by which the CORESET DMRS sequence can be calculated. You can select the method with the "Use DMRS Scrambling ID" parameter.

"On":

Calculates the sequence based on a pseudo-random seed value. You can define the seed value in the input field that becomes available when you select this method.

"Off":

Calculates the sequence based on the **cell ID**, if the higher layers provide no value. "n_ID^Cell" has the same value as the cell ID.

For this method, N_RNTI is assumed to be 0 as defined by 3GPP.

Remote command:

Method: `CONFigure[:NR5G]:DL[:CC<cc>]:FRAMe<fr>:BWPart<bwp>:SLOT<sl>:COREset<cr>:DMRS:SCRam[:STATe]` on page 359

Seed value: `CONFigure[:NR5G]:DL[:CC<cc>]:FRAMe<fr>:BWPart<bwp>:SLOT<sl>:COREset<cr>:DMRS:SID` on page 359

Allow PDSCH

Turns usage of CORESET resources for PDSCH transmission on and off.

By default, resource elements allocated to the CORESET are reserved for the CORESET, even if they are unused. When you allow PDSCH resources within a CORESET, unused CORESET resource elements can be allocated to the PDSCH.

Available if CORESET resources are **not contiguous**.

Remote command:

`CONFigure[:NR5G]:DL[:CC<cc>]:FRAMe<fr>:BWPart<bwp>:SLOT<sl>:COREset<cr>:PDSCh:STATe` on page 372

CORESET DMRS Rel Power

Defines the power of the CORESET DMRS relative to the power of the CORESET resource elements.

Remote command:

```
CONFigure[:NR5G]:DL[:CC<cc>]:FRAME<fr>:BWPart<bwp>:SLOT<sl>:
COReset<cr>:DMRS:POWer on page 358
```

CORESET DMRS Reference Point

Defines the reference point for the CORESET DMRS in the resource grid.

The CORESET DMRS position is either relative to the [reference point A](#) or the start of the CORESET.

Select "CORESET Start" if

- the CORESET is configured by the PBCH or
- the CORESET is configured by the controlResourceSetZero field in the PDCCH-ConfigCommon IE.

Remote command:

```
CONFigure[:NR5G]:DL[:CC<cc>]:FRAME<fr>:BWPart<bwp>:SLOT<sl>:
COReset<cr>:DMRS:RPOint on page 358
```

Interleaving

Interleaving defines the position of the PDCCH resource elements in the resource grid.

As long as you turn off interleaving, all PDCCH resource elements groups (REGs) use subcarriers next to each other. If you turn on interleaving, you can assign the REGs to non-adjacent subcarriers according to certain rules defined in 3GPP 38.211.

The "Bundle Size" defines the number of REGs in a REG bundle.

The "Shift Index" defines an offset of the REG bundles.

You can select one of two methods to define the offset.

- "N_ID^Cell": Select an offset based on the cell ID.
- "n_shift": Select the offset manually.

The "Interleaver Size" defines the distance between individual REG bundles in the frequency domain.

Remote command:

```
State: CONFigure[:NR5G]:DL[:CC<cc>]:FRAME<fr>:BWPart<bwp>:
SLOT<sl>:COReset<cr>:INTerleaving:STATe on page 362
```

```
Bundle size: CONFigure[:NR5G]:DL[:CC<cc>]:FRAME<fr>:BWPart<bwp>:
SLOT<sl>:COReset<cr>:INTerleaving:BSIZE on page 360
```

```
Shift index method: CONFigure[:NR5G]:DL[:CC<cc>]:FRAME<fr>:
BWPart<bwp>:SLOT<sl>:COReset<cr>:INTerleaving:SINDEX on page 361
```

```
Shift index: CONFigure[:NR5G]:DL[:CC<cc>]:FRAME<fr>:BWPart<bwp>:
SLOT<sl>:COReset<cr>:INTerleaving:NSHift on page 361
```

```
Interleaving size: CONFigure[:NR5G]:DL[:CC<cc>]:FRAME<fr>:BWPart<bwp>:
SLOT<sl>:COReset<cr>:INTerleaving:ISIZE
```

4.1.10.4 Enhanced CORESET settings: PDCCH

The enhanced CORESET settings also contains a table to define the downlink control information (DCI) fields (as defined in 38.212) contained in the PDCCH payload.

You can configure one PDCCH in each CORESET.

You can assign an RNTI type to the PDCCH in the CORESET. Each type of RNTI has a certain purpose in the network and the CRC of the information of several DCI formats is scrambled by a RNTI. The DCI format in turn determines the DCI fields that are available.

The base station transmits control information to the user equipment via several DCI formats. The control information can comprise all kinds of information about the transmitted data like resource allocation, bandwidth part usage, modulation type and many others. 3GPP defines various DCI formats, each of which carries different sets of information (DCI fields), depending on the system setup.

You can evaluate the DCI fields in the [channel decoder](#).

The DCI fields you can configure depend on the selected [DCI format](#) and the selected [RNTI type](#).

The DCI fields have a predefined order. This order is represented in the [DCI field configuration table](#), from left to right and top to bottom.

Example:

- RNTI type = C-RNTI
- DCI format = 0_0

	DCI Field	Bit Length		DCI Field	Bit Length
1. field:	Identifier for DCI formats	1	2. field:	Frequency Domain Resource Assignment	Auto
3. field:	Time Domain Resource Assignment	4	4. field:	Frequency Hopping Flag	1
5. field:	Modulation and Coding Scheme (TB1)	5	6. field:	New Data Indicator (TB1)	1
7. field:	Redundancy Version (TB1)	2	8. field:	HARQ Process Number	4
9. field:	UL/DL Command for Scheduled PUSCH	2	10. field:	Padding bits	0
11. field:	UL/SUL indicator	0	12. field:	ChannelAccess-CPeet	0

Figure 4-8: Order of DCI fields in DCI format 0_0

1 = Name of DCI field

2 = Bit length of DCI fields (grey fields: not editable, white fields: editable)

Order of DCI fields in the PDCCH:

"Identifier For DCI Formats" > "Frequency Domain Resource Assignment" > "Time Domain Resource Assignment" > "Frequency Hopping Flag" etc.

Each DCI field has a certain bit length. The sum of all bits must be the same as the [pattern length](#). The pattern length must be at least 12 bits and must be correct.

The bit lengths for each DCI field are defined in 3GPP 38.212.

- Fix bit lengths are always the same and defined by 3GPP (for example DCI field "X" always uses 1 bit). You cannot edit those values.
- Automatically calculated bit lengths are variable and depend on other parameters. The R&S FSV/A calculates them according to the conditions defined by 3GPP. You cannot edit those values.
- Variable bit lengths can have different values in a certain value range (for example DCI field "Y" uses either 1, 2 or 4 bits). You can edit those values as required.

Which bit lengths are variable depends on the DCI format and its corresponding RNTIs. Note that in some scenarios all bit lengths are fix.



There are a few test scenarios that allow you to ignore the DCI field bit lengths.

- If you are only interested in the bit stream, it is not necessary to define the bit lengths of each DCI field. The correct pattern length is sufficient in that case and does not have to match the bits of the individual fields.
- If you are only interested in the decoding of certain fields, it is sufficient to define the pattern length and the bit length up to the DCI field you are interested in correctly.
For example, if you are interested in the 4th DCI field, define the complete pattern length and the bit lengths of the first four DCI fields and ignore the subsequent ones.

For some DCI fields, you can define how often they are transmitted in a single PDCCH. For those DCI fields the total bit length = bit length * # indicator.

Example:

- RNTI type = SFI-RNTI
- DCI format = 2_0
- Slot format indicator bit length = 4
- # indicators = 4

Total bit length of the slot format indicator = 16 bits

For some DCI formats, you can define how often the complete set of DCI fields are transmitted in a single PDCCH. In that case the total bit length = bit length of all parameters * # blocks.

Example:

- RNTI type = TPC-PUCCH-RNTI
- DCI format = 2_2
- Closed loop indicator bit length = 4
- TPC commands bit length = 2 (fix value)
- # blocks = 2

Total bit length of the PDCCH = 12 bits

Configuring DCI fields

Here's an example for the usual process to define DCI fields.

1. Select the RNTI "Usage".
2. Select the "DCI Format".
3. Define the PDCCH "Pattern Length".
4. Select "Content" to define the details of the DCI.

For a list of available DCI fields, see [Table 6-4](#). For a comprehensive breakdown of availability of DCI fields, their bit lengths and dependencies, refer to 3GPP 38.212. 3GPP release 16 unlocks additional DCI formats and fields.

Usage.....	121
RNTI.....	121
DCI Format.....	121
Aggregation Level.....	121
CCE Index.....	121
Pattern Length.....	122
Content.....	122

Usage

Selects the type of radio network temporary identifier (RNTI) that the PDCCH uses. It also determines which [DCI formats](#) are available.

Remote command:

```
CONFigure[:NR5G]:DL[:CC<cc>]:FRAMe<fr>:BWPart<bwp>:SLOT<sl>:
COReset<cr>:PDCCh<cf>:USAGe on page 372
```

RNTI

Selects the radio network identifier.

Remote command:

```
CONFigure[:NR5G]:DL[:CC<cc>]:FRAMe<fr>:BWPart<bwp>:SLOT<sl>:
COReset<cr>:PDCCh<cf>:RNTI on page 371
```

DCI Format

Selects the DCI format.

The available DCI formats depend on the selected [RNTI type](#).

The selected DCI format in turn defines which information the PDCCH can carry.

3GPP release 16 unlocks additional DCI formats and fields.

Remote command:

```
CONFigure[:NR5G]:DL[:CC<cc>]:FRAMe<fr>:BWPart<bwp>:SLOT<sl>:
COReset<cr>:PDCCh<cf>:DCIFormat on page 363
```

Aggregation Level

Defines how many [control channel elements](#) (CCEs) the PDCCH uses in the resource grid.

Remote command:

```
CONFigure[:NR5G]:DL[:CC<cc>]:FRAMe<fr>:BWPart<bwp>:SLOT<sl>:
COReset<cr>:PDCCh<cf>:ALEVel on page 362
```

CCE Index

Defines an offset of the CCE relative to the first subcarrier.

Remote command:

```
CONFigure[:NR5G]:DL[:CC<cc>]:FRAMe<fr>:BWPart<bwp>:SLOT<sl>:
COReset<cr>:PDCCh<cf>:CCEindex on page 363
```

Pattern Length

Defines the number of bits the PDCCH uses. The number of bits is a custom value depending on your signal.

Remote command:

CONFigure[:NR5G]:DL[:CC<cc>]:FRAMe<fr>:BWPart<bwp>:SLOT<sl>:COReset<cr>:PDCCh<cf>:PLENgtH on page 371

Content

Opens a dialog box to define the information that the PDCCH carries.

The number and type of information depends on the selected [DCI format](#).

You can find an overview of all DCI fields that are available in one or more DCI formats, including the SCPI command you can use to change the bit length of the DCI field in [Table 6-4](#).

Special settings for certain DCI formats:

- DCI format 0_1: "Scope": Selection defines the DCI fields available in format 0_1.
- DCI format 1_0: "Frequency Domain Resource Assignment": Selection defines the DCI fields available in format 1_0.
- For other special fields, see [Chapter 4.1.10.4, "Enhanced CORESET settings: PDCCH"](#), on page 118.

3GPP release 16 unlocks additional DCI formats and fields.

Remote command:

Query DCI fields: CONFigure[:NR5G]:DL[:CC<cc>]:FRAMe<fr>:BWPart<bwp>:SLOT<sl>:COReset<cr>:PDCCh<cf>:DCISettings:LIST? on page 368

Configure DCI fields: CONFigure[:NR5G]:DL[:CC<cc>]:FRAMe<fr>:BWPart<bwp>:SLOT<sl>:COReset<cr>:PDCCh<cf>:DCISettings:ITEM on page 365

blocks: CONFigure[:NR5G]:DL[:CC<cc>]:FRAMe<fr>:BWPart<bwp>:SLOT<sl>:COReset<cr>:PDCCh<cf>:DCISettings:NOBLock on page 369

TCP commands: CONFigure[:NR5G]:DL[:CC<cc>]:FRAMe<fr>:BWPart<bwp>:SLOT<sl>:COReset<cr>:PDCCh<cf>:DCISettings:TPCCommand on page 370

Frequency resource assignment: CONFigure[:NR5G]:DL[:CC<cc>]:FRAMe<fr>:BWPart<bwp>:SLOT<sl>:COReset<cr>:PDCCh<cf>:DCISettings:FDRassign on page 364

Scope: CONFigure[:NR5G]:DL[:CC<cc>]:FRAMe<fr>:BWPart<bwp>:SLOT<sl>:COReset<cr>:PDCCh<cf>:DCISettings:SCOPE on page 369

4.1.10.5 Enhanced PDSCH settings: DMRS

Access: "Overview" > "Signal Description" > "Radio Frame Config" > "PDSCH / PDCCH Config" > "Enhanced Settings" > "PDSCH DMRS Config"

User ID		VRB-to-PRB Interleaver	
0		Non-Interleaved	
PDSCH DMRS Config			
Config Type	1	Codeword to Layer Mapping	
First DMRS Symb Rel to (Mapping Type)	Slot start (A)	Layers/Codewords 1/1	
First DMRS Symb (Type A Pos)	2	Antenna Ports 1000 +	0
DMRS Add Position Index	0	CDM groups w/o data	1
DMRS Length	1	Reference Point	Ref Point A
Sequence Generation	N_ID^Cell	DMRS-Downlink	On Off
n_SCID	0 1		
Rel Power (to PDSCH)	0.0 dB		

The remote commands required to configure the DMRS are described in [Chapter 6.9.14, "Enhanced PDSCH settings: DMRS"](#), on page 373.

User ID.....	123
VRB-to-PRB Interleaver.....	123
PDSCH DMRS Location.....	124
Multi Symbol DMRS.....	124
PDSCH DMRS Sequence Generation.....	124
PDSCH DMRS Rel Power.....	125
Codeword to Layer Mapping.....	125
Antenna Port.....	125
CDM Groups w/o Data.....	126
Reference Point.....	126
DMRS-Downlink.....	126

User ID

Selects the radio network temporary identifier (RNTI) used to identify different users currently accessing the network. The corresponding allocation and its configuration is assigned specifically to the ID you select in this field.

By default, the RNTI is the same the [bandwidth part index](#).

Remote command:

```
CONFigure[:NR5G]:DL[:CC<cc>]:FRAME<fr>:BWPart<bwp>:SLOT<sl>:
ALLocation<al>:UEID on page 382
```

VRB-to-PRB Interleaver

Selects the RB bundle size of the interleaver according to 3GPP 38.211, chapter 7.3.1.6. Interleaving means that virtual resource block bundles are mapped to different physical resource blocks in the physical resource grid.

A VRB bundle can consist of 2 or 4 resource blocks. "Non-interleaved" means that no interleaving or bundling is applied.

Remote command:

```
CONFigure[:NR5G]:DL[:CC<cc>]:FRAME<fr>:BWPart<bwp>:SLOT<sl>:
ALLocation<al>:VTPinter on page 382
```

PDSCH DMRS Location

The "Config Type" defines the mapping of the DMRS to physical resources elements as defined in 3GPP 38.211. You can select from configuration "Type 1" or "Type 2".

The "Mapping Type" defines the position of the first DMRS symbol in the resource grid. Mapping "Type A" is a location relative to the start of the slot. Mapping "Type B" is a location relative to the start of the PDSCH resources.

For mapping type A, you can select an additional parameter "Type A Pos" to select the first symbol that the DMRS uses.

The mapping type also limits the [number of symbols](#) the PDSCH allocations can use.

Remote command:

Configuration type: [CONFigure\[:NR5G\]:DL\[:CC<cc>\]:FRAME<fr>:](#)

[BWPpart<bwp>:SLOT<sl>:ALLocation<al>:DMRS:CTYPE](#) on page 376

Mapping type: [CONFigure\[:NR5G\]:DL\[:CC<cc>\]:FRAME<fr>:BWPpart<bwp>:](#)

[SLOT<sl>:ALLocation<al>:DMRS:MTYPE](#) on page 377

Type A position: [CONFigure\[:NR5G\]:DL\[:CC<cc>\]:FRAME<fr>:BWPpart<bwp>:](#)

[SLOT<sl>:ALLocation<al>:DMRS:TAPos](#) on page 381

Multi Symbol DMRS

The DMRS can be transmitted on one or two symbols, depending on the "DMRS Length".

You can also add additional DMRS with the "DMRS Add Position Index".

Remote command:

Length: [CONFigure\[:NR5G\]:DL\[:CC<cc>\]:FRAME<fr>:BWPpart<bwp>:](#)

[SLOT<sl>:ALLocation<al>:DMRS:MSYMBOL:LENGTH](#) on page 376

Position index: [CONFigure\[:NR5G\]:DL\[:CC<cc>\]:FRAME<fr>:BWPpart<bwp>:](#)

[SLOT<sl>:ALLocation<al>:DMRS:MSYMBOL:APOSITION](#) on page 376

PDSCH DMRS Sequence Generation

3GPP (38.211) defines two methods by which the PDSCH DMRS sequence can be calculated. You can select the method with the "Sequence Generation" parameter.

"n_ID^DMRS":

Calculates the sequence based on a pseudo-random seed value. You can define the seed value in the input field that becomes available when you select this method.

The scrambling ID "N_ID^1" is for low PAPR DMRS transmission. For other transmission types, use the "N_ID^0" scrambling ID.

"N_ID^1" is available if [DMRS-Downlink](#) = "On".

"n_ID^Cell":

Calculates the sequence based on the [cell ID](#), if the higher layers provide no value.

"n_ID^Cell" has the same value as the cell ID.

Remote command:

Method: [CONFigure\[:NR5G\]:DL\[:CC<cc>\]:FRAME<fr>:BWPpart<bwp>:](#)

[SLOT<sl>:ALLocation<al>:DMRS:SGENERATION](#) on page 379

Seed value N_ID^0: [CONFigure\[:NR5G\]:DL\[:CC<cc>\]:FRAME<fr>:](#)

[BWPpart<bwp>:SLOT<sl>:ALLocation<al>:DMRS:SID](#) on page 379

Seed value N_ID¹: [CONFigure\[:NR5G\]:DL\[:CC<cc>\]:FRAMe<fr>:BWPart<bwp>:SLOT<sl>:ALLocation<al>:DMRS:SIONe](#) on page 380
 Scrambling ID: [CONFigure\[:NR5G\]:DL\[:CC<cc>\]:FRAMe<fr>:BWPart<bwp>:SLOT<sl>:ALLocation<al>:DMRS:NSCid](#) on page 377

PDSCH DMRS Rel Power

Defines the power of the PDSCH DMRS relative to the power of the PDSCH resource elements.

Remote command:

[CONFigure\[:NR5G\]:DL\[:CC<cc>\]:FRAMe<fr>:BWPart<bwp>:SLOT<sl>:ALLocation<al>:DMRS:POWER](#) on page 378

Codeword to Layer Mapping

Selects the number of layers for a PDSCH allocation and the number of codewords. The combination of layers and number of codewords determines the layer mapping. Each layer is transmitted on a separate [antenna port](#).

The number of supported layers depends on:

- [DMRS configuration type](#)
- [DMRS length](#)

Remote command:

[CONFigure\[:NR5G\]:DL\[:CC<cc>\]:FRAMe<fr>:BWPart<bwp>:SLOT<sl>:ALLocation<al>:CLMapping](#) on page 374

Antenna Port

Each layer of a PDSCH allocation is mapped to a certain antenna port. The "Antenna Port 1000 +" dropdown menu selects the antenna ports that are used for the transmission of the PDSCH allocation.

Note that the R&S FSV/A has only one RF input and can therefore measure only one PDSCH. Which PDSCH is measured depends on the [antenna port mapping](#).

Example:

- [DMRS configuration type](#) = 1
- [DMRS length](#) = 2
- [Codeword to layer mapping](#) = 4/1, which corresponds to 4 layers

For this configuration you can map the layers to antenna ports "1000,1001,1004,1005", "1000,1002,1004,1006" or "1002,1003,1006,1007".

The antenna ports (layers) that are actually analyzed depend on the [antenna port configuration](#).

The contents of result displays that analyze antenna ports depend on the [beamforming selection](#).

Remote command:

[CONFigure\[:NR5G\]:DL\[:CC<cc>\]:FRAMe<fr>:BWPart<bwp>:SLOT<sl>:ALLocation<al>:DMRS:AP](#) on page 375

CDM Groups w/o Data

Selects the number of CDM groups that are reserved and contain no data. They are therefore not used by the PDSCH for data transmission. In the resource grid, the resource elements for CDM (between PDSCH DMRS resource elements) remain empty.

Note that the different values for this parameter change the default values of the [relative DMRS power](#) according to 3GPP 38.214, table 4.1-1.

Remote command:

```
CONFigure[:NR5G]:DL[:CC<cc>]:FRAMe<fr>:BWPart<bwp>:SLOT<sl>:
ALLocation<al>:DMRS:CGWD on page 375
```

Reference Point

Defines the reference point for the PDSCH DMRS in the resource grid.

The PDSCH DMRS position is either relative to the [reference point A](#) or the first sub-carrier of the [bandwidth part](#) it is in.

You can use the bandwidth part start as the reference point for the PDSCH DMRS to define the reference point according to 3GPP 38.211 chapter 7.4.1.1.2.

Remote command:

```
CONFigure[:NR5G]:DL[:CC<cc>]:FRAMe<fr>:BWPart<bwp>:SLOT<sl>:
ALLocation<al>:RPOint on page 381
```

DMRS-Downlink

Turns the higher layer parameter "dmrs-downlink" on and off.

This parameter reduces the peak-to-average power ratio (PAPR) of the PDSCH DMRS as defined 3GPP, release 16. Using the low PAPR also results in a different calculation of the DMRS sequence.

Remote command:

```
CONFigure[:NR5G]:DL[:CC<cc>]:FRAMe<fr>:BWPart<bwp>:SLOT<sl>:
ALLocation<al>:DMRS:RST on page 378
```

4.1.10.6 Enhanced PDSCH settings: PTRS

Access: "Overview" > "Signal Description" > "Radio Frame Config" > "PDSCH / PDCCH Config" > "Enhanced Settings" > "Phase-Tracking RS Config (PTRS)"

The phase tracking reference signal (PTRS) is a reference signal whose main purpose is to track the phase of the transmitter and the receiver. It thus helps to avoid phase errors which can disturb the signal transmission.

If you assign the PDSCH to [antenna ports](#) whose port number is higher than the maximum port that 3GPP allows for the PTRS, the PTRS settings become unavailable. For an overview of supported antenna ports, see 3GPP 38.211, table 6.4.1.2.2.1-1.

User ID 1	
PDSCH DMRS Config	Phase-tracking RS Config (PTRS) Scrambling/Coding
State	<input checked="" type="radio"/> On <input type="radio"/> Off
Rel Power (to PDSCH)	0.0 dB
L_PTRS	1
K_PTRS	2
DL-PTRS-RE-offset	00

The remote commands required to configure the PTRS are described in [Chapter 6.9.15, "Enhanced PDSCH settings: PTRS"](#), on page 383.

Functions in the "PTRS" dialog box described elsewhere:

- "User ID" on page 123
- "VRB-to-PRB Interleaver" on page 123

[PTRS Configuration](#)..... 127

PTRS Configuration

The phase tracking reference signal (PTRS) is a UE-specific reference signal that is used to compensate for the phase noise of the oscillator. The PTRS is transmitted in resource blocks used for the PDSCH.

If the PTRS "State" is on, you can define its "Power" relative to the PDSCH and its location in the resource grid.

The "L_PTRS" defines distance between the PTRS in terms of OFDM symbols (transmission every 1, 2 or 4 OFDM symbols). If the subcarrier used by the PTRS also contains a DMRS, the distance can be larger.

The "K_PTRS" and "DL-PTRS-RE-Offset" define the location of the PTRS in the frequency domain. K_{PTRS} defines the distances between the PTRS in terms of subcarrier. You can also define an additional frequency offset for the PTRS relative to the first subcarrier.

Remote command:

State: `CONFigure[:NR5G]:DL[:CC<cc>]:FRAMe<fr>:BWPART<bwp>:SLOT<sl>:ALLOCATION<al>:PTRS[:STATE]` on page 385

Power: `CONFigure[:NR5G]:DL[:CC<cc>]:FRAMe<fr>:BWPART<bwp>:SLOT<sl>:ALLOCATION<al>:PTRS:POWER` on page 384

L_PTRS: `CONFigure[:NR5G]:DL[:CC<cc>]:FRAMe<fr>:BWPART<bwp>:SLOT<sl>:ALLOCATION<al>:PTRS:L` on page 384

K_PTRS: `CONFigure[:NR5G]:DL[:CC<cc>]:FRAMe<fr>:BWPART<bwp>:SLOT<sl>:ALLOCATION<al>:PTRS:K` on page 383

Offset: `CONFigure[:NR5G]:DL[:CC<cc>]:FRAMe<fr>:BWPART<bwp>:SLOT<sl>:ALLOCATION<al>:PTRS:REOFFSET` on page 385

4.1.10.7 Enhanced PDSCH settings: scrambling / coding

Access: "Overview" > "Signal Description" > "Radio Frame Config" > "PDSCH / PDCCH Config" > "Enhanced Settings" > "Scrambling / Coding"

The screenshot shows a configuration window for 'Scrambling/Coding'. At the top, 'User ID' is 0 and 'VRB-to-PRB Interleaver' is 'Non-Interleaved'. Below are three tabs: 'PDSCH DMRS Config', 'Phase-tracking RS Config (PTRS)', and 'Scrambling/Coding'. The 'Channel Coding' section contains: 'MCS Table' (64QAM), 'I_MCS' (0), 'Redundancy Version Index' (0), 'TB Scaling Factor S' (1), and 'TB Size Including Allocation Gaps' (On). The 'Scrambling' section contains 'Data-Scrambling-ID' (0).

The remote commands required to configure the channel coding and scrambling are described in [Chapter 6.9.16, "Enhanced PDSCH settings: scrambling / coding"](#), on page 386.

Functions in the "Scrambling / Coding" dialog box described elsewhere:

- "User ID" on page 123
- "VRB-to-PRB Interleaver" on page 123

Channel Coding	128
PDSCH Scrambling	129

Channel Coding

Channel coding parameters determine the code rate of the PDSCH, which is the ratio between transmitted bits and maximum possible bits in a subframe (or 1 ms transport block). Because the number of bits in a subframe is variable, the target code rate has to be derived from the modulation order in combination with an index I_{MCS} .

In addition, the target code rate depends on a transport block scaling factor S .

You can select the modulation order for the PDSCH (one of several tables, one for each modulation type) from the "MCS Table" dropdown menu and select the corresponding index value (defined in the tables) in the "I_MCS" input field. The target code rates for modulation order and index are defined in 3GPP 38.214, chapter 5.1.3.

The size of a transport block (TB) depends on the "TB Scaling Factor S ", which in turn affects the code rate. Transport blocks can continue over combined allocations if you turn on "TB Size Including Allocation Gaps". This is only available when you [combine PDSCH allocations](#).

In addition to the modulation order and I_{MCS} , the number of transmitted bits depends on the "Redundancy Version Index", which is used to re-transmit data in case of transmission errors. Depending on the redundancy version index, the PDSCH contains a different amount of parity bits for error detection: Index 0 adds 1 sequence of parity bits, index 1 adds two sequences of parity bits etc.

Because redundancy version 1 and 2 do not transmit a complete set of data (only new bits that have not been transmitted correctly before), it is not possible to decode such signals, even if the signal-to-noise ratio is perfect. Only redundancy version 3 transmits a complete set of data, and can therefore be decoded without the knowledge of previous data.

Remote command:

Modulation order: `CONFigure[:NR5G]:DL[:CC<cc>]:FRAMe<fr>:`

`BWPart<bwp>:SLOT<sl>:ALLocation<al>:CCODing:MCSTable` on page 387

MCS index: `CONFigure[:NR5G]:DL[:CC<cc>]:FRAMe<fr>:BWPart<bwp>:`
`SLOT<sl>:ALLocation<al>:CCODing:IMCS` on page 386

Redundancy version: `CONFigure[:NR5G]:DL[:CC<cc>]:FRAMe<fr>:`

`BWPart<bwp>:SLOT<sl>:ALLocation<al>:CCODing:RVIndex` on page 388

Scaling factor: `CONFigure[:NR5G]:DL[:CC<cc>]:FRAMe<fr>:BWPart<bwp>:`
`SLOT<sl>:ALLocation<al>:CCODing:TBSFs` on page 388

TB size including allocation gaps: `CONFigure[:NR5G]:DL[:CC<cc>]:FRAMe<fr>:`
`BWPart<bwp>:SLOT<sl>:ALLocation<al>:CCODing:TBSize` on page 389

PDSCH Scrambling

3GPP (38.211) defines two methods by which the PDSCH scrambling can be calculated. You can select the method with the "Scrambling" parameter.

- "Data-Scrambling-ID"
Scrambles the PDSCH based on a pseudo-random seed value. You can define the seed value in the input field that becomes available when you select this method.
- "n_ID^Cell"
Scrambles the PDSCH based on the **cell ID**, if the higher layers provide no value for "DMRS-Scrambling-ID". "n_ID^Cell" has the same value as the cell ID.

Remote command:

Method: `CONFigure[:NR5G]:DL[:CC<cc>]:FRAMe<fr>:BWPart<bwp>:`
`SLOT<sl>:ALLocation<al>:SCRambling` on page 389

Seed value: `CONFigure[:NR5G]:DL[:CC<cc>]:FRAMe<fr>:BWPart<bwp>:`
`SLOT<sl>:ALLocation<al>:SCRambling:DSID` on page 390

4.1.11 Antenna port configuration

Access: "Overview" > "Signal Description" > "Ant Port Mapping"

Antenna ports are not physical antennas, but rather are a logical concept. Each antenna port carries certain signal components (= physical channels) that should be transmitted under the same conditions. Physical channels can be transmitted on a single antenna port, or on several antenna ports. Each antenna port in turn can be mapped to one of the physical antennas. Typically, one physical antenna combines several antenna ports. However, one specific antenna port can also be transmitted on more than one physical antenna.

The dialog is designed as a table with two rows representing the physical antennas ("Config 1" and "Config 2").

Only one of the two configurations can be on.

The columns represent the physical channels.

The "Ant Port Mapping" dialog box allows you to map the antenna ports used by the various physical channels defined by 3GPP to one or two layer configurations.

Signal Description	Radio Frame Config	Ant Port Mapping	Advanced Settings	Generator Control		
CC 1						
Antenna Port to Physical Antenna Mapping						
	State	PSS, SSS, PBCH	PDSCH	PDCCH	CSI-RS	PRS
Config 1	On	4000	1000, 1001, 1002, 1003, 1010, 1011	2000	3000	5000
Config 2	Off	4000	1001	2000	3000	5000

The remote commands required to configure the antenna ports are described in [Chapter 6.9.17, "Antenna port configuration"](#), on page 390.

State.....	130
PSS, SSS, PBCH.....	130
PDSCH.....	130
CORESET.....	131
CSI-RS.....	131

State

Turns the corresponding antenna port configuration on and off and applies it to the measurement.

Note that you can currently measure only one of the two configurations (physical antenna). If you turn on one configuration, the other is automatically turned off.

Remote command:

`CONFigure[:NR5G]:DL[:CC<cc>]:PAMapping<cf>:STATe` on page 391

PSS, SSS, PBCH

Shows the antenna ports that transmit the synchronization signals.

The synchronization signals are assumed to be transmitted on antenna port 4000.

Remote command:

not supported

PDSCH

Selects the antenna ports that transmit the PDSCH. You can assign the PDSCH to multiple antenna ports (1000 to 1011).

When you select the table cell, the R&S FSV/A opens another dialog box in which you can turn the transmission of the PDSCH on certain antenna ports on and off.

By default, the PDSCH is transmitted on antenna port 1000 (for physical antenna 1) and antenna port 1001 (for physical antenna 2).

Remote command:

`CONFigure[:NR5G]:DL[:CC<cc>]:PAMapping<cf>:PDSCh:AP<ap>`
on page 391

CORESET

Shows the antenna ports that transmit the CORESET.

The CORESET is assumed to be transmitted on antenna port 2000.

Remote command:

not supported

CSI-RS

Selects the antenna ports that transmit the CSI-RS. You can assign the CSI-RS to one or more of several antenna ports (3000 to 3031).

When you select the table cell, the R&S FSV/A opens another dialog box in which you can turn the transmission of the CSI-RS on a certain antenna port on and off.

By default, the CSI-RS is transmitted on antenna port 3000 (for both physical antennas).

Remote command:

`CONFigure[:NR5G]:DL[:CC<cc>]:PAMapping<cf>:CSIRs:AP<ap>`
on page 390

4.1.12 Advanced settings

Access: "Overview" > "Signal Description" > "Advanced Settings"

Advanced settings contain settings that are independent of the radio frame configuration.



Configuring component carriers

When you are doing measurements on [aggregated carriers](#), you can configure each carrier separately.

When available, each carrier in the dialog boxes is represented by an additional tab labeled "CC<x>", with <x> indicating the number of the component carrier.

Note that the additional tabs are only added to the user interface after you have selected more than "1" component carrier.

- [Global settings](#)..... 131
- [Reference point A](#)..... 134
- [LTE-CRS coexistence](#)..... 135

4.1.12.1 Global settings

Access: "Overview" > "Signal Description" > "Advanced Settings" > "Global Settings"

The global settings contain various settings that have an effect on how the R&S FSV/A analyzes the signal.

Signal Description	Radio Frame Config	Ant Port Mapping	Advanced Settings	Generator Control
CC 1 CC 2				
Global Settings Reference Point A LTE-CRS Coexistence	Handling of Carrier Leakage	None		
	Frame Number n_f	0		
	RF Upconversion			
	Phase Compensation	On Off		
	f_0 =	CF Manual		
		850.0 MHz		
	Exclude PDSCH Allocations From 3GPP EVM Evaluation			
	Exclude User IDs (e.g. 1,3,5-19)			
	Frequency Error Limit Check			
	State	On Off		
Category	Category A			
Shared Spectrum Channel Access	On Off			

The remote commands required to configure the global settings are described in [Chapter 6.9.18, "Advanced settings: global"](#), on page 392.

Handling of Carrier Leakage	132
Frame Number n_f	133
RF Upconversion	133
Exclude User IDs	133
Frequency Error Limit Check	133
Category	133
Shared Spectrum Channel Access	134
O-RAN Test Case	134

Handling of Carrier Leakage

Controls the way the DC carrier is handled during signal analysis.

You can either leave the DC carrier as it is, remove it from the analysis or compensate for carrier leakage effects.

Removing the DC carrier or compensating leakage effects is useful if the DC carrier is located on a subcarrier, which would have a negative effect on the EVM.

- If you leave the DC carrier as it is, the R&S FSV/A includes the DC carrier in all results.
- If you ignore the DC carrier, the R&S FSV/A removes the DC carrier from all results by ignoring the corresponding subcarriers. The DC carrier is assumed to be in the center of the channel bandwidth.
- If you compensate for carrier leakage, the R&S FSV/A includes the subcarriers used by the DC carrier in the result analysis, but compensates them mathematically.

Remote command:

`CONFigure [:NR5G] :DL[:CC<cc>] :IDC` on page 393

Frame Number n_f

Defines the system frame number n_f in the capture buffer. For multiple frame analysis it defines the system frame number of the first frame you are analyzing.

You can find out the system frame number in the [channel decoder results](#). The system frame number is useful for evaluation of periodic CSI-RS, for example.

Remote command:

[CONFigure\[:NR5G\]:DL\[:CC<cc>\]:FNNF](#) on page 392

RF Upconversion

It is necessary to upconvert the baseband signal to the radio frequency. The upconversion requires a frequency related phase compensation after each symbol according to 3GPP 38.211: 5.4 "Modulation and Upconversion".

When you turn off "Phase Compensation", the R&S FSV/A assumes that the applied signal is not phase-compensated and analyzes the signal accordingly.

When you turn on "Phase Compensation", the R&S FSV/A assumes that the applied signal is already phase-compensated for a specific frequency. This frequency is either the current center frequency ("CF") or an arbitrary frequency ("Manual"). You can define the frequency in the corresponding input field.

Remote command:

State: [CONFigure\[:NR5G\]:DL\[:CC<cc>\]:RFUC:STATE](#) on page 394

Mode: [CONFigure\[:NR5G\]:DL\[:CC<cc>\]:RFUC:FZERO:MODE](#) on page 393

Frequency: [CONFigure\[:NR5G\]:DL\[:CC<cc>\]:RFUC:FZERO:FREQUENCY](#) on page 393

Exclude User IDs

Defines certain [user IDs](#) that are excluded from the calculation of modulation-specific EVM results in the result summary.

You can define the numbers as a comma-separated list (1,2,6,7), a certain range with a dash (1-3), or a combination of both (1-3,5,6).

This is required by some test models defined in 38.141.

Remote command:

[CONFigure\[:NR5G\]:DL\[:CC<cc>\]:EUIDs](#) on page 392

Frequency Error Limit Check

Turns the frequency error limit check on and off.

When you turn on the frequency error limit check, the R&S FSV/A evaluates the limits of the frequency error and shows the results of the limit check in the [result summary](#).

Remote command:

[CONFigure\[:NR5G\]:FELC:STATE](#) on page 395

Category

Selects the base station category of the equipment you are testing (base station or user equipment).

The base station category has an effect on the limits of the [frequency error](#) and the [SEM](#) measurement.

You can select one of the following base station categories:

- Wide area base stations (category A and B)
- Local area base stations
- Medium range base stations

I/Q measurements: The base station category is relevant for the evaluation of the [frequency error](#).

SEM measurements only: For category B base stations, you can select the limit tables from the "Category B Options" dropdown menu.

Remote command:

Category: [\[SENSe:\]POWer:CATegory](#) on page 395

Category B options: [\[SENSe:\]POWer:CATegory:B](#) on page 435

Shared Spectrum Channel Access

Turns an increased number of available [SS/PBCH blocks](#) on and off.

The setting has an effect for FR1 deployments and [block patterns A and C](#).

Available with 3GPP release 16.

Unavailable for FR2-2 deployments.

Remote command:

[CONFigure\[:NR5G\]:DL\[:CC<cc>\]:SSCA](#) on page 394

O-RAN Test Case

Selects the O-RAN test case that the DSP uses for signal analysis.

Select "None" when you do not measure O-RAN signals.

See [Chapter 4.9, "O-RAN measurement guide"](#), on page 182 for more information about O-RAN measurements.

Remote command:

[CONFigure\[:NR5G\]:ORAN:TCASe](#) on page 395

4.1.12.2 Reference point A

Access: "Overview" > "Signal Description" > "Advanced Settings" > "Reference Point A"

Point A, as defined in 3GPP 38.211: 4.4.4.2 "Point A", is a reference point with a fixed frequency. The resource block grid for each subcarrier spacing is defined relative to the reference point A. It is aligned with the center of subcarrier 0 of common resource block 0, independent of the numerology.

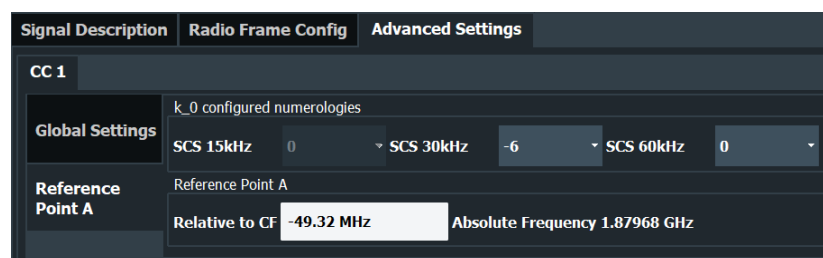

The remote commands required to configure the reference point A are described in [Chapter 6.9.18, "Advanced settings: global"](#), on page 392.

k_0	135
Reference Point A	135

k_0

The `k_0` defines an additional (subcarrier) offset of the resource grid with a specific subcarrier spacing relative to the reference point A.

You can select the offset you require from the "SCS <x> kHz" dropdown menus. Note that the dropdown menus are only available if you are using a bandwidth part with the corresponding subcarrier spacing.

Remote command:

SCS 15 kHz: `CONFigure[:NR5G]:DL[:CC<cc>]:RPA:KZERO:SCFT` on page 396

SCS 30 kHz: `CONFigure[:NR5G]:DL[:CC<cc>]:RPA:KZERO:SCTT` on page 398

SCS 60 kHz: `CONFigure[:NR5G]:DL[:CC<cc>]:RPA:KZERO:SCST` on page 398

SCS 120 kHz: `CONFigure[:NR5G]:DL[:CC<cc>]:RPA:KZERO:SCOT` on page 397

SCS 480 kHz: `CONFigure[:NR5G]:DL[:CC<cc>]:RPA:KZERO:SCFE` on page 396

SCS 960 kHz: `CONFigure[:NR5G]:DL[:CC<cc>]:RPA:KZERO:SCNS` on page 397

Reference Point A

You can define the location of the reference point relative to the center frequency of the carrier with the "Relative to CF" parameter.

The value range is limited, depending on various parameters like [channel bandwidth](#) or used [subcarrier spacing](#). You can change it in steps of 12 times the largest subcarrier spacing.

The R&S FSV/A also displays absolute frequency location of the reference point A and its offset to the first subcarrier of the channel ("TxBW").

Remote command:

Center frequency: `CONFigure[:NR5G]:DL[:CC<cc>]:RPA:RTCF` on page 398

Absolute frequency: `CONFigure[:NR5G]:DL[:CC<cc>]:RPA:AFRequency?`
on page 396

TxBW: `CONFigure[:NR5G]:DL[:CC<cc>]:RPA:TBOffset?` on page 399

4.1.12.3 LTE-CRS coexistence

Access: "Overview" > "Signal Description" > "Advanced Settings" > "LTE-CRS Coexistence"

5G NR deployments that are compatible to LTE can share their resources with LTE transmissions, aka dynamic spectrum sharing.

If you deploy such a scenario, the 5G NR are rate matched around the LTE cell specific reference signal (CRS). The reason is that in LTE, the location of the CRS resource elements in the resource grid is fixed, and must not be allocated to the 5G NR allocations. To make sure that this is the case, 5G NR uses rate matching.

Dynamic spectrum sharing is meant for bandwidth parts with 15 kHz subcarrier spacings (the LTE subcarrier spacing). However, you can also measure signals whose 5G

resources have different subcarrier spacings than LTE. If you do so, make sure to always turn on spectrum sharing in the 5G application, even if LTE and 5G resources do not overlap. Doing so increases the stability of the synchronization against interferences from the multi-numerology signal configuration.

Note that LTE CRS resources can overlap with the resources used by 5G DMRS symbols. In that case, the 5G DMRS symbols are shifted to a different position according to 38.211.

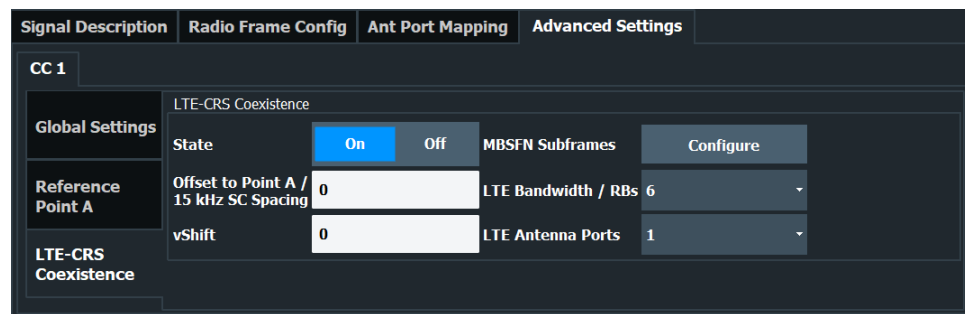

The remote commands required to configure the LTE coexistence are described in [Chapter 6.9.18, "Advanced settings: global"](#), on page 392.

State	136
MBSFN Subframes	136
Offset to Point A	136
LTE Bandwidth	137
vShift	137
LTE Antenna Ports	137

State

Turns the LTE-CRS coexistence on and off.

The setting is only available for certain 5G NR [signal characteristics](#).

Remote command:

`CONFigure[:NR5G]:DL[:CC<cc>]:LTE:STATE` on page 401

MBSFN Subframes

Opens a dialog box to define subframes that contain MBSFN resource elements. In MBSFN subframe, no LTE CRS are expected.

Remote command:

`CONFigure[:NR5G]:DL[:CC<cc>]:LTE:MBSFn:SUBFrame<sf>:STATE`
on page 399

Offset to Point A

Defines an offset of the LTE carrier in resource blocks relative to [reference point A](#).

The logic here is that an offset of 0 means that the center of the LTE carrier is exactly on the reference point A. This in turn means that one half of the LTE carrier is below the reference point A and parts below this point are not considered by the R&S FSV/A. Therefore you have to define an offset to reference point A that is at least half the bandwidth of the LTE carrier to align the LTE and 5G NR carriers.

Example:

The LTE carrier has a bandwidth of 5 MHz (or 25 resource blocks). 2.5 MHz of the carrier are above the reference point A (within the 5G NR resource grid), the other 2.5 MHz are below the reference point.

To analyze the complete LTE carrier, you have to define an offset of at least 13 resource blocks to analyze the complete LTE carrier.

Remote command:

[CONFigure\[:NR5G\]:DL\[:CC<cc>\]:LTE:POINTa](#) on page 400

LTE Bandwidth

Selects the bandwidth of the LTE carrier in number of resource blocks.

Channel bandwidth [MHz]	1.4	3	5	10	15	20
Number of resource blocks	6	15	25	50	75	100

Remote command:

[CONFigure\[:NR5G\]:DL\[:CC<cc>\]:LTE:CBW](#) on page 399

vShift

Defines the allocation of resource elements to the CRS.

"vShift" is a function of the cell ID and shifts the CRS patterns in LTE neighbor cells in the range of 0 to 5 subcarriers. The parameter thus prevents CRS pattern overlapping.

Remote command:

[CONFigure\[:NR5G\]:DL\[:CC<cc>\]:LTE:VSHift](#) on page 401

LTE Antenna Ports

Selects the number of antenna ports in the LTE configuration. This affects the location of the LTE CRS within the frame.

Remote command:

[CONFigure\[:NR5G\]:DL\[:CC<cc>\]:LTE:NAP](#) on page 400

4.1.13 Generator control

Access: "Overview" > "Signal Description" > "Generator Control"

Generator control settings provide an easy way to synchronize settings of the analyzer and a connected signal generator that is also equipped with the 5G NR application.

The generator settings become available after a successful connection to the generator.

Signal Description	Radio Frame Config	Ant Port Mapping	Advanced Settings	Generator Control
Generator IP Address <input type="radio"/> <input type="button" value="Configure..."/>				
Generator Control				
State	<input type="button" value="On"/>	<input type="button" value="Off"/>		
RF Output	<input type="button" value="On"/>	<input type="button" value="Off"/>		
<input checked="" type="checkbox"/>	Center Frequency	<input type="text" value="13.25 GHz"/>		
<input type="checkbox"/>	Level			
	Level (RMS)	<input type="text" value="0.0 dBm"/>		
<input type="checkbox"/>	Limit DUT Peak Input Power	<input type="text" value="30.0 dBm"/>		
	DUT Gain	<input type="text" value="0.0 dB"/>		
<input type="button" value="Query RF Settings From Generator"/>		<input type="button" value="Upload RF Settings To Generator"/>		
<input type="button" value="Query 5G NR Settings From Generator"/>				
Sync 5G NR Settings From Generator	<input type="button" value="On"/>	<input type="button" value="Off"/>	Polling Interval	<input type="text" value="10.0"/>

The remote commands required to configure the generator control are described in [Chapter 6.9.21, "Generator control"](#), on page 401.

Generator IP Address	138
Generator Control State	138
RF Output State	139
Center Frequency	139
Level Control State	139
L Level (RMS)	139
L Limit DUT Peak Input Power	140
L DUT Gain	140
Upload RF Settings to Generator	140
Query Settings from Generator	140
Periodic synchronization of 5G NR settings	140

Generator IP Address

Opens a dialog box to configure the network properties of the signal generator.

You can connect to the generator either by entering its IP address ("123" button), or its computer name ("ABC" button).

If you are not sure about the IP address or computer name of your generator, check its user interface or kindly ask your IT administrator to provide them.

After you have entered IP address or computer name, use "Connect" to establish the connection. The R&S FSV/A shows if the connection state, and, if the connection was successful, the connected generator type.

Remote command:

Define IP address: [CONFigure:GENErator:IPConnection:ADDRes](#) on page 402

Query connection state: [CONFigure:GENErator:IPConnection:LEDState?](#)
on page 403

Generator Control State

Activates or disables control of the signal generator by the R&S FSV/A.

If a connection was defined in another measurement channel, the connection is maintained when you switch to the 5G NR measurement application. However, generator control is disabled to protect the DUT from possibly erroneous or damaging settings. Check the settings, then enable the control state.

Note: While generator control is active, you cannot change the connection information. Only one channel can control a generator at any time. If you switch on generator control while it is still active in another channel, for example for parameter coupling with a generator, the control is disabled in the other channel.

Exception: The SCPI Recorder maintains control of the generator even if you switch channels.

Remote command:

[CONFigure:GENerator:CONTrol\[:STATe\]](#) on page 407

RF Output State

To protect the instrument from possibly erroneous or damaging settings, you must manually activate the RF output on the signal generator to start providing a signal. Check all settings on the signal generator, in particular the level settings, before activating the RF output.

A red LED on the "Generator Control" tab indicates a setting error on the generator.

Remote command:

[CONFigure:GENerator:RFOutput\[:STATe\]](#) on page 406

Center Frequency

Turns frequency synchronization on and off.

If you change the frequency on the analyzer, the generator automatically adjusts its [frequency](#).

Remote command:

Synchronization state: [CONFigure:GENerator:FREquency:CENTer:SYNC\[:STATe\]](#) on page 402

Center frequency: [\[SENSe:\]FREquency:CENTer\[:CC<cc>\]](#) on page 411

Level Control State

If enabled, the R&S FSV/A automatically controls the signal level provided by the signal generator as input to the R&S FSV/A. Initially, the [Level \(RMS\)](#) value is applied. Note that the reference level on the R&S FSV/A is also affected by the signal level:

$$\text{Ref_level}_{\text{Analyzer}} = \langle \text{Peak envelope power DUT} \rangle + \text{DUT Gain}$$

Where the current peak envelope power (PEP) value of the DUT is determined from the generator.

To protect the signal generator from possibly excess power levels, the level setting control is disabled by default.

Remote command:

[CONFigure:GENerator:POWer:LEVel:STATe](#) on page 403

Level (RMS) ← Level Control State

(Default:) The specified power level is used for the output power by the connected signal generator.

Remote command:

[CONFigure:GENerator:POWer:LEVel](#) on page 405

Limit DUT Peak Input Power ← Level Control State

If enabled, the generator does not exceed the maximum input power (peak envelope power, "PEP") that is currently allowed by the DUT and that is specified on the generator. The defined "PEP" value is indicated.

Remote command:

State: [CONFigure:GENerator:LEVel:DUTLimit:STATe](#) on page 404

Limit: [CONFigure:GENerator:LEVel:DUTLimit](#) on page 404

DUT Gain ← Level Control State

The R&S FSV/A considers a gain due to the DUT when determining the reference level.

During the reference calibration measurement, in which the DUT is removed from the signal path, the generator level is also adjusted according to the DUT gain value.

Remote command:

[CONFigure:GENerator:LEVel:DUTGain](#) on page 403

Upload RF Settings to Generator

Uploads the RF settings available in this dialog to the generator.

Useful when you change the level or frequency on the generator itself. In that case, those settings remain the same on the R&S FSV/A. To restore the original settings defined within the R&S FSV/A, use that button to restore the generator settings.

Remote command:

[CONFigure:GENerator:SETTings:UPDate:RF](#) on page 407

Query Settings from Generator

Downloads the generator settings to the R&S FSV/A. You can synchronize both, basic RF settings and 5G NR settings.

RF settings include the [frequency](#) and the [level](#) settings.

5G NR settings include the complete signal description.

Remote command:

RF settings: [CONFigure:SETTings:RF](#) on page 406

NR settings: [CONFigure:SETTings:NR5G](#) on page 405

Periodic synchronization of 5G NR settings

Instead of downloading the 5G NR settings from the generator once, you can synchronize the settings on a periodic basis. This synchronization makes sure that the analyzer always has the same signal description as the generator.

"Sync 5G NR Settings from Generator" turns the periodic synchronization of the settings on and off. The "Polling Interval" defines how often the synchronization takes place (in seconds).

Polling automatically stops when you change a parameter in the signal description on the analyzer.

Note that this only applies to the 5G NR settings, not the RF settings.

Remote command:

State: [CONFigure:SETTings:NR5G:SYNC](#) on page 406

Interval: [CONFigure:SETTings:NR5G:PINTerval](#) on page 405

4.1.14 Input source configuration

The R&S FSV/A supports several input sources and outputs.

For a comprehensive description of the supported inputs and outputs, refer to the R&S FSV/A user manual.

- [RF input](#)..... 141
- [External frontends](#)..... 141
- [I/Q file](#)..... 142

4.1.14.1 RF input

Access: "Overview" > "Input / Frontend" > "Input Source" > "Radio Frequency"

Functions to configure the RF input described elsewhere:

- ["Input Coupling"](#) on page 147
- ["Impedance"](#) on page 147

[YIG-Preselector](#)..... 141

YIG-Preselector

Enables or disables the YIG-preselector.

This setting requires an additional option R&S FSV3-B11 on the R&S FSV/A.

Note: Note that the YIG-preselector is active only on frequencies greater than 7.5 GHz. Therefore, switching the YIG-preselector on or off has no effect if the frequency is below that value.

For frequencies above 50 GHz (requires option R&S FSV3-B54G, for R&S FSVA3050 only), the YIG-preselector is automatically switched off (internally, not indicated in the display). In this case, image frequencies can occur, as specified in the data sheet.

Remote command:

[INPut<ip>:FILTer:YIG\[:STATe\]](#) on page 409

4.1.14.2 External frontends

Access: "Overview" > "Input / Frontend" > "Input Source" > "Ext. Frontend"

Controlling external frontends is available with the optional external generator control. The functionality is the same as in the I/Q analyzer application.

For more information about using external frontends, refer to the R&S FSV/A I/Q analyzer user manual.

4.1.14.3 I/Q file

Access: "Overview" > "Input / Frontend" > "Input Source" > "I/Q File"

As an alternative to capturing the measurement (I/Q) data live, you can also load previously recorded I/Q data stored in an `iq.tar` file. The file is then used as the input source for the application.

Available for I/Q based measurements.

For details, see the user manual of the I/Q analyzer.

I/Q Input File State.....	142
Select I/Q data file.....	142
File Repetitions.....	142
Selected Channel.....	142

I/Q Input File State

Enables input from the selected I/Q input file.

If enabled, the application performs measurements on the data from this file. Thus, most measurement settings related to data acquisition (attenuation, center frequency, measurement bandwidth, sample rate) cannot be changed. The measurement time can only be decreased to perform measurements on an extract of the available data only.

Note: Even when the file input is disabled, the input file remains selected and can be enabled again quickly by changing the state.

Remote command:

`INPut<ip>:SElect` on page 409

Select I/Q data file

Opens a file selection dialog box to select an input file that contains I/Q data.

The default storage location for I/Q data files is `C:\R_S\INSTR\USER`.

Remote command:

`INPut:FILE:PATH` on page 408

File Repetitions

Determines how often the data stream is repeatedly copied in the I/Q data memory to create a longer record. If the available memory is not sufficient for the specified number of repetitions, the largest possible number of complete data streams is used.

Remote command:

`TRACe:IQ:FILE:REPetition:COUNT` on page 410

Selected Channel

Only available for files that contain more than one data stream from multiple channels: selects the data stream to be used as input for the currently selected channel.

In "Auto" mode (default), the first data stream in the file is used as input for the channel. Applications that support multiple data streams use the first data stream in the file for the first input stream, the second for the second stream etc.

Remote command:

`MMEMory:LOAD:IQ:STReam` on page 409

`MMEMory:LOAD:IQ:STReam:AUTO` on page 410

`MMEMory:LOAD:IQ:STReam:LIST?` on page 410

4.1.15 Frequency configuration

Access: "Overview" > "Input / Frontend" > "Frequency"

Frequency settings define the frequency characteristics of the signal at the RF input. They are part of the "Frequency" tab of the "Signal Characteristics" dialog box.

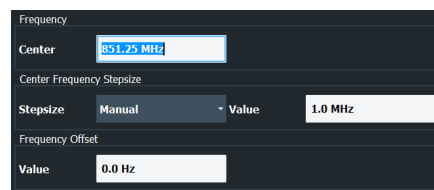

The remote commands required to configure the frequency are described in [Chapter 6.9.23, "Frequency configuration"](#), on page 410.

Signal Frequency.....	143
L Center Frequency.....	143
L Frequency Stepsize.....	143

Signal Frequency

For measurements with an RF input source, you have to match the **center frequency** of the analyzer to the frequency of the signal.

Center Frequency ← Signal Frequency

Defines the center frequency of the signal and thus the frequency the R&S FSV/A tunes to.

The frequency range depends on the hardware configuration of the analyzer you are using.

Remote command:

Center frequency: `[SENSe:] FREQuency:CENTer [:CC<cc>]` on page 411

Frequency offset: `[SENSe:] FREQuency:CENTer [:CC<cc>]:OFFSet` on page 411

Frequency Stepsize ← Signal Frequency

In addition to the frequency itself, you can also define a frequency stepsize. The frequency stepsize defines the extent of a frequency change if you change it, for example with the rotary knob.

You can define the stepsize in two ways.

- = Center
One frequency step corresponds to the current center frequency.
- Manual
Define any stepsize you need.

Remote command:

Frequency stepsize: [SENSe:]FREQuency:CENTer:STEP on page 412

4.1.16 Amplitude configuration

Access: "Overview" > "Input / Frontend" > "Amplitude"

Amplitude settings define the expected level characteristics of the signal at the RF input.

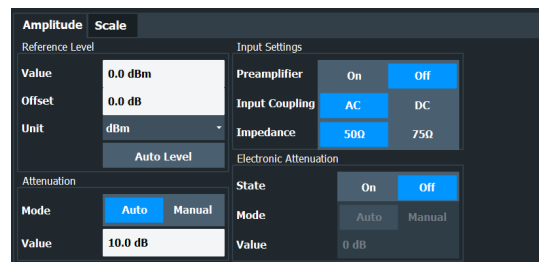

The remote commands required to configure the amplitude are described in [Chapter 6.9.24, "Amplitude configuration"](#), on page 412.

Reference Level.....	144
L Auto Level.....	145
L Reference Level Offset.....	145
Attenuating the Signal.....	145
L RF Attenuation.....	145
L Electronic Attenuation.....	146
Preamplifier.....	146
Input Coupling.....	147
Impedance.....	147

Reference Level

The reference level is the power level the analyzer expects at the RF input. Keep in mind that the power level at the RF input is the peak envelope power for signals with a high crest factor like 5G NR.

To get the best dynamic range, you have to set the reference level as low as possible. At the same time, make sure that the maximum signal level does not exceed the reference level. If it does, it will overload the A/D converter, regardless of the signal power. Measurement results can deteriorate (e.g. EVM), especially for measurements with more than one active channel near the one you are trying to measure (± 6 MHz).

Note that the signal level at the A/D converter can be stronger than the level the application displays, depending on the current resolution bandwidth. This is because the resolution bandwidths are implemented digitally after the A/D converter.

The reference level is a value in dBm.

Remote command:

Reference level: DISPLAY[:WINDOW<n>][:SUBWINDOW<w>]:TRACE<t>:Y[:SCALE]:RLEVEL on page 413

Auto Level ← Reference Level

Automatically determines the ideal reference level. The automatic leveling process measures the signal and defines the ideal reference signal for the measured signal.

Automatic level detection also optimizes RF attenuation.

Auto leveling slightly increases the measurement time, because of the extra leveling measurement prior to each sweep. By default, the R&S FSV/A automatically defines the time for auto leveling, but you can also define it manually ([Auto Set] > "Auto Level Config" > "Meas Time").

The application shows the current reference level (including RF and external attenuation) in the channel bar.

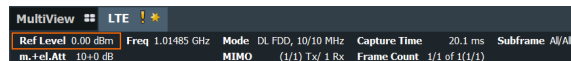

Remote command:

Automatic: `[SENSe:]ADJust:LEVel` on page 299

Auto level mode: `[SENSe:]ADJust:CONFigure:LEVel:DURation:MODE` on page 298

Auto level time: `[SENSe:]ADJust:CONFigure:LEVel:DURation` on page 298

Reference Level Offset ← Reference Level

The reference level offset is an arithmetic level offset. A level offset is useful if the signal is attenuated or amplified before it is fed into the analyzer. All displayed power level results are shifted by this value. Note however, that the reference value ignores the level offset. Thus, it is still mandatory to define the actual power level that the analyzer has to handle as the reference level.

Remote command:

`DISPlay[:WINDow<n>][:SUBWindow<w>]:TRACe<t>:Y[:SCALE]:RLEVel:OFFSet` on page 413

Attenuating the Signal

Attenuation of the signal becomes necessary if you have to reduce the power of the signal that you have applied. Power reduction is necessary, for example, to prevent an overload of the input mixer.

For a comprehensive information about signal attenuation, refer to the user manual of the R&S FSV/A.

The 5G NR measurement application provides several attenuation modes.

RF Attenuation ← Attenuating the Signal

Controls the RF (or mechanical) attenuator at the RF input.

If you select automatic signal attenuation, the attenuation level is coupled to the reference level.

If you select manual signal attenuation, you can define an arbitrary attenuation (within the supported value range).

Positive values correspond to signal attenuation and negative values correspond to signal gain.

Note that when you are using an external frontend, you can define attenuation for the analyzer and the external frontend separately. For more information about external frontends, refer to the user manual of the I/Q analyzer.

The application shows the attenuation level (mechanical and electronic) in the channel bar.

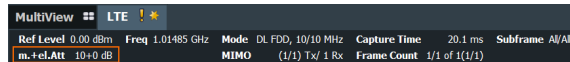

Remote command:

State: `INPut<ip>:ATTenuation<ant>:AUTO` on page 414

Level: `INPut<ip>:ATTenuation<ant>` on page 413

Electronic Attenuation ← Attenuating the Signal

Controls the optional electronic attenuator.

If you select automatic signal attenuation, the attenuation level is coupled to the reference level.

If you select manual signal attenuation, you can define an arbitrary attenuation (within the supported value range).

Positive values correspond to signal attenuation and negative values correspond to signal gain.

Note that the frequency range must not exceed the specification of the electronic attenuator for it to work.

The application shows the attenuation level (mechanical and electronic) in the channel bar.

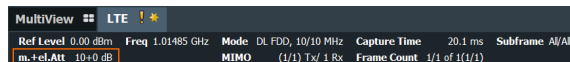

Remote command:

Electronic attenuation: `INPut<ip>:EATT<ant>:STATE` on page 416

Electronic attenuation: `INPut<ip>:EATT<ant>:AUTO` on page 416

Electronic attenuation: `INPut<ip>:EATT<ant>` on page 416

Preamplifier

If the (optional) internal preamplifier hardware is installed on the R&S FSV/A, a preamplifier can be activated for the RF input signal.

You can use a preamplifier to analyze signals from DUTs with low output power.

For an active external frontend, a preamplifier is not available.

For R&S FSV/A, the following settings are available:

- "Off" Deactivates the preamplifier.
- "15 dB" The RF input signal is amplified by about 15 dB.
- "30 dB" The RF input signal is amplified by about 30 dB.

For R&S FSV/A44 models, the preamplifier is only available under the following conditions:

- In zero span, the maximum center frequency is 43.5 GHz
- For frequency spans, the maximum stop frequency is 43.5 GHz

- For I/Q measurements, the maximum center frequency depends on the analysis bandwidth:

$$f_{center} \leq 43.5 \text{ GHz} - (<Analysis_bw> / 2)$$

If any of the conditions no longer apply after you change a setting, the preamplifier is automatically deactivated.

Using the preamplifier with the order number 1330.3465.02, only 30 dB preamplification is available.

Remote command:

[INPut<ip>:GAIN:STATe](#) on page 415

[INPut<ip>:GAIN\[:VALue\]](#) on page 415

Input Coupling

The RF input of the R&S FSV/A can be coupled by alternating current (AC) or direct current (DC).

For an active external frontend, input coupling is always DC.

AC coupling blocks any DC voltage from the input signal. AC coupling is activated by default to prevent damage to the instrument. Very low frequencies in the input signal can be distorted.

However, some specifications require DC coupling. In this case, you must protect the instrument from damaging DC input voltages manually. For details, refer to the data sheet.

Remote command:

[INPut<ip>:COUPling](#) on page 414

Impedance

For some measurements, the reference impedance for the measured levels of the R&S FSV/A can be set to 50 Ω or 75 Ω.

For an active external frontend, impedance is always 50 Ω.

Select 75 Ω if the 50 Ω input impedance is transformed to a higher impedance using a 75 Ω adapter of the RAZ type. (That corresponds to 25Ω in series to the input impedance of the instrument.) The correction value in this case is 1.76 dB = 10 log (75Ω/50Ω).

Remote command:

[INPut<ip>:IMPedance](#) on page 415

4.1.17 Trigger configuration

Access: "Overview" > "Trig / Sig Capture" > "Trigger"

A trigger allows you to capture those parts of the signal that you are really interested in.

While the application runs freely and analyzes all signal data in its default state, no matter if the signal contains information or not, a trigger initiates a measurement only under certain circumstances (the trigger event).

Except for the available trigger sources, the functionality is the same as that of the R&S FSV/A base system.

For a comprehensive description of the available trigger settings not described here, refer to the documentation of the R&S FSV/A.



Gated measurements

In addition to the general trigger functions, the frequency sweep measurements (for example ACLR) also support gated measurements.

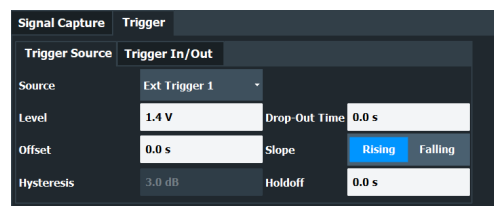

Trigger Source..... 148

Trigger Source

The application supports several trigger modes or sources.

- **Free Run**
Starts the measurement immediately and measures continuously.
- **External <x>**
The trigger event is the level of an external trigger signal. The measurement starts when this signal meets or exceeds a specified trigger level at the trigger input. Some measurement devices have several trigger ports. When you use one of these, several external trigger sources are available.
- **I/Q Power**
The trigger event is the magnitude of the sampled I/Q data. The measurement starts when the magnitude of the I/Q data meets or exceeds the trigger level.
- **IF Power**
The trigger event is the level of the intermediate frequency (IF). The measurement starts when the level of the IF meets or exceeds the trigger level.
- **RF Power**
The trigger event is the level measured at the RF input. The measurement starts when the level of the signal meets or exceeds the trigger level.
- **Time**
The trigger event is a certain time interval (every <x> seconds).

For all trigger sources, except "Free Run", you can define several trigger characteristics.

- The trigger "Level" defines the signal level that initiates the measurement.
- The trigger "Repetition Interval" defines the time interval that initiates a measurement for the time trigger.
- The trigger "Offset" is the time that must pass between the trigger event and the start of the measurement. This can be a negative value (a pretrigger).
- The trigger "Drop-out Time" defines the time the input signal must stay below the trigger level before triggering again.

- The trigger "Slope" defines whether triggering occurs when the signal rises to the trigger level or falls down to it.
- The trigger "Holdoff" defines a time period that must at least pass between one trigger event and the next.
- The trigger "Hysteresis" is available for the IF power trigger. It defines a distance to the trigger level that the input signal must stay below to fulfill the trigger condition.

For a detailed description of the trigger parameters, see the user manual of the I/Q analyzer.

Remote command:

Source: `TRIGger[:SEquence]:SOURce<ant>` on page 424

Level (external): `TRIGger[:SEquence]:LEVel<ant>[:EXternal<tp>]` on page 422

Level (I/Q power): `TRIGger[:SEquence]:LEVel<ant>:IQPower` on page 423

Level (IF power): `TRIGger[:SEquence]:LEVel<ant>:IFPower` on page 422

Level (RF power): `TRIGger[:SEquence]:LEVel<ant>:RFPower` on page 423

Offset: `TRIGger[:SEquence]:HOLDoff<ant>[:TIME]` on page 421

Hysteresis: `TRIGger[:SEquence]:IFPower:HYSTeresis` on page 422

Drop-out time: `TRIGger[:SEquence]:DTIME` on page 421

Slope: `TRIGger[:SEquence]:SLOPe` on page 424

Holdoff: `TRIGger[:SEquence]:IFPower:HOLDoff` on page 421

4.1.18 Data capture

Access: "Overview" > "Trigger / Signal Capture" > "Signal Capture"

The data capture settings contain settings that control various aspects of the data capture.

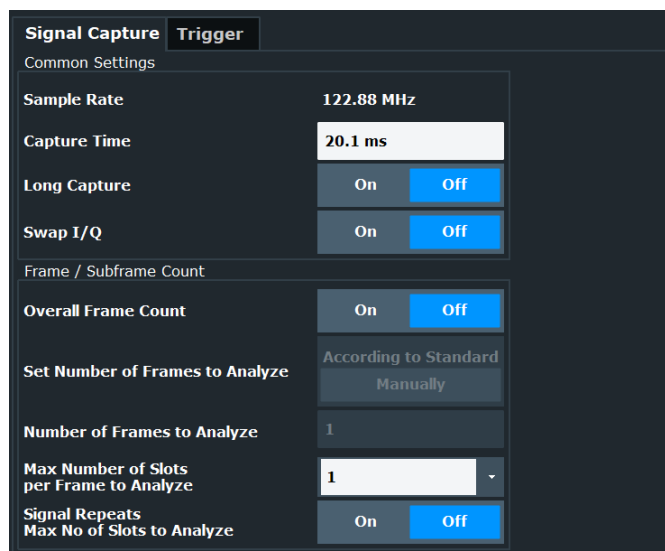

The "Maximum Number of Subframes per Frame to Analyze" setting available in older firmware versions is no longer supported.

The remote commands required to configure the data capture are described in [Chapter 6.9.25, "Data capture"](#), on page 417.

Capture Time.....	150
Long Capture.....	150
Swap I/Q.....	151
Overall Frame Count.....	151
Auto According to Standard.....	151
Number of Frames to Analyze.....	151
Maximum Number of Slots per Frame to Analyze.....	151
Signal Repeats Max No of Slots to Analyze.....	152

Capture Time

The "Capture Time" corresponds to the time of one measurement. Therefore, it defines the amount of data the application captures during a single measurement (or sweep).

By default, the application captures 20.1 ms of data to make sure that at least one complete 5G NR frame is captured in the measurement.

The maximum capture time is limited when you are only [measuring slots repeatedly](#).

For measurements in FR2-2, you can let the R&S FSV/A determine the capture time automatically or enter the capture time manually. For an automatic capture time, the R&S FSV/A makes the capture as small as possible but also makes sure that the first 80 slots are captured in one piece according to 3GPP specifications. If you are measuring a signals with different subcarrier spacings, the capture time is based on the smallest subcarrier spacing.

The application shows the current capture time in the channel bar.

Remote command:

[\[SENSe:\] SWEep:TIME](#) on page 420

Capture mode (FR2-2): [\[SENSe:\] SWEep:CTMode](#) on page 419

Long Capture

Turns a limitation of the [capture time](#) on and off.

When you turn off the long capture, the capture time is limited to 50.1 ms (maximum of 5 frames).

To capture more frames, turn on the long capture. The long capture allows you to capture data up to 1 s. However, the long capture has the following limitations.

- The long capture captures several frames, but analyzes only one. The analyzed frame is indicated by a horizontal green bar in the capture buffer. The analyzed frame depends on your [selection](#).
- Multiple frame configurations are not possible, because every frame must have the same configuration.
- The frame count settings (overall frame count etc.) are unavailable.
- Averaging results over several frames is not supported. Therefore, the R&S FSV/A does not evaluate EVM limits for long captures.
- Component carrier measurements are not supported.
- Measurements in FR2-2 are not supported.

Remote command:

[\[SENSe:\] SWEep:LCAPture](#) on page 419

Swap I/Q

Swaps the real (I branch) and the imaginary (Q branch) parts of the signal.

Remote command:

[\[SENSe:\] SWAPiQ](#) on page 419

Overall Frame Count

The "Overall Frame Count" turns the manual selection of the number of frames to capture (and analyze) on and off.

When you turn on the overall frame count, you can define the [number of frames to capture and analyze](#). The measurement runs until all frames have been analyzed, even if it takes more than one capture.

When you turn off the overall frame count, the application analyzes all 5G NR frames found in one capture buffer.

For more information about the effects on the results of capturing more frames than fit in the capture buffer, see [Chapter 4.1.6, "Radio frame configuration"](#), on page 82.

The application shows the current frame count in the channel bar.

Remote command:

[\[SENSe:\] NR5G:FRAMe:COUNT:STATe](#) on page 418

Auto According to Standard

Turns automatic selection of the number of frames to capture and analyze on and off.

When you turn on this feature, the R&S FSV/A captures and evaluates a number of frames the 3GPP standard specifies for EVM tests.

If you want to analyze an arbitrary number of frames, turn off the feature.

This parameter is not available when the overall frame count is inactive.

Remote command:

[\[SENSe:\] NR5G:FRAMe:COUNT:AUTO](#) on page 418

Number of Frames to Analyze

Defines the number of frames you want to capture and analyze.

If the number of frames you have set last longer than a [single measurement](#), the application continues the measurement until all frames have been captured.

The parameter is read only in the following cases:

- If you turn off the [overall frame count](#).
- If you capture the data [according to the standard](#).

Remote command:

[\[SENSe:\] NR5G:FRAMe:COUNT](#) on page 417

On / off power measurements: [CONFigure\[:NR5G\]:OOPower:NFRames](#) on page 433

Maximum Number of Slots per Frame to Analyze

Selects the number of slots that the application analyzes.

You can select to analyze "All" slots, or a certain number of slots - select the number from the dropdown menu and enter the number of slots to analyze. The maximum number of slots you can analyze depends on the subcarrier spacing.

If you select a certain number of slots, the R&S FSV/A analyzes the first <x> slots in a frame. By default, the R&S FSV/A analyzes 80 slots to comply with 3GPP specifications.

Reducing the number of slots to analyze improves measurement speed.

Remote command:

[SENSe:]NR5G:FRAMe:SLOT on page 418

Signal Repeats Max No of Slots to Analyze

Turns analysis of custom signals with repeating slots on and off.

You can use this setting to measure custom (shortened) signals that only contain a few slots per frame. This setting is useful to achieve a high measurement and analysis speed without trigger availability. Multiple frame analysis tailored to the custom signal is also possible.

Example:

Slot 0 | Slot 0 | Slot 0 etc.

Slot 0 | Slot 1 | Slot 0 | Slot 1 etc.

Note that the slot sequence must start with slot number 0.

Measuring such signals is not possible with the standard signal capture settings without a trigger.

Instead, configure the R&S FSV/A like this.

- Reduce the capture time based on the number of slots in the repeated signal and the subcarrier spacing. Make sure that the slot sequence is contained at least once in the capture buffer.
For example to measure 3 slots with a subcarrier spacing of 30 kHz (length of one slot = 500 μ s), reduce the capture time to 3.1 ms.
Capturing repeating slots limits the maximum allowed capture time based on the maximum number of slots you are capturing.
- Select a maximum number of slots to analyze that matches the number of slots in your signal.
For example: if you have a sequence of three slots being repeated in your signal, select 3 slots to analyze.
- Turn on the "Signal Repeats Max No of Slots to Analyze" setting.

Remote command:

[SENSe:]NR5G:FRAMe:SRSLOt on page 418

4.1.19 Tracking

Access: "Overview" > "Tracking"

Tracking settings contain settings that compensate various errors.

Parameter Estimation	
Channel Estimation	EVM 3GPP Definition ▾
Channel Estimation Time Averaging	EVM 3GPP Definition ▾
Tracking	
Phase Tracking	EVM 3GPP Definition ▾
Time Tracking	On <input type="radio"/> Off <input checked="" type="radio"/>
Level Tracking	On <input type="radio"/> Off <input checked="" type="radio"/>
I/Q Parameter	
Gain Imbalance / Quadrature Error	On <input type="radio"/> Off <input checked="" type="radio"/>

The remote commands required to configure error tracking are described in [Chapter 6.9.27, "Tracking"](#), on page 425.

Channel Estimation	153
Channel Estimation Time Averaging	154
Phase	154
Time Tracking	154
Level Tracking	155
Gain Imbalance / Quadrature Error	155
Throughput Measurement State	155

Channel Estimation

Selects the channel estimation method.

"EVM 3GPP definition"	Estimates the channel according to 3GPP (38.141-1 / -2, annex H.6). Recommended for standard conform measurements.
"Pilot Only (Linear Interpolation)"	Calculates the equalizer coefficients on all available reference signal subcarriers. All missing subcarriers are interpolated (linear interpolation). Uses the selected time averaging . This estimation method is more prone to noise, because it does not apply a frequency domain moving average. However, the estimation can adapt to the individual subcarrier.
"Pilot And Payload"	Calculates equalizer coefficients on all available resource elements of the reference signal and the payload. This implies that payload symbols could have been demodulated without wrong symbol decisions. If this is not the case, the reference signal generated from the payload is wrong and the calculated equalizer is not ideal. Uses the selected time averaging . This estimation method improves the equalizer estimate, because more subcarriers and symbols are used. This is beneficial for noisy signals (low SNR). Further subcarriers without pilots are taken into account
"Off"	Turns off channel estimation. Turning off channel estimation is useful if you want to see the impact of the channel frequency response on the signal quality (EVM).

Remote command:

[\[SENSe:\]NR5G:DEMod:CESTimation](#) on page 425

Channel Estimation Time Averaging

Select the averaging time interval for channel estimation.

"EVM 3GPP Definition"	Averages equalizer coefficients of DMRS across all symbols according to 38.141-1 / -2, annex H.6. Recommended for standard conform measurements.
"Per Allocation"	Averages equalizer coefficients across one allocation only. Equalizer coefficients between allocations are independent. An allocation is for example a single PDSCH. Because this method does no time averaging, this option is more prone to noise. However, the estimation can adapt better to the individual allocation.

Remote command:

[\[SENSe:\]NR5G:DEMod:CETaverage](#) on page 426

Phase

Turns phase tracking on and off.

Phase tracking aims to remove random phase fluctuations between OFDM symbols. The phases of all pilot subcarriers are estimated and averaged per symbol.

When you turn on phase tracking, the application removes the phase difference between consecutive symbols.

"Off"	Phase tracking is not applied. Allows you to evaluate the impact of phase noise and phase drifts on the signal quality.
"Pilot Only"	Uses the reference signal (PTRS) for phase tracking. Symbols without PTRS are interpolated (linear interpolation).
"Pilot and Payload"	Uses available reference signals (PTRS) and the payload resource elements for phase tracking. Allows you to improve tracking results (a better immunity to noise), because of the analysis of the payload. This method does not interpolate symbols without reference signals.
"EVM 3GPP Definition"	Estimation according to the 3GPP definition in 38.141-2, L.6. FR2 uses the PTRS for phase tracking. FR1 does not use phase tracking. Recommended for standard conform measurements.

Remote command:

[\[SENSe:\]NR5G:TRACking:PHASe](#) on page 426

Time Tracking

Turns time tracking on and off.

Clock deviations (slower or faster sampling time) lead to a drift of the ideal sampling instant over time, causing a rotating constellation diagram.

When you turn on time tracking, the application compensates measurement results for timing errors on a slot level.

Remote command:

[SENSe:]NR5G:TRACking:TIME on page 427

Level Tracking

Turns level tracking on and off.

Gain variations over time, caused for example by temperature drifts in power amplifiers, impact signal quality.

When you turn on level tracking, the R&S FSV/A corrects a gain value that is constant across frequency on symbol level.

Remote command:

[SENSe:]NR5G:TRACking:LEVel on page 426

Gain Imbalance / Quadrature Error

Turns the calculation of the I/Q gain imbalance and the quadrature error ([result summary](#)) on and off.

Remote command:

[SENSe:]NR5G:IQ:GIQE on page 426

Throughput Measurement State

Turns the throughput and block error rate measurement on and off.

The results of these measurements are displayed in the [result summary](#).

If you turn on the throughput measurement, selecting a [number of frames to analyze](#) according to standard is not supported. If that setting was active when you turn on the throughput measurement, it is automatically set to manual number of frames to analyze.

Remote command:

[SENSe:]NR5G:TRACking:TPUT:STAtE on page 427

4.1.20 Demodulation

Access: "Overview" > "Demodulation"

Demodulation settings contain settings that describe signal processing and the way the signal is measured.

Multicarrier Filter	
Use Multicarrier Filter	<input checked="" type="radio"/> On <input type="radio"/> Off
Demodulation Data	Before Descrambling ▾
CORESET Analysis Mode	<input checked="" type="radio"/> Auto <input type="radio"/> Manual
Calculation Method	Custom ▾
Symbol Time Adjustment	50.0 %
CORESET Reference Data	Auto Detect ▾
PDSCH Reference Data	Auto Detect ▾
Extended Frequency Lock Range	<input type="radio"/> On <input checked="" type="radio"/> Off

The remote commands required to configure the demodulation are described in [Chapter 6.9.28, "Demodulation"](#), on page 427.

Filter.....	156
Demodulation Data.....	156
CORESET Analysis Mode.....	156
EVM Calculation Method.....	157
Symbol Time Adjustment.....	157
PDSCH Reference Data.....	157
CORESET Reference Data.....	158
Extended Frequency Lock Range.....	158

Filter

Selects the filter to suppress interference of neighboring carriers.

"None"	No suppression of neighboring channels.
"Multicarrier Filter"	Suppresses interference for tests on multiradio base stations (LTE, WCDMA, GSM etc.). The R&S FSV/A automatically selects the multicarrier filter when you analyze more than 1 component carrier .
"Per BWP"	Suppresses interference for tests on multi BWP signals.

Remote command:

[SENSe:]NR5G:DEMod:FILTer on page 430

Demodulation Data

For the [bitstream](#) results, you can get the data at various points in the signal processing chain.

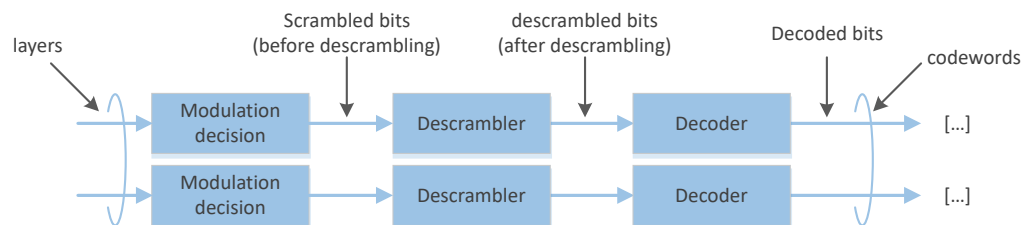

"Before Descrambling"	Demodulates the scrambled data.
"After Descrambling"	Demodulates the descrambled data.
"Decoded Payload Data"	Demodulates the descrambled and decoded PDSCH data.

Remote command:

[SENSe:]NR5G:DEMod:DDATa on page 429

CORESET Analysis Mode

Selects the way the R&S FSV/A demodulates the PDCCH.

"Auto"	The R&S FSV/A automatically demodulates the PDCCH by detecting the payload of the CORESET DMRS.
--------	---

"Manual" The R&S FSV/A demodulates the PDCCH based on the [PDCCH parameters](#) you have defined.

Remote command:

[\[SENSe:\]NR5G:DEMod:CAMode](#) on page 428

EVM Calculation Method

Selects the way the EVM is calculated.

"EVM 3GPP Definition" Calculates the EVM according to 3GPP TS 38.141-1 / -2. Evaluates the EVM at two trial timing positions and then uses the higher EVM of the two.

"At Optimal Timing Position" Calculates the EVM using the optimal timing position.

"EVM High Timing Position" Calculates the EVM at the high trial position defined by 3GPP.

"EVM Low Timing Position" Calculates the EVM at the low trial position defined by 3GPP.

Remote command:

[\[SENSe:\]NR5G:DEMod:CMETHod](#) on page 428

Symbol Time Adjustment

Defines the position of the FFT window within a symbol. The FFT window defines the time over which the FFT is calculated.

The value is a percentage relative to the beginning of the cyclic prefix.

- 0 %: FFT window starts at the beginning of the cyclic prefix.
- 100 %: FFT window starts at the end of the cyclic prefix.

Remote command:

[\[SENSe:\]NR5G:DEMod:STADjust](#) on page 430

PDSCH Reference Data

Selects the type of reference data to calculate the EVM for the PDSCH.

By default, the R&S FSV/A automatically detects the PDSCH reference values and maps the measured values to the nearest reference point.

If you expect noisy signals with a high EVM, however, the automatic detection is no longer reliable and can yield EVM values that are too good for the analyzed signal - measured values could be mapped to the wrong reference values by mistake, if they are too far from their original position.

Instead, you can set the PDSCH reference values to a fixed value of 0. This setting calculates the correct EVM, regardless of the signal quality. However, you have to make sure that the DUT transmits an all-zero data vector for the PDSCH.

Another option is to base the PDSCH reference values on the pseudo random sequence 23 (PN23) as defined by 3GPP. This method also yield correct EVM values. Again, the signal must use the NR-TM PN23 for this to work.

"Auto Detect" Automatically detects the PDSCH reference values.

"All 0"	Assumes the PDSCH to be all 0's, according to test model definitions.
"NR-TM PN23"	Assumes the PDSCH to be based on the pseudo random sequence 23, as defined by 3GPP. Each PDSCH / PDCCH has an individual sequence.
"NR-TM PN23 All Slots"	Assumes the PDSCH to be based on the pseudo random sequence 23, as defined by 3GPP. All PDSCH / PDCCH have the same sequence.
"ORAN PN23"	Assumes the PDSCH to be based on the pseudo random sequence 23, as defined by the ORAN alliance. Note that this type of reference data is automatically selected when you select an ORAN test case. The R&S FSV/A assumes that the measured signal actually contains the corresponding ORAN PN23 sequence. For this option, each PDSCH has an individual sequence.
"ORAN PN23 All Slots"	Assumes the PDSCH to be based on the pseudo random sequence 23, as defined by the ORAN alliance. Note that this type of reference data is automatically selected when you select an ORAN test case. The R&S FSV/A assumes that the measured signal actually contains the corresponding ORAN PN23 sequence. For this option, all PDSCH / PDCCH have the same sequence.

Remote command:

[\[SENSe:\]NR5G:DEMod:PRData](#) on page 430

CORESET Reference Data

Selects the type of reference data to calculate the EVM for the CORESET.

The logic and type of reference data is the same as that for the [PDSCH](#).

Remote command:

[\[SENSe:\]NR5G:DEMod:CRData](#) on page 428

Extended Frequency Lock Range

Selects the frequency error tolerance for successful signal synchronization.

Turn the setting off to have a small tolerance (0.5*subcarrier spacing).

Turn the setting on to have a large tolerance (10*subcarrier spacing).

For a large tolerance, we recommend to configure the synchronization signal manually, because the auto demodulation might not work properly depending on the actual frequency error.

Remote command:

[\[SENSe:\]NR5G:DEMod:EFLRange](#) on page 429

4.2 Time Alignment Error Configuration

Access: [MEAS CONFIG]

The settings for time alignment error measurements are similar to the settings of the I/Q measurements. For a comprehensive description of those, refer to the following chapters.

- [Chapter 4.1.3, "Physical signal description"](#), on page 73
- [Chapter 4.1.5, "Component carrier configuration"](#), on page 77 (intra-band component carriers only - contiguous and non-contiguous)
- [Chapter 4.1.7, "Synchronization signal configuration"](#), on page 86 (note that the time alignment error measurement does not support all synchronization signal settings)
- [Chapter 4.1.9, "Slot configuration"](#), on page 97 (configuring individual slots allows measurements according to TDD NR-TM's)
- [Chapter 4.1.10, "PDSCH and PDCCH configuration"](#), on page 109 (note that the enhanced PDSCH settings are the same for all PDSCH allocations in the entire frame and are available centrally in the "Slot" configuration tab - trying to open the enhanced PDSCH settings from the allocation table shows a corresponding message)
- [Chapter 4.1.14, "Input source configuration"](#), on page 141
- [Chapter 4.1.15, "Frequency configuration"](#), on page 143
- [Chapter 4.1.16, "Amplitude configuration"](#), on page 144
- [Chapter 4.1.18, "Data capture"](#), on page 149
- [Chapter 4.1.17, "Trigger configuration"](#), on page 147
- [Chapter 4.1.20, "Demodulation"](#), on page 155

4.3 Transmit On / Off Power Configuration

Access: [MEAS CONFIG]

The settings for transmit on / off power measurement are similar to the settings of the I/Q measurements.

Settings for the transmit on / off power measurement described elsewhere (not all settings described in the following chapters are available in the transmit on / off power measurement):

- [5G NR Mode](#)
- [Test Model](#)
- [Deployment](#)
- [Channel Bandwidth](#)
- [Synchronization signal](#)
- [Bandwidth part configuration](#)
- [Slot configuration](#)
- [PDSCH configuration](#)
- [Antenna port configuration](#)
- [Advanced settings](#)

- [Signal capture](#)
- [Trigger configuration](#)
- [Demodulation settings](#)

4.4 Frequency Sweep Measurement Configuration

Access: [MEAS CONFIG] > "Signal Description"

The signal description for ACLR and SEM measurements contains settings to describe general physical characteristics of the signal you are measuring.



Settings for frequency sweep measurements

When you start the frequency sweep measurement from within the 5G NR application, the R&S FSV/A automatically configures the measurement and limits according to the specification defined by 3GPP.

Therefore, it is sufficient for you to configure the details of the 5G NR signal description.

Note that ACLR and SEM measurements are currently unavailable for FR2-2 frequency deployment.

Functions in the "Signal Description" dialog box described elsewhere:

- [5G NR Mode](#)
- [Test Model](#)
- [Deployment](#)
- [Channel Bandwidth](#)
- [Subcarrier spacing](#)
(for FR2 deployments)
- For SEM measurements: [Base station category](#)
- For MC ACLR, Cumulative ACLR and Multi SEM measurements: [Component carriers](#)
 - ACLR measurements support a maximum of 16 component carriers.
 - SEM measurements support a maximum of 8 component carriers.

All other settings available for the ACLR and SEM measurements are the same as in the spectrum application. For more information, refer to the user manual of the R&S FSV/A.

Base Station Type	161
Adjacent Channels	161
Tx Power	161
Position of SEM and ACLR limits	162
Total Limit Pass Mode	162

Base Station Type

3GPP defines several types of base station for the different deployment [frequency ranges](#).

Each base station class sets different requirements for

- [SEM measurements](#) (the SEM limits)
- [ACLR measurements](#) (the power of the adjacent channels)
- [transmit on / off power measurements](#) (the transient limits)

See 3GPP 38.141-1 / -2 for details.

The type you should use for the measurement depends on the base station you are testing.

- "1-C": Base station for conducted transmission requirements in FR1. (Only supported for ACLR and SEM measurements.)
- "1-H": Base station for hybrid transmission requirements (conducted and over-the-air) in FR1. (Only supported for ACLR and SEM measurements.)
- "1-O": Base station for over-the-air transmission requirements in FR1. (Only supported for ACLR and SEM measurements.)
- "2-O": Base station for over-the-air transmission requirements in FR2.

[output power](#).

For SEM measurements on 2-O type base stations, you can also define the [output power](#).

For transmit on / off power measurements on 2-O type base stations, you can also define the [output power](#).

The output power in both cases has an effect on the limits.

Remote command:

Base station type: [CONFigure\[:NR5G\]:BStation](#) on page 437

Adjacent Channels

ACLR measurement only

Selects the assumed adjacent channel carrier for the ACLR measurement.

- "NR of Same BW": the neighboring channel is a 5G NR channel with the same bandwidth.
- "5 MHz E-UTRA": the neighboring channel is a LTE channel with 5 MHz bandwidth.

Remote command:

[\[SENSe:\]POWER:ACHannel:AACHannel](#) on page 435

Tx Power

SEM measurement only

For SEM tests on [medium range base station](#) and [2-O type base stations](#), you can measure or manually enter the "Tx Power" of the carrier.

If you select "Manual", you can define the power in the corresponding input field. Otherwise, the R&S FSV/A measures the power of the Tx channel automatically.

The exact label of the rated power value depends on the selected base station type as defined in 3GPP 38.141-1 / -2.

- "1-O": $P_{\text{rated, C, TRP}}$

- "1-C": P_{rated} , c, AC
- "1-H": P_{rated} , c, cell
- "2-O": P_{rated} , t, TRP

The value range depends on the selected base station type.

For 1-H medium range base station, the supported output power value range also depends on the "N_TXU, countedpercell" and "N_TABconnectors" parameters.

Remote command:

BS power mode: `[SENSe:] POWER:SEM:AMPower:AUTO` on page 436

BS power value: `[SENSe:] POWER:SEM:AMPower` on page 435

Position of SEM and ACLR limits

For tests on **1-H type base stations**, you can also define two parameters "N_TXU, countedpercell" and "# Tab connectors (n)".

For the spectrum emission mask, these two parameters shift the limits according to 3GPP 38.141-1, chapter 6.6.4.5.8. The parameters also select which SEM power class (SEM limits) applies to a given base station **output power** (P_{rated}).

For the adjacent channel leakage error, these two parameters define the limits according to 3GPP 38.141-1, chapter 6.6.3.5.4.

Remote command:

$N_{\text{TABconnectors}}$: `[SENSe:] POWER:SEM:NTAB` on page 436

N_{TXU} : `[SENSe:] POWER:SEM:NTXU` on page 436

Total Limit Pass Mode

Supported only by the LTE and 5G application.

Access (ACLR measurement): "Meas Config" > "CP / ACLR Config" > "Channel Settings" > "Limits"

Access (multi-carrier ACLR measurement): "Meas Config" > "CP / ACLR Config" > "MSR General Settings"

The "Total Limit Pass Mode" selects the logic the ACLR limits are evaluated with if you define both absolute limits and relative limits.

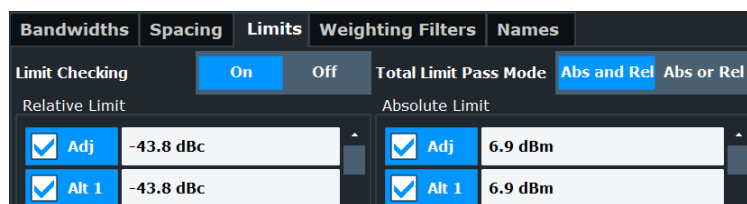

Figure 4-9: Evaluate both absolute and relative limits

If you define only relative or absolute limits, the R&S FSV/A only evaluates the corresponding limits.

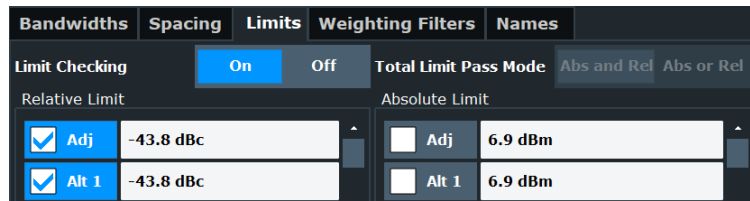

Figure 4-10: Evaluate only relative limits

If you change the limit evaluation method after the measurement, you have to refresh the measurement.

The selected method adjusts the contents of the following result displays.

- ACLR result summary
- MC ACLR result summary
- Cumulative ACLR result summary

The default value is according to 3GPP 38.141-1/2.

"Absolute"	Checks the absolute limits defined for the ACLR. The limit check passes when the signal level is within the absolute limits.
"Relative"	Checks the relative limits defined for the ACLR. The limit check passes when the signal level is within the relative limits.
"Absolute and Relative"	The limit check for both, the absolute and the relative limits, must pass to get an overall pass.
"Absolute or Relative"	The limit check for either the absolute or the relative limits must pass to get an overall pass.

Remote command:

`CALCulate<n>:LIMit:ACPower:PMODE` on page 437

4.5 Combined measurement configuration

Access: "Overview"

The configuration for combined measurements is a combination of the configuration for I/Q measurements, ACLR measurements and SEM measurements with several special settings.

For an introduction on combined measurements and their application, see [Chapter 4.6, "Combined measurement guide"](#), on page 169.

Channel bar

In combined measurement mode, the [channel bar](#) contains additional information.

Table 4-3: Information displayed in the channel bar in the combined measurement mode

Ref Level	Reference level.
Att	Mechanical and electronic RF attenuation.
Freq	Frequency for other input sources (RF etc.).

Combined measurement configuration

Mode*	5G NR mode (link direction and channel bandwidth).
Event Count	The first number represents the number of events that have already been captured. The second number represents the total number of events that will be captured.
Filtered Events	Number of events that have been filtered when you have applies an event filter .
Capture Time	Signal length that has been captured.
Selected Meas ID	Selected measurement.
BWP/SS*	Shows the signal part for which results are displayed (evaluation range). SS = synchronization signal BWP = bandwidth part
I/Q	Shows the type of memory used for I/Q data capture (RAM only).

Functions for combined measurements described elsewhere:

- [Input source settings](#)
- [Frequency settings](#)
- [Level settings](#)
- [Signal tracking](#)
- [Signal demodulation](#)
- [Signal description](#)..... 164
- [Signal capture](#)..... 165
- [Trigger configuration](#)..... 167

4.5.1 Signal description

Access: "Overview" > "Signal Description"

The signal description for combined measurements combines the signal description for I/Q, ACLR and SEM measurements.

Functions in the "Signal Description" dialog box described elsewhere:

- [Auto configuration](#)
- [Signal description](#)
- [Radio frame configuration](#), incl. synchronization signal configuration, bandwidth part configuration, slot configuration and allocation configuration.
- [Antenna port configuration](#)
- [Advanced signal settings](#)
- [Frequency sweep measurement configuration](#) (ACLR and SEM only)

EVM / ACLR / SEM	165
Manage User Standards	165
Restore Settings	165

EVM / ACLR / SEM

Turns the corresponding measurement on and off (blue = on, otherwise = off).

All selected measurements are part of the combined measurement sequence.

Remote command:

EVM state: `CONFigure[:NR5G]:EVM` on page 441

ACLR state: `CONFigure[:NR5G]:ACLR` on page 441

SEM state: `CONFigure[:NR5G]:SEM` on page 441

Manage User Standards

Available for ACLR and SEM measurements.

Opens a dialog that allows you to import custom ACLR or SEM settings from a xml file. The R&S FSV/A applies the ACLR and SEM settings stored in the selected file.

When you load custom ACLR or SEM settings, exporting I/Q data of an ACLR or SEM measurement also exports the custom settings that the corresponding measurement was done with. The settings are stored in a dedicated `settings.xml` file.

Select "Clear" to remove the file based settings.

Remote command:

ACLR: `CALCulate<n>:MARKer<m>:FUNction:POWer<sb>:PRESet` on page 440

SEM: `[SENSe:]ESpectrum<sb>:PRESet[:STANdard]` on page 438

Restore Settings

Restores the settings that were active during the last sequence of measurements. This can be a useful feature if you have changed the signal description since the last measurement sequence and want to restore the measurement settings. You can restore settings as long as you do not start a new measurement sequence.

Remote command:

`MMEMory:LOAD:SETTings` on page 442

4.5.2 Signal capture

Access: "Overview" > "Trigger / Signal Capture" > "Signal Capture"

The data capture settings contain settings that control various aspects of the data capture.

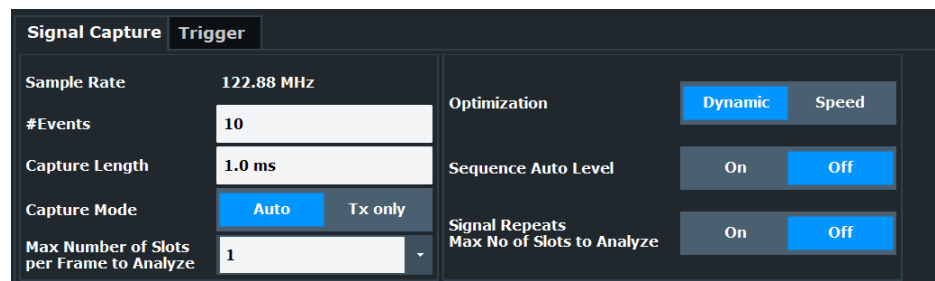

Functions in the "Signal Capture" dialog box described elsewhere:

- [Capture length](#)
- [Max number of slots to analyze](#)

- Signal repeats max no of slots to analyze

# Events.....	166
Capture Mode.....	166
Optimization.....	166
Sequence Auto Level.....	166

Events

Defines the number of measurements in the measurement sequence. Each event corresponds to one combined measurement. A combined measurement consists of one EVM, ACLR and / or SEM measurement.

Remote command:

[SENSe:] SWEp:EVENT on page 440

Capture Mode

Selects the capture mode for combined measurements. You can define the capture mode if the measurement sequence consists of a series of EVM measurements only (ACLR and SEM measurements must be inactive).

In "Auto" mode, the R&S FSV/A captures and analyzes the complete signal, including adjacent and alternate channels. For EVM measurements, these channels can be uninteresting, but their data capture slows down the measurement. To increase the measurement speed for EVM measurements, select "Tx Only". Using this mode, the R&S FSV/A captures and analyzes only the Tx channel.

Remote command:

[SENSe:] SWEp:MODE on page 440

Optimization

Selects the data capture method.

"Dynamic"	Captures the carrier and neighboring channels separately, and stitches them together during the data analysis. This method yields a higher dynamic range at the expense of measurement speed.
"Speed"	Captures the complete signal, including all neighboring channels at the same time. This method is faster at the expense of dynamic range and higher noise. Requires R&S FSV/A with enough bandwidth.

Remote command:

[SENSe:] NR5G:FRAMe:OPTimization on page 439

Sequence Auto Level

Turns [auto leveling](#) prior to each event in the measurement sequence on and off.

Remote command:

[SENSe:] NR5G:FRAMe:SALevel on page 439

4.5.3 Trigger configuration

Access: "Overview" > "Trigger / Signal Capture" > "Trigger"

Combined measurement mode provide an assistant that helps you to find a suitable trigger configuration for your test setup. The resulting trigger configuration depends on the combination of a trigger sequence and the availability of a frame trigger.

For a comprehensive description of all predefined trigger configurations, refer to the [combined measurement guide](#). This guide also contains a list of the trigger settings associated with each scenario.

If the assistant does not provide a suitable trigger configuration, you can still set up a custom trigger configuration in the "Advanced" trigger settings. These [advanced settings](#) are the same as for all other measurements.

You can change advanced trigger settings like trigger level, slope, drop-out time etc, even if the assistant already provides a scenario that fits your needs. However, if you select a different trigger source, gate source or trigger connector usage, the R&S FSV/A discards the selected trigger sequence and changes back to the "Manual" sequence.

Sequence	167
Frame Trigger	168
Event Delay	168
Recalibration Interval	168
Send Trigger 3	169
Auto Gating	169

Sequence

Selects the general sequence of the measurement, including the type of triggers available in the test setup and the number of trigger signals.

For a comprehensive description of the sequences, see [Chapter 4.6, "Combined measurement guide"](#), on page 169.

"Manual" Custom trigger configuration.

"Periodic" Measurement sequence defined by an [event delay](#).

"Open-loop"	Measurement sequence that includes a trigger to indicate that the DUT is ready for testing. Trigger is connected to trigger input 2.
"Closed-loop"	Measurement sequence that includes a trigger to indicate that the DUT is ready for testing and a trigger output that indicates that the I/Q data capture is done. Triggers are connected to trigger input 2 and trigger output 3.

Remote command:

[TRIGger:TSHelper:SEquence](#) on page 443

Frame Trigger

Selects the availability of a frame trigger. The availability of a frame trigger basically selects the trigger source.

For a comprehensive description on the effects of this setting, see [Chapter 4.6, "Combined measurement guide"](#), on page 169.

"Available"	Frame trigger available as an external trigger.
"n/a - Time Trigger"	Periodic measurement using a time trigger synchronized to the frame as the trigger source. Includes automatic calibration.
"n/a - Repeating Slots"	Free run measurement that captures a certain amount of data. The amount of data corresponds to a number of slots that are repeated in the signal.

Remote command:

[TRIGger:TSHelper:FTRigger](#) on page 442

Event Delay

Available for periodic and manual measurement sequences.

The "Event Delay" defines a time period between two events (or combined measurements). Therefore, the event delay is the time period spanning the time when an event occurs and the the point in time when a new event can occur.

For a manual [sequence](#), the event delay is available for all trigger sources, except the time trigger.

Remote command:

[TRIGger:TSHelper:EDELay](#) on page 442

Recalibration Interval

Available for open- and closed-loop scenarios using a time trigger.

Using a time trigger requires a synchronization to the frame start offset. Because the frame start offset drifts over time, you have to recalibrate the time trigger on a regular basis. In combined measurement mode, this is an automatic process, controlled by the "Recalibration Interval" - on each recalibration, the R&S FSV/A synchronizes the time trigger to the frame start offset.

The recalibration interval is in terms of events (single measurements).

For example, an interval of "5" recalibrates the time trigger after 5 events in the measurement sequence. To find out an appropriate interval, run several measurement, and check after how many measurements synchronization fails. Define an interval that recalibrates a few measurements before synchronization fails.

Increasing the recalibration interval increases the measurement speed for all events in which no recalibration is performed.

For a manual [sequence](#), the recalibration interval is available for the time trigger source.

Remote command:

[TRIGger:TSHelper:RINTerval](#) on page 443

Send Trigger 3

Access: "Trigger" > "Send Trigger 3" (softkey only)

Available for closed-loop [sequences](#).

Sends an initial trigger to start the measurement sequence for setups that use a trigger output to inform the test setup that the R&S FSV/A is ready for the measurement.

Remote command:

[OUTPut<up>:TRIGger<tp>:PULSe:IMMediate](#) on page 442

Auto Gating

Turns automated gating on and off.

Turning on the auto gating makes sure that the R&S FSV/A only measures the ACLR and SEM when the Tx channel is transmitted ("On" state). The gate is open during the on periods of the Tx channels that occur in the analysis range. The analysis range begins with a frame start. When the frame start is known, the R&S FSV/A can detect the on and off periods.

Note that auto gating is not possible for free run measurements on TDD signals and when the signal capture consists of several captures (for example for [dynamic capture](#) or if the available analysis bandwidth is smaller than the signal bandwidth). The R&S FSV/A shows a corresponding error message in that case.

Remote command:

[\[SENSe:\]SWEep:EGATe:AGATing](#) on page 439

4.6 Combined measurement guide

The combined measurement mode provides functionality to combine several, subsequent EVM, ACLR and (or) SEM measurements in a single sequence of measurement. If you combine the measurements into a sequence, the R&S FSV/A analyzes the captured data for EVM, ACLR and SEM in parallel (multi-processing) - the data capture itself is processed independent from the analysis. This in turn increases the speed of the measurement evaluation.

These measurements can occur on a single DUT, for example one that changes its position in space. Or they can occur on multiple DUTs, for example as an end test in a production line.

Combined measurements allow you to automate such measurement sequences and to increase the speed of such sequences. The measurement mode also provides tools to evaluate the results. However, combined measurements only work on a DUT whose

signal description and center frequency remain the same over the sequence of measurements.

Each single measurement is also called an event. Several events make up the measurement sequence. The number of events you can define depends on the capture length, bandwidth (or sampling rate) and the available memory (RAM). Events are also processed in parallel, which increases the measurement speed even more.

An event can be, for example, a new position of the DUT, or the next DUT in a production line. When the DUT is ready, some kind of trigger initiates the next measurement.

- [General configuration](#)..... 170
- [Trigger configuration](#)..... 171

4.6.1 General configuration

There are some basic settings that you should define for all measurements, regardless of your test setup.

Before you start configuring the application, set up the measurement physically.

Setting up the measurement

1. Enter the combined measurement mode.
("Meas" > "Combined EVM/ACLR/SEM")
2. Select the measurements you want to run.
("Meas Config" > "Signal Description" > "EVM", "ACLR" and / or "SEM")
3. Define the [signal characteristics](#), select a test model or load an allocation file.
Note that handling allocation files for combined measurements is [slightly different](#) compared to other measurements.
("Meas Config" > "Signal Description")
4. Adjust the [amplitude settings](#) to achieve an ideal EVM.
("Auto" > "Auto EVM" softkey).
As an alternative, you can optimize the amplitude settings for each event.
("Meas Config" > "Trigger / Signal Capture" > "Signal Capture" > "Sequence Auto Level")
5. Define the number of [events](#).
("Meas Config" > "Signal Capture" > "Events")
6. Define the [capture length](#) (slightly more than the amount of data you want to analyze).
("Meas Config" > "Signal Capture" > "Capture Time")
7. Select the [optimization](#) method.
("Meas Config" > "Signal Description" > "Optimization")
8. Define the trigger configuration. The trigger configuration that you apply depends on your setup. For details, see [Chapter 4.6.2, "Trigger configuration"](#), on page 171.
9. Run the measurement.

The R&S FSV/A initiates the sequence of measurement.

When an event that triggers a combined measurement occurs, the R&S FSV/A adds a line to the combined EVM / ACLR / SEM [result table](#).

The time until all events have happened varies, depending on your setup.

If you want to reevaluate the measurement sequence or a certain event after the sequence has finished, you can do so by [refreshing](#) the results.

("Sweep" > "Refresh" / "Refresh Current")

10. Evaluate the measurement, for example by:

- [Filtering the results](#) to view only certain events.
- [Selecting an event](#) to view the details of that event in graphical result displays.
- Exporting the results for the whole sequence, selected events or a single event.
- [Exporting the I/Q data](#) for later reevaluation.

You can export the I/Q data for a single event, or the I/Q data for the complete measurement sequence.

Using allocation files in combined measurement mode

[Allocation files](#) are basically the same in combined measurement mode. In combined mode, the allocation files combine the signal description for all selected measurements (EVM, ACLR and SEM). In addition, the allocation file also contains the measurement results for a measurement sequence (only the results, not the I/Q data).

1. Select a file name and location for the allocation file you want to save or load.
2. Select the measurements you want to include.
"General" settings are always included. Otherwise, you can select if you want to include the settings for EVM, ACLR and (or) SEM measurements.
3. Select if you want to include the measurement results ("Combined Result Table").

4.6.2 Trigger configuration

The trigger configuration is a vital part of the combined measurements. The trigger is what makes the automated combined measurements possible in the first place: Wait for the first event to initiate a measurement - run the measurement - wait for the next event - run the measurement and so on.

The R&S FSV/A provides several [trigger presets](#) for typical combined measurement scenarios. Other than those, you can, of course, use a custom trigger configuration (or even no trigger at all).

The main criteria for the trigger selection are:

- Is a frame trigger available or not?
- Which possibilities do you have to trigger the measurement sequence?



Advanced trigger settings

If you select one of the trigger presets ("Sequence" or "Frame Trigger" menus), and change something in the [advanced trigger settings](#), the preset becomes obsolete ("Sequence" = "Manual").

Using the trigger setup helper

The trigger setup helper allows you to select certain trigger configuration presets. These presets are typical trigger setups for certain test scenarios.

Of course it is also possible to apply a custom trigger configuration.

1. Select the trigger "Sequence".
 - "Manual" = custom trigger configuration
 - "Periodic" = measurements in certain interval
 - "Open-Loop" = an external trigger indicates that the DUT is ready
 - "Closed-Loop" = an external trigger indicates that the DUT is ready, plus the analyzer indicates that the data capture is finished
2. Select the frame trigger availability.
3. For periodic trigger, define the event delay.
4. For time trigger instead of dedicated frame trigger, define the recalibration interval.

Table 4-4: Trigger presets and their trigger configuration*

Trigger setup helper			Advanced trigger settings			
Sequence	Frame trigger		Trigger source	Source	Trigger 2	Trigger 3
Periodic	n/a	>>	Free run	n/a	n/a	n/a
Periodic	available	>>	Ext. trigger 1	n/a	n/a	n/a
Open-loop	n/a	>>	Free run	Ext. trigger 2	Input	n/a
Open-loop	n/a	>>	Time	Ext. trigger 2	Input	n/a
Open-loop	available	>>	Ext. trigger 1	Ext. trigger 2	Input	n/a
Closed-loop	n/a	>>	Free run	Ext. trigger 2	Input	Output
Closed-loop	n/a	>>	Time	Ext. trigger 2	Input	Output
Closed-loop	available	>>	Ext. trigger 1	Ext. trigger 2	Input	Output

*Changing one of these settings always returns to trigger sequence = manual; you can still change other trigger settings like level, drop-out time etc.



DUT reconfiguration

The following procedures use the term "DUT reconfiguration".

The DUT reconfiguration is a process that depends on your test scenario. For example, the term can refer to the DUT moving into another position or the DUT being replaced by another DUT in a production line.

Using a periodic sequence: no frame trigger

In this scenario, measurements take place periodically, every <x> seconds. A trigger is not available.

This scenario requires a capture time that is at least double the time of the data you want to capture - for example, if you want to capture a single slot with 30 kHz subcarrier spacing (slot length = 0.5 ms), the capture time must be greater than 1 ms.

Note that the number of slots that the signal repeats have to start with slot 0.

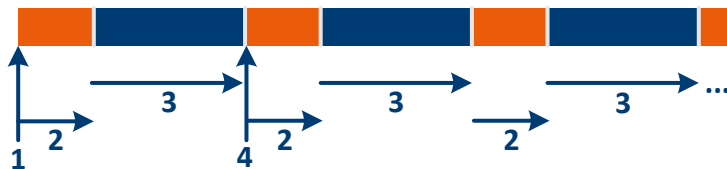

Figure 4-11: Workflow for a periodic measurement without frame trigger

- 1 = Start of measurement
- 2 = I/Q data capture
- 3 = DUT reconfiguration
- 4 = Subsequent I/Q data capture

The time a single measurement event lasts in the sequence is the sum of:

I/Q capture + DUT reconfiguration

Optional auto leveling for each measurement extends the measurement time a little.

The sequence of measurements runs like this:

1. Start of the measurement sequence.
2. The R&S FSV/A captures the I/Q data.
3. The DUT reconfigures itself.
Note that the event delay starts with the I/Q capture. Thus, make sure to define an event delay that is long enough to include the data capture and the DUT reconfiguration.
4. The I/Q data capture starts again after the event delay is over.
Steps 2 through 4 repeat until all events are captured.

Using a periodic sequence: frame trigger available

In this scenario, measurements take place periodically, every <x> seconds.

The scenario requires an external trigger, connected to trigger input 1. The external trigger is a frame trigger that initiates the I/Q data capture. The trigger event is the frame start.

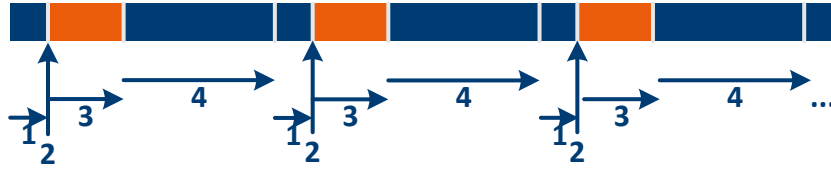

Figure 4-12: Workflow for a periodic measurement with frame trigger

- 1 = Wait for frame start
- 2 = Start of measurement
- 3 = I/Q data capture
- 4 = DUT reconfiguration

The time a single measurement event lasts in the sequence is the sum of:

I/Q capture + DUT reconfiguration + waiting on frame start

Optional auto leveling for each measurement extends the measurement time a little.

The sequence of measurements runs like this:

1. The R&S FSV/A waits for a frame start.
 2. A frame trigger initiates the measurement.
 3. The R&S FSV/A captures the I/Q data.
 4. The DUT reconfigures itself.
 - Note that the event delay starts with the I/Q capture. Thus, make sure to define an event delay that is long enough to include the data capture and the DUT reconfiguration.
 - The end of the event delay also rearms the frame trigger.
- Steps 1 through 4 repeat until all events are captured.

Using an open-loop sequence: frame trigger available

This scenario needs two trigger sources.

The first is an external frame trigger, connected to trigger input 1, that initiates the I/Q data capture. The trigger event is the frame start.

The second is an external trigger, connected to trigger input 2, that indicates that the DUT is ready for the measurement. This trigger is sent, for example, when the DUT has reached its measurement position.

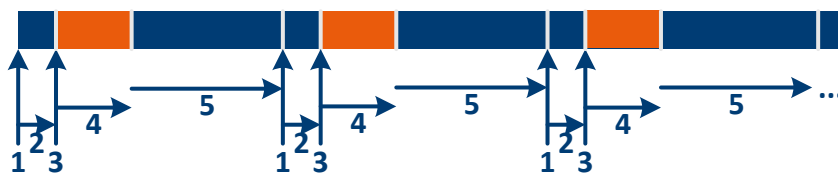

Figure 4-13: Workflow for an open loop measurement with frame trigger

- 1 = DUT ready for measurement
- 2 = Wait for frame start
- 3 = Frame trigger starts measurement
- 4 = I/Q data capture
- 5 = DUT reconfiguration

The time a single measurement event lasts in the sequence is the sum of:

I/Q capture + DUT reconfiguration + waiting on frame start + waiting for DUT ready trigger

Optional auto leveling for each measurement extends the measurement time a little.

The sequence of measurements runs like this:

1. The DUT sends a trigger signal to indicate that it is ready for the measurement.
 2. The R&S FSV/A waits for a frame start.
 3. A frame trigger initiates the measurement.
 4. The R&S FSV/A captures the I/Q data.
 5. The DUT reconfigures itself.
- Steps 1 through 5 repeat until all events are captured.

Using an open-loop sequence: using time trigger

This scenario needs two trigger sources.

The first is a [time trigger](#) that initiates a periodic I/Q data capture. Because the frame start and time trigger drift from each other over time, using the time trigger requires regular recalibration - in combined measurement mode, this is an automated process, defined by the [recalibration interval](#). The initial synchronization of the time trigger to the frame start is also an automated process.

The second is an external trigger, connected to trigger input 2, that indicates that the DUT is ready for the measurement. This trigger is sent, for example, when the DUT has reached its measurement position.

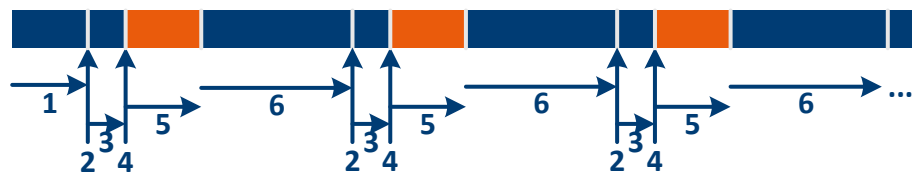

Figure 4-14: Workflow for an open loop measurement with time trigger

- 1 = Initial calibration of time trigger
- 2 = DUT ready for measurement
- 3 = Wait for frame start
- 4 = Start of measurement
- 5 = I/Q data capture
- 6 = DUT reconfiguration

The time a single measurement event lasts in the sequence is the sum of:

I/Q capture + DUT reconfiguration + time trigger recalibration + waiting on frame start + waiting for DUT ready trigger

Optional auto leveling for each measurement extends the measurement time a little.

Before you start the measurement sequence, define an appropriate recalibration interval.

The sequence of measurements runs like this:

1. The R&S FSV/A calibrates the time trigger by defining a trigger offset = frame start offset.
2. The DUT sends a trigger signal to indicate that it is ready for the measurement.
3. The R&S FSV/A waits for a frame start.
4. A frame synchronized time trigger initiates the measurement.
5. The R&S FSV/A captures the I/Q data.
6. The DUT reconfigures itself.
At the same time, the time trigger recalibration occurs.
7. The DUT sends a trigger signal to indicate it is ready for the next measurement.
Steps 2 through 6 repeat themselves until all events are captured.

Using an open-loop sequence: no trigger available (repeating slots)

In this scenario, the DUT uses an external trigger signal to indicate it is ready for a measurement. The trigger signal initiates a (free run) measurement.

This scenario requires a capture time that is at least double the time of the data you want to capture - for example, if you want to capture a single slot with 30 kHz subcarrier spacing (slot length = 0.5 ms), the capture time must be greater than 1 ms.

Note that the number of slots that the signal repeats have to start with slot 0.

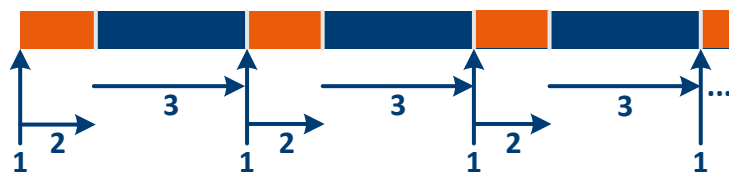

Figure 4-15: Workflow for an open-loop measurement without trigger

- 1 = DUT ready for measurement
- 2 = I/Q data capture
- 3 = DUT reconfiguration

The time a single measurement event lasts in the sequence is the sum of:

I/Q capture + DUT reconfiguration + waiting for DUT ready trigger

Optional auto leveling for each measurement extends the measurement time a little.

The sequence of measurements runs like this:

1. The DUT sends a trigger signal to indicate that it is ready for the measurement.

2. The R&S FSV/A captures the I/Q data.
3. The DUT reconfigures itself.
4. The DUT sends a trigger signal to indicate it is ready for the next measurement. Steps 1 through 3 repeat themselves until all events are captured.

Using an closed-loop sequence: frame trigger available

This scenario needs two trigger sources and one trigger output.

The first trigger source is an external frame trigger, connected to trigger input 1, that initiates the I/Q data capture. The trigger event is the frame start.

The second trigger source is an external trigger, connected to trigger input 2, that indicates that the DUT is ready for the measurement. This trigger is sent, for example, when the DUT has reached its measurement position.

The trigger output initiates the DUT reconfiguration after the R&S FSV/A is done capturing the I/Q data. The DUT must have a corresponding trigger interface. This signal is output on trigger 3, which is defined as a user-defined output.

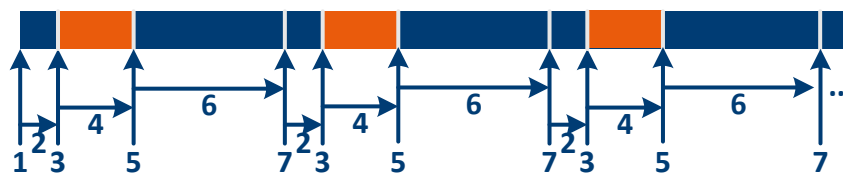

Figure 4-16: Workflow for a closed loop measurement with frame trigger

- 1 = Send initial trigger signal
- 2 = Wait for frame start
- 3 = Frame trigger starts measurement
- 4 = I/Q data capture
- 5 = I/Q data capture done - waiting for DUT reconfiguration
- 6 = DUT reconfiguration
- 7 = DUT ready for measurement

The time a single measurement event lasts in the sequence is the sum of:

I/Q capture + DUT reconfiguration + waiting on frame start + waiting for DUT ready trigger

Optional auto leveling for each measurement extends the measurement time a little.

The sequence of measurements runs like this:

1. Send an initial trigger with "Send Trigger 3" (optional).
2. The R&S FSV/A waits for a frame start.
3. A frame trigger initiates the measurement.
4. The R&S FSV/A captures the I/Q data.
5. The R&S FSV/A sends a trigger signal to the DUT to indicate the I/Q data capture is done.
6. The DUT reconfigures itself.

- The DUT sends a trigger signal to indicate that it is ready for the measurement. Steps 2 through 7 repeat until all events are captured.

Using an closed-loop sequence: using time trigger

This scenario needs two trigger sources and one trigger output.

The first is a **time trigger** that initiates a periodic I/Q data capture. Because the frame start and time trigger drift from each other over time, using the time trigger requires regular recalibration - in combined measurement mode, this is an automated process, defined by the **recalibration interval**. The initial synchronization of the time trigger to the frame start is also an automated process.

The second is an external trigger, connected to trigger input 2, that indicates that the DUT is ready for the measurement. This trigger is sent, for example, when the DUT has reached its measurement position.

The trigger output initiates the DUT reconfiguration after the R&S FSV/A is done capturing the I/Q data. The DUT must have a corresponding trigger interface. This signal is output on trigger 3, which is defined as a user-defined output.

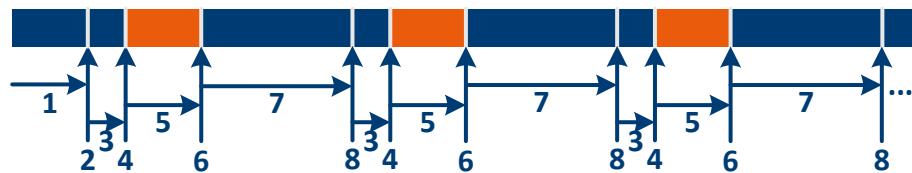

Figure 4-17: Workflow for a closed loop measurement with time trigger

- 1 = Initial calibration of time trigger
- 2 = Send initial trigger signal
- 3 = Wait for frame start
- 4 = Start of measurement
- 5 = I/Q data capture
- 6 = I/Q data capture done - waiting for DUT reconfiguration
- 7 = DUT reconfiguration
- 8 = DUT ready for measurement

The time a single measurement event lasts in the sequence is the sum of:

I/Q capture + DUT reconfiguration + time trigger recalibration + waiting on frame start + waiting for DUT ready trigger

Optional auto leveling for each measurement extends the measurement time a little.

Before you start the measurement sequence, define an appropriate recalibration interval.

The sequence of measurements runs like this:

- The R&S FSV/A calibrates the time trigger by defining a trigger offset = frame start offset.
- Send an initial trigger with "Send Trigger 3" (optional).
- The R&S FSV/A waits for a frame start.
- A frame synchronized time trigger initiates the measurement

5. The R&S FSV/A captures the I/Q data.
6. The R&S FSV/A sends a trigger signal to the DUT to indicate the I/Q data capture is done.
7. The DUT reconfigures itself.
At the same time, the time trigger recalibration occurs.
8. The DUT sends a trigger signal to indicate it is ready for the next measurement.
Steps 3 through 8 repeat themselves until all events are captured.

Using an closed-loop sequence: no trigger available (repeating slots)

In this scenario, the DUT uses an external trigger signal to indicate it is ready for a measurement. The trigger signal initiates a (free run) measurement.

In addition, the R&S FSV/A sends a trigger to the DUT to indicate that the I/Q capture is done.

This scenario requires a capture time that is at least double the time of the data you want to capture - for example, if you want to capture a single slot with 30 kHz subcarrier spacing (slot length = 0.5 ms), the capture time must be greater than 1 ms.

Note that the number of slots that the signal repeats have to start with slot 0.

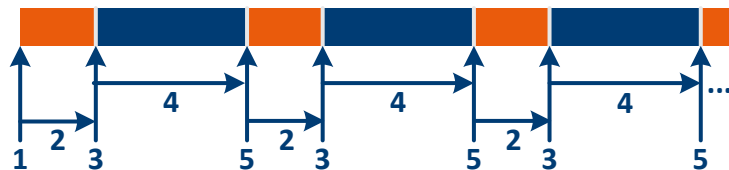

Figure 4-18: Workflow for an closed-loop measurement without trigger

- 1 = Send initial trigger signal
- 2 = I/Q data capture
- 3 = I/Q data capture done - waiting for DUT reconfiguration
- 4 = DUT reconfiguration
- 5 = DUT ready for measurement

The time a single measurement event lasts in the sequence is the sum of:

I/Q capture + DUT reconfiguration + waiting for DUT ready trigger

Optional auto leveling for each measurement extends the measurement time a little.

The sequence of measurements runs like this:

1. Send an initial trigger with "Send Trigger 3" (optional).
2. The R&S FSV/A captures the I/Q data.
3. The R&S FSV/A sends a trigger signal to the DUT to indicate the I/Q data capture is done.
4. The DUT reconfigures itself.
5. The DUT sends a trigger signal to indicate it is ready for the next measurement.

Steps 2 through 5 repeat themselves until all events are captured.

4.7 Time trigger measurement guide

The time trigger initiates a measurement in certain intervals (every $\langle x \rangle$ seconds). For the 5G NR application this means that you can use the time trigger to initiate a measurement at the start of each frame (every 10 ms). Therefore, the time trigger is a useful tool when you do not have access to a frame trigger (external trigger source), for example when you test a base station on-site.

Configured correctly, the time trigger also allows you to focus on the analysis of a single slot, which in turn speeds up the measurement. In that case, the idea is to capture only the I/Q data of a single slot (plus a certain tolerance) which increases the measurement speed accordingly.

Since the frequency references of the DUT and the R&S FSV/A are not necessarily coupled in such a scenario, the frame start and the time trigger may deviate over time. In this case, you can increase the capture time tolerance or readjust the time trigger offset periodically.

Analyzing signals with a time trigger

1. Connect the R&S FSV/A to the DUT.
2. Select the time trigger as the trigger source.
("Overview" > "Trigger / Signal Capture" > "Trigger" > "Trigger Source" = "Time")
3. Define a repetition interval of 10 ms (capture every frame).
("Overview" > "Trigger / Signal Capture" > "Trigger" > "Repetition Interval" = "10 ms")
4. Run a measurement to get the frame start offset readout in the capture buffer result display.
5. Define a trigger offset with a length that equals the [frame start offset](#) to synchronize the start of the measurement with the first slot in the frame.
("Overview" > "Trigger / Signal Capture" > "Trigger" > "Offset" = frame start offset)
6. Select one slot to analyze.
("Overview" > "Trigger / Signal Capture" > "Signal Capture" > "Set Number of Frames to Analyze" = "Manually")
("Overview" > "Trigger / Signal Capture" > "Signal Capture" > "Number of Frames to Analyze" = "1")
7. Define a capture length that corresponds to one slot (plus tolerance). The slot length depends on the [subcarrier spacing](#).
("Overview" > "Trigger / Signal Capture" > "Signal Capture" > "Capture Time" = slot length)
8. Run the measurement.

If synchronization to the signal fails (see message in the status bar), you have to increase the trigger offset slightly (a few μs).

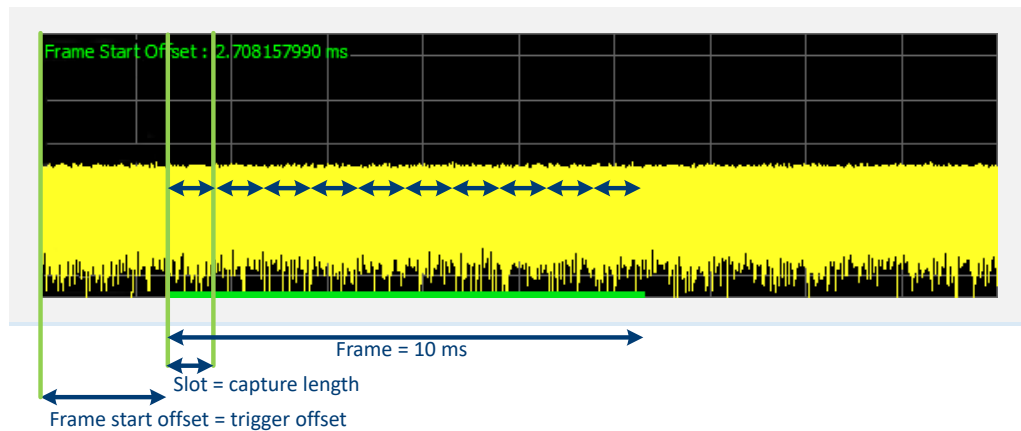

4.8 Microservice export

Access: / > "Export" > "Microservice Export"

In addition to [exporting the signal configuration](#) locally, you can export the signal configuration in a file format compatible to the cloud-based microservice (.m5g file extension).

Exporting signal configurations with multiple component carriers writes the configuration of each component carrier into a separate file. The number of files depends on the [analysis mode](#):

- If you analyze the viewed CCs only, the R&S FSV/A exports those two CCs (two files - config_CC1.m5g, config_CC2.m5g).
- If you analyze all CCs, the R&S FSV/A exports all CCs. The number of files depends on the number of component carriers (config_CC1.m5g, config_CC2.m5g etc.).

When you change the CC analysis mode (all to viewed or vice versa), you have to either refresh the I/Q data or re-run the sweep to reflect this change in the microservice export.

For a comprehensive description of the microservice, refer to the microservice user manual.

Remote command:

`MMEMory:STORe<n>:MSERvice` on page 297

4.9 O-RAN measurement guide

The O-RAN alliance specifies specific signal configurations (test cases) for standardized testing of O-RAN equipment. The R&S FSV/A provides these O-RAN test cases. When you apply one of them, the measurement configuration automatically adjusts to the values of the selected test case.

Basically, you can verify O-RAN based signals by certain bit sequences in the PDSCH and the positions of those sequences. The position of the bit sequence in the PDSCH is unique for each test case.

The [type of bit sequence](#) depends on the test case.

- Some test cases use a bit sequence of all 0's.
- Some test cases use an O-RAN specific PN23 bit sequence.

In addition, the [data demodulation](#) depends on the test case (before or after descrambling).

As pointed out, these settings are automatically selected, depending on the selected test case.

For valid measurement results, it is essential that the measured signal complies with the selected test case and uses the correct bit sequences in the correct locations. If you get unexpected measurement results, check if the signal is configured correctly. You can do a quick check to validate the signal as follows.

- Check if the selected test case in the "Advanced Settings" is the same as the test case in the "Test Models" dialog.
- Use the [Allocation ID vs Symbol x Carrier](#) result display to verify if the correct PDSCH allocations are analyzed. If the signal contains the correct bit sequence, the EVM should be good.
- Use the [Bitstream](#) result display to verify if the bits match the O-RAN specifications. Each test case has a typical bit sequence. Make sure to select the bit sequence as the [bitstream format](#).

4.10 Reference: structure of .allocation files

.allocation (and .ccallocation) files are basically xml files that follow a certain structure. The structure of the file is based on the structure of the dialogs in the user interface.

Basically, the structure is as follows:

- Each setting is stored in a dedicated element.
Example: <ChannelBandwidth>, <CellID>
- The settings are grouped as in the user interface.
Example: <ChannelBandwidth> and <CellID> belong to the <Physical_Settings> element.
- Some xml elements can occur multiple times.

Examples: `<Frame_Config>`, `<BWP_Config>`, `<Slot_Config>`. The number of occurrences depends on the number of frames, BWPs and slots in the signal.

- The values for all elements are the SCPI parameters of the corresponding setting.
Example: `<ChannelBandwidth>BW100</ChannelBandwidth>`, `<CellID>0</CellID>`



Probably the most comfortable way to describe a signal in an xml file is to save an `.allocation` file after a preset and then change the values within that file.

Root structure

For structure of child elements, see:

- "`<Information>` element" on page 183
- "`<PRACH>` element" on page 184
- "`<Signal_Description>` element" on page 184
- "`<Signal_Capture>` element" on page 184
- "`<Parameter_Estimation>` element" on page 184
- "`<CCSettings>` element" on page 185
- "`<RF_Parameter>` element" on page 186
- "`<MultiCarrier>` element" on page 187

```
<NR5G>
  <Information/>
  <!-- PRACH settings are relevant in uplink only -->
  <PRACH/>
  <Signal_Description/>
  <Signal_Capture/>
  <Parameter_Estimation/>
  <!-- CCSettings can occur several times -->
  <CCSettings/>
  <RF_Parameter/>
  <!-- MultiCarrier only for multiple carriers -->
  <MultiCarrier/>
</NR5G>
```

`<Information>` element

The `<Information>` element is a child element of the `<NR5G>` element.

```
<Information>
  <FWVersion/>
  <Device/>
  <Type/>
  <IQFrequency/>
  <Mode/>
  <ExportIssues/>
</Information>
```

<PRACH> element

The <PRACH> element is a child element of the <NR5G> element.

```
<PRACH>
  <PRACHFormat/>
  <PRACHSCS/>
  <L_RA/>
  <Restricted/>
  <LogicalRootSequenceIndex/>
  <ZeroCorrelationZone/>
  <PreambleIndex/>
  <RelPower/>
  <RBOffset/>
</PRACH>
```

<Signal_Description> element

The <Signal_Description> element is a child element of the <NR5G> element.

```
<Signal_Description>
  <Mode/>
  <DeployFrequencyRange/>
  <NumberOfCC/>
  <NumberOfInputSource/>
  <ORANTestCase/>
  <FreqErrLimitState/>
  <TestModelName/>
</Signal_Description>
```

<Signal_Capture> element

The <Signal_Capture> element is a child element of the <NR5G> element.

```
<Signal_Capture>
  <SwapIQ/>
  <LongCaptureMode/>
  <CaptureTime/>
  <CaptureTimeAuto/>
  <OverallFrameCount/>
  <SetNumberOfFramesToAnalyze/>
  <NumOfFramesToAnalyze/>
  <MaxOfSlotsPerFrameToAnalyze/>
  <AveragedFrame/>
  <SignalRepeatsMaxNoOfSlotsToAnalyze/>
</Signal_Capture>
```

<Parameter_Estimation> element

The <Parameter_Estimation> element is a child element of the <NR5G> element.

```
<Parameter_Estimation>
  <ChannelEstimation/>
```



```

<ChannelEstimationTimeAveraging/>
<TrackPhase/>
<TrackTiming/>
<TrackLevel/>
<MultiCarrierFilter/>
<DemodulatedData/>
<IQGainImbalance_QuadratureError/>
<TPUTState/>
<CORESETAnalysisMode/>
<EVMCalculationMethod/>
<CORESETReferenceData/>
<PDSCHReferenceData/>
<ExtendedFrequencyLockRange/>
<SymbolTimingPosition/>
</Parameter_Estimation>

```

<CCSettings> element

The <CCSettings> element is a child element of the <NR5G> element.

The <CCSettings> element can occur several times, one for each component carrier.

For structure of child elements, see:

- "[<Synchronization> element](#)" on page 187
- "[<Frame_Config> element](#)" on page 187

```

<CCSettings>
  <AutoBWPDetection/>
  <CCFrequency/>
  <FreqOffsetToCC0/>
  <PhysicalSettings>
    <ChannelBandwidth/>
    <CellIDAuto/>
    <CellID/>
    <P_rated_c_EIRP/>
    <P_rated_c_TRP/>
  </PhysicalSettings>
  <NumofAntPortMapping/>
  <!-- Ant_Port_Mapping occurs several times, once for each AP configuration -->
  <Ant_Port_Mapping>
    <State/>
    <SyncSignal_AP/>
    <PDSCH_APxxxx/>
    <PDCCH_AP/>
    <CSIRS_APx/>
  </Ant_Port_Mapping>
  <Advanced_Settings>
    <IgnoreDC/>
    <RFUpconversion_PhaseCompensation/>
    <RFUpconversion_f_0/>
    <RFUpconversion_f_0_Freq/>

```

```

<FrameNumber_n_f/>
<RefPointA_SCS15kHz/>
<RefPointA_SCS30kHz/>
<RefPointA_SCS60kHz/>
<RefPointA_SCS120kHz/>
<RefPointA_SCS480kHz/>
<RefPointA_SCS960kHz/>
<RefPointA_RelativeToCF/>
<ExcludeUserIDs/>
<SharedSpectrumChannelAccess/>
</Advanced_Settings>
<NumofSynchronization/>
<!-- Contents of synchronization element see below -->
<Synchronization/>
<NumofFrame/>
<!-- Frame_Config can occur several times, contents see below -->
<Frame_Config/>
<LTE_CRS_Coexistence/>
<State/>
<OffsToPoints/>
<VShift/>
<LTEBWRBs/>
<LTEAntPorts/>
<!-- The MBSFNsubframeConfiguration occurs once for each MBSFN subframe -->
<MBSFNsubframeConfiguration/>
  <IndexofSubframe/>
  <Active/>
</MBSFNsubframeConfiguration>
</LTE_CRS_Coexistence/>
</CCSetting>

```

<RF_Parameter> element

The <RF_Parameter> element is a child element of the <NR5G> element.

```

<RF_Parameter>
  <BaseStationType/>
  <ACLR>
    <AdjacentChannels/>
    <LimitCheckMode/>
  </ACLR>
  <SEM>
    <Category/>
    <CategoryBOption/>
    <TxPowerAuto/>
    <TxPowerValue/>
    <N_TXUcountedpercell/>
    <N_TABconnectors/>
    <IFF/>
  </SEM>

```

```
</RF_Parameter>
```

<MultiCarrier> element

The <MultiCarrier> element is a child element of the <NR5G> element.

```
<MultiCarrier>
  <CCSignalCapture/>
  <OperatingBand/>
  <CCResult/>
  <View1ComponentCarrierNo/>
  <View1FrameNo/>
  <View2ComponentCarrierNo/>
  <View2FrameNo/>
  <FixedCCOffset/>
  <GlobalMCCenter/>
  <OffsetRelto/>
  <OffsetMode/>
  <CarrierSpacing/>
</MultiCarrier>
```

<Synchronization> element

The <Synchronization> element is a child element of the <CCSettings> element.

```
<Synchronization>
  <SSBC_Detection/>
  <SubcarrierSpacing/>
  <Pattern/>
  <OffsetOption/>
  <RBOffset/>
  <AdditionalSubcarrierOffset/>
  <BurstSetPeriodicity/>
  <!-- One entry for each SSB -->
  <SSBStateX/>
  <NRPSSRelPower/>
  <NRSSRelPower/>
  <NRPBCHRelPower/>
  <PBCHDMRSRelPower/>
  <LSelection/>
  <HalfFrameOffset/>
</Synchronization>
```

<Frame_Config> element

The <Frame_Config> element is a child element of the <CCSettings> element.

- The <Frame_Config> element can occur several times, one for each configurable frame.
- Within the <Frame_Config> element, the <BWP_Config> element can occur several times, one for each bandwidth part.

- Within the <BWP_Config> element, the <Slot_Config> element can occur several times, one for each slot.
- Within the <Slot_Config> element, the <PXCCH> and <PXSCH> elements can occur several times, one for each PXCCH or PXSCH allocation.

For structure of child elements, see:

- "[<PXCCH> element](#)" on page 188
- "[<PXSCH> element](#)" on page 189
- "[<CSI_Settings> element](#)" on page 190

```
<Frame_Config>
  <NumofBWP/>
  <!-- BWP_Config can occur several times -->
  <BWP_Config>
    <SubcarrierSpacing/>
    <NumofRBs/>
    <RBOffset/>
    <NumberofUserConfigurableSlots/>
    <NumofSlot/>
    <!-- Slot_Config can occur several times -->
    <Slot_Config>
      <SlotAllocation/>
      <SlotFormat/>
      <CombinePDSCHAllocationsWithSameUserID/>
      <NumofPXCCH/>
      <!-- PXCCH can occur several times, description see below -->
      <PXCCH/>
      <NumofPXSCH/>
      <!-- PXSCH can occur several times, description see below -->
      <PXSCH/>
    </Slot_Config>
    <CSISettingsState/>
    <NumofCSI/>
    <!-- Contents of CS-RS element see below -->
    <CSI_Settings/>
    <PRSSettingsState/>
    <NumofPRS/>
    <!-- Contents of PRS element see below -->
    <PRS_Settings/>
  </BWP_Config>
</Frame_Config>
```

<PXCCH> element

The <PXCCH> element is a child element of the <Frame_Config> element.

The <PXCCH> element can occur several times, one for each PXCCH allocation.

```
<PXCCH>
  <NumberOfRBs/>
  <OffsetRB/>
```

```

<NumberOfSymbols/>
<OffsetSymbol/>
<RelPower_dB/>
<DMRS>
  <UseDMRSScramblingID/>
  <ScramblingID/>
  <RelPower/>
  <ReferencePoint/>
  <PrecoderGranularity/>
  <AllowPDSCH/>
  <InterleavingState/>
  <BundleSize/>
  <ShiftIndex/>
  <ShiftIndexNID/>
  <InterleaverSize/>
  <NumofPDCCH/>
  <PDCCH/>
  <RNTI/>
  <AggregationLevel/>
  <CCEIndex/>
  <PatternLength/>
  <DCIFormat/>
  <Usage/>
  <Scope/>
  <NumberOfBlocks/>
  <NumberOfTPCCCommands/>
  <FrequencyDomainResourceAssignment/>
  <!-- DCIBitLength occurs several times, once for each DCI field -->
  <DCIBitLength/>
</PDCCH>
</DMRS>
</PXCH>

```

<PXSCH> element

The <PXSCH> element is a child element of the <Slot_Config> element.

The <PXSCH> element can occur several times, one for each PXSCH allocation.

```

<PXSCH>
  <UserID/>
  <VRBtoPRBInterleaver/>
  <Modulation/>
  <NumberOfRBs/>
  <OffsetRB/>
  <NumberOfSymbols/>
  <OffsetSymbol/>
  <RelPower_dB/>
  <ModulationforCodeword2/>
  <DMRS>
  <ConfigType/>

```

```

    <FirstDMRSSymbolRelTo/>
    <FirstDMRSSymbol/>
    <DMRSAddPositionIndex/>
    <DMRSLength/>
    <SequenceGeneration/>
    <ScramblingID/>
    <ScramblingID1/>
    <n_SCID/>
    <RelPowerToPDSCH/>
    <Layer_Codewords/>
    <AntennaPort/>
    <CDMGroupWOData/>
    <ReferencePoint/>
    <DMRS_R16/>
  </DMRS>
  <PTRS>
    <State/>
    <RelPower/>
    <L_PTRS/>
    <K_PTRS/>
    <RE_Offset/>
  </PTRS>
  <ChannelCoding>
    <MCSTable/>
    <I_MCS/>
    <RedundancyVersionIndex/>
    <TBScalingFactorS/>
    <TBSizeIncAllocGaps/>
  </ChannelCoding>
  <Scrambling>
    <Type/>
    <DataScramblingID/>
  </Scrambling>
</PXSCH>

```

<CSI_Settings> element

The <CSI_Settings> element is a child element of the <BWP_Config> element.

```

<CSI_Settings>
  <SlotConfig>
    <SlotConfigMode/>
    <Periodicity/>
    <Offset/>
    <Slots/>
  </SlotConfig>
  <ZeroPower/>
  <Row/>
  <Ports/>
  <Density/>
  <CDMType/>

```

```

<Bitmap/>
<l0/>
<l1/>
<ScramblingID/>
<RelPower_dB/>
<NumberOfRBs/>
<StartRB/>
</CSI_Settings>

```

<PRS_Settings> element

The <PRS_Settings> element is a child element of the <BWP_Config> element.

```

<PRS_Settings>
  <SlotConfig>
    <SlotConfigMode/>
    <Slots/>
  </SlotConfig>
  <NumberOfRBs/>
  <StartRB/>
  <l_PRS_start/>
  <L_PRS/>
  <n_PRS_ID/>
  <K_PRS_comb/>
  <k_PRS_offset/>
  <RelPower_dB/>
</CSI_Settings>

```

4.11 Basics on input from I/Q data files

The I/Q data to be evaluated in a particular R&S FSV/A application cannot only be captured by the application itself, it can also be loaded from a file, provided it has the correct format. The file is then used as the input source for the application.

For example, you can capture I/Q data using the I/Q Analyzer application, store it to a file, and then analyze the signal parameters for that data later using the AM/FM/PM Modulation Analysis application.



An application note on converting Rohde & Schwarz I/Q data files is available from the Rohde & Schwarz website:

[1EF85: Converting R&S I/Q data files](#)

When importing data from an I/Q data file using the import functions provided by some R&S FSV/A applications, the data is only stored temporarily in the capture buffer. It overwrites the current measurement data and is in turn overwritten by a new measurement. If you use an I/Q data file as input, the stored I/Q data remains available for any number of subsequent measurements. Furthermore, the (temporary) data import requires the current measurement settings in the current application to match the set-

tings that were applied when the measurement results were stored (possibly in a different application). When the data is used as an input source, however, the data acquisition settings in the current application (attenuation, center frequency, measurement bandwidth, sample rate) can be ignored. As a result, these settings cannot be changed in the current application. Only the measurement time can be decreased, to perform measurements on an extract of the available data (from the beginning of the file) only.



5G NR signal description

When you export I/Q data from the 5G NR application, the `iq.tar` file also contains the signal description (`.allocation` file information). The signal description is included in the I/Q parameter XML file.

Therefore, it is no longer necessary to load the signal description separately before loading the I/Q data.

When using input from an I/Q data file, the [RUN SINGLE] function starts a single measurement (i.e. analysis) of the stored I/Q data, while the [RUN CONT] function repeatedly analyzes the same data from the file.



Sample `iq.tar` files

If you have the optional R&S FSV/A VSA application (R&S FSV3-K70), some sample `iq.tar` files are provided in the `C:\R_S\INSTR\USER\vsa/DemoSignals` directory on the R&S FSV/A.

Pre-trigger and post-trigger samples

In applications that use pre-triggers or post-triggers, if no pre-trigger or post-trigger samples are specified in the I/Q data file, or too few trigger samples are provided to satisfy the requirements of the application, the missing pre- or post-trigger values are filled up with zeros. Superfluous samples in the file are dropped, if necessary. For pre-trigger samples, values are filled up or omitted at the beginning of the capture buffer. For post-trigger samples, values are filled up or omitted at the end of the capture buffer.

5 Analysis

The R&S FSV/A provides various tools to analyze the measurement results.

- [General analysis tools](#)..... 193
- [Analysis tools for I/Q measurements](#)..... 196
- [Analysis tools for combined measurements](#).....206
- [Analysis tools for frequency sweep measurements](#)..... 208

5.1 General analysis tools

The general analysis tools are tools available for all measurements.



Event-based actions

The 5G NR measurement application supports event-based actions, as described in the R&S FSV/A User Manual.

When using event based actions, make sure that all frames are included in a single I/Q capture. Event based actions only evaluate the last I/Q capture.

- [Data export](#).....193
- [Diagram scale](#)..... 194
- [Zoom](#)..... 195
- [Markers](#)..... 196

5.1.1 Data export

Access: [TRACE] > "Trace Export Config"

You can export the measurement results to an ASCII file, for example to backup the results or analyze the results with external applications (for example in a Microsoft Excel spreadsheet).

You can also export the I/Q data itself, for example if you want to keep it for later reevaluation.

The data export is available for:

- I/Q measurements
- Time alignment error measurements
- Transmit power on / off measurements
- Combined measurements

Exporting trace data

1. Select the "Trace Export Config" dialog box via the [TRACE] key.
2. Select the data you would like to export.

3. Select the results you would like to export from the "Specifics For" dropdown menu.
4. Export the data with the "Export Trace to ASCII File" feature.
5. Select the location where you would like to save the data (as a .dat file).

Note that the measurement data stored in the file depend on the selected result display ("Specifics For" selection).

Exporting I/Q data

1. Select the disk icon in the toolbar.
2. Select "Export" > "I/Q Export".
3. Define a file name and location for the I/Q data.
The file type is `iq.tar`.
4. Later on, you can import the I/Q data using the [I/Q file input source](#).

Combined measurements have additional features for the I/Q data export and import. You can either

- export I/Q data for specific measurements ("I/Q Export" and import using the I/Q file input source) or
- export and import the I/Q data of all measurements in the sequence ("I/Q Export All" / "I/Q Import All").

Data import and export

The basic principle for both trace export and I/Q data export and import is the same as in the spectrum application. For a comprehensive description, refer to the R&S FSV/A user manual.

Exporting and importing "all" measurements is available in combined measurement mode - it selects all measurements in a sequence.

Remote command:

Trace export: `TRACe<n>[:DATA]?` on page 292

I/Q export: `MMEMoRY:STORe<n>:IQ:STATe` on page 296

I/Q export (all): `MMEMoRY:STORe<n>:IQ:STATe:ALL` on page 296

I/Q import: `INPut:FILE:PATH` on page 408

I/Q import (all): `MMEMoRY:LOAD:IQ:STATe:ALL` on page 296

5.1.2 Diagram scale

Access: "Overview" > "Analysis" > "Scale"

You can change the scale of the y-axis in various diagrams. The y-axis scale determines the vertical resolution of the measurement results.

The scale of the x-axis in the diagrams is fix. If you want to get a better resolution of the x-axis, you have to [zoom](#) into the diagram.

The remote commands required to configure the y-axis scale are described in [Chapter 6.10.1.2, "Diagram scale"](#), on page 445.

Manual scaling of the y-axis	195
Automatic scaling of the y-axis	195

Manual scaling of the y-axis

The "Y Minimum" and "Y Maximum" properties define a custom scale of the y-axis.

The "Y Minimum" corresponds to the value at the origin. The "Y Maximum" corresponds to the last value on the y-axis. The scale you select applies to the currently active window.

You can restore the original scale anytime with the "Restore Scale" button.

Remote command:

`DISPlay[:WINDow<n>][:SUBWindow<w>]:TRACe<t>:Y[:SCALE]:MAXimum`
on page 446

`DISPlay[:WINDow<n>][:SUBWindow<w>]:TRACe<t>:Y[:SCALE]:MINimum`
on page 446

Automatic scaling of the y-axis

Usually, the best way to view the results is if they fit ideally in the diagram area and display the complete trace. The "Auto Scale Once" automatically determines the scale of the y-axis that fits this criteria in the currently active window.

Tip: You can also scale the windows in the "Auto Set" menu. In addition to scaling the selected window ("Auto Scale Window"), you can change the scale of all windows at the same time ("Auto Scale All").

You can restore the original scale anytime with the "Restore Scale" button.

Remote command:



`DISPlay[:WINDow<n>][:SUBWindow<w>]:TRACe<t>:Y[:SCALE]:AUTO`
on page 446

5.1.3 Zoom

The zoom feature allows you to zoom into any graphical result display. This can be a useful tool if you want to analyze certain parts of a diagram in more detail.

The zoom functionality is the same as in the spectrum application.

The following zoom functions are supported.

- : Magnifies the selected diagram area.
- : Magnifies the selected diagram area, but keeps the original diagram in a separate window.
- : Restores the original diagram.

Note that the zoom is a graphical feature that magnifies the data in the capture buffer. Zooming into the diagram does not reevaluate the I/Q data.

For a comprehensive description of the zoom, refer to the R&S FSV/A user manual.

5.1.4 Markers

Access: "Overview" > "Analysis" > "Marker"

Markers are a tool that help you to identify measurement results at specific trace points. When you turn on a marker, it gives you the coordinates of its position, for example the frequency and its level value or the symbol and its EVM value.

In general, the marker functionality of setting and positioning markers is similar to the spectrum application.

For I/Q measurement, the R&S FSV/A supports up to four markers, for frequency sweep measurements there are more. Markers give either absolute values (normal markers) or values relative to the first marker (deltamarkers). If a result display has more than one trace, for example the "EVM vs Symbol" result display, you can position the marker on either trace. By default, all markers are positioned on trace 1.

Note that if you analyze more than one bandwidth part, each bandwidth part is represented by a different trace.

The R&S FSV/A also supports several automatic positioning mechanisms that allow you to move the marker to the maximum trace value (peak), the minimum trace value or move it from peak to subsequent peak.

The [marker table](#) summarizes the marker characteristics.

For a comprehensive description, refer to the R&S FSV/A user manual.

Markers in result displays with a third quantity

In result displays that show a third quantity, for example the "EVM vs Symbol x Carrier" result, the R&S FSV/A provides an extended marker functionality.

You can position the marker on a specific resource element, whose position is defined by the following coordinates:

- The "BWP/SS" dropdown menu selects the bandwidth part.
- The "Symbol" input field selects the symbol.
- The "Carrier" input field selects the carrier.

Alternatively, you can define the marker position in the "Marker Configuration" dialog box, which is expanded accordingly.

The marker information shows the EVM, the power and the allocation ID of the resource element you have selected as the marker position.

5.2 Analysis tools for I/Q measurements

The following analysis tools are available exclusively for I/Q measurements.

- [Layout of numerical results](#)..... 197
- [Result settings](#)..... 197
- [Table configuration](#)..... 200

- [Result views](#).....201
- [Evaluation range](#).....203
- [Beamforming selection](#).....206

5.2.1 Layout of numerical results

You can customize the displayed information of some numerical result displays or tables, for example the [allocation summary](#).

You can identify these result display by the "Table Config" button in the result display header.



When you select the "Table Config" button, the R&S FSV/A opens a dialog box that allows you to add or remove table columns. Note that some columns are mandatory and cannot be removed.

Alternatively, select some point in the header row of the table to open the dialog box.

5.2.2 Result settings

Access: "Overview" > "Analysis" > "Result Settings"

The result settings control the way various results are displayed.

EVM Unit	197
Bit Stream Format	197
Carrier Axes	198
Symbol Axes	198
Carrier Axes Reference	198
EVM Max Hold	198
Subwindow Coupling	199
3D View	199
ACLR Limit Pass Mode	199
Constellation Diagram Relative Power	200
Constellation Color	200

EVM Unit

The "EVM Unit" selects the unit for the EVM measurement results in diagrams and numerical result displays.

Possible units are dB and %.

Remote command:

`UNIT:EVM` on page 462

Bit Stream Format

Selects the way the bit stream is displayed.

The bit stream is either a stream of raw bits or of symbols. In case of the symbol format, the bits that belong to a symbol are shown as hexadecimal numbers with two digits.

Selecting the bit stream format is possible when [data demodulation](#) occurs before or after descrambling.

Remote command:

[UNIT:BSTR](#) on page 461

Carrier Axes

The "Carrier Axes" selects the unit of the x-axis in result displays that show results over the subcarriers.

- "Hertz"
X-axis shows the results in terms of the subcarrier frequency.
- "Subcarrier Number"
X-axis shows the results in terms of the subcarrier number.

Remote command:

[UNIT:CAXes](#) on page 461

Symbol Axes

The "Symbol Axes" selects the unit of the x-axis in result displays that show results over the OFDM symbols.

- "Time"
X-axis shows the results in terms of time.
- "Symbol Number"
X-axis shows the results in terms of the symbol number.

Remote command:

[UNIT:SAXes](#) on page 462

Carrier Axes Reference

Selects the way the frequency is displayed in result displays that plot (carrier) frequency information on the x-axis. In these result displays, the x-axis covers the whole [channel bandwidth](#).

"Lowest RB"	Frequency values relative to the first resource block in the channel. The origin of the x-axis (0 Hz) corresponds to the first resource block in the channel.
"Relative to CF"	Frequency values relative to the center frequency of the carrier. The center frequency of the carrier corresponds to 0 Hz, which is displayed at the center of the x-axis.

Remote command:

[UNIT:CAReference](#) on page 461

EVM Max Hold

The "EVM Max Hold" turns the display of the highest EVM values in graphical result displays on and off.

Depending on the result display and the evaluation range, this means that

- either the maximum trace is displayed
- or the highest value in a data bin is displayed instead of the average.

Remote command:

[\[SENSe:\]NR5G:EMHold](#) on page 459

Subwindow Coupling

Couples or decouples result display tabs (subwindows).

If the coupling is on and you select another tab in a result display, the application automatically selects the same tab for all result displays.

Subwindow coupling is available for measurements with multiple data streams (for example carrier aggregation).

Remote command:

[DISPlay\[:WINDow<n>\]\[:SUBWindow<w>\]:COUPling](#) on page 457

3D View

The "3D View" turns the display of a 3D view of the following result displays on and off.

- ["Allocation ID vs Symbol x Carrier"](#) on page 40
- ["EVM vs Symbol x Carrier"](#) on page 39
- ["Power vs Symbol x Carrier"](#) on page 39

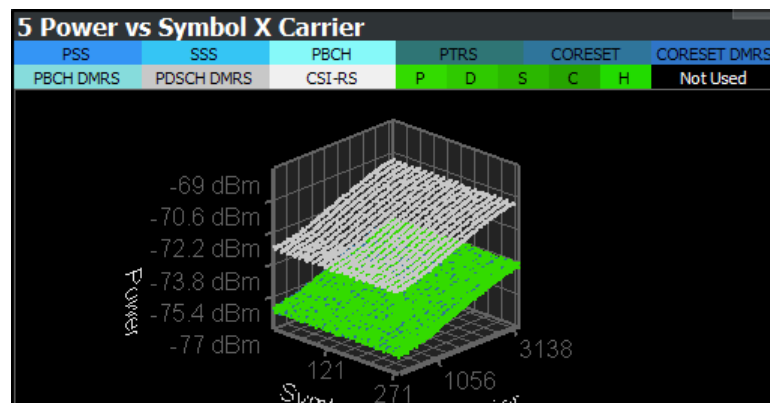

The 3D diagram shows a point cloud of all measurement points in the capture buffer. The information is the same as in the 2D views. The 3D diagram can help you find value distributions more easily, for example.

The 3D view supports the following controls:

- Changing the scale of the axes.
- Turning the diagram in any direction.
The view from the top corresponds to the 2D views.
- Zooming in and out of the diagram to see more details.

Remote command:

[\[SENSe:\]NR5G:TDView](#) on page 460

ACLR Limit Pass Mode

Available for combined measurements.

The "ACLR Limit Pass Mode" selects the method the ACLR limits are evaluated with.

By default, the R&S FSV/A evaluates the relative and absolute limits according to 3GPP. One of the two must pass for an overall pass.

If you want to evaluate only the absolute or relative limits, select the corresponding evaluation method. If you want to change the limit evaluation method after the measurement, you have to [refresh the measurement](#).

The selected method adjusts the contents [combined result summary](#) and the [ACLR result summary](#) accordingly.

"Absolute"	Checks the absolute limits defined for the ACLR. The limit check passes when the signal level is within the absolute limits.
"Relative"	Checks the relative limits defined for the ACLR. The limit check passes when the signal level is within the relative limits.
"Absolute or Relative"	The limit check for either the absolute or the relative limits must pass to get an overall pass.

Remote command:

[\[SENSe:\]NR5G:ACPower:ALPMode](#) on page 439

Constellation Diagram Relative Power

Turns the consideration of a boosting factor to calculate the constellation points in the [constellation diagram](#) on and off.

Remote command:

[\[SENSe:\]NR5G:CDRPower](#) on page 459

Constellation Color

Selects the information that the colors of the constellation points in the [constellation diagram](#) represent.

"Modulation"	Colors represent modulation types.
"Allocation"	Colors represent allocation types.

Remote command:

[\[SENSe:\]NR5G:CCOLor](#) on page 458

5.2.3 Table configuration

Access: "Result Settings" > "Table Config"

The result summary and allocation summary contain all sorts of results and information. If you only want to see a selected set of results, you can customize the contents of these result displays by adding or removing individual results.



Accessing the "Table Config" tab

Note that the contents of the "Table Config" dialog box are only available after you have selected the "Specifics for: Result Summary" or "Specifics for: Allocation Summary" item from the corresponding dropdown menu at the bottom of the dialog box.

Specifics for 2: Result Summary ▾

CC Result

Selects the way the R&S FSV/A analyzes [multiple carriers](#).

The component carrier analysis method also changes the layout of the [result summary](#).

"All"	Analyzes all component carriers and shows information about all of them in the result summary overview ("All" tab). Note that measuring all component carriers can take a while, depending on the number of component carriers.
"Viewed"	Analyzes the two component carriers assigned to the two views . The result summary overview ("All" tab) only shows information about those two component carriers.

Remote command:

[\[SENSe:\]NR5G:RSUMmary:CCResult](#) on page 459

Power Mode

Selects the power averaging mode for the results in the [result summary](#).

Available if the signal only contains a single numerology.

"Average Active Slots"	Averages the power of all OFDM symbols in the slot.
"Average Active Symbols"	Averages the OFDM symbols that are used. If all symbols are occupied, the results are the same as averaging over all symbols. This setting has an effect on TDD signals that combine both downlink and uplink symbols in a slot.

Remote command:

[\[SENSe:\]NR5G:RSUMmary:PMODE](#) on page 460

Result state

Turn individual results on and off by selecting or deselecting the corresponding result labels.

Note that some information is always visible, the corresponding checkboxes are greyed out.

Remote command:

Result selection: [DISPlay\[:WINDow<n>\]:TABLE:ITEM](#) on page 458

5.2.4 Result views

When you capture multiple data streams, for example [several component carriers](#), the R&S FSV/A displays the results for each single data stream in a separate diagram. Because this can lead to literally dozens of diagrams in each result display, the R&S FSV/A only shows two data streams simultaneously.

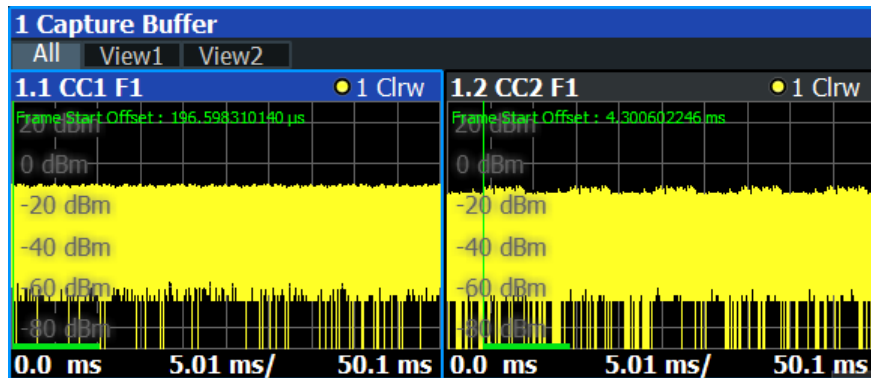

Result displays are made up out of three tabs in such cases.

- The first tab labeled "All" shows the two data streams next to each other, in two subwindows.
- The other two tabs labeled "View <x>" show each of the two data streams in a single window.

There are always just two views, but you can assign the data streams you would like to see to those two views. If you measure more than two data streams, you have to select the data streams you want to display.

If you measure [several frames](#) in addition to multiple data streams, you can also select a specific frame whose information is displayed in the two diagrams.

You can see the currently displayed component carriers in the window title bar and the channel bar.

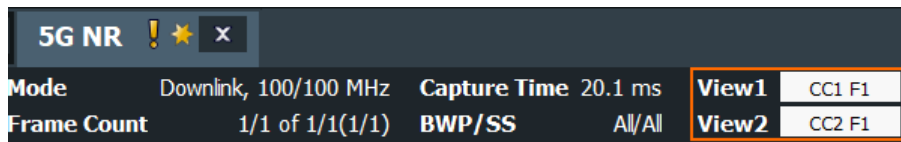

CC = Component carrier number
F = Frame number

[Component Carrier No](#)..... 202
[Frame No](#)..... 202

Component Carrier No

Selects the number of the component carrier that the R&S FSV/A displays in the two views.

Remote command:

`DISPlay[:WINDow<n>][:SUBWindow<w>]:CCNumber` on page 456

Frame No

Selects the frame that the R&S FSV/A displays in the two views.

Note that the frame selection in the "Result View" dialog box and the ["Evaluation Range"](#) dialog box are coupled.

Remote command:

`DISPlay[:WINDow<n>][:SUBWindow<w>]:FNUMBER` on page 457

5.2.5 Evaluation range

Access: "Overview" > "Evaluation Range" > "Global / Constellation"

You can filter various result displays by the type of information they display.

The remote commands required to configure the results are described in [Chapter 6.10.2.3, "Evaluation range"](#), on page 462.

Frame Selection.....	203
Selected Meas ID.....	203
BWP/SS Selection.....	203
Subframe Selection.....	204
Slot Selection.....	205
Evaluation range for the constellation diagram.....	205

Frame Selection

The "Frame" selection filters the results by a specific frame number.

If you apply the filter, only the results for the frame you have selected are displayed. Otherwise, the R&S FSV/A shows the results for the first frame.

Note that the frame selection in the "Evaluation Range" dialog box and the ["Result Views"](#) dialog box are coupled.

For more information about the effects on results when you capture multiple frames, see ["Effects of capturing multiple frames on results"](#) on page 85.

Remote command:

`[SENSe:]NR5G[:CC<cc>]:FRAME:SElect` on page 464

Selected Meas ID

Available for combined measurements.

Selects one of the events in the measurement sequence.

Remote command:

`[SENSe:]NR5G[:CC<cc>]:SMID` on page 467

BWP/SS Selection

The "BWP/SS" selection filters the results by a specific bandwidth part.

If you apply the filter, only the results for the bandwidth part you have selected are displayed. Otherwise, the R&S FSV/A shows the results for all bandwidth parts that have been analyzed.

Selecting "SS/PBCH Block" shows only the results for the synchronization signal and PBCH block. Selecting one of the numbers only shows the results for the corresponding bandwidth part.

The R&S FSV/A shows several traces if the filter is not active, one for each bandwidth part and one for SS/PBCH block.

If you apply the filter, the number of traces depends on the result display. For some result displays, the minimum, maximum and average result are displayed in three traces, for others only one trace.

You can apply the filter to the following result displays.

- EVM vs Carrier
- EVM vs Symbol
- Flatness vs Carrier
- Constellation Diagram
- Allocation Summary
- Alloc ID vs Symbol x Carrier
- EVM vs Symbol x Carrier
- Power vs Symbol x Carrier

Remote command:

[SENSe:]NR5G[:CC<cc>]:BWPart:SElect on page 464

Subframe Selection

The "Subframe" selection filters the results by a specific subframe number.

If you apply the filter, only the results for the subframe you have selected are displayed. Otherwise, the R&S FSV/A shows the results for all subframes that have been analyzed.

The R&S FSV/A shows three traces if you display the results for all subframes.

- One trace ("Min") shows the minimum values measured over all analyzed subframes.
- One trace ("Max") shows the maximum values measured over all analyzed subframes.
- One trace ("Avg") shows the average values measured over all subframes.

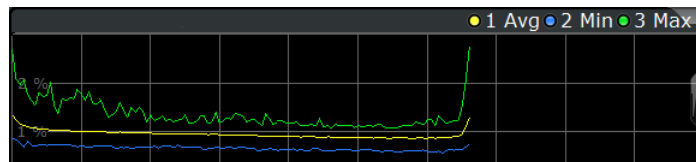

If you filter by a single subframe, the R&S FSV/A still shows three traces, but with different information.

- One trace ("Min") shows the minimum values measured over all slots in the selected subframe.
- One trace ("Max") shows the maximum values measured over all slots in the selected subframe.
- One trace ("Avg") shows the average values measured over all slots in the selected subframe.

The number of traces is only reduced to one trace if you filter by a single [slot](#).

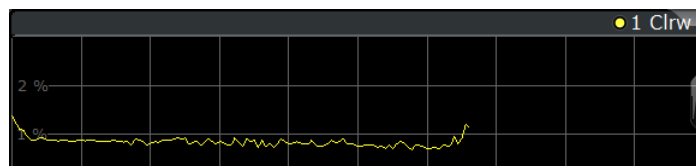

You can apply the filter to the following result displays.

- EVM vs Carrier

- EVM vs Symbol
- Flatness vs Carrier
- Constellation Diagram
- Allocation Summary
- Alloc ID vs Symbol x Carrier
- EVM vs Symbol x Carrier
- Power vs Symbol x Carrier

Remote command:

`[SENSe:]NR5G[:CC<cc>]:SUBFrame:SElect` on page 466

Slot Selection

The "Slot" selection filters the results by a specific slot number.

If you apply the filter, only the results for the slot you have selected are displayed. Otherwise, the R&S FSV/A shows the results for all slots.

The R&S FSV/A shows three traces if you display the results for all slots.

- One trace ("Min") shows the minimum values measured over all slots.
- One trace ("Max") shows the maximum values measured over all slots.
- One trace ("Avg") shows the average values measured over all slots.

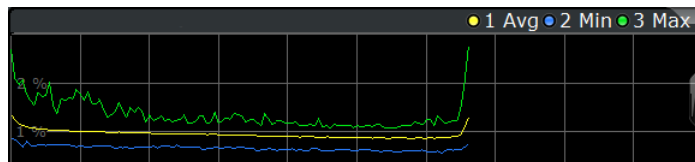

If you filter by a single slot, the R&S FSV/A shows one trace that represents the values measured for that slot only.

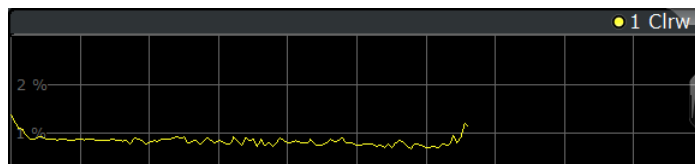

You can apply the filter to the following result displays.

- EVM vs Carrier
- EVM vs Symbol
- Flatness vs Carrier
- Constellation Diagram
- Allocation Summary
- Alloc ID vs Symbol x Carrier
- EVM vs Symbol x Carrier
- Power vs Symbol x Carrier

Remote command:

`[SENSe:]NR5G[:CC<cc>]:SLOT:SElect` on page 466

Evaluation range for the constellation diagram

The "Evaluation Range" for the constellation diagram selects the information displayed in the [constellation diagram](#).

By default, the constellation diagram contains the constellation points of the complete data that has been analyzed. However, you can filter the results by several aspects.

- Modulation
Filters the results by the selected type of modulation.
- Allocation
Filters the results by a certain type of allocation.
- Symbol (OFDM)
Filters the results by a certain OFDM symbol.
- Carrier
Filters the results by a certain subcarrier.

Remote command:

Modulation: `[SENSe:]NR5G[:CC<cc>]:MODulation:SElect` on page 465

Allocation: `[SENSe:]NR5G[:CC<cc>]:ALlocation:SElect` on page 463

Symbol: `[SENSe:]NR5G[:CC<cc>]:SYMBOL:SElect` on page 466

Carrier: `[SENSe:]NR5G[:CC<cc>]:CARRIER:SElect` on page 464

5.2.6 Beamforming selection

Access: "Overview" > "Evaluation Range" > "Beamforming"

You can filter various beamforming result displays by the type of information they display.

The remote commands required to configure the results are described in [Chapter 6.10.2.3, "Evaluation range"](#), on page 462.

RS Weights	206
Reference AP	206

RS Weights

Filters the displayed results to include only certain antenna port(s).

The availability of antenna ports depends on the number of channels and the number of beamforming layers you are testing.

Remote command:

`CONFigure[:NR5G]:DL[:CC<cc>]:BF:AP[:UERS]` on page 462

Reference AP

Selects the reference antenna port for relative beamforming results.

Remote command:

`[SENSe:]NR5G[:CC<cc>]:RAP` on page 465

5.3 Analysis tools for combined measurements

Access: "Overview" > "Analysis"

Access: "Overview" > "Evaluation Range"

Access: [Meas Config] > "Result Settings"

Combined measurements provide several analysis tools. In addition to the tools available in other measurement modes, combined measurement also provide specific tools.

- [Event filter](#).....207
- [General analysis tools](#).....208

5.3.1 Event filter

Access: [Meas Config] > "Result Settings" > "Table Config" > "Event Filter"

Access: "Table Config" (header of result summary) > "Event Filter"

Depending on your test setup, you can have a lot of measurement events in your measurement sequence. Thus, the result summary for combined measurements can become pretty large. To make the list more manageable, and inspect the results of selected events in detail, you can filter the results by all kinds criteria.

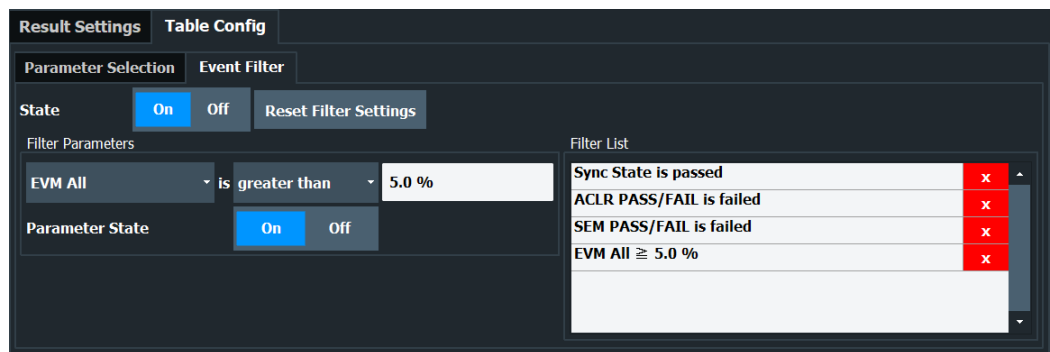

1. Turn on the event filter.
2. Select a filter parameter.
The filter parameter is usually one of the results from combined measurement [result summary](#).
3. Select a filter condition.
4. Turn on the filter to add it to the filter list.
You can add as many filter conditions as you like to the filter list.
You can remove a filter with the x in the filter list or remove all filters with "Reset Filter Settings".

[State](#).....207

[Reset Filter Settings](#).....208

[Filter Parameters](#).....208

State

Turns on the event filter.

Remote command:

[SENSe:]NR5G:EFILter:STATe on page 469

Reset Filter Settings

Clears the filter list.

Remote command:

[\[SENSe:\]NR5G:EFILter:PRESet](#) on page 469

Filter Parameters

Selects the filter conditions.

The filter condition is a combination of a filter parameter and a condition for that parameter, for example "Sync State" = "Passed".

The "Parameter State" adds a filter to the filter list.

Remote command:

Condition: [\[SENSe:\]NR5G:EFILter:FPARAMeters](#) on page 467

State: [\[SENSe:\]NR5G:EFILter:FPARAMeters:STATE](#) on page 468

Query number of filtered events: [\[SENSe:\]NR5G:FEVents:COUNT?](#) on page 469

5.3.2 General analysis tools

Analysis tools described elsewhere:

- [Data and trace export](#)
- [Diagram scale](#)
- [Zoom](#)
- [Markers](#)
Note that the markers you set remain on their position when you browse through the measurements in a sequence.
- [Table layout](#)
- [General result setting](#)
- [Evaluation range](#)
- [Beamforming selection](#)

5.4 Analysis tools for frequency sweep measurements

Access: "Overview" > "Analysis"

Access: "Overview" > "Analysis"

The analysis tools available for the frequency sweep measurements are the same as in the spectrum analyzer.

For more information, refer to the R&S FSV/A user manual.

6 Remote control

The following remote control commands are required to configure and perform 5G NR measurements in a remote environment. The R&S FSV/A must already be set up for remote operation in a network as described in the base unit manual.



Universal functionality

Note that basic tasks that are also performed in the base unit in the same way are not described here. For a description of such tasks, see the R&S FSV/A User Manual.

In particular, this includes:

- Managing Settings and Results, i.e. storing and loading settings and result data.
- Basic instrument configuration, e.g. checking the system configuration, customizing the screen layout, or configuring networks and remote operation.
- Using the common status registers.

• Common suffixes	209
• Introduction	210
• 5G NR application selection	215
• Screen layout	218
• Measurement control	228
• Remote commands to retrieve numeric results	232
• Limit check results	257
• Retrieve trace data	271
• Configuration	294
• Analysis	444

6.1 Common suffixes

In the 5G NR measurement application, the following common suffixes are used in remote commands:

Table 6-1: Common suffixes used in remote commands in the 5G NR measurement application

Suffix	Value range	Description
<m>	1..4	Marker
<n>	1..16	Window (in the currently selected channel)
<t>	1..6	Trace
	1 to 8	Limit line
<al>	0..99	Selects a subframe allocation.
<bwf>	1..12	Selects a bandwidth part.
<cc>	1..16	Selects a component carrier. (8 CCs for MC ACLR, cum. ACLR and Multi SEM)

Suffix	Value range	Description
<csi>	1..64	Selects a CSI-RS.
<fr>	1..n	Selects a frame. The maximum value depends on the signal configuration.
<k>	---	Selects a limit line. Irrelevant for the 5G NR application.
<sf>	0..n	Selects a subframe. The maximum value depends on the signal configuration.
<sl>	0..n	Selects a slot. The maximum value depends on the signal configuration.
<ss>	0..64	Selects a synchronization signal block (SSB).
<ssb>	1..4	irrelevant
<sym>	0..13	Selects an OFDM symbol
<w>	1..2	Selects a subwindow (view)

6.2 Introduction

Commands are program messages that a controller (e.g. a PC) sends to the instrument or software. They operate its functions ('setting commands' or 'events') and request information ('query commands'). Some commands can only be used in one way, others work in two ways (setting and query). If not indicated otherwise, the commands can be used for settings and queries.

The syntax of a SCPI command consists of a header and, usually, one or more parameters. To use a command as a query, you have to append a question mark after the last header element, even if the command contains a parameter.

A header contains one or more keywords, separated by a colon. Header and parameters are separated by a "white space" (ASCII code 0 to 9, 11 to 32 decimal, e.g. blank). If there is more than one parameter for a command, they are separated by a comma from one another.

Only the most important characteristics that you need to know when working with SCPI commands are described here. For a more complete description, refer to the user manual of the R&S FSV/A.



Remote command examples

Note that some remote command examples mentioned in this general introduction are possibly not supported by this particular application.

6.2.1 Conventions used in descriptions

The following conventions are used in the remote command descriptions:

- **Command usage**
If not specified otherwise, commands can be used both for setting and for querying parameters.
If a command can be used for setting or querying only, or if it initiates an event, the usage is stated explicitly.
- **Parameter usage**
If not specified otherwise, a parameter can be used to set a value and it is the result of a query.
Parameters required only for setting are indicated as **Setting parameters**.
Parameters required only to refine a query are indicated as **Query parameters**.
Parameters that are only returned as the result of a query are indicated as **Return values**.
- **Conformity**
Commands that are taken from the SCPI standard are indicated as **SCPI confirmed**. All commands used by the R&S FSV/A follow the SCPI syntax rules.
- **Asynchronous commands**
A command which does not automatically finish executing before the next command starts executing (overlapping command) is indicated as an **Asynchronous command**.
- **Reset values (*RST)**
Default parameter values that are used directly after resetting the instrument (*RST command) are indicated as ***RST values**, if available.
- **Default unit**
The default unit is used for numeric values if no other unit is provided with the parameter.
- **Manual operation**
If the result of a remote command can also be achieved in manual operation, a link to the description is inserted.

6.2.2 Long and short form

The keywords have a long and a short form. You can use either the long or the short form, but no other abbreviations of the keywords.

The short form is emphasized in uppercase letters. Note however, that this emphasis only serves the purpose to distinguish the short from the long form in the manual. For the instrument, the case does not matter.

Example:

SENSe:FREQuency:CENTer is the same as SENS:FREQ:CENT.

6.2.3 Numeric suffixes

Some keywords have a numeric suffix if the command can be applied to multiple instances of an object. In that case, the suffix selects a particular instance (e.g. a measurement window).

Numeric suffixes are indicated by angular brackets (<n>) next to the keyword.

If you do not quote a suffix for keywords that support one, a 1 is assumed.

Example:

`DISPlay[:WINDow<1...4>]:ZOOM:STATe` enables the zoom in a particular measurement window, selected by the suffix at `WINDow`.

`DISPlay:WINDow4:ZOOM:STATe ON` refers to window 4.

6.2.4 Optional keywords

Some keywords are optional and are only part of the syntax because of SCPI compliance. You can include them in the header or not.



If an optional keyword has a numeric suffix and you need to use the suffix, you have to include the optional keyword. Otherwise, the suffix of the missing keyword is assumed to be the value 1.

Optional keywords are emphasized with square brackets.

Example:

Without a numeric suffix in the optional keyword:

`[SENSe:]FREQuency:CENTer` is the same as `FREQuency:CENTer`

With a numeric suffix in the optional keyword:

`DISPlay[:WINDow<1...4>]:ZOOM:STATe`

`DISPlay:ZOOM:STATe ON` enables the zoom in window 1 (no suffix).

`DISPlay:WINDow4:ZOOM:STATe ON` enables the zoom in window 4.

6.2.5 Alternative keywords

A vertical stroke indicates alternatives for a specific keyword. You can use both keywords to the same effect.

Example:

`[SENSe:]BANDwidth|BWIDth[:RESolution]`

In the short form without optional keywords, `BAND 1MHZ` would have the same effect as `BWID 1MHZ`.

6.2.6 SCPI parameters

Many commands feature one or more parameters.

If a command supports more than one parameter, they are separated by a comma.

Example:

```
LAYout:ADD:WINDow Spectrum,LEFT,MTABLE
```

Parameters can have different forms of values.

- [Numeric values](#)..... 213
- [Boolean](#)..... 214
- [Character data](#)..... 214
- [Character strings](#)..... 214
- [Block data](#)..... 215

6.2.6.1 Numeric values

Numeric values can be entered in any form, i.e. with sign, decimal point or exponent. For physical quantities, you can also add the unit. If the unit is missing, the command uses the basic unit.

Example:

With unit: `SENSe:FREQuency:CENTer 1GHZ`

Without unit: `SENSe:FREQuency:CENTer 1E9` would also set a frequency of 1 GHz.

Values exceeding the resolution of the instrument are rounded up or down.

If the number you have entered is not supported (e.g. for discrete steps), the command returns an error.

Instead of a number, you can also set numeric values with a text parameter in special cases.

- **MIN/MAX**
Defines the minimum or maximum numeric value that is supported.
- **DEF**
Defines the default value.
- **UP/DOWN**
Increases or decreases the numeric value by one step. The step size depends on the setting. Sometimes, you can customize the step size with a corresponding command.

Querying numeric values

When you query numeric values, the system returns a number. For physical quantities, it applies the basic unit (e.g. Hz for frequencies). The number of digits after the decimal point depends on the type of numeric value.

Example:

Setting: `SENSe:FREQuency:CENTer 1GHZ`

Query: `SENSe:FREQuency:CENTer?` would return `1E9`

Sometimes, numeric values are returned as text.

- **INF/NINF**
Infinity or negative infinity. Represents the numeric values `9.9E37` or `-9.9E37`.
- **NAN**
Not a number. Represents the numeric value `9.91E37`. NAN is returned if errors occur.

6.2.6.2 Boolean

Boolean parameters represent two states. The "on" state (logically true) is represented by "ON" or the numeric value 1. The "off" state (logically untrue) is represented by "OFF" or the numeric value 0.

Querying Boolean parameters

When you query Boolean parameters, the system returns either the value 1 ("ON") or the value 0 ("OFF").

Example:

Setting: `DISPlay:WINDow:ZOOM:STATe ON`

Query: `DISPlay:WINDow:ZOOM:STATe?` would return `1`

6.2.6.3 Character data

Character data follows the syntactic rules of keywords. You can enter text using a short or a long form. For more information, see [Chapter 6.2.2, "Long and short form"](#), on page 211.

Querying text parameters

When you query text parameters, the system returns its short form.

Example:

Setting: `SENSe:BANDwidth:RESolution:TYPE NORMAL`

Query: `SENSe:BANDwidth:RESolution:TYPE?` would return `NORM`

6.2.6.4 Character strings

Strings are alphanumeric characters. They have to be in straight quotation marks. You can use a single quotation mark (') or a double quotation mark (").

Example:

```
INSTRument:DELeTe 'Spectrum'
```

6.2.6.5 Block data

Block data is a format which is suitable for the transmission of large amounts of data.

The ASCII character # introduces the data block. The next number indicates how many of the following digits describe the length of the data block. The data bytes follow. During the transmission of these data bytes, all end or other control signs are ignored until all bytes are transmitted. #0 specifies a data block of indefinite length. The use of the indefinite format requires an NL^END message to terminate the data block. This format is useful when the length of the transmission is not known or if speed or other considerations prevent segmentation of the data into blocks of definite length.

6.3 5G NR application selection

INSTRument:CREate:DUPLicate.....	215
INSTRument:CREate[:NEW].....	215
INSTRument:CREate:REPLace.....	216
INSTRument:DELeTe.....	216
INSTRument:LIST?.....	216
INSTRument:REName.....	217
INSTRument[:SELeCt].....	218

INSTRument:CREate:DUPLicate

Duplicates the currently selected channel, i.e. creates a new channel of the same type and with the identical measurement settings. The name of the new channel is the same as the copied channel, extended by a consecutive number (e.g. "IQAnalyzer" -> "IQAnalyzer 2").

The channel to be duplicated must be selected first using the `INST:SEL` command.

Example:

```
INST:SEL 'IQAnalyzer'
INST:CRE:DUPL
```

Duplicates the channel named 'IQAnalyzer' and creates a new channel named 'IQAnalyzer2'.

Usage:

Event

INSTRument:CREate[:NEW] <ChannelType>, <ChannelName>

Adds a measurement channel. You can configure up to 10 measurement channels at the same time (depending on available memory).

Parameters:

- <ChannelType> Channel type of the new channel.
For a list of available channel types, see [INSTrument:LIST?](#) on page 216.
- <ChannelName> String containing the name of the channel.
Note that you cannot assign an existing channel name to a new channel. If you do, an error occurs.

Example:

```
INST:CRE SAN, 'Spectrum 2'
```

Adds a spectrum display named "Spectrum 2".

INSTrument:CREate:REPLace <ChannelName1>,<ChannelType>,<ChannelName2>

Replaces a channel with another one.

Setting parameters:

- <ChannelName1> String containing the name of the channel you want to replace.
- <ChannelType> Channel type of the new channel.
For a list of available channel types, see [INSTrument:LIST?](#) on page 216.
- <ChannelName2> String containing the name of the new channel.
Note: If the specified name for a new channel already exists, the default name, extended by a sequential number, is used for the new channel (see [INSTrument:LIST?](#) on page 216).
Channel names can have a maximum of 31 characters, and must be compatible with the Windows conventions for file names. In particular, they must not contain special characters such as ":", "*", "?".

Example:

```
INST:CRE:REPL 'IQAnalyzer2',IQ,'IQAnalyzer'
```

Replaces the channel named "IQAnalyzer2" by a new channel of type "IQ Analyzer" named "IQAnalyzer".

Usage:

Setting only

INSTrument:DELeTe <ChannelName>

Deletes a channel.

Setting parameters:

- <ChannelName> String containing the name of the channel you want to delete.
A channel must exist to delete it.

Usage:

Setting only

INSTrument:LIST?

Queries all active channels. The query is useful to obtain the names of the existing channels, which are required to replace or delete the channels.

Return values:

<ChannelType>
<ChannelName>

For each channel, the command returns the channel type and channel name (see tables below).

Tip: to change the channel name, use the `INSTrument:REName` command.

Example:

```
INST:LIST?
```

Result for 3 channels:

```
'ADEM', 'Analog Demod', 'IQ', 'IQ Analyzer', 'IQ', 'IQ Analyzer2'
```

Usage:

Query only

Table 6-2: Available channel types and default channel names

Application	<ChannelType> Parameter	Default Channel Name*)
Spectrum	SANALYZER	Spectrum
5G NR (R&S FSV3-K144)	NR5G	5G NR
3GPP FDD BTS (R&S FSV3-K72)	BWCD	3G FDD BTS
3GPP FDD UE (R&S FSV3-K73)	MWCD	3G FDD UE
Amplifier Measurements (R&S FSV3-K18)	AMPLifier	Amplifier
AM/FM/PM Modulation Analysis	ADEM	Analog Demod
Bluetooth (R&S FSV/A-K8)	BTO	Bluetooth
GSM (R&S FSV3-K10)	GSM	GSM
I/Q Analyzer	IQ	IQ Analyzer
LTE (R&S FSV3-K10x)	LTE	LTE
NB-IoT (R&S FSV3-K106)	NIOT	NB-IoT
Noise Figure Measurements	NOISE	Noise
Phase Noise (R&S FSV3-K40)	PNOISE	Phase Noise
Pulse (R&S FSV3-K6)	PULSE	Pulse
Vector Signal Analysis (VSA, R&S FSV3-K70)	DDEM	VSA
WLAN (R&S FSV3-K91)	WLAN	WLAN

Note: the default channel name is also listed in the table. If the specified name for a new channel already exists, the default name, extended by a sequential number, is used for the new channel.

INSTrument:REName <ChannelName1>, <ChannelName2>

Renames a channel.

Setting parameters:

<ChannelName1> String containing the name of the channel you want to rename.

<ChannelName2> String containing the new channel name.

Note that you cannot assign an existing channel name to a new channel. If you do, an error occurs.

Channel names can have a maximum of 31 characters, and must be compatible with the Windows conventions for file names. In particular, they must not contain special characters such as ":", "*", "?".

Example:

```
INST:REN 'IQAnalyzer2', 'IQAnalyzer3'
```

Renames the channel with the name 'IQAnalyzer2' to 'IQAnalyzer3'.

Usage:

Setting only

INSTrument[:SElect] <ChannelType>

Selects a new measurement channel with the defined channel type.

Parameters:

<ChannelType> **NR5G**
5G NR measurement channel

Example:

```
//Select 5G NR application
INST NR5G
```

6.4 Screen layout

- [General layout](#).....218
- [Layout of a single channel](#)..... 220

6.4.1 General layout

The following commands are required to configure general window layout, independent of the application.

Note that the suffix <n> always refers to the window *in the currently selected measurement channel*.

[DISPlay:FORMat](#)..... 219
[DISPlay\[:WINDow<n>\]:SIZE](#)..... 219
[DISPlay\[:WINDow<n>\]\[:SUBWindow<w>\]:SElect](#)..... 219
[DISPlay\[:WINDow<n>\]:TAB<tab>:SElect](#).....220

DISPlay:FORMat <Format>

Determines which tab is displayed.

Parameters:

<Format>

SPLit

Displays the MultiView tab with an overview of all active channels

SINGle

Displays the measurement channel that was previously focused.

*RST: SING

Example:

```
DISP:FORM SPL
```

DISPlay[:WINDow<n>]:SIZE <Size>

Maximizes the size of the selected result display window *temporarily*. To change the size of several windows on the screen permanently, use the `LAY:SPL` command (see [LAYout:SPLitter](#) on page 224).

Suffix:

<n>

[Window](#)**Parameters:**

<Size>

LARGE

Maximizes the selected window to full screen. Other windows are still active in the background.

SMALI

Reduces the size of the selected window to its original size. If more than one measurement window was displayed originally, these are visible again.

*RST: SMALI

Example:

```
DISP:WIND2:SIZE LARG
```

DISPlay[:WINDow<n>][:SUBWindow<w>]:SElect

Sets the focus on the selected result display window.

This window is then the active window.

For measurements with multiple results in subwindows, the command also selects the subwindow. Use this command to select the (sub)window before querying trace data.

Suffix:

<n>

[Window](#)

<w>

subwindow

Not supported by all applications

Example:

```
//Put the focus on window 1
```

```
DISP:WIND1:SEL
```

Example: //Put the focus on subwindow 2 in window 1
 DISP:WIND1:SUBW2:SEL

DISPlay[:WINDow<n>]:TAB<tab>:SElect

Selects a tab in diagrams with multiple subwindows (or views).

Note that selecting a tab does not actually select a subwindow. To select a subwindow, for example to query the results of a subwindow, use `DISPlay[:WINDow<n>][:SUBWindow<w>]:SElect`.

Suffix:

<n>	Window
<tab>	1..n Tab

Example: //Select a tab
 DISP:WIND2:TAB2:SEL

6.4.2 Layout of a single channel

The following commands are required to change the evaluation type and rearrange the screen layout for a measurement channel as you do using the SmartGrid in manual operation. Since the available evaluation types depend on the selected application, some parameters for the following commands also depend on the selected measurement channel.

Note that the suffix <n> always refers to the window *in the currently selected measurement channel*.

LAYout:ADD[:WINDow]?	220
LAYout:CATalog[:WINDow]?	223
LAYout:IDENtify[:WINDow]?	223
LAYout:REMOve[:WINDow]	224
LAYout:REPLace[:WINDow]	224
LAYout:SPLitter	224
LAYout:WINDow<n>:ADD?	226
LAYout:WINDow<n>:IDENtify?	226
LAYout:WINDow<n>:REMOve	227
LAYout:WINDow<n>:REPLace	227
LAYout:WINDow<n>:TYPE	228

LAYout:ADD[:WINDow]? <WindowName>, <Direction>, <WindowType>

Adds a window to the display in the active channel.

Is always used as a query so that you immediately obtain the name of the new window as a result.

To replace an existing window, use the `LAYout:REPLace[:WINDow]` command.

Query parameters:

<WindowName>	String containing the name of the existing window the new window is inserted next to. By default, the name of a window is the same as its index. To determine the name and index of all active windows, use the LAYout:CATalog[:WINDow]? query .
<Direction>	LEFT RIGHT ABOVE BELOW Direction the new window is added relative to the existing window.
<WindowType>	text value Type of result display (evaluation method) you want to add. See the table below for available parameter values.

Return values:

<NewWindowName>	When adding a new window, the command returns its name (by default the same as its number) as a result.
-----------------	---

Usage: Query only

Manual operation: See ["Capture Buffer"](#) on page 28
 See ["EVM vs Carrier"](#) on page 29
 See ["EVM vs Symbol"](#) on page 30
 See ["EVM vs RB"](#) on page 31
 See ["Frequency Error vs Symbol"](#) on page 31
 See ["Frequency Error vs Subframe"](#) on page 32
 See ["Power Spectrum"](#) on page 33
 See ["Flatness"](#) on page 33
 See ["CCDF"](#) on page 34
 See ["Constellation Diagram"](#) on page 35
 See ["Allocation Summary"](#) on page 36
 See ["Channel Decoder Results"](#) on page 36
 See ["Bitstream"](#) on page 37
 See ["EVM vs Symbol x Carrier"](#) on page 39
 See ["Power vs Symbol x Carrier"](#) on page 39
 See ["Allocation ID vs Symbol x Carrier"](#) on page 40
 See ["RS Magnitude"](#) on page 40
 See ["RS Phase"](#) on page 41
 See ["RS Phase Difference"](#) on page 42
 See ["Beamforming Summary"](#) on page 43
 See ["Marker Table"](#) on page 43
 See ["Time Alignment Error"](#) on page 46
 See ["Marker Peak List"](#) on page 59

Table 6-3: <WindowType> parameter values for 5G NR measurement application

Parameter value	Window type
I/Q measurements	
AISC	"Allocation ID vs. Symbol X Carrier"
ASUM	"Allocation Summary"

Parameter value	Window type
BSUM	"Beamforming Summary"
BSTR	"Bitstream"
CBUF	"Capture Buffer"
CCDF	"CCDF"
CDEC	"Channel Decoder"
CONS	"Constellation Diagram"
EVCA	"EVM vs. Carrier"
EVRB	"EVM vs. RB"
EVSC	"EVM vs. Symbol X Carrier"
EVSY	"EVM vs. Symbol"
FEVS	"Frequency Error vs Symbol"
FLAT	"Channel Flatness"
FVSU	"Frequency Error vs Subframe"
MTAB	"Marker Table"
PSPE	"Power Spectrum"
PVSC	"Power vs. Symbol X Carrier"
RSUM	"Result Summary"
RSMA	"RS Magnitude"
RSPD	"RS Phase Difference"
RSWP	"RS Phase"
Time alignment error	
CBUF	"Capture Buffer"
MTAB	"Marker Table"
PSPE	"Power Spectrum"
TAL	"Time Alignment Error"
Transmit on / off power	
DIAG	"Diagram"
FALL	"Falling Period"
OOPL	"On / Off Power List"
RIS	"Rising Period 1"
ACLR and SEM measurements	
DIAG	"Diagram"
PEAK	"Peak List"

Parameter value	Window type
MTAB	"Marker Table"
RSUM	"Result Summary"
Combined measurements: same as I/Q measurements, plus:	
ADI	"ACLR Diagram"
ARS	"ACLR Result Summary"
CMS	"Combined EVM / ACLR / SEM Result"
RSUM	"Result Summary EVM"
SDI	"SEM Diagram"
SRS	"SEM Result Summary"

LAYout:CATalog[:WINDow]?

Queries the name and index of all active windows in the active channel from top left to bottom right. The result is a comma-separated list of values for each window, with the syntax:

<WindowName_1>,<WindowIndex_1>..

Return values:

<WindowName> string
Name of the window.
In the default state, the name of the window is its index.

<WindowIndex> **numeric value**
Index of the window.

Example:

LAY:CAT?

Result:

'2',2,'1',1

Two windows are displayed, named '2' (at the top or left), and '1' (at the bottom or right).

Usage: Query only

LAYout:IDENtify[:WINDow]? <WindowName>

Queries the **index** of a particular display window in the active channel.

Note: to query the **name** of a particular window, use the [LAYout:WINDow<n>:IDENtify?](#) query.

Query parameters:

<WindowName> String containing the name of a window.

Return values:

<WindowIndex> Index number of the window.

Example: `LAY:IDEN:WIND? '2'`
 Queries the index of the result display named '2'.
Response:
 2

Usage: Query only

LAYout:REMOve[:WINDow] <WindowName>

Removes a window from the display in the active channel.

Setting parameters:

<WindowName> String containing the name of the window. In the default state, the name of the window is its index.

Example: `LAY:REM '2'`
 Removes the result display in the window named '2'.

Usage: Setting only

LAYout:REPLace[:WINDow] <WindowName>, <WindowType>

Replaces the window type (for example from "Diagram" to "Result Summary") of an already existing window in the active channel while keeping its position, index and window name.

To add a new window, use the `LAYout:ADD[:WINDow]?` command.

Setting parameters:

<WindowName> String containing the name of the existing window.
 By default, the name of a window is the same as its index. To determine the name and index of all active windows in the active channel, use the `LAYout:CATalog[:WINDow]?` query.

<WindowType> Type of result display you want to use in the existing window.
 See `LAYout:ADD[:WINDow]?` on page 220 for a list of available window types.

Example: `LAY:REPL:WIND '1',MTAB`
 Replaces the result display in window 1 with a marker table.

Usage: Setting only

LAYout:SPLitter <Index1>, <Index2>, <Position>

Changes the position of a splitter and thus controls the size of the windows on each side of the splitter.

Note that windows must have a certain minimum size. If the position you define conflicts with the minimum size of any of the affected windows, the command does not work, but does not return an error.

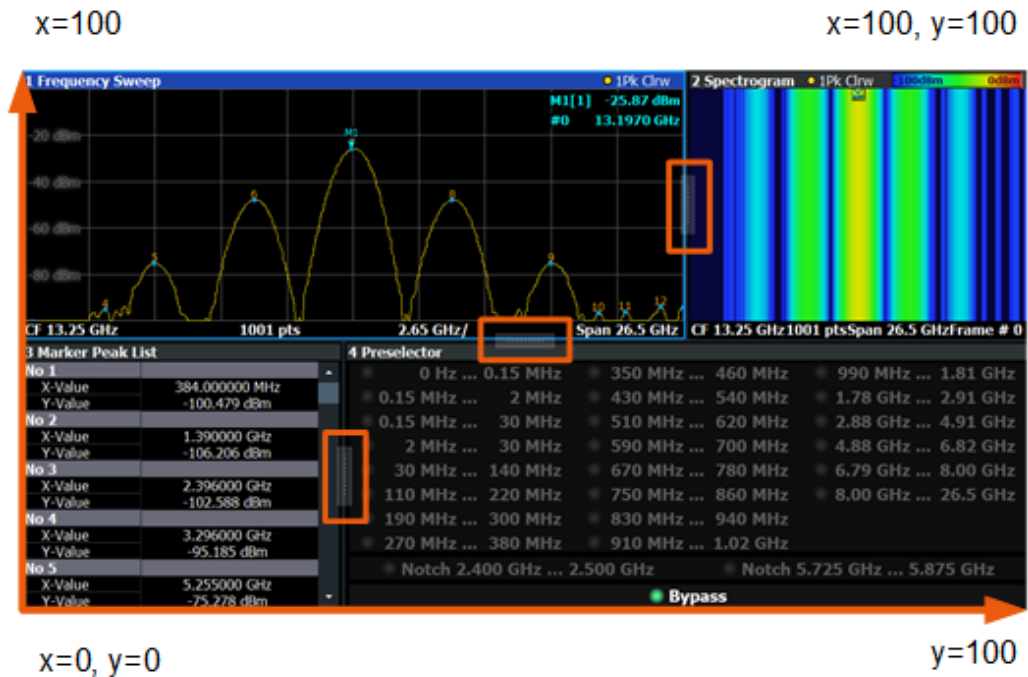

Figure 6-1: SmartGrid coordinates for remote control of the splitters

Setting parameters:

- <Index1> The index of one window the splitter controls.
- <Index2> The index of a window on the other side of the splitter.
- <Position> New vertical or horizontal position of the splitter as a fraction of the screen area (without channel and status bar and softkey menu).
The point of origin ($x = 0$, $y = 0$) is in the lower left corner of the screen. The end point ($x = 100$, $y = 100$) is in the upper right corner of the screen. (See [Figure 6-1](#).)
The direction in which the splitter is moved depends on the screen layout. If the windows are positioned horizontally, the splitter also moves horizontally. If the windows are positioned vertically, the splitter also moves vertically.

Range: 0 to 100

Example:

LAY:SPL 1,3,50

Moves the splitter between window 1 ("Frequency Sweep") and 3 ("Marker Table") to the center (50%) of the screen, i.e. in the figure above, to the left.

Example: `LAY:SPL 1,4,70`
 Moves the splitter between window 1 ('Frequency Sweep') and 3 ('Marker Peak List') towards the top (70%) of the screen. The following commands have the exact same effect, as any combination of windows above and below the splitter moves the splitter vertically.

`LAY:SPL 3,2,70`
`LAY:SPL 4,1,70`
`LAY:SPL 2,1,70`

Usage: Setting only

LAYout:WINDow<n>:ADD? <Direction>,<WindowType>

Adds a measurement window to the display. Note that with this command, the suffix <n> determines the existing window next to which the new window is added. Unlike [LAYout:ADD\[:WINDow\]?](#), for which the existing window is defined by a parameter.

To replace an existing window, use the [LAYout:WINDow<n>:REPLace](#) command.

Is always used as a query so that you immediately obtain the name of the new window as a result.

Suffix:

<n> [Window](#)

Query parameters:

<Direction> LEFT | RIGHT | ABOVE | BELOW

<WindowType> Type of measurement window you want to add.
 See [LAYout:ADD\[:WINDow\]?](#) on page 220 for a list of available window types.

Return values:

<NewWindowName> When adding a new window, the command returns its name (by default the same as its number) as a result.

Example: `LAY:WIND1:ADD? LEFT,MTAB`
Result:
`'2'`
 Adds a new window named '2' with a marker table to the left of window 1.

Usage: Query only

LAYout:WINDow<n>:IDENTify?

Queries the **name** of a particular display window (indicated by the <n> suffix) in the active channel.

Note: to query the **index** of a particular window, use the [LAYout:IDENTify\[:WINDow\]?](#) command.

Suffix:	
<n>	Window
Return values:	
<WindowName>	String containing the name of a window. In the default state, the name of the window is its index.
Example:	LAY:WIND2:IDEN? Queries the name of the result display in window 2. Response: '2'
Usage:	Query only

LAYout:WINDow<n>:REMOve

Removes the window specified by the suffix <n> from the display in the active channel.
The result of this command is identical to the [LAYout:REMOve\[:WINDow\]](#) command.

Suffix:	
<n>	Window
Example:	LAY:WIND2:REM Removes the result display in window 2.
Usage:	Event

LAYout:WINDow<n>:REPLace <WindowType>

Changes the window type of an existing window (specified by the suffix <n>) in the active channel.

The effect of this command is identical to the [LAYout:REPLace\[:WINDow\]](#) command.

To add a new window, use the [LAYout:WINDow<n>:ADD?](#) command.

Suffix:	
<n>	Window
Setting parameters:	
<WindowType>	Type of measurement window you want to replace another one with. See LAYout:ADD[:WINDow]? on page 220 for a list of available window types.
Example:	LAY:WIND2:REPL MTAB Replaces the result display in window 2 with a marker table.
Usage:	Setting only

LAYout:WINDow<n>:TYPE <WindowType>

Queries or defines the window type of the window specified by the index <n>. The window type determines which results are displayed. For a list of possible window types, see [LAYout:ADD\[:WINDow\]?](#) on page 220.

Note that this command is not available in all applications and measurements.

Suffix:

<n> 1..n
Window

Parameters:

<WindowType>

Example: LAY:WIND2:TYPE?

6.5 Measurement control

6.5.1 Measurements

ABORt	228
INITiate<n>:CONTinuous	229
INITiate<n>[:IMMEDIATE]	229
[SENSe:]SYNC[:CC<cc>][:STATe]?	230

ABORt

Aborts the measurement in the current channel and resets the trigger system.

To prevent overlapping execution of the subsequent command before the measurement has been aborted successfully, use the *OPC? or *WAI command after ABOR and before the next command.

For details on overlapping execution see [Remote control via SCPI](#).

Note on blocked remote control programs:

If a sequential command cannot be completed, for example because a triggered sweep never receives a trigger, the remote control program will never finish and the remote channel to the R&S FSV/A is blocked for further commands. In this case, you must interrupt processing on the remote channel first in order to abort the measurement.

To do so, send a "Device Clear" command from the control instrument to the R&S FSV/A on a parallel channel to clear all currently active remote channels. Depending on the used interface and protocol, send the following commands:

- **Visa:** viClear()

Now you can send the ABORt command on the remote channel performing the measurement.

Example:	ABOR; : INIT: IMM Aborts the current measurement and immediately starts a new one.
Example:	ABOR; *WAI INIT: IMM Aborts the current measurement and starts a new one once abortion has been completed.
Usage:	Event

INITiate<n>:CONTInuous <State>

Controls the measurement mode for an individual channel.

Note that in single measurement mode, you can synchronize to the end of the measurement with *OPC, *OPC? or *WAI. In continuous measurement mode, synchronization to the end of the measurement is not possible. Thus, it is not recommended that you use continuous measurement mode in remote control, as results like trace data or markers are only valid after a single measurement end synchronization.

For details on synchronization see [Remote control via SCPI](#).

Suffix:

<n> irrelevant

Parameters:

<State> ON | OFF | 0 | 1
ON | 1
 Continuous measurement
OFF | 0
 Single measurement
 *RST: 1 (some applications can differ)

Example:	INIT:CONT OFF Switches the measurement mode to single measurement. INIT:CONT ON Switches the measurement mode to continuous measurement.
-----------------	---

INITiate<n>[:IMMEDIATE]

Starts a (single) new measurement.

You can synchronize to the end of the measurement with *OPC, *OPC? or *WAI.

For details on synchronization see [Remote control via SCPI](#).

Suffix:

<n> irrelevant

Usage: Asynchronous command

[SENSe:]SYNC[:CC<cc>][:STATe]?

Queries the current synchronization state.

Suffix:

<cc> irrelevant

Return values:

<State> The string contains the following information:
A zero represents a failure and a one represents a successful synchronization.

Example: //Query synchronization state
 SYNC:STAT?

Usage: Query only

6.5.2 Measurement sequences

INITiate:SEQuencer:ABORt	230
INITiate:SEQuencer:IMMediate	230
INITiate:SEQuencer:MODE	230
SYSTem:SEQuencer	231

INITiate:SEQuencer:ABORt

Stops the currently active sequence of measurements.

You can start a new sequence any time using [INITiate:SEQuencer:IMMediate](#) on page 230.

Usage: Event

INITiate:SEQuencer:IMMediate

Starts a new sequence of measurements by the Sequencer.

Before this command can be executed, the Sequencer must be activated (see [SYSTem:SEQuencer](#) on page 231).

Example: SYST:SEQ ON
 Activates the Sequencer.
 INIT:SEQ:MODE SING
 Sets single sequence mode so each active measurement is performed once.
 INIT:SEQ:IMM
 Starts the sequential measurements.

INITiate:SEQuencer:MODE <Mode>

Defines the capture mode for the entire measurement sequence and all measurement groups and channels it contains.

Note: To synchronize to the end of a measurement sequence using *OPC, *OPC? or *WAI, use `SINGLE` Sequencer mode.

Parameters:

<Mode>

SINGLE

Each measurement group is started one after the other in the order of definition. All measurement channels in a group are started simultaneously and performed once. After *all* measurements are completed, the next group is started. After the last group, the measurement sequence is finished.

CONTInuous

Each measurement group is started one after the other in the order of definition. All measurement channels in a group are started simultaneously and performed once. After *all* measurements are completed, the next group is started. After the last group, the measurement sequence restarts with the first one and continues until it is stopped explicitly.

*RST: CONTInuous

SYSTem:SEQuencer <State>

Turns the Sequencer on and off. The Sequencer must be active before any other Sequencer commands (`INIT:SEQ...`) are executed, otherwise an error occurs.

Parameters:

<State>

ON | OFF | 0 | 1

ON | 1

The Sequencer is activated and a sequential measurement is started immediately.

OFF | 0

The Sequencer is deactivated. Any running sequential measurements are stopped. Further Sequencer commands (`INIT:SEQ...`) are not available.

*RST: 0

Example:

`SYST:SEQ ON`

Activates the Sequencer.

`INIT:SEQ:MODE SING`

Sets single Sequencer mode so each active measurement is performed once.

`INIT:SEQ:IMM`

Starts the sequential measurements.

`SYST:SEQ OFF`

6.6 Remote commands to retrieve numeric results

• Result summary.....	232
• Time alignment error.....	252
• Marker table.....	253
• CCDF table.....	256

6.6.1 Result summary

FETCh[:CC<cc>][:ISRC<ant>][:FRAMe<fr>]:SUMMary:ALL?	233
FETCh[:CC<cc>][:ISRC<ant>]:SUMMary:CRESt[:AVERAge]?	234
FETCh[:CC<cc>][:ISRC<ant>][:FRAMe<fr>]:SUMMary:AAPFail?	234
FETCh[:CC<cc>][:ISRC<ant>][:FRAMe<fr>]:SUMMary:APFail?	235
FETCh[:CC<cc>][:ISRC<ant>][:FRAMe<fr>]:SUMMary:ARPFail?	235
FETCh[:CC<cc>][:ISRC<ant>][:FRAMe<fr>]:SUMMary:BLER:MAXimum?	236
FETCh[:CC<cc>][:ISRC<ant>][:FRAMe<fr>]:SUMMary:BLER:MINimum?	236
FETCh[:CC<cc>][:ISRC<ant>][:FRAMe<fr>]:SUMMary:BLER[:AVERAge]?	236
FETCh:ALL:SUMMary:EVM:ALL?	236
FETCh[:CC<cc>][:ISRC<ant>][:FRAMe<fr>]:SUMMary:EVM[:ALL]:MAXimum?	236
FETCh[:CC<cc>][:ISRC<ant>][:FRAMe<fr>]:SUMMary:EVM[:ALL]:MINimum?	237
FETCh[:CC<cc>][:ISRC<ant>][:FRAMe<fr>]:SUMMary:EVM[:ALL][:AVERAge]?	237
FETCh:ALL:SUMMary:EVM:DS1K?	237
FETCh[:CC<cc>][:ISRC<ant>][:FRAMe<fr>]:SUMMary:EVM:DS1K:MAXimum?	237
FETCh[:CC<cc>][:ISRC<ant>][:FRAMe<fr>]:SUMMary:EVM:DS1K:MINimum?	237
FETCh[:CC<cc>][:ISRC<ant>][:FRAMe<fr>]:SUMMary:EVM:DS1K[:AVERAge]?	237
FETCh:ALL:SUMMary:EVM:DSQP?	238
FETCh[:CC<cc>][:ISRC<ant>][:FRAMe<fr>]:SUMMary:EVM:DSQP:MAXimum?	238
FETCh[:CC<cc>][:ISRC<ant>][:FRAMe<fr>]:SUMMary:EVM:DSQP:MINimum?	238
FETCh[:CC<cc>][:ISRC<ant>][:FRAMe<fr>]:SUMMary:EVM:DSQP[:AVERAge]?	238
FETCh:ALL:SUMMary:EVM:DSSF?	238
FETCh[:CC<cc>][:ISRC<ant>][:FRAMe<fr>]:SUMMary:EVM:DSSF:MAXimum?	238
FETCh[:CC<cc>][:ISRC<ant>][:FRAMe<fr>]:SUMMary:EVM:DSSF:MINimum?	239
FETCh[:CC<cc>][:ISRC<ant>][:FRAMe<fr>]:SUMMary:EVM:DSSF[:AVERAge]?	239
FETCh:ALL:SUMMary:EVM:DSST?	239
FETCh[:CC<cc>][:ISRC<ant>][:FRAMe<fr>]:SUMMary:EVM:DSST:MAXimum?	239
FETCh[:CC<cc>][:ISRC<ant>][:FRAMe<fr>]:SUMMary:EVM:DSST:MINimum?	239
FETCh[:CC<cc>][:ISRC<ant>][:FRAMe<fr>]:SUMMary:EVM:DSST[:AVERAge]?	239
FETCh:ALL:SUMMary:EVM:DSTS?	240
FETCh[:CC<cc>][:ISRC<ant>][:FRAMe<fr>]:SUMMary:EVM:DSTS:MAXimum?	240
FETCh[:CC<cc>][:ISRC<ant>][:FRAMe<fr>]:SUMMary:EVM:DSTS:MINimum?	240
FETCh[:CC<cc>][:ISRC<ant>][:FRAMe<fr>]:SUMMary:EVM:DSTS[:AVERAge]?	240
FETCh:ALL:SUMMary:EVM:PCHannel?	241
FETCh[:CC<cc>][:ISRC<ant>][:FRAMe<fr>]:SUMMary:EVM:PCHannel:MAXimum?	241
FETCh[:CC<cc>][:ISRC<ant>][:FRAMe<fr>]:SUMMary:EVM:PCHannel:MINimum?	241
FETCh[:CC<cc>][:ISRC<ant>][:FRAMe<fr>]:SUMMary:EVM:PCHannel[:AVERAge]?	241
FETCh:ALL:SUMMary:EVM:PEAK?	241
FETCh[:CC<cc>][:ISRC<ant>][:FRAMe<fr>]:SUMMary:EVM:PEAK:MAXimum?	241
FETCh[:CC<cc>][:ISRC<ant>][:FRAMe<fr>]:SUMMary:EVM:PEAK:MINimum?	241

Remote commands to retrieve numeric results

FETCh[:CC<cc>][:ISRC<ant>][:FRAMe<fr>]:SUMMary:EVM:PEAK[:AVERAge]?	241
FETCh:ALL:SUMMary:EVM:PSIGnal?	242
FETCh[:CC<cc>][:ISRC<ant>][:FRAMe<fr>]:SUMMary:EVM:PSIGnal:MAXimum?	242
FETCh[:CC<cc>][:ISRC<ant>][:FRAMe<fr>]:SUMMary:EVM:PSIGnal:MINimum?	242
FETCh[:CC<cc>][:ISRC<ant>][:FRAMe<fr>]:SUMMary:EVM:PSIGnal[:AVERAge]?	242
FETCh[:CC<cc>][:ISRC<ant>][:FRAMe<fr>]:SUMMary:FERRor:MAXimum?	243
FETCh[:CC<cc>][:ISRC<ant>][:FRAMe<fr>]:SUMMary:FERRor:MINimum?	243
FETCh[:CC<cc>][:ISRC<ant>][:FRAMe<fr>]:SUMMary:FERRor[:AVERAge]?	243
FETCh[:CC<cc>][:ISRC<ant>][:FRAMe<fr>]:SUMMary:GIMBalance:MAXimum?	243
FETCh[:CC<cc>][:ISRC<ant>][:FRAMe<fr>]:SUMMary:GIMBalance:MINimum?	243
FETCh[:CC<cc>][:ISRC<ant>][:FRAMe<fr>]:SUMMary:GIMBalance[:AVERAge]?	243
FETCh[:CC<cc>][:ISRC<ant>][:FRAMe<fr>]:SUMMary:IQOFset:MAXimum?	244
FETCh[:CC<cc>][:ISRC<ant>][:FRAMe<fr>]:SUMMary:IQOFset:MINimum?	244
FETCh[:CC<cc>][:ISRC<ant>][:FRAMe<fr>]:SUMMary:IQOFset[:AVERAge]?	244
FETCh[:CC<cc>][:ISRC<ant>][:FRAMe<fr>]:SUMMary:OSTP:MAXimum?	244
FETCh[:CC<cc>][:ISRC<ant>][:FRAMe<fr>]:SUMMary:OSTP:MINimum?	244
FETCh[:CC<cc>][:ISRC<ant>][:FRAMe<fr>]:SUMMary:OSTP[:AVERAge]?	244
FETCh:ALL:SUMMary:POWer?	245
FETCh[:CC<cc>][:ISRC<ant>][:FRAMe<fr>]:SUMMary:POWer:MAXimum?	245
FETCh[:CC<cc>][:ISRC<ant>][:FRAMe<fr>]:SUMMary:POWer:MINimum?	245
FETCh[:CC<cc>][:ISRC<ant>][:FRAMe<fr>]:SUMMary:POWer[:AVERAge]?	245
FETCh[:CC<cc>][:ISRC<ant>][:FRAMe<fr>]:SUMMary:QUADerror:MAXimum?	246
FETCh[:CC<cc>][:ISRC<ant>][:FRAMe<fr>]:SUMMary:QUADerror:MINimum?	246
FETCh[:CC<cc>][:ISRC<ant>][:FRAMe<fr>]:SUMMary:QUADerror[:AVERAge]?	246
FETCh[:CC<cc>][:ISRC<ant>][:FRAMe<fr>]:SUMMary:RSRP:CSI:MAXimum?	246
FETCh[:CC<cc>][:ISRC<ant>][:FRAMe<fr>]:SUMMary:RSRP:CSI:MINimum?	246
FETCh[:CC<cc>][:ISRC<ant>][:FRAMe<fr>]:SUMMary:RSRP:CSI[:AVERAge]?	246
FETCh[:CC<cc>][:ISRC<ant>][:FRAMe<fr>]:SUMMary:RSRP:SS:MAXimum?	247
FETCh[:CC<cc>][:ISRC<ant>][:FRAMe<fr>]:SUMMary:RSRP:SS:MINimum?	247
FETCh[:CC<cc>][:ISRC<ant>][:FRAMe<fr>]:SUMMary:RSRP:SS[:AVERAge]?	247
FETCh[:CC<cc>][:ISRC<ant>][:FRAMe<fr>]:SUMMary:RSTP:MAXimum?	247
FETCh[:CC<cc>][:ISRC<ant>][:FRAMe<fr>]:SUMMary:RSTP:MINimum?	247
FETCh[:CC<cc>][:ISRC<ant>][:FRAMe<fr>]:SUMMary:RSTP[:AVERAge]?	247
FETCh[:CC<cc>][:ISRC<ant>][:FRAMe<fr>]:SUMMary:SERRor:MAXimum?	248
FETCh[:CC<cc>][:ISRC<ant>][:FRAMe<fr>]:SUMMary:SERRor:MINimum?	248
FETCh[:CC<cc>][:ISRC<ant>][:FRAMe<fr>]:SUMMary:SERRor[:AVERAge]?	248
FETCh[:CC<cc>][:ISRC<ant>][:FRAMe<fr>]:SUMMary:OVLD?	248
FETCh[:CC<cc>][:ISRC<ant>][:FRAMe<fr>]:SUMMary:SPFaiL?	249
FETCh[:CC<cc>][:ISRC<ant>][:FRAMe<fr>]:SUMMary:SSTate?	250
FETCh[:CC<cc>][:ISRC<ant>][:FRAMe<fr>]:SUMMary:TPUT:MAXimum?	250
FETCh[:CC<cc>][:ISRC<ant>][:FRAMe<fr>]:SUMMary:TPUT:MINimum?	250
FETCh[:CC<cc>][:ISRC<ant>][:FRAMe<fr>]:SUMMary:TPUT[:AVERAge]?	250
FETCh[:CC<cc>][:ISRC<ant>][:FRAMe<fr>]:SUMMary:TSDelta?	251
FETCh[:CC<cc>][:ISRC<ant>][:FRAMe<fr>]:SUMMary:TSTamp?	251
FETCh[:CC<cc>][:ISRC<ant>]:SUMMary:TFRame?	252

FETCh[:CC<cc>][:ISRC<ant>][:FRAMe<fr>]:SUMMary:ALL?

Queries all results in the numerical result summary.

Suffix:

<cc> [Component Carrier](#)

<ant> irrelevant

<fr> [Frame](#)

Return values:

<Result> String containing all results in the following format.
<ResultType>, <AverageResult>, <MaximumResult>,
<MinimumResult>
If a result has not been calculated, the command returns NAN.

Example:

```
//Query all numerical results
FETC:SUMM:ALL?
would return, e.g.
EVM PDSCH QPSK,
+2.695721388E-001, +2.695721388E-001,
+2.695721388E-001,
EVM PDSCH 16QAM, NAN, NAN, NAN,
...
```

Usage: Query only

Manual operation: See "[Remote queries](#)" on page 24

FETCh[:CC<cc>][:ISRC<ant>]:SUMMary:CRESt[:AVERAge]?

Queries the average crest factor as shown in the result summary.

Suffix:

<cc> [Component Carrier](#)

<ant> irrelevant

Return values:

<CrestFactor> Default unit: dB

Example:

```
//Query crest factor
FETC:SUMM:CRES?
```

Usage: Query only

Manual operation: See "[Crest Factor](#)" on page 27

FETCh[:CC<cc>][:ISRC<ant>][:FRAMe<fr>]:SUMMary:AAPFail? [<Result>]

Queries the absolute ACLR limit check of an event.

Suffix:

<cc> [Component Carrier](#)

<ant> irrelevant

<fr> [Frame](#)

Query parameters:

<Result> ALL
 Available for combined measurements.
 Queries the ACLR limit check of all events (meas IDs).
 Omitting this parameter queries the ACLR limit check of the selected event.

Return values:

<State> 0 | 1

Example:

```
//Query absolute ACLR limit check
FETC:CC2:FRAM3:SUMM:AAPF?
```

Usage:

Query only

Manual operation: See "[ACLR Pass / Fail](#)" on page 62

FETCh[:CC<cc>][:ISRC<ant>][:FRAMe<fr>]:SUMMary:APFail? [<Result>]

Queries the overall ACLR limit check of an event (absolute and relative). If one limit check passes (abs. or rel.), the overall limit check passes as well.

Suffix:

<cc> [Component Carrier](#)

<ant> irrelevant

<fr> [Frame](#)

Query parameters:

<Result> ALL
 Available for combined measurements.
 Queries the ACLR limit check of all events (meas IDs).
 Omitting this parameter queries the ACLR limit check of the selected event.

Return values:

<State> 0 | 1

Example:

```
//Query ACLR limit check
FETC:CC2:FRAM3:SUMM:APF?
```

Usage:

Query only

Manual operation: See "[ACLR Pass / Fail](#)" on page 62

FETCh[:CC<cc>][:ISRC<ant>][:FRAMe<fr>]:SUMMary:ARPFail? [<Result>]

Queries the relative ACLR limit check of an event.

Suffix:

<cc> [Component Carrier](#)

<ant> irrelevant

<fr> [Frame](#)

Query parameters:

<Result> ALL
 Available for combined measurements.
 Queries the ACLR limit check of all events (meas IDs).
 Omitting this parameter queries the ACLR limit check of the selected event.

Return values:

<State> 0 | 1

Example: //Query relative ACLR limit check
 FETC:CC2:FRAM3:SUMM:ARPF?

Usage: Query only

Manual operation: See "[ACLR Pass / Fail](#)" on page 62

FETCh[:CC<cc>][:ISRC<ant>][:FRAMe<fr>]:SUMMary:BLER:MAXimum?
FETCh[:CC<cc>][:ISRC<ant>][:FRAMe<fr>]:SUMMary:BLER:MINimum?
FETCh[:CC<cc>][:ISRC<ant>][:FRAMe<fr>]:SUMMary:BLER[:AVERAge]?

Queries the EVM of all resource elements.

Prerequisites for this command

- Turn on throughput measurement ([\[SENSe:\]NR5G:TRACking:TPUT:STATe](#)).
- Turn on BLER measurement ([DISPlay\[:WINDow<n>\]:TABLe:ITEM](#)).

Suffix:

<cc> [Component Carrier](#)
 <ant> irrelevant
 <fr> [Frame](#)

Return values:

<BLER> Default unit: PCT

Example: //Query BLER
 NR5G:TRAC:TPUT:STAT ON
 DISP:TABL:ITEM BLER,ON
 FETC:CC2:FRAM3:SUMM:BLER?

Usage: Query only

Manual operation: See "[BLER \(%\)](#)" on page 24

FETCh:ALL:SUMMary:EVM:ALL? <Result>
FETCh[:CC<cc>][:ISRC<ant>][:FRAMe<fr>]:SUMMary:EVM[:ALL]:MAXimum?
 [<Result>]

FETCh[:CC<cc>][:ISRC<ant>][:FRAMe<fr>]:SUMMary:EVM[:ALL]:MINimum?
 [<Result>]

FETCh[:CC<cc>][:ISRC<ant>][:FRAMe<fr>]:SUMMary:EVM[:ALL][:AVERAge]?
 [<Result>]

Queries the EVM of all resource elements.

FETCh:ALL:SUMMary:EVM:ALL queries the average result over all carriers. Prerequisites:

- Select to evaluate all carriers ([\[SENSe:\]NR5G:RSUMmary:CCResult](#)).

Suffix:

<cc> [Component Carrier](#)

<ant> irrelevant

<fr> [Frame](#)

Query parameters:

<Result> ALL
 Available for combined measurements.
 Queries the EVM of all events (meas IDs).
 Omitting this parameter queries the EVM of the selected event.

Return values:

<EVM> EVM in % or dB.

Example: //Query EVM
 FETC:CC2:FRAM3:SUMM:EVM?

Usage: Query only

Manual operation: See "[EVM All](#)" on page 25

FETCh:ALL:SUMMary:EVM:DS1K? <Result>

FETCh[:CC<cc>][:ISRC<ant>][:FRAMe<fr>]:SUMMary:EVM:DS1K:MAXimum?
 [<Result>]

FETCh[:CC<cc>][:ISRC<ant>][:FRAMe<fr>]:SUMMary:EVM:DS1K:MINimum?
 [<Result>]

FETCh[:CC<cc>][:ISRC<ant>][:FRAMe<fr>]:SUMMary:EVM:DS1K[:AVERAge]?
 [<Result>]

Queries the EVM of all PDSCH resource elements with a 1024QAM modulation.

FETCh:ALL:SUMMary:EVM:DS1K queries the average result over all carriers. Prerequisites:

- Select to evaluate all carriers ([\[SENSe:\]NR5G:RSUMmary:CCResult](#)).

Suffix:

<cc> [Component Carrier](#)

<ant> irrelevant

<fr> [Frame](#)

Query parameters:

<Result> ALL
 Available for combined measurements.
 Queries the EVM of all events (meas IDs).
 Omitting this parameter queries the EVM of the selected event.

Return values:

<EVM> EVM in % or dB.

Example:

```
//Query EVM
FETC:CC2:FRAM3:SUMM:EVM:DS1K?
```

Usage:

Query only

FETCh:ALL:SUMMary:EVM:DSQP? <Result>

FETCh[:CC<cc>][:ISRC<ant>][:FRAMe<fr>]:SUMMary:EVM:DSQP:MAXimum?
 [<Result>]

FETCh[:CC<cc>][:ISRC<ant>][:FRAMe<fr>]:SUMMary:EVM:DSQP:MINimum?
 [<Result>]

FETCh[:CC<cc>][:ISRC<ant>][:FRAMe<fr>]:SUMMary:EVM:DSQP[:AVERage]?
 [<Result>]

Queries the EVM of all PDSCH resource elements with a QPSK modulation.

FETCh:ALL:SUMMary:EVM:DSQP queries the average result over all carriers. Prerequisites:

- Select to evaluate all carriers ([\[SENSe:\]NR5G:RSUMmary:CCResult](#)).

Suffix:

<cc> [Component Carrier](#)

<ant> irrelevant

<fr> [Frame](#)

Query parameters:

<Result> ALL
 Available for combined measurements.
 Queries the EVM of all events (meas IDs).
 Omitting this parameter queries the EVM of the selected event.

Return values:

<EVM> EVM in % or dB.

Example:

```
//Query EVM
FETC:CC2:FRAM3:SUMM:EVM:DSQP?
```

Usage:

Query only

Manual operation: See ["EVM PDSCH"](#) on page 24

FETCh:ALL:SUMMary:EVM:DSSF? <Result>

FETCh[:CC<cc>][:ISRC<ant>][:FRAMe<fr>]:SUMMary:EVM:DSSF:MAXimum?
 [<Result>]

FETCh[:CC<cc>][:ISRC<ant>][:FRAMe<fr>]:SUMMary:EVM:DSSF:MINimum?
 [<Result>]

FETCh[:CC<cc>][:ISRC<ant>][:FRAMe<fr>]:SUMMary:EVM:DSSF[:AVERage]?
 [<Result>]

Queries the EVM of all PDSCH resource elements with a 64QAM modulation.

FETCh:ALL:SUMMary:EVM:DSSF queries the average result over all carriers. Prerequisites:

- Select to evaluate all carriers ([\[SENSe:\]NR5G:RSUMmary:CCResult](#)).

Suffix:

<cc> [Component Carrier](#)

<ant> irrelevant

<fr> [Frame](#)

Query parameters:

<Result> ALL
 Available for combined measurements.
 Queries the EVM of all events (meas IDs).
 Omitting this parameter queries the EVM of the selected event.

Return values:

<EVM> EVM in % or dB.

Example: //Query EVM
 FETC:CC2:FRAM3:SUMM:EVM:DSSF?

Usage: Query only

Manual operation: See "[EVM PDSCH](#)" on page 24

FETCh:ALL:SUMMary:EVM:DSST? <Result>

FETCh[:CC<cc>][:ISRC<ant>][:FRAMe<fr>]:SUMMary:EVM:DSST:MAXimum?
 [<Result>]

FETCh[:CC<cc>][:ISRC<ant>][:FRAMe<fr>]:SUMMary:EVM:DSST:MINimum?
 [<Result>]

FETCh[:CC<cc>][:ISRC<ant>][:FRAMe<fr>]:SUMMary:EVM:DSST[:AVERage]?
 [<Result>]

Queries the EVM of all PDSCH resource elements with a 16QAM modulation.

FETCh:ALL:SUMMary:EVM:DSST queries the average result over all carriers. Prerequisites:

- Select to evaluate all carriers ([\[SENSe:\]NR5G:RSUMmary:CCResult](#)).

Suffix:

<cc> [Component Carrier](#)

<ant> irrelevant

<fr> [Frame](#)

Query parameters:

<Result> ALL
 Available for combined measurements.
 Queries the EVM of all events (meas IDs).
 Omitting this parameter queries the EVM of the selected event.

Return values:

<EVM> EVM in % or dB.

Example:

```
//Query EVM
FETC:CC2:FRAM3:SUMM:EVM:DSST?
```

Usage:

Query only

Manual operation: See "EVM PDSCH" on page 24

FETCh:ALL:SUMMary:EVM:DSTS? <Result>

FETCh[:CC<cc>][:ISRC<ant>][:FRAMe<fr>]:SUMMary:EVM:DSTS:MAXimum?
 [<Result>]

FETCh[:CC<cc>][:ISRC<ant>][:FRAMe<fr>]:SUMMary:EVM:DSTS:MINimum?
 [<Result>]

FETCh[:CC<cc>][:ISRC<ant>][:FRAMe<fr>]:SUMMary:EVM:DSTS[:AVERAge]?
 [<Result>]

Queries the EVM of all PDSCH resource elements with a 256QAM modulation.

FETCh:ALL:SUMMary:EVM:DSTS queries the average result over all carriers. Prerequisites:

- Select to evaluate all carriers ([SENSe:]NR5G:RSUMmary:CCResult).

Suffix:

<cc> [Component Carrier](#)

<ant> irrelevant

<fr> [Frame](#)

Query parameters:

<Result> ALL
 Available for combined measurements.
 Queries the EVM of all events (meas IDs).
 Omitting this parameter queries the EVM of the selected event.

Return values:

<EVM> EVM in % or dB.

Example:

```
//Query EVM
FETC:CC2:FRAM3:SUMM:EVM:DSTS?
```

Usage:

Query only

Manual operation: See "EVM PDSCH" on page 24

```

FETCh:ALL:SUMMary:EVM:PCHannel? <Result>
FETCh[:CC<cc>][:ISRC<ant>][:FRAMe<fr>]:SUMMary:EVM:PCHannel:
MAXimum? [<Result>]
FETCh[:CC<cc>][:ISRC<ant>][:FRAMe<fr>]:SUMMary:EVM:PCHannel:MINimum?
  [<Result>]
FETCh[:CC<cc>][:ISRC<ant>][:FRAMe<fr>]:SUMMary:EVM:PCHannel[:
AVERAge]? [<Result>]

```

Queries the EVM of the physical channel.

`FETCh:ALL:SUMMary:EVM:PCHannel` queries the average result over all carriers.

Prerequisites:

- Select to evaluate all carriers (`[SENSe:]NR5G:RSUMmary:CCResult`).

Suffix:

<cc> [Component Carrier](#)

<ant> irrelevant

<fr> [Frame](#)

Query parameters:

<Result> ALL
 Available for combined measurements.
 Queries the EVM of all events (meas IDs).
 Omitting this parameter queries the EVM of the selected event.

Return values:

<EVM> EVM in % or dB.

Example:

```
//Query EVM
FETC:CC2:FRAM3:SUMM:EVM:PCH?
```

Usage:

Query only

Manual operation: See "[EVM Phys Channel](#)" on page 25

```

FETCh:ALL:SUMMary:EVM:PEAK? <Result>
FETCh[:CC<cc>][:ISRC<ant>][:FRAMe<fr>]:SUMMary:EVM:PEAK:MAXimum?
  [<Result>]
FETCh[:CC<cc>][:ISRC<ant>][:FRAMe<fr>]:SUMMary:EVM:PEAK:MINimum?
  [<Result>]
FETCh[:CC<cc>][:ISRC<ant>][:FRAMe<fr>]:SUMMary:EVM:PEAK[:AVERAge]?
  [<Result>]

```

Queries the peak EVM.

`FETCh:ALL:SUMMary:EVM:PEAK` queries the average result over all carriers. Prerequisites:

- Select to evaluate all carriers (`[SENSe:]NR5G:RSUMmary:CCResult`).

Suffix:

<cc> [Component Carrier](#)

<ant> irrelevant

<fr> [Frame](#)

Query parameters:

<Result> ALL
Available for combined measurements.
Queries the EVM of all events (meas IDs).
Omitting this parameter queries the EVM of the selected event.

Return values:

<EVM> EVM in % or dB.

Example:

```
//Query peak EVM
FETC:CC2:FRAM3:SUMM:EVM:PEAK?
```

Usage: Query only

Manual operation: See "[EVM Peak](#)" on page 25

```
FETCh:ALL:SUMMary:EVM:PSIGnal? <Result>
FETCh[:CC<cc>][:ISRC<ant>][:FRAMe<fr>]:SUMMary:EVM:PSIGnal:MAXimum?
  [<Result>]
FETCh[:CC<cc>][:ISRC<ant>][:FRAMe<fr>]:SUMMary:EVM:PSIGnal:MINimum?
  [<Result>]
FETCh[:CC<cc>][:ISRC<ant>][:FRAMe<fr>]:SUMMary:EVM:PSIGnal[:AVERage]?
  [<Result>]
```

Queries the EVM of the physical signal.

FETCh:ALL:SUMMary:EVM:PSIGnal queries the average result over all carriers.

Prerequisites:

- Select to evaluate all carriers ([\[SENSe:\]NR5G:RSUMmary:CCResult](#)).

Suffix:

<cc> [Component Carrier](#)

<ant> irrelevant

<fr> [Frame](#)

Query parameters:

<Result> ALL
Available for combined measurements.
Queries the EVM of all events (meas IDs).
Omitting this parameter queries the EVM of the selected event.

Return values:

<EVM> EVM in % or dB.

Example:

```
//Query EVM
FETC:CC2:FRAM3:SUMM:EVM:PSIG?
```

Usage: Query only

```
FETCh[:CC<cc>][:ISRC<ant>][:FRAMe<fr>]:SUMMary:FERRor:MAXimum?
  [<Result>]
```

```
FETCh[:CC<cc>][:ISRC<ant>][:FRAMe<fr>]:SUMMary:FERRor:MINimum?
  [<Result>]
```

```
FETCh[:CC<cc>][:ISRC<ant>][:FRAMe<fr>]:SUMMary:FERRor[:AVERage]?
  [<Result>]
```

Queries the frequency error.

Suffix:

<cc> [Component Carrier](#)

<ant> irrelevant

<fr> [Frame](#)

Query parameters:

<Result> ALL
 Available for combined measurements.
 Queries the frequency error of all events (meas IDs).
 Omitting this parameter queries the frequency error of the
 selected event.

Return values:

<FrequencyError> Default unit: Hz

Example: //Query frequency error
 FETC:CC2:FRAM3:SUMM:FERR?

Usage: Query only

Manual operation: See "[Frequency Error](#)" on page 26

```
FETCh[:CC<cc>][:ISRC<ant>][:FRAMe<fr>]:SUMMary:GIMBalance:MAXimum?
  [<Result>]
```

```
FETCh[:CC<cc>][:ISRC<ant>][:FRAMe<fr>]:SUMMary:GIMBalance:MINimum?
  [<Result>]
```

```
FETCh[:CC<cc>][:ISRC<ant>][:FRAMe<fr>]:SUMMary:GIMBalance[:AVERage]?
  [<Result>]
```

Queries the gain imbalance.

Suffix:

<cc> [Component Carrier](#)

<ant> irrelevant

<fr> [Frame](#)

Query parameters:

<Result> ALL
 Available for combined measurements.
 Queries the gain imbalance of all events (meas IDs).
 Omitting this parameter queries the gain imbalance of the
 selected event.

Return values:

<GainImbalance> Default unit: dB

Example:

```
//Query gain imbalance
FETC:CC2:FRAM3:SUMM:GIMB?
```

Usage:

Query only

Manual operation: See "[I/Q Gain Imbalance](#)" on page 26

```
FETCh[:CC<cc>][:ISRC<ant>][:FRAMe<fr>]:SUMMary:IQOffset:MAXimum?
[<Result>]
```

```
FETCh[:CC<cc>][:ISRC<ant>][:FRAMe<fr>]:SUMMary:IQOffset:MINimum?
[<Result>]
```

```
FETCh[:CC<cc>][:ISRC<ant>][:FRAMe<fr>]:SUMMary:IQOffset[:AVERage]?
[<Result>]
```

Queries the I/Q offset.

Suffix:

<cc> [Component Carrier](#)

<ant> irrelevant

<fr> [Frame](#)

Query parameters:

<Result> ALL
Available for combined measurements.
Queries the I/Q offset of all events (meas IDs).
Omitting this parameter queries the I/Q offset of the selected event.

Return values:

<IQOffset> Default unit: dB

Example:

```
//Query I/Q offset
FETC:CC2:FRAM3:SUMM:IQOF?
```

Usage:

Query only

Manual operation: See "[I/Q Offset](#)" on page 26

```
FETCh[:CC<cc>][:ISRC<ant>][:FRAMe<fr>]:SUMMary:OSTP:MAXimum?
[<Result>]
```

```
FETCh[:CC<cc>][:ISRC<ant>][:FRAMe<fr>]:SUMMary:OSTP:MINimum?
[<Result>]
```

```
FETCh[:CC<cc>][:ISRC<ant>][:FRAMe<fr>]:SUMMary:OSTP[:AVERage]?
[<Result>]
```

Queries the OSTP.

Suffix:

<cc> [Component Carrier](#)

<ant> irrelevant

<fr> [Frame](#)

Query parameters:

<Result> ALL
Available for combined measurements.
Queries the OSTP of all events (meas IDs).
Omitting this parameter queries the OSTP of the selected event.

Return values:

<OSTP> Default unit: dBm

Example:

```
//Query OSTP
FETC:CC2:FRAM3:SUMM:OSTP?
```

Usage: Query only

Manual operation: See "[OSTP](#)" on page 27

```
FETCh:ALL:SUMMary:POWer? <Result>
FETCh[:CC<cc>][:ISRC<ant>][:FRAMe<fr>]:SUMMary:POWer:MAXimum?
  [<Result>]
FETCh[:CC<cc>][:ISRC<ant>][:FRAMe<fr>]:SUMMary:POWer:MINimum?
  [<Result>]
FETCh[:CC<cc>][:ISRC<ant>][:FRAMe<fr>]:SUMMary:POWer[:AVERage]?
  [<Result>]
```

Queries the total signal power.

FETCh:ALL:SUMMary:POWer queries the average result over all carriers. Prerequisites:

- Select to evaluate all carriers ([\[SENSe:\]NR5G:RSUMmary:CCResult](#)).

Suffix:

<cc> [Component Carrier](#)

<ant> irrelevant

<fr> [Frame](#)

Query parameters:

<Result> ALL
Available for combined measurements.
Queries the total power of all events (meas IDs).
Omitting this parameter queries the total power of the selected event.

Return values:

<Power> Default unit: dBm

Example:

```
//Query signal power
FETC:CC2:FRAM3:SUMM:POW?
```

Usage: Query only

Manual operation: See "[Power](#)" on page 26

```
FETCh[:CC<cc>][:ISRC<ant>][:FRAMe<fr>]:SUMMary:QUADerror:MAXimum?
  [<Result>]
```

```
FETCh[:CC<cc>][:ISRC<ant>][:FRAMe<fr>]:SUMMary:QUADerror:MINimum?
  [<Result>]
```

```
FETCh[:CC<cc>][:ISRC<ant>][:FRAMe<fr>]:SUMMary:QUADerror[:AVERage]?
  [<Result>]
```

Queries the quadrature error.

Suffix:

<cc> [Component Carrier](#)

<ant> irrelevant

<fr> [Frame](#)

Query parameters:

<Result> ALL
 Available for combined measurements.
 Queries the quadrature error of all events (meas IDs).
 Omitting this parameter queries the quadrature error of the
 selected event.

Return values:

<QuadratureError> Default unit: DEG

Example: //Query quadrature error
 FETC:CC2:FRAM3:SUMM:QUAD?

Usage: Query only

```
FETCh[:CC<cc>][:ISRC<ant>][:FRAMe<fr>]:SUMMary:RSRP:CSI:MAXimum?
  [<Result>]
```

```
FETCh[:CC<cc>][:ISRC<ant>][:FRAMe<fr>]:SUMMary:RSRP:CSI:MINimum?
  [<Result>]
```

```
FETCh[:CC<cc>][:ISRC<ant>][:FRAMe<fr>]:SUMMary:RSRP:CSI[:AVERage]?
  [<Result>]
```

Queries the CSI-RSRP.

Suffix:

<cc> [Component Carrier](#)

<ant> irrelevant

<fr> [Frame](#)

Query parameters:

<Result> ALL
 Available for combined measurements.
 Queries the CSI-RSRP of all events (meas IDs).
 Omitting this parameter queries the CSI-RSRP of the selected
 event.

Return values:

<EVM> Default unit: dBm

Example:

```
//Query CSI-RSRP
FETC:CC2:FRAM3:SUMM:RSRP:CSI?
```

Usage:

Query only

Manual operation: See "[RSRP](#)" on page 27

```
FETCh[:CC<cc>][:ISRC<ant>][:FRAMe<fr>]:SUMMary:RSRP:SS:MAXimum?
[<Result>]
```

```
FETCh[:CC<cc>][:ISRC<ant>][:FRAMe<fr>]:SUMMary:RSRP:SS:MINimum?
[<Result>]
```

```
FETCh[:CC<cc>][:ISRC<ant>][:FRAMe<fr>]:SUMMary:RSRP:SS[:AVERage]?
[<Result>]
```

Queries the SS-RSRP.

Suffix:

<cc> [Component Carrier](#)

<ant> irrelevant

<fr> [Frame](#)

Query parameters:

<Result> ALL
Available for combined measurements.
Queries the SS-RSRP of all events (meas IDs).
Omitting this parameter queries the SS-RSRP of the selected event.

Return values:

<EVM> Default unit: dBm

Example:

```
//Query SS-RSRP
FETC:CC2:FRAM3:SUMM:RSRP:SS?
```

Usage:

Query only

Manual operation: See "[RSRP](#)" on page 27

```
FETCh[:CC<cc>][:ISRC<ant>][:FRAMe<fr>]:SUMMary:RSTP:MAXimum?
[<Result>]
```

```
FETCh[:CC<cc>][:ISRC<ant>][:FRAMe<fr>]:SUMMary:RSTP:MINimum? [<Result>]
```

```
FETCh[:CC<cc>][:ISRC<ant>][:FRAMe<fr>]:SUMMary:RSTP[:AVERage]?
[<Result>]
```

Queries the RSTP.

Suffix:

<cc> [Component Carrier](#)

<ant> irrelevant

<fr> [Frame](#)

Query parameters:

<Result> ALL
 Available for combined measurements.
 Queries the RSTP of all events (meas IDs).
 Omitting this parameter queries the RSTP of the selected event.

Return values:

<RSTP> Default unit: dBm

Example:

```
//Query RSTP
FETC:CC2:FRAM3:SUMM:RSTP?
```

Usage: Query only

Manual operation: See "[RSTP](#)" on page 27

```
FETCh[:CC<cc>][:ISRC<ant>][:FRAMe<fr>]:SUMMary:SERRor:MAXimum?
  [<Result>]
```

```
FETCh[:CC<cc>][:ISRC<ant>][:FRAMe<fr>]:SUMMary:SERRor:MINimum?
  [<Result>]
```

```
FETCh[:CC<cc>][:ISRC<ant>][:FRAMe<fr>]:SUMMary:SERRor[:AVERage]?
  [<Result>]
```

Queries the sampling error.

Suffix:

<cc> [Component Carrier](#)

<ant> irrelevant

<fr> [Frame](#)

Query parameters:

<Result> ALL
 Available for combined measurements.
 Queries the sampling error of all events (meas IDs).
 Omitting this parameter queries the sampling error of the selected event.

Return values:

<SamplingError> Default unit: ppm

Example:

```
//Query sampling error
FETC:CC2:FRAM3:SUMM:SERR?
```

Usage: Query only

Manual operation: See "[Sampling Error](#)" on page 26

```
FETCh[:CC<cc>][:ISRC<ant>][:FRAMe<fr>]:SUMMary:OVLd? [<Result>]
```

Queries the overload state of an event.

Suffix:

<cc>	Component Carrier
<ant>	irrelevant
<fr>	Frame

Query parameters:

<Result>	ALL Available for combined measurements. Queries the overload state of all events (meas IDs). Omitting this parameter queries the overload state of the selected event.
----------	--

Return values:

<State>	NAN no overload situation 0 RF OVLD 2 ADC OVLD 3 INPUT OVLD
---------	--

Example: //Query overload state
FETC:CC2:FRAM3:SUMM:OVLD?

Usage: Query only

Manual operation: See "OVLD" on page 62

FETCh[:CC<cc>][:ISRC<ant>][:FRAMe<fr>]:SUMMary:SPFail? [<Result>]

Queries the SEM limit check of an event.

Suffix:

<cc>	Component Carrier
<ant>	irrelevant
<fr>	Frame

Query parameters:

<Result>	ALL Available for combined measurements. Queries the SEM limit check of all events (meas IDs). Omitting this parameter queries the SEM limit check of the selected event.
----------	--

Return values:

<State>	0 1
---------	-------

Example: //Query SEM limit check
FETC:CC2:FRAM3:SUMM:SPF?

Usage: Query only
Manual operation: See "[SEM Pass / Fail](#)" on page 62

FETCh[:CC<cc>][:ISRC<ant>][:FRAMe<fr>]:SUMMary:SSTate? [<Result>]

Queries the synchronization state of an event.

Suffix:

<cc> [Component Carrier](#)

<ant> irrelevant

<fr> [Frame](#)

Query parameters:

<Result> ALL
 Available for combined measurements.
 Queries the synchronization state of all events (meas IDs).
 Omitting this parameter queries the synchronization state of the selected event.

Return values:

<State> 0 | 1

Example: //Query synchronization state
 FETC:CC2:FRAM3:SUMM:SST?

Usage: Query only

Manual operation: See "[Sync State](#)" on page 62

FETCh[:CC<cc>][:ISRC<ant>][:FRAMe<fr>]:SUMMary:TPUT:MAXimum?

FETCh[:CC<cc>][:ISRC<ant>][:FRAMe<fr>]:SUMMary:TPUT:MINimum?

FETCh[:CC<cc>][:ISRC<ant>][:FRAMe<fr>]:SUMMary:TPUT[:AVERage]?

Queries the EVM of all resource elements.

Prerequisites for this command

- Turn on throughput measurement ([\[SENSe:\]NR5G:TRACking:TPUT:STATe](#)).

Suffix:

<cc> [Component Carrier](#)

<ant> irrelevant

<fr> [Frame](#)

Return values:

<TPUT> Default unit: PCT

Example: //Query BLER
 NR5G:TRAC:TPUT:STAT ON
 FETC:CC2:FRAM3:SUMM:TPUT?

Usage: Query only

Manual operation: See "TPUT (%)" on page 25

FETCh[:CC<cc>][:ISRC<ant>][:FRAMe<fr>]:SUMMary:TSDelta? [<Result>]

Queries the time stamp delta of an event.

Suffix:

<cc> [Component Carrier](#)
 <ant> irrelevant
 <fr> [Frame](#)

Query parameters:

<Result> ALL
 Available for combined measurements.
 Queries the time stamp delta of all events (meas IDs).
 Omitting this parameter queries the time stamp delta of the selected event.

Return values:

<Time> Default unit: s

Example:

//Query time stamp
 FETC:CC2:FRAM3:SUMM:TSD?

Usage:

Query only

Manual operation: See "Time Stamp Delta" on page 61

FETCh[:CC<cc>][:ISRC<ant>][:FRAMe<fr>]:SUMMary:TSTamp? [<Result>]

Queries the time stamp of an event.

Suffix:

<cc> [Component Carrier](#)
 <ant> irrelevant
 <fr> [Frame](#)

Query parameters:

<Result> ALL
 Available for combined measurements.
 Queries the time stamp of all events (meas IDs).
 Omitting this parameter queries the time stamp of the selected event.

Return values:

<Time> Default unit: s

Example:

//Query time stamp
 FETC:CC2:FRAM3:SUMM:TST?

Usage:

Query only

Manual operation: See ["Time Stamp"](#) on page 61

FETCh[:CC<cc>][:ISRC<ant>]:SUMMary:TFRame?

Queries the frame start offset as shown in the capture buffer.

Suffix:

<cc> [Component Carrier](#)

<ant> irrelevant

Return values:

<Offset> Default unit: s

Example:

```
//Query frame start offset
FETC:SUMM:TFR?
```

Usage:

Query only

Manual operation: See ["Frame Start Offset"](#) on page 25
See ["Capture Buffer"](#) on page 28

6.6.2 Time alignment error

FETCh:TAERror[:CC<cc>]:AP<ap>:MAXimum?	252
FETCh:TAERror[:CC<cc>]:AP<ap>:MINimum?	252
FETCh:TAERror[:CC<cc>]:AP<ap>[:AVERage]?	252

FETCh:TAERror[:CC<cc>]:AP<ap>:MAXimum?

FETCh:TAERror[:CC<cc>]:AP<ap>:MINimum?

FETCh:TAERror[:CC<cc>]:AP<ap>[:AVERage]?

Suffix:

<cc> [Component Carrier](#)

<ap> 1000 ... 1011
[Antenna port](#)

Return values:

<TAE> Minimum, maximum or average time alignment error, depending on the last command syntax element.

Example:

```
//Query average TAE between reference antenna port and
antenna port 1006
FETC:TAER:AP1001?
```

Usage:

Query only

Manual operation: See ["Time Alignment Error"](#) on page 46

6.6.3 Marker table

CALCulate<n>:DELTaMarker<m>:X.....	253
CALCulate<n>:DELTaMarker<m>:Y?.....	253
CALCulate<n>:MARKer<m>:X.....	254
CALCulate<n>:MARKer<m>:Y.....	254
CALCulate<n>:MARKer<m>:Z?.....	255
CALCulate<n>:MARKer<m>:Z:ALL?.....	255

CALCulate<n>:DELTaMarker<m>:X <Position>

Moves a delta marker to a particular coordinate on the x-axis.

If necessary, the command activates the delta marker and positions a reference marker to the peak power.

Suffix:

<n> Window

<m> Marker

Parameters:

<Position> Numeric value that defines the marker position on the x-axis.
 Range: The value range and unit depend on the measurement and scale of the x-axis.

Example:

CALC:DELT:X?
 Outputs the absolute x-value of delta marker 1.

CALCulate<n>:DELTaMarker<m>:Y?

Queries the position of a deltamarker on the y-axis.

If necessary, the command activates the deltamarker first.

To get a valid result, you have to perform a complete measurement with synchronization to the end of the measurement before reading out the result. This is only possible for single measurement mode.

See also [INITiate<n>:CONTinuous](#) on page 229.

Note that result displays with a third aspect (for example "EVM vs Symbol x Carrier") do not support deltamarkers.

Suffix:

<n> Window

<m> Marker

Return values:

<Result> <numeric value>
 Result at the deltamarker position. The return value is a value relative to the position of marker 1.
 The type of value and its unit depend on the selected result display.

Example: //Query coordinates of deltamarker 2 in window 4
 CALC4:DELT2:X?
 CALC4:DELT2:Y?

Usage: Query only

CALCulate<n>:MARKer<m>:X <Position>

Moves a marker to a specific coordinate on the x-axis.

If necessary, the command activates the marker.

If the marker has been used as a delta marker, the command turns it into a normal marker.

Suffix:

<n> [Window](#)

<m> [Marker](#)

Note that 3D diagrams only support one marker.

Parameters:

<Position> Numeric value that defines the marker position on the x-axis.
 The unit depends on the result display.

Range: The range depends on the current x-axis range.
 Default unit: Hz

Example: CALC:MARK2:X 1.7MHz
 Positions marker 2 to frequency 1.7 MHz.

Manual operation: See "[Marker Table](#)" on page 43
 See "[Marker Peak List](#)" on page 59

CALCulate<n>:MARKer<m>:Y <Result>

Queries the position of a marker on the y-axis.

In result displays with a third aspect (for example "EVM vs Symbol x Carrier"), you can also use the command to define the position of the marker on the y-axis.

If necessary, the command activates the marker first.

To get a valid result, you have to perform a complete measurement with synchronization to the end of the measurement before reading out the result. This is only possible for single measurement mode.

See also [INITiate<n>:CONTinuous](#) on page 229.

Suffix:

<n> [Window](#)

<m> [Marker](#)

Note that 3D diagrams only support one marker.

Parameters:

<Result> <numeric value>
 Result at the marker position.
 The type of value and its unit depend on the selected result display.

Example: //Query coordinates of marker 2 in window 4
 CALC4:MARK2:X?
 CALC4:MARK2:Y?

Example: //Define position of marker in 3D diagram
 CALC:MARK:X 16
 CALC:MARK:Y 6

Manual operation: See "[Marker Table](#)" on page 43
 See "[Marker Peak List](#)" on page 59

CALCulate<n>:MARKer<m>:Z?

Queries the marker position on the z-axis of three-dimensional result displays.

Returns the type of value displayed in the selected result display (EVM, Power or Allocation ID).

Suffix:

<n> [Window](#)

<m> [Marker](#)

Return values:

<Position> <numeric value>
 Default unit: Depends on result display

Example: //Query marker position
 CALC:MARK:Z?

Usage: Query only

Manual operation: See "[Marker Table](#)" on page 43

CALCulate<n>:MARKer<m>:Z:ALL?

Queries the marker position on the z-axis of three-dimensional result displays.

Instead of returning a certain type of value (EVM, Power **or** Allocation ID), which is possible with [CALCulate<n>:MARKer<m>:Z?](#), this command returns all types of values (EVM, Power **and** Allocation ID), regardless of the result display type.

Suffix:

<n> [Window](#)

<m> irrelevant

Return values:

<Position> <numeric value>

EVM

EVM at the marker position.

Power

Power at the marker position.

Allocation ID

Allocation ID at the marker position.

Example: //Query EVM, Power and Allocation ID at the marker position.
CALC:MARK:Z:ALL?

Usage: Query only

Manual operation: See "[Marker Table](#)" on page 43

6.6.4 CCDF table

CALCulate<n>:STATistics:CCDF:X<t>?	256
CALCulate<n>:STATistics:RESult<res>?	256

CALCulate<n>:STATistics:CCDF:X<t>? <Probability>

Queries the results of the CCDF.

Suffix:<n> [Window](#)<t> [Trace](#)**Query parameters:**

<Probability> **P0_01**
Level value for 0.01 % probability

P0_1
Level value for 0.1 % probability

P1
P1: Level value for 1 % probability

P10
Level value for 10 % probability

Return values:

<CCDF Result>

Example: CALC:STAT:CCDF:X1? P10
Returns the level values that are over 10 % above the mean value.

Usage: Query only

Manual operation: See "[CCDF](#)" on page 34

CALCulate<n>:STATistics:RESult<res>? <ResultType>

Queries the results of a measurement for a specific trace.

Suffix:<n> [Window](#)<res> [Trace](#)**Query parameters:**

<ResultType>

MEAN

Average (=RMS) power in dBm measured during the measurement time.

PEAK

Peak power in dBm measured during the measurement time.

CFACTOR

Determined crest factor (= ratio of peak power to average power) in dB.

ALL

Results of all three measurements mentioned before, separated by commas: <mean power>,<peak power>,<crest factor>

Example:

CALC:STAT:RES2? ALL

Reads out the three measurement results of trace 2. Example of answer string: 5.56,19.25,13.69 i.e. mean power: 5.56 dBm, peak power 19.25 dBm, crest factor 13.69 dB

Usage: Query only**Manual operation:** See "[CCDF](#)" on page 34

6.7 Limit check results

- [EVM limits](#)..... 257
- [Transmit power on / off limits](#)..... 262
- [Frequency sweep limits](#).....263

6.7.1 EVM limits

CALCulate<n>:LIMit[:CC<cc>][:ISRC<ant>][:FRAME<fr>]:SUMMARY:ALL:RESult?.....	258
CALCulate<n>:LIMit[:CC<cc>][:ISRC<ant>][:FRAME<fr>]:SUMMARY:EVM:DS1K[: AVERage]:RESult?.....	258
CALCulate<n>:LIMit[:CC<cc>][:ISRC<ant>][:FRAME<fr>]:SUMMARY:EVM:DSQP[: AVERage]:RESult?.....	259
CALCulate<n>:LIMit[:CC<cc>][:ISRC<ant>][:FRAME<fr>]:SUMMARY:EVM:DSSF[: AVERage]:RESult?.....	259
CALCulate<n>:LIMit[:CC<cc>][:ISRC<ant>][:FRAME<fr>]:SUMMARY:EVM:DSST[: AVERage]:RESult?.....	260
CALCulate<n>:LIMit[:CC<cc>][:ISRC<ant>][:FRAME<fr>]:SUMMARY:EVM:DSTS[: AVERage]:RESult?.....	261
CALCulate<n>:LIMit[:CC<cc>][:ISRC<ant>][:FRAME<fr>]:SUMMARY:EVM:FERRor[: AVERage]:RESult?.....	261

CALCulate<n>:LIMit[:CC<cc>][:ISRC<ant>][:FRAMe<fr>]:SUMMary:ALL:RESult?

Queries the limits and limit check results for all numerical results that evaluate 3GPP limits.

Suffix:

<n>	irrelevant
	irrelevant
<cc>	irrelevant
<ant>	irrelevant
<fr>	irrelevant

Return values:

<Result> String containing the limit information for all results that evaluate limits.
 For each limit, the command returns the following information:
 <ResultType>, <Limit>, <LimitCheckAverage>, <LimitCheckMin>, <LimitCheckMax>
 For results that are not checked against a limit, the command returns NOTEVALUATED.

Example:

```
//Query limit check information
CALC:LIM:SUMM:ALL:RES?
would return, e.g.
EVM PDSCH QPSK,
+1.850000000E+001, PASSED, NOTEVALUATED,
NOTEVALUATED,
EVM PDSCH 16QAM,
+1.350000000E+001, NOTEVALUATED, NOTEVALUATED,
NOTEVALUATED,
...
```

Usage: Query only

Manual operation: See "[Remote queries](#)" on page 24

CALCulate<n>:LIMit[:CC<cc>][:ISRC<ant>][:FRAMe<fr>]:SUMMary:EVM:DS1K[:AVERAge]:RESult?

Queries the limit specified by 3GPP for the EVM of all PDSCH resource elements with a 1024QAM modulation.

Suffix:

<n>	irrelevant
	irrelevant
<cc>	irrelevant
<ant>	irrelevant

<fr> irrelevant

Return values:

<LimitCheck>

FAILED

Limit check has failed.

PASSED

Limit check has passed.

NOTEVALUATED

Limits have not been evaluated.

Example:

```
//Query limit check result
CALC:LIM:SUMM:EVM:DS1K:RES?
```

Usage:

Query only

CALCulate<n>:LIMit[:CC<cc>][:ISRC<ant>][:FRAME<fr>]:SUMMary:EVM:DSQP[:AVERAge]:RESult?

Queries the limit specified by 3GPP for the EVM of all PDSCH resource elements with a QPSK modulation.

Suffix:

<n> irrelevant

 irrelevant

<cc> irrelevant

<ant> irrelevant

<fr> irrelevant

Return values:

<LimitCheck>

FAILED

Limit check has failed.

PASSED

Limit check has passed.

NOTEVALUATED

Limits have not been evaluated.

Example:

```
//Query limit check result
CALC:LIM:SUMM:EVM:DSQP:RES?
```

Usage:

Query only

Manual operation: See "EVM PDSCH" on page 24

CALCulate<n>:LIMit[:CC<cc>][:ISRC<ant>][:FRAME<fr>]:SUMMary:EVM:DSSF[:AVERAge]:RESult?

Queries the limit specified by 3GPP for the EVM of all PDSCH resource elements with a 64QAM modulation.

Suffix:

<n>	irrelevant
	irrelevant
<cc>	irrelevant
<ant>	irrelevant
<fr>	irrelevant

Return values:

<LimitCheck>	FAILED Limit check has failed.
	PASSED Limit check has passed.
	NOTEVALUATED Limits have not been evaluated.

Example:

```
//Query limit check result
CALC:LIM:SUMM:EVM:DSSF:RES?
```

Usage:

Query only

Manual operation:

See "EVM PDSCH" on page 24

**CALCulate<n>:LIMit[:CC<cc>][:ISRC<ant>][:FRAMe<fr>]:SUMMery:EVM:
DSST[:AVERAge]:RESult?**

Queries the limit specified by 3GPP for the EVM of all PDSCH resource elements with a 16QAM modulation.

Suffix:

<n>	irrelevant
	irrelevant
<cc>	irrelevant
<ant>	irrelevant
<fr>	irrelevant

Return values:

<LimitCheck>	FAILED Limit check has failed.
	PASSED Limit check has passed.
	NOTEVALUATED Limits have not been evaluated.

Example:

```
//Query limit check result
CALC:LIM:SUMM:EVM:DSST:RES?
```

Usage:

Query only

Manual operation:

See "EVM PDSCH" on page 24

**CALCulate<n>:LIMit[:CC<cc>][:ISRC<ant>][:FRAMe<fr>]:SUMMary:EVM:
DSTS[:AVERAge]:RESult?**

Queries the limit specified by 3GPP for the EVM of all PDSCH resource elements with a 256QAM modulation.

Suffix:

<n>	irrelevant
	irrelevant
<cc>	irrelevant
<ant>	irrelevant
<fr>	irrelevant

Return values:

<LimitCheck>	FAILED Limit check has failed.
	PASSED Limit check has passed.
	NOTEVALUATED Limits have not been evaluated.

Example: //Query limit check result
CALC:LIM:SUMM:EVM:DSTS:RES?

Usage: Query only

Manual operation: See "[EVM PDSCH](#)" on page 24

**CALCulate<n>:LIMit[:CC<cc>][:ISRC<ant>][:FRAMe<fr>]:SUMMary:EVM:
FERRor[:AVERAge]:RESult?**

Queries the limit specified by 3GPP for the frequency error.

Suffix:

<n>	irrelevant
	irrelevant
<cc>	irrelevant
<ant>	irrelevant
<fr>	irrelevant

Return values:

<LimitCheck>	FAILED Limit check has failed.
	PASSED Limit check has passed.
	NOTEVALUATED Limits have not been evaluated.

Example: //Query limit check result
CALC:LIM:SUMM:EVM:FERR:RES?

Usage: Query only

Manual operation: See "Frequency Error" on page 26

6.7.2 Transmit power on / off limits

CALCulate<n>:LIMit:OOPower:OFFPower?..... 262
CALCulate<n>:LIMit:OOPower:TRANSient?..... 262

CALCulate<n>:LIMit:OOPower:OFFPower?

Queries the results of the limit check in the "Off" periods of On/Off Power measurements.

Suffix:

<n> irrelevant

 irrelevant

Return values:

<Results> Returns one value for every "Off" period.

PASSED
Limit check has passed.

FAILED
Limit check has failed.

Example: //Query the results for the limit check during the signal OFF periods
CALC:LIM:OOP:OFFP?

Usage: Query only

CALCulate<n>:LIMit:OOPower:TRANSient? <Result>

Queries the results of the limit check during the transient periods of the On/Off power measurement.

Suffix:

<n> irrelevant

 irrelevant

Query parameters:

<Result> **ALL**
Queries the overall limit check results.

FALLing
Queries the limit check results of falling transients.

RISing

Queries the limit check results of rising transients.

Return values:

<LimitCheck> Returns one value for every "Off" period.

PASSED

Limit check has passed.

FAILED

Limit check has failed.

Example:

```
//Query the limit check result of rising transients
CALC:LIM:OOP:TRAN? RIS
```

Usage:

Query only

6.7.3 Frequency sweep limits

CALCulate<n>:LIMit:ACPpower:ACHannel:RESult?	263
CALCulate<n>:LIMit:ACPpower:ACHannel:RESult:ABSolute	264
CALCulate<n>:LIMit:ACPpower:ACHannel:RESult:RELative	264
CALCulate<n>:LIMit:ACPpower:ALTernate<alt>:RESult?	265
CALCulate<n>:LIMit:ACPpower:ALTernate<ch>:RESult:ABSolute	266
CALCulate<n>:LIMit:ACPpower:ALTernate<ch>:RESult:RELative	266
CALCulate<n>:LIMit:ACPpower:GAP<gap>:ACLR:RESult?	267
CALCulate<n>:LIMit:ACPpower:GAP<gap>:ACLR:RESult:ABSolute?	267
CALCulate<n>:LIMit:ACPpower:GAP<gap>:ACLR:RESult:RELative?	268
CALCulate<n>:LIMit:ACPpower:GAP<gap>[:CACLR]:RESult?	268
CALCulate<n>:LIMit:ACPpower:GAP<gap>[:CACLR]:RESult:ABSolute?	269
CALCulate<n>:LIMit:ACPpower:GAP<gap>[:CACLR]:RESult:RELative?	269
CALCulate<n>:LIMit:FAIL?	270

CALCulate<n>:LIMit:ACPpower:ACHannel:RESult? [<Result>]

Queries the limit check results for the adjacent channels during ACLR measurements.

Suffix:

<n> irrelevant

 irrelevant

Query parameters:

<Result> **REL**
Queries the channel power limit check results.

ABS

Queries the distance to the limit line.

Return values:

<LimitCheck> Returns two values, one for the upper and one for the lower adjacent channel.

PASSED

Limit check has passed.

FAILED

Limit check has failed.

- Example:** //Query results of the adjacent channel limit check
CALC:LIM:ACP:ACH:RES?
- Example:** //Query results of the adjacent channel limit check
CALC:LIM:ACP:ACH:RES? ABS
- Usage:** Query only
- Manual operation:** See "Result summary" on page 55
See "Result summary" on page 57

CALCulate<n>:LIMit:ACPpower:ACHannel:RESult:ABSolute

Queries the absolute limit check results for adjacent channels (ACLR measurements).

Prerequisites for this command

- Select absolute limit check mode evaluation mode
ACLR: CALCulate<n>:LIMit:ACPpower:PMODE.
Combined measurements: [SENSe:]NR5G:ACPpower:ALPMode on page 439

Suffix:

<n> irrelevant

 irrelevant

Return values:

<LimitCheck> Returns two values, one for the upper and one for the lower adjacent channel.

PASSED

Limit check has passed.

FAILED

Limit check has failed.

- Example:** //Query results of the adjacent channel limit check
CALC:LIM:ACP:ACH:RES:ABS?

- Manual operation:** See "Result summary" on page 54
See "Result summary" on page 55
See "Result summary" on page 57

CALCulate<n>:LIMit:ACPpower:ACHannel:RESult:RELative

Queries the relative limit check results for the adjacent channels (ACLR measurements).

Prerequisites for this command

- Select relative limit check mode
ACLR: CALCulate<n>:LIMit:ACPpower:PMODE.
Combined measurements: [SENSe:]NR5G:ACPpower:ALPMode on page 439

Suffix:

<n> irrelevant

 irrelevant

Return values:

<LimitCheck> Returns two values, one for the upper and one for the lower adjacent channel.

PASSED

Limit check has passed.

FAILED

Limit check has failed.

Example:

//Query results of the adjacent channel limit check

CALC:LIM:ACP:ACH:RES:REL?

Manual operation:

See ["Result summary"](#) on page 54

See ["Result summary"](#) on page 55

See ["Result summary"](#) on page 57

CALCulate<n>:LIMit:ACPpower:ALternate<alt>:RESult? [<Result>]

Queries the limit check results for the alternate channels during ACLR measurements.

Suffix:

<n> irrelevant

 irrelevant

<alt> irrelevant

Query parameters:

<Result> **REL**

Queries the channel power limit check results.

ABS

Queries the distance to the limit line.

Return values:

<LimitCheck> Returns two values, one for the upper and one for the lower alternate channel.

PASSED

Limit check has passed.

FAILED

Limit check has failed.

Example:

//Query results of the alternate channel limit check

CALC:LIM:ACP:ALT:RES?

Example:

//Query results of the alternate channel limit check

CALC:LIM:ACP:ACH:RES? ABS

Usage:

Query only

Manual operation:

See ["Result summary"](#) on page 55

See ["Result summary"](#) on page 57

CALCulate<n>:LIMit:ACPpower:ALternate<ch>:RESult:ABSolute

Queries the absolute limit check results for the alternate channels (MC ACLR measurements).

Prerequisites for this command

- Select absolute limit check mode
ACLR: `CALCulate<n>:LIMit:ACPpower:PMODE.`

Suffix:

<n>	irrelevant
	irrelevant
<ch>	irrelevant

Return values:

<LimitCheck> Returns two values, one for the upper and one for the lower adjacent channel.

PASSED

Limit check has passed.

FAILED

Limit check has failed.

Example:

```
//Query results of the alternate channel limit check
CALC:LIM:ACP:ALT:RES:ABS?
```

Manual operation: See ["Result summary"](#) on page 55
See ["Result summary"](#) on page 57

CALCulate<n>:LIMit:ACPpower:ALternate<ch>:RESult:RELative

Queries the relative limit check results for the alternate channels (MC ACLR measurements).

Prerequisites for this command

- Select relative limit check mode
ACLR: `CALCulate<n>:LIMit:ACPpower:PMODE.`

Suffix:

<n>	irrelevant
	irrelevant
<ch>	irrelevant

Return values:

<LimitCheck> Returns two values, one for the upper and one for the lower adjacent channel.

PASSED

Limit check has passed.

FAILED

Limit check has failed.

Example: //Query results of the alternate channel limit check
 CALC:LIM:ACP:ALT:RES:REL?

Manual operation: See "Result summary" on page 55
 See "Result summary" on page 57

CALCulate<n>:LIMit:ACPpower:GAP<gap>:ACLR:RESult?

Queries the ACLR power limit check results for the gap channels (MC ACLR measurements).

Suffix:

<n> irrelevant
 irrelevant
 <gap> irrelevant

Return values:

<LimitCheck> Returns two values, one for the upper and one for the lower adjacent channel.

PASSED

Limit check has passed.

FAILED

Limit check has failed.

Example: //Query results of the gap channel limit check
 CALC:LIM:ACP:GAP:ACLR:RES?

Usage: Query only

CALCulate<n>:LIMit:ACPpower:GAP<gap>:ACLR:RESult:ABSolute?

Queries the absolute power limit check results for the gap channels (MC ACLR measurements).

Prerequisites for this command

- Select absolute limit check mode
 evaluation mode

ACLR: CALCulate<n>:LIMit:ACPpower:PMODE.

Combined measurements: [SENSe:]NR5G:ACPpower:ALPMode on page 439

Suffix:

<n> irrelevant
 irrelevant
 <gap> irrelevant

Return values:

<LimitCheck> Returns two values, one for the upper and one for the lower adjacent channel.

PASSED

Limit check has passed.

FAILED

Limit check has failed.

Example: //Query results of the gap channel limit check
 CALC:LIM:ACP:GAP:ACLR:RES:ABS?

Usage: Query only

CALCulate<n>:LIMit:ACPpower:GAP<gap>:ACLR:RESult:RELative?

Queries the relative power limit check results for the gap channels (MC ACLR measurements).

Prerequisites for this command

- Select relative limit check mode evaluation mode

ACLR: [CALCulate<n>:LIMit:ACPpower:PMODE](#).

Combined measurements: [\[SENSe:\]NR5G:ACPpower:ALPMode](#) on page 439

Suffix:

<n> irrelevant

 irrelevant

<gap> irrelevant

Return values:

<LimitCheck> Returns two values, one for the upper and one for the lower adjacent channel.

PASSED

Limit check has passed.

FAILED

Limit check has failed.

Example: //Query results of the gap channel limit check
 CALC:LIM:ACP:GAP:ACLR:RES:REL?

Usage: Query only

CALCulate<n>:LIMit:ACPpower:GAP<gap>[:CACLR]:RESult?

Queries the limit check results for the gap channels (MC ACLR measurements).

Suffix:

<n> irrelevant

 irrelevant

<gap> irrelevant

Return values:

<LimitCheck> Returns two values, one for the upper and one for the lower adjacent channel.

PASSED

Limit check has passed.

FAILED

Limit check has failed.

Example: //Query results of the gap channel limit check
 CALC:LIM:ACP:GAP:RES?

Usage: Query only

CALCulate<n>:LIMit:ACPower:GAP<gap>[:CACLR]:RESult:ABSolute?

Queries the absolute limit check results for the gap channels (MC ACLR measurements).

Prerequisites for this command

- Select absolute limit check mode evaluation mode

ACLR: [CALCulate<n>:LIMit:ACPower:PMODE](#).

Combined measurements: [\[SENSe:\]NR5G:ACPower:ALPMode](#) on page 439

Suffix:

<n> irrelevant

 irrelevant

<gap> irrelevant

Return values:

<LimitCheck> Returns two values, one for the upper and one for the lower adjacent channel.

PASSED

Limit check has passed.

FAILED

Limit check has failed.

Example: //Query results of the gap channel limit check
 CALC:LIM:ACP:GAP:RES:ABS?

Usage: Query only

CALCulate<n>:LIMit:ACPower:GAP<gap>[:CACLR]:RESult:RELative?

Queries the relative limit check results for the gap channels (MC ACLR measurements).

Prerequisites for this command

- Select relative limit check mode evaluation mode

ACLR: [CALCulate<n>:LIMit:ACPower:PMODE](#).

Combined measurements: [\[SENSe:\]NR5G:ACPower:ALPMode](#) on page 439

Suffix:

<n>	irrelevant
	irrelevant
<gap>	irrelevant

Return values:

<LimitCheck> Returns two values, one for the upper and one for the lower adjacent channel.

PASSED

Limit check has passed.

FAILED

Limit check has failed.

Example:

```
//Query results of the gap channel limit check
CALC:LIM:ACP:GAP:RES:REL?
```

Usage:

Query only

CALCulate<n>:LIMit:FAIL?

Queries the limit check results for all measurements that feature a limit check.

For ACLR measurements: Returns the result of the overall limit check (absolute and relative limit evaluation).

Suffix:

<n>	1..n Window
	irrelevant

Return values:

<LimitCheck>	0 Limit check has passed.
	1 Limit check has failed. For spectrum flatness: Limit out of selected band.
	2 For spectrum flatness: Limit out of band.
	3 For spectrum flatness: Limit check has failed.

Example:

```
//Query the limit check in the active result display
CALC:LIM:FAIL?
```

Usage:

Query only

Manual operation: See "[Result summary](#)" on page 54

6.8 Retrieve trace data

- [Using the TRACe\[:DATA\] command](#)..... 271
- [Read measurement results](#)..... 289

6.8.1 Using the TRACe[:DATA] command

This chapter contains information on the `TRACe:DATA` command and a detailed description of the characteristics of that command.

The `TRACe:DATA` command queries the trace data or results of the currently active measurement or result display. The type, number and structure of the return values are specific for each result display. In case of results that have any kind of unit, the command returns the results in the unit you have currently set for that result display.

For several result displays, the command also supports various SCPI parameters in combination with the query. If available, each SCPI parameter returns a different aspect of the results. If SCPI parameters are supported, you have to quote one in the query.

Example:

```
TRAC2:DATA? TRACE1
```

The format of the return values is either in ASCII or binary characters and depends on the format you have set with `FORMat[:DATA]`.

Following this detailed description, you will find a short summary of the most important functions of the command (`TRACe<n>[:DATA]?`).



Selecting a measurement window

Before querying results, you have to select the measurement window with the suffix `<n>` at `TRACe`. The range of `<n>` depends on the number of active measurement windows.

For measurements on aggregated carriers, where each measurement window has subwindows, you have to select the subwindow first with `DISPlay[:WINDow<n>][:SUBWindow<w>]:SElect`.

- [Capture buffer](#)..... 272
- [EVM vs carrier](#)..... 272
- [EVM vs symbol](#)..... 273
- [EVM vs RB](#)..... 273
- [Frequency error vs symbol](#)..... 274
- [Frequency error vs subframe](#)..... 275
- [Power spectrum](#)..... 275
- [Flatness vs carrier](#)..... 275
- [CCDF](#)..... 276
- [Constellation diagram](#)..... 277
- [Allocation summary](#)..... 277

• Bitstream.....	279
• Channel decoder results.....	280
• EVM vs symbol x carrier.....	281
• Power vs symbol x carrier.....	281
• Allocation ID vs symbol x carrier.....	282
• RS phase.....	283
• RS magnitude.....	283
• RS phase difference.....	284
• Beamforming summary.....	285
• Adjacent channel leakage ratio.....	285
• Spectrum emission mask.....	286
• On/off power.....	287
• Combined EVM / ACLR / SEM.....	287
• Return value codes.....	288

6.8.1.1 Capture buffer

For the capture buffer result display, the command returns one value for each I/Q sample in the capture buffer.

```
<absolute power>, ...
```

The unit is always dBm.

The following parameters are supported.

- TRAC:DATA TRACE1

Note that the command returns positive peak values only.

6.8.1.2 EVM vs carrier

For the EVM vs carrier result display, the command returns one value for each subcarrier that has been analyzed.

```
<EVM>, ...
```

The unit depends on [UNIT:EVM](#).

The following parameters are supported.

- TRAC:DATA TRACE1

The return values depend on the evaluation range:

- All bandwidth parts: average EVM of the SS/PBCH block over all subframes (or the first bandwidth part if the SS/PBCH block does not exist).
- A specific bandwidth part: average EVM of the selected BWP over all subframes.
- A specific subframe: average EVM of that subframe over all slots.
- A specific slot: EVM of that slot.

- TRAC:DATA TRACE2

The return values depend on the evaluation range:

- All bandwidth parts: average EVM of the first BWP over all subframes.

- A specific bandwidth part: minimum EVM of the selected BWP block over all subframes.
- A specific subframe: minimum EVM of that subframe over all slots.
- A specific slot: not supported.
- `TRAC:DATA TRACE3`
The return values depend on the evaluation range:
 - All bandwidth parts: average EVM of the second BWP over all subframes.
 - A specific bandwidth part: maximum EVM of the selected BWP block over all subframes.
 - A specific subframe: maximum EVM of that subframe over all slots.
 - A specific slot: not supported.
- `TRAC:DATA TRACE4 | TRACE5 | TRACE6 | TRACE7 | TRACE8`
Only supported for evaluation over all bandwidth parts.
Returns the average EVM of the corresponding bandwidth part over all subframes (for example TRACE4 for the 4th bandwidth part).

6.8.1.3 EVM vs symbol

For the EVM vs symbol result display, the command returns one value for each OFDM symbol that has been analyzed.

<EVM>, ...

The unit depends on [UNIT:EVM](#).

The following parameters are supported.

- `TRAC:DATA TRACE1`
The return values depend on the evaluation range:
 - All bandwidth parts: EVM of the SS/PBCH block over all subframes (or the first bandwidth part if the SS/PBCH block does not exist).
 - A specific bandwidth part: EVM of the selected BWP over all subframes.
 - A specific subframe: EVM of that subframe over all slots.
 - A specific slot: EVM of that slot.
- `TRAC:DATA TRACE2 to TRACE8`
Only supported for evaluation over all bandwidth parts.
Returns the EVM of the corresponding bandwidth part over all subframes (for example TRACE4 for the 4th bandwidth part).

6.8.1.4 EVM vs RB

For the EVM vs RB result display, the command returns one value for each resource block that has been analyzed.

<EVM>, ...

The unit depends on [UNIT:EVM](#).

The following parameters are supported.

- TRAC:DATA TRACE1

The return values depend on the evaluation range:

- All bandwidth parts: average EVM of the first bandwidth part if the SS/PBCH block does not exist (if the SS/PBCH block exists, it returns an error).
- A specific bandwidth part: average EVM of the selected BWP over all subframes.
- A specific subframe: average EVM of that subframe over all slots.
- A specific slot: EVM of that slot.

- TRAC:DATA TRACE2

The return values depend on the evaluation range:

- All bandwidth parts: average EVM of the first bandwidth part if the SS/PBCH block does exist. If the SS/PBCH block does not exist, it returns the results of the second bandwidth part).
- A specific bandwidth part: minimum EVM of the selected BWP block over all subframes.
- A specific subframe: minimum EVM of that subframe over all slots.
- A specific slot: not supported.

- TRAC:DATA TRACE3

The return values depend on the evaluation range:

- All bandwidth parts: average EVM of the third BWP over all subframes.
- A specific bandwidth part: maximum EVM of the selected BWP block over all subframes.
- A specific subframe: maximum EVM of that subframe over all slots.
- A specific slot: not supported.

- TRAC:DATA TRACE4 | TRACE5 | TRACE6 | TRACE7 | TRACE8

Only supported for evaluation over all bandwidth parts.

Returns the average EVM of the corresponding bandwidth part over all subframes (for example TRACE4 for the 4th bandwidth part).

6.8.1.5 Frequency error vs symbol

For the frequency error vs symbol result display, the command returns one value for each OFDM symbol that has been analyzed.

<frequency error>,...

The unit is always Hz.

The following parameters are supported.

- TRAC:DATA TRACE1

The return values depend on the evaluation range:

- All bandwidth parts: Frequency error of the SS/PBCH block over all subframes (or the first bandwidth part if the SS/PBCH block does not exist).

- A specific bandwidth part: Frequency error of the selected BWP over all subframes.
- A specific subframe: Frequency error of that subframe over all slots.
- A specific slot: Frequency error of that slot.
- `TRAC:DATA TRACE2 to TRACE8`
Only supported for evaluation over all bandwidth parts.
Returns the average EVM of the corresponding bandwidth part over all subframes (for example TRACE4 for the 4th bandwidth part).

6.8.1.6 Frequency error vs subframe

For the frequency error vs symbol result display, the command returns one value for each of the nine subframes that have been analyzed.

`<frequency error>, ...`

The unit is always Hz.

The following parameters are supported.

- `TRAC:DATA TRACE1`
The return values depend on the evaluation range:
 - All bandwidth parts: Frequency error for the subframes of the SS/PBCH block (or the first bandwidth part if the SS/PBCH block does not exist).
 - A specific bandwidth part: Frequency error for the subframes of the selected BWP.
- `TRAC:DATA TRACE2 to TRACE8`
Only supported for evaluation over all bandwidth parts.
Returns the frequency error for the subframes of the corresponding bandwidth part (for example TRACE4 for the 4th bandwidth part).

6.8.1.7 Power spectrum

For the power spectrum result display, the command returns one value for each trace point.

`<power>, ...`

The unit is always dBm/Hz.

The following parameters are supported.

- `TRAC:DATA TRACE1`

6.8.1.8 Flatness vs carrier

For the flatness vs carrier result display, the command returns one value for each trace point.

`<relative power>, ...`

The unit is always dB. The number of values depends on the selected 5G NR bandwidth.

The following parameters are supported.

- `TRAC:DATA TRACE1`

The return values depend on the evaluation range:

- All bandwidth parts: average power of the SS/PBCH block over all subframes.
- A specific bandwidth part: average power of the selected BWP over all subframes.
- A specific subframe: average power of that subframe over all slots.
- A specific slot: power of that slot.

- `TRAC:DATA TRACE2`

The return values depend on the evaluation range:

- All bandwidth parts: average power of the first BWP over all subframes.
- A specific bandwidth part: minimum power of the selected BWP block over all subframes.
- A specific subframe: minimum power of that subframe over all slots.
- A specific slot: not supported.

- `TRAC:DATA TRACE3`

The return values depend on the evaluation range:

- All bandwidth parts: average power of the second BWP over all subframes.
- A specific bandwidth part: maximum power of the selected BWP block over all subframes.
- A specific subframe: maximum power of that subframe over all slots.
- A specific slot: not supported.

- `TRAC:DATA TRACE4 | TRACE5 | TRACE6 | TRACE7 | TRACE8`

Only supported for evaluation over all bandwidth parts.

Returns the average EVM of the corresponding bandwidth part over all subframes (for example TRACE4 for the 4th bandwidth part).

6.8.1.9 CCDF

For the CCDF result display, the type of return values depends on the parameter.

- `TRAC:DATA TRACE1`

Returns the probability values (y-axis).

<# of values>, <probability>, ...

The unit is always %.

The first value that is returned is the number of the following values.

- `TRAC:DATA TRACE2`

Returns the corresponding power levels (x-axis).

<# of values>, <relative power>, ...

The unit is always dB.

The first value that is returned is the number of the following values.

6.8.1.10 Constellation diagram

For the constellation diagram, the command returns two values for each constellation point.

```
<I[SF0][Sym0][Carrier1]>, <Q[SF0][Sym0][Carrier1]>, ..., <I[SF0][Sym0][Carrier(n)]>, <Q[SF0][Sym0][Carrier(n)]>,
<I[SF0][Sym1][Carrier1]>, <Q[SF0][Sym1][Carrier1]>, ..., <I[SF0][Sym1][Carrier(n)]>, <Q[SF0][Sym1][Carrier(n)]>,
<I[SF0][Sym(n)][Carrier1]>, <Q[SF0][Sym(n)][Carrier1]>, ..., <I[SF0][Sym(n)][Carrier(n)]>, <Q[SF0][Sym(n)][Carrier(n)]>,
<I[SF1][Sym0][Carrier1]>, <Q[SF1][Sym0][Carrier1]>, ..., <I[SF1][Sym0][Carrier(n)]>, <Q[SF1][Sym0][Carrier(n)]>,
<I[SF1][Sym1][Carrier1]>, <Q[SF1][Sym1][Carrier1]>, ..., <I[SF1][Sym1][Carrier(n)]>, <Q[SF1][Sym1][Carrier(n)]>,
<I[SF(n)][Sym(n)][Carrier1]>, <Q[SF(n)][Sym(n)][Carrier1]>, ..., <I[SF(n)][Sym(n)][Carrier(n)]>, <Q[SF(n)][Sym(n)][Carrier(n)]>
```

With SF = subframe and Sym = symbol of that subframe.

The I and Q values have no unit.

The number of return values depends on the constellation selection. By default, it returns all resource elements including the DC carrier.

For each bandwidth part, the command returns the values for all resource elements. However, only the resource elements allocated to the corresponding bandwidth part have a value. All others are returned as NAN. If you query the constellation for a signal with SS/PBCH and 2 bandwidth parts, for example, the stream of values would look like this:

- 1st block of values: NAN, NAN, (. . .) , RE [SS/PBCH] , RE [SS/PBCH] , (. . .) , NAN, NAN, (. . .)
- 2nd block of values: NAN, NAN, (. . .) , RE [BWP0] , RE [BWP0] , (. . .) , NAN, NAN, (. . .)
- 3rd block of values: NAN, NAN, (. . .) , RE [BWP1] , RE [BWP1] , (. . .) , NAN, NAN, (. . .)

The following parameters are supported.

- TRAC:DATA TRACE1
Returns all constellation points included in the selection.

6.8.1.11 Allocation summary

For the allocation summary, the command returns several values for each line of the table.

- <bwp>
- <subframe>
- <slot>
- <allocation ID>

- <number of RB>
- <relative power>
- <modulation>
- <absolute power>
- <EVM>

The data format of the return values is always ASCII.

The return values have the following characteristics.

- The <bwp> for bandwidth part containing the synchronization signals is -1. For all other bandwidth parts, the corresponding bandwidth part number, beginning with 0.
- The <allocation ID is encoded.
For the code assignment, see [Chapter 6.8.1.25, "Return value codes"](#), on page 288.
- The unit for <relative power> is always dB.
- The <modulation> is encoded.
For the code assignment, see [Chapter 6.8.1.25, "Return value codes"](#), on page 288.
- The unit for <absolute power> is always dBm.
- The unit for <EVM> depends on `UNIT:EVM`.

Example:

BWP/SF/Slot	Allocation ID	No of RBs	Rel Power [dB]	Modulation	Power per RE [dBm]	EVM [%]
SS / 0 / 0	PSS		0.000	RBPSK	-16.611	3.781
	SSS		0.000	RBPSK	-17.569	0.219
	PBCH DMRS		0.000	QPSK	-17.117	5.935
	PBCH		0.000	QPSK	-17.229	3.278

TRAC:DATA? TRACE1 would return:

```
-1,0,0,-20,,+0.000000000,1,-1.611724981E+001,+3.781490920E-003,
-1,0,0,-21,,+0.000000000,1,-1.756929651E+001,+0.219507916E-003,
-1,0,0,-11,,+0.000000000,2,-1.711705594E+001,+5.935088581E-003,
-1,0,0,-30,,+0.000000000,2,-1.722917126E+001,+3.278761694E-003,
```

Additional information "ALL"

In addition, there is a line at the end of the allocation summary that shows the average EVM over all analyzed subframes. This information is also added as the last return values. The "ALL" information has the subframe ID and allocation ID code "-2".

A query result would thus look like this, for example:

```
//For subframe 0:
0, -40, 10, 2, 2, -84.7431947342849, 2.68723483754626E-06,
0, -41, 0, 0, 6, -84.7431432845264, 2.37549449584568E-06,
(...)
//For subframe 1:
1, -40, 10, 2, 2, -84.7431947342849, 2.68723483754626E-06,
1, -41, 0, 0, 6, -84.7431432845264, 2.37549449584568E-06,
(...)
```

```
//ALL for all subframes
-2,-2,,,,,2.13196434228374E-06
```

6.8.1.12 Bitstream

For the bitstream result display, the number of return values depends on the parameter.

- `TRACE:DATA TRACE1`
Returns several values and the bitstream for each line of the table.
<bwp>, <subframe>, <slot>, <allocation ID>, <codeword>, <modulation>, <# of decoded bits>, <# of decoded bit errors>, <# of symbols/bits>, <hexadecimal/binary numbers>,...
- `TRACE:DATA TRACE2`
Returns the CRC status of an allocation, but not the bitstream.
<bwp>, <subframe>, <slot>, <allocation ID>, <codeword>, <crc status>,...
- `TRAC:DATA TRACE3`
Returns all informative values of an allocation, but not the bitstream.
<bwp>, <subframe>, <slot>, <allocation ID>, <codeword>, <crc status>, <modulation>, <# of decoded bits>, <# of decoded bit errors>, <# of symbols/bits>,...
- `TRAC:DATA TRACE4`
Note that this query is only available under certain circumstances. For more information see the description of the [bitstream](#) result display.
Returns all informative values of an allocation, including the totals over all PDSCH allocations that contribute to the bitstream, but not the bitstream itself.
<bwp>, <subframe>, <slot>, <allocation ID>, <codeword>, <crc status>, <modulation>, <# of decoded bits>, <# of decoded bit errors>, <# of symbols/bits>, ..., <total # decoded bits>, <total # bit errors>, <total # bits>, <total bit error rate>
- `TRAC:DATA TRACE5`
Returns the CRC status of an allocation, including the number of bits in the bitstream.
<bwp>, <subframe>, <slot>, <allocation ID>, <codeword>, <crc status>, <#Bits>,...
- `TRAC:DATA TRACE6`
Note that this query is only available under certain circumstances. For more information see the description of the [bitstream](#) result display.
Returns all informative values of an allocation, including the totals over all PDSCH allocations that contribute to the bitstream, but not the bitstream itself. The difference to `TRACE3` is that this query includes the Bit/s result.
<bwp>, <subframe>, <slot>, <allocation ID>, <codeword>, <crc status>, <modulation>, <# of decoded bits>, <# of decoded bit errors>, <# of symbols/bits>, ..., <total # decoded bits>, <total # bit errors>, <total # bits>, <total bit error rate>, <bit per second>

All values have no unit. The format of the bitstream depends on the [demodulation data](#) property.

The <allocation ID>, <codeword>, <crc status> and <modulation> are encoded. For the code assignment see [Chapter 6.8.1.25, "Return value codes"](#), on page 288.

For symbols or bits that are not transmitted, the command returns

- "FFFF" if the bitstream is analyzed [before decoding](#)
- "9" if the bitstream is analyzed [after decoding](#).

Note that the data format of the return values is always ASCII.

Example:

Sub-frame	Allocation ID	Code-word	Modulation	Symbol Index	Bit Stream
0	PBCH	1/1	QPSK	0	01 01 00 02 03 00 01 02 01 02 01 00 03 00 02 02
0	PBCH	1/1	QPSK	16	02 03 02 03 03 03 00 02 00 03 00 02 02 03 01 01
0	PBCH	1/1	QPSK	32	03 02 03 03 03 03 01 03 00 03 00 03 03 00 03 02

TRAC:DATA? TRACE1 would return:

```
-1,0,0,-500200,0,2,0,0,432, 01, 01, 00, 02, 03, 00, 01, 02, 01, 02, 01, ...
<continues like this until the next data block starts or the end of data is reached>
0,0,0,-200000,0,2,0,0,2430,02,03,03,03,01,01, 01, 03, 00, 03, ...
```

6.8.1.13 Channel decoder results

For the channel decoder Results, the number and type of return values depend on the parameter.

- TRAC:DATA CORESET

Returns the results for DCI decoding. The results are made up out of the following values.

<bwp>, <subframe>, <slot>, <allocationID>, <dci_info>

The <allocationID> is encoded. For the code assignment see [Chapter 6.8.1.25, "Return value codes"](#), on page 288.

If decoding was not successful, the command returns NAN.

<dci_info> is a string with information about the DCI field:

<field_name:bit_length>
- TRAC:DATA PBCH

Returns the results for the PBCH if PBCH decoding (or CRC check) was successful. The results are made up out of the following values.

<subframe>, <ssb>, <ik0_msb_fr1>, <ia6a7_reserved_fr1>, <ssb_index>, <half frame>, <system frame>, <subcarrier spacing>, <subcarrier offset>, <dmrs type a position>, <pdccch config>, <cell barred>, <intra frequency reselection>, <spare>

The unit for <subcarrier spacing> is Hz. All other values have no unit.

The <cell barred> and <intra frequency reselection> are encoded.

For the code assignment see [Chapter 6.8.1.25, "Return value codes"](#), on page 288.

If PBCH decoding was not successful, the command returns NAN.

6.8.1.14 EVM vs symbol x carrier

For the EVM vs symbol x carrier, the command returns one value for each resource element.

```
<SS/BWP>,<Subcarrier Spacing>,<Symbol Start Offset>,  
<Freq Start Offset>,<#Symbols>,<#Carriers>,  
<EVM[Symbol(0),Carrier(1)]>, ..., <EVM[Symbol(0),Carrier(n)]>,  
<EVM[Symbol(1),Carrier(1)]>, ..., <EVM[Symbol(1),Carrier(n)]>,  
...  
<EVM[Symbol(n),Carrier(1)]>, ..., <EVM[Symbol(n),Carrier(n)]>
```

The unit depends on [UNIT:EVM](#).

The number of values depends on the [evaluation range](#).

Resource elements that are unused return NAN.

The following parameters are supported.

- TRAC:DATA TRACE1
 - The return values depend on the evaluation range:
 - All bandwidth parts: EVM of the SS/PBCH block (or the first bandwidth part if the SS/PBCH block does not exist).
 - A specific bandwidth part: EVM of the selected BWP.
- TRAC:DATA TRACE2 to TRACE8
 - Only supported for evaluation over all bandwidth parts.
 - Returns the EVM of the corresponding bandwidth part (for example TRACE4 for the 4th bandwidth part).

6.8.1.15 Power vs symbol x carrier

For the power vs symbol x carrier, the command returns one value for each resource element.

```
<SS/BWP>,<Subcarrier Spacing>,<Symbol Start Offset>,  
<Freq Start Offset>,<#Symbols>,<#Carriers>,  
<P[Symbol(0),Carrier(1)]>, ..., <P[Symbol(0),Carrier(n)]>,  
<P[Symbol(1),Carrier(1)]>, ..., <P[Symbol(1),Carrier(n)]>,  
...  
<P[Symbol(n),Carrier(1)]>, ..., <P[Symbol(n),Carrier(n)]>
```

with P = Power of a resource element.

The unit is always dBm.

The number of values depends on the [evaluation range](#).

Resource elements that are unused return NAN.

The following parameters are supported.

- TRAC:DATA TRACE1

The return values depend on the evaluation range:

- All bandwidth parts: EVM of the SS/PBCH block (or the first bandwidth part if the SS/PBCH block does not exist).
- A specific bandwidth part: EVM of the selected BWP.

- TRAC:DATA TRACE2 to TRACE8

Only supported for evaluation over all bandwidth parts.

Returns the EVM of the corresponding bandwidth part (for example TRACE4 for the 4th bandwidth part).

6.8.1.16 Allocation ID vs symbol x carrier

For the allocation ID vs symbol x carrier, the command returns one value for each resource element.

```
<SS/BWP>,<Subcarrier Spacing>,<Symbol Start Offset>,  
<Freq Start Offset>,<#Symbols>,<#Carriers>,  
<ID[Symbol(0),Carrier(1)]>, ..., <ID[Symbol(0),Carrier(n)]>,  
<ID[Symbol(1),Carrier(1)]>, ..., <ID[Symbol(1),Carrier(n)]>,  
...  
<ID[Symbol(n),Carrier(1)]>, ..., <ID[Symbol(n),Carrier(n)]>
```

The <allocation ID> is encoded.

For the code assignment, see [Chapter 6.8.1.25, "Return value codes"](#), on page 288.

The number of values depends on the [evaluation range](#).

The following parameters are supported.

- TRAC:DATA TRACE1

The return values depend on the evaluation range:

- All bandwidth parts: EVM of the SS/PBCH block (or the first bandwidth part if the SS/PBCH block does not exist).
- A specific bandwidth part: EVM of the selected BWP.

- TRAC:DATA TRACE2 to TRACE8

Only supported for evaluation over all bandwidth parts.

Returns the EVM of the corresponding bandwidth part (for example TRACE4 for the 4th bandwidth part).

6.8.1.17 RS phase

For the RS phase result display, the command returns one value for each subcarrier that has been analyzed.

<Phase>, ...

The unit is degrees.

The following parameters are supported.

- TRAC:DATA TRACE1

The return values depend on the evaluation range:

- All antenna ports: average phase of the antenna port mapped to trace 1.
- A specific antenna port: average phase of the selected antenna port over all slots.
- A specific bandwidth part or subframe: average phase of the selected antenna port over all slots.
- A specific slot: phase of that slot.

- TRAC:DATA TRACE2

The return values depend on the evaluation range:

- All antenna ports: average phase of the antenna port mapped to trace 1.
- A specific antenna port: minimum phase of the selected antenna port over all slots.
- A specific bandwidth part or subframe: minimum phase of the selected antenna port over all slots.
- A specific slot: not supported.

- TRAC:DATA TRACE3

The return values depend on the evaluation range:

- All antenna ports: average phase of the antenna port mapped to trace 1.
- A specific antenna port: maximum phase of the selected antenna port over all slots.
- A specific bandwidth part or subframe: maximum phase of the selected antenna port over all slots.
- A specific slot: not supported.

- TRAC:DATA TRACE4 | TRACE5 | TRACE6 | TRACE7 | TRACE8

Only supported for evaluation over all antenna ports.

Returns the average phase of the corresponding antenna port over all subcarriers (for example TRACE4 for the antenna port mapped to the 4th trace).

6.8.1.18 RS magnitude

For the RS magnitude result display, the command returns one value for each subcarrier that has been analyzed.

<Magnitude>, ...

The unit is dB.

The following parameters are supported.

- `TRAC:DATA TRACE1`

The return values depend on the evaluation range:

- All antenna ports: average magnitude of the antenna port mapped to trace 1.
- A specific antenna port: average magnitude of the selected antenna port over all slots.
- A specific bandwidth part or subframe: average magnitude of the selected antenna port over all slots.
- A specific slot: magnitude of that slot.

- `TRAC:DATA TRACE2`

The return values depend on the evaluation range:

- All antenna ports: average magnitude of the antenna port mapped to trace 1.
- A specific antenna port: minimum magnitude of the selected antenna port over all slots.
- A specific bandwidth part or subframe: minimum magnitude of the selected antenna port over all slots.
- A specific slot: not supported.

- `TRAC:DATA TRACE3`

The return values depend on the evaluation range:

- All antenna ports: average magnitude of the antenna port mapped to trace 1.
- A specific antenna port: maximum magnitude of the selected antenna port over all slots.
- A specific bandwidth part or subframe: maximum magnitude of the selected antenna port over all slots.
- A specific slot: not supported.

- `TRAC:DATA TRACE4 | TRACE5 | TRACE6 | TRACE7 | TRACE8`

Only supported for evaluation over all antenna ports.

Returns the average magnitude of the corresponding antenna port over all subcarriers (for example `TRACE4` for the antenna port mapped to the 4th trace).

6.8.1.19 RS phase difference

For the RS phase difference result display, the command returns one value for each subcarrier that has been analyzed. The value is the phase deviation to a reference antenna port.

<Phase>, ...

The unit is degrees.

The following parameters are supported.

- `TRAC:DATA TRACE1`

The return values depend on the evaluation range:

- All antenna ports: average phase deviation of the antenna port mapped to trace 1.

- A specific antenna port: average phase deviation of the selected antenna port over all slots.
- A specific bandwidth part or subframe: average phase deviation of the selected antenna port over all slots.
- A specific slot: phase deviation of that slot.
- `TRAC:DATA TRACE2`
The return values depend on the evaluation range:
 - All antenna ports: average phase deviation of the antenna port mapped to trace 1.
 - A specific antenna port: minimum phase deviation of the selected antenna port over all slots.
 - A specific bandwidth part or subframe: minimum phase deviation of the selected antenna port over all slots.
 - A specific slot: not supported.
- `TRAC:DATA TRACE3`
The return values depend on the evaluation range:
 - All antenna ports: average phase deviation of the antenna port mapped to trace 1.
 - A specific antenna port: maximum phase deviation of the selected antenna port over all slots.
 - A specific bandwidth part or subframe: maximum phase deviation of the selected antenna port over all slots.
 - A specific slot: not supported.
- `TRAC:DATA TRACE4 | TRACE5 | TRACE6 | TRACE7 | TRACE8`
Only supported for evaluation over all antenna ports.
Returns the average phase deviation of the corresponding antenna port over all subcarriers (for example `TRACE4` for the antenna port mapped to the 4th trace).

6.8.1.20 Beamforming summary

For the beamforming summary result display, the command returns four values for each allocation that has been found.

```
<BWP>, <Subframe>, <Slot>, <AllocationType>, <AP>, <Phase>,
<PhaseDifference>, ...
```

The unit for `<Phase>` and `<PhaseDifference>` is always degrees. The other values have no unit.

The `<AllocationType>` is encoded. For the code assignment see [Chapter 6.8.1.25, "Return value codes"](#), on page 288.

6.8.1.21 Adjacent channel leakage ratio

For the ACLR result display, the number and type of returns values depend on the parameter.

- `TRAC:DATA TRACE1`
Returns one value for each trace point.
- `TRAC:DATA RESult`
Combined mode only. Returns the results for all ACLR measurements in a measurement sequence.
For each measurement event, the command returns the following information.
`<event number>`, `<channel power>`,
`<abs. power lower adj. ch.>`, `<abs. power upper adj. ch.>`,
`<rel. power lower adj. ch.>`, `<rel. power upper adj. ch.>`,
`<abs. power lower alt. ch.>`, `<abs. power upper alt. ch.>`,
`<rel. power lower alt. ch.>`, `<rel. power upper alt. ch.>`,
etc.
The number of values for alternate channels depends on the number of alternate channels in the measurement.
- `TRAC:DATA LIMit`
Combined mode only. Returns the results for all ACLR limit checks in a measurement sequence.
For each measurement event, the command returns the following information.
`<event number>`,
`<adj. ch. limit check result>`,
`<abs. limit lower adj. ch.>`, `<abs. limit upper adj. ch.>`,
`<rel. limit lower adj. ch.>`, `<rel. limit upper adj. ch.>`,
`<alt. ch. limit check result>`,
`<abs. power lower alt. ch.>`, `<abs. power upper alt. ch.>`,
`<rel. power lower alt. ch.>`, `<rel. power upper alt. ch.>`
etc.
The limit check results are either `PASSED` or `FAILED`. The number of results for alternate channels depends on the number of alternate channels in the measurement.

6.8.1.22 Spectrum emission mask

For the SEM measurement, the number and type of returns values depend on the parameter.

- `TRAC:DATA TRACE1`
Returns one value for each trace point.
`<absolute power>`, ...
The unit is always dBm.
- `TRAC:DATA LIST`
Returns the contents of the SEM table. For every frequency in the spectrum emission mask, it returns 11 values.
`<index>`, `<start frequency in Hz>`, `<stop frequency in Hz>`,
`<RBW in Hz>`, `<limit fail frequency in Hz>`, `<absolute power in dBm>`,
`<relative power in dBc>`, `<limit distance in dB>`, `<limit check result>`,
`<reserved>`, `<reserved>`...
The `<limit check result>` is either a 0 (for PASS) or a 1 (for FAIL).
- `TRAC:DATA RESult`
Combined mode only. Returns the results for all SEM measurements in a measurement sequence.

For each measurement event, the command returns the following information.
 <event number>, <channel power>, <range index>, <start frequency in Hz>, <stop frequency in Hz>, <RBW in Hz>, <frequency>, <absolute power in dBm>, <relative power in dBc>, <limit distance in dB>, <limit check result>, <reserved>, <reserved>, etc.

The number of SEM ranges depend on the SEM configuration.

- TRAC:DATA LIMIT

Combined mode only. Returns the results for all SEM limit checks in a measurement sequence.

For each measurement event, the command returns the following information.
 <event number>, <limit check result>, etc.

The limit check results are either PASSED or FAILED.

6.8.1.23 On/off power

For the on/off power measurement, the number and type of return values depend on the parameter.

- TRAC:DATA TRACE1
Returns the power for the Off power regions.
<absolute power>, ...
The unit is always dBm.
- TRAC:DATA TRACE2
Returns the power for the transient regions.
<absolute power>, ...
The unit is always dBm.
- TRAC:DATA LIST
Returns the contents of the on/off power table. For each line, it returns seven values.
<off period start limit>, <off period stop limit>, <time at delta to limit>, <absolute off power>, <distance to limit>, <falling transient period>, <rising transient period>, ...
The unit for the <absolute off power> is dBm. The unit for the <distance to limit> is dB. All other values have the unit s.

6.8.1.24 Combined EVM / ACLR / SEM

For the combined EVM / ACLR / SEM result summary, the command returns eight values for each measurement.

<measID>, <time stamp>, <EVM>, <power>, <sync state>, <ACLR result>, <SEM result>, <OVLN>, ...

The <SyncState>, <ACLR result> and <SEM result> are encoded:

- 1 for a pass and 0 for a fail.

The <OVLN> state is encoded.

- NAN: no overload

- 0: RF OVLD
- 2: IF OVLD
- 3: INPUT OVLD

The following parameters are supported.

- `TRAC:DATA TRACE1`
Returns the results for all events.
- `TRAC:DATA TRACE2`
Returns the results for a selected event (`[SENSe:]NR5G[:CC<cc>]:SMID`).

In addition, you can query individual results (for example the time stamp). To query other results from the combined result summary, use the standard commands to query the results.

For a detailed list, see [Chapter 6.6.1, "Result summary"](#), on page 232.

6.8.1.25 Return value codes

<allocation ID>

Represents the allocation ID. The range is as follows.

- `0xxxxx` = PDSCH
- `-1` = INVALID
- `-1xxxxx` = PDSCH DMRS
- `-2xxxxx` = CORESET
- `-3xxxxx` = CORESET DMRS
- `-4xxxxx` = PDSCH PTRS
- `-5000xx` = PSS
- `-5001xx` = SSS
- `-5002xx` = PBCH
- `-5003xx` = PBCH DMRS

Note. `xxxxx` is a placeholder for the ID of the channel.

If the channel has, for example, the ID 22, the return value would be -100022, -200022 or -300022 (depending on the configuration)

<AllocationType>

- `0` = SS/PBCH
- `1` = CORESET
- `2` = PDSCH
- `3` = CSI-RS

<modulation>

Represents the modulation scheme.

- `0` = unrecognized

- 1 = RBPSK
- 2 = QPSK
- 3 = 16QAM
- 4 = 64QAM
- 14 = 256QAM
- 15 = 1024QAM

<crc status>

The range is {0...1}.

- 0 = fail
- 1 = pass

<cell barred>

The range is {0...1}.

- 0 = not barred
- 1 = barred

<intra frequency reselection>

The range is {0...1}.

- 0 = not allowed
- 1 = allowed

<codeword>

Represents the codeword of an allocation. The range is {0...6}.

- 0 = 1/1
- 1 = 1/2
- 2 = 2/2
- 3 = 1/4
- 4 = 2/4
- 5 = 3/4
- 6 = 4/4

6.8.2 Read measurement results

CALCulate<n>:MARKer<m>:FUNction:POWer<sb>:RESult[:CURRent]?.....	290
CALCulate<n>:MARKer<m>:FUNction:POWer<sb>:RESult:DEtails.....	291
FORMat[:DATA].....	292
TRACe<n>:CATalog?.....	292
TRACe<n>[:DATA]?.....	292
TRACe<n>[:DATA]:X?.....	293

CALCulate<n>:MARKer<m>:FUNction:POWer<sb>:RESult[:CURRent]?
 [<Measurement>]

Queries the results of the ACLR measurement or the total signal power level of the SEM measurement.

To get a valid result, you have to perform a complete measurement with synchronization to the end of the measurement before reading out the result. This is only possible for single sweeps.

Suffix:

<n>	Window
<m>	Marker
<sb>	irrelevant

Query parameters:

<Measurement>

CPOW

This parameter queries the channel power of the reference range.

MCAC

Queries the channel powers of the ACLR measurements as shown in the ACLR table.

Where available, this parameter also queries the power of the adjacent channels (for example in the ACLR measurement).

Return values:

<Result>

Results for the Spectrum Emission Mask measurement:

Power level in dBm.

Results for the ACLR measurements:

Relative power levels of the ACLR channels. The number of return values depends on the number of transmission and adjacent channels. The order of return values is:

- <TXChannelPower> is the power of the transmission channel in dBm
- <LowerAdjChannelPower> is the relative power of the lower adjacent channel in dB
- <UpperAdjChannelPower> is the relative power of the upper adjacent channel in dB
- <1stLowerAltChannelPower> is the relative power of the first lower alternate channel in dB
- <1stUpperAltChannelPower> is the relative power of the first lower alternate channel in dB
- (...)
- <nthLowerAltChannelPower> is the relative power of a subsequent lower alternate channel in dB
- <nthUpperAltChannelPower> is the relative power of a subsequent lower alternate channel in dB

Example:

```
CALC1:MARK:FUNC:POW:RES? MCAC
```

Returns the current ACLR measurement results.

Usage:	Query only
Manual operation:	See "Result summary" on page 54 See "Result summary" on page 55 See "Result summary" on page 57

CALCulate<n>:MARKer<m>:FUNCtion:POWer<sb>:RESult:DEtails <Measurement>

Queries the results of the ACLR measurement.

To get a valid result, you have to perform a complete measurement with synchronization to the end of the measurement before reading out the result. This is only possible for single sweeps.

Prerequisites for this command

- Available for combined measurements only.

Suffix:

<n>	Window
<m>	Marker
<sb>	irrelevant

Parameters:

<Measurement>	ACPower
---------------	---------

Return values:

<Result>

Results for the ACLR measurements:

Absolute and relative power levels of the ACLR channels. The number of return values depends on the number of transmission and adjacent channels. The order of return values is:

- <TXChannelPower> is the power of the transmission channel in dBm
- <LowerAdjChannelPower> is the relative power of the lower adjacent channel in dB
- <UpperAdjChannelPower> is the relative power of the upper adjacent channel in dB
- <1stLowerAltChannelPower> is the relative power of the first lower alternate channel in dB
- <1stUpperAltChannelPower> is the relative power of the first lower alternate channel in dB
- (...)
- <nthLowerAltChannelPower> is the relative power of a subsequent lower alternate channel in dB
- <nthUpperAltChannelPower> is the relative power of a subsequent lower alternate channel in dB

Example:

```
//Query the current ACLR measurement results.
CALC1:MARK:FUNC:POW:RES? ACP
```

Manual operation: See ["Result summary"](#) on page 54

FORMat[:DATA] <Format>

Selects the data format for the data transmission between the R&S FSV/A and the remote client.

Parameters:

<Format> ASCII | REAL
*RST: ASCII

Example: //Select data format
FORM REAL

TRACe<n>:CATalog?

Queries the types of traces in a diagram.

Prerequisites for this command

- Query results in a window that contains one or more line traces.

Suffix:

<n> [Window](#)

Return values:

<TraceType> CLRW | SSB<x> | BWP<x> | AVG | MIN | MAX

CLRW

For result displays with a single trace (for example the capture buffer).

SSB<x> | BWP<x>

For unfiltered result displays that show all signal parts (for example unfiltered EVM vs Carrier).

(SSB = synchronization signal block, BWP = bandwidth part)

AVG | MIN | MAX

For result displays that are filtered by a specific bandwidth part or subframe and show the average, minimum or maximum results of the slots (for example filtered EVM vs Carrier).

Example: //Query trace types
TRAC2 : CAT?

Usage: Query only

TRACe<n>[:DATA]? <Result>

This command queries the trace data for each measurement point (y-axis values).

In combination with [TRACe<n> \[: DATA \] : X?](#), you can thus query the coordinates of each measurement point.

Suffix:

<n> [Window](#)

Parameters:

RESult	Combined mode only: Queries the results of all ACLR or SEM measurements in a measurement sequence.
LIMit	Combined mode only: Queries the limit check results of all ACLR or SEM measurements in a measurement sequence.

Query parameters:

<TraceNumber>	TRACE1 TRACE2 TRACE3 Queries the trace data of the corresponding trace.
LIST	Queries the results for the SEM measurement.
PBCH	Queries the results for the PBCH in the channel decoder.
CORESET	Queries the results for the PDCCH in the channel decoder.

Return values:

<TraceData>	For more information about the type of return values in the different result displays, see Chapter 6.8.1, "Using the TRACe[:DATA] command" , on page 271.
-------------	---

Example:

//Query results of the second measurement window. The type of data that is returned by the parameter (TRACE1) depends on the result display shown in measurement window 2.
TRAC2? TRACE1

Example:

//Query results of the channel decoder result display
TRAC2? PBCH
TRAC2? CORESET

Usage:

Query only

Manual operation: See ["Data import and export"](#) on page 194

TRACe<n>[:DATA]:X? <Result>

Queries the horizontal trace data for each measurement point (x-axis values).

In combination with [TRACe<n>\[:DATA\]?](#), you can thus query the coordinates of each measurement point.

Suffix:

<n> [Window](#)

Query parameters:

<TraceNumber> TRACe1 | TRACe2 | TRACe3 | TRACe4 | TRACe5 | TRACe6

Return values:

<TraceData> The type of value depends on the information displayed on the x-axis of the result display whose contents you query.

Example:

//Query trace data of trace 1 in window 2
TRAC2? TRACE1
TRAC2:X? TRACE1

Usage:	Query only
Manual operation:	See "Capture Buffer" on page 28
	See "EVM vs Carrier" on page 29
	See "EVM vs Symbol" on page 30
	See "EVM vs RB" on page 31
	See "Frequency Error vs Symbol" on page 31
	See "Frequency Error vs Subframe" on page 32
	See "Power Spectrum" on page 33
	See "Flatness" on page 33

6.9 Configuration

• General configuration.....	295
• Automatic configuration.....	297
• Physical settings.....	302
• Component carrier configuration.....	306
• General radio frame configuration.....	311
• Synchronization signal configuration.....	312
• Bandwidth part configuration.....	319
• Slot configuration.....	323
• CSI reference signal configuration.....	330
• Positioning reference signal.....	339
• CORESET allocation configuration.....	343
• PDSCH allocation configuration.....	349
• Enhanced CORESET allocation configuration.....	357
• Enhanced PDSCH settings: DMRS.....	373
• Enhanced PDSCH settings: PTRS.....	383
• Enhanced PDSCH settings: scrambling / coding.....	386
• Antenna port configuration.....	390
• Advanced settings: global.....	392
• Advanced settings: reference point A.....	396
• Advanced settings: LTE-CRS coexistence.....	399
• Generator control.....	401
• Input configuration.....	407
• Frequency configuration.....	410
• Amplitude configuration.....	412
• Data capture.....	417
• Trigger.....	420
• Tracking.....	425
• Demodulation.....	427
• Time alignment measurement.....	431
• Transmit on/off power measurements.....	431
• Frequency sweep measurements.....	434
• Combined measurements.....	438

6.9.1 General configuration

The following remote control command control general configuration of the application.

The remote control commands to select the result displays for I/Q measurements are described in [Chapter 6.4, "Screen layout"](#), on page 218.

CONFigure[:NR5G]:MEASurement.....	295
MMEMory:LOAD:IQ:STATe:ALL.....	296
MMEMory:STORe<n>:IQ:STATe.....	296
MMEMory:STORe<n>:IQ:STATe:ALL.....	296
MMEMory:STORe<n>:MSERvice.....	297
SYSTem:PRESet:CHANnel[:EXEC].....	297

CONFigure[:NR5G]:MEASurement <Measurement>

Selects the measurement type.

Parameters:

<Measurement>	ACLR Selects the adjacent channel leakage ratio (ACLR) measurement.
	CACLR Selects the Cumulative ACLR measurement.
	CMEasurement Selects combined EVM / ACLR / SEM measurement.
	ESpectrum Selects the spectrum emission mask (SEM) measurement.
	EVM Selects I/Q measurements.
	MCAClr Selects Multi-Carrier ACLR measurement.
	MCESpectrum Selects Multi-Carrier SEM measurement.
	TAERor Selects the time alignment error measurement.
	TPOO Selects the transmit on / off power measurement.
	*RST: EVM

Example: //Select a measurement
 CONF:MEAS EVM

Manual operation: See ["EVM"](#) on page 18
 See ["Time alignment error"](#) on page 19
 See ["Transmit on / off power"](#) on page 19
 See ["Channel power ACLR"](#) on page 19
 See ["SEM"](#) on page 19
 See ["Transmit On / Off Power"](#) on page 48
 See ["Adjacent Channel Leakage Ratio \(ACLR\)"](#) on page 53
 See ["Multi Carrier ACLR \(MC ACLR\)"](#) on page 54
 See ["Cumulative ACLR"](#) on page 56
 See ["Spectrum Emission Mask \(SEM\)"](#) on page 58
 See ["Select Measurement"](#) on page 69

MMEMory:LOAD:IQ:STATE:ALL 1, <FileName>

Restores the captured I/Q data of all measurements in a combined measurement sequence to a file.

The file extension is *.iq.tar.

Parameters:

1 Fixed value.

<FileName> String containing the path and name of the target file.

Example: //Import I/Q data
 MMEM:LOAD:IQ:STAT:ALL 1, 'C:
 \R_S\Instr\user\data.iq.tar'

Manual operation: See ["Data import and export"](#) on page 194

MMEMory:STORE<n>:IQ:STATE <Value>,<FileName>

Saves I/Q data to a file.

Suffix:

<n> irrelevant

Parameters:

<Value> 1

<FileName> String containing the path and name of the target file.

Example: MMEM:STOR:IQ:STAT 'C:
 \R_S\Instr\user\data.iq.tar'
 Saves I/Q data to the specified file.

Manual operation: See ["Data import and export"](#) on page 194

MMEMory:STORE<n>:IQ:STATE:ALL 1, <FileName>

Writes the captured I/Q data of all measurements in a combined measurement sequence to a file.

The file extension is *.iq.tar. By default, the contents of the file are in 32-bit floating point format.

Suffix:

<n> irrelevant

Parameters:

1 Fixed value.

<FileName> String containing the path and name of the target file.

Example:

```
//Export I/Q data
MME:STOR:IQ:STAT:ALL 1, 'C:
\R_S\Instr\user\data.iq.tar'
```

Manual operation: See ["Data import and export"](#) on page 194

MME:STOR:n:MSERvice <FileName>

Exports the signal configuration to the microservice.

Suffix:

<n> irrelevant

Parameters:

<FileName> String containing the path and name of the file.
The file extension is .m5g.

Example:

```
//Export to microservice
MME:STOR:MSER 'signal.xxx'
```

SYSTem:PRESet:CHANnel[:EXEC]

Restores the default instrument settings in the current channel.

Use `INST:SEL` to select the channel.

Example:

```
INST:SEL 'Spectrum2'
Selects the channel for "Spectrum2".
SYST:PRESet:CHAN:EXEC
Restores the factory default settings to the "Spectrum2"channel.
```

Usage: Event

Manual operation: See ["Preset Channel"](#) on page 69

6.9.2 Automatic configuration

Commands to automatically configure measurements described elsewhere.

- `DISPlay[:WINDow<n>][:SUBWindow<w>]:TRACe<t>:Y[:SCALE]:AUTO`
on page 446

[SENSe:]ADJust:CONFigure:LEVel:DURation.....	298
[SENSe:]ADJust:CONFigure:LEVel:DURation:MODE.....	298
[SENSe:]ADJust:DEMod.....	298
[SENSe:]ADJust:EVM.....	299
[SENSe:]ADJust:EVM:SLOTs.....	299
[SENSe:]ADJust:LEVel.....	299
[SENSe:]ADJust:LEVel<ant>:ALL.....	300
CONFigure[:NR5G]:DL[:CC<cc>]:DEMod:AUTO.....	300
CONFigure[:NR5G]:DL[:CC<cc>]:FRAMe<fr>:BWPART<bwp>:DETectiOn.....	301
CONFigure[:NR5G]:DL[:CC<cc>]:SSBLock<ssb>:DETectiOn.....	301

[SENSe:]ADJust:CONFigure:LEVel:DURation <Duration>

To determine the ideal reference level, the R&S FSV/A performs a measurement on the current input data. This command defines the length of the measurement if [SENSe:]ADJust:CONFigure:LEVel:DURation:MODE is set to MANual.

Parameters:

<Duration> Numeric value in seconds
 Range: 0.001 to 16000.0
 *RST: 0.001
 Default unit: s

Example:

```
ADJ:CONF:DUR:MODE MAN
Selects manual definition of the measurement length.
ADJ:CONF:LEV:DUR 5ms
Length of the measurement is 5 ms.
```

Manual operation: See "Auto Level" on page 145

[SENSe:]ADJust:CONFigure:LEVel:DURation:MODE <Mode>

To determine the ideal reference level, the R&S FSV/A performs a measurement on the current input data. This command selects the way the R&S FSV/A determines the length of the measurement .

Parameters:

<Mode> **AUTO**
 The R&S FSV/A determines the measurement length automatically according to the current input data.
MANual
 The R&S FSV/A uses the measurement length defined by [SENSe:]ADJust:CONFigure:LEVel:DURation on page 298.
 *RST: AUTO

Manual operation: See "Auto Level" on page 145

[SENSe:]ADJust:DEMod

Automatically demodulates the signal once.

For continuous automatic demodulation, use `CONFigure[:NR5G]:DL[:CC<cc>]:DEMod:AUTO`.

Usage: Event

Manual operation: See "Complete Signal Demodulation" on page 71

[SENSe:]ADJust:EVM

Adjusts the amplitude settings, including attenuator and preamplifier, to achieve the optimal EVM using the maximum dynamic range.

Note that this process can up to several minutes, depending on the number of component carriers you are measuring.

For the auto EVM routine, it is sufficient to send this command. It is not necessary to send `INITiate<n>[:IMMediate]`.

Example: `//Optimize EVM
ADJ:EVM`

Usage: Event

Manual operation: See "Auto EVM" on page 70

[SENSe:]ADJust:EVM:SLOTs <Slots>

Selects the number of slots to be used during the auto EVM routine.

Prerequisites for this command

- Select manual automatic measurement time mode (`[SENSe:]ADJust:CONFigure:LEVel:DURation:MODE`).
- Define an appropriate automatic measurement time (`[SENSe:]ADJust:CONFigure:LEVel:DURation` on page 298).

Parameters:

<Slots> *RST: 1

Example: `//Define number of slots for automatic EVM measurement
CONF:LEV:DUR:MODE MAN
ADJ:EVM:SLOT 2`

Manual operation: See "Auto EVM" on page 70

[SENSe:]ADJust:LEVel

Adjusts the level settings, including attenuator and preamplifier, to achieve the best dynamic range.

Compared to `[SENSe:]ADJust:EVM` on page 299, which achieves the best amplitude settings to optimize the EVM, you can use this command for a quick determination of preliminary amplitude settings.

Example:	//Adjust level settings ADJ:LEV
Usage:	Event
Manual operation:	See "Auto Level" on page 70 See "Auto Level" on page 145

[SENSe:]ADJust:LEVel<ant>:ALL

Determines the ideal reference level based on the current measurement data and settings on all connected input sources.

This ensures that the settings of the RF attenuation and the reference level are optimally adjusted to the signal level without overloading the R&S FSV/A or limiting the dynamic range by an S/N ratio that is too small.

The command is available for MIMO measurements with more than one input source.

Suffix:	
<ant>	irrelevant
Example:	//Auto level all connected instruments ADJ:LEV:ALL
Usage:	Event

CONFigure[:NR5G]:DL[:CC<cc>]:DEMod:AUTO <Mode>

Turns automatic signal demodulation on and off.

Suffix:	
<cc>	Component Carrier

Parameters:	
<Mode>	ON OFF 1 0
	ON
	Automatically detects the following signal properties.
	<ul style="list-style-type: none"> • Synchronization signal configuration • Bandwidth part configuration • Slot configuration • PDSCH and CORESET configuration
	OFF
	Lets you configure the signal manually.
	*RST: MANual

Example:	//Select manual configuration mode CONF:DL:CC2:DEM:AUTO OFF
Usage:	Setting only
Manual operation:	See "Complete Signal Demodulation" on page 71

CONFigure[:NR5G]:DL[:CC<cc>]:FRAMe<fr>:BWPart<bwp>:DETectioN <State>

Turns automatic detection of the bandwidth part configuration on and off.

Suffix:

<cc>	Component Carrier
<fr>	irrelevant
<bwp>	irrelevant

Parameters:

<State>	AUTO Automatically detects the following signal properties. <ul style="list-style-type: none"> • Bandwidth part configuration • Slot configuration • PDSCH and CORESET configuration
---------	---

MANual

Lets you configure the bandwidth parts manually.

*RST: MANual

Example:

```
//Select configuration mode
CONF:DL:CC2:FRAM:BWP:DET AUTO
```

Manual operation: See "[Bandwidth Parts Demodulation](#)" on page 72

CONFigure[:NR5G]:DL[:CC<cc>]:SSBLock<ssb>:DETectioN <Mode>

Turns automatic detection of the synchronization signal configuration on and off.

Suffix:

<cc>	Component Carrier
<ssb>	irrelevant

Parameters:

<Mode>	AUTO Automatically detects the following synchronization signal properties. <ul style="list-style-type: none"> • Subcarrier spacing • SS/PBCH block pattern • RB offset • Additional subcarrier offset • Cell ID
--------	---

MANual

Lets you configure the SS/PBCH block manually.

*RST: AUTO

Example:

```
//Select configuration mode
CONF:DL:CC2:SSBL:DET AUTO
```

Manual operation: See "[Synchronization Signal Demodulation](#)" on page 73

6.9.3 Physical settings

CONFigure[:NR5G]:OBANd.....	302
CONFigure[:NR5G]:DL[:CC<cc>]:BW.....	302
CONFigure[:NR5G]:DL[:CC<cc>]:DFRange.....	303
CONFigure[:NR5G]:DL[:CC<cc>]:PLC:CID.....	303
CONFigure[:NR5G]:LDIRection.....	304
FETCh[:CC<cc>]:PLC:CID?.....	304
MMEMory:LOAD:TMODeI[:CC<cc>].....	304
MMEMory:LOAD:DEModsetting:ALL.....	305
MMEMory:LOAD:DEModsetting[:CC<cc>].....	305
MMEMory:STORe<n>:DEModsetting:ALL.....	306
MMEMory:STORe<n>:DEModsetting[:CC<cc>].....	306

CONFigure[:NR5G]:OBANd <OperatingBand>

Selects the operating band.

Prerequisites for this command

- Select at least 2 component carriers ([CONFigure\[:NR5G\]:NOCC](#) on page 309).

Parameters:

<OperatingBand> N1 | N2 | N3 | N5 | N7 | N8 | N12 | N13 | N14 | N18 | N20 | N24 |
 N25 | N26 | N28 | N29 | N30 | N34 | N38 | N39 | N40 | N41 |
 N46 | N48 | N50 | N51 | N53 | N65 | N66 | N67 | N70 | N71 |
 N74 | N75 | N76 | N77 | N78 | N79 | N80 | N81 | N82 | N83 |
 N84 | N85 | N86 | N89 | N90 | N91 | N92 | N93 | N94 | N95 |
 N96 | N97 | N98 | N99 | N100 | N101 | N102 | N257 | N258 |
 N259 | N260 | N261 | N262 | N263
 *RST: n1

Example: //Select operating band
 CONF:NOCC 2
 CONF:OBAN N20

Manual operation: See "[Operating Band](#)" on page 75

CONFigure[:NR5G]:DL[:CC<cc>]:BW <Bandwidth>

Selects the channel bandwidth of the 5G NR carrier.

Suffix:

<cc> [Component Carrier](#)

Parameters:

<Bandwidth> BW5 | BW10 | BW15 | BW20 | BW25 | BW30 | BW35 | BW40 |
 BW45 | BW50 | BW60 | BW70 | BW80 | BW90 | BW100 |
 BW200 | BW400 | BW800 | BW1600 | BW2000
 *RST: BW100

Example: //Select carrier bandwidth
 CONF:DL:BW BW20

Manual operation: See ["Physical settings of the signal"](#) on page 75
See ["Bandwidth configuration"](#) on page 80

CONFigure[:NR5G]:DL[:CC<cc>]:DFRange <Deployment>

Selects the deployment frequency range of the signal.

Suffix:

<cc> [Component Carrier](#)

Parameters:

<Deployment> **LOW**
Deployment in FR1 ≤ 3 GHz.
MIDDLE
Deployment in FR1 > 3 GHz.
HIGH
Deployment in FR2-1.
EHIGH
Deployment in FR2-2.
*RST: MIDDLE

Example: //Select frequency range of signal
CONF:DL:DFR LOW

Manual operation: See ["Deployment Frequency Range"](#) on page 74

CONFigure[:NR5G]:DL[:CC<cc>]:PLC:CID <CellID>

Defines the cell ID.

Suffix:

<cc> [Component Carrier](#)

Parameters:

<CellID> **AUTO**
Automatically determines the cell ID.
<numeric value> (integer only)
Number of the cell ID.
Range: 0 to 503

Example: //Define cell ID
CONF:DL:CC2:PLC:CID 12

Manual operation: See ["Physical settings of the signal"](#) on page 75

CONFigure[:NR5G]:LDIRection <Mode>

Selects the link direction you want to analyze.

Parameters:

<Mode>	DL Selects the downlink application to analyze 5G NR downlink signals. Requires option R&S FSV/A-K144.
	UL Selects the uplink application to analyze 5G NR uplink signals. Requires option R&S FSV/A-K145.

Example: //Select uplink application
CONF:LDIR UL

Manual operation: See "[Selecting the 5G NR mode](#)" on page 74

FETCh[:CC<cc>]:PLC:CID?

Queries the cell ID.

Suffix:

<cc> [Component Carrier](#)

Return values:

<CellID> <numeric value> (integer only)

Example: //Query cell ID
FETC:PLC:CID?

Usage: Query only

MMEMory:LOAD:TMODeI[:CC<cc>] <TestModel>

Loads a test model (NR-FR-TM) as defined by 3GPP (38.141-1 / -2).

You can also select an O-RAN test case with the command.

Suffix:

<cc> [Component Carrier](#)

Parameters:

<TestModel> String containing the name of the test model (file name).
Alternatively, a string that contains the name of the O-RAN test case, e.g. 'ORAN-FR1-TC32311__FDD_5MHZ_15KHZ'.

Example: //Select test model
:MMEM:LOAD:TMOD:CC1
'NR-FR1-TM1_1__FDD_5MHZ_15KHZ'

Example: //Select O-RAN test case
MMEM:LOAD:TMOD:DL
'ORAN-FR1-TC32311__FDD_5MHZ_15KHZ'

Manual operation: See ["3GPP test models"](#) on page 76
See ["ORAN test cases"](#) on page 76

MMEMory:LOAD:DEModsetting:ALL <FileName>

Restores the signal description of multiple carriers from a single file.

Parameters:

<FileName> String containing the path and name of the file.
The file extension is `.ccallocation`.

Example: `//Restore signal description for multiple carriers in a single files`
`CONF:NOCC 2`
`MMEM:LOAD:DEM:ALL 'c:\TestSignal.ccallocation'`

Manual operation: See ["Test scenarios for carrier aggregation"](#) on page 77

MMEMory:LOAD:DEModsetting[:CC<cc>] <FileName>[, <Item>, <Item>, <Item>, <Item>, <Item>]

Restores the signal description.

Suffix:

<cc> [Component Carrier](#)

Parameters:

<FileName> String containing the path and name of the file.
The file extension is `.allocation`.

<Item> Combined measurements only: Selects the allocation data you want to load.

ACLR

Loads the allocation data for ACLR measurements.

ALL

Loads the allocation data for all measurements (EVM, ACLR, SEM and results).

CRT

Loads the allocation data for EVM measurements.

EVM

Loads the results of a combined measurement sequence.

SEM

Loads the allocation data for SEM measurements.

Example: `//Restore signal description for a single component carrier`
`MMEM:LOAD:DEM 'c:\TestSignal.allocation'`

Example: `//Restore signal description for multiple carriers in individual files`
`CONF:NOCC 2`
`MMEM:LOAD:DEM:CC1 'c:\TestSignalCC1.allocation'`
`MMEM:LOAD:DEM:CC2 'c:\TestSignalCC2.allocation'`

Example: //Restore combined measurement allocation
 MMEM:LOAD:DEM 'c:
 \TestSignalComb.allocation',EVM,SEM

Manual operation: See ["User defined test scenarios"](#) on page 77

MMEMory:STORe<n>:DEModsetting:ALL <FileName>

Saves the signal description of multiple carriers in a single file.

Suffix:

<n> irrelevant

Parameters:

<FileName> String containing the path and name of the file.
 The file extension is .ccallocation.

Example: //Save signal description for multiple carriers in a single files
 CONF:NOCC 2
 MMEM:STOR:DEM:ALL 'c:\TestSignal.ccallocation'

Manual operation: See ["Test scenarios for carrier aggregation"](#) on page 77

MMEMory:STORe<n>:DEModsetting[:CC<cc>] <FileName>

Saves the signal description.

Suffix:

<n> irrelevant

<cc> [Component Carrier](#)

Parameters:

<FileName> String containing the path and name of the file.
 The file extension is .allocation.

Example: //Save signal description for a single component carrier
 MMEM:STOR:DEM 'c:\TestSignal.allocation'

Example: //Save signal description for multiple carriers in individual files
 CONF:NOCC 2
 MMEM:STOR:DEM:CC1 'c:\TestSignalCC1.allocation'
 MMEM:STOR:DEM:CC2 'c:\TestSignalCC2.allocation'

Manual operation: See ["User defined test scenarios"](#) on page 77

6.9.4 Component carrier configuration

Commands to configure component carrier described elsewhere.

- [\[SENSe:\] FREQuency:CENTer \[:CC<cc>\]](#)
- [\[SENSe:\] FREQuency:CENTer \[:CC<cc>\]:OFFSet](#)
- [CONFigure \[:NR5G\]:DL\[:CC<cc>\]:BW](#)

CONFigure[:NR5G]:CENTer.....	307
CONFigure[:NR5G]:CRASter.....	307
CONFigure[:NR5G]:CSPacing.....	308
CONFigure[:NR5G]:CSCapture.....	308
CONFigure[:NR5G]:FCOFFset.....	308
CONFigure[:NR5G]:GMCFreq.....	309
CONFigure[:NR5G]:NCSPacing.....	309
CONFigure[:NR5G]:NOCC.....	309
CONFigure[:NR5G]:OMODe.....	309
CONFigure[:NR5G]:OREL.....	310
[SENSe:]FREQUENCY:CENTer[:CC<cc>]:MCOFFset.....	310

CONFigure[:NR5G]:CENTer

Synchronizes the global multicarrier frequency to the current center frequency (= center of all carriers).

Use `CONFigure[:NR5G]:GMCFreq` to query the global multicarrier frequency.

Example:

```
//Synchronize global multicarrier frequency
CONF:CENT
//Query global MC frequency
CONF:GMCF?
```

Usage: Event

Manual operation: See "[Center frequency configuration](#)" on page 82

CONFigure[:NR5G]:CRASter <Bandwidth>

Selects the channel raster of a component carrier.

Prerequisites for this command

- Select an operating band that supports different channel raster (`CONFigure[:NR5G]:OBAND`).
For all other operating bands, the command works as a query only.

Parameters:

<Bandwidth>

C15
15 kHz channel raster

C15
100 kHz channel raster

Example:

```
//Select channel raster
CONF:OBAN N90
CONF:CRAS C100
```

Manual operation: See "[Channel Raster](#)" on page 80

CONFigure[:NR5G]:CSPacing <Frequency>

Defines the carrier spacing for equidistant frequency offsets in a multicarrier setup. This frequency offset applies to all component carriers in the setup.

Prerequisites for this command

- Select equidistant frequency offset ([CONFigure\[:NR5G\]:OMODE](#)).

Parameters:

<Frequency> *RST: 0
 Default unit: Hz

Example: //Define carrier spacing
 CONF:OMOD EQU
 CONF:CSP 500MHZ

Manual operation: See "[Frequency offset configuration](#)" on page 82

CONFigure[:NR5G]:CSCapture <Mode>

Selects the capture mode for measurements on multiple component carriers.

Parameters:

<Mode> **AUTO**
 Automatically selects the number of component carriers that can be analyzed in a single capture. If there are more carriers than can be analyzed in a single measurement, the other carriers are analyzed in subsequent measurements.

SINGLE

Capture each component carrier subsequently in individual measurements.

*RST: AUTO

Example: //Select component carrier capture mode
 CONF:CSC AUTO

Manual operation: See "[Component carrier data capture](#)" on page 78

CONFigure[:NR5G]:FCOffset <State>

Turns a fixed frequency offset for component carriers on and off.

Parameters:

<State> ON | OFF | 1 | 0
 *RST: OFF

Example: //Turn on fixed frequency offset
 CONF:FCOF ON

Manual operation: See "[Frequency offset configuration](#)" on page 82

CONFigure[:NR5G]:GMCFreq <Frequency>

Defines the global multicarrier frequency for component carrier setups.

Parameters:

<Frequency> Default unit: Hz

Example: //Define global MC frequency
CONF:GMCF 950MHZ

Manual operation: See "[Center frequency configuration](#)" on page 82

CONFigure[:NR5G]:NCSPacing

Resets the channel spacing of component carriers to its default value.

Example: //Reset channel spacing
CONF:NCSP

Usage: Event

Manual operation: See "[Nominal Channel Spacing](#)" on page 81

CONFigure[:NR5G]:NOCC <Carrier>

Selects the number of component carriers analyzed in the measurement.

Parameters:

<Carrier> Number of the component carriers that you would like to measure. The range depends on the measurement. For more information see [Chapter 4.1.5, "Component carrier configuration"](#), on page 77.

*RST: 1

Example: //Select number of component carriers
CONF:NOCC 2

Manual operation: See "[Number of component carriers](#)" on page 78

CONFigure[:NR5G]:OMODE <Mode>

Selects the frequency offset mode for component carriers in a multicarrier setup.

Parameters:

<Mode>

ARbitrary

Distance between component carriers is arbitrary. You can define the frequency offsets with [\[SENSE:\]FREQUENCY:CENTER\[:CC<cc>\]:OFFSet](#).

EQUidistant

Component carriers have the same distance between each other.

You can define the spacing between carriers with [CONFigure\[:NR5G\]:CSPacing](#).

Example: ***RST:** ARB

 //Select arbitrary frequency offsets relative to CC1
CONF:OREL CC1
CONF:OMOD ARB
FREQ:CENT:CC2:OFFS 200MHZ
FREQ:CENT:CC3:OFFS 300MHZ
FREQ:CENT:CC4:OFFS 800MHZ

Example: //Select equidistant frequency offsets relative to CC1
CONF:OREL CC1
CONF:OMOD EQU
CONF:CSP 200MHZ

Manual operation: See "[Frequency offset configuration](#)" on page 82

CONFigure[:NR5G]:OREL <Reference>

Selects the reference point for frequency offsets of component carriers in a multicarrier setup.

Parameters:

<Reference>

CC1

Reference point is the center frequency of first component carrier.

GMCFreq

Reference point the global multicarrier frequency.

***RST:** CC1

Example: //Select reference point for frequency offsets
CONF:OREL GMCF

Manual operation: See "[Frequency offset configuration](#)" on page 82

[SENSe:]FREQUency:CENTer[:CC<cc>]:MCOFFset <Offset>

Defines the frequency offset of a component carrier.

Prerequisites for this command

- Select the global MC frequency as the reference point for the frequency offset ([CONFigure\[:NR5G\]:OREL](#)).

Suffix:

<cc>

[Component Carrier](#)

Parameters:

<Offset>

<numeric value>

- Component carrier offset: frequency offset relative to the first component carrier in Hz.

Default unit: Hz

Example: //Define a frequency offset of 15 MHz for the second component carrier relative to the first component carrier.

```
CONF:OREL GMCF
FREQ:CENT:CC2:OFFS 150MHZ
```

Manual operation: See ["Frequency configuration"](#) on page 79

6.9.5 General radio frame configuration

CONFigure[:NR5G]:DL[:CC<cc>]:FRAMe<fr>:COPY.....	311
CONFigure[:NR5G]:DL[:CC<cc>]:FRAMe<fr>:PASTe:ALL.....	311
CONFigure[:NR5G]:DL[:CC<cc>]:FRAMe<fr>:PASTe[:FRAMe].....	312
CONFigure[:NR5G]:DL[:CC<cc>]:FTConfig.....	312

CONFigure[:NR5G]:DL[:CC<cc>]:FRAMe<fr>:COPY

Copies a frame configuration.

Suffix:

<cc> [Component Carrier](#)
 <fr> [Frame](#)

Example: //Copy configuration of frame 3
 CONF:DL:CC2:FRAM3:COPY

Usage: Event

Manual operation: See ["Frame Configuration Management"](#) on page 86

CONFigure[:NR5G]:DL[:CC<cc>]:FRAMe<fr>:PASTe:ALL

Applies an existing frame configuration to all other frames.

Prerequisites for this command

- Copy a frame configuration ([CONFigure\[:NR5G\]:DL\[:CC<cc>\]:FRAMe<fr>:COPY](#) on page 311).

Suffix:

<cc> [Component Carrier](#)
 <fr> irrelevant

Example: //Copy configuration of frame 3
 CONF:DL:CC2:FRAM3:COPY
 //Apply configuration to all other frames
 CONF:DL:CC2:FRAM:PAST:ALL

Usage: Event

Manual operation: See ["Frame Configuration Management"](#) on page 86

CONFigure[:NR5G]:DL[:CC<cc>]:FRAMe<fr>:PASTe[:FRAMe]

Applies an existing frame configuration to another one.

Prerequisites for this command

- Copy a frame configuration ([CONFigure\[:NR5G\]:DL\[:CC<cc>\]:FRAMe<fr>:COPY](#) on page 311).

Suffix:

<cc> [Component Carrier](#)

<fr> [Frame](#)

Example:

```
//Copy configuration of frame 3
CONF:DL:CC2:FRAM3:COPY
//Apply configuration to frame 4
CONF:DL:CC2:FRAM4:PAST
```

Usage: Event

Manual operation: See "[Frame Configuration Management](#)" on page 86

CONFigure[:NR5G]:DL[:CC<cc>]:FTConfig <Frames>

Defines the number of configurable frames.

Suffix:

<cc> [Component Carrier](#)

Parameters:

<Frames> <numeric value> (integer only)

*RST: 1

Example:

```
//Define number of configurable frames
CONF:DL:CC2:FTC 2
```

Manual operation: See "[Frame Configuration](#)" on page 84

6.9.6 Synchronization signal configuration

CONFigure[:NR5G]:DL[:CC<cc>]:SSBLock<ssb>:ASOffset	313
CONFigure[:NR5G]:DL[:CC<cc>]:SSBLock<ssb>:BSPeriod	313
CONFigure[:NR5G]:DL[:CC<cc>]:SSBLock<ssb>:HFOffset	313
CONFigure[:NR5G]:DL[:CC<cc>]:SSBLock<ssb>:L	314
CONFigure[:NR5G]:DL[:CC<cc>]:SSBLock<ssb>:OFFSet	315
CONFigure[:NR5G]:DL[:CC<cc>]:SSBLock<ssb>:PATtern	315
CONFigure[:NR5G]:DL[:CC<cc>]:SSBLock<ssb>:PBCH:POWer	316
CONFigure[:NR5G]:DL[:CC<cc>]:SSBLock<ssb>:PDMRs:POWer	316
CONFigure[:NR5G]:DL[:CC<cc>]:SSBLock<ssb>:PSS:POWer	317
CONFigure[:NR5G]:DL[:CC<cc>]:SSBLock<ssb>:RTO	317
CONFigure[:NR5G]:DL[:CC<cc>]:SSBLock<ssb>:SSPacing	317
CONFigure[:NR5G]:DL[:CC<cc>]:SSBLock<ssb>:SSS:POWer	318
CONFigure[:NR5G]:DL[:CC<cc>]:SSBLock<ssb>[:STATe<ss>]	319

CONFigure[:NR5G]:DL[:CC<cc>]:SSBLock<ssb>:ASOffset <Offset>

Defines a frequency offset for the synchronization signal block.

Prerequisites for this command

- Select manual configuration mode for SS (`CONFigure[:NR5G]:DL[:CC<cc>]:SSBLock<ssb>:DETection`).

Suffix:

<cc> [Component Carrier](#)

<ssb> irrelevant

Parameters:

<Offset> <numeric value> (integer only)

Offset in terms of subcarrier, relative to the first subcarrier of a resource block.

Range: 0 to 11

*RST: 0

Example:

```
//Define synchronization signal offset in terms of resource blocks
CONF:DL:CC2:SSBL:DET MAN
CONF:DL:CC2:SSBL:OFFS 50
//Define additional offset in terms of subcarrier
CONF:DL:CC2:SSBL:OFFS 6
```

Manual operation: See "[Synchronization Signal Offset](#)" on page 89

CONFigure[:NR5G]:DL[:CC<cc>]:SSBLock<ssb>:BSPeriod <Periodicity>

Selects the burst set periodicity of a synchronization signal block.

Suffix:

<cc> [Component Carrier](#)

<ssb> irrelevant

Parameters:

<Periodicity> **AUTO**

Determines the burst set periodicity of the signal automatically.

MS05 | MS10 | MS20 | MS40

Selects one of the following periodicities:

5 ms, 10 ms, 20 ms, 40 ms

*RST: MS10

Example:

```
//Select burst set periodicity
CONF:DL:CC2:SSBL:BSP MS05
```

Manual operation: See "[Burst Set Periodicity](#)" on page 91

CONFigure[:NR5G]:DL[:CC<cc>]:SSBLock<ssb>:HFOffset <HalfFrame>

Selects the half frame that contains the synchronization signal.

Prerequisites for this command

- Select a SSB periodicity > 5 ms ([CONFigure\[:NR5G\]:DL\[:CC<cc>\]:SSBLock<ssb>:BSPeriod](#) on page 313).

Suffix:

<cc> [Component Carrier](#)

<ssb> irrelevant

Parameters:

<HalfFrame> **ZERO**
SSB in first half frame.

ONE
SSB in second half frame.

*RST: ZERO

Example: //Select half frame that contains SSB

```
CONF:DL:CC2:SSBL:BSP MS10
```

```
CONF:DL:CC2:SSBL:HFOF ONE
```

Manual operation: See "[Half Frame Offset](#)" on page 91

CONFigure[:NR5G]:DL[:CC<cc>]:SSBLock<ssb>:L <Blocks>

Selects the number of SS/PBCH blocks in the deployment range < 3 GHz.

Prerequisites for this command

- Select a deployment < 3 GHz ([CONFigure\[:NR5G\]:DL\[:CC<cc>\]:DFRange](#)).
- Select a 30 kHz subcarrier spacing ([CONFigure\[:NR5G\]:DL\[:CC<cc>\]:SSBLock<ssb>:SSPacing](#)).
- Select the case C block pattern ([CONFigure\[:NR5G\]:DL\[:CC<cc>\]:SSBLock<ssb>:PATTern](#)).

Suffix:

<cc> [Component Carrier](#)

<ssb> irrelevant

Parameters:

<Blocks> 4 | 8

*RST: 4

Example: //Select 8 SS/PBCH blocks

```
CONF:DL:CC2:DFR LOW
```

```
CONF:DL:CC2:SSBL:SSP SS30
```

```
CONF:DL:CC2:SSBL:PATT C
```

```
CONF:DL:CC2:SSBL:L 8
```

Manual operation: See "[SS/PBCH Block State](#)" on page 91

CONFigure[:NR5G]:DL[:CC<cc>]:SSBLock<ssb>:OFFSet <Offset>

Defines a frequency offset for the synchronization signal block.

Prerequisites for this command

- Select manual configuration mode for SS (`CONFigure[:NR5G]:DL[:CC<cc>]:SSBLock<ssb>:DETection`).

Suffix:

<cc> [Component Carrier](#)

<ssb> irrelevant

Parameters:

<Offset> <numeric value> (integer only)

Offset in terms of resource blocks, relative to the first subcarrier.

*RST: 125

Example:

//Define synchronization signal offset

CONF:DL:CC2:SSBL:DET MAN

CONF:DL:CC2:SSBL:OFFS 50

Manual operation: See "[Synchronization Signal Offset](#)" on page 89

CONFigure[:NR5G]:DL[:CC<cc>]:SSBLock<ssb>:PATtern <Pattern>

Selects the pattern of a synchronization signal block.

Prerequisites for this command

- Select manual configuration mode for SS (`CONFigure[:NR5G]:DL[:CC<cc>]:SSBLock<ssb>:DETection`).

Suffix:

<cc> [Component Carrier](#)

<ssb> irrelevant

Parameters:

<Pattern> A | B | C | D | E | F | G

The SSB patterns are linked to the subcarrier spacing.

Patterns A, D, E, F and G cannot be set. They are always selected automatically when you select a subcarrier spacing of 15 kHz (pattern A), 120 kHz (pattern D), 240 kHz (pattern E), 480 kHz (pattern F) or 960 kHz (pattern G). For these subcarrier spacing, the command is a query only.

For subcarrier spacing of 30 kHz, you can select pattern B or C.

*RST: B

Example:

```
//Query SSB pattern
CONF:DL:CC2:SSBL:SSP SS15
CONF:DL:CC2:SSBL:PATT?
returns
A
//Select SSB pattern
CONF:DL:CC2:DFR LOW
CONF:DL:CC2:SSBL:DET MAN
CONF:DL:CC2:SSBL:SSP SS30
CONF:DL:CC2:SSBL:PATT B
```

Manual operation: See "[SS/PBCH Block Pattern](#)" on page 89

CONFigure[:NR5G]:DL[:CC<cc>]:SSBLock<ssb>:PBCH:POWer <Power>

Defines the relative power of the PBCH.

Suffix:

<cc> [Component Carrier](#)

<ssb> irrelevant

Parameters:

<Power> <numeric value>

*RST: 0

Default unit: dB

Example:

```
//Define relative power of the PBCH
CONF:DL:CC2:SSB:PBCH:POW 3
```

Manual operation: See "[Relative Power](#)" on page 92

CONFigure[:NR5G]:DL[:CC<cc>]:SSBLock<ssb>:PDMRs:POWer <Power>

Defines the relative power of the PBCH DMRS.

Suffix:

<cc> [Component Carrier](#)

<ssb> irrelevant

Parameters:

<Power> <numeric value>

*RST: 0

Default unit: dB

Example:

```
//Define relative power of the PBCH DMRS
CONF:DL:CC2:SSB:PDMR:POW 3
```

Manual operation: See "[Relative Power](#)" on page 92

CONFigure[:NR5G]:DL[:CC<cc>]:SSBLoCk<ssb>:PSS:POWer <Power>

Defines the relative power of the primary synchronization signal (PSS).

Suffix:

<cc> [Component Carrier](#)
<ssb> irrelevant

Parameters:

<Power> <numeric value>
*RST: 0
Default unit: dB

Example: //Define relative power of the PSS
CONF:DL:CC2:SSB:PSS:POW 3

Manual operation: See "[Relative Power](#)" on page 92

CONFigure[:NR5G]:DL[:CC<cc>]:SSBLoCk<ssb>:RTO <Reference>

Selects the reference point for a synchronization signal offset.

Prerequisites for this command

- For selection of TxBW: Use at least one bandwidth part that has the same subcarrier spacing as the synchronization signal.
For subcarrier spacing = 240 kHz, TxBW is not supported.

Suffix:

<cc> [Component Carrier](#)
<ssb> irrelevant

Parameters:

<Reference> **RPA**
Offset relative to the reference point A.
TXBW
Offset relative to the the first subcarrier.
*RST: TXBW

Example: //Select reference point for SSB offset
CONF:DL:CC2:SSBL:RTO TXBW

Manual operation: See "[Synchronization Signal Offset](#)" on page 89

CONFigure[:NR5G]:DL[:CC<cc>]:SSBLoCk<ssb>:SSPacing <SubcarrierSpacing>

Selects the subcarrier spacing of a synchronization signal block.

Prerequisites for this command

- Select manual configuration mode for SS ([CONFigure\[:NR5G\]:DL\[:CC<cc>\]:SSBLoCk<ssb>:DETectioN](#)).

Suffix:

<cc> [Component Carrier](#)

<ssb> irrelevant

Parameters:

<SubcarrierSpacing> **SS15**
15 kHz subcarrier spacing.
Only for signal deployment in FR1.

SS30
30 kHz subcarrier spacing.
Only for signal deployment in FR1.

SS120
120 kHz subcarrier spacing.
Only for signal deployment in FR2.

SS240
240 kHz subcarrier spacing.
Only for signal deployment in FR2.

SS480
240 kHz subcarrier spacing.
Only for signal deployment in FR2-2.

SS960
240 kHz subcarrier spacing.
Only for signal deployment in FR2-2.

*RST: SS30

Example:

```
//Select subcarrier spacing
CONF:DL:CC2:DFR LOW
CONF:DL:CC2:SSBL:DET MAN
CONF:DL:CC2:SSBL:SSP SS30
```

Manual operation: See "[Subcarrier Spacing \(synchronization signal\)](#)" on page 88

CONFigure[:NR5G]:DL[:CC<cc>]:SSBLock<ssb>:SSS:POWer <Power>

Defines the relative power of the secondary synchronization signal (SSS).

Suffix:

<cc> [Component Carrier](#)

<ssb> irrelevant

Parameters:

<Power> <numeric value>

*RST: 0
Default unit: dB

Example:

```
//Define relative power of the SSS
CONF:DL:CC2:SSB:SSS:POW 3
```

Manual operation: See "[Relative Power](#)" on page 92

CONFigure[:NR5G]:DL[:CC<cc>]:SSBLock<ssb>[:STATe<ss>] <State>

Turns an individual SS/PBCH block on and off.

Suffix:

<cc>	Component Carrier
<ssb>	SS block
<ss>	1...64 SS/PBCH block

Parameters:

<State>	ALL Turns on all synchronization blocks.
	NONE Turns off all synchronization blocks.
	ON 1 Turns on a single synchronization block (selected by the suffix at STATE).
	ON 1 Turns off a single synchronization block (selected by the suffix at STATE).
*RST:	ON

Example:

```
//Configure first four SS blocks
CONF:DL:CC2:SSBL:STAT0 ON
CONF:DL:CC2:SSBL:STAT1 ON
CONF:DL:CC2:SSBL:STAT2 OFF
CONF:DL:CC2:SSBL:STAT3 OFF
```

Manual operation: See "[SS/PBCH Block State](#)" on page 91

6.9.7 Bandwidth part configuration

CONFigure[:NR5G]:DL[:CC<cc>]:FRAMe<fr>:BWPart<bwp>:ADD.....	319
CONFigure[:NR5G]:DL[:CC<cc>]:FRAMe<fr>:BWPart<bwp>:CLEAr.....	320
CONFigure[:NR5G]:DL[:CC<cc>]:FRAMe<fr>:BWPart<bwp>:DUPLicate.....	320
CONFigure[:NR5G]:DL[:CC<cc>]:FRAMe<fr>:BWPart<bwp>:RBCount.....	320
CONFigure[:NR5G]:DL[:CC<cc>]:FRAMe<fr>:BWPart<bwp>:RBOFFset.....	321
CONFigure[:NR5G]:DL[:CC<cc>]:FRAMe<fr>:BWPart<bwp>:REMOve.....	321
CONFigure[:NR5G]:DL[:CC<cc>]:FRAMe<fr>:BWPart<bwp>:SSPacing.....	322
CONFigure[:NR5G]:DL[:CC<cc>]:FRAMe<fr>:BWPCount?.....	322

CONFigure[:NR5G]:DL[:CC<cc>]:FRAMe<fr>:BWPart<bwp>:ADD

Adds a bandwidth part to the signal configuration.

The new bandwidth part has the highest index number. Index numbers start at 0. For example, if you already have three bandwidth parts and add a fourth one, the new one has the index number 3.

Suffix:

<cc> [Component Carrier](#)

<fr> irrelevant

<bwp> irrelevant

Example: //Add a bandwidth part
CONF:DL:CC2:FRAM:BWP:ADD

Usage: Event

Manual operation: See "[BWP Configuration Tools](#)" on page 95

CONFigure[:NR5G]:DL[:CC<cc>]:FRAMe<fr>:BWPart<bwp>:CLEar

Deletes all bandwidth parts.

Suffix:

<cc> [Component Carrier](#)

<fr> irrelevant

<bwp> irrelevant

Example: //Delete all bandwidth parts
CONF:DL:CC2:FRAM:BWP:CLE

Usage: Event

Manual operation: See "[BWP Configuration Tools](#)" on page 95

CONFigure[:NR5G]:DL[:CC<cc>]:FRAMe<fr>:BWPart<bwp>:DUPLicate

Duplicates an existing bandwidth part.

A duplication of a bandwidth part also duplicates its slot and PDSCH configuration.

Suffix:

<cc> irrelevant

<fr> [Frame](#)

<bwp> [Bandwidth part](#)

Example: //Duplicate a bandwidth part
CONF:DL:CC2:FRAM:BWP2:DUPL

Usage: Event

Manual operation: See "[BWP Configuration Tools](#)" on page 95

CONFigure[:NR5G]:DL[:CC<cc>]:FRAMe<fr>:BWPart<bwp>:RBCount <ResourceBlocks>

Defines the number of physical resource blocks a bandwidth part occupies.

Suffix:

<cc> [Component Carrier](#)

<fr> irrelevant

<bwp> [Bandwidth part](#)

Parameters:

<ResourceBlocks> <numeric value> (integer only)

*RST: 10

Example:

```
//Define number of PRB for a BWP
CONF:DL:CC2:FRAM:BWP2:RBC 20
```

Manual operation: See "[# RBs](#)" on page 97

CONFigure[:NR5G]:DL[:CC<cc>]:FRAMe<fr>:BWPart<bwp>:RBOffset <Offset>

Defines a resource block offset for a bandwidth part.

Suffix:

<cc> [Component Carrier](#)

<fr> irrelevant

<bwp> [Bandwidth part](#)

Parameters:

<Offset> <numeric value> (integer only)

*RST: 0

Example:

```
//Define resource block offset for BWP
CONF:DL:CC2:FRAM:BWP2:RBOF 6
```

Manual operation: See "[RB Offset](#)" on page 97

CONFigure[:NR5G]:DL[:CC<cc>]:FRAMe<fr>:BWPart<bwp>:REMOve

Deletes a bandwidth part.

Suffix:

<cc> [Component Carrier](#)

<fr> irrelevant

<bwp> [Bandwidth part](#)

Example:

```
//Remove a bandwidth part
CONF:DL:CC2:FRAM:BWP2:REM
```

Usage:

Event

Manual operation: See "[BWP Configuration Tools](#)" on page 95

CONFigure[:NR5G]:DL[:CC<cc>]:FRAMe<fr>:BWPart<bwp>:SSPacing
 <SubcarrierSpacing>

Selects the subcarrier spacing of a bandwidth part.

Suffix:

<cc>	Component Carrier
<fr>	Frame
<bwp>	Bandwidth part

Parameters:

<SubcarrierSpacing>	SS15 15 kHz subcarrier spacing. Only for signal deployment in FR1.
	SS30 30 kHz subcarrier spacing. Only for signal deployment in FR1.
	SS60 60 kHz subcarrier spacing with normal cyclic prefix. For all signal deployments.
	SS120 120 kHz subcarrier spacing. Only for signal deployment in FR2.
	SS480 480 kHz subcarrier spacing. Only for signal deployment in FR2-2.
	SS960 960 kHz subcarrier spacing. Only for signal deployment in FR2-2 and a 2000 MHz bandwidth.
	X60 60 kHz subcarrier spacing with extended cyclic prefix. For all signal deployments.

Example: //Select BWP subcarrier spacing
 CONF:DL:DFR LOW
 CONF:DL:FRAM:BWPart:SSP SS30

Manual operation: See "[Subcarrier Spacing \(user data\)](#)" on page 96

CONFigure[:NR5G]:DL[:CC<cc>]:FRAMe<fr>:BWPCount?

Queries the number of analyzed bandwidth parts.

Suffix:

<cc>	Component Carrier
<fr>	irrelevant

Return values:

<BWPs> <numeric value> (integer)

Example:

```
//Query number of bandwidth parts
CONF:DL:FRAM:BWPC?
```

Usage:

Query only

6.9.8 Slot configuration

CONFigure[:NR5G]:DL[:CC<cc>]:FRAMe<fr>:BWPart<bwp>:CSLot.....	323
CONFigure[:NR5G]:DL[:CC<cc>]:FRAMe<fr>:BWPart<bwp>:SCOunt?.....	323
CONFigure[:NR5G]:DL[:CC<cc>]:FRAMe<fr>:BWPart<bwp>:SLOT<sl>:ATYPe.....	324
CONFigure[:NR5G]:DL[:CC<cc>]:FRAMe<fr>:BWPart<bwp>:SLOT<sl>:COPY.....	324
CONFigure[:NR5G]:DL[:CC<cc>]:FRAMe<fr>:BWPart<bwp>:SLOT<sl>:FORMat.....	325
CONFigure[:NR5G]:DL[:CC<cc>]:FRAMe<fr>:BWPart<bwp>:SLOT<sl>:PASTe:ALL.....	325
CONFigure[:NR5G]:DL[:CC<cc>]:FRAMe<fr>:BWPart<bwp>:SLOT<sl>:PASTe:TO: DURation.....	326
CONFigure[:NR5G]:DL[:CC<cc>]:FRAMe<fr>:BWPart<bwp>:SLOT<sl>:PASTe:TO:MODE...	326
CONFigure[:NR5G]:DL[:CC<cc>]:FRAMe<fr>:BWPart<bwp>:SLOT<sl>:PASTe:TO.....	327
CONFigure[:NR5G]:DL[:CC<cc>]:FRAMe<fr>:BWPart<bwp>:SLOT<sl>:PASTe:TO:PERiod..	328
CONFigure[:NR5G]:DL[:CC<cc>]:FRAMe<fr>:BWPart<bwp>:SLOT<sl>:PASTe:TO:SLOTs...	328
CONFigure[:NR5G]:DL[:CC<cc>]:FRAMe<fr>:BWPart<bwp>:SLOT<sl>:PASTe[:SLOT].....	329
CONFigure[:NR5G]:DL[:CC<cc>]:FRAMe<fr>:BWPart<bwp>:SLOT<sl>:PRESet.....	329

CONFigure[:NR5G]:DL[:CC<cc>]:FRAMe<fr>:BWPart<bwp>:CSLot <Slots>

Defines the number of slots that you can configure.

Suffix:

<cc> Component Carrier

<fr> Frame

<bwp> Bandwidth part

Parameters:

<Slots> <numeric value> (integer only)

The maximum number of configurable slots depends on the sub-carrier spacing in the bandwidth part.

*RST: 1

Example:

```
//Select number of custom slots
CONF:DL:CC2:FRAM3:BWP2:CSL 2
```

Manual operation: See "[Number of Configurable Slots](#)" on page 99

CONFigure[:NR5G]:DL[:CC<cc>]:FRAMe<fr>:BWPart<bwp>:SCOunt?

Queries the number of analyzed slots.

Suffix:	
<cc>	Component Carrier
<fr>	Frame
<bwp>	Bandwidth part
Return values:	
<Slots>	<numeric value> (integer)
Example:	//Query number of analyzed slots CONF:DL:CC2:FRAM3:BWP2:SCO?
Usage:	Query only

CONFigure[:NR5G]:DL[:CC<cc>]:FRAMe<fr>:BWPart<bwp>:SLOT<sl>:ATYPe
<Type>

Selects the allocation type of a slot.

Suffix:	
<cc>	Component Carrier
<fr>	Frame
<bwp>	Bandwidth part
<sl>	Bandwidth part
Parameters:	
<Type>	DATA Slot contains information.
	UNUSed Slot contains no information.
	*RST: DATA
Example:	//Select slot allocation CONF:DL:CC2:FRAM3:BWP2:SLOT4:ATYP DATA
Manual operation:	See " Slot Allocation " on page 101

CONFigure[:NR5G]:DL[:CC<cc>]:FRAMe<fr>:BWPart<bwp>:SLOT<sl>:COPY

Copies a slot configuration.

Suffix:	
<cc>	Component Carrier
<fr>	Frame
<bwp>	Bandwidth part
<sl>	Bandwidth part
Example:	//Copy configuration of a slot CONF:DL:CC2:FRAM3:BWP2:SLOT4:COPY

Usage: Event

Manual operation: See "[Slot Configuration Tools](#)" on page 100

CONFigure[:NR5G]:DL[:CC<cc>]:FRAMe<fr>:BWPart<bwp>:SLOT<sl>:FORMat
 <SlotFormat>

Selects the slot format for a slot.

Suffix:

<cc> [Component Carrier](#)

<fr> [Frame](#)

<bwp> [Bandwidth part](#)

<sl> [Bandwidth part](#)

Parameters:

<SlotFormat> <numeric value> (integer only)

Range: 0 to 61

*RST: 0

Example: //Select a slot format

```
CONF:DL:CC2:FRAM3:BWP2:SLOT4:ATYP 6
```

Manual operation: See "[Slot Format](#)" on page 101

CONFigure[:NR5G]:DL[:CC<cc>]:FRAMe<fr>:BWPart<bwp>:SLOT<sl>:PASTe:
 ALL

Applies an existing slot configuration to all other slots.

Prerequisites for this command

- Copy a slot configuration (`CONFigure[:NR5G]:DL[:CC<cc>]:FRAMe<fr>:BWPart<bwp>:SLOT<sl>:COPY`).

Suffix:

<cc> [Component Carrier](#)

<fr> [Frame](#)

<bwp> [Bandwidth part](#)

<sl> [Bandwidth part](#)

Example: //Copy configuration of slot 4

```
CONF:DL:CC2:FRAM3:BWP2:SLOT4:COPY
```

//Apply configuration to all other slots

```
CONF:DL:CC2:FRAM3:BWP2:SLOT:PAST:ALL
```

Usage: Event

Manual operation: See "[Slot Configuration Tools](#)" on page 100

**CONFigure[:NR5G]:DL[:CC<cc>]:FRAMe<fr>:BWPart<bwp>:SLOT<sl>:PASTe:
TO:DURation <Value>**

Defines to which slots a slot configuration is copied to.

Prerequisites for this command

- A slot configuration is in the clipboard (`CONFigure[:NR5G]:DL[:CC<cc>]:FRAMe<fr>:BWPart<bwp>:SLOT<sl>:COPY`).
- Number of configurable slots > 1 (`CONFigure[:NR5G]:DL[:CC<cc>]:FRAMe<fr>:BWPart<bwp>:CSLot`).
- Select custom paste mode (`CONFigure[:NR5G]:DL[:CC<cc>]:FRAMe<fr>:BWPart<bwp>:SLOT<sl>:PASTe:TO:MODE`).

Suffix:

<cc>	Component Carrier
<fr>	Frame
<bwp>	Bandwidth part
<sl>	Bandwidth part

Parameters:

<Value> The paste duration corresponds to a certain number of slots in a row.

*RST: 1

Example:

```
//Paste configuration of slot 0 to 2 slots in a row, every 3rd slot
(0,1,3,4,6,7,9,10,12)
CONF:DL:CC2:FRAM3:BWP2:CSL 12
CONF:DL:CC2:FRAM3:BWP2:SLOT0:COPY
CONF:DL:CC2:FRAM3:BWP2:SLOT0:PAST:TO:MODE CUST
CONF:DL:CC2:FRAM3:BWP2:SLOT0:PAST:TO:PER 3
CONF:DL:CC2:FRAM3:BWP2:SLOT0:PAST:TO:DUR 2
```

**CONFigure[:NR5G]:DL[:CC<cc>]:FRAMe<fr>:BWPart<bwp>:SLOT<sl>:PASTe:
TO:MODE <Mode>**

Selects the paste logic when you copy a slot configuration to other slots.

Prerequisites for this command

- A slot configuration is in the clipboard (`CONFigure[:NR5G]:DL[:CC<cc>]:FRAMe<fr>:BWPart<bwp>:SLOT<sl>:COPY`).
- Number of configurable slots > 1 (`CONFigure[:NR5G]:DL[:CC<cc>]:FRAMe<fr>:BWPart<bwp>:CSLot`).

Suffix:

<cc>	Component Carrier
<fr>	Frame
<bwp>	Bandwidth part

<sl> [Bandwidth part](#)

Parameters:

<Mode>

CUSTom

Copies the slot configuration to specific set of slots according to the logic defined with:

- `CONFigure[:NR5G]:DL[:CC<cc>]:FRAMe<fr>:BWPart<bwp>:SLOT<sl>:PASTe:TO:PERiod`
- `CONFigure[:NR5G]:DL[:CC<cc>]:FRAMe<fr>:BWPart<bwp>:SLOT<sl>:PASTe:TO:DURation`

DATA

Copies the slot configuration to all data slots.

SLOTS

Copies the slot configuration to a specific set of slots.

UNUSed

Copies the slot configuration to all unused slots.

Example:

```
//Paste configuration of slot 0 to every DATA slot
CONF:DL:CC2:FRAM3:BWP2:CSL 12
CONF:DL:CC2:FRAM3:BWP2:SLOT0:COPY
CONF:DL:CC2:FRAM3:BWP2:SLOT0:PAST:TO:MODE DATA
```

CONFigure[:NR5G]:DL[:CC<cc>]:FRAMe<fr>:BWPart<bwp>:SLOT<sl>:PASTe:TO

Copies a slot configuration to other slots.

Prerequisites for this command

- A slot configuration is in the clipboard (`CONFigure[:NR5G]:DL[:CC<cc>]:FRAMe<fr>:BWPart<bwp>:SLOT<sl>:COPY`).
- Number of configurable slots > 1 (`CONFigure[:NR5G]:DL[:CC<cc>]:FRAMe<fr>:BWPart<bwp>:CSLot`).
- Select custom paste mode (`CONFigure[:NR5G]:DL[:CC<cc>]:FRAMe<fr>:BWPart<bwp>:SLOT<sl>:PASTe:TO:MODE`).

Suffix:

<cc> [Component Carrier](#)

<fr> [Frame](#)

<bwp> [Bandwidth part](#)

<sl> [Bandwidth part](#)

Example:

```
//Paste configuration of slot 0 to 2 slots in a row, every 3rd slot
(0,1,3,4,6,7,9,10,12)
CONF:DL:CC2:FRAM3:BWP2:CSL 12
CONF:DL:CC2:FRAM3:BWP2:SLOT0:COPY
CONF:DL:CC2:FRAM3:BWP2:SLOT0:PAST:TO:MODE CUST
CONF:DL:CC2:FRAM3:BWP2:SLOT0:PAST:TO:PER 3
CONF:DL:CC2:FRAM3:BWP2:SLOT0:PAST:TO:DUR 2
CONF:DL:CC2:FRAM3:BWP2:SLOT0:PAST:TO
```

Usage: Event

Manual operation: See "Slot Configuration Tools" on page 100

**CONFigure[:NR5G]:DL[:CC<cc>]:FRAMe<fr>:BWPart<bwp>:SLOT<sl>:PASTe:
TO:PERiod <Period>**

Defines to which slots a slot configuration is copied to.

Prerequisites for this command

- A slot configuration is in the clipboard (`CONFigure[:NR5G]:DL[:CC<cc>]:FRAMe<fr>:BWPart<bwp>:SLOT<sl>:COPY`).
- Number of configurable slots > 1 (`CONFigure[:NR5G]:DL[:CC<cc>]:FRAMe<fr>:BWPart<bwp>:CSLot`).
- Select custom paste mode (`CONFigure[:NR5G]:DL[:CC<cc>]:FRAMe<fr>:BWPart<bwp>:SLOT<sl>:PASTe:TO:MODE`).

Suffix:

<cc> Component Carrier

<fr> Frame

<bwp> Bandwidth part

<sl> Bandwidth part

Parameters:

<Period> The paste period corresponds to every nth slot.

*RST: 1

Example:

```
//Paste configuration of slot 0 to every 3rd slot (0,3,6,9,12)
CONF:DL:CC2:FRAM3:BWP2:CSL 12
CONF:DL:CC2:FRAM3:BWP2:SLOT0:COPY
CONF:DL:CC2:FRAM3:BWP2:SLOT0:PAST:TO:MODE CUST
CONF:DL:CC2:FRAM3:BWP2:SLOT0:PAST:TO:PER 3
```

**CONFigure[:NR5G]:DL[:CC<cc>]:FRAMe<fr>:BWPart<bwp>:SLOT<sl>:PASTe:
TO:SLOTs <Slot>**

Copies a slot configuration to a specific set of slots.

Prerequisites for this command

- Number of configurable slots > 1 (`CONFigure[:NR5G]:DL[:CC<cc>]:FRAMe<fr>:BWPart<bwp>:CSLot`).
- Select slot paste mode (`CONFigure[:NR5G]:DL[:CC<cc>]:FRAMe<fr>:BWPart<bwp>:SLOT<sl>:PASTe:TO:MODE`).

Suffix:

<cc> Component Carrier

<fr> Frame

<bwp> Bandwidth part

<sl> Slot

Parameters:

<Slot> String that contains a list of slots either as comma-separated list ("2,5,8"), a range ("3-5") or a combination of both ("2-5,8,10").

Example:

```
//Copy allocation configuration to several slots
CONF:DL:CC2:FRAM3:BWP2:CSL 12
CONF:DL:CC2:FRAM3:BWP2:SLOT0:PAST:TO:MODE SLOT
CONF:DL:CC2:FRAM3:BWP2:SLOT0:PAST:TO:SLOT
"3, 6, 9"
```

CONFigure[:NR5G]:DL[:CC<cc>]:FRAMe<fr>:BWPart<bwp>:SLOT<sl>:PASTe[:SLOT]

Applies an existing slot configuration to another one.

Prerequisites for this command

- Copy a slot configuration (CONFigure[:NR5G]:DL[:CC<cc>]:FRAMe<fr>:BWPart<bwp>:SLOT<sl>:COPY).

Suffix:

<cc> Component Carrier

<fr> Frame

<bwp> Bandwidth part

<sl> Bandwidth part

Example:

```
//Copy configuration of slot 4
CONF:DL:CC2:FRAM3:BWP2:SLOT4:COPY
//Apply configuration to slot 3
CONF:DL:CC2:FRAM3:BWP2:SLOT5:PAST
```

Usage: Event

Manual operation: See "Slot Configuration Tools" on page 100

CONFigure[:NR5G]:DL[:CC<cc>]:FRAMe<fr>:BWPart<bwp>:SLOT<sl>:PRESet

Resets the slot configuration of a bandwidth part to its default state.

Suffix:

<cc> Component Carrier

<fr> Frame

<bwp> Bandwidth part

<sl> irrelevant

Example:

```
//Reset the slot configuration
CONF:DL:CC2:FRAM3:BWP2:SLOT:PRESet
```

Usage: Event

Manual operation: See "Slot Configuration Tools" on page 100

6.9.9 CSI reference signal configuration

CONFigure[:NR5G]:DL[:CC<cc>]:FRAME<fr>:BWPart<bwp>:CSI<csi>:BITMap.....	330
CONFigure[:NR5G]:DL[:CC<cc>]:FRAME<fr>:BWPart<bwp>:CSI<csi>:CTYPe?.....	331
CONFigure[:NR5G]:DL[:CC<cc>]:FRAME<fr>:BWPart<bwp>:CSI<csi>:DENSity.....	331
CONFigure[:NR5G]:DL[:CC<cc>]:FRAME<fr>:BWPart<bwp>:CSI<csi>:LONE.....	331
CONFigure[:NR5G]:DL[:CC<cc>]:FRAME<fr>:BWPart<bwp>:CSI<csi>:LZERo.....	332
CONFigure[:NR5G]:DL[:CC<cc>]:FRAME<fr>:BWPart<bwp>:CSI<csi>:NORBs.....	333
CONFigure[:NR5G]:DL[:CC<cc>]:FRAME<fr>:BWPart<bwp>:CSI<csi>:PORT?.....	333
CONFigure[:NR5G]:DL[:CC<cc>]:FRAME<fr>:BWPart<bwp>:CSI<csi>:POWER.....	333
CONFigure[:NR5G]:DL[:CC<cc>]:FRAME<fr>:BWPart<bwp>:CSI<csi>:RESources.....	334
CONFigure[:NR5G]:DL[:CC<cc>]:FRAME<fr>:BWPart<bwp>:CSI<csi>:ROW.....	334
CONFigure[:NR5G]:DL[:CC<cc>]:FRAME<fr>:BWPart<bwp>:CSI<csi>:SID.....	335
CONFigure[:NR5G]:DL[:CC<cc>]:FRAME<fr>:BWPart<bwp>:CSI<csi>:SLOT:APERiodic.....	335
CONFigure[:NR5G]:DL[:CC<cc>]:FRAME<fr>:BWPart<bwp>:CSI<csi>:SLOT:MODE.....	336
CONFigure[:NR5G]:DL[:CC<cc>]:FRAME<fr>:BWPart<bwp>:CSI<csi>:SLOT:PERiodicity.....	336
CONFigure[:NR5G]:DL[:CC<cc>]:FRAME<fr>:BWPart<bwp>:CSI<csi>:SLOT:POFFset.....	337
CONFigure[:NR5G]:DL[:CC<cc>]:FRAME<fr>:BWPart<bwp>:CSI<csi>:SRB.....	337
CONFigure[:NR5G]:DL[:CC<cc>]:FRAME<fr>:BWPart<bwp>:CSI<csi>:STATe.....	338
CONFigure[:NR5G]:DL[:CC<cc>]:FRAME<fr>:BWPart<bwp>:CSI<csi>:ZPOWER.....	338

CONFigure[:NR5G]:DL[:CC<cc>]:FRAME<fr>:BWPart<bwp>:CSI<csi>:BITMap <Value>

Defines the bitmap setting for the CSI-RS.

Note that you cannot change the bitmap value for selected location settings (CONFigure[:NR5G]:DL[:CC<cc>]:FRAME<fr>:BWPart<bwp>:CSI<csi>:ROW on page 334).

Suffix:

<cc>	Component Carrier
<fr>	Frame
<bwp>	Bandwidth part
<csi>	CSI-RS

Parameters:

<Value> The value range depends on the selected location setting.

Example:

```
//Define bitmap
CONF:DL:CC2:FRAM:BW2:CSI:ROW 1
CONF:DL:CC2:FRAM:BW2:CSI:BITM 0011
```

Manual operation: See "Bitmap" on page 106

CONFigure[:NR5G]:DL[:CC<cc>]:FRAMe<fr>:BWPart<bwp>:CSI<csi>:CTYPe?

Queries the CDM type of the CSI-RS.

Suffix:

<cc>	Component Carrier
<fr>	Frame
<bwp>	Bandwidth part
<csi>	CSI-RS

Return values:

<CDMType> NOCDm | FDCCdm2 | CDM4 | CDM8

Example:

```
//Query CDM type
CONF:DL:CC2:FRAM:BWP2:CSI:ROW 4
CONF:DL:CC2:FRAM:BWP2:CSI:CTYP?
returns: FDCC
```

Usage: Query only

Manual operation: See "Row" on page 105

**CONFigure[:NR5G]:DL[:CC<cc>]:FRAMe<fr>:BWPart<bwp>:CSI<csi>:DENSity
<Configuration>**

Selects the density configuration for the CSI-RS.

Suffix:

<cc>	Component Carrier
<fr>	Frame
<bwp>	Bandwidth part
<csi>	CSI-RS

Parameters:

<Configuration> DEN1 | DEN3 | EVEN | ODD

The availability and default value of the configurations depends on the location setting ([CONFigure\[:NR5G\]:DL\[:CC<cc>\]:FRAMe<fr>:BWPart<bwp>:CSI<csi>:ROW](#)).

Example:

```
//Define density
CONF:DL:CC2:FRAM:BWP2:CSI:ROW 4
CONF:DL:CC2:FRAM:BWP2:CSI:DENS DEN1
```

Manual operation: See "Density" on page 105

**CONFigure[:NR5G]:DL[:CC<cc>]:FRAMe<fr>:BWPart<bwp>:CSI<csi>:LONE
<Value>**

Defines parameter I_1 of the CSI-RS.

Prerequisites for this command

- Select a location setting that supports I_1 (`CONFigure[:NR5G]:DL[:CC<cc>]:FRAMe<fr>:BWPART<bwp>:CSI<csi>:ROW`).

Effects of this command

- Changing I_1 can have an effect on the value of I_0 (`CONFigure[:NR5G]:DL[:CC<cc>]:FRAMe<fr>:BWPART<bwp>:CSI<csi>:LZERo`).

Suffix:

<cc>	Component Carrier
<fr>	Frame
<bwp>	Bandwidth part
<csi>	CSI-RS

Parameters:

<Value> The range of values and default value depend on the selected CSI-RS location setting.

Example:

```
//Define location of CSI-RS
CONF:DL:CC2:FRAM:BWP2:CSI:ROW 16
CONF:DL:CC2:FRAM:BWP2:CSI:LZER 10
```

Manual operation: See "I0 / I1" on page 106

CONFigure[:NR5G]:DL[:CC<cc>]:FRAMe<fr>:BWPART<bwp>:CSI<csi>:LZERo
<Value>

Defines parameter I_0 of the CSI-RS.

Effects of this command

- Changing I_0 can have an effect on the value of I_1 (`CONFigure[:NR5G]:DL[:CC<cc>]:FRAMe<fr>:BWPART<bwp>:CSI<csi>:LONE`).

Suffix:

<cc>	Component Carrier
<fr>	Frame
<bwp>	Bandwidth part
<csi>	CSI-RS

Parameters:

<Value> The range of values and default value depend on the selected CSI-RS location setting (`CONFigure[:NR5G]:DL[:CC<cc>]:FRAMe<fr>:BWPART<bwp>:CSI<csi>:ROW`).

Example:

```
//Define location of CSI-RS
CONF:DL:CC2:FRAM:BWP2:CSI:ROW 1
CONF:DL:CC2:FRAM:BWP2:CSI:LZER 5
```

Manual operation: See "I0 / I1" on page 106

CONFigure[:NR5G]:DL[:CC<cc>]:FRAMe<fr>:BWPart<bwp>:CSI<csi>:NORBs
 <ResourceBlocks>

Selects the number of resource blocks occupied by the CSI reference signal.

Suffix:

<cc>	Component Carrier
<fr>	Frame
<bwp>	Bandwidth part
<csi>	CSI-RS

Parameters:

<ResourceBlocks>

Example: //Select number of resource blocks
 CONF:DL:CC2:FRAM:BWP2:CSI:NORB 4

Manual operation: See "No. RBs" on page 105

CONFigure[:NR5G]:DL[:CC<cc>]:FRAMe<fr>:BWPart<bwp>:CSI<csi>:PORT?

Queries the port configuration of the CSI-RS.

Suffix:

<cc>	Component Carrier
<fr>	Frame
<bwp>	Bandwidth part
<csi>	CSI-RS

Return values:

<Value>

Example: //Query ports
 CONF:DL:CC2:FRAM:BWP2:CSI:ROW 16
 CONF:DL:CC2:FRAM:BWP2:CSI:PORT?
 returns: 32

Usage: Query only

Manual operation: See "Row" on page 105

CONFigure[:NR5G]:DL[:CC<cc>]:FRAMe<fr>:BWPart<bwp>:CSI<csi>:POWER
 <Power>

Defines the relative power of the CSI-RS.

Suffix:

<cc>	Component Carrier
<fr>	Frame
<bwp>	Bandwidth part

<csi> [CSI-RS](#)

Parameters:

<Power> *RST: 0
Default unit: dB

Example: //Define relative power
CONF:DL:CC2:FRAM:BWP2:CSI:POW 6

Manual operation: See "[Rel Power](#)" on page 106

CONFigure[:NR5G]:DL[:CC<cc>]:FRAMe<fr>:BWPart<bwp>:CSI<csi>:RESources
<Resource>

Defines the number of different CSI-RS resources.

Suffix:

<cc> [Component Carrier](#)

<fr> [Frame](#)

<bwp> [Bandwidth part](#)

<csi> [CSI-RS](#)

Parameters:

<Resource> *RST: 1

Example: //Define number of CSI-RS resources
CONF:DL:CC2:FRAM:BWP2:CSI:RES 5

Manual operation: See "[Resources](#)" on page 103

CONFigure[:NR5G]:DL[:CC<cc>]:FRAMe<fr>:BWPart<bwp>:CSI<csi>:ROW
<Value>

Selects the location setting for the CSI-RS.

Effects of this command

- Selecting a location setting has effects on the range and availability of the other CSI-RS parameters.

Suffix:

<cc> [Component Carrier](#)

<fr> [Frame](#)

<bwp> [Bandwidth part](#)

<csi> [CSI-RS](#)

Parameters:

<Value> The numeric value corresponds to the number of the row in 3GPP 38.211, table 7.4.1.5.3-1.

Range: 1 to 18

*RST: 1

Example: //Select row
CONF:DL:CC2:FRAM:BWP2:CSI:ROW 16

Manual operation: See "Row" on page 105

CONFigure[:NR5G]:DL[:CC<cc>]:FRAMe<fr>:BWPart<bwp>:CSI<csi>:SID
<Value>

Defines the seed value for the CSI-RS sequence generation.

Suffix:

<cc> Component Carrier
<fr> Frame
<bwp> Bandwidth part
<csi> CSI-RS

Parameters:

<Value> *RST: 0

Example: //Define seed value
CONF:DL:CC2:FRAM:BWP2:CSI:SID 4

Manual operation: See "Scrambling ID" on page 106

CONFigure[:NR5G]:DL[:CC<cc>]:FRAMe<fr>:BWPart<bwp>:CSI<csi>:SLOT:
APERiodic <Slot>

Defines the slots in which a CSI reference signal is transmitted.

Prerequisites for this command

- Select aperiodic transmission (CONFigure[:NR5G]:DL[:CC<cc>]:FRAMe<fr>:BWPart<bwp>:CSI<csi>:SLOT:MODE).

Suffix:

<cc> Component Carrier
<fr> Frame
<bwp> Bandwidth part
<csi> CSI-RS

Parameters:

<Slot> String containing the slot numbers a CSI-RS is allocated to.
Example: To transmit the CSI-RS in slots 1,2,3,4,5,7,11, enter the string '1-5,7,11'.

Example: //Define CSI-RS transmission
CONF:DL:CC2:FRAM:BWP2:CSI:SLOT:MODE APER
CONF:DL:CC2:FRAM:BWP2:CSI:SLOT:APER '1,3,5-10'

Manual operation: See "Aperiodic transmission" on page 104

**CONFigure[:NR5G]:DL[:CC<cc>]:FRAMe<fr>:BWPart<bwp>:CSI<csi>:SLOT:
MODE <Configuration>**

Selects the transmission method for the CSI reference signal.

Suffix:

<cc>	Component Carrier
<fr>	Frame
<bwp>	Bandwidth part
<csi>	CSI-RS

Parameters:

<Configuration>	APERiodic Aperiodic transmission.
	PERiodic Periodic transmission every <x> slots.
*RST:	PERiodic

Example: //Select transmission method for CSI-RS
CONF:DL:CC2:FRAM:BWP2:CSI:SLOT:MODE PER

Manual operation: See "Slot Config" on page 104

**CONFigure[:NR5G]:DL[:CC<cc>]:FRAMe<fr>:BWPart<bwp>:CSI<csi>:SLOT:
PERiodicity <Slot>**

Selects the periodicity of CSI-RS transmission in terms of slots.

Prerequisites for this command

- Select periodic transmission (CONFigure[:NR5G]:DL[:CC<cc>]:FRAMe<fr>:
BWPart<bwp>:CSI<csi>:SLOT:MODE).

Suffix:

<cc>	Component Carrier
<fr>	Frame
<bwp>	Bandwidth part
<csi>	CSI-RS

Parameters:

<Slot>	SL4 SL5 SL8 SL10 SL16 SL20 SL32 SL40 SL64 SL80 S160 S320 S640 Example: SL4 selects a periodicity of 4 (transmission every four slots). The availability of parameters depends on the subcarrier spacing in the bandwidth part you are configuring.
*RST:	SL4

Example: //Define CSI-RS transmission periodicity
 CONF:DL:CC2:FRAM:BWP2:CSI:SLOT:MODE PER
 CONF:DL:CC2:FRAM:BWP2:CSI:SLOT:PER SL8

Manual operation: See "[Periodic transmission](#)" on page 104

**CONFigure[:NR5G]:DL[:CC<cc>]:FRAMe<fr>:BWPart<bwp>:CSI<csi>:SLOT:
 POFFset <Offset>**

This command defines an offset for the first CSI-RS relative to the first slot in a bandwidth part.

Prerequisites for this command

- Select periodic transmission (CONFigure[:NR5G]:DL[:CC<cc>]:FRAMe<fr>:BWPart<bwp>:CSI<csi>:SLOT:MODE).

Suffix:

<cc> Component Carrier
 <fr> Frame
 <bwp> Bandwidth part
 <csi> CSI-RS

Parameters:

<Offset> Example: An offset of 2 assigns the first CSI-RS to the second slot.
 *RST: 0

Example: //Define CSI-RS transmission periodicity
 CONF:DL:CC2:FRAM:BWP2:CSI:SLOT:MODE PER
 CONF:DL:CC2:FRAM:BWP2:CSI:SLOT:POFF 2

Manual operation: See "[Periodic transmission](#)" on page 104

**CONFigure[:NR5G]:DL[:CC<cc>]:FRAMe<fr>:BWPart<bwp>:CSI<csi>:SRB
 <ResourceBlock>**

Select the first resource block occupied by the CSI reference signal.

Suffix:

<cc> Component Carrier
 <fr> Frame
 <bwp> Bandwidth part
 <csi> CSI-RS

Parameters:

<ResourceBlock>

Example: //Select starting resource block
 CONF:DL:CC2:FRAM:BWP2:CSI:NORB 10

Manual operation: See "Start RB" on page 105

CONFigure[:NR5G]:DL[:CC<cc>]:FRAMe<fr>:BWPart<bwp>:CSI<csi>:STATe
<State>

Turns the transmission of the CSI reference signal on and off.

Suffix:

<cc> Component Carrier
<fr> Frame
<bwp> Bandwidth part
<csi> CSI-RS

Parameters:

<State> ON | OFF | 1 | 0
*RST: OFF

Example: //Turn on transmission of CSI-RS
CONF:DL:CC2:FRAM:BWP2:CSI:STAT ON

Manual operation: See "State" on page 103

CONFigure[:NR5G]:DL[:CC<cc>]:FRAMe<fr>:BWPart<bwp>:CSI<csi>:ZPOWer
<State>

Turns zero power transmission of the CSI reference signal on and off.

Effects of this command

- Turning on zero power transmission disables the scrambling ID and relative power parameters (CONFigure[:NR5G]:DL[:CC<cc>]:FRAMe<fr>:BWPart<bwp>:CSI<csi>:SID and CONFigure[:NR5G]:DL[:CC<cc>]:FRAMe<fr>:BWPart<bwp>:CSI<csi>:POWer).

Suffix:

<cc> Component Carrier
<fr> Frame
<bwp> Bandwidth part
<csi> CSI-RS

Parameters:

<State> ON | OFF | 1 | 0
*RST: OFF

Example: //Turn on zero power transmission
CONF:DL:CC2:FRAM:BWP2:CSI:ZPOW ON

Manual operation: See "Zero Power" on page 104

6.9.10 Positioning reference signal

CONFigure[:NR5G]:DL[:CC<cc>]:FRAMe<fr>:BWPart<bwp>:PRS:KPComb.....	339
CONFigure[:NR5G]:DL[:CC<cc>]:FRAMe<fr>:BWPart<bwp>:PRS:KPOffset.....	339
CONFigure[:NR5G]:DL[:CC<cc>]:FRAMe<fr>:BWPart<bwp>:PRS:LPRS.....	340
CONFigure[:NR5G]:DL[:CC<cc>]:FRAMe<fr>:BWPart<bwp>:PRS:LPSTart.....	340
CONFigure[:NR5G]:DL[:CC<cc>]:FRAMe<fr>:BWPart<bwp>:PRS:NORBs.....	340
CONFigure[:NR5G]:DL[:CC<cc>]:FRAMe<fr>:BWPart<bwp>:PRS:NPID.....	341
CONFigure[:NR5G]:DL[:CC<cc>]:FRAMe<fr>:BWPart<bwp>:PRS:POWER.....	341
CONFigure[:NR5G]:DL[:CC<cc>]:FRAMe<fr>:BWPart<bwp>:PRS:SLOT:APERiodic.....	341
CONFigure[:NR5G]:DL[:CC<cc>]:FRAMe<fr>:BWPart<bwp>:PRS:SRB.....	342
CONFigure[:NR5G]:DL[:CC<cc>]:FRAMe<fr>:BWPart<bwp>:PRS:STATE.....	342

CONFigure[:NR5G]:DL[:CC<cc>]:FRAMe<fr>:BWPart<bwp>:PRS:KPComb <Subcarrier>

Defines the number of subcarriers the positioning reference signal uses.

Suffix:

<cc>	Component Carrier
<fr>	Frame
<bwp>	Bandwidth part

Parameters:

<Subcarrier>	Available values depend on the number of symbols the PRS uses (CONFigure[:NR5G]:DL[:CC<cc>]:FRAMe<fr>:BWPart<bwp>:PRS:LPRS).
*RST:	2

Example:

```
//Select number of subcarrier
CONF:DL:CC2:FRAM:BWPart:PRS:LPRS 4
CONF:DL:CC2:FRAM:BWPart:PRS:KPC 4
```

Manual operation: See "[K^PRS_comb](#)" on page 108

CONFigure[:NR5G]:DL[:CC<cc>]:FRAMe<fr>:BWPart<bwp>:PRS:KPOffset <Offset>

Defines an offset in the frequency domain for the positioning reference signal.

Suffix:

<cc>	Component Carrier
<fr>	Frame
<bwp>	Bandwidth part

Parameters:

<Offset>	*RST: 0
----------	---------

Example:

```
//Define offset in frequency domain
CONF:DL:CC2:FRAM:BWPart:PRS:KPOF 4
```

Manual operation: See "[K^PRS_Offset](#)" on page 108

CONFigure[:NR5G]:DL[:CC<cc>]:FRAMe<fr>:BWPart<bwp>:PRS:LPRS
<Symbols>

Defines the number of symbols the positioning reference signal uses.

Suffix:

<cc> [Component Carrier](#)

<fr> [Frame](#)

<bwp> [Bandwidth part](#)

Parameters:

<Symbols> *RST: 2

Example: //Select number of symbol for PRS
CONF:DL:CC2:FRAM:BWP2:PRS:LPRS 6

Manual operation: See "[L_PRS](#)" on page 108

CONFigure[:NR5G]:DL[:CC<cc>]:FRAMe<fr>:BWPart<bwp>:PRS:LPStart
<Symbol>

Defines the first symbol the positioning reference signal uses.

Suffix:

<cc> [Component Carrier](#)

<fr> [Frame](#)

<bwp> [Bandwidth part](#)

Parameters:

<Symbol> *RST: 0

Example: //Select first symbol for PRS
CONF:DL:CC2:FRAM:BWP2:PRS:LPST 4

Manual operation: See "[I^PRS_Start](#)" on page 108

CONFigure[:NR5G]:DL[:CC<cc>]:FRAMe<fr>:BWPart<bwp>:PRS:NORBs
<ResourceBlocks>

Selects the number of resource blocks occupied by the positioning reference signal.

Suffix:

<cc> [Component Carrier](#)

<fr> [Frame](#)

<bwp> [Bandwidth part](#)

Parameters:

<ResourceBlocks>

Example: //Select number of resource blocks
 CONF:DL:CC2:FRAM:BWP2:PRS:NORB 4

Manual operation: See "No. RBs" on page 107

CONFigure[:NR5G]:DL[:CC<cc>]:FRAMe<fr>:BWPart<bwp>:PRS:NPID <Value>

Defines the seed value for the positioning reference signal sequence generation.

Suffix:

<cc> [Component Carrier](#)

<fr> [Frame](#)

<bwp> [Bandwidth part](#)

Parameters:

<Value> *RST: 0

Example: //Define seed value
 CONF:DL:CC2:FRAM:BWP2:PRS:SID 4

Manual operation: See "n^PRS_ID,Seq" on page 108

CONFigure[:NR5G]:DL[:CC<cc>]:FRAMe<fr>:BWPart<bwp>:PRS:POWER <Power>

Defines the relative power of the positioning reference signal.

Suffix:

<cc> [Component Carrier](#)

<fr> [Frame](#)

<bwp> [Bandwidth part](#)

Parameters:

<Power> *RST: 0
 Default unit: dB

Example: //Define relative power
 CONF:DL:CC2:FRAM:BWP2:PRS:POW 6

Manual operation: See "Rel Power" on page 109

**CONFigure[:NR5G]:DL[:CC<cc>]:FRAMe<fr>:BWPart<bwp>:PRS:SLOT:
 APERiodic <Slot>**

Defines the slots in which a positioning reference signal is transmitted.

Suffix:

<cc> [Component Carrier](#)

<fr> [Frame](#)

<bwp> [Bandwidth part](#)

Parameters:

<Slot> String containing the slot numbers a PRS is allocated to.
 Example: To transmit the CSI-RS in slots 1,2,3,4,5,7,11, enter the string '1-5,7,11'.

Example:

```
//Define PRS transmission
CONF:DL:CC2:FRAM:BWP2:CSI:SLOT:APER '1,3,5-10'
```

Manual operation: See ["Slot Config"](#) on page 107

CONFigure[:NR5G]:DL[:CC<cc>]:FRAMe<fr>:BWPart<bwp>:PRS:SRB
 <ResourceBlock>

Select the first resource block occupied by the positioning reference signal.

Suffix:

<cc> [Component Carrier](#)

<fr> [Frame](#)

<bwp> [Bandwidth part](#)

Parameters:

<ResourceBlock>

Example:

```
//Select starting resource block
CONF:DL:CC2:FRAM:BWP2:PRS:NORB 10
```

Manual operation: See ["Start RB"](#) on page 108

CONFigure[:NR5G]:DL[:CC<cc>]:FRAMe<fr>:BWPart<bwp>:PRS:STATe <State>

Turns the transmission of the positioning reference signal on and off.

Suffix:

<cc> [Component Carrier](#)

<fr> [Frame](#)

<bwp> [Bandwidth part](#)

Parameters:

<State> ON | OFF | 1 | 0

*RST: OFF

Example:

```
//Turn on transmission of PRS
CONF:DL:CC2:FRAM:BWP2:PRS:STAT ON
```

Manual operation: See ["State"](#) on page 107

6.9.11 CORESET allocation configuration

CONFigure[:NR5G]:DL[:CC<cc>]:FRAME<fr>:BWPpart<bwp>:SLOT<sl>:COReset<cr>: COPY:DURation.....	343
CONFigure[:NR5G]:DL[:CC<cc>]:FRAME<fr>:BWPpart<bwp>:SLOT<sl>:COReset<cr>: COPY:MODE.....	344
CONFigure[:NR5G]:DL[:CC<cc>]:FRAME<fr>:BWPpart<bwp>:SLOT<sl>:COReset<cr>: COPY.....	344
CONFigure[:NR5G]:DL[:CC<cc>]:FRAME<fr>:BWPpart<bwp>:SLOT<sl>:COReset<cr>: COPY:PERiod.....	345
CONFigure[:NR5G]:DL[:CC<cc>]:FRAME<fr>:BWPpart<bwp>:SLOT<sl>:COReset<cr>: COPY:SLOT.....	346
CONFigure[:NR5G]:DL[:CC<cc>]:FRAME<fr>:BWPpart<bwp>:SLOT<sl>:COReset<cr>: POWer.....	346
CONFigure[:NR5G]:DL[:CC<cc>]:FRAME<fr>:BWPpart<bwp>:SLOT<sl>:COReset<cr>: RBCount.....	347
CONFigure[:NR5G]:DL[:CC<cc>]:FRAME<fr>:BWPpart<bwp>:SLOT<sl>:COReset<cr>: RBOFset.....	347
CONFigure[:NR5G]:DL[:CC<cc>]:FRAME<fr>:BWPpart<bwp>:SLOT<sl>:COReset<cr>: SCOut.....	348
CONFigure[:NR5G]:DL[:CC<cc>]:FRAME<fr>:BWPpart<bwp>:SLOT<sl>:COReset<cr>: SOFFset.....	348
CONFigure[:NR5G]:DL[:CC<cc>]:FRAME<fr>:BWPpart<bwp>:SLOT<sl>:CRSCount.....	349

CONFigure[:NR5G]:DL[:CC<cc>]:FRAME<fr>:BWPpart<bwp>:SLOT<sl>: COReset<cr>:COPY:DURation <Value>

Defines to which slots a CORESET configuration is copied to.

Prerequisites for this command

- Number of configurable slots > 1 (CONFigure[:NR5G]:DL[:CC<cc>]:
FRAME<fr>:BWPpart<bwp>:CSLot).
- Select custom paste mode (CONFigure[:NR5G]:DL[:CC<cc>]:FRAME<fr>:
BWPpart<bwp>:SLOT<sl>:COReset<cr>:COPY:MODE).

Suffix:

<cc>	Component Carrier
<fr>	Frame
<bwp>	Bandwidth part
<sl>	Bandwidth part
<cr>	CORESET

Parameters:

<Value>	The paste duration corresponds to a certain number of slots in a row.
*RST:	1

Example: //Paste CORESET configuration to 2 slots in a row, every 3rd slot (0,1,3,4,6,7,9,10,12)
 CONF:DL:CC2:FRAM3:BWP2:CSL 12
 CONF:DL:CC2:FRAM3:BWP2:SLOT0:COR2:COPY:MODE
 CUST
 CONF:DL:CC2:FRAM3:BWP2:SLOT0:COR2:COPY:PER 3
 CONF:DL:CC2:FRAM3:BWP2:SLOT0:COR2:COPY:DUR 2

**CONFigure[:NR5G]:DL[:CC<cc>]:FRAMe<fr>:BWPart<bwp>:SLOT<sl>:
 COREset<cr>:COPY:MODE <Mode>**

Selects the paste logic when you copy a CORESET configuration to other slots.

Prerequisites for this command

- Number of configurable slots > 1 (CONFigure[:NR5G]:DL[:CC<cc>]:FRAMe<fr>:BWPart<bwp>:CSLot).

Suffix:

<cc> Component Carrier
 <fr> Frame
 <bwp> Bandwidth part
 <sl> Bandwidth part
 <cr> CORESET

Parameters:

<Mode> **CUSTOM**
 Copies the slot configuration to specific set of slots according to the logic defined with:

- CONFigure[:NR5G]:DL[:CC<cc>]:FRAMe<fr>:BWPart<bwp>:SLOT<sl>:COREset<cr>:COPY:PERiod
- CONFigure[:NR5G]:DL[:CC<cc>]:FRAMe<fr>:BWPart<bwp>:SLOT<sl>:COREset<cr>:COPY:DURation

SLOT

Copies the slot configuration to a specific set of slots.
 Select the slots with CONFigure[:NR5G]:DL[:CC<cc>]:FRAMe<fr>:BWPart<bwp>:SLOT<sl>:COREset<cr>:COPY:SLOT.

Example: //Select paste mode
 CONF:DL:CC2:FRAM3:BWP2:CSL 12
 CONF:DL:CC2:FRAM3:BWP2:SLOT0:COR2:COPY:MODE
 SLOT

**CONFigure[:NR5G]:DL[:CC<cc>]:FRAMe<fr>:BWPart<bwp>:SLOT<sl>:
 COREset<cr>:COPY**

Copies a CORESET configuration to other slots.

Prerequisites for this command

- Number of configurable slots > 1 (`CONFigure[:NR5G]:DL[:CC<cc>]:FRAME<fr>:BWPpart<bwp>:CSLot`).
- Select paste mode (`CONFigure[:NR5G]:DL[:CC<cc>]:FRAME<fr>:BWPpart<bwp>:SLOT<sl>:COReset<cr>:COPY:MODE`).

Suffix:

<cc>	Component Carrier
<fr>	Frame
<bwp>	Bandwidth part
<sl>	Bandwidth part
<cr>	<100 CORESET

Example: //Paste CORESET configuration to 2 slots in a row, every 3rd slot (0,1,3,4,6,7,9,10,12)

```
CONF:DL:CC2:FRAM3:BWP2:CSL 12
CONF:DL:CC2:FRAM3:BWP2:SLOT0:COR2:COPY:MODE
CUST
CONF:DL:CC2:FRAM3:BWP2:SLOT0:COR2:COPY:PER 3
CONF:DL:CC2:FRAM3:BWP2:SLOT0:COR2:COPY:DUR 2
CONF:DL:CC2:FRAM3:BWP2:SLOT0:COR2:COPY
```

Manual operation: See "Copy to" on page 116

**CONFigure[:NR5G]:DL[:CC<cc>]:FRAME<fr>:BWPpart<bwp>:SLOT<sl>:
COReset<cr>:COPY:PERiod <Period>**

Defines to which slots a CORESET configuration is copied to.

Prerequisites for this command

- Number of configurable slots > 1 (`CONFigure[:NR5G]:DL[:CC<cc>]:FRAME<fr>:BWPpart<bwp>:CSLot`).
- Select custom paste mode (`CONFigure[:NR5G]:DL[:CC<cc>]:FRAME<fr>:BWPpart<bwp>:SLOT<sl>:COReset<cr>:COPY:MODE`).

Suffix:

<cc>	Component Carrier
<fr>	Frame
<bwp>	Bandwidth part
<sl>	Bandwidth part
<cr>	CORESET

Parameters:

<Period> The paste period corresponds to every nth slot.
*RST: 1

Example: //Paste CORESET configuration to every 3rd slot (0,3,6,9,12)
 CONF:DL:CC2:FRAM3:BWP2:CSL 12
 CONF:DL:CC2:FRAM3:BWP2:SLOT0:COR2:COPY:MODE
 CUST
 CONF:DL:CC2:FRAM3:BWP2:SLOT0:COR2:COPY:PER 3

**CONFigure[*NR5G*]:DL[*CC*<*cc*>]:FRAMe<*fr*>:BWPart<*bwp*>:SLOT<*sl*>:
 COREset<*cr*>:COPY:SLOT <*Slot*>**

Copies a CORESET allocation configuration to a specific set of slots.

Prerequisites for this command

- Number of configurable slots > 1 (CONFigure[*NR5G*]:DL[*CC*<*cc*>]:FRAMe<*fr*>:BWPart<*bwp*>:CSLot).
- Select slot paste mode (CONFigure[*NR5G*]:DL[*CC*<*cc*>]:FRAMe<*fr*>:BWPart<*bwp*>:SLOT<*sl*>:COREset<*cr*>:COPY:MODE).

Suffix:

< <i>cc</i> >	Component Carrier
< <i>fr</i> >	Frame
< <i>bwp</i> >	Bandwidth part
< <i>sl</i> >	Slot
< <i>cr</i> >	PUCCH

Parameters:

< <i>Slot</i> >	List of slots either as comma-separated list (2,5,8), a range (3-5) or a combination of both (2-5,8,10).
-----------------	--

Example: //Copy allocation configuration to several slots
 CONF:DL:CC2:FRAM3:BWP2:CSL 12
 CONF:DL:CC2:FRAM3:BWP2:SLOT0:COR2:COPY:MODE
 SLOT
 CONF:DL:CC2:FRAM3:BWP2:SLOT0:COR2:COPY:SLOT
 '3,6,9'

**CONFigure[*NR5G*]:DL[*CC*<*cc*>]:FRAMe<*fr*>:BWPart<*bwp*>:SLOT<*sl*>:
 COREset<*cr*>:POWer <*Power*>**

Defines the relative power of a CORESET.

Suffix:

< <i>cc</i> >	irrelevant
< <i>fr</i> >	irrelevant
< <i>bwp</i> >	Bandwidth part
< <i>sl</i> >	Bandwidth part
< <i>cr</i> >	CORESET

Parameters:

<Power> <numeric value>
 *RST: 0
 Default unit: dB

Example:

```
//Define CORESET power
CONF:DL:CC2:FRAM3:BWP2:SLOT4:COR3:POW 3
```

Manual operation: See "[Rel Power / dB](#)" on page 115

**CONFigure[:NR5G]:DL[:CC<cc>]:FRAME<fr>:BWPart<bwp>:SLOT<sl>:
 COREset<cr>:RBCount <ResourceBlocks>**

Selects the number of resource blocks that a CORESET allocation occupies.

Suffix:

<cc> [Component Carrier](#)
 <fr> [Frame](#)
 <bwp> [Bandwidth part](#)
 <sl> [Bandwidth part](#)
 <cr> [CORESET](#)

Parameters:

<ResourceBlocks> <numeric value> (integer only)
 *RST: 270

Example:

```
//Define number of CORESET resource blocks
CONF:DL:CC2:FRAM3:BWP2:SLOT4:COR3:RBC 40
```

Manual operation: See "[Number of RBs](#)" on page 115

**CONFigure[:NR5G]:DL[:CC<cc>]:FRAME<fr>:BWPart<bwp>:SLOT<sl>:
 COREset<cr>:RBOffset <Offset>**

Defines the resource block offset of a CORESET allocation.

Suffix:

<cc> [Component Carrier](#)
 <fr> [Frame](#)
 <bwp> [Bandwidth part](#)
 <sl> [Bandwidth part](#)
 <cr> [CORESET](#)

Parameters:

<Offset> <numeric value> (integer only)
 The offset is a value relative to the first resource block of the slot.
 *RST: 0

Example: //Define RB offset of CORESET
 CONF:DL:CC2:FRAM3:BWP2:SLOT4:COR3:RBOF 10

Manual operation: See ["Offset RB"](#) on page 115

**CONFigure[:NR5G]:DL[:CC<cc>]:FRAMe<fr>:BWPart<bwp>:SLOT<sl>:
 COREset<cr>:SCOunt <Symbols>**

Selects the number of symbols that a CORESET allocation occupies.

Suffix:

<cc> [Component Carrier](#)
 <fr> [Frame](#)
 <bwp> [Bandwidth part](#)
 <sl> [Bandwidth part](#)
 <cr> [CORESET](#)

Parameters:

<Symbols> <numeric value> (integer only)
 *RST: 14

Example: //Define number of CORESET symbols
 CONF:DL:CC2:FRAM3:BWP2:SLOT4:COR3:SCO 7

Manual operation: See ["Number of Symbols"](#) on page 115

**CONFigure[:NR5G]:DL[:CC<cc>]:FRAMe<fr>:BWPart<bwp>:SLOT<sl>:
 COREset<cr>:SOFFset <Offset>**

Defines the symbol offset of a CORESET allocation.

Suffix:

<cc> [Component Carrier](#)
 <fr> [Frame](#)
 <bwp> [Bandwidth part](#)
 <sl> [Bandwidth part](#)
 <cr> [CORESET](#)

Parameters:

<Offset> <numeric value> (integer only)
 The offset is a value relative to the first symbol in the slot.
 *RST: 0

Example: //Define CORESET symbol offset
 CONF:DL:CC2:FRAM3:BWP2:SLOT4:COR3:SOFF 2

Manual operation: See ["Offset Symbols"](#) on page 115

**CONFigure[:NR5G]:DL[:CC<cc>]:FRAMe<fr>:BWPart<bwp>:SLOT<sl>:
CRSCoUnt <CORESETs>**

Defines the number of CORESETs in a slot.

Suffix:

<cc>	Component Carrier
<fr>	Frame
<bwp>	Bandwidth part
<sl>	Bandwidth part

Parameters:

<CORESETs>	<numeric value> (integer only)
	Range: 0 to 100
	*RST: 1

Example:

```
//Define number of CORESETs
CONF:DL:CC2:FRAM3:BWP2:SLOT4:ALC 10
```

Manual operation: See "# CORESETs" on page 112

6.9.12 PDSCH allocation configuration

CONFigure[:NR5G]:DL[:CC<cc>]:FRAMe<fr>:BWPart<bwp>:SLOT<sl>:ALCoUnt.....	350
CONFigure[:NR5G]:DL[:CC<cc>]:FRAMe<fr>:BWPart<bwp>:SLOT<sl>: ALLoCation<al>:COpy:DUrAtion.....	350
CONFigure[:NR5G]:DL[:CC<cc>]:FRAMe<fr>:BWPart<bwp>:SLOT<sl>: ALLoCation<al>:COpy:MODe.....	351
CONFigure[:NR5G]:DL[:CC<cc>]:FRAMe<fr>:BWPart<bwp>:SLOT<sl>: ALLoCation<al>:COpy.....	351
CONFigure[:NR5G]:DL[:CC<cc>]:FRAMe<fr>:BWPart<bwp>:SLOT<sl>: ALLoCation<al>:COpy:PERiod.....	352
CONFigure[:NR5G]:DL[:CC<cc>]:FRAMe<fr>:BWPart<bwp>:SLOT<sl>: ALLoCation<al>:COpy:SLOT.....	353
CONFigure[:NR5G]:DL[:CC<cc>]:FRAMe<fr>:BWPart<bwp>:SLOT<sl>: ALLoCation<al>:CW<cw>:MOduLation.....	353
CONFigure[:NR5G]:DL[:CC<cc>]:FRAMe<fr>:BWPart<bwp>:SLOT<sl>: ALLoCation<al>:POWer.....	354
CONFigure[:NR5G]:DL[:CC<cc>]:FRAMe<fr>:BWPart<bwp>:SLOT<sl>: ALLoCation<al>:RBCoUnt.....	354
CONFigure[:NR5G]:DL[:CC<cc>]:FRAMe<fr>:BWPart<bwp>:SLOT<sl>: ALLoCation<al>:RBOFset.....	355
CONFigure[:NR5G]:DL[:CC<cc>]:FRAMe<fr>:BWPart<bwp>:SLOT<sl>: ALLoCation<al>:SCOunt.....	355
CONFigure[:NR5G]:DL[:CC<cc>]:FRAMe<fr>:BWPart<bwp>:SLOT<sl>: ALLoCation<al>:SOFFset.....	356
CONFigure[:NR5G]:DL[:CC<cc>]:FRAMe<fr>:BWPart<bwp>:SLOT<sl>:CUID.....	356

**CONFigure[:NR5G]:DL[:CC<cc>]:FRAMe<fr>:BWPart<bwp>:SLOT<sl>:ALCount
<Allocations>**

Defines the number of PDSCH allocations in a slot.

Suffix:

<cc>	Component Carrier
<fr>	Frame
<bwp>	Bandwidth part
<sl>	Bandwidth part

Parameters:

<Allocations>	<numeric value> (integer only)
	Range: 0 to 100
	*RST: 1

Example:

```
//Define number of PDSCH allocations
CONF:DL:CC2:FRAM3:BWP2:SLOT4:ALC 10
```

Manual operation: See "[# PDSCH Allocations](#)" on page 112

**CONFigure[:NR5G]:DL[:CC<cc>]:FRAMe<fr>:BWPart<bwp>:SLOT<sl>:
ALLocation<al>:COPY:DURation <Value>**

Defines to which slots a PDSCH configuration is copied to.

Prerequisites for this command

- Number of configurable slots > 1 (`CONFigure[:NR5G]:DL[:CC<cc>]:FRAMe<fr>:BWPart<bwp>:CSLot`).
- Select custom paste mode (`CONFigure[:NR5G]:DL[:CC<cc>]:FRAMe<fr>:BWPart<bwp>:SLOT<sl>:ALLocation<al>:COPY:MODE`).

Suffix:

<cc>	Component Carrier
<fr>	Frame
<bwp>	Bandwidth part
<sl>	Bandwidth part
<al>	Allocation

Parameters:

<Value>	The paste duration corresponds to a certain number of slots in a row.
	*RST: 1

Example: //Paste PDSCH configuration to 2 slots in a row, every 3rd slot (0,1,3,4,6,7,9,10,12)
 CONF:DL:CC2:FRAM3:BWP2:CSL 12
 CONF:DL:CC2:FRAM3:BWP2:SLOT0:ALL2:COPY:MODE
 CUST
 CONF:DL:CC2:FRAM3:BWP2:SLOT0:ALL2:COPY:PER 3
 CONF:DL:CC2:FRAM3:BWP2:SLOT0:ALL2:COPY:DUR 2

**CONFigure[:NR5G]:DL[:CC<cc>]:FRAMe<fr>:BWPart<bwp>:SLOT<sl>:
 ALLocation<al>:COPY:MODE <Mode>**

Selects the paste logic when you copy a PDSCH configuration to other slots.

Prerequisites for this command

- Number of configurable slots > 1 (CONFigure[:NR5G]:DL[:CC<cc>]:FRAMe<fr>:BWPart<bwp>:CSLot).

Suffix:

<cc> Component Carrier
 <fr> Frame
 <bwp> Bandwidth part
 <sl> Bandwidth part
 <al> Allocation

Parameters:

<Mode>

CUSTOM

Copies the slot configuration to specific set of slots according to the logic defined with:

- CONFigure[:NR5G]:DL[:CC<cc>]:FRAMe<fr>:BWPart<bwp>:SLOT<sl>:ALLocation<al>:COPY:PERiod
- CONFigure[:NR5G]:DL[:CC<cc>]:FRAMe<fr>:BWPart<bwp>:SLOT<sl>:ALLocation<al>:COPY:DURation

SLOT

Copies the slot configuration to a specific set of slots.

Select the slots with CONFigure[:NR5G]:DL[:CC<cc>]:FRAMe<fr>:BWPart<bwp>:SLOT<sl>:ALLocation<al>:COPY:SLOT.

Example: //Select paste mode
 CONF:DL:CC2:FRAM3:BWP2:CSL 12
 CONF:DL:CC2:FRAM3:BWP2:SLOT0:ALL2:COPY:MODE
 SLOT

**CONFigure[:NR5G]:DL[:CC<cc>]:FRAMe<fr>:BWPart<bwp>:SLOT<sl>:
 ALLocation<al>:COPY**

Copies a PDSCH configuration to other slots.

Prerequisites for this command

- Number of configurable slots > 1 (`CONFigure[:NR5G]:DL[:CC<cc>]:FRAME<fr>:BWPpart<bwp>:CSLot`).
- Select paste mode (`CONFigure[:NR5G]:DL[:CC<cc>]:FRAME<fr>:BWPpart<bwp>:SLOT<sl>:ALLocation<al>:COPY:MODE`).

Suffix:

<cc>	Component Carrier
<fr>	Frame
<bwp>	Bandwidth part
<sl>	Bandwidth part
<al>	<100 Allocation

Example: //Paste PDSCH configuration to 2 slots in a row, every 3rd slot (0,1,3,4,6,7,9,10,12)
`CONF:DL:CC2:FRAM3:BWP2:CSL 12`
`CONF:DL:CC2:FRAM3:BWP2:SLOT0:ALL2:COPY:MODE CUST`
`CONF:DL:CC2:FRAM3:BWP2:SLOT0:ALL2:COPY:PER 3`
`CONF:DL:CC2:FRAM3:BWP2:SLOT0:ALL2:COPY:DUR 2`
`CONF:DL:CC2:FRAM3:BWP2:SLOT0:ALL2:COPY`

Manual operation: See "Copy to" on page 116

CONFigure[:NR5G]:DL[:CC<cc>]:FRAME<fr>:BWPpart<bwp>:SLOT<sl>:ALLocation<al>:COPY:PERiod <Period>

Defines to which slots a PDSCH configuration is copied to.

Prerequisites for this command

- Number of configurable slots > 1 (`CONFigure[:NR5G]:DL[:CC<cc>]:FRAME<fr>:BWPpart<bwp>:CSLot`).
- Select custom paste mode (`CONFigure[:NR5G]:DL[:CC<cc>]:FRAME<fr>:BWPpart<bwp>:SLOT<sl>:ALLocation<al>:COPY:MODE`).

Suffix:

<cc>	Component Carrier
<fr>	Frame
<bwp>	Bandwidth part
<sl>	Bandwidth part
<al>	Allocation

Parameters:

<Period> The paste period corresponds to every nth slot.
 *RST: 1

Example: //Paste PDSCH configuration to every 3rd slot (0,3,6,9,12)
 CONF:DL:CC2:FRAM3:BWP2:CSL 12
 CONF:DL:CC2:FRAM3:BWP2:SLOT0:ALL2:COPY:MODE
 CUST
 CONF:DL:CC2:FRAM3:BWP2:SLOT0:ALL2:COPY:PER 3

**CONFigure[*NR5G*]:DL[:CC<cc>]:FRAMe<fr>:BWPart<bwp>:SLOT<sl>:
 ALLocation<al>:COPY:SLOT <Slot>**

Copies a PDSCH allocation configuration to a specific set of slots.

Prerequisites for this command

- Number of configurable slots > 1 (CONFigure[*NR5G*]:DL[:CC<cc>]:FRAMe<fr>:BWPart<bwp>:CSLot).
- Select slot paste mode (CONFigure[*NR5G*]:DL[:CC<cc>]:FRAMe<fr>:BWPart<bwp>:SLOT<sl>:ALLocation<al>:COPY:MODE).

Suffix:

<cc>	Component Carrier
<fr>	Frame
<bwp>	Bandwidth part
<sl>	Slot
<al>	Allocation

Parameters:

<Slot> String that contains a list of slots either as comma-separated list ("2,5,8"), a range ("3-5") or a combination of both ("2-5,8,10").

Example: //Copy allocation configuration to several slots
 CONF:DL:CC2:FRAM3:BWP2:CSL 12
 CONF:DL:CC2:FRAM3:BWP2:SLOT0:ALL2:COPY:MODE
 SLOT
 CONF:DL:CC2:FRAM3:BWP2:SLOT0:ALL2:COPY:SLOT
 "3, 6, 9"

**CONFigure[*NR5G*]:DL[:CC<cc>]:FRAMe<fr>:BWPart<bwp>:SLOT<sl>:
 ALLocation<al>[:CW<cw>]:MODulation <Modulation>**

Selects the modulation of a PDSCH allocation.

Suffix:

<cc>	Component Carrier
<fr>	Frame
<bwp>	Bandwidth part
<sl>	Bandwidth part
<al>	Allocation

<cw> [Codeword](#)

Parameters:

<Modulation> DMRS | Q1K | QPSK | QAM16 | QAM64 | QAM256
 *RST: QPSK

Example:

//Define allocation modulation
 CONF:DL:CC2:FRAM3:BWP2:SLOT4:ALL5:MOD QAM16

Manual operation: See "[Modulation](#)" on page 114

**CONFigure[[NR5G](#)]:DL[[CC](#)<cc>]:FRAMe<fr>:BWPart<bwp>:SLOT<sl>:
 ALLocation<al>:POWER <Power>**

Defines the relative power of a PDSCH allocation.

Suffix:

<cc> [Component Carrier](#)
 <fr> [Frame](#)
 <bwp> [Bandwidth part](#)
 <sl> [Bandwidth part](#)
 <al> [Allocation](#)

Parameters:

<Power> <numeric value>
 *RST: 0
 Default unit: dB

Example:

//Define relative allocation power
 CONF:DL:CC2:FRAM3:BWP2:SLOT4:ALL5:POW 6

Manual operation: See "[Rel Power / dB](#)" on page 115

**CONFigure[[NR5G](#)]:DL[[CC](#)<cc>]:FRAMe<fr>:BWPart<bwp>:SLOT<sl>:
 ALLocation<al>:RBCount <ResourceBlocks>**

Selects the number of resource blocks that a PDSCH allocation occupies.

Suffix:

<cc> [Component Carrier](#)
 <fr> [Frame](#)
 <bwp> [Bandwidth part](#)
 <sl> [Bandwidth part](#)
 <al> [Allocation](#)

Parameters:

<ResourceBlocks> <numeric value> (integer only)
 *RST: 273

Example: //Define number of PDSCH resource blocks
 CONF:DL:CC2:FRAM3:BWP2:SLOT4:ALL5:RBC 40

Manual operation: See "Number of RBs" on page 115

**CONFigure[:NR5G]:DL[:CC<cc>]:FRAMe<fr>:BWPart<bwp>:SLOT<sl>:
 ALLOcation<al>:RBOFset <Offset>**

Defines the resource block offset of a PDSCH allocation.

Suffix:

<cc> Component Carrier
 <fr> Frame
 <bwp> Bandwidth part
 <sl> Bandwidth part
 <al> Allocation

Parameters:

<Offset> <numeric value> (integer only)
 The offset is a value relative to the first resource block of the slot.
 *RST: 0

Example: //Define allocation RB offset
 CONF:DL:CC2:FRAM3:BWP2:SLOT4:ALL5:RBOF 10

Manual operation: See "Offset RB" on page 115

**CONFigure[:NR5G]:DL[:CC<cc>]:FRAMe<fr>:BWPart<bwp>:SLOT<sl>:
 ALLOcation<al>:SCOunt <Symbols>**

Selects the number of symbols that a PDSCH allocation occupies.

Suffix:

<cc> Component Carrier
 <fr> Frame
 <bwp> Bandwidth part
 <sl> Bandwidth part
 <al> Allocation

Parameters:

<Symbols> <numeric value> (integer only)
 *RST: 14

Example: //Define number of allocation symbols
 CONF:DL:CC2:FRAM3:BWP2:SLOT4:ALL5:SCO 7

Manual operation: See "Number of Symbols" on page 115

**CONFigure[:NR5G]:DL[:CC<cc>]:FRAMe<fr>:BWPart<bwp>:SLOT<sl>:
ALLocation<al>:SOFFset <Offset>**

Defines the symbol offset of a PDSCH allocation.

Suffix:

<cc>	Component Carrier
<fr>	Frame
<bwp>	Bandwidth part
<sl>	Bandwidth part
<al>	Allocation

Parameters:

<Offset>	<numeric value> (integer only)
	The offset is a value relative to the first symbol in the slot.
*RST:	0

Example: //Define allocation symbol offset
CONF:DL:CC2:FRAM3:BWP2:SLOT4:ALL5:SOFF 2

Manual operation: See "[Offset Symbols](#)" on page 115

**CONFigure[:NR5G]:DL[:CC<cc>]:FRAMe<fr>:BWPart<bwp>:SLOT<sl>:CUID
<State>**

Turns PRB bundling for PDSCH allocations on and off.

Suffix:

<cc>	Component Carrier
<fr>	Frame
<bwp>	Bandwidth part
<sl>	Bandwidth part

Parameters:

<State>	ON OFF 1 0
*RST:	OFF

Example: //Combine PDSCH allocations
CONF:DL:CC2:FRAM3:BWP2:SLOT4:CUID ON

Manual operation: See "[Combine PDSCH Allocations With Same User ID](#)" on page 112

6.9.13 Enhanced CORESET allocation configuration

CONFigure[:NR5G]:DL[:CC<cc>]:FRAME<fr>:BWPart<bwp>:SLOT<sl>:COReset<cr>: DMRS:POWer.....	358
CONFigure[:NR5G]:DL[:CC<cc>]:FRAME<fr>:BWPart<bwp>:SLOT<sl>:COReset<cr>: DMRS:RPOint.....	358
CONFigure[:NR5G]:DL[:CC<cc>]:FRAME<fr>:BWPart<bwp>:SLOT<sl>:COReset<cr>: DMRS:SID.....	359
CONFigure[:NR5G]:DL[:CC<cc>]:FRAME<fr>:BWPart<bwp>:SLOT<sl>:COReset<cr>: DMRS:SCRam[:STATe].....	359
CONFigure[:NR5G]:DL[:CC<cc>]:FRAME<fr>:BWPart<bwp>:SLOT<sl>:COReset<cr>: INTerleaving:BSIZe.....	360
CONFigure[:NR5G]:DL[:CC<cc>]:FRAME<fr>:BWPart<bwp>:SLOT<sl>:COReset<cr>: INTerleaving:ISIZe.....	360
CONFigure[:NR5G]:DL[:CC<cc>]:FRAME<fr>:BWPart<bwp>:SLOT<sl>:COReset<cr>: INTerleaving:NSHift.....	361
CONFigure[:NR5G]:DL[:CC<cc>]:FRAME<fr>:BWPart<bwp>:SLOT<sl>:COReset<cr>: INTerleaving:SINDeX.....	361
CONFigure[:NR5G]:DL[:CC<cc>]:FRAME<fr>:BWPart<bwp>:SLOT<sl>:COReset<cr>: INTerleaving:STATe.....	362
CONFigure[:NR5G]:DL[:CC<cc>]:FRAME<fr>:BWPart<bwp>:SLOT<sl>:COReset<cr>: PDCCh<cf>:ALEVel.....	362
CONFigure[:NR5G]:DL[:CC<cc>]:FRAME<fr>:BWPart<bwp>:SLOT<sl>:COReset<cr>: PDCCh<cf>:CCEindex.....	363
CONFigure[:NR5G]:DL[:CC<cc>]:FRAME<fr>:BWPart<bwp>:SLOT<sl>:COReset<cr>: PDCCh<cf>:DCIFormat.....	363
CONFigure[:NR5G]:DL[:CC<cc>]:FRAME<fr>:BWPart<bwp>:SLOT<sl>:COReset<cr>: PDCCh<cf>:DCISettings:FDRassign.....	364
CONFigure[:NR5G]:DL[:CC<cc>]:FRAME<fr>:BWPart<bwp>:SLOT<sl>:COReset<cr>: PDCCh<cf>:DCISettings:ITEM.....	365
CONFigure[:NR5G]:DL[:CC<cc>]:FRAME<fr>:BWPart<bwp>:SLOT<sl>:COReset<cr>: PDCCh<cf>:DCISettings:LIST?.....	368
CONFigure[:NR5G]:DL[:CC<cc>]:FRAME<fr>:BWPart<bwp>:SLOT<sl>:COReset<cr>: PDCCh<cf>:DCISettings:NOBLoCk.....	369
CONFigure[:NR5G]:DL[:CC<cc>]:FRAME<fr>:BWPart<bwp>:SLOT<sl>:COReset<cr>: PDCCh<cf>:DCISettings:SCOPE.....	369
CONFigure[:NR5G]:DL[:CC<cc>]:FRAME<fr>:BWPart<bwp>:SLOT<sl>:COReset<cr>: PDCCh<cf>:DCISettings:TPCCommand.....	370
CONFigure[:NR5G]:DL[:CC<cc>]:FRAME<fr>:BWPart<bwp>:SLOT<sl>:COReset<cr>: PDCCh<cf>:PLENgtH.....	371
CONFigure[:NR5G]:DL[:CC<cc>]:FRAME<fr>:BWPart<bwp>:SLOT<sl>:COReset<cr>: PDCCh<cf>:RNTI.....	371
CONFigure[:NR5G]:DL[:CC<cc>]:FRAME<fr>:BWPart<bwp>:SLOT<sl>:COReset<cr>: PDCCh<cf>:USAGe.....	372
CONFigure[:NR5G]:DL[:CC<cc>]:FRAME<fr>:BWPart<bwp>:SLOT<sl>:COReset<cr>: PDSCh:STATe.....	372
CONFigure[:NR5G]:DL[:CC<cc>]:FRAME<fr>:BWPart<bwp>:SLOT<sl>:COReset<cr>: PGRanularity.....	373

```
CONFigure[:NR5G]:DL[:CC<cc>]:FRAMe<fr>:BWPart<bwp>:SLOT<sl>:
COReset<cr>:DMRS:POWer <Power>
```

Defines the power of a CORESET DM-RS relative to the CORESET.

Suffix:

<cc> [Component Carrier](#)
 <fr> [Frame](#)
 <bwp> [Bandwidth part](#)
 <sl> [Bandwidth part](#)
 <cr> [CORESET](#)

Parameters:

<Power> <numeric value>
 *RST: 0
 Default unit: dB

Example: //Define CORESET power
 CONF:DL:CC2:FRAM3:BWP2:SLOT4:COR3:DMRS:POW 1.5

Manual operation: See "[CORESET DMRS Rel Power](#)" on page 117

```
CONFigure[:NR5G]:DL[:CC<cc>]:FRAMe<fr>:BWPart<bwp>:SLOT<sl>:
COReset<cr>:DMRS:RPOint <Reference>
```

Defines the reference point of the CORESET DMRS.

Suffix:

<cc> [Component Carrier](#)
 <fr> [Frame](#)
 <bwp> [Bandwidth part](#)
 <sl> [Bandwidth part](#)
 <cr> [CORESET](#)

Parameters:

<Reference> **CStart**
 Reference point is the start of the CORESET.
RPA
 Reference point is the reference point A.
 *RST: RPA

Example: //Select reference point for CORESET DMRS
 CONF:DL:CC2:FRAM3:BWP2:SLOT4:COR2:DMRS:RPO RPA

Manual operation: See "[CORESET DMRS Reference Point](#)" on page 118

**CONFigure[:NR5G]:DL[:CC<cc>]:FRAMe<fr>:BWPART<bwp>:SLOT<sl>:
COReset<cr>:DMRS:SID <Value>**

Defines the seed value for the CORESET DM-RS sequence generation.

Prerequisites for this command

- Select sequence generation method "n_ID^DMRS" (`CONFigure[:NR5G]:DL[:CC<cc>]:FRAMe<fr>:BWPART<bwp>:SLOT<sl>:COReset<cr>:DMRS:SCRam[:STATe]`).

Suffix:

<cc> [Component Carrier](#)
 <fr> [Frame](#)
 <bwp> [Bandwidth part](#)
 <sl> [Bandwidth part](#)
 <cr> [CORESET](#)

Parameters:

<Value> <numeric value> (integer only)
 *RST: 0

Example:

```
//Define seed value
CONF:DL:CC2:FRAM3:BWP2:SLOT4:COR3:DMRS:SGEN
DSID
CONF:DL:CC2:FRAM3:BWP2:SLOT4:COR3:DMRS:SID 15
```

Manual operation: See "[CORESET DMRS Sequence Generation](#)" on page 117

**CONFigure[:NR5G]:DL[:CC<cc>]:FRAMe<fr>:BWPART<bwp>:SLOT<sl>:
COReset<cr>:DMRS:SCRam[:STATe] <State>**

Selects the CORESET DM-RS sequence generation method.

Suffix:

<cc> [Component Carrier](#)
 <fr> [Frame](#)
 <bwp> [Bandwidth part](#)
 <sl> [Bandwidth part](#)
 <cr> [CORESET](#)

Parameters:

<State> **ON**
 Sequence generation based on a pseudo-random seed value.
OFF
 Sequence generation based on the cell ID.
 *RST: OFF

Example: //Select CORESET sequence generation method
 CONF:DL:CC2:FRAM3:BWP2:SLOT4:COR3:DMRS:SCR ON

Manual operation: See "[CORESET DMRS Sequence Generation](#)" on page 117

**CONFigure[:NR5G]:DL[:CC<cc>]:FRAMe<fr>:BWPart<bwp>:SLOT<sl>:
 COREset<cr>:INTERleaving:BSIZe <Size>**

Selects the REG bundle size of the PDCCH.

Prerequisites for this command

- Turn on interleaving ([CONFigure\[:NR5G\]:DL\[:CC<cc>\]:FRAMe<fr>:
 BWPart<bwp>:SLOT<sl>:COREset<cr>:INTERleaving:STATe](#)).

Suffix:

<cc>	Component Carrier
<fr>	Frame
<bwp>	Bandwidth part
<sl>	Bandwidth part
<cr>	CORESET

Parameters:

<Size>	2 6
*RST:	6

Example: //Define bundle size
 CONF:DL:CC2:FRAM3:BWP2:SLOT4:COR3:INT:STAT ON
 CONF:DL:CC2:FRAM3:BWP2:SLOT4:COR3:INT:BSIZ 2

Manual operation: See "[Interleaving](#)" on page 118

**CONFigure[:NR5G]:DL[:CC<cc>]:FRAMe<fr>:BWPart<bwp>:SLOT<sl>:
 COREset<cr>:INTERleaving:ISIZe <Size>**

Selects the interleaving size of the PDCCH.

Prerequisites for this command

- Turn on interleaving ([CONFigure\[:NR5G\]:DL\[:CC<cc>\]:FRAMe<fr>:
 BWPart<bwp>:SLOT<sl>:COREset<cr>:INTERleaving:STATe](#)).

Suffix:

<cc>	Component Carrier
<fr>	Frame
<bwp>	Bandwidth part
<sl>	Bandwidth part
<cr>	CORESET

Parameters:

<Size> 2 | 3 | 6
 *RST: 2

Example:

```
//Define interleaving size
CONF:DL:CC2:FRAM3:BWP2:SLOT4:COR3:INT:STAT ON
CONF:DL:CC2:FRAM3:BWP2:SLOT4:COR3:INT:ISIZ 3
```

Manual operation: See ["Interleaving"](#) on page 118

**CONFigure[:NR5G]:DL[:CC<cc>]:FRAMe<fr>:BWPPart<bwp>:SLOT<sl>:
 COREset<cr>:INTERleaving:NSHift <Value>**

Defines the shift index of the PDCCH.

Prerequisites for this command

- Turn on interleaving (`CONFigure[:NR5G]:DL[:CC<cc>]:FRAMe<fr>:BWPPart<bwp>:SLOT<sl>:COREset<cr>:INTERleaving:STATe`).
- Select manual shift index (`CONFigure[:NR5G]:DL[:CC<cc>]:FRAMe<fr>:BWPPart<bwp>:SLOT<sl>:COREset<cr>:INTERleaving:SINDex`).

Suffix:

<cc> Component Carrier
 <fr> Frame
 <bwp> Bandwidth part
 <sl> Bandwidth part
 <cr> CORESET

Parameters:

<Value> *RST: 0

Example:

```
//Define shift index
CONF:DL:CC2:FRAM3:BWP2:SLOT4:COR3:INT:STAT ON
CONF:DL:CC2:FRAM3:BWP2:SLOT4:COR3:INT:SIND NSH
CONF:DL:CC2:FRAM3:BWP2:SLOT4:COR3:INT:NSH 2
```

Manual operation: See ["Interleaving"](#) on page 118

**CONFigure[:NR5G]:DL[:CC<cc>]:FRAMe<fr>:BWPPart<bwp>:SLOT<sl>:
 COREset<cr>:INTERleaving:SINDex <Method>**

Defines the shift index of the PDCCH.

Prerequisites for this command

- Turn on interleaving (`CONFigure[:NR5G]:DL[:CC<cc>]:FRAMe<fr>:BWPPart<bwp>:SLOT<sl>:COREset<cr>:INTERleaving:STATe`).

Suffix:

<cc> Component Carrier
 <fr> Frame

<bwp> Bandwidth part

<sl> Bandwidth part

<cr> CORESET

Parameters:

<Method> **NIDCell**
Shift index based on cell ID.

NShift

Manual shift index (CONFigure[:NR5G]:DL[:CC<cc>]:
FRAMe<fr>:BWPart<bwp>:SLOT<sl>:COReset<cr>:
INTerleaving:NShift).

Example: //Define shift index calculation method
CONF:DL:CC2:FRAM3:BWP2:SLOT4:COR3:INT:STAT ON
CONF:DL:CC2:FRAM3:BWP2:SLOT4:COR3:INT:SIND NIDC

Manual operation: See "Interleaving" on page 118

**CONFigure[:NR5G]:DL[:CC<cc>]:FRAMe<fr>:BWPart<bwp>:SLOT<sl>:
COReset<cr>:INTerleaving:STATE <State>**

Turns interleaving of the PDCCH on and off.

Suffix:

<cc> Component Carrier

<fr> Frame

<bwp> Bandwidth part

<sl> Bandwidth part

<cr> CORESET

Parameters:

<State> ON | OFF | 1 | 0

Example: //Turn on interleaving
CONF:DL:CC2:FRAM3:BWP2:SLOT4:COR3:INT:STAT ON

Manual operation: See "Interleaving" on page 118

**CONFigure[:NR5G]:DL[:CC<cc>]:FRAMe<fr>:BWPart<bwp>:SLOT<sl>:
COReset<cr>:PDCCh<cf>:ALEVel <Value>**

Selects the aggregation level of the PDCCH.

Suffix:

<cc> Component Carrier

<fr> Frame

<bwp> Bandwidth part

<sl> Bandwidth part

<cr> CORESET

<cf> 0

Parameters:

<Value> *RST: 1

Example:

//Select aggregation level
CONF:DL:CC2:FRAM3:BWP2:SLOT4:COR3:PDCC0:ALEV 2

Manual operation: See "[Aggregation Level](#)" on page 121

**CONFigure[:NR5G]:DL[:CC<cc>]:FRAMe<fr>:BWPART<bwp>:SLOT<sl>:
COReset<cr>:PDCCh<cf>:CCEindex <Value>**

Select the CCE index for the PDCCH.

Suffix:

<cc> Component Carrier

<fr> Frame

<bwp> Bandwidth part

<sl> Bandwidth part

<cr> CORESET

<cf> 0

Parameters:

<Value> *RST: 0

Example:

//Select CCE index
CONF:DL:CC2:FRAM3:BWP2:SLOT4:COR3:PDCC0:CCE 2

Manual operation: See "[CCE Index](#)" on page 121

**CONFigure[:NR5G]:DL[:CC<cc>]:FRAMe<fr>:BWPART<bwp>:SLOT<sl>:
COReset<cr>:PDCCh<cf>:DCIFormat <Format>**

Selects the DCI format for a PDCCH.

Prerequisites for this command

- The availability of DCI formats depends on the selected RNTI type ([CONFigure\[:NR5G\]:DL\[:CC<cc>\]:FRAMe<fr>:BWPART<bwp>:SLOT<sl>:COReset<cr>:PDCCh<cf>:USAGE](#)).

Suffix:

<cc> Component Carrier

<fr> Frame

<bwp> Bandwidth part

<sl> Bandwidth part

<cr> CORESET

<cf> 0

Parameters:

<Format> F00 | F01 | F02 | F10 | F11 | F12 | F20 | F21 | F22 | F23 | F24 |
F25 | F26
*RST: F00

Example:

```
//Select DCI format
CONF:DL:CC2:FRAM3:BWP2:SLOT4:COR3:PDCC0:USAG
CRNT
CONF:DL:CC2:FRAM3:BWP2:SLOT4:COR3:PDCC0:DCIF
F00
```

Manual operation: See "DCI Format" on page 121

**CONFigure[:NR5G]:DL[:CC<cc>]:FRAMe<fr>:BWPART<bwp>:SLOT<sl>:
COREset<cr>:PDCCh<cf>:DCISettings:FDRAssign <Assignment>**

Defines the frequency domain resource assignment of the DCI fields.

Prerequisites for this command

- Select DCI format 1_0 (CONFigure[:NR5G]:DL[:CC<cc>]:FRAMe<fr>:
BWPART<bwp>:SLOT<sl>:COREset<cr>:PDCCh<cf>:DCIFormat).

Suffix:

<cc> Component Carrier
<fr> Frame
<bwp> Bandwidth part
<sl> Bandwidth part
<cr> CORESET
<cf> 0

Parameters:

<Assignment> **CUSTOM**
Custom
ALL
All ones
*RST: CUSTOM

Example:

```
//Select frequency resource assignment for DCI transmission
CONF:DL:CC2:FRAM3:BWP2:SLOT4:COR3:PDCC0:USAG
CRNT
CONF:DL:CC2:FRAM3:BWP2:SLOT4:COR3:PDCC0:DCIF
F10
CONF:DL:CC2:FRAM3:BWP2:SLOT4:COR3:PDCC0:DCIS:
SCOP ALL
```

Manual operation: See "Content" on page 122

CONFigure[:NR5G]:DL[:CC<cc>]:FRAMe<fr>:BWPART<bwp>:SLOT<sl>:CORESet<cr>:PDCCh<cf>:DCISettings:ITEM <DCIField>, <BitLength>

Defines the bit length for DCI fields.

Prerequisites for this command

- Availability of parameters depend on the selected DCI format ([CONFigure\[:NR5G\]:DL\[:CC<cc>\]:FRAMe<fr>:BWPART<bwp>:SLOT<sl>:CORESet<cr>:PDCCh<cf>:DCIFormat](#) on page 363).

Note that, depending on the DCI format, some bit lengths are fix and cannot be changed.

Suffix:

<cc>	Component Carrier
<fr>	Frame
<bwp>	Bandwidth part
<sl>	Bandwidth part
<cr>	CORESET
<cf>	0

Parameters:

<DCIField>	For an overview of parameters, see Table 6-4 .
<BitLength>	*RST: depends on DCI field

Example:

```
//Define bit length for "Time Domain Resource Assignment"
CONF:DL:CC2:FRAM3:BWP2:SLOT4:COR3:PDCC0:USAG
CRNT
CONF:DL:CC2:FRAM3:BWP2:SLOT4:COR3:PDCC0:DCIF
F01
CONF:DL:CC2:FRAM3:BWP2:SLOT4:COR3:PDCC0:DCIS:
ITEM TDR, 2
```

Example:

```
//Define bit length for "Slot Format Indicator" incl. number of indi-
cators
CONF:DL:CC2:FRAM3:BWP2:SLOT4:COR3:PDCC0:USAG
SFIR
CONF:DL:CC2:FRAM3:BWP2:SLOT4:COR3:PDCC0:DCIF
F20
CONF:DL:CC2:FRAM3:BWP2:SLOT4:COR3:PDCC0:DCIS:
ITEM SFIN, 4
CONF:DL:CC2:FRAM3:BWP2:SLOT4:COR3:PDCC0:DCIS:
ITEM N, 2
```

Manual operation: See ["Content"](#) on page 122

Table 6-4: List of DCI fields

DCI field	SCPI parameter
"Identifier for DCI formats"	IFDFormats
"Frequency Domain Resource Assignment"	FDRAssign
"Time Domain Resource Assignment"	TDRAssign
"Frequency Hopping Flag"	FHFLag
"Modulation and Coding Scheme (TB1)"	MCS1
"New Data Indicator (TB1)"	NDI1
"Redundancy Version (TB1)"	RV1
"HARQ Process Number"	HPNumber
"TPC Command for Scheduled PUSCH"	TCSPush
"Padding Bits"	PBITs
"UL/SUL Indicator"	USUL
"ChannelAccess-Cpext"	CACPext
"Carrier Indicator"	CARRier
"DFI Flag"	DFIFlag
"HARQ-ACK Bitmap"	HABitmap
"Bandwidth Part Indicator"	BPIndicator
"(1st) Downlink Assignment Index"	DAI1
"2nd Downlink Assignment Index"	DAI2
"SRS Resource Indicator"	SRIndicator
"Precoding Information and Number of Layers"	PINLayers
"Antenna Ports"	APORTs
"SRS Request"	SRSRequest
"CSI Request"	CSIRequest
"CBG Transmission Information (CBGTI)"	CBGTi
"PTRS-DMRS Association"	PDASso
"beta_offset Indicator"	BOIndicator
"DMRS Sequence Initialization"	DSINit
"UL-SCH Indicator"	USCH
"ChannelAccess-Cpext-CAPC"	CAPC
"Open-loop Power Control Parameter Set Indication"	OPCParam
"Priority Indicator"	PIndicator
"Invalid Symbol Pattern Indicator"	ISPIndicator

DCI field	SCPI parameter
"Minimum Applicable Scheduling Offset Indicator"	MASoffset
"SCell Dormancy Indication"	SDIndicator
"Random Access Preamble Index"	RAPIndex
"SS/PBCH Index"	SPIndex
"PRACH Mask Index"	PMIndex
"Reserved Bits"	RBITs
"VRB-to-PRB Mapping"	VTPMapping
"PUCCH Resource Indicator"	PRIndicator
"PDSCH-to-HARQ Feedback Timing Indicator"	PHFTiming
"Short Message Indicator"	SMIndicator
"Short Message"	SMESsage
"TB Scaling"	TBScaling
"System Information Indicator"	SIIndicator
"LBSs of SFN"	LOSFn
"PRB Bundling Size Indicator"	PBSIndicator
"Rate Matching Indicator"	RMIndicator
"ZP CSI-RS Trigger"	ZCRTrigger
"Modulation and Coding Scheme (TB2)"	MCS2
"New Data Indicator (TB2)"	NDI2
"Redundancy Version (TB2)"	RV2
"One-shot HARQ-ACK Request"	OHARRequest
"PDSCH Group Index"	PGIndex
"New Feedback Indicator"	NFIndicator
"Number of Requested PDSCH Group"	NRPGroup
"Transmission Configuration Indication"	TCIndication
"CBG Flushing out Information (CBGFI)"	CBGFi
"Slot Format Indicator" Indicator index	SFIndicator N
"Available RB Set Indicator" Indicator index	ARBSet N1
"COT Duration Indicator" Indicator index	COTDuration N2
"Monitoring Group Flag" Indicator index	MGFLag M

DCI field	SCPI parameter
"Pre-emption Indication" Indicator index	PEINdication N
"Closed Loop Indicator"	CLINdicator
"TPC Command"	TPCCommand
"Cancellation Indication" Indicator index	CINdication N
"Availability Indicator" Indicator index	AINdicator N
"Wake Up Indication"	WUINdication
"SCell Dormancy Indication"	SDINdication

CONFigure[:NR5G]:DL[:CC<cc>]:FRAMe<fr>:BWPart<bwp>:SLOT<sl>: COReset<cr>:PDCCh<cf>:DCISettings:LIST?

Queries the DCI fields available for the currently selected DCI format and the number of bits each DCI field uses.

Prerequisites for this command

- Select a DCI format `(CONFigure[:NR5G]:DL[:CC<cc>]:FRAMe<fr>:BWPart<bwp>:SLOT<sl>:COReset<cr>:PDCCh<cf>:DCIFormat)`.
- Assign bits to the DCI fields `(CONFigure[:NR5G]:DL[:CC<cc>]:FRAMe<fr>:BWPart<bwp>:SLOT<sl>:COReset<cr>:PDCCh<cf>:DCISettings:ITEM)`.

Suffix:

<cc>	Component Carrier
<fr>	Frame
<bwp>	Bandwidth part
<sl>	Bandwidth part
<cr>	CORESET
<cf>	0

Return values:

<List> String that contains the names of the DCI fields and the number of bits they use as a comma separated list.

Example: //Query DCI field information
 CONF:DL:CC2:FRAM3:BWP2:SLOT4:COR3:PDCC0:USAG
 TPUC
 CONF:DL:CC2:FRAM3:BWP2:SLOT4:COR3:PDCC0:DCIF
 F22
 CONF:DL:CC2:FRAM3:BWP2:SLOT4:COR3:PDCC0:DCIS:
 LIST?
 would return:
 'Closed Loop Indicator,0,TPC Command,2'

Usage: Query only

Manual operation: See "[Content](#)" on page 122

**CONFigure[:NR5G]:DL[:CC<cc>]:FRAMe<fr>:BWPart<bwp>:SLOT<sl>:
 COREset<cr>:PDCCh<cf>:DCISettings:NOBLock <Blocks>**

Defines the number of blocks that DCI is transmitted in.

Prerequisites for this command

- Select a DCI format that supports multiple transmission (CONFigure[:NR5G]:DL[:CC<cc>]:FRAMe<fr>:BWPart<bwp>:SLOT<sl>:COREset<cr>:PDCCh<cf>:DCIFormat).

Suffix:

<cc>	Component Carrier
<fr>	Frame
<bwp>	Bandwidth part
<sl>	Bandwidth part
<cr>	CORESET
<cf>	0

Parameters:

<Blocks>	*RST: 1
----------	---------

Example: //Select number of blocks for DCI transmission
 CONF:DL:CC2:FRAM3:BWP2:SLOT4:COR3:PDCC0:USAG
 TPUS
 CONF:DL:CC2:FRAM3:BWP2:SLOT4:COR3:PDCC0:DCIF
 F22
 CONF:DL:CC2:FRAM3:BWP2:SLOT4:COR3:PDCC0:DCIS:
 NOBL 4

Manual operation: See "[Content](#)" on page 122

**CONFigure[:NR5G]:DL[:CC<cc>]:FRAMe<fr>:BWPart<bwp>:SLOT<sl>:
 COREset<cr>:PDCCh<cf>:DCISettings:SCOPE <Scope>**

Defines the scope of the DCI fields.

Prerequisites for this command

- Select DCI format 0_1 (`CONFigure[:NR5G]:DL[:CC<cc>]:FRAMe<fr>:BWPart<bwp>:SLOT<sl>:COReset<cr>:PDCCh<cf>:DCIFormat`).

Suffix:

<cc>	Component Carrier
<fr>	Frame
<bwp>	Bandwidth part
<sl>	Bandwidth part
<cr>	CORESET
<cf>	0

Parameters:

<Scope>	ICDF Indicate CG-DFI
	SPUS Schedule PUSCH
	*RST: ICDF

Example:

```
//Select scope of DCI transmission
CONF:DL:CC2:FRAM3:BWP2:SLOT4:COR3:PDCCH0:USAG
SPCR
CONF:DL:CC2:FRAM3:BWP2:SLOT4:COR3:PDCCH0:DCIF
F01
CONF:DL:CC2:FRAM3:BWP2:SLOT4:COR3:PDCCH0:DCIS:
SCOP SPUS
```

Manual operation: See "[Content](#)" on page 122

**CONFigure[:NR5G]:DL[:CC<cc>]:FRAMe<fr>:BWPart<bwp>:SLOT<sl>:
COReset<cr>:PDCCh<cf>:DCISettings:TPCCommand <Value>**

Defines the number of TCP commands that are transmitted in the DCI.

Prerequisites for this command

- Select a DCI format that supports transmission of multiple TCP commands (`CONFigure[:NR5G]:DL[:CC<cc>]:FRAMe<fr>:BWPart<bwp>:SLOT<sl>:COReset<cr>:PDCCh<cf>:DCIFormat`).

Suffix:

<cc>	Component Carrier
<fr>	Frame
<bwp>	Bandwidth part
<sl>	Bandwidth part
<cr>	CORESET
<cf>	0

Parameters:

<Value> *RST: 1

Example:

```
//Select number of TCP commands
CONF:DL:CC2:FRAM3:BWP2:SLOT4:COR3:PDCC0:USAG
TSRN
CONF:DL:CC2:FRAM3:BWP2:SLOT4:COR3:PDCC0:DCIF
F23
CONF:DL:CC2:FRAM3:BWP2:SLOT4:COR3:PDCC0:DCIS:
TPCC 2
```

Manual operation: See ["Content"](#) on page 122

**CONFigure[:NR5G]:DL[:CC<cc>]:FRAMe<fr>:BWPART<bwp>:SLOT<sl>:
COREset<cr>:PDCCh<cf>:PLENgtH <Bits>**

Defines the bit length of the PDCCH.

Suffix:

<cc> [Component Carrier](#)
 <fr> [Frame](#)
 <bwp> [Bandwidth part](#)
 <sl> [Bandwidth part](#)
 <cr> [CORESET](#)
 <cf> 0

Parameters:

<Bits> *RST: 44

Example:

```
//Select PDCCH pattern length
CONF:DL:CC2:FRAM3:BWP2:SLOT4:COR3:PDCC0:PLEN 22
```

Manual operation: See ["Pattern Length"](#) on page 122

**CONFigure[:NR5G]:DL[:CC<cc>]:FRAMe<fr>:BWPART<bwp>:SLOT<sl>:
COREset<cr>:PDCCh<cf>:RNTI <Value>**

Selects the CORESET radio network identifier (RNTI).

Suffix:

<cc> [Component Carrier](#)
 <fr> [Frame](#)
 <bwp> [Bandwidth part](#)
 <sl> [Bandwidth part](#)
 <cr> [CORESET](#)
 <cf> 0

Parameters:

<Value> *RST: 0

Example:

```
//Select RNTI
CONF:DL:CC2:FRAM3:BWP2:SLOT4:COR3:PDCC0:RNTI 2
```

Manual operation: See "RNTI" on page 121

**CONFigure[:NR5G]:DL[:CC<cc>]:FRAMe<fr>:BWPPart<bwp>:SLOT<sl>:
COReset<cr>:PDCCh<cf>:USAGe <Usage>**

Selects the RNTI type for a PDCCH.

Suffix:

<cc> [Component Carrier](#)
 <fr> [Frame](#)
 <bwp> [Bandwidth part](#)
 <sl> [Bandwidth part](#)
 <cr> [CORESET](#)
 <cf> 0

Parameters:

<Usage> CRNT | CSRN | MCSC | TCRN | SPCR | PRNT | SIRD | RNRN |
 MSGB | SFIR | INTR | TPUS | TPUC | TSRN | CIRN | AIRN |
 PSRN
 *RST: CRNT

Example:

```
//Select RNTI type
CONF:DL:CC2:FRAM3:BWP2:SLOT4:COR3:PDCC0:USAG  

CSRN
```

Manual operation: See "Usage" on page 121

**CONFigure[:NR5G]:DL[:CC<cc>]:FRAMe<fr>:BWPPart<bwp>:SLOT<sl>:
COReset<cr>:PDSCh:STATe <State>**

Turns usage of CORESET allocations for PDSCH transmission on and off.

Prerequisites for this command

- Select precoder granularity = REG bundle ([CONFigure\[:NR5G\]:DL\[:CC<cc>\]:
FRAMe<fr>:BWPPart<bwp>:SLOT<sl>:COReset<cr>:PGRanularity](#)).

Suffix:

<cc> [Component Carrier](#)
 <fr> [Frame](#)
 <bwp> [Bandwidth part](#)
 <sl> [Bandwidth part](#)
 <cr> [CORESET](#)

Parameters:

<State> ON | OFF | 1 | 0
 *RST: OFF

Example:

```
//Allow PDSCH transmission in CORESET
CONF:DL:CC2:FRAM3:BWP2:SLOT4:COR3:PGR REGB
CONF:DL:CC2:FRAM3:BWP2:SLOT4:COR3:PDSC:STAT ON
```

Manual operation: See "[Allow PDSCH](#)" on page 117

**CONFigure[:NR5G]:DL[:CC<cc>]:FRAMe<fr>:BWPart<bwp>:SLOT<sl>:
 COREset<cr>:PGRanularity <Method>**

Selects the precoder granularity for the PDCCH DMRS.

Suffix:

<cc> [Component Carrier](#)
 <fr> [Frame](#)
 <bwp> [Bandwidth part](#)
 <sl> [Bandwidth part](#)
 <cr> [CORESET](#)

Parameters:

<Method> **ACRBs**
 All contiguous RBs.
REGBundle
 REG bundles only.

Example:

```
//Define precoder granularity
CONF:DL:CC2:FRAM3:BWP2:SLOT4:COR3:PGR ACRB
```

Manual operation: See "[Precoder Granularity](#)" on page 117

6.9.14 Enhanced PDSCH settings: DMRS

CONFigure[:NR5G]:DL[:CC<cc>]:FRAMe<fr>:BWPart<bwp>:SLOT<sl>: ALLocation<al>:CLMapping.....	374
CONFigure[:NR5G]:DL[:CC<cc>]:FRAMe<fr>:BWPart<bwp>:SLOT<sl>: ALLocation<al>:DMRS:AP.....	375
CONFigure[:NR5G]:DL[:CC<cc>]:FRAMe<fr>:BWPart<bwp>:SLOT<sl>: ALLocation<al>:DMRS:CGWD.....	375
CONFigure[:NR5G]:DL[:CC<cc>]:FRAMe<fr>:BWPart<bwp>:SLOT<sl>: ALLocation<al>:DMRS:CTYPe.....	376
CONFigure[:NR5G]:DL[:CC<cc>]:FRAMe<fr>:BWPart<bwp>:SLOT<sl>: ALLocation<al>:DMRS:MSYMBOL:APOSITION.....	376
CONFigure[:NR5G]:DL[:CC<cc>]:FRAMe<fr>:BWPart<bwp>:SLOT<sl>: ALLocation<al>:DMRS:MSYMBOL:LENGTH.....	376
CONFigure[:NR5G]:DL[:CC<cc>]:FRAMe<fr>:BWPart<bwp>:SLOT<sl>: ALLocation<al>:DMRS:MTYPe.....	377

CONFigure[:NR5G]:DL[:CC<cc>]:FRAMe<fr>:BWPart<bwp>:SLOT<sl>: ALLocation<al>:DMRS:NSCid.....	377
CONFigure[:NR5G]:DL[:CC<cc>]:FRAMe<fr>:BWPart<bwp>:SLOT<sl>: ALLocation<al>:DMRS:POWer.....	378
CONFigure[:NR5G]:DL[:CC<cc>]:FRAMe<fr>:BWPart<bwp>:SLOT<sl>: ALLocation<al>:DMRS:RST.....	378
CONFigure[:NR5G]:DL[:CC<cc>]:FRAMe<fr>:BWPart<bwp>:SLOT<sl>: ALLocation<al>:DMRS:SGENeration.....	379
CONFigure[:NR5G]:DL[:CC<cc>]:FRAMe<fr>:BWPart<bwp>:SLOT<sl>: ALLocation<al>:DMRS:SID.....	379
CONFigure[:NR5G]:DL[:CC<cc>]:FRAMe<fr>:BWPart<bwp>:SLOT<sl>: ALLocation<al>:DMRS:SIONe.....	380
CONFigure[:NR5G]:DL[:CC<cc>]:FRAMe<fr>:BWPart<bwp>:SLOT<sl>: ALLocation<al>:DMRS:TAPos.....	381
CONFigure[:NR5G]:DL[:CC<cc>]:FRAMe<fr>:BWPart<bwp>:SLOT<sl>: ALLocation<al>:RPOint.....	381
CONFigure[:NR5G]:DL[:CC<cc>]:FRAMe<fr>:BWPart<bwp>:SLOT<sl>: ALLocation<al>:UEID.....	382
CONFigure[:NR5G]:DL[:CC<cc>]:FRAMe<fr>:BWPart<bwp>:SLOT<sl>: ALLocation<al>:VTPinter.....	382

CONFigure[:NR5G]:DL[:CC<cc>]:FRAMe<fr>:BWPart<bwp>:SLOT<sl>: ALLocation<al>:CLMapping <Mapping>

Selects the codeword to layer mapping.

Suffix:

<cc>	Component Carrier
<fr>	Frame
<bwp>	Bandwidth part
<sl>	Slot
<al>	Allocation

Parameters:

<Mapping>	LC11 LC21 LC31 LC41 LC51 LC61 LC71 LC81 LC91 LC101 LC111 LC121 LC22 LC32 LC42 LC52 LC62 LC72 LC82
-----------	---

The availability of codeword to layer mappings depends on:

- DM-RS configuration type (CONFigure[:NR5G]:DL[:CC<cc>]:FRAMe<fr>:BWPart<bwp>:SLOT<sl>:
ALLocation<al>:DMRS:CTYPE)
- DM-RS length (CONFigure[:NR5G]:DL[:CC<cc>]:FRAMe<fr>:BWPart<bwp>:SLOT<sl>:ALLocation<al>:
DMRS:MSYMBOL:LENGTH)

*RST: LC11

Example:

```
//Select codeword to layer mapping
CONF:DL:CC2:FRAM3:BWP2:SLOT4:ALL5:CLM LC21
```

Manual operation: See "[Codeword to Layer Mapping](#)" on page 125

**CONFigure[:NR5G]:DL[:CC<cc>]:FRAMe<fr>:BWPart<bwp>:SLOT<sl>:
ALLocation<al>:DMRS:AP <AntennaPorts>...**

Selects the antenna ports for PDSCH transmission.

Suffix:

<cc>	Component Carrier
<fr>	Frame
<bwp>	Bandwidth part
<sl>	Slot
<al>	Allocation

Parameters:

<AntennaPorts> The number of numeric values depends on how many layers you have. For a single layer, add one value. For two layers, add two values etc.
The value range depends on the codeword to layer mapping you have selected (`CONFigure[:NR5G]:DL[:CC<cc>]:FRAMe<fr>:BWPart<bwp>:SLOT<sl>:ALLocation<al>:CLMapping`).

Example:

```
//Map layers to antenna ports
CONF:DL:CC2:FRAM3:BWP2:SLOT4:ALL5:CLM LC21
CONF:DL:CC2:FRAM3:BWP2:SLOT4:ALL5:DMRS:AP
1000,1001
```

Manual operation: See "[Antenna Port](#)" on page 125

**CONFigure[:NR5G]:DL[:CC<cc>]:FRAMe<fr>:BWPart<bwp>:SLOT<sl>:
ALLocation<al>:DMRS:CGWD <CDMGroups>**

Suffix:

<cc>	Component Carrier
<fr>	Frame
<bwp>	Bandwidth part
<sl>	Slot
<al>	Allocation

Parameters:

<CDMGroups> *RST: 0

Example:

```
//Select CMD groups without data
CONF:DL:CC2:FRAM3:BWP2:SLOT4:ALL5:DMRS:CGWD 2
```

Manual operation: See "[CDM Groups w/o Data](#)" on page 126

**CONFigure[:NR5G]:DL[:CC<cc>]:FRAMe<fr>:BWPART<bwp>:SLOT<sl>:
ALLOCATION<al>:DMRS:CTYPE <Configuration>**

Selects the PDSCH DM-RS configuration type.

Suffix:

<cc>	Component Carrier
<fr>	Frame
<bwp>	Bandwidth part
<sl>	Bandwidth part
<al>	Allocation

Parameters:

<Configuration>	1 2
*RST:	1

Example:

```
//Define DM-RS configuration
CONF:DL:CC2:FRAM3:BWP2:SLOT4:ALL5:DMRS:CTYP 1
```

Manual operation: See "[PDSCH DMRS Location](#)" on page 124

**CONFigure[:NR5G]:DL[:CC<cc>]:FRAMe<fr>:BWPART<bwp>:SLOT<sl>:
ALLOCATION<al>:DMRS:MSYMBOL:APOSITION <Symbol>**

Defines the position of additional DM-RS.

Suffix:

<cc>	Component Carrier
<fr>	Frame
<bwp>	Bandwidth part
<sl>	Bandwidth part
<al>	Allocation

Parameters:

<Symbol>	0 1 2 3
----------	---------------

Example:

```
//Define position of additional DM-RS
CONF:DL:CC2:FRAM3:BWP2:SLOT4:ALL5:DMRS:MSYM:
APOS 3
```

Manual operation: See "[Multi Symbol DMRS](#)" on page 124

**CONFigure[:NR5G]:DL[:CC<cc>]:FRAMe<fr>:BWPART<bwp>:SLOT<sl>:
ALLOCATION<al>:DMRS:MSYMBOL:LENGTH <Symbols>**

Defines the length of the DM-RS.

Suffix:

<cc>	Component Carrier
------	-------------------

<fr>	Frame
<bwp>	Bandwidth part
<sl>	Bandwidth part
<al>	Allocation

Parameters:

<Symbols>	1 DM-RS transmitted on 1 symbol.
	2 DM-RS transmitted on 2 symbols.
*RST:	1

Example: //Define DM-RS length
CONF:DL:CC2:FRAM3:BWP2:SLOT4:ALL5:DMRS:MSYM:
LENG 2

Manual operation: See "Multi Symbol DMRS" on page 124

**CONFigure[:NR5G]:DL[:CC<cc>]:FRAMe<fr>:BWPPart<bwp>:SLOT<sl>:
ALLocation<al>:DMRS:MTYPE <Mapping>**

Selects the mapping type of the PDSCH DM-RS.

Suffix:

<cc>	Component Carrier
<fr>	Frame
<bwp>	Bandwidth part
<sl>	Bandwidth part
<al>	Allocation

Parameters:

<Mapping>	A Location of DM-RS relative to the start of the slot.
	B Location relative to the start of the PDSCH resource elements.
*RST:	A

Example: //Define DM-RS mapping
CONF:DL:CC2:FRAM3:BWP2:SLOT4:ALL5:DMRS:MTYP B

Manual operation: See "PDSCH DMRS Location" on page 124

**CONFigure[:NR5G]:DL[:CC<cc>]:FRAMe<fr>:BWPPart<bwp>:SLOT<sl>:
ALLocation<al>:DMRS:NSCid <Value>**

Defines the scrambling ID for the PDSCH DM-RS sequence generation.

Prerequisites for this command

- Select sequence generation method "n_ID^DMRS" (CONFigure[:NR5G]:DL[:CC<cc>]:FRAMe<fr>:BWPart<bwp>:SLOT<sl>:ALLocation<al>:DMRS:SGENeration).

Suffix:

<cc>	Component Carrier
<fr>	Frame
<bwp>	Bandwidth part
<sl>	Bandwidth part
<al>	Allocation

Parameters:

<Value> 0 | 1

Example:

```
//Define DM-RS scrambling ID
CONF:DL:CC2:FRAM3:BWP2:SLOT4:ALL5:DMRS:SGEN
DSID
CONF:DL:CC2:FRAM3:BWP2:SLOT4:ALL5:DMRS:NSC 1
```

Manual operation: See "PDSCH DMRS Sequence Generation" on page 124

**CONFigure[:NR5G]:DL[:CC<cc>]:FRAMe<fr>:BWPart<bwp>:SLOT<sl>:
ALLocation<al>:DMRS:POWER <Power>**

Defines the PDSCH DM-RS power relative to the PDSCH.

Suffix:

<cc>	Component Carrier
<fr>	Frame
<bwp>	Bandwidth part
<sl>	Bandwidth part
<al>	Allocation

Parameters:

<Power> <numeric value>
*RST: 0
Default unit: dB

Example:

```
//Define DM-RS power
CONF:DL:CC2:FRAM3:BWP2:SLOT4:ALL5:DMRS:POW 0.5
```

Manual operation: See "PDSCH DMRS Rel Power" on page 125

**CONFigure[:NR5G]:DL[:CC<cc>]:FRAMe<fr>:BWPart<bwp>:SLOT<sl>:
ALLocation<al>:DMRS:RST <State>**

Turns low peak to average power ratio for the PDSCH DMRS on and off.

Suffix:

<cc>	Component Carrier
<fr>	Frame
<bwp>	Bandwidth part
<sl>	Slot
<al>	Allocation

Parameters:

<State>	ON OFF 1 0
*RST:	OFF

Example:

```
//Turn on dmrs-downlink-r16
CONF:DL:CC2:FRAM3:BWP2:SLOT4:ALL5:DMRS:RST ON
```

Manual operation: See "[DMRS-Downlink](#)" on page 126

**CONFigure[[NR5G](#)]:DL[[CC](#)<cc>]:FRAMe<fr>:BWPart<bwp>:SLOT<sl>:
ALLOcation<al>:DMRS:SGENeration <Method>**

Selects the PDSCH DM-RS sequence generation method.

Suffix:

<cc>	Component Carrier
<fr>	Frame
<bwp>	Bandwidth part
<sl>	Bandwidth part
<al>	Allocation

Parameters:

<Method>	NIDCell Sequence generation based on the cell ID.
	NIDDmrs Sequence generation based on a pseudo-random seed value.
*RST:	NIDCell

Example:

```
//Define DM-RS sequence type
CONF:DL:CC2:FRAM3:BWP2:SLOT4:ALL5:DMRS:SGEN
NIDC
```

Manual operation: See "[PDSCH DMRS Sequence Generation](#)" on page 124

**CONFigure[[NR5G](#)]:DL[[CC](#)<cc>]:FRAMe<fr>:BWPart<bwp>:SLOT<sl>:
ALLOcation<al>:DMRS:SID <Value>**

Defines the seed value ("N_ID^0") for the PDSCH DM-RS sequence generation.

Prerequisites for this command

- Select sequence generation method DMRS-Scrambling-ID (`CONFigure[:NR5G]:DL[:CC<cc>]:FRAMe<fr>:BWPart<bwp>:SLOT<sl>:ALLocation<al>:DMRS:SGENeration`).

Suffix:

<cc>	Component Carrier
<fr>	Frame
<bwp>	Bandwidth part
<sl>	Bandwidth part
<al>	Allocation

Parameters:

<Value>	<numeric value> (integer only)
*RST:	0

Example:

```
//Define seed value
CONF:DL:CC2:FRAM3:BWP2:SLOT4:ALL5:DMRS:SGEN
DSID
CONF:DL:CC2:FRAM3:BWP2:SLOT4:ALL5:DMRS:SID 15
```

Manual operation: See "PDSCH DMRS Sequence Generation" on page 124

CONFigure[:NR5G]:DL[:CC<cc>]:FRAMe<fr>:BWPart<bwp>:SLOT<sl>:ALLocation<al>:DMRS:SIONe <Value>

Defines the scrambling ID ("N_ID^1") for the PDSCH DM-RS sequence generation.

Prerequisites for this command

- Select sequence generation method "n_ID^DMRS" (`CONFigure[:NR5G]:DL[:CC<cc>]:FRAMe<fr>:BWPart<bwp>:SLOT<sl>:ALLocation<al>:DMRS:SGENeration`).
- Turn on "DMRS-Downlink" (`CONFigure[:NR5G]:DL[:CC<cc>]:FRAMe<fr>:BWPart<bwp>:SLOT<sl>:ALLocation<al>:DMRS:RST`).

Suffix:

<cc>	Component Carrier
<fr>	Frame
<bwp>	Bandwidth part
<sl>	Bandwidth part
<al>	Allocation

Parameters:

<Value>	*RST: 0
---------	---------

Example: //Define DM-RS scrambling ID
 CONF:DL:CC2:FRAM3:BWP2:SLOT4:ALL5:DMRS:SGEN
 DSID
 CONF:DL:CC2:FRAM3:BWP2:SLOT4:ALL5:DMRS:RST ON
 CONF:DL:CC2:FRAM3:BWP2:SLOT4:ALL5:DMRS:SION 15

Manual operation: See "PDSCH DMRS Sequence Generation" on page 124

**CONFigure[:NR5G]:DL[:CC<cc>]:FRAMe<fr>:BWPart<bwp>:SLOT<sl>:
 ALLocation<al>:DMRS:TAPos <Symbol>**

Defines the first symbol that the DM-RS uses.

Prerequisites for this command

- Select DM-RS mapping type A (CONFigure[:NR5G]:DL[:CC<cc>]:FRAMe<fr>:BWPart<bwp>:SLOT<sl>:ALLocation<al>:DMRS:MTYPE).

Suffix:

<cc> Component Carrier
 <fr> Frame
 <bwp> Bandwidth part
 <sl> Bandwidth part
 <al> Allocation

Parameters:

<Symbol> 2 | 3

Example: //Define position of DM-RS
 CONF:DL:CC2:FRAM3:BWP2:SLOT4:ALL5:DMRS:MTYP A
 CONF:DL:CC2:FRAM3:BWP2:SLOT4:ALL5:DMRS:TAP 3

Manual operation: See "PDSCH DMRS Location" on page 124

**CONFigure[:NR5G]:DL[:CC<cc>]:FRAMe<fr>:BWPart<bwp>:SLOT<sl>:
 ALLocation<al>:RPOint <Reference>**

Defines the reference point of the PDSCH DMRS.

Suffix:

<cc> Component Carrier
 <fr> Frame
 <bwp> Bandwidth part
 <sl> Bandwidth part
 <al> Allocation

Parameters:

<Reference> **BWPStart**
 Reference point is the first subcarrier of the bandwidth part the PDSCH DMRS is in.

RPA

Reference point is the reference point A.

*RST: RPA

Example:

```
//Select reference point for PDSCH DMRS
CONF:DL:CC2:FRAM3:BWP2:SLOT4:ALL5:RPO BWPS
```

Manual operation: See ["Reference Point"](#) on page 126

**CONFigure[:NR5G]:DL[:CC<cc>]:FRAMe<fr>:BWPart<bwp>:SLOT<sl>:
ALLocation<al>:UEID <ID>**

Defines the user ID of a PDSCH allocation.

Suffix:

<cc> [Component Carrier](#)
 <fr> [Frame](#)
 <bwp> [Bandwidth part](#)
 <sl> [Bandwidth part](#)
 <al> [Allocation](#)

Parameters:

<ID> <numeric value> (integer only)

Example:

```
//Define allocation ID
CONF:DL:CC2:FRAM3:BWP2:SLOT4:ALL5:UEID 8
```

Manual operation: See ["ID"](#) on page 114
 See ["User ID"](#) on page 123

**CONFigure[:NR5G]:DL[:CC<cc>]:FRAMe<fr>:BWPart<bwp>:SLOT<sl>:
ALLocation<al>:VTPinter <Type>**

Selects the interleaving size of VRB bundles.

Suffix:

<cc> [Component Carrier](#)
 <fr> [Frame](#)
 <bwp> [Bandwidth part](#)
 <sl> [Bandwidth part](#)
 <al> [Allocation](#)

Parameters:

<Type> **NINT**
 No resource block bundling.
<numeric_value> (integer only)
 Size of a VRB bundle (2 or 4 resource blocks).
 *RST: NINT

Example: //Select interleaving size
 CONF:DL:CC2:FRAM3:BWP2:SLOT4:ALL5:VTP 4

Manual operation: See "[VRB-to-PRB Interleaver](#)" on page 123

6.9.15 Enhanced PDSCH settings: PTRS

Commands to configure the PTRS described elsewhere.

- `CONFigure[:NR5G]:DL[:CC<cc>]:FRAMe<fr>:BWPart<bwp>:SLOT<sl>:ALLocation<al>:UEID` on page 382

<code>CONFigure[:NR5G]:DL[:CC<cc>]:FRAMe<fr>:BWPart<bwp>:SLOT<sl>:ALLocation<al>:PTRS:K</code>	383
<code>CONFigure[:NR5G]:DL[:CC<cc>]:FRAMe<fr>:BWPart<bwp>:SLOT<sl>:ALLocation<al>:PTRS:L</code>	384
<code>CONFigure[:NR5G]:DL[:CC<cc>]:FRAMe<fr>:BWPart<bwp>:SLOT<sl>:ALLocation<al>:PTRS:POWer</code>	384
<code>CONFigure[:NR5G]:DL[:CC<cc>]:FRAMe<fr>:BWPart<bwp>:SLOT<sl>:ALLocation<al>:PTRS:REOfset</code>	385
<code>CONFigure[:NR5G]:DL[:CC<cc>]:FRAMe<fr>:BWPart<bwp>:SLOT<sl>:ALLocation<al>:PTRS[:STATe]</code>	385

CONFigure[:NR5G]:DL[:CC<cc>]:FRAMe<fr>:BWPart<bwp>:SLOT<sl>:ALLocation<al>:PTRS:K <Value>

Defines an offset for the PTRS in the frequency domain.

Prerequisites for this command

- Turn on PTRS (`CONFigure[:NR5G]:DL[:CC<cc>]:FRAMe<fr>:BWPart<bwp>:SLOT<sl>:ALLocation<al>:PTRS[:STATe]`).

Suffix:

<cc>	Component Carrier
<fr>	Frame
<bwp>	Bandwidth part
<sl>	Bandwidth part
<al>	Allocation

Parameters:

<Value> 2 | 4 [subcarrier]
 *RST: 1

Example: //Define PTRS offset
 CONF:DL:CC2:FRAM3:BWP2:SLOT4:ALL5:PTRS ON
 CONF:DL:CC2:FRAM3:BWP2:SLOT4:ALL5:PTRS:K 4

Manual operation: See "[PTRS Configuration](#)" on page 127

**CONFigure[:NR5G]:DL[:CC<cc>]:FRAMe<fr>:BWPart<bwp>:SLOT<sl>:
ALLocation<al>:PTRS:L <Value>**

Defines an offset for the PTRS in the time domain.

Prerequisites for this command

- Turn on PTRS (`CONFigure[:NR5G]:DL[:CC<cc>]:FRAMe<fr>:
BWPart<bwp>:SLOT<sl>:ALLocation<al>:PTRS[:STATe]`).

Suffix:

<cc>	Component Carrier
<fr>	Frame
<bwp>	Bandwidth part
<sl>	Bandwidth part
<al>	Allocation

Parameters:

<Value>	1 2 4 [OFDM symbols]
*RST:	1

Example:

```
//Define PTRS offset
CONF:DL:CC2:FRAM3:BWP2:SLOT4:ALL5:PTRS ON
CONF:DL:CC2:FRAM3:BWP2:SLOT4:ALL5:PTRS:L 4
```

Manual operation: See "[PTRS Configuration](#)" on page 127

**CONFigure[:NR5G]:DL[:CC<cc>]:FRAMe<fr>:BWPart<bwp>:SLOT<sl>:
ALLocation<al>:PTRS:POWer <Power>**

Defines the relative power of the PTRS.

Prerequisites for this command

- Turn on PTRS (`CONFigure[:NR5G]:DL[:CC<cc>]:FRAMe<fr>:
BWPart<bwp>:SLOT<sl>:ALLocation<al>:PTRS[:STATe]`).

Suffix:

<cc>	Component Carrier
<fr>	Frame
<bwp>	Bandwidth part
<sl>	Bandwidth part
<al>	Allocation

Parameters:

<Power>	<numeric value>
*RST:	0
	Default unit: dB

Example: //Define PTRS power
 CONF:DL:CC2:FRAM3:BWP2:SLOT4:ALL5:PTRS ON
 CONF:DL:CC2:FRAM3:BWP2:SLOT4:ALL5:PTRS:POW 1DB

Manual operation: See "[PTRS Configuration](#)" on page 127

**CONFigure[:NR5G]:DL[:CC<cc>]:FRAME<fr>:BWPart<bwp>:SLOT<sl>:
 ALLocation<al>:PTRS:REOffset <Offset>**

Defines the location of the PTRS in the frequency domain relative to the first subcarrier.

Prerequisites for this command

- Turn on PTRS (CONFigure[:NR5G]:DL[:CC<cc>]:FRAME<fr>:BWPart<bwp>:SLOT<sl>:ALLocation<al>:PTRS[:STATE]).

Suffix:

<cc>	Component Carrier
<fr>	Frame
<bwp>	Bandwidth part
<sl>	Bandwidth part
<al>	Allocation

Parameters:

<Offset>	OS00 OS01 OS10 OS11 Defines an offset.
	NONE No offset.
	*RST: 00

Example: //Define PTRS offset
 CONF:DL:CC2:FRAM3:BWP2:SLOT4:ALL5:PTRS ON
 CONF:DL:CC2:FRAM3:BWP2:SLOT4:ALL5:PTRS:REOF
 OS10

Manual operation: See "[PTRS Configuration](#)" on page 127

**CONFigure[:NR5G]:DL[:CC<cc>]:FRAME<fr>:BWPart<bwp>:SLOT<sl>:
 ALLocation<al>:PTRS[:STATE] <State>**

Turns the PTRS on and off.

Suffix:

<cc>	Component Carrier
<fr>	Frame
<bwp>	Bandwidth part
<sl>	Bandwidth part
<al>	Allocation

Parameters:

<State> ON | OFF | 1 | 0
 *RST: OFF

Example:

//Turn on PTRS
 CONF:DL:CC2:FRAM3:BWP2:SLOT4:ALL5:PTRS ON

Manual operation: See "[PTRS Configuration](#)" on page 127

6.9.16 Enhanced PDSCH settings: scrambling / coding

Commands to configure the PTRS described elsewhere.

- `CONFigure[:NR5G]:DL[:CC<cc>]:FRAMe<fr>:BWPart<bwp>:SLOT<sl>:ALLocation<al>:UEID` on page 382

<code>CONFigure[:NR5G]:DL[:CC<cc>]:FRAMe<fr>:BWPart<bwp>:SLOT<sl>:ALLocation<al>:CCODing:IMCS</code>	386
<code>CONFigure[:NR5G]:DL[:CC<cc>]:FRAMe<fr>:BWPart<bwp>:SLOT<sl>:ALLocation<al>:CCODing:MCSTable</code>	387
<code>CONFigure[:NR5G]:DL[:CC<cc>]:FRAMe<fr>:BWPart<bwp>:SLOT<sl>:ALLocation<al>:CCODing:RVIndex</code>	388
<code>CONFigure[:NR5G]:DL[:CC<cc>]:FRAMe<fr>:BWPart<bwp>:SLOT<sl>:ALLocation<al>:CCODing:TBSFs</code>	388
<code>CONFigure[:NR5G]:DL[:CC<cc>]:FRAMe<fr>:BWPart<bwp>:SLOT<sl>:ALLocation<al>:CCODing:TBSsize</code>	389
<code>CONFigure[:NR5G]:DL[:CC<cc>]:FRAMe<fr>:BWPart<bwp>:SLOT<sl>:ALLocation<al>:SCRambling</code>	389
<code>CONFigure[:NR5G]:DL[:CC<cc>]:FRAMe<fr>:BWPart<bwp>:SLOT<sl>:ALLocation<al>:SCRambling:DSID</code>	390

`CONFigure[:NR5G]:DL[:CC<cc>]:FRAMe<fr>:BWPart<bwp>:SLOT<sl>:ALLocation<al>:CCODing:IMCS` <Value>

Selects the MCS index (I_{MCS}).

Suffix:

<cc> Component Carrier
 <fr> Frame
 <bwp> Bandwidth part
 <sl> Slot
 <al> Allocation

Parameters:

<Value>

The value range depends on:

- The modulation order (CONFigure[:NR5G]:DL[:CC<cc>]:FRAMe<fr>:BWPart<bwp>:SLOT<sl>:ALLocation<al>:CCODing:MCSTable).
- The modulation scheme of the PDSCH (CONFigure[:NR5G]:DL[:CC<cc>]:FRAMe<fr>:BWPart<bwp>:SLOT<sl>:ALLocation<al>[:CW<cw>]:MODulation).

*RST: 0

Example:

```
//Select MCS index for modulation order 256QAM
CONF:DL:CC2:FRAM3:BWP2:SLOT4:ALL5:MOD QAM256
CONF:DL:CC2:FRAM3:BWP2:SLOT4:ALL5:CCOD:MCST
Q256
CONF:DL:CC2:FRAM3:BWP2:SLOT4:ALL5:CCOD:IMCS 2
```

Manual operation: See "Channel Coding" on page 128

CONFigure[:NR5G]:DL[:CC<cc>]:FRAMe<fr>:BWPart<bwp>:SLOT<sl>:ALLocation<al>:CCODing:MCSTable <Table>

Selects the modulation order (MCS table) of the PDSCH.

Suffix:

<cc> Component Carrier
 <fr> Frame
 <bwp> Bandwidth part
 <sl> Slot
 <al> Allocation

Parameters:

<Table>

Q64

Table for 64QAM.

Q64L

Table for 64QAM LowSE.

Q256

Table for 256QAM.

Q1024

Table for 1024QAM.

*RST: Q64

Example:

```
//Select modulation order
CONF:DL:CC2:FRAM3:BWP2:SLOT4:ALL5:CCOD:MCST Q64
```

Manual operation: See "Channel Coding" on page 128

**CONFigure[:NR5G]:DL[:CC<cc>]:FRAMe<fr>:BWPart<bwp>:SLOT<sl>:
 ALLOcation<al>:CCODing:RVINdex <Index>**

Selects the redundancy version index.

Suffix:

<cc>	Component Carrier
<fr>	Frame
<bwp>	Bandwidth part
<sl>	Slot
<al>	Allocation

Parameters:

<Index>	Range: 0 to 3
	*RST: 0

Example: //Select redundancy version index
 CONF:DL:CC2:FRAM3:BWP2:SLOT4:ALL5:CCOD:RVIN 1

Manual operation: See "Channel Coding" on page 128

**CONFigure[:NR5G]:DL[:CC<cc>]:FRAMe<fr>:BWPart<bwp>:SLOT<sl>:
 ALLOcation<al>:CCODing:TBSFs <Factor>**

Selects the transport block scaling factor S.

Suffix:

<cc>	Component Carrier
<fr>	Frame
<bwp>	Bandwidth part
<sl>	Slot
<al>	Allocation

Parameters:

<Factor>	ONE S = 1
	HALF S = 0.5
	QUAR S = 0.25
	*RST: ONE

Example: //Select TB scaling factor S
 CONF:DL:CC2:FRAM3:BWP2:SLOT4:ALL5:CCOD:TBSF
 HALF

Manual operation: See "Channel Coding" on page 128

**CONFigure[:NR5G]:DL[:CC<cc>]:FRAMe<fr>:BWPart<bwp>:SLOT<sl>:
ALLOcation<al>:CCODing:TBSize <State>**

Turns transport block size calculation including allocation gaps on and off.

Prerequisites for this command

- Combine PDSCH allocations ([CONFigure\[:NR5G\]:DL\[:CC<cc>\]:FRAMe<fr>:
BWPart<bwp>:SLOT<sl>:CUID](#) on page 356).

Suffix:

<cc>	Component Carrier
<fr>	Frame
<bwp>	Bandwidth part
<sl>	Slot
<al>	Allocation

Parameters:

<State>	ON OFF 1 0
*RST:	OFF

Example: //Calculate transport block size including allocation gaps
CONF:DL:CC2:FRAM3:BWP2:SLOT4:CUID ON
CONF:DL:CC2:FRAM3:BWP2:SLOT4:ALL5:CCOD:TBS ON

Manual operation: See "[Channel Coding](#)" on page 128

**CONFigure[:NR5G]:DL[:CC<cc>]:FRAMe<fr>:BWPart<bwp>:SLOT<sl>:
ALLOcation<al>:SCRambling <Method>**

Selects the PDSCH scrambling method.

Suffix:

<cc>	Component Carrier
<fr>	Frame
<bwp>	Bandwidth part
<sl>	Slot
<al>	Allocation

Parameters:

<Method>	DSID Sequence generation based on a pseudo-random seed value.
	NIDCell Sequence generation based on the cell ID.
*RST:	NIDCell

Example: //Define PDSCH scrambling method
CONF:DL:CC2:FRAM3:BWP2:SLOT4:ALL5:SCR NIDC

Manual operation: See "[PDSCH Scrambling](#)" on page 129

**CONFigure[:NR5G]:DL[:CC<cc>]:FRAMe<fr>:BWPart<bwp>:SLOT<sl>:
ALLocation<al>:SCRambling:DSID <Value>**

Defines the seed value for the PDSCH scrambling.

Prerequisites for this command

- Select sequence generation method DMRS-Scrambling-ID (`CONFigure[:NR5G]:DL[:CC<cc>]:FRAMe<fr>:BWPart<bwp>:SLOT<sl>:ALLocation<al>:SCRambling`).

Suffix:

<cc>	Component Carrier
<fr>	Frame
<bwp>	Bandwidth part
<sl>	Slot
<al>	Allocation

Parameters:

<Value>	<numeric value> (integer only)
*RST:	0

Example:

```
//Define seed value
CONF:DL:CC2:FRAM3:BWP2:SLOT4:ALL5:SCR DSID
CONF:DL:CC2:FRAM3:BWP2:SLOT4:ALL5:SCR:DSID 10
```

Manual operation: See "PDSCH Scrambling" on page 129

6.9.17 Antenna port configuration

<code>CONFigure[:NR5G]:DL[:CC<cc>]:PAMapping<cf>:CSIRs:AP<ap></code>	390
<code>CONFigure[:NR5G]:DL[:CC<cc>]:PAMapping<cf>:PDSCh:AP<ap></code>	391
<code>CONFigure[:NR5G]:DL[:CC<cc>]:PAMapping<cf>:STaTe</code>	391

CONFigure[:NR5G]:DL[:CC<cc>]:PAMapping<cf>:CSIRs:AP<ap> <State>

Selects the antenna port(s) on which the CSI reference signal is transmitted.

Suffix:

<cc>	Component Carrier
<cf>	1...2 Antenna port configuration
<ap>	3000...3031 Antenna port

Parameters:

<State>	ON OFF 1 0 Turns a specific CSI-RS antenna port on and off.
	ALL NONE Turns all CSI-RS antenna port on and off.

*RST: AP 3000 = ON

Example: //Transmit CSI RS on antenna port 3010 in configuration 2
CONF:DL:CC2:PAM2:CSIR:AP3010

Manual operation: See "[CSI-RS](#)" on page 131

CONFigure[:NR5G]:DL[:CC<cc>]:PAMapping<cf>:PDSCh:AP<ap> <State>

Selects the antenna port(s) on which the PDSCH is transmitted.

Suffix:

<cc> [Component Carrier](#)
<cf> 1...2
[Antenna port configuration](#)
<ap> 1000...1011
[Antenna port](#)

Parameters:

<State> **ON | OFF | 1 | 0**
Turns the transmission on a specific antenna port on and off.
ALL
Turns on the transmission on all antenna ports (1000 to 1011).
NONE
Turns off the transmission on all antenna ports.
By default, the transmission is on antenna port 1000 (configuration 1) and 1001 (configuration 2).

Example: //Turn on transmission on antenna port 1002 in configuration 1
CONF:DL:CC1:PAM1:PDSCH:AP1002 ON

Manual operation: See "[PDSCH](#)" on page 130

CONFigure[:NR5G]:DL[:CC<cc>]:PAMapping<cf>:STATE <State>

Selects one of the antenna port configurations.

Effects of this command

- If you turn on a configuration, the other antenna port configuration is automatically turned off (and vice versa).

Suffix:

<cc> [Component Carrier](#)
<cf> 1...2
[Antenna port configuration](#)

Parameters:

<State> **ON | OFF | 1 | 0**
*RST: ON for configuration 1

Example: //Turn on antenna port configuration 2
CONF:DL:CC2:PAM2:STAT ON

Manual operation: See "State" on page 130

6.9.18 Advanced settings: global

CONFigure[:NR5G]:DL[:CC<cc>]:EUIDs.....	392
CONFigure[:NR5G]:DL[:CC<cc>]:FNNF.....	392
CONFigure[:NR5G]:DL[:CC<cc>]:IDC.....	393
CONFigure[:NR5G]:DL[:CC<cc>]:RFUC:FZERo:FREQuency.....	393
CONFigure[:NR5G]:DL[:CC<cc>]:RFUC:FZERo:MODE.....	393
CONFigure[:NR5G]:DL[:CC<cc>]:RFUC:STATe.....	394
CONFigure[:NR5G]:DL[:CC<cc>]:SSCA.....	394
CONFigure[:NR5G]:FELC:STATe.....	395
CONFigure[:NR5G]:ORAN:TCASe.....	395
[SENSe:]POWer:CATegory.....	395

CONFigure[:NR5G]:DL[:CC<cc>]:EUIDs <IDs>

Defines user IDs that are excluded from the calculation of modulation-specific EVM results.

Suffix:

<cc> Component Carrier

Parameters:

<IDs> String containing the user IDs to exclude. This is either a comma-separated list (1,2,5,6), a range (1-6) or a combination of both.

Example: //Exclude user IDs
CONF:DL:EUID "1,3,5-6"

Manual operation: See "Exclude User IDs" on page 133

CONFigure[:NR5G]:DL[:CC<cc>]:FNNF <FrameNumber>

Defines the 5G NR system frame number.

Suffix:

<cc> irrelevant

Parameters:

<FrameNumber> *RST: 0

Example: //Define frame number
CONF:UL:FNNF 432

Manual operation: See "Frame Number n_f" on page 133

CONFigure[:NR5G]:DL[:CC<cc>]:IDC <State>

Turns analysis of the DC carrier on and off.

Suffix:

<cc> [Component Carrier](#)

Parameters:

<State>

OFF | 0

Includes the DC carrier in the analysis.

ON | 1

Excludes the DC carrier from the analysis.

COMPensate

Compensates the DC carrier.

*RST: OFF

Example:

```
//Do not analyze DC carrier
CONF:DL:CC2:IDC ON
```

Manual operation: See "[Handling of Carrier Leakage](#)" on page 132

CONFigure[:NR5G]:DL[:CC<cc>]:RFUC:FZERo:FREQuency <Frequency>

Selects a frequency for RF upconversion.

Prerequisites for this command

- Turn on phase compensation ([CONFigure\[:NR5G\]:DL\[:CC<cc>\]:RFUC:STATE](#)).
- Select mode to select custom frequency ([CONFigure\[:NR5G\]:DL\[:CC<cc>\]:RFUC:FZERo:MODE](#)).

Suffix:

<cc> [Component Carrier](#)

Parameters:

<Frequency>

<numeric value>

*RST: 0

Default unit: Hz

Example:

```
//Define frequency for RF upconversion
CONF:DL:CC2:RFUC:STAT ON
CONF:DL:CC2:RFUC:FZER:MODE MAN
CONF:DL:CC2:RFUC:FZER:FREQ 800MHZ
```

Manual operation: See "[RF Upconversion](#)" on page 133

CONFigure[:NR5G]:DL[:CC<cc>]:RFUC:FZERo:MODE <Mode>

Selects the frequency selection mode for RF upconversion.

Prerequisites for this command

- Turn on phase compensation (`CONFigure[:NR5G]:DL[:CC<cc>]:RFUC:STATE`).

Suffix:

<cc> [Component Carrier](#)

Parameters:

<Mode>

CF

Converts the signal to the center frequency.

MANual

Converts the signal to another frequency.

You can define the frequency with `CONFigure[:NR5G]:DL[:CC<cc>]:RFUC:FZERo:FREQuency`.

*RST: CF

Example:

```
//Select frequency mode for RF upconversion
CONF:DL:CC2:RFUC:STAT ON
CONF:DL:CC2:RFUC:FZER:MODE CF
```

Manual operation: See "[RF Upconversion](#)" on page 133

CONFigure[:NR5G]:DL[:CC<cc>]:RFUC:STATE <State>

Turns RF upconversion and corresponding phase compensation on and off.

Suffix:

<cc> [Component Carrier](#)

Parameters:

<State>

ON | OFF | 1 | 0

*RST: ON

Example:

```
//Turn on phase compensation
CONF:DL:CC2:RFUC:STAT ON
```

Manual operation: See "[RF Upconversion](#)" on page 133

CONFigure[:NR5G]:DL[:CC<cc>]:SSCA <State>

Turn shared spectrum channel access on and off.

Suffix:

<cc> [Component Carrier](#)

Parameters:

<State>

ON | OFF | 1 | 0

*RST: OFF

Example:

```
//Turn on shared spectrum channel acces
CONF:DL:SSCA ON
```

Manual operation: See "[Shared Spectrum Channel Access](#)" on page 134

CONFigure[:NR5G]:FELC:STATe <State>

Turns the frequency error limit check on and off.

Parameters:

<State> ON | OFF | 1 | 0
*RST: ON

Example: //Turn on frequency error limit check
CONF:FELC:STAT ON

Manual operation: See "[Frequency Error Limit Check](#)" on page 133

CONFigure[:NR5G]:ORAN:TCASe <Testcase>

Selects an O-RAN test case.

Parameters:

<Testcase> <string>
String containing the name of the test case, e.g. "TC 3.2.3.1.1".
The string "NONE" removes a test case.
*RST: NONE

Example: //Select O-RAN test case TC 3.2.3.1.4
CONF:ORAN:TCAS "TC 3.2.3.1.4"

Manual operation: See "[O-RAN Test Case](#)" on page 134

[SENSe:]POWer:CATegory <Category>

Selects the base station category-

Parameters:

<Category> **A**
Category A base station.
B
Category B base station.
LARE
Large area base station.
MED
Medium area base station.
*RST: A

Example: //Select base station category
POW:CAT B

Manual operation: See "[Category](#)" on page 133

6.9.19 Advanced settings: reference point A

CONFigure[:NR5G]:DL[:CC<cc>]:RPA:AFRequency?	396
CONFigure[:NR5G]:DL[:CC<cc>]:RPA:KZERo:SCFE	396
CONFigure[:NR5G]:DL[:CC<cc>]:RPA:KZERo:SCFT	396
CONFigure[:NR5G]:DL[:CC<cc>]:RPA:KZERo:SCNS	397
CONFigure[:NR5G]:DL[:CC<cc>]:RPA:KZERo:SCOT	397
CONFigure[:NR5G]:DL[:CC<cc>]:RPA:KZERo:SCST	398
CONFigure[:NR5G]:DL[:CC<cc>]:RPA:KZERo:SCTT	398
CONFigure[:NR5G]:DL[:CC<cc>]:RPA:RTCF	398
CONFigure[:NR5G]:DL[:CC<cc>]:RPA:TBOFset?	399

CONFigure[:NR5G]:DL[:CC<cc>]:RPA:AFRequency?

Queries the absolute frequency of the reference point A.

Suffix:

<cc> [Component Carrier](#)

Return values:

<Frequency> <numeric value>
 Default unit: Hz

Example: //Query location of reference point A
 CONF:DL:CC2:RPA:AFR?

Usage: Query only

Manual operation: See "[Reference Point A](#)" on page 135

CONFigure[:NR5G]:DL[:CC<cc>]:RPA:KZERo:SCFE <Offset>

Defines an offset relative to reference point A for bandwidth parts with 480 kHz subcarrier spacing.

Prerequisites for this command

- Bandwidth part with 480 kHz subcarrier spacing is available.

Suffix:

<cc> [Component Carrier](#)

Parameters:

<Offset> -6 | 0 | 6

Example: //Define offset
 CONF:DL:CC2:RPA:KZER:SCFE 0

Manual operation: See "[k_0](#)" on page 135

CONFigure[:NR5G]:DL[:CC<cc>]:RPA:KZERo:SCFT <Offset>

Defines an offset relative to reference point A for bandwidth parts with 15 kHz subcarrier spacing.

Prerequisites for this command

- Bandwidth part with 15 kHz subcarrier spacing is available.

Suffix:

<cc> [Component Carrier](#)

Parameters:

<Offset> -6 | 0 | 6

Example:

```
//Define offset
CONF:DL:CC2:RPA:KZER:SCFT 0
```

Manual operation: See "[k_0](#)" on page 135

CONFigure[:NR5G]:DL[:CC<cc>]:RPA:KZERo:SCNS <Offset>

Defines an offset relative to reference point A for bandwidth parts with 960 kHz subcarrier spacing.

Prerequisites for this command

- Bandwidth part with 960 kHz subcarrier spacing is available.

Suffix:

<cc> [Component Carrier](#)

Parameters:

<Offset> -6 | 0 | 6

Example:

```
//Define offset
CONF:DL:CC2:RPA:KZER:SCNS 0
```

Manual operation: See "[k_0](#)" on page 135

CONFigure[:NR5G]:DL[:CC<cc>]:RPA:KZERo:SCOT <Offset>

Defines an offset relative to reference point A for bandwidth parts with 120 kHz subcarrier spacing.

Prerequisites for this command

- Bandwidth part with 120 kHz subcarrier spacing is available.

Suffix:

<cc> [Component Carrier](#)

Parameters:

<Offset> -6 | 0 | 6

Example:

```
//Define offset
CONF:DL:CC2:RPA:KZER:SCOT 0
```

Manual operation: See "[k_0](#)" on page 135

CONFigure[:NR5G]:DL[:CC<cc>]:RPA:KZERo:SCST <Offset>

Defines an offset relative to reference point A for bandwidth parts with 60 kHz subcarrier spacing.

Prerequisites for this command

- Bandwidth part with 60 kHz subcarrier spacing is available.

Suffix:

<cc> [Component Carrier](#)

Parameters:

<Offset> -6 | 0 | 6

Example:

```
//Define offset
CONF:DL:CC2:RPA:KZER:SCST 0
```

Manual operation: See "[k_0](#)" on page 135

CONFigure[:NR5G]:DL[:CC<cc>]:RPA:KZERo:SCTT <Offset>

Defines an offset relative to reference point A for bandwidth parts with 30 kHz subcarrier spacing.

Prerequisites for this command

- Bandwidth part with 30 kHz subcarrier spacing is available.

Suffix:

<cc> [Component Carrier](#)

Parameters:

<Offset> -6 | 0 | 6

Example:

```
//Define offset
CONF:DL:CC2:RPA:KZER:SCTT 0
```

Manual operation: See "[k_0](#)" on page 135

CONFigure[:NR5G]:DL[:CC<cc>]:RPA:RTCF <Frequency>

Defines the frequency of the reference point A relative to the carrier's center frequency.

Suffix:

<cc> [Component Carrier](#)

Parameters:

<Frequency> <numeric value>
Default unit: Hz

Example:

```
//Define location of reference point A
CONF:DL:CC2:RPA:RTCF -54.5MHZ
```

Manual operation: See "[Reference Point A](#)" on page 135

CONFigure[:NR5G]:DL[:CC<cc>]:RPA:TBOffset?

Queries the TxBW offset of the reference point A.

Suffix:

<cc> [Component Carrier](#)

Return values:

<Offset> <numeric value>

Default unit: Hz

Example:

//Query TxBW offset

CONF:DL:CC2:RPA:TBOF?

Usage:

Query only

Manual operation: See "[Reference Point A](#)" on page 135

6.9.20 Advanced settings: LTE-CRS coexistence

CONFigure[:NR5G]:DL[:CC<cc>]:LTE:CBW	399
CONFigure[:NR5G]:DL[:CC<cc>]:LTE:MBSFn:SUBFrame<sf>:STATe	399
CONFigure[:NR5G]:DL[:CC<cc>]:LTE:NAP	400
CONFigure[:NR5G]:DL[:CC<cc>]:LTE:POINTa	400
CONFigure[:NR5G]:DL[:CC<cc>]:LTE:STATe	401
CONFigure[:NR5G]:DL[:CC<cc>]:LTE:VSHift	401

CONFigure[:NR5G]:DL[:CC<cc>]:LTE:CBW <ResourceBlocks>

Selects the channel bandwidth of an LTE carrier.

Prerequisites for this command

- Turn on LTE-CRS coexistence ([CONFigure\[:NR5G\]:DL\[:CC<cc>\]:LTE:STATe](#)).

Suffix:

<cc> [Component Carrier](#)

Parameters:

<ResourceBlocks> N6 | N15 | N25 | N50 | N75 | N100

*RST: N6

Example:

//Select LTE channel bandwidth

CONF:DL:CC2:LTE:STAT ON

CONF:DL:CC2:LTE:CBW N25

Manual operation: See "[LTE Bandwidth](#)" on page 137

CONFigure[:NR5G]:DL[:CC<cc>]:LTE:MBSFn:SUBFrame<sf>:STATe <State>

Turns MBSFN transmission in specific subframes on and off.

Prerequisites for this command

- Turn on LTE-CRS coexistence (`CONFigure[:NR5G]:DL[:CC<cc>]:LTE:STATE`).

Suffix:

<cc> [Component Carrier](#)

<sf> 1...9
Subframe

Parameters:

<State> ON | OFF | 1 | 0
*RST: OFF (all subframes)

Example: //Turn on MBSFN transmission in subframe 2
`CONF:DL:LTE:MBSF:SUBF2:STAT ON`

Manual operation: See "[MBSFN Subframes](#)" on page 136

CONFigure[:NR5G]:DL[:CC<cc>]:LTE:NAP <APs>

Selects the number of antenna ports for an LTE signal.

Prerequisites for this command

- Turn on LTE-CRS coexistence (`CONFigure[:NR5G]:DL[:CC<cc>]:LTE:STATE`).

Suffix:

<cc> [Component Carrier](#)

Parameters:

<APs> AP1 | AP2 | AP4
1-, 2-, or 4 antenna port configurations.
*RST: AP1

Example: //Select number of LTE antenna ports
`CONF:DL:CC2:LTE:STAT ON`
`CONF:DL:CC2:LTE:NAP AP2`

Manual operation: See "[LTE Antenna Ports](#)" on page 137

CONFigure[:NR5G]:DL[:CC<cc>]:LTE:POINTa <Offset>

Defines an LTE carrier offset relative to reference point A (in terms of resource blocks).

Prerequisites for this command

- Turn on LTE-CRS coexistence (`CONFigure[:NR5G]:DL[:CC<cc>]:LTE:STATE`).

Suffix:

<cc> [Component Carrier](#)

Parameters:

<Offset> *RST: 0

Example: //Define carrier offset
 CONF:DL:CC2:LTE:STAT ON
 CONF:DL:CC2:LTE:POIN 25

Manual operation: See "Offset to Point A" on page 136

CONFigure[:NR5G]:DL[:CC<cc>]:LTE:STATe <State>

Turns coexistence with LTE resources on and off.

Prerequisites for this command

- Select subcarrier spacing of 15 kHz (CONFigure[:NR5G]:DL[:CC<cc>]:FRAMe<fr>:BWPart<bwp>:SSPacing).

Suffix:

<cc> [Component Carrier](#)

Parameters:

<State> ON | OFF | 1 | 0
 *RST: OFF

Example: //Turn on LTE coexistence
 CONF:DL:CC2:FRAM:BWp1:SSP SS15
 CONF:DL:CC2:LTE:STAT ON

Manual operation: See "State" on page 136

CONFigure[:NR5G]:DL[:CC<cc>]:LTE:VSHift <Value>

Selects the vShift parameter for an LTE signal.

Prerequisites for this command

- Turn on LTE-CRS coexistence (CONFigure[:NR5G]:DL[:CC<cc>]:LTE:STATe).

Suffix:

<cc> [Component Carrier](#)

Parameters:

<Value> *RST: 0

Example: //Define vShift parameter
 CONF:DL:CC2:LTE:STAT ON
 CONF:DL:CC2:LTE:VSH 2

Manual operation: See "vShift" on page 137

6.9.21 Generator control

CONFigure:GENerator:FREQuency:CENTer:SYNC[:STATe].....	402
CONFigure:GENerator:IPConnection:ADDRess.....	402
CONFigure:GENerator:IPConnection:LEDState?.....	403

CONFigure:GENerator:POWer:LEVel:STATe.....	403
CONFigure:GENerator:LEVel:DUTGain.....	403
CONFigure:GENerator:LEVel:DUTLimit.....	404
CONFigure:GENerator:LEVel:DUTLimit:STATe.....	404
CONFigure:GENerator:POWer:LEVel.....	405
CONFigure:GENerator:QERRor?.....	405
CONFigure:SETTings:NR5G.....	405
CONFigure:SETTings:NR5G:PINTerVal.....	405
CONFigure:SETTings:NR5G:SYNC.....	406
CONFigure:SETTings:RF.....	406
CONFigure:GENerator:RFOutput[:STATe].....	406
CONFigure:GENerator:CONTRol[:STATe].....	407
CONFigure:GENerator:SETTings:UPDate:RF.....	407

CONFigure:GENerator:FREQuency:CENTer:SYNC[:STATe] <State>

Turns frequency synchronization between analyzer and generator on and off.

You can define the frequency itself with [*SENSe*:] *FREQuency:CENTer* [:*CC*<*cc*>] .

Prerequisites for this command

- IP connection to a signal generator.
- Generator control state is on (*CONFigure:GENerator:CONTRol* [:*STATe*]).

Parameters:

<State> ON | OFF | 1 | 0
 *RST: OFF

Example: //Turn on RF output
 CONF:GEN:CONT ON
 CONF:GEN:FREQ:CENT ON

Manual operation: See "[Center Frequency](#)" on page 139

CONFigure:GENerator:IPConnection:ADDRess <IPAddress>

This command defines the IP address of the connected signal generator.

Make sure to synchronize with *OPC? or *WAI to make sure that the command was successfully applied on the generator before sending the next command.

Parameters:

<IPAddress> String containing the IP address or computer name.

Example: //Connect to the generator with the stated IP address
 CONF:GEN:IPC:ADDR '192.0.2.0';*WAI

Example: //Connect to the generator with a computer name
 CONF:GEN:IPC:ADDR 'MyGenerator';*WAI

Manual operation: See "[Generator IP Address](#)" on page 138

CONFigure:GENerator:IPConnection:LEDState?

This command queries the state of connection to the signal generator.

Return values:

<State>	GREen Connection was successful.
	GREY Unknown connection state.
	RED Connection was not successful.

Example:

```
CONF:GEN:IPC:LEDS?
would return, e.g.:
RED
```

Usage: Query only**Manual operation:** See "[Generator IP Address](#)" on page 138

CONFigure:GENerator:POWer:LEVel:STATe <State>

Turns level synchronization between analyzer and generator on and off.

Prerequisites for this command

- IP connection to a signal generator.
- Generator control state is on ([CONFigure:GENerator:CONTRol\[:STATe\]](#)).

Parameters:

<State>	ON OFF 1 0
*RST:	OFF

Example:

```
//Turn on level synchronization
CONF:GEN:CONT ON
CONF:GEN:POW:LEV:STAT ON
```

Manual operation: See "[Level Control State](#)" on page 139

CONFigure:GENerator:LEVel:DUTGain <Level>

Defines DUT level gain for generator level control.

Prerequisites for this command

- IP connection to a signal generator.
- Generator control state is on ([CONFigure:GENerator:CONTRol\[:STATe\]](#)).
- Level control is on ([CONFigure:GENerator:POWer:LEVel:STATe](#)).

Parameters:

<Level>	*RST: 0
	Default unit: dB

Example: //Define DUT gain
 CONF:GEN:CONT ON
 CONF:GEN:LEV:DUTG ON

Manual operation: See "DUT Gain" on page 140

CONFigure:GENerator:LEVel:DUTLimit <Level>

Defines the output power RMS level of the generator.

Prerequisites for this command

- IP connection to a signal generator.
- Generator control state is on (CONFigure:GENerator:CONTRol[:STATe]).
- Level control is on (CONFigure:GENerator:POWer:LEVel:STATe).
- DUT peak input power limit is on (CONFigure:GENerator:LEVel:DUTLimit:STATe).

Parameters:

<Level> *RST: 30
 Default unit: dB

Example: //Define peak input power
 CONF:GEN:CONT ON
 CONF:GEN:POW:LEV:STAT ON
 CONF:GEN:LEV:DUTL:STAT ON
 CONF:GEN:LEV:DUTL 10

Manual operation: See "Limit DUT Peak Input Power" on page 140

CONFigure:GENerator:LEVel:DUTLimit:STATe <State>

Turns a limitation of the DUT peak input power on and off.

Define the peak input power with CONFigure:GENerator:LEVel:DUTLimit.

Prerequisites for this command

- IP connection to a signal generator.
- Generator control state is on (CONFigure:GENerator:CONTRol[:STATe]).
- Level control is on (CONFigure:GENerator:POWer:LEVel:STATe).

Parameters:

<State> ON | OFF | 1 | 0
 *RST: OFF

Example: //Turn on DUT input power limitation
 CONF:GEN:CONT ON
 CONF:GEN:POW:LEV:STAT ON
 CONF:GEN:LEV:DUTL:STAT ON

Manual operation: See "Limit DUT Peak Input Power" on page 140

CONFigure:GENerator:POWer:LEVel <Level>

Defines the output power RMS level of the generator.

Prerequisites for this command

- IP connection to a signal generator.
- Generator control state is on ([CONFigure:GENerator:CONTRol\[:STATe\]](#)).
- Level control is on ([CONFigure:GENerator:POWer:LEVel:STATe](#)).

Parameters:

<Level> *RST: 0
 Default unit: dBm

Example: //Define generator output level
 CONF:GEN:CONT ON
 CONF:GEN:POW:LEV:STAT ON
 CONF:GEN:POW:LEV -10

Manual operation: See "[Level \(RMS\)](#)" on page 139

CONFigure:GENerator:QERRor?

Queries any errors that might have occurred for the generator control

Return values:

<Message> String containing the error messages.

Example: //Query error messages
 CONF:GEN:QERR?

Usage: Query only

CONFigure:SETTings:NR5G

Downloads the NR signal description from the generator to the analyzer.

Prerequisites for this command

- IP connection to a signal generator.
- Generator control state is on ([CONFigure:GENerator:CONTRol\[:STATe\]](#)).

Example: //Synchronize signal description
 CONF:GEN:CONT ON
 CONF:SETT:NR5G

Usage: Event

Manual operation: See "[Query Settings from Generator](#)" on page 140

CONFigure:SETTings:NR5G:PINterval <Time>

Defines the polling interval for periodic synchronization between analyzer and generator.

Prerequisites for this command

- IP connection to a signal generator.
- Generator control state is on (`CONF:GEN:CONTROL[:STATE]`).
- Periodic synchronization is on (`CONF:SETT:NR5G:SYNC`).

Parameters:

<Time> Default unit: s

Example:

```
//Define polling interval
CONF:GEN:CONT ON
CONF:SETT:NR5G:SYNC ON
CONF:SETT:NR5G:PINT 30
```

Manual operation: See "[Periodic synchronization of 5G NR settings](#)" on page 140

`CONF:SETT:NR5G:SYNC <State>`

Turns periodic synchronization of the signal description on the analyzer on and off.

Prerequisites for this command

- IP connection to a signal generator.
- Generator control state is on (`CONF:GEN:CONTROL[:STATE]`).

Parameters:

<State> ON | OFF | 1 | 0
*RST: OFF

Example:

```
//Define polling interval
CONF:GEN:CONT ON
CONF:SETT:NR5G:SYNC ON
```

Manual operation: See "[Periodic synchronization of 5G NR settings](#)" on page 140

`CONF:SETT:RF`

Downloads the RF settings (frequency, level) from the generator to the analyzer.

Prerequisites for this command

- IP connection to a signal generator.
- Generator control state is on (`CONF:GEN:CONTROL[:STATE]`).

Example:

```
//Synchronize signal description
CONF:GEN:CONT ON
CONF:SETT:RF
```

Usage:

Event

Manual operation: See "[Query Settings from Generator](#)" on page 140

`CONF:GEN:RFOutput[:STATE] <State>`

Turns the RF output of the generator on and off.

Prerequisites for this command

- IP connection to a signal generator.
- Generator control state is on (`CONF:GEN:CONTROL[:STATE]`).

Parameters:

<State> ON | OFF | 1 | 0
*RST: OFF

Example:

```
//Turn on RF output
CONF:GEN:CONT ON
CONF:GEN:RFO ON
```

Manual operation: See "[RF Output State](#)" on page 139

CONF:GEN:CONTROL[:STATE] <State>

Turns control over the signal generator on and off.

Prerequisites for this command

- IP connection to a signal generator.

Parameters:

<State> ON | OFF | 1 | 0
*RST: OFF

Example:

```
//Turn on generator control
CONF:GEN:CONT ON
```

Manual operation: See "[Generator Control State](#)" on page 138

CONF:GEN:SETTINGS:UPDATE:RF

Uploads the RF settings (frequency, level) from analyzer to the generator.

Prerequisites for this command

- IP connection to a signal generator.
- Generator control state is on (`CONF:GEN:CONTROL[:STATE]`).

Example:

```
//Upload RF settings
CONF:GEN:CONT ON
CONF:GEN:SETT:UPD:RF
```

Usage:

Event

Manual operation: See "[Upload RF Settings to Generator](#)" on page 140

6.9.22 Input configuration

Remote commands to configure the input described elsewhere:

- `INPut<ip>:COUPling` on page 414

- [INPut<ip>:IMPedance](#) on page 415

INPut:FILE:PATH	408
INPut<ip>:FILTer:YIG[:STATe]	409
INPut<ip>:SELEct	409
MMEMory:LOAD:IQ:STReam	409
MMEMory:LOAD:IQ:STReam:AUTO	410
MMEMory:LOAD:IQ:STReam:LIST?	410
TRACe:IQ:FILE:REPetition:COUNT	410

INPut:FILE:PATH <FileName>[, <AnalysisBW>]

Selects the I/Q data file to be used as input for further measurements.

The I/Q data file must be in one of the following supported formats:

- .iq.tar
- .iqw
- .csv
- .mat
- .wv
- .aid

Only a single data stream or channel can be used as input, even if multiple streams or channels are stored in the file.

For some file formats that do not provide the sample rate and measurement time or record length, you must define these parameters manually. Otherwise the traces are not visible in the result displays.

Parameters:

<FileName>	String containing the path and name of the source file. The file extension is *.iq.tar.
<AnalysisBW>	Optionally: The analysis bandwidth to be used by the measurement. The bandwidth must be smaller than or equal to the bandwidth of the data that was stored in the file. Default unit: HZ

Example: `INP:FILE:PATH 'C:\R_S\Instr\user\data.iq.tar'`
Uses I/Q data from the specified file as input.

Example:

```
//Load an IQW file
INP:SEL:FIQ
INP:FILE:PATH 'C:\R_S\Instr\user\data.iqw'
//Define the sample rate
TRAC:IQ:SRAT 10MHz
//Define the measurement time
SENSE:SWEp:TIME 0.001001
//Start the measurement
INIT:IMM
```

Manual operation: See "[Select I/Q data file](#)" on page 142
See "[Data import and export](#)" on page 194

INPut<ip>:FILTer:YIG[:STATe] <State>

Enables or disables the YIG filter.

Suffix:

<ip> 1 | 2
 irrelevant

Parameters:

<State> ON | OFF | 0 | 1

Example:

```
INP:FILT:YIG OFF
Deactivates the YIG-preselector.
```

Manual operation: See "[YIG-Preselector](#)" on page 141

INPut<ip>:SELEct <Source>

Selects the signal source for measurements, i.e. it defines which connector is used to input data to the R&S FSV/A.

If no additional input options are installed, only RF input or file input is supported.

Suffix:

<ip> 1 | 2
 irrelevant

Parameters:

<Source> **RF**
 Radio Frequency ("RF INPUT" connector)
FIQ
 I/Q data file
 (selected by [INPut:FILE:PATH](#) on page 408)
***RST:** RF

Manual operation: See "[I/Q Input File State](#)" on page 142

MMEMory:LOAD:IQ:STReam <Channel>

Only available for files that contain more than one data stream from multiple channels: selects the data stream to be used as input for the currently selected channel.

Automatic mode ([MMEMory:LOAD:IQ:STReam:AUTO](#)) is set to OFF.

Parameters:

<Channel> String containing the channel name.

Example:

```
MMEM:LOAD:IQ:STR?
//Result: 'Channel1','Channel2'
MMEM:LOAD:IQ:STR 'Channel2'
```

Manual operation: See "[Selected Channel](#)" on page 142

MMEMory:LOAD:IQ:STReam:AUTO <State>

Only available for files that contain more than one data stream from multiple channels: automatically defines which data stream in the file is used as input for the channel.

Parameters:

<State> ON | OFF | 0 | 1

OFF | 0

The data stream specified by `MMEMory:LOAD:IQ:STReam` is used as input for the channel.

ON | 1

The first data stream in the file is used as input for the channel. Applications that support multiple data streams use the first data stream in the file for the first input stream, the second for the second stream etc.

*RST: 1

Manual operation: See "[Selected Channel](#)" on page 142

MMEMory:LOAD:IQ:STReam:LIST?

Returns the available channels in the currently loaded input file.

Example: `MMEM:LOAD:IQ:STR?`
//Result: 'Channel1', 'Channel2'

Usage: Query only

Manual operation: See "[Selected Channel](#)" on page 142

TRACe:IQ:FILE:REPetition:COUNT <RepetitionCount>

Determines how often the data stream is repeatedly copied in the I/Q data memory. If the available memory is not sufficient for the specified number of repetitions, the largest possible number of complete data streams is used.

Parameters:

<RepetitionCount> integer

Example: `TRAC:IQ:FILE:REP:COUN 3`

Manual operation: See "[File Repetitions](#)" on page 142

6.9.23 Frequency configuration

[SENSe:]FREQuency:CENTer[:CC<cc>]	411
[SENSe:]FREQuency:CENTer[:CC<cc>]:OFFSet	411
[SENSe:]FREQuency:CENTer:STEP	412

[SENSe:]FREQuency:CENTer[:CC<cc>] <Frequency>

Sets the center frequency for RF measurements.

Component carrier measurements

- Defining or querying the frequency of the first carrier is possible with `FREQ:CENT:CC1`. The `CC1` part of the syntax is mandatory in that case.
- `FREQ:CENT?` queries the measurement frequency (center of the two carriers).

Suffix:

<cc> [Component Carrier](#)

Parameters:

<Frequency> <numeric value>
 Range: fmin to fmax
 *RST: 1 GHz
 Default unit: Hz

Example: //Define frequency for measurement on one carrier:
`FREQ:CENT 1GHZ`

Example: //Define frequency for measurement on aggregated carriers:
`FREQ:CENT:CC1 850MHZ`

Manual operation: See "[Frequency configuration](#)" on page 79
 See "[Center Frequency](#)" on page 139
 See "[Center Frequency](#)" on page 143

[SENSe:]FREQuency:CENTer[:CC<cc>]:OFFSet <Offset>

Defines the general frequency offset.

For measurements on multiple component carriers, the command defines the frequency offset for a component carrier. The effect of the command depends on the syntax:

- When you omit the `[CC<cc>]` syntax element, the command defines the overall frequency offset.
 In that case, the value is added to the measurement frequency and, in case of measurements with component carriers, the center frequency of the component carriers.
- When you include the `[CC<cc>]` syntax element, the command defines the offset of the component carrier relative the first component carrier.
 In that case, the command is not available for the first component carrier - thus, `...:CC1:...` is not possible.

Prerequisites for this command

- Select the first component carrier (CC1) as the reference point for the frequency offset (`CONFigure[:NR5G]:OREL`).

Suffix:

<cc> [Component Carrier](#)

Parameters:

<Offset> <numeric value>

- General frequency offset: frequency offset in Hz.
- Component carrier offset: frequency offset relative to the first component carrier in Hz.

Default unit: Hz

Example: //Add a frequency offset of 50 Hz to the measurement frequency.
//If you are measuring component carriers, the value is also added to the center frequencies of those carriers.
FREQ:CENT:OFFS 50HZ

Example: //Define a frequency offset of 15 MHz for the second component carrier relative to the first component carrier.
CONF:OREL CC1
FREQ:CENT:CC2:OFFS 15MHZ

Manual operation: See "[Frequency configuration](#)" on page 79
See "[Center Frequency](#)" on page 143

[SENSe:]FREQuency:CENTer:STEP <StepSize>

Defines the center frequency step size.

Parameters:

<StepSize> f_{\max} is specified in the data sheet.
Range: 1 to fMAX
*RST: 0.1 x span
Default unit: Hz

Example: //Set the center frequency to 110 MHz.
FREQ:CENT 100 MHz
FREQ:CENT:STEP 10 MHz
FREQ:CENT UP

Manual operation: See "[Frequency Stepsize](#)" on page 143

6.9.24 Amplitude configuration

DISPlay[:]WINDow<n>[:]SUBWindow<w>[:]TRACe<t>:Y[:]SCALE[:]RLEVel.....	413
DISPlay[:]WINDow<n>[:]SUBWindow<w>[:]TRACe<t>:Y[:]SCALE[:]RLEVel:OFFSet.....	413
INPut<ip>:ATTenuation<ant>.....	413
INPut<ip>:ATTenuation<ant>:AUTO.....	414
INPut<ip>:COUPling.....	414
INPut<ip>:GAIN:STATe.....	415
INPut<ip>:GAIN[:]VALue]......	415
INPut<ip>:IMPedance.....	415
INPut<ip>:EATT<ant>.....	416
INPut<ip>:EATT<ant>:AUTO.....	416
INPut<ip>:EATT<ant>:STATe.....	416

DISPlay[:WINDow<n>][:SUBWindow<w>]:TRACe<t>:Y[:SCALe]:RLEVel
 <ReferenceLevel>

Defines the reference level (for all traces in all windows).

With a reference level offset $\neq 0$, the value range of the reference level is modified by the offset.

Suffix:

<n>	irrelevant
<w>	subwindow Not supported by all applications
<t>	irrelevant

Parameters:

<ReferenceLevel>	The unit is variable. Range: see datasheet *RST: 0 dBm Default unit: DBM
------------------	---

Example: DISP:TRAC:Y:RLEV -60dBm

Manual operation: See "[Reference Level](#)" on page 144

DISPlay[:WINDow<n>][:SUBWindow<w>]:TRACe<t>:Y[:SCALe]:RLEVel:OFFSet
 <Offset>

Defines a reference level offset (for all traces in all windows).

Suffix:

<n>	irrelevant
<w>	subwindow Not supported by all applications
<t>	irrelevant

Parameters:

<Offset>	Range: -200 dB to 200 dB *RST: 0dB Default unit: DB
----------	---

Example: DISP:TRAC:Y:RLEV:OFFS -10dB

Manual operation: See "[Reference Level Offset](#)" on page 145

INPut<ip>:ATTenuation<ant> <Attenuation>

Defines the RF attenuation level.

Prerequisites for this command

- Decouple attenuation from reference level (INPut<ip>:ATTenuation<ant>: [AUTO](#)).

Suffix:

<ip> irrelevant

<ant> irrelevant

Parameters:

<Attenuation> *RST: 10 dB
Default unit: dB

Example: //Define RF attenuation
INP:ATT:AUTO OFF
INP:ATT 10

Manual operation: See "[RF Attenuation](#)" on page 145

INPut<ip>:ATTenuation<ant>:AUTO <State>

Couples and decouples the RF attenuation to the reference level.

Suffix:

<ip> irrelevant

<ant> irrelevant

Parameters:

<State> ON | OFF | 1 | 0
*RST: ON

Example: //Couple attenuation to reference level (auto attenuation)
INP:ATT:AUTO ON

Manual operation: See "[RF Attenuation](#)" on page 145

INPut<ip>:COUPling <CouplingType>

Selects the coupling type of the RF input.

If an external frontend is active, the coupling is automatically set to AC.

Suffix:

<ip> 1 | 2
irrelevant

Parameters:

<CouplingType> AC | DC
AC
AC coupling
DC
DC coupling
*RST: AC

Example: INP:COUP DC

Manual operation: See "[Input Coupling](#)" on page 147

INPut<ip>:GAIN:STATe <State>

Turns the internal preamplifier on and off. It requires the optional preamplifier hardware.

For R&S FSV/A44 or higher models, note the restrictions described in "[Preamplifier](#)" on page 146.

Suffix:

<ip> 1 | 2
irrelevant

Parameters:

<State> ON | OFF | 0 | 1
OFF | 0
Switches the function off
ON | 1
Switches the function on
*RST: 0

Example: INP:GAIN:STAT ON
INP:GAIN:VAL 15
Switches on 15 dB preamplification.

Manual operation: See "[Preamplifier](#)" on page 146

INPut<ip>:GAIN[:VALue] <Gain>

Selects the "gain" if the preamplifier is activated (INP:GAIN:STAT ON, see [INPut<ip>:GAIN:STATe](#) on page 415).

The command requires the additional preamplifier hardware option.

Suffix:

<ip> 1 | 2
irrelevant

Example: INP:GAIN:STAT ON
INP:GAIN:VAL 30
Switches on 30 dB preamplification.

Manual operation: See "[Preamplifier](#)" on page 146

INPut<ip>:IMPedance <Impedance>

Selects the nominal input impedance of the RF input. In some applications, only 50 Ω are supported.

Suffix:

<ip> 1 | 2
irrelevant

Parameters:

<Impedance> 50 | 75
 *RST: 50 Ω
 Default unit: OHM

Example: INP:IMP 75

Manual operation: See "[Impedance](#)" on page 147

INPut<ip>:EATT<ant> <Attenuation>

Defines the electronic attenuation level.

If the current reference level is not compatible with an attenuation that has been set manually, the command also adjusts the reference level.

Suffix:

<ip> irrelevant
 <ant> Connected instrument

Parameters:

<Attenuation> Attenuation level in dB.
 Default unit: dB

Example: //Define signal attenuation
 INP:EATT 10

Manual operation: See "[Electronic Attenuation](#)" on page 146

INPut<ip>:EATT<ant>:AUTO <State>

Turns automatic selection of the electronic attenuation on and off.

If on, electronic attenuation reduces the mechanical attenuation whenever possible.

Suffix:

<ip> irrelevant
 <ant> 1...4
 Connected instrument

Parameters:

<State> ON | OFF | 1 | 0
 *RST: OFF

Example: //Turn on automatic selection of electronic attenuation
 INP:EATT:AUTO ON

Manual operation: See "[Electronic Attenuation](#)" on page 146

INPut<ip>:EATT<ant>:STATe <State>

Turns the electronic attenuator on and off.

Suffix:	
<ip>	irrelevant
<ant>	1...4 Connected instrument
Parameters:	
<State>	ON OFF *RST: OFF
Example:	//Turn on electronic attenuation INP:EATT:STAT ON
Manual operation:	See " Electronic Attenuation " on page 146

6.9.25 Data capture

[SENSe:]NR5G:FRAMe:COUNt.....	417
[SENSe:]NR5G:FRAMe:COUNt:AUTO.....	418
[SENSe:]NR5G:FRAMe:COUNt:STATe.....	418
[SENSe:]NR5G:FRAMe:SLOT.....	418
[SENSe:]NR5G:FRAMe:SRSLot.....	418
[SENSe:]SWAPiq.....	419
[SENSe:]SWEep:CTMode.....	419
[SENSe:]SWEep:LCAPture.....	419
[SENSe:]SWEep:TIME.....	420
TRACe:IQ:SRATe?.....	420

[SENSe:]NR5G:FRAMe:COUNt <Frames>

Defines the number of frames to analyze.

Prerequisites for this command

- Turn on overall frame count ([SENSe:]NR5G:FRAMe:COUNt:STATe on page 418).
If the overall frame count is off, this command is a query only.

Parameters:

<Frames>	<numeric value> (integer only)
*RST:	1

Example: //Define number of frames to analyze manually
NR5G:FRAM:COUN:STAT ON
NR5G:FRAM:COUN 10

Manual operation: See "[Number of Frames to Analyze](#)" on page 151

[SENSe:]NR5G:FRAMe:COUNT:AUTO <State>

Turns automatic selection of the number of frames to analyze on and off.

Parameters:

<State> **ON | 1**
 Selects the analyzed number of frames as specified by 3GPP.

OFF | 0
 Turns on manual selection of the number of frames.

Example: //Turn on automatic selection of analyzed frames
 NR5G:FRAM:COUN:AUTO ON

Manual operation: See "[Auto According to Standard](#)" on page 151

[SENSe:]NR5G:FRAMe:COUNT:STATe <State>

Turns manual definition of number of frames to analyze on and off.

Parameters:

<State> **OFF | 0**
 The R&S FSV/A analyzes all frames in the capture buffer.

ON | 1
 Define the number of frames to analyze with [\[SENSe:\]NR5G:FRAMe:COUNT](#).

*RST: ON

Example: //Turn on overall frame count.
 NR5G:FRAM:COUN:STAT ON

Manual operation: See "[Overall Frame Count](#)" on page 151

[SENSe:]NR5G:FRAMe:SLOT <Slots>

Defines the number of slots that are analyzed.

Parameters:

<Slots> **ALL**
 Analyzes all slots in a frame.

<numeric value> (integer only)
 Analyzes a certain number of slots in a frame.

*RST: ALL

Example: //Analyze all slots in a frame
 NR5G:FRAM:SLOT ALL

Manual operation: See "[Maximum Number of Slots per Frame to Analyze](#)" on page 151

[SENSe:]NR5G:FRAMe:SRSLot <State>

Turns analysis of custom signals with repeating slots on and off.

Parameters:

<State> ON | OFF | 1 | 0
 *RST: OFF

Example:

```
//Turn on repeated slot analysis
NR5G:FRAM:SRSL ON
```

Manual operation: See ["Signal Repeats Max No of Slots to Analyze"](#) on page 152

[SENSe:]SWAPiq <State>

Turns a swap of the I and Q branches on and off.

Parameters:

<State> ON | OFF | 1 | 0
 *RST: OFF

Example:

```
//Swap I and Q branches
SWAP ON
```

Manual operation: See ["Swap I/Q"](#) on page 151

[SENSe:]SWEep:CTMode <Mode>

Selects the capture mode.

Prerequisites for this command

- Select FR2-2 ([CONFigure \[:NR5G\]:DL\[:CC<cc>\]:DFRange](#)).

Parameters:

<Mode> **AUTO**
 Automatic determination of the capture time.
MANual
 Manual definition of the capture time.
 Define the capture time with [\[SENSe:\]SWEep:TIME](#).

Example:

```
//Select capture time mode
CONF:DL:DFR EHIG
SWE:CTM AUTO
```

Manual operation: See ["Capture Time"](#) on page 150

[SENSe:]SWEep:LCAPture <State>

Turns the long capture on and off.

Prerequisites for this command

- Number of component carriers must be "1" ([CONFigure \[:NR5G\]:NOCC](#)).
- Multi frame configuration is not supported. Every frame must have the same configuration.

Effects of this command

- Frame count functions become unavailable:
`[SENSe:]NR5G:FRAME:COUNT`
`[SENSe:]NR5G:FRAME:COUNT:AUTO`
- `[SENSe:]NR5G:FRAME:COUNT:STATE`

Parameters:

<State> ON | OFF | 1 | 0
 *RST: OFF

Example: //Turn on long capture
`SWE:LCAP ON`

Manual operation: See "Long Capture" on page 150

`[SENSe:]SWEep:TIME <CaptureLength>`

Defines the capture time.

Parameters:

<CaptureLength> <numeric value>
 *RST: 20.1 ms
 Default unit: s

Example: //Define capture time
`SWE:TIME 40ms`

Manual operation: See "Capture Time" on page 150

`TRACe:IQ:SRATe?`

Queries the capture sampling rate.

Return values:

<SamplingRate> <numeric value> (integer only)

Example: //Query sample rate
`TRAC:IQ:SRAT?`

Usage: Query only

6.9.26 Trigger

<code>TRIGger[:SEQuence]:DTIME</code>	421
<code>TRIGger[:SEQuence]:HOLDoff<ant>[:TIME]</code>	421
<code>TRIGger[:SEQuence]:IFPower:HOLDoff</code>	421
<code>TRIGger[:SEQuence]:IFPower:HYSTeresis</code>	422
<code>TRIGger[:SEQuence]:LEVel<ant>[:EXTernal<tp>]</code>	422
<code>TRIGger[:SEQuence]:LEVel<ant>:IFPower</code>	422
<code>TRIGger[:SEQuence]:LEVel<ant>:IQPower</code>	423
<code>TRIGger[:SEQuence]:LEVel<ant>:RFPower</code>	423

TRIGger[:SEQuence]:PORT<ant>.....	424
TRIGger[:SEQuence]:SLOPe.....	424
TRIGger[:SEQuence]:SOURce<ant>.....	424

TRIGger[:SEQuence]:DTIME <DropoutTime>

Defines the time the input signal must stay below the trigger level before a trigger is detected again.

Parameters:

<DropoutTime> Dropout time of the trigger.
 Range: 0 s to 10.0 s
 *RST: 0 s
 Default unit: S

Manual operation: See "[Trigger Source](#)" on page 148

TRIGger[:SEQuence]:HOLDoff<ant>[:TIME] <Offset>

Defines the trigger offset.

Suffix:

<ant> [Instrument](#)

Parameters:

<Offset> <numeric value>
 *RST: 0 s
 Default unit: s

Example: //Define trigger offset
 TRIG:HOLD 5MS

Manual operation: See "[Trigger Source](#)" on page 148

TRIGger[:SEQuence]:IFPower:HOLDoff <Period>

Defines the holding time before the next trigger event.

Note that this command can be used for **any trigger source**, not just IF Power (despite the legacy keyword).

Parameters:

<Period> Range: 0 s to 10 s
 *RST: 0 s
 Default unit: S

Example: TRIG:SOUR EXT
 Sets an external trigger source.
 TRIG:IFP:HOLD 200 ns
 Sets the holding time to 200 ns.

Manual operation: See "[Trigger Source](#)" on page 148

TRIGger[:SEQuence]:IFPower:HYSTeresis <Hysteresis>

Defines the trigger hysteresis, which is only available for "IF Power" trigger sources.

Parameters:

<Hysteresis> Range: 3 dB to 50 dB
 *RST: 3 dB
 Default unit: DB

Example:

```
TRIG:SOUR IFP
Sets the IF power trigger source.
TRIG:IFP:HYST 10DB
Sets the hysteresis limit value.
```

Manual operation: See "[Trigger Source](#)" on page 148

TRIGger[:SEQuence]:LEVel<ant>[:EXTeRnal<tp>] <Level>

Defines the level for an external trigger.

Suffix:

<ant> [Instrument](#)
<tp> [Trigger port](#)

Parameters:

<Level> Range: 0.5 V to 3.5 V
 *RST: 1.4 V
 Default unit: V

Example:

```
//Define trigger level
TRIG:LEV 2V
```

Manual operation: See "[Trigger Source](#)" on page 148

TRIGger[:SEQuence]:LEVel<ant>:IFPower <Level>

Defines the power level at the third intermediate frequency that must be exceeded to cause a trigger event.

Note that any RF attenuation or preamplification is considered when the trigger level is analyzed. If defined, a reference level offset is also considered.

Suffix:

<ant> [Instrument](#)

Parameters:

<Level> <numeric value>

For details on available trigger levels and trigger bandwidths see the data sheet.

*RST: -10 dBm
Default unit: dBm

Example: //Define trigger level
 TRIG:SOUR IFP
 TRIG:LEV:IFP -30dBm

Manual operation: See "[Trigger Source](#)" on page 148

TRIGger[:SEQuence]:LEVel<ant>:IQPower <Level>

Defines the magnitude the I/Q data must exceed to cause a trigger event.

Note that any RF attenuation or preamplification is considered when the trigger level is analyzed. If defined, a reference level offset is also considered.

Suffix:
 <ant> [Instrument](#)

Parameters:
 <Level> <numeric value>
 Range: -130 dBm to 30 dBm
 *RST: -20 dBm
 Default unit: dBm

Example: //Define trigger level
 TRIG:SOUR IQP
 TRIG:LEV:IQP -30dBm

Manual operation: See "[Trigger Source](#)" on page 148

TRIGger[:SEQuence]:LEVel<ant>:RFPower <Level>

Defines the power level the RF input must exceed to cause a trigger event. Note that any RF attenuation or preamplification is considered when the trigger level is analyzed. If defined, a reference level offset is also considered.

The input signal must be between 500 MHz and 8 GHz.

Suffix:
 <ant> [Instrument](#)

Parameters:
 <Level> <numeric value>
 For details on available trigger levels and trigger bandwidths see the data sheet.
 *RST: -20 dBm
 Default unit: dBm

Example: //Define trigger level
 TRIG:SOUR RFP
 TRIG:LEV:RFP -30dBm

Manual operation: See "[Trigger Source](#)" on page 148

TRIGger[:SEQuence]:PORT<ant> <port>

Selects the trigger port for measurements with devices that have several trigger ports.

Suffix:

<ant> [Analyzer](#)

Parameters:

<port> **PORT1**
PORT2
PORT3

Example: //Select trigger port 1
TRIG:PORT PORT1

TRIGger[:SEQuence]:SLOPe <Type>

Selects the trigger slope.

Parameters:

<Type> POSitive | NEGative

POSitive

Triggers when the signal rises to the trigger level (rising edge).

NEGative

Triggers when the signal drops to the trigger level (falling edge).

*RST: POSitive

Example: TRIG:SLOP NEG

Manual operation: See "[Trigger Source](#)" on page 148

TRIGger[:SEQuence]:SOURce<ant> <Source>

Selects the trigger source.

Note on external triggers:

If a measurement is configured to wait for an external trigger signal in a remote control program, remote control is blocked until the trigger is received and the program can continue. Make sure this situation is avoided in your remote control programs.

Suffix:

<ant> [Analyzer](#)

Parameters:

<Source> **IMMediate**
Free run (no trigger event to start a measurement).

EXTernal

Measurement starts when the external trigger signal exceeds a certain level.

Trigger signal from the "Trigger Input/Output" connector.

Note: Connector must be configured for "Input".

EXT2

Trigger signal from the "Trigger Input / Output" connector.
Note: Connector must be configured for "Input".

RFPower

Measurement starts when the first intermediate frequency exceeds a certain level.
(Frequency and time domain measurements only.)

IFPower

Measurement starts when the second intermediate frequency exceeds a certain level.

IQPower

Measurement starts when the sampled I/Q data exceeds a certain magnitude.
For applications that process I/Q data, such as the I/Q analyzer or optional applications.

PSEN

External power sensor

*RST: IMMEDIATE

Manual operation: See "Trigger Source" on page 148

6.9.27 Tracking

[SENSe:]NR5G:DEMod:CESTimation.....	425
[SENSe:]NR5G:DEMod:CETaverage.....	426
[SENSe:]NR5G:IQ:GIQE.....	426
[SENSe:]NR5G:TRACking:LEVel.....	426
[SENSe:]NR5G:TRACking:PHASe.....	426
[SENSe:]NR5G:TRACking:TIME.....	427
[SENSe:]NR5G:TRACking:TPUT:STATe.....	427

[SENSe:]NR5G:DEMod:CESTimation <State>

Selects the channel estimation method.

Parameters:

<State>

LINT

Channel estimation by interpolating the missing information.

NORMal

Channel estimation according to 3GPP.

OFF

Turns off channel estimation.

PILPay

Channel estimation by examining both the reference signal and the payload resource elements.

Example:

```
//Select channel estimation method
NR5G:DEM:CEST PILP
```

Manual operation: See ["Channel Estimation"](#) on page 153

[SENSe:]NR5G:DEMod:CETaverage <State>

Select the averaging interval for channel estimation.

Parameters:

<State> **PALL**
 Averaging every allocation.

TGPP
 Averaging according to 3GPP.

*RST: TGPP

Example: //Select time averaging
 NR5G:DEMod:CET PALL

Manual operation: See ["Channel Estimation Time Averaging"](#) on page 154

[SENSe:]NR5G:IQ:GIQE <State>

Turns the calculation of the gain imbalance and the quadrature error in the result summary on and off.

Parameters:

<State> ON | OFF | 1 | 0

*RST: ON

Example: //Turn off calculation of results
 NR5G:IQ:GIQE OFF

Manual operation: See ["Gain Imbalance / Quadrature Error"](#) on page 155

[SENSe:]NR5G:TRACking:LEVeI <State>

Turns level tracking on and off.

Parameters:

<State> ON | OFF | 0 | 1

*RST: OFF

Example: //Turn on level tracking
 TRAC:LEV ON

Manual operation: See ["Level Tracking"](#) on page 155

[SENSe:]NR5G:TRACking:PHASe <State>

Turns phase tracking on and off.

Parameters:

<State> **OFF**
 Deactivate phase tracking

PIL

Pilot only

PILPAY

Pilot and payload

TGPP

3GPP EVM

*RST: OFF

Example: //Use pilots and payload for channel estimation
SENS:TRAC:PHAS PILPAY

Manual operation: See "Phase" on page 154

[SENSe:]NR5G:TRACking:TIME <State>

Turns time tracking on and off.

Parameters:

<State> ON | OFF | 1 | 0
*RST: OFF

Example: //Turn on time tracking
NR5G:TRAC:TIME ON

Manual operation: See "Time Tracking" on page 154

[SENSe:]NR5G:TRACking:TPUT:STATe <State>

Turns the throuput measurement on and off.

Effects of this command

- Number of analyzed frames is set to manual ([SENSe:]NR5G:FRAME:COUNT: AUTO).

Parameters:

<State> ON | OFF | 1 | 0
*RST: OFF

Example: //Turn on throughput measurement
NR5G:TRAC:TPUT:STAT ON

Manual operation: See "Throughput Measurement State" on page 155

6.9.28 Demodulation

[SENSe:]NR5G:DEMod:CAMode.....	428
[SENSe:]NR5G:DEMod:CMETHod.....	428
[SENSe:]NR5G:DEMod:CRData.....	428
[SENSe:]NR5G:DEMod:DDATa.....	429
[SENSe:]NR5G:DEMod:EFLRange.....	429

[SENSe:]NR5G:DEMod:FILTER.....	430
[SENSe:]NR5G:DEMod:PRData.....	430
[SENSe:]NR5G:DEMod:STADjust.....	430

[SENSe:]NR5G:DEMod:CAMode <Mode>

Selects the CORESET analysis mode.

Parameters:

<Mode>	AUTO Automatic demodulation of the PDCCH.
	MANual Demodulation based on the PDCCH configuration.
	*RST: AUTO

Example: //Select PDCCH demodulation mode
NR5G:DEM:CAM MAN

Manual operation: See "[CORESET Analysis Mode](#)" on page 156

[SENSe:]NR5G:DEMod:CMETHOD <State>

Selects the EVM calculation method.

Parameters:

<State>	HPOS EVM at high timing position
	LPOS EVM at low timing position
	OTP EVM at optimal timing position
	TGPP EVM according to 3GPP definition
	*RST: TGPP

Example: //Select EVM calculation method
NR5G:DEM:CMET TGPP

Manual operation: See "[EVM Calculation Method](#)" on page 157

[SENSe:]NR5G:DEMod:CRData <Reference>

Selects the CORESET reference data.

Parameters:

<Reference>	AUTO Automatic detection of reference values.
	ALLO CORESET consists of 0's only.

PASLots

CORESET based on NR-TM PN23 (pseudo random sequence 23) with all PDCCH having the same sequence.

If an ORAN test case is selected ([CONFigure\[:NR5G\]:ORAN:TCASe](#)), this parameter selects the ORAN PN23 sequence for all PDCCH.

PN23

CORESET based on NR-TM PN23 (pseudo random sequence 23).

*RST: AUTO

Example: //Select CORESET reference data
NR5G:DEM:CRD ALL0

Manual operation: See "[CORESET Reference Data](#)" on page 158

[SENSe:]NR5G:DEMod:DDATa <State>

Selects the point at which the data is demodulated for the bitstream.

Parameters:

<State>

ADEScramble

Demodulates the descrambled data.

BDEScramble

Demodulates the scrambled data.

DPData

Demodulates the decoded data.

*RST: BDEScramble

Example: //Demodulate decoded data
NR5G:DEM:DDAT DPD

Manual operation: See "[Demodulation Data](#)" on page 156

[SENSe:]NR5G:DEMod:EFLRange <State>

Turns the extended frequency lock range on and off.

Parameters:

<State>

ON | OFF | 1 | 0

*RST: OFF

Example: Turn on extended frequency lock range
NR5G:DEM:EFLR ON

Manual operation: See "[Extended Frequency Lock Range](#)" on page 158

[SENSe:]NR5G:DEMod:FILTer <Filter>

Selects the filter for suppression of neighboring channels.

Parameters:

<Filter>

MFILter
Multicarrier filter.

NONE
No filter.

PBWP
Bandwidthpart filter.

*RST: NONE

Example: //Select multicarrier filter
NR5G:DEMod:FILT MFIL

Manual operation: See "[Filter](#)" on page 156

[SENSe:]NR5G:DEMod:PRData <Reference>

Selects the PDSCH reference data.

Note that when you select an ORAN test case, this setting is automatically adjusted to the ORAN test case.

Parameters:

<Reference>

AUTO
Automatic detection of reference values.

ALLO
PDSCH consists of 0's only.

PASLots
PDSCH based on NR-TM PN23 (pseudo random sequence 23) with all PDSCH having the same sequence.
If an ORAN test case is selected ([CONFigure\[:NR5G\]:ORAN:TCASe](#)), this parameter selects the ORAN PN23 sequence for all PDSCH.

PN23
PDSCH based on NR-TM PN23 (pseudo random sequence 23) with each PDSCH getting its own sequence.
If an ORAN test case is selected ([CONFigure\[:NR5G\]:ORAN:TCASe](#)), this parameter selects the ORAN PN23 sequence.

*RST: AUTO

Example: //Select PDSCH reference data
NR5G:DEMod:PRD AUTO

Manual operation: See "[PDSCH Reference Data](#)" on page 157

[SENSe:]NR5G:DEMod:STADjust <Value>

Defines the symbol time adjustment.

Parameters:

<Value> Range: 0 to 100
 *RST: 50
 Default unit: PCT

Example:

//Define symbol time adjustment
 NR5G:DEM:STAD 75

Manual operation: See "[Symbol Time Adjustment](#)" on page 157

6.9.29 Time alignment measurement

Commands to configure time alignment measurements described elsewhere.

- General configuration: [Chapter 6.9.1, "General configuration"](#), on page 295
- Physical settings: [Chapter 6.9.3, "Physical settings"](#), on page 302
(Component carrier are not supported in the time alignment measurement.)
- Radio frame configuration: [Chapter 6.9.5, "General radio frame configuration"](#), on page 311
- Synchronization signal: [Chapter 6.9.6, "Synchronization signal configuration"](#), on page 312
- Bandwidth parts: [Chapter 6.9.7, "Bandwidth part configuration"](#), on page 319
- Slot configuration: [Chapter 6.9.8, "Slot configuration"](#), on page 323
- PDSCH allocations: [Chapter 6.9.12, "PDSCH allocation configuration"](#), on page 349
(Only one PDSCH allocation is supported in the time alignment measurement.)
- PDSCH DMRS: [Chapter 6.9.14, "Enhanced PDSCH settings: DMRS"](#), on page 373
- Advanced signal configuration: [Chapter 6.9.18, "Advanced settings: global"](#), on page 392
- Input: [Chapter 6.9.22, "Input configuration"](#), on page 407
- Frequency: [Chapter 6.9.23, "Frequency configuration"](#), on page 410
- Amplitude: [Chapter 6.9.24, "Amplitude configuration"](#), on page 412
- Data capture: [Chapter 6.9.25, "Data capture"](#), on page 417
- Trigger: [Chapter 6.9.26, "Trigger"](#), on page 420
- Demodulation: [Chapter 6.9.28, "Demodulation"](#), on page 427
- Automatic configuration: [Chapter 6.9.2, "Automatic configuration"](#), on page 297

6.9.30 Transmit on/off power measurements

Commands to configure time alignment measurements described elsewhere.

- General configuration: [Chapter 6.9.1, "General configuration"](#), on page 295
- Physical settings: [Chapter 6.9.3, "Physical settings"](#), on page 302
(Component carrier are not supported in the time alignment measurement.)
- Radio frame configuration: [Chapter 6.9.5, "General radio frame configuration"](#), on page 311

- Synchronization signal: [Chapter 6.9.6, "Synchronization signal configuration"](#), on page 312
- Bandwidth parts: [Chapter 6.9.7, "Bandwidth part configuration"](#), on page 319
- Slot configuration: [Chapter 6.9.8, "Slot configuration"](#), on page 323
- PDSCH / CORESET allocations: [Chapter 6.9.12, "PDSCH allocation configuration"](#), on page 349
- CORESET DMRS: [Chapter 6.9.13, "Enhanced CORESET allocation configuration"](#), on page 357
- PDSCH DMRS: [Chapter 6.9.14, "Enhanced PDSCH settings: DMRS"](#), on page 373
- PTRS: [Chapter 6.9.15, "Enhanced PDSCH settings: PTRS"](#), on page 383
- Scrambling / Coding: [Chapter 6.9.16, "Enhanced PDSCH settings: scrambling / coding"](#), on page 386
- Advanced signal configuration: [Chapter 6.9.18, "Advanced settings: global"](#), on page 392
- Input: [Chapter 6.9.22, "Input configuration"](#), on page 407
- Frequency: [Chapter 6.9.23, "Frequency configuration"](#), on page 410
- Amplitude: [Chapter 6.9.24, "Amplitude configuration"](#), on page 412
- Data capture: [Chapter 6.9.25, "Data capture"](#), on page 417
- Trigger: [Chapter 6.9.26, "Trigger"](#), on page 420
- Demodulation: [Chapter 6.9.28, "Demodulation"](#), on page 427
- Automatic configuration: [Chapter 6.9.2, "Automatic configuration"](#), on page 297

CONFigure[:NR5G]:DL[:CC<cc>]:PLC:EIRP	432
CONFigure[:NR5G]:DL[:CC<cc>]:PLC:TRP	433
CONFigure[:NR5G]:OOPower:NFRames	433
DISPlay[:WINDow<n>]:TPOO:PERiod:SElect	433
[SENSe:]NR5G:OOPower:ATIMing	433
[SENSe:]NR5G:OOPower:NCORrection	434
UNIT:OPOWer	434

CONFigure[:NR5G]:DL[:CC<cc>]:PLC:EIRP <Power>

Defines the base station output power for limit selection ($P_{\text{rated}, C}$, EIRP).

Prerequisites for this command

- Select FR2 deployment ([CONFigure\[:NR5G\]:DL\[:CC<cc>\]:DFRange](#)).

Suffix:

<cc> [Component Carrier](#)

Parameters:

<Power> Default unit: dBm

Example:

```
//Define output power
CONF:DL:DFR HIGH
CONF:DL:PLC:EIRP 0.5
```

CONFigure[:NR5G]:DL[:CC<cc>]:PLC:TRP <Power>

Defines the base station output power for limit selection (P_{rated} , c, TRP).

Prerequisites for this command

- Select FR2 deployment ([CONFigure\[:NR5G\]:DL\[:CC<cc>\]:DFRange](#)).

Suffix:

<cc> [Component Carrier](#)

Parameters:

<Power> Default unit: dBm

Example:

```
//Define output power
CONF:DL:DFR HIGH
CONF:DL:PLC:TRP 0.5
```

CONFigure[:NR5G]:OOPower:NFRames <Frames>

Defines the number of frames to analyze in on / off power measurements.

Parameters:

<Frames> *RST: 25

Example:

```
//Define number of frames to analyze
CONF:OOP:NFR 20
```

Manual operation: See ["Number of Frames to Analyze"](#) on page 151

DISPlay[:WINDow<n>]:TPOO:PERiod:SElect <Period>

Selects the period to display the rising or falling edge in the on / off power measurement.

Suffix:

<n> [Window](#)

Parameters:

<Period>

Example:

```
//Add diagram for rising edge and view edge for period 2
LAY:ADD? '1',BEL,RIS
DISP:WIND2:TPOO:PER:SEL 2
```

Manual operation: See ["Transmit On / Off Power"](#) on page 48

[SENSe:]NR5G:OOPower:ATIMing

Adjusts the timing for on / off power measurements.

Example:

```
//Adjust the on / off power timing
NR5G:OOP:ATIM
```

Usage:

Event

Manual operation: See ["Adjust Timing"](#) on page 51

[SENSe:]NR5G:OOPower:NCORrection <State>

Turns noise correction for transmit on / off power measurements on and off.

Parameters:

<State> ON | OFF | 1 | 0
*RST: OFF

Example: //Turn on noise cancelling
NR5G:OOP:NCOR ON

Manual operation: See ["Noise Cancellation"](#) on page 51

UNIT:OPOWer <Unit>

Selects the unit the off power (transmit on / off power measurements) is displayed in.

Parameters:

<Unit> **DBM**
Displays the power as an absolute value in dBm.
DMHZ
Displays the power as a relative value in dBm/MHz.
*RST: DMHZ

Example: //Select the unit dBm.
UNIT:OPOW DBM

Manual operation: See ["Transmit On / Off Power"](#) on page 48

6.9.31 Frequency sweep measurements

Commands to configure frequency sweep measurements described elsewhere.

- [CONFigure\[:NR5G\]:LDIRrection](#) on page 304
- [MMEMoRY:LOAD:DEModsetting:ALL](#) on page 305
- [MMEMoRY:LOAD:DEModsetting\[:CC<cc>\]](#) on page 305
- [MMEMoRY:STORe<n>:DEModsetting:ALL](#) on page 306
- [MMEMoRY:STORe<n>:DEModsetting\[:CC<cc>\]](#) on page 306
- [CONFigure\[:NR5G\]:DL\[:CC<cc>\]:BW](#) on page 302
- [\[SENSe:\]POWer:CATegory](#) on page 395

Refer also to the user manual of the R&S FSV/A base unit for a list of commands supported by the frequency sweep measurements that are not specific to the 5G NR application.

[SENSe:]POWer:ACHannel:AACHannel	435
[SENSe:]POWer:CATegory:B	435
[SENSe:]POWer:SEM:AMPower	435

[SENSe:]POWer:SEM:AMPower:AUTO.....	436
[SENSe:]POWer:SEM:NTAB.....	436
[SENSe:]POWer:SEM:NTXU.....	436
CALCulate<n>:LIMit:ACPower:PMODE.....	437
CONFigure[:NR5G]:BSTation.....	437

[SENSe:]POWer:ACHannel:AACHannel <Channel>

Selects the bandwidth of the adjacent channel for ACLR measurements.

Parameters:

<Channel>

E500

Selects an LTE signal with 5 MHz bandwidth as assumed adjacent channel carrier.

NOSBw

Selects an 5G NR signal as assumed adjacent channel carrier.

*RST: NOSBw

Example:

```
//Select assumed adjacent channel
POW:ACH:AACH NOSB
```

Manual operation: See "[Adjacent Channels](#)" on page 161

[SENSe:]POWer:CATegory:B <Category>

Selects the limit table for category B stations.

Prerequisites for this command

- Select category B base station ([SENSe:]POWer:CATegory).

Parameters:

<Category>

OPT1 | OPT2

*RST: OPT1

Example:

```
//Select limits for category B base station
POW:CAT B
POW:CAT:B OPT1
```

Manual operation: See "[Category](#)" on page 133

[SENSe:]POWer:SEM:AMPower <Power>

Defines the power of a medium range base station.

Prerequisites for this command

- Select a medium range base station ([SENSe:]POWer:CATegory).
- Select manual definition of Tx power ([SENSe:]POWer:SEM:AMPower:AUTO).

Parameters:

<Power>

<numeric value>

*RST: 0

Default unit: dBm

Example: //Determine power of medium range base station
 POW:CAT MED
 POW:SEM:AMP:AUTO OFF
 POW:SEM:AMP 3

Manual operation: See ["Tx Power"](#) on page 161

[SENSe:]POWer:SEM:AMPower:AUTO <State>

Selects how the R&S FSV/A determines the power of a medium range base station.

Prerequisites for this command

- Select a medium range base station ([\[SENSe:\]POWer:CATegory](#)).

Parameters:

<State> **ON | 1**
 Automatically determines the Tx power.

OFF | 0
 Define a Tx power manually with [\[SENSe:\]POWer:SEM:AMPower](#).

*RST: ON

Example: //Determine power of medium range base station
 POW:CAT MED
 POW:SEM:AMP:AUTO ON

Manual operation: See ["Tx Power"](#) on page 161

[SENSe:]POWer:SEM:NTAB <Value>

Defines the parameter $N_{TABconnectors}$ that defines the position of the spectrum emission mask for 1-H base stations.

Prerequisites for this command

- Select a 1-H base station ([CONFigure\[:NR5G\]:BSTation](#)).

Parameters:

<Value> *RST: 1

Example: //Define N_TABconnector
 CONF:BST FR1H
 POW:SEM:NTAB 5

Manual operation: See ["Position of SEM and ACLR limits"](#) on page 162

[SENSe:]POWer:SEM:NTXU <Value>

Defines the parameter N_{TXU} that defines the position of the spectrum emission mask for 1-H base stations.

Prerequisites for this command

- Select a 1-H base station ([CONFigure\[:NR5G\]:BSTation](#)).

Parameters:

<Value> *RST: 1

Example:

```
//Define N_TXU
CONF:BST FR1H
POW:SEM:NTXU 5
```

Manual operation: See "[Position of SEM and ACLR limits](#)" on page 162

CALCulate<n>:LIMit:ACPpower:PMODE <Mode>

Selects the limit evaluation mode for ACLR measurements.

Supported for ACLR measurements in the LTE and 5G applications.

Suffix:

<n> irrelevant

 irrelevant

Parameters:

<Mode>

AND

Overall limit check passes if both absolute and relative limit checks pass.

OR

Overall limit check passes if either absolute or relative limit checks pass.

*RST: AND

Example:

```
//Select evaluation mode
CALC:LIM:ACP:PMOD AND
```

Manual operation: See "[Total Limit Pass Mode](#)" on page 162

CONFigure[:NR5G]:BSTation <BSType>

Selects the base station type.

Parameters:

<BSType>

FR1C

Base station for conducted requirements.

FR1H

Base station for hybrid requirements.

FR1O

Base station for over-the-air requirements in FR1.
(Only for ACLR and SEM measurements.)

FR2O

Base station for over-the-air requirements in FR2.
(Only for ACLR and SEM measurements.)

*RST: FR1O

Example: //Select base station type
 CONF:BST FR1H

Manual operation: See "Base Station Type" on page 161

6.9.32 Combined measurements

In addition to the commands otherwise supported for I/Q measurements and frequency sweep measurements, combined mode supports the following commands.

[SENSe:]ESpectrum<sb>:PRESet[:STANdard].....	438
[SENSe:]NR5G:ACPower:ALPMode.....	439
[SENSe:]NR5G:FRAMe:OPTimization.....	439
[SENSe:]NR5G:FRAMe:SALevel.....	439
[SENSe:]SWEp:EGATe:AGATing.....	439
[SENSe:]SWEp:EVENT.....	440
[SENSe:]SWEp:MODE.....	440
CALCulate<n>:MARKer<m>:FUNCTion:POWER<sb>:PRESet.....	440
CONFigure[:NR5G]:ACLR.....	441
CONFigure[:NR5G]:EVM.....	441
CONFigure[:NR5G]:SEM.....	441
MMEMory:LOAD:SETTings.....	442
OUTPut<up>:TRIGger<tp>:PULSe:IMMEDIATE.....	442
TRIGger:TSHelper:EDELay.....	442
TRIGger:TSHelper:FTRigger.....	442
TRIGger:TSHelper:RINTerval.....	443
TRIGger:TSHelper:SEQuence.....	443

[SENSe:]ESpectrum<sb>:PRESet[:STANdard] <Standard>

Loads an SEM settings file for combined measurements.

Suffix:

<sb> irrelevant

Parameters:

<Standard> <string>
String that contains the path to the settings file (.xml format).

NONE

Removes the settings file.

Example: //Select and subsequently remove settings file
 ESP:PRES 'c:\settings.xml'
 ESP:PRES NONE

Manual operation: See "Manage User Standards" on page 165

[SENSe:]NR5G:ACPower:ALPMode <Mode>

Selects the limit evaluation mode for ACLR measurements in combined measurement mode.

Parameters:

<Mode>

ABSolute

Checks against the absolute limits.

RELative

Checks against the relative limits.

OR

Checks against both absolute and relative limits according to 3GPP.

*RST: OR

Example:

```
//Select ACLR limit evaluation mode
NR5G:ACP:ALPM ABS
```

Manual operation: See "[ACLR Limit Pass Mode](#)" on page 199

[SENSe:]NR5G:FRAMe:OPTimization <State>

Selects the data capture method for combined measurements.

Parameters:

<State>

DYNamic

Separate capture of carrier and neighboring channels.

SPEed

Capture all channels in one take.

*RST: DYNamic

Example:

```
//Select capture method
NR5G:FRAM:OPT SPE
```

Manual operation: See "[Optimization](#)" on page 166

[SENSe:]NR5G:FRAMe:SALevel <Level>

Turns auto leveling for each event in combined measurement sequence on and off.

Parameters:

<Level>

ON | OFF | 1 | 0

*RST: OFF

Example:

```
//Turn on auto leveling sequence
NR5G:FRAM:SAL ON
```

Manual operation: See "[Sequence Auto Level](#)" on page 166

[SENSe:]SWEep:EGATe:AGATing <State>

Turns auto gating on and off.

Parameters:

<State> ON | OFF | 1 | 0
 *RST: ON

Example: //Turn on auto gating

Manual operation: See "[Auto Gating](#)" on page 169

[SENSe:]SWEep:EVENT <Event>

Defines the number of events in a combined measurement sequence.

Parameters:

<Event> *RST: 10

Example: //Define number of events
 SWE:EVEN 25

Manual operation: See "[# Events](#)" on page 166

[SENSe:]SWEep:MODE <Mode>

Selects the capture mode for combined measurements.

Prerequisites for this command

- Measure the EVM only:
 - `CONFigure[:NR5G]:ACLR = OFF`
 - `CONFigure[:NR5G]:SEM = OFF`
 - `CONFigure[:NR5G]:EVM = ON`

Parameters:

<Mode> **AUTO**
 Captures and analyzes the complete signal.
TX
 Captures and analyzes the Tx channel only.
 *RST: AUTO

Example: //Select capture mode
 CONF:ACLR OFF
 CONF:SEM OFF
 CONF:EVM ON
 SWE:MODE TX

Manual operation: See "[Capture Mode](#)" on page 166

CALCulate<n>:MARKer<m>:FUNctioN:POWer<sb>:PRESet <Standard>

Loads an ACLR settings file for combined measurements.

Suffix:

<n> irrelevant

<m> irrelevant

<sb> irrelevant

Parameters:

<Standard>

<string>

String that contains the path to the settings file (.xml format).

NONE

Removes the settings file.

Example:

```
//Select and subsequently remove settings file
CALC:MARK:FUNC:POW:PRES 'c:\settings.xml'
CALC:MARK:FUNC:POW:PRES NONE
```

Manual operation: See ["Manage User Standards"](#) on page 165

CONFigure[:NR5G]:ACLR <State>

Includes or excludes ACLR measurements from combined measurements.

Parameters:

<State>

ON | OFF | 1 | 0

*RST: ON

Example:

```
//Include ACLR measurements
CONF:ACLR ON
```

Manual operation: See ["EVM / ACLR / SEM"](#) on page 165

CONFigure[:NR5G]:EVM <State>

Includes or excludes EVM measurements from combined measurements.

Parameters:

<State>

ON | OFF | 1 | 0

*RST: ON

Example:

```
//Include EVM measurements
CONF:EVM ON
```

Manual operation: See ["EVM / ACLR / SEM"](#) on page 165

CONFigure[:NR5G]:SEM <State>

Includes or excludes SEM measurements from combined measurements.

Parameters:

<State>

ON | OFF | 1 | 0

*RST: ON

Example:

```
//Include SEM measurements
CONF:SEM ON
```

Manual operation: See ["EVM / ACLR / SEM"](#) on page 165

MMEMory:LOAD:SETTings

Restores the settings of the last measurement sequence in combined mode.

Example: //Restore settings
 MMEM:LOAD:SETT

Usage: Event

Manual operation: See "[Restore Settings](#)" on page 165

OUTPut<up>:TRIGger<tp>:PULSe:IMMEDIATE

Sends a trigger signal from the analyzer to the DUT.

For combined measurement, this command is useful to start a closed-loop trigger sequence.

Suffix:

<up> irrelevant
<tp> 1..3
 Trigger port

Example: //Send trigger signal from trigger output 3
 OUTP:TRIG3:PULS:IMM

Usage: Event

Manual operation: See "[Send Trigger 3](#)" on page 169

TRIGger:TSHelper:EDELay <Time>

Defines the event delay for combined measurements.

Prerequisites for this command

- Select periodic sequence ([TRIGger:TSHelper:SEQUence](#)).

Parameters:

<Time> *RST: 1.0
 Default unit: s

Example: //Define event delay
 TRIG:TSH:SEQ PER
 TRIG:TSH:EDEL 2S

Manual operation: See "[Event Delay](#)" on page 168

TRIGger:TSHelper:FTRigger <Source>

Select the availability of a frame trigger in a combined measurement sequence.

Parameters:

<Source> **AVailable**
 Frame trigger available (external trigger).

NAvailable

Time trigger available.

RSLots

No trigger available.

*RST: AVAilable

Example: //Select trigger source
TRIG:TSH:FTR RSL

Manual operation: See "[Frame Trigger](#)" on page 168

TRIGger:TSHelper:RINterval <Interval>

Defines the recalibration interval for combined measurements.

Prerequisites for this command

- Select time trigger ([TRIGger:TSHelper:SEquence](#)).

Parameters:

<Interval> *RST: 1

Example: //Define recalibration interval
TRIG:TSH:SEQ OLO
TRIG:TSH:FTR NAV
TRIG:TSH:RINT 5

Manual operation: See "[Recalibration Interval](#)" on page 168

TRIGger:TSHelper:SEquence <Source>

Select the type of measurement sequence for combined measurement.

Parameters:

<Source>

The selected sequence has an impact on the trigger settings. If you select a certain sequence and change, for example, the trigger source or trigger input / output configuration, the sequence type automatically returns to manual.

CLOop

Closed-loop sequence.

MANual

Custom trigger configuration.

OLOop

Open-loop sequence.

PERiodic

Periodic sequence.

*RST: MANual

Example: //Select sequence type
TRIG:TSH:SEQ OLO

Manual operation: See "[Sequence](#)" on page 167

6.10 Analysis

- [General analysis tools](#)..... 444
- [Analysis tools for I/Q measurements](#)..... 456
- [Analysis tools for combined measurements](#)..... 467

6.10.1 General analysis tools

- [Trace export](#)..... 444
- [Diagram scale](#)..... 445
- [Zoom](#)..... 447
- [Markers](#)..... 450

6.10.1.1 Trace export

- [FORMat:DEXPort:DSEParator](#)..... 444
- [FORMat:DEXPort:HEADer](#)..... 444
- [FORMat:DEXPort:TRACes](#)..... 445
- [MMEMory:STORe<n>:TRACe](#)..... 445

FORMat:DEXPort:DSEParator <Separator>

Selects the decimal separator for data exported in ASCII format.

Parameters:

<Separator> POINT | COMMa

COMMa

Uses a comma as decimal separator, e.g. *4,05*.

POINT

Uses a point as decimal separator, e.g. *4.05*.

*RST: *RST has no effect on the decimal separator.
Default is POINT.

Example:

FORM:DEXP:DSEP POIN

Sets the decimal point as separator.

FORMat:DEXPort:HEADer <State>

If enabled, additional instrument and measurement settings are included in the header of the export file for result data. If disabled, only the pure result data from the selected traces and tables is exported.

Parameters:

<State> ON | OFF | 0 | 1

*RST: 1

FORMat:DEXPort:TRACes <Selection>

Selects the data to be included in a data export file (see [MMEMory:STORe<n>:TRACe](#) on page 445).

Parameters:

<Selection> SINGle | ALL

SINGle

Only a single trace is selected for export, namely the one specified by the [MMEMory:STORe<n>:TRACe](#) command.

ALL

Selects all active traces and result tables (e.g. "Result Summary", marker peak list etc.) in the current application for export to an ASCII file.

The <trace> parameter for the [MMEMory:STORe<n>:TRACe](#) command is ignored.

*RST: SINGle

MMEMory:STORe<n>:TRACe <Trace>, <FileName>

Exports trace data from the specified window to an ASCII file.

Secure User Mode

In secure user mode, settings that are stored on the instrument are stored to volatile memory, which is restricted to 256 MB. Thus, a "memory limit reached" error can occur although the hard disk indicates that storage space is still available.

To store data permanently, select an external storage location such as a USB memory device.

For details, see "Protecting Data Using the Secure User Mode" in the "Data Management" section of the R&S FSV3000/ FSVA3000 base unit user manual.

Suffix:

<n> [Window](#)

Parameters:

<Trace> Number of the trace to be stored

<FileName> String containing the path and name of the target file.

Example:

MMEM:STOR1:TRAC 1, 'C:\TEST.ASC'

Stores trace 1 from window 1 in the file TEST.ASC.

6.10.1.2 Diagram scale

DISPlay[:WINDow<n>][:SUBWindow<w>]:TRACe<t>:Y[:SCALe]:AUTO	446
DISPlay[:WINDow<n>][:SUBWindow<w>]:TRACe<t>:Y[:SCALe]:MAXimum	446
DISPlay[:WINDow<n>][:SUBWindow<w>]:TRACe<t>:Y[:SCALe]:MINimum	446

DISPlay[:WINDow<n>][:SUBWindow<w>]:TRACe<t>:Y[:SCALe]:AUTO <ONCE>

Automatically scales the y-axis of a diagram based on the displayed results.

Suffix:

<n>	Window
<w>	Subwindow
<t>	irrelevant

Setting parameters:

<ONCE>	ALL Scales the y-axis in all windows for an ideal viewing experience.
	DEFault Restores the default scale of the y-axis.
	ONCE Scales the y-axis in a specific window for an ideal viewing experience.

Example: //Automatically scale the y-axis in subwindow 2 of window 2
DISP:WIND2:SUBW2:TRAC:Y:AUTO ONCE

Usage: Setting only

Manual operation: See ["Auto Scale"](#) on page 71
See ["Automatic scaling of the y-axis"](#) on page 195

**DISPlay[:WINDow<n>][:SUBWindow<w>]:TRACe<t>:Y[:SCALe]:MAXimum
<Value>**

Defines the maximum value displayed on the y-axis of a diagram.

Suffix:

<n>	Window
<w>	Subwindow
<t>	irrelevant

Parameters:

<Value>	Maximum displayed value. The unit and value range depend on the selected diagram.
---------	---

Example: //Define maximum value on y-axis in subwindow 2 of window 2
DISP:WIND2:SUBW2:TRAC:Y:MAX 0

Manual operation: See ["Manual scaling of the y-axis"](#) on page 195

**DISPlay[:WINDow<n>][:SUBWindow<w>]:TRACe<t>:Y[:SCALe]:MINimum
<Value>**

Defines the minimum value displayed on the vertical diagram axis.

Suffix:

<n>	Window
<w>	Subwindow
<t>	irrelevant

Parameters:

<Value>	Minimum displayed value. The unit and value range depend on the selected diagram.
---------	---

Example:

```
//Define minimum value on y-axis in subwindow 2 of window 2
DISP:WIND2:SUBW2:TRAC:Y:MIN -50
```

Manual operation: See "Manual scaling of the y-axis" on page 195

6.10.1.3 Zoom

DISPlay[:WINDow<n>][:SUBWindow<w>]:ZOOM:AREA.....	447
DISPlay[:WINDow<n>][:SUBWindow<w>]:ZOOM:MULTiple<zn>:AREA.....	448
DISPlay[:WINDow<n>][:SUBWindow<w>]:ZOOM:MULTiple<zn>[:STATe].....	449
DISPlay[:WINDow<n>][:SUBWindow<w>]:ZOOM[:STATe].....	450

DISPlay[:WINDow<n>][:SUBWindow<w>]:ZOOM:AREA <x1>,<y1>,<x2>,<y2>

Defines the zoom area.

To define a zoom area, you first have to turn the zoom on.

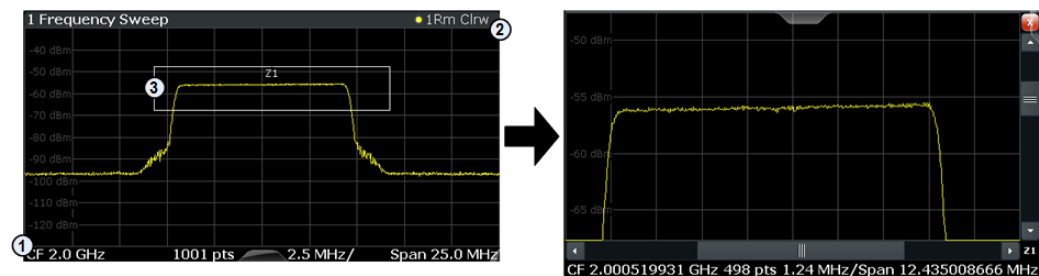

- 1 = origin of coordinate system (x1 = 0, y1 = 0)
- 2 = end point of system (x2 = 100, y2 = 100)
- 3 = zoom area (e.g. x1 = 60, y1 = 30, x2 = 80, y2 = 75)

Suffix:

<n>	Window
<w>	subwindow
	Not supported by all applications

Parameters:

- <x1> Diagram coordinates in % of the complete diagram that define the zoom area.
The lower left corner is the origin of coordinate system. The upper right corner is the end point of the system.
Range: 0 to 100
Default unit: PCT
- <y1> Diagram coordinates in % of the complete diagram that define the zoom area.
The lower left corner is the origin of coordinate system. The upper right corner is the end point of the system.
Range: 0 to 100
Default unit: PCT
- <x2> Diagram coordinates in % of the complete diagram that define the zoom area.
The lower left corner is the origin of coordinate system. The upper right corner is the end point of the system.
Range: 0 to 100
Default unit: PCT
- <y2> Diagram coordinates in % of the complete diagram that define the zoom area.
The lower left corner is the origin of coordinate system. The upper right corner is the end point of the system.
Range: 0 to 100
Default unit: PCT

DISPlay[:WINDow<n>][:SUBWindow<w>]:ZOOM:MULTiple<zn>:AREA
 <x1>,<y1>,<x2>,<y2>

Defines the zoom area for a multiple zoom.

To define a zoom area, you first have to turn the zoom on.

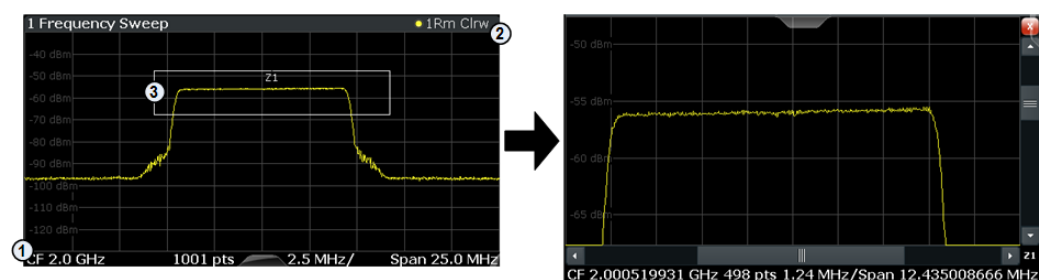

- 1 = origin of coordinate system (x1 = 0, y1 = 0)
 2 = end point of system (x2 = 100, y2 = 100)
 3 = zoom area (e.g. x1 = 60, y1 = 30, x2 = 80, y2 = 75)

Suffix:

<n> [Window](#)

<w>	subwindow Not supported by all applications
<zn>	Selects the zoom window.
Parameters:	
<x1>	Diagram coordinates in % of the complete diagram that define the zoom area. The lower left corner is the origin of coordinate system. The upper right corner is the end point of the system. Range: 0 to 100 Default unit: PCT
<y1>	Diagram coordinates in % of the complete diagram that define the zoom area. The lower left corner is the origin of coordinate system. The upper right corner is the end point of the system. Range: 0 to 100 Default unit: PCT
<x2>	Diagram coordinates in % of the complete diagram that define the zoom area. The lower left corner is the origin of coordinate system. The upper right corner is the end point of the system. Range: 0 to 100 Default unit: PCT
<y2>	Diagram coordinates in % of the complete diagram that define the zoom area. The lower left corner is the origin of coordinate system. The upper right corner is the end point of the system. Range: 0 to 100 Default unit: PCT

DISPlay[:WINDow<n>][:SUBWindow<w>]:ZOOM:MULTiple<zn>[:STATe] <State>

Turns the multiple zoom on and off.

Suffix:

<n>	Window
<w>	subwindow Not supported by all applications
<zn>	Selects the zoom window. If you turn off one of the zoom windows, all subsequent zoom windows move up one position.

Parameters:

<State>	ON OFF 0 1 OFF 0 Switches the function off
---------	---

ON | 1

Switches the function on

DISPlay[:WINDow<n>][:SUBWindow<w>]:ZOOM[:STATe] <State>

Turns the zoom on and off.

Suffix:

<n>	Window
<w>	subwindow Not supported by all applications

Parameters:

<State>	ON OFF 0 1
	OFF 0 Switches the function off
	ON 1 Switches the function on

Example: DISP:ZOOM ON
 Activates the zoom mode.

6.10.1.4 Markers

Commands to configure markers described elsewhere.

- CALCulate<n>:DELTaMarker<m>:X
- CALCulate<n>:DELTaMarker<m>:Y?
- CALCulate<n>:MARKer<m>:X
- CALCulate<n>:MARKer<m>:Y
- CALCulate<n>:MARKer<m>:Z?
- CALCulate<n>:MARKer<m>:Z:ALL?

CALCulate<n>:DELTaMarker<m>:AOFF.....	451
CALCulate<n>:DELTaMarker<m>:MAXimum:LEFT.....	451
CALCulate<n>:DELTaMarker<m>:MAXimum:NEXT.....	451
CALCulate<n>:DELTaMarker<m>:MAXimum:RIGHT.....	451
CALCulate<n>:DELTaMarker<m>:MAXimum[:PEAK].....	452
CALCulate<n>:DELTaMarker<m>:MINimum:LEFT.....	452
CALCulate<n>:DELTaMarker<m>:MINimum:NEXT.....	452
CALCulate<n>:DELTaMarker<m>:MINimum:RIGHT.....	452
CALCulate<n>:DELTaMarker<m>:MINimum[:PEAK].....	452
CALCulate<n>:DELTaMarker<m>[:STATe].....	453
CALCulate<n>:DELTaMarker<m>:TRACe.....	453
CALCulate<n>:MARKer<m>:AOFF.....	453
CALCulate<n>:MARKer<m>:MAXimum:LEFT.....	454
CALCulate<n>:MARKer<m>:MAXimum:NEXT.....	454
CALCulate<n>:MARKer<m>:MAXimum:RIGHT.....	454
CALCulate<n>:MARKer<m>:MAXimum[:PEAK].....	454

CALCulate<n>:MARKer<m>:MINimum:LEFT.....	454
CALCulate<n>:MARKer<m>:MINimum:NEXT.....	455
CALCulate<n>:MARKer<m>:MINimum:RIGHT.....	455
CALCulate<n>:MARKer<m>[:STATE].....	455
CALCulate<n>:MARKer<m>:TRACe.....	455
DISPlay[:WINDow<n>]:MTABLE.....	456

CALCulate<n>:DELTamarker<m>:AOFF

Turns off *all* delta markers.

Suffix:

<n> Window

<m> irrelevant

Example:

CALC:DELT:AOFF

Turns off all delta markers.

CALCulate<n>:DELTamarker<m>:MAXimum:LEFT

Moves a delta marker to the next positive peak value.

The search includes only measurement values to the left of the current marker position.

Suffix:

<n> Window

<m> Marker

CALCulate<n>:DELTamarker<m>:MAXimum:NEXT

Moves a marker to the next positive peak value.

Suffix:

<n> 1..n
Window

<m> 1..n
Marker

CALCulate<n>:DELTamarker<m>:MAXimum:RIGHT

Moves a delta marker to the next positive peak value on the trace.

The search includes only measurement values to the right of the current marker position.

Suffix:

<n> Window

<m> Marker

CALCulate<n>:DELTamarker<m>:MAXimum[:PEAK]

Moves a delta marker to the highest level.

If the marker is not yet active, the command first activates the marker.

Suffix:

<n> [Window](#)

<m> [Marker](#)

CALCulate<n>:DELTamarker<m>:MINimum:LEFT

Moves a delta marker to the next minimum peak value.

The search includes only measurement values to the right of the current marker position.

Suffix:

<n> [Window](#)

<m> [Marker](#)

CALCulate<n>:DELTamarker<m>:MINimum:NEXT

Moves a marker to the next minimum peak value.

Suffix:

<n> [Window](#)

<m> [Marker](#)

CALCulate<n>:DELTamarker<m>:MINimum:RIGHT

Moves a delta marker to the next minimum peak value.

The search includes only measurement values to the right of the current marker position.

Suffix:

<n> [Window](#)

<m> [Marker](#)

CALCulate<n>:DELTamarker<m>:MINimum[:PEAK]

Moves a delta marker to the minimum level.

If the marker is not yet active, the command first activates the marker.

Suffix:

<n> [Window](#)

<m> [Marker](#)

CALCulate<n>:DELTaMarker<m>[:STATE] <State>

Turns delta markers on and off.

If necessary, the command activates the delta marker first.

No suffix at DELTmarker turns on delta marker 1.

Suffix:

<n> [Window](#)

<m> [Marker](#)

Parameters:

<State> ON | OFF | 0 | 1

OFF | 0

Switches the function off

ON | 1

Switches the function on

Example:

CALC:DELT2 ON

Turns on delta marker 2.

CALCulate<n>:DELTaMarker<m>:TRACe <Trace>

Selects the trace a delta marker is positioned on.

Note that the corresponding trace must have a trace mode other than "Blank".

If necessary, the command activates the marker first.

Suffix:

<n> [Window](#)

<m> [Marker](#)

Parameters:

<Trace> Trace number the marker is assigned to.

Example:

CALC:DELT2:TRAC 2

Positions delta marker 2 on trace 2.

CALCulate<n>:MARKer<m>:AOFF

Turns off all markers.

Suffix:

<n> [Window](#)

<m> [Marker](#)

Example:

CALC:MARK:AOFF

Switches off all markers.

CALCulate<n>:MARKer<m>:MAXimum:LEFT

Moves a marker to the next positive peak.

The search includes only measurement values to the left of the current marker position.

Suffix:

<n> [Window](#)

<m> [Marker](#)

CALCulate<n>:MARKer<m>:MAXimum:NEXT

Moves a marker to the next positive peak.

Suffix:

<n> [Window](#)

<m> [Marker](#)

CALCulate<n>:MARKer<m>:MAXimum:RIGHT

Moves a marker to the next positive peak.

The search includes only measurement values to the right of the current marker position.

Suffix:

<n> [Window](#)

<m> [Marker](#)

CALCulate<n>:MARKer<m>:MAXimum[:PEAK]

Moves a marker to the highest level.

If the marker is not yet active, the command first activates the marker.

Suffix:

<n> [Window](#)

<m> [Marker](#)

CALCulate<n>:MARKer<m>:MINimum:LEFT

Moves a marker to the next minimum peak value.

The search includes only measurement values to the right of the current marker position.

Suffix:

<n> [Window](#)

<m> [Marker](#)

CALCulate<n>:MARKer<m>:MINimum:NEXT

Moves a marker to the next minimum peak value.

Suffix:

<n> [Window](#)
<m> [Marker](#)

CALCulate<n>:MARKer<m>:MINimum:RIGHT

Moves a marker to the next minimum peak value.

The search includes only measurement values to the right of the current marker position.

Suffix:

<n> [Window](#)
<m> [Marker](#)

CALCulate<n>:MARKer<m>[:STATe] <State>

Turns markers on and off. If the corresponding marker number is currently active as a delta marker, it is turned into a normal marker.

Suffix:

<n> [Window](#)
<m> [Marker](#)

Parameters:

<State> ON | OFF | 0 | 1
 OFF | 0
 Switches the function off
 ON | 1
 Switches the function on

Example:

CALC:MARK3 ON
Switches on marker 3.

CALCulate<n>:MARKer<m>:TRACe <Trace>

Selects the trace the marker is positioned on.

Note that the corresponding trace must have a trace mode other than "Blank".

If necessary, the command activates the marker first.

Suffix:

<n> [Window](#)
<m> [Marker](#)

Parameters:

<Trace> **1 to 16**
Trace number (or bandwidth part if the trace represents one) the marker is assigned to.

Example:

```
//Assign marker to trace 1
CALC:MARK3:TRAC 2
```

DISPlay[:WINDow<n>]:MTABle <DisplayMode>

Turns the marker table on and off.

Suffix:

<n> irrelevant

Parameters:

<DisplayMode> **ON | 1**
Turns on the marker table.

OFF | 0
Turns off the marker table.

AUTO
Turns on the marker table if 3 or more markers are active.

*RST: AUTO

Example:

```
DISP:MTAB ON
Activates the marker table.
```

6.10.2 Analysis tools for I/Q measurements

- [Result views](#).....456
- [Result settings](#).....457
- [Evaluation range](#).....462

6.10.2.1 Result views

- [DISPlay\[:WINDow<n>\]\[:SUBWindow<w>\]:CCNumber](#)..... 456
- [DISPlay\[:WINDow<n>\]\[:SUBWindow<w>\]:FNUMber](#).....457

DISPlay[:WINDow<n>][:SUBWindow<w>]:CCNumber <Carrier>

Assigns a specific component carrier to a view.

Prerequisites for this command

- Capture more than one component carrier.

Suffix:

<n> irrelevant

<w> [View](#)

Parameters:

<Carrier> <numeric value> (integer only)

Example:

```
//Select a component carrier to analyze in view 2
DISP:SUBW2:CCN 2
```

Manual operation:

See ["Views"](#) on page 79
See ["Component Carrier No"](#) on page 202

DISPlay[:WINDow<n>][:SUBWindow<w>]:FNUMber <Frame>

Assigns a specific frame to a view.

Prerequisites for this command

- Capture more than one frame.

Suffix:

<n> irrelevant

<w> [View](#)

Parameters:

<Frame> <numeric value> (integer only)

Example:

```
//Select a frame to analyze in view 2
DISP:SUBW2:FNUM 2
```

Manual operation:

See ["Effects of capturing multiple frames on results"](#) on page 85
See ["Frame No"](#) on page 202

6.10.2.2 Result settings

DISPlay[:WINDow<n>][:SUBWindow<w>]:COUPling	457
DISPlay[:WINDow<n>]:TABLe:ITEM	458
[SENSe:]NR5G:CCOLor	458
[SENSe:]NR5G:CDRPower	459
[SENSe:]NR5G:EMHold	459
[SENSe:]NR5G:RSUMmary:CCResult	459
[SENSe:]NR5G:RSUMmary:PMODE	460
[SENSe:]NR5G:RSUMmary:SHOW	460
[SENSe:]NR5G:TDView	460
UNIT:BSTR	461
UNIT:CAReference	461
UNIT:CAXes	461
UNIT:EVM	462
UNIT:SAXes	462

DISPlay[:WINDow<n>][:SUBWindow<w>]:COUPling <State>

Couples or decouples result display tabs (subwindows).

Subwindow coupling is available for measurements with multiple data streams (like carrier aggregation).

Suffix:

<n> Window

<w> Subwindow

Parameters:

<State> ON | OFF | 1 | 0

*RST: OFF

Example://Turn on subwindow coupling
DISP:COUP ON**Manual operation:** See "Subwindow Coupling" on page 199**DISPlay[:WINDow<n>]:TABLe:ITEM** <Result>, <State>

Turns the display of individual results in the numerical result summary on and off.

Suffix:

<n> Window

Parameters:<Result> BLER | CRES | DSQP | DSSF | DSST | DSTS | UPRach |
FSOFFset | EVM | EVMPeak | FERRor | GIMBalance | IQOFFset
| MODulation | NORB | OSTP | RSTP | SSPower | CSIPower |
PCHannel | POWER | PPRE | PSIGnal | QUADrature | SDPB |
SDQP | SDSF | SDST | SDTS | SERRor | TPUT | UCCD | UCCH
| USPB | USQP | USSF | USST | USTS
Combined measurements only: TSTamp | TSDelta | MID |
SState | APFail | AAPFail | ARPFail | SPFail

<State> ON | OFF | 1 | 0

Example://Display or hide results
DISP:WIND2:TABL:ITEM DSSF,ON
DISP:WIND2:TABL:ITEM DSQP,OFF**Manual operation:** See "Result state" on page 201**[SENSe:]NR5G:CCOLor** <Type>

Selects the information that the colors of the constellation points in the constellation diagram represent.

Parameters:

<Type>

ALLocation

Colors represent allocation types.

MODulation

Colors represent modulation types.

*RST: MODulation

Example://Select colors for constellation diagram
NR5G:CCOL MOD

Manual operation: See ["Constellation Color"](#) on page 200

[SENSe:]NR5G:CDRPower <State>

Turns the consideration of a boosting factor to calculate the constellation points in the constellation diagram on and off.

Parameters:

<State> ON | OFF | 1 | 0
*RST: OFF

Example: //Turn on boosting factor
NR5G:CDRP ON

Manual operation: See ["Constellation Diagram Relative Power"](#) on page 200

[SENSe:]NR5G:EMHold <State>

Turns the EVM max hold function on and off.

Parameters:

<State> ON | OFF | 1 | 0
*RST: OFF

Example: //Turn on EVM max hold
NR5G:EMH ON

Manual operation: See ["EVM Max Hold"](#) on page 198

[SENSe:]NR5G:RSUMmary:CCResult <Result>

Selects the way multiple carriers are analyzed.

Prerequisites for this command

- Select mutple carriers ([CONFigure\[:NR5G\]:NOCC](#)).

Parameters:

<Result> **ALL**
Analyzes all component carriers and shows information about all of them in the result summary.
VIEWed
Analyzes the two component carriers assigned to the two views. The result summary only shows information about those two component carriers.
*RST: VIEWed

Example: //Analyze all carriers
CONF:NOCC 4
NR5G:RSUM:CCR ALL

Manual operation: See ["CC Result"](#) on page 200

[SENSe:]NR5G:RSUMmary:PMODE <Result>

Selects the power averaging mode.

Parameters:

<Result>

AASL

Power avergaing over all symbols in a slot.

AASY

Power avergaing over all used symbols in a slot.

*RST: AASL

Example:

```
//Select power averaging mode
NR5G:RSUM:PMOD AASY
```

Manual operation: See ["Power Mode"](#) on page 201

[SENSe:]NR5G:RSUMmary:SHOW <Result>

Selects the way the contents of the result summary are calculated.

Parameters:

<Result>

AVERage

Shows the average over all analyzed frames.

SINGle

Shows the result for the frame selected with [\[SENSe:\]NR5G\[:CC<cc>\]:FRAMe:SElect](#).

If only one frame has been captured, the results are the same in both cases.

*RST: AVERage

Example:

```
//Display results for a single frame
DISP:SUBW2:FNUM 2
NR5G:RSUM:SHOW SING
```

[SENSe:]NR5G:TDView <State>

Turns the 3D view for [selected diagrams](#) on and off.

Parameters:

<State>

ON | OFF | 1 | 0

*RST: OFF

Example:

```
//Turn on 3D view
NR5G:TDV ON
```

Manual operation: See ["3D View"](#) on page 199

UNIT:BSTR <Unit>

Selects the way the bit stream is displayed.

Parameters:

<Unit>

SYMBOLS

Displays the bit stream using symbols

BITS

Displays the bit stream using bits

*RST: SYMBOLS

Example:

//Display bit stream as bits

UNIT:BSTR BIT

Manual operation: See ["Bit Stream Format"](#) on page 197

UNIT:CARReference <Reference>

Selects the reference for result displays whose x-axis shows frequency characteristics of the signal.

Parameters:

<Reference>

LRB

Frequency values relative to the lowest resource block.

RTCF

Frequency values relative to the center frequency of the carrier.

*RST: LRB

Example:

//Select carrier reference

UNIT:CAR RTCF

Manual operation: See ["Carrier Axes Reference"](#) on page 198

UNIT:CAXes <Unit>

Selects the scale of the x-axis for result displays that show subcarrier results.

Parameters:

<Unit>

CARR

Shows the number of the subcarriers on the x-axis.

HZ

Shows the frequency of the subcarriers on the x-axis.

Example:

//Display frequency on the x-axis

UNIT:CAX HZ

Manual operation: See ["Carrier Axes"](#) on page 198

UNIT:EVM <Unit>

Selects the EVM unit.

Parameters:

<Unit> **DB**
EVM results returned in dB

PCT
EVM results returned in %

*RST: PCT

Example: //Display EVM results in %
UNIT:EVM PCT

Manual operation: See "EVM Unit" on page 197

UNIT:SAXes <Unit>

Selects the scale of the x-axis for result displays that show symbol results.

Parameters:

<Unit> **SYMBOL**
Shows the number of the symbol on the x-axis.

TIME
Shows the time stamp of the symbols on the x-axis.

Example: //Display symbol numbers on the x-axis
UNIT:SAX SYMB

Manual operation: See "Symbol Axes" on page 198

6.10.2.3 Evaluation range

CONFigure[:NR5G]:DL[:CC<cc>]:BF:AP[:UERS]	462
[SENSe:]NR5G[:CC<cc>]:ALLocation:SElect	463
[SENSe:]NR5G[:CC<cc>]:ANTenna:SElect	463
[SENSe:]NR5G[:CC<cc>]:BWPart:SElect	464
[SENSe:]NR5G[:CC<cc>]:CARRier:SElect	464
[SENSe:]NR5G[:CC<cc>]:FRAMe:SElect	464
[SENSe:]NR5G[:CC<cc>]:LOCation:SElect	465
[SENSe:]NR5G[:CC<cc>]:MODulation:SElect	465
[SENSe:]NR5G[:CC<cc>]:RAP	465
[SENSe:]NR5G[:CC<cc>]:SLOT:SElect	466
[SENSe:]NR5G[:CC<cc>]:SUBFrame:SElect	466
[SENSe:]NR5G[:CC<cc>]:SYMBOL:SElect	466

CONFigure[:NR5G]:DL[:CC<cc>]:BF:AP[:UERS] <Port>

Selects an antenna port to analyze.

Suffix:

<cc> [Component Carrier](#)

Parameters:

<Port> **ALL**
 Selects all antenna ports.

<numeric_value> (integer only)
 Selects a specific antenna port. The value corresponds to the antenna port number.

*RST: ALL

Example:

```
//Select antenna port
CONF:DL:BF:AP 1002
```

Manual operation: See "[RS Weights](#)" on page 206

[SENSe:]NR5G[:CC<cc>]:ALlocation:SElect <Allocation>

Filters the displayed results in the constellation diagram by a certain allocation.

Suffix:

<cc> irrelevant

Parameters:

<Allocation> **ALL**
 Shows the results for all allocations.

<numeric value> (integer only)
 Shows the results for a single allocation type. Allocation types are mapped to numeric values. For the code assignment, see [Chapter 6.8.1.25, "Return value codes"](#), on page 288.

*RST: ALL

Example:

```
//Display results for all allocations
NR5G:ALL:SEL ALL
```

Manual operation: See "[Evaluation range for the constellation diagram](#)" on page 205

[SENSe:]NR5G[:CC<cc>]:ANTenna:SElect <Antenna>

Filters the constellation points by a certain antenna port.

Prerequisites for this command

- Create the constellation diagram after MIMO decoding ([SENSe:]NR5G[:CC<cc>]:LOCation:SElect).

Suffix:

<cc> irrelevant

Parameters:

<Antenna> Number of the antenna port (for example 1001).

Example: //Filter constellation points by antenna port
 LOC:SEL AMD
 ANT:SEL 1001

[SENSe:]NR5G[:CC<cc>]:BWPart:SElect <BWP>

Filters the displayed results by a certain bandwidth part.

Suffix:
 <cc> irrelevant

Parameters:
 <BWP> **ALL**
 Shows the results for all bandwidth parts, including the SS/
 PBCH block.
SSBLock
 Shows the results for the SS/PBCH block.
<numeric value> (integer only)
 Shows the results for a single bandwidth part.
 *RST: ALL

Example: //Display results for SS/PBCH block
 NR5G:BWP:SEL SSBL

Manual operation: See "[BWP/SS Selection](#)" on page 203

[SENSe:]NR5G[:CC<cc>]:CARRier:SElect <Carrier>

Filters the displayed results in the constellation diagram by a certain subcarrier.

Suffix:
 <cc> irrelevant

Parameters:
 <Carrier> **ALL**
 Shows the results for all subcarriers.
<numeric value> (integer only)
 Shows the results for a single subcarrier.
 *RST: ALL

Example: //Display results for all subcarriers
 NR5G:CARR:SEL ALL

Manual operation: See "[Evaluation range for the constellation diagram](#)"
 on page 205

[SENSe:]NR5G[:CC<cc>]:FRAMe:SElect <Frame>

Filters the displayed results by a specific frame.

Suffix:
 <cc> irrelevant

Parameters:

<Frame> *RST: 1

Example:

```
//Display results for frame 2
NR5G:FRAM:SEL 2
```

Manual operation: See ["Effects of capturing multiple frames on results"](#) on page 85
See ["Frame Selection"](#) on page 203

[SENSe:]NR5G[:CC<cc>]:LOCation:SElect <Location>

Selects the point in the signal processing at which the constellation diagram is created.

Suffix:

<cc> irrelevant

Parameters:

<Location> **AMD**
After MIMO decoding.

BMD
Before MIMO decoding.

*RST: BMD

Example:

```
//Select constellation diagram data source
LOC:SEL AMD
```

[SENSe:]NR5G[:CC<cc>]:MODulation:SElect <Modulation>

Filters the displayed results in the constellation diagram by a certain modulation type.

Suffix:

<cc> irrelevant

Parameters:

<Modulation> **ALL**
Shows the results for all modulation types.

<numeric value> (integer only)

Shows the results for a single modulation type.

Modulation types are mapped to numeric values. For the code assignment, see [Chapter 6.8.1.25, "Return value codes"](#), on page 288.

*RST: ALL

Example:

```
//Display results for all elements with a QPSK modulation
NR5G:MOD:SEL 2
```

Manual operation: See ["Evaluation range for the constellation diagram"](#) on page 205

[SENSe:]NR5G[:CC<cc>]:RAP <Port>

Selects the reference antenna port for relative beamforming results.

Suffix:

<cc> irrelevant

Parameters:

<Port> Value corresponds to the antenna port.

*RST: 1000

Example:

//Select reference antenna port

NR5G:RAP 2000

Manual operation: See "[Reference AP](#)" on page 206

[SENSe:]NR5G[:CC<cc>]:SLOT:SElect <Slot>

Filters the displayed results by a certain slot.

Suffix:

<cc> irrelevant

Parameters:

<Slot> **ALL**

Shows the results for all slots.

<numeric value> (integer only)

Shows the results for a single slot.

*RST: ALL

Example:

//Display result for slot 4

NR5G:SLOT:SEL 4

Manual operation: See "[Slot Selection](#)" on page 205

[SENSe:]NR5G[:CC<cc>]:SUBFrame:SElect <Subframe>

Filters the displayed results by a certain OFDM subframe.

Suffix:

<cc> irrelevant

Parameters:

<Subframe> **ALL**

Shows the results for all subframes.

<numeric value> (integer only)

Shows the results for a single subframe.

*RST: ALL

Example:

//Display result for subframe 1

NR5G:SUBF:SEL 1

Manual operation: See "[Subframe Selection](#)" on page 204

[SENSe:]NR5G[:CC<cc>]:SYMBOL:SElect <Symbol>

Filters the displayed results in the constellation diagram by a certain OFDM symbol.

Suffix:	
<cc>	irrelevant
Parameters:	
<Symbol>	ALL Shows the results for all symbols.
	<numeric value> (integer only) Shows the results for a single OFDM symbol.
	*RST: ALL
Example:	//Display result for OFDM symbol 2 NR5G:SYMB:SEL 2
Manual operation:	See " Evaluation range for the constellation diagram " on page 205

6.10.3 Analysis tools for combined measurements

[SENSe:]NR5G[:CC<cc>]:SMID.....	467
[SENSe:]NR5G:EFILter:FPAParameters.....	467
[SENSe:]NR5G:EFILter:FPAParameters:STATe.....	468
[SENSe:]NR5G:EFILter:PRESet.....	469
[SENSe:]NR5G:EFILter:STATe.....	469
[SENSe:]NR5G:FEVents:COUNT?.....	469

[SENSe:]NR5G[:CC<cc>]:SMID <Event>

Selects a specific measurement (meas ID) from the measurement sequence in combined measurements.

Suffix:	
<cc>	irrelevant
Parameters:	
<Event>	*RST: 1
Example:	//Select a measurement NR5G:SMID 5

Manual operation: See "[Selected Meas ID](#)" on page 203

[SENSe:]NR5G:EFILter:FPAParameters <Result>[, <Condition>, <Value>]

Defines a filter condition for the event filter in combined measurements.

Parameters:

<Result> SSTate | APFail | AAPFail | ARPFail | SPFail | MID | TSTamp | TSDelta | EVM | POWER | DSQP | DSST | DSSF | DSTS | FSOFFset | PCHannel | PSIGnal | FERRor | SERRor | IQOFFset | GIMBalance | QUADrature | OSTP | RSTP | RSSI | CSIPower | SSPower | CREST | OVLD | MODulation | NORB | BLER | TPUT
Selects the result that you want to define a filter for.

<Condition>

FAILed

Filter condition: test failed (for boolean results only).

GTEQual

Filter condition: greater than or equal (for numerical results only).

LTEQual

Filter condition: lower than or equal (for numerical results only).

PASSed

Filter condition: test passed (for boolean results only).

<Value>

For numerical results only.

Example:

```
//Define filter condition: time stamp deltas greater than 0.25 seconds
NR5G:EFIL:FPAR TSD,GTH,0.25S
```

Example:

```
//Define filter condition: signal synchronization pass
NR5G:EFIL:FPAR SST,PASS
```

Manual operation: See "[Filter Parameters](#)" on page 208**[SENSe:]NR5G:EFILter:FPARameters:STATe** <Result>, <State>

Turns an event filter on and off.

Turning on an event filter adds it to the filter list and removes the results from the result summary that do not fulfill the filter conditions.

Turning it off removes it from the list.

Prerequisites for this command

- Define a filter condition ([\[SENSe:\]NR5G:EFILter:FPARameters](#)).

Parameters:

<Result> CREST | DSQP | DSSF | DSST | DSTS | FSOFFset | EVM | OVLD | FERRor | GIMBalance | IQOFFset | MODulation | NORB | OSTP | RSTP | RSSI | SSPower | CSIPower | PCHannel | POWER | PPRE | PSIGnal | QUADrature | SERRor | MID | TSTamp | TSDelta | SSTate | APFail | AAPFail | ARPFail | SPFail | BLER | TPUT
Selects the result that you want to add a filter for.

<State>

ON | OFF | 1 | 0

*RST: OFF

Example: //Add two filter conditions to the filter list
 NR5G:EFIL:FPAR TSD,GTH,0.25S
 NR5G:EFIL:FPAR TSD,ON
 NR5G:EFIL:FPAR SST,PASS
 NR5G:EFIL:FPAR SST,ON

Manual operation: See ["Filter Parameters"](#) on page 208

[SENSe:]NR5G:EFILter:PRESet

Removes all event filters.

Example: //Remove all event filters
 NR5G:EFIL:PRES

Usage: Event

Manual operation: See ["Reset Filter Settings"](#) on page 208

[SENSe:]NR5G:EFILter:STATe <State>

Turns an event filter for combined measurement results on and off.

Parameters:

<State> ON | OFF | 0 | 1
 *RST: OFF

Example: //Turn on event filter
 NR5G:EFIL:STAT ON

Manual operation: See ["State"](#) on page 207

[SENSe:]NR5G:FEVents:COUNT?

Queries the number of filtered events for combined measurements.

Prerequisites for this command

- Define and turn on an event filter.

Return values:

<Count>

Example: //Query filtered events
 NR5G:EFIL:STAT ON
 NR5G:FEV:COUNT?

Usage: Query only

Manual operation: See ["Filter Parameters"](#) on page 208

List of Commands (5G NR Downlink)

[SENSe:]ADJust:CONFigure:LEVel:DURation.....	298
[SENSe:]ADJust:CONFigure:LEVel:DURation:MODE.....	298
[SENSe:]ADJust:DEMod.....	298
[SENSe:]ADJust:EVM.....	299
[SENSe:]ADJust:EVM:SLOTs.....	299
[SENSe:]ADJust:LEVel.....	299
[SENSe:]ADJust:LEVel<ant>:ALL.....	300
[SENSe:]ESpectrum<sb>:PRESet[:STANdard].....	438
[SENSe:]FREQuency:CENTer:STEP.....	412
[SENSe:]FREQuency:CENTer[:CC<cc>].....	411
[SENSe:]FREQuency:CENTer[:CC<cc>]:MCOFFset.....	310
[SENSe:]FREQuency:CENTer[:CC<cc>]:OFFSet.....	411
[SENSe:]NR5G:ACPower:ALPMode.....	439
[SENSe:]NR5G:CCOLor.....	458
[SENSe:]NR5G:CDRPower.....	459
[SENSe:]NR5G:DEMod:CAMode.....	428
[SENSe:]NR5G:DEMod:CESTimation.....	425
[SENSe:]NR5G:DEMod:CETaverage.....	426
[SENSe:]NR5G:DEMod:CMETHod.....	428
[SENSe:]NR5G:DEMod:CRData.....	428
[SENSe:]NR5G:DEMod:DDATa.....	429
[SENSe:]NR5G:DEMod:EFLRange.....	429
[SENSe:]NR5G:DEMod:FILTer.....	430
[SENSe:]NR5G:DEMod:PRData.....	430
[SENSe:]NR5G:DEMod:STADjust.....	430
[SENSe:]NR5G:EFILter:FPARameters.....	467
[SENSe:]NR5G:EFILter:FPARameters:STATe.....	468
[SENSe:]NR5G:EFILter:PRESet.....	469
[SENSe:]NR5G:EFILter:STATe.....	469
[SENSe:]NR5G:EMHold.....	459
[SENSe:]NR5G:FEVents:COUNT?.....	469
[SENSe:]NR5G:FRAMe:COUNT.....	417
[SENSe:]NR5G:FRAMe:COUNT:AUTO.....	418
[SENSe:]NR5G:FRAMe:COUNT:STATe.....	418
[SENSe:]NR5G:FRAMe:OPTimization.....	439
[SENSe:]NR5G:FRAMe:SALevel.....	439
[SENSe:]NR5G:FRAMe:SLOT.....	418
[SENSe:]NR5G:FRAMe:SRSLot.....	418
[SENSe:]NR5G:IQ:GIQE.....	426
[SENSe:]NR5G:OOPower:ATIMing.....	433
[SENSe:]NR5G:OOPower:NCORrection.....	434
[SENSe:]NR5G:RSUMmary:CCResult.....	459
[SENSe:]NR5G:RSUMmary:PMODE.....	460
[SENSe:]NR5G:RSUMmary:SHOW.....	460
[SENSe:]NR5G:TDView.....	460
[SENSe:]NR5G:TRACking:LEVel.....	426
[SENSe:]NR5G:TRACking:PHASe.....	426

[SENSe:]NR5G:TRACking:TIME.....	427
[SENSe:]NR5G:TRACking:TPUT:STATe.....	427
[SENSe:]NR5G[:CC<cc>]:ALLocation:SElect.....	463
[SENSe:]NR5G[:CC<cc>]:ANTenna:SElect.....	463
[SENSe:]NR5G[:CC<cc>]:BWPart:SElect.....	464
[SENSe:]NR5G[:CC<cc>]:CARRier:SElect.....	464
[SENSe:]NR5G[:CC<cc>]:FRAMe:SElect.....	464
[SENSe:]NR5G[:CC<cc>]:LOCation:SElect.....	465
[SENSe:]NR5G[:CC<cc>]:MODulation:SElect.....	465
[SENSe:]NR5G[:CC<cc>]:RAP.....	465
[SENSe:]NR5G[:CC<cc>]:SLOT:SElect.....	466
[SENSe:]NR5G[:CC<cc>]:SMID.....	467
[SENSe:]NR5G[:CC<cc>]:SUBFrame:SElect.....	466
[SENSe:]NR5G[:CC<cc>]:SYMBol:SElect.....	466
[SENSe:]POWer:ACHannel:AAChannel.....	435
[SENSe:]POWer:CATegory.....	395
[SENSe:]POWer:CATegory:B.....	435
[SENSe:]POWer:SEM:AMPower.....	435
[SENSe:]POWer:SEM:AMPower:AUTO.....	436
[SENSe:]POWer:SEM:NTAB.....	436
[SENSe:]POWer:SEM:NTXU.....	436
[SENSe:]SWAPiq.....	419
[SENSe:]SWEep:CTMode.....	419
[SENSe:]SWEep:EGATe:AGATing.....	439
[SENSe:]SWEep:EVENT.....	440
[SENSe:]SWEep:LCAPture.....	419
[SENSe:]SWEep:MODE.....	440
[SENSe:]SWEep:TIME.....	420
[SENSe:]SYNC[:CC<cc>][:STATe]?.....	230
ABORT.....	228
CALCulate<n>:DELTamarker<m>:AOFF.....	451
CALCulate<n>:DELTamarker<m>:MAXimum:LEFT.....	451
CALCulate<n>:DELTamarker<m>:MAXimum:NEXT.....	451
CALCulate<n>:DELTamarker<m>:MAXimum:RIGHT.....	451
CALCulate<n>:DELTamarker<m>:MAXimum[:PEAK].....	452
CALCulate<n>:DELTamarker<m>:MINimum:LEFT.....	452
CALCulate<n>:DELTamarker<m>:MINimum:NEXT.....	452
CALCulate<n>:DELTamarker<m>:MINimum:RIGHT.....	452
CALCulate<n>:DELTamarker<m>:MINimum[:PEAK].....	452
CALCulate<n>:DELTamarker<m>:TRACe.....	453
CALCulate<n>:DELTamarker<m>:X.....	253
CALCulate<n>:DELTamarker<m>:Y?.....	253
CALCulate<n>:DELTamarker<m>[:STATe].....	453
CALCulate<n>:LIMit:ACPower:ACHannel:RESult:ABSolute.....	264
CALCulate<n>:LIMit:ACPower:ACHannel:RESult:RELative.....	264
CALCulate<n>:LIMit:ACPower:ACHannel:RESult?.....	263
CALCulate<n>:LIMit:ACPower:ALternate<alt>:RESult?.....	265
CALCulate<n>:LIMit:ACPower:ALternate<ch>:RESult:ABSolute.....	266
CALCulate<n>:LIMit:ACPower:ALternate<ch>:RESult:RELative.....	266
CALCulate<n>:LIMit:ACPower:GAP<gap>:ACLR:RESult:ABSolute?.....	267

CALCulate<n>:LIMit:ACPoweR:GAP<gap>:ACLR:RESult:RELative?	268
CALCulate<n>:LIMit:ACPoweR:GAP<gap>:ACLR:RESult?	267
CALCulate<n>:LIMit:ACPoweR:GAP<gap>[:CACLR]:RESult:ABSolute?	269
CALCulate<n>:LIMit:ACPoweR:GAP<gap>[:CACLR]:RESult:RELative?	269
CALCulate<n>:LIMit:ACPoweR:GAP<gap>[:CACLR]:RESult?	268
CALCulate<n>:LIMit:ACPoweR:PMODE	437
CALCulate<n>:LIMit:FAIL?	270
CALCulate<n>:LIMit:OOPoweR:OFFPoweR?	262
CALCulate<n>:LIMit:OOPoweR:TRANsient?	262
CALCulate<n>:LIMit[:CC<cc>][:ISRC<ant>][:FRAME<fr>]:SUMMary:ALL:RESult?	258
CALCulate<n>:LIMit[:CC<cc>][:ISRC<ant>][:FRAME<fr>]:SUMMary:EVM:DS1K[:AVERAge]:RESult?	258
CALCulate<n>:LIMit[:CC<cc>][:ISRC<ant>][:FRAME<fr>]:SUMMary:EVM:DSQP[:AVERAge]:RESult?	259
CALCulate<n>:LIMit[:CC<cc>][:ISRC<ant>][:FRAME<fr>]:SUMMary:EVM:DSSF[:AVERAge]:RESult?	259
CALCulate<n>:LIMit[:CC<cc>][:ISRC<ant>][:FRAME<fr>]:SUMMary:EVM:DSST[:AVERAge]:RESult?	260
CALCulate<n>:LIMit[:CC<cc>][:ISRC<ant>][:FRAME<fr>]:SUMMary:EVM:DSTS[:AVERAge]:RESult?	261
CALCulate<n>:LIMit[:CC<cc>][:ISRC<ant>][:FRAME<fr>]:SUMMary:EVM:FERRor[:AVERAge]:RESult?	261
CALCulate<n>:MARKer<m>:AOFF	453
CALCulate<n>:MARKer<m>:FUNctioN:POWeR<sb>:PRESet	440
CALCulate<n>:MARKer<m>:FUNctioN:POWeR<sb>:RESult:DETailS	291
CALCulate<n>:MARKer<m>:FUNctioN:POWeR<sb>:RESult[:CURRent]?	290
CALCulate<n>:MARKer<m>:MAXimum:LEFT	454
CALCulate<n>:MARKer<m>:MAXimum:NEXT	454
CALCulate<n>:MARKer<m>:MAXimum:RIGHT	454
CALCulate<n>:MARKer<m>:MAXimum[:PEAK]	454
CALCulate<n>:MARKer<m>:MINimum:LEFT	454
CALCulate<n>:MARKer<m>:MINimum:NEXT	455
CALCulate<n>:MARKer<m>:MINimum:RIGHT	455
CALCulate<n>:MARKer<m>:TRACe	455
CALCulate<n>:MARKer<m>:X	254
CALCulate<n>:MARKer<m>:Y	254
CALCulate<n>:MARKer<m>:Z:ALL?	255
CALCulate<n>:MARKer<m>:Z?	255
CALCulate<n>:MARKer<m>[:STATe]	455
CALCulate<n>:STATisticS:CCDF:X<t>?	256
CALCulate<n>:STATisticS:RESult<res>?	256
CONFigure:GENerator:CONTRol[:STATe]	407
CONFigure:GENerator:FREQuency:CENTer:SYNC[:STATe]	402
CONFigure:GENerator:IPConnectioN:ADDReSS	402
CONFigure:GENerator:IPConnectioN:LEDState?	403
CONFigure:GENerator:LEVel:DUTGain	403
CONFigure:GENerator:LEVel:DUTLimit	404
CONFigure:GENerator:LEVel:DUTLimit:STATe	404
CONFigure:GENerator:POWeR:LEVel	405
CONFigure:GENerator:POWeR:LEVel:STATe	403
CONFigure:GENerator:QERRor?	405
CONFigure:GENerator:RFOutput[:STATe]	406
CONFigure:GENerator:SETTingS:UPDate:RF	407
CONFigure:SETTingS:NR5G	405
CONFigure:SETTingS:NR5G:PINTeRval	405

CONFigure:SETTings:NR5G:SYNC.....	406
CONFigure:SETTings:RF.....	406
CONFigure[:NR5G]:ACLR.....	441
CONFigure[:NR5G]:BSTation.....	437
CONFigure[:NR5G]:CENTer.....	307
CONFigure[:NR5G]:CRASter.....	307
CONFigure[:NR5G]:CSCapture.....	308
CONFigure[:NR5G]:CSPacing.....	308
CONFigure[:NR5G]:DL[:CC<cc>]:BF:AP[:UERS].....	462
CONFigure[:NR5G]:DL[:CC<cc>]:BW.....	302
CONFigure[:NR5G]:DL[:CC<cc>]:DEMod:AUTO.....	300
CONFigure[:NR5G]:DL[:CC<cc>]:DFRange.....	303
CONFigure[:NR5G]:DL[:CC<cc>]:EUIDs.....	392
CONFigure[:NR5G]:DL[:CC<cc>]:FNNF.....	392
CONFigure[:NR5G]:DL[:CC<cc>]:FRAMe<fr>:BWPart<bwp>:ADD.....	319
CONFigure[:NR5G]:DL[:CC<cc>]:FRAMe<fr>:BWPart<bwp>:CLEar.....	320
CONFigure[:NR5G]:DL[:CC<cc>]:FRAMe<fr>:BWPart<bwp>:CSI<csi>:BITMap.....	330
CONFigure[:NR5G]:DL[:CC<cc>]:FRAMe<fr>:BWPart<bwp>:CSI<csi>:CTYPe?.....	331
CONFigure[:NR5G]:DL[:CC<cc>]:FRAMe<fr>:BWPart<bwp>:CSI<csi>:DENSity.....	331
CONFigure[:NR5G]:DL[:CC<cc>]:FRAMe<fr>:BWPart<bwp>:CSI<csi>:LONE.....	331
CONFigure[:NR5G]:DL[:CC<cc>]:FRAMe<fr>:BWPart<bwp>:CSI<csi>:LZERo.....	332
CONFigure[:NR5G]:DL[:CC<cc>]:FRAMe<fr>:BWPart<bwp>:CSI<csi>:NORBs.....	333
CONFigure[:NR5G]:DL[:CC<cc>]:FRAMe<fr>:BWPart<bwp>:CSI<csi>:PORT?.....	333
CONFigure[:NR5G]:DL[:CC<cc>]:FRAMe<fr>:BWPart<bwp>:CSI<csi>:POWER.....	333
CONFigure[:NR5G]:DL[:CC<cc>]:FRAMe<fr>:BWPart<bwp>:CSI<csi>:RESources.....	334
CONFigure[:NR5G]:DL[:CC<cc>]:FRAMe<fr>:BWPart<bwp>:CSI<csi>:ROW.....	334
CONFigure[:NR5G]:DL[:CC<cc>]:FRAMe<fr>:BWPart<bwp>:CSI<csi>:SID.....	335
CONFigure[:NR5G]:DL[:CC<cc>]:FRAMe<fr>:BWPart<bwp>:CSI<csi>:SLOT:APERiodic.....	335
CONFigure[:NR5G]:DL[:CC<cc>]:FRAMe<fr>:BWPart<bwp>:CSI<csi>:SLOT:MODE.....	336
CONFigure[:NR5G]:DL[:CC<cc>]:FRAMe<fr>:BWPart<bwp>:CSI<csi>:SLOT:PERiodicity.....	336
CONFigure[:NR5G]:DL[:CC<cc>]:FRAMe<fr>:BWPart<bwp>:CSI<csi>:SLOT:POFFset.....	337
CONFigure[:NR5G]:DL[:CC<cc>]:FRAMe<fr>:BWPart<bwp>:CSI<csi>:SRB.....	337
CONFigure[:NR5G]:DL[:CC<cc>]:FRAMe<fr>:BWPart<bwp>:CSI<csi>:STATe.....	338
CONFigure[:NR5G]:DL[:CC<cc>]:FRAMe<fr>:BWPart<bwp>:CSI<csi>:ZPOWER.....	338
CONFigure[:NR5G]:DL[:CC<cc>]:FRAMe<fr>:BWPart<bwp>:CSLot.....	323
CONFigure[:NR5G]:DL[:CC<cc>]:FRAMe<fr>:BWPart<bwp>:DETection.....	301
CONFigure[:NR5G]:DL[:CC<cc>]:FRAMe<fr>:BWPart<bwp>:DUPLicate.....	320
CONFigure[:NR5G]:DL[:CC<cc>]:FRAMe<fr>:BWPart<bwp>:PRS:KPComb.....	339
CONFigure[:NR5G]:DL[:CC<cc>]:FRAMe<fr>:BWPart<bwp>:PRS:KPOFFset.....	339
CONFigure[:NR5G]:DL[:CC<cc>]:FRAMe<fr>:BWPart<bwp>:PRS:LPRS.....	340
CONFigure[:NR5G]:DL[:CC<cc>]:FRAMe<fr>:BWPart<bwp>:PRS:LPStart.....	340
CONFigure[:NR5G]:DL[:CC<cc>]:FRAMe<fr>:BWPart<bwp>:PRS:NORBs.....	340
CONFigure[:NR5G]:DL[:CC<cc>]:FRAMe<fr>:BWPart<bwp>:PRS:NPID.....	341
CONFigure[:NR5G]:DL[:CC<cc>]:FRAMe<fr>:BWPart<bwp>:PRS:POWER.....	341
CONFigure[:NR5G]:DL[:CC<cc>]:FRAMe<fr>:BWPart<bwp>:PRS:SLOT:APERiodic.....	341
CONFigure[:NR5G]:DL[:CC<cc>]:FRAMe<fr>:BWPart<bwp>:PRS:SRB.....	342
CONFigure[:NR5G]:DL[:CC<cc>]:FRAMe<fr>:BWPart<bwp>:PRS:STATe.....	342
CONFigure[:NR5G]:DL[:CC<cc>]:FRAMe<fr>:BWPart<bwp>:RBCount.....	320
CONFigure[:NR5G]:DL[:CC<cc>]:FRAMe<fr>:BWPart<bwp>:RBOFFset.....	321
CONFigure[:NR5G]:DL[:CC<cc>]:FRAMe<fr>:BWPart<bwp>:REMOve.....	321

CONFigure[:NR5G]:DL[:CC<cc>]:FRAMe<fr>:BWPart<bwp>:SCOut?.....	323
CONFigure[:NR5G]:DL[:CC<cc>]:FRAMe<fr>:BWPart<bwp>:SLOT<sl>:ALCount.....	350
CONFigure[:NR5G]:DL[:CC<cc>]:FRAMe<fr>:BWPart<bwp>:SLOT<sl>:ALLocation<al>:CCODing:IMCS.....	386
CONFigure[:NR5G]:DL[:CC<cc>]:FRAMe<fr>:BWPart<bwp>:SLOT<sl>:ALLocation<al>:CCODing: MCSTable.....	387
CONFigure[:NR5G]:DL[:CC<cc>]:FRAMe<fr>:BWPart<bwp>:SLOT<sl>:ALLocation<al>:CCODing: RVINdex.....	388
CONFigure[:NR5G]:DL[:CC<cc>]:FRAMe<fr>:BWPart<bwp>:SLOT<sl>:ALLocation<al>:CCODing: TBSFs.....	388
CONFigure[:NR5G]:DL[:CC<cc>]:FRAMe<fr>:BWPart<bwp>:SLOT<sl>:ALLocation<al>:CCODing: TBSize.....	389
CONFigure[:NR5G]:DL[:CC<cc>]:FRAMe<fr>:BWPart<bwp>:SLOT<sl>:ALLocation<al>:CLMapping.....	374
CONFigure[:NR5G]:DL[:CC<cc>]:FRAMe<fr>:BWPart<bwp>:SLOT<sl>:ALLocation<al>:COPY.....	351
CONFigure[:NR5G]:DL[:CC<cc>]:FRAMe<fr>:BWPart<bwp>:SLOT<sl>:ALLocation<al>:COPY:DURation.....	350
CONFigure[:NR5G]:DL[:CC<cc>]:FRAMe<fr>:BWPart<bwp>:SLOT<sl>:ALLocation<al>:COPY:MODE.....	351
CONFigure[:NR5G]:DL[:CC<cc>]:FRAMe<fr>:BWPart<bwp>:SLOT<sl>:ALLocation<al>:COPY:PERiod.....	352
CONFigure[:NR5G]:DL[:CC<cc>]:FRAMe<fr>:BWPart<bwp>:SLOT<sl>:ALLocation<al>:COPY:SLOT.....	353
CONFigure[:NR5G]:DL[:CC<cc>]:FRAMe<fr>:BWPart<bwp>:SLOT<sl>:ALLocation<al>:DMRS:AP.....	375
CONFigure[:NR5G]:DL[:CC<cc>]:FRAMe<fr>:BWPart<bwp>:SLOT<sl>:ALLocation<al>:DMRS:CGWD.....	375
CONFigure[:NR5G]:DL[:CC<cc>]:FRAMe<fr>:BWPart<bwp>:SLOT<sl>:ALLocation<al>:DMRS:CTYPe.....	376
CONFigure[:NR5G]:DL[:CC<cc>]:FRAMe<fr>:BWPart<bwp>:SLOT<sl>:ALLocation<al>:DMRS: MSYMBOL:APOSition.....	376
CONFigure[:NR5G]:DL[:CC<cc>]:FRAMe<fr>:BWPart<bwp>:SLOT<sl>:ALLocation<al>:DMRS: MSYMBOL:LENGth.....	376
CONFigure[:NR5G]:DL[:CC<cc>]:FRAMe<fr>:BWPart<bwp>:SLOT<sl>:ALLocation<al>:DMRS:MTYPe.....	377
CONFigure[:NR5G]:DL[:CC<cc>]:FRAMe<fr>:BWPart<bwp>:SLOT<sl>:ALLocation<al>:DMRS:NSCid.....	377
CONFigure[:NR5G]:DL[:CC<cc>]:FRAMe<fr>:BWPart<bwp>:SLOT<sl>:ALLocation<al>:DMRS:POWER.....	378
CONFigure[:NR5G]:DL[:CC<cc>]:FRAMe<fr>:BWPart<bwp>:SLOT<sl>:ALLocation<al>:DMRS:RST.....	378
CONFigure[:NR5G]:DL[:CC<cc>]:FRAMe<fr>:BWPart<bwp>:SLOT<sl>:ALLocation<al>:DMRS: SGENeration.....	379
CONFigure[:NR5G]:DL[:CC<cc>]:FRAMe<fr>:BWPart<bwp>:SLOT<sl>:ALLocation<al>:DMRS:SID.....	379
CONFigure[:NR5G]:DL[:CC<cc>]:FRAMe<fr>:BWPart<bwp>:SLOT<sl>:ALLocation<al>:DMRS:SIONe.....	380
CONFigure[:NR5G]:DL[:CC<cc>]:FRAMe<fr>:BWPart<bwp>:SLOT<sl>:ALLocation<al>:DMRS:TAPos.....	381
CONFigure[:NR5G]:DL[:CC<cc>]:FRAMe<fr>:BWPart<bwp>:SLOT<sl>:ALLocation<al>:POWER.....	354
CONFigure[:NR5G]:DL[:CC<cc>]:FRAMe<fr>:BWPart<bwp>:SLOT<sl>:ALLocation<al>:PTRS:K.....	383
CONFigure[:NR5G]:DL[:CC<cc>]:FRAMe<fr>:BWPart<bwp>:SLOT<sl>:ALLocation<al>:PTRS:L.....	384
CONFigure[:NR5G]:DL[:CC<cc>]:FRAMe<fr>:BWPart<bwp>:SLOT<sl>:ALLocation<al>:PTRS:POWER.....	384
CONFigure[:NR5G]:DL[:CC<cc>]:FRAMe<fr>:BWPart<bwp>:SLOT<sl>:ALLocation<al>:PTRS:REOFset.....	385
CONFigure[:NR5G]:DL[:CC<cc>]:FRAMe<fr>:BWPart<bwp>:SLOT<sl>:ALLocation<al>:PTRS[:STATe].....	385
CONFigure[:NR5G]:DL[:CC<cc>]:FRAMe<fr>:BWPart<bwp>:SLOT<sl>:ALLocation<al>:RBCount.....	354
CONFigure[:NR5G]:DL[:CC<cc>]:FRAMe<fr>:BWPart<bwp>:SLOT<sl>:ALLocation<al>:RBOFset.....	355
CONFigure[:NR5G]:DL[:CC<cc>]:FRAMe<fr>:BWPart<bwp>:SLOT<sl>:ALLocation<al>:RPOint.....	381
CONFigure[:NR5G]:DL[:CC<cc>]:FRAMe<fr>:BWPart<bwp>:SLOT<sl>:ALLocation<al>:SCOut.....	355
CONFigure[:NR5G]:DL[:CC<cc>]:FRAMe<fr>:BWPart<bwp>:SLOT<sl>:ALLocation<al>:SCRambling.....	389
CONFigure[:NR5G]:DL[:CC<cc>]:FRAMe<fr>:BWPart<bwp>:SLOT<sl>:ALLocation<al>: SCRambling:DSID.....	390
CONFigure[:NR5G]:DL[:CC<cc>]:FRAMe<fr>:BWPart<bwp>:SLOT<sl>:ALLocation<al>:SOFFset.....	356
CONFigure[:NR5G]:DL[:CC<cc>]:FRAMe<fr>:BWPart<bwp>:SLOT<sl>:ALLocation<al>:UEID.....	382
CONFigure[:NR5G]:DL[:CC<cc>]:FRAMe<fr>:BWPart<bwp>:SLOT<sl>:ALLocation<al>:VTPinter.....	382

CONFigure[:NR5G]:DL[:CC<cc>]:FRAMe<fr>:BWPart<bwp>:SLOT<sl>:ALLocation<al>[: CW<cw>]:MODulation.....	353
CONFigure[:NR5G]:DL[:CC<cc>]:FRAMe<fr>:BWPart<bwp>:SLOT<sl>:ATYPe.....	324
CONFigure[:NR5G]:DL[:CC<cc>]:FRAMe<fr>:BWPart<bwp>:SLOT<sl>:COPY.....	324
CONFigure[:NR5G]:DL[:CC<cc>]:FRAMe<fr>:BWPart<bwp>:SLOT<sl>:COReset<cr>:COPY.....	344
CONFigure[:NR5G]:DL[:CC<cc>]:FRAMe<fr>:BWPart<bwp>:SLOT<sl>:COReset<cr>:COPY:DURation...	343
CONFigure[:NR5G]:DL[:CC<cc>]:FRAMe<fr>:BWPart<bwp>:SLOT<sl>:COReset<cr>:COPY:MODE.....	344
CONFigure[:NR5G]:DL[:CC<cc>]:FRAMe<fr>:BWPart<bwp>:SLOT<sl>:COReset<cr>:COPY:PERiod.....	345
CONFigure[:NR5G]:DL[:CC<cc>]:FRAMe<fr>:BWPart<bwp>:SLOT<sl>:COReset<cr>:COPY:SLOT.....	346
CONFigure[:NR5G]:DL[:CC<cc>]:FRAMe<fr>:BWPart<bwp>:SLOT<sl>:COReset<cr>:DMRS:POWer.....	358
CONFigure[:NR5G]:DL[:CC<cc>]:FRAMe<fr>:BWPart<bwp>:SLOT<sl>:COReset<cr>:DMRS:RPOint.....	358
CONFigure[:NR5G]:DL[:CC<cc>]:FRAMe<fr>:BWPart<bwp>:SLOT<sl>:COReset<cr>:DMRS: SCRam[:STATe].....	359
CONFigure[:NR5G]:DL[:CC<cc>]:FRAMe<fr>:BWPart<bwp>:SLOT<sl>:COReset<cr>:DMRS:SID.....	359
CONFigure[:NR5G]:DL[:CC<cc>]:FRAMe<fr>:BWPart<bwp>:SLOT<sl>:COReset<cr>: INTerleaving:BSIZe.....	360
CONFigure[:NR5G]:DL[:CC<cc>]:FRAMe<fr>:BWPart<bwp>:SLOT<sl>:COReset<cr>:INTerleaving:ISIZe	360
CONFigure[:NR5G]:DL[:CC<cc>]:FRAMe<fr>:BWPart<bwp>:SLOT<sl>:COReset<cr>: INTerleaving:NSHift.....	361
CONFigure[:NR5G]:DL[:CC<cc>]:FRAMe<fr>:BWPart<bwp>:SLOT<sl>:COReset<cr>: INTerleaving:SINDEX.....	361
CONFigure[:NR5G]:DL[:CC<cc>]:FRAMe<fr>:BWPart<bwp>:SLOT<sl>:COReset<cr>: INTerleaving:STATe.....	362
CONFigure[:NR5G]:DL[:CC<cc>]:FRAMe<fr>:BWPart<bwp>:SLOT<sl>:COReset<cr>:PDCCh<cf>: ALEVel.....	362
CONFigure[:NR5G]:DL[:CC<cc>]:FRAMe<fr>:BWPart<bwp>:SLOT<sl>:COReset<cr>:PDCCh<cf>: CCEindex.....	363
CONFigure[:NR5G]:DL[:CC<cc>]:FRAMe<fr>:BWPart<bwp>:SLOT<sl>:COReset<cr>:PDCCh<cf>: DCIFormat.....	363
CONFigure[:NR5G]:DL[:CC<cc>]:FRAMe<fr>:BWPart<bwp>:SLOT<sl>:COReset<cr>:PDCCh<cf>: DCISettings:FDRassign.....	364
CONFigure[:NR5G]:DL[:CC<cc>]:FRAMe<fr>:BWPart<bwp>:SLOT<sl>:COReset<cr>:PDCCh<cf>: DCISettings:ITEM.....	365
CONFigure[:NR5G]:DL[:CC<cc>]:FRAMe<fr>:BWPart<bwp>:SLOT<sl>:COReset<cr>:PDCCh<cf>: DCISettings:LIST?.....	368
CONFigure[:NR5G]:DL[:CC<cc>]:FRAMe<fr>:BWPart<bwp>:SLOT<sl>:COReset<cr>:PDCCh<cf>: DCISettings:NOBLock.....	369
CONFigure[:NR5G]:DL[:CC<cc>]:FRAMe<fr>:BWPart<bwp>:SLOT<sl>:COReset<cr>:PDCCh<cf>: DCISettings:SCOPE.....	369
CONFigure[:NR5G]:DL[:CC<cc>]:FRAMe<fr>:BWPart<bwp>:SLOT<sl>:COReset<cr>:PDCCh<cf>: DCISettings:TPCCCommand.....	370
CONFigure[:NR5G]:DL[:CC<cc>]:FRAMe<fr>:BWPart<bwp>:SLOT<sl>:COReset<cr>:PDCCh<cf>: PLENgtH.....	371
CONFigure[:NR5G]:DL[:CC<cc>]:FRAMe<fr>:BWPart<bwp>:SLOT<sl>:COReset<cr>:PDCCh<cf>:RNTI.	371
CONFigure[:NR5G]:DL[:CC<cc>]:FRAMe<fr>:BWPart<bwp>:SLOT<sl>:COReset<cr>:PDCCh<cf>: USAGe.....	372
CONFigure[:NR5G]:DL[:CC<cc>]:FRAMe<fr>:BWPart<bwp>:SLOT<sl>:COReset<cr>:PDSCh:STATe.....	372
CONFigure[:NR5G]:DL[:CC<cc>]:FRAMe<fr>:BWPart<bwp>:SLOT<sl>:COReset<cr>:PGRanularity.....	373
CONFigure[:NR5G]:DL[:CC<cc>]:FRAMe<fr>:BWPart<bwp>:SLOT<sl>:COReset<cr>:POWer.....	346
CONFigure[:NR5G]:DL[:CC<cc>]:FRAMe<fr>:BWPart<bwp>:SLOT<sl>:COReset<cr>:RBCount.....	347

CONFigure[:NR5G]:DL[:CC<cc>]:FRAMe<fr>:BWPart<bwp>:SLOT<sl>:COReset<cr>:RBOffset.....	347
CONFigure[:NR5G]:DL[:CC<cc>]:FRAMe<fr>:BWPart<bwp>:SLOT<sl>:COReset<cr>:SCOut.....	348
CONFigure[:NR5G]:DL[:CC<cc>]:FRAMe<fr>:BWPart<bwp>:SLOT<sl>:COReset<cr>:SOFFset.....	348
CONFigure[:NR5G]:DL[:CC<cc>]:FRAMe<fr>:BWPart<bwp>:SLOT<sl>:CRSCount.....	349
CONFigure[:NR5G]:DL[:CC<cc>]:FRAMe<fr>:BWPart<bwp>:SLOT<sl>:CUID.....	356
CONFigure[:NR5G]:DL[:CC<cc>]:FRAMe<fr>:BWPart<bwp>:SLOT<sl>:FORMat.....	325
CONFigure[:NR5G]:DL[:CC<cc>]:FRAMe<fr>:BWPart<bwp>:SLOT<sl>:PASTe:ALL.....	325
CONFigure[:NR5G]:DL[:CC<cc>]:FRAMe<fr>:BWPart<bwp>:SLOT<sl>:PASTe:TO.....	327
CONFigure[:NR5G]:DL[:CC<cc>]:FRAMe<fr>:BWPart<bwp>:SLOT<sl>:PASTe:TO:DURation.....	326
CONFigure[:NR5G]:DL[:CC<cc>]:FRAMe<fr>:BWPart<bwp>:SLOT<sl>:PASTe:TO:MODE.....	326
CONFigure[:NR5G]:DL[:CC<cc>]:FRAMe<fr>:BWPart<bwp>:SLOT<sl>:PASTe:TO:PERiod.....	328
CONFigure[:NR5G]:DL[:CC<cc>]:FRAMe<fr>:BWPart<bwp>:SLOT<sl>:PASTe:TO:SLOTs.....	328
CONFigure[:NR5G]:DL[:CC<cc>]:FRAMe<fr>:BWPart<bwp>:SLOT<sl>:PASTe[:SLOT].....	329
CONFigure[:NR5G]:DL[:CC<cc>]:FRAMe<fr>:BWPart<bwp>:SLOT<sl>:PRESet.....	329
CONFigure[:NR5G]:DL[:CC<cc>]:FRAMe<fr>:BWPart<bwp>:SSPacing.....	322
CONFigure[:NR5G]:DL[:CC<cc>]:FRAMe<fr>:BWPCount?.....	322
CONFigure[:NR5G]:DL[:CC<cc>]:FRAMe<fr>:COPY.....	311
CONFigure[:NR5G]:DL[:CC<cc>]:FRAMe<fr>:PASTe:ALL.....	311
CONFigure[:NR5G]:DL[:CC<cc>]:FRAMe<fr>:PASTe[:FRAMe].....	312
CONFigure[:NR5G]:DL[:CC<cc>]:FTConfig.....	312
CONFigure[:NR5G]:DL[:CC<cc>]:IDC.....	393
CONFigure[:NR5G]:DL[:CC<cc>]:LTE:CBW.....	399
CONFigure[:NR5G]:DL[:CC<cc>]:LTE:MBSFn:SUBFrame<sf>:STATe.....	399
CONFigure[:NR5G]:DL[:CC<cc>]:LTE:NAP.....	400
CONFigure[:NR5G]:DL[:CC<cc>]:LTE:POINta.....	400
CONFigure[:NR5G]:DL[:CC<cc>]:LTE:STATe.....	401
CONFigure[:NR5G]:DL[:CC<cc>]:LTE:VSHift.....	401
CONFigure[:NR5G]:DL[:CC<cc>]:PAMapping<cf>:CSIRs:AP<ap>.....	390
CONFigure[:NR5G]:DL[:CC<cc>]:PAMapping<cf>:PDSch:AP<ap>.....	391
CONFigure[:NR5G]:DL[:CC<cc>]:PAMapping<cf>:STATe.....	391
CONFigure[:NR5G]:DL[:CC<cc>]:PLC:CID.....	303
CONFigure[:NR5G]:DL[:CC<cc>]:PLC:EIRP.....	432
CONFigure[:NR5G]:DL[:CC<cc>]:PLC:TRP.....	433
CONFigure[:NR5G]:DL[:CC<cc>]:RFUC:FZERo:FREquency.....	393
CONFigure[:NR5G]:DL[:CC<cc>]:RFUC:FZERo:MODE.....	393
CONFigure[:NR5G]:DL[:CC<cc>]:RFUC:STATe.....	394
CONFigure[:NR5G]:DL[:CC<cc>]:RPA:AFREquency?.....	396
CONFigure[:NR5G]:DL[:CC<cc>]:RPA:KZERo:SCFE.....	396
CONFigure[:NR5G]:DL[:CC<cc>]:RPA:KZERo:SCFT.....	396
CONFigure[:NR5G]:DL[:CC<cc>]:RPA:KZERo:SCNS.....	397
CONFigure[:NR5G]:DL[:CC<cc>]:RPA:KZERo:SCOT.....	397
CONFigure[:NR5G]:DL[:CC<cc>]:RPA:KZERo:SCST.....	398
CONFigure[:NR5G]:DL[:CC<cc>]:RPA:KZERo:SCTT.....	398
CONFigure[:NR5G]:DL[:CC<cc>]:RPA:RTCF.....	398
CONFigure[:NR5G]:DL[:CC<cc>]:RPA:TBOFset?.....	399
CONFigure[:NR5G]:DL[:CC<cc>]:SSBLoCk<ssb>:ASOFFset.....	313
CONFigure[:NR5G]:DL[:CC<cc>]:SSBLoCk<ssb>:BSPeriod.....	313
CONFigure[:NR5G]:DL[:CC<cc>]:SSBLoCk<ssb>:DETectioN.....	301
CONFigure[:NR5G]:DL[:CC<cc>]:SSBLoCk<ssb>:HFOFFset.....	313
CONFigure[:NR5G]:DL[:CC<cc>]:SSBLoCk<ssb>:L.....	314

CONFigure[:NR5G]:DL[:CC<cc>]:SSBLoCk<ssb>:OFFSet.....	315
CONFigure[:NR5G]:DL[:CC<cc>]:SSBLoCk<ssb>:PATtern.....	315
CONFigure[:NR5G]:DL[:CC<cc>]:SSBLoCk<ssb>:PBCH:POWer.....	316
CONFigure[:NR5G]:DL[:CC<cc>]:SSBLoCk<ssb>:PDMRs:POWer.....	316
CONFigure[:NR5G]:DL[:CC<cc>]:SSBLoCk<ssb>:PSS:POWer.....	317
CONFigure[:NR5G]:DL[:CC<cc>]:SSBLoCk<ssb>:RTO.....	317
CONFigure[:NR5G]:DL[:CC<cc>]:SSBLoCk<ssb>:SSPacing.....	317
CONFigure[:NR5G]:DL[:CC<cc>]:SSBLoCk<ssb>:SSS:POWer.....	318
CONFigure[:NR5G]:DL[:CC<cc>]:SSBLoCk<ssb>[:STATe<ss>].....	319
CONFigure[:NR5G]:DL[:CC<cc>]:SSCA.....	394
CONFigure[:NR5G]:EVM.....	441
CONFigure[:NR5G]:FCOFFset.....	308
CONFigure[:NR5G]:FELC:STATe.....	395
CONFigure[:NR5G]:GMCFreq.....	309
CONFigure[:NR5G]:LDIReCtion.....	304
CONFigure[:NR5G]:MEASurement.....	295
CONFigure[:NR5G]:NCSPacing.....	309
CONFigure[:NR5G]:NOCC.....	309
CONFigure[:NR5G]:OBANd.....	302
CONFigure[:NR5G]:OMODE.....	309
CONFigure[:NR5G]:OOPower:NFRames.....	433
CONFigure[:NR5G]:ORAN:TCASe.....	395
CONFigure[:NR5G]:OREL.....	310
CONFigure[:NR5G]:SEM.....	441
DISPlay:FORMat.....	219
DISPlay[:WINDow<n>]:MTABLE.....	456
DISPlay[:WINDow<n>]:SIZE.....	219
DISPlay[:WINDow<n>]:TAB<tab>:SElect.....	220
DISPlay[:WINDow<n>]:TABLE:ITEM.....	458
DISPlay[:WINDow<n>]:TPOO:PERiod:SElect.....	433
DISPlay[:WINDow<n>][:SUBWIndow<w>]:CCNumber.....	456
DISPlay[:WINDow<n>][:SUBWIndow<w>]:COUPling.....	457
DISPlay[:WINDow<n>][:SUBWIndow<w>]:FNUMber.....	457
DISPlay[:WINDow<n>][:SUBWIndow<w>]:SElect.....	219
DISPlay[:WINDow<n>][:SUBWIndow<w>]:TRACe<t>:Y[:SCALe]:AUTO.....	446
DISPlay[:WINDow<n>][:SUBWIndow<w>]:TRACe<t>:Y[:SCALe]:MAXimum.....	446
DISPlay[:WINDow<n>][:SUBWIndow<w>]:TRACe<t>:Y[:SCALe]:MINimum.....	446
DISPlay[:WINDow<n>][:SUBWIndow<w>]:TRACe<t>:Y[:SCALe]:RLEVel.....	413
DISPlay[:WINDow<n>][:SUBWIndow<w>]:TRACe<t>:Y[:SCALe]:RLEVel:OFFSet.....	413
DISPlay[:WINDow<n>][:SUBWIndow<w>]:ZOOM:AREA.....	447
DISPlay[:WINDow<n>][:SUBWIndow<w>]:ZOOM:MULTiple<zn>:AREA.....	448
DISPlay[:WINDow<n>][:SUBWIndow<w>]:ZOOM:MULTiple<zn>[:STATe].....	449
DISPlay[:WINDow<n>][:SUBWIndow<w>]:ZOOM[:STATe].....	450
FETCh:ALL:SUMMary:EVM:ALL?.....	236
FETCh:ALL:SUMMary:EVM:DS1K?.....	237
FETCh:ALL:SUMMary:EVM:DSQP?.....	238
FETCh:ALL:SUMMary:EVM:DSSF?.....	238
FETCh:ALL:SUMMary:EVM:DSST?.....	239
FETCh:ALL:SUMMary:EVM:DSTS?.....	240
FETCh:ALL:SUMMary:EVM:PCHannel?.....	241

FETCh:ALL:SUMMary:EVM:PEAK?.....	241
FETCh:ALL:SUMMary:EVM:PSIGnal?.....	242
FETCh:ALL:SUMMary:POWer?.....	245
FETCh:TAERror[:CC<cc>]:AP<ap>:MAXimum?.....	252
FETCh:TAERror[:CC<cc>]:AP<ap>:MINimum?.....	252
FETCh:TAERror[:CC<cc>]:AP<ap>[:AVERage]?.....	252
FETCh[:CC<cc>]:PLC:CID?.....	304
FETCh[:CC<cc>][:ISRC<ant>]:SUMMary:CRESt[:AVERage]?.....	234
FETCh[:CC<cc>][:ISRC<ant>]:SUMMary:TFRame?.....	252
FETCh[:CC<cc>][:ISRC<ant>][:FRAMe<fr>]:SUMMary:AAPFail?.....	234
FETCh[:CC<cc>][:ISRC<ant>][:FRAMe<fr>]:SUMMary:ALL?.....	233
FETCh[:CC<cc>][:ISRC<ant>][:FRAMe<fr>]:SUMMary:APFail?.....	235
FETCh[:CC<cc>][:ISRC<ant>][:FRAMe<fr>]:SUMMary:ARPFail?.....	235
FETCh[:CC<cc>][:ISRC<ant>][:FRAMe<fr>]:SUMMary:BLER:MAXimum?.....	236
FETCh[:CC<cc>][:ISRC<ant>][:FRAMe<fr>]:SUMMary:BLER:MINimum?.....	236
FETCh[:CC<cc>][:ISRC<ant>][:FRAMe<fr>]:SUMMary:BLER[:AVERage]?.....	236
FETCh[:CC<cc>][:ISRC<ant>][:FRAMe<fr>]:SUMMary:EVM:DS1K:MAXimum?.....	237
FETCh[:CC<cc>][:ISRC<ant>][:FRAMe<fr>]:SUMMary:EVM:DS1K:MINimum?.....	237
FETCh[:CC<cc>][:ISRC<ant>][:FRAMe<fr>]:SUMMary:EVM:DS1K[:AVERage]?.....	237
FETCh[:CC<cc>][:ISRC<ant>][:FRAMe<fr>]:SUMMary:EVM:DSQP:MAXimum?.....	238
FETCh[:CC<cc>][:ISRC<ant>][:FRAMe<fr>]:SUMMary:EVM:DSQP:MINimum?.....	238
FETCh[:CC<cc>][:ISRC<ant>][:FRAMe<fr>]:SUMMary:EVM:DSQP[:AVERage]?.....	238
FETCh[:CC<cc>][:ISRC<ant>][:FRAMe<fr>]:SUMMary:EVM:DSSF:MAXimum?.....	238
FETCh[:CC<cc>][:ISRC<ant>][:FRAMe<fr>]:SUMMary:EVM:DSSF:MINimum?.....	239
FETCh[:CC<cc>][:ISRC<ant>][:FRAMe<fr>]:SUMMary:EVM:DSSF[:AVERage]?.....	239
FETCh[:CC<cc>][:ISRC<ant>][:FRAMe<fr>]:SUMMary:EVM:DSST:MAXimum?.....	239
FETCh[:CC<cc>][:ISRC<ant>][:FRAMe<fr>]:SUMMary:EVM:DSST:MINimum?.....	239
FETCh[:CC<cc>][:ISRC<ant>][:FRAMe<fr>]:SUMMary:EVM:DSST[:AVERage]?.....	239
FETCh[:CC<cc>][:ISRC<ant>][:FRAMe<fr>]:SUMMary:EVM:DSTS:MAXimum?.....	240
FETCh[:CC<cc>][:ISRC<ant>][:FRAMe<fr>]:SUMMary:EVM:DSTS:MINimum?.....	240
FETCh[:CC<cc>][:ISRC<ant>][:FRAMe<fr>]:SUMMary:EVM:DSTS[:AVERage]?.....	240
FETCh[:CC<cc>][:ISRC<ant>][:FRAMe<fr>]:SUMMary:EVM:PCHannel:MAXimum?.....	241
FETCh[:CC<cc>][:ISRC<ant>][:FRAMe<fr>]:SUMMary:EVM:PCHannel:MINimum?.....	241
FETCh[:CC<cc>][:ISRC<ant>][:FRAMe<fr>]:SUMMary:EVM:PCHannel[:AVERage]?.....	241
FETCh[:CC<cc>][:ISRC<ant>][:FRAMe<fr>]:SUMMary:EVM:PEAK:MAXimum?.....	241
FETCh[:CC<cc>][:ISRC<ant>][:FRAMe<fr>]:SUMMary:EVM:PEAK:MINimum?.....	241
FETCh[:CC<cc>][:ISRC<ant>][:FRAMe<fr>]:SUMMary:EVM:PEAK[:AVERage]?.....	241
FETCh[:CC<cc>][:ISRC<ant>][:FRAMe<fr>]:SUMMary:EVM:PSIGnal:MAXimum?.....	242
FETCh[:CC<cc>][:ISRC<ant>][:FRAMe<fr>]:SUMMary:EVM:PSIGnal:MINimum?.....	242
FETCh[:CC<cc>][:ISRC<ant>][:FRAMe<fr>]:SUMMary:EVM:PSIGnal[:AVERage]?.....	242
FETCh[:CC<cc>][:ISRC<ant>][:FRAMe<fr>]:SUMMary:EVM[:ALL]:MAXimum?.....	236
FETCh[:CC<cc>][:ISRC<ant>][:FRAMe<fr>]:SUMMary:EVM[:ALL]:MINimum?.....	237
FETCh[:CC<cc>][:ISRC<ant>][:FRAMe<fr>]:SUMMary:EVM[:ALL][:AVERage]?.....	237
FETCh[:CC<cc>][:ISRC<ant>][:FRAMe<fr>]:SUMMary:FERRor:MAXimum?.....	243
FETCh[:CC<cc>][:ISRC<ant>][:FRAMe<fr>]:SUMMary:FERRor:MINimum?.....	243
FETCh[:CC<cc>][:ISRC<ant>][:FRAMe<fr>]:SUMMary:FERRor[:AVERage]?.....	243
FETCh[:CC<cc>][:ISRC<ant>][:FRAMe<fr>]:SUMMary:GIMBalance:MAXimum?.....	243
FETCh[:CC<cc>][:ISRC<ant>][:FRAMe<fr>]:SUMMary:GIMBalance:MINimum?.....	243
FETCh[:CC<cc>][:ISRC<ant>][:FRAMe<fr>]:SUMMary:GIMBalance[:AVERage]?.....	243
FETCh[:CC<cc>][:ISRC<ant>][:FRAMe<fr>]:SUMMary:IQOfset:MAXimum?.....	244

FETCh[:CC<cc>][:ISRC<ant>][:FRAMe<fr>]:SUMMary:IQOFfset:MINimum?.....	244
FETCh[:CC<cc>][:ISRC<ant>][:FRAMe<fr>]:SUMMary:IQOFfset[:AVERage]?.....	244
FETCh[:CC<cc>][:ISRC<ant>][:FRAMe<fr>]:SUMMary:OSTP:MAXimum?.....	244
FETCh[:CC<cc>][:ISRC<ant>][:FRAMe<fr>]:SUMMary:OSTP:MINimum?.....	244
FETCh[:CC<cc>][:ISRC<ant>][:FRAMe<fr>]:SUMMary:OSTP[:AVERage]?.....	244
FETCh[:CC<cc>][:ISRC<ant>][:FRAMe<fr>]:SUMMary:OVLD?.....	248
FETCh[:CC<cc>][:ISRC<ant>][:FRAMe<fr>]:SUMMary:POWer:MAXimum?.....	245
FETCh[:CC<cc>][:ISRC<ant>][:FRAMe<fr>]:SUMMary:POWer:MINimum?.....	245
FETCh[:CC<cc>][:ISRC<ant>][:FRAMe<fr>]:SUMMary:POWer[:AVERage]?.....	245
FETCh[:CC<cc>][:ISRC<ant>][:FRAMe<fr>]:SUMMary:QUADerror:MAXimum?.....	246
FETCh[:CC<cc>][:ISRC<ant>][:FRAMe<fr>]:SUMMary:QUADerror:MINimum?.....	246
FETCh[:CC<cc>][:ISRC<ant>][:FRAMe<fr>]:SUMMary:QUADerror[:AVERage]?.....	246
FETCh[:CC<cc>][:ISRC<ant>][:FRAMe<fr>]:SUMMary:RSRP:CSI:MAXimum?.....	246
FETCh[:CC<cc>][:ISRC<ant>][:FRAMe<fr>]:SUMMary:RSRP:CSI:MINimum?.....	246
FETCh[:CC<cc>][:ISRC<ant>][:FRAMe<fr>]:SUMMary:RSRP:CSI[:AVERage]?.....	246
FETCh[:CC<cc>][:ISRC<ant>][:FRAMe<fr>]:SUMMary:RSRP:SS:MAXimum?.....	247
FETCh[:CC<cc>][:ISRC<ant>][:FRAMe<fr>]:SUMMary:RSRP:SS:MINimum?.....	247
FETCh[:CC<cc>][:ISRC<ant>][:FRAMe<fr>]:SUMMary:RSRP:SS[:AVERage]?.....	247
FETCh[:CC<cc>][:ISRC<ant>][:FRAMe<fr>]:SUMMary:RSTP:MAXimum?.....	247
FETCh[:CC<cc>][:ISRC<ant>][:FRAMe<fr>]:SUMMary:RSTP:MINimum?.....	247
FETCh[:CC<cc>][:ISRC<ant>][:FRAMe<fr>]:SUMMary:RSTP[:AVERage]?.....	247
FETCh[:CC<cc>][:ISRC<ant>][:FRAMe<fr>]:SUMMary:SERRor:MAXimum?.....	248
FETCh[:CC<cc>][:ISRC<ant>][:FRAMe<fr>]:SUMMary:SERRor:MINimum?.....	248
FETCh[:CC<cc>][:ISRC<ant>][:FRAMe<fr>]:SUMMary:SERRor[:AVERage]?.....	248
FETCh[:CC<cc>][:ISRC<ant>][:FRAMe<fr>]:SUMMary:SPFfail?.....	249
FETCh[:CC<cc>][:ISRC<ant>][:FRAMe<fr>]:SUMMary:SState?.....	250
FETCh[:CC<cc>][:ISRC<ant>][:FRAMe<fr>]:SUMMary:TPUT:MAXimum?.....	250
FETCh[:CC<cc>][:ISRC<ant>][:FRAMe<fr>]:SUMMary:TPUT:MINimum?.....	250
FETCh[:CC<cc>][:ISRC<ant>][:FRAMe<fr>]:SUMMary:TPUT[:AVERage]?.....	250
FETCh[:CC<cc>][:ISRC<ant>][:FRAMe<fr>]:SUMMary:TSDelta?.....	251
FETCh[:CC<cc>][:ISRC<ant>][:FRAMe<fr>]:SUMMary:TSTamp?.....	251
FORMat:DEXPort:DSEParator.....	444
FORMat:DEXPort:HEADer.....	444
FORMat:DEXPort:TRACes.....	445
FORMat[:DATA].....	292
INITiate:SEQuencer:ABORT.....	230
INITiate:SEQuencer:IMMediate.....	230
INITiate:SEQuencer:MODE.....	230
INITiate<n>:CONTInuous.....	229
INITiate<n>[:IMMediate].....	229
INPut:FILE:PATH.....	408
INPut<ip>:ATTenuation<ant>.....	413
INPut<ip>:ATTenuation<ant>:AUTO.....	414
INPut<ip>:COUPling.....	414
INPut<ip>:EATT<ant>.....	416
INPut<ip>:EATT<ant>:AUTO.....	416
INPut<ip>:EATT<ant>:STATe.....	416
INPut<ip>:FILTer:YIG[:STATe].....	409
INPut<ip>:GAIN:STATe.....	415
INPut<ip>:GAIN[:VALue].....	415

INPut<ip>:IMPedance.....	415
INPut<ip>:SElect.....	409
INSTRument:CREate:DUPLicate.....	215
INSTRument:CREate:REPLace.....	216
INSTRument:CREate[:NEW].....	215
INSTRument:DELeTe.....	216
INSTRument:LIST?.....	216
INSTRument:REName.....	217
INSTRument[:SElect].....	218
LAYout:ADD[:WINDow]?.....	220
LAYout:CATalog[:WINDow]?.....	223
LAYout:IDENtify[:WINDow]?.....	223
LAYout:REMove[:WINDow].....	224
LAYout:REPLace[:WINDow].....	224
LAYout:SPLitter.....	224
LAYout:WINDow<n>:ADD?.....	226
LAYout:WINDow<n>:IDENtify?.....	226
LAYout:WINDow<n>:REMove.....	227
LAYout:WINDow<n>:REPLace.....	227
LAYout:WINDow<n>:TYPE.....	228
MMEMory:LOAD:DEModsetting:ALL.....	305
MMEMory:LOAD:DEModsetting[:CC<cc>].....	305
MMEMory:LOAD:IQ:STATe:ALL.....	296
MMEMory:LOAD:IQ:STReam.....	409
MMEMory:LOAD:IQ:STReam:AUTO.....	410
MMEMory:LOAD:IQ:STReam:LIST?.....	410
MMEMory:LOAD:SETTings.....	442
MMEMory:LOAD:TMODeI[:CC<cc>].....	304
MMEMory:STORe<n>:DEModsetting:ALL.....	306
MMEMory:STORe<n>:DEModsetting[:CC<cc>].....	306
MMEMory:STORe<n>:IQ:STATe.....	296
MMEMory:STORe<n>:IQ:STATe:ALL.....	296
MMEMory:STORe<n>:MSERvice.....	297
MMEMory:STORe<n>:TRACe.....	445
OUTPut<up>:TRIGger<tp>:PULSe:IMMediate.....	442
SYSTem:PRESet:CHANnel[:EXEC].....	297
SYSTem:SEQuencer.....	231
TRACe:IQ:FILE:REPetition:COUNT.....	410
TRACe:IQ:SRATe?.....	420
TRACe<n>:CATalog?.....	292
TRACe<n>[:DATA]:X?.....	293
TRACe<n>[:DATA]?.....	292
TRIGger:TSHelper:EDELay.....	442
TRIGger:TSHelper:FTRigger.....	442
TRIGger:TSHelper:RINTerval.....	443
TRIGger:TSHelper:SEQuence.....	443
TRIGger[:SEQuence]:DTIME.....	421
TRIGger[:SEQuence]:HOLDoff<ant>[:TIME].....	421
TRIGger[:SEQuence]:IFPower:HOLDoff.....	421
TRIGger[:SEQuence]:IFPower:HYSteresis.....	422

TRIGger[:SEQuence]:LEVel<ant>:IFPower.....	422
TRIGger[:SEQuence]:LEVel<ant>:IQPower.....	423
TRIGger[:SEQuence]:LEVel<ant>:RFPower.....	423
TRIGger[:SEQuence]:LEVel<ant>[:EXTernal<tp>].....	422
TRIGger[:SEQuence]:PORT<ant>.....	424
TRIGger[:SEQuence]:SLOPe.....	424
TRIGger[:SEQuence]:SOURce<ant>.....	424
UNIT:BSTR.....	461
UNIT:CAReference.....	461
UNIT:CAXes.....	461
UNIT:EVM.....	462
UNIT:OPower.....	434
UNIT:SAXes.....	462

Index

A

AC/DC coupling	147
ACLR	53
ACLR (Cumulative)	56
Adjust timing	51
Allocation	
Filter by	205
Allocation ID vs symbol x carrier	40
Allocation summary	36
Amplitude	144
Application cards	11
Application notes	11
Attenuation	145
Auto level	144

B

Beamforming summary	43
Bit stream	37
Bitstream format	197
Brochures	10

C

Capture buffer	28
Capture time	150
Carrier	
Filter by	205
Carrier axis scale	198
CCDF	34
Center frequency	143
Channel	
Creating (remote)	216
Deleting (remote)	216
Duplicating (remote)	215
Querying (remote)	216
Renaming (remote)	217
Replacing (remote)	216
Channel decoder results	36
Closing	
Channels (remote)	216
Windows (remote)	227
Configuration overview	68
Constellation diagram	35
Configuration	205
Constellation selection	205
Conventions	
SCPI commands	211
Copying	
Channel (remote)	215
Cumulative ACLR	56

D

Data capture	149
Data format	
Remote	444, 445
Data sheets	10
Duplexing	74
Duplicating	
Channel (remote)	215

E

Evaluation methods	
Remote	220
EVM calculation method	157
EVM unit	197
EVM vs Carrier	29
EVM vs RB	31
EVM vs symbol	30
EVM vs symbol x carrier	39
External Attenuation	145

F

Files	
I/Q data input	191
Filters	
YIG (remote)	409
Flatness vs carrier	33
Format	
Data (remote)	444, 445
Frequency	
Configuration	143
Frequency error vs subframe	32
Frequency error vs symbol	31
Frequency sweep	52

G

Getting started	9
-----------------------	---

H

Hardware settings	
Displayed	16, 163

I

I/Q data	
Input file	142
Input files	191
I/Q measurement	28
Impedance	
Setting	147
Input	
Coupling	147
I/Q data files	142
Input sources	
I/Q data file	142
I/Q data files	191
Installation	15
Instrument security procedures	10

L

Level configuration	144
Link direction	74

M

Marker table	
Evaluation method	43
Markers	
Table (evaluation method)	43

Maximizing		
Windows (remote)	219	
MC ACLR	54	
Measurement	18	
ACLR	53	
alloc ID vs sym x carrier	40	
allocation summary	36	
Beamforming summary	43	
bit stream	37	
Capture buffer	28	
CCDF	34	
channel decoder results	36	
constellation	35	
Continuous	20	
Cumulative ACLR	56	
EVM vs carrier	29	
EVM vs RB	31	
EVM vs sym x carr	39	
EVM vs symbol	30	
flatness vs carrier	33	
freq err vs subframe	32	
freq err vs symbol	31	
MC ACLR	54	
on/off power	48	
power spectrum	33	
power vs sym x carr	39	
Refresh	20	
Result displays	20	
Single	20	
spectrum mask	58	
Measurement time	150	
Modulation		
Filter by	205	
N		
Noise cancellation	51	
O		
Offset		
Frequency	143	
Reference level	144	
On/off power	48	
Options		
Preamplifier	146	
Overview	68	
P		
PDSCH reference data	157	
Peak list		
Evaluation method	59	
Phase error	154	
Physical signal description	73	
Power spectrum	33	
Power vs symbol x carrier	39	
Preamplifier		
Setting	146	
Softkey	146	
Presetting		
Channels	69	
R		
Reference Level	144	
Release notes	10	
Remote commands		
Basics on syntax	210	
Boolean values	214	
Capitalization	211	
Character data	214	
Data blocks	215	
Numeric values	213	
Optional keywords	212	
Parameters	213	
Strings	214	
Suffixes	212	
Restoring		
Channel settings	69	
Result displays	20	
Marker table	43	
Peak list	59	
Results		
Data format (remote)	444, 445	
RF measurement	52	
S		
Safety instructions	10	
Security procedures	10	
SEM position	162	
Sequencer		
Activating (remote)	230	
Remote	229	
Sequences		
Aborting (remote)	230	
Mode (remote)	230	
Service manual	10	
Settings		
Bitstream format	197	
Capture time	150	
Carrier axes	198	
Constellation selection	205	
EVM calculation method	157	
EVM unit	197	
Ext Att	145	
Frequency	143	
PDSCH reference data	157	
Phase tracking	154	
Ref Level	144	
Slot selection	205	
Standard	74	
Subframe selection	204	
Swap I/Q	151	
Timing error	154	
Signal capture	149	
Signal description	73	
Slope		
Trigger	424	
Slot selection	205	
Softkeys		
Preamp	146	
Specifics for		
Configuration	69	
Spectrum mask	58	
Standard selection	74	
Step size	143	
Subframe selection	204	
Suffixes		
Common	209	
Remote commands	212	
Swap I/Q	151	

Symbol	
Filter by	205
T	
Time alignment error	44
Timing error	154
Tracking	152
Phase	154
Timing	154
Transmission path	74
Transmit on / off power	47
Trigger	
Slope	424
Trigger configuration	147
Trigger source	148
V	
Videos	11
W	
White papers	11
Window title bar information	17
Windows	
Adding (remote)	220
Closing (remote)	227
Configuring	69
Layout (remote)	224
Maximizing (remote)	219
Querying (remote)	223
Replacing (remote)	224
Splitting (remote)	219
Types (remote)	220
Y	
YIG-preselector	
Activating/Deactivating	141
Activating/Deactivating (remote)	409
Z	
Zoom	
Capture buffer	28
Zooming	
Activating (remote)	450
Area (Multiple mode, remote)	448
Area (remote)	447
Multiple mode (remote)	449